

**ELECTRONICS
HOBBY-THEORY
PROJECTS**

THE FUN WAY TO LEARN ELECTRONICS

VOLUME XIII

\$3.95

ELECTRONICS HANDBOOK

WPS 36286

IN CANADA \$4.50

**CIRCUIT
FRAGMENTS**

**HOME AUTOMATION
PRIMER**

**AUDIO TRACER
STEREO
LOAD BANK**

**WORKBENCH
PROJECTS**

**THE
CRYSTAL
RADIO
TODAY**

**BUILD AN
ELECTRONIC
CRUTCH**

**BUILD A QRM
CIRCUIT**



**COMPLETE PLANS FOR
PRACTICAL PROJECTS**



Other Schools The Best Computer At NRI, We Graduates Do

Train With The Leader—NRI

Train with NRI and prepare for a high-paying position as a computer service technician, even a computer service business of your own! Regardless of your previous electronics background, you can succeed with NRI, the leader in career-building at-home electronics training for over 78 years. You begin with the basics, rapidly building on the fundamentals of electronics to master today's advanced microcomputer concepts.

Learn By Doing

NRI's highly acclaimed learn-by-doing approach gives you a complete understanding of the intricate electronics behind the 1 meg RAM, 32-bit CPU computer system included in your course. You perform hands-on electronics experiments with your NRI Discovery Lab and digital multimeter, then build and test the powerful 486sx/25 MHz computer you train with and keep. You install the 1.2 meg, 5-1/4" floppy disk drive, learning disk drive operation and adjustment. Later, you dramatically improve your computer's data storage capacity by installing a powerful 80 meg IDE hard drive. You even learn to diagnose and service virtually any computer

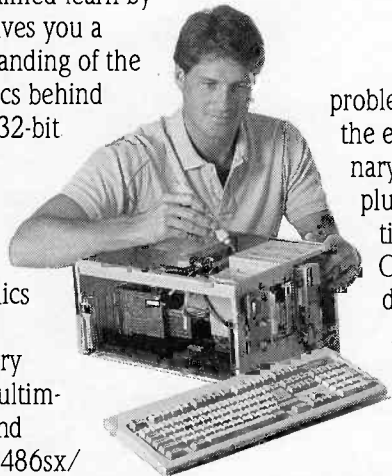

problem with the extraordinary R.A.C.E.R. plug-in diagnostic card and QuickTech diagnostic software included in your course.

Study At Your Own Pace

With NRI, you study in the privacy and convenience of your own home — with your personal instructor and NRI's team of technical professionals behind you every step of the way. You learn at your own pace — no classroom pressures, no night school, no need to quit your present job until you're ready to make your move. Step by step

you're guided through the assembly of a powerful 486sx-based computer system — the centerpiece of your coursework — complete with monitor, floppy drive, 80 meg hard drive, operating and applications software. You get the hands-on experience you need to work with, troubleshoot, and service any IBM PC/AT-compatible computer, plus the confidence to tackle any service job you take on.



"I recommend NRI to anyone looking for a change, success, and REAL challenge. The Action Learning Kits allow you to build what you study: lessons — no better way exists to learn troubleshoot and service computers!"

R. Buda
Tinley Park, IL

V. Bender
Calgary, Alberta

Just two years after finishing the NRI training in microcomputer servicing, I set up my own company. I contract myself out to several computer retailers as their service technician. I have never regretted the NRI course and now have control of and confidence in my business.

"Al
look
real
and i
the r
than t
know

"With four NRI courses under my belt, I've set up a workshop at home repairing everything from TVs to VCRs to appliances and now, computers! The computer I received in the micro course is a lifesaver in keeping track of my customers, invoicing, inventory of supplies, and personal finances. I have prospered financially as a result of my NRI training, owing to the income my small business generates — and to my regular salary increasing three times since completing the first NRI course!"

C. Bane
Chicago, IL

Say They Offer Service Training... Let Our The Talking.

service business of your own — you'll be well prepared, continuously drawing on the real-world experience of your NRI training. Master electronics and computers the NRI way and master your future!

Learn More About NRI Today

Let NRI hear from you next. Send today for NRI's free, full-color catalog which describes every aspect of NRI's innovative microcomputer training, as well as hands-on training in other growing high-tech fields. If the coupon is missing, write to NRI Schools, McGraw-Hill Continuing Education Center, 4401 Connecticut Avenue, NW, Washington, DC 20008.

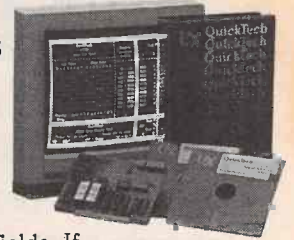

N. Tenerelli, II
Millington, IN

ough many technical training courses I've ed at are almost 100% theory-oriented, NRI zes that a technician's ability to troubleshoot repair equipment is where 'the rubber meets ad.' As a result, NRI graduates are more textbook...

"No doubt, the excellent back-up of your staff was a significant factor in my swift completion of NRI's microcomputer servicing training. Their helpfulness, by phone or by letter, has been nothing short of amazing. I can see why you are so proud of your thing I read in your catalog was

J. Preusker
Angston, SA Australia

D. Gattin
Carrollton, GA

wide-open opportunity and become a high-paid computer service technician. Whether you choose a full- or part-time job — or start a computer

As a family man, a home study course was the only way to go. It has up to me to spend as much, or as little time as I needed on course material — showing down on the tough stuff and racing through the familiar! After completing NRI's microcomputer course, new doors began to open for me. I literally created the job I now hold and am considered 'the one to call' in the event someone needs help with computer hardware or programs.

What's more, you work with today's most popular integrated software package, Microsoft Works, learning to use its word processing, spreadsheet, database, and communications utilities for your own personal and professional applications.

Master Your Future

The Department of Labor forecasts over 220,000 jobs for computer service technicians by the year 2005 — a 38 percent increase over today's level. With the right training and skills, you can cash in on this



NRI Schools



McGraw-Hill Continuing Education Center
4401 Connecticut Avenue, NW, Washington, DC 20008

For career courses approved under GI Bill, check for details

- Check one FREE catalog only**
- Microcomputer Servicing
 - TV/Video/Audio Servicing
 - Industrial Electronics & Robotics
 - Basic Electronics
 - Computer-Aided Drafting
 - Computer Programming
 - Desktop Publishing & Design
 - PC Applications Specialist
 - Programming in C++ with Windows

Name _____ (please print) Age _____

Address _____

City/State/Zip _____ Accredited Member, National Home Study Council **22-0493**

ELECTRONICS HANDBOOK

CONTENTS

FROM THE EDITOR'S DESK	6
NEW BOOK REVIEWS	8
NEW PRODUCTS PARADE	12
CLASSIFIED FLEAMARKET	15
THE HOME AUTOMATION PRIMER	17



CIRCUIT FRAGMENTS	26
------------------------------------	-----------

LAB REPORT: (TRIPLETT MODEL 2202 DMM)	32
UNDERSTANDING ELECTRICITY	35
LED BATTERY AND CONTINUITY TESTER	39
SOUND ACTIVATED SWITCH	43
AUDIO TRACER STEREO LOAD BANK	45



WORKBENCH PROJECTS	50
-------------------------------------	-----------

ANTIQUE RADIO BUILD A (QRM) REJECTOR CIRCUIT	55
THE CRYSTAL RADIO TODAY (PART II)	60
THE ELECTRONIC CRUTCH	67
THE CATALOG CORNER	73

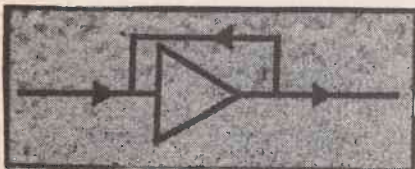

IC TESTBENCH	77
---------------------------	-----------

ELECTRIC TROUBLE SHOOTING	83
SOLID STATE UPDATE	85

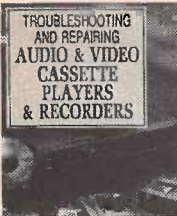

3795 \$29.95

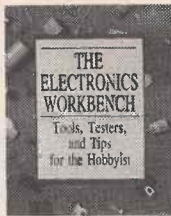

3672P \$18.95
Softcover



4143 \$22.95



3475P \$18.95
Softcover



2790P \$15.95
Softcover



3145P \$12.95
Softcover



3485 \$27.95



3671P \$18.95
Softcover



2613P \$18.95
Softcover

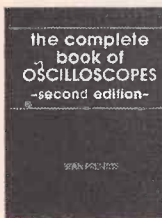

3825 \$26.95

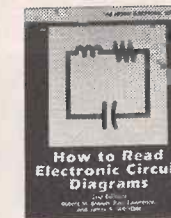

2880P \$14.95
Softcover



3804P \$19.95
Softcover



3258P \$19.95
Softcover



2800P \$17.95
Softcover



3886 \$22.95

Select any 5 books

for only \$4.95

(values up to \$145.75)

when you join the Electronics Book Club®



3827 \$29.95



1367P \$29.95
Softcover



2883P \$18.95
Softcover

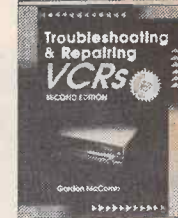

3777-XX \$32.95
Counts as 2



3589 \$27.95

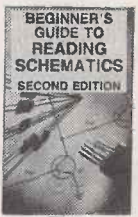

3632P \$10.95
Softcover

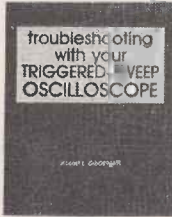

3659 \$27.95

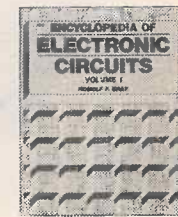

1938-XXX \$60.00
Counts as 3

If coupon is missing, write to: Electronics Book Club, Blue Ridge Summit, PA 17294-0810

As a member of the Electronics Book Club . . .

. . . you'll enjoy receiving Club bulletins every 3-4 weeks containing exciting offers on the latest books in the field at savings of up to 50% off of regular publishers' prices. If you want the Main Selection do nothing and it will be shipped automatically. If you want another book, or no book at all, simply return the reply form to us by the date specified. You'll have at least 10 days to decide. And you'll be eligible for **FREE** books through the **NEW Bonus Book Program**. Your only obligation is to purchase 3 more books during the next 12 months, after which you may cancel your membership at any time.

A shipping/handling charge & sales tax will be added to all orders. If you select a book that counts as 2 choices, write the book number in one box and XX in the next. If you select a Counts as 3 choice, write the book number in one box and XXX in the next 2 boxes. Publishers' prices shown. ©1993 EBC

Your most complete and comprehensive source for the finest electronics books.

ELECTRONICS BOOK CLUB®

Blue Ridge Summit, PA 17294-0810

YES! Please send me the books listed below, billing me for just \$4.95 plus shipping/handling & tax. Enroll me as a member of the **Electronics Book Club** according to the terms outlined in this ad. If not satisfied, I may return the books within 10 days without obligation and have my membership cancelled. A shipping/handling charge & tax will be added to all orders.

--	--	--	--

If you select a book that counts as 2 choices, write the book number in one box and XX in the next. If you select a Counts as 3 choice, write the book number in one box and XXX in the next 2 boxes.

Name _____

Address _____

City/State _____

Zip _____ Phone _____

Valid for new members only, subject to acceptance by EBC. Canada *must* remit in U.S. funds drawn on U.S. banks. Applicants outside the U.S. and Canada will receive special ordering instructions. All books are hardcover unless otherwise noted. Publishers' prices shown. A shipping/handling charge & sales tax will be added to all orders.

CEHB493

IN THIS ISSUE

As we put a "wrap" on this issue of the "Handbook," it is appropriate that we pause and reflect on what we have compiled for our readers.

In addition to the customary columns, "New Products," "Editor's Desk," "Book Reviews," "The Catalog Corner," and "Solid State Up-date," we have an interesting potpourri of projects in the "project" sections, "Circuit Fragments," "Workbench Projects" and the "IC Testbench." Some are challenging, some are relatively simple but all should be fun and an evening or weekend of entertainment for the hobbyist.

Our lead story in this issue is about "Home Automation" which is capturing the imagination of Electronics Hobbyists and homeowners everywhere. Thanks to our author, Phil Parker, and the generous cooperation of **Stanley Home Automation** and the **Heath/Zenith Company**, we can offer a rather comprehensive story on this subject that will open many doors for the hobbyist with a fertile imagination.

Not to be outdone, we also have an excellent manuscript contribution from our good friend, Tony Lee, "An Electronic Crutch" that seems quite compatible with "Home Automation," although the object is to provide electronic devices to make life easier for the handicapped and/or physically disabled. This is a comprehensive project that should challenge many of our readers.

So much for the meat and potatoes, Homer Davidson has contributed to the desert with his "Audio Tracer Stereo Load Bank," Elliot Jackson has contributed a "Lab Report" on the "Triplett 2200 DMM" and Lance Borden is back with another contribution to the "Antique Radio Corner," "How To Build A Rejector (QRM) Circuit" and Part II of the "Crystal Radio Today" by Lyle Russell Williams.

All in all, a pretty well-rounded issue with some additional surprises that we didn't have room to mention, but you'll find them.... Good luck and have fun!

Don Gabree

DON GABREE, PUBLISHER



WANTED: PROJECTS

How would you like to find your own home-brew project in a future issue of the **ELECTRONICS HANDBOOK**? It could happen. It's up to you! Build your project for yourself...It should have a real purpose. Then, if you think that it is good enough to appear in the **ELECTRONICS HANDBOOK**, let us know about it...

Write us a brief letter describing your project. Tell us what the project does. Provide us with a legible schematic diagram and a few black-and-white photographs of the project...photos, with good contrast, are important. After we have read your letter describing your project, we'll let you know, one way or the other, whether we would like to purchase your article describing the project.

If you would like some "Editorial Guidelines", send us a S.A.S.E. with your request...All correspondence should be addressed to:

DON GABREE, PUBLISHER

C&E HOBBY HANDBOOKS

P.O. BOX #5148

NORTH BRANCH, N.J. 08876

ELECTRONICS HANDBOOK

PUBLISHER
AND
EDITORIAL DIRECTOR
Don Gabree
SECRETARY/TREASURER
L. M. Gabree
ASSOCIATE EDITOR
Holly Love
CONTRIBUTING AUTHORS
Homer Davidson
Walter Sikonowiz
Tony Lee
Steve Sokolowski
Lance Borden

Lyle Russell Williams
Andrew Singmin, Phd.
George Williamson
Richard Stuart
Darren Yates
John Iovine

ISSN 0897-7631

ADVERTISING SALES
C&E Hobby Handbooks
P.O. Box #5148
North Branch, N.J. 08876
(201) 231-1518

Published by C&E Hobby Handbooks, Inc. Editorial and Business address, P.O. Box #5148, North Branch, N.J. 08876 (908) 231-1518. PERMISSIONS: Material in this publication may not be duplicated or reproduced in any form without permission. Requests for permission should be directed to — Don Gabree, C&E HOBBY HANDBOOKS, INC. P.O. Box #5148, North Branch, N.J. 08876 (908) 231-1518.

EDITORIAL CONTRIBUTIONS must be accompanied by return postage and will be handled with reasonable care; however, the publisher assumes no responsibility for the return or safety of manuscripts, artwork or photographs. All contributions should be addressed to: PUBLISHER, C&E HOBBY HANDBOOKS, P.O. Box #5148, North Branch, N.J. 08876.

As a service to readers, C&E HOBBY HANDBOOKS publishes available plans and/or information relating to products, techniques of scientific and technological developments. Because of possible variances in the quality and condition of materials and workmanship used by readers, C&E HOBBY HANDBOOKS disclaims any responsibility for the safe and proper functioning of reader-built projects based upon or from plans and/or information published by C&E HOBBY HANDBOOKS.

Second Class Entry applied for. Copyright © 1993 by C&E HOBBY HANDBOOKS, INC.
Printed in U.S.A.

AMAZING SCIENTIFIC & ELECTRONIC PRODUCTS

LASERS AND SCIENTIFIC DEVICES	VRL2K	3mw Vis Red Laser Diode System Kit	\$159.50
	LLS1K	Laser Beam "Bounce" Listener Kit	\$199.50
	LHC2K	Visible Simulated 3 Color Laser Kit	\$44.50
	LC7	40 Watt Burning Cutting Laser Plans	\$20.00
	RUB4	Hi Powered Pulsed Drilling Laser Plans	\$20.00
	LGU40	1 to 2mw HeNe Vis Red Laser Gun Assembled	\$199.00
	LLS1	Laser Lite Show - 3 Methods Plans	\$20.00
	SD5K	See in the Dark Kit	\$299.50
	EML1K	Electromagnetic Coil Gun Kit	\$69.50
	MCP1	Hi Velocity Coil Gun Plans	\$15.00
HIGH VOLTAGE AND PLASMA DISPLAY DEVICES	LEV1	Levitating Device Plans	\$10.00
	EH1	Electronic Hypnotism Techniques Plans	\$10.00
	HVM7K	75,000 Volt DC Variable Output Lab Source Kit	\$149.50
	IOG3K	Ion Ray Gun Kit, project energy without wires	\$69.50
	NIG9K	12V/115 VAC Hi Out Neg Ion Generator Kit	\$34.50
	EMA1K	Telekinetic Enhancer/Electric Man Assembled	\$99.50
	LG5K	Lightning Display Globe Kit	\$54.50
	BTC1K	Worlds Smallest Tesla Coil Kit	\$49.50
	BTC3K	250KV Table Top Tesla Coil Kit	\$249.50
	BTC5	1.5 Million Volts Tesla Coil Plans	\$20.00
SECURITY AND PROTECTION DEVICES	JL3	Jacobs Ladder - 3 Models Plans	\$15.00
	GRA1	Anti Gravity Generator Plans	\$10.00
	PFS20	Plasma Fire Saber Assembled	\$69.50
	DPL20	Dancing Plasma to Music and Sounds Assembled	\$79.50
	ITM10	100,000 Volt Intimidator up to 20' Assembled	\$129.50
	IPG70	Invisible Pain Field Blast Wave Gen Assembled	\$74.50
	PSP4K	Phasor Sonic Blast Wave Pistol Kit	\$59.50
	LIST10	Infinity Xmr, Listen in Via Phone Assembled	\$199.50
	TAT30	Automatic Tel Recording Device Assembled	\$24.50
	VWPM7K	3 Mi. FM Auto Tel Transmitter Kit	\$49.50
FMV1K	3 Mi. FM Voice Transmitter Kit	\$39.50	
HOD1K	Homing/Tracking Beeper Transmitter Kit	\$49.50	

EASY ORDERING PROCEDURE TOLL FREE 1-800-221-1705
or 24 HRS ON 1-603-673-4730 or FAX IT TO 1-603-672-5406
VISA, MC, CHECK, MO IN US FUNDS. INCLUDE 10% SHIPPING. ORDERS
\$100.00 & UP ONLY ADD \$10.00. CATALOG \$1.00 OR FREE WITH ORDER.

INFORMATION UNLIMITED
P.O. BOX 716, DEPT. HB, AMHERST, NH 03031



ATTACH LABEL HERE

NEW ADDRESS HERE

PLEASE PRINT

NAME _____

ADDRESS _____

CITY _____ STATE _____

DATE _____ ZIP _____

V13

FROM THE EDITOR'S DESK

Ask The Editor, He Knows!

Got a question or a problem with a project—ask The Editor. Please remember that The Editors' column is limited to answering specific electronic project questions that you send to him. Personal replies cannot be made. Sorry, he isn't offering a circuit design service. Write to:
The Editor
C&E HOBBY HANDBOOKS INC.
P.O. Box #5148
North Branch, N.J. 08876

Three Satisfied Readers

I want to thank you for a magazine that I can finally understand. I am 65 years old and have bought many electronics magazines over the years. Please keep writing with the average person in mind.

— **Walter Jarvis, Bronx, NY**

Unlike other magazines, your projects and articles are ideal for a novice like me. Too many publications, it seems, are intended for someone with a masters degree in electrical engineering. I've just passed my Novice exam and am interested in projects directed at the ham radio operator. Tnx.

— **Wilmer Andrews, Pulaski, VA**

Wow! I've just enjoyed reading your magazine for the fourth time. It makes me want to go out and buy parts, plug them in, and create something. You'll find my subscription check enclosed.

— **Dennis Irving, Regina, Sask., Canada**

Well, fellas, what can we say except thanks for the compliments, and we'll do our best to continue producing the kind of magazine you want. Naturally, we appreciate compliments, but we're open to constructive criticism as well, so if there is anything you'd like to see added or changed, write and tell us about it.

VCR Parts

I have been trying to locate a supplier who carries the parts needed to service a VCR. Mine has broken down, and rather than take it to a repair shop, I'd like to see if I can do the job myself.

— **Mike Kelly, Boston, MA**

*Two sources come to mind, Mike. One is **Parts Express, 340 E. First St., Dayton, OH, 45402. Their phone number is (513) 222-0173. The other supplier is MCM Electronics, 650 Congress Park Dr., Centerville, OH, 45459. MCM's phone number is (513) 434-0031. Both companies feature an extensive selection of VCR repair parts in their catalogs, and that includes mechanical as well as electrical parts. In addition, they carry parts for microwave ovens, too.***

Project Meltdown

I built and now enjoy using the 3&1 power supply illustrated in Volume XII of **Electronics Handbook**. It does everything the article said it would.

I did have a problem, however, with the value of R1. The schematic diagram called for a 240-ohm resistor, but the parts list indicated that a 240K resistor was required. I built it with the 240K resistor and burned out R2 and the meter. After replacing R1 with a 240-ohm resistor, and replacing R2 and the meter, everything worked OK.

— **G.F. Michaels, Chillicothe, OH**

Thanks for calling our attention to the error, G.F., and for being such a good sport about it, too. As a gesture of gratitude, we're sending you the next four issues of the "Handbook" free of charge. Lest someone get the wrong idea, though, let me point out that this magnanimous act is a one-time-only deal, so don't expect a free subscription every time you report a typographical error.

We strive to weed out the typos, and most of the time we're successful, but occasionally one will

slip through. Some readers have suggested that the editor responsible for an error be staked out on an anthill, but that's hardly practical, owing to current labor laws as well as the relative scarcity of anthills here in New Jersey. Instead, editors responsible for typos run on a treadmill connected to a generator, which supplies electricity for the office. G.F., you'll be pleased to know that the culprit who caused you so much trouble is now on his third pair of sneakers.

High Compression

How can you achieve an overdriven sound for a home stereo system? What I am seeking is a strong, blown-out sound that I'm told is produced by intense compression. One method of overdriving an amplifier is, of course, by feeding it too much input, but this unfortunately produces distortion, and that's not what I want.

The effect I want gives the most incredible sound to music, by squashing and blowing out the sound in a strong burst. You'll sometimes hear this on radio and television. Normal sound from disks, vinyl, etc., is by comparison so puny and quiet. Why don't I ever hear about compression for home stereo use? Guitar compression effects I've heard, but never anything in conjunction with a home stereo system. Please help.

— **Jonathan Windham, Chicago, IL**

The first thing I'd like to say, Jonathan, is that I'm damn glad you don't live next door to me. Furthermore, the main reason you don't find compressors used with home stereo systems is that people who have tried to use them have been



driven into the hills by angry neighbors. I'm tempted to leave it at that, but since you're obviously looking for a technical answer of some sort, prepare to be edified. Compression is an effect which raises the sound level of quiet musical passages, and diminishes the level of loud ones, thus compressing the ratio of high to low. You'll hear the effects of compression during radio and television commercials. Compression makes the message seem louder, but in fact what it does is keep the sound level from varying as much as it normally would. The hapless listener is thereby subjected to every nuance of the commercial message. The degree of compression attained is variable, progressing from zero compression (i.e., normal sound) to infinite. A circuit providing infinite compression is usually known as an automatic level control (ALC); it allows no variation in the average sound level.

Compression goes hand-in-hand with a complementary effect known as expansion. The effect of an expander on music is to make quiet passages quieter, and loud passages even louder. Its net effect, therefore, is to expand the ratio of high levels to low levels in a musical passage.

Compression and expansion are used together whenever a signal is stored (for example, on tape) or transmitted (over wires or through space). Storing or transmitting a signal invariably degrades it due to the adverse effects of noise in the transmission or storage medium. One way of getting around noise in the medium would simply be to use so much amplification that even the lowest levels of our signal exceeded the inherent noise level of the medium. That is not always physically possible, and even when it is, excessive amplification may boost the high levels of the signal so much that clipping and distortion occur. The answer to the problem is to compress the signal

before storing or transmitting it, and then to expand it when the signal is retrieved from storage or picked up by a receiver. Remember, compression boosts the low levels, making them louder than the noise, and squashes the high levels, so that they don't exceed the physical limits of the system and cause distortion. Subsequent expansion of the signal will restore it to its original form. Further information on the use of compression and expansion can be found in most books on audio recording.

Getting back to the original question—i.e., why are there no compressors available for home stereo use?—the answer is that audiophiles don't want them, since compressing a signal runs counter to the goal of high-fidelity music reproduction. In fact, in the pioneering days of high fidelity, a well-heeled audiophile might actually have had an **expander**, not a compressor, in his audio system in order to enhance the dynamic range of the sound. That's hardly necessary today, given the wide dynamic range of compact discs.

If you'd like to experiment with compression and expansion, try the NE570 or NE572 compandor (compressor/expandor) chips from Signetics. Volume I of the **Signetics Linear Data Manual** (subtitled "Communications") provides data sheets for these ICs as well as some informative application notes. For the current price and availability of this data manual, write to **Signetics Corp., 811 E. Arques Ave., Sunnyvale, CA, 94088-3409**. The NE570 chip is available from **JDR Microdevices, 2233 Samaritan Dr., San Jose, CA, 95124**. JDR is the only hobbyist-oriented distributor I know of who carries this IC.

One final word of caution: If you use a compressor with a home audio system, don't use too much compression, and don't crank up the sound too loud, because home stereo speakers are simply not capable of carrying large amounts of

power on a continuous basis.

ICs Get Hot

I've noticed that ICs, particularly in commercially-manufactured sets, often feel hot my touch. But I thought heat was the great enemy of integrated circuits. We're told to be very careful about heat, for example, to use pliers as a heat sink when soldering IC leads. Are the manufacturers on to something we aren't? —**David Ross, Pewaukee, Wisconsin.**

No, David, they're not on to anything new. All electrical currents (electrons) create heat when they pass through components. And ICs, with hundred, even thousands of transistors inside, passing millions of electrons every second, get lots of heat because the few microwatts crossing each transistor junction inside add up to enough heat so you can feel it. The trick is to keep the heat below the point where it will cause the IC to self-destruct. Careful design keeps most ICs below that temperature. Keep on being careful, or you'll be sorry.

Back Issues

I have thoroughly enjoyed Volume X of **Electronics Handbook** and am interested in getting the other volumes in this series. If these are still available, I would be interested in knowing which ones you have and their price.

— **Steve Sullivan, West Bend, IN**

Glad to hear that you enjoyed Volume X, Steve. As far as back issues are concerned, we have the following in stock: Sept./Oct. 1986, Winter 1986, Spring 1987, Fall 1987, Fall 1988, and Volume 6 through Volume 11 inclusive. Please include \$5.00 for each volume ordered. By the way, the price includes delivery direct to your door by a uniformed representative of the United States government. How's that for service?

NEW BOOK REVIEWS

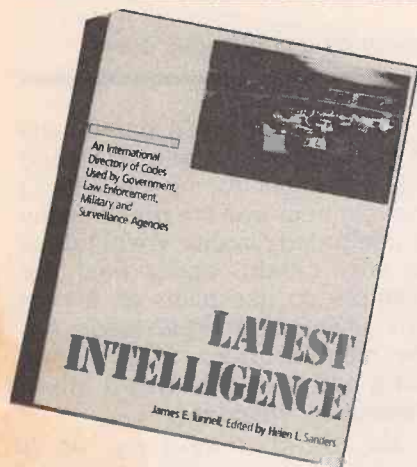

LATEST INTELLIGENCE by James E. Tunnell

Latest Intelligence declares itself to be an international directory of the codes used by government, law enforcement, military, and surveillance agencies. Arranged like a dictionary, the book contains information on clandestine organizations, their activities, and the secret jargon that they use. For anyone who likes to snoop with a scanner or shortwave receiver, **Latest Intelligence** should be required reading. It will also appeal to journalists, communications specialists, pilots, police officers, spy novelists, and spies-in-training. Perhaps the best way for me to describe this book is by sharing a few of its 35,000 entries with you.

You'll find background info on terrorist groups such as the Red Army Faction, Black September, and the PLO. Also biographical sketches of noteworthy terrorists, such as the infamous Abu Nidal. Descriptions of high-tech military electronics gear, like ANAVS-6 nightvision goggles, and the KH series of spy satellites. Listings of the frequencies used by law-enforcement agencies such as the DEA, FBI, and U.S. Marshall's Service. Spy terminology: black-back job, bleep box, agent provocateur, etc. Exotic weaponry like the deadly radiation pistol, developed by both the KGB and CIA (not jointly, of course). International civil

aircraft markings. A complete listing of the ten-codes used by law-enforcement agencies. Street slang (now at last I can understand rap music). Background information on top-secret agencies like the CIA and NSA. Listings of cellular telephone frequencies. Communications frequencies used by the Goodyear Blimp. Descriptions of military aircraft like the A-10 Warthog and F-117 Stealth fighter. Military slang. And lots more.

James Tunnell has written an excellent book that will add immeasurably to the listening enjoyment of anyone with an interest in sub rosa communications. Highly recommended.

Latest Intelligence, 305 pages, softcover: \$16.95. TAB Book Division, McGraw-Hill Inc., Blue Ridge Summit, PA, 17294-0850. Phone (800) 822-8138.



THE MIDI MANUAL by David Miles Huber

If you are an electronic musician, the term MIDI will no doubt be familiar to you. For the sake of those of you who aren't musicians, but want to be, I'll let author **David Miles Huber** explain what MIDI means:

"Simply stated, Musical Instrument Digital Interface (MIDI) is a digital communications language and compatible hardware specification that allows multiple elec-

tronic instruments, performance controllers, computers, and other related devices to communicate with each other within a connected network. It is used to translate performance- or control-related events (such as the actions of playing a keyboard, selecting a patch number, varying a modulation wheel, etc.) into equivalent digital messages and to transmit these messages to other MIDI devices where they can be used to control the sound generation and parameters of such devices within a performance setting. In addition, MIDI data can be recorded into a digital device (known as a sequencer), which can be used to record, edit, and output MIDI performance data."

This book begins by describing the MIDI command code and some of the hardware that makes up a MIDI network, including computers. From there, the author proceeds to discuss the musical instruments that can be connected to a MIDI network: keyboards, synthesizers, drum machines, and samplers. Software is important, too. Various chapters are devoted to programs that perform such functions as sequencing, editing, and printing a musical score. MIDI-based signal processing, synchronization, and mixing are some of the other topics covered.

Gone are the days when a musician could make a name for himself just by smashing his guitar to smithereens on stage. Today you need digital savvy, and this is a book that can give it to you.

The MIDI Manual, 267 pages, softcover: \$24.95. Sams Division, Prentice-Hall Computer Publishing, P.O. Box 90, Carmel, IN, 46032. Telephone (800) 428-5331.

THE RADIO AMATEUR'S DIGITAL COMMUNICATIONS HANDBOOK

by Jonathan L. Mayo, KR3T

The popular image of the radio amateur is, I suppose, that of a guy

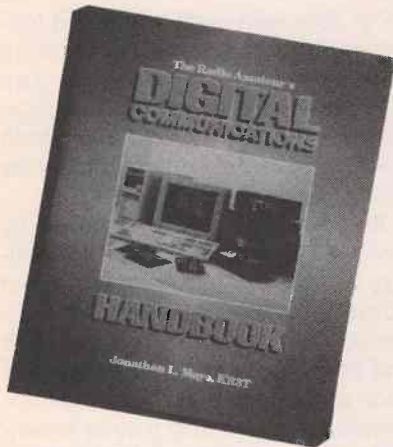

hunkered down in his basement listening to a series of dits and dahs emanating from a radio receiver, and then tapping out his response on a telegraph key. That image is way out of date, however. Thanks to the ongoing revolution in microcomputers, today's radio amateur is more likely to be found seated before a video terminal, tapping out his messages on the keyboard and reading the response off his video screen. It sure sounds more interesting than Morse code, doesn't it? Well, if you agree and think you'd like to get started in digital ham radio, **The Radio Amateur's Digital Communications Handbook** was written to help you do just that.

Author **Jonathan Mayo** begins with an introduction to some of the principles of digital communications, and then proceeds to address in turn each of the various modes of digital communication in use by amateurs today. There is a short discussion of radiotelegraphy (Morse code) just for the sake of completeness, but the real emphasis is on what follows: RTTY (radioteletype), AMTOR (a form of radioteletype with sophisticated error-checking capabilities), and packet radio (the most significant new communications protocol of the past decade). Brief attention is given to digital imaging like fast-scan and slow-scan TV, too, but the primary focus is on the aforementioned RTTY and packet radio. The

author provides advice on setting up a digital communications station, selecting a terminal, and connecting terminal and radio together via the appropriate interface. Sample station set-ups are shown, along with photographs and descriptions of some of the more popular equipment available today.

Amateur radio certainly has changed. If you'd like a quick and painless introduction to the new world of digital communications, this may be the book for you.

The Radio Amateur's Digital Communications Handbook, 208 pages, softcover: \$14.95. TAB Book Division, McGraw-Hill Inc., Blue Ridge Summit, PA, 17294-0850. Phone (800) 822-8138.

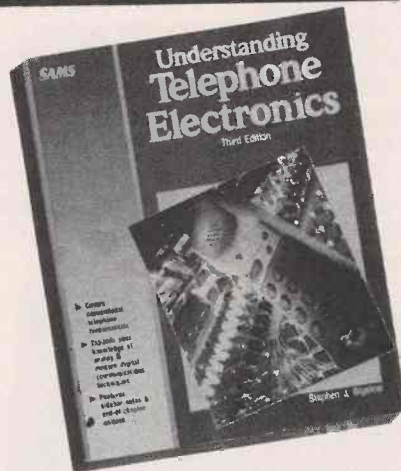

UNDERSTANDING TELEPHONE ELECTRONICS, 3rd Ed.
by Stephen J. Bigelow

We've featured books on telephone electronics before, but this one is a bit different, since it is not a collection of telephone-based projects but a detailed, serious explanation of how the telephone system works. Don't let the detailed, serious part bother you; information is presented in easy-to-understand language and accompanied by lots of charts and schematics to aid comprehension. As a result, this book should be accessible to just about anyone who wants to know more about the phone system.

The book begins with an examination of telephone sets, covering everything from the old rotary-dial antiques to the most modern electronic phones. This is followed by an introduction to electronic processing of voice information. Along the way, the author provides examples of the use of a variety of specialized telecomm ICs from suppliers like Motorola and Silicon Systems. Electronic dialing and ringing circuits have a chapter to themselves.

Voice input is transmitted primarily in digital form today. The book gives a thorough account of how analog voice signals are converted to digital form, processed, transmitted, and finally converted back to their original analog form. As part of the discussion, we get a glimpse of the electronic circuitry of a typical central office, as well as an introduction to the coding and multiplexing of data in the telephone network. The book concludes with a look at the operation of modems, fax machines, and wireless telephones.

It used to be that in order to gain access to information like this, you needed to be a high-caliber nerd capable of deciphering the arcane jargon of the **Bell Systems Technical Journal**. With the publication of this book, however, all that has changed. I recommend this book to anyone whose curiosity has ever been piqued by the sound of a ringing telephone.

Understanding Telephone Electronics, 365 pages, softcover: \$24.95. Sams Division, Prentice-Hall Computer Publishing, P.O. Box 90, Carmel, In, 46032. Phone (800) 428-5331.

EMBEDDED MICROCONTROLLERS AND PROCESSORS
by the staff of Intel Inc.

Anyone planning to incorporate a microprocessor or embedded microcontroller into his next project

NEW BOOK REVIEWS



will want a copy of the latest edition of this databook from Intel. In it can be found a thorough description of such chips as the popular 80186, the workhorse MCS-51, and a host of others. Detailed accounts of the software and hardware characteristics of each processor are provided, along with timing diagrams, sample software listings, and application notes. Charts, graphs, and tables abound. But I'd be lying if I said this was an interesting book; it's not meant to be. What we have here, folks, is data pure and simple. If you want charm and wit, read Mark Twain. But if you're doing serious work with Intel processors, you need this book. Enough said.

Embedded Microcontrollers and Processors, Vols. I and II. 2500+ pages, softcover: \$25.95/set. TAB Book Division, McGraw-Hill Inc., Blue Ridge Summit, PA, 17294-0850. Telephone (800) 822-8138.

UNDERSTANDING DATA COMMUNICATIONS by Gilbert Held

Computers are commonly regarded as being cold and impersonal, the very antithesis of human beings. But in one respect, computers and humans are very much alike: they both love to communicate. This shared need to communicate has spawned the growth of database services, information util-

ities, electronic bulletin board systems, and local-area networks (LANs). In order to deal with such systems in an efficient manner, you need to know how data communication takes place and what types of equipment are needed. That's what this book is all about.

The author deals with codes and protocols, data terminals, message content, and transmission channels. He also discusses in considerable detail modems of the asynchronous and synchronous types. Next comes an introduction to multiplexing, which allows hundreds or thousands of different messages to travel over the same wire or fiber-optic cable. Not all messages are earthbound; some are bounced off a satellite, and the reader is shown how this is accomplished. The further you send a message, the more likely it is to be degraded by noise, thus introducing errors. Techniques to detect and correct errors have been developed, and the author gives a good account of the most important ones.

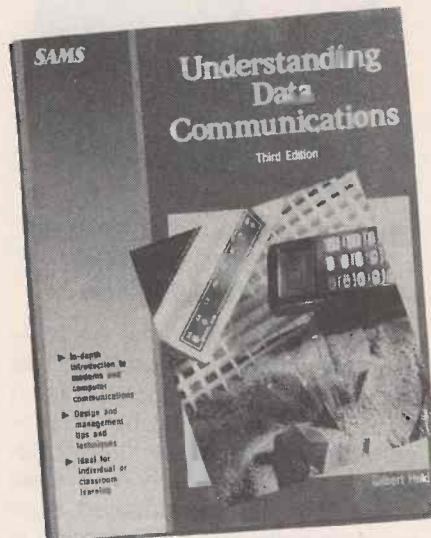

The principal avenue of communication for most business users is likely to be the local-area network. Mr. Held provides an explanation of how these systems work, and compares the relative advantages of the various LANs now in use. He goes

on to deal with such advanced topics as packet networks, network management and design, and ISDN (the Integrated Services Digital Network, designed to carry both voice and data communications over common telephone lines).

As you've no doubt surmised by now, this is a serious book for serious users of computers that must communicate with the outside world. The presentation is as clear and concise as can be expected of such a complex topic, and most interested readers with a solid knowledge of computers will find reading it a rewarding experience.

Understanding Data Communications, 368 pages, softcover: \$24.95. Sams Division, Prentice-Hall Computer Publishing, P.O. Box 90, Carmel, IN, 46032. Phone (800) 428-5331.



OLD TIME RADIOS by Joseph J. Carr

If you're one of the many people who enjoy collecting antique radios, this new book by Joseph J. Carr deserves your attention. **Old Time Radios** is a detailed, easy-to-understand guide to the restoration and repair of the elegant, tube-operated radios that graced American living rooms over 50 years ago. The author begins with a brief history of radio receivers, then delves into the

theory and operation of vacuum tubes. Subsequent chapters go on to discuss the repair of the various stages of a radio receiver, i.e., the RF amplifier, IF amplifier, detector, audio amplifier, and power supply.

As you can imagine, it's often difficult to obtain repair parts for these old sets. The author tells where to find the parts you'll need and how to improvise when you can't. There is a good discussion of the test equipment you'll need to repair and realign these old sets (multimeters, signal generators, and scopes), and detailed troubleshooting techniques. Most often the exterior of these old sets will require sprucing up, too, and the author offers practical advice on how to do this. In sum, this book contains just about all you'll need to know about restoring old radio receivers.

Old Time Radios, 256 pages, softcover: \$16.95, hardcover: \$25.95. TAB Book Co., Blue Ridge Summit, PA, 17214-9988. Telephone (800) 822-8138.

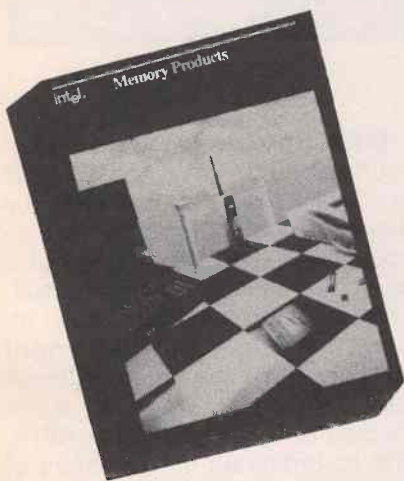

MEMORY PRODUCTS
by the staff of Intel Inc.

Planning on doing any experimentation with microprocessors in the near future? If so, you're going to be needing some memory for your system, and Intel's **Memory Products** databook will show you

how to use it. The memory technologies covered here include DRAM (dynamic random access memory), EPROM (erasable programmable read-only memory), and flash memory (electrically erasable and reprogrammable non-volatile memory). The book contains data sheets for each Intel memory product, replete with timing diagrams, pinouts, charts, and graphs. In addition, an assortment of application notes is included to provide guidance in the application of these memory chips. Essential reading for digital aficionados.

Memory Products, 1500+ pages, softcover: \$21.95. TAB Book Division, McGraw-Hill Inc., Blue Ridge Summit, PA, 17294-0850. Telephone (800) 822-8138.

SOUND RECORDING HANDBOOK
by John M. Woram

Anyone looking for a solid, no-nonsense introduction to the art of sound recording would do well to take note of the **Sound Recording Handbook**, a veritable treasure trove of knowledge that will be of use to the serious home recordist as well as the working professional. The book begins with a brief explanation of the principles of acoustics and the characteristics of human hearing. Next comes a discussion of some of the physical characteristics of music—pitch, scales, harmonics, and so forth.

Good microphone technique is essential if a high-quality recording is to be made. You can't just stick a microphone anywhere and expect to get good results. Realizing that fact, the author devotes more than 90 pages of the book to microphones—the various types available, their relative strengths and weaknesses, and how best to apply them in real-world recording situations.

Of equal importance in the chain of audio reproduction is the speaker

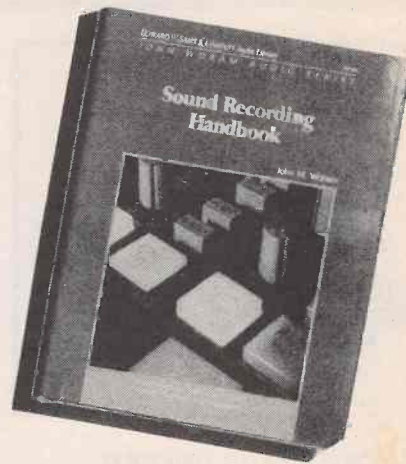

system. The book offers up some useful information on drivers, enclosures, radiation patterns, etc.

Delay and reverberation techniques have become an important part of the modern recording process. The author describes how natural reverberation occurs, and goes on to show how it can be mimicked by means of spring systems, reverberation plates, and digital reverb. Related effects such as flanging, phasing, and chorus are also covered. After that, Mr. Woram gets into equalization, compression, expansion, de-essing (the removal of sibilants from a vocal) and other signal-processing techniques.

No book on recording would be complete without saying something about magnetic tape. Three chapters here are devoted to the subject, covering everything from tape heads to tape transports and noise-reduction systems.

All things considered, the book does an admirable job of presenting what might have been a daunting topic in an easy-to-understand form that will appeal to a wide range of audio enthusiasts and recording engineers. As they say on TV, two thumbs up.

Sound Recording Handbook, 586 pages, hardcover: \$49.95. Sams Division, Prentice-Hall Computer Publishing, P.O. Box 90, Carmel, IN, 46032. Telephone (800) 428-5331.

NEW PRODUCTS PARADE

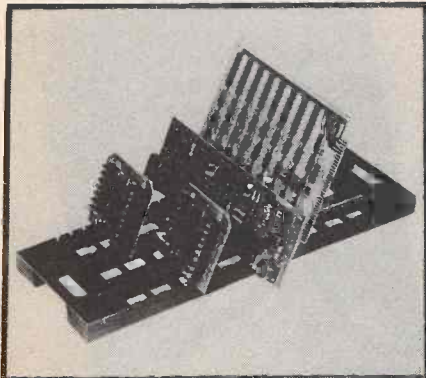

PC BOARD HOLDER

Designed to replace slotted wooden boards, styrofoam and cookie sheets, this PC board holder offers adjustment-free, easy-to-use racking of any size board. The model RA20CP is injection molded in conductive polypropylene for static protection and does not warp or absorb moisture. In addition to being static-safe, it is unaffected by acids, solvents, and cleaning solutions, and can withstand temperatures up to 180 degrees F. Other features include open carrying handles, stackability, drainage holes, and 21 easy loading slots that are 1/8" wide x 5/16" deep on a 3/4" pitch. The RA20CP rack measures 20" long and 7" wide and two units can easily fit in a 22"L x 17"W tote box.

For further information on the "PC Board Holder" contact **HMC, 33 Springdale Avenue, Canton, MA 02021, Phone (617) 821-1870, FAX (617) 821-4133.**

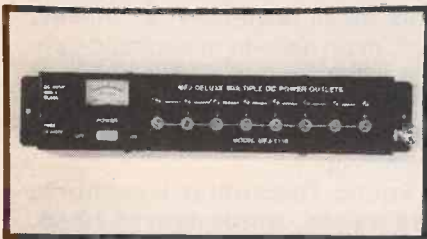

DC POWER OUTLET

MFJ Enterprises, Inc. announces the new **MFJ-1116 Deluxe DC Power Outlet** with voltmeter,

switch, and fuse...\$44.95.

Need a neat and easy way to distribute 12VDC to various transceivers and accessories? The new MFJ-1116 is the ideal answer! This multiple DC power outlet strip features eight terminals for connecting rigs and keyers, TNCs, tuners, etc. Output voltage is continuously monitored on its built-in voltmeter.

The MFJ-1116 has a heavy duty master power switch and 15 amp fuse. Each of its eight outlets utilize heavy duty five-way binding posts with standard spacing for dual banana jacks. Outlets are also RF bypassed. Strip measures 2.75x13.5x2.50 inches (H, W, D).

The MFJ-1116 can be installed on the rear of your desk and be used to eliminate "haywires." Perfect for experimenters and clean station enthusiasts alike! Built-in meter is a great aid for studying loads.

It comes with MFJ's one year unconditional guarantee.

For more information or to order, contact any **MFJ dealer or MFJ Enterprises, Inc., P.O. Box 494, Mississippi State, MS 39762 or call (601) 323-5869, Fax: (601) 323-6551, Telex: (601) 323-6551, or order toll-free at 1-800-647-1800.**



CURRENT GUN

This hand-held unit is a complete current meter. A large 3 1/2 digit LCD readout located on top of the pistol-grip handle makes it easy to take readings as fast as you can clamp around the conductor and press the

switch. Accepts conductors up to 3/4" in diameter. The Model CG100D reads DC, AC, and AC-on-DC currents to 200A with frequency response from DC to 1KHz. This unit's standard banana jacks permit current measurements to be viewed on an oscilloscope or read on a voltmeter as average, true RMS (AC and DC) or peak, depending on the type of meter used. Other features include an automatic readout hold (for 5 seconds), and a low battery indicator. Comes complete with four AA batteries, instruction manual, and 1-year warranty. Size: 9" x 4 1/2" x 1 7/16". Weight: 1 lb.

For further details, contact: **HMC, 33 Springdale Avenue, Canton, MA 02021, Phone (617) 821-1870, FAX (617) 821-4133.**



U.S.A. LINKS SOVIET STATES

MFJ Enterprises, Inc. announces the donation of MFJ-1287 Multimode Data Controllers to the Russian Amateur Emergency Service. The MFJ-1278s will be used to set up an Amateur Emergency Network based in the R3A station inside the Russian Parliament Building to link the different Soviet states together. The units were shipped to Rick Palm of the ARRL who co-ordinated the shipment of equipment. The MFJ-1278 Multimode Data Controllers will transmit and receive Packet, Fax and other digital modes. For more information about the MFJ-1278 Multimode Data Controller, call 601-323-5869 or write **MFJ Enterprises, Inc., P.O. Box #494, Mississippi State, MS 39762.**

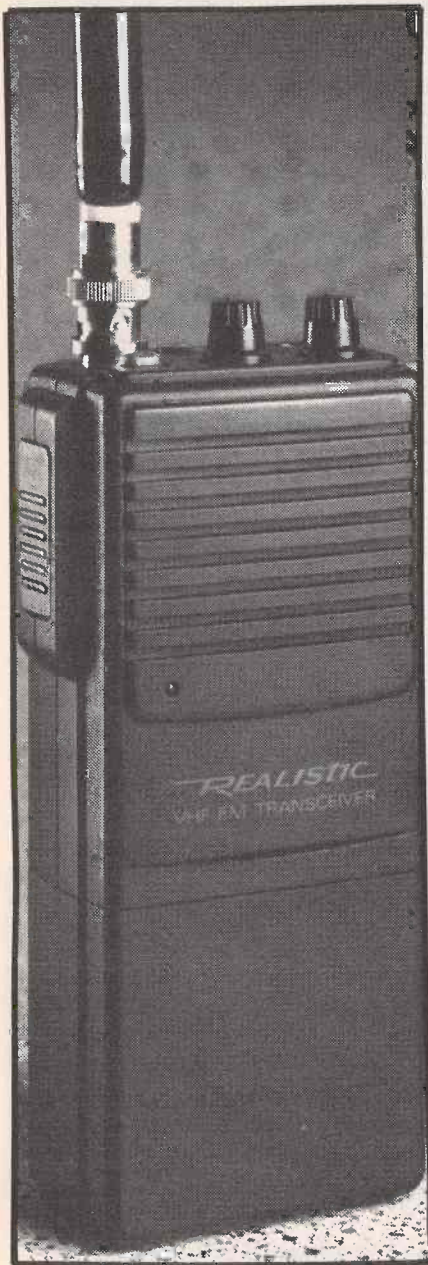

**BUSINESS BAND
TRANSCEIVER**

Radio Shack is now offering its first two-way business radio service transceiver, the Realistic® BTX-120. The 2-channel, VHF-FM handheld unit is designed specifically for business use and is ideal for construction sites, factories, warehouses, school campuses,

hospitals and entertainment complexes—wherever dependable, short-range business communication is needed.

This compact, lightweight radio (less than 15 oz.) comes ready to operate on the 151.625 MHz business channel. Optional plug-in crystals permit operation on a second channel, if desired. A built-in circuit automatically adjusts for a wide variety of voice levels to ensure clear and understandable transmissions. The adjustable squelch control eliminates background noise between transmissions.

The Realistic BTX-120 operates at 1-watt power with an effective range of up to one mile. A three-way indicator lights when transmitting, receiving or when battery power is low.

The unit comes with a removable and rechargeable nickel-cadmium battery pack and UL-listed AC charger. A 150mm detachable antenna, belt clip and vinyl carrying case are also supplied.

A Federal Communications Commission license is required to operate the BTX-120. An application form is included with the owner's manual.

The Realistic BTX-120 2-Channel VHF-FM Portable Business Band Transceiver (Cat. no. 19-1201) sells for \$149.95 at nearly 7000 Radio Shack® stores and participating dealers nationwide.

MFJ Enterprises, Inc. announces a new super multi-purpose instrument for tuning mobile and home antennas alike: the MFJ 247 for...\$189.95.

The new MFJ-247 is your perfect answer for "quick and easy" tuning of HF beams, verticals, dipoles, and mobile antennas for lowest SWR at your desired frequency. This fully self-contained unit shows your antenna's SWR over the entire band and works without a trans-



ceiver, SWR bridge or other additional equipment! You can see SWR change while rotating your beam, effects of ice and snow, changes on mobile whips while moving, and much more. You can even check the SWR on the input of your linear amplifier or pretune your antenna tuner without even switching on your transceiver!

The handheld MFJ-247 is fully self-contained: you can use it anywhere. Ideal for setting antennas to exact frequencies right on the roof or tower. No need to even switch on your transceiver until all antenna work is complete! Further, this unit's large LCD readout can be viewed in direct sunlight!

The MFJ-247 is super easy to use: you simply plug in your antenna to its top SO-239 socket, set the MFJ-247's readout to the frequency you wish to operate and read the SWR directly on its meter. You can then shorten or lengthen your antenna's element(s) or mobile whip for lowest SWR at your desired frequency, tune to band edges

NEW PRODUCTS PARADE

and read bandwidth of antenna, and more. Tuning couldn't be easier! Unit reads SWR directly from 160-10 meters. Also reads frequencies with high accuracy to 150MHz.

The MFJ-247 consists of a precise digital frequency counter plus low power signal generator and SWR meter in one cabinet. Its weak signal on your selected frequency is fed to the antenna, then the antenna's SWR is read directly on the MFJ SWR Analyzer's meter. This concept is ten times better than using a noise bridge!

The revolutionary MFJ-247 has a separate BNC input connector for use as a high accuracy frequency counter. Counter has one PPM accuracy. Uses six AA cells or 110VAC with MFJ-1312 (\$12.95).

It comes with MFJ-s one full year unconditional guarantee.

For more information or to order, contact any MFJ dealer or MFJ Enterprises, Inc., P.O. Box 494, Mississippi State, MS 39762 or call (601) 323-5869, Fax: (601) 323-6551, Telex: (601) 323-6551, or order toll-free at 1-800-647-1800.



MIL-SPEC SOLDERING STATION

The Model WCC100 is an electronically controlled soldering station that meets all government specifications including MIL-STD-

2000. Its temperature is adjustable from 350°F-850°F and is stable within 10°F at idle. Tip leakage is less than 2mV and tip-to-ground resistance is less than 2 ohms. The 40-watt pencil is fitted with an ETA (1/16" screwdriver) tip and can be used with a full range of tips to cover many soldering applications. A zero voltage circuit ensures that no high voltage spikes or magnetic fields are present at the tip to damage sensitive components. Other features include a compact space-saving design, housing and handle that are both impact-resistant and static-safe, lighted on/off switch, and grounded power cord. For further details, contact HMC (Hub Material Company), 33 Springdale Avenue, Canton, MA 02021, Phone (617) 821-1870, FAX (617) 821-4133.



SELF-CONTAINED DESOLDERING GUN

This unique compact Model SC7000 is a self-contained, multi-function desoldering tool that features an integrated diaphragm vacuum pump and temperature control unit inside the hand-grip. No additional benchtop station or factory air is required to operate the unit. The

SC7000 is truly portable, weighing about 1 lb. Power source is a standard wall outlet. The combination of a high output 100W ceramic heating element, tips designed for optimum heat distribution, and sensor-feedback temperature control circuitry (variable from 572°F to 842°F) allow for fast heat build-up and prompt recovery. Direct in-line connection between the quick-rise diaphragm pump and desoldering tip provides high vacuum efficiency enabling desoldering of multi-layer PC boards. Internal zero-crossover circuitry eliminates leakage current and RF noises. The carbon-impregnated housing and a basic 3-prong grounded power cord protects against static electricity. Other features include ergonomically designed, easy-to-replace quick-disconnect plastic filter, SMD removal capability in Hot Air Blow mode.

For further details, contact HMC, 33 Springdale Avenue, Canton, MA 02021, Phone (617) 821-1870, FAX (617) 821-4133.

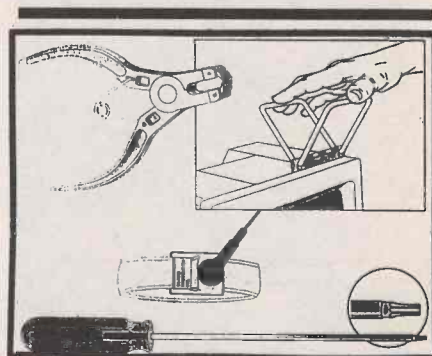

THE MAC-KIT

The Mac-Kit is a unique set of tools to service Apple-Macintosh computer's and other PC's. The MacKit includes an extra long torx (T-15x12") Tech-Stat, Wrist Strap, Tech-Stat IC Puller, and a Mac-Cracker. For more information and a **FREE** Catalog on the complete line of Computer Aided Tools: Call 941-2400 (24 Hr.) FAX (215) 828-5623, or write: **Techni-Tool, 5 Apollo Road, P.O. Box 368, Plymouth Meeting, PA 19462 USA.**

CLASSIFIED FLEAMARKET



PC BOARD and schematic design software for the IBM PC/compatible. Create professional PCB layouts (with autorouting—requires EGA) and electronic schematics (CGA) with these inexpensive shareware programs. Both for \$7.00. **Suncoast Technologies, PO Box 5835EH, Spring Hill, Florida 34606.**

PROGRAM THE 8051 microcontroller in Basic with this PC/compatible shareware collection. Disk contains Editor, Basic Compiler, Assembler, Disassembler, Procomm plus 3 surprise programs. Only \$7.00 from **Suncoast Technologies, PO Box 5835EH, Spring Hill, Florida 34606.**

TELEPHONE CONTINUITY TESTER Instructional guide to building your own. Indispensable for the electrical enthusiast: for trouble-shooting, communications and much more! \$4.95 **MCG ADVANCED, P.O. Box #155, Waterville, ME 04901.**

SPACE ENERGY RECEIVERS— Power from the Wheelwork of Nature Send \$6.50 plus \$1.00 (P&H) to **Simplified Tech. Service, P.O. Box 2140A, Champaign, IL 61825.** Space energy receivers may be defined as a class of devices, which apparently collect electrical energy from the surrounding space without applied force, by some process other than chemical or mechanical action. This book describes eight inventors and their devices, covering the years 1901 to 1945.

FREE! Fabulous catalog of sensational electronic kits. **LNS TECHNOLOGIES, 20993 Foothill Blvd. Suite 307H, Hayward, CA 94541-1511.**

Design Tesla Coils! Any size, any power, quickly and easily on your IBM computer. Fantastic, fully graphic program! Only \$29.95. **W.C.N., 3283 Belvedere, Riverside, CA 92507**

ALL ABOUT CRYSTAL SETS. Theory and construction of crystal set radios. \$7.95 ppd USA. **Allabout Books, Dept. "H", Box #14155, Fremont, CA 94539.**

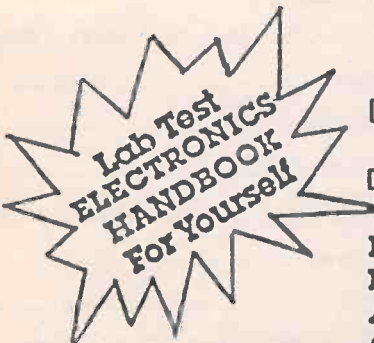

ELECTRONICS HANDBOOK

V13

P.O. Box #5148, N. Branch, N.J. 08876

- Yes. Enter my subscription — 4 issues ONLY \$15.00 (Canada \$18.00...Foreign Postage add \$8.00...U.S. Funds)
- Payment enclosed. (Payable to: C&E Hobby Handbooks)

PLEASE PRINT

NAME: _____

ADDRESS: _____

CITY: _____

STATE: _____ ZIP _____

What's better than speed reading? *Speed Learning.*

Speed Learning has replaced speed reading. It's a whole new way to read and learn. It's easy to learn...lasts a lifetime... applies to everything you read. It may be the most productive course you've ever taken.

Do you have too much to read and too little time to read it? Do you mentally pronounce each word as you read? Do you frequently have to go back and reread words, or whole paragraphs, you just finished reading? Do you have trouble concentrating? Do you quickly forget most of what you read?

If you answer "Yes" to any of these questions — then here at last is the practical help you've been waiting for. Whether you read for business or pleasure, school or college, you will build exceptional skills from this major breakthrough in effective reading, created by Dr. Russell Stauffer at the University of Delaware.

**Not just "speed reading" — but
speed reading — thinking —
understanding — remembering —
and — learning**

The new *Speed Learning Program* shows you, step-by-proven step, how to increase your reading skill and speed, so you understand more, remember more and use more of everything you read. The typical remark from over one million people taking the *Speed Learning* program is, "Why didn't someone teach me this a long time ago." They were no longer held back by their lack of skills and poor reading habits. They could read almost as fast as they could think.

What makes *Speed Learning* so successful?

The new *Speed Learning Program* does not offer you a rehash of the usual eye-exercises, timing devices, and costly gadgets you've probably heard about in connection with speed reading courses, or even tried and found ineffective.

In just a few spare minutes a day of easy reading and exciting listening, you discover an entirely new way to read and think — a radical departure from anything you have ever seen or heard about. *Speed Learning* is the largest selling self-study reading program in the world. Successful with Fortune 500 corporations, colleges, government agencies and accredited by 18 professional societies. Research shows that reading is 95% *thinking* and only 5% eye movement. Yet most of today's speed reading programs spend their time teaching you rapid eye movement (5% of the problem), and ignore the most important part, (95%) *thinking*. In brief, *Speed Learning* gives you what *speed reading* can't.

Imagine the new freedom you'll have when you learn how to dash through all types of reading material at least twice as fast as you do now, and with greater comprehension. Think of being able to get on top of the avalanche of newspapers, magazines and correspondence you have to read...finishing a stimulating book and retaining facts and details

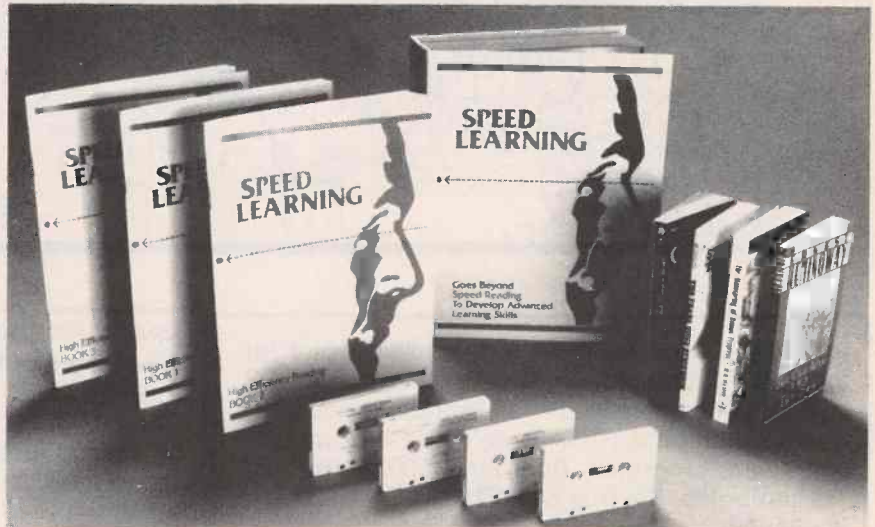

FOR FASTER SHIPMENT CALL 1-800-729-7323 OR FAX 1-609-273-7766

more clearly, and with greater accuracy, than ever before.

Listen — and learn — at your own pace

This is a practical, easy-to-learn program that will work for you — no matter how slow a reader you think you are now. The *Speed Learning Program* is scientifically planned to get you started quickly...to help you in spare minutes a day. It brings you a "teacher-on-cassettes" who guides you, instructs, and encourages, explaining material as you read. Interesting items taken from *Time Magazine*, *Business Week*, *Wall Street Journal*, *Money*, *Reader's Digest*, *N.Y. Times* and many others, make the program stimulating, easy and fun...and so much more effective.

Executives, students, professional people, men and women in all walks of life from 15 to 70 have benefitted from this program. *Speed Learning* is a fully accredited course...costing only 1/4 the price of less effective speed reading classroom courses. Now you can examine the same easy, practical and proven methods at home...in your spare time...without risking a penny.

Examine *Speed Learning* RISK FREE for 15 days

You will be thrilled at how quickly this program will begin to develop new thinking and reading skills. After listening to just one cassette and reading the preface, you will quickly see how you can achieve increases in both the speed at which you read, and in the amount you understand and remember.

You must be delighted with what you see, or you pay nothing. Examine this remark-

able program for 15 days. If, at the end of that time you are not convinced that you would like to master *Speed Learning*, simply return the program for a prompt refund. (See the coupon for low price and convenient credit terms.)

RISK-FREE ORDER FORM

YES! I want to try *Speed Learning* for 15 days without risk. Enclosed is the first of 4 monthly payments of \$32.25*. If I'm not completely satisfied, I may return it for a prompt refund.

SAVE 8.00! I prefer to pay the \$129.00 now, and save the \$8.00 shipping & handling charge: I may still return the program for a full refund.

Method of payment: (Federal Tax Deductible)

Check or money order payable to Learn Incorporated

Charge to: Visa MC Am Ex Discover

Card # _____ Exp _____

Signature _____

Phone (_____) _____

Name _____

Address _____

City _____ State _____ Zip _____

*Plus \$8.00 shipping and handling. U.S. funds only. For New Jersey residents, sales tax will be added.

learn INCORPORATED Dept. JVE-01 113 Gaither Drive, Mt. Laurel, NJ 08054-9987

THE HOME AUTOMATION PRIMER

By
Phil Parker



The automated operation of factories and laboratories has been with us for so long that most of us just take it for granted. But until quite recently the application of the same principles of automation to the home had been stymied by factors of complexity and cost. Thus, home automation remained just a dream for all but a few diehard innovators.

All that is changing today. Thanks to new advances in microelectronics, control-system technology that was once prohibitively expensive is now within the budget of almost everyone.

Why bother automating your home? Well, the reasons are as diverse as the needs of the individual homeowner. Someone who enjoys long vacations might wish for automatic operation of the lights and draperies in his home to give the illusion of occupancy. A person for whom movement is difficult would certainly appreciate the convenience of being able to turn on lights and appliances using a handheld transmitter. Programmable temperature control might appeal to anyone who is tired of paying exorbitant heating and cooling bills. And for some of us, the sheer joy of tinkering in the name of home improvement is sufficient justification for automating a home. New houses are not the only candidates for home automation; even an old house can be easily automated using the products we will discuss here. But before we consider any of the available home controls, let's examine some of the fundamental characteristics of a control system.

Control Schemes

Control can be manual or automatic. An example of manual control would be throwing a switch to turn on a fan. Automatic control of that same fan might be accomplished by means of a timer, a thermostat, or a central computer that runs the whole house. Practical systems are a mixture of manual and automatic control.

Another point worth realizing is that control can be centralized, as in the case of the above-mentioned home-control computer, or it can be distributed, in

which case different functions will be regulated by independent, autonomous controllers. Central control can be expensive, and so the emphasis in this article will be on distributed control. Nevertheless, those of you who already own a computer may be interested in applying it to home control. With that in mind, we will discuss some aspects of interfacing a computer with the products to be covered here.

In any control system, we must provide some means by which the controller can communicate with the device being controlled. The simplest method is to hardwire the controller and the controlled device together. A simple example of this would be a switch panel with wires running to motors, lights, etc. Another example would be a timer directly connected to the desired load. The advantages of direct connection are low cost, reliability, and immunity to noise and interference. The down side, though, is that a hardwired system is inflexible and can be difficult to install, particularly in an already built house, where you're faced with the problem of routing wires behind sheetrock or beneath the floor.

Radio control can be an attractive alternative to hardwiring. A radio-control link is flexible, easily installed, and even allows portability of the transmitter. Still, there are disadvantages. Radio control can be hindered by electromagnetic interference or, in some cases, be the source of interference in other equipment. Furthermore, radio control is relatively expensive and has a

limited range of operation.

Carrier-current remote control is the final communications option that will be considered here. A carrier-current control system uses the 120 VAC power line as its communications medium. The digitally coded control signal, which operates at frequencies much greater than the 60-Hz power-line frequency, is injected into the AC line by a transmitter, travels through the house wiring, and finally reaches a waiting receiver, which decodes the signal and performs some action. Both the transmitter and the receiver are connected through filters to the AC line. These filters block the unwanted and potentially destructive 60-Hz power-line voltage, but allow the higher-frequency control signals to pass through unhindered. Carrier-current remote control has the advantage of being easy to install and modify; furthermore, it is not too expensive. As for the disadvantages, carrier-current transmission is always at the mercy of power-line noise, which can sometimes be extremely disruptive. Large power-line transients, such as those produced by the switching of heavy inductive loads or close hits by lightning, may even destroy carrier-current equipment.

A practical home-control system will make use of hardwiring, radio control, and carrier-current remote control. The carrier-current method of home control was first made popular by the X-10 Powerhouse people, and their method of encoding control signals has been adopted by a host of other manufacturers, including Leviton, Radio Shack, Sears, Stanley, and GE. Thus, although this article specifically discusses equipment from Stanley and Heath, you should bear in mind that similar products are available from other manufacturers, and that products from different manufacturers will work harmoniously together as long as they are X-10 compatible. Let's begin by looking at some devices that initiate an activity in response to a carrier-current signal.



Fig. 1 Stanley Appliance Module (left) and Lamp Module (right). Two rotary switches allow programming of house code and unit code.

X-10 Controlled Modules

The Stanley Lightmaker Lamp Module, shown in Figure 1, is capable of controlling up to 300 watts of incandescent light. The module plugs directly into an AC wall socket; your lamp cord then plugs into the Lamp Module. Carrier-current signals received by the module produce on/off control or variable dimming of the attached

lamp. The control element here is a triac, which can be destroyed by large transient voltages on the power line. Lamp modules should, therefore, be considered expendable. Fortunately, they are relatively cheap, and failures are infrequent. Two switches on the front of the Lamp Module allow you to select the house code and the unit code. A module responds only to signals that have the proper house code and unit code; all others are ignored.

Also shown in Figure 1 is a related device known as an Appliance Module. Its function is similar to that of the Lamp Module, but in this case the control element is a latching relay rather than a triac. As a result, Appliance Modules have no dimming capability. The Appliance Module can handle a resistive load of 15 amps, or 500 watts of incandescent or fluorescent light, or a $\frac{1}{3}$ horsepower motor. Because the Appliance Module uses a latching relay, should AC power be interrupted and later restored, the proper status of the Appliance Module's output is maintained. By contrast, if power is interrupted and then restored to a Lamp Module, the output remains off until a new "ON" command is received.

To gain carrier-current control of a lamp connected to a wall-mounted switch, you can replace the old wall switch with a new Wall Switch Module. Up to 500 watts of incandescent light can be turned on or off or dimmed by a Wall Switch Module. Not only does the Wall Switch Module respond to carrier-current control signals, it also provides a pushbutton for direct control of the lamp it drives.



Fig. 2 Stanley Premier Home Control is capable of controlling up to sixteen devices and dimming lamps, too.

X-10 Controllers

There is a wide variety of devices designed to send control signals to the modules we've just finished discussing. For example, Figure 2 shows the Stanley Lightmaker Premier Home Control, which is capable of controlling up to 16 Light and Appliance Modules. Light

Modules can be dimmed or brightened. An ALL LIGHTS button turns on all Lamp Modules and Wall Switch Modules, but not the Appliance Modules. This comes in handy when you want to turn on all the lights quickly, but don't want to turn on the air conditioner or some other appliance. An ALL UNITS OFF button turns everything off, including the Appliance Modules. A house code switch determines which group of modules will be controlled by the Premier Home Control. So, for example, you could restrict the range of a Premier Home Control by assigning a different house code to each floor of your home. Each lamp module and controller on a given floor would have the same house code, and control signals originating on some other floor would be ignored.



Fig. 3 Basic Stanley Lightmaker Home Control offers on/off control of up to eight devices as well as lamp dimming.

A simpler and somewhat less expensive Home Control is shown in Figure 3. This device can control up to eight X-10 compatible modules. Lamp Modules can be dimmed or brightened. ALL LIGHTS ON and ALL UNITS OFF buttons are again available here, along with a house code switch.

For automatic control of your modules, try the Stanley Lightmaker Power Timer, shown in Figure 4. Like the Home Control, the Power Timer has a keyboard that allows you to manually control as many as 8 modules. Lamp Modules and Wall Switch Modules can be dimmed or brightened. In addition, the Power Timer has a built-in digital alarm clock and timer capable of automatically controlling up to four X-10 compatible modules. The timer can be programmed to provide up to two on/off cycles in a 24-hour period for each of the four devices it controls. One rather obvious use for the Power Timer is to make it seem as if you're home when you're not. Before you leave, program the Power Timer to turn on various lights and appliances (such as a radio) so that a normal semblance of domestic activity is maintained. If you plan on being gone for several days, use the Power Timer's security mode to provide slight random variations in the on and off times you've programmed. That way, no one will catch on to the fact that

a timer is being used.



Fig. 4 This Power Timer unit from Stanley can be programmed for on/off control of any X-10 compatible device and also functions as a handy digital clock.

The convenience and flexibility of radio control is provided by the Stanley Lightmaker Mobile Control and Base Unit shown in Figure 5. The Mobile Control is a handheld transmitter with a range of more than 200 feet. Power comes from four AAA cells, and the unit fits comfortably into a shirt pocket. Radio signals from the Mobile Control transmitter are picked up by the Base Unit and converted into standard X-10 code, which is then broadcast over the power lines. The Mobile Control and Base Unit are capable of controlling up to 8 devices. Lamp Modules can be dimmed or brightened. As long as your house doesn't have aluminum-clad insulation or siding, which will block radio signals, you can even control things inside when you're outside.

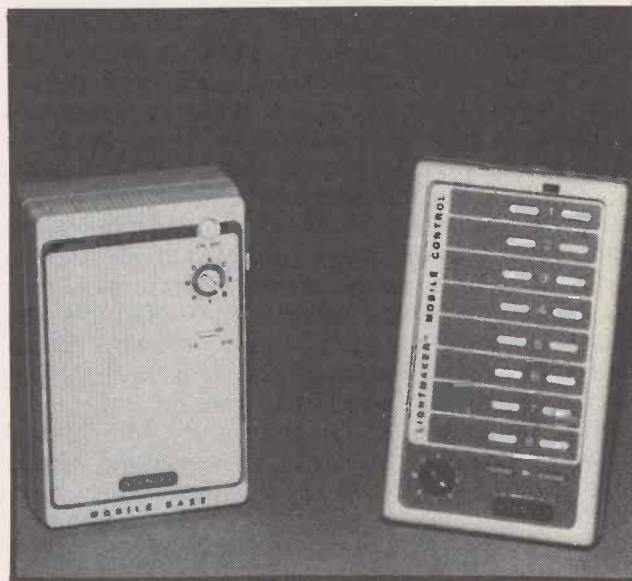

Fig. 5 The handheld Stanley Mobile Control transmitter on the right sends radio signals to the base unit on the left, which then rebroadcasts the information over the 120 VAC power lines. Up to eight X-10 compatible devices can be controlled.

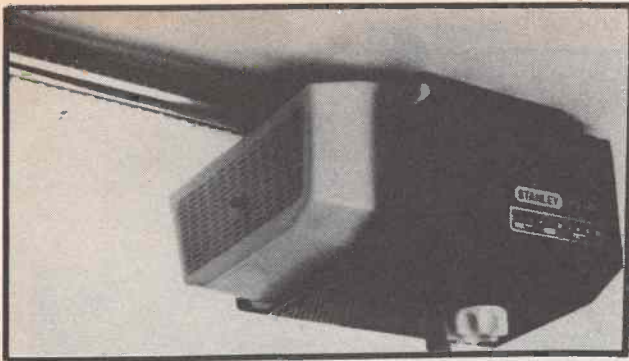

Fig. 6 Stanley Lightmaker X-10 compatible garage-door opener. (courtesy of Stanley Home Automation)

ceases. In most instances, these modules will be connected to lights, but anything is possible. A built-in photocell prevents activation of the floodlights during daylight hours. The passive infrared sensor has a range of 40 feet and senses motion within a 110° arc. The built-in floodlight can be turned on or off using any X-10 controller in the house.

The Stanley Radio-Controlled Motion Detector and Light Control shown in Figure 8 is an interesting variation on the theme just discussed. The passive-infrared motion detector can be mounted anywhere, indoors or out. When the detector senses motion within its 38-foot range, it transmits a radio message to the Base Unit, which is plugged into the AC power line. The Base Unit

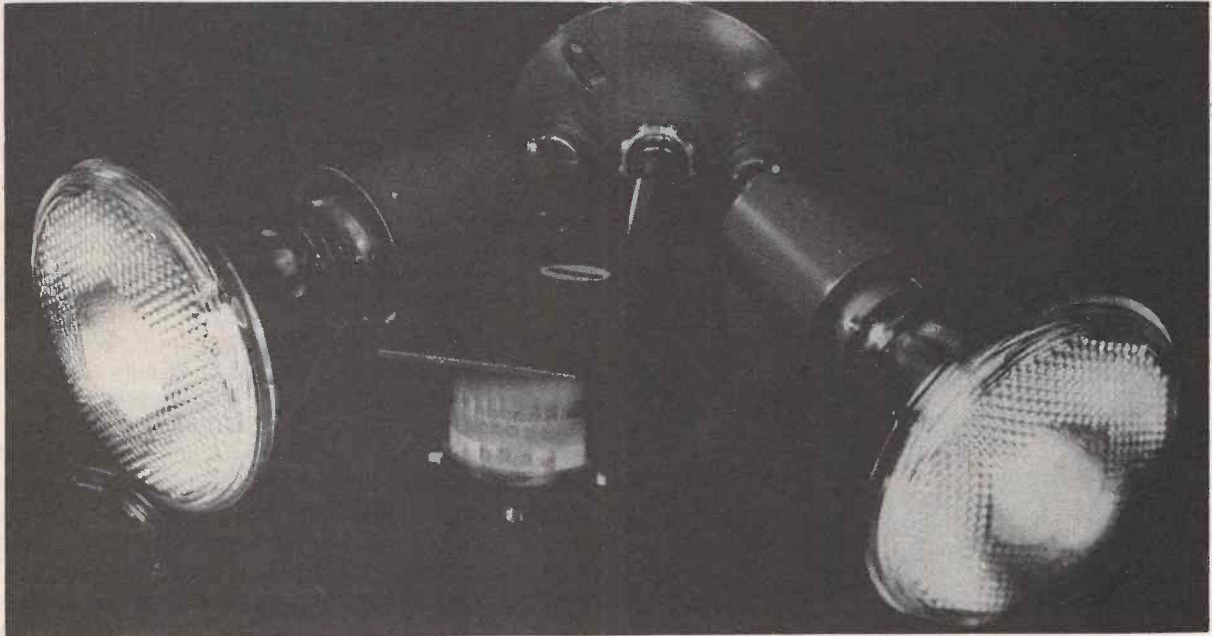

Fig. 7 Stanley Lightmaker Motion Detector and Light Control. (courtesy of Stanley Home Automation).

Special Functions

Most of the items discussed so far are available in one form or another from a variety of manufacturers. However, the Lightmaker Garage Door Opener and Remote Control shown in Figure 6 appears to be unique to Stanley. In essence, what we have here is the familiar garage door opener with handheld remote transmitter, but there is an extra twist. One button on the transmitter raises and lowers the door and turns on the garage light; the other can be used to turn on selected house lights, thus affording an extra measure of security. The house lights that are controlled in this way must be connected to Lamp Modules. A safety reversing feature returns the garage door to its full open position if it encounters an obstacle while closing.

The Stanley Motion Detector and Light Control shown in Figure 7 combines passive-infrared motion sensing with X-10 transmit and receive capability, making this a far more versatile device than the common motion-sensing light which it resembles. When motion of an intruder is detected, the unit lights up and at the same time sends X-10 codes to as many as four additional modules located inside or outside the house. Modules remain on for a selectable amount of time ranging from 10 seconds to 30 minutes after motion



Fig. 8 When the passive infrared sensor picks up movement by an intruder, it beams a radio signal to the base unit at the left, which then rebroadcasts the information over the AC power lines, causing lights to go on or an alarm to sound.

converts the signal to an X-10 compatible carrier-current message, which it transmits to a Lamp or Appliance Module via the power line. Multiple detectors can be used with a single Base Unit. Modules remain on for a selectable time interval ranging from 10 seconds to 30 minutes after motion ceases. A built-in photocell can be used to automatically disable the detector in daylight, if desired.

For computer aficionados, both Heath and Radio Shack offer a Computer Control Interface that allows your computer to control the on/off sequencing and dimming of up to 256 X-10 compatible modules. The nice thing about this is that your computer is not tied down to the job of running your home. Operation is simple. Connect your computer to the Computer Control Interface, enter the desired home-control program, then detach the computer from the Interface Unit. Modules can be made to go on and off at various times on different days of the week, and Lamp Modules can be dimmed to any desired brightness level. A backup battery protects the programming in the event of a power outage. Different versions of the Computer Control Interface are available for IBM PCs, Apple IIs, and Macs. The major shortcoming of this set up is that there is no feedback in the system. Things happen in a fixed sequence, with no allowance for changing conditions in the home. Nevertheless, in many instances fixed-sequence control of this kind is entirely adequate. Moreover, the \$60 cost of the Computer Control Interface is much cheaper than the cost of a full-fledged computer control system.

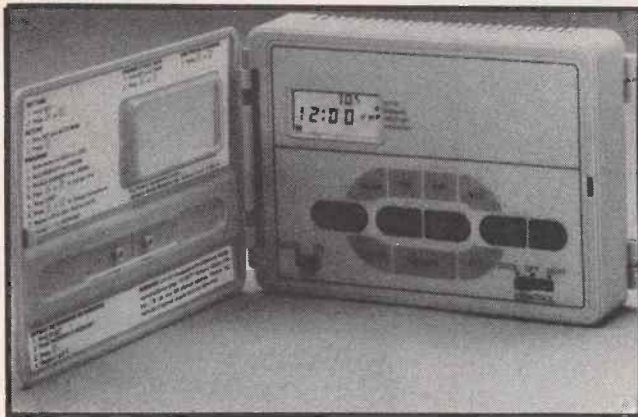

Fig. 9 A programmable thermostat provides automatic adjustment of house temperature and is an effective means of conserving energy. (courtesy of the Heath Co.)

Devices Without X-10 Capability

Most of the devices we have encountered thus far have X-10 carrier-current remote-control capability. This is convenient and useful, but definitely not essential in every part of a home automation system. As evidence of that fact, let us examine four devices without X-10 capability, beginning with the programmable thermostat shown in Figure 9. By lowering the temperature in your house when no one is home or when everyone is asleep, you can save as much as 30% on your annual heating bill. It's pretty difficult to remember to change the temperature setting yourself, but with a microprocessor-controlled thermostat, the changes are

made automatically. The Heath EnerGenius thermostat in Figure 9 can be programmed to provide up to four temperature changes a day, with separate settings for weekdays and weekends, and separate memories for summer and winter. The unit is compatible with gas, oil and electric heating and cooling systems with 24-volt controls, and with electronic spark-ignition systems.

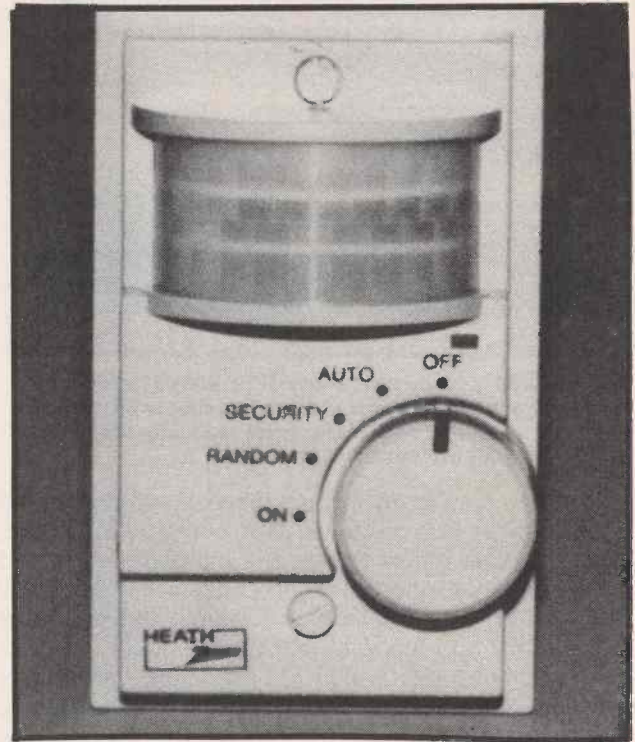

Fig. 10 Heath/Zenith's motion-sensing wall switch turns on the lights when it detects movement in the room.

The Motion Sensing Security Switch of Figure 10 brings passive infrared motion sensing indoors. In the AUTO mode, it turns the light on automatically as soon as you enter the room, and turns it off again after you leave. To give your house a lived-in look when you're away, set the switch to its RANDOM mode. Over a 4½ hour period the light will go on and stay on for randomly determined lengths of time, simulating normal light use. Finally, the switch can be put in a SECURITY mode, which will cause the light to flash on and off if someone enters the room. After a period of time, the light stops flashing and remains on, thereby alerting you to the fact that an intrusion occurred in your absence.

The Heath House Sitter security monitor and auto-dialer of Figure 11 plugs into your AC outlet and phone jack. When you call home, the House Sitter answers in a synthesized voice and reports on such things as the indoor temperature, the occurrence of noises louder than some predetermined level, and the presence of AC line voltage. You then get the opportunity to listen to sounds in the house for a preset interval of 1-99 seconds. If an abnormal condition should occur in the home, the House Sitter can call up to four different telephone numbers. When someone answers, the House Sitter announces its own telephone number and describes the abnormal condition it has sensed: temperature too low or too high, loud noise, AC power outage, or the opening or closing of a sensor switch. The latter

provides a convenient means of interfacing a home burglar alarm with the House Sitter. By the way, the quality of the digitized voice is excellent.



Fig. 11 Heath's innovative House Sitter allows the user to check on the status of his home simply by placing a telephone call. In the event of an emergency, the unit will even call for help.

Now we come to my favorite piece of equipment, the Heath Barking Dog Security Alarm of Figure 12. Whenever, someone enters the field of the passive infrared motion detector, furious barking erupts from the control box, which is mounted indoors. Owing to the small size of the driver and the relatively large amount of power that is pumped into it, you will hear some distortion, particularly if you're close to the unit. Nevertheless, when the barking is heard through the walls of the house—which is how the intruder hears it—it sounds entirely lifelike and convincing. You can switch from barking to a chime sound, if the barking gets on your nerves. If you're wondering how realistic the barking

actually is, let me just note that during the entire time I was testing this unit, our cats were cowering in the closet.

Where To Go From Here

It may seem as if we've covered a lot of ground here, but in fact we've only taken the first steps in what promises to be a long and interesting odyssey. Home automation is the wave of the future, that much is certain. To learn more about home automation, begin by checking out local building-supply stores. Home-control products by Stanley, Leviton, and others are usually carried in these outlets. In all likelihood, however, your local building-supply center will stock only a limited selection of items. To find some of the more esoteric home-control devices, you need to resort to mail order. The Heath Company puts out an interesting Home Automation catalog (see below for the addresses of Heath and the other suppliers to be mentioned here). Most items are readily affordable. However, if you're looking for a centralized computer system to run everything in your home, be prepared to shell out several thousand dollars. By contrast, most of the devices covered in this article cost between \$20 and \$50, and are thus ideal for most users.

Another good source for home-automation products is Home Control Concepts. This company is a one-stop source for equipment from a variety of manufacturers, including Stanley, Leviton, JDS, X-10 Powerhouse, Heath/Zenith, Mastervoice, and Enerlogic. Price discounts are the norm here. Home Control Concepts even carries drapery control motors—ideal for giving a house a lived-in look while you're away, or for regulating the influx of sunlight.

If you like to build your own home-control projects, check out **Circuit Cellar INK**, a bimonthly magazine devoted to digital control topics as well as general elec-

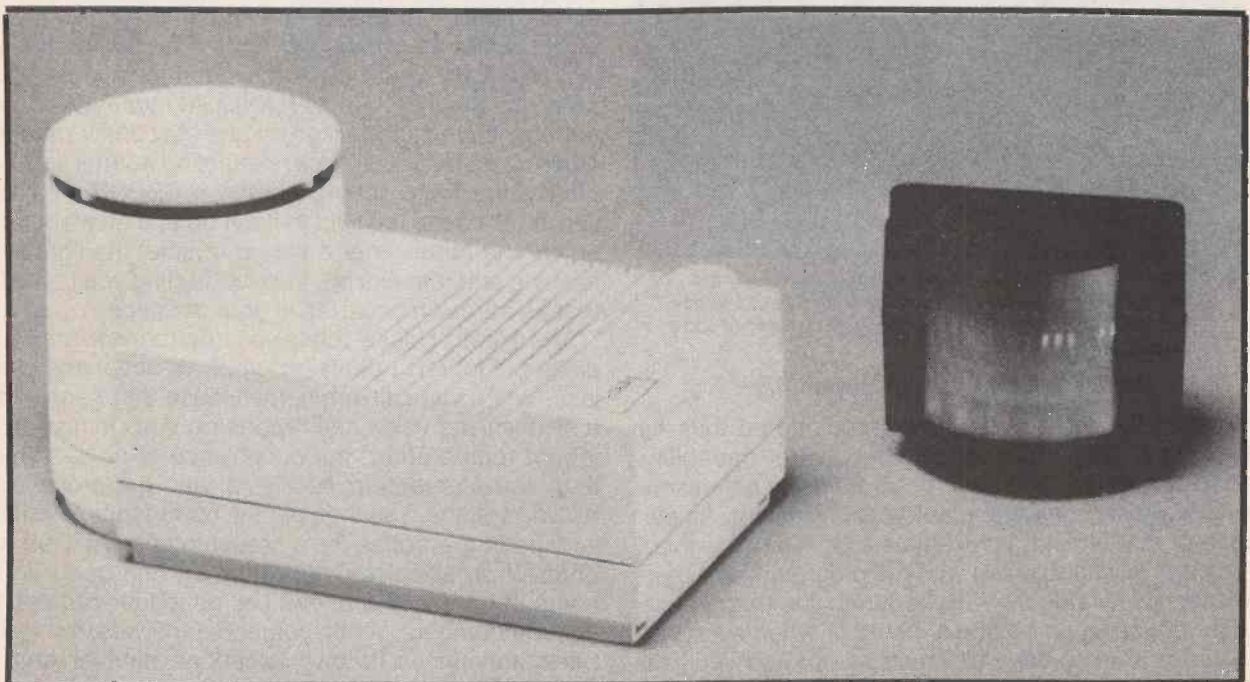

Fig. 12 This barking dog security alarm lets out a digitized bark whenever it detects the motion of an intruder. (courtesy of the Heath Co.)

tronics. Home-control articles are frequently featured. The level of presentation is fairly advanced—many of the subscribers are engineers, as are the authors—but the projects are usually available as kits which can be assembled by just about anyone. The magazine recently has been featuring a series of articles on Micromint's Home Control System II (or HCS II for short). HCS II is a sophisticated, expandable system consisting of a central supervisory microcomputer plus a variety of semi-autonomous satellite processors. The system doesn't just produce a timed series of actions; it senses the minute-by-minute status of the home and responds according to the program it has been given. Since the system is readily expandable, you can start out with just a nucleus of functions and add other capabilities later when the need arises. And since you build it yourself, the price is quite reasonable.

Many home-control tasks can be carried out by taking an off-the-shelf single-board microcomputer and adding some input and output circuitry, and then writing a suitable control program. Writing the software is often the hardest part, particularly if you have to work in assembly language. For the novice, it's nice to be able to work in a familiar language like BASIC. Well, there are single-board computers with built-in BASIC interpreters. A particularly nice example of this is the EC-25/EC-35/EC-45 family of microcontrollers from Iota Systems. These little control computers come complete with memory, communications ports, and a variety of optional interface circuits (analog-to-digital converters, parallel ports, etc.). Maximum clock speed is a snappy 20 MHz—fast enough to make even a pokey BASIC interpreter acceptable for home control. The 80C32 microprocessor at the heart of these single-board computers can even be programmed in assembly language, if faster response is needed. Cost of the single-board computer is less than \$150; add another \$30 for the BASIC interpreter in ROM. You do need an external computer such as a PC clone to program the microcon-

troller. Once the program has been entered into memory, however, the external computer can be disconnected. Besides BASIC, Iota Systems also offers "C" language compilers for its single-board computers.

Finally, for those of you who are curious about what the home of the future might look like, an inspirational video, documenting the construction of such a home is available for \$9.99 (plus \$2.50 P&H) from Hometime. In addition to home automation, the video covers architecture, building materials, appliances, and landscaping. Whether you plan on building a new home or not, there is plenty of food for thought in this video.

This completes our look at the world of home automation. Hopefully, you've found an idea or two that can be applied to your own home. If so, let us know what you tried and how well it worked. ■

COMPANY ADDRESSES

Stanley Home Automation
41700 Gardenbrook
Novi, MI 48050
(313) 344-0070

Circuit Cellar INK
P.O. Box 3050-C
Southeastern, PA 19398
(215) 630-1914

Home Control Concepts
9353C Activity Rd.
San Diego, CA 92126
(619) 693-8887

Iota Systems Inc.
P.O. Box 8987
Incline Village, NV 89452
(702) 831-6302

Hometime
Home of the Future
150 N. 6th St.
Philadelphia, PA 19106
(800) 736-3033

Micromint Inc.
4 Park St.
Vernon, CT 06066
(203) 871-6170

Heath Company
P.O. Box 8589
Benton Harbor, MI 49022-8589
(800) 253-0570

Economical Single Board Computers

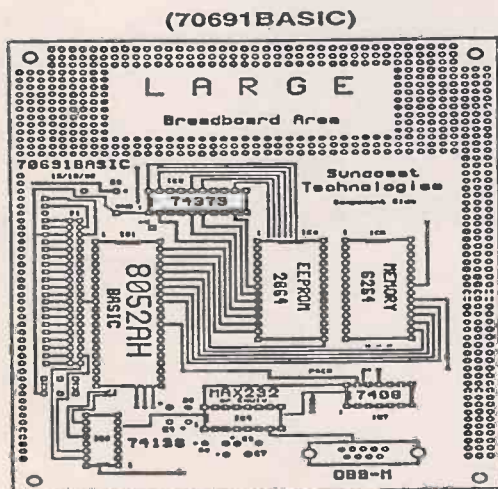

- * BASIC-52 Development Board Using Intel's 8052AH BASIC Microcontroller
- * Completely Assembled & Tested
- * Socketed EEPROM to save program using Tokenized Basic software (included)
- * Large Prototyping Area for Interfacing
- * 40 Pin Header for easy expansion
- * Comes with RS-232 Interface Circuitry
- * DB9 Male Connector for RS232
- * Requires ONLY 5V DC Power
- * 8K-Address Decoder Chip (2K Blocks)
- * 8K External Memory Chip
- * 11.0592MHz. Operation
- * Large 4.5 Inch by 6 Inch High Quality PC Board with plated holes
- * Compatible with Binary Technology's BXC51 or compatible
- * Create BASIC-52 Programs on 70691BASIC. Compile with BXC51. Use new .ASM software on our inexpensive 70691RAM Board. Programs run faster in .ASM You also save \$\$\$

\$70.00 each
(Plus \$2.90 Shipping)

SUNCOAST TECHNOLOGIES

P.O. BOX #5835

SPRING HILL, FL 34606

If You're Serious About a Future in Electronics, Ensure that Future with the Best Educational Training Available.

FREE!

SEND FOR YOUR CIE HOME STUDY COURSE CATALOG AND RECEIVE A FREE 24 PAGE CIE ELECTRONICS SYMBOL HANDBOOK!

Includes hundreds of the most frequently used electronic symbols. Published by CIE exclusively for our students and alumni. Yours free when you request a CIE Course Catalog.

electronics

Procedure

Figure 16 shows the circuit diagram for this experiment. You'll note that pin numbers for the IC aren't included on the diagram. For those, you'll have to refer to Fig. 17, which shows pertinent 74151A data. For the data inputs, you'll use an eight-pole DIP switch in conjunction with 10-k Ω pull-up resistors. For the Select and Strobe lines, finally, you'll use the trainer data switches.

1. With the power off, mount the 74151A IC and the DIP switch on the breadboard.
2. Connect the eight 10-k Ω resistors to the DIP switch as shown in Fig. 16. Connect the opposite end of each of these resistors to the +5V supply. The second terminal of each switch is to be connected to trainer ground.
3. Connect the IC V_{CC} pin to +5V; connect the GND to trainer ground.

Next, connect the trainer data switches to the Select and Strobe inputs on the IC, using Fig. 17 as a guide. Initially, set SW1 through SW4 (0).

5. Connect the trainer Y LED to the Y output, and connect the H LED to the H' output.

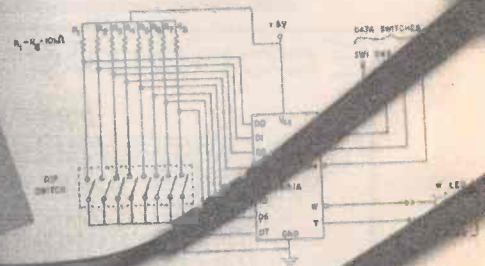

Fig. 16 Circuit for Experiment 2.



Fig. 17 Pin diagram for 74151A.

7. Turn the power on. The Y LED on your trainer should be off. The H' LED should be on. If you don't observe these conditions, turn the power off and check your connections.

8. From the present input conditions on the inputs, you can see which output will be enabled.

9. Set the appropriate DIP switch H1 (open), and verify your results. Record your results in terms of the selected input D_n (where n is the number of the selected data line) in the appropriate space in the table in Fig. 18.

If you want to learn about electronics, and earn a good income with that knowledge then CIE is your best educational value.

CIE's reputation as the world leader in home study electronics is based solely on the success of our graduates. And we've earned that reputation with an unconditional commitment to provide our students with the very best electronics training.

Just ask any of the 150,000-plus graduates of the Cleveland Institute of Electronics who are working in high-paying positions with aerospace, computer, medical, automotive and communication firms throughout the world.

They'll tell you success didn't come easy...but, it did come...thanks to CIE. And today, a career in electronics offers more opportunities and greater rewards than ever before.

CIE'S COMMITTED TO BEING THE BEST....IN ONE AREA....ELECTRONICS.

CIE isn't another be-everything-to-everybody school. We teach only one subject and we believe we're the best at what we do. Also, CIE is accredited by the National Home Study Council. And with more than a 1,000 graduates each year, we're the largest home study school specializing exclusively in electronics. CIE has been training career-minded students like yourself for nearly 60 years and we're the best at our subject
ELECTRONICS ... BECAUSE IT'S THE ONLY SUBJECT WE TEACH!



CIE PROVIDES YOU WITH A LEARNING METHOD SO GOOD, IT'S PATENTED.

CIE's Auto-programmed lessons are a proven learning method for building valuable electronics career skills. Each lesson is designed to take you step-by-step and principle-by-principle. And while all CIE lessons are designed for independent study, CIE's instructors are personally available to assist you

with just a toll-free call. The result is practical training... the kind of experience you can put to work in today's marketplace.

LEARN BY DOING...WITH STATE-OF-THE-ART FACILITIES AND EQUIPMENT.

In 1969, CIE pioneered the first Electronics Laboratory course and in 1984, the first Microprocessor Laboratory course. Today, no other home study school can match CIE's state-of-the-art equipment and training. And all your laboratory equipment, books, and lessons are included in your tuition. It's all yours to use while you study at home and for on-the-job after graduation.

PERSONALIZED TRAINING....TO MATCH YOUR BACKGROUND.

While some of our students have a working knowledge of electronics others are just starting out. That's why we've developed twelve career courses and an A.A.S. Degree program to choose from. So, even if your not sure which electronics career is best for you, CIE can get you started with

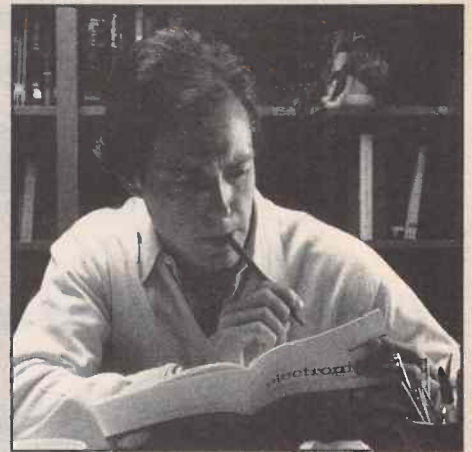

core lessons applicable to all areas of electronics. And every CIE course you take earns you credit towards completion of your Associate in Applied Science Degree. So you can work toward your degree in stages or as fast as you wish. In fact, CIE is the only school that actually rewards you for fast study, which can save you thousands of dollars.

SEND TODAY FOR YOUR CIE COURSE CATALOG AND WE'LL SEND YOU A FREE 24 PAGE CIE ELECTRONICS SYMBOL HANDBOOK!

FINANCIAL AID AVAILABLE TO QUALIFIED INDIVIDUALS.

WHY CHOOSE CIE FOR YOUR TRAINING?

- 150,000 successful graduates from every country around the world.
- Only CIE rewards you for fast study. CIE offers an Associate Degree program based on actual study time used. The faster you complete your degree the less your overall tuition.
- State-of-the-art laboratory equipment is yours to keep and it comes assembled, ready for hands-on experiments.
- Approved for educational benefits under the G.I. Bill for veterans and other eligible persons.
- Upon graduation, CIE offers free preparation to pass the Certified Electronics Technician Exams.

YES! I want to get started.
Send me my CIE school catalog including details about the Associate Degree Program. (For your convenience, CIE will have a representative contact you - there is no obligation.)

Name: _____

Address: _____

City: _____ State: _____

Zip: _____ Age: _____

Phone No. (_____) _____

Check box for G.I. Bulletin Benefits

Veteran Active Duty



CLEVELAND INSTITUTE OF ELECTRONICS

1776 East 17th Street
Cleveland, Ohio 44114
(216) 781-9400



A school of thousands.
A class of one.
Since 1934.

AEE06

CIRCUIT FRAGMENTS

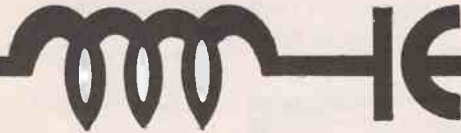

Reading about electronics can be fun and instructive, but the only way to become a knowledgeable technician is to get hands-on experience, by actually connecting resistors and capacitors together in circuits that do something. These circuits can be as simple as turning a light on or off, or making some kind of alarm sound. As long as we have a power source and a load connected together by wires, we have a functioning circuit.

Another way to think about circuits is to consider one part the input, and another part the output. This is notably true of amplifiers. The circuits in the following Circuit Fragments section are like this; they all Do something.

These projects are comparatively simple—and each uses fewer parts than those in our **Workbench Projects** and **IC Testbench** sections. If you study them and put several together you will increase your understanding of how all electronic components and circuits work.

MONO TO STEREO

There are times when you may want to record on a stereo recorder from a monophonic signal, such as from a TV set or a mono tape recorder. A simple circuit to accomplish this is shown in the accompanying diagram. The mono signal is applied across the 150 k resistor, and transferred through the capacitors to the LEFT and RIGHT channels of the stereo recorder.

Construction is simple and non-critical. The assembly of parts can easily be placed in a tape-wrapped portion of the connecting leads or in a small container, such as an empty 35 mm film can.

Interestingly, this circuit can often be used in reverse mode, so stereo can be recorded on a mono tape recorder. However, in some cases, the resistor

may have to be changed to a lower value for optimum results.

IMPORTANT: Check the two units carefully to make certain that neither chassis is connected directly to one side of the 117 Volt line.

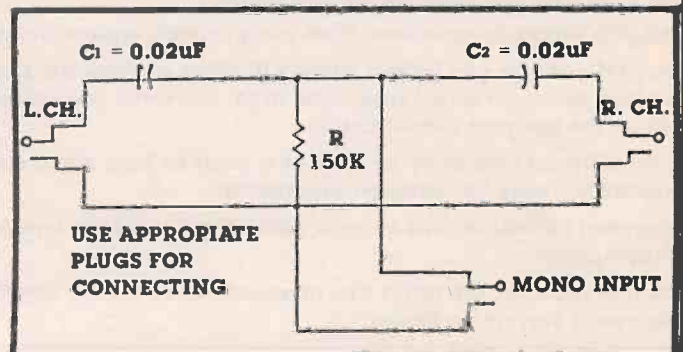

ELECTRIC GUITAR TREBLE ENHANCER

A low cost simple method of achieving an enhanced treble sound from your electric guitar can be obtained by using the circuit shown. For musicians whose style of playing emphasizes quality single note dexterity as opposed to high volume heavy metal, the subtle improvements gained here can be appreciated. The signal input from your electric guitar is capacitively coupled through C1 which forms part of a frequency sensitive impedance potential divider. The signal output is taken from the C1, R1 junction and capacitively coupled through C3 to your power Amp. For best results, use a quality speaker capable of reproducing the high frequency enhanced notes. Component values are critical; stick to the values given. ■

PARTS LIST FOR ELECTRIC GUITAR TREBLE ENHANCER

- C1—0.001uF capacitor
- C2—0.01uF capacitor
- C3—0.1uF capacitor
- R1—100K resistor

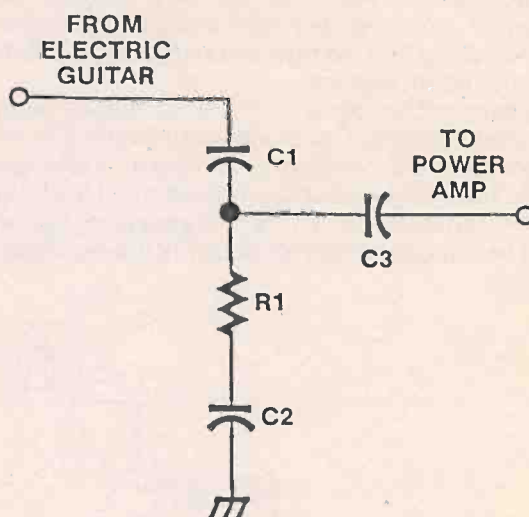

TELEPHONE LINE TESTER

Most of us have some phone lines in our home and/or office but how many of us have even a simple telephone line tester. There are times when it would be nice to know if a line has any power, or the polarity of the line.

This simple tester is extremely small, easily made and uses a modular plug. It is even appropriate for the Christmas holidays since it uses a bicolor LED that glows red or green depending on the polarity of the line.

The unit can be assembled with one bicolor LED or one red and one green LED, wired as shown in the circuit diagram.

The assembly can be sealed with RTV silicone coating the components, however, any waterproof sealer will be satisfactory.

The tester is small enough and inexpensive enough to make several for friends.

The LEDs should light red with the red lead in the cable positive and green with the green lead positive.

PARTS LIST FOR THE TELEPHONE LINE TESTER

- R1—12K Ohm, 1/2 Watt Resistor
- 1 Bicolor LED or one red and one green LED
- 6" Telephone cable with modular connector on one end.

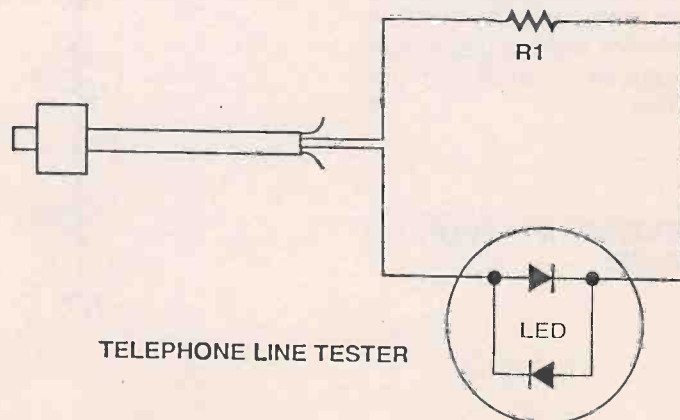

TELEPHONE LINE TESTER

SIMPLEST BATTERY CHARGER

So-called disposable batteries can actually be recharged with the simple circuit shown in this illustration. As long as they haven't been discharged too much, dry cells and alkaline batteries will give about ten charge/discharge cycles before they must be thrown out.

The battery charger circuit is essentially a rectifier and current limiter. The diode rectifies the 120 VAC, changing it to DC. While also serving as a pilot lamp, the light bulb limits the charging current of the battery to under 20 milliamps. At this charging level, batteries should be left connected for about 12 hours, although

they can remain for much longer without damage. Up to 25 volts worth of batteries connected in series can be charged with this circuit. Parts selection is not critical; the lamp can be an incandescent Christmas tree bulb and the diode can be any one with a reverse voltage rating of 200 volts or better.

Although their labels warn of explosion and other dire consequences if recharged, dry cell and alkaline batteries present little danger. If one does go bad while recharging, it will usually do so by slowly leaking at the seams, not exploding. If you want to be safe though, cover the batteries with a box or heavy rag. ■

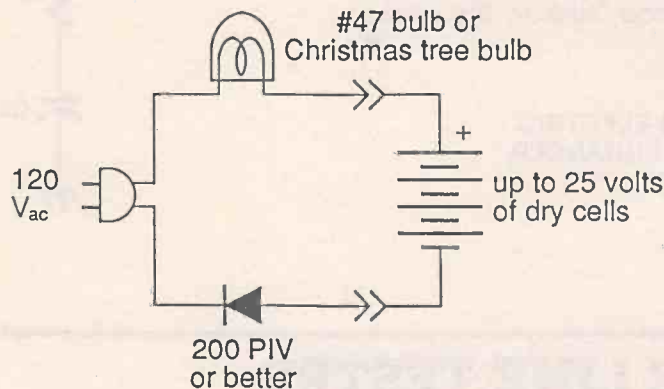

IMPROVED HI-FI SOUND SYSTEM

Quite often the beginner's first home-built audio amplifier is sadly lacking in quality, when compared to a commercial hi-fi system. By using the circuit shown, between the pre-amp output and the power AM input, you can add an extra amount of bass boost and hence an increase in the richness of sound. The signal input is capacitively coupled through C1. A resistor divider chain is made up of R1, R2, and R3. Capacitor C2 is the frequency sensitive component, controlling the base response. The output signal is capacitively coupled via C3. For best results, use a good quality speaker capable of reproducing the bass frequencies (avoid tiny transistor radio replacement speakers.) Component values are critical; do not deviate from the values shown. ■

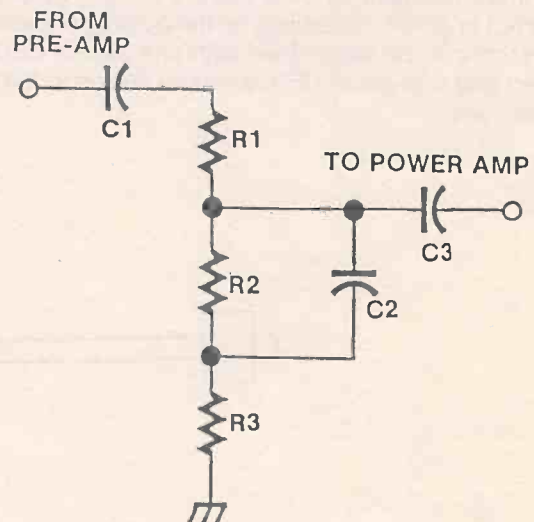

PARTS LIST FOR IMPROVED HI-FI SOUND SYSTEM

- C1—0.1uF capacitor
- C2—0.01uF capacitor
- C3—0.1uF capacitor
- R1—10K resistor
- R2—100K resistor
- R3—1K resistor

HARMONIC REDUCTION CIRCUIT

Electric guitars generate a tremendous amount of signal harmonics, especially when six-string power chords are played. Small speakers often sound distorted as a result. In order to protect your small guitar practice Amp speaker from premature burnout, limiting the low frequencies produced has been found to work. The signal input is fed directly from your electric guitar to capacitor C1. Depending upon the capability of your power Amp, there might be a need to use a pre-Amp also. The resistor chain R1, 2, 3 forms a potential divider, with the signal output taken from the junction of R2 and R3. Capacitor C2 is the critical frequency dependent component, controlling the amount of bass cut. The output signal is fed through capacitor C3. Component values are critical—keep to the values shown. For best results, use a heavy duty type of speaker, i.e. one with a decent sized magnet assembly. The size does not have to be large, 3" to 4" diameter have been found to work.

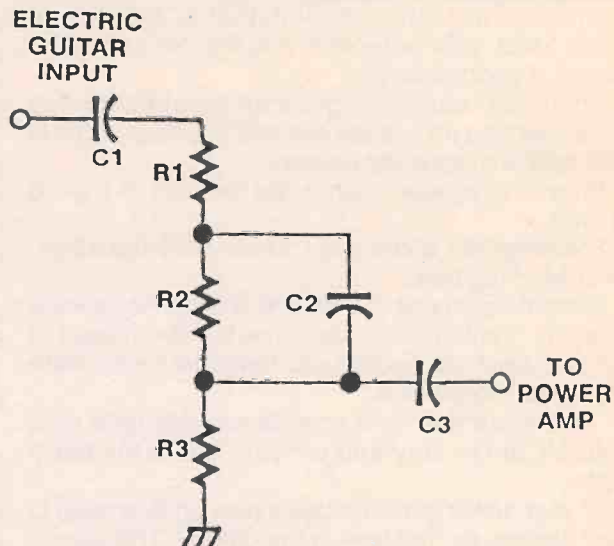

PARTS LIST FOR HARMONIC REDUCTION CIRCUIT

- C1—0.1uF capacitor
- C2—0.01uF capacitor
- C3—0.1uF capacitor
- R1—10K resistor
- R2—100K resistor
- R3—1K resistor

DOORBELL LIGHT

This simple circuit addition is for appearance and testing too.

All you have to do is drill a small hole close to your present doorbell button, or above it, and mount the resistor and LED in the hole. A small piece of sheet aluminum makes a good cover, with a hole drilled in it for the LED. Any size or color of LED can be used and polarity of the LED is not important since the doorbell power is AC. The resistors can be optimized for maximum light output or any fraction.

This is done by measuring the AC voltage at the doorbell transformer and finding the current that the LED requires, and calculating the correct resistance needed for that level of voltage and current. Divide voltage by current to get resistance.

I typically make the resistance 10% higher than needed as a safety factor. At least 10%.

Since the resistor and LED are connected across the doorbell buttons, the LED will be lit until you push the button to ring the bell. Closure of the contacts in the button shorts out the LED, and it goes out. This tells you that there is power, and the button contacts make and break.

PARTS LIST FOR DOORBELL LIGHT

- R1, 2—390 Ohm, 1 watt resistors
- L1, 2—LED's

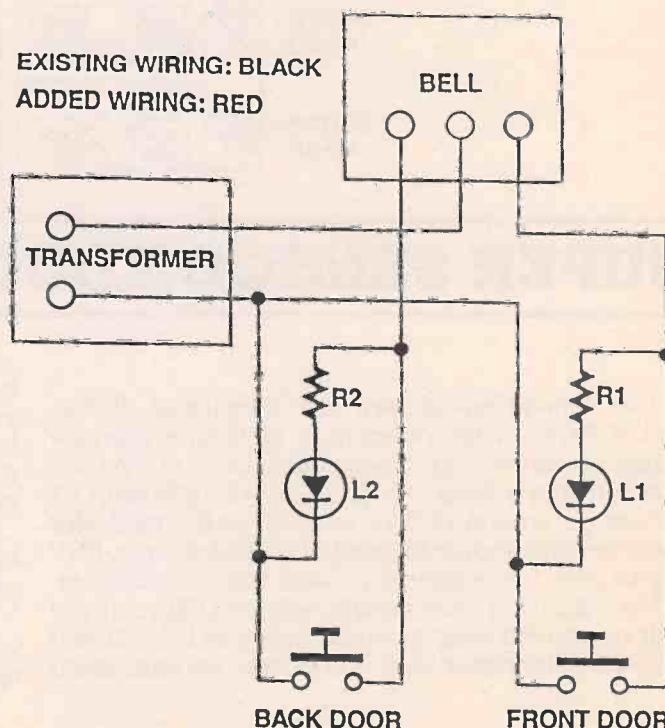

A WELL-GROUNDED GROUND

Grounds are often needed, that is, grounds to earth. Most radio antennas, and lightning arrestors require a good ground.

The main reason for grounds is lightning. Any metal, such as an outside antenna or power wiring is susceptible to lightning strikes.

Protecting against such is the function of a good ground.

Following are some ways to enhance the effectiveness of a ground.

Since the purpose of a ground is to convey energy to earth, it stands to reason that the larger area of metal to earth connection you have, the better. Here are some suggestions:

1. Use more than one ground rod. Multiple rods spread the energy and convey it into the earth better.
2. If your power goes through a pipe underground to your garage, tie that pipe to the ground. This pipe is usually a very good ground.
3. Chain link fence is grounded by its supports, tie into it for additional grounding.
4. Bury metal screen mesh flat and several feet down. Drive the ground rod through the middle of the

screening. The screen mesh will give more area in contact with the earth.

5. See figure one: This is for sand or really bad grounds.

Dig down five feet, and bury leaves and grass clippings, newspaper, hay, and small sticks a foot deep, with three layers of screen mesh in the material. Cover with a foot of sand after thoroughly wetting the material.

Make another pad of mesh and organic material at the 3 foot level. Wet thoroughly and fill hole to surface level.

Drive two 8 foot ground rods into this about a foot apart and interconnect them.

If, in a really dry area, make a dripper with water pipe that drips one drop per second and install next to the ground rod. This will moisten the earth and help ground conductivity.

6. Always wire earth grounds with heavy wire. At least #6 stranded is minimum. Lightning is such high current that it can vaporize #14 wire easily.

Remember: a good ground could save your equipment, even your life.

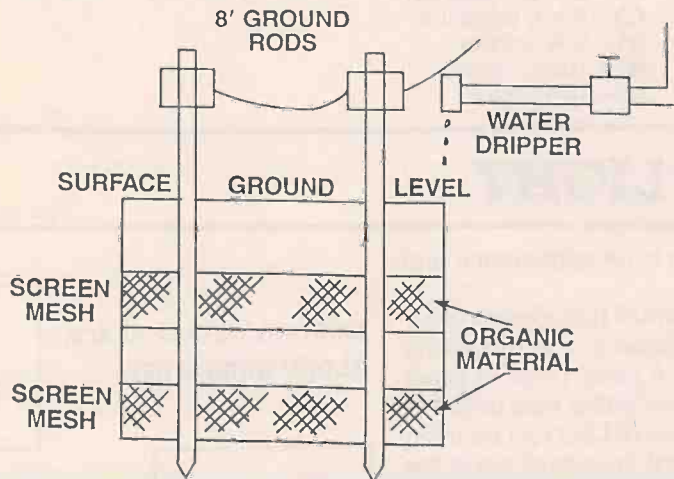

SUPER SEMICONDUCTOR TESTER

This little device will test your transistors, diodes, and SCRs, by making them work. NPN transistors are tested by connecting 1 to the collector, 2 to the base and 3 to the emitter. As you vary R2, the lamp L1 should go on and LED L2 goes off as the transistor turns on. This should be gradual with transistors. PNP transistors: 1 is emitter, 2 is base, and 3 is collector. SCRs will switch more rapidly, with the LED going out quickly and the lamp going on faster, as R2 is turned past the gate trigger level. 1 is Anode, 2 is gate, and 3

is Cathode. Triacs are tested like SCRs except that you also reverse the connections on 1 and 3, in order to test both sections. Failure of either lamp to light during the test, or wrong lamp or lamps lighting indicates a faulty device.

Diodes are connected between 1 and 3, with forward being 1 to anode, and 3 to Cathode. L1 will glow and L2 should go out.

Connections to test components should be made with alligator clips or some easily removable temporary "grab on" connectors. ■

SUPER SEMICONDUCTOR TESTER

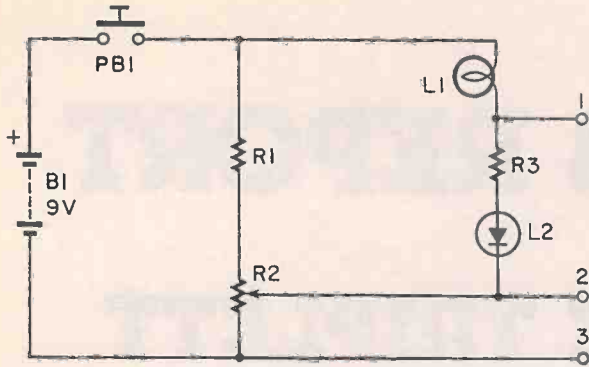

PARTS LIST FOR SUPER SEMICONDUCTOR TESTER

- R1—1000 ohm, ¼ Watt resistor
- R2—2 Megohm linear taper potentiometer
- R3—470 ohm, ¼ Watt resistor
- L1—12 volt miniature lamp
- L2—Green LED
- PB1—Normally open pushbutton (push to test) switch
- B1—9 volt battery

PHONE LINE PROTECTOR

The electronics industry has long recognized the danger to equipment that power line spikes and surges pose, as can be seen in the number of suppressors presently on the market. Recently, the danger to people as well as equipment on phone lines is being acknowledged by the introduction of suppressors for phone lines.

People have been killed while talking on the phone during lightning. That fact alone justifies the installation of one of these phone line surge suppressors.

We offer you the "LINE SHIELD," with its protection triad. This combination of gas gaps, MOVs, and fast acting semiconducting suppressors will absorb 300 Joules, which is quite a shot.

As you can see by the diagram, the suppression is

line to ground and line to line. All devices are rated for 110 volts or higher as there is over 200 volts AC on the phone line when in ring mode.

Construction of this unit is best in a metal box which is earth grounded.

Should a surge or spike enter the protector, the semiconductors fire first, then the Metal Oxide Varistors, or MOVs, and lastly, the gas gaps. ■

Response time is in the nanosecond range except for the gaps. Should the surge be so huge or long-lived, the fuse blows. LED X1 will light, indicating fuse failure.

This powerful protector could save your life!

FIGURE 1: LINE SHIELD PHONE LINE PROTECTOR

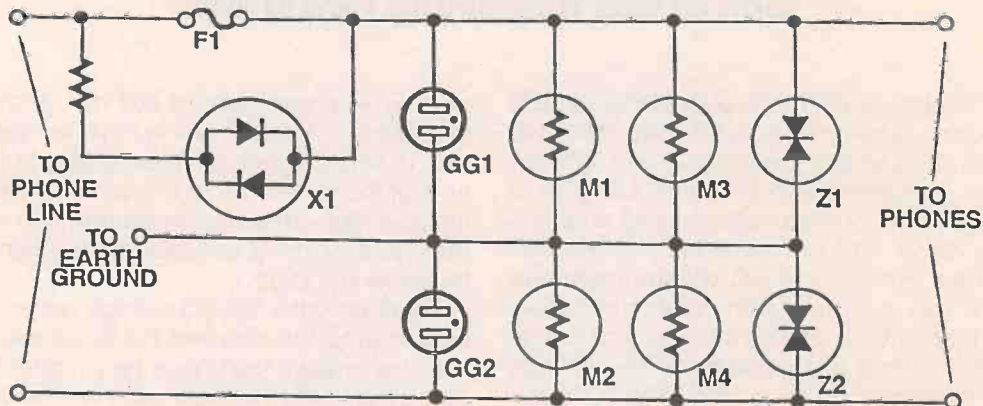

PARTS LIST: FOR THE PHONE LINE PROTECTOR

- R1—10K ohm, ½ watt resistor
 - X1—Bicolor LED
 - GG1, 2—C P Clare gas gaps, 145 volt or higher
 - M1, 2, 3, 4—20 Joule MOVs, 130 volts or higher
 - Z1, 2—1.5KE400 transorbs, or P2202AB Sidactors
- Unit should be wired with #18 wire or heavier.



LAB REPORT

THE TRIPLETT MODEL 2202 DMM

By
Elliot Jackson

Let's suppose you were in the market for a new digital multimeter. What criteria would influence your selection? Assuming you're a typical electronics enthusiast, it's likely that accuracy and reliability would be given top priority. At the same time, you'd probably want a meter that was nice looking and easy to use. Suppose I said that a handheld DMM with all these features exists—the new Triplet Model 2202—and that you could have it for less than \$50. Would you be interested? If the answer is yes, get ready to take a close look at this interesting new DMM.

First, some basic facts: The Triplet Model 2202 is an auto-zero, auto-polarity, 3-1/2 digit DMM that measures AC and DC voltage, AC and DC current, resistance, continuity, and transistor DC gain. It will also measure the forward voltage drop across a semiconductor diode, and test 9-volt and 1.5-volt batteries under load. For AC and DC voltage measurements, the unit has a 10-megohm input impedance. Readings are updated 2.5 times a second, and the results are displayed on a high-contrast, 0.77-inch-high LCD having a maximum count of 1999. The combination of large digits and high contrast makes it possible to read this display from a distance of 15 feet or more, which is nice if you need to monitor a reading while working on something else.

SPECIFICATIONS

It's time now to take a detailed look at the specs and features of the Model 2202. Refer to Table 1 as we go along. There are five DC voltage ranges, with 200 millivolts being the smallest full-scale reading, and 1000 volts the largest. Accuracy is specified as $\pm(0.5\%$

reading + 1 count) on the 200-mV range, and $\pm(0.8\%$ of reading + 1 count) on the other ranges. More expensive meters may sport better specs, but the cold hard truth of the matter is that unless you routinely design or service high-precision instrumentation, you are not likely to ever need accuracy better than that provided by the Model 2202.

There are also five AC voltage ranges, with 200 mV again being the smallest full-scale reading, and 750 volts the largest. Many economy-model DMMs cut corners by omitting the most sensitive AC voltage ranges. Thankfully, that's not the case here. Accuracy on the AC voltage ranges is specified as $\pm(1.2\%$ of reading + 3 counts)—a bit less accurate than the DC voltage ranges, but that is to be expected. Note that this level of accuracy is guaranteed only over the 40-500 Hz frequency range. This is typical behavior for handheld DMMs. To accurately measure higher-frequency AC signals, you must resort to a bench-style DMM, an oscilloscope, or a vacuum-tube voltmeter.

If you look at Table 1, you'll see that the DC and AC voltage ranges are protected against overloads as high

DCV

Range	Resolution	Accuracy	Input Impedance	Overload Protection
200mV	0.1mV	0.5% + 1	10M Ω	DC 500V AC 350V rms
2V	1mV			DC 1100V AC 800V rms
20V	10mV	0.8% + 1	10M Ω	DC 1100V AC 800V rms
200V	100mV			
1000V	1V			

ACV

Range	Resolution	Accuracy	Input Impedance	Overload Protection
200mV	0.1mV	1.2% + 3 (40Hz - 500Hz)	10MΩ	DC 500V AC 350V rms
2V	1mV			DC 1100V AC 800V rms
20V	10mV			
200V	100mV			
750V	1V			

DCA

Range	Resolution	Accuracy	Burden Voltage	Overload Protection
200μA	0.1μA	0.8% + 1	0.3V	0.5A Fuse & Diodes
2mA	1μA		0.3V	
20mA	10μA		0.3V	
200mA	100μA		0.3V	
10A	10mA	2% + 1	0.7V	

ACA

Range	Resolution	Accuracy	Burden Voltage	Overload Protection
200μA	0.1μA	1.2% + 3 (40Hz - 500Hz)	0.3V max	0.5A Fuse & Diodes
2mA	1μA		0.3V max	
20mA	10μA		0.3V max	
200mA	100μA		0.3V max	
10A	10mA	2% + 3	0.7V max	

Continuity Test (••)

Range	Resolution	Sound	Open Voltage	Overload Protection
••	1Ω	below 40Ω	below ± 2.8V	AC/DC 500V rms

Resistance (Ω)

Range	Resolution	Accuracy	Open Voltage	Overload Protection
200Ω	0.1Ω	1% + 2	± 2.8V	DC/AC 500V rms
2KΩ	1Ω		± 0.35V	
20KΩ	10Ω		0.35V	
200KΩ	100Ω		0.35V	
2MΩ	1KΩ	2% + 2	0.35V	
20MΩ	10KΩ		0.35V	

Diode Test

Range	Resolution	Test Current	Open Voltage	Overload Protection
→	1mV	1mA	± 2.8V	DC/AC 500V rms

Table 1 Electrical Specifications of the Triplet Model 2202.

as 1100 VDC or 800 VAC (rms). That's a notably excellent level of protection, and should be especially reassuring to anyone who works on high-voltage circuits. However, this meter is not intended for use on high-energy circuits such as power distribution transformers and bus bars. Such circuits are dangerous because they can supply tremendous amounts of current, and should they be inadvertently shorted by someone trying to make a measurement, an explosive arc could result. Thus, if you intend working on high-energy circuits, the Model 2202 is not for you. But for the everyday kinds of measurements that most of us make with a DMM, the Model 2202 will perform admirably.

DC and AC current are both measured in five ranges, with 200 microamps being the smallest full-scale reading, and 10 Amps the largest. AC readings are rms, but as you would expect, the meter actually responds to the average value of an AC signal (current or voltage). Once again, Triplet has wisely chosen not to cut corners by eliminating the most sensitive AC current ranges.

Resistance is measured in six ranges. The lowest range has a full-scale reading of 200 ohms, the highest a full-scale reading of 20 megohms. Note that the

open-circuit voltage on most ranges is just 0.35 V. The continuity test sounds a buzzer whenever the resistance between the test probes drops below 40 ohms. Unfortunately, the buzzer doesn't pack much of a punch, and the tightly sealed case only serves to further muffle the sound. The end result is that unless the room is silent and your ear is fairly close to the meter, you won't hear the sound of the buzzer.

The diode check sends a one-milliamp current through the device under test and displays the voltage developed across the p-n junction. Similarly, the meter will measure the DC gain (hFE) of an NPN or PNP transistor using a base current of about 10 microamps. And finally, 1.5-volt and 9-volt batteries can be tested under load, using built-in load resistances of 19 ohms and 1300 ohms, respectively. This provides a quick way of assessing the AA cells and 9-volt transistor batteries that power your projects.

Accuracy of the meter on its various voltage, current, and resistance ranges was verified by comparison against a Fluke 8842A, a high-accuracy bench-style DMM having specs at least an order of magnitude (10X) better than those of the Model 2202. Comparisons were made at multiple points spanning the vari-

ous ranges, and in every instance our sample of the Model 2202 proved to be well within spec at room temperature (70° F).



Figure 1 A swing-out stand supports the Model 2202 at a convenient viewing angle, and then folds flat when not in use.

ERGONOMICS AND AESTHETICS

Accuracy is, of course, not the sole determinant of a meter's success in the marketplace. Equally important are the ergonomic and aesthetic factors of its design, i.e., how easy it is to use, and how good it looks. On both counts, the Triplet 2202 comes up a winner. Evidence of good styling can be found in the photographs. Note the nicely rounded contours that give the meter an elegant, high-tech look, and the large, easy-to-read LCD display.

What you can't see in the photos, though, is how convenient the meter is to operate. One-hand operation is possible with the meter lying flat, thanks to rubber strips on the backside that prevent the case from moving as you turn the rotary range switch. There is no need to find a prop for better visibility, because the meter has a built-in stand (see Fig. 1) that swings out when needed. In addition, the unit measures just 143 x 74 x 38 mm, which, for those of you who still haven't gotten the hang of the metric system, is small enough to fit comfortably in a shirt pocket.

The case of the meter, while not waterproof, is nev-

ertheless rugged and well-sealed against dust and dirt. You may have noticed a pair of "ears" situated on the upper right and left sides of the case. These projections



Figure 2 A pair of test leads and a soft vinyl case with belt loop are among the accessories supplied with the meter.

not only serve as convenient finger grips, they also have grooves into which the test prods can be inserted for storage. It's kind of ingenious, though you probably won't use the feature very much.

The Model 2202 comes with a one-year warranty. Besides that, you get a vinyl carrying case with belt loop, a 9-volt battery, instructions, test leads, and a spare fuse.

FINAL IMPRESSIONS

After numerous hours of testing and use, the Triplet Model 2202 proved itself to be a capable and reliable performer with high-end looks and a bargain-basement price tag. In short, it's just the kind of instrument that a lot of *Electronics Handbook* readers will appreciate. The Model 2202 is available from Triplet dealers worldwide; however, if you can't find a source close to home, it is also available by mail from **Herbach & Rademan (18 Canal St., Bristol, PA, 19007-0122)**, and from **EIL Instruments Inc. (10946A Golden West Drive, Hunt Valley, MD, 21031-1320)**. At the time of this writing, both companies were selling the Model 2202 for \$47.00 plus postage and handling. ■

READING SCHEMATICS

To the neophyte electronics hobbyist and/or electronics project builder, reading an electronics schematic can sometimes be a little overwhelming, if not downright discouraging. Don't be disheartened. With a little effort and a lot of patience, you can one day interpret the multitude of symbols in the most complex schematic and read their significance to the overall project as you would read a novel.

Following are some of the more common symbols that you will find in the **ELECTRONICS HANDBOOK**: It behooves the hobbyist to become acquainted with these symbols and what they represent for future reference in your project building.

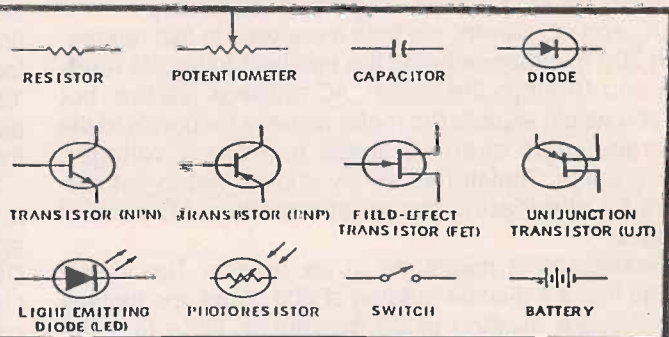

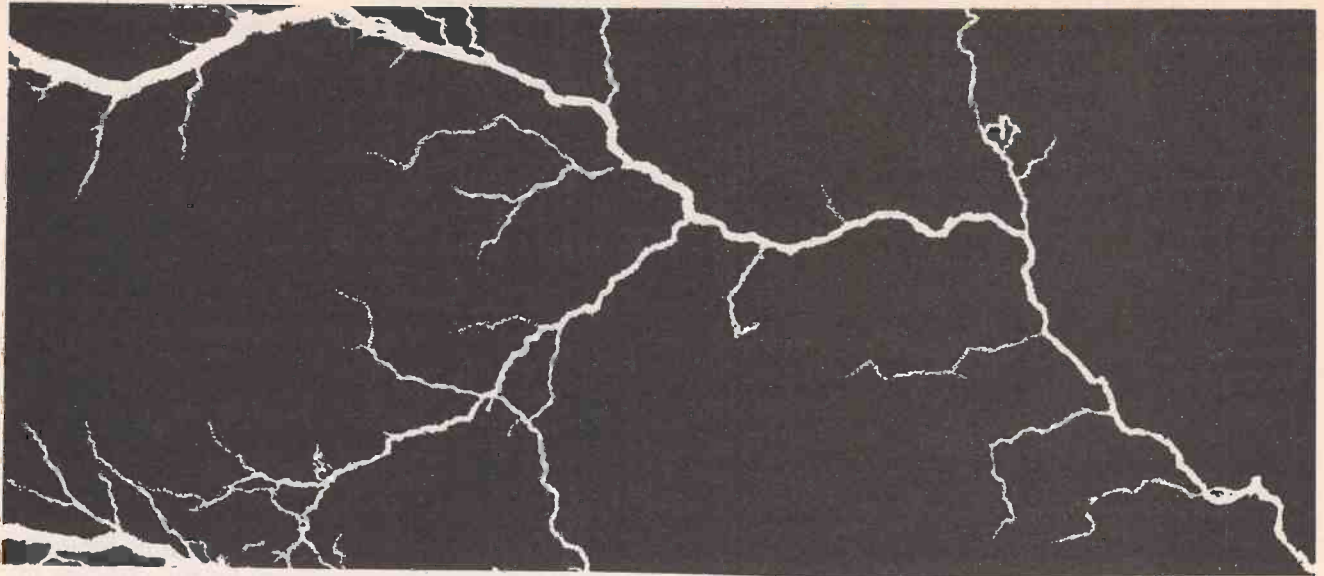

UNDERSTANDING ELECTRICITY

By Ron C. Johnson, C.E.T.

PART V

Welcome, again, to our series on basic electricity. In the past few issues we have talked about the very basic concepts of electric circuits and how to handle voltage, current, resistance and power, as well as some theory about circuit analysis using some simple mathematics. This time we'll delve back into the realm of subatomic particles to see the principles of how capacitors work. This is the area of electrostatics.

Take courage...Here we go again.

ELECTROSTATICS AND CAPACITANCE

We said back in the early stages of this series that "like" charges repel and "unlike" charges attract. Electrons are negatively charged particles while protons are positively charged. (Protons, you might remember, have much more mass and don't move around as easily as electrons.) This force of attraction is what holds electrons in their orbits around the nucleus of an atom. Actually, the attractive force balances the centrifugal force of the electron's orbit and the position is maintained.

I know it's a bit early for a formula, but let's go for it anyway. Just for information:

$$F = \frac{1}{4\pi\epsilon} \times \frac{Q_1 Q_2}{d^2}$$

This is called Coulomb's Law of Electrostatics, and all it really says is that there is a force, (F), exerted between two particles of a given charge, (Q_1 and Q_2), which are a distance apart, (d). The first part of the equation ($1/4\pi\epsilon$) relates to the material between the two charges, but we'll get to that later. The important thing about this is that the force is inversely proportional to the square of the distance between the charges.

(Just the kind of thing to bring up for light conversation at coffee break... Well, maybe not.)

Now let's visualize these two particles, fixed in space, with this force acting between them. (See Figure 1) We can imagine a field made up of lines of force,

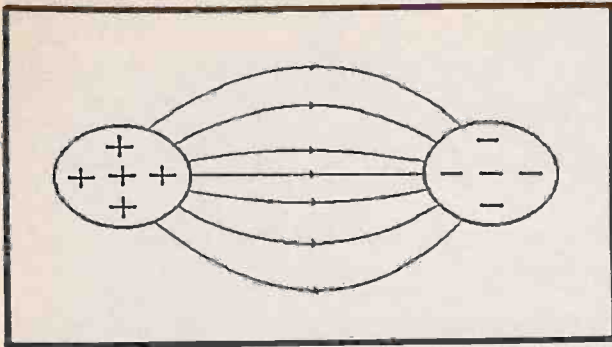

Figure 1. Two charged bodies producing an electric field.

between the two particles. These lines of force are oriented from positive charge to negative charge, always begin and end on a charged body, always enter or exit a body at a right angle and never cross. In many ways they are similar to magnetic lines of force from a magnet and, in fact are called electric flux, similar to magnetic flux. Electric flux is symbolized by, (ψ), the Greek letter psi and has the units, coulombs.

One important characteristic of this electric field is how dense, or close together, the lines of flux are compressed. This, as you might expect, is called flux density, D , and is given in coulombs per square meter. Another characteristic is the electric field strength, or intensity. Imagine, for a moment, that we put a one coulomb charged particle at some fixed point in space between the two charged particles. Electric field strength is determined by the force (which we talked about earlier) which would act on this charged particle at that point. Flux density and field strength may be helpful in understanding what is coming up shortly.

Okay, now we can start to talk application:

Consider two charged metal plates separated with vacuum between them. (Figure 2) One plate is positive, the other negative. This is the same situation as we had

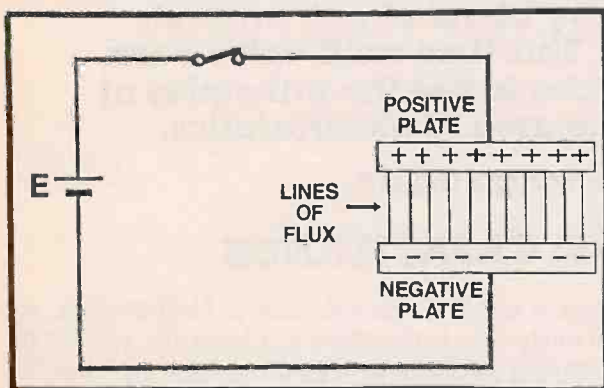

Figure 2. A simple capacitor.

with our imaginary charged particles and the same thing happens: An electric field is established between the two plates. The plates are close enough together that there is an attractive force between the positive charges on one and the negative (electrons) on the other. According to Coulomb's Law if we increase the amount of charge the force will increase. Of course the plates are fixed so the force cannot move them but the field intensity will increase. If the charge is increased,

the flux and thus the flux density will increase as well.

So what?

Well, what we have created is a way of storing charge, and in electronics we can use that for various purposes. We call the device that stores charge a capacitor. But there's a little more to a capacitor than what we have said.

The capacitor we looked at in Figure 2 stored charge on the plates which were of a given size at some distance apart. The more electrons we add to the negative plate, the more attraction there is to the positive plate, but all those electrons are the same charge and they repel each other. Eventually we run into a problem, essentially, with the force of repulsion between the like charges which are limited to a fixed area, and yet we may want more capacitance.

There are several ways to increase the value of capacitance:

First we can increase the area of the capacitor's plates. Then there is more room for the charges to spread out along its surface. Second, we can move the plates closer together. The closer the plates the stronger the electrostatic force drawing the charges together. Third, we can change the material between the plates.

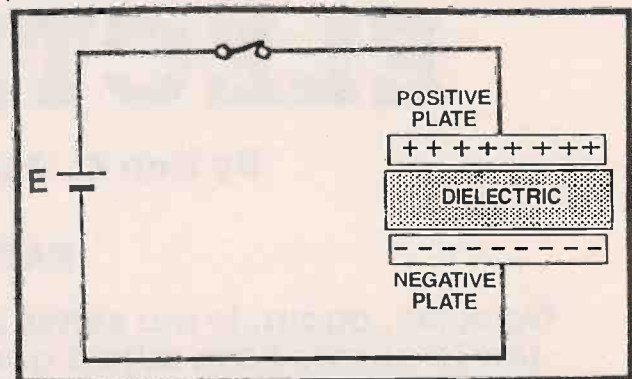

Figure 3. A capacitor with dielectric.

Remember, we said that part of Coulomb's Law related to the material between the charges. Various materials have characteristics which are related to their atomic structure which allow electric lines of flux to be established through them. This characteristic is called "permittivity," the characteristic that determines the dielectric constant of a material. When a material with a permittivity higher than vacuum (which is close to that of air) is placed between the capacitor plates, (Figure 3), there is a decrease in the amount of flux for the same amount of charge on the plates. This allows more charge to be stored on the plates to establish the same amount of flux. In addition to the benefits of the dielectric's permittivity, the dielectric also serves as an insulator which allows the plates to be brought much closer together without touching. Its insulating qualities also allow higher voltages to be impressed across the plates without arcing.

So the capacitance of a capacitor is determined by the permittivity of the dielectric, the area of the plates and the distance between them:

$$C = \epsilon \frac{A}{d}$$

Capacitance is symbolized by a C and is given in the units, Farads, F, but usually capacitors have values much smaller than a Farad and so you will see them specified in microFarads, nanoFarads, or picoFarads. Schematic symbols for capacitors are shown in Figure 4.

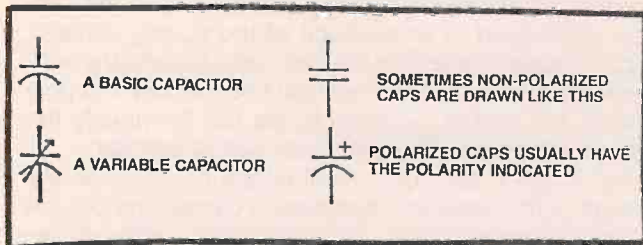

Figure 4. Schematic symbols for capacitors.

We said that using a dielectric between the plates, we could bring them closer together and impress higher voltages across the capacitor. Even so, there is a limit to the dielectric strength of any material and this is specified as the breakdown voltage of a capacitor.

Time to recap...What have we got so far?

Charged particles set up an electric field between them which is related to the amount of charge, distance apart and the material separating them. We can use this principle to build capacitors, which will store charge, (something we want to be able to do in electronics). We can make capacitors smaller in size and larger in value by using dielectric material between the charged plates to increase charge capacity and decrease distance between the plates.

Great! Let's look at some practical aspects of capacitors and then some applications.

Capacitors, the component, come in lots of different sizes and shapes and are made in several ways. (See Figure 5) One way to categorize them is polarized and non-polarized. Electrolytics and tantalums are two examples of polarized capacitors. Without going into the construction details, let's say that polarized capacitors have to be connected in the correct polarity to DC voltages because if not the dielectric may break down, in short, draw lots of current, and sometimes explode. (That demonstration always seems to generate a bit of excitement in my classroom.) Non-polarized are not a problem for polarity but are used for other applications than polarized capacitors.

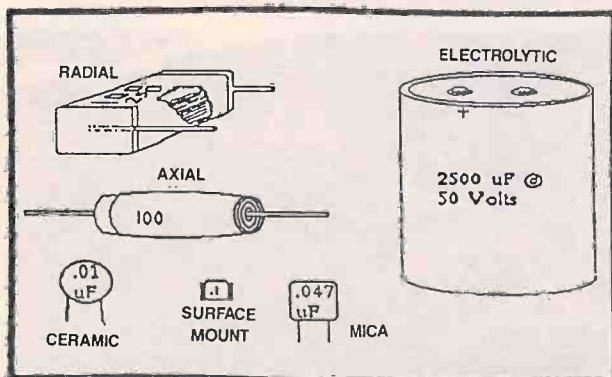

Figure 5. Various types of capacitors.

Another way of classifying capacitors might be their general usage. For instance, electrolytic capacitors (polarized, by the way) are usually in the large value range, say, 1 μF to 10,000 μF . The upper end of this range is usually power supply filter capacitors while the lower end may have various uses including timing capacitors. These caps have inherent energy losses which means they are not used for some applications. Capacitors ranging from .01 μF to 1 μF have lots of uses but some might be signal coupling caps and decoupling caps for logic circuits. Below .01 μF down to the pF ranges, there are also many uses including radio frequency coupling caps, tuning caps, etc. These smaller caps, from .1 μF down come in various types: mica, polystyrene, ceramic and others. If you are not familiar with some of these terms, not to worry. That will come with experience.

Capacitors can also be divided into types of construction or materials used. The larger capacitors are made by rolling thin layers of foil with insulating dielectric film between them. In electrolytics the dielectric is a paste manufactured in such a way to produce the insulating properties in a very thin profile. Again, if these caps are connected in the wrong polarity, the paste starts to conduct instead of insulate, with disastrous results.

Some capacitors use a number of discrete layers (plates or foil layers) with dielectric between them while others deposit conductive material on a dielectric using electrochemical processes. There are many shapes and sizes ranging from surface mount caps the size of a large pin head to large electrolytics the size of soup cans. (Even larger in some applications.)

There are two lead configurations: Axial and Radial. (See Figure 3). Axial lead capacitors have leads emerging from each end of a cylinder. Radial caps have both leads emerging from the same end or side of the cap. This is just a physical consideration for mounting purposes. It should be noted that surface mount configurations are being used more all the time in manufacturing although not many hobbyists are into it yet as it requires some fairly specialized equipment and skills. (Surface mount components do not have leads, just contacts to solder to. The device is precisely positioned on the printed circuit board and soldered directly to the pads.)

Well, let's finish up by checking out the DC circuit characteristics of capacitors. We'll leave the AC characteristics for another time.

First, in terms of DC, what do we use capacitors for? We know that they store charge but what can we accomplish with a device which stores charge?

The primary application of capacitors in DC is as a timing device. The voltage across a capacitor is proportional to the amount of charge in the cap and the value of capacitance. Because current flow is actually the rate of charge flowing past a given point, it takes time for charge to accumulate in the capacitor and hence, it takes time for the voltage across the cap to reach any given value. The larger the capacitor, the longer it takes for the cap to reach that voltage (if the current is kept the same.)

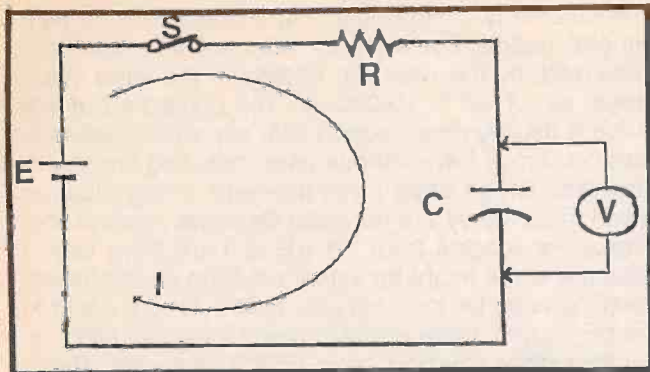

Figure 6. A series RC circuit.

Figure 6 shows a simple circuit with a voltage source, switch, series resistor and a capacitor. The thing to remember about RC (Resistor-Capacitor) circuits with DC is that they are time related. That is why the switch is there. We have to consider what happens when the switch is first closed and determine what happens over a period of time. In this case, when the switch is first closed, the voltage source, E, tries to impress a voltage across the resistor/capacitor series combination but, because there is no charge stored in the cap, there is no voltage across it, all is across the resistor. Any free electrons present are drawn out of the positive plate of the capacitor toward the positive side of the battery.

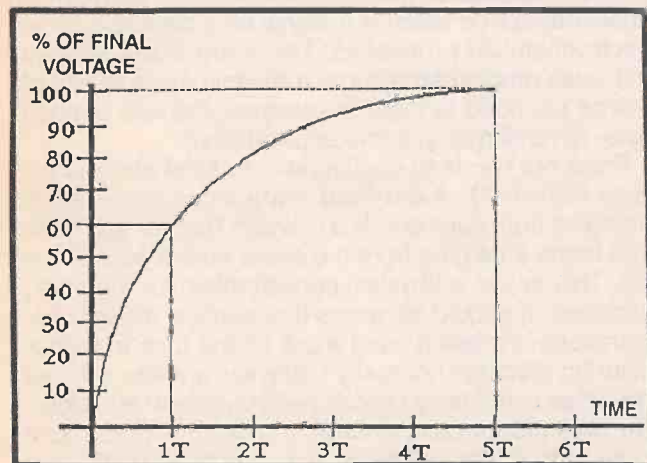

Figure 7. An RC time constant curve.

The battery, in turn, supplies electrons to the negative

side of the capacitor. The resistor limits the current, (rate of flow of the charge) and determines how fast the capacitor charges up (or increases in voltage). Also the available capacitance determines how fast the voltage rises.

Figure 7 shows the standard exponential charging curve of a capacitor where the vertical axis is the voltage, expressed in percentage of the supply voltage, and the horizontal axis is the time axis. Initially, the voltage rises quickly, but as it approaches the power supply voltage the rate of increase levels off. Eventually the voltage will be equal to the power supply voltage.

The curve is an exponential shape because as the voltage of the capacitor increases it causes the current in the loop to decrease. Why does that happen? Remember Kirchoff's Voltage Law? The voltage rises and drops around a loop equal zero. Initially there is no voltage across the cap; it is all dropped across the resistor. This means that the current will be determined by the resistor value. As the voltage across the cap increases, to keep Kirchoff honest, the voltage across the resistor decreases and thus the circuit current decreases. Another way to look at a cap is that when it is uncharged it looks like a short to DC but when it is fully charged it looks like an open circuit.

Back to our graph: The shape of the curve is always the same, but the time and the final voltage depend on the values of supply voltage, resistance and capacitance. Now, given the values of R and C, if we multiply them together we will have the time constant of that combination. The time constant, T, (τ) is the time required for the capacitor voltage to change from zero to 63% of its final voltage (the supply voltage in this case). We also know that by the end of 5 T, the capacitor will have attained virtually 100% of the final voltage.

Okay, so what does it all mean?

It means that by choosing the correct values for a resistor capacitor combination we can predict the voltage across the cap (or the resistor using Kirchoff) at any point in time and use that voltage for whatever purpose we want. A typical application which you will find in lots of hobbyist circuits is the 555 timer being used to supply a pulse, level or oscillator output. The 555 timer IC uses an RC time constant to set up the voltage waveforms used internally for its operation.

Well, all of that should be enough to get started on capacitors. There is lots more, especially when we get into AC but we'll cover that later. ■

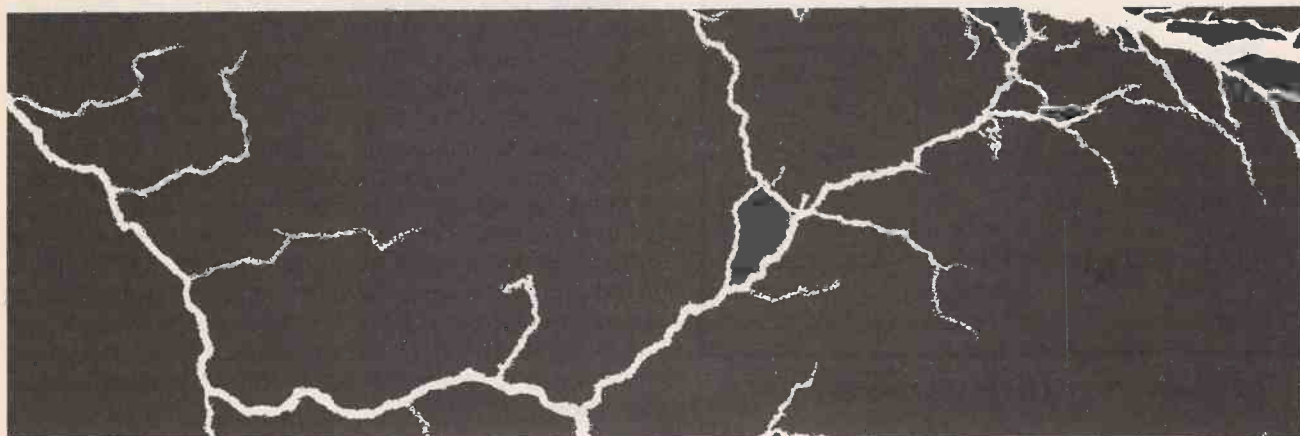

LED BATTERY AND



CONTINUITY TESTER

By Homer L. Davidson

Build this handy tester from budget parts!

Portable multi-band radios that sit around too long may not operate. Sometimes the small batteries may leak or become weak from an over extended shelf life. In either case (and other instances also) the batteries may not have enough life to power the small radio. But then, they might not be as weak as you think, or they may be serviceable. You either guess that the batteries are defective and insert new ones or to save some money, test them on this small LFD Battery and Continuity Tester. The Tester offers battery economy that's important to every budget-minded experimenter.

In fact, the LED Battery and Continuity Tester will check any battery up to twelve volts. Besides the portable radio, you can check those batteries in the garage door transmitter, flashlights, burglar alarms, and battery lanterns; or whatever. Although, the LED Battery Tester is not as accurate as a voltmeter, you still may save several dollars in new batteries by testing and replacing those dead or weak cells. yourself.

Not only does the Tester check those batteries, but one LED is also used on a continuity testing circuit. Here, you can check those defective appliances for open or grounded circuits. You may check the toaster for open elements, the can opener for an open motor winding, and test those screw-type house or car radio fuses for open elements. In fact, the continuity tester section of the Tester can check most electrical things around the house. You may have a 1000-ohm insulation leakage in an appliance, the Tester will show this on the continuity LED circuit.

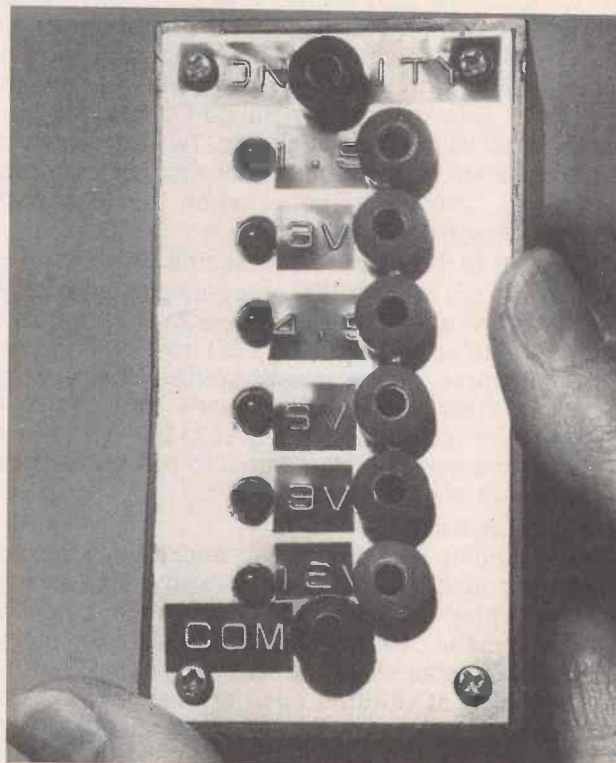

Figure 1. This is what the finished Tester should look like when your construction is completed. It is capable of checking batteries from 1.5 to 9 volts.

If possible, select LED's with a 1.5 forward voltage. Although, if not available, you may use the 1.6 or 1.75 voltage types. The test lights will be a little dimmer—but they still will do the job. The LED Battery and Continuity Tester is so accurate on the lower voltage ranges (1.5 to 4.5 volts), a 0.5-voltage change of the suspected battery will not light up the LED's.

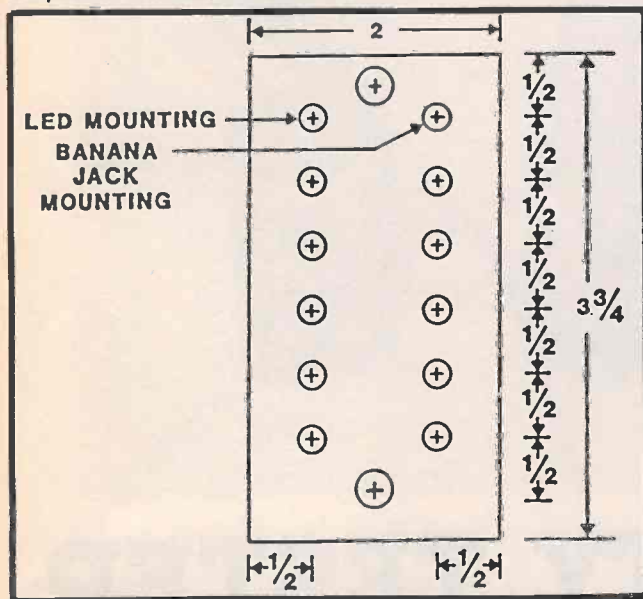

Figure 2. Cover the front panel with masking tape and mark out all holes to be drilled. It's best to drill these small holes in a block of wood to check for a correct fit before drilling the metal plate. All measurements are in inches.

Preparing the Panel

Use a 4x2 1/4-inch bakelite box (Radio-Shack 270-231) to house the LED Battery and Continuity Tester. Remove the front metal panel and drill six holes for banana jack (Fig. 2) Drill these holes just large enough so the plastic ridge (top of the jack) will fit inside the metal hole. This keeps the metal part of the jack from shorting against the metal template. Two additional for banana jack are centered at the top and bottom of the front panel. These are the common and continuity terminals mounting holes.

To the left of the six in-line holes drill six small holes to mount the LED's. The LED holes are just big enough to let the top tip of the LED to slip through and the bottom hub or lip will keep the LED from pulling clear through the hole. These holes should be close enough to each corresponding banana jack for easy sight voltage-reference reading. It's best to place a layer of masking tape over the front panel to prevent marring and to layout the front panel.

Mounting the Parts.

Start mounting the components after all eleven holes have been drilled. You may want to ream out or enlarge the banana plug holes with the pocket knife. Since the template is made of aluminum it's very easy to cut and shape. First, install all of the banana jacks. Place the soldering eye let towards each corresponding LED. Snug up each lock nut so the test jacks will not loosen up. You may want to later dab some cement on each nut and template to hold them in position. Clear nail polish is good for that purpose.

Now, mount the LED's to the front panel. Place each

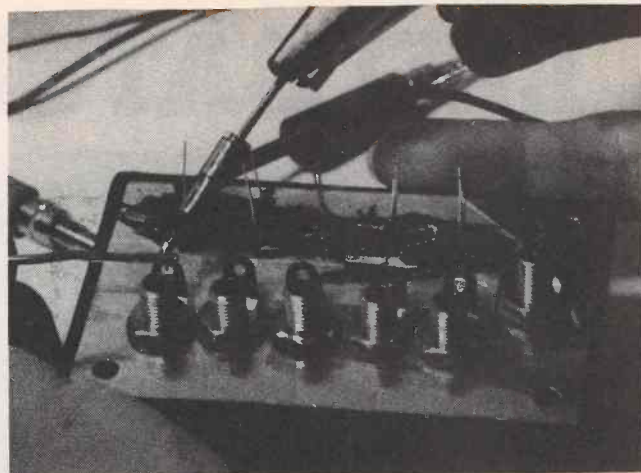

Soldering connections on the LED Battery and Continuity Tester with a low wattage soldering iron. Mount each corresponding resistor as it is soldered into the circuit.

LED through the holes with the collector lead towards the banana jack (red). Apply black rubber silicone cement over each LED and let it set up for two hours. You may want to entirely cover the red head area of the LED with the cement. Make sure the LED's are straight and upright after the cement has been applied. This will secure the LED's to the front cover and into position. After the cement has set up, the Tester can be completely wired as detailed in (Fig. 3).

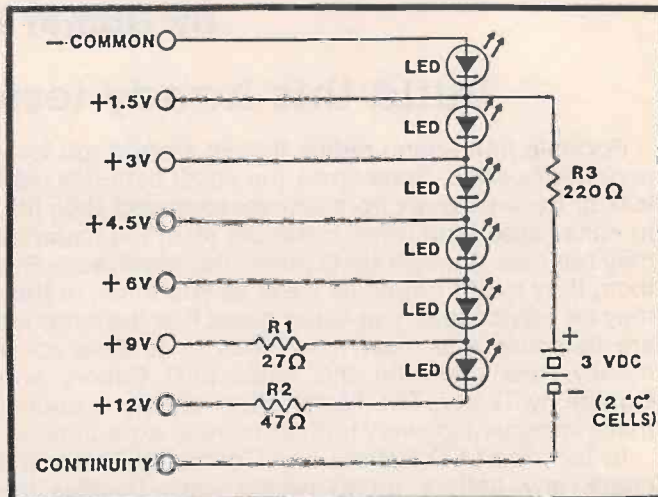

Figure 3. Here is the schematic wiring diagram showing the resistors are in series with each LED and banana jack. Now is the time to check out the wiring and eliminate any mistakes that you might have made.

Wiring the Unit

First, connect all the LED's in series. The common or anode terminal of the LED will connect directly to the common jack terminal. It's collector terminal will connect to the anode of the second LED, etc., until all LED's are wired in a series circuit. Run a bare piece of hookup wire between each series connection and corresponding banana jack. The 9-volt dropping resistor (R1) connects to the anode terminal of the last LED. Then connect a 47-ohm resistor to the collector terminal of the last LED and solder to the 12-volt jack. Always use a low-wattage soldering iron when soldering the small LED terminals.

Now, wire up the continuity jack at the top and bottom of the front panel. Connect the 3-volt dropping resistor in series with the collector terminal of the first LED. Wire the two "C" cells in series with resistor and continuity jack. Only the first LED is used in the continuity tests. Go over the wiring diagram, at least twice, and check each soldered connection (Fig. 3). You will find the small batteries fit nicely in the bottom of the bakelite case. See fig. 4. In fact, only a small piece of styrofoam is needed to keep the batteries from rattling around.

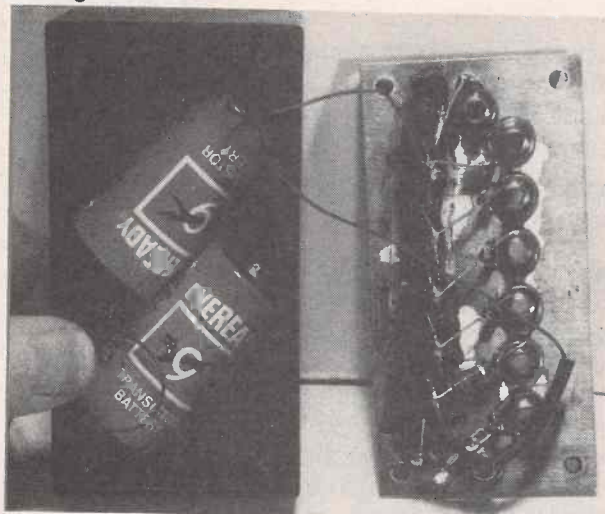

Figure 4. A peek inside the completed LED Battery and Continuity Tester reveals the two "C" cells in the bottom of the case.

Testing

After the LED Battery and Continuity Tester is completely wired, check each LED for correct voltage measurement. Plug in the black test lead to black common terminal and the red lead to the 1.5-volt scale.

Select a "C" or "D" battery to the test leads and see if the LED lights up at the 1.5 volt jack. Connect two of the same batteries in series to test the 3-volt scale. A 4.5-, 6- and 9-volt battery may be used to check out the remaining test jacks. Sometimes it's difficult to know the positive or negative terminal of some batteries, so quickly reverse the test leads when the voltage LED does not light up. Always, start at the highest voltage measurement, if the battery is not properly marked, to prevent damaging the LED's. All LED's will light up when checked in the 12-volt jack. Likewise, five of the LED's will light up on the 9-volt measurement.

Plug both test leads into the top and bottom middle jacks to check out the continuity tester. Simply touch the two test leads together and the first LED should light up. Now you can check the continuity of many electrical projects in the home. ■

PARTS LIST FOR LED BATTERY TESTER

- 6—Red banana jack (Radio-Shack 274-725 or equivalent)
- 2—Black banana jack (Radio-Shack 274-725 or equivalent)
- 6—1.5-volt light-emitting diode (LED) or 1.6-volt type (Radio-Shack 276-040 or equivalent)
- 2—Male banana solderless plug (Radio-Shack 274-721 or equivalent)
- 2—Solderless test plug (Radio-Shack 274-720 or equivalent)
- 1—Bakelite box, 4×2¼×2¼-inch (Radio-Shack 270-231 or equivalent)
- 2—"C" flashlight battery 1.5 volts
- R1—27-ohm, ½-Watt, 10% resistor
- R2—47-ohm, ½-Watt, 10% resistor
- R3—220-ohm, ½-Watt, 10% resistor
- Miscellaneous—Test lead lead wire, hookup wire, solder, decals, etc.

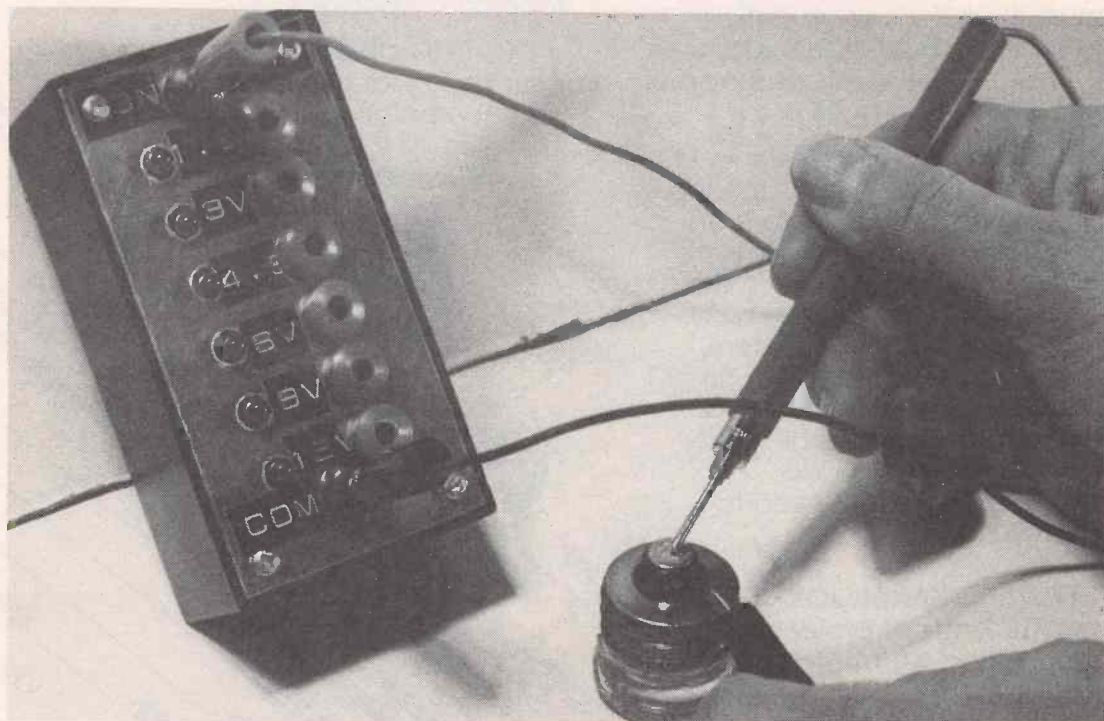

Figure 5. With this Continuity Tester, you can check your toaster for open elements, the can opener for an open motor winding or cord or you can even check those screw-type house fuses...demonstrated above.

THE FUN WAY TO LEARN ELECTRONICS

Get switched on

Lab Test ELECTRONICS HANDBOOK For Yourself

In case you're not all that familiar with us, we're not a publication for electrical engineers and other wizards. No way, ELECTRONICS HANDBOOK is expressly for people who like to build their own projects and gadgets — and maybe get a little knee-deep in tape, solder and wire clippings in the process.

In fact, we have a sneaking suspicion that our readers like us because they think we're just as bug-eyed and downright crazy over great new project ideas as they are. And I guess they're right!

ELECTRONICS HANDBOOK thinks of you who dig electronics as the last of a special breed. It's more than just the "do-it-yourself" angle — It's also the spirit of adventure. In this pre-packaged, deodorized world, building your own stereo system, shortwave receiver, darkroom timer or CB outfit is like constructing a fine-tuned little universe all your own. And when it all works perfectly — It really takes you to another world.

ELECTRONICS HANDBOOK knows the kinds of projects you like — and we bring 'em to you by the truckload!

Of course, we can't make you a master electrician overnight. But we can show you the fundamentals of repair plus maintenance tips.

IF YOU'RE NEW TO ELECTRONICS YOU GET A "BASIC COURSE"!

It gives you a complete, ground-floor lowdown on a variety of important electronic subjects. For example — Understanding Transistors...How Radio Receivers Pull in Signals...Cathode Ray Tubes Explained...How Capacitors Work...Using Magnetism in Electronics, and much, much more!

TRY A FEW ISSUES AND EVALUATE OUR...

- **HOW-TO-DO-IT HELP.** Tips and pointers that add up to money saved. For example — tuning up your tape player...all about radios ...whys and hows of turntables...care and feeding of speakers.

- **EXCITING DISCOVERIES.** Whatever your particular interest in electronics, you'll be entering a world of discovery in the pages of the ELECTRONICS HANDBOOK

ORDER TODAY!



"PLUG IN"

to the excitement and satisfaction of

ELECTRONICS HANDBOOK

- Yes. Enter my subscription — 4 issues only \$15.00 (Canada \$18.00...Foreign Postage add \$8.00...U.S. Funds)
- Payment enclosed. (Payable to: C&E Hobby Handbooks)

PLEASE PRINT
NAME: _____

ADDRESS: _____

CITY: _____

STATE: _____

ZIP: _____
V13

CONSTRUCTION QUICKIE

SOUND ACTIVATED SWITCH

Bill Axsen

With the clap of your hands, the Sound Activated Switch can turn almost any electrical appliance, such as a lamp, television, or radio on and off. The circuit has a range of approximately 20 feet and can be tailored to fit your individual needs. It is inexpensive to build and requires no hard-to-find parts. Though it will respond to any sound it is most sensitive to the noise generated from the clapping of your hands. As long as the Electret Microphone is not placed directly in front of the television or radio speaker, it will not be falsely triggered.

How it works

When a signal is received by the Electret Microphone, it is amplified by transistor Q1 and the signal is fed to transistor Q2 via transformer T1. Potentiometer R3 acts as a gain control for transistor Q1. The output signal from T1 is in the form of a D.C. pulse, and for this reason the secondary leads may

have to be reversed if operation of the circuit is erratic. Q2 is biased just before conduction, approximately .6 volts. When a signal is received from T1, Q2 is forced into conduction causing the one shot (pulse stretcher) IC1 to be triggered. IC1 stretches the signal, in this case for .1 of a second and feeds the output to IC2. The one shot prevents IC2 from being falsely triggered. Toggle flip flop IC2 is then forced to change states from high to low or low to high. The output from IC2 is then fed to Q3 which turns relay K1 on or off. Diode D1 protects Q3 from inductive spikes generated by relay K1 when it is energized.

Construction Tips

The sound activated switch can be constructed using almost any construction technique. However, placement of the Electret Microphone leads should be made as far away as possible from relay, K1 to prevent it from picking up stray pulses which may be

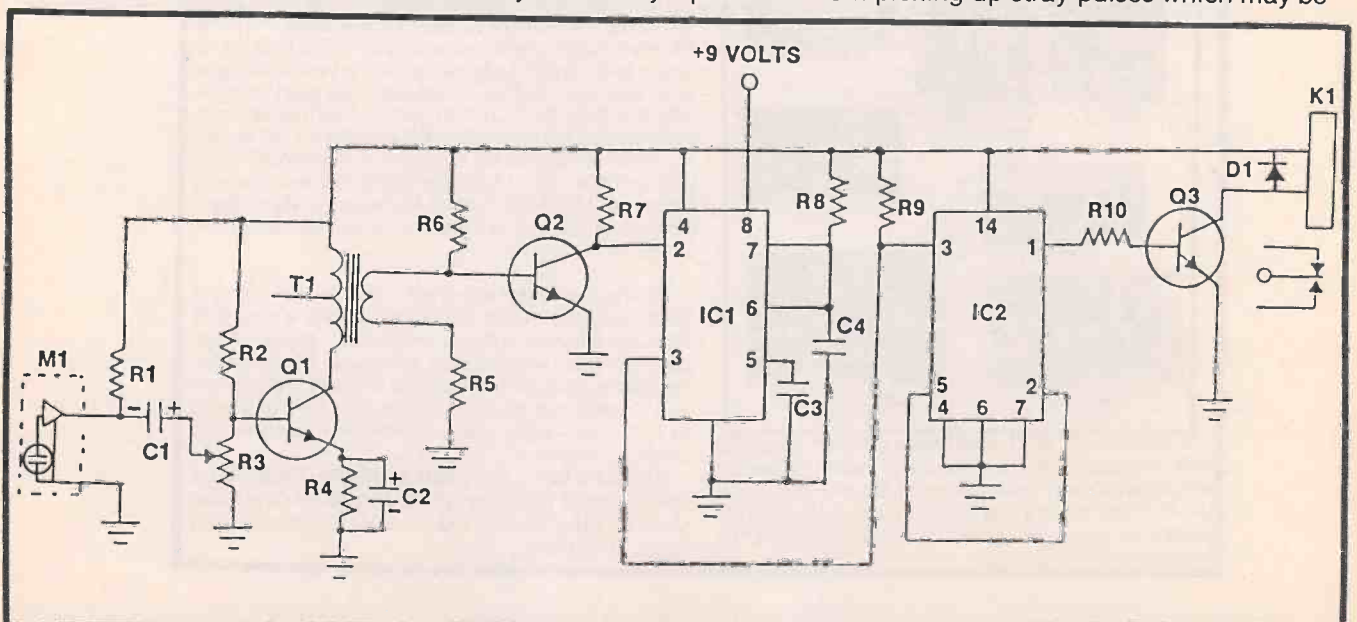



AUDIO TRACER STEREO LOAD BANK

By Holmer L. Davidson

Here is a small signal tracer that will locate audio problems in any product in the consumer electronic field. The signal tracer comes in handy to signal trace mono or stereo audio signals lost in the defective amplifier. Besides the lost signal, weak or distorted stages may be located with the signal tracer. The audio tracer is equipped with an audio output jack connecting just about any size PM speaker. Here, a plastic speaker enclosure did the trick.

When servicing high-powered transistors or IC amps, the output speaker connections should always be loaded down to prevent damage to the output components. Indirectly-coupled high powered amplifiers, a miss-match or balance, caused by a defective component, may provide DC voltage directly on the speaker terminals, damaging a good speaker. By placing high wattage resistors at the load, speaker damage is prevented.

Two, 60-watt wire wound resistors provide a 2 or 4 ohm stereo load up to 60 watts. Greater wattage or ohm resistance may be obtained by either switching in or adding another output jack in each stereo load. For instance, an 8 ohm load can be provided by adding two 2-ohm 60 watt resistors in series with each stereo channel and add another 8-ohm jack. The four 60 watt resistors used here had 2.5 ohm total resistance with a sliding metal tab.

Tracer Circuit

The circuit of the audio signal tracer consists of a 14 pin IC (LM 380) and an FET (MP 102) transistor. The FET transistor acts as the pre-amp stage and the power IC may produce 1.5 watts with a 15V DC source. Although, greater voltage (18-20 V DC) applied to the output IC may raise the wattage over 2 watts, plenty of volume is provided with 15 volts (Figure 1).

SW2 switches in the pre-amp circuit or for higher signal tracing output volume, the direct input 2 is switched in. Use input 2 when servicing high powered audio driver and output circuits, in the defective audio amplifier, where greater volume is produced. The volume is controlled by either input jack with R5. The audio output may drive up to 6 to 10 inch PM speakers without any problems.

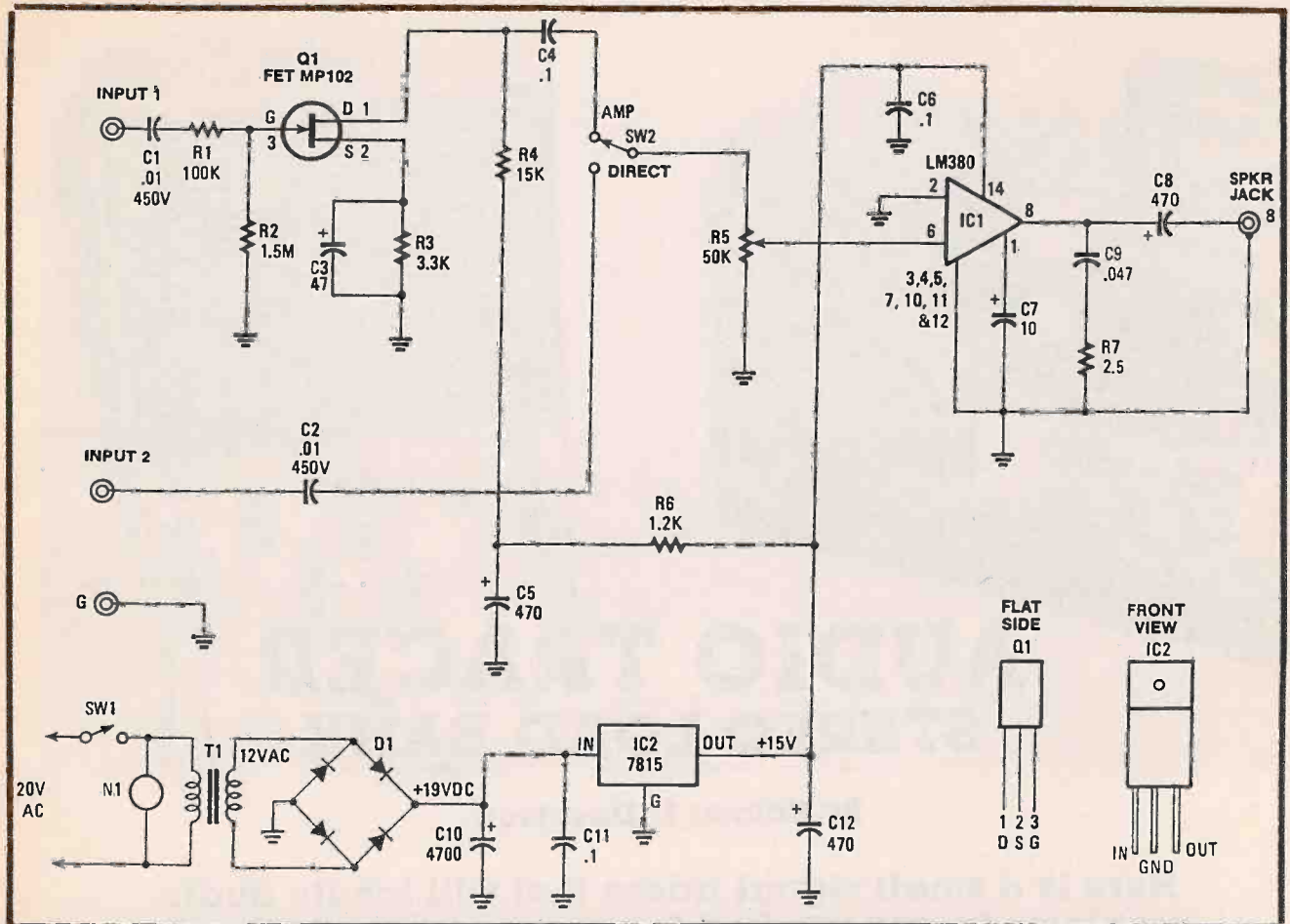

Figure 1. The signal tracer circuit is quite simple with an FET pre-amp, transistor and IC power amp, up to 1.5 watts.

Since 15 volts were needed to drive the LM 380 IC component, power is derived from a 15 volt regulated power supply instead of batteries. T1 can have a secondary of 12 to 18 volts AC at 1 or 2 amps. The bridge rectifier (DC) provides 19 volts DC with a 12 volt AC secondary winding. C10 provides adequate filtering with IC2 voltage regulator. A voltage decoupling capacitor C5 and resistor R6 provide filtering and isolation for the audio FET. N1 indicates the signal trace is in operation.

Board Preparation

Cut a piece 2×6 inches of copper clad PC board from a larger piece. Lay out the PC wiring as shown in Figure 2. The common ground wiring should be a little larger than the rest of the PC wiring. Keep the audio output IC (LM 380) at one end and the input circuits at the other (Q1). Place the bridge rectifier and transformer connections, in the middle, at the back side of the PC board.

All PC wiring connections, wiring and IC pin connections are taken from regular PC wiring symbols. Make sure all wiring is complete. It's best to overlap the PC wiring and square it up with a razor blade. Rub down each wiring connection. Re-check with the PC board wiring to make sure none has been missed. It takes about 30 to 45 minutes to etch the board.

There are only two wire loops to make in the whole board. After all parts are mounted, make a bare wire loop, on top of board, to tie in pin 6 and the volume control center tap connections. Second tie is accomplished with an IC metal shield when soldered into place. Terminals 3, 4, 5, 7 are connected to terminals 10, 11 and 12 with heat sink tabs. Double-check all IC terminals so they are not touching. Use a hand magnifying glass, if necessary. Although, the layout of parts is not critical, keep input leads to the volume control and the input as short as possible. Lay out the front panel with the jacks close to the PC board.

Mounting Of Parts

The various components may be dropped into the respective holes and soldered into the PC board. Try to keep capacitors away from the heat sink by using a little longer leads or bend the bypass capacitors flat along the top of the board. Keep all connecting leads to the PC board as short as possible (Figure 3). Mount the PC board close to the input jacks and volume control. To prevent pickup hiss or hum, shield the input jacks up to the PC board terminals.

The power transformer (T1) is mounted off the PC board on the cabinet bottom panel. Twist the two AC switch leads running from the AC power cord. When mounting Q1 and IC components, check for correct

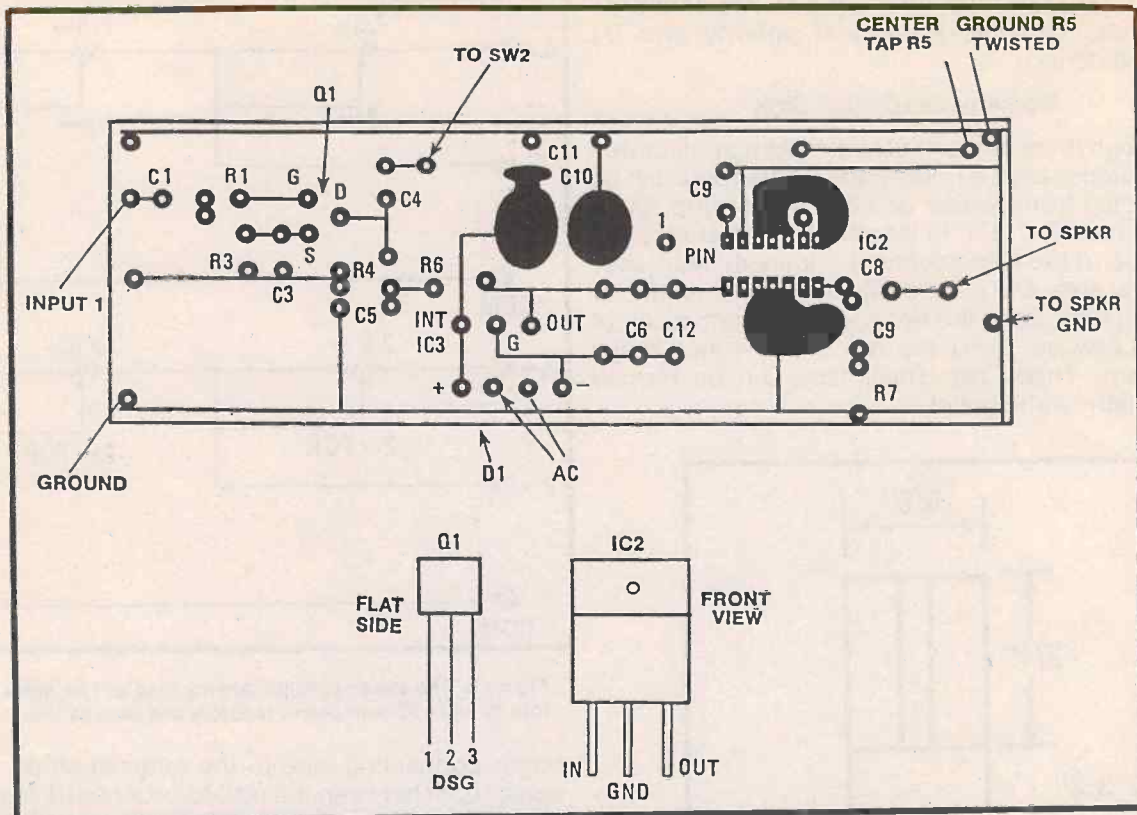

Figure 2. All signal tracing components are placed on a 2x6 inch PC board, except the power transformer, volume control and test jacks.

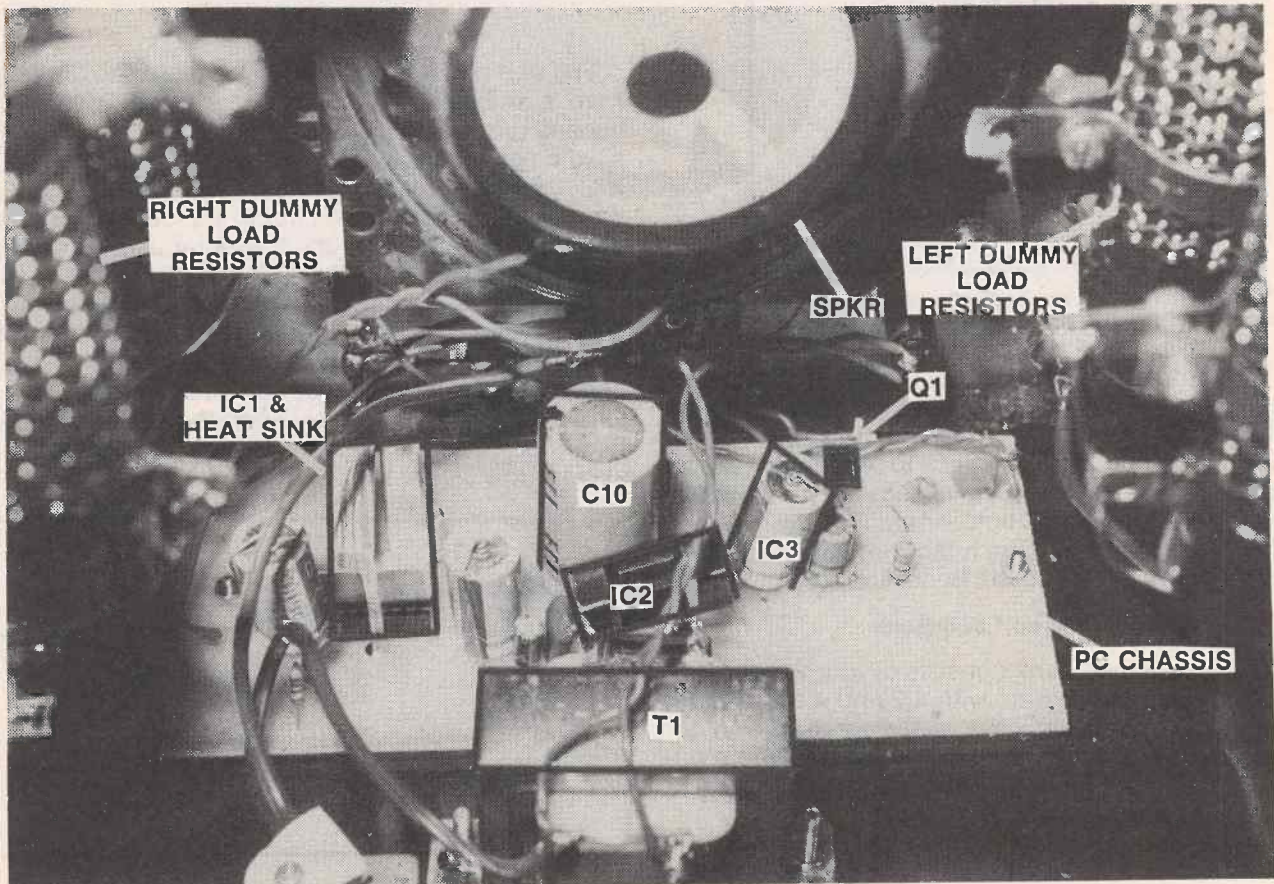

Figure 3. The components are mounted, soldered and ready to go. The tracer may be tested before fastening down inside the cabinet.

polarity and terminal connections. Re-check all electrolytic capacitors terminal polarity and D1 before soldering.

Homemade IC Heat Sink

Although there are several heat sinks manufactured for IC components, a homemade IC heat sink can be constructed from copper or a light metal strip. Cut a piece of metal $\frac{3}{8}$ " \times 1 $\frac{1}{8}$ " in length. The center area will lay on top of the IC component (Figure 4). Mark over the center area. Cut a $\frac{1}{8}$ inch strip down the middle for soldering tabs. Bend the two ends up to form a pair of wings. Likewise, bend the two small $\frac{1}{8}$ inch strips downward. These two small tabs can be formed underneath (wiring side).

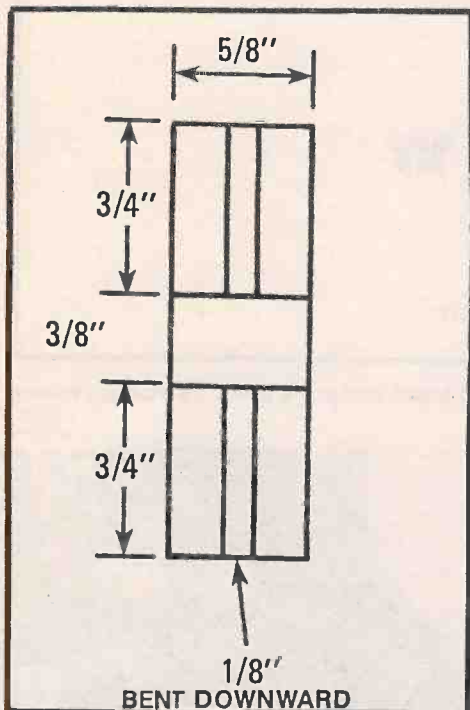

Figure 4. The homemade heat sink may be made from a small piece of copper or metal and formed with tin shears.

Mount the IC component (LM 380) after all wiring and parts mounting are double checked. Place the white dot of IC to pin #1 position. Insert the IC and push down until seated. Check to see that all pins are inserted in the correct socket. Place a layer of silicone grease on top of the IC before mounting the heat sink. Make sure the small $\frac{1}{8}$ inch tabs are cut to length for soldering on the PC board. Bend tabs over and solder.

Stereo Load Bank

The stereo load bank consists of four 2.5 ohm 60-watt wirewound resistors with a 2 and 4 ohm output load. These resistors have a sliding metal tab for selecting the correct resistance. Use four more 60-watt resistors for an 8 ohm load. Connect all resistors in a series arrangement (Figure 5).

Select a cabinet big enough to hold all of the resistors and the signal tracer. The power resistors were mounted on the terminal strips with number 14 or 22 hookup wire. The resistors will not droop with

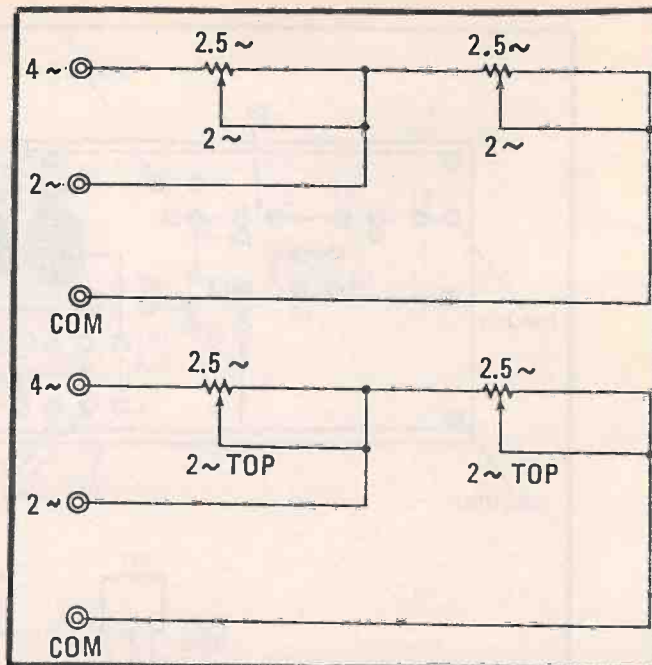

Figure 5. The stereo speaker dummy load can be made up of four or eight 60-watt power resistors and banana jacks.

larger connecting wire to the terminal strips. Leave some room between the resistors for heat dissipation. Banana jacks were used to couple the load to the front panel. Notice all resistors are connected in series in each channel with a different ohm tap.

Test Probes

The audio test probes may be purchased or made from a shielded alligator clip, test probe and male banana plugs. At least the common test lead should have a banana plug and insulated alligator clip while the other may be a regular test probe. When clipping the signal tracer into the circuit, standard hook clips are ideal to connect to the transistor, capacitor and resistor leads on the PC board.

The audio signal tracer may be used to check the signal in the RF, oscillator and IF stages with an RF test probe (Figure 6). Simply place the small components in a probe type container with a shielded lead to the input terminal. Keep the shielded cable under 2 $\frac{1}{2}$ feet, if possible, to prevent hum pickup and also for low signal loss.

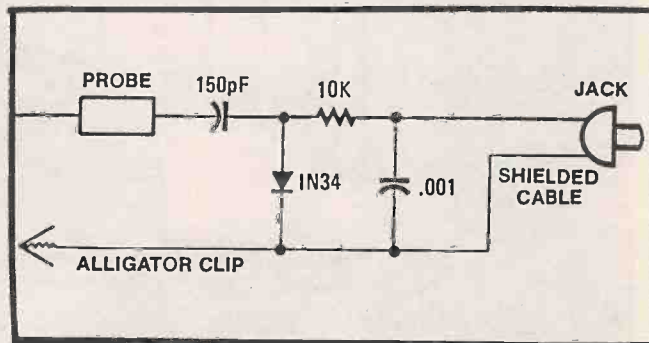

Figure 6. The RF test probe may be constructed with a few electronic parts and a container, with shielded leads.

Testing - Testing

Before fastening the signal tracer board to the bottom cabinet, give it a test. Clip on a small PM speaker and fire up the unit. You should hear a click in the speaker or a rush as the volume control is advanced. Just place a finger on the center tap of the volume control for hum pickup.

Check for approximately 15 volts at the output terminal (3) of IC2. Next, check for 19 volts at the positive terminal of C10. No voltage at either point, check for poor connections of D1 or improper polarity hookup. If the voltages are all low, check the current in series with the IC2 output terminal and B+ line. Excessive current drain indicates a defective component or one that is inserted wrong.

Remove IC1 from the socket and notice if the voltage is around 15 volts at pin 14. IC1 may be leaky or C8 and C10 may be connected backwards. If audio is found at input 2 and not at input 1, suspect defective Q1 or improper components. Check all soldered connections and correct component polarity.

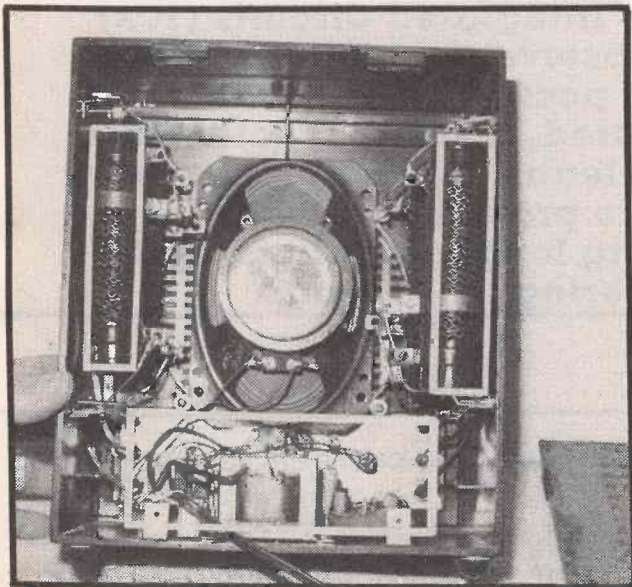

Figure 7. The finished product of signal tracer and dummy 60-watt audio load. The instrument panel was constructed of a double-sided PC board with PC lettering and several coats of clear matte spray.

Troubleshooting Audio Circuits

Give the signal tracer a good audio test after completion (Figure 7). The audio circuits of the defective amplifier can be checked by starting at the audio input stages and tracing the signal until it stops. Check the amplifier out in the combination stereo player with either signal from the radio, cassette player or at the phono input.

Weak stereo audio circuits may be signal-traced by comparing the normal signal of the good stage with the weak one. Then, take critical voltage, resistance, transistor and IC tests of that weak circuit. Defective bypass and/or coupling capacitors, leaky transistors, and burned bias resistors may cause weak audio.

Usually, distortion occurs in the audio output circuits. Check the audio output transistors for open and leaky conditions. A leaky coupling capacitor may cause distortion. Check for burned or open-bias resistors for audio output distortion. If both stereo circuits have distortion, suspect a leaky audio IC component.

The RF, oscillator and IF circuits may be signal traced with the RF probe plugged into input jack #1. Often, the gain must be quite high compared to the defective audio circuits. Keep the volume real low when signal tracing audio circuits. Start at the RF transistor stage and work towards the audio circuits to locate defective stages in the front end circuits.

Connect the dummy load to each stereo speaker terminals instead of the speaker for servicing. Use only one set of dummy loads when troubleshooting mono audio circuits. After connecting the dummy load, check the voltage at the output terminals. No DC voltage should be found at the speaker terminals. If DC voltage is measured, suspect audio output transistors, IC output, and burned bias resistors. ■

PARTS LIST

- Q1—MP102 FET transistor.
- IC1—LM380 2 watt audio amp.
- IC2—7815-15 volt voltage regulator.
- C1 & C2—.01 45 volt ceramic capacitor.
- C3—47 uF, 35 volt electrolytic capacitor.
- C4, C6 & C11—.1 uF, 100 volt ceramic capacitor.
- C5, C8, & C12—470 uF, 35 volt electrolytic capacitor.
- C7—10 uF, 35 volt electrolytic capacitor.
- C9—.047 uF, 100 volt capacitor.
- C10—4700 uF, 35 volt capacitor.
- C12—1 uF, 35 volt capacitor.
- R1—100 K, ¼ watt resistor.
- R2—1.5 Meg., ¼ watt resistor.
- R3—3.3 K, ¼ watt resistor.
- R4—15 K, ¼ watt resistor.
- R5—50 K, audio control.
- R6—1.8 K, ¼ watt resistor.
- R7—2.5 ohm, ¼ watt resistor.
- SW1—SPST switch on back of R5.
- SW2—SPDT toggle switch.
- D1—2 amp bridge rectifier.
- N1—Red 120 volt neon pilot light.
- T1—12 volt secondary 1 amp power transformer.
- J1, J2 & J3—RCA metal chassis jack.
- Cabinet—At least 10×7×4 inches to handle all components.
- 2—2.5 ohm, 60 watt power resistors with slide tap #80-182 Hosfelt Electronic Inc., \$1.99 each.
- 6—Plastic banana jacks.
- 4—Four lug terminal strips.
- Misc.—Rubber AC line cord, rubber grommet, PC board, nuts & bolts, etc.

WORKBENCH PROJECTS

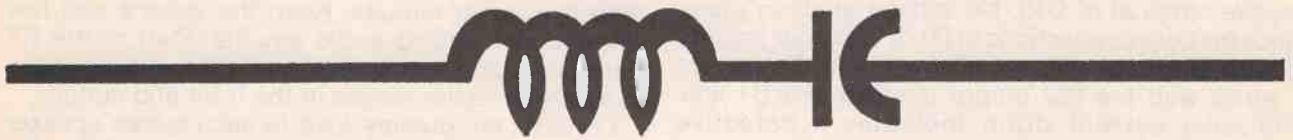

With any electronics assembly and/or project construction, it is important that you understand how the various parts of the circuit work together and the objective of each component before you start gathering the components together and assembling them. With any project that requires Integrated Circuits (ICs) or transistors, be careful to observe precautions about overheating their leads. If possible, use sockets designed for the IC chip required, instead of soldering directly into the chip's wire leads. If you don't have sockets available, be sure to protect the IC and/or transistor lead wires by using long-nose pliers as a "heat-sink" when soldering these leads.

LED CAR BRAKE LIGHT

Light Emitting Diodes, or LEDs are getting brighter as technology improves them. Now, there is an LED flashlight on the market, and some cars are using them. Why not build a custom brake light with your initials in LEDs?

Using this circuit you can do just that, as 50 sets of two LEDs and two resistors can be driven by this circuit. Only six sets are shown, but more can be added in parallel with the present six. You might want to use a magic marker to draw the letters first then mount the LEDs so they light up the letters. Or the LEDs could be installed in a pattern. A red lens over the circuit and a box around it is a good protection even though you will most probably mount it inside the rear window, bottom middle.

The unit connects to the wires that feed the filament which lights when the brake pedal is depressed.

For the car owner that has almost everything, a monogrammed brake light!

PARTS LIST FOR CAR BRAKE LIGHT

D1, D2 — 1N4007 Diodes
All resistors: 100 Ohms, 1 Watt
All LEDs: High Brightness Red

SCHEMATIC OF CAR BRAKE LIGHT

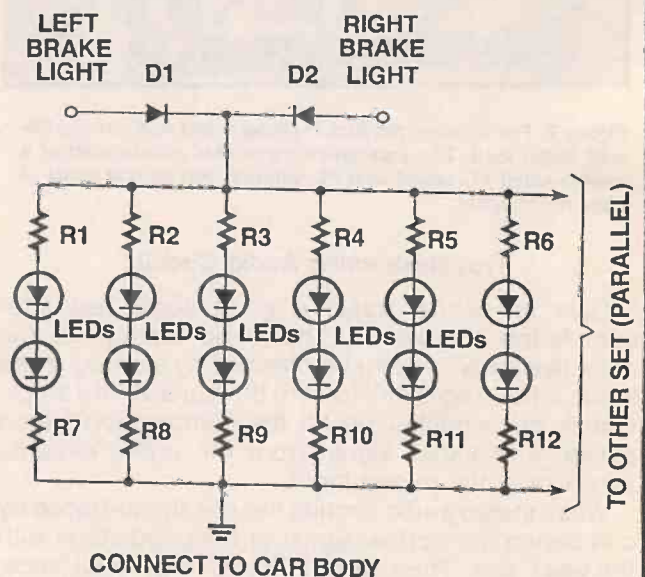

WRONG-WAY PROTECTION CONTROL SWITCH

Here's a good two-transistor toggle flip flop which drives a relay. This circuit is especially useful when you need a toggle switch with a memory. The relay changes only when switch S1 is closed. This protects against unintended or accidental operation.

The circuit is a bistable multivibrator with trigger-pulse steering. When power is applied, the order in which transistor Q1 or Q2 will conduct is random and is dependent on transistor gain and component values. If Q1 conducts first, a positive voltage is placed on the base of Q2 through R1. This will prevent Q2 from conducting until a positive trigger pulse is applied to the base of Q1. When S1 is closed, C3 will conduct heavily, causing a positive trigger pulse to be applied through diode CR1 to the base of Q1. With Q1 no longer conducting, a negative bias voltage will be present at the base of Q2, through resistors R1 and R2 causing Q2 to conduct. C1 in parallel with R1, reduces the amount of time that is required to turn Q2 on. The collector voltage at Q2 will drop to about 0.6 volts, preventing sufficient base current to be present at Q3, cutting it off and de-energizing relay K1. When S1 is

pressed again, Q2 will be cut off and the process will be repeated.

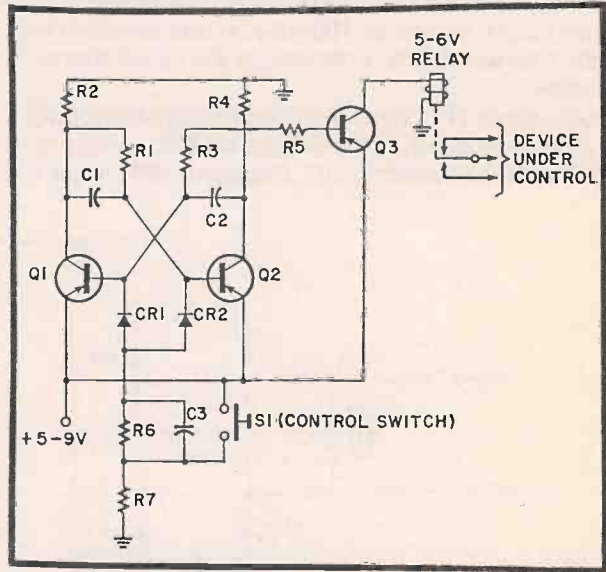

PARTS LIST FOR WRONG-WAY PROTECTION SWITCH

C1, C2— .01 uF capacitor, 15VDC
C3— .05 uF capacitor, 15VDC
R1, R3— 22,000 ohms resistor

R2, R4, R7— 1000 ohms resistor
R5, R6— 10,000 ohms resistor
Q1, Q2, Q3— general-purpose PNP transistors
S1— Normal-off single-throw switch
K1— 5 to 6 VDC relay coil to handle current of device being controlled

POWER MONITOR

How do you know when you have a power failure? Obviously, you say, the lights go out or some electrical appliance stops operating. It so happens that all power failures are not so easy to detect, since many power failures are either momentary or incomplete and we are not aware of them until too late. For certain types of electronic circuits, even a brief power failure can be disastrous. Control systems, computer systems, even your AC-powered digital clock or radio can go awry when the power is interrupted.

This simple little circuit will alert you when power is lost. For remote control, BZ1 can be replaced with a

dc coil relay of appropriate voltage and the relay contacts can transfer power to a remote indicator.

The LED, D1 and R3, the photocell are mounted together with black, electrical tape, facing each other, so that only light from the LED reflects on the photocell element. Since this circuit can monitor AC or DC voltages from 3 volts on up, RX is calculated to allow no more than 20 mA through the LED. Divide the voltage you are using by .020Amps and you will get the resistance required. To calculate the wattage of the Resistor Rx, multiply the voltage by .020 and double it. For example; for 5 volts, use a 250, 1/4 watt resistor. ■

PARTS LIST FOR THE POWER MONITOR

B1— 9-18 volts. For the specified buzzer, two 9V transistor batteries work quite well.
BZ1— Piezo Buzzer (Radio Shack #273-065A or Equiv.)
D1— LED (Radio Shack #276-066A or Equiv.)
Q1— 2N2222 or 2N3904 NPN transistor or Equiv.
R1— 560,000 ohm, 1/4 watt resistor.
R2— 12,000 ohm, 1/4 watt resistor.
R3— Photocell (Radio Shack #276-116A resistive photocell).
RX— See text.

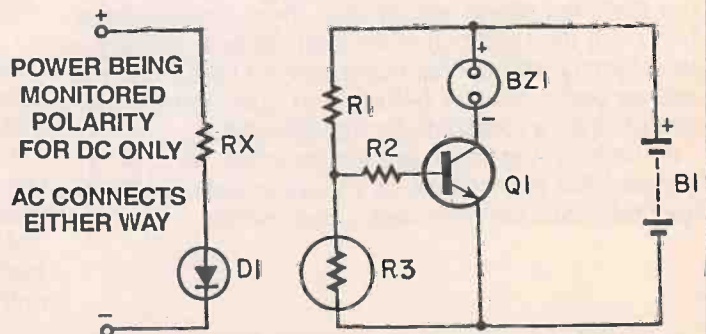

WALKMAN POWER SUPPLY

If you want to save some money on batteries to power your "Walkman", this project may be the answer. The power supply is based on the LM723, precision voltage regulator. All parts are available from your local Radio Shack for about \$15.00 total. The power supply has an output current of 100mA and has excellent regulation characteristics. Following is the circuit theory of operation:

Transformer (T1) steps the voltage down to 12.6 volts AC. This is applied to the bridge rectifier, which converts the AC to pulsating DC. Capacitor (C1) filters the

pulsating DC, providing approximately 16 volts DC to the LM723. Resistors (R1 & R2) set the output voltage to 3 volts DC. Resistor (R3) is used to provide minimum change in output voltage due to a temperature change. Capacitor (C2) provides compensation to the error amplifier. Short circuit Resistor (Rsc) limits the output current to 100mA. If more than 100mA of current flows, the Voltage Regulator will shut down and reduce the output voltage to zero volts. This is the short circuit protection, necessary to protect the power supply and the load.

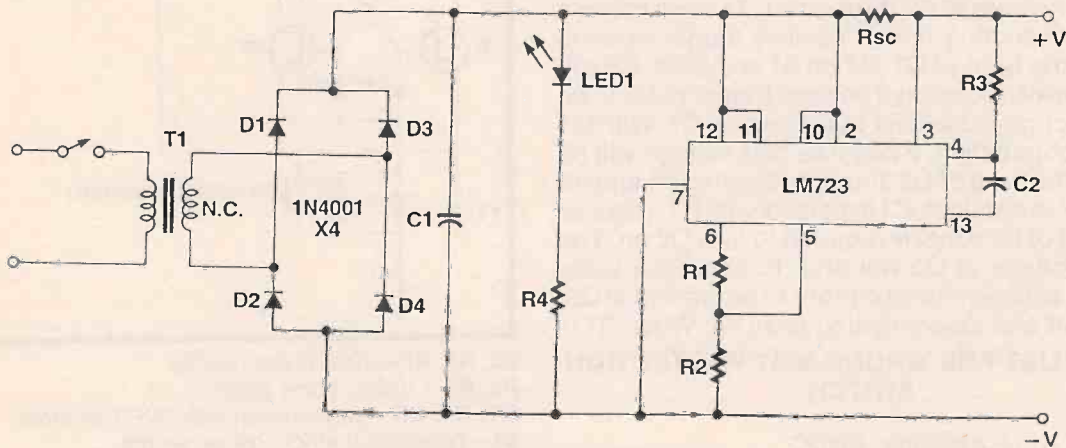

Schematic of Walkman Power Supply

PARTS LIST FOR THE WALKMAN POWER SUPPLY

- | | |
|--|---------------------------------------|
| T1—12.6, 300 mA Transformer | R1—3.9K ohm, 1/4W, 5% Resistor |
| D1-D4—1N4001 Rectifier Diodes | R2—3.0K ohm, 1/4W, 5% Resistor |
| C1—25V, 1000uF Electrolytic capacitor | R3—1.8K ohm, 1/4W, 5% Resistor |
| LED1—Light Emitting Diode (Any Color) | C—.001uF, 50V, Ceramic Disc Capacitor |
| R4—15K ohm, 1/4W, 5% Resistor | Rsc—5.6 ohm, 1/4W, 5% Resistor |
| LM723—2V-37V, Adj. Precision Voltage Regulator | |

BATTERY TEST ADAPTER

Testing batteries can be a useless exercise if the test is done with no load applied. Also, the correct type of tester can be expensive.

You do not need anything but a voltmeter, anything from a simple one to an expensive Digital unit will work. The test load allows you to read the no-load voltage, then push the right button for load reading. Usually, a good battery will not drop much from no-load voltage to voltage under load. A battery that does drop significantly will be a candidate for replacement.

In the following chart, are the switches and the battery load that they control, as well as an estimated voltage under load that indicates a bad battery.

SWITCH	BATTERY TESTED	MIN. VOLTAGE
S1	N, AAA, AA	1.3
S2	C, D	1.2
S3	LITHIUM CELLS	2.5
S4	6 VOLT	5.5
S5	9 VOLT	8.0
S6	12 VOLT	11.5

Naturally, the drop, under load, of a battery depends upon what kind of battery it is, since alkaline and rechargeable units will exhibit different characteristics than carbon-zinc. Try some good batteries of the specific type you use and record the readings. This will give you a standard for testing suspect batteries.

Also, always use the right load, and do not hit two switches at one time, as this may damage the battery or the test load.

BATTERY TEST ADAPTER

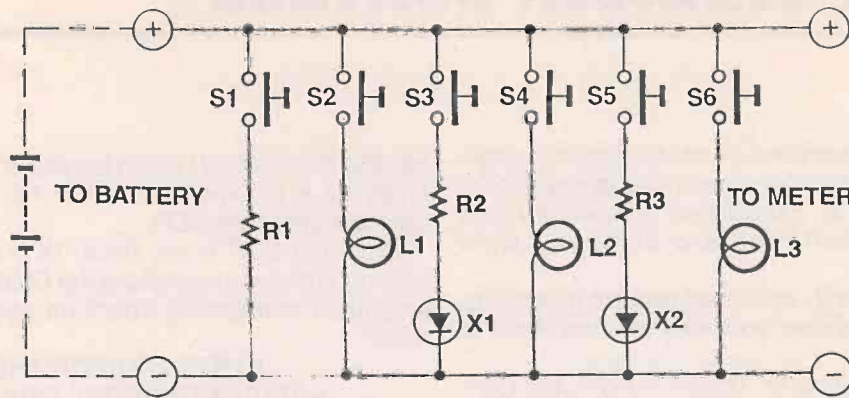

PARTS LIST FOR BATTERY TEST ADAPTER

- S1, 2, 3, 4, 5, 6 — normally open pushbuttons
- R1 — 100 ohm, 1 watt resistor
- R2 — 1K ohm
- R3 — 390 ohm
- L1 — #222 1 Amp
- L2 — #44 1 Amp
- L3 — 12 volt lamp no higher than 100mA
- X1, 2 — LEDs
- Misc: Box, Connectors, Wire

BICYCLE DIRECTION SIGNALS

Why not fix your bike up like a car? It could prevent an accident.

This circuit uses a 6 volt lantern battery that will power enough LEDs to make an arrow shape.

Oscillator IC1 sets the speed of the flash which is easily changed by changing C1. Raising the capacitance slows the flash rate and lowering it increases the flash rate.

The diagram shows one LED resistor string for each direction. You can use two for each, without changing the transistor Q1. Q1 can be any switching transistor that is NPN, and that will switch from the output of IC1.

Mount the battery and other parts in waterproof boxes on the bike. The wiring should be done only with wire suitable for outdoor use. You should mount the pushbuttons by the grips on the handlebars for ease of operation.

PARTS LIST FOR BICYCLE DIRECTION SIGNALS

- B1 — 6 Volt Battery
- S1 — SPST toggle switch
- IC1 — 1M 555V
- R1, 2 — 100K Ohm resistors, 1/4 watt
- R3 — 1K Ohm
- R4, 5, 7, 8 — 100 Ohm, 1 watt
- R6 — 10K Ohm
- C1 — 10Mfd, 25 WVDC capacitor
- Q1 — 2N2222 transistor
- L1, 2, 3, 4 — Red high brightness LEDs
- PB1, 2 — Normally open pushbuttons

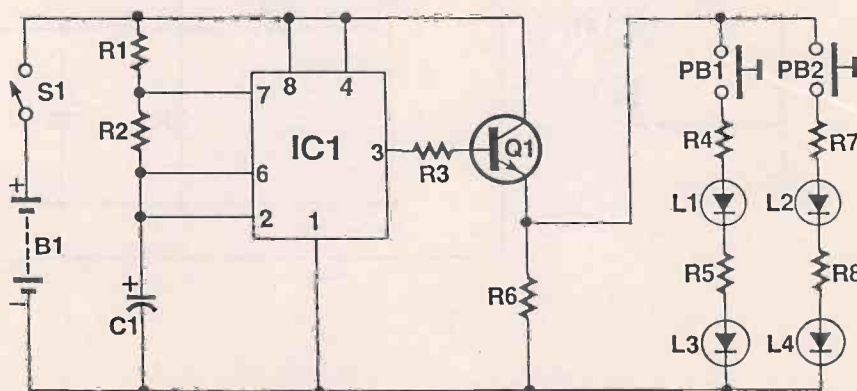

BATTERY CHARGER CONTROL

You can simplify the procedure of charging rechargeable batteries. Many chargers are only supposed to be on and charging for an established number of hours and many times batteries are damaged from overcharging.

This "Charger Control" circuit will prevent overcharging and is useful whenever you want a timed event to occur only one time.

The circuit has three parts: Timer, Charger, and Control. The Timer section is simply a 110 volt automatic timer, similar to those used to turn lamps on and off when the house is empty. Since the Timer determines the "on" and "off" time for charging and one rarely requires this kind of charge more than once a day, you can use the inexpensive version of the Timer, with one "on" and one "off" setting.

A short extension cord is used for connecting the control circuit to the Timer and Charger. This minimizes the connections having 110 volts potential. It also allows it to be used with other Timers and Chargers.

Operation of the circuit is simple. First, plug in the Timer, then turn on battery power (S1). This starts the charge cycle. While the Timer is on, Q2 is also on, pre-

venting the SCR (Q1) from turning on. When the Timer shuts off, at the end of the cycle, Q2 turns off, allowing gate current to the SCR.

Once the SCR is on, Relay (K1) is locked on, preventing power from reaching the Charger. Only by shutting off S1 and turning it back on again will the system reset.

PARTS LIST FOR THE BATTERY CHARGER CONTROL

- R1—390 ohms, All resistors 1/4 w 10%
- R2—47K ohms
- R3—1K ohms
- R4, 5, 6—10K ohms
- C1—330 Mfd, 25 WVDC, electrolytic
- C2—10 Mfd, 25 WVDC
- D1, 2—1N4004
- Q1 SCR—1 Amp, 50 PIV
- Q2—2N2222
- X1—Green LED
- X2—Neon lamp
- B1—9 Volt battery
- S1—SPST switch
- K1 Relay—SPDT contacts, 9 volt coil
- T1—110 to 12 volt transformer, @ .1 Amp or higher.
- Misc: Extension cord, wire, solder, box.

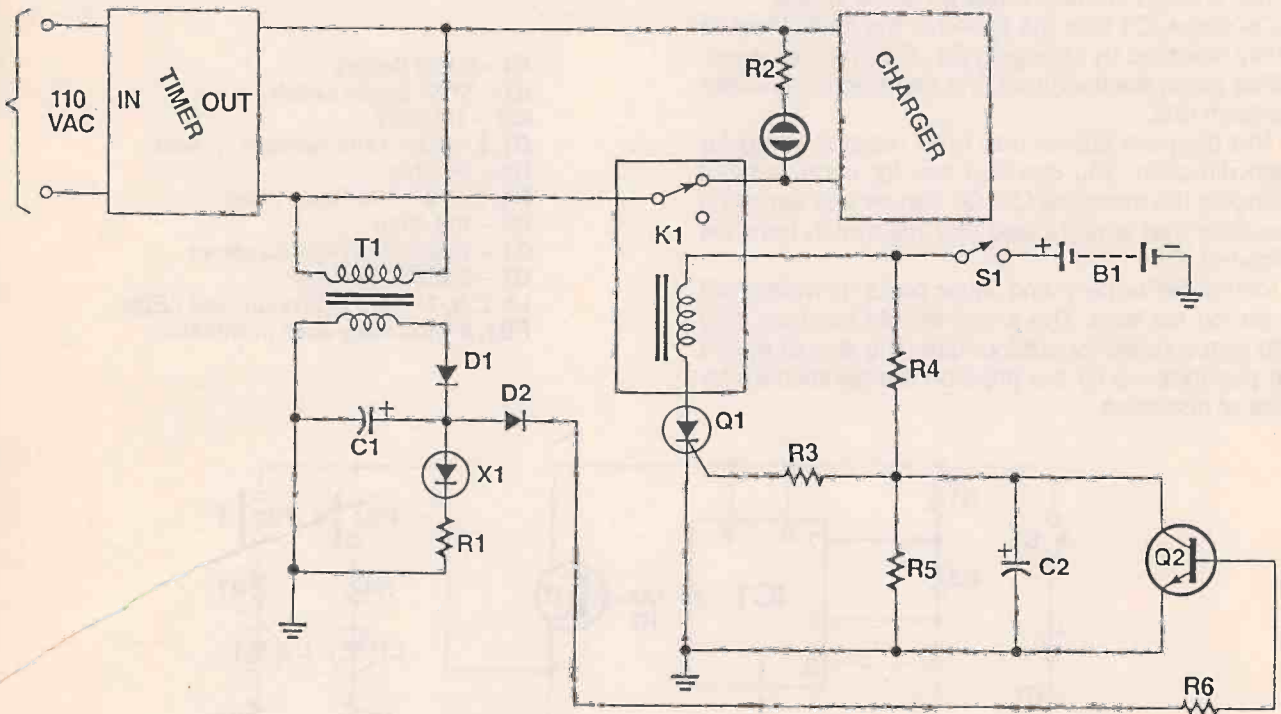



ANTIQUE RADIO CORNER

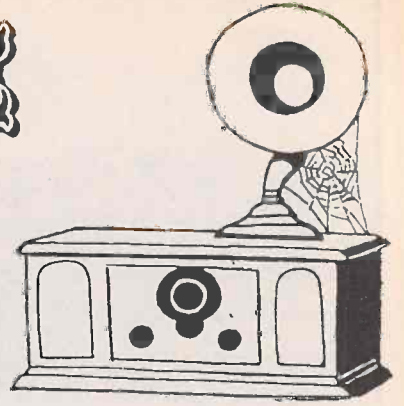

HOW TO BUILD A REJECTOR (QRM) CIRCUIT

By Lance Borden (WB5REX)

The most difficult problem facing crystal set DX'ers who live in or near the city is trying to hear weak DX stations while being bombarded by strong local stations. A very effective method of overcoming this problem is to build a rejector trap.

This circuit is connected, in series, between your antenna and your set. When it is tuned to an interfering station, it will absorb most of the signal at that frequency and allow you to hear the weak ones on either side of the frequency.

Several of these circuits can be hooked in series, if necessary, to reject several strong stations. I have three connected to my crystal set and plan to build a couple more because I am swamped with strong locals. This rejector trap also works well with other low selectivity sets such as antique regenerative and TRF receivers. I have even used it with a modern solid state receiver to attenuate a local 50 KW station on 740 KHZ in order to hear a DX station on 750 KHZ.

The following is a description of how to build this rejector trap using simple construction methods and easy-to-obtain parts: (Refer to the parts list, photos, and illustrations before beginning)

STEP 1:

Spray a cardboard toilet paper tube inside and out with one good coat of clear acrylic spray and let it dry. Use a razor blade to cut the form in-half, giving two forms, each 2 $\frac{1}{4}$ inches long.

STEP 2:

Punch two small holes $\frac{1}{4}$ inch from the end of the form and loop #30 wire through these twice to anchor the top end of this coil. Leave about 4 inches of lead at this anchor point.



PHOTO #1—Parts required to build the Rejector, including acrylic spray and double-sided mounting tape.

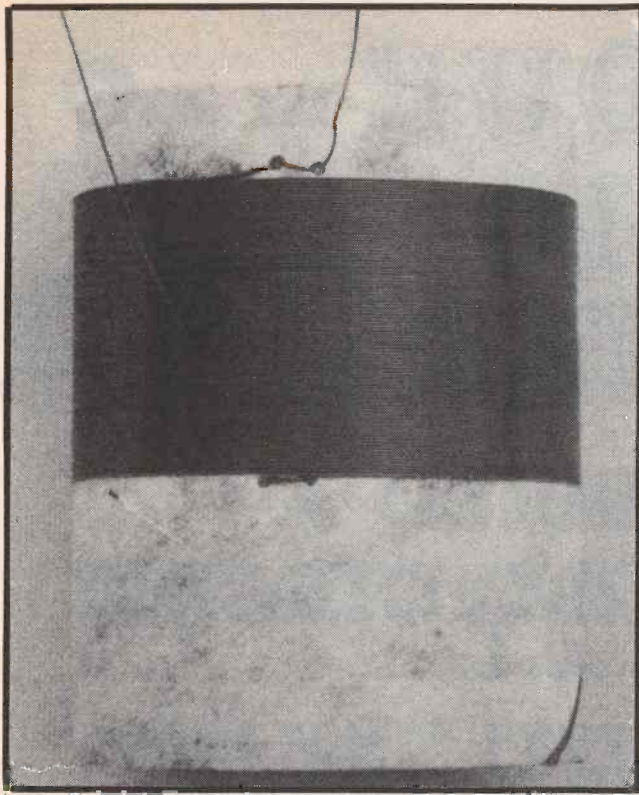

PHOTO #2—Coil form with first winding of #30 A.W.G. wire.

Wind 90 turns, close, but not overlapping, and punch two more holes to anchor the bottom end of this coil. The direction you choose to wind the coil does not matter at this point. Wind in the direction that you are most comfortable with. Leave about 4 inches of lead at this point too.

Spray the coil with one coat of clear acrylic and let it dry. (See photo #2)

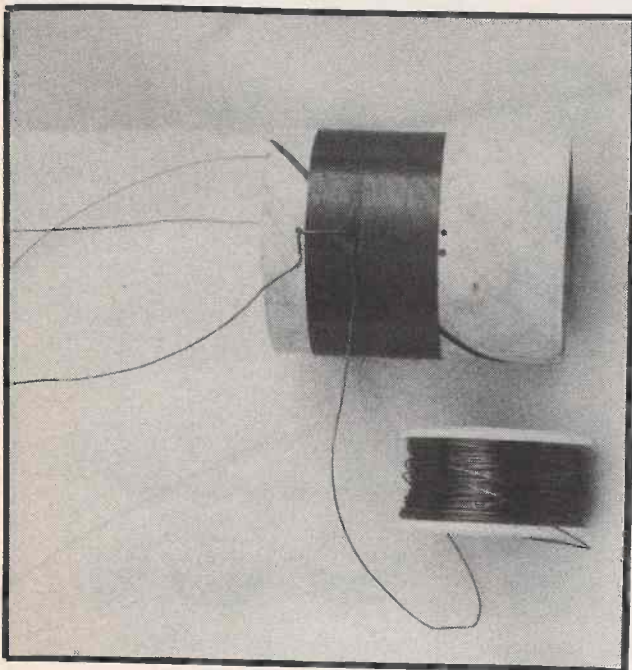

PHOTO #3—Anchoring the beginning of the second winding with Super-glue.

STEP 3:

Punch two holes on the opposite side of the first anchor point, at the top of the coil, and anchor the #26 wire, leaving a 4 inch lead.

Run this wire $\frac{3}{8}$ inch down the first coil and attach it with a small drop of superglue. Wind 12 turns over the first coil, in the same direction as that coil, close, but not overlapping, and attach this end with another small drop of superglue. Punch two more small holes opposite the bottom anchor point of the first coil and anchor this wire, the same as the others. Spray the finished coil with clear acrylic and let it dry. (See photos #3 and #4)

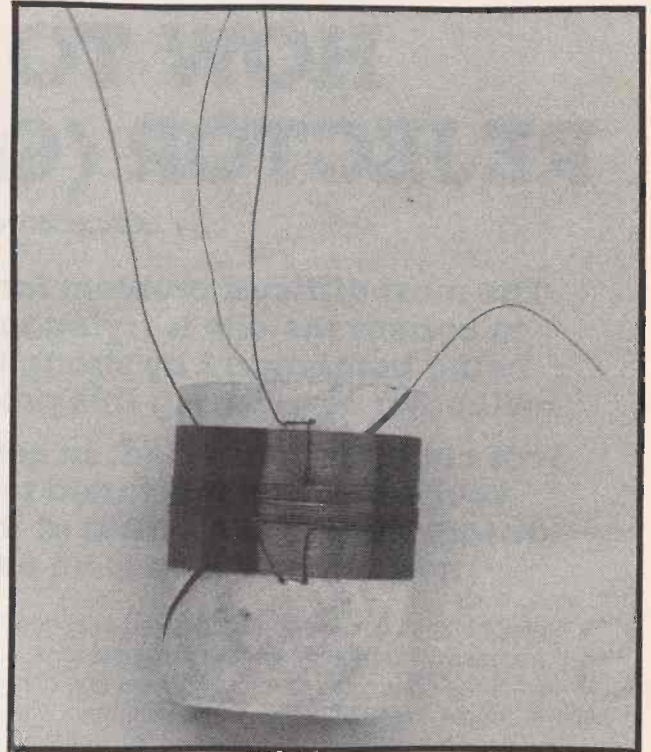
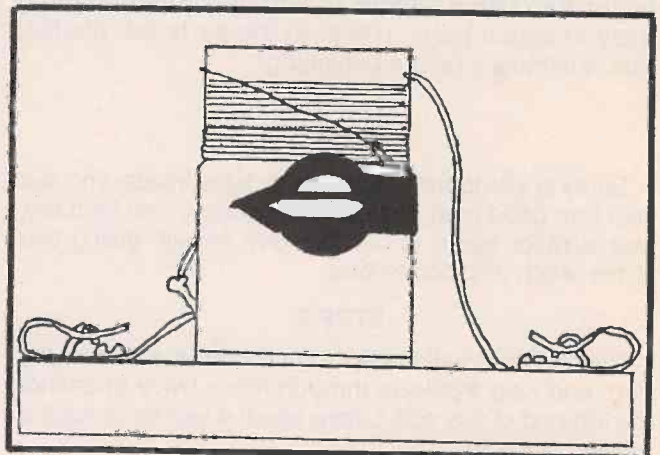

PHOTO #4—The completed coil.

STEP 4:

Spray the mounting board with three coats of clear acrylic, letting it dry between coats. The purpose of the



FRONT VIEW

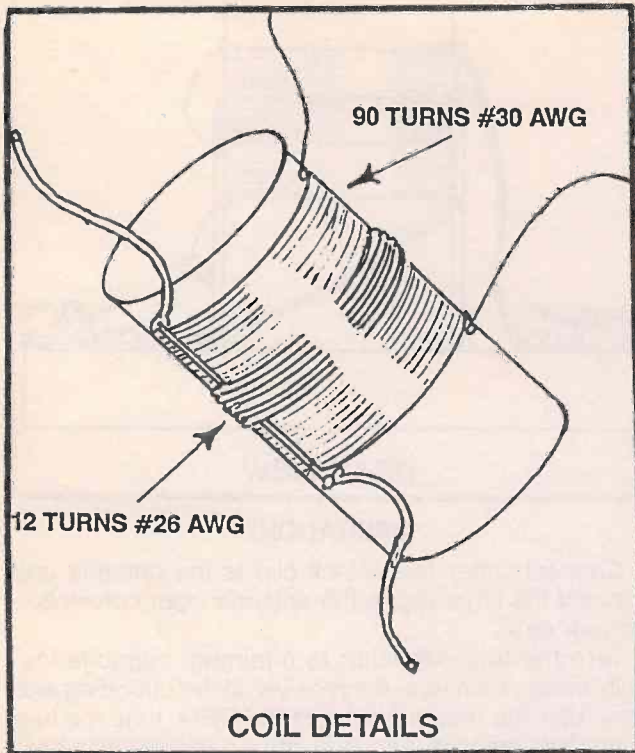

clear acrylic coating on the coil and board is to keep them from absorbing moisture which would decrease the "Q", or overall efficiency of the circuit. Cut some double-sided mounting tape to match the size of the tuning capacitor bottom and apply it to the mounting board as shown in the illustration and photos. Mount the tuning capacitor by placing it on the tape and pressing it down hard. Be careful not to bend the capacitor plates when doing this. Mount the coil, as shown, with superglue. Mount the fahnestock clips with wood screws, as shown. (See photos #5 and #6 and the illustration)

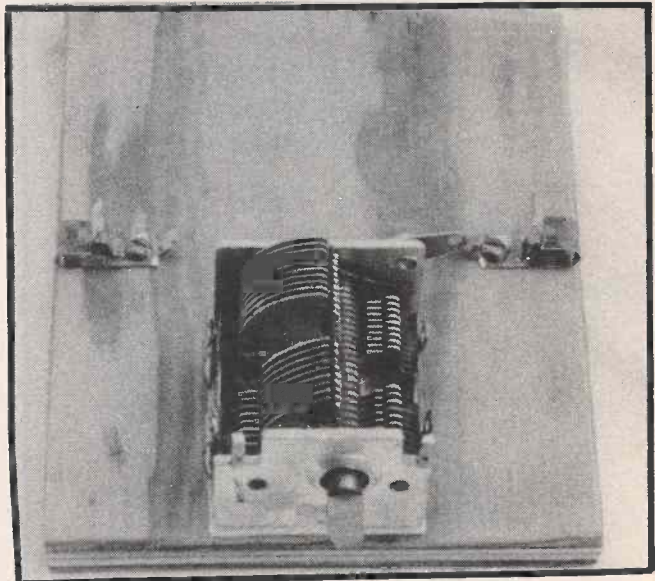

PHOTO #6-The mounting board with tuning capacitor and Fahnestock clips in place.

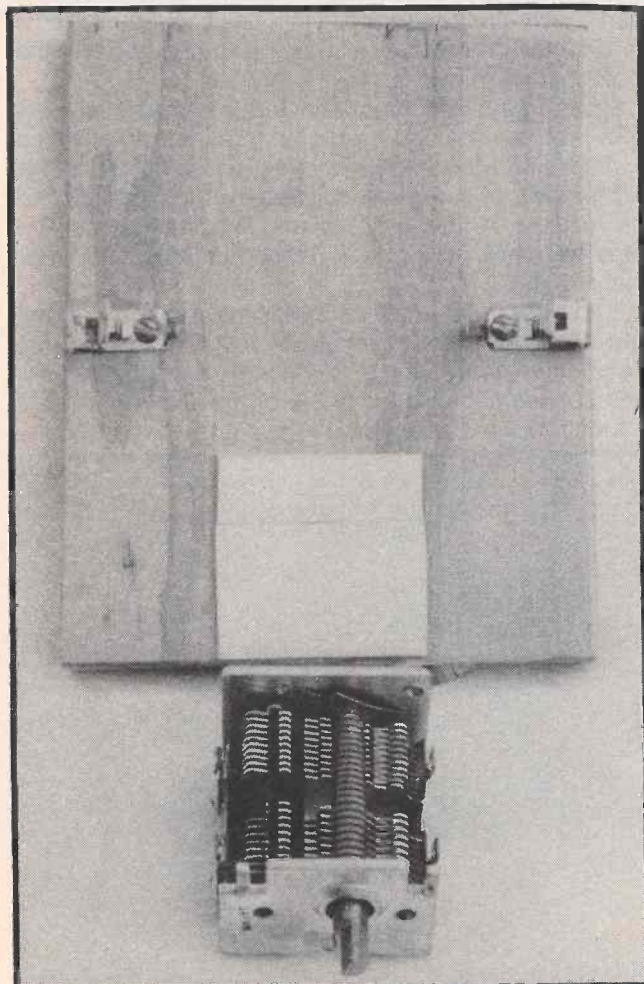
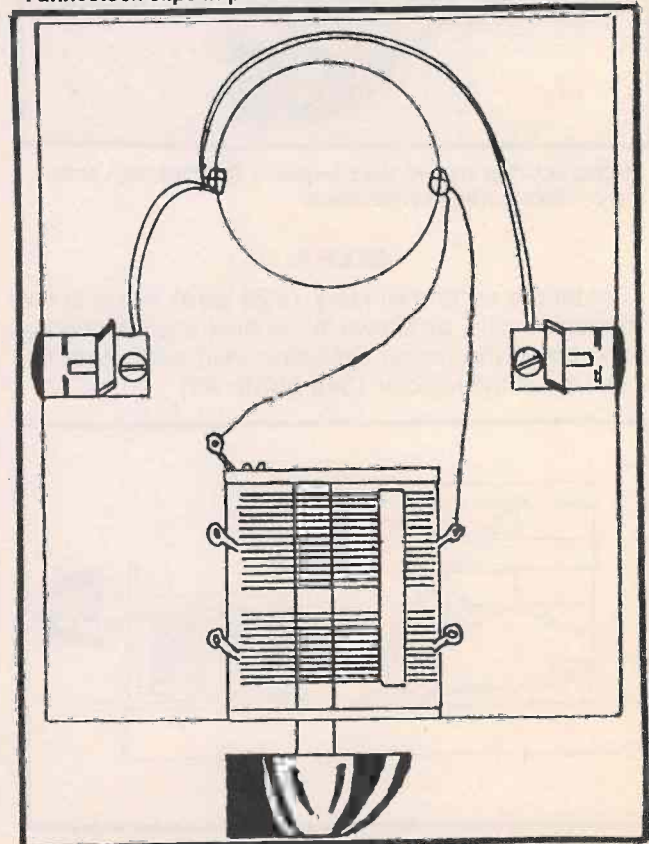

PHOTO #5-Positioning the double-sided mounting tape before securing the tuning capacitor and mounting the Fahnestock clips.



TOP VIEW

STEP 5:

Trim the coil leads to the best length to reach their connections, and then scrape the enamel off the wire where solder connections are to be made.

Solder the lower end of the first winding, (#30 wire), to the stator, (side lug), of the large section of the tuning capacitor. Solder the upper lead of this coil to the rotor, (or case), of the capacitor. (See photo #7)

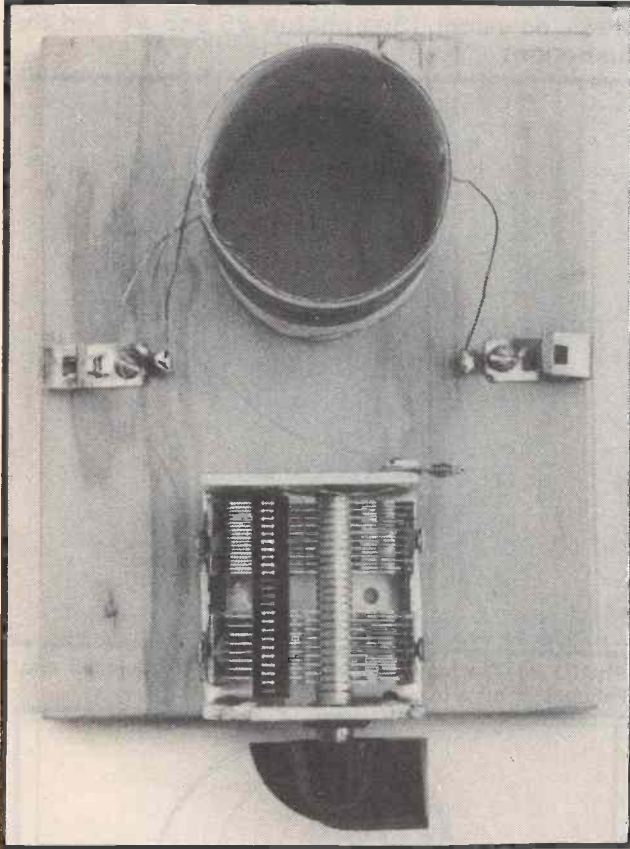
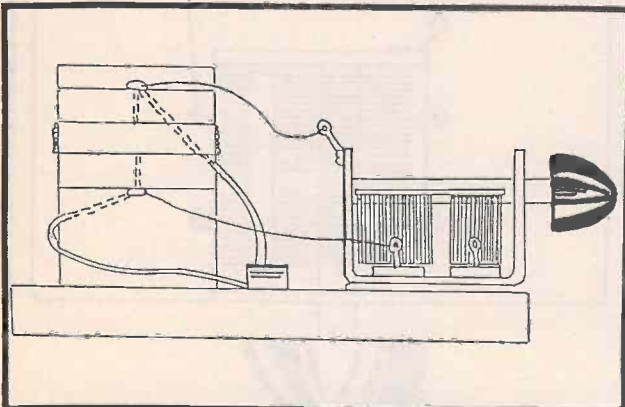

PHOTO #7—Top view of the completed Rejector trap, showing coil location and connections.

STEP 6:

Solder the second winding, (#26 wire), leads to the fahnestock clips, as shown in the illustration. Mounting the knob on the tuning capacitor shaft completes the assembly of the rejector. (See photo #7)



SIDE VIEW

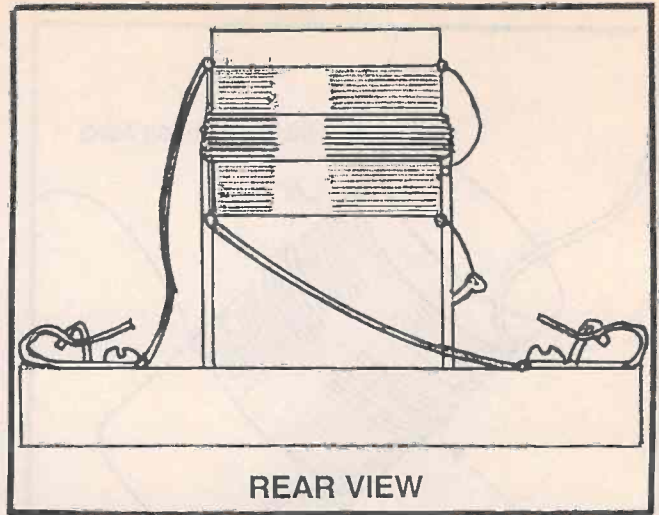

REAR VIEW

OPERATION:

Connect either fahnestock clip to the antenna and connect the other clip to the antenna input connection on your radio.

Turn the trap capacitor to minimum capacitance, (fully open), then tune the receiver to the offending station. After the receiver is set to the QRM, tune the trap through its range and you will find a narrow point where the interfering station disappears or is greatly attenuated. Leave the trap tuned to this position. You will now be able to hear weaker stations on either side of the "notch" created by the trap.

Several traps can be connected in series to null out QRM from several loud stations. If more than one trap is used, simply repeat the above process for each trap.

There will be some interaction between the traps and the receiver. A little practice and experience with the traps will show you how to "touch-up" the tuning for best results.

If you use a two section capacitor and find that the trap does not tune low enough, you can connect the stator of the small section to the large section. This will increase the capacitance of the circuit and will cause it to tune lower in frequency.

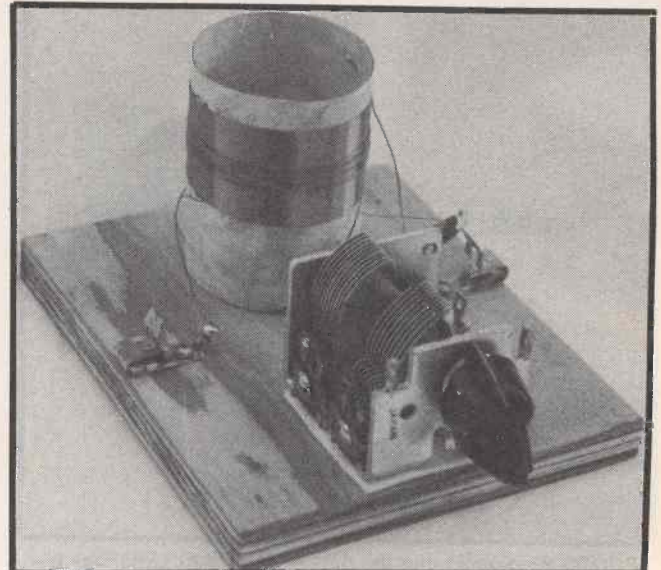

PHOTO #8—The completed Rejector.

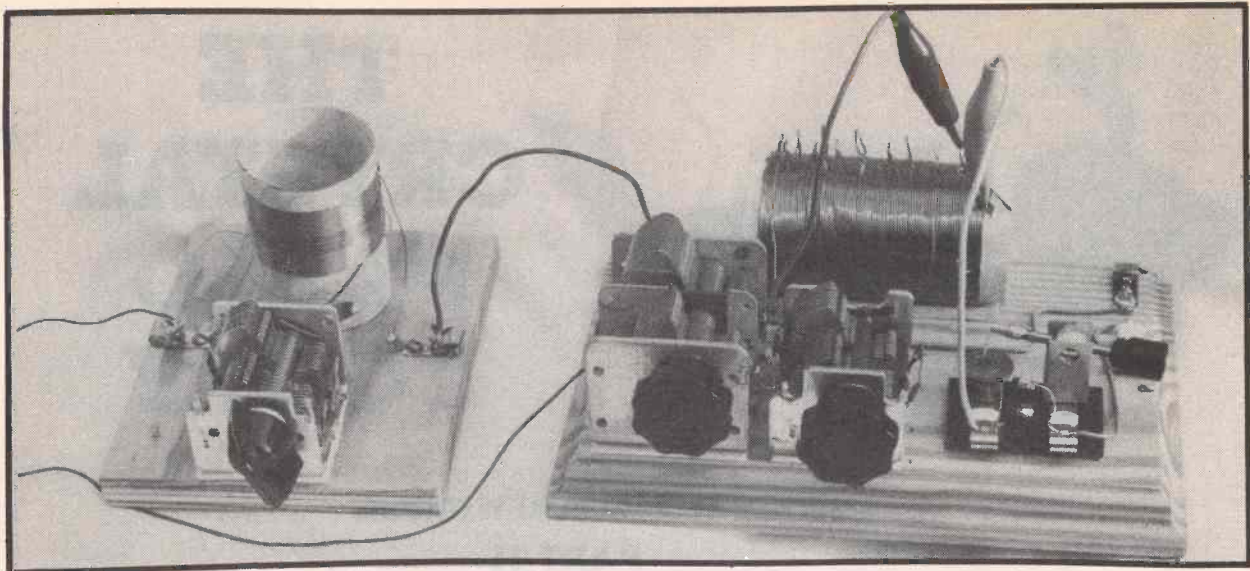
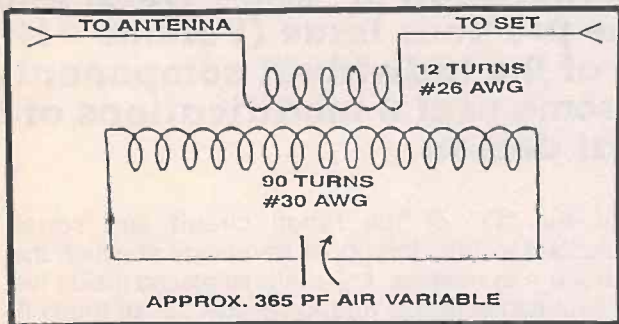

PHOTO #9—The completed Rejector connected to a high-performance crystal set.



SCHEMATIC

HOW IT WORKS:

The tuning capacitor and large winding of the coil form a parallel tuned tank circuit that will tune the entire A.M. broadcast band.

When this tank circuit is tuned to resonance at the frequency of an interfering station, it absorbs a significant amount of that signal from the small winding and thus from the antenna circuit of the receiver. Signals above and below this frequency are passed on to the receiver with very little attenuation.

GOOD LUCK WITH YOUR REJECTOR AND HAPPY DX'ing!!

PARTS LIST FOR REJECTOR (QRM) CIRCUIT

PART	SOURCE
Coil Form—	Cardboard Toilet paper tube. (1½" x 4½")
Coil wire— #26 AWG & #30 AWG@200'	Radio Shack (Part #278-1345 Contains 3 sizes: #22 @40', #26 @75' & #30 @200')
Tuning capacitor— (Approx. 365 pf)	Antique Electronic Supply 6221 Maple Avenue Tempe, AZ 85283 (602) 666-1541 Part #CV-230 @ \$3.50 plus S&H. This is a single gang capacitor of the correct value. Ask for catalog. (The author used the large section of a capacitor removed from an old Superhet.) Modern Radio Laboratories P.O. Box 14902 Minneapolis, MN 55414 Part #8-132 @ \$4.50 plus S&H. This is also a single gang capacitor but has more plates to give it a value of 400pf. (MRL sells crystal set parts and literature. They will send a catalog for \$1.00). Antique Audio 5555 N. Lamar, Suite H-105 Austin, Texas 78751 (512) 467-0304 This company carries a 365pf single-gang tuning capacitor for \$3.50, plus S&H. They also carry Fahnestock clips and a fine line of other crystal set and antique radio parts. Ask for catalog.
Miscellaneous—	4" x 5" x ½" board, knob, clear acrylic spray, fahnestock clips, wood screws, double-sided foam mounting tape, superglue. Fahnestock clips are available from A.E.S., Antique Radio, and M.R.L. (Referenced in Parts List).

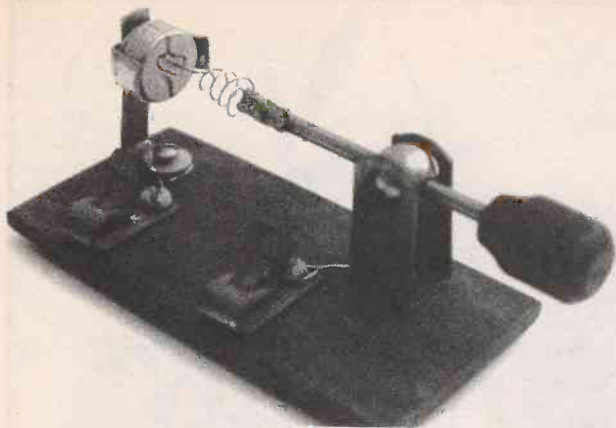

THE CRYSTAL RADIO TODAY

By Lyle Russell Williams

PART II

Here we are again! This is the conclusion of "The Crystal Radio Today," which we started in the previous issue (Volume #12). In this issue we will discuss some of the individual components that make up the crystal radio and some useful modifications of the traditional design.

Tuning Capacitor

The old fashioned air variable capacitor is preferred over the modern plastic insulated miniature. The plastic variables tend to be fragile and change capacitance due to pressure on the dial or shaft. It is harder to attach a reasonable sized knob and dial to the plastic variable. The air variable is very rugged. It may become intermittent but it can be cleaned and restored. Air variables are still available newly manufactured and from surplus outlets. (Volume #10 of the ELECTRONICS HANDBOOK has a comprehensive "Build Your Own Vario-Coupler Receiver" article by Homer Davidson, that may help the project builder).

Inductor

The coil was usually home built in the 1920's. Magnet wire was wound around a round cereal box. The coil was tapped at various points to make it variable. Figure 1 shows a crystal radio with this type of coil. As the inductance changes in rather large steps, it is necessary to use a variable capacitor for precise tuning of the desired station. Crystal set DX'ers prefer tapped coils because they can exactly duplicate a previous setting in order to find a station previously logged. With a slider coil is difficult to exactly duplicate a previous setting on the coil.

It is easier to provide a slider adjustment when the coil is wound on a square coil form such as wood. A slider will provide an almost continuous adjustment of inductance. This would be necessary when the inductor is the only tuning element as with the circuit in Figure 2.

Two things to be considered when building an inductor are losses and series capacitance. Losses

limit the "Q" of the tuned circuit and series capacitance limits the upper frequency at which the inductor can operate. Any material placed inside the coil will cause losses and lower the "Q" of the coil. Some inductors are made self supporting for this reason.

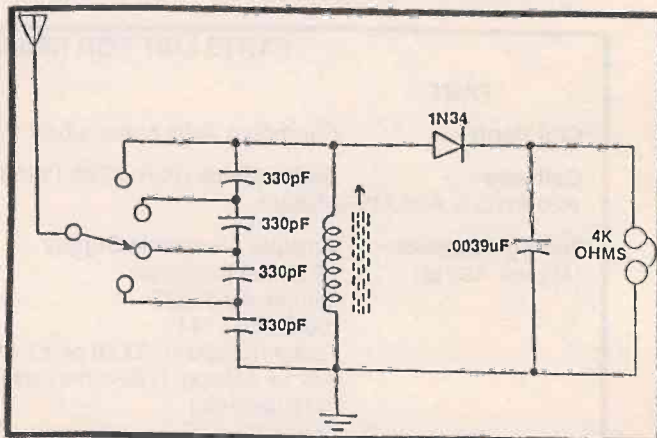

Figure 1. A tapped capacitor crystal radio uses a variable slug tuned ferrite coil or other variable inductor. The switch selects the best impedance match to the antenna.

Though wood and cardboard are not ideal materials for coil forms, nevertheless coils built with these materials can be quite good. These materials introduce losses to the coil largely due to water trapped in the material. Thin cardboard such as a cereal box is not a bad coil form because the amount of material inside the coil is minimal. Some modern packaging materials such as English muffin cans are made from thinner cardboard than the old cereal boxes and therefore will probably exhibit lower losses when used as a coil form. Do not use cans that have a

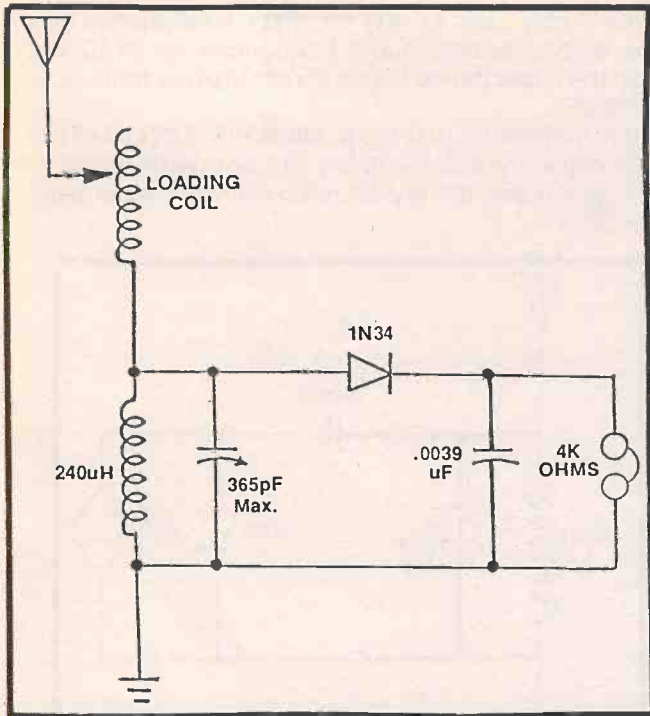

Figure 2. A loading coil (variable inductor) increases the tuning range of a crystal radio.

foil inner lining. Wood that has been kept indoors for a year or more is recommended for coil forms. Place wood in cardboard in an oven at 150°F for several hours to drive off moisture. Coat the material with shellac while still warm to prevent moisture from re-entering the material.

The lowest loss materials for coil forms are plastic and ceramic materials. These are often used for commercially built coils. Commercially built ferrite coils typically have a "Q" of over 200 and theoretically should greatly outperform the old fashioned cereal box inductors. However, the old coils with multiple taps or slider adjustment can provide a better match to the antenna and headphones. It is not unusual for a home made coil to produce a higher output than a ferrite coil.

Ferrite coils come in adjustable and non-adjustable types. Both types may be tapped at one point but the tap is often not at a convenient point for crystal radio use. The variable ferrites, such as the Miller #9001, are slug tuned and provide an inductance range of about 40 uH to 240 uH. The highest "Q" is obtained only at the highest inductance.

One way to provide multiple taps with a variable ferrite coil is to replace the parallel capacitor with several equal value capacitors wired in series and tap between these capacitors shown (Figure 1). The inductance is varied in order to change frequency. The tuning range is determined by the value of the series capacitors. This type of circuit has never been encountered in crystal radio literature, but it is a useful technique.

Detectors

In the 1920's minerals such as galena, iron pyrites, chalcopyrites, and silicates were used as detectors.

These were made available encapsulated in a low melting point metal such as tin with the surface of the crystal exposed. The metal was molded into a standardized cylindrical shape so that different crystals would fit into a standard crystal holder. The holder was one terminal of the detector. A moveable arm with a springy wire known as a "cat's whisker" on the end formed the other terminal of the detector.

The "cat's whisker" has to be moved over the surface of the crystal while listening in the phones in order to obtain a sensitive spot. Unfortunately, the setting deteriorates over time and requires frequent readjustment.

The characteristics of the natural crystal detector are similar to those of the semiconductor diode but are much more variable depending on the type of crystal used and the adjustment of the "cat's whisker." The sensitivity of the natural crystal detector often equals that of semiconductor diodes. The advantages of semiconductor diodes over the natural crystal are more predictable characteristics, freedom from having to make adjustments, and a much smaller size.

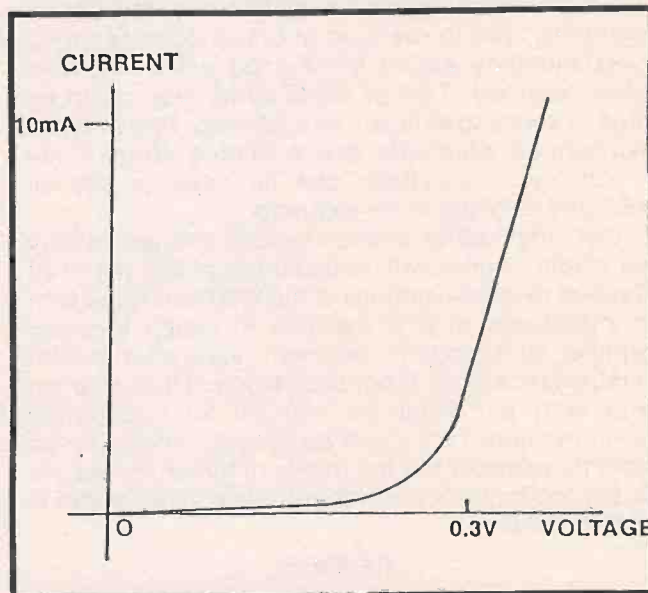

Figure 3. The volt/ampere characteristic of a diode detector.

Figure 3 shows the voltage current characteristic of a rectifying type detector. The diode is very nonlinear at the lower voltage part of its curve. A consequence of that nonlinearity is that there is a threshold of a few tens of millivolts below which the diode will not detect no matter how much audio amplification follows the detector. Even when the signal is well above this threshold, the diode tends to clip the negative portion of the detected audio signal. An oscilloscope display of the audio from a diode detected signal (even from an expensive superhet) often reveals this telltale negative clipping. In view of these disadvantages, it is surprising that the single diode AM detector has been used almost exclusively in commercial circuits of the last sixty years.

Headphones

Headphones for use with a traditional unamplified

crystal set should have an impedance between 2.0 K Ω and 100 K Ω . The headphones used in the 1920's were magnetic phones with an impedance of about 1.0 to 4.0 K Ω . These phones evolved from the telephone receiver which had an impedance of about 75 Ω . As previously mentioned, piezo crystal phones of the 1950's came with impedances of 25 K Ω to 100 K Ω . Headphones load the tuned circuit and reduce the "Q" and selectivity of the circuit. As the impedance of the phones increases the load on the tuned circuit is decreased and the voltage output rises. Due to this rise in output, the sensitivity of crystal phones is greater than would be expected. Crystal phones offer a good compromise between selectivity and sensitivity. Crystal set DX'ers usually prefer the more traditional magnetic phones.

Neither high impedance magnetic nor quality crystal phones are manufactured today. But magnetic phones were popular for decades and used sets are not difficult to obtain. Quality crystal phones were only briefly popular and used sets are very rare.

Cheap piezo crystal earphones are often supplied with commercially available crystal sets today. Cheap earphones tend to overload at only moderate sound levels but they sound fairly good when operated below overload. Two of these earphones could be wired in series to simulate headphones. Piezo crystal microphone elements are available from some surplus sources. These can be used as crystal earphone or headphone elements.

Lower impedance phones include antique military and studio phones with impedances of 600 Ω and 50 Ω , stereo magnetic phones of the 1960's and later with an impedance of 8 Ω per side to match a power amplifier, and modern "walkman" style phones with an impedance of 33 Ω per side. None of these can be used with a crystal set without an impedance transformation. This could be accomplished with an audio transformer but the losses of these devices are usually too high for consideration. An active buffer is a better solution.

RF Filter

Magnetic and crystal headphones and audio amplifiers often work well following a crystal set without adding an RF filter capacitor. However, adding a capacitor across the headphones or load resistor will remove the radio frequency component from the detector output and should improve the detection efficiency and the sensitivity of a crystal radio. The result of the filter can readily be seen on an oscilloscope connected across the phones or output resistor. Choose the size of the capacitor by use of the following equation:

$$C = \frac{1}{2 \times \text{PI} \times F \times Z}$$

Where C is the filter capacitance to be calculated.

PI is 3.1416

F is the maximum audio frequency to be passed.

Z is the impedance of the headphones or the value of the output resistor.

Thus if one uses 4.0 K Ω magnetic headphones and one wishes to hear audio frequencies up to 10 khz then the capacitance to use across the headphones is .0039 μF .

It is interesting that the position in the circuit of the filter capacitor and the diode can be interchanged as in Figure 4 and the crystal radio will work essentially the same.

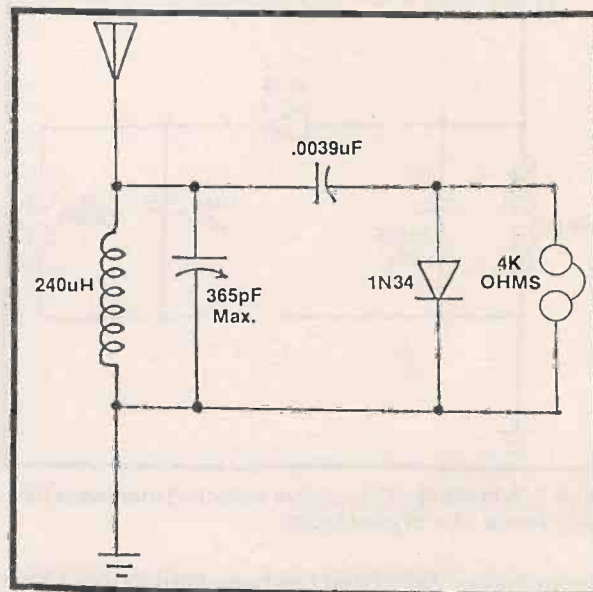

Figure 4. Crystal radio with the positions of the diode and the filter capacitor interchanged. The performance is essentially the same as before the components were reversed.

Modifications

One of the traditional modifications of crystal radios is the addition of a loading coil in the antenna circuit. Due to the reactive loading of the antenna, a crystal set will not usually tune the entire broadcast band with a standard 365 pf tuning capacitor. The variable inductance loading coil in the antenna circuit tunes out some of the capacitive reactance of the antenna and allows the entire band to be covered.

Another traditional modification is the trap which is installed in the antenna circuit to remove a station that is interfering with the desired station. The trap, which is shown in Figure 5, is tuned to the interfering station in order to remove it. The main tuned circuit is tuned to the desired station.

The practice of using the crystal radio with an audio amplifier is itself a crystal set modification. If 4.0 K Ω magnetic phones have been used, the phones can be replaced by a 4.7 K Ω resistor. The shunt filter capacitor calculated by Equation 1 will be .0033 μF . The input impedance of the audio amplifier may be as low as 25 K Ω although higher impedances would be preferred. The crystal radio for use with an audio amplifier is shown in Figure 6.

Headphones place a heavy load on the tuned circuit. The selectivity, sensitivity and distortion characteristics can all be improved by using a larger detector load impedance. This can be accomplished by placing a buffer between the detector and the headphones or amplifier input. Figures 7, 8, and 9

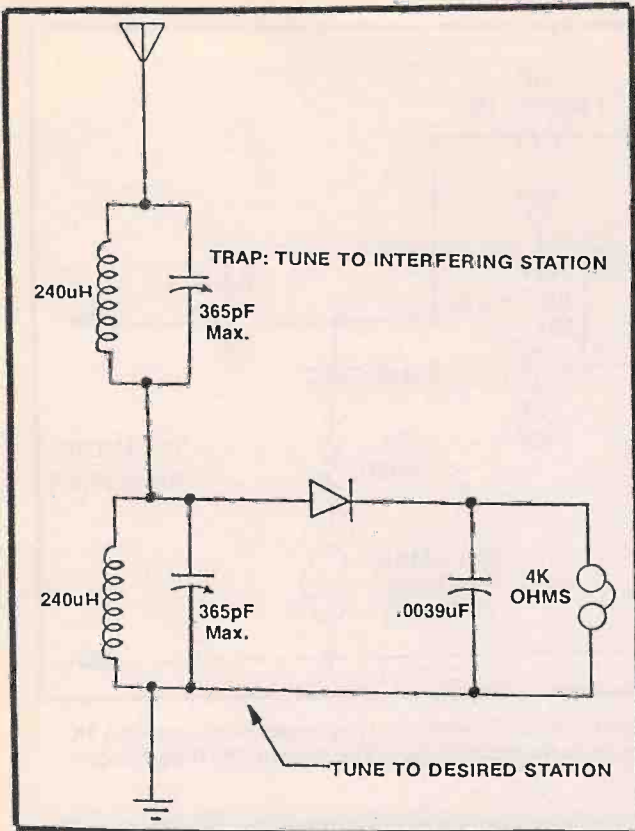

Figure 5. A trap is added to remove a strong interfering station. The trap is tuned to the interfering station while the main tuned circuit is tuned to the desired station.

show three circuits that can be used as buffers.
 In Figure 7, an FET source follower circuit provides a high impedance to the detector and a low impedance output to an audio amplifier. The voltage gain of the circuit is 1. The input impedance is 1 meg Ω and has an almost negligible effect on the "Q" of the tuned circuit. The variable inductor is a wooden core single slider similar to the double slider version shown in Part I.

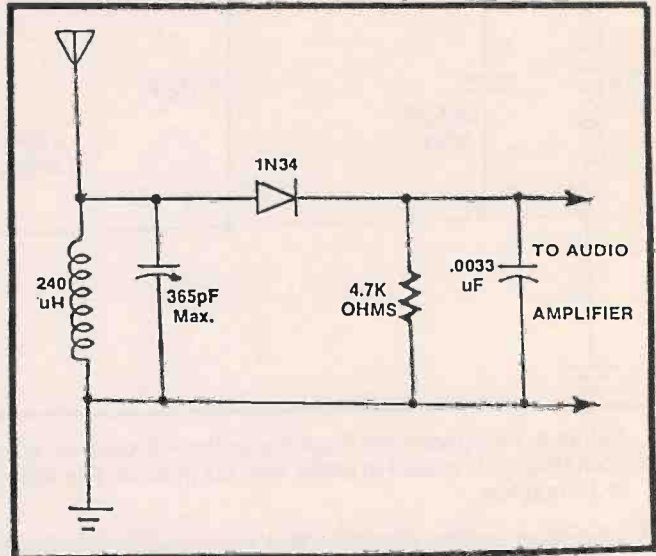

Figure 6. A resistor replaces the headphones when an audio amplifier is used. Amplifier input impedance should be 25K ohms or greater.

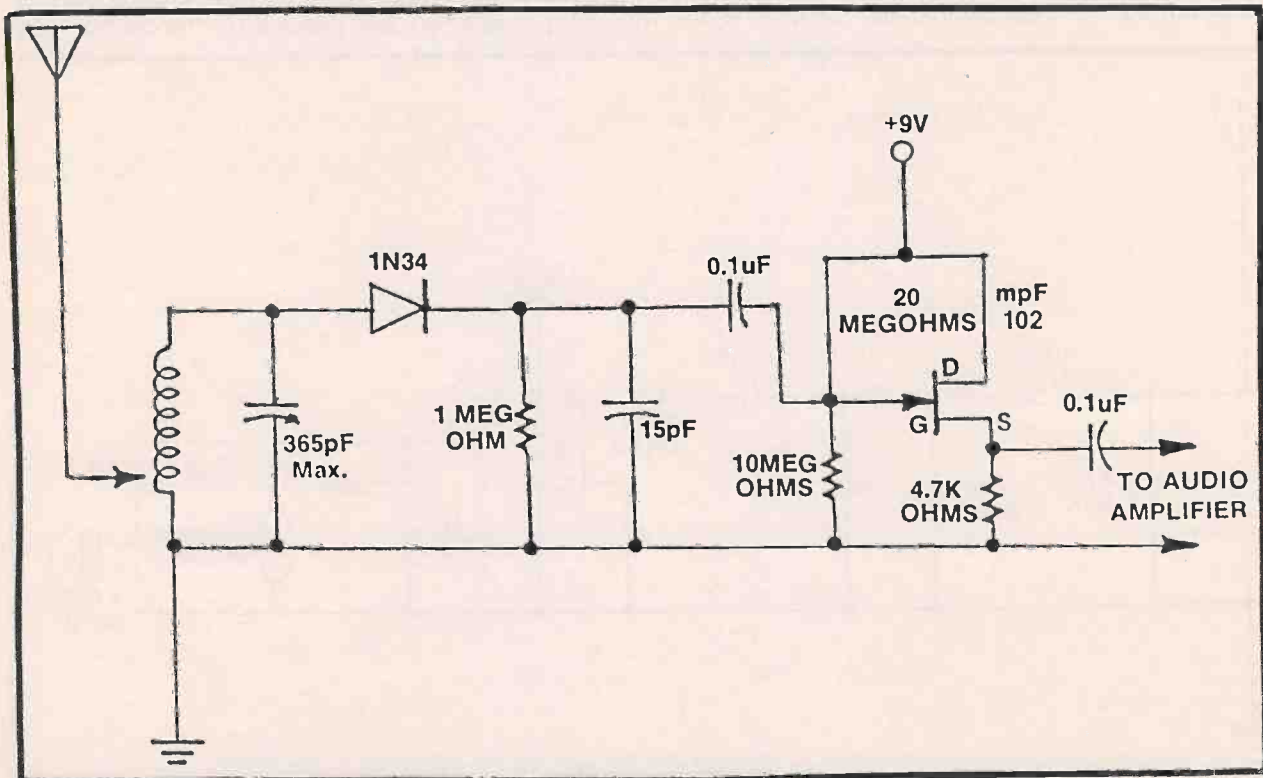

Figure 7. A crystal radio with a source follower buffer between the detector and the audio amplifier. The voltage gain of the buffer is 1. The load on the tuned circuit is 1 megohm.

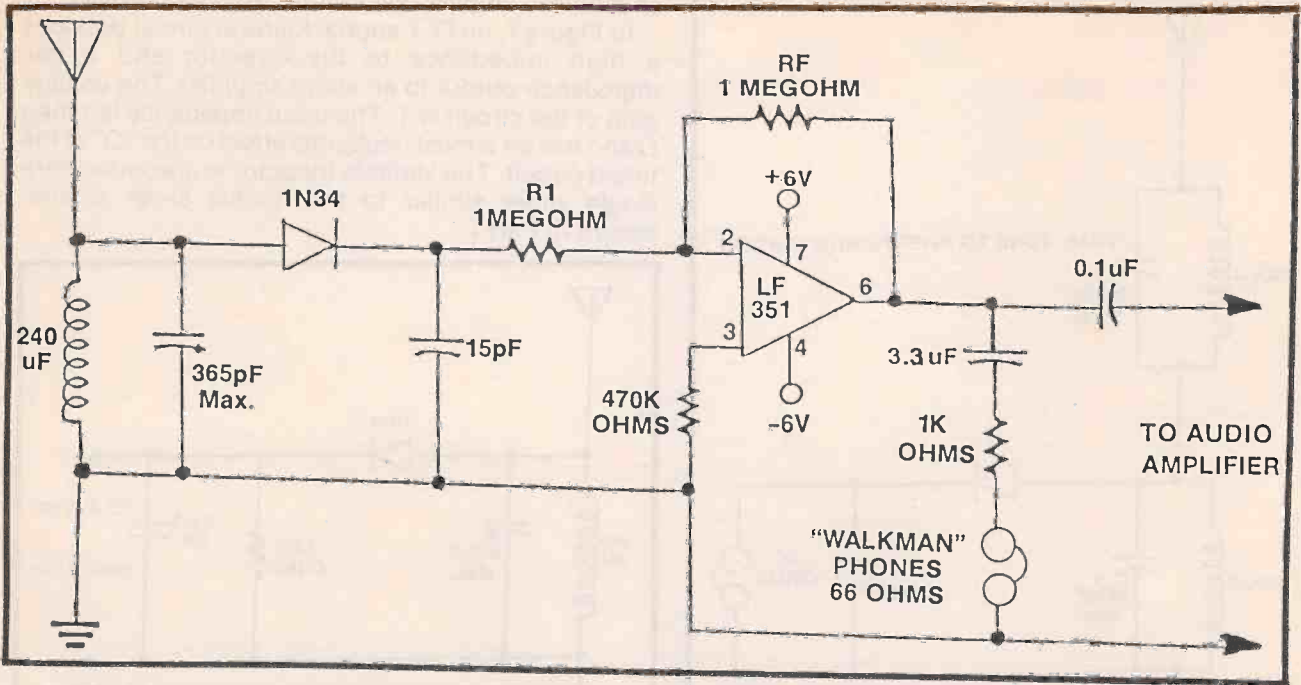

Figure 8. An operational amplifier buffer will drive an audio amplifier or "Walkman" type headphones when a 1K ohm resistor is placed in series with the phones. The voltage gain of the amplifier is 1. The load on the tuned circuit is 1 megohm.

An op-amp buffer can be used as in Figure 8, to provide a high impedance load to the detector. The value of R1 sets the input impedance and is equal to 1 meg Ω . The circuit will have a voltage gain equal to the ratio R_f/R_1 . The values here provide a gain of 1. To increase the gain, increase the value of R_f . "Walkman" style low impedance headphones can be used if a 1

K Ω resistor is placed in series with the phones. The resistor results in a loss in voltage gain but the resultant sensitivity is about the same as 4 K Ω magnetic phones placed across the amplifier output without the series resistor. The Op-Amp amplifies the DC output of the detector as well as the audio so that blocking capacitors are needed on the output. The

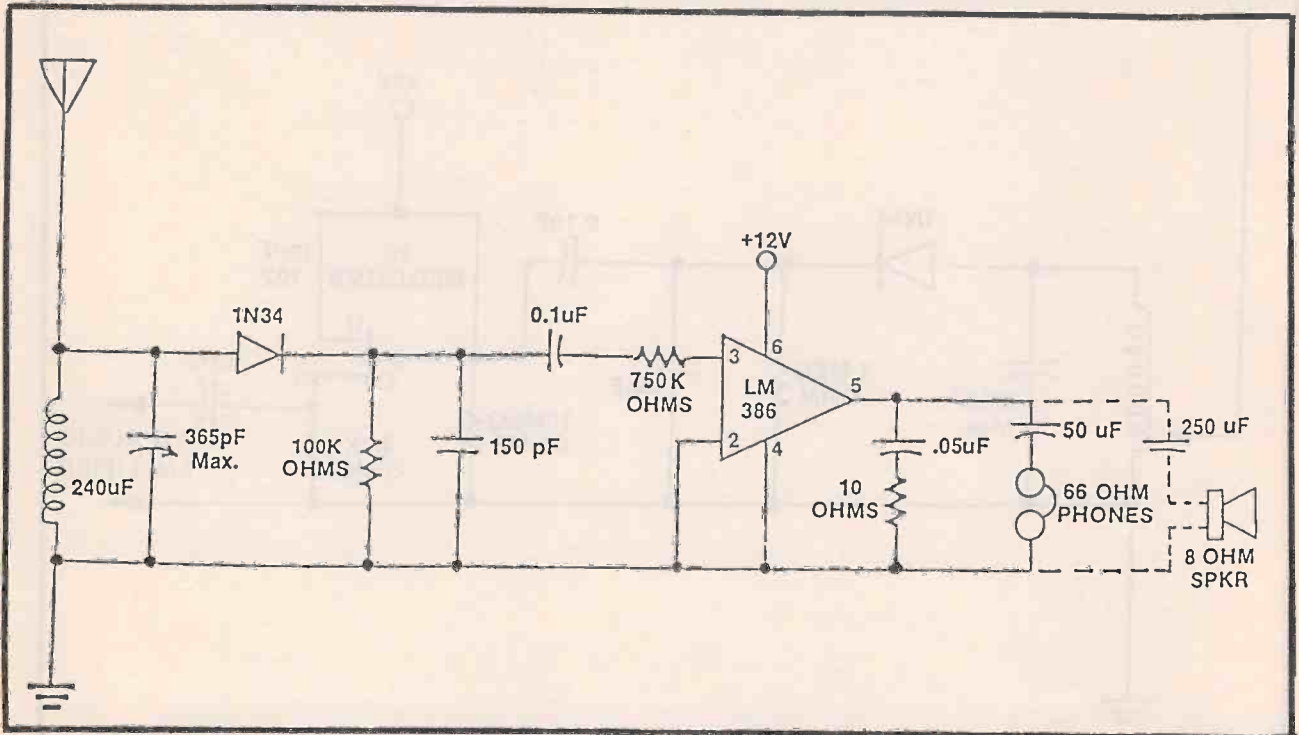

Figure 9. A power amplifier buffer will drive low impedance phones or a speaker. The voltage gain is 1. The load on the tuned circuit is 100K ohms.

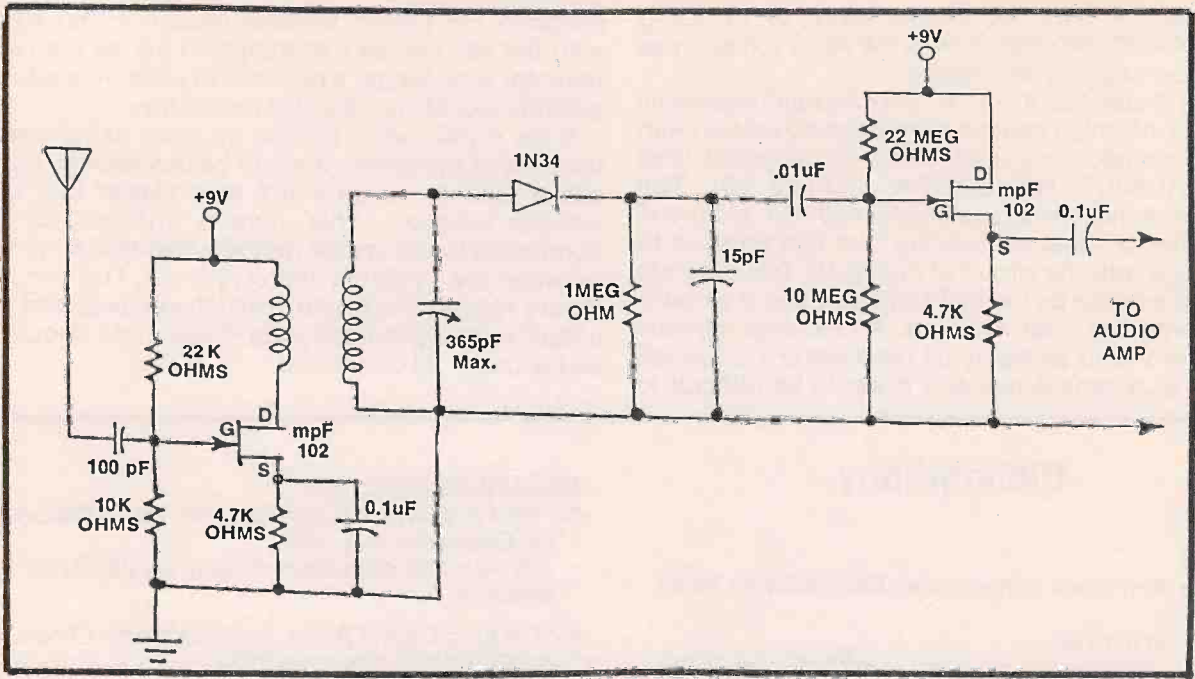

Figure 10. Both input and output of the tuned circuit is buffered so that tuning will be unaffected by either the antenna or the audio load. The tuning capacitor can be fitted with a dial and calibrated. The antenna input is high impedance.

DC output is sometimes useful for applications such as tuning meters.

Figure 9 is a small power amplifier which can drive a speaker, 8 Ω headphones, 33 Ω "Walkman" type phones, or higher impedance phones. In Figure 9, the detector load impedance is 100 K Ω , the input impedance of the amplifier is 800 K Ω and the voltage gain is 1.

The circuits of Figures 7, 8, and 9 effectively isolate the phones or audio load from the tuned circuit. A change in the audio load will no longer affect the tuning. A buffer can also be placed between the

antenna and the tuned circuit as in Figure 10. This will make the tuning independent of the antenna. Assuming the inductor connections are made permanent, a calibrated dial can then be placed on the variable capacitor and the same frequency would always appear at the same place on the dial regardless of the antenna used. The number of coupling turns on the inductor can be chosen so that the sensitivity of the circuit is about the same as the radio was before the buffer was added. The circuit of Figure 10 may be marginally stable. Stability can be improved by using a MOSFET instead of a JFET, by

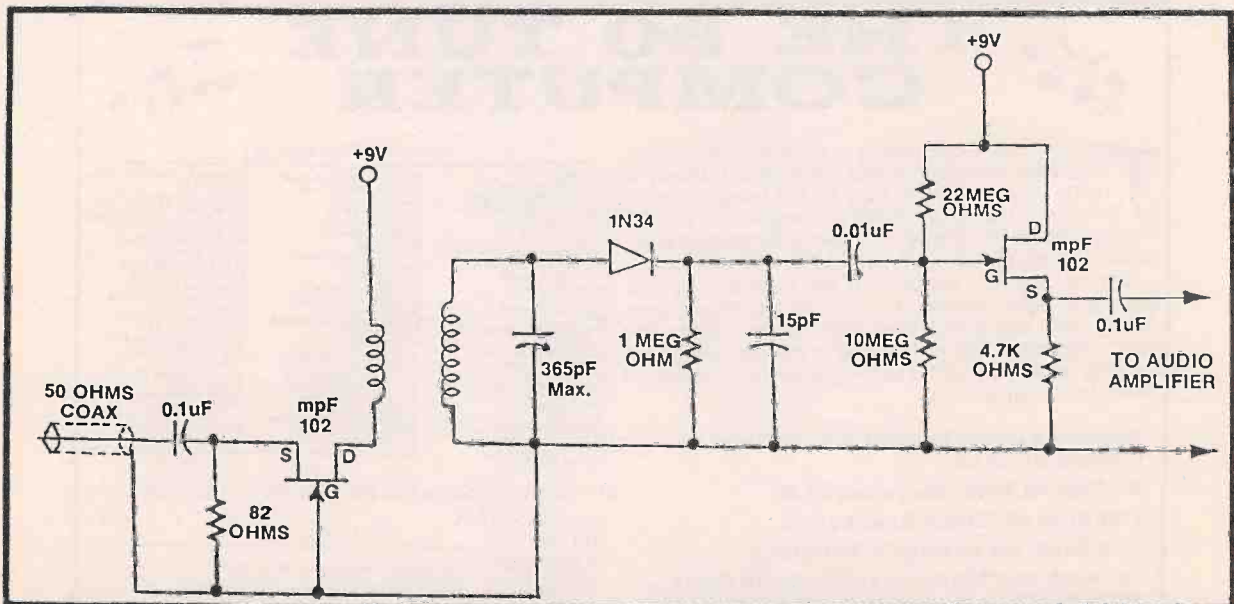

Figure 11. The antenna is buffered as in Figure #10 but the input impedance of the buffer is 50 ohms for use with antennas that have a 50 ohm coax feed.

changing the input or output loads, or by using neutralization techniques. Also the two 9 volt sources should be properly decoupled.

Radio Shack has a line of "Science Fair" electronic kits some of which contain a crystal radio section with a ferrite inductor and a plastic variable capacitor. (See *ELECTRONICS HANDBOOK*, Volume #8). The inductor of these kits (such as Kit #28-161, picture in Part I, has a separate winding that can be used to advantage with the circuit of Figure 10. The separate winding is driven by the FET transistor and is wired in series with the main winding. An external variable capacitor would probably be used since it is desired to add a calibrated dial and it would be difficult to

calibrate the plastic variable capacitor that comes with the kit. The lack of multiple taps on the ferrite inductor is no longer a problem as changing inductor settings would ruin the dial calibration.

If the crystal set is picking up noise at the desired location of operation, it might be desirable to use an active antenna or an active loop placed in a quiet remote location. This remote antenna can be connected to the crystal radio by means of 50 Ω coax between the antenna and crystal set. The circuit of Figure 11 has a 50 Ω input to match a coaxial feed. The circuit is the grounded gate design and should be stable under all conditions. ■

Bibliography

BOOKS:

1. *Boy's First Book of Radio and Electronics* by Alfred Morgan (Chapter 8, p126)

This 1956 book is long out of print but is commonly available in public libraries. It is written for children but contains excellent construction details for crystal radios containing wooden core slider type inductors such as the one shown in Figure 7. The single slider and double slider radios (slightly modified, see Figure 6) from this book have been used with excellent results.

2. *Radios That Work for Free* by K. E. Edwards (available from Lindsay Publications: P.O. Box 583; Mantero, IL 60950-0583).

First published in 1977, this book provides a very detailed discussion of all aspects of traditional crystal radio building.

MAGAZINES ARTICLES:

3. "The Early Days of Radio, Part 1" by Martin Clifford *Radio Electronics*, July 1986

A historical discussion of early crystal radios and detectors.

4. "The Early Days of Radio, Part 2" by Martin Clifford *Radio Electronics*, November 1986

A continuation of the discussion of crystal sets plus a beginning discussion of vacuum tube receivers. There are three more articles in this series in the April '87, July '87, and December '87 issues. Only the first two articles deal with crystal sets.

5. "Old Time Crystal Radio" by Pat O'Brien *Radio Electronics*, October 1986

A construction article for a crystal radio using stagger wound "spider" coils with multiple switched taps.

6. "The Lyonadyne" by R. M. Tuggle *Radio Age* Feb.-Mar. 1987

A construction article for a crystal radio using a self supporting stagger wound "basket" type coil.



THE 80 TUNE COMPUTER



The 80-Tune Computer is a project which is not only easy to build but also fun to use. Its uses are many and are limited only by the imagination of the builder. This is an excellent beginner's project because of its simplicity. A masked microprocessor (special Integrated Circuit, or IC) does all the work.

Any of the 80 songs can be selected by the telephone-style keypad. A push of the *Play* button makes the selection. The *Stop* button resets the microprocessor. The selected tune will start each time the *Play* button is pushed as long as power is on and no *Reset* (or *Stop*) occurs.

Complete plans to build the "80-Tune Computer" \$2.95

U1 Custom Microprocessor \$9.00

PCB Printed Circuit Board \$4.95

Add \$2.00 for postage & handling

For each combination of the above items, send check or money order (U.S. funds) to: C&E Hobby Handbooks, Inc. P.O. Box #5148, North Branch, N.J. 08876

80 TUNE COMPUTER SONG LIST

0 AMERICA	37 IN HEAVEN IS NO DEER	83 BUCKLE UP ON WINSOCKI
1 ANCHORS AWEIGH	38 JIMMY CRACK CORN	84 CHARGE
2 BATTLE HYMN REPUBLIC	39 JINGLE BELLS	85 DEAR OLD NEBRASKA U.
3 CARBONS GO ROLLING	40 KING OF ROAD	86 THE EYES OF TEXAS
4 CALL TO COLORS	41 LA CUCARACHA	87 ABOVE CAYUGA'S WATER
5 CAVALRY CHARGE	42 LONE RANGER	88 FIGHT ON USC
6 DIBIE	43 MODEL T	89 CO. NORTHWESTERN
7 HAIL BRITANNIA	44 THE OLD GREY MARE	90 HAIL PURDUE
8 YANKEE DOODLE OANOT	45 POPEYE	91 HEY LOOK ME OVER
9 LA MARSEILLAISE	46 RAINDROPS	92 HOLD THAT TIGER
10 MARINE HYMN	47 SAILORS HORNPIPE	93 ILLINOIS LOYALTY
11 REVELLE	48 SAN ANTONIO ROSE	94 INDIANA, OUR INDIANA
12 STARS & STRIPES	49 SEE THE USA	95 I'M A JAYHAWK
13 TAP	50 DUTY TO THE BALLOON	96 IOWA FIGHT SONG
14 WILD BLUE YONDER	51 TIJUANA TAXI	97 LOVE YA BLUE
15 ALOUETTE	52 TWO BITS	98 MICHIGAN STATE FIGHT
16 AIR VICTORIES HONOR	53 WABASH CANNONBALL	99 MINNESOTA HOUSEH
17 CAMPTOWN RACES	54 SAINTS GO MARCHING	100 MITTANY LION
18 CANDY MAN	55 WOODY WOODPECKER	101 NOTRE DAME FIGHT
19 CHARLESTON CHOO-CHOO	56 YELLOW ROSE OF TEXAS	102 OLE MISS
20 CLEMENTINE	57 ACROSS THE FIELD	103 OH, BRAVE ARMY TEAM
21 DALLAS TIME	58 AGGIE WAR HYMN	104 OH WISCONSIN
22 EL PASO	59 ARKANSAS FIGHT SONG	105 WEECK FROM OIL TECH
23 THE ENTERTAINER	60 BE SHARP	106 ROLL ON TULANE
24 JULY JULIE FELLOW	61 BUONDI BUONDI	107 THE VICTORIS
25 FUNERAL MARCH	62 BOW DOWN WASHINGTON	108 WASHINGTON/LEE SWING
26 NAVA NAOLAH		109 YEA ALABAMA

Payment enclosed. to: C&E Hobby Handbooks

PLEASE PRINT

V13

NAME: _____

ADDRESS: _____

CITY: _____

STATE: _____ ZIP _____

Foreign Postage add \$8.00...U.S. Funds

AN ELECTRONIC CRUTCH

By Tony Lee

Here's an opportunity to help someone who is disabled toward at least a partially independent lifestyle.

Perhaps you know someone...a relative, a friend or even an acquaintance, who is physically disadvantaged and finds even the simple functions, most of us take for granted, like switching on a light, a difficult if not impossible task; requiring dependence on others.

Even if you don't know anyone personally, there are many organizations, who assist the handicapped that could benefit from your electronic expertise. Children, in particular, love novel ways of switching on electrically operated toys and games, no matter whether they are handicapped or not. You could become a hero among the younger set and perhaps among the young at heart.

The designs presented here are just a few ideas to whet your appetite. No doubt you will think of a few of your own, or perhaps modify some that are presented here to operate differently. Left to your imagination and innovative skills, the possibilities are unlimited.

Whatever you decide to construct, you can be reasonably certain that it will cost you far less than a commercially available model...assuming one is available. Specialized items such as this often cost exorbitant prices...probably because of low volume production.

These electronic switches are capable of activating any reasonably low-powered household appliance, such as table lamps, fans, TV's, radios, etc. as well as an AC plug adapter to operate low voltage equipment that is normally powered by batteries. Many of these items are designed to accept either batteries or an adapter. However, those that aren't can be easily modified to accommodate an adapter. This means that almost everything in the home, except for electrically heated appliances (radiators, toasters, etc.) can be made available to a disabled person.

We can now look at the overall system design (Figure 1) and the first feature to be noted is that it can be used by the person or several participating in some group activity such as "Wheel of Fortune" or "throwing" a dice, or a team quiz game (first to press), all of which comprise electronic circuitry. The design of these are not included in this instance but would make an interesting future article for use in conjunction with the switches described here or as stand-alone projects.

We will start with the Central Control Unit. It comprises a 12 volt regulated supply and a built-in

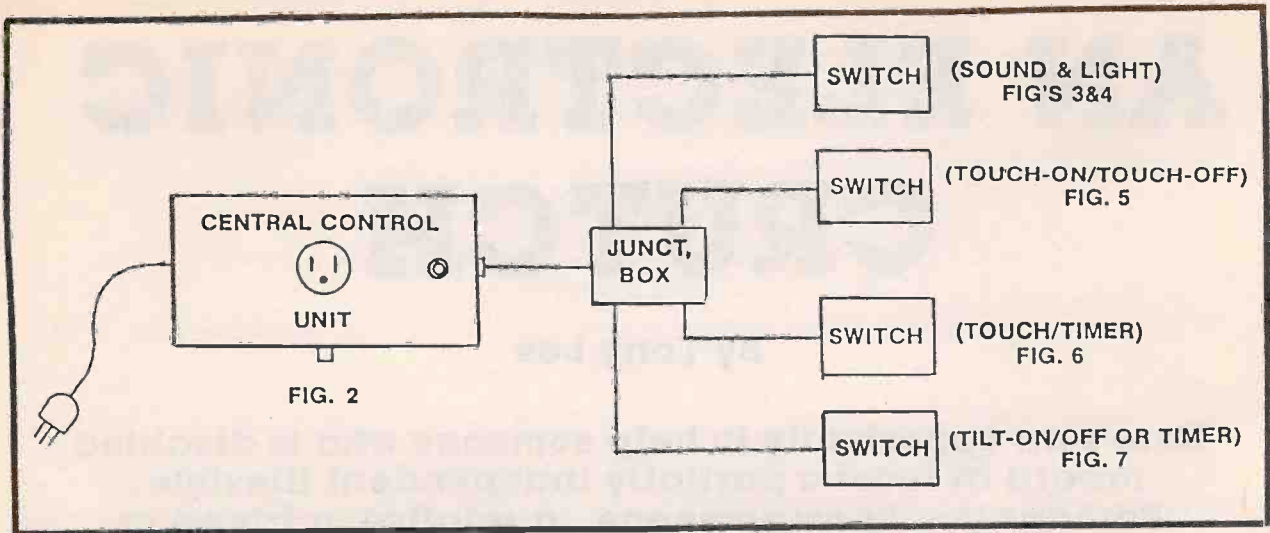

Figure 1. Overall switching system

relay. A power take-off socket is provided, into which the desired appliance is plugged. An electronic switch is plugged into the Central Unit and when the switch is turned on, it activates the relay and this in turn, switches on the appliance.

Several switches of different designs can be plugged into the Central Unit via a junction box. Any number of sockets wired in parallel can be fitted into the junction box, depending on the size of the box.

One other facility incorporated in the Central Unit is a socket to accept a low-voltage AC lamp which will be discussed under "Sound and Light Sensor Switch."

When the lamp is in use, a "mode switch" in the unit is switched from the normally open (NO) relay contacts to the normally closed.

The first switch to be discussed in general terms is the Sound and Light Sensor Switch. Figure 3

illustrates its various modes of operation. These are as follows:

1. The user speaks one word within a few inches of the top surface of the box to initiate a pre-set time interval. The appliance plugged into the Central Unit switches on and automatically turns off at the end of the time period. For anyone with a speech impairment, the time interval can be initiated by gently blowing briefly on the surface of the box.

2. The user switches on a table or bedside light to operate an appliance by remote control. If the user also has difficulty switching on a normal light, one of the switches described here may be suitable but it will need its own Central Unit. If such case arises, it is more expedient to house the switch and the Central Unit in one box for the sake of compactness. (The Sound and Light Switch by the way, is not affected by ordinary daylight).

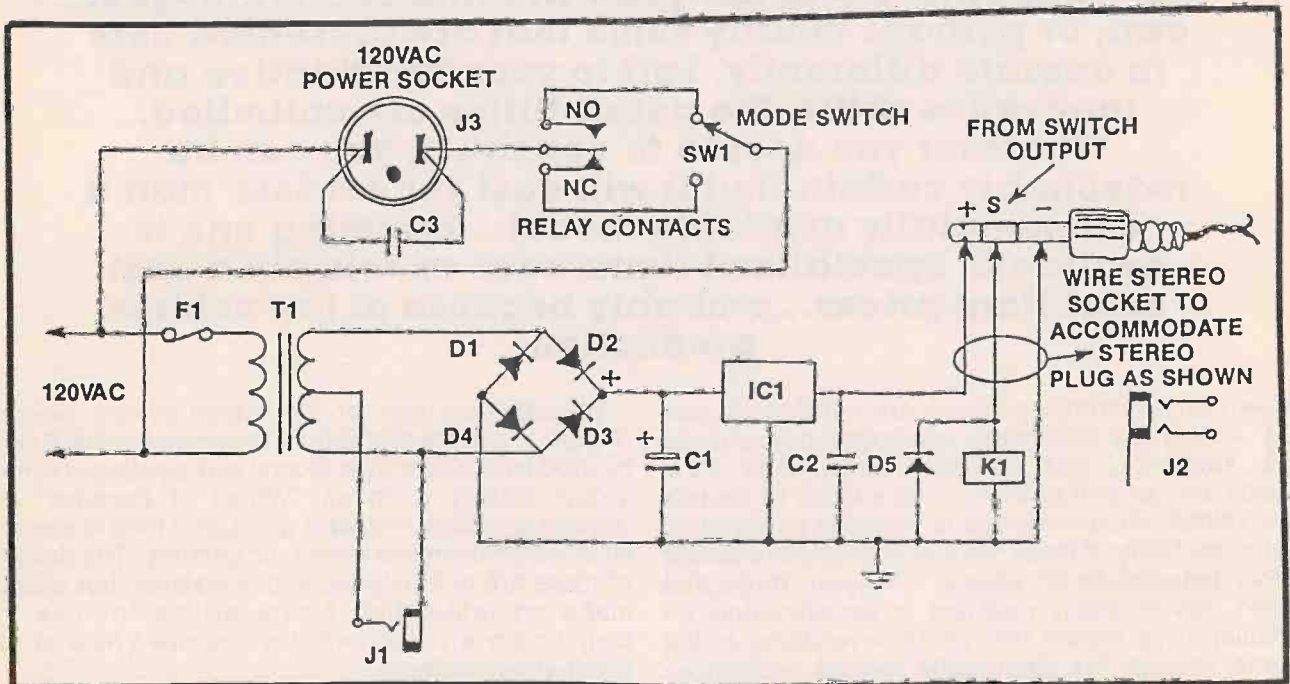

Figure 2. Central control unit

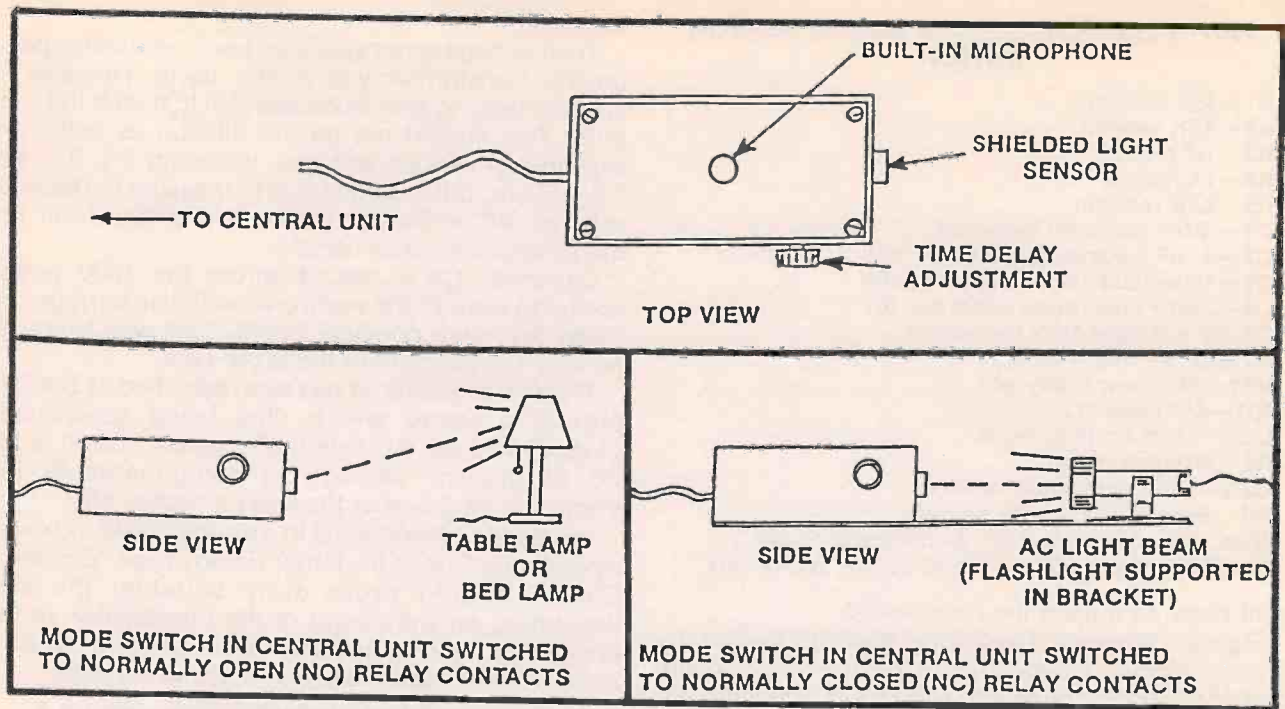

Figure 3. Three methods of operating the sound and light sensor switch

PARTS LIST FOR CENTRAL UNIT

- T1—120VAC/15V ½ or 1A with tapings
- F1—.5A fuse and holder
- D1-D5—1N4002 rectifier diodes
- C1—1000uF 25V electrolytic capacitor
- C2—.22 polyester capacitor
- IC1—7812 voltage regulator
- K1—12VDC relay SPDT or DPDT, 120VAC contacts 5A
- J1—3/32" mono panel socket
- J2—¼" stereo panel socket
- J3—120VAC surface mounted power socket
- SW1—120VAC SPDT panel switch 5A
- C3—.1uF 125VAC suppression capacitor

The time control can be adjusted to a minimum setting so that the appliance switches off the moment the lamp is switched off. Alternatively, the time

control can be turned to a maximum setting and the light flicked on and off. This method of operation is ideal for anyone wishing to be lulled to sleep with music.

3. With the mode switch in the Central Unit switched to "NC relay contacts" and the modified flashlight set up as shown in Figure 3, the user activates the switch by breaking the light beam with any part of the body (arm, leg, foot, etc.). The timer setting is applied in a similar manner to the procedure described in Note 2. When the timer setting is at a minimum, the unit can be operated as an on/off switch by continually obstructing the light beam to hold it on, and removing the obstruction to turn it off. Alternatively, with the timer setting at maximum or somewhere in between, the user can briefly break the

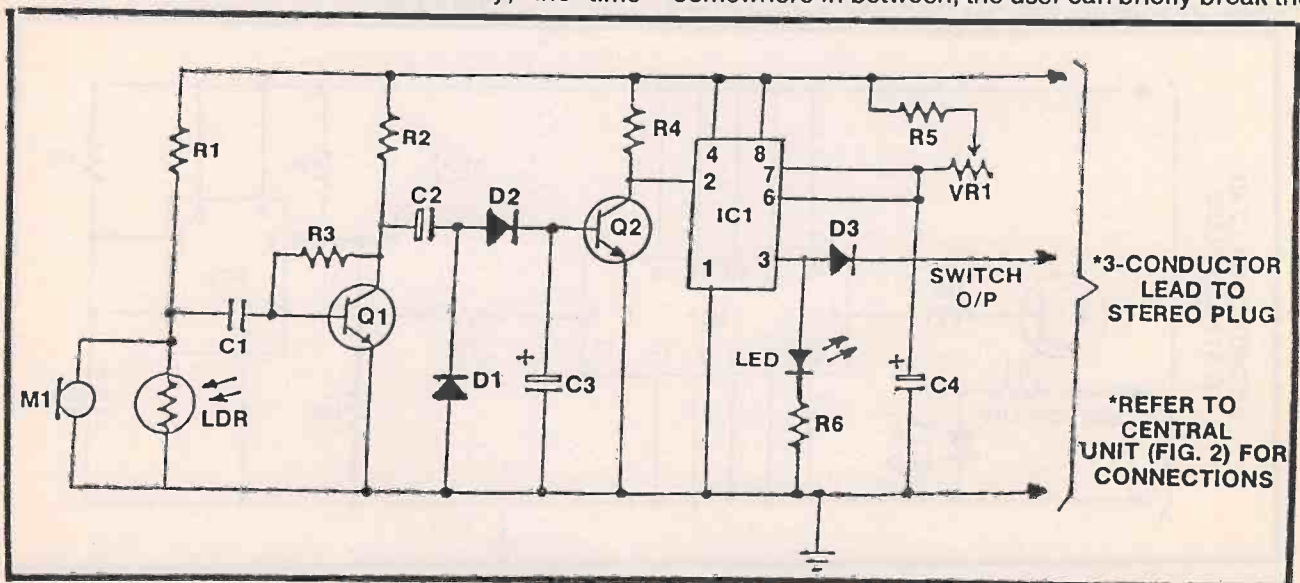

Figure 4. Schematic diagram of sound and light sensor switch

PARTS LIST FOR LIGHT & SOUND SENSOR SWITCH

- R1—15K resistor
- R2—4.7K resistor
- R3—1M resistor
- R4—1K resistor
- R5—2.7K resistor
- C1—.27uF polyester capacitor
- C2—4.7uF electrolytic capacitor 16V
- C3—100uF electrolytic capacitor 16V
- C4—220uF electrolytic capacitor 16V
- Q1-Q2—2N3904 NPN transistors
- D1,D2,D3—1N914 diodes
- VR1—2M linear rotary pot.
- IC1—555 timer I.C.
- LED—Light emitting diode
- R6—470 ohm resistor
- LDR—Light dependent resistor
- M1—Electret Mic. insert
- Misc.— $\frac{1}{8}$ " stereo plug; 3Ft 3-core cable or use 3 wires of rainbow cable; 8 pin IC socket; plastic box.

light beam to initiate the time period.

Figure 5 shows a Touch on/Touch off Switch. By briefly touching the metal lid of the box with any bare part of the body, the switch can be activated and deactivated. Figure 6 is also a touch switch but it initiates a time period when the lid is briefly touched.

The switch shown in Figure 7 is activated when it is tilted at approximately 90 degrees. It can be attached to the wrist or the forehead. When switch SW2 is opened, the Tilt Switch operates in the on/off mode. When closed, it initiates a fixed period.

The control unit and the switches will now be discussed in greater detail but not too much time will be spent on circuit description. Rather, some pointers will be given on construction, hardware and the avoidance of malfunctions.

Central Control Unit - Figure 2

The power supply for the switches is housed in the central unit and is a conventional voltage regulated type requiring little explanation. One or more secondary voltage tappings on the transformer are needed to operate the AC light beam used in the

Sound and Light Switch.

Their voltage is not specified because it will depend on the transformer you intend using. However, a suitable tapping should be selected to match the light bulb. This should not be too difficult as bulbs are available in various voltages, including 2.4, 3.6, 4.8, 6.0, 7.2, etc., but it is advisable to measure the tapping with an AC voltmeter to see if it differs from the manufacturers specifications.

Capacitor C3 is placed across the 120V power socket to prevent the electronic switches retriggering when the relay contacts break. This was found to remedy the problem in the proto-type.

The size of socket J1 has been specified as 3/32" to prevent a stereo switch plug being accidentally plugged into the AC side of the supply. Install diode D5 to prevent damage to components in the electronic switches as the relay switches off.

House the components in a sturdy plastic box with a plastic lid. One of the larger Radio Shack "Economy Cases" should prove quite suitable; the size depending on the height of the transformer. In the proto-type, the transformer was laid on its side. Anchor the power cable with a clamp for safety.

Sound and Light sensor Switch - Figure 4

Briefly, the circuit functions in the following manner. Resistor R1, with the Light Dependent Resistor LDR form a potential divider and the fluctuating light intensity detected by the LDR from an AC source is

PARTS LIST FOR TOUCH ON/TOUCH OFF SWITCH

- R1—470 ohm resistor
- R2,R3—15K resistors
- R4,R5—20M resistors
- R6—4.7K resistor
- Q1—2N3904 NPN transistor
- LED—Red light emitting diode
- IC1—4027 dual J-K flip-flop IC
- IC2—TL555 CMOS type timer IC
- C1—47uF electrolytic capacitor 16V
- Misc.— $\frac{1}{8}$ " stereo plug; 3Ft. 3 core cable; small brass or copper washer; 16 pin and 8 pin IC sockets; plastic box with metal lid; etc.

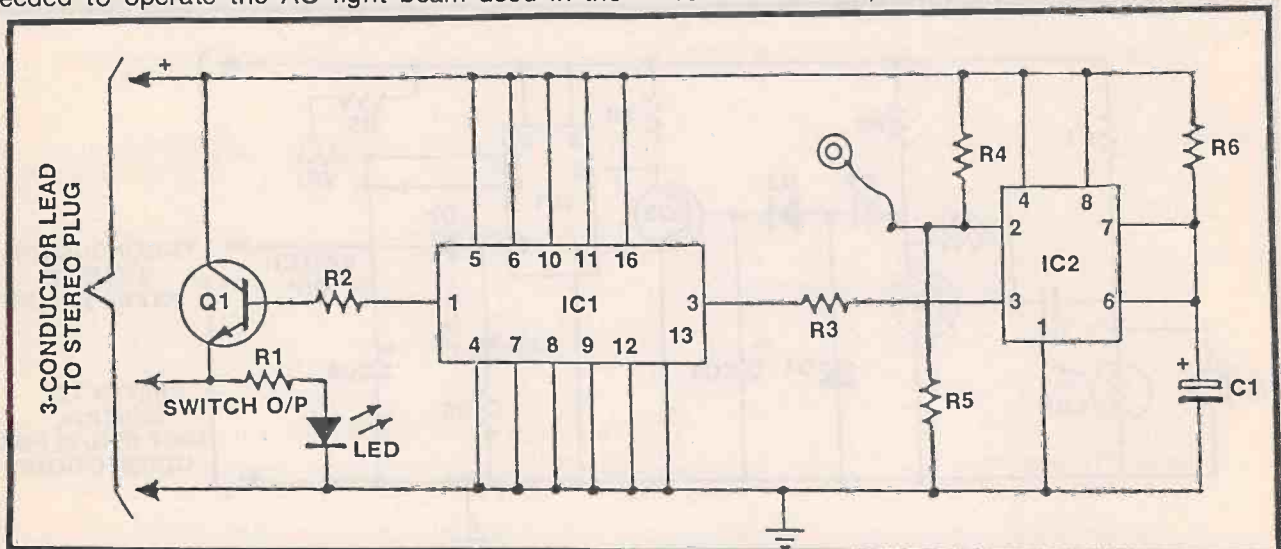

Figure 5. Touch-on/Touch-off switch

fed to a single transistor amplifier Q1 via capacitor C1, which effectively blocks DC. The amplifier, therefore, only responds to alternating current and is unaffected by natural daylight or slowly changing light conditions.

The AC output of Q1 is rectified and smoothed out through the diode/capacitor network comprising D1, D2 and C2, C3. The resulting DC output switches on transistor Q2 which in turn, triggers pin 2 of the 555 timer IC with a negative-going pulse.

The LED with its current limiting resistor indicates when the light switch (and the relay) is activated. Its installation is optional and was not included in the proto-type. Diode D3 removes any small residual voltage at the output of pin 3 after the time period has ended, to ensure the relay completely switches off. Because of the .6 volt drop across the diode, you should ensure that the relay contacts pull in at 11.4V or better still, 11.0V to play safe.

The electret microphone M1 is placed in parallel with the LDR so that either "activator" can initiate the time period. It can be omitted if only the "light" function is required. The values chosen for the RC timing circuit, C4, VR1 and R5 will provide a maximum time interval of about 8 minutes and a minimum of ½ second. These can be altered if required but you may run into trouble using a larger electrolytic capacitor due to their leakage. Use the low-leakage type if necessary.

Here are a few suggestions for the construction of this unit. They were incorporated in the proto-type seen in the photograph. (See Figure 3). Try three strands of "rainbow cable" for the output lead. It's economical (you get four leads from one length) and the colored insulation helps identify the connections

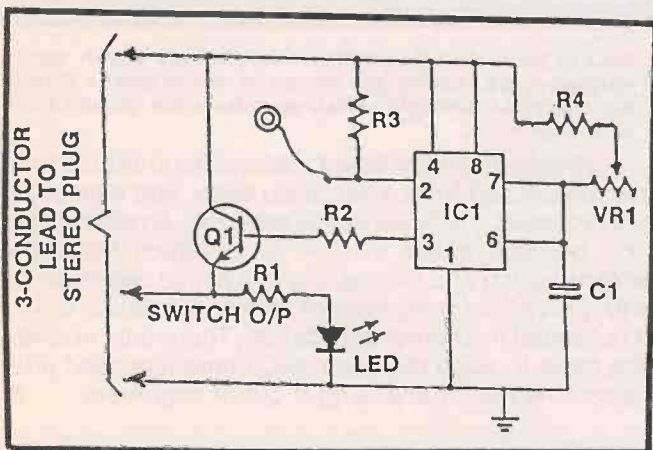

Figure 6. Touch/Timer switch

PARTS LIST FOR TOUCH/TIMER SWITCH

- R1—470 ohm resistor
- R2—15K resistor
- R3—20M resistor
- R4—4.7K resistor
- Q1—2N3904 NPN transistor
- LED—Red light emitting diode
- IC1—TL555 CMOS type timer
- C1—100uF electrolytic capacitor 16V
- VR1—4.7M linear pot.
- Misc.—Similar to Fig. 5 parts list.

to the circuit board and the stereo plug. It is far less bulky than other types of 3-conductor cable, i.e., twin shielded audio cable, and more flexible.

Two 1/16" holes were drilled in the end of the box to take the LDR leads, and the LDR was glued to the outside of the box. A piece of black plastic tubing measuring 5/16" inside by ½" long was glued over the LDR. There are several reasons for this: it affords protection for the LDR; it shields the LDR from ceiling lights, and although it is immune to daylight, it tends to "water down" the AC light source and render it less sensitive without the shield. In some situations, the shield is not necessary.

To hold the microphone insert in place under the lid, a similar piece of tubing about ¼" long and split along its length, was glued to the underside of the lid with the Mic inserted in the tube while the glue set. It holds it firmly in place and allows the Mic to be removed when it is necessary to remove the lid from the box.

Touch on/Touch off Switch - Figure 5

To achieve the "touch on/touch off" effect, a CMOS 555 timer chip is used in a rather unorthodox manner. Its extremely high input impedance is utilized by coupling the "hum" picked up by the human body from electrical wiring, to the trigger, pin 2. This occurs when a finger or any part of the body contacts pin 2.

The 555 is wired up as a conventional monostable which, when triggered, delivers a fairly fast single square wave to a JK flip-flop (IC1). The flip-flop acts as an electronic toggle switch; alternately switching on and switching off transistor Q1 at its output, each time the 555 trigger is briefly touched.

To obtain reliable hum pick-up, it is necessary to tie pin 2 to very high value resistors (R4, R5). These resistors of 20Megohm each could not be purchased for the proto-type so two 10Meg's were connected in series. A short length of wire with a small brass washer soldered to one end was connected to the junction of R4, R5 and pin 2. A small plastic box with an aluminum lid was used to house the circuitry and the washer was placed under the lid at one corner and the lid secured with its four fixing screws. The lid therefore serves as an ideal touch plate.

The unit was kept neat and compact by using the smallest "Experimenter Box" from Radio Shack (270-230) and making up two circuit boards, one containing the 555 chip and the other, the flip-flop chip. These were placed one on top of the other with insulation tape in between.

Touch/Timer Switch - Figure 6

This unit functions in a similar manner to the touch switch just described, with the exception of the flip-flop. Just a brief touch initiates a time interval determined by the setting of the variable resistor (Pot.) VR1.

The high value resistor between pin 2 and ground is not required in this application. Note that if we were using the standard 555 chip, the buffer transistor Q1, would probably not be necessary as it is capable of sourcing up to 200mA. In the case of the CMOS version however, the transistor must be used to drive the relay.

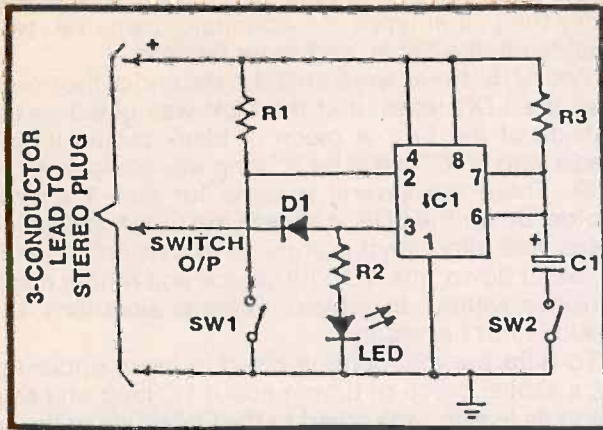

Figure 7. Tilt-on/off or timer switch

PARTS LIST FOR ON/OFF OR TIMER TILT SWITCH

- R1—22K resistor
- R2—470 ohm resistor
- R3—1M resistor
- D1—1N914 diode
- LED—Red light emitting diode
- IC1—555 timer IC
- C1—220uF electrolytic capacitor (16V)
- SW1—Mercury tilt switch
- SW2—SPST slide or toggle switch
- Misc.— $\frac{1}{8}$ " stereo plug; 3Ft. 3-core cable; 8 pin IC socket; plastic box; Velcro strapping as req'd.

Tilt on/off or Timer Switch

Little explanation is needed for this unit. It is a conventional monostable time switch, using a standard bipolar 555 IC. The mercury tilt switch (SW1) is the trigger mechanism. Switch SW2 isolates the timing capacitor when only the "on/off" is required. If the user has the switch strapped to their wrist and turns the wrist about 90 degrees and keeps it there, it will hold the relay on until the switch is returned to its original position.

With SW2 closed, the user can initiate the time period by briefly turning the wrist one way, then the other. In fact, once the timing starts, subsequent movement of the wrist has no effect on it but it can be aborted if SW2 is opened. This may prove difficult though if the user is disabled. Variable time periods were not provided for in the proto-type but can easily be installed, similar to the circuitry shown in Figure 6.

Velcro Strapping was glued to the bottom of the box in the proto-type and was found to be quite effective in holding it finally on the wrist. It should work equally well on the forehead.

One final piece of equipment requiring some discussion regarding its preparation is the AC light beam source used in conjunction with the Sound and Light Sensor Switch. For the proto-type, a small plastic flashlight was used which worked well over a distance of several feet but you may come up with a better idea or perhaps find something ready-made.

The batteries were removed and a small hole was drilled in the end of the flashlight (see photo). Two

strands of wire were stripped from the rainbow cable and passed up through the body, then soldered to the bottom terminal of the bulb and its metal holder. The cable was knotted just inside the end of the body to prevent strain on the solder connections. A 6 volt heavy-duty bulb was chosen which matched up with a suitable transformer tapping and if anything, it slightly under-powered the bulb to ensure long life, keeping in mind that changing the bulb involves soldering.

A 3/32" mono plug was fitted to the other end of the cable. Just a reminder that the Mode Switch on the Central Control Unit should be switched to "NC relay contacts" so that when the light beam is directed at the photo-cell, the contacts will open. Breaking the light beam will therefore operate your electrical appliance.

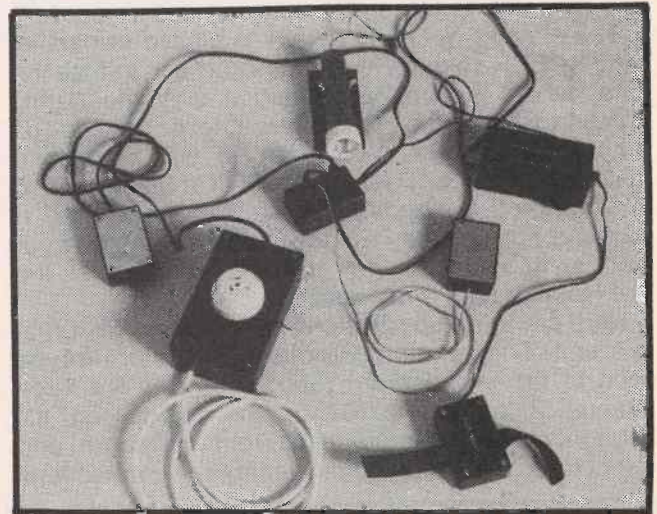

Four of the proto-type electronic switches are shown here plugged into a junction box for use by several people. Note the converted flashlight, which provides a low voltage AC light source.

A simple flashlight stand was made up from a tool clip purchased from a hardware store, and a piece of plastic sheet which served as the base. An alternative and perhaps better method is to attach both the sensor switch and the flashlight to a rigid base board, with provision for removal of the sensor switch when it is needed in another application. This would obviate the need to align the beam each time it is used and lessen the risk of knocking it out of alignment. ■

Publishers note: The power socket seen in the photo is an Australian design.

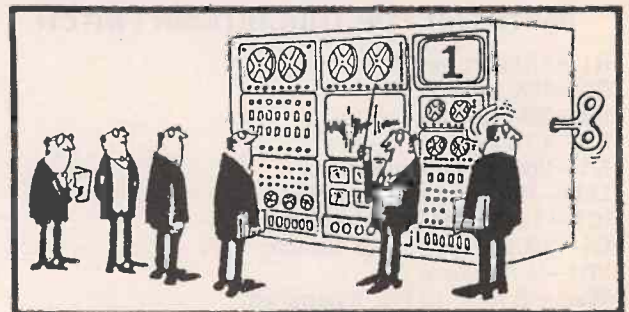

THE CATALOG CORNER

If you live in a relatively remote area that doesn't have ready sources for electronic parts, you can send away to numerous supply houses, who have good catalogs of electronic parts and assemblies...many of them real bargains.

Following are several catalogs that we have recently received in the mail, with brief descriptions and comments. Most of these suppliers send out new catalogs every four to six months, with many of the items repeated and new ones added, plus some new "specials"...usually on the first couple pages and the last few pages of each issue.

PAN-COM INTERNATIONAL

Plans, kits, and books for the electronics hobbyist are what you'll find in the latest catalog from Pan-Com International. What kind of plans, you ask? Well, for the ham and SWL they've got transmitters, receivers, test gear, and antennas. If you'd like to communicate without a license, there's plenty of information related to the 1750-meter experimenter's band. Amateur and professional sleuths will revel in the wide assortment of clandestine devices—miniature transmitters, bug detectors, parabolic microphones, voice scramblers, and the like. Science projects include such things as Tesla coils, Geiger counters, Van de Graff generators, and an earthquake detector (de rigueur if your house is near a fault line). Then there are metal detectors, a stun gun, and a whole slew of other interesting things. For a catalog, write to **Pan-Com International, P.O. Box 130, Paradise, CA, 95967-0130. Or telephone (916) 534-0417.**



GLOBAL COMPUTER SUPPLIES

Ever notice how a particular product or industry tends to spawn subordinate products or industries? For example, would there be any need for suspenders if nobody wore trousers? And what purpose would hubcaps serve if someone hadn't invented the wheel? Do you see what we're getting at? Well, we won't belabor the point any further, except to note that the computer has generated a huge market for supplies and accessories, and that anyone needing such accessories would do well to acquire the latest catalog from the folks at Global Computer Supplies. Global's 162-page catalog lists just about every accessory a computer could need. They've got all sorts of computer furniture, printer ribbons, diskettes, magnetic tape, data binders, cleaning supplies, printers, plotters, scanners, software, surge suppressors, and cables. For a free copy of the Global catalog, write to **Global Computer Supplies, 11 Harbor Park Dr., Port Washington, NY, 11050; or call 1-800-845-6225.**



POMONA ELECTRONICS

It is impossible to browse through the new catalog of electronic test accessories from Pomona Electronics and not be struck by the realization that we as electronics enthusiasts use a bewildering array of different jacks, plugs, terminal strips, and sundry other items to connect one electronic circuit with another. Wouldn't it be simpler if there was just one type of plug and one type of jack? Was the Fahnestock clip really so bad? Ah well, things have gotten way out of hand now, and there's little sense in pining for simpler times. Instead, why not obtain a copy of Pomona's new catalog, so that the next time you need a plug or a jack or a clip that you can't buy locally or find in your junk box, all you'll have to do is send an order to Pomona. That's **Pomona Electronics, 1500 E. Ninth St., Pomona, CA, 91769. Telephone (714) 623-3463.**

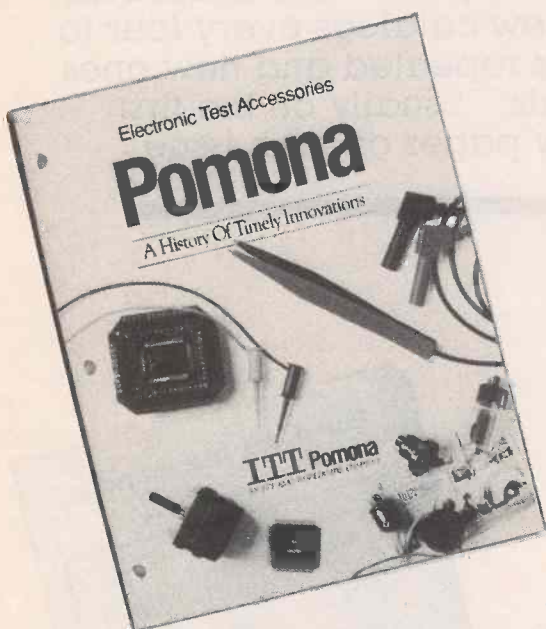

CONSOLIDATED ELECTRONICS

Consolidated Electronics is the distributor of a wide array of electronic parts. Their latest catalog is a good source of all kinds of semiconductors, including the often hard-to-find Japanese transistors and ICs. For all those tube lovers who say phooey to transistors, Consolidated has a good selection of vacuum tubes, ranging from the venerable OA2 to the 12AX7 and beyond. And then there are all the usual circuit components you'd expect to find, like resistors, capacitors, switches, plugs, jacks, and so forth. Tools and test equipment are also well represented; the familiar brand names featured include B&K Precision, Beckman Industrial, OK Industries, Goldstar, and Simpson. We've probably neglected a lot of things, but that's OK because you can get the whole story by requesting a catalog from **Consolidated Electronics, 705 Watervliet Ave., Dayton, OH, 45420-2599. Telephone (800) 543-3568.**

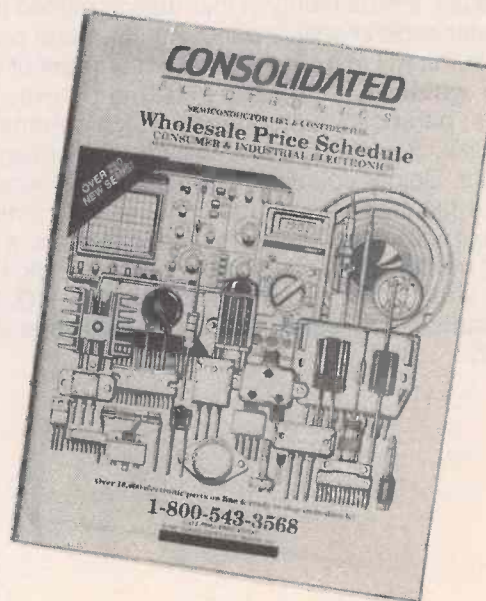

CONTACT EAST

If you happen to be in the market for new test gear, you'll want to check out the latest full-color catalog from Contact East. This magazine-size publication contains 195 pages worth of tools and electronic test equipment that will be of use to the technician, engineer and hobbyist.

They've got the old standbys such as multimeters, oscilloscopes, frequency counters, signal generators, capacitance meters, and power supplies. In addition, there is an especially good selection of more esoteric test equipment—things like electronic thermometers, calibrators, memory-chip testers, EPROM programmers, sound-level meters, wattmeter, high-voltage insulation testers, and data-network analyzers. Lots of hand and power tools useful in the construction or repair of electronic equipment are also featured.

You can obtain a free copy of the Contact East catalog by writing to **Contact East Inc., 335 Willow St., North Andover, MA, 01845-5995. Telephone (508) 682-2000.**

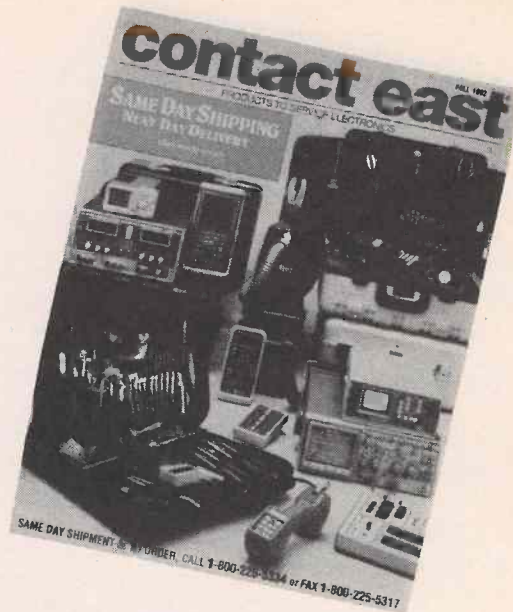

DIGI-KEY

Newcomers to electronics often have a hard time trying to find all the parts needed to build the projects they find in magazines like **Electronics Handbook**. Mall stores like Radio Shack find it impossible to stock every conceivable electronic part, and so they carry only the most popular components. The upshot of this is that most of us have grown accustomed to ordering the parts we need by mail, and then waiting weeks for the components to arrive. Well, if you're fed up with waiting, you might want to give **Digi-Key Corp.** a try. The cover of **Digi-Key's** latest magnum opus (250 pages) promises same-day shipment on orders placed by 3:00 PM central time. Along with fast service, **Digi-Key** provides an almost overwhelming selection of components from which to choose: integrated circuits, resistors, capacitors, connectors, transformers, test gear, switches, etc. Write to **Digi-Key Corp., P.O. Box 677, Thief River Falls, MN, 56701-0677. Phone (800) 344-4539.**



LEADER INSTRUMENTS

The new catalog from **Leader Instruments** is a 118-page, full-color showcase for the wide range of electronic test equipment made by this company. You'll find a good selection of oscilloscopes with specifications ranging from general-purpose to advanced. Some of the scopes are conventional analog models, some are digital-storage types, and some are scope/multimeter hybrids with LCD displays that fit handily into an attache case.

In addition to oscilloscopes, Leader makes video test equipment such as NTSC color bar/pattern generators, vectorscopes, and wave form monitors. Need audio test gear? Leader's got that, too—everything from low-distortion signal generators to sensitive AC millivoltmeters. Finally, anyone who services radios, TVs, or communications gear will be interested in Leader's lineup of RF signal generators and frequency counters. Contact **Leader Instrument Corp., 380 Oser Ave., Hauppauge, NY, 11788. Telephone (516) 231-6900.**

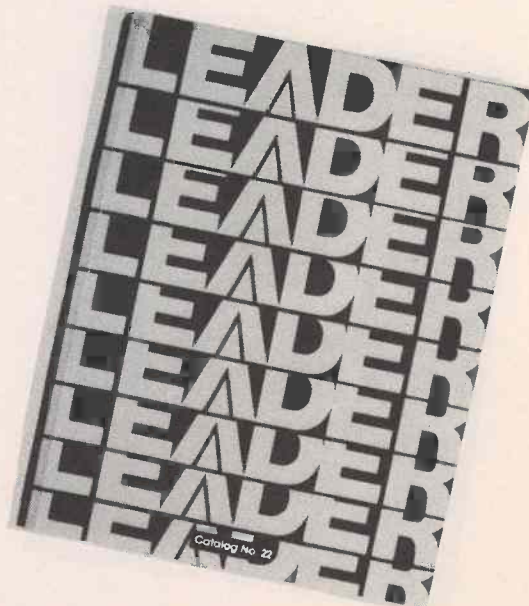

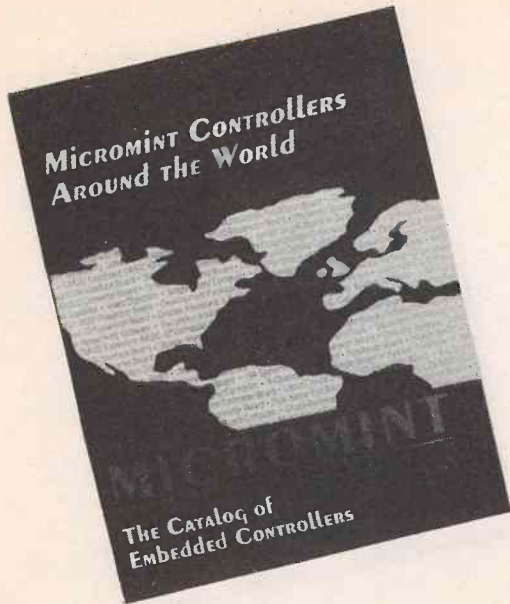

MICROMINT

Highlighted in the new catalog from **Micromint** is a wide array of embedded controllers and support equipment. What's an embedded controller, you ask? It's the electronic industry's buzzword for a microcomputer used to control the operation of a product whose function is something other than pure computation. For example, the microcomputer that controls the operation of an autofocus 35-mm camera or a microwave oven would be considered an embedded controller. **Micromint** is one of the industry's leading suppliers of board-level embedded controller products (**board level** meaning that the microprocessor and most of its needed peripherals, like memory, are supplied assembled and tested on a PC board, and all that you need to provide is some interface circuitry and the software to run it). Great things can be accomplished with an embedded controller and a little imagination, and if you're up to the challenge, contact **Micromint Inc., 4 Park St., Vernon, CT, 06066. Phone (800) 635-3355.**

CIRCUIT SPECIALISTS

Whether your interest in electronics is casual or serious, you'll want a copy of the latest catalog from **Circuit Specialists** on your desk. The folks at **Circuit Specialists** have been in business a long time, they ship your merchandise quickly, and they don't stick you with a \$25 minimum order as some other suppliers do.

Merchandise in the **Circuit Specialists** catalog runs the gamut from components to computers, tools to test gear. The listing of integrated circuits and discrete semiconductors is extensive, making this an excellent source for all those chips you can't find elsewhere. In addition, the company also carries a nice selection of reasonably priced test equipment, including DMMs and oscilloscopes. Last but not least, they've got resistors, capacitors, enclosures, and printed-circuit supplies. For a copy of this catalog, write to **Circuit Specialists, P.O. Box 3047, Scottsdale, AZ, 85271. Or call (800) 528-1417.**

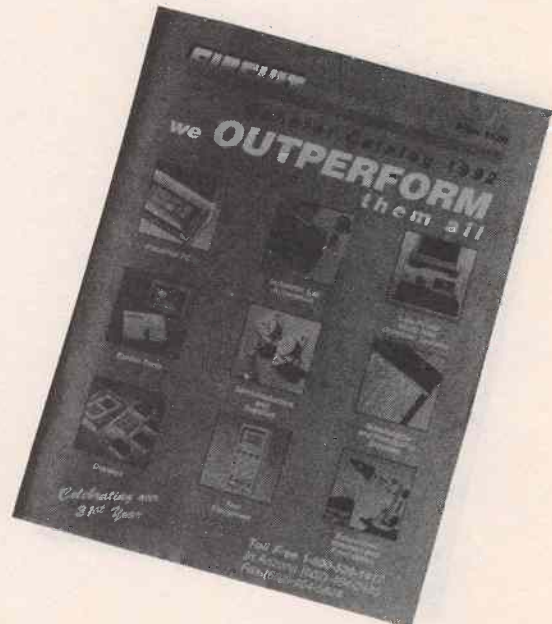

DAVIS INSTRUMENTATION

Need an instrument of some sort, but can't seem to find it anywhere? Well, before you give up, why not give **Davis Instruments** a try? Their latest 912-page catalog is loaded with all kinds of instrumentation — not just the usual electronic test gear, but real oddities as well.

Davis stocks sensors and instruments for measuring a broad range of physical properties, including air velocity, pressure, flow, liquid level, temperature, humidity, dew point, moisture content, power, voltage, current, rate of rotation, vibration, sound level, light intensity, force, thickness (of coatings), pH, gas concentration, and weather variables (wind velocity, rainfall, etc.). Complementing the lineup of instruments, Davis offers calibrators, data recorders, process indicators, and data acquisition systems. A good selection of reference books is also featured. Contact **Davis Instrument Co., 4701 Mt. Hope Dr., Baltimore, MD, 21215. Phone (800) 368-2516.**

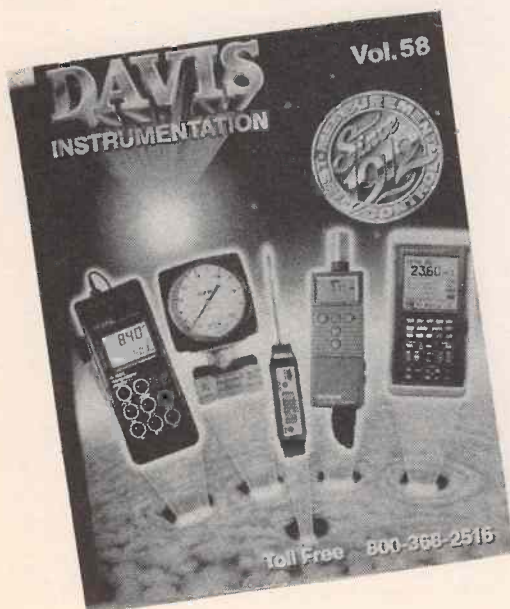

IC TESTBENCH

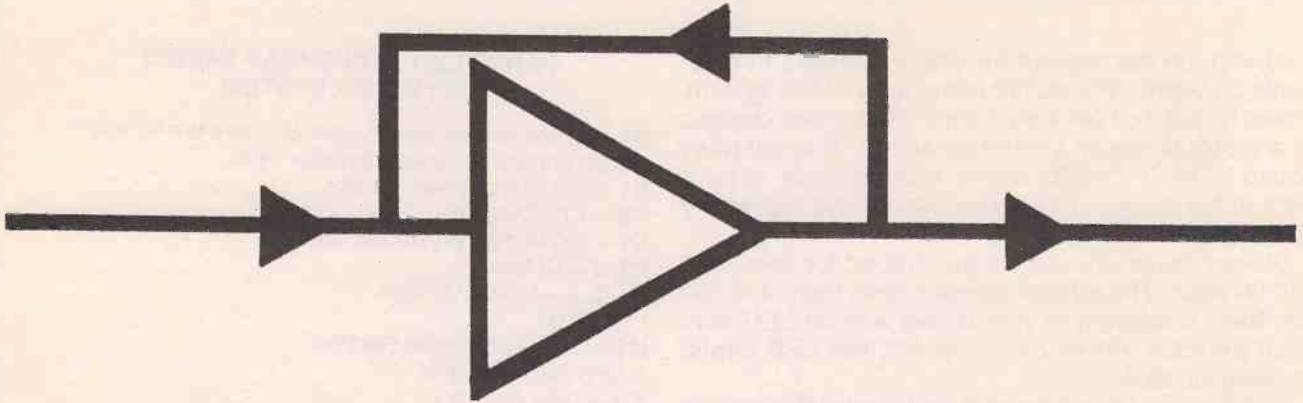

While integrated circuits are basically composed of groups of transistors and other common electronic components, many, if not most, of them require special handling techniques, therefore, it behooves the inexperienced project builder to try some of the simpler transistor projects in this issue to become familiar with the components involved before attempting these more complicated projects.

Some types of integrated circuits, especially CMOS, are susceptible to damage in some very strange ways. To protect your investment in these components, we offer some important suggestions and precautions for the handling of the ICs used in the following projects. We strongly suggest that you become acquainted with these precautions before you even take a trip to your local parts supply store to make a purchase.

Even though almost all devices are now designed with resistor/diode protection circuits on the input leads, it is possible for the static electrical charge built up in your body to cause damage to parts of the IC and you'll never know it happened until it is too late. It might be a good idea to invest in a pair of non-conductive tweezers, or a standard IC puller/installer made expressly for the purpose.

If you solder the IC leads directly into the circuit, which we don't recommend, be sure to use a heat sink on the lead between the chip and the tip of the soldering iron.

Use a low power iron, and apply heat for the shortest period possible. Always ground the tip of the iron before applying it to an IC. Stray AC in the tip of the iron can also damage a chip severely, and again, you'll never know until it's too late.

CHEAP SMOKE DETECTOR SYSTEM



Always on the lookout for cheap answers to electronic problems. The author came up with this system. Power is supplied centrally from a battery and charger, to a group of cheap smoke detectors. A small relay added to each detector allows each detector to be a zone in the system. This allows you to save big money on a 'system' installation.

Smoke detectors can be purchased for less than \$10.00 each. This system interconnects them and you can have a diagram of your house with an LED from each detector. When one goes off, the LED lights, showing location.

Switches for "Pull Stations" and heat detectors, as well as flow switches can be added, along with trouble circuitry and line supervision. All that you want to use can be added, even a dialer to call the fire department.

The objective of this circuit is to save money on smoke detector based systems. Most smoke detectors for system-use cost over \$50.00 each.

PARTS LIST FOR CHEAP SMOKE DETECTOR SYSTEM

- B1** — 12 volt battery and charger. Should have 10 mA charge current per smoke detector used.
 - R1** — 390 Ohm, 1/2 watt resistor
 - R2** — 4.7K Ohm
 - C1** — 100 Mfd 35 WVDC capacitor
 - C2, 3** — 10 Mfd
 - D1, 2, 3** — 1N4007 diodes
 - L1** — LED
 - Q1** — Silicon Controlled Rectifier
1 Amp min. @ 50 PIV
 - IC1** — 7809 regulator
 - K1** — Relay, SPST, normally open, 9 volt coil
 - Smoke Detector** — First Alert simple version or equivalent.
 - S1** — Normally closed pushbutton, SCR reset switch
- Note:** 9 volt battery clips were used to connect power to the smoke detectors, connection polarity is important, wire as shown!

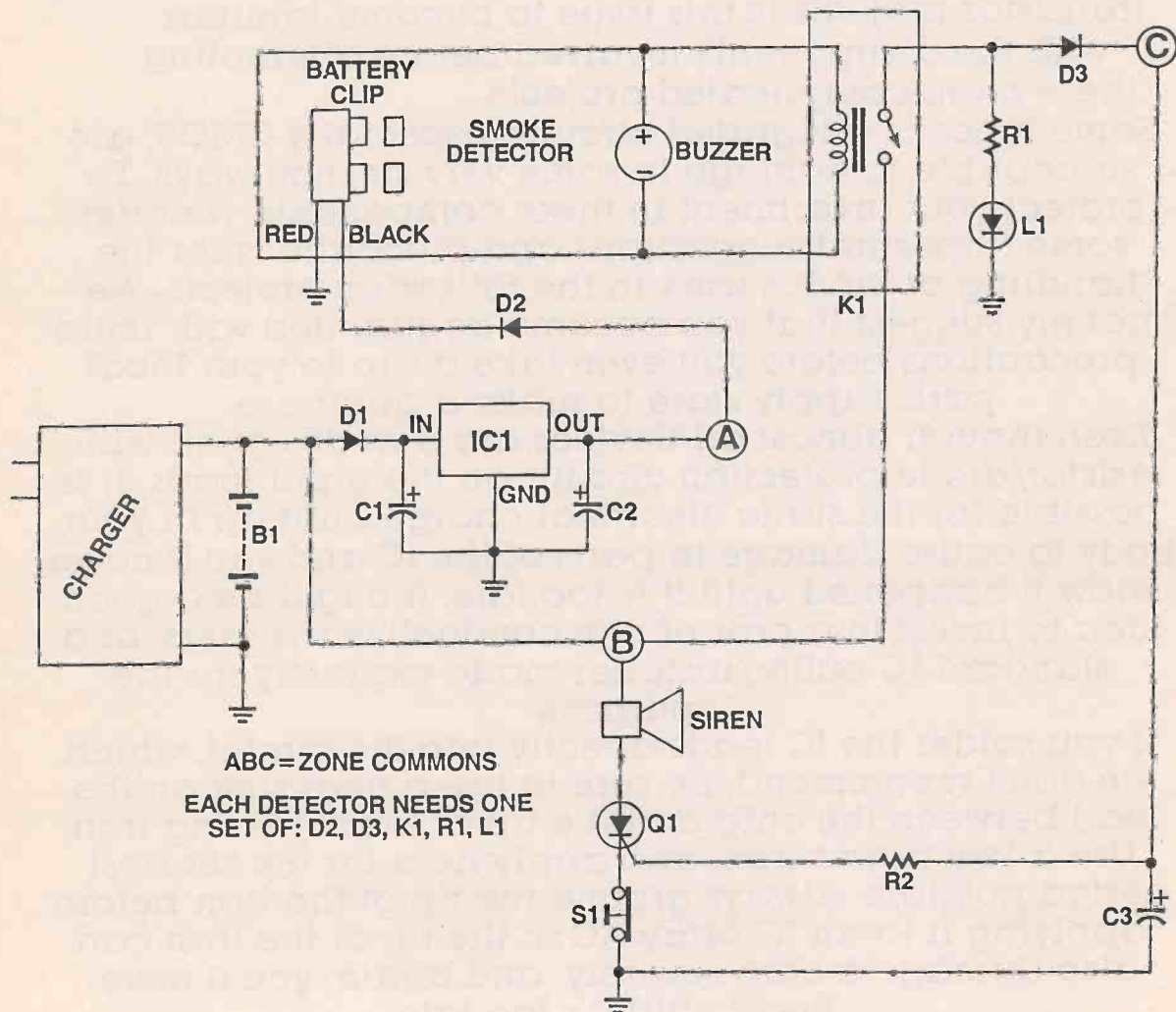

CUP-LIGHT FLASHER



The author got the idea for this "flasher" when he saw this translucent reddish plastic cup with a gemlike pattern for sale in a local drugstore, for about a dollar. No doubt drugstores in your area have similar cups for sale, if you are interested in trying this project.

This is a simple circuit that easily fits into the cup with batteries included and will convert the cup into an emergency flasher that can be used as an emergency signal for traffic while you make repairs or change a tire on a dark lonely road.

IC1 is a 555 timer that flashes about twice each second. This drives the Darlington transistor (Q1), which controls the LEDs.

The mercury switch controls the power. When the cup is right side up, it is off. Turn the cup over and the

LEDs receive power and flash intermittently.

Place the cup on the top of your car and it provides a perfect warning to approaching motorists and may even save your life.

PARTS LIST FOR CUP-LIGHT FLASHER

- R1, R2—560K Ohms, ¼ watt, resistors
- R3—150 Ohms
- C1—.1 Mfd, 50 WVDC, capacitor
- Rx—100 Ohms, 2 watt, resistors
- Lx—LEDs, preferably high brightness
- IC1—LM555V IC
- S1—Mercury Switch (Radio Shack #275-040) or equivalent
- Q1—TIP 120 Darlington Transistor

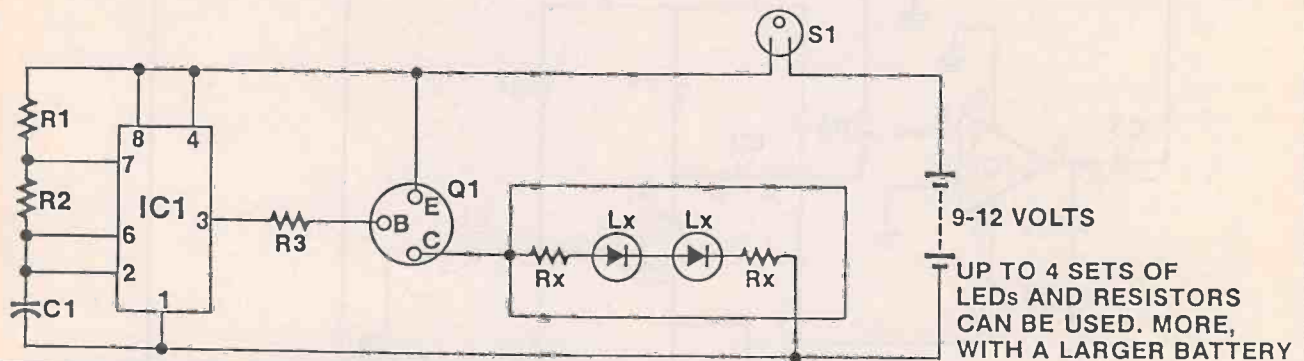

TWO STATION INTERCOM



If you have ever needed an inexpensive, two station intercom for your home or your shop, this circuit can do the job. It requires a minimum of parts, has reasonable output, and can be run from a 9 volt battery. Many of the parts used to construct this project, can be found in your junk box. The intercom uses only two speakers to transmit and receive, which also reduces the cost of construction. Once you use the two station intercom, you will find many uses for it.

How it Works

The two station intercom consists basically of a one transistor voltage amplifier, which is connected to a LM386 low voltage power amplifier, which provides current gain. Transistor Q1, is designed around a stabilized common emitter amplifier with a capacitor bypassing the emitter resistor. This circuit will provide maximum voltage gain, but lower input impedance. Resistors R1, and R2 form a voltage divider which biases the transistor for correct operation. Transformer T1 is used to match the

impedance of the 8 ohm speaker to that of the amplifier. The transistor amplifier is RC coupled to power amplifier LM386 through capacitor C4. Power amplifier LM386 is fixed for a gain of 20. Speaker 1 and speaker 2 are used for both transmitting and receiving. Capacitor C4 is a decoupling capacitor and is used to prevent the circuit from motorboating.

Construction Hints

The intercom can be either constructed on a perf board or wire wrapped. Make sure leads are short to prevent the circuit from oscillating. If you would like switches S1 and S2 to function as one switch, drill a small hole through the plastic part of the switch and drive a small nail or pin through the holes. If you hear feedback from the receiver speaker move it farther from the transmitter speaker or turn down the gain using potentiometer R5.

To operate the intercom, depress switch S3, and with your other hand slide both switches S1 and S2 up or down to transmit or receive. ■

TWO STATION INTERCOM

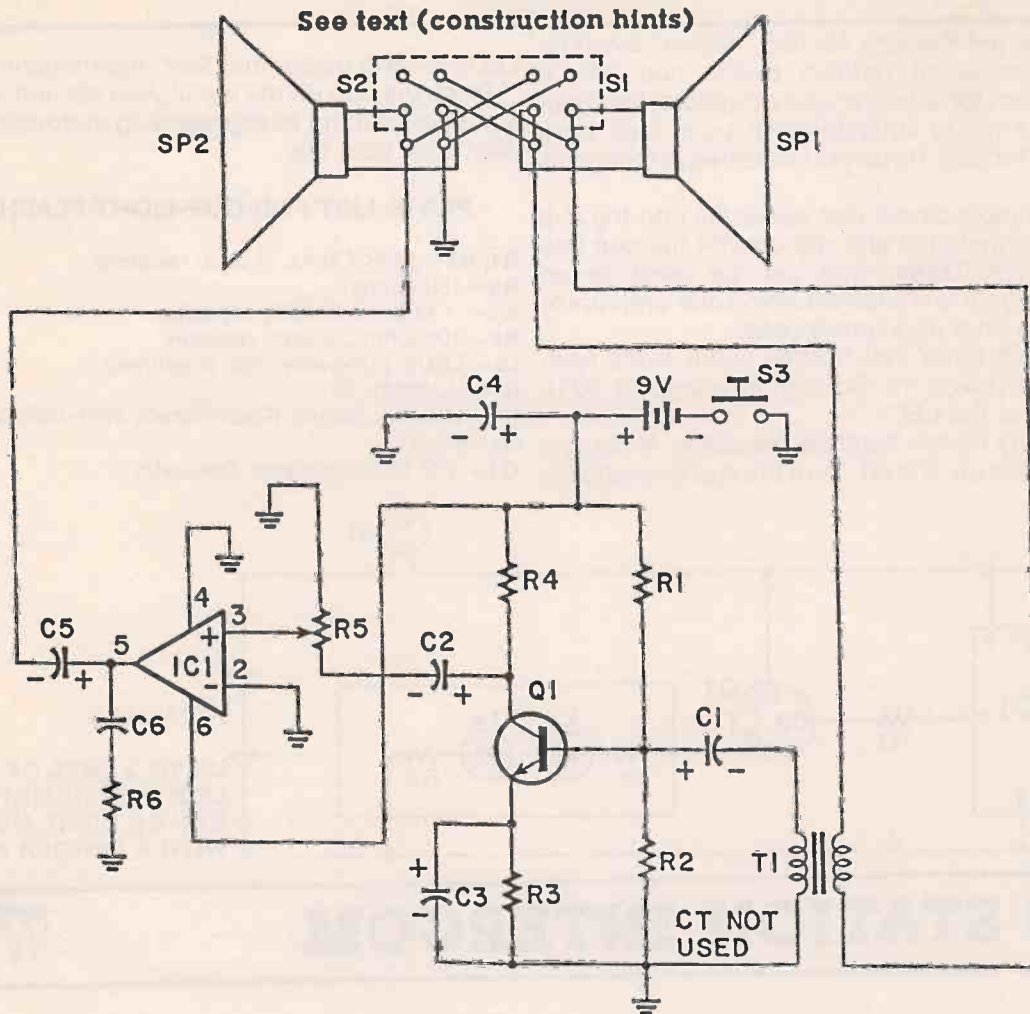

PARTS LIST FOR TWO STATION INTERCOM

- | | |
|---|---|
| C1, C2 —10uf 16 WVDC | R5 —10,000 - ohm audio potentiometer |
| C3 —47uf 16 WVDC | R6 —10 - ohm, ¼ watt |
| C4 —1000uf 16 WVDC | S1, S2 —Slide Switch DPDT (Radio Shack #275-403 or equivalent) |
| C5 —220uf 16 WVDC | S3 —SPST Momentary (Radio Shack #275-1571 or equivalent) |
| C6 —.047uF Ceramic Disc | SP1, SP2 —8 ohm speaker 1 watt (Radio Shack #40-248 or equivalent) |
| IC1 —LM386 Low Voltage Audio Power Amplifier | T1 —Audio Output Transformer 1000 - ohm center taped primary 8 - ohm secondary (Radio Shack #273-1380 or equivalent) |
| Q1 —MPS2222A, 2N3903, or equivalent | |
| R1 —6800 - ohm, ¼ watt | |
| R2, R4 —1000 - ohm, ¼ watt | |
| R3 —100 - ohm, ¼ watt | |

DOORBELL POWER SUPPLY



The title is somewhat confusing, as doorbells systems are typically powered by a transformer that is continuously producing from 8 to 24 VAC. This circuit could be best described as a power using supply as it takes the power generated by that transformer and puts it to continuous use.

Keeping that doorbell powered is not making use of the power without this supply. Typically, the supply will deliver one Amp of current at a voltage adjustable from about 3 volts to at least 12 volts, or in systems

using 16 or 24 volts, as high as 34 volts.

A problem with this circuit is its drastic loss of power when the doorbell is used. A way to compensate for this is to increase C1 to 10,000 Mfd and C2 to 3300 Mfd. The capacitors will help a little. For total elimination of the problem, C1 should be 2 farads!

This circuit makes a good battery charger or eliminator.

DOORBELL POWER SUPPLY

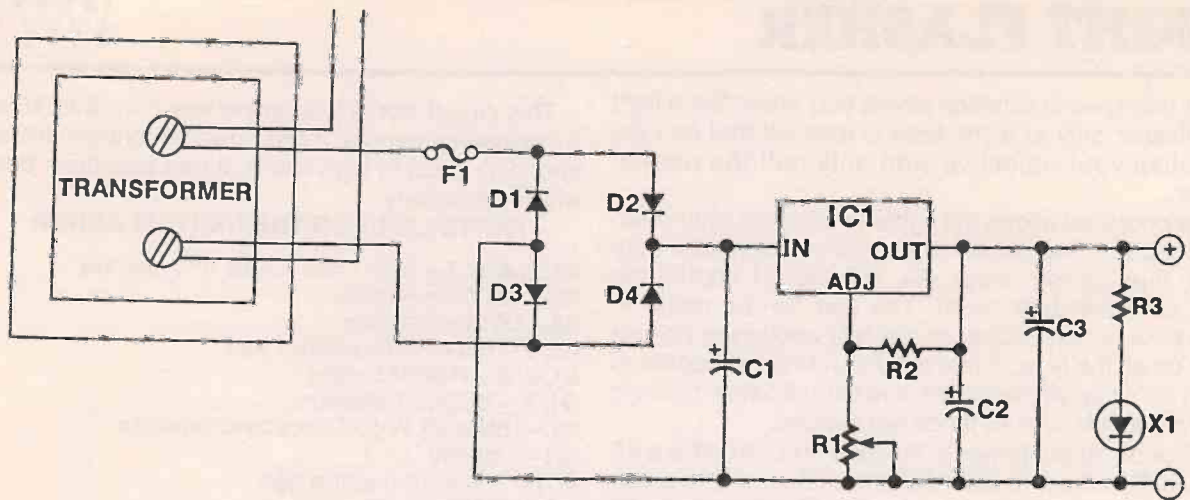

PARTS LIST FOR DOORBELL POWER SUPPLY

- | | |
|--|---------------------------------------|
| R1 —5K Ohm potentiometer (linear taper) | C2 —100 Mfd, 50 WVDC capacitor |
| R1 —330 Ohm, ¼ watt resistor | C3 —.1 Mfd, 50 WVDC capacitor |
| R3 —560 Ohm, ½ watt resistor | F1 —1 amp fuse |
| D1, D2, D3, D4 —1N4004 diodes | X1 —LED |
| C1 —1000 Mfd, 50 WVDC capacitor | IC1 —LM317 T IC |

CAR THIEF THRILLER



Ever think about what would happen if someone "borrowed" your car? It is not a pleasant experience even if your car may be what is politely classed as 'mature,' or not so politely, a 'beater.'

This little device, though not an alarm type circuit, would give crooks some thrills. The circuit blows the horn and flashes the headlights if the car is started without switching it off.

The switch for this device should be concealed carefully. Only people you trust should know where it is.

Changing the flash rate is accomplished by increasing or decreasing the value of C2. As shown, the circuit should cycle once per second.

Adding an additional relay would also allow flashing tail lights or brake lights. Or, you might want to have the radio come on real loud, or a tape playing through a

sound system. What you put on the tape would be at your discretion. Loud police car sirens, barking dogs, screams, whatever.

All the parts will mount inside a small box so it should conceal easily.

PARTS LIST FOR CAR THIEF THRILLER

- | |
|--|
| R1, 2 —100K ohm, ¼ watt resistors |
| R3 —1K ohm |
| R4 —10K ohm |
| C1 —100Mfd, 35 WVDC capacitor |
| C2 —10Mfd |
| D1, 2, 3 —1M4007 diodes |
| IC1 —1N555V |
| Q1 —2N2222 transistor |
| S1 —SPST Switch |
| K1, 2 —12 volt 30 Amp relays, Radio Shack #275-226 or Equivalent. |

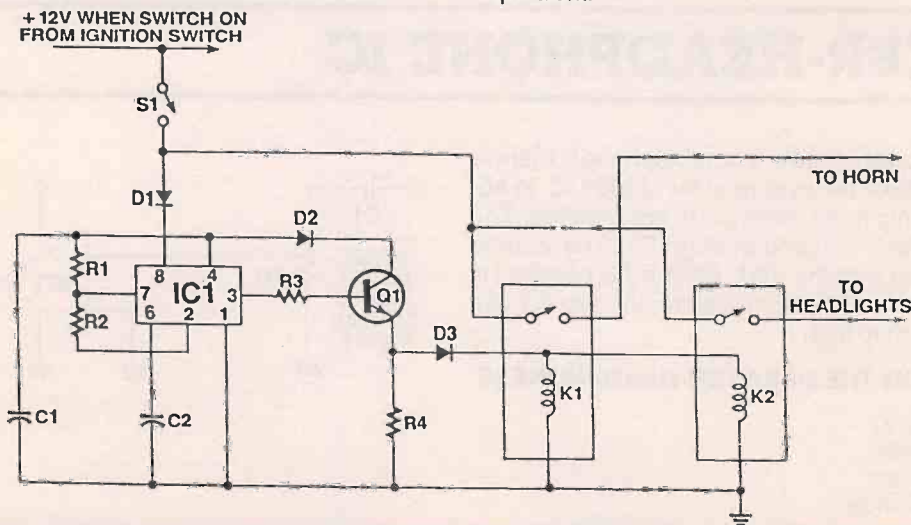

NIGHT FLASHER



For that special situation where you would like a light or a flasher only at night, here is a circuit that can accomplish your objective with only half the normal power.

The photocell allows the lights to come on only when it is dark. IC1, the oscillator, can be set for a 50% duty cycle, thus saving power. R4, R5 and C1 control the flash rate (the duty cycle). The unit can be made to flash slow or fast strobe, or run fast enough to appear to be on all the time. A fast repetition rate will appear to be on continuously since the eye cannot follow flashing at a rate much over 40 times per second.

D3 feeds output power to the load and can drive a 15 Amp SCR in order to flash AC powered lamps, or a pair of 2N3055s, switching 12 volts DC at as much as 18 Amps, if properly heatsinked.

This circuit works with anywhere from 6 to 15 volts. By adjusting outputs, it can power incandescent lamps and LED loads to high levels. It can also drive buzzers where necessary.

PARTS LIST FOR THE NIGHT FLASHER

- R1, 3, 4, 5, 7 — 100K Ohm 1/4 watt 10% resistors
- R2 — 10K Ohm Resistor
- R6 — 1K Ohm Resistor
- R8, 9 — 100 Ohm Resistors 1 watt
- D1, 2, 3 — 1N4004 Diodes
- Q1, 2 — 2N2222 Transistors
- C1 — 10Mfd, 25 WVDC electrolytic capacitor
- IC1 — 1M555V
- PC1 — Photocell, resistive type
- L1, 2 — LEDs

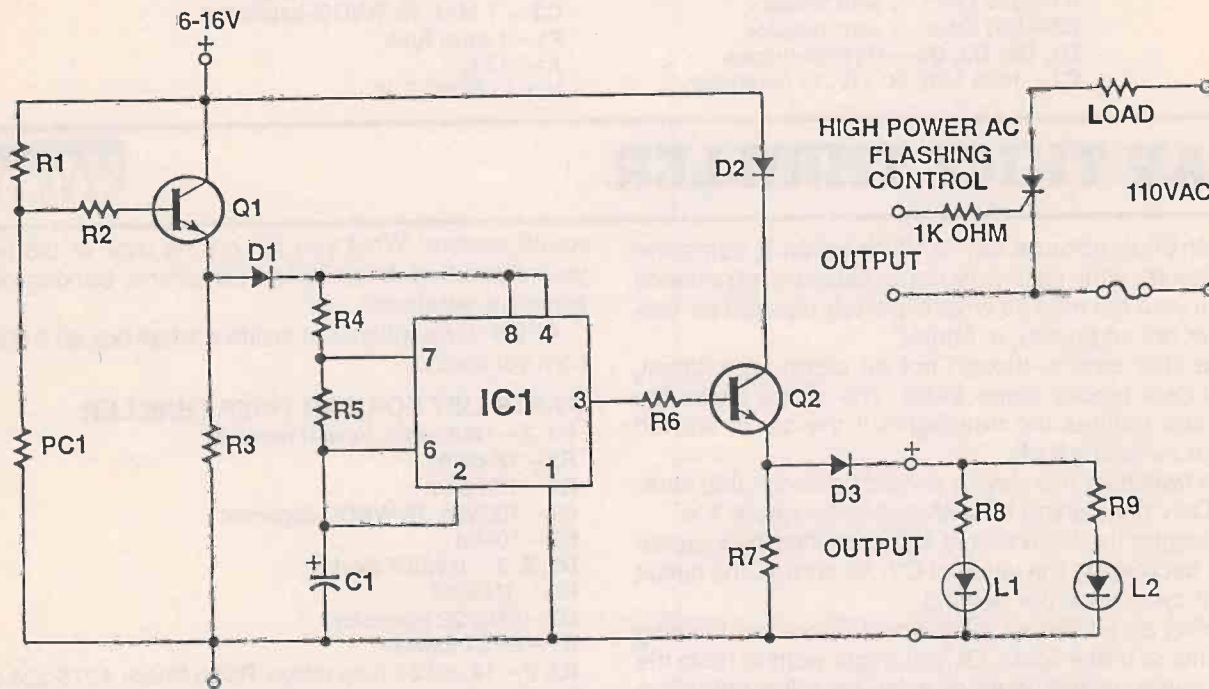

SPEAKER-HEADPHONE IC



For driving low power speakers or headphones, there is nothing that can beat the ever popular LM386 IC. In addition to the IC, only three other parts are required. The signal is capacitively coupled through C1. The volume control is achieved with the VR1. Output AC coupling is fed from C2. Gain is x20 and, therefore, the signal input has to be reasonably high.

PARTS LIST FOR THE SPEAKER-HEADPHONE IC

- IC1 — LM386 Audio IC
- C1 — 0.1 uF Capacitor
- C2 — 100 uF Capacitor
- VR1 — 10K Potentiometer

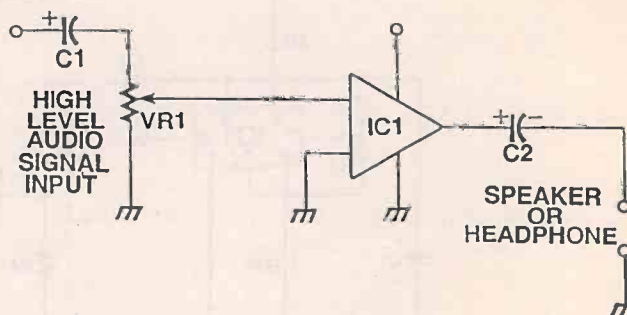

ELECTRICAL TROUBLESHOOTING

By George Williamson

Finding and fixing most electrical problems around your home can be both quick and easy. All it takes are a few inexpensive test devices and your common sense. You will need three testers, all of which are available from your local Radio Shack. First is the #22-103 AC Voltage Sensor. This little device detects power by the field it produces and, when held next to a wire or conductor, will tell you if power is present. Next is the #22-101 that tests outlets for proper wiring and will tell you if an outlet has power. Third is a simple Multimeter. This could be a #22-212, or one of the more expensive units. Most important is the ability of not only accurately measuring AC power, and DC for batteries, but also it should have an ohms or resistance range. All three should cost you less than \$40.00 total.

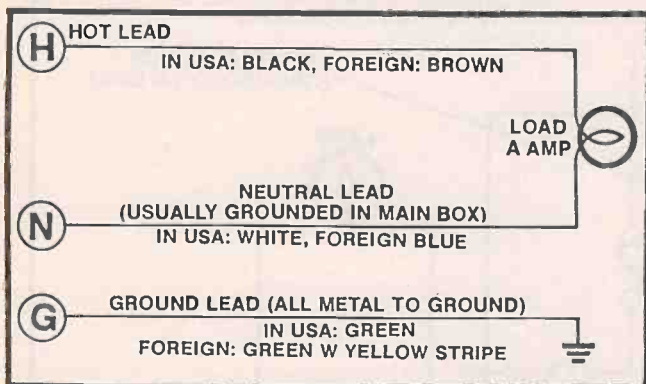

FIGURE 1
STANDARD 3-WIRE

If the short is in a device, such as a lamp, you should find and fix the short simply by measuring the resistance hot to neutral at the power plug and disconnecting bulbs one by one until the short clears. Should the wires inside the device be shorted, you will have to disassemble it and replace them. For shorts in the house wiring, it now becomes necessary to trace the circuit. With the power off the shorted circuit and on all other circuits, you can find out where the power is lost with the AC Sensor and the outlet checker. Once you have found all the lights and outlets that are not powered, begin checking their wiring. Especially check the hot wire that it is not grounded. And be sure to use the AC sensor to check for powered wires in the boxes. Sometimes, two or more circuits are in one box. Usually the problem will be found in an electrical box, outlet, switch, or device that is accessible. Repair is often a matter of replacing a switch, freeing a pinched wire, or grounded outlet receptacle.

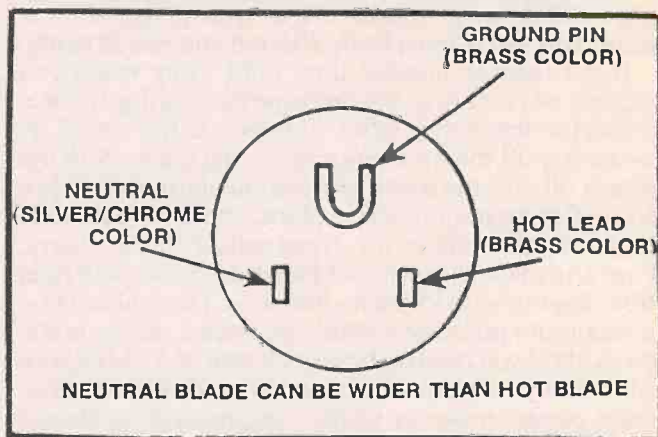

FIGURE 2
PLUG WIRING WITH BLADES FACING
STANDARD 3-WIRE

Finding an open circuit is usually easy as it involves only one light, outlet, or device. The AC Sensor and the Outlet Tester can help isolate the affected portion of the wiring. Once found, opens are easily fixed. Probably the most common cause is a loose or disconnected wire. This is common with aluminum wires and a good reason to replace them.

Often wires will loosen over time, and screws that hold down wires should be tightened when accessible during a repair. Another common problem involves overloads, or too much power drawn from a circuit. Check your circuits to not only locate what is powered by each, but also that no one circuit has too much current draw. Each appliance usually has current draw marked on its nameplate. Each lamp can be figured out thus: 120 watts is a current of one Amp.

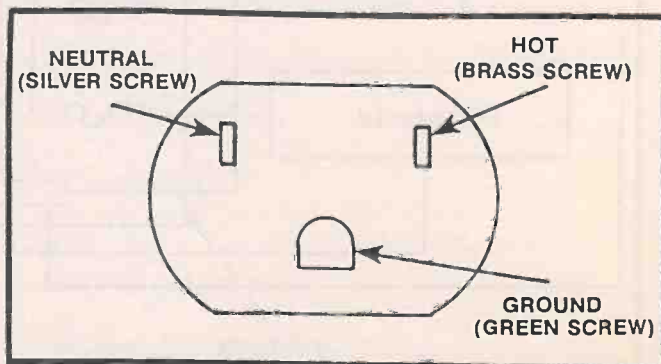

FIGURE 3
RECEPTACLE

Isolate The Problem

Now you are ready to isolate problems. To locate the cause of that blown fuse or circuit breaker, first unplug or shut off all the lamps and appliances on that circuit. Next, reset the circuit breaker or replace the fuse. If the power is protected by a standard screw in glass fuse, screw in a 60 watt lightbulb in its place. As you plug in each device that was on the circuit, watch for one that causes the light to glow bright, or that pops the fuse or breaker. What you plugged in or turned on last is most likely shorted and needs fixing.

If the fuse or breaker trips right away when you replace or reset it, or the lamp glows brightly, there is a short in the wiring. Shut off power to the circuit by switching off the breaker or removing fuses. With the power off, test the wires with the meter to see if it has a short. Set the multimeter to ohms, short the test prods together, and adjust the "zero adjust" if necessary. Find an outlet on the circuit that is off power and read from the hot wire to the neutral wire. There should be a maximum resistance reading unless a device is still on. A short will read 0 ohms or close to it. The hot wire will usually be black or brown but could be any other color except green or white. The "neutral" is always

white in the U.S.A. or blue in foreign countries. Green is ground and even foreign countries use green with a yellow stripe for ground.

Thus, a 60 watt bulb draws half an Amp. Add up the current draw on each circuit, and make sure the total current for each circuit is less than the Amp capacity of the fuse or breaker on it.

You should never increase fuse rating. Never replace a 15 Amp one with a 20 Amp or larger one, for instance. Circuit Breakers can cause a problem if they trip due to excess heat. They won't reset until they cool down. If you have one that will not reset, let it cool before trying it again. Should you have any difficulty in finding problems or if you have not worked with electrical wiring before, your local library has the Time-Life books on wiring that contain many pictorials which show how wiring is done and what to look for. These will aid you in becoming familiar with your wiring. One caution: Never touch live wires or exposed connections and always work on the wiring with the power off. Follow safe procedures.

These few tools and tips can save you substantial electrical repair bills. ■

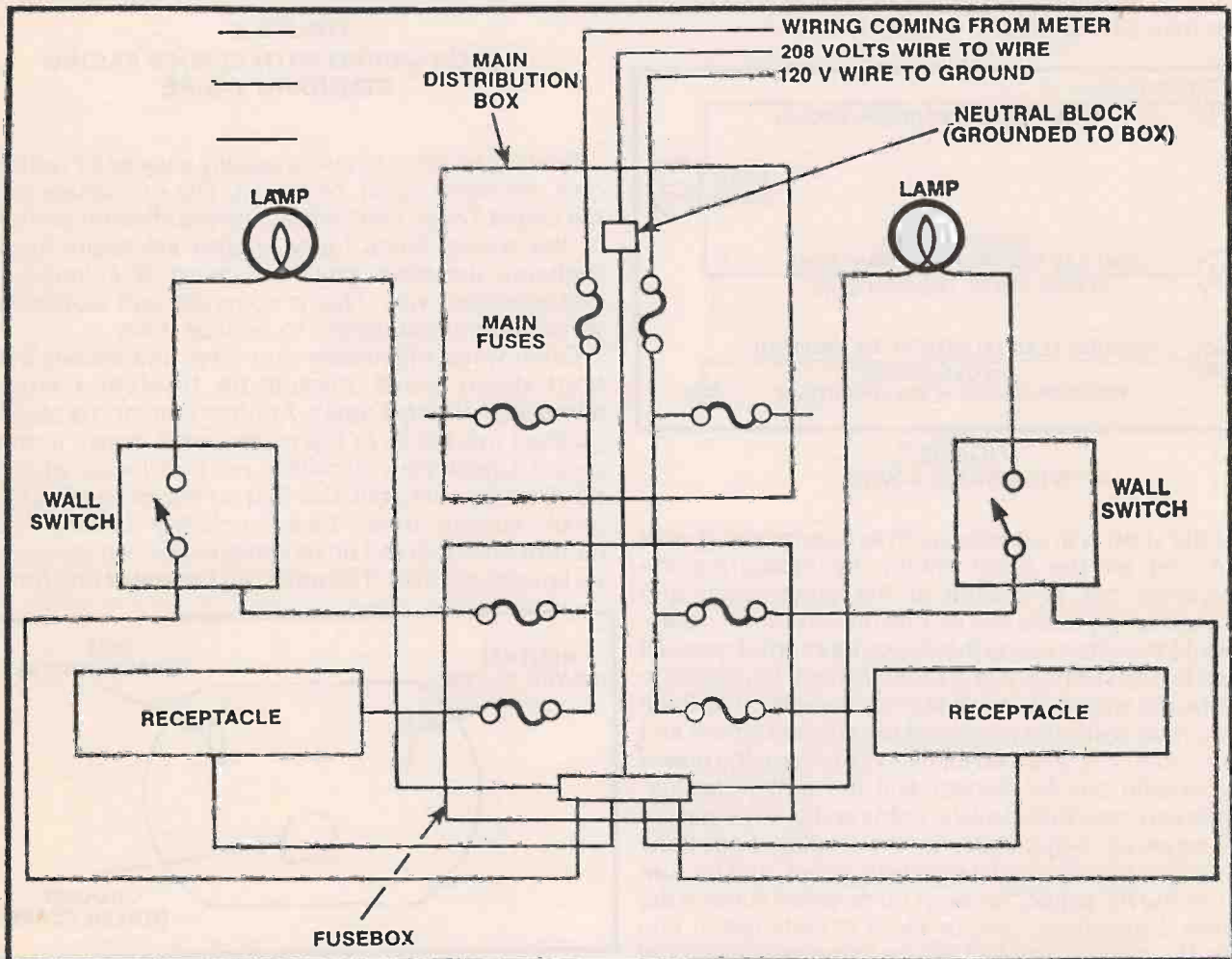

FIGURE 4
SIMPLE DIAGRAM OF HOUSE WIRING WITH FUSES

SOLID STATE UPDATE

Each month, the manufacturers of solid state components release literally hundreds of new devices. While we cannot report on all of these, we do intend to feature some of these devices that are most likely to interest our readers. For further information on any of these solid-state components, write directly to the manufacturers. They can provide you with data sheets and application notes at no charge.



BICMOS LOGIC

Over the years, we've seen continuous evolution in the design of digital integrated circuitry. This evolution has been directed toward two goals: greater speed and lower power consumption. Historically, we started out with RTL (resistor-transistor logic), moved on to DTL (diode-transistor logic) and HTL (high-threshold logic), and finally settled on TTL (transistor-transistor logic), which dominated digital design for almost two decades. The greatest challenges to TTL came from CMOS (complementary metal-oxide substrate) logic, which consumed less power than TTL but was slower, and ECL (emitter-coupled logic), which was faster than TTL but a real pig in terms of power consumption. Today, there's a new kid on the block. It's called BICMOS (for bipolar and CMOS), and it combines the low power drain of CMOS with the high speed of bipolar transistors. You can learn more about Motorola's BICMOS products by requesting manual DL141/D. Motorola Inc., Box 52073, Phoenix, AZ, 85072.

PRESSURE GAUGE KIT

Motorola has announced availability of a Compensated Bar Graph Pressure Gauge Kit that provides an economical method of converting pressure into a voltage compatible with microcomputer A/D inputs. This kit demonstrates how easy it is to interface Motorola's MPX2000 family of pressure sensors with digital systems. Circuitry of the kit converts the output of an MPX2100 pressure sensor into a 0.5-4.5V signal that in turn drives a 10-segment LED bar graph display. These evaluation boards are designed to provide a 15 psi full-scale pressure measurement. Any of the MPX2000 series of pressure sensors can be used on this board. The Compensated Bar Graph Pressure Gauge Kit contains a completely assembled PC board, application note, MPX2100 data sheet, MC33274 data sheet, and a sensor brochure. The kit costs \$75.00 and can be ordered from Motorola Inc., Literature Distribution Center, P.O. Box 20924, Phoenix, AZ, 85063. Request KITDEV147/D.

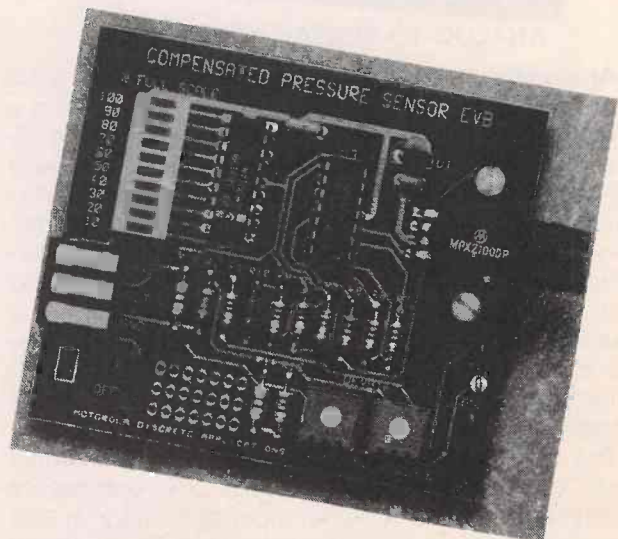

1993 IC MASTER

The 1993 edition of the **IC Master** provides revised and expanded IC specification data for more than 80,000 commercially available integrated circuits. The 3-volume set is organized to suit the user's needs. Volume I contains master selection guides in which ICs are organized by type, function, and key parameters.

Volume II is devoted to part-number identification, military parts, and alternate sources. The part number index helps to locate devices with the same base number, while the alternate source directory pinpoints second sources and functionally equivalent devices quickly and accurately. Application notes published by the various IC manufacturers are also listed.

Volume III is dedicated entirely to manufacturers' data pages and contact information. Also included is a directory of the addresses and phone numbers of manufacturers, sales reps, and distributors. Price is \$170 plus \$10 shipping. **Hearst Business Communications Inc.**, 645 Stewart Ave., Garden City, NY, 11530.

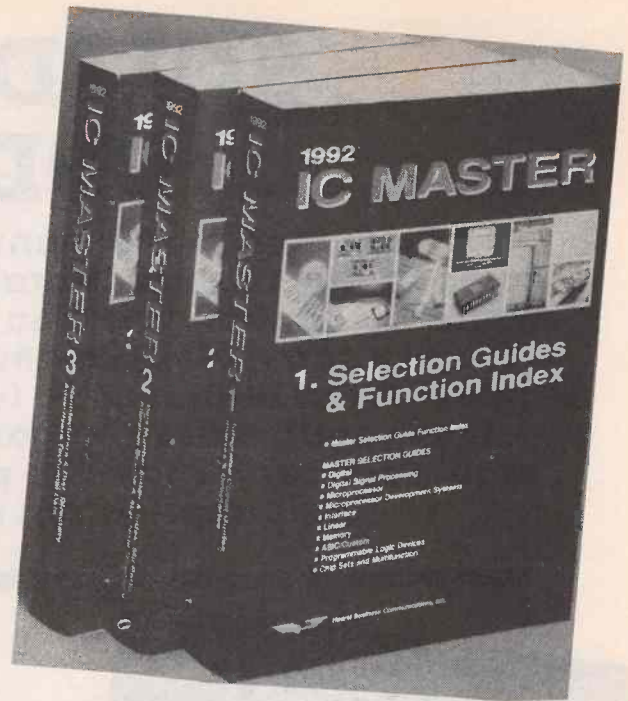

STEP MOTOR DESIGN GUIDE

Curious about DC stepping motors, but unsure of where to turn for information? Well, you're in luck, because **Superior Electric** has published the **Design Engineer's Guide to DC Stepping Motors**, a concise, no-nonsense introduction to stepping motors and their applications. Despite the booklet's imposing title, the material it contains is quite easy to understand; a rudimentary knowledge of algebra and circuit theory is all that's required of the reader. The text explains how DC step motors work, gives needed formulas, and describes typical application circuits. Once you've satisfied your curiosity about step motors, flip the book over and it becomes the **Design Engineer's Guide to AC Synchronous Motors**. Very clever. Once again, the booklet provides a description of motor characteristics along with relevant formulas and some design examples. Contact **Superior Electric Co.**, 383 Middle St., Bristol, CT, 06010.



ANALOG-TO-DIGITAL CONVERTER

Analog Devices' AD7880 is the industry's first 12-bit sampling analog-to-digital converter to operate from a single +5-volt supply, feature both AC and DC specifications, and offer a power-down (idle) mode. Primarily intended for battery-powered applications, the AD7880 guarantees no missing codes, 70-dB minimum signal-to-noise ratio, and +1 LSB (least-significant bit) differential and integral nonlinearity. Total harmonic distortion, intermodulation distortion, and peak harmonic noise specifications are all 80 dB. The power dissipation is low: even in normal operation the AD7880 dissipates just 20 milliwatts—and much less in the "idle" mode (3.75 mW max).

The monolithic AD7880 combines a track-and-hold amplifier, analog-to-digital converter, microprocessor interface logic, and a signal input attenuator in one package. **Analog Devices Inc.**, One Technology Way, Norwood, MA, 02062-9106.



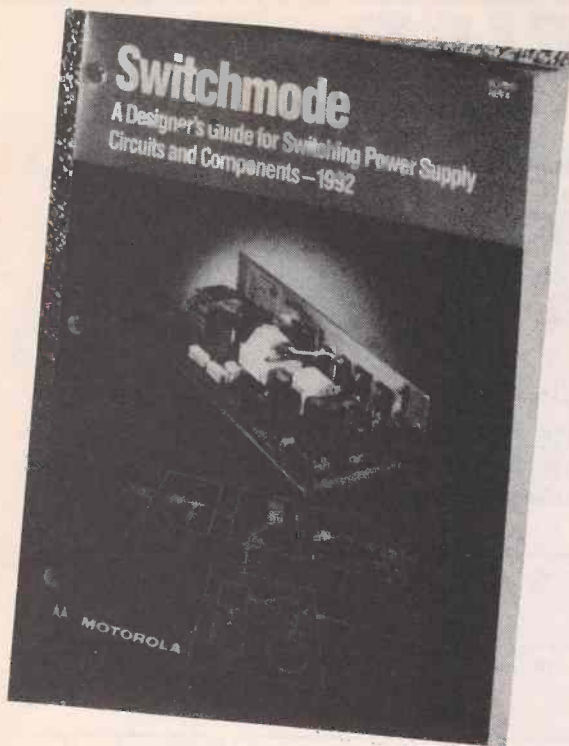

SWITCHMODE DESIGN GUIDE

From **Motorola** comes news of a new Switchmode guide, which is designed to give the prospective designer an overview of all the issues involved in designing switchmode power supplies. With the completely revised product selection charts, the designer can select all the semiconductor components needed for a switching power supply from this one source.

The guide describes the basic mode of operation of some of the more popular types of switching power supplies. Relevant parameters of the various circuits are described in detail. Also included are handy circuit design tips plus information on power-factor correction. Handy tables make it easy for the user to select the bipolar power transistors, power MOSFETs, rectifiers, zener diodes, reference diodes, optocouplers, control and supervisory ICs, and driver ICs required to build each circuit. **Free copy (#SG79/D) available from Motorola Inc., Literature Distribution, P.O. Box 20924, Phoenix, AZ, 85063.**

INDICATOR LIGHT DATA BOOK

The new data book from **Industrial Devices Inc.** features the firm's extensive line of indicator lamps. Three kinds of lamp are available: neon, incandescent, and LED. Application notes contained in the data book describe the characteristics of each type of lamp and provide suggestions for use. Neon lamps consume little power but produce relatively little illumination. Incandescent types are capable of providing higher light output, but consume more power and generally don't last very long. And LEDs are generally not as bright as incandescents, but they consume less power and last much longer. Picking the right indicator light for the job requires a knowledge of the relative strengths and weaknesses of each type of lamp. The **Design Engineers' Data Book** from **IDI** provides all the information you'll need to select just the right lighting component. For a free copy, write to **Industrial Devices Inc., 260 Railroad Ave., Hackensack, NJ, 07601.**

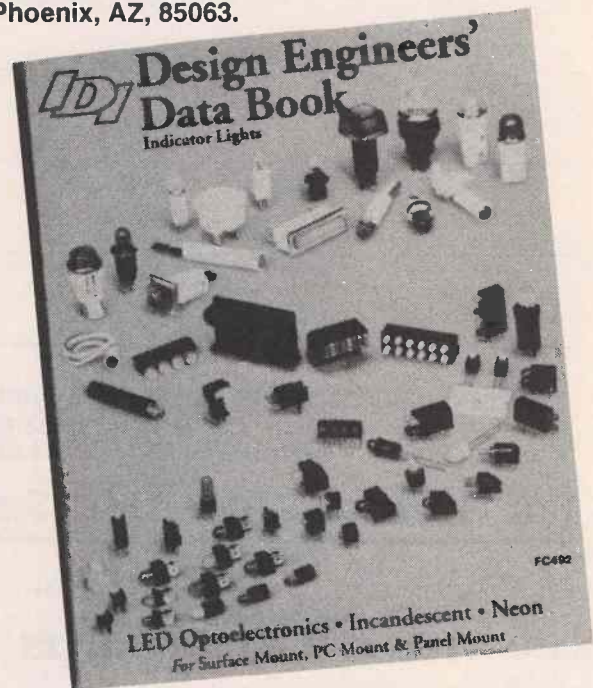

Motorola has announced the introduction of its new MOC2A40-10 POWER OPTO Isolator, the first in a family of optically isolated AC and DC power interface circuits. The POWER OPTO Isolator was designed in response to requests from the industrial-controls industry for a more rugged, reliable and thermally efficient POWER OPTO Isolator.

The MOC2A40-10 provides both optical isolation and medium power-handling capability. The device will handle 2 amps and 400 VAC peak, has zero-crossing detection, and an optically coupled triac output. The input can be driven directly from TTL logic. Furthermore, the device is rugged enough to survive in the harsh operating environments inherent in industrial control applications. Its thermally optimized SIP package allows high-density mounting on 0.2" centers. No heat sink is required, provided load current remains less than or equal to 2 Amps at 40° C. **Motorola Inc., P.O. Box 52073, Phoenix, AZ, 85072.**

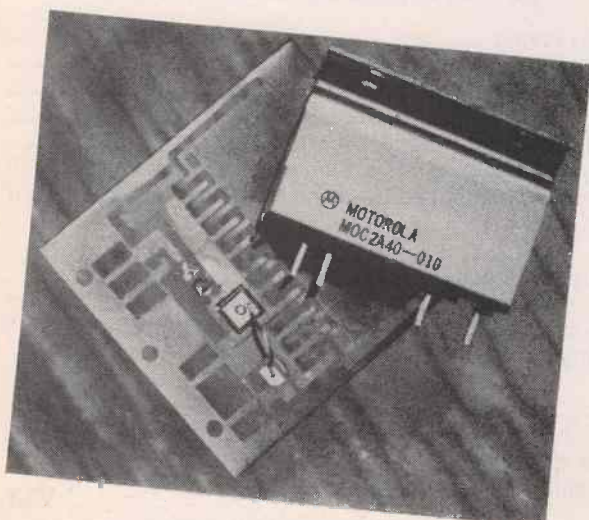

CLASSIFIED FLEAMARKET



NO CHARGE FOR ZIP CODE...NO CHARGE FOR CAPITALIZING FIRST WORD...ADDITIONAL WORDS IN CAPS—40¢

To run your own classified ad, put one word on each of the lines below and send this form along with your check

1	2	3	4	5	6
7	8	9	10	11	12
13	14	15	16	17	18
19	20	21	22	23	24
25	26	27	28	29	30

CLASSIFIED AD ORDER FORM. PLEASE PRINT EACH WORD SEPARATELY, IN BLOCK LETTERS.

The rate per word for CLASSIFIED ADVERTISEMENTS is \$1.00 payable in advance—minimum ad \$15.00. Capitalized words 40¢ per word additional.

For Greater Classified Savings...Results...and Profits...

DISPLAY RATES:

1"×2" (\$125), 2"×2" (\$225), 2"×3" (\$300), 2"×4" (\$400)

CLASSIFIED AD REQUIREMENTS

Minimum ad 15 words—Please remember to be sure to count your name and address—Count each Abbreviation (B.J. Jones = 3 words), Initial (W. Main Street = 3 words), Single Figure (P.O. Box 3333 = 3 words) or Groups of Figures (10 x 12, 35mm, F.O.B., etc = 1 word). Your Zip and State are one word each, there is no charge for your ZIP. Code numbers for keying count as one word.

There will be regular headings and when no heading is requested, our judgement will decide. If you desire a special heading, there will be a \$10.00 service charge.

Ads are set in uniform style with the first word in CAPS—Extra CAPS are 40¢ per word.

Proofs are not submitted on classified ads—correct insertion is guaranteed. There is no deduction for Key Number error due to illegibly written copy.

We reserve the right to refuse objectionable copy and revise copy to conform to our standards.

We also reserve the right to request literature and merchandise from the advertiser before accepting the ad. Advertisers using a P.O. Box must furnish complete name and address for our records.

C&E HOBBY HANDBOOKS

Call (201) 231-1518 or write to:
L. M. Gabree, P.O. Box #5148, North Branch, N.J. 08876

MAIL TO: C&E HOBBY HANDBOOKS—CLASSIFIED,
P.O. BOX #5148, North Branch, N.J. 08876

Your Name _____
Firm Address _____
Street Address _____
City _____ State _____ Zip _____
Telephone Number () _____

Advertisers using a Post Office Box number must furnish a complete street address and telephone number for our records.

Date Of Order _____
5% discount for the same Ad placed in 3 successive issues. 10% discount for the same Ad placed in 6 successive issues.

No. of words rate per word _____ equals remittance, less discount.
Remittance of \$ _____ is Enclosed.

V13

Lab Test
**ELECTRONICS
HANDBOOK**
For Yourself

Get switched on

In case you're not all that familiar with us, we're not a publication for electrical engineers and other wizards. No way, **ELECTRONICS HANDBOOK** is expressly for people who like to build their own projects and gadgets—and maybe get a little knee-deep in tape, solder and wire clippings in the process.

In fact, we have a sneaking suspicion that our readers like us because they think we're just as bug-eyed and downright crazy over great new project ideas as they are. And I guess they're right!

ELECTRONICS HANDBOOK thinks of you who dig electronics as the last of a special breed. It's more than just the "do-it-yourself" angle—it's also the spirit of adventure. In this pre-packaged, deodorized world, building your own stereo system, shortwave receiver, darkroom timer or CB outfit is like constructing a fine-tuned little universe all your own. And when it all works perfectly—it really takes you to another world.

IF YOU'RE NEW TO ELECTRONICS YOU GET A "BASIC COURSE"!

It gives you a complete, ground-floor lowdown on a variety of important electronic subjects. For example—Understanding Transistors...How Radio Receivers Pull In Signals...Cathode Ray Tubes Explained...How Capacitors Work...Using Magnetism in Electronics, and much, much more!



Of course, we can't make you a master electrician overnight. But we can show you the fundamentals of repair plus maintenance tips.

TRY A FEW ISSUES AND EVALUATE OUR...

- **HOW-TO-DO-IT HELP** Tips and pointers that add up to money saved. For example—tuning up your tape player...all about radios...whys and hows of turntables...care and feeding of speakers.
- **EXCITING DISCOVERIES.** Whatever your particular interest in electronics, you'll be entering a world of discovery in the pages of the **ELECTRONICS HANDBOOK**

Don't Despair...REPAIR!

Here's how to troubleshoot and repair your electronics successfully!

You Can Be Your Own Repair Expert!

For VCRs, camcorders, audio equipment, TV equipment, computer hardware, office equipment, home appliances, automobile electronics, and outdoor equipment.

- Pinpoint and analyze problems quickly.
- Successfully complete repairs with hands-on troubleshooting instructions.
- Become skilled understanding flowcharts and schematic diagrams.
- Confidently use test equipment such as oscilloscopes, frequency counters, and video analyzers.
- Keep your equipment in top condition with effective preventive maintenance techniques.

Continue to Broaden Your Repair Expertise!

You'll receive quarterly supplements, up to 160 pages, with new step-by-step repair and maintenance instructions, valuable schematics and new repair techniques. Learn how to repair a growing variety of appliances with hands-on repair projects that will keep you up-to-date with later models and technology. You'll be thrilled with your ability to repair a growing list of electronic equipment! Supplements may be returned or cancelled at any time.

Free Schematic Service!

Build a schematic library at no cost to you. As a paid subscriber you'll receive valuable coupons for your choice of schematic diagrams. No more hassles identifying manufacturers and ordering costly schematics from different sources! Redeem your coupons - through us - any time!

Order today for your 30-day, no-risk review of The Electronics Repair Manual.

For Faster Service Call TOLL-FREE
1-800-222-WEKA
Or Fax To: 1-203-622-4187

MONEYBACK GUARANTEE

There's no risk in trying the ELECTRONICS REPAIR MANUAL to see if it's right for you. If you are not delighted, simply return the manual after the 30-day trial period and receive a prompt refund.



97 Indian Field Rd.
Greenwich, CT 06830

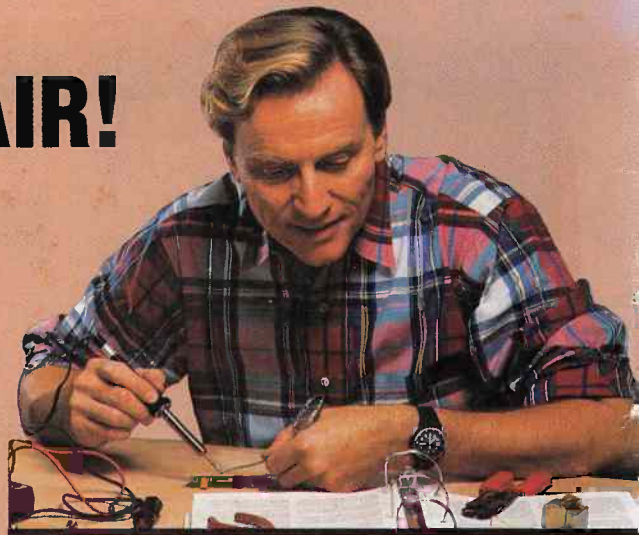

One Source For All Your Repair Needs!

Better organized than a magazine, more current than a book.

- 900-page manual
- easy-to-follow, detailed instructions
- trouble analysis flowcharts
- safety precaution checklists
- comprehensive replacement parts list
- directory of manufacturers

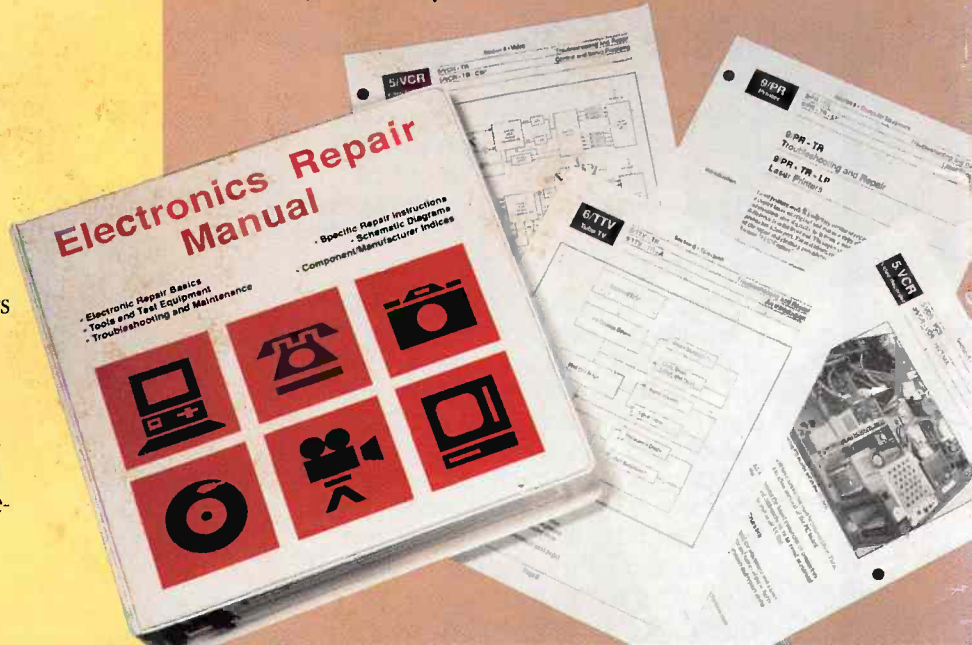

YES! Please rush me a copy of the new Electronics Repair Manual for only \$59.95 + \$5.50 shipping and handling. I understand that if I am not satisfied I may return the manual within 30 days for a complete refund. Supplements are sent quarterly for 25¢ per page (never more than \$30) and may be returned or cancelled at any time.

- My payment is enclosed Bill me later
 Charge my Visa MasterCard

Acct. No. _____ Exp. Date _____

Signature _____

Phone () _____ Signature and phone number are required for all orders.

Name _____

Address _____

City _____ State _____ Zip _____

All payments must be in U.S. funds. Canada add \$10.
All other countries add \$15. CT residents add 6% sales tax.

Mail to: WEKA Publishing, 97 Indian Field Rd.,
Greenwich, CT 06830

400034