

SCIENCE EXPERIMENTER

DOZENS OF SCIENCE FAIR PROJECTS

- MIDGET VAN DE GRAAFF GENERATOR
- LIGHT-BEAM "TELEPHONE"
- MOIRÉ PATTERNS
- GOLD-LEAF ELECTROSCOPE
- SCHLIEREN OPTICS TO SEE THE INVISIBLE

SPECIAL YOUNG EXPERIMENTER SECTION!

Magnetism Experiments
Stunts with Dry Cells
Insect Collections
Scales and Balances

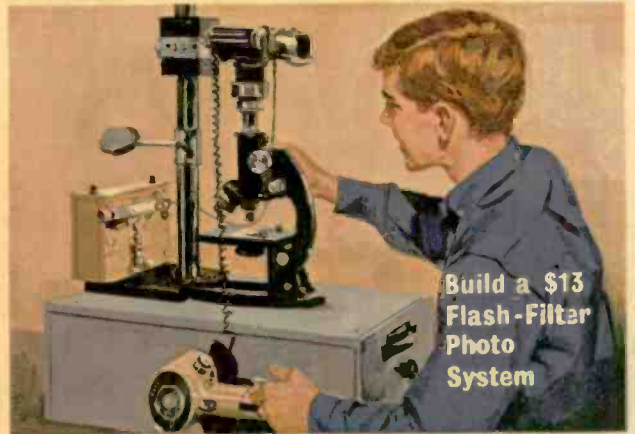

Build a \$13 Flash-Filter Photo System

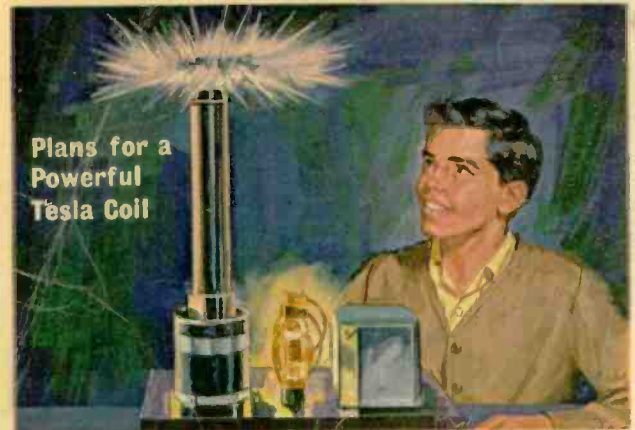

Plans for a Powerful Tesla Coil



Construct a \$10 Ion-Exchange Fuel Cell

5,000 FIRMS HAVE EMPLOYED DEVRY TECH ELECTRONICS GRADUATES...

There Must be a Reason!

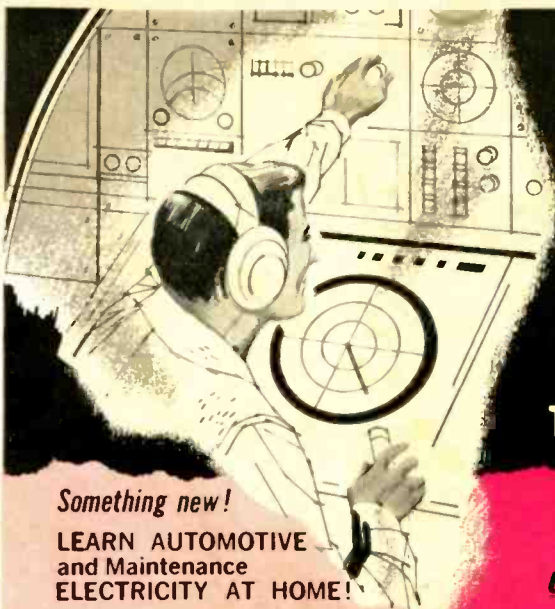

Something new!

LEARN AUTOMOTIVE and Maintenance ELECTRICITY AT HOME!

Here's another great opportunity for the man who wants his own business or a bigger pay check with a brighter future. It is a NEW DeVry program that gives you the advantage of earning while you learn.

Prepare in spare time at home for profitable jobs which can take you all the way from trouble-shooting on the electrical systems of automobiles, marine engines, trucks, tractors and other gasoline engines, to the general maintenance of electrical equipment in the home or in light industry.

DeVry's new program "brings the classroom to your home" through the magic of AUDIO-VISUAL AIDS: Lectures recorded by DeVry instructors combined with colorful 8 x 10" transparencies to make learning easier. You get the advantages of "programmed" learning through modern texts which are also handy for future



reference. To develop practical skill, you get and keep valuable shop equipment and manuals. This includes building the brand-new DeVry Transistorized Automotive Analyzer and the DeVry Silicon Battery Charger — ideal "tools" for earning extra money as you go.

This new program covers the entire electrical systems in automobiles and other vehicles, including transistorized ignition systems, alternators and regulators, and other applications. In the maintenance field, it covers lighting, electric motors, controls, wiring — even transistors. The graduate from this program can be either a specialist as a troubleshooter on the electrical system of an automobile, or handle electrical lighting, heating, alarm and control systems. It is ideal for "one man" maintenance departments.

Check coupon at right and mail it today for FREE facts.

Let Us Prepare You at Home or In
One of Our Two Big Resident Schools
for a Profitable Career in

ELECTRONICS

Across the continent, leading employers of personnel trained in electronics tell us that DeVry training is "Tops." Get the full story of DeVry Tech and the advantages it offers, by filling in the coupon below. The two free booklets pictured below tell of many fine opportunities for trained men in electronics: the great variety of jobs, from research, production, operation, maintenance and servicing of electronic equipment — to a neighborhood TV-radio sales and service business of your own. They'll tell you how DeVry has prepared men for good jobs with outstanding firms: of practical, "brass-tacks" problems with actual electronic equipment.

Here's good news: you don't need advanced education or previous technical experience to get started. If you can follow simple directions, you should be able to prepare with DeVry's help for real money in a field that may offer the opportunity of your lifetime.

Employment Service: With many employers so enthusiastic about DeVry Tech graduates, it's no wonder our Employment Service can help our graduates get started in electronics, or can assist them toward promotions later.

FREE!

SEND COUPON
FOR BOOKLETS
ON ELECTRONICS
AS A CAREER



DEVRY TECHNICAL INSTITUTE
4141 Belmont Ave., Chicago, Ill. 60641, Dept. SE-1-W

I AM INTERESTED IN ELECTRONICS. Please give me your two free booklets, "Pocket Guide to Real Earnings" and "Electronics in Space Travel"; also include details on how to prepare for a career in this field. The following opportunity fields (check one or more) interest me:

- | | |
|--|---|
| <input type="checkbox"/> Space & Missile Electronics | <input type="checkbox"/> Communications |
| <input type="checkbox"/> Television & Radio | <input type="checkbox"/> Computers |
| <input type="checkbox"/> Microwaves | <input type="checkbox"/> Industrial Electronics |
| <input type="checkbox"/> Automation Electronics | <input type="checkbox"/> Broadcasting |
| <input type="checkbox"/> Radar | <input type="checkbox"/> Electronic Control |

I AM INTERESTED IN AUTOMOTIVE AND MAINTENANCE ELECTRICITY. Please supply further information.

NAME _____ AGE _____

ADDRESS _____ APT. _____

CITY _____ STATE _____ ZIP _____

Check here if you are under 16 years of age.

2095A Available in Canada

ACCREDITED MEMBER OF NATIONAL HOME STUDY COUNCIL

DeVry Technical Institute

Chicago • Canada

KEEP PACE WITH SPACE AGE! SEE MANNED MOON SHOTS, SPACE FLIGHTS, CLOSE-UP!



AMAZING SCIENCE BOYS

for FUN, STUDY or PROFIT



EDMUND ITEMS FOR SCIENCE EXPERIMENTER'S HANDBOOK PROJECTS

EXPLORE THE WORLD OF "OP ART"

Fascinating New Experimenters' MOIRE PATTERN KITS

Fantastic Visual Effects!
Limitless Applications

Now! Experiment with the amazing new tool of tomorrow. Basis of "OP ART"—latest rage sweeping the country in art, fashion, packaging industries. 1,000's of uses for hobbyists, photographers, designers, lab and home experimenters. Full! Profitable! Unlimited potential! Here's your complete introduction kit developed by Dr. Gerald Oster, Brooklyn Poly. Inst. Contains 8 basic patterns on both clear acetate lantern slide size $3\frac{1}{2}'' \times 4''$ (0.20 thick) and .012" thick white Kromekote paper $3\frac{1}{2}'' \times 4\frac{1}{2}''$ (coated one side); two pieces $3\frac{1}{2}'' \times 4''$ 150-dot screen on film, copy Dr. Oster's book, "The Science of Moire Patterns," an authoritative introduction to the fascinating world of moire.

Stock No. 70,719-EZ (KIT "A") \$8.50 Postpaid
Stock No. 60,464-EZ (without book) \$6.50 Postpaid

NOW AVAILABLE IN FULL COLOR

Wait 'til you see the fantastic rainbow of color—all 8 patterns above in full transparent colors, red, yellow and blue, plus black (total 40). Compl. instructions.

Stock No. 60,530-EZ (KIT A) \$12.50 Postpaid

NEW DE LUXE EXPERIMENTERS' MOIRE KIT "B"

Eight new totally different black and white patterns: Coarse lines; 65-line sizes; perspective squares; medium grating; Gaussian grating; converging circles, elliptical zone plate; 30-line logarithmic spiral; plus inst.

Stock No. 70,790-EZ \$6.00 Postpaid

NEW MOIRE KIT "B" IN COLOR

8 new patterns above in red, yellow and blue; plus black with inst.

Stock No. 60,531-EZ \$12.50 Postpaid

MOIRE PATTERN ACCESSORY KIT. For additional experiments. Incl. metallic balloon, calcite, two kinds of diffracting gratings, one-way mirror foil, polarizing materials, Ronchi rulings, assortments of lenses.

Stock No. 60,487-EZ \$8.00 Postpaid

Convert Sun Light Into Electric Power With

SOLAR CONVERSION KIT

A striking and revealing demonstration for home or classroom. Immediate conversion of the sun's rays into enough electric power to run a motor. Kit includes high-output silicon solar cell which is connected to a small ball-bearing motor. Cardboard disc with spiral design is attached to motor shaft. As sun strikes energy-absorbing cells, rotation of disc becomes plainly visible. No batteries or wall plugs needed. Motor, leads, photo cells, cardboard disc with grommet, complete directions, included.

Stock No. 60,241-EZ \$6.95 Postpaid

MOTOR ONLY—adaptable to many other hobby uses.

Stock No. 40,507-EZ \$2.95 Postpaid

NOW! EDMUND IS HEADQUARTERS FOR SCIENCE FAIR ITEMS

SCIENCE TREASURE CHESTS

For Boys—Girls—Adults

Science Treasure Chest—Extra-powerful magnets, polarizing filters, compass, one-way-mirror film, prism, diffraction grating, and lots of other items for hundreds of thrilling experiments, plus a Ten-Lens Kit for making telescopes, microscopes, etc. Full instructions included.

Stock No. 70,342-EZ \$5.50 Postpaid

Science Treasure Chest—DeLuxe

Stock No. 70,343-EZ \$10.50 Postpaid

BUILD A SOLAR ENERGY FURNACE

A fascinating new field. Build your own Solar Furnace for experimentation—many practical uses. Easy! Inexpensive! Use scrapwood! We furnish instructions.

This sun powered furnace will generate terrific heat—2000° to 3000°. Fuses enamel to metal. Sets paper aflame in seconds. Use our Fresnel Lens—11" Sq. F.L. 19".

Stock No. 70,533-EZ \$6.00 Postpaid

MINIATURE WATER PUMP

Wonderful for experiments, miniature waterfalls, fountains, Christmas gardens, HO gage railroad backdrops, etc. Tiny (2 1/2" x 1 3/4") electric motor and pump ideal for hobbyists, labs, schools. Pumps continuous flow of water at rate of one pint per minute at a 12" head. With 2 D Batteries in series will pump to 24" high. Works in either direction.

Stock No. 50,345-EZ \$2.25 Postpaid

'FISH' WITH A MAGNET

Go Treasure Hunting On The Bottom

Great idea! Fascinating fun and sometimes tremendously profitable! Tie a line to our 5-lb. Magnet—drop it overboard in bay, river, lake or ocean. Trawl it along the bottom—your "treasure" haul can be outboard motors, anchors, fishing tackle, all kinds of metal valuables. 5 lb. Magnet is war surplus—Alnico V Type—Gov't. Cost, \$50. Lifts over 125 lbs. on land—much greater weights under water. Order now and try this new sport.

Stock No. 70,571-EZ 5 lb. Magnet \$12.50 Postpaid

Stock No. 70,570-EZ 3 1/2 lb. size \$8.75 Postpaid

Stock No. 85,152-EZ 15 lb. Lifts 250 lbs. \$33.60 Postpaid

ORDER BY STOCK NUMBER—SEND CHECK OR MONEY ORDER—SATISFACTION GUARANTEED

EDMUND SCIENTIFIC CO., BARRINGTON, N. J.

NEW... MOBILE, REFLECTED LIGHT IMAGE KIT



Delight And Dazzle Guests With This Full Color "OP ART" SLIDE SHOW

Now make light from your 35mm projector dance with radiant splendor in rhythm with your favorite recordings. Place easy-to-prepare multi-color slides in projector. Aim projector at flexible reflector. Move reflector to fill the screen with indescribably graceful flares of brilliant, prancing hues. Make fantastic multi-colored forms appear and fade with the rhythm of the music. Use this fascinating new form of art expression at home, in schools or as unique entertainment. Kit includes: 5 reusable glass slide mounts, 44 (1" x 4") transparent color sheets, 8 (8" x 10") sheets of reflecting foil in 4 colors, 1 (6" x 6") section of regular mirror with flexible backing (1/2" squares), 4 (8" x 10") aluminized mylar reflectors, 2 (8 1/2" x 11") sheets of non-reflecting flock paper, 1 (4" x 5") sheets of reflecting-type diffraction grating, complete instructions.

Stock No. 70,805-EZ \$6.00 Postpaid

Superior Quality For Professional Use

25X TO 900X LABORATORY MICROSCOPE



Sturdy, monocular-type, precision-made instrument. 3 achromatic objective lenses: objectives—5X (0.10 NA), 10X (0.25 NA), 60X (0.85 NA); triple revolving nosepiece. Automatic focusing stop prevents damage to objectives and slides, fixed 160mm tube. Rack and pinion coarse focusing and micrometer type slide fine adjustments. 3 Huygenian eyepieces: 5X, 10X, 15X. Bakelite stage 4 1/2" x 4-5/16", 2 stage clips accept Edmund graduated mech. stage No. 30,060. Substage equipment: Fixed-condenser lens, iris diaphragm, 1 3/8" diam. plano-concave mirror. Complete in fitted hardwood cabinet with handle. Sbgp. wt. 11 lbs.

Stock No. 85,049-EZ \$84.75 F.O.B.

2" x 2" Acetate Filter Sheets

Stock No. 40,676-EZ 75c

Polarizing Filters

Stock No. 2,721-EZ 75c

MAGNETISM KIT

Based on magnetism demonstrations developed by UNESCO.

Stock No. 70,325-EZ \$3.75 Postpaid

CRYSTAL-GROWING KIT

Do a crystallography project illustrated with large beautiful crystals you grow yourself. Kit includes the book "Crystals and Crystal Growing" and a generous supply of the chemicals you need to grow large display crystals of potassium aluminum sulfate (clear), potassium sulfate (purple), potassium sodium tartrate (clear), nickel sulfate hexahydrate (blue-green) or heptahydrate (green), potassium ferriyanide (red) and copper acetate (blue-green).

Stock No. 70,336-EZ \$9.50 Postpaid

See the Stars, Moon, Planets Close Up! 3" ASTRONOMICAL REFLECTING TELESCOPE



60 TO 180 POWER! Famous Mt. Palomar Type! An Unusual Buy! See the Rings of Saturn, the fascinating planet Mars, huge craters on the Moon, phases of Venus. Equatorial Mount with lock on both axes. Aluminized and overcoated 3" diameter high-speed f/10 mirror. Telescope equipped with a 60X eyepiece and a mounted Barlow Lens. Optical Finder Telescope Included. Hardwood, portable tripod. FREE with Scope: Valuable STAR CHART plus 272-page "HANDBOOK OF HEAVENS" plus "HOW TO USE YOUR TELESCOPE" BOOK.

Stock No. 85,050-EZ \$29.95 Postpaid

4 1/4" Reflecting Telescope—up to 225 Power

Stock No. 85,105-EZ \$79.50 F.O.B.

Order by Stock No.—Send Check or M. O.—Money-Back Guarantee

MAIL COUPON FOR FREE CATALOG "EZ"

Completely New and Enlarged. 148 pages. Nearly 4000 Bargains.

EDMUND SCIENTIFIC CO., Barrington, N. J.
Please rush Free Giant Catalog "EZ"

Name

Address

City..... Zone..... State.....



SCIENCE EXPERIMENTER

1988 EDITION

CONTENTS/INDEX	Feature	For Children	Demonstration	Construction	Equipment	Astronomy	Chemistry	Electronics	Math	Optics	Physics	Related Subjects
Research Challenges.....	6	✓										
Dial-A-Flash.....	8			✓	✓			✓		✓		
Moiré Patterns.....	19	✓	✓	✓						✓		✓
Three-Cent Slide Rule.....	23			✓	✓				✓			✓
See the Invisible.....	24			✓	✓					✓	✓	✓
Measure Hidden Distances.....	32			✓	✓				✓	✓		✓
Tell Time by the Stars.....	36			✓	✓	✓				✓		✓
Talk on a Light Beam.....	40		✓	✓				✓			✓	
Harness the Sun.....	43		✓	✓	✓			✓			✓	✓
New, Improved Tesla Coil.....	44		✓	✓				✓				✓
CdS Power Control.....	54			✓	✓			✓				✓
Gold-Leaf Electroscope.....	57		✓	✓	✓						✓	✓
Repulsion Coil.....	58		✓	✓				✓			✓	✓
Polarity Indicators.....	63		✓	✓	✓			✓				✓
Ion-Exchange Fuel Cell.....	64		✓	✓			✓	✓			✓	✓
Transistor Amplifiers.....	68	✓						✓				✓
Motor-Generator Demonstration....	69		✓	✓							✓	✓
Midget Van de Graaff.....	70		✓	✓	✓			✓			✓	✓
Stunts with Dry Cells.....	76		✓	✓							✓	
Insect Collections.....	78	✓	✓	✓								
Experiments with Magnetism.....	85		✓	✓								✓
Anti-Snooper Alarm.....	88		✓	✓	✓							
Scales and Balances.....	89		✓	✓	✓						✓	✓
Magic in Chemistry.....	92		✓	✓			✓					✓

A SCIENCE & MECHANICS ANNUAL

Editor
JOE DAFFRON

Art Director
ANTHONY MACCARRONE

Associate Art Director
EUGENE F. LANDINO

Cover Design
IRVING BERNSTEIN

Art Editor
JOHN YUSKO

Art Associates
LINDA KALMAN
MANUEL INFANTE

Advertising Director
ELLIOT S. KRANE

Advertising Manager
MAURICE CHAWES

Production Director
LEONARD F. PINTO

Production Manager
CARL BARTEE

Production Assistant
STEVE LEVINSON

Promotion Director
CLIFFORD SHEARER

President and Publisher
B. G. DAVIS

Executive Vice President and Assistant Publisher
JOEL DAVIS

Vice President and Editorial Director
HERB LEAVY

SCIENCE EXPERIMENTER (784A) is published annually by SCIENCE & MECHANICS PUBLISHING CO., a subsidiary of Davis Publications, Inc. Editorial, business and subscription offices, 505 Park Ave., New York, N.Y. 10022. Advertising offices: New York (10022), 505 Park Ave., PL 2 6200 Chicago (60611); 520 N. Michigan Ave., 527-0330; Los Angeles (90028) 6253 Hollywood Blvd., 463-5143, 463-5144, 463-3413. Copyright 1966 by Science & Mechanics Publishing Co.

CHEMICALS

IN SMALL QUANTITIES

Biologicals—Apparatus—Pyrotechnics
Laboratory Glassware—Science Books

At Prices the Student
Experimenter Can Afford

New Illustrated Catalog Only 25¢

DOVER SCIENTIFIC CO.

Box 6011-M

Astoria, N. Y. 11106

'How to Make Money with Simple Cartoons'



A book everyone who likes to draw should have. It is free; no obligation. Simply address **FREE BOOK**

CARTOONISTS' EXCHANGE
Dept. 1973, Pleasant Hill, Ohio

There's always many construction projects in each and every issue of **ELEMENTARY ELECTRONICS**. The March/April issue is on sale now—75¢.

Your newsstand sold out? Write **ELEMENTARY ELECTRONICS/505 Park Avenue/New York/10022**. Enclose \$1. Includes postage and handling.



There's excitement in "For A Wild Hunt . . . Try Wild Dogs" by Gene Round in the Spring **SHOOTING GUIDE**, on sale March 8 at your newsstand—\$1.00. Catahoulas dogs and 5 hunters team up to hunt the wild feral hog, a descendent of animals brought to Tennessee in 1912 by a group of wealthy English sportsmen. Read this and more in the 96 page **SHOOTING GUIDE**.

SHOOTING GUIDE SE-784A
505 Park Avenue/New York, N. Y. 10022

I am enclosing \$1.25 (includes postage and handling, for my copy of the Spring issue of **SHOOTING GUIDE** (Check or money-order.)

Name _____
(please print)

Address _____

City _____ State _____ Zip _____

The
April/May
 issue of
**RADIO-TV
 EXPERIMENTER**
 at your
 Newsstand
 Now—75¢



Features a solid-state 6-meter transmitter for the amateur. Mates with the 6-meter receiver in March/April Elementary Electronics at your newsstand. Put together for a battery-operated walkie-talkie that cannot be bought commercially.

RADIO-TV EXPERIMENTER SE-784A
 505 Park Avenue/New York, N.Y./10022

I'M ENCLOSING \$4.00 FOR A 1 YEAR SUBSCRIPTION TO RADIO-TV EXPERIMENTER. \$7.00 FOR 2 YEARS; \$10.00 FOR 3 YEARS; BILL ME. (FOREIGN: ADD 75¢ A YEAR.)

Name _____
 (please print)
 Address _____
 City _____ State _____ Zip _____

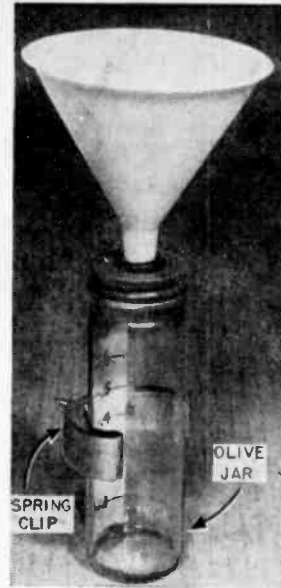

Simple,
 THE glass graduate for this simple rain gage at left can be any bottle or container with straight sides, such as the bottles used for olives. The smaller size bottles or jars will do a more accurate job of measuring the average fall of rain, which rarely ranges over one inch. To record extended or heavy downpours, the amateur scientist simply builds a larger gage.

Drill or ream a 1/2-in. hole in the cap of the bottle. Then fit this hole with a 1/2-inch radio grommet. If the bottle has a snap vacuum cap, or if you don't have a 1/2-in. grommet, drill a hole

**LEARN HOW
 TO ADJUST YOUR
 NEW COLOR TV SET
 and save money too!**

**In the Spring/Summer Radio TV
 REPAIRS—at your newsstand—75¢**

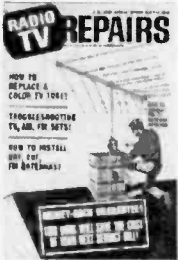

If you already own a color TV set, or if you plan to buy one, this feature story on "COLOR TV SET ADJUSTMENTS" is important to you.

In easy-to-understand language, complete with illustrations, the money saving steps to making color TV adjustments are explained. This and more can be found in the new RADIO TV REPAIRS.

RADIO TV REPAIRS/505 Park Ave./New York/10022
 I am enclosing \$1.00 (includes postage & handling).
 Please send me my copy of RADIO TV REPAIRS.

NAME _____
 (PLEASE PRINT)
 ADDRESS _____
 CITY _____ STATE _____ ZIP _____
 SE-784A

**How the
 Weather House Works**

YOU'VE seen the weather houses like the one in Fig. 1B. In fair weather, a girl appears at the doorway. Comes a change in the weather and she goes in, and an old man with an umbrella appears in the opposite doorway. They operate because a hair or strand of animal gut expands and contracts when surrounding air is more or less moist. This fact was discovered by H. B. de Saussure (1740-99), a Swiss geologist. To test the principle upon which Saussure invented the hair hygrometer, you can build a simple "forecaster."

Fit a 3 x 5-in. block with a wood dowel about 6 1/2 in. long. Through a hole near the top of the dowel, insert a meat or baking potato skewer whose end is formed into a circle. Select a cork large enough to fit into the skewer ring, and drill a small hole through the center of the cork. Then run a short length of gut tennis racquet, violin or uke string through the center hole of the cork, and glue it in place. Finally, drill a small hole in a wood tongue depressor or Popsicle stick, run other end of gut string through this hole and glue string in place.

You must use genuine gut string, and not nylon, which will not work here. Racquets and instruments today are usually strung with nylon,

Accurate Rain Gage

in the right size of cork instead. Force a 4-in. plastic funnel through the grommet or the hole in the cork, so that the funnel is held rigid.

To keep winds from upsetting the rain gage, mount it outdoors to a fence or pole, using a spring clip holder, such as is used to hang up brooms, mops or rakes.

Calibrating the gage. Place it outdoors in an unobstructed place before a rain. When the rain is over and the weather clears, measure the amount of water in the bottle by inserting a plastic ruler in the container. Now check your local radio station, newspaper or weather station to determine the official amount of rainfall.

Let's say, for example, that the official amount of rainfall was 0.1 inch, and your olive bottle with an outside diameter of 1½ in., contained ½-in. of standing water. You can then attach a strip of paper to the back of the bottle (with Scotch tape or clear shellac), calibrated in 10ths every ½-inch on a ruler scale. A 4-inch strip of paper ruled every ½-inch would read from zero to 0.8 inch of rainfall.

Once a small container has been calibrated, it may be filled with a suitable amount of tap water and used to calibrate a larger gage.—T.A.B.

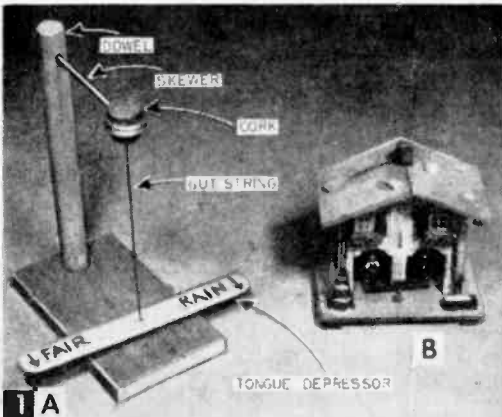

but you can buy gut strings from many sporting goods or music stores, surgical supply houses, or science supply houses.

When the glue has dried, lift cork out of skewer ring and turn so that the paddle showing existing weather conditions is out. Then, when the weather changes, the paddle will swing around slowly to indicate the opposite condition. In dry weather the gut will lose its moisture and contract with a twisting motion, causing the paddle to turn in one direction. Dampness will cause the gut to stretch and unwind, so to speak, thus reversing the paddle motion to indicate approaching rain or high humidity.—T.A.B.

Togetherness Project



The construction of the 6-meter receiver, featured in the March/April issue of **ELEMENTARY ELECTRONICS** now on sale—75¢—plus the 6-meter transmitter featured in this issue of **Radio-TV Experimenter** gives you a battery-operated walkie-talkie that cannot be purchased commercially. No matter what your electronic interest, you'll find it all in **ELEMENTARY ELECTRONICS**.

ELEMENTARY ELECTRONICS SE-784A
505 Park Avenue/New York, N. Y./10022

I am enclosing \$4.00 for a 1 year subscription to **ELEMENTARY ELECTRONICS**; \$7.00 for 2 yrs.; \$10.00 for 3 yrs. (Foreign: add 75¢ a yr. for postage.)

NAME _____ (please print)

ADDRESS _____

CITY _____ STATE _____ ZIP _____

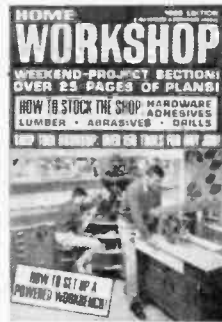

How good a finished project is depends a great deal on the tools you are working with. **HOME WORKSHOP**'s shop tool roundup discusses the relative importance of specific tools for specific jobs.

Among other interesting features, there's a 30 page section devoted exclusively to home workshop projects.

HOME WORKSHOP—96 pages—on sale at your favorite newsstand March 1—75¢, or use the coupon.

HOME WORKSHOP SE-784A
505 Park Avenue/New York, N. Y. 10022

I am enclosing \$1.00 (check or money-order includes postage & handling).

Send me my copy of **HOME WORKSHOP**.

Name _____ (please print)

Address _____

City _____ State _____ Zip _____

Research Challenges

THE projects in this issue of SCIENCE EXPERIMENTER were chosen with an eye to functional versatility, foolproof construction and low cost. Each and every one is well worth making.

But don't expect any one of these to be a science fair winner if all you do is to copy what our science authors describe. Fair judges will look for evidences of original research contributions of your own. These projects should therefore be viewed as springboards to more extensive projects of your own devising.

Here are some random research ideas to get you started thinking in the right directions. Frankly, we haven't tested these inspirational flashes in the laboratory; some may work, some may not—but all, we think, deserve careful consideration. It's up to you to probe deeper and decide whether they are feasible, then find ways to solve them in practical, experimental ways.

In no case have we listed all the "research challenges" that each article might inspire. Undoubtedly there are many more. If you can come up with still better ones—more power to you, and good luck at the next science fair!

Star Time: What more could you do after constructing the simple device used to tell time by the stars (p. 36)? One possibility is to construct a model celestial sphere with which to demonstrate the nocturnal indoors at science fairs.

For a more ambitious project, consider making an electronic sensing device that would respond only when the light from specific pre-selected stars (e.g. Ursa Major) fall on a series of properly oriented photoelectric cells. Assume that the sensing device could be rotated as a unit to set it for a specific time. Then set the motorized celestial sphere into rotation (speeded up, of course). When the light from Ursa Major "stars" fall on the sensors, a meter would indicate that the desired time was at hand. One and only one constellation would activate the sensors. Use "star light" strong enough to activate the photoelectric cells to test the principle in theory. In actual practice, the weak star light would have to be intensified with image-intensifier units (don't shop for these; they now cost as much as \$5,000 each).

Home-Made Equipment: How often have you given up on good experiment ideas because "the equipment costs too much?" Probably more often than you should have, unless you are an experienced gadgeteer.

The articles about scales and balances and the gold-leaf electroscope (pages 89 and 57) provide fine examples of low-cost answers to equipment problems.

To develop your inventive ability, turn into a sort of scientific pack-rat by collecting such household "junk" as plastic bottle caps, old light bulbs, scrap rubber, bits of plastic and metal, gears, wheels, springs, etc. You will be amazed at how often you will dip into this hoard for "just the right piece" to solve a tough construction problem.

And more. When you have one of those "I don't know what to do with myself" days, browse through your junk reflectively. Many a fine project has begun by someone asking himself: "Now, what could I possibly make out of this old phonograph motor or egg beater."

Dial-A-Flash: The imaginative experimenter studies all types of science articles because even an article whose subject matter seems basically alien to his current interests may contain useful ideas or inspirations.

The Dial-A-Flash (page 8) would seem to be of interest only to microscopists; and yet modifications of the equipment might be used for many other purposes. For example, the collector of insects (page 78) might dispense with the microscope and photograph living insects directly with a camera fitted with close-up accessories; the filter system might be ideal for studying insect responses to colored lights, and the short-duration flash might freeze wing and body motions in a most revealing manner.

Sometimes the experimenter just borrows a simple idea concerning an optical or electronic principle, a mechanical movement, or a unitized component such as the solenoid trigger system. Or the article may simply stimulate the asking of a question such as this: "What other experimental use—besides taking pictures—could I make of the electronic flash unit gathering dust on the closet shelf?"

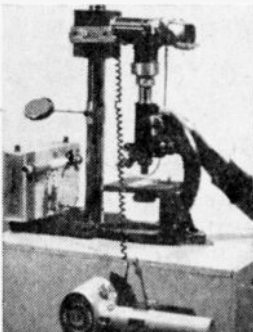
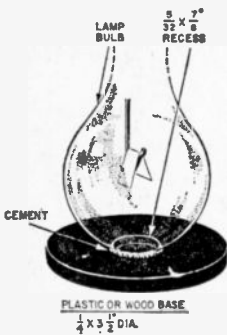

Insects: The methodical collection and classification of insects is a rewarding pursuit (page 78), but the bigger thrills come from deeper explorations.

Insect reactions to environmental changes (e.g. light intensity and color, heat, cold, chemicals) provide endless opportunities for worthwhile research. The investigation of the nature and purposes of special insect characteristics such as scents and chemiluminescence could lead to knowledge of great importance as, for example, the discovery of ways to attract and capture individual insect species.

The experimenter with a flair for craftwork could find truly rewarding challenges in the creation of large-scale models of insects, the relative sizes and shapes of insect body parts—legs, antenna, wings, etc.—could be studied with the aid of photomicrographs or by projection of their images on a screen with a slide projector. The ultimate challenge would be the production of models that accurately simulate the wing and/or leg movements of actual insects.

Talk on a Light Beam: You will have a lot of fun making and demonstrating the simple device used to transmit sound with a light beam (page 40). When the novelty wears thin, study the equipment to see what else you can make it—or parts of it—do.

You know that the volume of the transmitted signal changes when the beam is gradually blocked off. How could this phenomenon be used to convert the device into something that can (1) measure the surface areas of irregularly-shaped flat objects, (2) count the number of objects passing through the beam, (3) trigger other electronic or optical equipment by light-interception (perhaps selectively according to the weight or size of the beam-intercepting objects)? To what further research applications would such devices be suitable?

The basic principle used in this gadget is employed to translate the optical sound track on motion picture film into audible sound. How could you modify this set-up to effectively demonstrate how sound movies work?

Moiré Patterns: Moiré patterns (page 19) have important applications in such diverse science areas as cartography, microwave phenomena, thermal gradient studies, hydrodynamic and aerodynamic studies, etc.

One off-beat observation that intrigues us is the production of Moiré fringes when certain Moiré patterns (on transparent plastic sheets) are placed over inked fingerprints. This suggests that Moiré patterns might be used to rapidly scan and classify fingerprint collections.

Why not collect a large number of fingerprints among friends, then analyze and classify them according to characteristic Moiré patterns you obtain using a variety of Moiré plates?

See The Invisible: The Schlieren system of optics is not an end in itself, but comprises an extremely versatile tool for scientific investigations as the article on page 24 points out.

You can couple Schlieren experiments with many other scientific activities. The most obvious application is to build a model wind tunnel, then use Schlieren optics to indicate the air-flow patterns around models of airplanes, rockets, etc. Perhaps an even more intriguing problem would be the design of a hydrodynamic tunnel with which you could study water-flow patterns around models of submarines, marine exploration submersibles, etc. The shapes of the submerged models would be primary factors affecting flow patterns; but might not the temperatures of the submerged bodies also have some measurable effects on water turbulence? How could you use Schlieren optics to find out?

Tesla and Repulsion Coils: The Tesla and repulsion coils described on pages 44 and 58 are fine examples of equipment in the "science spectacular" category. But many a science fair exhibitor has discovered that while fair visitors crowded around such exhibits, the judges passed them by as award winners. Why? Because the projects did not go beyond the construct-and-show stage; they showed no signs of original research.

The challenge here is to find novel ways to use such equipment or the scientific information that can be obtained by their use. Even some revealing work concerning the factors that influence formation of different types of discharges, or the efficiency of repulsion with repulsion coils, could lead to fair awards. Slow-motion cinematography might be used to reveal spark discharge characteristics in terms of specific operating conditions.—J. H.

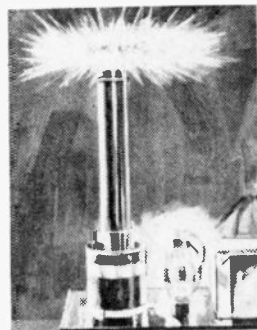
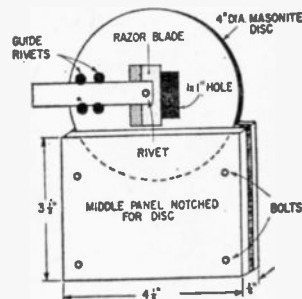
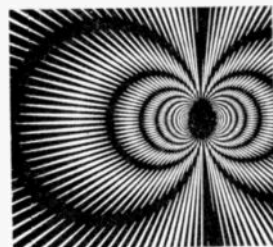
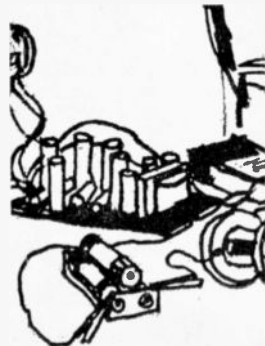

DIAL-A-FLASH

This flash-filter

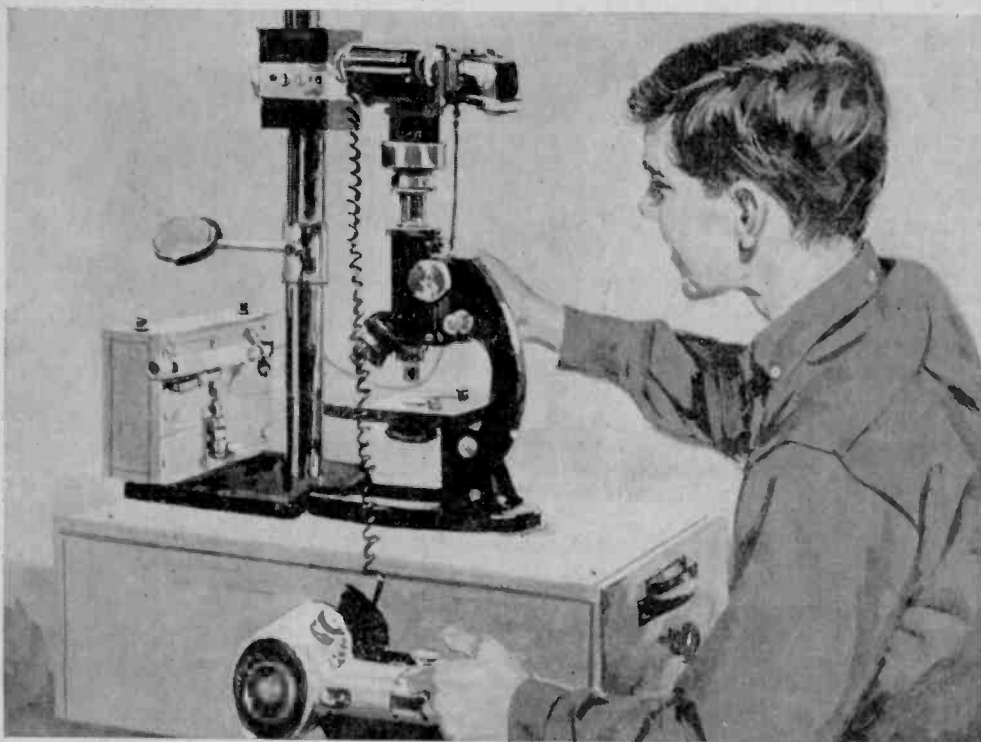

FIG. 1. Dial-A-Flash in use. Single-lens-reflex camera, electronic flash are preferable. See text.

IF you have ever tried to photograph microscopic forms of life with ordinary photomicrography equipment, you know it's like going after tigers with a pea-shooter. You can kill the creatures first, but you get only pictures of obviously dead animals. What you need is a high-powered, fast-acting photo-gun that captures the live ones in the peak of action. Couple your camera flash to your microscope, and you can do just that.

If you aren't a biologist, there are plenty of other types of action you can "stop" with this equipment. The dissolving of solids in liquids, fusion processes, crystallization phenomena, decomposition of substances by heat or chemical action, gas formation, flocculation of colloids, and countless other chemical and physical phenomena—all involve movements that are hard or impossible to photograph sharply with orthodox equipment. With Dial-A-Flash, it's a cinch.

The stopping of motion is just one advantage of using electronic flash. Live organisms, and many chemical/physical sub-

jects are sensitive to the heat of strong microscope illuminators; using flash, you can view with low-intensity, relatively cool light, but take the picture with the high-intensity flash. The flash also provides plenty of light when using dense polarizing filters, and the color temperature of the light is ideal for color photography.

We have done more than just hook a flash gun to the microscope; there's also a unique filter system which permits you to quickly dial various color filters used in black-and-white as well as color photography, polarizing filters, and neutral density filters used to control the light intensity. The entire system works equally well with transparent or translucent specimens illuminated from below by transmitted light and with opaque specimens which need to be lighted from above.

If the complete equipment exceeds your needs, you can still build parts of it to advantage. For example, you can build:

- The completely automatic system which instantly blanks out the viewing light (to

system shoots microscopic specimens in action/by Jorma Hyypia



FIG. 1-A. Ammonium oxalite crystal growth "stopped"; polarized light.

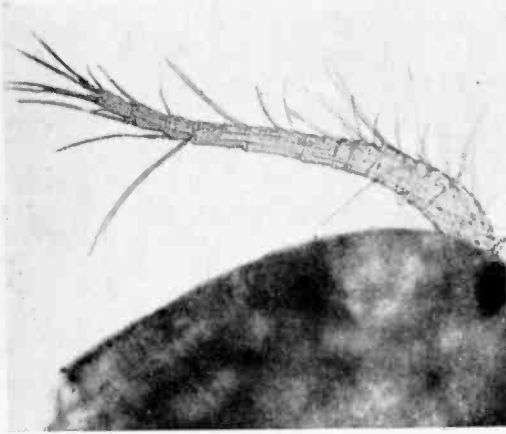

FIG. 1-B. Flash photomicrograph of live mosquito larva. Dial-A-Flash makes such pictures an easy task.

FIG. 1-C. Flash photo of antenna of Cyclops—a microscopic creature found in pond, swamp waters.

eliminate possible secondary images), trips the camera shutter and flash in perfect synchronization to take the picture, and then promptly returns the system to normal viewing conditions.

- A semi-automatic system in which the camera and flash are tripped individually by manual action. Not as handy as the fully automatic system but equally capable of "freezing" the fastest action.

- Only the filter system for efficient control of lighting for purely visual, non-photographic use of the microscope.

- Only the filter system plus the opaque-specimen illuminator for more flexible light control and for projecting enlarged images onto a wall or screen for group viewing.

Basic Equipment. Any microscope you happen to own can be used with the Dial-a-Flash. Of course the sharpness of your pictures (aside from motion-blurring which is eliminated by use of flash) depends on the quality of your microscope optics. The photomicrographs used in this article (they

lose detail in reproduction) were made with an \$85 microscope (No. 85,049; Edmund Scientific Co.); this is inexpensive equipment compared with industrial microscopes costing hundreds, or even thousands of dollars. Actually, microscope manufacturing has improved so much in recent years that you can get very creditable pictures with still cheaper equipment.

The flash equipment shown here is a Honeywell Strobonar unit. You can use any electronic flash unit you have simply by modifying the mounting bracket on the side of Dial-a-Flash. The light outputs of different makes and models of electronic flash vary, so you will have to calibrate exposures (in terms of the neutral-density filters) to fit your equipment. As a matter of fact, you can even use a reflector with ordinary flash bulbs—if you can stand the high cost of the bulbs.

The best type of camera is a single lens reflex (SLR) because it enables you to watch the microscope field up to the instant of

DIAL-A-FLASH

exposure. If your camera is not an SLR, check microscope supply houses for a beam-splitter adapter; this goes between the microscope and camera to divide the emergent light, sending part of it into the camera and part to your eye through a small viewing telescope. Most microscope textbooks describe this adapter.

Of course Dial-a-Flash can be used, without the beam-splitter, as a filtered light source for ordinary photo-micrography using non-reflex 35-mm cameras, press cameras, or those made specially for photomicrography. You are then pretty much limited to slow-moving or stationary subjects. But even in this case the use of flash is justified because of its high intensity, economy, and because the light is excellent for color photography.

How Dial-a-Flash Works. Fig. 1 shows the unit set up for operation; Fig. 2 shows it stripped of microscope, camera and flash to reveal structural details more clearly.

The unit consists of a box with holes cut into each side and the top. Light from a regular microscope illuminator enters the hole on the right side and is reflected upward by a mirror—through preselected filters set into two dials—through the top panel opening and into the microscope. This light is used for visual viewing prior to picture taking.

When ready to take a picture, you give the knob on the front panel a quarter turn. This tilts the mirror inside the box into the opposite direction to catch the light from the flash gun; in this position, the light from the other illuminator is cut off automatically. When the mirror reaches its maximum left position, it trips a microswitch connected to the solenoid trigger system (the cigar-box unit behind the camera support post); three flashlight batteries inside the box activate the solenoid to trip a plunger mechanism which pushes a cable release attached to the camera. The flash, plugged into the camera in the normal way, is set off by the shutter action.

When the mirror knob is released, a spring pulls the mirror back into its original position for viewing. The entire action takes only a fraction of a second.

Box Construction. Begin by building the box according to the dimensions shown in Fig. 3, using $\frac{1}{2}$ -in. thick plywood for all sides and top, and $\frac{1}{4}$ -in.-thick plywood for the front vertical panel. Make the box

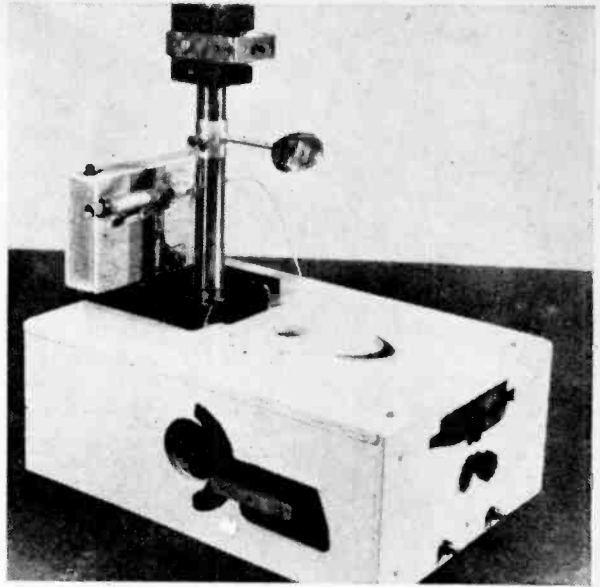

FIG. 2. Basic unit. Mirror on post is for overhead illumination of opaque specimens.

FIG. 3, right. Dimensions for box parts. Refer to "Box Construction" in the text.

strong to eliminate vibrations. The top panel is fastened with screws or bolts to permit easy removal.

Cut the indicated holes on the left and right sides and on the top panel. Also cut the horizontal dial slot in the front panel (the two filter discs protrude through this opening for turning, to make filter selections).

The flash mount (A; Fig. 3) duplicates the standard mount used to hook a Strobunar flash to a press camera. The stop plate (B)—made from $\frac{1}{8}$ -in.-thick Masonite—automatically positions the flash at the exact center of the hole each time it is slipped onto the mount. Devise your own mounting and stop plate if you use another make or model of flash gun.

A similar Masonite stop plate (C) is fastened to the top panel. This is shaped to fit the curvature of the rear of the microscope base, and is positioned so that the microscope snubs against it to align the instrument's optical axis with the hole in the top panel.

Note the two guide blocks at the rear of the top panel. These hold down and support a sliding block on which is mounted the camera-support post. The sliding action,

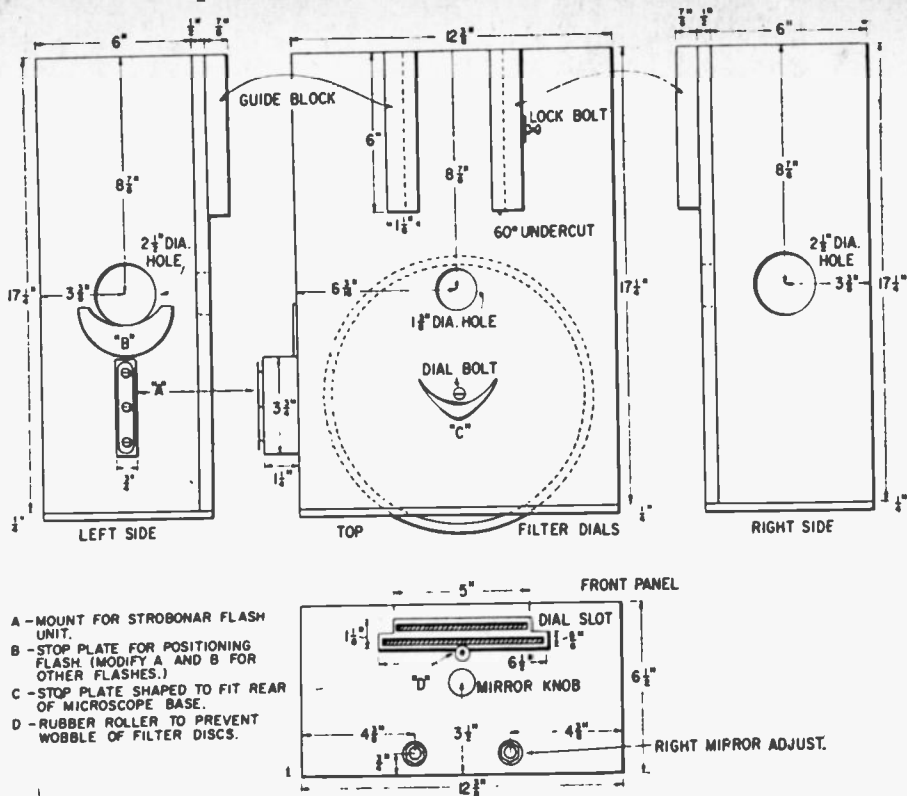

needed to position the camera accurately over the microscope, is especially important if you use more than one type of camera.

The two guides and the sliding block are cut from a single piece of wood as shown in Fig. 4. The sliding section is shortened somewhat, and notched at the front so that it can slide between the front arms of the microscope base. If you don't have a bench saw with which to cut the 60° bevels accurately, use straight-down 90° cuts and fasten flat strips of wood or metal on top of each guide so they overlap the sliding section.

Note the lock bolt on one of the guide blocks in Fig. 3. The bolt goes through the guide block and tightens against the sliding block to keep it in position. The nut assembly can be made by drilling three holes along a strip of flat sheet iron and soldering a nut over the center hole; use the other holes to screw the nut assembly onto the guide block.

If you line the undercut beveled surfaces with sheet metal, the sliding action will be smoother and the lock bolt won't dig into the wood of the sliding block but will press against the metal lining. Cut the sheet metal to fit the bevel surface, leaving a little

extra length on each end which can be bent around the front and backs of the guide blocks to keep the linings from slipping out; no nailing or other fastening is needed or desirable.

A piece of dowel about 2 in. long is glued and screwed firmly to the top of the sliding block. The steel post used to support the camera slips onto this dowel and is held in place with three screws inserted through holes drilled in the post. The post should be about 1 1/4 in. in diameter and at least 21 1/2 in. long. I used a section of metal wand from a discarded vacuum cleaner, fitting the slightly enlarged end over the dowel; another section of the wand is kept in reserve, as an extension, in case a camera with a long bellows extension is used. Another type of post is mentioned in the following.

Camera Support Bracket. Next you need some sort of bracket to slide up and down along the steel post and hold the camera. You save a lot of work if you can dig up the easel and post assembly of an old photo-enlarger. You may even be able to use the easel as the top panel of the box.

The camera support shown in Figs. 5 and 6 was made from readily available

DIAL-A-FLASH

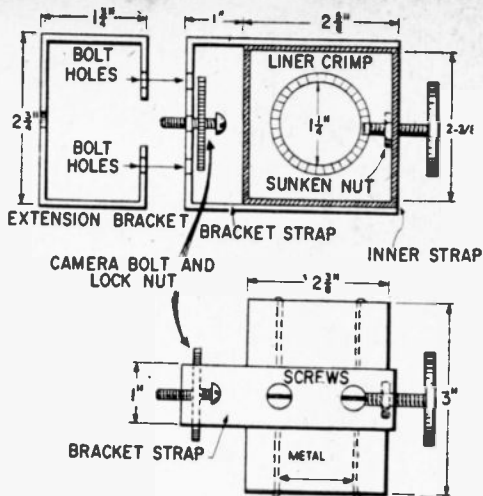
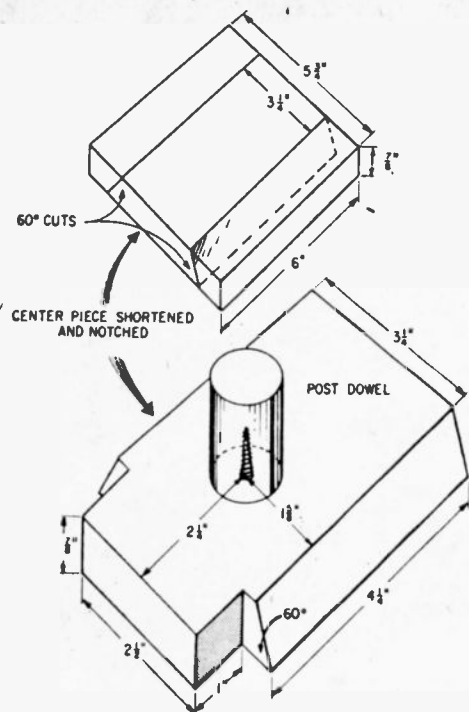

FIG. 4, left. Guides and sliding block are cut from single piece to dimensions shown. Text gives alternate to 60° cuts indicated.

FIG. 5, atop page. Camera support which is made of readily available materials. Plumber's pipe-suspension strap is recommended.

materials. First obtain a hardwood block measuring approximately $2\frac{3}{8} \times 2\frac{3}{8} \times 3$ in. and drill a hole into it that is slightly larger than the diameter of your post. The wood surface tends to bind against the metal post even if the fit is otherwise good, so line the hole with galvanized sheet metal or tinfoil cut from a can.

Leave a $\frac{1}{2}$ -in. gap at the rear of the liner so that the tightening bolt can reach the post. Also, a full liner is much harder to fit into the hole. Cut the metal liner long enough to project $\frac{1}{8}$ in. from each end of the hole in the block of wood. Make a series of cuts along these exposed edges and bend the tabs back onto the block to form a crimped edge to hold the liner in place. Solder over the crimp makes a neater, more durable job.

Obtain some rigid but bendable metal strapping about 1 in. wide. The perforated iron strap used by plumbers to suspend pipes from basement ceiling beams is good; it also has pre-cut holes that you can use. Bend one piece snugly around the mid-section of the block, positioning it so that one hole in the strap is just where the lock bolt goes into

the block. Just underneath this hole, cut a notch in the wood to hold a square nut so it cannot turn.

Make a U-shaped strap and overlap it first along the sides (not back) so that it projects about 1 in. in front of the block. These two straps are screwed tightly to the block, utilizing the holes already in the strapping.

If your camera is light-weight, you can dispense with the inner reinforcing strap which is desirable if heavy cameras (e.g. press cameras) are to be supported by the bracket.

A bolt with threads matching your camera's tripod socket is fitted with a knurled lock nut (a big washer soldered to a regular nut will do); this is inserted into the middle hole in the projecting part of the U-strap to hold the camera to the bracket.

Note the extension bracket shown in Fig. 5. You use this when the microscope is shifted from its normal position over the light hole to permit use of oblique overhead illumination of opaque subjects (Fig. 14). Use the same type of plumber's strapping and bend as shown. The bracket is bolted to the U-strap as shown in Fig. 6.

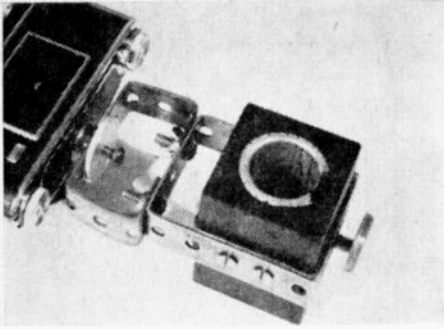

FIG. 6. Bracket is bolted to U-strap as picture shows you.

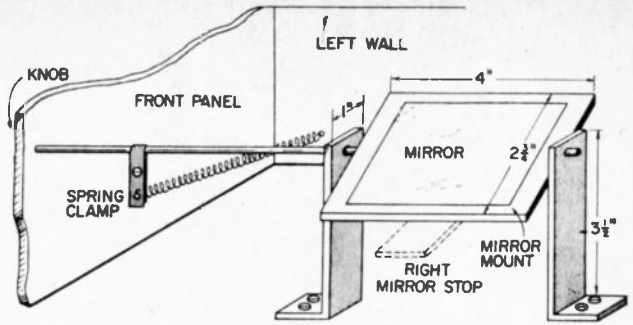

FIG. 7. Mirror assembly within the box. Rigid angle irons support the mirror. Household draw-drape rods were used.

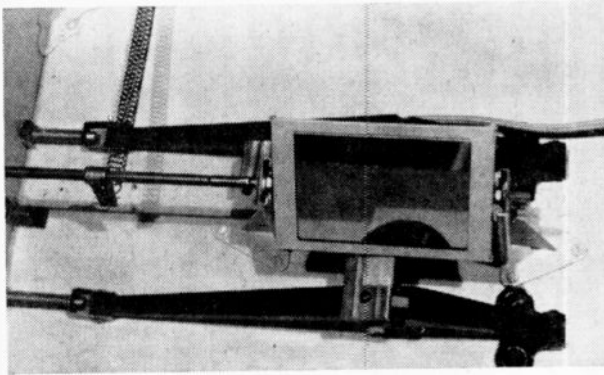

FIG. 8. Mirror is rotated 90° by knob at end of shaft (see above also). Spring automatically returns mirror to viewing position after each exposure. Adjustable brackets (black) control mirror position. Microswitch is on the farther arm, behind the mirror.

Mirror Assembly. Figs. 7 and 8 show the mirror assembly inside the box. You need two rigid angle irons to support the mirror. I used extendable brackets intended to support household draw-drape rods; these are easily extended to any desirable height. However, plain angle-irons do just as well but be sure they are sturdy and firmly mounted.

The mirror can be mounted in several ways. I used the front section of a photographic film-pack container to form the holder shown. You may find it easier to mount the mirror on a piece of plywood, and then fasten the wood to the shaft used to rotate the mirror. Mount the mirror at such height that its horizontal axis is at the same level as the centers of the holes in the box's side walls.

The long rod goes through the front panel, and a knob (from a radio supply store) is affixed to its end. Turning this knob tilts the mirror from side to side.

Now bend a strip of sheet metal (about $2\frac{3}{4} \times \frac{3}{8}$ in.) double on itself and around the mirror rod to form the spring clamp. Place a bit of rubber tubing on the rod first to prevent slippage. Tighten the clamp

securely to the rod using the nut and bolt in the upper hole.

A long spring, fastened to the lower hole of the clamp, is extended to the left wall of the box. Adjust the spring tension by altering its length and by adjusting the clamp until the mirror can be turned to the flash position but so that it will promptly flip back to its original position when the knob is released. Rubber bands can be used instead of the spring, but these require periodic replacement.

The "right mirror stop" indicated in Fig. 7 limits the right-hand swing of the mirror as described in the following.

Mirror Adjustments. Figs. 8 and 9 show one way of making adjustable stops for the mirrors; there are many others. Although stationary stops could be used, better control of the light beams is obtained by use of adjustable stops.

I used two hinged metal brackets that had been used to support the end pieces of a drop-leaf table. These are easily modified to form efficient, rigid stops.

First remove the spring from the long arm of the bracket, leaving it attached to

DIAL-A-FLASH

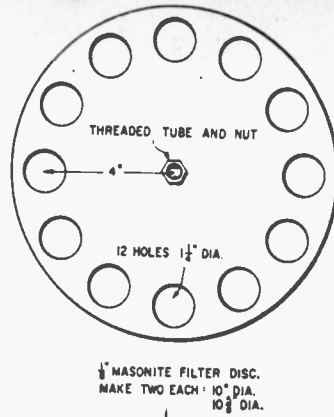
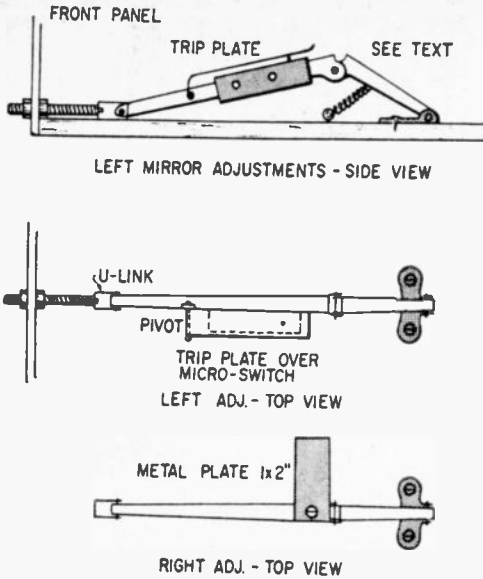
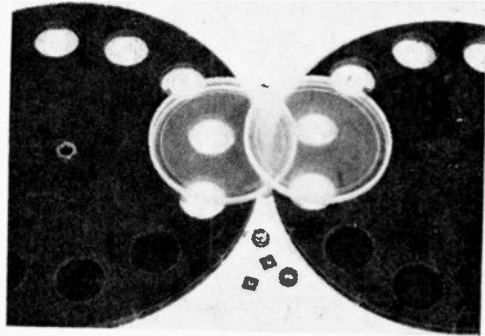

FIG. 9. For adjustable stops for mirrors, drop-leaf-table support brackets were used. See text for details of the modification.

FIGS. 10 (top) and 11. Filter system parts: two discs (for 24 filters); plastic coffee-can lids for spacers; spring, washer, nuts.



the shorter arm. The spring will be stretched to a screw-eye on the bottom of the box to provide a downward tension on the bracket. Remove the butterfly mounting piece from the long arm only, and replace it with a metal U-shaped connector made from stiff sheet metal. Bolt or cotter-pin the U link to the arm of the bracket so that it can pivot freely.

Drill two bolt holes through the front panel of the box as shown in Fig. 3, positioning the holes carefully so that the nuts on the bolts—inside the box—bear against the box bottom to prevent them from turning. Square nuts are better than hex nuts.

The bolts are made from 1/4-in.-diam. threaded rod. The inner ends are filed down to form pins that project through holes drilled into the mid sections of the U linkages.

Lay the bracket assemblies flat on the bottom of the box and screw the bolts out most of the way. Fasten the butterfly mountings on the short arms to the bottom of the box and hook the springs to their respective screw-eyes. Now screw in the bolts, and the

hinged brackets will gradually rise. The nuts on the outside of the box are used to lock the brackets into place when properly positioned.

Both stop brackets are identical in construction up to this point; the strike plates attached to them differ. The right stop is the simplest—nothing more than a 1x2-in. rigid metal plate bolted to the high end of the long arm so that the edge of the mirror mounting strikes it.

A pressure-sensitive microswitch (radio supply store) is bolted to the inner side of the left bracket. A flat "trip plate" is mounted over the microswitch. This is a strip of sheet metal about 3/4 x 3 1/2 in. in size, curled upward slightly at one end, and rolled into a tube at the other end. A bolt slipped through the tube section and bolted to the side of the bracket permits the trip plate to pivot up and down freely.

The purpose of the trip plate is to insure foolproof action of the tiny button on the microswitch when the mirror edge presses against the plate. A double lead wire from the microswitch terminals is run out through

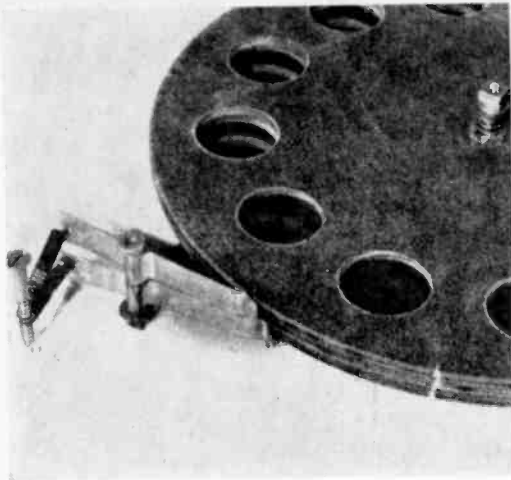

FIG. 12. Mounted discs and "click-stop" arms. Angular bend near end of each arm drops into notches on discs.

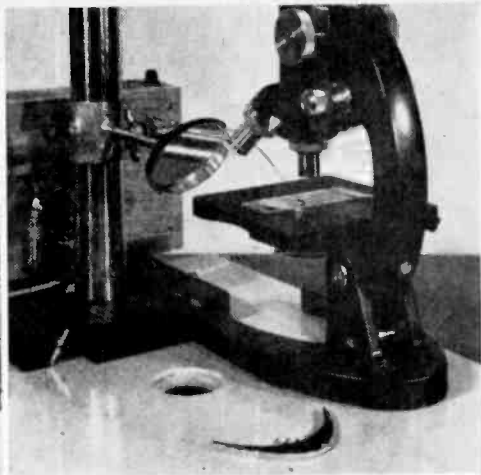

FIG. 13, right. Flash mounting and front panel. Note 2 discs, mirror (exposure) knob, mirror adjustment bolts.

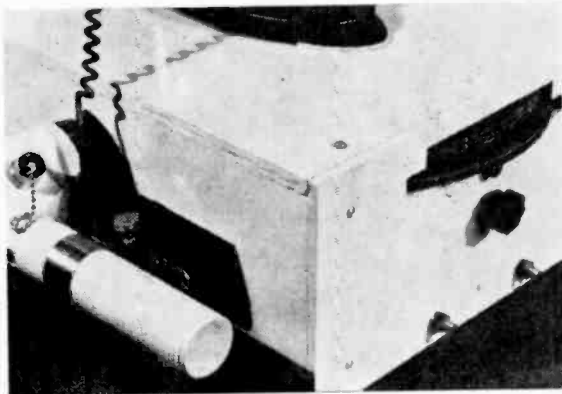

FIG. 14, top right. Mirror reflects light from hole onto stage for overhead lighting. Note hood, light-tight seal used between microscope, camera.

the rear of the box to the jack on the solenoid trigger box (cigar-box assembly).

Filter Discs. Fig. 11 shows the parts of the two filter discs. Each complete disc assembly is made from two Masonite discs sandwiched together so that filters can be slipped between them. The two disc assemblies are of slightly different diameters.

Sandwich each matching pair together (smooth sides out) and fasten at the center with pieces of threaded tubing of the type used in table lamps and other electrical fixtures (hardware or electric supply store), using very thin nuts. Radio stores have thin nuts—or you can split an ordinary nut in half and file it smooth. Use a nut on each side of the assembly, tighten firmly, cut off all extra tubing, and file smooth.

If the paired discs do not lie perfectly flat against each other, use two or three small brads to hold them together. Keep the brads in the inner part of the disc, away from the filter holes.

To determine the position of the hole for the dial bolt (Fig. 3), place a filter disc on

the box so that one of its holes centers perfectly with the hole in the box panel. Mark and drill a $\frac{1}{4}$ -in. hole through the box top.

Obtain a $1\frac{1}{2}$ -in. length of metal tubing ($\frac{1}{4}$ -in. O.D.) for use as a bearing sleeve around the dial bolt which should be about $\frac{3}{16}$ in. in diameter and about $2\frac{1}{2}$ in. long. Insert the bolt through the hole (counter-sink the head) and add the sleeve, forcing its end into the hole in the box top.

Make two plastic spacers by drilling $\frac{1}{4}$ -in.-diam. holes in the centers of plastic coffee can lids (see Fig. 11). Drop one of these onto the sleeved bolt (rim outward) then add the smaller filter disc, another plastic spacer, the larger disc, a short length of compression spring, washer, and two nuts. The discs should rotate smoothly and without undue wobble.

The filter discs are a great deal easier to use if you add the simple "click stops" shown in Fig. 12. Solder a short length of metal tubing to each of two $3\frac{1}{2} \times \frac{1}{2}$ -in. strips of sheet metal to form bearing sleeves. Bend one end of each strip slightly to form a V-bump

DIAL-A-FLASH

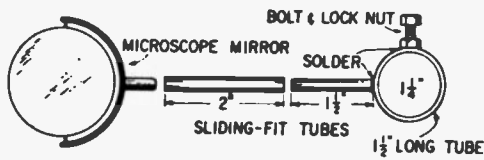

FIG. 15. Adapter construction details. It will also be useful as a projection device.

to engage small notches filed into the edges of the discs. Springs attached to the other ends of the strips provide tension to keep the strips snubbed against the disc edges.

To locate the notches on the disc edges, move the discs around to carefully center each hole over the hole in the box top. Mark these positions, and file the notches with a few strokes of a small file.

You can now place the panel back on the box by thrusting the projecting edges of the filter discs through the slots in the front panel (Fig. 13). The types of filters you should add to the discs will be discussed later.

Opaque-Specimen Illuminator. Your Dial-a-Flash will be far more useful if you make the simple adapter (shown in use in Fig. 14) to light opaque specimens which will not transmit light. The microscope is moved to one side from its normal position over the light hole. The extension bracket shown in Fig. 6 provides the extended reach needed to position the camera over the microscope.

Filtered light (both viewing and flash) emerging from the light hole is reflected onto the microscope stage by the adjustable mirror (use your regular microscope mirror). The mirror can be moved up and down and swivelled about to obtain any angle of lighting from a low grazing beam to a high oblique beam. The flat side of the mirror provides soft lighting; the concave side provides an intense, concentrated beam.

Fig. 15 shows how to make the adapter. Wrap a 1½-in.-wide strip of galvanized sheet iron around your camera post, allowing about ⅜-in. overlap for joining to form sliding sleeve. Tack solder lightly at this point.

Drill two holes half way down the sleeve at 90° to each other. Over one hole solder a nut for tightening the bolt. A 1½-in. length of tubing is soldered in the other hole

as shown. To fasten the tube firmly to the sleeve, flare one end and flatten out to form a narrow rim that will keep the tube from sliding out of the sleeve. Drop a washer on the outer side of the tube, against the sleeve. Flow solder into the joint for a firm bond. File away excess metal and solder from inside the tube.

A 2-in. length of tubing, slightly larger in diameter, slides onto the first tube. The tube diameters are not given because you should pick them so that the pin on your microscope mirror will fit snugly into the outer tube.

Now melt the tack solder holding the sleeve in shape, re-fit around the post for a smooth sliding fit, and resolder firmly.

You can use this adapter as a handy projection device when it is not being used for photomicrography. Slide it up on the post until the mirror is directly above your microscope eyepiece (camera removed). By tilting the mirror, you can focus the microscope field in greatly enlarged size onto the room wall or a screen a few feet away for group viewing.

Solenoid Trigger System. At this point (after adding filters to the filter discs) you can put your Dial-a-Flash to use as a semi-automatic system. Simply connect the microswitch directly to your flash gun—not to the camera shutter. To take a picture, swing the mirror just short of activating the microswitch to cut out the viewing light from the microscope, open the camera shutter (set to “bulb” or “time”), turn the mirror a bit more to activate the switch and thereby the flash, and close the camera shutter. All this takes far less time than it takes to tell about it—only 2 or 3 seconds at the most.

To make your Dial-a-Flash completely automatic, you should build the solenoid trigger system shown in Figs. 16 and 17. The box dimensions are not critical, so long as you can fit all the parts on the outside and insert three size-D flashlight batteries inside. A cigar box will do very well, or you can easily build a box measuring about 8x5x2-in.

(Note: This equipment could be incorporated into the large box. But if you make it as a separate unit, you may find other uses for it, as in remote firing of camera and/or flash in nature photography, etc.)

A trigger mechanism, solenoid, cable-release mount, and a plate holding a small radio jack are mounted on the top of the box. One long side of the box is made removable for battery changes.

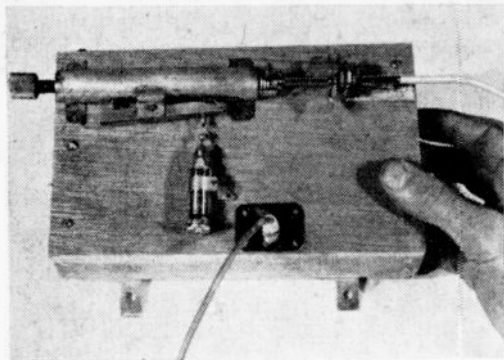

FIGS. 16 and 17. Solenoid trigger system. Plunger triggering mechanism is at top, solenoid below it. Wire leads to micro-switch inside the main box.

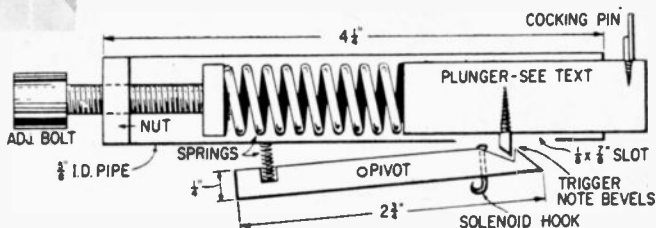
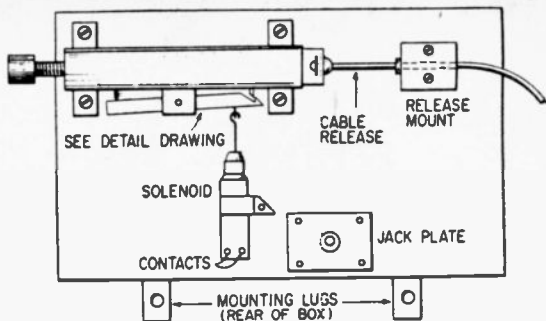

You can either buy a photographic solenoid (I paid \$5 for a used one in excellent condition), or you can make a solenoid if you are electronically experienced. The larger radio supply houses also sell 6-volt D.C. solenoids for a few dollars.

The cable release can be mounted by drilling a hole into a small block of wood through which the release can pass. Mount the block onto the box, in alignment with the plunger tube. (I used an angle iron with a U-slot holding an ordinary radio phono-jack through which the cable release can be passed.)

Small jacks cannot be mounted onto plywood, hence mount the jack onto a small metal panel and fasten this to a larger hole cut into the box top.

Build the spring and plunger mechanism inside a 4 1/4-in. length of 3/8-in.-dia. BX cable conduit pipe obtainable from any electrician. Into one end solder a nut to fit a bolt about 1/4-in. in diameter and about 2-in. long. Insert the bolt in the nut from *inside* the pipe so that the bolt head will bear against the spring. Fashion some sort of knurled knob on the other end of the bolt for easy turning.

Obtain a 2-in. length of compression spring (hardware store) to fit the inside of the pipe. Make a plunger about 2 in. long that will slide smoothly in the pipe. This can be a hardwood dowel. I found a discarded lipstick case of just the right size, and filled it with wood dowel; the metal case provides better sliding action against the pipe than does wood.

Screw a wood screw part way into the front end of the plunger to form a cocking pin. This pin is easier to push if you file one side flat and solder a washer onto the protruding pin for a thumb plate.

Before adding the spring and plunger to the pipe, cut a 1/8 x 3/8-in. slot lengthwise along the pipe, about 3/8 in. from the open end. The trigger pin protrudes from and slides along this slot. Place the spring and plunger in the tube (do not compress), and locate the trigger pin about one-third of the way from the front of the slot. Insert the screw only part way as shown, cut off the head, and file the trigger bevel.

Next make the pivot-arm mounted below the pipe. I used some 1/4-in.-square aluminum alloy stock; round stock will do as well but is not as easy to drill.

Locate a pivot hole about midway along this rod and fasten to a U-bracket soldered on the underside of the pipe. Use a bolt or rivet of such size that the pivot action is smooth and free of wobble. The front end of the rod is filed to form the notch and front bevel. A hole is drilled nearby to take a solenoid hook made from a small nail.

Near the other end of the rod, drill a small hole part way through to hold a small spring that bears against the underside of the pipe. Alternately, use a tension spring that pulls the rear end of the rod away from the pipe.

Solder two flat metal strips, with screw holes, onto the rear of the pipe for fastening to the box top. Line up the solenoid and cable release carefully with the pipe assembly and fasten into place.

DIAL-A-FLASH

Incidentally, the solenoid "contacts" consist of two small holes to take pin plugs. Just insert nails into these and hammer through the box; they will help hold the solenoid in place and will provide wiring contacts inside the box.

The interior of the box is shown in Fig. 18. Insert a partition in the box to snugly hold the three size D batteries in place against the removable long side. Note that one battery is inverted to permit easier wiring of the batteries in series. The black button contacts should actually be small springy strips of metal fastened at one end and pulled up slightly to make good contact with the battery terminals. Wire as shown, using the protruding nail ends as solenoid contacts.

The long side of the box is kept in place with bolts (heads removed) so that the batteries may be replaced when necessary.

Projecting metal straps on the rear of the box are used to mount the solenoid unit onto bolts set into the rear ends of the guide blocks that hold the camera post block.

Use of Solenoid Trigger. Plug the wire leading from the light-box microswitch into jack on the trigger box. Screw out the trigger mechanism's bolt most of the way so there is only slight pressure against the plunger by the spring. Using the cocking pin, push the plunger back into the tube until the trigger rod catches onto the plunger pin. This action is smooth if pin and rod bevels are properly made. Fasten the cable release (it

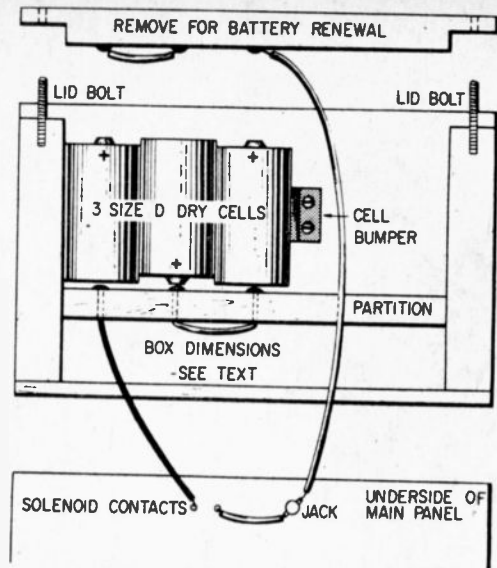

FIG. 18. Partition in box holds batteries in place against removable long side. One battery is inverted for easy series wiring.

should be at least 20 in. long) to the camera, and plug the flash unit into the camera socket.

Turn the mirror knob on the light box counter-clockwise until it activates the microswitch. This closes the solenoid-battery circuit, and the solenoid should instantly pull down on the trigger arm to release the plunger which pushes the cable release. If the shutter and flash do not operate, screw the adjustment bolt in a bit further to increase spring pressure against the plunger. Repeat this procedure until the cable release activates the shutter and flash repeatedly; then leave the adjustment bolt as is. Avoid excessive plunger pressure so that the camera shutter is not damaged.

Filter System. Use one filter disc to hold neutral density filters and the other to hold color and polarizing filters. Just slip the gelatin, film or acetate sheet filters over the holes, between the paired discs.

There are many uses for colored filters in black-and-white photomicrography; for example, special "M" filters for this purpose are made by Eastman Kodak. Note the listing on page 94.

Your photo store can obtain such filters for you (2x2-in. sizes are adequate). But for experimental purposes you can use far less expensive acetate filters; for example, you can obtain six 2x2-in. sheets (red, green, (Continued on page 94)

BILL OF MATERIALS

1/4-in. plywood (ea. 2 1/2 sq. ft.)	\$0.35
1/2-in. plywood (ea. 4 1/2 sq. ft.)	0.90
1/2-in. Masonite (ea. 4 sq. ft.)	0.40
Microswitch	1.65
3 flashlight batteries (size D)	0.60
Mirror (ea. 3x4 in.)	0.25
Mirror knob	0.10
Jack and plug	0.70
Set color filters (Edmund No. 40676)*	0.75
Two polarizing filters (Edmund No. 2721)*	0.75
Solenoid (used, photographic) (See text for alternatives)	5.00
Misc. wood and metal scraps, discarded vacuum-cleaner wand, nuts, bolts, screws, springs, wire, scraps of metal tubing and rod, paint, two junked table-leaf brackets.	

Estimated cost: \$11.00-15.00

*Edmund Scientific Company, Barrington, N. J. (08007)

MOIRÉ PATTERNS

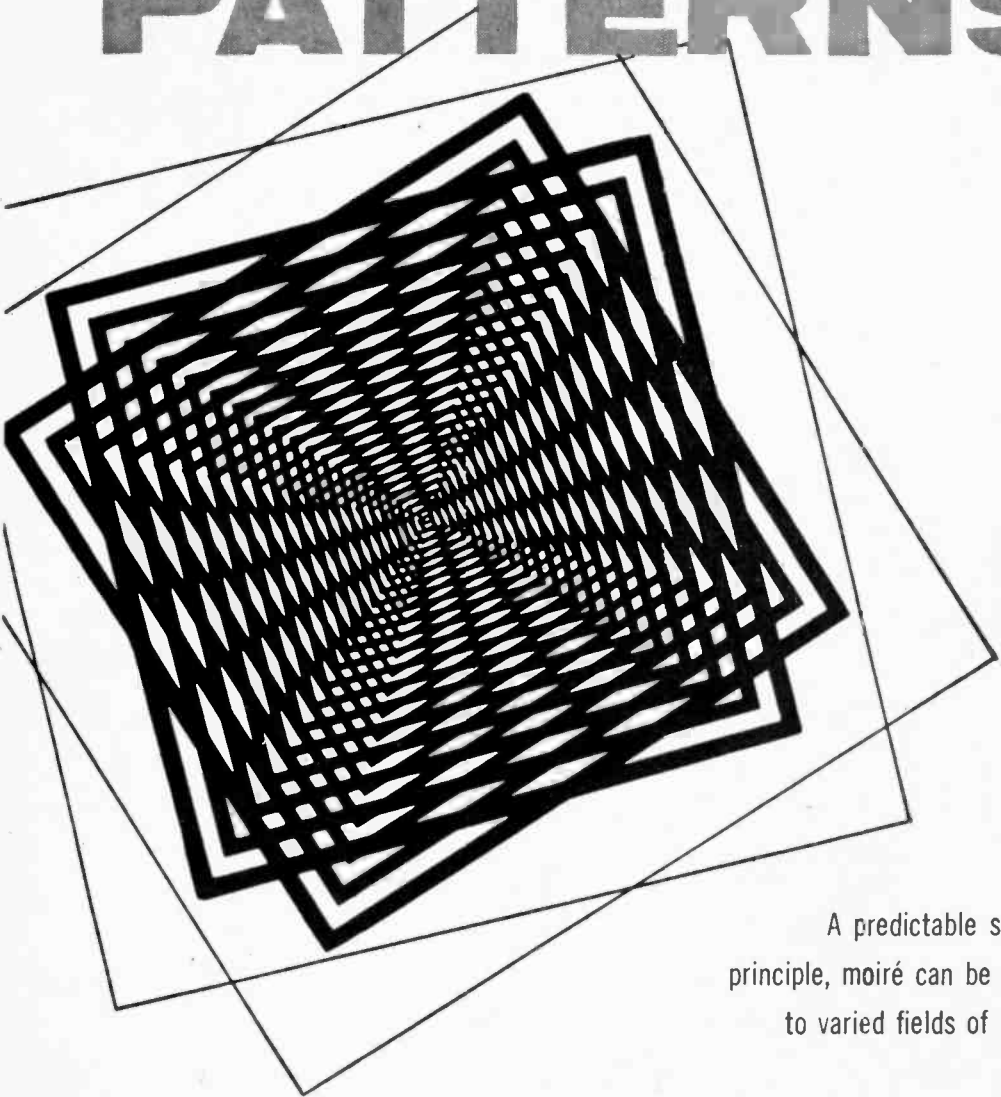

A predictable scientific principle, moiré can be adapted to varied fields of learning

EVERYWHERE we look these days we see patterns of lines—straight lines, circular lines, wavy lines. They assault the eye from every side—from newspaper ads, magazine covers, posters, TV and movie screens, and even from the walls of art galleries. Fashion has contributed to this phenomenon with dress fabrics and even bathing suits that contain a dazzling array of so-called “Op” art

patterns.

More than just a wonder of the graphic arts field, the visual effect achieved by these patterns is based on scientific principles. Moiré patterns—from the French word meaning “watered” or “shimmering,”—is best known in fabrics like moiré silk. The science is the brainchild of Dr. Gerald Oster of Brooklyn Polytechnic Institute.

MOIRÉ PATTERNS

Dr. Oster has developed a new concept of moiré patterns. Working with a Japanese colleague, Nishijima, he has succeeded in formalizing moiré into a predictable scientific principle. Since this principle can be readily adapted to the study of mathematics and physics, as well as chemistry and other fields of learning, students throughout the country are finding in it a new approach to classroom experiments.

Technically, moiré patterns are a visual phenomenon resulting from the superpositioning of equi-spaced lines. Oster has deduced that the varying patterns which emerge are the visualization of mathematical and physical principles, and thus can be used to envision and study problems involving these principles.

While the moiré principle has been known and studied for years, it wasn't until a year ago that basic patterns were available to the public. At that time, Dr. Oster—working with the Edmund Scientific Co., Barrington, N. J.—developed a complete moiré kit. The original kit included eight basic design sheets in black and white which, when superposed, produce a fascinating array of patterns.

Since then, eight new patterns have been added, bringing the number now available to 16. With these 16, experimenters can open up a whole new world of fascinating possibilities. Edmund moiré kits consist of figures which have been constructed with great precision. Each design is produced on clear film as a transparency and also as an opaque positive of the transparency.

Color Moiré. The most recent development has been the addition of color. The 16 basic patterns are now available in specially-printed transparent inks in yellow, magenta (red) and cyan (blue). Color moiré patterns are stunningly beautiful. Combined with the basic black, they enable experimenters to produce more moiré patterns and to demonstrate many interesting phenomena of color perception.

Another important feature of the color moiré kits is that they permit demonstration of the subtractive color theory and the effects associated with the juxtaposition of colors.

Though the colors used do not conform precisely to the idealized theory, they were chosen with great care. They are filters which pass light of only certain regions of the visible

spectrum. Y (yellow) passes green (G) and red (R); *i.e.* white (W) without blue (B). Magenta (M) passes B and R, *i.e.* W without G. Cyan (C) passes B and G, *i.e.* W without R. It is therefore seen that Y, M and C are colors produced by the subtraction of some color from white and hence are referred to as the subtractive colors.

The additive colors, namely B, G and R, as well as black (N for night or for *noiré*, if you like) can be produced by the subtractive colors. For greatest precision, with both color and black and white kits, the image side of the transparency should be in direct contact with the opaque print.

There are several ways of viewing the patterns to see the moiré effects. It is often sufficient to lay the transparency over the print. Another procedure is to view the overlaid figure with a photographic viewer.

You can also produce moiré patterns by the reflection technique for which you will need a front surface mirror such as Edmund No. 40,041—\$1.25. This procedure can only be used for superposing of one figure on its image.

The science of moiré is visual proof that science can be fun. The color transparencies lend themselves to an almost endless combination of the figures. By experimenting with these combinations and then overlaying the result on its own or a varying opaque black and white print, unusual—even fantastic—multi-colored "Op" art pieces suitable for framing can be created. Additional effects can be produced by varying the distances between the transparencies.

Moiré Mobiles. Another artistic possibility with moiré patterns is the construction of 3- or 4-sided mobiles. Many versions can be easily constructed.

Cut the opaque black and white prints and their respective transparencies into individual figures. If front lighting will be used, Scotch tape the opaque prints together and construct a 3- or 4-sided figure (as illustrated). Tape along the long edge. If back lighting is to be used, substitute the black and clear transparencies for the opaque prints. To make the structure more rigid, tape the black and clear transparencies to thin pieces of glass or plexiglass $3\frac{3}{4}$ in. x $4\frac{1}{2}$ in. and then construct the 3- or 4-sided figure.

Next, using spacers, put a small piece ap-

proximately $\frac{3}{8}$ in. thick in the 4 corners of each print. Sponge rubber, such as weather stripping, may be used for spacers.

Now affix the respective transparencies over the opaque print and continue to use spacers in each corner as the transparencies are added. For the best results of color effect, place the yellow closest to the opaque print and each transparency should be off center with respect to the one under it.

When completed, hang the mobile from a weak spring so that air currents in the room will vibrate it. The harmonic motion will create varying and unusual moiré effects. These mobiles are sure to attract attention and keep visitors busy observing the different patterns which become visible as the mobiles turn.

Overhead Projection. The color transparencies can be overlaid on one another on an overhead projector. By rotating or sliding

the transparencies over one another, moiré patterns are projected on a screen.

Another idea for budding fashion or fabric designers to try is to create "Op" art dresses by projecting the color moirés onto a model wearing a white dress. This might easily prove the start of a financially rewarding career!

Light Box. Diffused backlighting of the color moiré transparencies, as well as the black and clear will greatly enhance their effectiveness. Commercial light boxes or 35-mm slide-sorting trays are recommended.

For experimenters, a diffused backlit source is quickly and easily improvised with: an opal (milk-white glass or plastic (such as Edmund Translucent Projection Screening, No. 70,662, 12 in. x 24 in. for \$1); ground glass and onion paper or tracing paper.

Using fluorescent light or the new white incandescent lamp as a source of back light,

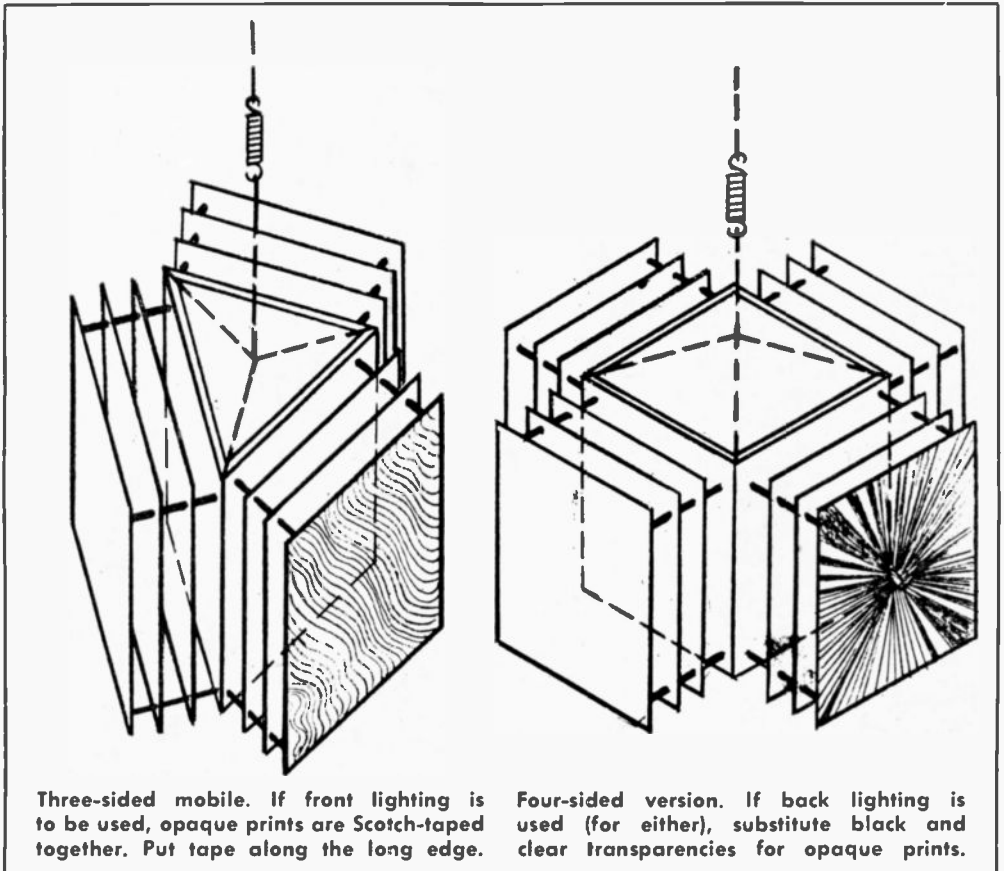

Three-sided mobile. If front lighting is to be used, opaque prints are Scotch-taped together. Put tape along the long edge.

Four-sided version. If back lighting is used (for either), substitute black and clear transparencies for opaque prints.

MOIRÉ PATTERNS

opal glass or plastic will diffuse the light evenly. The moiré transparencies can be overlaid on the glass. By sliding one transparency over the other, the moiré patterns will be instantly generated and well back-lighted.

A piece of ground glass will also be satisfactory as will a piece of typewriter onion paper or tracing paper. If the onion or tracing paper is used, tape it down over a piece of ordinary window glass and then use it as described for the opal glass.

Advertising or Display. For the advertising or marketing student, attention-getting displays can be fashioned with moiré patterns available in larger sizes. Edmund Scientific offers black and white only of all its 16 figures in 8½ x 11 in. size and of four of the figures in 20 x 35 in. size. The centro-symmetric figures lend themselves to rotating motion displays, by the use of low-speed motors.

Using color moiré patterns as backgrounds, photographs or other advertising material can be superposed on the background to create unusual and eye-catching effects.

Calcite Crystal Experiments. Most of the experiments described above are in the graphic arts field. There are experiments with calcite crystals which illustrate the power of moiré effects in their application to optical crystallography.

Calcite (also called Iceland Spar) occurs naturally in the form of rhombs with edge angles of 102° and 78°. Light passed through the parallel faces of the crystal is refracted into two beams. Place the crystal over a spot on a piece of paper. The spot appears as two spots.

When the crystal is rotated one of the spots remains stationary (formed by the ordinary ray) while the other (formed by the extraordinary ray) moves around it. The line connecting the two spots passes along the optic axis of the crystal and is in the direction of the obtuse vertex of the rhomb.

The two rays are polarized at right angles to one another as can be seen by rotating a Polaroid dichroic filter on the double spot image and noting the disappearance of one of the spots.

When the calcite crystal is placed over any of the centro-symmetric figures one observes

moiré patterns as gray lines. These are the moiré patterns produced by the figures and their copies with their centers being slightly displaced. Applying the Polaroid over the moiré pattern destroys the pattern and only the single figure is observed.

If the calcite crystal is placed between two equispaced gratings and the system is illuminated (from underneath) with white light, strongly colored moiré fringes are observed. In only one orientation, namely when the grating lines lie along the optic axis, are the moiré fringes free of color. In other orientations the colored fringes indicate the dispersion (the variation of refractive index with wave length of light) of the extraordinary ray.

When a calcite crystal is cut into a plate with its optic axis parallel to the surface of the plate and viewed between Polaroids, the illumination being provided by a convergent beam of light (the so-called conoscopic condition), one observes patterns of rectangular hyperbolas.

These curves are the curves of equal optical path difference (equal retardation) between the ordinary and extraordinary components. The wave lengths (inversely proportional to the refractive index) of the extraordinary waves are different for different directions of propagation of light through the crystal, whereas the wave length for the ordinary waves are the same for all directions of transmission.

Myriad Experiments Possible. Mathematical analyses of optical problems are possible in endless variety with the science of moiré. We have given you but a few possibilities here. *The Science of Moiré Patterns*, By Dr. Gerald Oster (Edmund No. 9068, \$2) will give many more detailed examples of experiments possible.

Moiré pattern kits are now available in four versions: Experimenters Moiré Pattern Kit, Series A, in black and white, No. 70,719—\$8.50 (includes 32-page text, *The Science of Moiré Patterns*); in color, No. 60,530—\$12.50. Series B, in black and white, No. 70,790—\$6.00; in color, No. 60,531—\$12.50. Kits are also available in combination.

Join in the fun. Experiment with this exciting new science which opens up a whole new field of visual psychology. ■

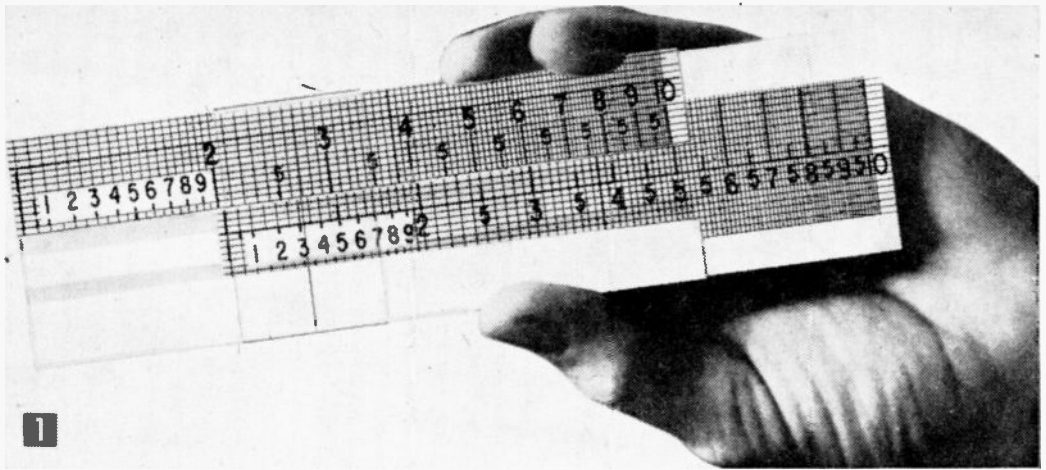

Three-Cent Slide Rule

A SHEET of two-cycle semi-logarithmic paper can be transformed into an analog calculator (slide rule) in just a few minutes. For mine I used K and E 359-63 paper. Cut off a strip 1 in. wide along the length of sheet and then cut this strip at the middle "1" marking.

Next, mark graduations and numbers on the scales as shown in Fig. 2. Note that the small numbers between the large 1 and 2 are two spaces apart. Between 2 and 3 and between all the other numbers, the small 5 is five spaces between the large numbers.

The body of the rule is a 2¾-in. strip of 5-in. filing card, bent as shown in Fig. 3 to form a track for the slide. The slide (the B scale) is a 1½-in. strip of 5-in. filing card. Attach the scales with rubber cement and assemble rule.

Make the indicator from celluloid or the thin plastic material sold to protect walls around light switches. Cut out a piece 1½ x 4¼ in., use a compass or ice pick point and a straight edge to scratch a line on the transparent material, and fill the scratch with India ink. Then bend the indicator material around the edges of the slide rule and crease it. Fasten the ends of the indicator with scotch tape on the back side of the slide rule. That's all there is to it. To multiply, you add logarithmic distances; to divide, you subtract logarithmic distances. For example: $2 \times 3 = ?$ To solve, set 1 on scale B opposite 2 on scale A. Set indicator hairline over 3 on scale B. The answer 6 appears under the hairline on Scale A. You've added the log distance 3 on scale B to the log distance 2 on scale A.

How about $2.15 \times 4.1 = ?$

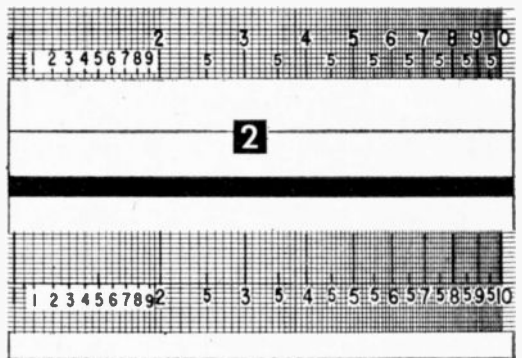
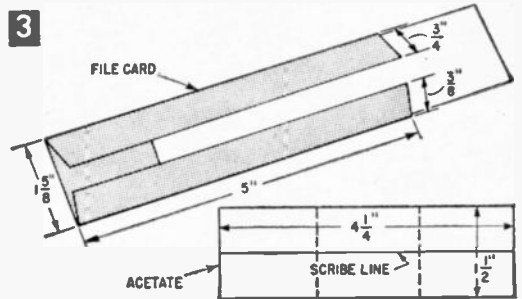

Set 1 on B opposite 2.15 on A. Set hairline over 4.1 on B. Read the answer 8.8 under the hairline on scale A.

The exact answer is 8.815. The size of the slide rule, the accuracy of the scale calibration, and the care you exercise in setting and reading numbers limit the accuracy. The numbers between 5 and 10 are particularly crowded on this small rule, and you can't expect to get closer than 8.8 in this instance. Note, however, that the error is less than one-fourth of 1%! Always convert to numbers between 1 and 10. In this case, $(2.15 \times 10) \times (4.1 \times 10) = 8.8 \times (10 \times 10) = 880$.—F.H.F.

SEE THE INVISIBLE

By Jorma Hyypia

*Long neglected by experimenters,
Schlieren optics enable you
to observe and take pictures of
continually changing densities
in air or liquid environments*

SCHLIEREN optics have been known for a long time, but amateur experimenters seem to have paid little or no attention to them. Perhaps there has been a failure to recognize the vast experimental applications of the fascinating technique. Or perhaps there is a mistaken belief that the equipment is expensive or hard to obtain, or that the technique is too difficult. Not so—as you can prove by assembling easily available equipment costing only a few dollars.

The word Schlieren, in German, means “streaks” or “striae,” and the optical system it denotes is capable of revealing very small changes and differences in the refractive indexes of gases and liquids. This phenomenon enables you to observe continually changing densities in air or liquid environments.

The air around a hot object such as a soldering iron or flame is in constant turbulence and exhibits changing, invisible areas of high and low densities. A colorless crystal dissolving in water exhibits another kind of invisible turbulence as it diffuses—and again there are localized density

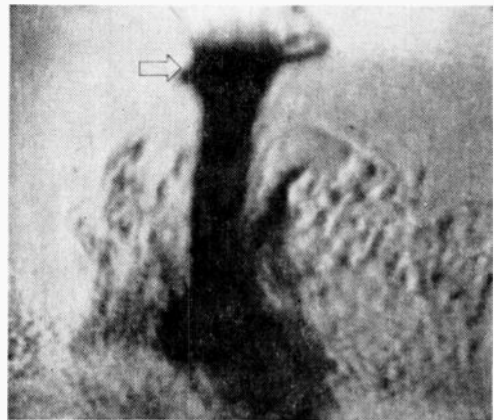
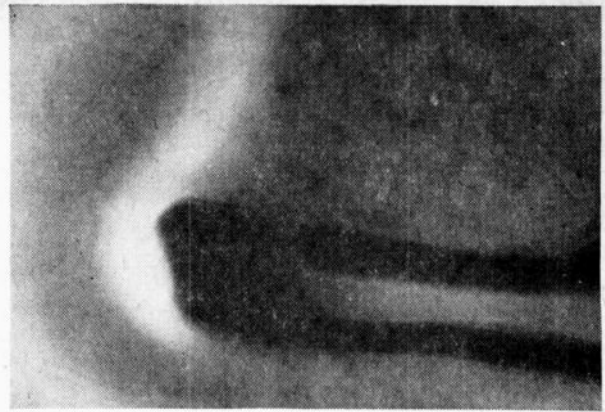

changes. A stream of clear water mixing with water that is a few degrees cooler or warmer has its own invisible variable-density turbulence. All such conditions are made dramatically evident by Schlieren techniques. The still photographs accompanying this article can only suggest the dramatic fascination of actual Schlieren patterns *in motion*.

Aside from these examples, what kinds of projects could you plan using the Schlieren apparatus? A little probing of the scientific literature relating to Schlieren research will reveal a wide diversity of ideas worth pursuing. Schlieren methods have been used to study crystal growth, analyze sound, and study air layers on the surfaces of textiles; they have been used in medical and biological research, and in the testing of lenses and other optical equipment.

The Schlieren technique has important industrial research applications in the study of flame characteristics, air jets, etc. Specially modified procedures have even been used to study magnetic fields in tape recording equipment.

Perhaps best known—in terms of pub-

FIG. 1, left. Schlieren photo shows heat flow about soldering-iron tip.

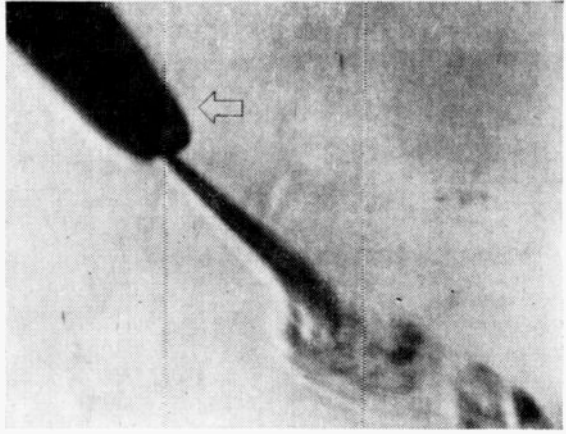
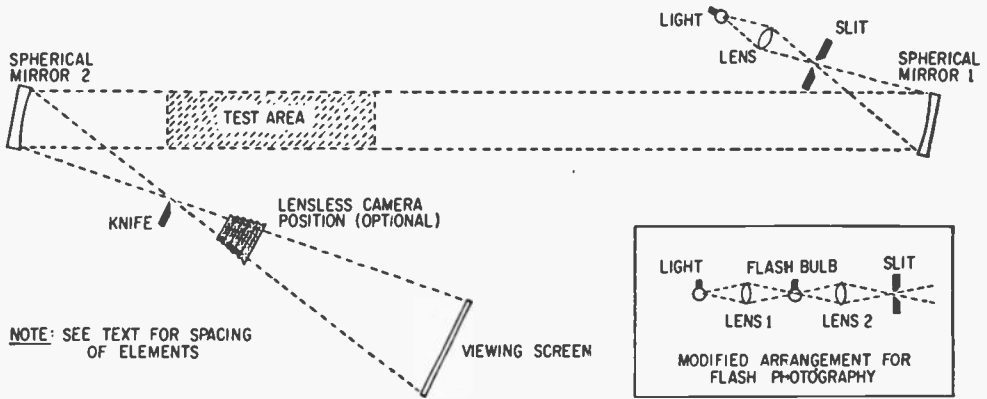

FIG. 2, lower left. Colorless crystal (arrow) dissolving in water.

FIG. 3, right. Clear water from medicine dropper (arrow) flows into cooler water. Note the turbulence.

FIG. 4. Basic Schlieren system. Use of photo techniques is unneeded.



lished pictures—are Schlieren studies having to do with the analysis of shock waves associated with bullets, rockets and supersonic aircraft. And although we won't here get into the area of *color* Schlieren techniques, aeronautical researchers (North American Aviation scientists in particular) have worked out methods by which colored Schlieren patterns can be used to obtain important information about density variations in the air surrounding fast-moving missiles or planes. Using this specialized technique, *compression* patterns in the air are seen in tones of red while *expansion* patterns are revealed in blue or violet.

Whatever scientific field appeals to you most—biology, chemistry, physics, aeronautics, etc.—you are sure to find many unique applications of the Schlieren optics. Let's say you have built a model wind tunnel for aeronautical research. Try using the Schlieren technique to observe air-flow patterns around models placed in the tunnel. Comparable experimental applications could be cited in virtually any area of scientific investigation.

The basic Schlieren system is really quite simple. A *point* source of light (Fig. 4) is focused, by means of a simple lens, onto an optical slit of variable width. The light passes through the slit to a spherical mirror which reflects it (as parallel rays) to a second spherical mirror. The subject to be studied is placed between the two mirrors, in the beam of light. The second mirror focuses an image of the subject onto a viewing screen (or camera film if a picture is to be taken) after part of the light has been blocked off by a special optical "knife."

Fig. 4 also shows a modified lighting system which can be used to take Schlieren photographs using flash bulbs. But as we'll show later, it is quite possible to obtain good pictures with the basic set-up alone, without using flash bulbs. In fact, the photographs used in this article were made without any supplementary lighting. If you are a movie fan, you might try loading your camera with fast black-and-white film to capture the Schlieren patterns in motion. You may wind up with some fascinating footage.

It should be emphasized—to avoid any

SEE THE INVISIBLE

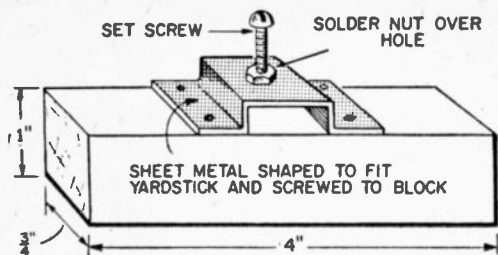

END SUPPORTS (MAKE FOUR)

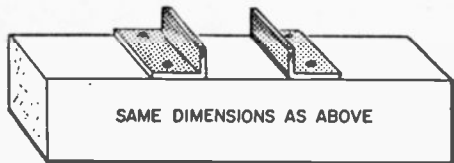

ROVING SUPPORTS (MAKE TWO)

misunderstanding—that the Schlieren technique *per se* does not require the use of photographic techniques in any form. The patterns can be observed visually on nothing more than a simple cardboard or ground glass screen.

Optical Bench. Any type of optical bench can be used provided it has provision to line up, raise and lower, and rotate the various optical elements to get them into proper relationship to one another. You may already have an optical bench, or prefer to construct one of your own design from odds and ends. The one shown here was made from two yardsticks, scraps of metal and wood, and six adjustable curtain rod brackets. The metal brackets serve well because they are sturdy, and can be raised or lowered easily after loosening a single set-screw.

Note that you will need *two* optical benches, each about 3 ft. long. The light source, lens, slit and mirror No. 1 are placed on one bench; the knife and mirror No. 2 are placed on the other bench which must be positioned about 12 feet from the first bench when Schlieren experiments are performed.

If you use yardsticks as the bases of your optical benches, select good-quality, rigid sticks—not the flimsy ones often given away by stores. The inch and centimeter markings on yardsticks speed positioning of the optical elements, but you can get by very well with yard-long strips of wood cut from unwarped pine or other available wood.

The support blocks at the ends of the yardsticks (Figs. 5 and 6) have set screws

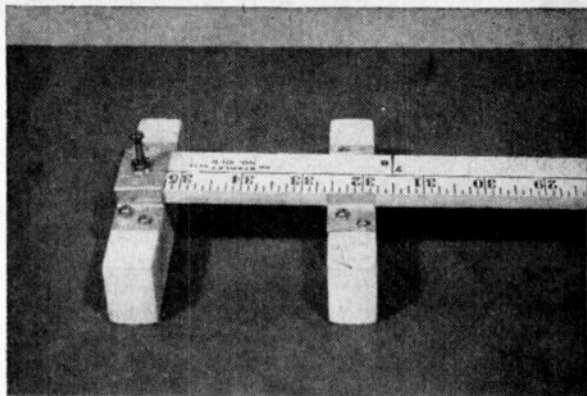

FIG. 5, left. Details of supports. Note the set screws that keep yardsticks in place.

FIG. 6. Pictorial view of same. Yardsticks should be good quality, not giveaway type.

to keep them in place. The “roving” supports can be quickly slipped on and off for re-positioning without necessitating removal of any optical elements from the yardstick.

Figs. 7 and 8 show how to convert curtain rod brackets for use on the optical bench. First straighten the hook at the top, then bend this top section to right angles with the main body of the bracket. Sweat solder a $\frac{3}{8}$ -in. by 3-in. strip of sheet iron—and on top of this a 6-32 hex nut—to the rear part of the bracket base. The metal strip folds under the yardstick, and a bolt through the hex nut passes through a hole in the bracket to tighten the assembly on the yardstick.

The front end of the bracket is kept from shifting about by dropping 6-32 bolts through the two front screw holes in the base and passing them through plastic or metal tube spacers and then through holes drilled in a short bar made of plastic or metal. The plastic or metal tubing keeps the bar from binding against the yardstick, and also stops lateral sway of the bracket. Lacking suitable plastic or metal tubing, simply wrap some tape around the bolts.

The mirror holders are bolted directly to the tops of their respective brackets, the slit and knife assemblies are attached by means of rigid angle irons, and the light bulb and lens are secured by short lengths of wood dowel (Fig. 9). All these methods of attachment permit the units to be rotated.

Light Source. The light must come from as nearly a *point* source as is possible. If you own an arc light, use it—you couldn't ask for anything better; the light is intense,

and originates from a small area. However, many experimenters do not have arc lights and have little inclination to build or buy one. Consequently I searched about for an acceptable substitute.

Certain types of straight-filament projection bulbs (flat ribbon filaments) and some concentrated-arc bulbs are available, but are hard to find and expensive. Much cheaper, and easy to obtain, is an automobile light replacement bulb sold for about 35 cents at any auto supply store. Look for a 12-volt, bayonet base, dome-light bulb with a *single* straight filament coil. Avoid those types that have two filament coils. You will also need a 12-volt transformer (available at radio supply houses) to operate the bulb; or you can use a variable Powerstat transformer, as I do in my lab.

This source of light is not actually a *point* source and, therefore, is not ideal. But neither is economy its only virtue. I think you will be amazed—as I was—how well this low-priced substitute works. Start your Schlieren experiments with this light source and shift to an arc light if you get into more ambitious projects. The auto bulb is bright enough, even after part of the light has been blocked off with the optical knife, to yield bright images of a foot or more in diameter for visual observation. And there is also plenty of light to make photographs using a $1/1,000$ th of a second shutter speed!

If available, buy a bayonet socket to fit the bulb. If you can't find one, file the lock-

ing pins off the base of the bulb, solder lead wires to the base and terminal contact, wrap some electrical tape around the base and push it into a 1-in. length of electrical conduit or other metal tubing.

Mount the bulb on the end of a wood dowel (Fig. 9), and make a light shield for it out of sheet metal (Fig. 10). Do *not* use a reflector which would tend to diffuse the light. The open shield eliminates most glare and permits air to circulate freely to keep the bulb cool. Any objectionable light spillage onto other parts of the equipment can be shielded with a piece of cardboard. Proper placement of the light will be discussed later under experimental procedure.

Lens. Almost any short focal-length lens available (2 to 3 in. is ideal) that can form a sharp image of the light filament can be used. A simple double-convex magnifying glass will do; I used an old camera lens with a 2-in. focal length. Mount the lens on a wood dowel (Fig. 9).

Mirrors. You will need two *spherical* mirrors which should be at least 7 in. in diameter. Ordinary flat mirrors will *not* do because they cannot focus the light properly. Two 7-in. "magnifying shaving mirrors," obtainable at most dime stores, are satisfactory and should cost no more than two dollars. Smaller sizes are available, but they are not recommended.

Remove the wire stands that are attached to the mirrors and replace them with new holders bent from some stiff strap metal

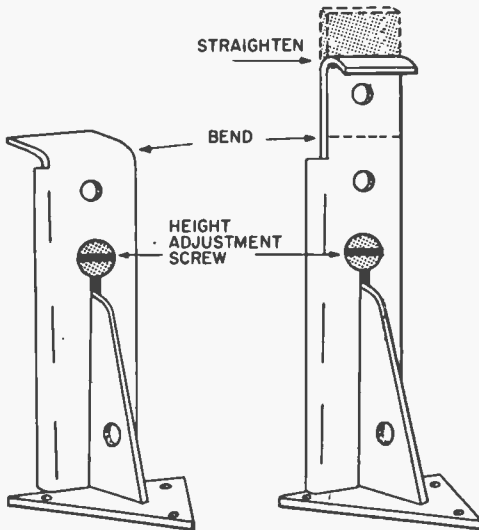

FIGS. 7 and 8. Convert curtain-rod brackets for use on the optical bench in this manner.

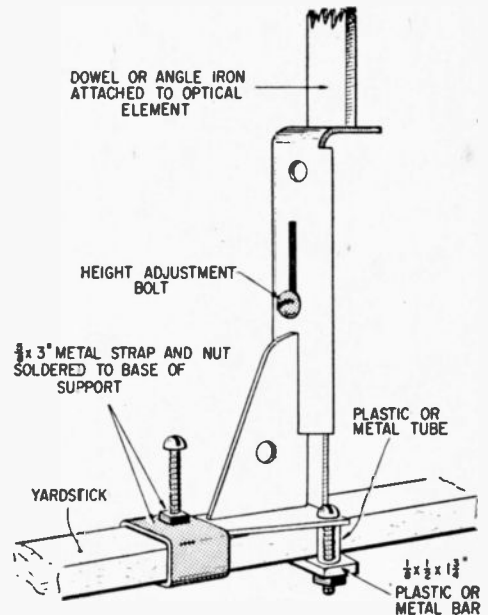

SEE THE INVISIBLE

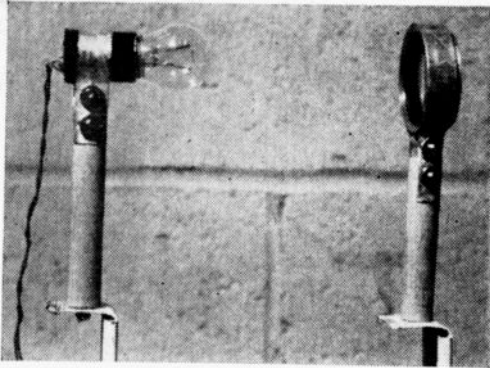

FIG. 9. Dowels, metal straps mount, bulb and lens. Upper, tightening bolt bypasses dowel.

(Fig. 11). Projecting 6-32 bolts fastened to the ends of the brackets slip into the holes in the mirror frame. Remember to clean the mirror carefully before starting Schlieren experiments.

Optical Slit. You can short-cut the construction of the adjustable optical slit (Figs. 12 and 13) by simply cutting a $\frac{1}{4}$ -in. x 1-in. vertical slot in the middle of a $\frac{1}{8}$ -in. thick Masonite panel (about 8 x 8 in.). Tape two new single-edge razor blades over the slot so that their sharp edges form a slit about $\frac{1}{16}$ in. wide. However, this make-shift slit does not have the manipulative flexibility offered by an adjustable slit. If you build the more versatile slit, chances are you will ultimately use it in other types of optical experiments.

The slit described here is admittedly not a precision instrument of the same caliber sold, at high prices, for critical scientific work. But it serves well and has the advantages of low cost and ease of construction (no fancy thread cutting or other machining jobs are required).

Fig. 13 is, in general, self-explanatory. But a few vital points should be noted. Cut the six $\frac{1}{2}$ -in. wide moving arms from stiff sheet aluminum or iron, and lay out the hole positions carefully. Mark all hole positions with a center punch, before drilling, to insure accuracy. Small aluminum rivets are used to join the arms together; these should be hammered down just enough to eliminate any wobble while leaving the arms free enough to pivot smoothly.

New single-edged razor blades are riveted firmly to the horizontal arms; the blades already have convenient center holes for this

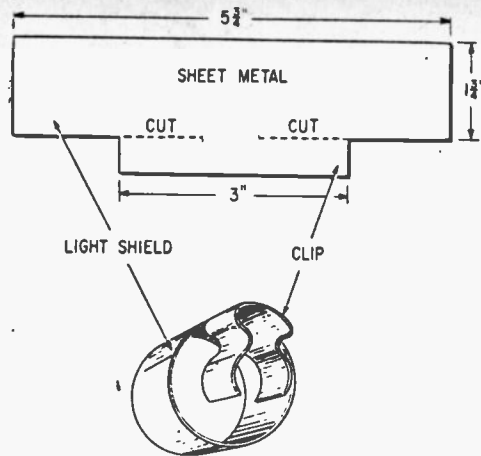

FIG. 10. Sheet-metal light shield for bulb.

purpose.

The two "pivot rivets," (split rivets), extend through the Masonite panel to hold the arm assembly on the board. These, too, should be tightened just enough to prevent wobble but not so much that rotation of the arms is impeded.

The angle iron at the top of the arm assembly, which is attached to the adjustment bolt, is also made from flat sheet metal. Bend it so that it rides against the Masonite panel (Detail A, Fig. 13). Note that the two rivets do *not* pass through the metal arm which must be free to move up and down; the rivets are placed next to the arm with the shanks touching the arm edges and the heads overlapping the arm.

A small angle iron is also bolted to the top of the panel, with one leg projecting forward; a suitable nut is soldered over a hole in this leg. The adjustment bolt is threaded through the nut until its end passes through a hole in the top end of the moving arm (Detail A). Washers are soldered to the bolt, one on each side of the moving arm. These washers push and pull the arm when the adjustment screw is turned.

The razor arm channels (Detail B) can be made from wood, metal or plastic. Plastic is preferred because it is *easily* drilled and shaped, and because the razor arms slide easily against its surface. In any case, construct and position the channel blocks very carefully so that they guide the razor arms without binding and with a minimum of side-play. Cut a $\frac{1}{4}$ -in. x 1-in. slot in the middle of the Masonite panel.

To assemble the unit, lay out the pre-joined razor blade-arm system on the board,

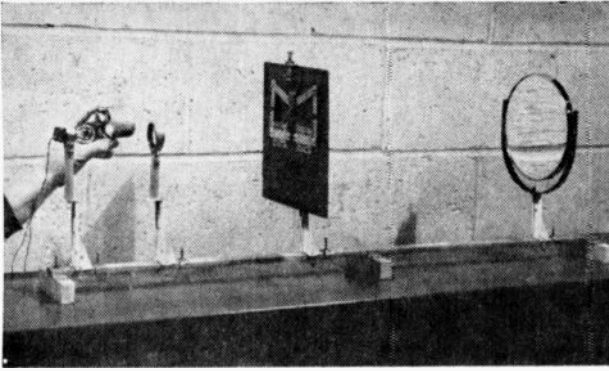

FIG. 11. Light source (shade removed), lens, adjustable slit, mirror in approx. positions. Transformer is unseen.

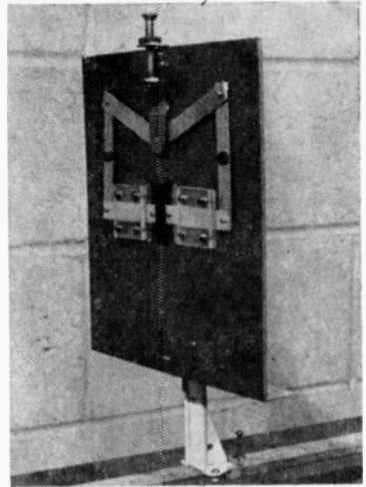

FIG. 12. Top bolt moves arms. Razor blades are blackened.

positioning the blades accurately over the opening and checking to see that the vertical moving arm and adjustment screw line up accurately. Tape the parts to the board while drilling the two pivot rivet holes and the bolt holes for the channel blocks.

Optical Knife. Construction of the optical knife is shown in Figs. 14 and 15. Three $\frac{1}{8}$ -in.-thick Masonite panels, measuring approximately $3\frac{1}{2} \times 4\frac{1}{4}$ in., are bolted together with 6-32 bolts after an arced notch has been cut into the top of the middle panel (Fig. 15). Bolt an angle iron to the bottom (rear) of the Masonite sandwich to fasten the unit onto one of the optical bench brackets.

Cut a 1-in. square hole in the center of a Masonite disc, 4 in. in diameter. Fasten a single-edged razor blade onto a sheet metal arm, as shown, and fasten this arm to the disc with four split rivets. Note that the rivets act as guides and do not pass through the arm itself. When the completed disc assembly is dropped into the Masonite pocket, it can be rotated through 180° .

Viewing Screen. You can perform Schlieren experiments without the adjustable ground-glass viewing screen (Fig. 16) by projecting the image onto white paper. But you will soon see why a ground-glass screen is a near necessity.

The Schlieren equipment extends for some 12 ft. because the mirrors must be spaced several yards apart. It is often necessary to view the image from two sides of the ground glass when the various optical elements are being aligned. The adjustable support is convenient because the glass can be quickly shifted up or down to keep the image prop-

erly centered on the glass. The dimensions are not critical, and you can use a ground-glass sheet of almost any size (preferably larger than the one shown). If a piece of ground glass is not readily available, a piece of translucent acetate sheet, obtained from most art supply stores, will do.

Experimental Procedure. Fig. 11 shows the approximate positions of the optical units on the first bench. The exact positions

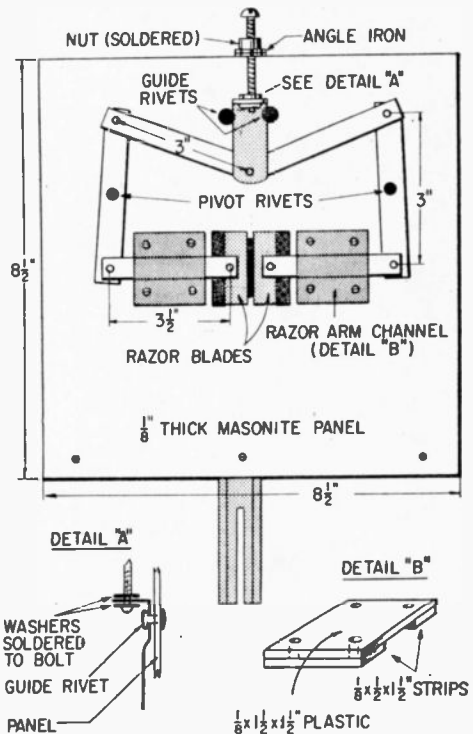
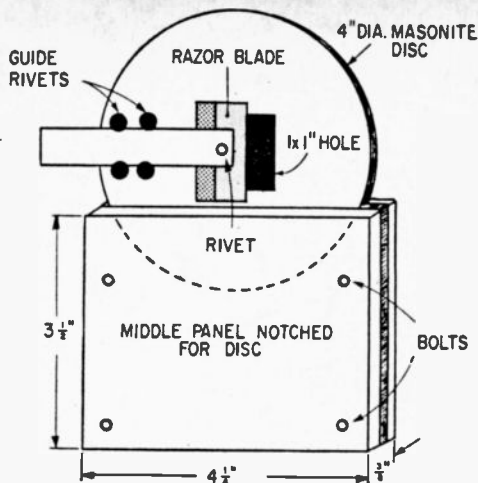
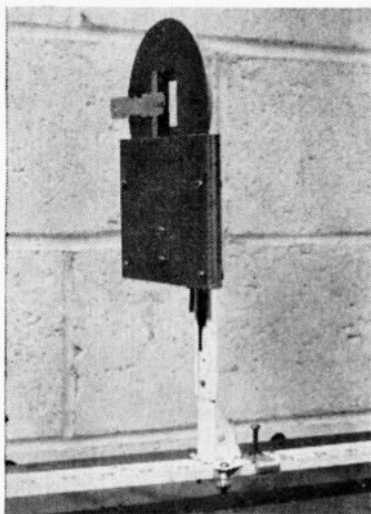

FIG. 13. Adjustable optical slit details.

SEE THE INVISIBLE



FIGS. 14 and 15. Optical knife. The razor blade "knife" can be moved back and forth across square hole. Disc rotates freely.

will depend largely on the focal length of your lens; you will have to work out the proper space relationships according to the procedure described below.

The second bench (Fig. 17) holds a mirror at one end and the optical knife approximately 2 ft. away from the mirror. The ground-glass screen is generally positioned, independently, several feet from the optical bench.

Position the optical benches parallel to each other (Fig. 4) so that the mirrors (turned slightly in their mounts) face each other and are about 12 ft. apart. Although the distance is not critical, it should not be less than 10 ft.

Check the light bulb to see that its filament is in a *vertical* position. Close the slit, or tape a thin piece of paper over it temporarily, while making the next adjustment.

Starting with the lens fairly close to the bulb, move the lens and slit mountings, alternately, away from the lamp until you get a clear image of the lamp filament on the slit. Twist the lamp mounting, if necessary, to accurately align the filament image with the slit. Remove the paper from the slit, and open the slit to let the light fall on mirror No. 1. Raise or lower the various elements until the light hits the exact center of the mirror. This operation is easier if you aim the mirror so that the light is bounced back through the slit onto the center of the lens. The mirror functions best when placed so that it is its own focal length away from the

lens. (To find the focal length of the mirror, focus the sun's image on a piece of paper, then measure the distance from the mirror to the paper.)

After these preliminary adjustments have been made, turn the mirror so that it throws a parallel beam of light onto mirror No. 2. This second mirror is turned so that it beams the light onto the ground glass screen, positioned about 6 ft. away.

Arrange the two optical benches so that the beams of light are angled no more than necessary to send them through the optical elements. Excessive angling increases image distortion.

When all the optical elements are properly aligned, and a bright spot of light appears on the screen, locate the subject test area (Fig. 4). The best position for the subject to be studied depends on the position of the viewing screen (or camera). A quick way to find the position of sharpest focus is to move a piece of wire mesh screen back and forth along the parallel beam of light, observing what position provides the sharpest image on the ground glass. Place your subject (e.g. flame) at this spot. If you change the position of the viewing screen, you will have to relocate the test spot.

Incidentally, you will get a brighter image if you place a piece of white cardboard over the ground glass. Remove the cardboard when you need to view the image from the back side of the ground glass.

Having found the best subject position in

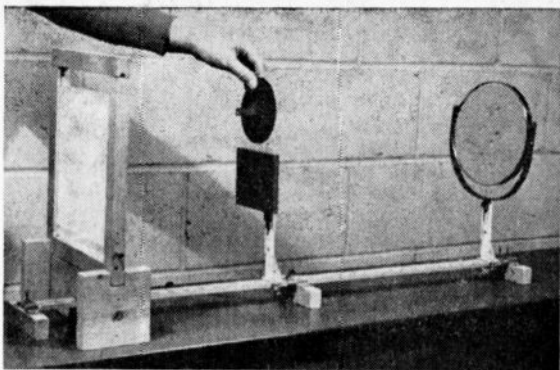
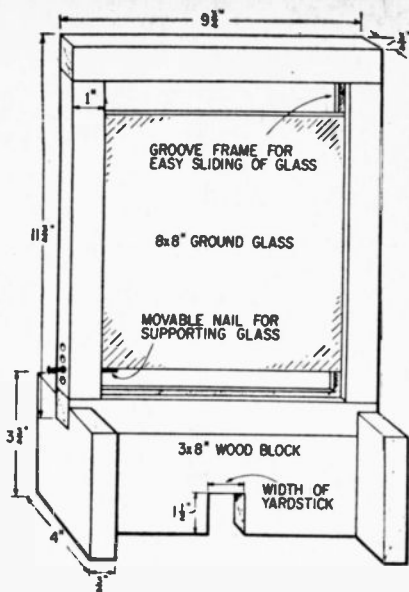

FIG. 16, left. Construction details of ground-glass viewing screen. Image can be seen on white paper.

FIG. 17, above. Disc holding "knife" goes in pocket of holder-light shield. Screen is used farther away.

the test area, place a lighted candle or alcohol lamp at that spot. You should now see a clearly projected image of the flame on the screen—but you will not yet see the full Schlieren effect. A *critical* adjustment of the knife must first be made.

Move the knife so that it covers the hole in the disc, and the light falls on the blade surface, which should be blackened. Move the knife unit back and forth along the optical bench to focus the sharpest possible image of the *slit* on the knife. If the image does not seem bright or sharp, check alignment of all elements, starting with the light source. Make certain the light passes properly through the slit. Vary the slit width if necessary.

When you have a sharp image of the slit on the knife surface, move the knife aside until about *half* of the light is passed to the screen and the other half is blocked by the knife edge. You should see a thin, bright line of light along the blade edge. The disc holding the knife may need to be rotated to obtain proper alignment.

Don't expect perfect results immediately. The adjustments are delicate, and you will have to get the feel of the equipment. Keep re-checking all elements until you get an image containing bright areas and deep black areas. When the system is working well, log the positions of all elements so that you can set up the equipment speedily next time.

Schlieren Photographs. The modified optical arrangement for making Schlieren pho-

tographs with a flash bulb (Fig. 4) is mentioned here for the benefit of those who may wish to extend experimentation into these directions. Do not use ordinary wire-filled, combustible bulbs; the light would be too diffused to yield good images. Some experts recommend use of a GE-type FT 230 flash tube.

If you have a camera with a removable lens, load it with fast black-and-white film and try taking pictures without flash. The pictures in this article were made with a 35-mm single-lens-reflex camera loaded with Tri-X film. After removal of the lens, the camera was positioned about 12 in. from the optical knife as shown in Fig. 4.

The subject (soldering iron, crystal, water jet) was moved back and forth in the test area of the light beam until a clear image was observed in the camera viewfinder. The camera shutter was set at its fastest speed (1/1,000 second) in order to stop the fast motion of the Schlieren image. The very short exposure notwithstanding, there was plenty of light to produce good negatives on development of the film according to normal procedures. In these experiments, the fast shutter speed was used primarily to demonstrate the adequacy of the light. You may find much slower speeds adequate.

Even if you don't care about photographing your experiments, experiment with the Schlieren technique. Making the invisible visible is highly instructive—and an awful lot of fun! ■



An accurate homemade transit for measuring vertical and horizontal angles.

Measuring Hidden Distances

Modern uses of ancient triangulation principles

By W. F. GEPHART

MANY centuries ago Greek mathematicians worked out the principles of triangulation which enable us to measure distances without stretching a tape between points, to navigate oceans, and even to measure distances inside solid objects or across great expanses of space. These same principles, for example, enabled the Greeks to make the early astronomical calculations.

The name of the individual, if it was a single individual, who actually discovered these principles is lost in antiquity, but whoever it was

determined that there is always a definite relationship or ratio between the lengths of the sides of a right triangle—dependent on the angles in the triangle. A table of these relationships was made up, probably by drawing and measuring thousands of triangles, and today we call these relationships the *natural functions of an angle*. There are six of these relationships (three of them reciprocals of the other three), and these, with their Greek names (which are still used), are given in Fig. 2A.

Highly accurate versions of these ratios are now published in tables. They are constantly used in all sorts of work; certain fields, such as surveying and navigation, would be virtually impossible to work in without them, and information from such tables is stored in electronic brains in connection with electronic navigation systems.

To show a simple use of these *functions*, suppose you wanted to measure the height of a tree. It would be quite a job to stretch a tape from the very top of the tree straight down along the

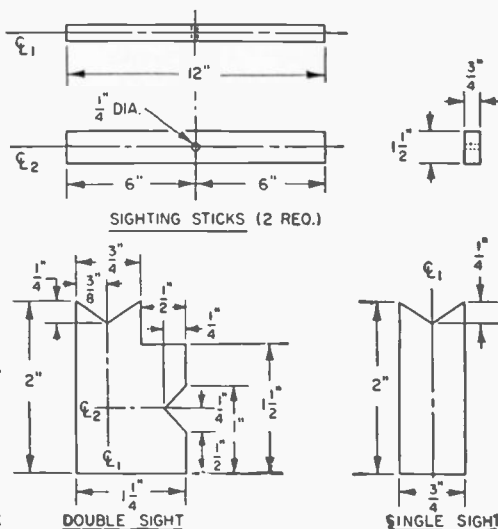
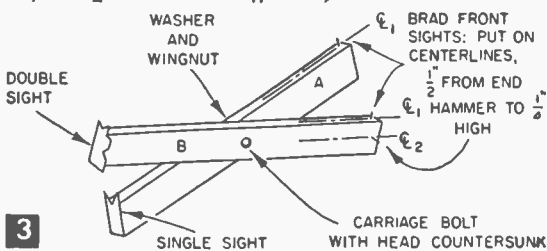
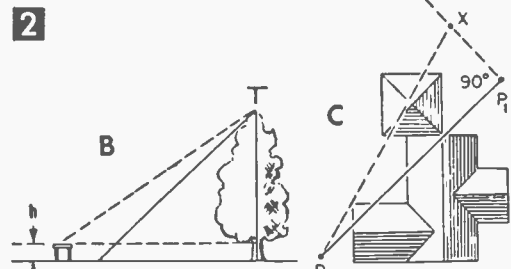
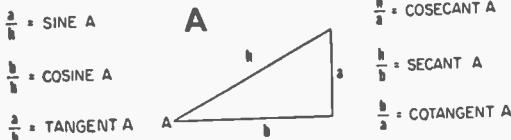

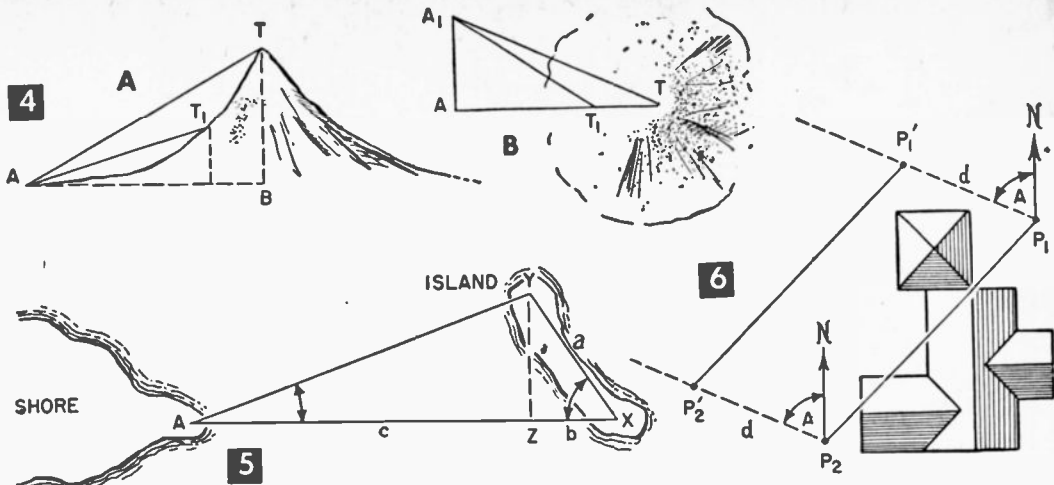

trunk, because of all of the branches and, of course, because of the difficulty of getting to the very top. But if you measured out a certain distance from the trunk, such as distance AB in Fig. 2B, sighted to the top of the tree (along line AT) to get angle TAB, you could determine the height of the tree, using the function of the angle. In this case, the height of the tree would be equal to the distance out (AB) multiplied by the tangent of angle TAB.

To experiment with triangulation, make a set of sighting bars as shown in Fig. 3. Centerlines must be accurate, as well as the dimensions and centering of the notches on the sights. To measure the height of a tree, set sighting bar "B" on the edge of a table, and sight along bar "A" to the top of the tree. (This arrangement is shown by the dotted lines in Fig. 2B. Keep in mind that the height of the table [h] must be added to the computed height of the tree.)

Triangulation also permits measurement of distances through obstacles. For example, suppose you wanted to know the distance between two poles, such as P_1 and P_2 in Fig. 2C, but couldn't measure between them because of a house. You could sight along a line at right angles to the line of poles, such as line P_1Y , and measure out a convenient distance to establish point X. Then, by sighting on the two poles from this point, you can measure angle P_1XP_2 and with this angle and distance P_1X , you can compute the distance between poles, using the tangent of the angle. (To use your sighting bars in this case, lay bar "A" on its side on a flat surface. Sight sideways across "A" for one sighting and, using the second set

of sights, sight across "B" for the other sight.)

Surveyors make use of triangulation, but often great distances are involved, and sometimes both vertical and horizontal triangulation must be used for a single measurement. Suppose a surveyor wanted to measure the height of a mountain, as in Fig. 4A. Since he couldn't measure line AB, as was done in measuring the tree, he would establish a second point A_1 (as shown in Fig. 4B, seen from above) and, knowing the distance AA_1 and the angle TA_1A , he could deter-

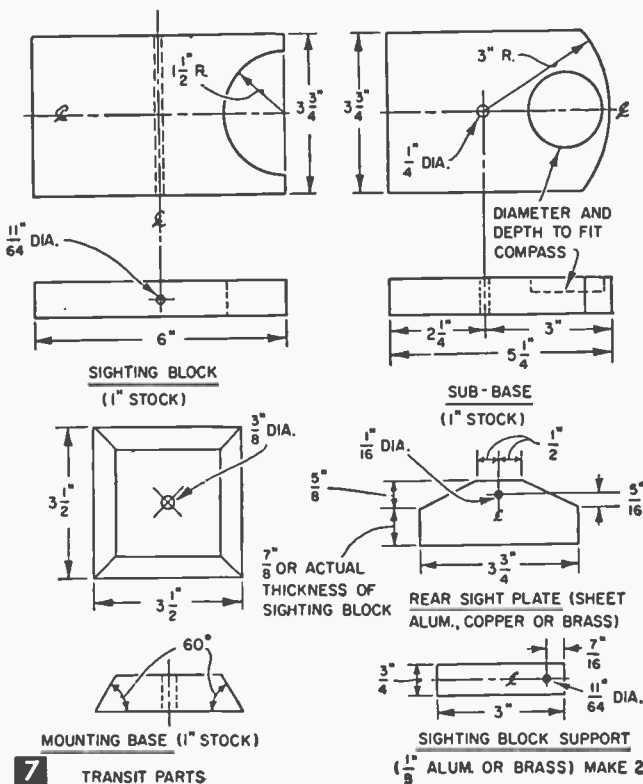

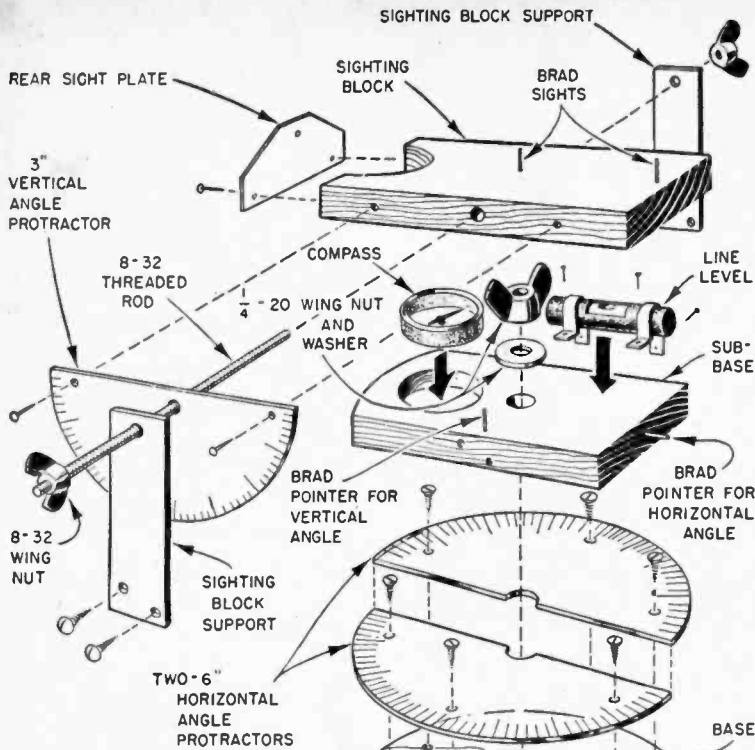

Homemade transit mounted on camera tripod.

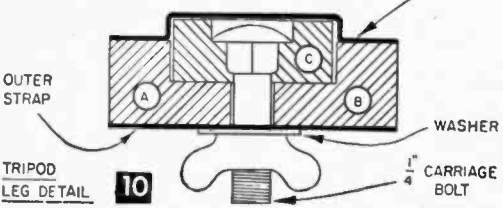
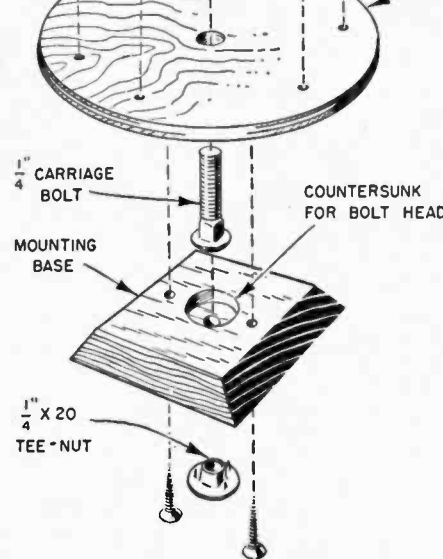

mine distance AT . With this distance and angle TAB (in Fig. 4A), he could compute distance TB , which is the height of the mountain. The height of any point on the mountain, such as T_1 , could be determined in a similar way.

With great distances and natural obstacles involved, surveying can become complicated; it is not always possible to work with right triangles. Since the natural functions work only with right-angled triangles, surveyors will often create "artificial" right-angled triangles.

For example, suppose a surveyor wanted to find the distance between point "A" on the shore and point "X" on an island (Fig. 5). He would establish point Y on the island, and measure to get distance a . Using the functions of angle YXZ , he can get artificial distance YZ as well as distance b . Then, using artificial distance YZ and the functions of angle YAX , he can get distance c , which, added to b , gives the total distance between A and X.

Often compass bearings are helpful or even required in surveying. In our example in Fig. 2C, it was assumed that the poles were high enough to sight at over the house. If this were not possible, line P_1P_2 could be "moved out" using compass bearings as shown in Fig. 6. First, a line P_1P_1' is established by sighting a certain number of degrees (angle A) off North from point P_1 . A similar line (P_2P_2') is established by sighting the same number of degrees (angle A) from P_2 . By measuring equal distances (d) along these lines, a new line, $P_1'P_2'$ is established, parallel to and equal in length to the original line. This can then be measured by tape or triangulation.

TRANSIT—MATERIALS LIST

No.	Description
1 pc	1 x 3 3/4 x 6" hardwood
1 pc	1 x 3 3/4 x 5 1/4" hardwood
1 pc	1 x 3 1/2 x 3 1/2" hardwood
1 pc	3/8" plywood, 6" dia.
2 pcs	1/8 x 3 x 3/4" aluminum strap
1 pc	1/2 x 3 3/4" aluminum sheet
2	6" protractors
1	3" protractor
1	small compass
1	line level
1 pc	8-32 threaded rod, 4 1/2" long
2	8-32 wing nuts
1	1/4 x 1 1/2" carriage bolt
1	1/2" x 20 wing nut and washer
	Miscellaneous screws and brads, including 1/4" x 20 "Tee-Nut"

Triangulation is used in even more complex fields. By taking sights on the sun and stars, ships and planes navigate and plot their course. In these cases, the movement of the plane or ship, the movement of the sun and stars, as well as the time of the year further complicate matters. However, accuracy in navigation usually does not have to be as great as in surveying.

One of the projects in the International Geophysical Year was to better survey many parts of the earth's surface. There have been indications that some of our best maps are several miles in error. While this has not been too important in the past, an error of a few miles makes a big difference in aiming guided missiles. You have to know *exactly* where the launching pad and landing spot are in relation to each other when feeding information to mechanized navigation equipment. A missile can't look out, see that it's a few miles off course and correct for it, as a manned airplane navigator can.

So both maps and navigation equipment will have to be more accurate and, as far as we know, any improvement made will still use the principles of triangulation, principles developed by the Greeks when the last word in missiles was a spear.

For a project, make a transit similar to that shown in Fig. 1. Figure 7 shows the material required, with the exception of the base, which is a 6-in. circle of 3/8-in. plywood. For most accurate and permanent results, hardwood, such as oak or maple, should be used. It is of prime importance that centerlines be exact, that drilling centers be marked and drilled exactly, and that pointers and sights be placed carefully if the unit is to be accurate.

Figure 8 shows the assembly. All metal, including screws and bolts, should be non-ferrous (brass, copper, aluminum, etc.) wherever possible, and extreme care should be in placing the protractors. On the two horizontal protractors, it may be necessary to cut some off of the base to make an exact circle, and on the vertical protractor the 90-degree line must be *exactly* 90

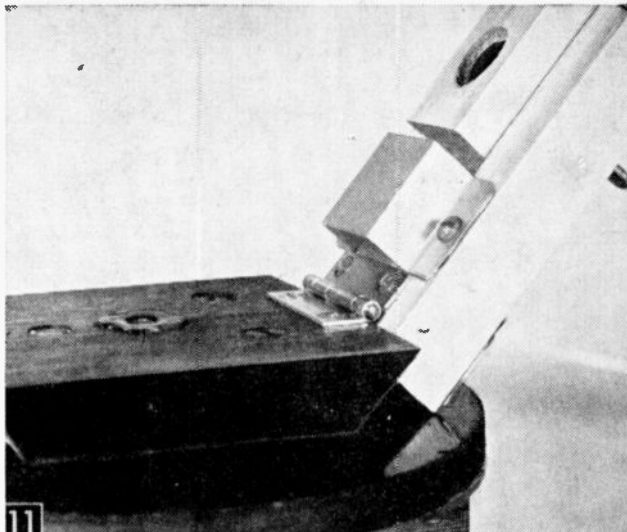

Tripod leg mounting details.

degrees to the sighting block.

The side of the sighting block on which the protractor is to be mounted must be planed down so that the width of the block plus the thickness of the protractor is exactly the same as the width of the sub-base. This planing should be done on one side of the block only, so that the centerline of the sighting block remains in line with the centerline of the sub-base.

Some modifications that would make this unit more accurate and easier to use might include a rifle telescopic sight on the sighting block; using pointers more accurate than brads; using two levels at right angles to each other on the sub-base, mounting the base on a second circular piece with four leveling screws, etc.

The unit shown in Fig. 1 has a mounting block with a 1/4-in. x 20 screw socket for mounting on a camera tripod as shown in Fig. 9. In this case, leveling is done by adjusting the tripod legs, turning the unit 90 degrees so that the same level can be used for both leveling steps.

If a camera tripod is not available, one can be made as shown in Figs. 9, 10 and 11. For simplicity in leveling, it is suggested that four legs be used instead of three, and the mounting block base (Fig. 8) is designed accordingly.

The legs of the tripod should be attached to the mounting block with tight-pin brass hinges as shown in Fig. 11. Fig. 10 shows the cross-section of one of the legs. It has two sections of equal length. The dimensions are not critical, although fully opened length ought to be about six feet.

When assembling the legs, put the three pieces together with a cardboard shim between piece C and A (Fig. 10) and between C and B when fastening the metal straps in place. This will allow enough slack for piece C to move easily when the wing nut is loosened. Details of the bolt mounting and inner strap for a leg can be seen in Fig. 10.

TELL

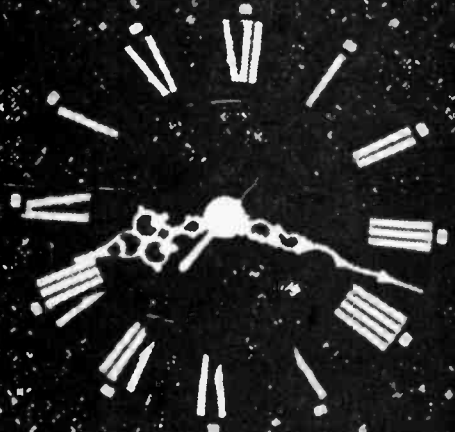
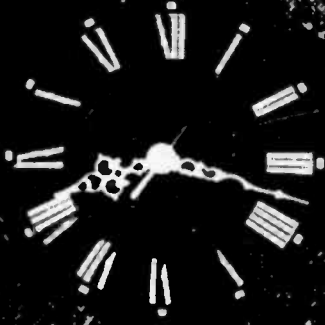



TIME BY THE STARS

By Robert I. Johnson

Director, Adler Planetarium and Astronomical Museum, Chicago, Ill.

HAVE you ever been amazed by the vast number of stars, by their steadiness and constancy, and by the slow movements of the constellations? Besides being very beautiful, the stars have been extremely useful to man. They are the source of light and life, they are the inspiration of dreams. Many sea captains today still sail and navigate their ships according to the positions of the stars.

You can even tell time, down to the very hour, just by looking at the stars. All you need do is make a nocturnal, locate the Big Dipper, and sight in.

First, let's talk a little bit about time. There are basically two types, sidereal time and mean solar time. Sidereal time is based on the apparent motion of the stars, depended upon by the astronomers, and sometimes called "star time." The stars always rise and set at the same sidereal time. It is reckoned through 24 hours for each day, equivalent to 23 hours and 56 minutes of mean solar time.

Mean solar time is the time kept by our clocks and watches. Sidereal time agrees with mean solar standard time on about September 21, and after that it gains nearly four minutes each day, or one full day over a year. Sidereal time is not convenient for ordinary purposes, and must be changed to mean solar time in order to be useful.

Mean solar time is average sun time. The actual solar day varies in length, and cannot be used for clocks and watches. Mean solar days are of the same length throughout the year, and are measured by the mean sun, which is an imaginary sun that moves uniformly eastward along the celestial equator, instead of along the apparent path of the real sun.

The mean solar day is considered to begin at midnight, and two periods of twelve hours are recorded. This method was adopted because the real sun is not

10-in. diam
(variable)

Fig. 1

Two paper clips and stiff cardboard required. Paper clips hold arm to disc.

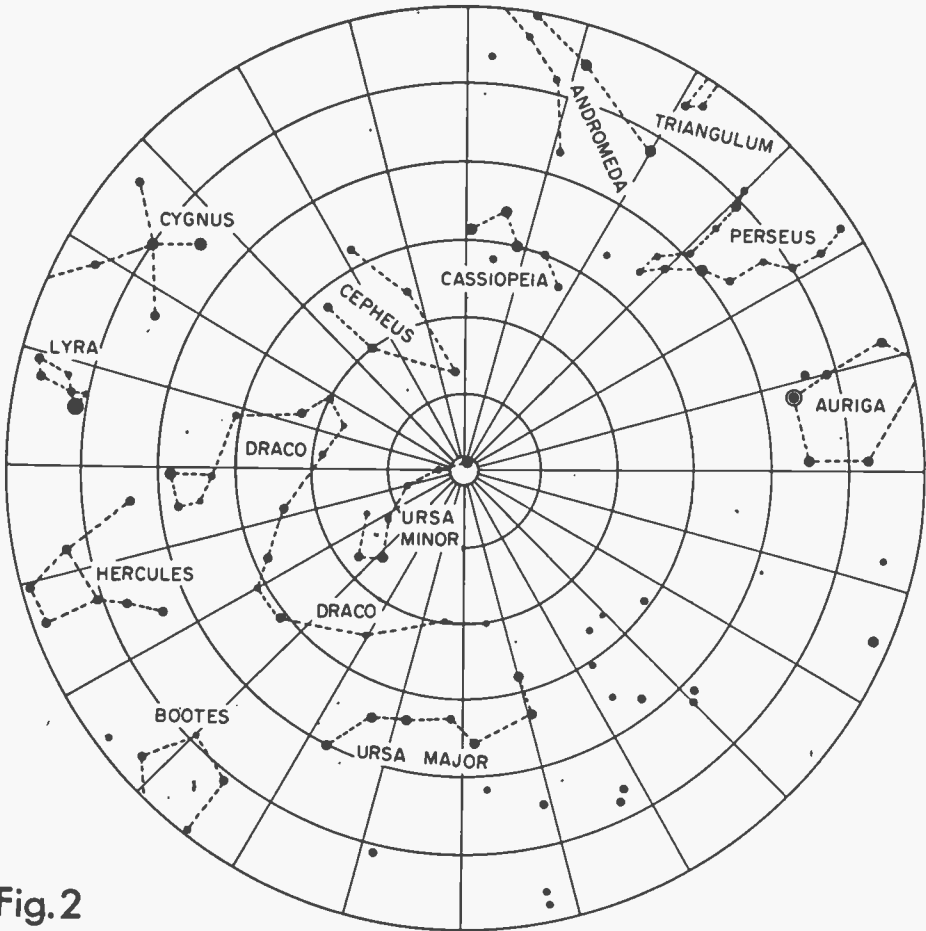
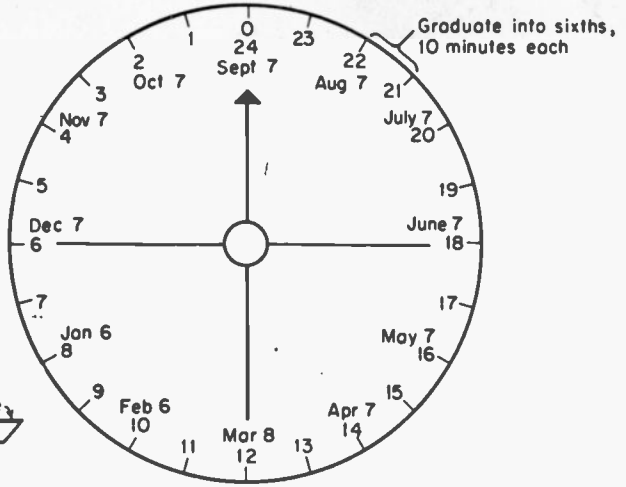
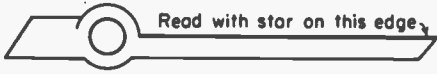
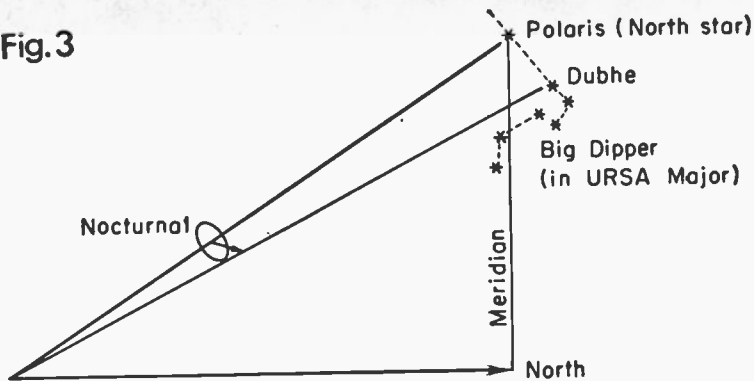

Fig. 2

CONSTELLATION CHART will help find Ursa Major in relation to Polaris (center of chart).

Fig. 3



Tell Time by Stars

a very good timekeeper. Due to the varying speed of the earth in its elliptical orbit and to the obliquity of the elliptic, the sun apparently runs fast or slow.

Sidereal time is the time we read when we use a nocturnal, and we convert this time mentally into mean solar time.

The nocturnal was evidently first described by Apianus (Peter Bennewitz, 1495-1552) in 1533. It consists of a disk with a central hole through which an observer sights at the North Star (Polaris) while holding the instrument so that the plane of the disk is perpendicular to the earth's axis of rotation. The vertical line through the instrument, marked by the loop at the top and the point at the opposite edge of the disk, is at the same time kept in the plane of the observer's celestial meridian. Figure 3 demonstrates this.

The protruding arm is then rotated about the center until it is directed along an imaginary line in the sky from the North Star to the star Dubhe in the Big Dipper.

To construct a nocturnal, make the design shown in Fig. 1 on paper and paste it to a piece of cardboard. Or you can make the design on metal if you wish. The edge of the disk is divided into 24 equal parts by heavy lines. The date, September 7, is at the top of the disk. The second line from this one, going in a counter-clockwise direction, is marked October 7. The fourth line is marked November 7; the sixth, December 7; the eighth, January 6; the tenth, February 6; and the twelfth, March 8. The alternate lines, continuing counter-clockwise, are marked April 7, May 7, June 7, July 7, and August 7. Then, beginning with September 7, each consecutive line in the counter-clockwise is marked 0, 1, 2 . . . to 24.

The central hole should be cut approxi-

mately $\frac{7}{16}$ -in. in diameter. Draw a line from December 7 through June 7 to provide a horizon indicator, and one from September 7 through March 8 as a meridian indicator.

When using the nocturnal, hold the horizon line parallel to the actual horizon. Hold September 7 at the top and sight Polaris through the central hole. Keep the disk face at right angles to the line from the eye to the star while the disk is held at the distance from the eye, where the inside pointer star, Alpha Ursae Majoris, is just outside the edge of the disk. Rotate the movable arm until the edge of it lines up with the star. Clip the arm in place, and read the nocturnal. The number of hours and sixths of hours (ten minute intervals) between the graduations on the disk correspond to the date of observation and the time according to the position of the pointers. Reading counter-clockwise, in the direction of the increasing numbers from the date position for the night of your observation to the position of the arm's edge, gives the number of hours which have elapsed since noon.

For example, if the hour angle of Dubhe is measured to be 15 hours, since the star's right ascension is 11 hours, the sidereal time (right ascension plus the hour angle of the star) is two hours. If, at the time of observation, the sun's right ascension is 18 hours, then the hour angle of the sun, or the apparent solar time, is 8 hours.

Suppose you wanted to change local mean time to standard time. You have to know the difference in time between the place where you make your observation and the standard meridian of the time zone in which you are located. If you are west of the standard meridian, the time difference is added to the observed time. If you are east of the standard meridian, the time difference is subtracted. It might be a good idea to keep this information on the nocturnal. ■

talk on a light beam

By Forrest Frantz, Sr.

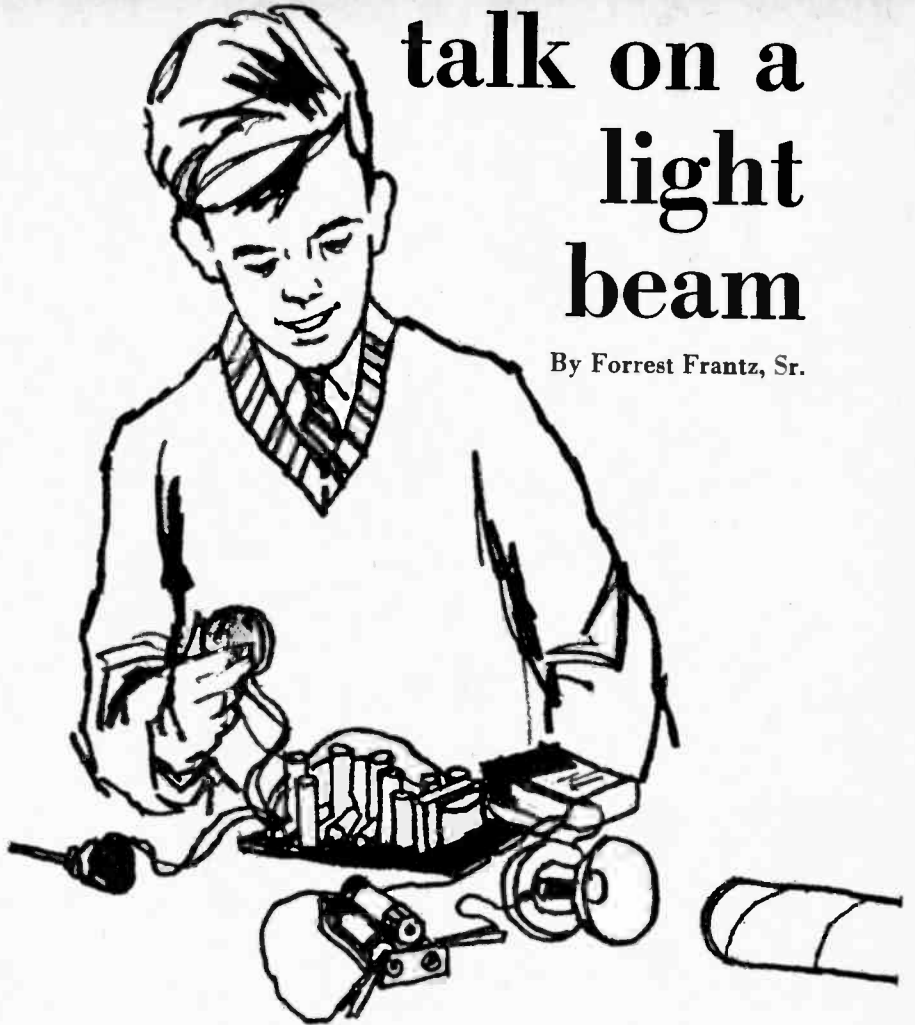

You've read a lot about the possibilities of using laser-beam communications, but did you know that ordinary light could be modulated to carry messages also? You can set up a simple light-beam communications demonstrator in about half an hour and for less than \$15, and all the components can also be used for other experiments and gadgets later.

How It's Done. The basic techniques for light-beam communication consists of converting sound energy to electrical energy and then using the electrical energy to modulate a beam of light. The modulated light beam is picked up by a photocell, and converted back to electrical energy. The electrical energy serves to drive a speaker which produces sound energy at the receiving end of the apparatus.

The complete apparatus that is shown in the photos is intended for demonstration

purposes only, and will not work over long distances. To simplify construction two ready-made low-cost (\$3.75 each) transistor amplifiers were used, one for the transmitter and one for the receiver.

Refer to the photo of the transmitter setup, the schematic drawing and parts list. Although the photo shows only one 1.5-volt bias cell in the transmitter's lamp circuit, experiments have proved that 3 volts worked better and two series-connected dry cells should be used. No need to observe polarity when connecting lamp bias cells. The reason for using the bias battery in the output-lamp circuit deserves mention. The bias battery sets a steady light level. This light level serves as a carrier for the audio signal from the amplifier just as radio frequencies serve as the carrier in a radio transmitter. Another reason for the bias is that the lamp will respond better to the amplifier signal when

The secret of communicating on a radio wave is modulation and demodulation—that's also the secret of talking on a light beam!

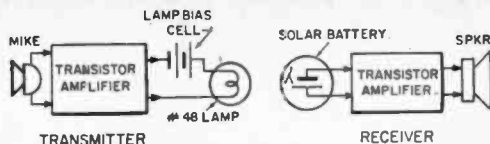

Block diagram for a simple light transmission system. No need for exotic lenses.

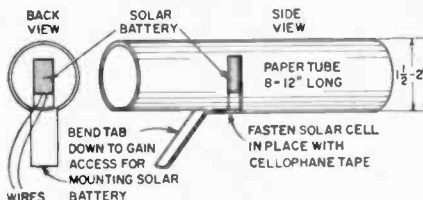

Paper tube from 8 to 12-inches long serves as shield for photo cell—conserves gain.

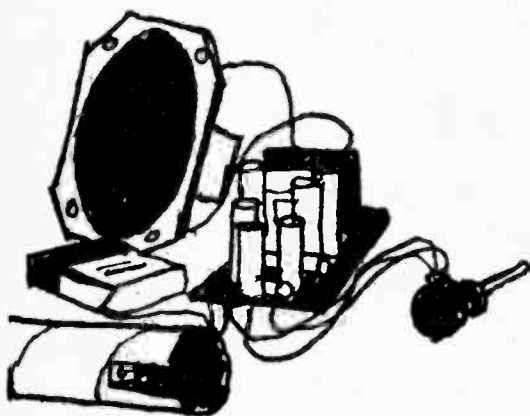

it is biased. The transistor-amplifier connections are explained on the data sheet that comes with the amplifier.

Putting It Together. In the actual setup, it is desirable to add a parabolic reflector to the lamp. The author used a reflector from an old flashlight and glued it to a lamp socket as shown in the photo.

The receiver employs a solar battery as a sensor whose output is fed to an amplifier that drives a loudspeaker. The solar battery is mounted in a mailing tube (for shielding against "light noise") that is pointed toward the lamp. The paper tube's diameter isn't critical—1½ or 2 inches is fine. Length should be 8 to 12 inches. Cut two slits about ½-inch apart and about 2-inches long in the tube and bend down the resulting tab. Fasten the solar battery in the tube with cellophane tape as shown in the drawing with the tab replaced. Try reversing the solar



All set up and ready to go! For Science Fairs, mount system on shellacked blocks.

PARTS LIST

- 2—Amplifier, 3-transistor (Lafayette 99G9039 or equiv.)
- 1—Microphone, crystal (Lafayette 99G6019 or equiv.)
- 2—5000-ohm volume control with switch
- 1—Socket, miniature screw-type pilot lamp
- 1—Pilot lamp, #48
- 2—9-volt transistor battery (Burgess 2U6 or equiv.)
- 2—1.5-volt penlight cells (Size AA)
- 1—battery holder for two AA cells
- 1—Reflector (See text)
- 1—Cardboard mailing tube (See text)
- 1—2½-inch speaker, 8-10 ohms (Lafayette 99G6097)
- 1—Solar battery (IRC B2M or equiv.)

Estimated cost: \$15.00

Estimated construction time: 2 hours

battery leads—output may be increased somewhat.

If you own an amplifier with sufficient gain, you may use it in place of one of the amplifiers but if it has too much power it may blow out the #48 bulb.

Getting More Range. The arrangement described is for demonstration purposes and

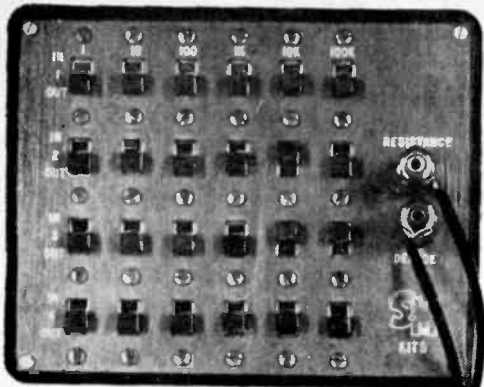

BUILD THE S&M PRECISION DECADE RESISTANCE BOX AND SAVE MONEY

Designed so that the electronic experimenter can get any value of resistance at 1% accuracy. Made of precision components, features fast fingertip switching from any resistance value from 1 ohm to 1,111,111 ohms within seconds. Add or subtract as little as 1 ohm with 1% accuracy. Put it together in less than 2 hours.

SCIENCE & MECHANICS KIT DIVISION
505 Park Ave./New York/10022

Please send me the Decade Resistance Box
in kit form \$24.95
fully assembled \$29.95

If I am not completely satisfied, I will return it within 10 days for a complete refund of the purchase price.
add 10% for Canadian & Foreign orders.
New York City residents add 5% for NYC sales tax.

SE-784A

NAME _____ (please print)

ADDRESS _____

CITY _____ STATE _____ ZIP _____

- Check or money order enclosed; ship post-paid
- Enclosed \$3.00 deposit. Ship balance C.O.D., plus postage & C.O.D. charges.

Talk on a Light Beam

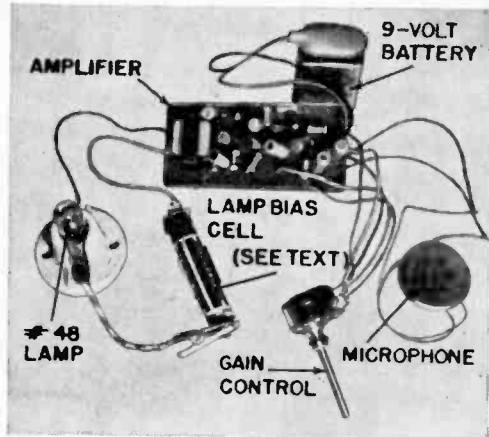
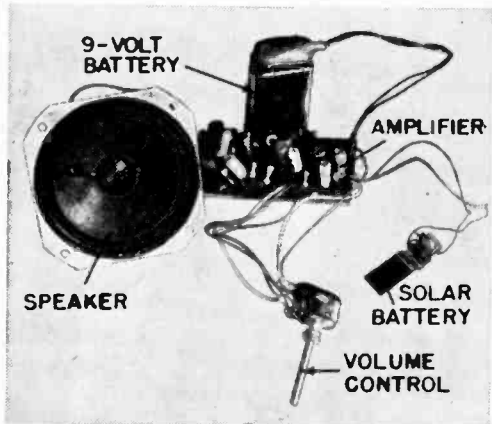

Table-top setup for talking on a light beam is shown in the photos. Above, the transmitter or light amplifier is shown, and below, the light-actuated sound amplifier.



shouldn't be expected to work at a range over a couple of feet. If you operate in a darkened room and go to some trouble in positioning the lamp and solar cell relative to each other, you can gain some range. For longer distances you need an amplifier with greater gain and power output handling capability and a larger bulb (perhaps a #47) with a better focusing system. For demonstration purposes at Science Fairs, you can use your hand as a volume control. Slowly place your hand between the lamp and solar cell. The volume of the signal transmitted on the light beam will be reduced and eventually eliminated. ■

What makes it turn? The whirling disk connected to the motor shaft is activated by energy generated within the selenium cells from the light source, either sunlight or photographic flood lights.



HARNESS THE SUN

This solar conversion kit puts sunpower within reach of young experimenters

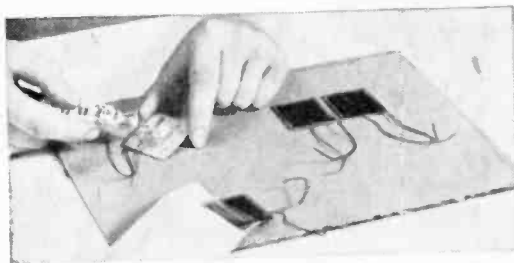

Fig. 1: Cells are glued to a cardboard base; a motor stand is made from a block of wood and a piece of sheet metal cut and bent to hold the motor.

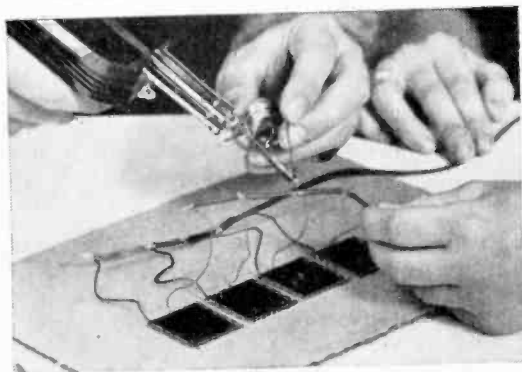

Fig. 2: With all four cells mounted, lead wires are soldered from the cells, joined with other wires of the same color, and soldered to motor leads.

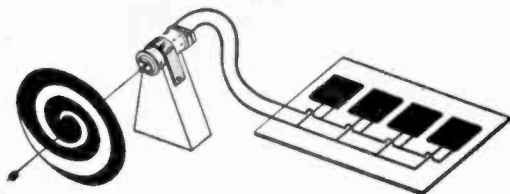

Fig. 3: Artist's diagram of the assembled conversion kit. The four selenium cells are mounted in tandem and connected to motor on home-made stand.

THE sun is man's chief source of energy. Without the sun and its life-giving properties, it is inconceivable that human life as we know it could exist on the earth. Yet man has only begun to tap its energy.

Both the Telstar orbitings and the Tiros space experiments have made use of solar energy to put into orbit telemetering equipment that required a minimum of activational mechanisms. The Tiros satellite, for example, literally harnessed sunlight, using the sun's rays in space to prolong its own mechanical performance. Electrical energy was generated within the orbiting sphere by solar cells.

Today's youth, within their lifetimes, will participate in a virtual revolution of technology, much of it surrounding the harnessing of solar energy. You can conduct your own sunpower studies and gain an understanding of this remarkable energy source with a Solar Conversion Unit (No. 60,505—\$10.45 ppd.) from Edmund Scientific, Barrington, N. J. The kit contains a high-output silicon solar cell, ball-bearing motor, spiral card-board disc, grommet and instructions. Also available from Edmund are selenium solar cells such as are shown in use here (No. 30,411—\$1.50 ea.). By exposing the cells to sunlight, a reservoir of electric power is built within the cells. When the wire leads are connected to the motor and the oscillator affixed, the motor shaft and oscillator begin to rotate and will continue to do so until light is removed.

Many similar experiments are possible with this basic sunpower equipment. Most small motors can be powered by solar cells, both selenium and silicon types, and amplifiers also can be connected. Usually, in order to generate sufficient current, solar cells are connected together in tandems.

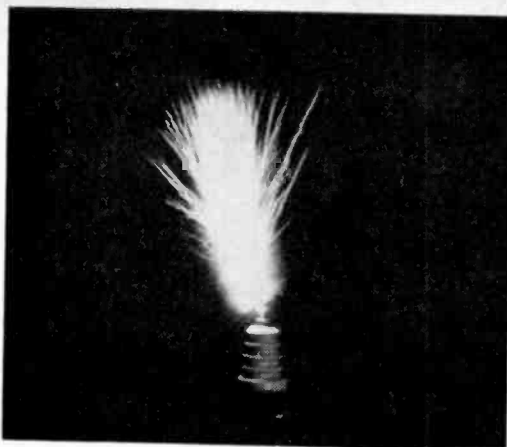
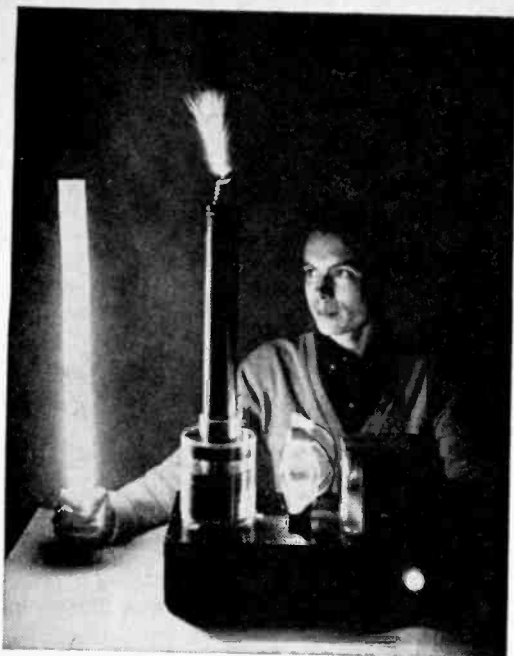

Fig. 4: High voltage at high frequencies produces some weird effects. The scattering of electricity from atop the coil (above) is called a static brush.

Fig. 5: Hold a fluorescent lamp near the coil, and with your body acting as an antenna, sufficient energy is picked up to make the fluorescent glow.

New and Improved Tesla Coil

By HAROLD P. STRAND

THERE is nothing so fascinating and instructive to the science student and experimenter as a Tesla coil. This was originally developed by the electrical genius, Nikola Tesla, in the 1800s. He demonstrated his coil at many lectures abroad and when he came to this country, a large model was built in an attempt to broadcast electrical power to a distance without using wires. The plan failed however, due to the comparatively low efficiency, lack of directional control and other factors.

The Tesla coil is a generator of high voltage at high frequency. It is capable of weird effects not possible with any other apparatus. It is no wonder that most science fairs have one or more Tesla coils among the exhibits which many times have won awards!

The early coils of Tesla's time employed spark gap oscillators, Leyden jars and such insulation as parafin and guttapercha. Today, we can use the more efficient vacuum tubes as oscillators, high quality mica capacitors and high voltage insulation such as plastic and Bakelite, all of which are featured in coils of modern design.

The model to be described here was de-

signed to retain the good features of the popular "souped-up" coil, built by many science students over the past several years, but with improvements that result in simpler construction, lower cost and smaller size. Among other things the 5514 tubes that are now obsolete have been replaced with 811-As. A standard, lower cost plate transformer is employed and the hard-to-get mica transmitting capacitors have been reduced to one unit in a size that is available from a source given in the materials list. The other required capacitors are the familiar TV door-knob type which are available from most electronic supply dealers. All parts, connections and wiring that should be protected from accidental contact, are contained in a hollow plywood base and the tubes, plate transformer and wound coils are mounted on a top Bakelite panel. The design is neat and compact with a feature that allows the tall secondary coil to be easily unscrewed for removal when it is desired to move the coil. (To the Science Fair.)

Constructing The Coil: The drawings and photos make all details of the construction clear. Start work on the tall coil, L-3 which is

FIG.1 L-1 AND L-2 COIL DETAILS

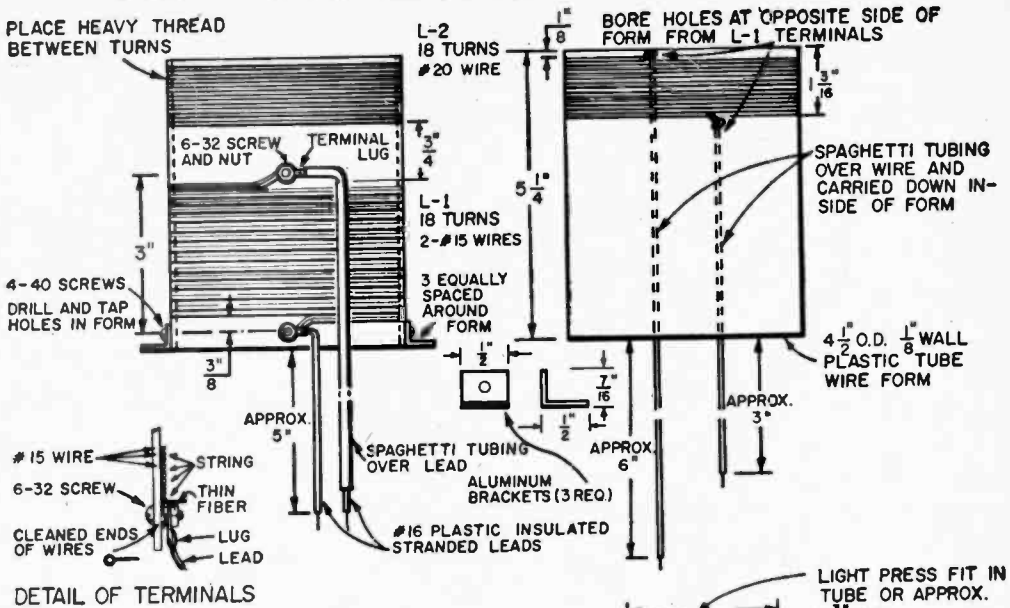

**FIG. 1A
DETAILS
OF L-3**

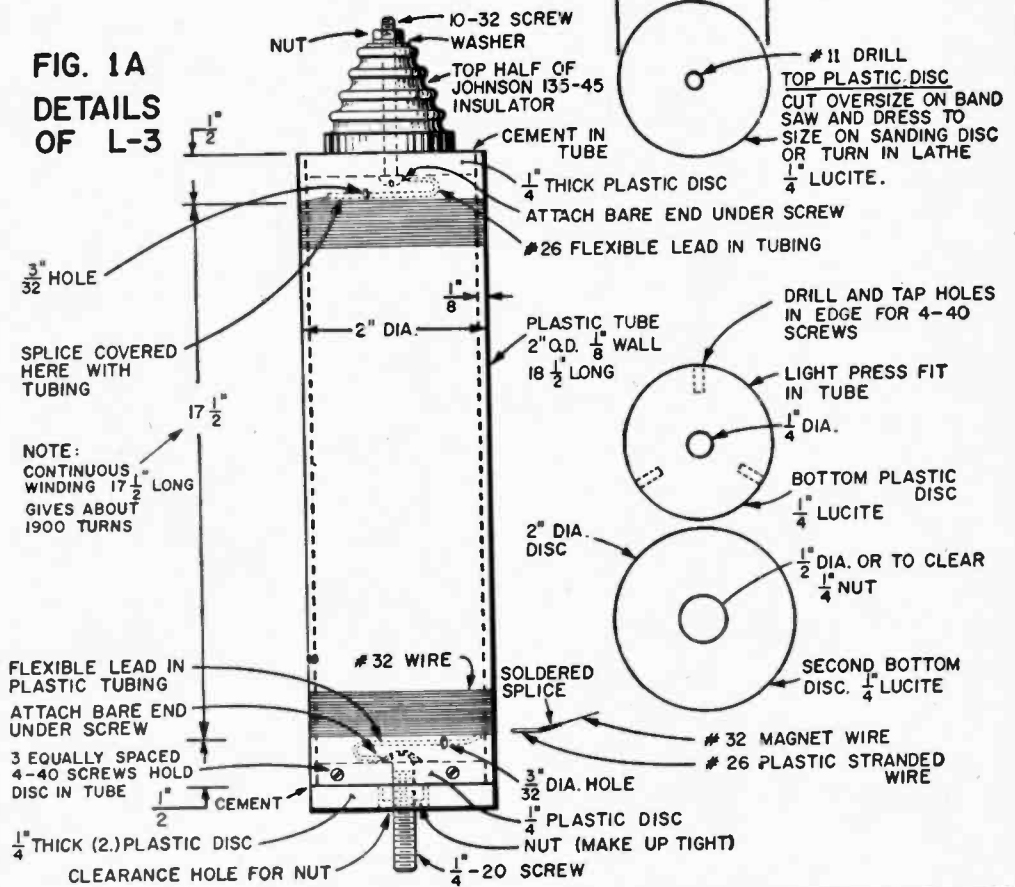
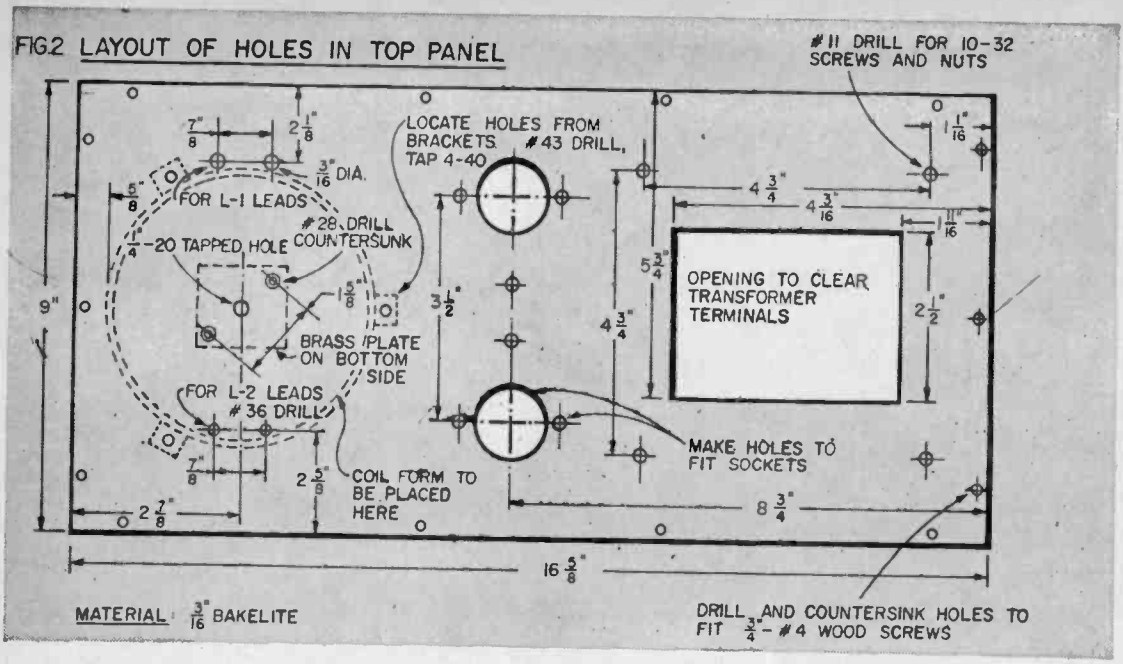

FIG2 LAYOUT OF HOLES IN TOP PANEL



wound on a plastic tube, using a simple hand-winding jig. This is shown in Fig. 1. It has a wood base and two heavy sheet metal side brackets with a hand crank for winding. Fit a tapered wood plug in one end of the tube so a wood screw used through a hole in the bracket will support this end. Equip the

other end with a plastic disc secured in the tube with small machine screws. It has a 1/4-20 bolt in a center hole to which the crank is attached with two clamping nuts. Details of this disc are given in the drawings. Start the winding with #32 Formvar wire about 1/2-in. from the end and hold the end of the



Fig. 6: A sheet of aluminum held in the hand serves as antenna, helps light a small incandescent lamp.

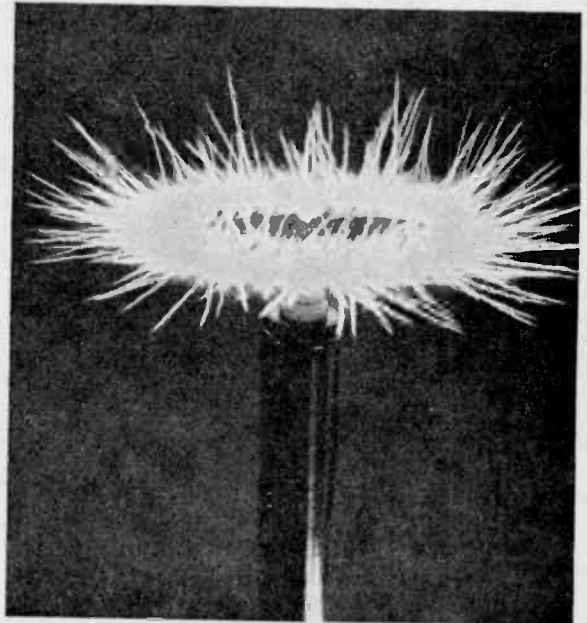

Fig. 7: Pinwheels of electrical fireworks appear dramatically when viewed in a darkened room.

FIG. 2A BASE DETAILS $\frac{1}{2}$ " FIR PLYWOOD

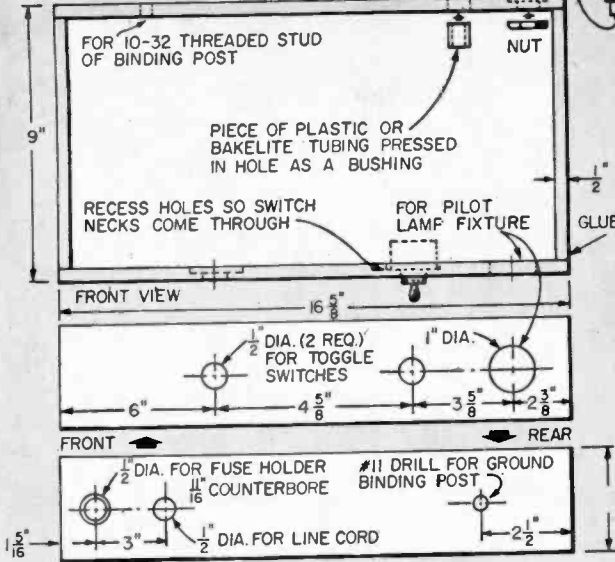
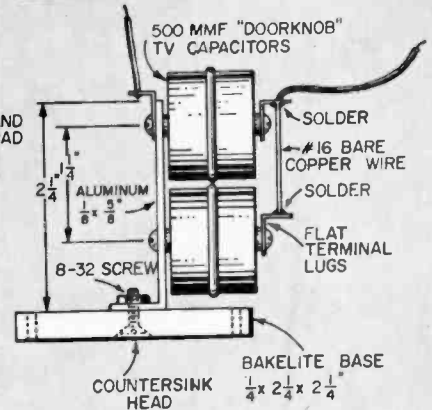

FIG. 2B
DETAIL OF CAPACITOR MOUNTING



wire with a band of paper masking tape. Put the turns on in an even layer avoiding laps in the turns or spaces between them. Care must be taken also to avoid breaking the wire as it is quite fragile. The spool of wire should be mounted on a suitable support between the operator and the bench so it will come off the

MATERIALS LIST—NEW, IMPROVED TESLA COIL

Electronic Components

Amt. Req.	Size and Description
1	1200-v., 300 ma. secondary power transformer UTC S-42
1	6.3 v. 10 a. filament transformer. Thordarson 21F12, or equivalent
3	2500 ohms, 50 w., non-adjustable Ohmite resistor
2	500 mmf. 20,000 v. TV door-knob type capacitors
2	6 amp. at 120 v. s.p.s.t. toggle switches, with solder terminals
2	ON-OFF toggle switch plates
1	120 v., 6 w., lamp pilot light assembly for 1" red jewel
1	6 w. 120 v. pilot lamp, candelabra base
1	porcelain insulator Johnson 135-45. Use top section only
1	3AG fuse holder, panel type with finger knob
1	3AG 5 a. Slo-Blo fuse
2	4 pin tube sockets, steatite with oval flange. Amphenol 49RSS4 or equivalent
2	7/16" steatite plate caps, Millen 36001
1	3 term. barrier strip, Cinch Jones, #3-141
1	5-way binding post. Superior DF30BC or equivalent
4	5/8" rubber mounting feet. General Cement #H056-F

Magnet Wire

1/4 pound	#20 heavy Formvar
1 pound	#15 heavy Formvar on two separate 1/2-lb. spools
1/2 pound	#32 heavy Formvar

The above wire can be obtained from Linwood Products Co., Box 186, Wollaston, 70, Mass. for \$4.45 postpaid in U.S. This firm can also supply 10 ft. #34 Nichrome wire for experiment. 50c, with above order.

Plastic and Bakelite

1	1/4 x 2 1/4 x 2 1/4" black Bakelite, paper base
1	3/4 x 9 x 16 5/8" black Bakelite, paper base
1	1/8" wall, 2" O.D., 18 1/2" long Lucite tubing
1	1/8" wall, 2 1/2" O.D., 6 1/2" long Lucite tubing
1	1/8" wall, 4 1/2" O.D., 5 1/4" long Lucite tubing
3	1/4 x 2 x 2" pieces Lucite (cut to make discs as per drawings)

Above material can be obtained cut to size except for the discs, from Forest Products Co., 145 Portland St., Cambridge, Mass., for \$17.50 postpaid.

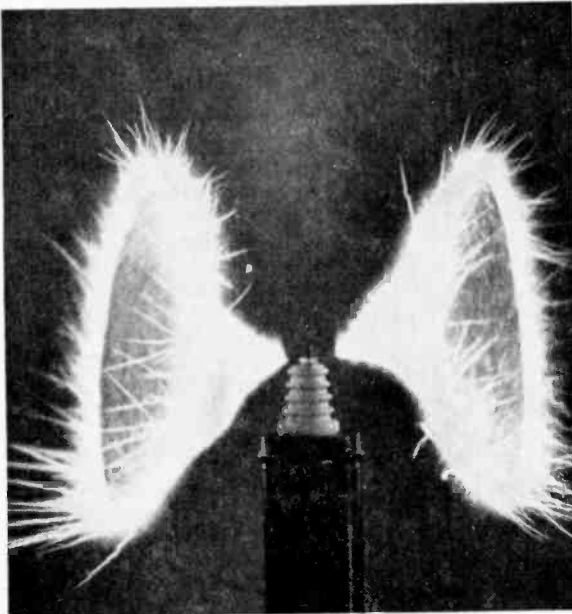

Fig. 8: More unusual effects are available to the experimenter than can be illustrated here. Try them.



Fig. 9: A simple hand-winding jig can easily be assembled to facilitate winding the larger coil.

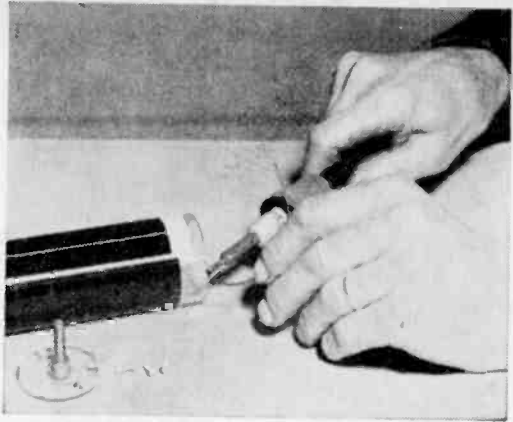

Fig. 10: Hold the loose wire end in place temporarily while you solder the connection in place.

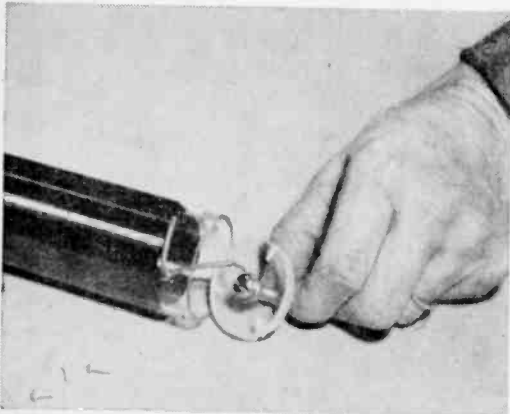

Fig. 11: With the connection soldered, slip the end plug in place and fix it with screws and glue.



Fig. 12: Finish with a strip of electrical tape, making sure you have sufficient overlap to cover.

spool easily without kinks. If it is necessary to stop for any reason, place a band of tape around the last turns to hold them.

Continue winding for a distance of $17\frac{1}{2}$ -in. which should bring it around $\frac{1}{2}$ -in. from the finish end of the tube, with the result that about 1900 turns be put on, although it is not necessary to count them. Bore a hole through the plastic tube at each end just beyond the last wire turns of a size that will pass small spaghetti tubing of about $\frac{1}{16}$ -in. diameter. Solder short flexible leads to the start and finish ends of the wire and carried through the holes for connections.

Figure 10 illustrates the soldering of the lead at the lower end of the coil. Be sure to clean off the wire insulation by holding a match under the end a second or two and then use fine sandpaper. Trim off the end of the plastic covered lead and make a neat splice. Place some spaghetti tubing over the lead, completely covering the splice and then pass it through the hole and connect tightly under the screw head. Fig. 11 shows it con-

nected as described.

A second plastic disk is now made, having a center hole to clear the nut on the screw and this is attached to the first one with Pliobond cement. Apply a band of plastic tape around the end of the tube, covering the first turns and tightly binding the spliced lead, as shown in Fig. 12.

At the top end of the coil, fit a porcelain insulator to a plastic disk with a long screw and nut and connect the spliced lead to this screw. Apply some varnish or shellac to the bare screw head as shown in Fig. 13 to help prevent corona discharge here. The disk is secured in the tube with cement.

Apply plastic tape around this end of the tube over the last wire turns and the splice. To make a better appearance, place a short piece of the spaghetti tubing around the tube, with the ends meeting the tubing over the lead to make a continuous bead around the tube, as illustrated in Fig. 14.

To complete L-3 apply two coats of varnish from a pressure can, allowing each coat to

FIG. 3 PICTORIAL DIAGRAM

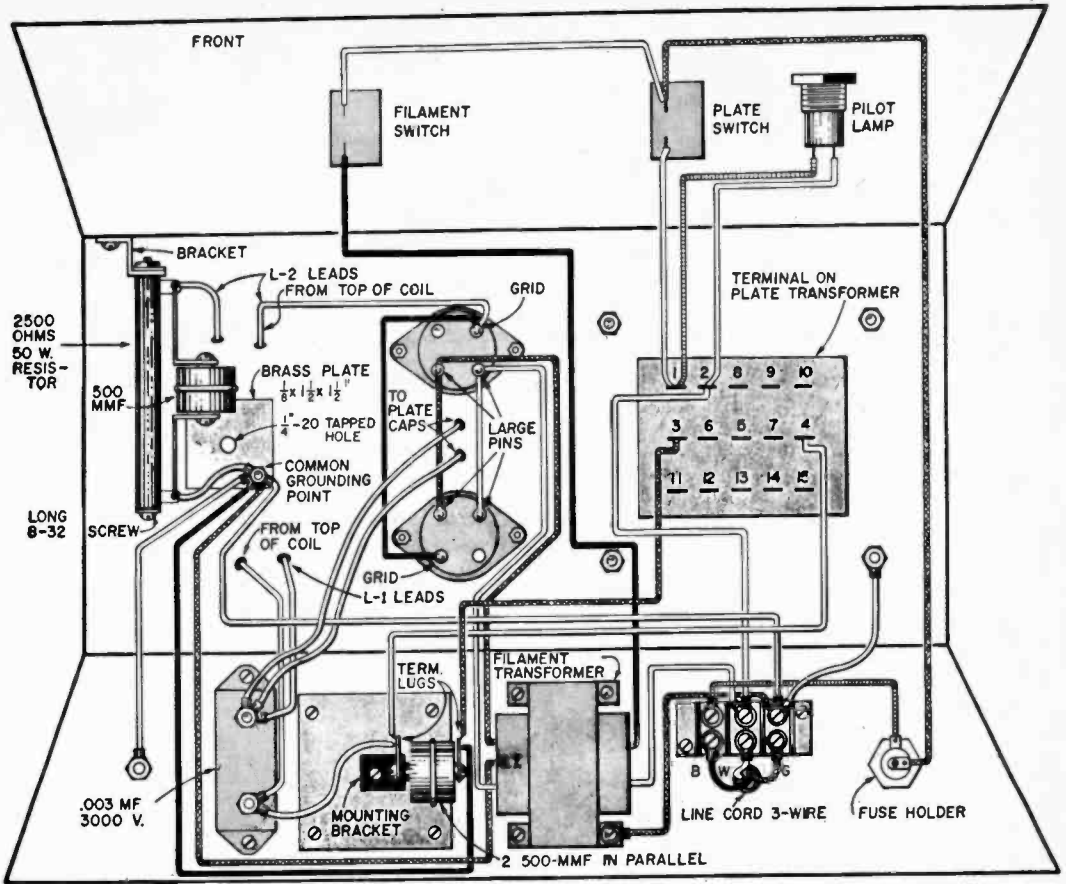
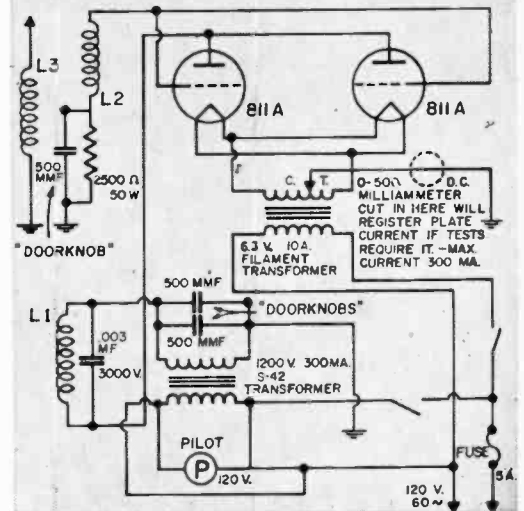

FIG. 3A SCHEMATIC CIRCUIT



-
- Plywood
- 2 $\frac{1}{2}$ x $3\frac{1}{2}$ x $16\frac{1}{2}$ " Fir
- 2 $\frac{1}{2}$ x $3\frac{1}{2}$ x 8" Fir
- Tubes
- 2 811-A special purpose tubes. Can be obtained from Barry Electronics Corp., 512 Broadway, New York 12, N. Y., for \$8.85 the pair including postage and handling
- Miscellaneous
- 7 feet #18 3-wire SJ rubber cord
- 1 grounding type attachment plug. Can be obtained from electrician's supply stores
- Plastic hook-up wire, screws, nuts, scrap aluminum for brackets, terminal lugs, piece of $\frac{1}{8}$ " brass for grounding plate, paint etc.
-



Fig. 13: After mounting the porcelain insulator on the top disk, use corona dope on the screw head.



Fig. 14: Put the top disk in place and again, apply tape to finish, as on the bottom and overlap.



Fig. 15: Carefully apply at least two coats of a good spray-type insulation. Allow each coat to dry.

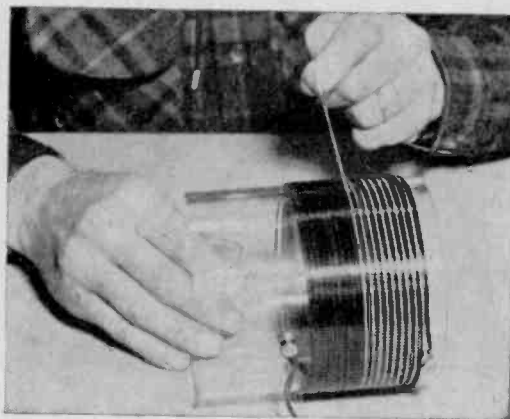

Fig. 16: You can get accurate spacing on the turns of the large coil by winding cord between wires.

thoroughly dry. This is shown being done in Fig. 15. Do not use a lacquer-base varnish which might attack the wire insulation and thus detract rather than add to the insulation value. Apply the varnish in light coats, avoiding runs and sags.

The Other Coils: Wind L-1 and L-2 on a 4½-in. diameter plastic tube with L-1 at the bottom and spaced about ½-in. from the edge. Two binding posts are provided with 6-32 screws and nuts in drilled holes for the heavy winding terminals. Two #15 wires wound in parallel are used with string pulled between the turns to slightly separate them. Fig. 16 shows the string being applied. Clean the ends of the wire thoroughly, form them into loops and attach under the nuts. The string can be tied to the terminals to hold in

place.

Form L-2 above the first winding, leaving a space of about ¾-in. using #20 wire which also has heavy thread or light string between the turns. Both coils have 18 turns. The ends of this winding are equipped with spaghetti tubing and carried through drilled holes in the plastic tube to the inside and from there they go directly into the base. Flexible leads of #16 wire are connected to the terminals of L-1 and these leads are also carried down to the base section. Fig. 17 shows both coils completed.

Apply two coats of insulating varnish to the entire unit as illustrated in Fig. 18. This can be sprayed on or applied with a brush. Note that three small aluminum brackets have been made up and attached to the lower

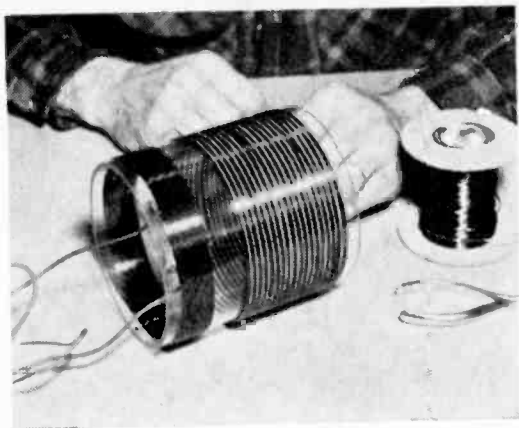

Fig. 17: Both coils wound on the same form are now finished. Wires are brought to the base.



Fig. 18: Apply two coats of insulating material, either by spraying or brushing, as above, let dry.

edge of the tube with small machine screws for attaching the unit to the Bakelite panel.

Make the base from $\frac{1}{2}$ -in. fir plywood which is glued and bradded together as shown in Fig. 13. It will be found somewhat easier to make the required openings before assembly but they can also be made later.

Assembling The Unit: The Bakelite panel requires a number of holes and openings, the largest one being to clear the plate transformer terminals. Cut this out on a jig or band saw. (A saber saw is shown in use in Fig. 22.) Before attaching the top panel, mount some of the parts to the sides of the base as in Fig. 19, where the filament transformer, capacitor support, .003 mfd. mica capacitor and line terminal strip are shown. The parts that come through the sides are also seen in place. A few of the connections can also be made at this time as illustrated in Fig. 20. A three-wire line cord and plug

are used as a means of grounding the transformer frames for safety and providing a ground connection for the circuit.

Attach the Bakelite top with short oval or flathead screws as shown in Fig. 23. Then mount the parts in place.

The connections at the three-wire plug are illustrated in Fig. 24 and the drawings. The green wire connects to the long prong at the green colored screw and the other two go to the brass and silvered terminal screws. An adapter is shown on the bench for use where the modern grounding receptacles are not found. Connect the pigtail lead under the receptacle plate screw to provide the necessary ground.

A view of the underside of the base with all wiring completed is given in Fig. 25. The final connection at one of the high voltage transformer terminals is shown being soldered. Protect the leads from these two ter-

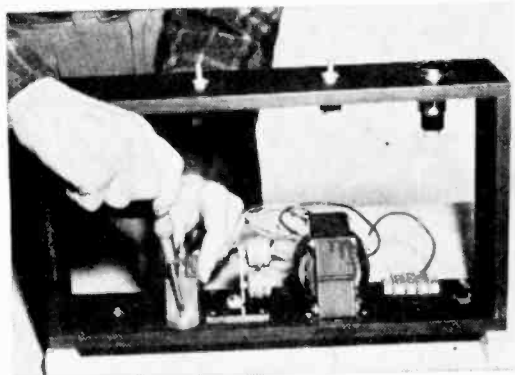

Fig. 19: Mount the major electrical components to the side of the base, before starting the wiring.

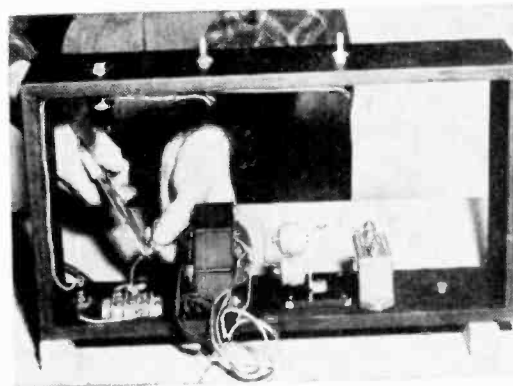

Fig. 20: Following the diagrams and the information in the text, proceed to wire parts in place.



Fig. 21: The base is assembled with wire brads and Casein cement. Follow dimensions given in diagrams.

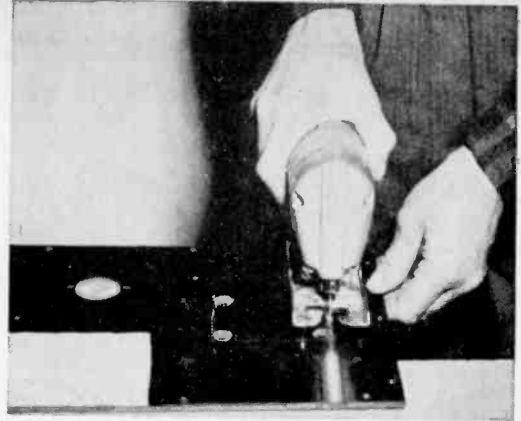

Fig. 22: The Bakelite panel can be cut to size with a coping saw or with a saber saw, as shown above.

minals with some plastic spaghetti tubing where they cross over to connect to the capacitor unit.

Figure 26 is a top view showing the tubes in place and the plate caps being put on. Fig. 27 shows the use of a piece of plastic tubing that is slipped down over L-3 and allowed to rest on the Bakelite top. It acts as added insulation between primary and secondary windings to help prevent a possible breakdown. The tall coil, L-3 simply screws down in the threaded hole provided in the brass plate at the underside of the top, no further connections being necessary.

A view of the completed coil from the back is given in Fig. 28, which shows the line cord, fuse holder and ground terminal. The top corners of the transformer have been bent down lightly with a hammer for better appearance, since these mounting tabs are not required for this job.

Figures 4 and 5 illustrate some of the experiments that are familiar to most Tesla coil experimenters. The brush discharge from the top terminal is shown. Fluorescent lamps are lighted when held in the hand, a small 120-volt incandescent lamp is lighted from energy picked up by a piece of sheet aluminum as an antenna and pinwheels of electrical fireworks are produced which are especially effective when seen in a darkened room.

While the voltage is high of probably around 60,000 volts or more, the high frequency prevents shock upon contact with the output discharge, but painful burns are possible from the heat at contact. Take care to avoid contact with any parts or connections in the base where conditions could be such as to produce a shock. Be sure to remove the cord before touching anything in this area.

While it is difficult to measure the voltage

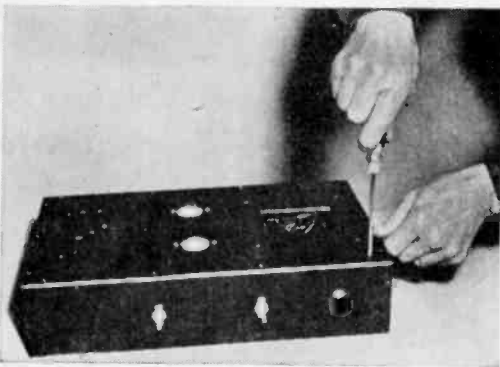

Fig. 23: With the major parts wired to the sides of the base, attach the Bakelite cover to the base.

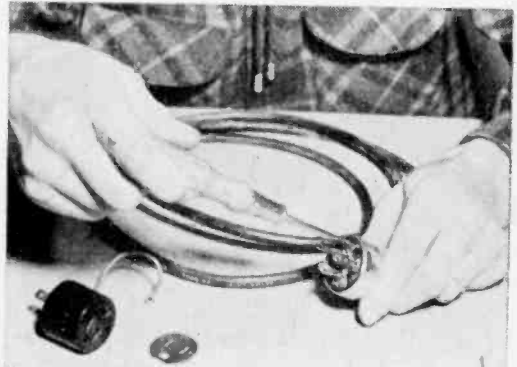

Fig. 24: Wire the three-conductor cord to the three terminal plug, connecting the green wire to ground.

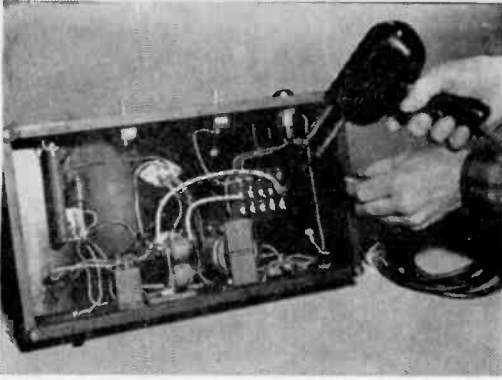

Fig. 25: Mount the remaining parts to the Bakelite panel and wire them according to the diagram. Take care not to burn leads, to avoid shorting.



Fig. 26: Place the tubes in their proper sockets and attach the porcelain plate caps. You can bend upper transformer tabs with a hammer (Fig. 28).

due to the high frequency that prevents accurate measurements on ordinary instruments, the frequency can be calculated. Determine the inductance of the coil, $L-1$ and the capacitance used across it or .003 mfd. is the second factor. By using a Shure cardboard reactance slide rule, obtainable from many electronic supply concerns at low cost, the resonant frequency can be found. In our case a reading of .5 megs. (500 kc or 500,000 cycles)

was obtained by this calculation.

When operating the coil, be sure to turn on the filament switch first and allow about 20 seconds before turning on the plate switch. It is not good for the tubes to operate them otherwise. Do not operate the coil continuously as the tubes and other components may become over heated. Turning the switches off periodically will allow them to cool off and result in longer life.

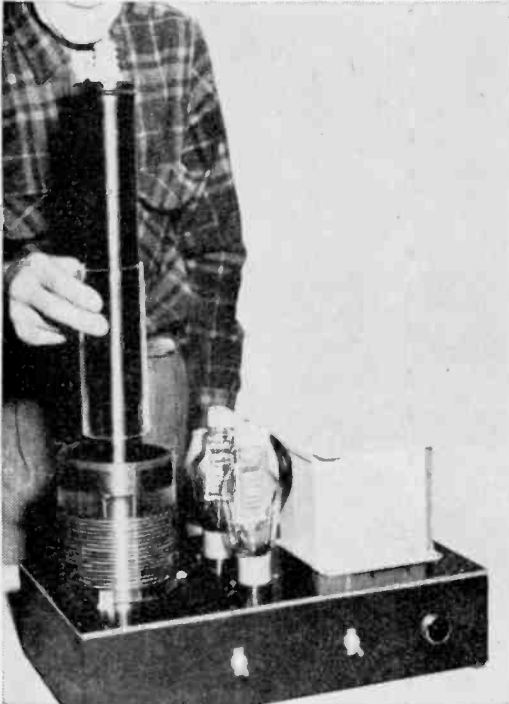

Fig. 27: Slip the plastic insulating tube over the coil, and inside the well formed by the smaller coil. This completes the entire assembly procedure.

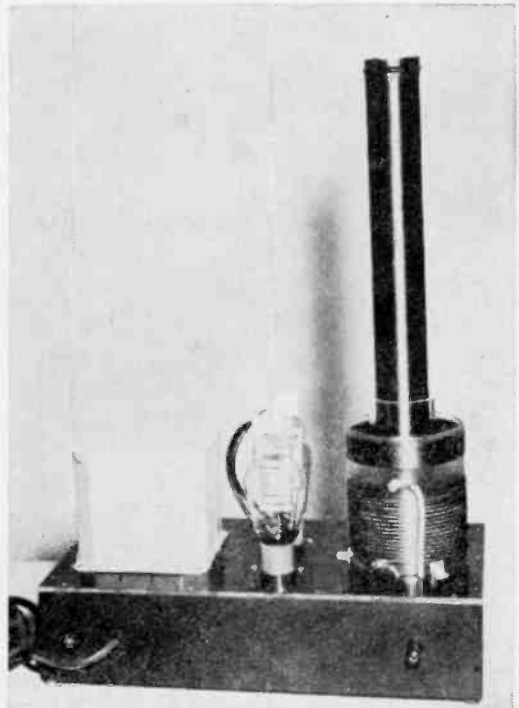

Fig. 28: And there it is, seen from the rear and ready to go. Be sure to allow tube filaments to warm up for 20 seconds before applying plates.

CdS POWER CONTROL

Now you can have variable low-power control for HO trains, thermal devices, transformers

Any electrical engineer can tell you that after power is generated, the big problem is how to control it. To a lesser degree, the home experimenter has the same problem. Of course, he doesn't have to *generate* power, it's there for the taking at the nearest 115-volt AC wall outlet. The experimenter's problem is how to get operating power at his test bench or for his gadgets at the voltages and the currents that he needs.

One of the latest power-controlling devices suitable for the experimenter, oddly

enough, is based on a semiconductor that responds to light. Known as the cadmium-sulfide (CdS) cell, this interesting photo device has the property to change its resistance in proportion to the intensity of the light falling on it. For this reason, the CdS cell is also referred to as a light-dependent resistor.

Until fairly recently, the CdS cell was limited to low-power applications like light meters (the SCIENCE & MECHANICS A-3 Supersensitive Darkroom Meter uses a CdS cell) and electric-eye relays. Recently how-

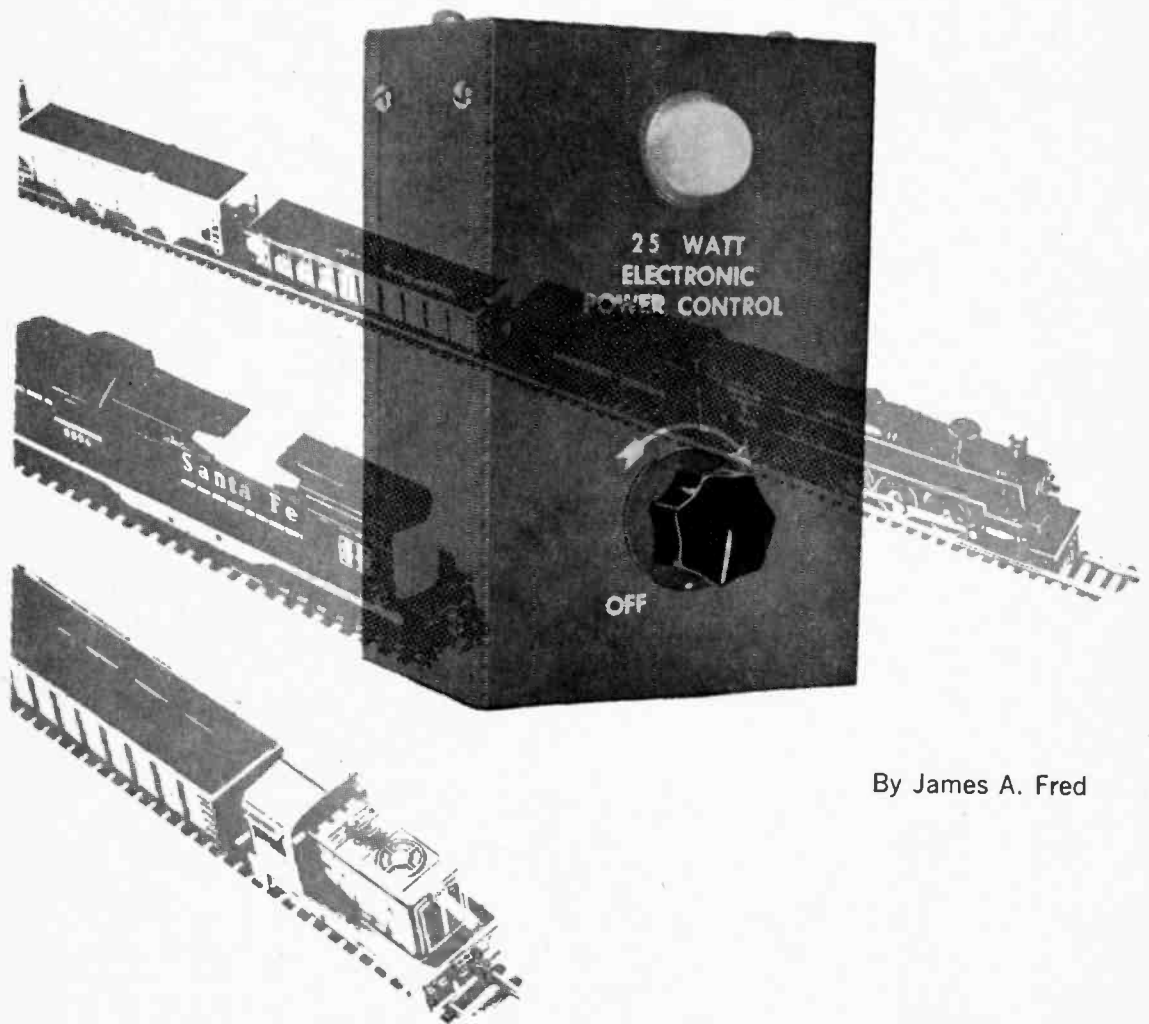

By James A. Fred

ever, Delco Radio introduced the LDR-25, an hermetically-sealed CdS cell that will handle up to 25 watts of power when properly heat sunk. In total darkness, the LDR-25 has a resistance of about 500,000 ohms. Under a strong light, the resistance can fall as low as 15 ohms.

Theory of Operation. The voltage to the 3-watt lamp I2 is controlled by wire-wound potentiometer (R1). The varying light output of I2 in turn varies the resistance of R2, the CdS cell. Since the cell is connected in series with the AC line and load receptacle, X1, its resistance determines the amount of power fed to anything plugged into X1. This means you have a handy speed control for small AC or DC motors drawing not more than 25 watts. Or you have a heat control for a pencil-type soldering iron that does not draw more than 25 watts. And, of course, it will also vary the brightness of a 25-watt or smaller light bulb. An excellent application for this control box is as a speed control for an HO-gauge model train. As is shown graphically on page 87, an inexpensive HO-power supply is plugged into the CdS control box which is then used to control the speed of the train.

Construction. Layout of the control unit is not critical, but certain precautions should be taken during construction. Make sure that

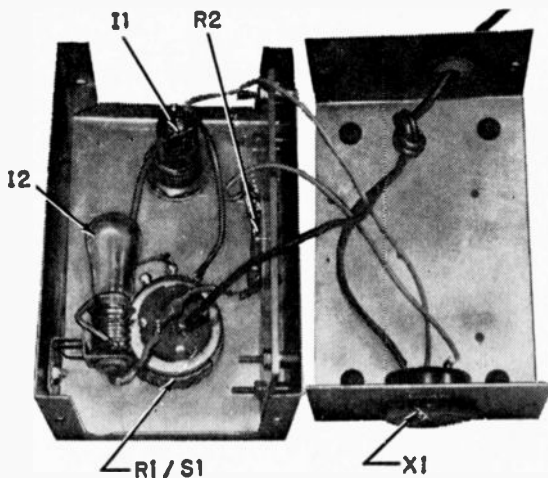

Construction is quite simple as photo shows. Position I2 and R2 apart to avoid overheating.

PARTS LISTS

F1—3/16-ampere fuse (type 3AG) and fuse holder
 I1—Neon pilot-light assembly with built-in resistor
 I2—3-watt, 115-volt lamp (type 3S6) and socket (Dialco 605)
 R1/S1—5,000-ohm, 3-watts or larger, wire-wound potentiometer with switch. Separate switch can be used if available.
 R2—CdS cell (Delco LDR-25. \$1.50 each from Graham Electronics Co., 1222 So. Senate Ave., Indianapolis, Ind.)
 X1—Panel-mounting AC receptacle
 1—4 1/2" x 3" x 2" aluminum box, exact size not critical
 1—Heat sink made from aluminum sheet scrap, approx. 3 3/4" x 1 1/2"
 Misc.—Line cord, knob, rubber grommets, nuts and bolts, wire, etc.

Estimated cost: \$7.00
 Estimated construction time: 3 hours

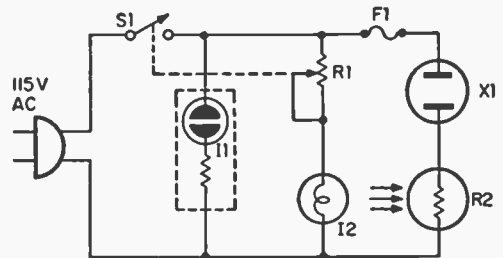

Schematic diagram shows electrical connections between parts but fails to show control I2 has over R2. Light from I2 must fall on window of R2 in order to decrease resistance.

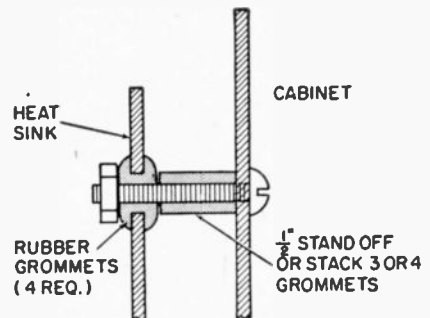

The heat sink for the CdS cell can be made from aluminum sheet stock. Cut to largest size possible without shorting to case. Rubber grommets insulate heat sink from hardware.

25-watt bulb is used to check unit out. If case gets too hot, punch a few vent holes.

bulb I1 is mounted so that its light impinges on the CdS cell R2. R2's heavy aluminum heat sink that is fastened to one side of the cabinet must be insulated from the cabinet since one side of the AC line connects directly to CdS cell R2.

A word of caution is necessary in regard to mounting CdS cell R2. If available, apply some silicone grease to the back of R2 where it contacts the heat sink. This will allow a more efficient transfer of heat. Also the CdS cell is made of a thin, fragile, ceramic disc which must be mounted carefully. Be sure that the metal where the cell is mounted is flat and free of burrs. Also be careful not to overheat the LDR when soldering the lead wires.

After you have used the CdS power-control box for a while, many more uses for it will occur to you. Remember though before using the power-control box, always check the load drawn by the device you wish to control. Fuse F1 will prevent damage to the cell and as long as you don't exceed its wattage rating and operating temperature it should have practically unlimited life. ■



NEW! DO-IT-YOURSELF PLANS CATALOG #6 25 cents

A fully illustrated catalog of the most popular boat plans available. Includes Sailboats, Cabin Cruisers, Runabouts, Outboards, Hydroplanes and all sorts of sport boats; plus Trailers and Campers and various electrical equipment.

If you especially enjoy the creative challenge and the subsequent satisfaction of building things for yourself, you'll be pleased with the infinite variety of plans available to you in the NEW CATALOG #6. Write for yours today.



BOATCRAFT / 505 PARK AVENUE / NEW YORK, N. Y. 10022
I AM ENCLOSED 25c. PLEASE SEND ME A COPY OF YOUR
NEW PLANS CATALOG #6.

Name _____ (please print)

Address _____

City _____ State _____ Zip _____

SE-784A

Gold Leaf Electroscope Detects Static Electricity

A PIECE of gold foil installed in a discarded light bulb makes an inexpensive demonstration electroscope that will detect very tiny electrical charges. All parts can be found in the ordinary scrap box. Gold leaves are available from sign painters supply houses. At the most, the project will cost \$2.

Obtain a 150-watt clear lamp bulb, a size often used in stores and offices. Pry off the brass disc at the end of the base with diagonal pliers. Then use long nose pliers to break away the tapered glass at the end of the lamp seal which gives access to the filament support inside. *Be SURE to wear safety glasses.*

Tap lightly with a metal rod and mallet to break the glass filament supports. Then smooth up the edges of the lamp base with pliers or reamer. Make the base by cutting a $\frac{7}{8}$ -in. recess in a $3\frac{1}{2}$ -in. diameter disc of black plastic or wood, and cement the bulb in place with epoxy or the metal filler available in auto body shops. Clean the inside of the bulb and add a small quantity of silica gel which helps to absorb moisture and prevent leakage of static electricity.

Make the gold leaf support of a brass rod, and fit into a rubber stopper. A turn of plastic tape will give you a tight fit. Solder the brass disc to the top of the rod. The gold leaf is very fragile. Use sharp scissors to cut a piece of $\frac{5}{16} \times 1\frac{3}{4}$ -in. Put a drop of Pliobond cement on the top of the bent rod, and carefully install the leaf. You must do it right the first time since the leaf cannot be shifted once it is placed.

Carefully lower the rod into the lamp bulb, and your electroscope is ready for use.

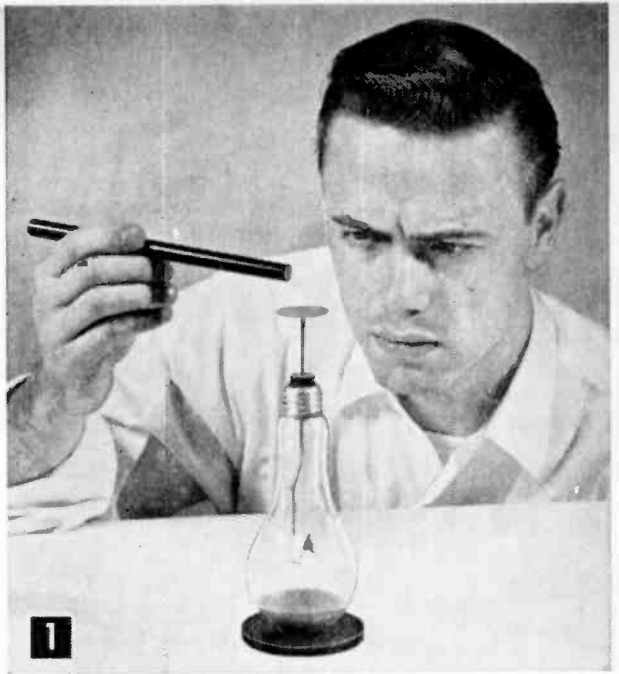

When a charged object such as this plastic rod rubbed with silk approaches the brass disc, the gold leaves separate, because like charges repel. The amount of separation is proportional to the charge.

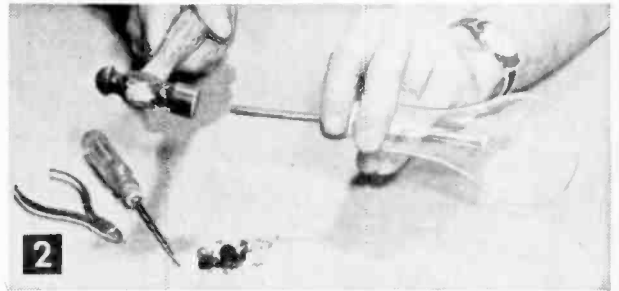

Tap lightly against a metal rod to break out the filament support.

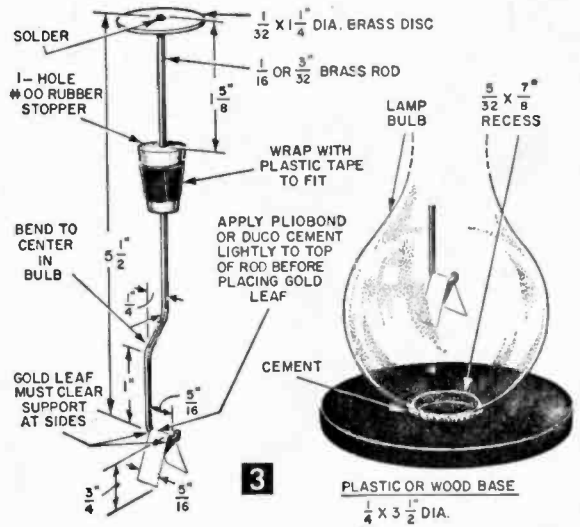

Electromagnetic

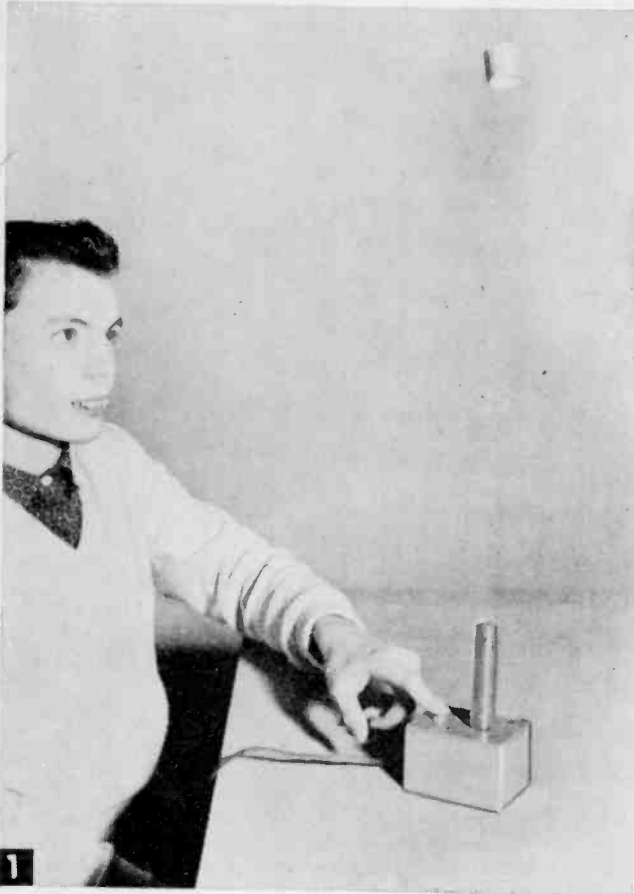

1 This repulsion coil packs enough power to propel a thick aluminum cylinder into the air for a distance of two or more feet.

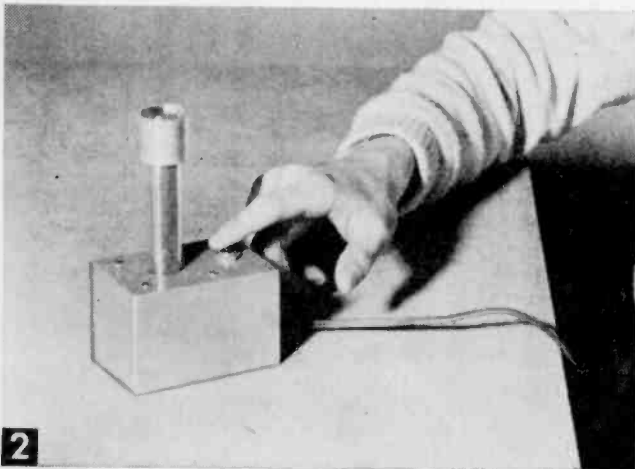

By varying the magnetic field you can produce an electromotive force capable of suspending an object in the field or repelling it

By HAROLD STRAND

EXPERIMENTS performed with this repulsion coil enable you to further understand such electromagnetic principles as Lenz's law of induced current and how the number of turns of wire in a transformer determine the voltage that will be produced.

Lenz's law holds that an induced current is always in such a direction that the magnetic field build-up around the conductor will oppose the magnetic field which induced it. This principle is shown in Fig. 1 where the magnetic field built around the coil actually threw the aluminum ring in the air.

The thick-wall aluminum ring acts like a closed-circuit single turn secondary winding through which the magnetic flux produced by the larger primary cuts. This induces a heavy current in the ring and a magnetic field around it and since the two fields are in opposition to each other, the result is to throw the ring out of the field.

These Repulsion Forces can be observed by holding the ring down with your finger when the button is depressed. Slowly allow the ring to raise to its maximum point which will be near the top of the core. Pressing down on the ring will show how the opposing fields react, because it will take considerable pressure to hold it down.

When repulsion force equals pull of gravity ring can "float" on magnetic field.

Repulsion Coil

When near to the main coil, the maximum current is developed in the ring and the resulting magnetic field around the ring is also maximum. The reaction between this strong field and that from the main coil is responsible for the repulsion effect.

Heat produced in the ring when it is held down shows why electrical conductors have to have a suitable cross-sectional area in order to carry the required current without overheating. In wiring, this is determined by consulting a table which gives the size of wire required to safely carry a given current without heating.

Suspend the aluminum ring on the magnetic field (Fig. 2) by allowing it to move up the core to a point where the strength of the field just balances the weight of the ring, or the repulsion force equals the pull of gravity. When it is down near to the main coil and the maximum magnetic field is present, the repulsion force of reaction effect greatly exceeds the pull of gravity so the ring is violently thrown into the air.

Transfer of Energy from one coil to another by electromagnetic induction is another experiment that can be conducted. This coil can be used to show the principles of all transformers, where a primary and secondary winding are placed on a laminated iron core. The relation of the number of turns on each winding determines the voltage that will be produced at the secondary.

Place a portable coil of wire with a small lamp connected to its ends over the core to act as the secondary (Fig. 8), with the main coil as the primary. When held near the top of the core the lamp will barely light, but as it is slowly moved down the core, the light increases until it burns at full candlepower at the bottom (Fig. 9).

The transformer principle works this way. When an alternating current is applied to the primary, an alternating magnetic flux which rises and falls in step with

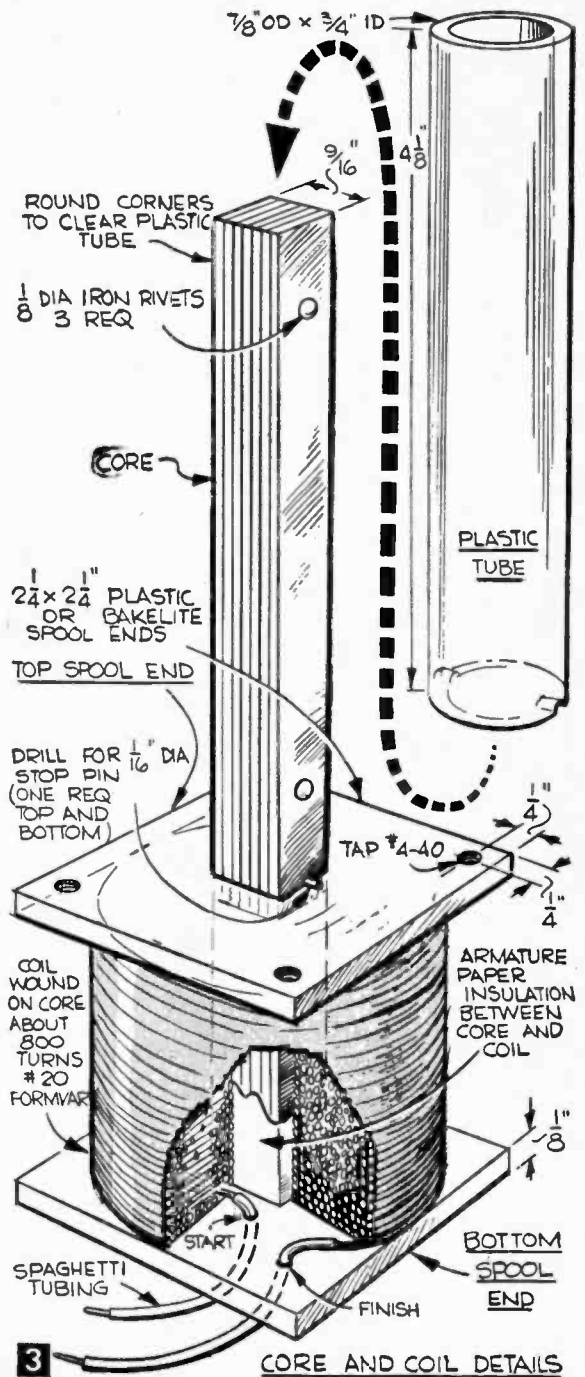

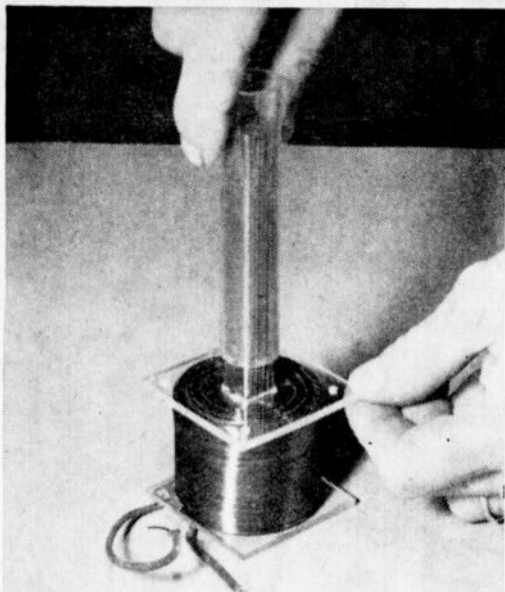

4

Notches have to be filed on the end of the plastic core tube to clear stop pins used to hold the spool end.

the current is developed. This flux cuts through the turns of the secondary winding and through the laws of electromagnetic induction, a voltage is induced in the secondary. If the secondary circuit is closed with a load, a current will flow. If the primary has 100 turns of wire and the secondary has 10 turns, the ratio will be 10:1 or the voltage developed in the secondary will be 1/10 of the applied voltage or 10 volts, less a small value

for losses and regulation.

In commercial transformers the core is made as a compact unit with a closed circuit for the flux to be as short as possible. This minimizes leakage reactance.

In our experiment the coil has about 800 turns, or with 115 volts that is about seven turns per volt. Theoretically this would call for about 7×6.3 or 44.1 turns on the secondary to light a 6.3-volt pilot lamp. There are, however, certain iron and copper losses and most important in this case the core does not provide a closed path for the flux but is simply a bundle of straight iron strips and the flux has to pass through the air in its path from the top to the lower end so the core, as a transformer is very inefficient. Therefore, you have to add more turns to offset these losses.

From experiment it was found that about 78 turns on the secondary will produce around 6 volts to the lamp when the coil was fully down on the base and only about 1 volt while near the top.

This Difference in Voltage is due to the fact that when at the top of the core, the maximum flux lines cannot cut through the secondary winding. The flux is weak at this point so a weak voltage is induced. On the other hand, the greatest amount of flux can link through the turns when the coil is down close to the main coil so maximum voltage is developed. A secondary coil designed to be adjustable is the principle of a regulating transformer used for special applications requiring variable voltage.

You can demonstrate the principles explained very easily with your repulsion coil by following the methods described. With a little ingenuity you should be able to work out other interesting experiments.

When operating the coil, do not hold the switch button depressed any longer than necessary to perform the experiment, because the coil may overheat. It is designed to carry the maximum amount of current it will stand in order to provide good repulsion for the aluminum ring. Continuous use would cause an overload on the winding. If the coil becomes quite warm after a number of experiments, allow it to cool a while before continuing.

Start Construction (Fig. 3) by making up the iron core. Cut enough pieces of $\frac{1}{2}$ -in.-wide and 6-in.-long soft sheet metal (see Materials list) so that when clamped tightly together they make a stack about $\frac{9}{16}$ in. thick. You can use almost any soft steel, except galvanized iron or turned sheet steel and the thickness is not too important. I used stock that was $\frac{1}{32}$ in. thick.

Clamp the stock together and drill $\frac{1}{8}$ -in. holes for three iron rivets (Fig. 3). Also drill the two small holes used for pin stops that hold the plastic coil spools. Round the cor-

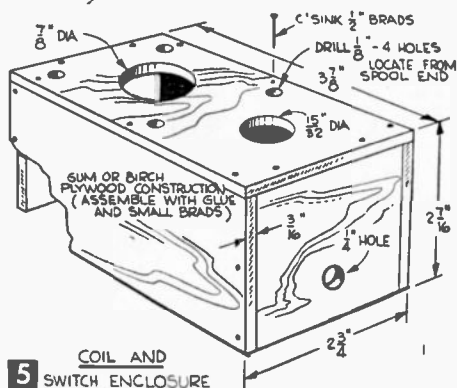

5

COIL AND SWITCH ENCLOSURE

ners so a piece of $\frac{3}{4}$ -in. inside diameter (id) plastic tubing (Fig. 3C) can be fitted over the core.

For spool ends, mark off two $2\frac{1}{4}$ -in. squares on $\frac{1}{8}$ -in. plastic (Fig. 3A) with a sharp-pointed tool and cut to size. Position core on plastic and mark center hole so plastic will fit snug over the core. The core opening can be cut with a jig or coping saw or shaped by hand. If the latter method is used, drill a series of holes within the marked area to remove waste (Fig. 3A), then file to dress it to size and shape. One spool end should be drilled and tapped so the unit can be attached to the base top. The other piece has an opening for the start and finish ends of the winding (Fig. 3B).

Winding Space Is Provided by driving a steel pin in the small hole farthest from the end and then slipping on the spool end with the four tapped holes to rest against the pin. Press the start-finish spool end on the core just far enough in so the second pin will hold it.

Wrap a turn of 0.010 armature paper around the core between the ends, taking care to have the insulation come fully up to the ends so the wire turns cannot touch the metal core. Hold the insulation together with a piece of cellophane tape. If armature paper is not available, substitute two turns of heavy wrapping paper and give this a coat of shellac.

The winding consists of 20 layers of #20 heavy *Formvar* magnet wire laid with the turns close together, which with the winding space provided will average about 40 turns to a layer or about 800 total turns. Equip the start and finish ends with a 3-in.-length of spaghetti tubing and carry them out the holes in the plastic spool end. The coil wire should be put on neatly and tight to make a good job of it. If a winding machine or lathe is available, this would be the best way to do it, but the wire can be put on by hand-winding with a bit of patience.

Fit the plastic tubing down over the core (Fig. 4) and mark the position of the stop pins. Use a file to cut the two notches (Fig. 3C) so the tube end will rest squarely on the spool.

Next Step is to make the coil enclosure (Fig. 5). Metal cannot be used for the base, because it surrounds the core and current could be induced in the metal to cause heating and also rob the coil of some of its energy needed for the experiments. Use wood or some

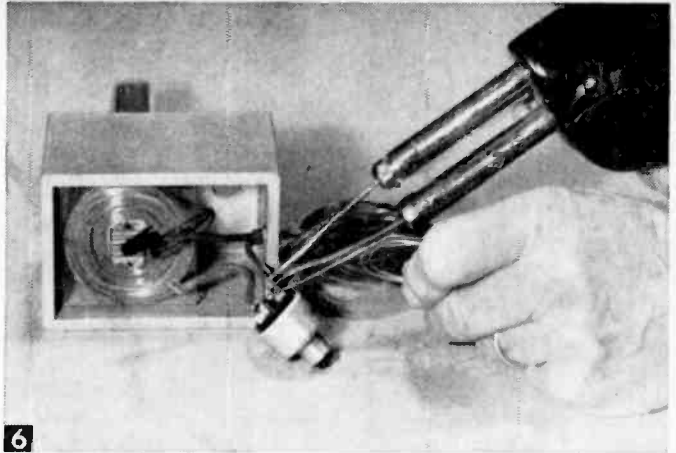

6 Solder coil and line leads to switch before attaching it to the base with a washer and locknut.

other insulating material.

Gum plywood worked out well for me and it can be glued and bradded together. Cut the pieces to dimension (Fig. 5) from $\frac{3}{16}$ -in. plywood. Make a $\frac{1}{8}$ -in.-diameter hole in the top so the plastic tube that fits over the core will rest on the spool end, then mark the position of the screw openings from the plastic spool end on the top and drill the openings. Bore a $\frac{15}{32}$ -in. hole for the push switch. You can drill a $\frac{5}{16}$ -in. opening in the side for the line cord and use a piece of fibre or plastic tubing pressed in the hole as an insulating bushing (Fig. 5), or make a $\frac{1}{4}$ -in. hole and allow the cord to enter through this if you prefer.

Countersink the brads and fill with *Plastic Wood*. Use a fine sandpaper to smooth the surface and round off the corners. Finish with an attractive hammertone gray that's sprayed on from an aerosol can. Two coats of paint may be required for a good finish.

The Switch Must be Capable of handling the heavy current surge of the inductive load, or coil in the circuit. The *Acro 3D05-5P* momentary contact switch with a 12 amp rating at 125 volts will meet specifications

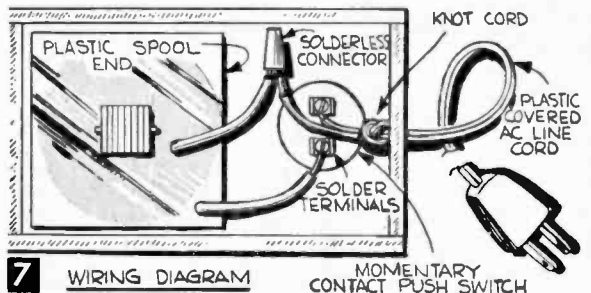

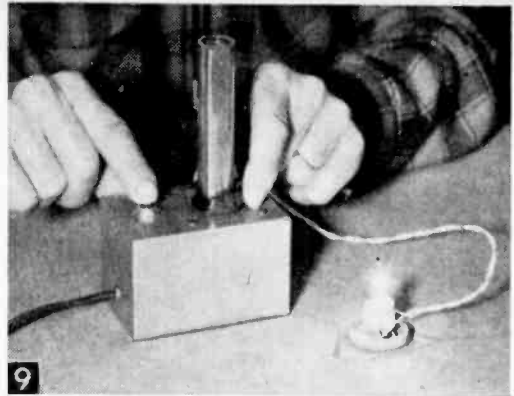
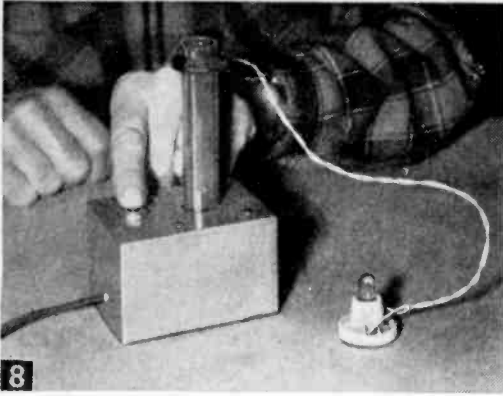

8 Magnetic field at top of core (left) is only strong enough to induce a very small voltage and the lamp filament is hardly lighted, but when placed down close to the bottom of the core (right) the maximum flux cuts through the turns of the small coil and voltage increased to light the lamp to full candlepower.

and its physical size is comparatively small. Don't attempt to use other types of push switches with a low amp rating, because their contacts will quickly burn away.

Solder the switch (Fig. 6) into the circuit or in series with the line cord after attaching the coil-core unit to the wood base with four 4-40x 3/8-in. round or binder head machine screws through the top. Splice between one lead wire and coil lead can be made with a solderless connector (Fig. 7). Thoroughly remove the insulation on the ends of the coil leads with sandpaper before making the connections. After wires are connected to the switch, use a washer and locknut to attach the switch to the top of the enclosure.

This completes the work in the main unit.

Connect an AC ammeter in series with one side of the line with clip leads and press the switch button. If you have made the coil correctly, the current should be around 6 amps. A higher current indicates shorted turns or not enough turns for the size of coil specified.

Make the Aluminum Ring from a piece of 1-in. aluminum pipe used by electricians as conduit. If you can't find conduit this size, these rings can be purchased cut-to-size (see Materials List).

This ring is very important to the operation of the coil. It must have a heavy-wall thickness to carry the 100 amps or so that is induced in it by electromagnetic induction. In addition to being a good conductor of electricity it must be lightweight. Actual size

(Continued on page 67)

MATERIALS LIST—REPULSION COIL*

Amt. Req.	Size and Description
	26 gauge to 1/32 x 1/2 x 6" strips of soft sheet metal to make 9/16" stack when compressed
3	1/8 x 5/8" soft iron rivets
	1/8 x 2 1/4 x 2 1/4" plastic or Bakelite for spool ends, and 3/4 id x 7/8 od x 4 1/8" plastic core tube
2 pcs.	0.060 x 3/4" steel rod or wire stop pins for end spools
1 pc.	0.010 x 1 3/4 x 2 1/4" armature insulating paper for core
1 1/4 lbs.	#20 heavy Formvar magnetic wire
2 pcs.	1/8 od x 3" spaghetti tubing
1 pc.	3/16 x 4 x 12 1/4" gum or birch plywood
4	4-40 x 3/8" round or binder head machine screws
1	Acro 3D05-5P momentary contact push switch, 12 amps, 125 volts
1	solderless connector for two #18 wires
1	plastic covered AC line cord with attached plug (electronic supply houses)
1 pc.	1 x 1 1/8" aluminum pipe
PORTABLE SECONDARY COIL	
2 oz.	#24 heavy Formvar or enamel magnet wire
2 pcs.	#20 x 12" long flexible insulated wire
1	surface-type socket for screw-base lamp
1	6.3-volt screw-base pilot lamp

* All materials to build the coil can be purchased for \$14.95 from Linwood Products Co., P.O. Box 186, Wollaston 70, Mass., who can also furnish aluminum ring cut to size and other parts separately.

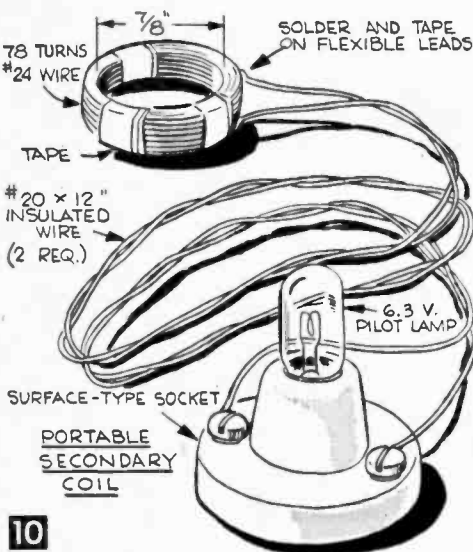

10



TWO TYPES of polarity indicators: in front, alkacid test paper; rear, soak strips of filter paper in strong solution of salt containing few drops of phenolphthalein indicator. Either type produces color at negative terminal.

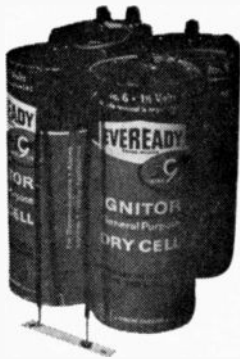

ELECTRICAL POLARITY INDICATORS

INDICATOR PAPERS that you can buy or prepare yourself will quickly and reliably reveal what parts of an electrical circuit are negative, what are positive.

Ready-made indicator papers such as neutral litmus or *Alkacid Test Ribbon* supplied by Fisher Scientific Co. of New York City are convenient. The litmus paper costs 15¢ for 100 strips; the *Alkacid Test Ribbon* costs \$1.74 for three rolls, each containing 15 feet of ribbon. To use, wet the paper with some salt solution (used to increase conductivity) and touch to the two poles. A dark blue color forms at the negative terminal.

To prepare your own polarity test paper, soak some unglazed absorbent white paper—filter paper is excellent—in a strong salt solution to which a few drops of phenolphthalein indicator solution has been added. The

amount of salt in the water is not critical, but make the solution fairly concentrated. The phenolphthalein is a common indicator used in chemical acid-base titration procedures. If the salt-phenolphthalein solution turns pink, add just enough acetic acid or vinegar, drop by drop, to discharge the color. Use no more acid than is necessary.

Wet the filter paper in this solution and put aside to dry; then cut the paper into convenient strips about $\frac{1}{4}$ in. wide and 2 in. long. To use, wet a strip with water and bridge the circuit with it as with the ready-made indicator papers. In this case a bright red color forms at the negative terminal.

In each case an alkali is formed at the negative terminal because of an electrolytic reaction; the alkali reacts with the indicators to form the red and blue colors. ■

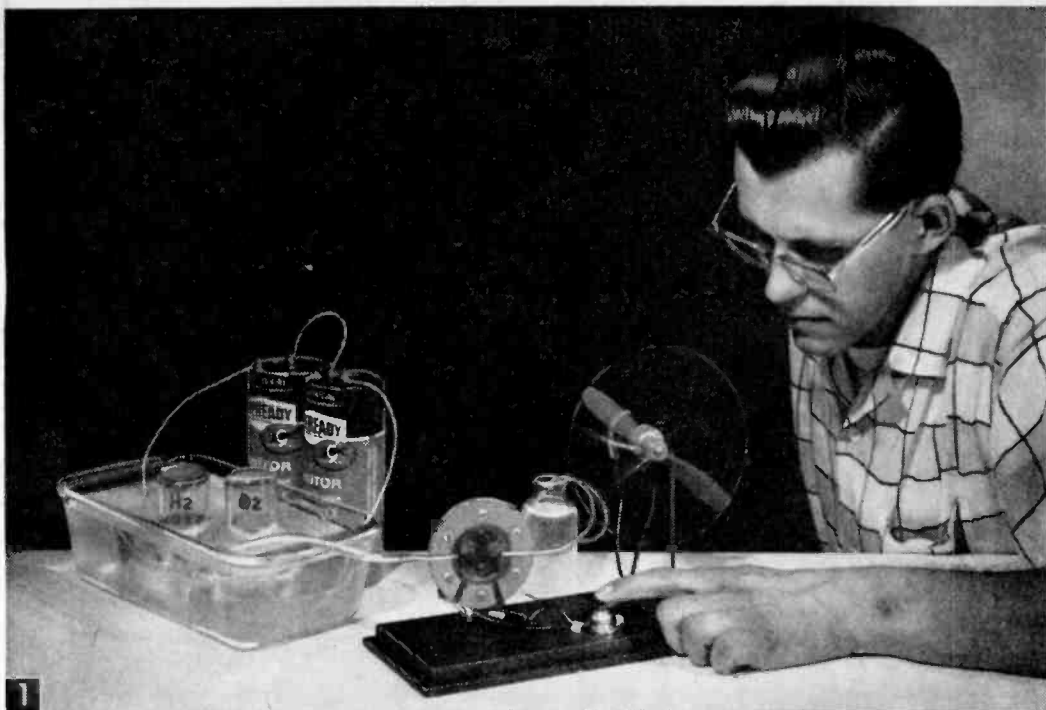

Hydrogen and oxygen produced by electrolysis react in the fuel cell to create electricity. In practice a motor could be temporarily reversed to generate current for electrolysis, eliminating batteries.

Build Your Own Working Model Ion-Exchange Fuel Cell

One of these power supply units of the future
makes an excellent science fair project

By ELTON J. CAIRNS

AT ITS present stage of development, the fuel cell is a highly efficient, compact power unit that produces no toxic exhaust fumes, high temperatures, high pressures or noise. In special cases, it can be used to manufacture its own fuel and oxidant; usually hydrogen and oxygen.

Since these attributes are just those being sought in power plants for long-distance submarines and space ships, it is not surprising that the fuel cell has attracted the attention of today's engineers and scientists.

The fuel cell itself is not a new concept; the first one was constructed in 1839 by W. R. Grove. Now, however, the growing demand for a power plant with the characteristics of the fuel cell has created new interest

in it, and attempts are being made to build fuel cells which will produce enough power per unit volume to make them practical.

Basically, a fuel cell is an electrochemical device for conversion of chemical energy into electrical energy. The principle of operation is generally the same as an ordinary flashlight or automobile

battery, except that the fuel and oxidant are supplied from outside of the cell while it is operating.

You can build a fuel cell and a hydrogen-oxygen generator (Fig. 1) from about \$10-\$15 worth of materials to demonstrate this principle and serve as a model for future experiments. Remember that the fuel cell is not a toy, but a device with tremendous potential for experimental improvement. As such, it involves working with hydrogen, oxygen and corrosive solutions. These demand use of ordinary laboratory precautions, such as careful handling of the liquids and avoidance of open flames in the area while hydrogen is being produced or used.

Make the Fuel-Cell Casing from two $\frac{1}{8}$ x

$3\frac{1}{8} \times 3\frac{1}{8}$ " pieces of plastic. Lay out the eight $\frac{1}{8}$ -in. holes (Fig. 2A) and tape the pieces together, drilling through both sheets at the same time. Temporarily insert three or four bolts and saw the 3-in. dia. casing from the sheets. Using one of the cell casings as a template, lay out the six bolt holes on two pieces of $\frac{1}{16}$ -in. rubber gasket material. Punch the holes and cut a $1\frac{1}{2}$ -in. opening (Fig. 2B) in the center of each gasket. Save six of the $\frac{1}{8}$ -in. slugs punched from the gaskets to be used as spacers when assembling the casing.

Cut the electrodes (Fig. 2C) from 100-150 mesh nickel screen, providing $\frac{1}{4} \times 1$ -in. tabs to be used as terminals. The nickel electrodes are given a coating of platinum-black which serves as a catalyst to speed up the reaction of hydrogen and oxygen at room temperatures. Remove all grease and oil from the screens with dry cleaning fluid, dry them thoroughly, and place them in a 5% platinum chloride solution until they have become blackened (about 20 minutes). Take them from the solution with a tweezers, rinse with water and dry between blotters.

Cut a 2-in. disc from a sheet of anion exchange resin or Whatman #50 filter paper. This disc will serve to store the electrolyte and must be soaked in it before assembly. The electrolyte is made of 30 grams of potassium hydroxide in 100 cc of water. Add the hydroxide to the water slowly to prevent dangerous overheating. Handle the solution carefully as it is harmful to your skin and highly corrosive on material other than plastic, rubber or glass. When the disc has ab-

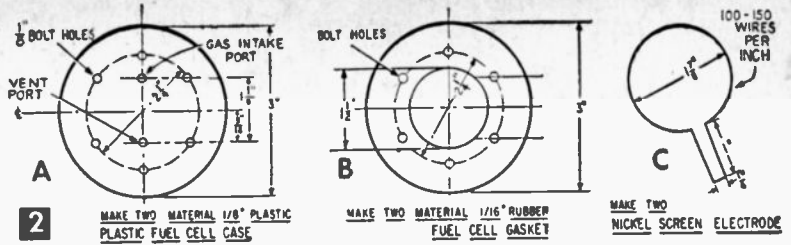

2 MAKE TWO MATERIAL $\frac{1}{8}$ " PLASTIC FUEL CELL CASE

MAKE TWO MATERIAL $\frac{1}{16}$ " RUBBER FUEL CELL GASKET

MAKE TWO NICKEL SCREEN ELECTRODE

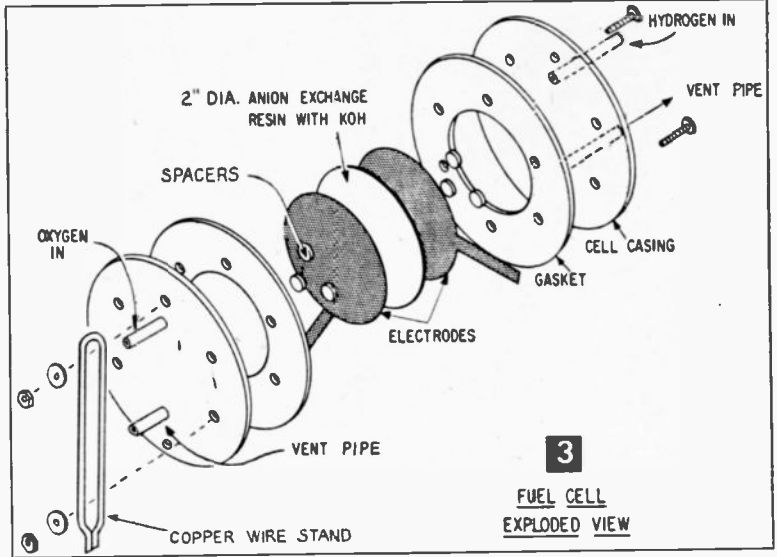

3 FUEL CELL EXPLODED VIEW

MATERIALS LIST—FUEL CELL AND GENERATOR

Amt. Req.	Size and Description	Use
2	$\frac{1}{8} \times 3\frac{1}{8} \times 3\frac{1}{8}$ " clear plastic	cell casings
2	$\frac{1}{16} \times 3\frac{1}{8} \times 3\frac{1}{8}$ " rubber (inner tube)	gaskets and spacers
6	10-32 x $\frac{3}{4}$ " bolts and nuts	gas intake and vent pipes
4	$\frac{1}{8}$ " o.d. x 1" metal or plastic pipe	electrodes
1	6 x 6", 100-150 mesh nickel screen (Available from C. O. Jelliff Mfg. Corp., Southport, Conn., for \$3 postpaid).	electrolyte storage disc
1	$\frac{1}{4} \times 2 \times 2$ " anion exchange resin (Editor's Note: Available from Ionics, Inc., Cambridge 39, Mass.) or substitute Whatman #50 filter paper.	electrolyte catalyst
1 lb.	potassium hydroxide pellets	electrolyte
35cc	5% platinum chloride, or: Mix one gram pure platinum chloride in $\frac{1}{3}$ cc (10-15 drops) concentrated hydrochloric acid and 35cc water.	electrolyte
7 ft.	$\frac{1}{8}$ " i.d. plastic tubing (Filter paper, potassium hydroxide, platinum chloride and plastic tubing available from Scientific Supply Co., 1743 W. Rosehill Dr., Chicago 26, Ill., or Fisher Scientific Co., 1458 No. Lamon, Chicago 51, Ill.)	feed and vent tubes
1	4 x 4 x 8" Pyrex loaf pan	electrolysis tank
2	$1\frac{1}{2}$ " alligator clips	tube clamps
3	glass (aspirin) bottles	fuel reservoirs and trap
2	$1\frac{1}{2}$ volt dry cells	
7 ft.	copper bell wire	
1	$\frac{1}{16} \times 3 \times 12$ " sheet plastic	bottle support
1	16 ga. x 8" stiff copper wire	cell mount

sorbed as much of the electrolyte as possible, take it from the solution and remove the excess liquid with a blotter, leaving the disc damp, but not wet.

To Assemble the Cell (Fig. 3), place a gasket and three of the spacers on one of the casing-halves. Place one of the electrodes on top of the plugs with the tab extending beyond the edge of the case. Cover the elec-

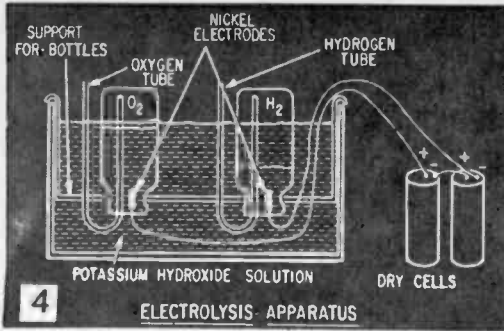

$\frac{1}{2}$ x 5 x 12-in. board to which you have attached a miniature toggle switch with four 6-in. leads and alligator clips. Drill holes in the board in which the cell and test loads, such as a motor, lights or a meter, can be placed. Mount the cell by bending a stiff copper wire around the ends of the screws and forming a leg to fit in the test stand (Fig. 3).

A Generator to manufacture oxygen and hydrogen is made by using an electrolysis setup (Fig. 4) with potassium hydroxide as the electrolyte and nickel screens as electrodes. Fill a 5-in. deep pyrex pan $\frac{3}{4}$ full of a 10% solution of potassium hydroxide ($\frac{1}{2}$ lb. of hydroxide to $\frac{1}{2}$ gallon water). Fill two small bottles with the solution and place them upside down in a support in the liquid with no air in the bottles. Clamp one end of two 3-ft. pieces of $\frac{1}{8}$ -in. plastic tubing and place the other ends well up into each of the bottles. Connect two 3-ft. insulated copper wires to 1 x 2-in. nickel screen electrodes and place one of the electrodes just

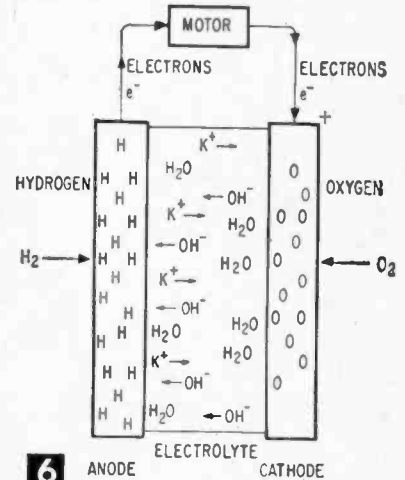

6 SCHEMATIC OF FUEL CELL PRINCIPLE

5 Rubber respirator bags filled with purchased hydrogen and oxygen run Aristo-Rev midget motor and 6-in. propeller for several hours.

trode with the disc containing the electrolyte and place the second electrode on this. Be sure the electrodes do not touch each other by arranging the tabs so one is on each side of the vent ports. Now place the remaining gasket, spacers, and casing-half on top, line up the bolt holes and ports, and fasten the cell together with 10-32 x $\frac{3}{4}$ -in. bolts and nuts. Do not fasten the nuts so tightly as to force the gasket beyond the edge of the case. Glue $\frac{1}{8}$ -in. o.d. metal or rigid plastic pipes in the intake and vent ports so the feed tubes can be slipped over them.

Now make a testing stand (Fig. 1) from a

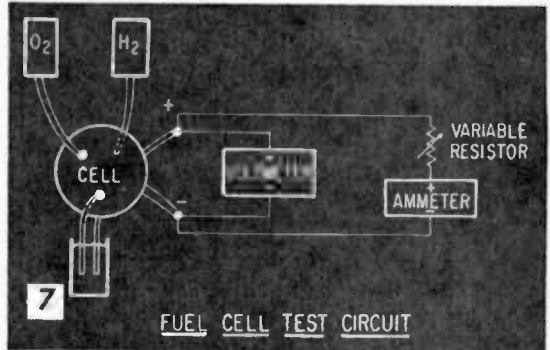

FUEL CELL TEST CIRCUIT

inside of the mouth of each bottle. Then connect the wire to two or three 1½v, series wired, dry cells. Gas will immediately begin to collect in the bottles; hydrogen at the negative electrode and oxygen at the positive. (*Caution: hydrogen is combustible. Keep flame away while the generator is operating.*) Allow gas to collect until the oxygen, which is generated only half as fast as the hydrogen, has forced the liquid level in the bottle below that in the pan. Now loosen the tube clamps to bleed the liquid from the gas feed tubes, re-clamp them, and attach one to each intake pipe.

Attach a length of tubing to each vent pipe with the other ends of the tubes in a bottle of water (Fig. 1). Open the clamps on the feed tubes to allow gas to reach the cell and then lift the vent tubes to the surface of the water, bleeding the air which has been trapped in the cell during assembly. As soon as the cell begins to produce current, as shown by the action of a motor or ammeter, replace the tube ends in the water to prevent loss of fuel.

Principle of Operation. As the oxygen (O₂) enters the cell, it is adsorbed by the electrode (cathode) on its side (Fig. 6) and, aided by the platinum-black catalyst, is split into oxygen atoms (O). These atoms react with the water molecules in the electrolyte (KOH + H₂O) and produce negatively charged hydroxyl (OH⁻) ions. In this process the cathode becomes positively charged by a loss of electrons.

The hydroxyl ions migrate through the electrolyte and react with hydrogen atoms

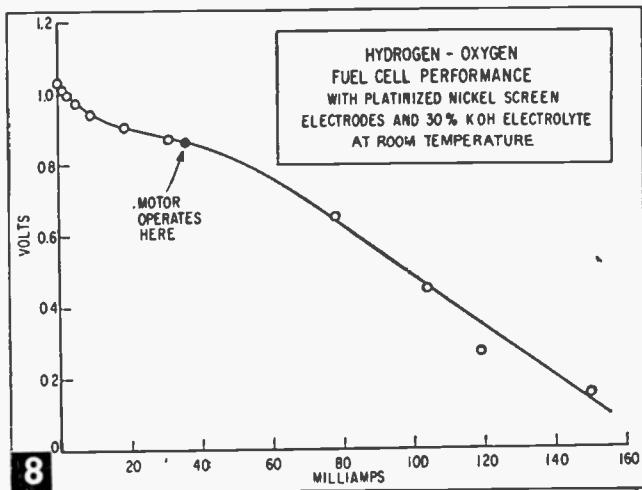

(H), which have been formed from hydrogen gas (H₂) on the opposite electrode (anode), to form water again. The anode receives electrons in the process, and when a load circuit is connected between the electrodes, electrons will flow to the cathode from the negatively charged anode.

A Fuel Cell Test Circuit is set up by wiring an ammeter and a variable resistor parallel to a voltmeter (Fig. 7). The output of the cell can be plotted on a graph to show its performance. Various electrolytes (sodium hydroxide is a good substitute), electrodes and catalysts (finely divided nickel, platinum, or carbon) may be tested. Fig. 8 shows the performance curve of the cell described here. By observing the elementary rules of electricity, experiments can be conducted with several fuel cells wired either in parallel or in series.

Repulsion Coil

(Continued from page 62)

of the 1-in. pipe measures about 1 5/16-in. outside diameter (od) and 1 1/16-in. (id) which gives a very desirable 1/8-in. wall thickness.

The ring should be 1 1/8 in. long and the ends dressed square and smooth with a file or preferably in a lathe. Smooth the outside of the ring with a fine abrasive paper for good appearance.

If the ring is held down close to the main coil for a moment the current registered on the ammeter will be about 7 to 8 amps. This represents some added primary current which a transformer draws from the line when there is a load on the secondary. It will also be found that the ring becomes warm when held

down due to the heavy current flowing in it.

A Portable Secondary Coil (Fig. 10) required for the lamp experiment (Figs. 8 and 9) is made by winding 78 turns of #24 heavy Formvar or enamel magnet wire on a dowel or other suitable form which will give the coil, when taped, an id of about 7/8 in. so it can be pressed over the plastic core tubing. Bind the turns with three narrow bands of tape to hold it together. Two pieces of #20 flexible insulated wire are then soldered and taped to the ends of the coil. The other ends of the leads are connected to a miniature screw-base socket and a 6.3-volt screw-base pilot lamp put in the socket.

Other accessories can be made up as required for other experiments which may be developed by the teacher or student.

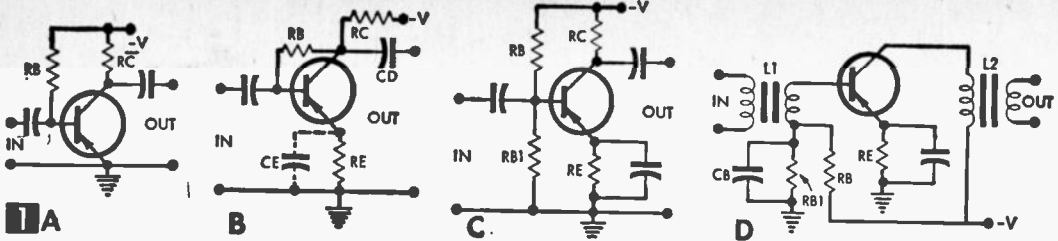

Understanding

Transistor Amplifiers

TRANSISTOR amplifier stage configurations may take numerous forms. In the simple circuit of Fig. 1A resistor RB provides base bias. Resistor RC provides collector bias and is part of the transistor load. The input and the output to an external load (another transistor) are coupled through the capacitors. The weaknesses of this configuration are that: resistor RB must be selected for the individual transistor that is in the circuit if best results are desired; the circuit operating point, and consequently the gain, vary with temperature; and the circuit is limited in handling signals.

The values of the parts are generally 1 to 20 mf for the capacitors, about 47K to 270K for RB, and about 1K to 10K for RC, depending on characteristics of the transistors. Input impedance is between 500 ohms and 2K, depending on transistor type and components.

The circuit of Fig. 1B is considerably better. It is temperature-stabilized and with proper design permits realization of relatively uniform results, regardless of individual tolerances within a transistor type. Resistor RE provides dc feedback, and if CE is omitted provides ac feedback. The dc feedback maintains operating point in spite of temperature changes. If CE is included in the circuit, ac gain remains high, but varies with individual transistors, and input impedance remains low (about 500 ohms to 2K). If CE is omitted from the circuit, gain is reduced, but remains fairly constant with variations in transistors.

Input impedance is high, roughly RE times the transistor current gain. Current gain ranges from about 20 to 120 for available 50 to 150 milliwatt audio transistors in the common emitter configuration. RE is usually from 100 ohms to 2K and CE is 10 to 100 mf.

The base bias resistor RB tends to stabilize for temperature variation effects, but is most frequently connected in the manner shown to minimize the effects of individual transistor variations. Since RB provides ac as well as dc feedback, this feature lowers circuit gain. RB also influences input impedance.

It should be apparent from the discussion

to this point that anything you get in a circuit costs some other advantages. Thus, to get interchangeability of transistors without wide variations in gain, or to get high input impedance, you must sacrifice available gain.

The circuit of Figure 1C shows another biasing arrangement which permits interchangeability of transistors with minimum operating point shift. This scheme also provides temperature stabilization. Gain is reduced slightly, but not as much as with the arrangement of Fig. 1B. Gain varies more from one circuit to the next; in most cases, however, variation in stage gain from unit to unit isn't too important.

The circuit configuration of Fig. 1D is that of a transformer-coupled transistor stage. Note that the same emitter biasing arrangement is used, and that RC is merely replaced by the primary of L2. Even the base biasing arrangement is the same except that the secondary of L1 is connected in series with the junction of RB and RB1 and the transistor base. And CB has been added to bypass ac around RB1 to prohibit the audio degeneration that would otherwise occur. The transformer-coupled transistor amplifier was at first popular because it was simple and because optimum gains can be realized with the better impedance matches provided by transformers. But this configuration has lost much of its popularity because the frequency response of transformers is poor, higher gain transistors have become available, and transformers add expense to the cost of an amplifier stage. Note that the configuration of Fig. 1C contains only one more resistor but two less transformers than the circuit of Fig. 1D.

The transformer-coupled transistor amplifier stage does have a place of its own, however, namely as a power amplifier or output stage. Although schemes for coupling from transistor to speaker without a transformer exist, they're generally marginal, tricky, or they require a host of parts to accomplish the desired result. Consequently, the output transformer has the field pretty well to itself. Frequently the input transformer is not employed in an output stage. The output stage circuit looks more like Fig. 1C except that RC is replaced with the output transformer primary.

MOTOR GENERATOR DEMONSTRATION

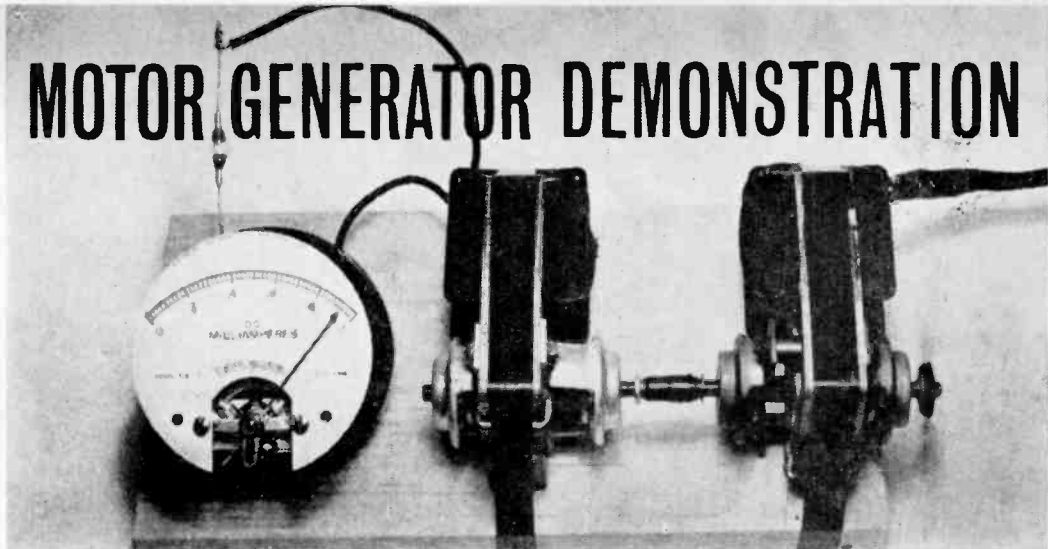

TWO old phono motors, salvaged from junked 78-rpm record players, can be used to demonstrate the fundamentals of a motor-generator set. Two motors are strapped to a piece of board, and the shafts are coupled with tape so that one motor drives the other. The captive motor generates a small ac current which is rectified to dc by a germanium diode and then registered on a dc milliammeter.

Ordinarily, a generator produces current by revolving a coil in a magnetic field, or by revolving a magnet within a coil. But in this experimental set-up there is very little magnetism in the captive motor because it is not connected to the ac lines, so it only generates a feeble current.

Figures 1 and 2 show the construction. The two motors are strapped on a $\frac{3}{4} \times 3\frac{1}{2} \times 8$ -in. wood base using friction tape, and the two shafts are coupled with a few turns of plastic

tape. If necessary, one of the motors can be blocked-up a little so that the shafts line up well. Connect a line cord and plug to the right hand motor, and tape the connections well to avoid shocks and shorts. Connect the two leads on the captive motor to the two posts on the rear of a 0-1 or 0-5 dc milliammeter. When you start the motor you will note that the meter needle barely moves and vibrates rapidly—that's because you are feeding ac current into a dc meter. Connect a common general-purpose germanium diode (1N34A, etc.) in one meter lead, as shown, then the ac will be rectified to dc because the current can only pass through the diode in one direction. Be sure to observe correct polarity—the cathode (plus) lead of the diode goes to the plus post on the meter. A soft sponge rubber pad under the meter protects it from motor vibrations. Other 110-volt motors could be used for this experiment.—ART TRAUFFER.

FIG. 2 EXPERIMENTAL MOTOR-GENERATOR

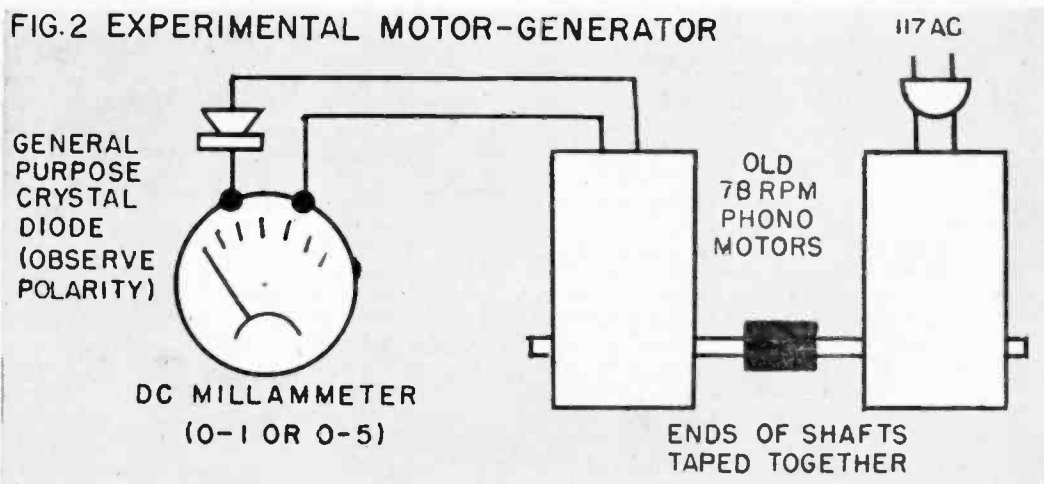

Midget Van de Graaff Generator Develops Up to 50,000 Volts



Repulsion and attraction forces at work. Many strips of facial tissue taped to the sphere get a similar charge from the generator and stand rigidly apart. But point your finger, which has an opposite charge, and they'll reach over and grab it as though they were alive.

Build the world's tiniest working model for \$10 and run it on dry cells to perform electrostatic experiments for your science fair project

Craft Print Project
No. 315



By HAROLD P. STRAND

UNTIL we see a smaller one that actually works, we will call this the smallest electrostatic generator in the world! Standing but 6½ in. high, it will develop 30,000 to 50,000 volts, depending on humidity! Yet the current is so small, there is no shock hazard.

Operating on 3 volts from two dry cells, it will perform the fascinating "satellite" and "electric wind" experiments as surely as its big brothers (400,000-volt model, Craft Print 301, and the 150,000-250,000-volt model, Craft Print 283). With the midget, you can demonstrate many variations of repulsion and attraction as in Figs. 1 and 2. And by adding a spark gap electrode and wire capacitor you can produce a continuous series of lightning-like discharges as in Fig. 3.

If you're used to working with small parts, construction will not be difficult, using mainly hand tools. Many of the pieces may well be in your scrap and you can obtain the slotted plastic tube and other plastic parts for \$3.95 (see Materials List). Cost of all materials for the generator alone should average about \$10, plus batteries.

Dr. Robert J. Van de Graaff invented the generator which bears his name in 1931. Ever since, laboratories and research organizations throughout the world have used it in various forms and sizes, including the multi-million-volt machines employed in atomic research.

How the Midget Works. Since static charges are created whenever two dissimilar materials are repeatedly brought together and separated, the subminiature model devel-

ops its charge by passing a rubber belt over an aluminum foil-covered plastic pulley (Fig. 4). Charges are carried by the belt inside the plastic tube and up to the sphere where they are picked up by a comb brush and directed to the outer surface. The charges build up to a high potential until they are either discharged by jumping the spark gap provided at one end of the base or taken off and directed elsewhere for experimentation.

Constructing the Generator. Cut out the base from aluminum sheet as in Fig. 6, drill all holes indicated and bend to shape. Attach small end tabs to sides with small rivets to hold lower corners together. Shape a clamp from soft brass or aluminum for a snug slide fit with a $\frac{1}{8}$ in. rod as in Fig. 6A and rivet it to the end of the base nearest the column location.

Now invert the base and position a #55 Cer-Mag d-c motor as in Fig. 7A, so that a $\frac{3}{8}$ -in. section at the end of the shaft is centered over the $\frac{7}{8}$ -in. hole. Locate and drill mounting holes, then attach motor to the base with 4-40 x $\frac{1}{4}$ -in. binder head machine screws and nuts. Install insulated banana jacks in the two $\frac{1}{4}$ -in. holes on one end and solder a motor lead to each as in Fig. 7A. Insert a 6-32 x $\frac{1}{4}$ -in. binder head machine screw in the tapped hole between jacks to hold the wire capacitor when an experiment calls for its use.

Make the small bracket for the ground brush as in Fig. 7B and solder a short piece of copper or bronze screen wire at the free end. Mount brush assembly to side of box as in Fig. 7A. Return base to upright position for installation of the column.

Column and Pulleys. If plastic parts are easily available, you can cut and shape the generator column and pul-

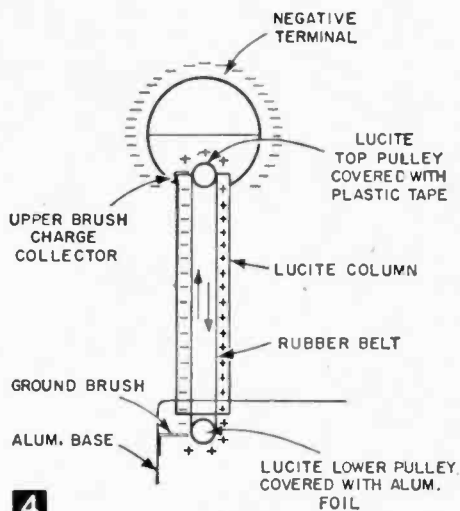

4

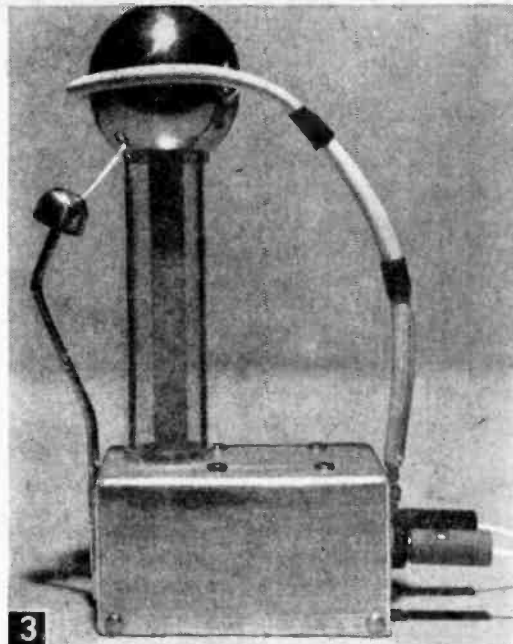

Husky spark, $\frac{3}{4}$ -in. long and representing about 50,000 volts, occurs when spark gap electrode and capacitor accessories are attached to energized generator. Electrode alone produces thinner spark, demonstrating effect of capacitance.

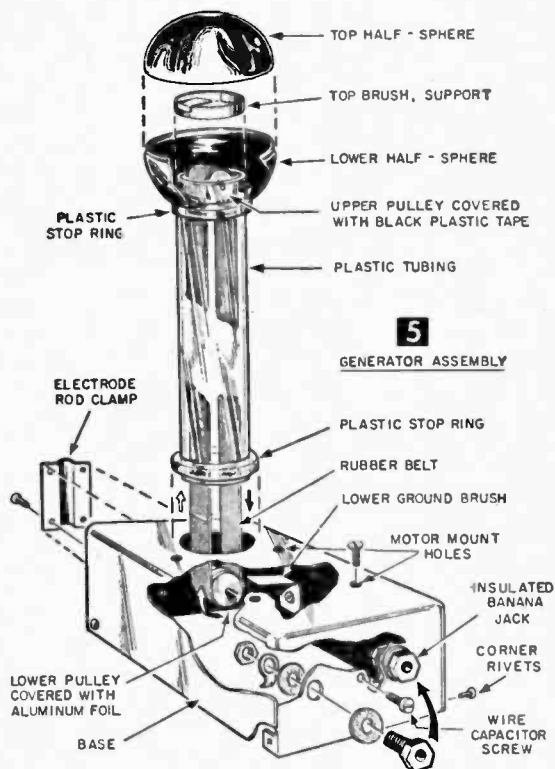

5

GENERATOR ASSEMBLY

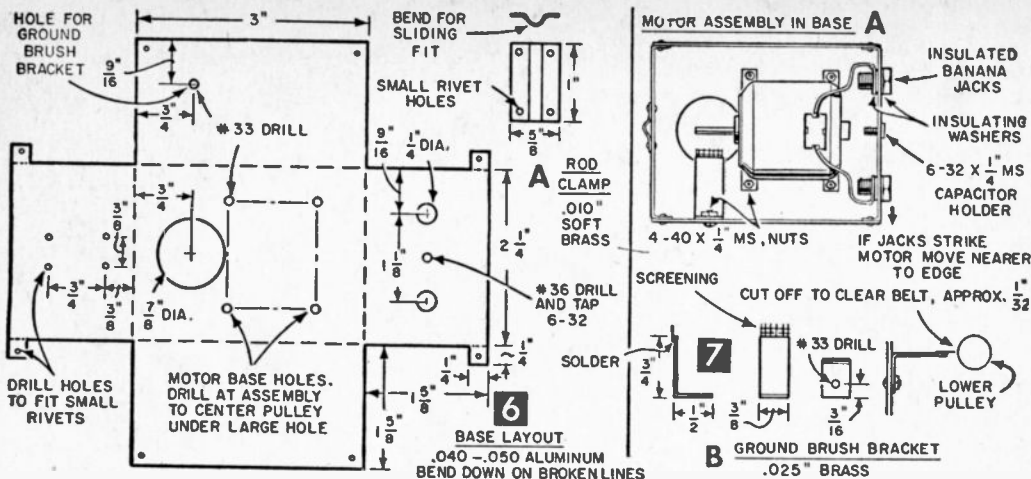

leys as in Fig. 8A and C; however, you can get all the pieces slotted and drilled for installation in a package deal for \$3.95 (see Materials List). The same source offers an alternate package at slightly higher cost to simplify the installation by eliminating the need for stop rings.

Place lower end of the column, with plastic stop rings cemented in place as in Fig. 8A or ends turned as in Fig. 8B, in the base hole to make a tight press fit as in Fig. 5. Add some *Pliobond* cement at the joint to assure a tight job. Turn the column in the hole before the cement sets to align pulley slots at the top with motor shaft below the hole.

Pulleys will be cut to correct length and center drilled as required, if you order one of the plastic kits specified, but you can make your own as in Fig. 8C if you have 3/8-in. plastic rod stock and can drill the shaft holes perfectly centered. Cut a 7/8-in. length of 1/8-in. dia. smooth steel rod for a press fit in the upper pulley hole. Center pulley on shaft with spacers of brass tubing about 3/32-in. long to leave just enough of the shaft exposed at each end to fit in the column slots.

Cover the upper pulley with a turn of black plastic adhesive tape and butt ends as in Fig. 8C. Add two additional turns of the tape cut 1/8-in. wide and applied the same way at the center. This crowns the pulley to help keep the belt in place. Apply tape smoothly by rubbing it down with a small round object.

The lower pulley should be drilled for a press fit on the motor shaft, but before installing, cover it in the same manner as the other pulley, substituting aluminum foil adhesive tape for the black tape. If you do not have the adhesive product, use strips of aluminum foil cemented on with *Pliobond*. You can now press the pulley on the motor shaft, being sure to center it under the column. *Important:* Wipe all finger marks off the foil when pulley is in

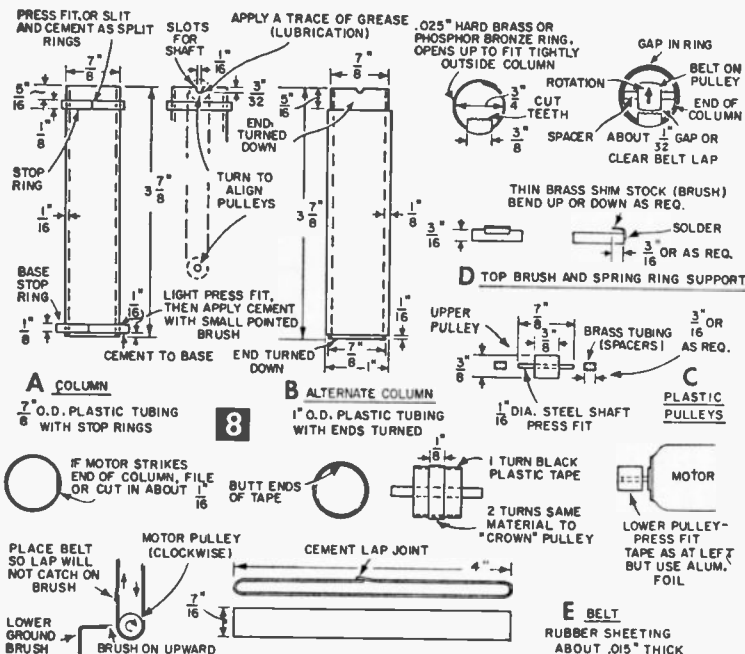

place.

Make the belt out of thin rubber sheet as in Fig. 8E and install it on the pulley so that outside of cemented lapped joint will not tend to catch on the lower ground brush. When stretched in place, the $\frac{1}{16}$ -in. wide belt will narrow down to pulley width. If necessary, trim wire at end of lower ground brush to maintain $\frac{1}{32}$ -in. clearance from the belt.

Now is a good time to test the rotating parts. Apply a trace of light grease to upper pulley shaft for lubrication. Hook up two No. 6 dry cells in series, connect leads to banana plugs and insert them in the jacks on the base. The belt should travel clockwise around the pulleys—ground brush may be on either side. If not, transpose the plugs to reverse the motor rotation. Mark a plus sign on the base below the jack connected to the positive pole of the battery.

Make sure the belt rides centered on the pulleys by adjusting alignment or the belts on the pulleys. The motor should run at high speed and all parts work smoothly.

Next, make the upper brush assembly as in Fig. 8D. Curve a thin, $2\frac{1}{16}$ -in. long strip of hard brass or phosphor bronze into a small spring ring, overlapping the edges. Expand the ring just enough to slip over the column and fit snugly against it, as in Fig. 5. If ring still overlaps, cut off excess to butt ends.

Cut out a $\frac{3}{8} \times \frac{3}{8}$ -in. piece from thin brass shim stock for the brush and solder one end to the edge of the ring as in Fig. 8D. Turn ring in position until brush is parallel to the pulley on the side where the belt travels upward. Now bend the brass shim at a right

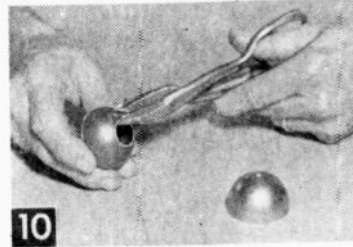
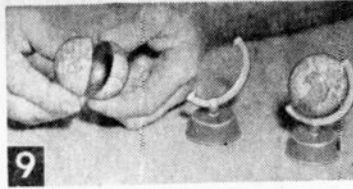

Small world globe makes a good sphere (top to bottom). After paint is removed, hole in bottom half is enlarged with duckbill tin snips to about $13/16$ -in. diameter. Pair of hammers and a homemade die put a smooth well-rounded edge on the hole for a press fit on plastic column.

MATERIALS LIST—MIDGET VAN DE GRAAFF GENERATOR

No. Req.	Size and Description
1	3-6 volt Cer-Mag #55 d-c motor (average price \$1.75 at hobby shops or write Polk's Model Craft Hobbies, Inc., 314 5th Ave., New York 1, N. Y.)
1	$1\frac{1}{2}$ or $1\frac{3}{8}$ " dia. metal world globe-pencil sharpener combination (try stationery stores, price 19¢ to 39¢)
2	insulated banana jacks with matching plugs (electronic supply houses)
1 pc.	$\frac{3}{16}$ or $\frac{1}{4}$ " O.D. x 18" high voltage T.V. cable with heavy white plastic insulation (wire capacitor) (electronic supply house, surplus store)
1	solder spade lug (for capacitor)
2 pcs.	#24 gage x 12" long flexible insulated hookup wire
2	#6 dry cells
1 pc.	.040-.050 x $5\frac{1}{2}$ x $6\frac{1}{4}$ " half hard sheet aluminum (base)
1 pc.	.025-.030 x $\frac{3}{8}$ x $1\frac{1}{4}$ " brass (lower brush)
1 pc.	.025 x $\frac{3}{16}$ x $2\frac{1}{16}$ " hard brass or phosphor bronze (upper brush)
1 pc.	$\frac{3}{8}$ x $\frac{3}{8}$ " thin shim brass (upper brush)
1 pc.	$\frac{3}{8}$ x $\frac{3}{8}$ " bronze window screening (lower brush)
1 pc.	$\frac{1}{16}$ " dia. x $\frac{7}{8}$ " smooth steel rod stock (upper pulley shaft)
1 pc.	$\frac{1}{16}$ I.D. x $\frac{1}{8}$ " O.D. x $\frac{1}{2}$ " brass tubing (upper pulley spacers)
1 pc.	$\frac{1}{8}$ " dia. x $4\frac{1}{2}$ " brass rod stock (spark gap rod)
1 pc.	.010 x $\frac{7}{8}$ x 1" soft brass (clamp for rod)
1 pc.	$\frac{5}{16}$ " dia. x $\frac{3}{4}$ " brass rod stock (ball end for spark gap)
1	6-32 x $\frac{1}{4}$ " binder head machine screw (capacitor holder)
5	4-40 x $\frac{1}{4}$ " binder head machine screws with nuts (motor, brush mounts)

The following kits can be obtained from Forest Products Co., 145 Portland St., Cambridge, Mass.

Plan #1, postpaid in U.S. for \$3.95, includes:	
1 pc.	$\frac{7}{8}$ " O.D. x $\frac{1}{16}$ " wall x $3\frac{3}{8}$ " plastic tubing, slotted for upper pulley shaft (column)
2 pcs.	$\frac{7}{8}$ " I.D. x $\frac{1}{8}$ " plastic tubing (column stop rings)
2 pcs.	$\frac{3}{8}$ " dia. x $\frac{3}{8}$ " plastic rod stock, center holes drilled as required (pulleys)
1 pc.	aluminum foil tape with self-adhesive (upper pulley)
1 pc.	black plastic adhesive tape (lower pulley)
1 pc.	thin rubber sheet (belt)
Plan #2, postpaid in U.S. for \$4.95, substitutes a 1" O.D. x $\frac{1}{8}$ " wall x $3\frac{3}{8}$ " length of plastic tubing for the column in place of the $\frac{7}{8}$ " wall plastic tubing and stop rings; includes all other parts furnished in Plan #1. Column has ends turned as in Fig. 8B and top slotted for pulley shaft.	

angle toward the pulley. Trim the edge as needed to clear belt by $\frac{1}{16}$ -in. and cut teeth in it with a small scissors.

High Voltage Terminal. A small metal-globe pencil sharpener (Fig. 9) commonly sold in 5 and 10¢ stores and at stationers for 19 to 39¢ is adequate for the all-important high voltage sphere. Look for one about $1\frac{1}{2}$ in. in diameter and with smooth sides, rather than a raised ridge, at the equator.

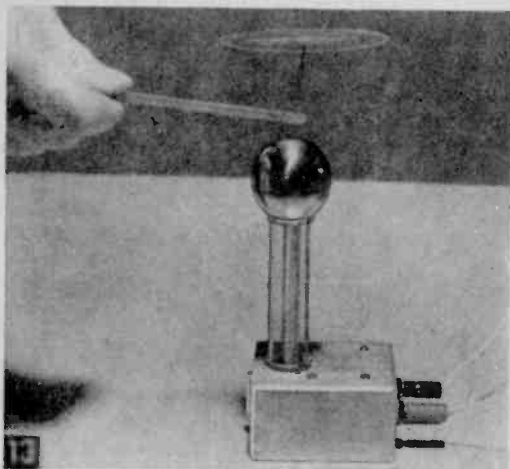
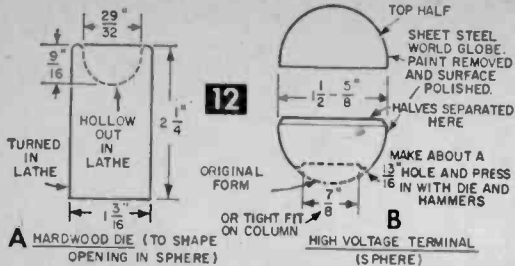

12 Pointed rotor of thin aluminum spins rapidly while balanced on needle placed near the charged sphere. Holder is small plastic stick.

in Figs. 5 and 12B. This should be a press fit. If sphere is loose, tap the metal in or out as needed to tighten the joint. Replace top brush, slipping ring support down against the sphere. Complete the generator assembly by rejoining the two halves of the sphere.

No switch is provided to control the motor because of the limited space in the base. Instead, you can start and stop the motor by insertion and removal of one of the plugs in its jack, while the other plug remains connected. If desired, you can make the unit more compact by using a Burgess #F2BP 3-volt battery. It can be hidden in a small

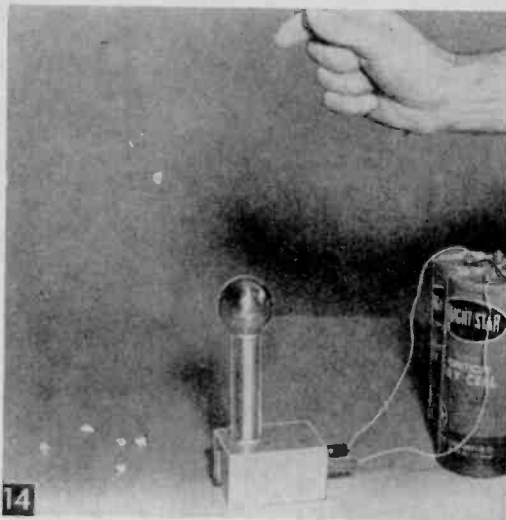

14 Small wads of tissue are drawn to the sphere when thrown, then bounced violently away as soon as they touch it.

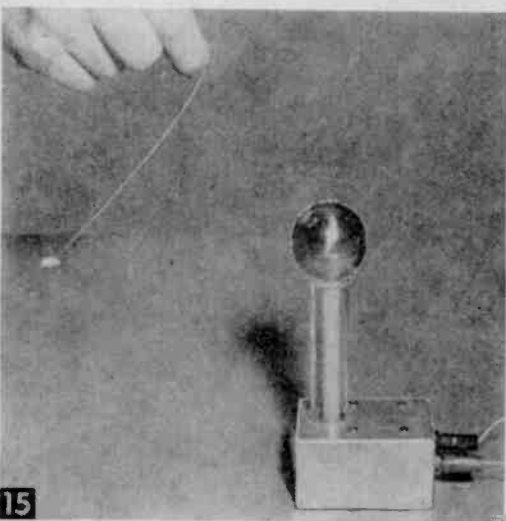

15 Tissue ball suspended on thread and allowed to touch the sphere will then swing like a pendulum when held in the right position.

After removing the globe from its plastic base, you can separate the two halves with a bit of prying. Soak them in paint remover or lacquer thinner for about a half-hour, then wipe off the softened paint with a cloth dampened with the solvent. Now, enlarge the small hole in the half with the inside edge as in Fig. 10, using tin snips.

Since this opening will be the point where the sphere fits over the column, it is very important to have a well-rounded edge to minimize leakage at this joint. We solved this problem by making a simple die in a wood-turning lathe from a piece of scrap hardwood as in Fig. 12A, then driving in and shaping the edge with two hammers as in Fig. 11. Fill the small hole in the other half of the sphere with solder, file flat and then polish both halves to a high sheen, using rouge or tripoli (dust-like silica) on a buffing wheel.

Any dents or small ridges in the metal caused by the die-stamping process should be removed. You can do this by holding a piece of round metal inside and using a small hammer in much the same way as an auto body man removes dents. Best results depend on a smooth and highly polished surface.

Now remove the top brush and fit the lower half of the sphere on top of the column as

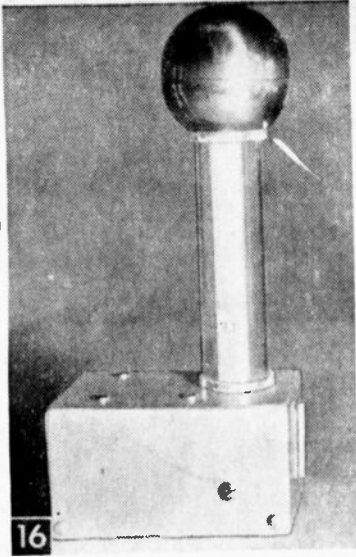

High speed strobe light "stopped" this phenomenon—a satellite in orbit. Small, specially-shaped piece of aluminum foil revolves on its own axis as it travels around lower edge of sphere.

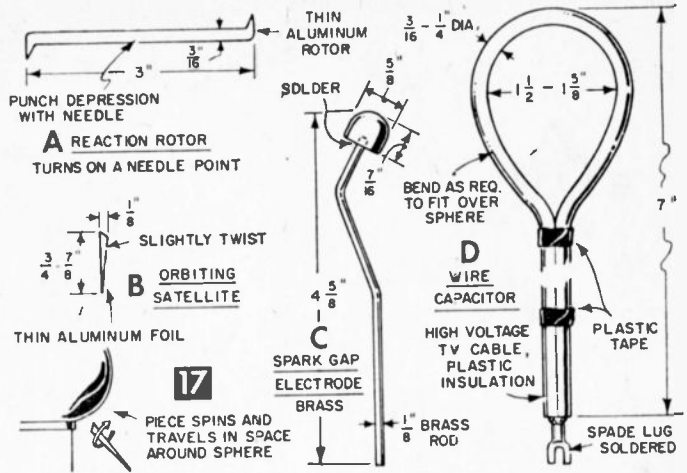

wooden box placed under the generator base, with leads to connect with the jacks. However, the dry cells will last much longer.

Vivid Demonstrations of electrostatic force are easy to conduct with this pygmy generator. Make an "electrified plume" by attaching several tissue strips to the sphere with cellophane tape. When you turn on the motor, the charge will be transferred to the strips. Since like charges repel, the strips will stand rigid and try to get away from each other as in Fig. 1. They'll even remain standing when power is shut off, until the charge slowly leaks off the sphere. Turn on motor again and point your finger. The strips will be attracted by its opposite charge and flock around it.

Electric Wind. Cut a strip of thin aluminum to the shape of a reaction rotor as in Fig. 17A. Press one end of a needle in a small hole near the end of a strip of plastic. Now balance strip on the upraised needle. As you bring it close to the charged sphere (Fig. 13), the rotor will react to the "electric wind" effect of corona discharges at points by rotating like a high speed pinwheel.

Bouncing, Swinging Tissue. Roll up pieces of facial tissue into small balls and toss them at the sphere. They are first attracted, then violently repelled as in Fig. 14, because the charge in the paper changed on contact. Tie one of the balls on the end of some thread and suspend it to touch the sphere. It will swing away immediately with considerable repelling force. If held in the right position, the ball will emulate a pendulum as in Fig. 15. This experiment is often more effective if the ball is coated with powdered graphite to make it more conductive.

Satellite in Orbit. Cut a small piece of aluminum foil from a cigarette pack to shape

as in Fig. 17B. Hold it in your fingers with the broad end facing the lower section of the sphere. After some experimenting, you'll get it to float a short distance from the sphere surface as in Fig. 16, apparently defying gravity. It will then orbit around the sphere and rotate on its own axis.

Adjustable Spark Gap. For lightning-like discharges, make the spark gap electrode as in Fig. 17C and the wire capacitor as in Fig. 17D. Attach each to the base as in Fig. 3, shaping capacitor in the fingers to fit in place. Plug in battery lead jacks. The resultant fat spark across the gap between the electrode and sphere is intensified by the capacitor.

Without the capacitor, sparks are much less intense but occur with greater frequency, because a short time is required to charge up the capacitor. Spark gap rod can be bent to secure gap desired. Results will be best when the room's relative humidity is about 30 per cent or less. Moisture causes leaks down the column, at pulleys and belt, as well as from the sphere to surrounding air.

To dry out accumulated moisture, it is sometimes helpful to direct warm air from a portable hair dryer on the parts under the base and also on the column. Dust particles on the sphere also cause poor discharges since they form corona points from which the charges can escape and thus prevent the full voltage from building up.

● Craft Print No. 315 in enlarged size for building the midget Van de Graaff is available at \$3. Order by print number. To avoid possible loss of coin or currency in the mail, we suggest you remit by check or money order (no C.O.D.'s or stamps) to Craft Print Div., SCIENCE and MECHANICS, 505 Park Ave., New York 22, N. Y. Please allow three to four weeks for delivery. Special quantity discount! If you order two or more craft prints (this or any other print), you may deduct 25¢ from regular price of each print. Hence, for two prints, deduct 50¢; three prints, subtract 75¢, etc. Now available, our new illustrated catalog of 212 do-it-yourself plans, 25¢ (refundable, first order).

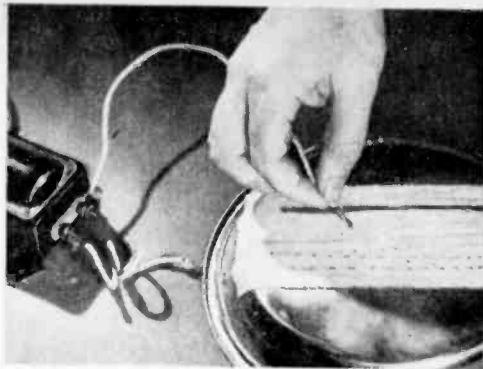

With dry cell batteries, you can draw a line with direct current—and make dots when the current is supplied by a doorbell transformer.

Science Stunts With Dry Cells

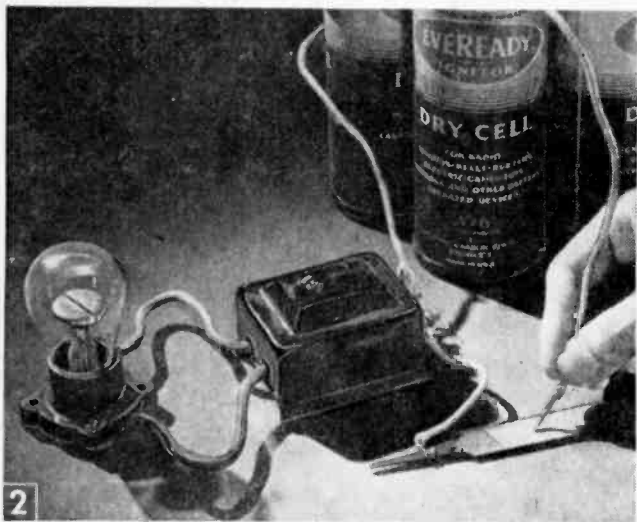

By scraping the lead across a file you can change 6 volts into 60 or more and light half of a small neon or argon bulb.

THESSE experiments with electrical current are designed to provide you with a working understanding of the fundamentals of electricity that can be used to entertain or inform your friends.

Difference between alternating current (ac) and direct current (dc) is illustrated in Fig. 1. To conduct this experiment, soak a piece of cloth in water containing a mixture

of cornstarch and a little potassium iodide that you can buy at the drug store.

Squeeze out the cloth and smooth it over the bottom of a metal pie plate as in Fig. 1. You can use one or more dry cells for this experiment. Run a lead from the negative terminal to the pie pan. Hook a wire to the positive post and draw the end of it across the wet cloth to produce a continuous dark line. This line is caused by the release of free iodide when the electric current comes in contact with the potassium iodide.

Use a doorbell or toy train transformer instead of batteries to illustrate ac. *Don't use 110-volt directly from the main outlet in this part of the experiment, because it is very dangerous.* Connect one wire from the low voltage side of the transformer to the pan and start to draw once more with the other wire. This time you get a broken line, a dark spot appearing only when current from the wire is flowing in the positive half of its alternating cycle.

Light Half a Bulb with reversed current. The function of a doorbell transformer is to reduce 110-volt ac to 10 volts to operate the bell. With a small neon or argon bulb and the hook-up in Fig. 2, you can reverse this procedure.

Attach the wires that would ordinarily be connected to the house current to the bulb fixture (Fig. 2). Run a lead from the trans-

former to one dry cell terminal, and a short piece of wire from the transformer to the file. Wrap electrical tape around one end of another lead to protect your fingers, and fasten the other end to the dry cell.

Draw the taped end of the wire rapidly across the file teeth to make and break the current and half the bulb will light. You have changed 6 volts into 60 or more.

The Mystery Motor (Fig. 3) seems to consist of only a copper wire loosely hung from the hooked end of a lead connected to a single dry cell, with its lower end just barely dipping into a shallow pool of mercury.

When the second lead from the cell is touched to the mercury, the wire whirls in a circle. The secret of this experiment is an Alnico bar magnet that is concealed in a jar of sand, with one pole just touching the bottom of the cardboard or plastic top that rests on top of the jar. This container is filled with just enough mercury to cover the bottom.

The magnetic field produced around the wire, when the circuit is closed, reacts with that of the magnet and causes the wire to be repelled in a circular motion. Reversing the cell leads reverses the wire whirl.

Move a Weighted Object with heated wires. Because wire expands when heated and the heat produced in a wire is proportional to the square of the current flowing through it, the heating effect of electricity is used to measure amperage in an electric meter. This principle was used in the ammeter in older cars to indicate the charging rate of the generator.

To demonstrate how this "hot wire" ammeter works, stretch a strand of steel picture wire horizontally between two nails as in Fig. 4. Suspend a weight from the center of the wire with string and a wire hook. Make the indicator by drilling a 1/8-in. hole through a short piece of 3/8-in. dowel, then cut a cardboard pointer and glue it to the dowel. Use a

1-in. common nail to attach the dowel to the 1/4-in. plywood meter face board. Turn the dowel so it operates freely. Loop the string once around the dowel so the pointer moves to the right when the weight is pulled down.

Connect a single dry cell to the supporting nails as in Fig. 4 and the pointer will move slightly as the current passes through the wire and heats it so it expands and sags. Connect two dry cells to step up the current and the dial movement will increase.

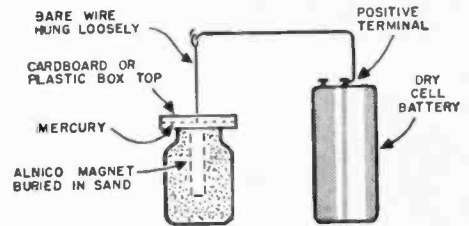
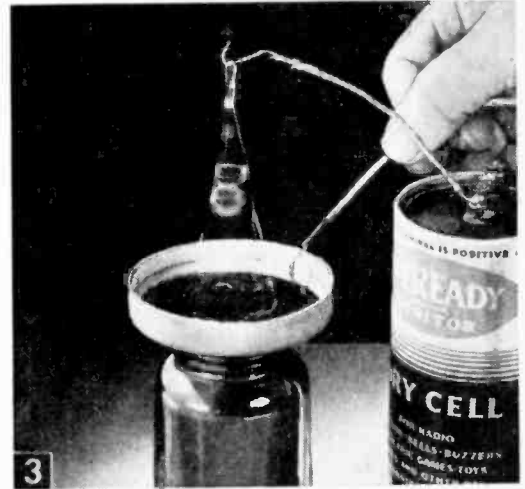

Magnetic field around the wire suspended in the mercury causes it to be repelled in a circular motion.

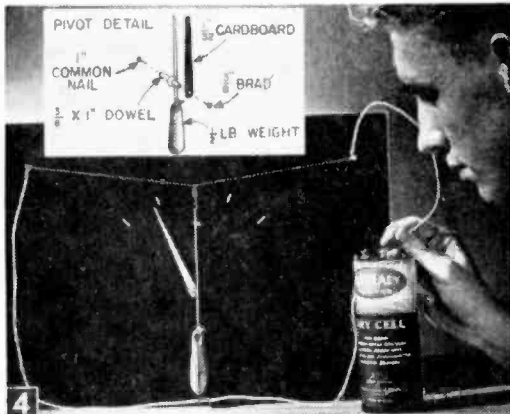

Increase the temperature between the two nails and the pointer will move like an ammeter or temperature indicator in a car.

CORRECT PINNING - DOT SHOWS RIGHT SPOT FOR PIN

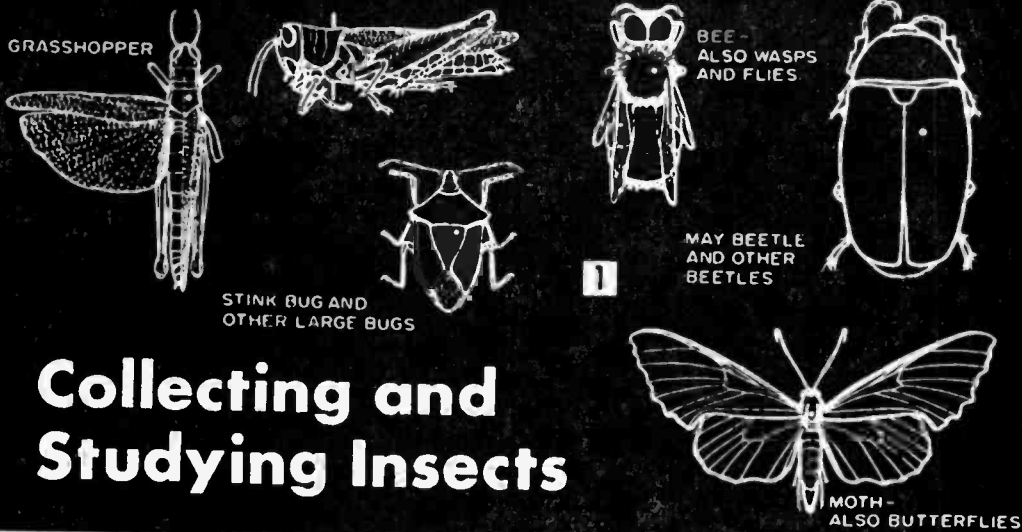

Collecting and Studying Insects

By FRANK WOODS, JR. and L. G. ANDERSEN

INSTEAD of swatting that pesky fly or squashing that unpleasant-looking beetle under your heel, capturing it may prove more rewarding.

Insects have been around us for more than 200 million years, and may outlive man in the event of a nuclear war. There are some 800,000 identified species of insects on earth—more than any other single group of animals. But just because we can't lick them, we don't necessarily have to join them. What we can do is collect and study them—for pleasure, recreation and education. In fact, the amateur insect collector may contribute to the knowledge of the entire world—by adding to the list of known insect species, or by carrying out some serious, original study.

Mighty Projects from Tiny Insects Grow. You can, of course, simply make a collection of insects for identification and mounting. Or, you may wish to study and observe body structure or habits of insects in general, or the traits of a certain group of live captive insects. Try to discover all the habitats of a certain insect, and try to obtain and study all the stages of his metamorphosis

(egg, larva, pupa, adult) raising them at home if necessary. Study the length of his life cycle, the food he eats, the job he does, the ways he adapts himself to changes in environment. Note, for example, the variations in a certain type of butterfly depending on the time and the place where he was captured. Going further in science, study the effects of drugs or radiation on certain insects.

It would be interesting to weigh a grasshopper, measure his length and the length of his jumps. Then, on the basis of his size

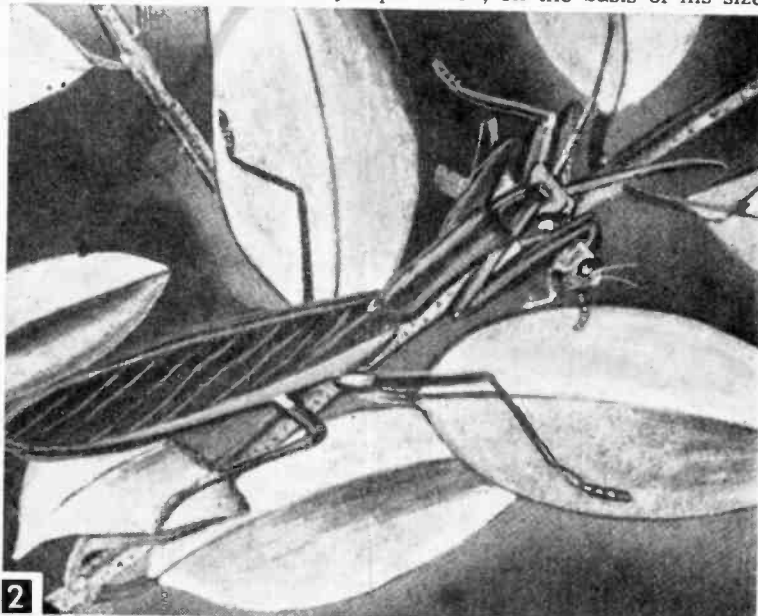

U.S.D.A.

Praying mantis is of order Orthoptera. Other Orthoptera are grasshopper, cricket, walking stick, and katydid.

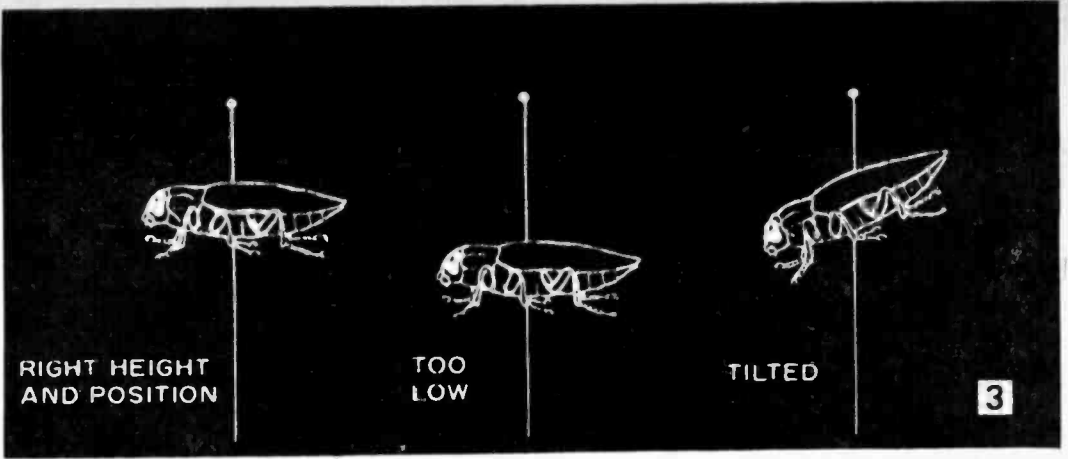

and weight, compare it to a human's, determining how far vertically and horizontally a man would have to jump to perform a similar feat.

A winning National Science Fair project recently consisted of the collection and identification of all the insects on a single farm.

If your tastes are more artistic than scientific, you might photograph or draw pictures of insects in their natural environment, or mount them in lifelike poses with painted or reconstructed backgrounds resembling their original homes, or use them as home decoration (mounted in a wall-hanging box, under the glass top of a cocktail table or within plastic bookends or placemats).

You may be able to dig up fossil insects that would be unusually interesting along with modern counterparts to show the evolution of the insects in your area. For example, fossil forms of dragonflies and damselflies have been found from the Paleozoic Era (about 200 million to 500 million years ago).

What Is An Insect? Whatever your reason for collecting insects, you must be able to recognize an insect when you meet it (see Table A).

Just what will he look like? Generally, an adult insect has three parts to its body: head, thorax, and abdomen. The head of most species has a set of jaws, a pair of antennae, and typically has two kinds of eyes, simple and compound.

The thorax is composed of three fused segments, each of which bears one pair of legs. Thus, the adult insect has six legs. Usually, however, spiders, scorpions, centipedes and other wingless arthropods which have more than six legs but are not strictly insects are included in the category. Two pairs of wings may be attached to the thorax, or one pair, or none at all.

The segments of the abdomen are not fused; they are distinct and are able to function independently. Insects breathe by means of paired pores on each of the abdominal segments and usually on the posterior thoracic

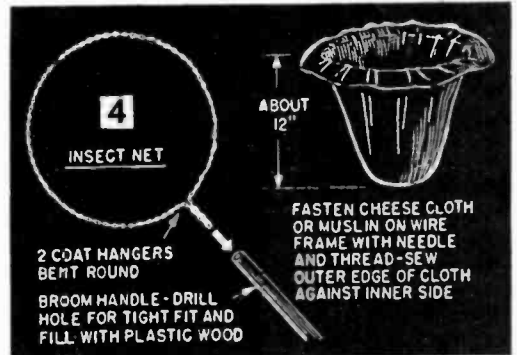

segments. The skeletons of insects are on the outside of their bodies (exoskeleton) rather than within the body as is man's skeleton (called an endoskeleton).

Various parts of an insect's body differ from insect to insect as the particular species are modified by the insect's habit and its environment. For example, eating habits determine the way the mouth parts operate and how they are formed. Adaptations of the legs also vary widely. Special pads on the feet of some insects enable them to climb up smooth vertical windows or walk upside down on ceilings. The bee's legs are equipped with baskets for carrying pollen from flower to flower. Grasshoppers have powerful hind legs that enable them to move their weight

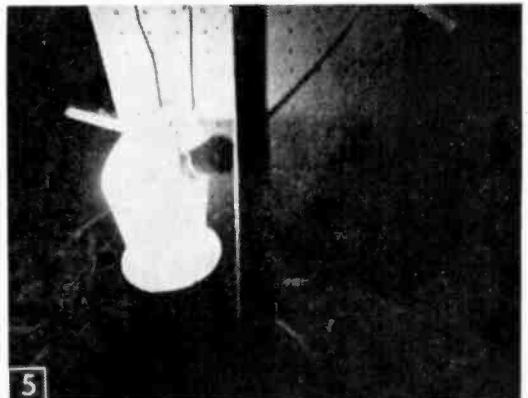

Light brings insects to trap.

TABLE A—THE INSECT ORDERS

Order	General Characteristics	Wings	Mouth Parts	Metamorphosis	Common Members
Anoplura	flat body, sometimes claws on legs	none	piercing and sucking; strong beaks for breaking through skin	gradual	true lice: head louse, body louse, crab louse
Coleoptera	armored body	front wings horny and cover membranous hind wings	chewing	complete; larvae called grubs and are often very destructive	ground beetle, weevil, tiger beetle, tumble bugs, fire-flies, click beetle, larder beetle, carrion beetle, June bugs, meal worms, potato beetles
Dermaptera	paired cerci, usually forceps-like, at posterior tip of abdomen	forewings meet in straight line down back like beetle elytra. One pair small and leathery; one pair membranous and folding; some have no wings	chewing; eat plants	gradual	earwigs
Diptera	terrestrial larvae often called maggots; aquatic larvae (mosquito) called wigglers	one pair used for flying; second pair are balances	piercing and sucking, biting and sucking, or lapping	complete	Short Horned flies: horse flies, robber flies, bee flies, house flies, bot-flies, tsetse flies, tachina flies, fruit flies Long Horned flies: mosquito, crane flies, midges, gnats
Ephemeroptera	three long projections trail from the posterior tip of the abdomen	one pair large membranous wings, one pair smaller, often vestigial (absent in some species)	vestigial	incomplete, eggs land in or on water. Naiads live in water, adults of many species live less than 12 hours, mate, lay eggs, and die	mayflies
Heteroptera	beak attached underneath head; at front broad, flat body	front wings thickened at base, hind wings membranous, folding	piercing and sucking	gradual	true bugs: water bugs, assassin bugs, bedbugs, stink bugs, squash bugs, chinch bugs
Homoptera	beak attached underneath head at back	two pairs wings or none, front wings of uniform texture, often membranous-like folding hind wings	piercing and sucking	gradual; may spend up to 17 years in ground	true bugs: cicadas, leaf hoppers, tree hoppers, aphids (plant lice), scale insects, kissing bugs, bedbugs, shield bugs
Hymenoptera	social insects	two pairs membranous wings; all wings used in flying	chewing or chewing and sucking	complete	bees, ants, wasps

Order	General Characteristics	Wings	Mouth Parts	Metamorphosis	Common Members
Isoptera	social insects; photosensitive; differentiated into castes	reproductives with two pairs membranous of equal size; other castes are wingless	chewing; most eat cellulose	gradual	termites
Lepidoptera	larvae called caterpillars	two pairs large membranous wings covered with powdery scales. Butterfly wings are colorful and held erect. Moth wings usually are drab and lie along back; some moths' wings are highly colored	sucking in adults, chewing in larvae	complete	butterflies and moths
Mallophaga	flat body, sometimes banded and colored	none	chewing; eat skin, hair or feathers	gradual	biting (bird) lice
Neuroptera	long, slender antennae; larvae are carnivorous	two pairs membranous wings usually similar and approximately equal in size	chewing	complete	aphis lion, ant lion (doodlebug), scorpion flies, alder flies, dobson flies, lacewing flies
Odonata	long slender body; eat other insects	two pair, almost equal in size, membranous. Dragonfly wings held straight out at rest; damselfly wings held above back at rest.	chewing	incomplete; naiads live in water, eat other insect larvae	dragonflies, damselflies
Orthoptera	young look, act like adults	most species have two pairs, some are wingless; leathery pair covers membranous pair used for flying	chewing	gradual	grasshoppers (shorthorned and longhorned), crickets, cockroaches, praying mantises, walking sticks, katydids
Plecoptera	two cerci project from tip of abdomen	two pairs membranous, hind pair larger and folding	chewing	incomplete	stone flies
Siphonaptera or Suctoria	strongly laterally compressed	none	sucking	complete	fleas
Trichoptera	larvae live in water; cover bodies with gravel and shells	wings have fine hairs that look like moth's scales. Two pairs of equal size	chewing	complete	caddisflies

INSECT RELATIVES

While not strictly insects, the following small animals belong to the same phylum (Arthropoda) and are often collected and displayed with insects.

Arachnida Class

Order	General Characteristics	Wings	Mouth Parts	Metamorphosis	Common Members
Scorpionida	large pair of pinchers; one long, slender clawlike sting	none			scorpions
Phalangida	four pairs long legs; short round body	none			daddy longlegs
Araneida	four pairs legs	none			spiders

Diplopoda Class

	wormlike, segmented body; each segment has two pairs legs	none			millipedes
--	---	------	--	--	------------

Chilopoda Class

	long slender, segmented body; one pair legs on each segment	none			centipedes
--	---	------	--	--	------------

through distances hundreds of times their body length.

Before an insect reaches the adult stage of its life, it may pass through several stages. Insect eggs hatch into a wormlike creature called a larva. The larva enters into a relatively inactive stage of life termed a pupa, during which time the adult insect develops. This form of development is called complete metamorphosis.

Some insects, such as the grasshopper, appear from the egg in a form resembling the adult. In successive stages they grow larger, shedding their hard, external skeleton as they outgrow it and growing a new one. This development is called gradual metamorphosis.

Some insects, such as the dragonfly, undergo a third type of development called incomplete metamorphosis. The immature stages do not resemble the adult, do not eat the same foods, and do not have the same habits. Various body structures are unlike those of the adult.

Silverfish and lice have no metamorphosis. The form as hatched just grows into the adult with little change in bodily form save for size.

Collecting Methods. Probably the easiest and most popular method of collecting insects consists of sweeping grass, trees, or the surface of ponds with a sack or net attached to the end of a long stick (Fig. 2). Another rewarding method of collecting for the beginner is the sifting method.

Soil, rubbish and rotting logs and leaves contain adult insects as well as larvae and pupae that may be sifted out through a screen.

Since many insects appear only at night, you will need an illuminated insect trap (Fig. 3). This consists of an electric light bulb or flashlight suspended over a white cloth or paper funnel supported in a collecting vessel. Attracted by the light, the insects fly against the funnel and fall through bottom opening into the jar. You can, however, collect many noctur-

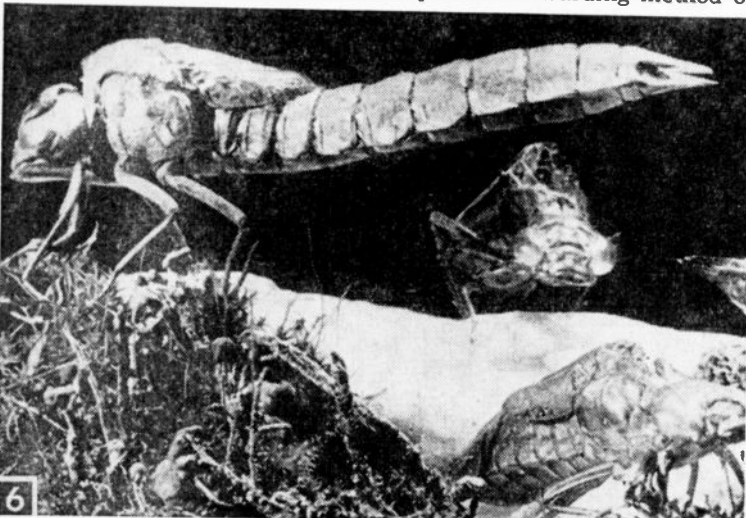

Dragonflies (order Odonata) in nymph stage, wings not yet sprouted. Naiads live in water.

UPI

TABLE B. SOURCES OF INFORMATION

H. S. Zim and C. Cottam, *Insects* (\$1.00 paperbound, \$2.50 hardbound), Simon and Schuster. For the amateur insect hobbyist.

General Zoology (\$1.25 paperback), Barnes and Noble College Outline series. For the more serious nature student.

Herbert Ross, *Textbook of Entomology*, John Wiley and Sons.

Herbert Ross, *How to Collect and Preserve Insects*, Circular #39, Illinois Natural History Survey, 189 Natural Resources Bldg., Urbana, Ill.

P. Oman and Arthur D. Cushman, *Collection and Preservation of Insects*, Misc. Publ. #601 (20¢), U. S. Dept. of Agriculture.

4-H Club *Insect Manual*, Misc. Publ. #318, U. S. Dept. of Agriculture.

How to Make an Insect Collection (50¢), Ward's Natural Science Establishment, Inc., P. O. Box 1712, Rochester 3, N. Y.

Raymond F. Yates, *Fun with Your Microscope*, Appleton-Century-Crofts, Inc., N. Y., 1943.

nal insects around street and porch lights, brightly-lighted store windows, and even around lamps in your house.

Carefully remove insects you have caught from the trap or net and place a few at a time in a wide-mouth bottle having a small wad of cotton in the bottom which has been saturated in ethyl acetate. This will kill in-

TABLE C. BASIC EQUIPMENT FOR THE INSECT COLLECTOR

Collecting net

Sifting screen

Trowel or other digging tool

Wide-mouth jars of assorted sizes (empty pickle or olive jars, test tubes, drugstore prescription bottles; must have tight-fitting cork or screw cap).

Ethyl acetate

Small forceps, tongs or tweezers

Several small camel's-hair brushes

Folded papers for butterflies

Insect pins (assorted sizes)

Pinning block

Spreading board for butterflies

Labels

Mounting boxes of various types

Magnifying Lens (triple aplanat lens or Coddington lens)

Note: A low-power microscope is necessary for serious study, but small field of view makes it difficult to use in studying larger species.

Fluid preservative

Bag to hold equipment and specimens while in field

Diary or notebook



UPI

Trap door spider never leaves his shell-like home. He pokes his head out, grabs a bug, and pulls the lid over himself. Spiders are not strictly insects; they are of the Arachnida Class.

sects safely with little damage to the specimen and no injury to the collector. Cover bottle tightly.

Displaying Your Collection. When dead, most adult insects may be mounted on pins, run through the solid part of the body, with little thought to the possibility of the specimen deteriorating (Fig. 5). However, the soft bodies of immature forms should be preserved in grain alcohol after they have been sterilized in boiling water for about 30 seconds. Use special rustless insect pins, rather than plain sewing pins, because they are thinner and sharper and thus lessen the possibility of damaging the specimen.

Attach labels to each insect pin to identify the specimen, the place and date of capture, and other pertinent facts.

Stick the pins into corrugated cardboard, balsa or cork to form an insect display board. To prevent damage to the insects, always handle the pins by grasping near the pinhead. Mounted insects may be kept in cigar boxes or plastic cases lined with cork into which pins are stuck. For unmounted specimens, line shallow boxes (such as glass-topped Piker mounts available through biological supply houses) with cotton.

A mothball placed in each display box protects the mounted specimen from insect parasites.

If you wish to keep live insects for study or display, house them in glass jars (punch holes in the lids or fasten cheesecloth covers

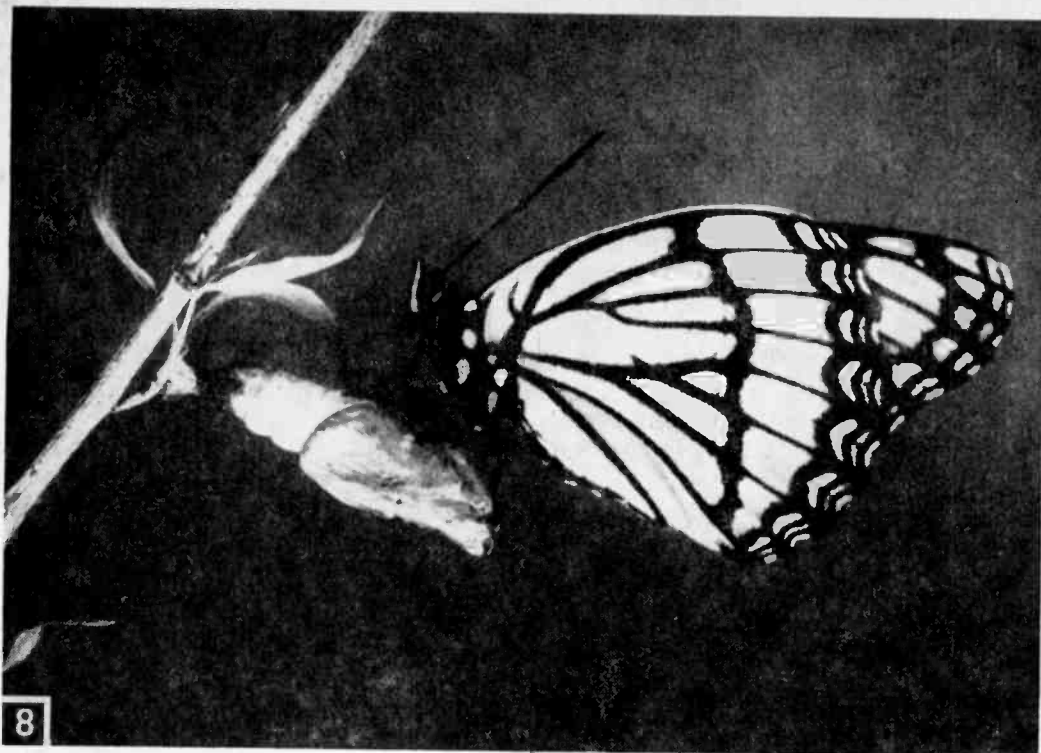

8

Butterfly (order Lepidoptera) goes through complete metamorphosis during life. Its larva stage is caterpillar. Acme

Table D. Where to Buy Equipment

Ward's Natural Science Establishment, Inc.
Insect Collecting Dept.
P. O. Box 1712
Rochester 3, N. Y.

Bio Metal Associates
Box 61
Santa Monica, Calif.

Robert G. Wind
827-SM Congress Ave.
Pacific Grove, Calif.

General Biological Supply House
Insect Collecting Div.
8200 S. Hoyne
Chicago, Ill.

over jar mouths), or in inexpensive plastic boxes which do not have optical distortions sometimes evident in glass jars.

Tiny holes drilled in the lid or a small paper wedge to prevent complete closure of box will admit air to the insect inside. Be sure, however, that such a gap is not large enough to permit escape of the insects.

Captive insects may stay alive for several weeks. Remember, however, that each insect must be given food that it normally eats in its free state if it is to remain alive for a long period. Books on insects or the collectors experience provide the necessary guidance for proper feeding (see Table B).

The only meaningful insect collection is one that is properly sorted and classified. This work can be done during the winter months when collecting pressures have subsided. As you gain experience you may wish to limit your collection to, say, beetles or butterflies or moths. Your decision will probably be based upon the collection you already have classified and sorted.

Finally, keep a diary, as do most professional biologists, in which you enter all important events and details other than insect descriptions: descriptions of the areas from which specimens are taken, the natural history of the area, some of your collecting adventures or misadventures. Aside from its scientific content, such a diary may furnish much entertaining reading for your friends and yourself during non-collecting months.

The Sound of Fish Talk

- Some fish "talk" sounds like the noisy eating of celery, while a chorus of shrimp sounds like fat frying, according to scientists at the Bermuda Biological Station. The fish-listeners at the BBS also found that lobsters, like men, develop deeper voices as they mature—and that salt water fish talk more than their fresh water cousins.—SHIRLEY MOTTER LINDE.

Experiments with Magnetism

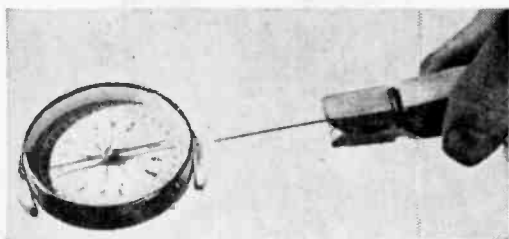

Fig. 1: Magnetize a needle and hold near a pocket compass. Note how it attracts the compass needle.

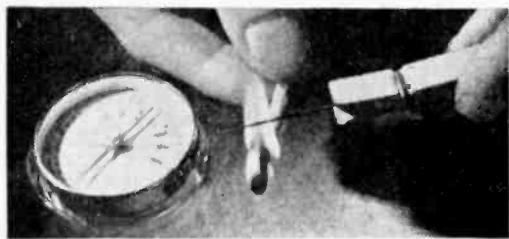

Fig. 2: Heat needle and test again. Needle shows no polarity, since magnetism has been destroyed.



Fig. 3: Magnetized iron filings can also be used to illustrate the molecular theory of magnetism.

The facts about this force are fascinating and instructive

MAGNETISM has a great fascination for junior mechanics, scientists, inventors, and all interested in the makeup of the physical world and the ways in which its various forces can be utilized. Experiments with magnetism can be entertaining as well as most instructive, and the knowledge gained can be put to use in a variety of projects in the home workshop or laboratory.

One Theory of Magnetism holds that individual molecules of magnetic materials are themselves tiny magnets. Ordinarily, these molecular magnets are arranged haphazardly and hence neutralize each other. When a piece of iron or steel is magnetized, however, they are forced to line up in the same direction and the whole object becomes a magnet. The fact that heating a magnet, and so loosening the molecular bonds, helps destroy magnetism bears out this theory.

To prove this, magnetize a needle by drawing it several times across one pole of a magnet. Then, holding it in forceps or a spring clothespin, bring one end near a pocket compass and note how it attracts the compass needle (Fig. 1). Now heat the needle red hot and test again (Fig. 2). This time the needle shows no polarity, indicating that the magnetism has been destroyed.

Magnetized Iron Filings illustrate the molecular theory of magnetism in another way. Fill a test tube nearly full of filings and, tak-

ing care not to shake the filings, magnetize them by stroking the tube over a permanent magnet. Tested with a compass, they have the same effect as the magnetized steel needle, attracting one end of the compass needle and repelling the other (Fig. 3). Now shake the tube so that the filings assume a haphazard arrangement. Either end of the compass needle can then be attracted feebly to either end of the tube. This is because distributing the arrangement destroys the magnetism of the filings just as heating did that of the needle in Fig. 2.

Strange As It May Seem to the uninitiated, materials that are the best insulators against the flow of electricity have practically no effect on magnetic lines of force. You can show this by placing a magnet on two sheets of glass or plastic separated slightly by matchsticks and supported several inches above a table (Fig. 4). Steel tacks held near the lower glass will cling to it as if the glass were not there, and insulating materials as well as non-magnetic metals placed between the two sheets will not cause the tacks to fall off.

But place some magnetic material, such as the steel blade of a knife, between the glass sheets and the tacks immediately fall off (Fig. 5). The steel acts as a short circuit to the lines of force, and the lines contract to pass readily through the steel rather than extending to the air beneath.



Fig. 4: Steel tacks held near lower of separated pieces of glass are attracted by magnet on upper.

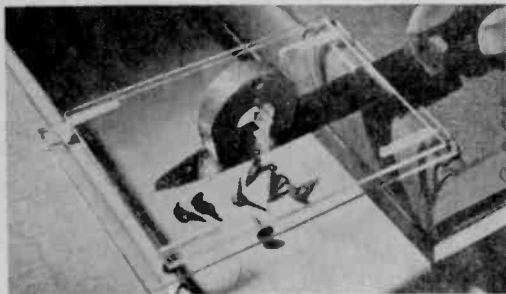

Fig. 5: Placing a knife between pieces of glass contracts magnetic lines, causes tacks to fall.

Copper Isn't Normally Magnetic, but spin a disk of it close to the poles of a strong magnet and it becomes a generator of electricity which sets up magnetic poles in itself. You can demonstrate this with the setup shown in Fig. 6. A glass stirring rod has a copper disk fastened to one end with wax, and its other end is supported loosely in the hole of a large spool. A magnet is suspended about $\frac{1}{2}$ in. above the disk with fish line. Wind another piece of fish line around the rod near the spool and rotate the rod rapidly by pulling on this line. A magnetic field will be set up in the disk which will cause the magnet to spin with it.



Fig. 6: Spinning glass rod with copper disk on top sets up magnetic field, causing magnet to spin too.

Iron Loses Its Magnetic Properties if chemically combined with sulfur to form iron sulfide, but when the two materials are merely mixed together there is no change. In fact, a magnet is your best bet for separating a mixed pile of iron filings and powdered sulfur. Rub the magnet around in the mixture and the filings will cling to it (Fig. 7), leaving the sulfur behind.

Now, chemically combine these ingredients to form iron sulfide. Mix 2 parts of sulfur to 3 parts of iron by weight, and place the mixture in a test tube. Heat the tube until a glow starts through the mixture; then remove it from the flame. The glow will continue until all the mixture has combined. After heating the tube again to eliminate the excess sulfur, allow it and the contents to cool. Remove the contents and place them once more under a magnet (Fig. 8). This time you will find that no part of the combination is attracted.

Held Near a Piece of Soft Iron or Steel, a magnet can produce temporary magnetism in the material, even though it doesn't touch it. Soften the steel in a large nail by heating it to redness and then letting it cool slowly. You can now magnetize this nail so that it will pick up tacks (Fig. 9) merely by holding a pole of the magnet above a finger that rests on the nail head. Move the nail slowly away from the magnet and the tacks will fall off.

Extreme Heat can rob iron of its magnetic response. This is the basis for the simple magneto-heat engine in Figs. 10 and 11. Support



Fig. 9: Magnet held near soft iron or steel produces temporary magnetism, even though not touching it.

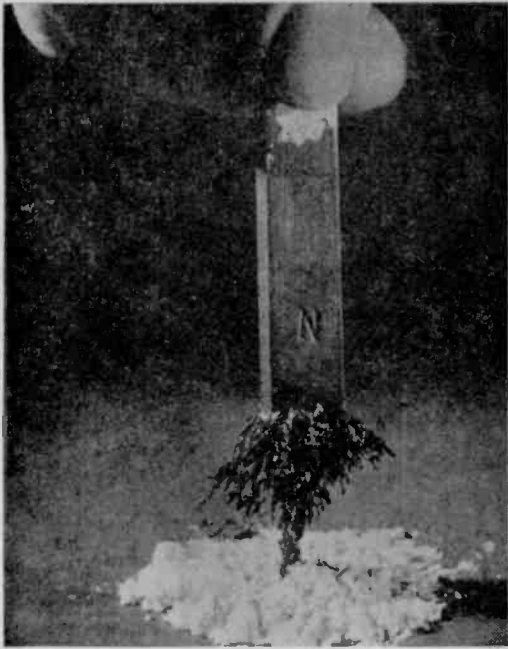

Fig. 7: Mixture of iron filings and powdered sulfur is easily separated with magnet attracting the iron.

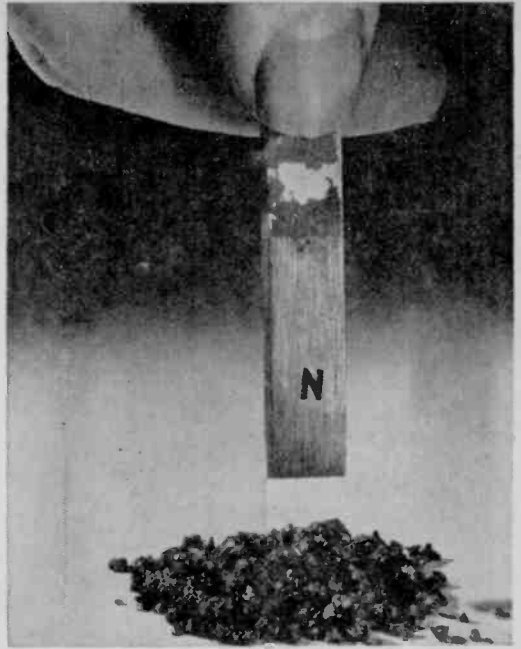

Fig. 8: When these ingredients are chemically combined as iron sulfide, magnet has no attraction.

an alnico magnet (submerged in water in a small aluminum pan to prevent overheating) so its poles are parallel to the flat flame of a bunsen burner provided with a flame spreader. Above the magnet suspend a swing of iron wire, its ends hooked loosely over a nail through a dowel. Before the burner is lit, the wire will be attracted to the magnet.

As soon as the wire is heated to about 740°C ., it loses its magnetism and swings away (Fig. 11). On cooling slightly, it regains it and swings back. By experimenting with the distance between the swing and the magnet, you can find a point at which the wire will swing back and forth automatically as it alternately heats and cools.

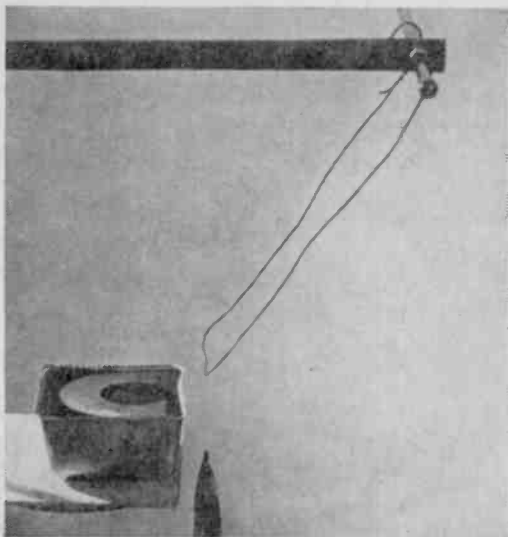

Fig. 10: Iron wire swing is strongly attracted to magnet submerged in water in aluminum pan.

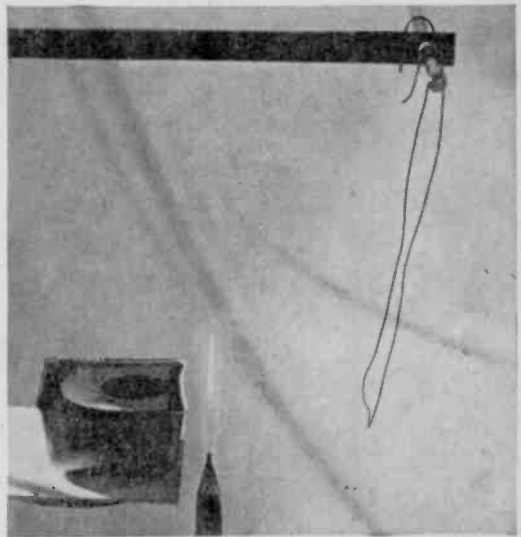

Fig. 11: When wire is heated, it loses magnetism and swings away. On cooling slightly, it swings back.

Anti-Snooper Alarm

If a marauder is quiet as a mouse, he won't get past this one! It uses a mouse-trap to trigger a bell!

By WILLIAM L. ROPER

RUSSELL HALL, a 13-year-old Chino, Calif., boy, invented this simple device when he was 12. It has proved very successful in safeguarding his electronic gadgets from his two younger brothers. It is easy to make.

When a snooper brushes against a black silk thread stretched across the room or in front of a work-bench, it will start a bell ringing. The unexpected noise usually sends the would-be marauder scampering.

All you need to construct your own alarm are: a door bell, a dry cell of sufficient voltage to ring the bell (a 5-volt dry cell will do it), an ordinary mouse-trap, a small piece of copper about the size of a penny, a 6-foot length of black silk thread, and about 12 ft. of insulated door bell wire. The drawing explains the circuit.

The piece of copper is fastened with a thumb tack or small nail to the upper surface of the mouse-trap, so that when the trap is sprung, the wire of the trap completes the circuit. Only a slight tug at the silk thread is needed to trip the trap, completing the circuit and setting off the alarm.

The thread, which is invisible at night and barely visible during daylight hours, can be stretched across a window or doorway, and the bell placed several feet away, or even next door, if you have enough connecting wire.



Russ Hall, 13, of Chino, Calif., with anti-snooper alarm. "It keeps my two younger brothers out of my electronics lab," he says.

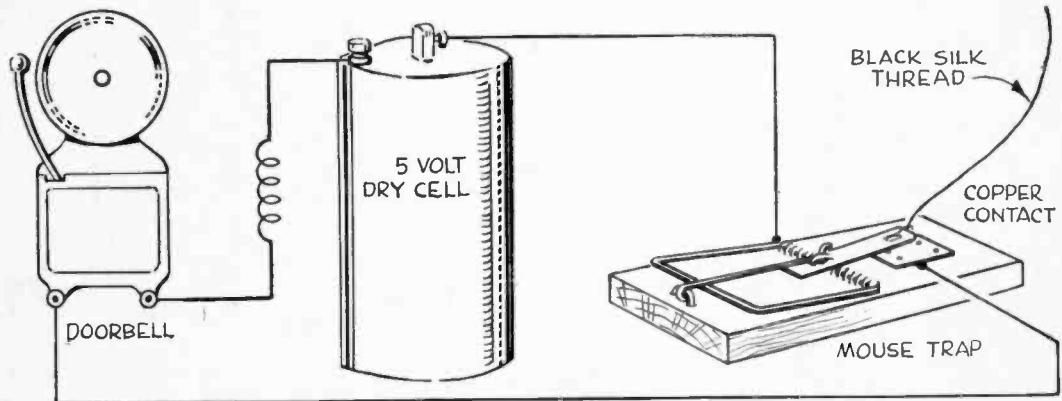

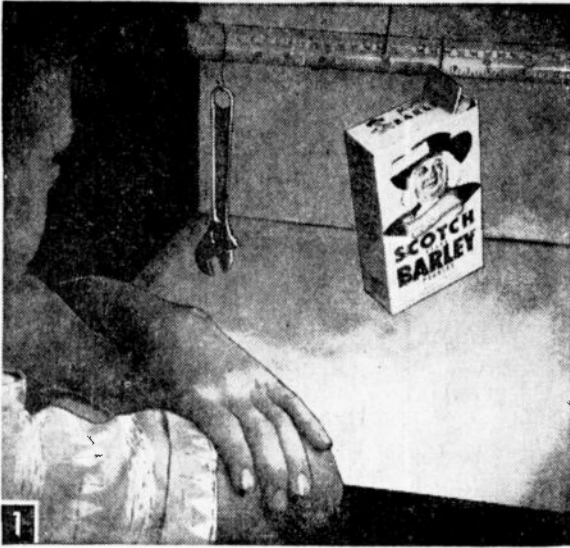

Scales and Balances

—Build Your Own

By FORREST H. FRANTZ, SR.

An experimental torque balance with which you can increase your understanding of weight measure.

THE most obvious way to measure anything is by comparison with a known standard. The Bureau of Standards at Washington maintains standard units of length, mass, and time. These standards are considered to be *primary* standards. Other standards, calibrated by comparison with primary standards are known as *secondary* standards. In a laboratory the best standard is usually referred to as the primary standard, the less accurate standards as secondary standards.

It is rather difficult to weigh things by comparison. Assume that you want to determine the weight of an object by comparison. You have a spring and a set of weights. You fasten the spring at one end and equip it with a pan or hook and pointer at the other end. Then you place the unknown weight on the pan or hook, the spring is stretched and the pointer moves downward. You mark this position of the pointer on a scale adjacent to the pointer, then you remove the unknown weight and you put standard weights on the pan till you deflect the pointer to the mark. Unless the object being weighed has a very special weight, such as 100 grams, you'll have to use many weights to deflect the pointer to the mark because laboratory weights are made in standard denominations. Table A lists these standard denominations and allowable tolerances. Class M and S weights are for high precision measurement and the tolerances are very close. Class S-2 weights have greater tolerances and are used for routine laboratory measurements and elementary student experiments.

If the unknown weight of our example is 168.73 grams, say, it would take 10 weights to make the pointer on the spring scale deflect to the mark. That is, if the spring were accurate enough to "resolve" the weight to five decimal places. It is improbable that a spring with this kind of resolution would be available to the home experimenter.

To perform more precise comparison weighing, you're forced to use another method. The balance method is very accurate. Figure 2 is a simplified diagram of a laboratory balance. A rigid beam **A** is supported at midpoint with a wire or knife edge. A long pointer **C** is fastened to the beam and indicates balance on scale **D**. Pans **E** and **F** are supported on the ends of the beam. When the weights on the pans are equal, the pointer will swing past the center or zero mark on the scale by equal amounts when one of the pans is displaced slightly, and will eventually come to rest at zero. It is customary to look for equal swings on both sides of zero in achieving balance. By doing this you minimize frictional effects between the knife edge and the beam bearing.

Direct Reading Spring Scale. To make a direct reading spring scale (no comparison with standard weights necessary), hang your spring on one of the nails or machine screws on the weighing frame (Fig. 3). Provide a pointer made from a piece of wire fastened to the lower end of the spring, making the pointer extend equal distances from both sides of the spring so that it will remain balanced. You can use a ruler as shown in Fig. 4 for weight indications, or you can fasten a piece of paper adjacent to the pointer and mark your calibrations on it directly. The hook is made out of iron wire.

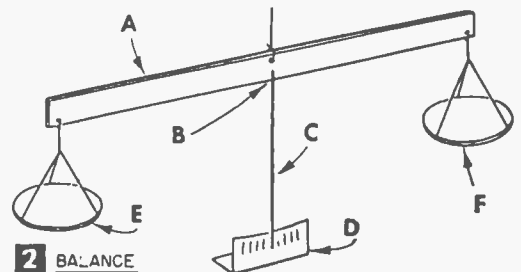

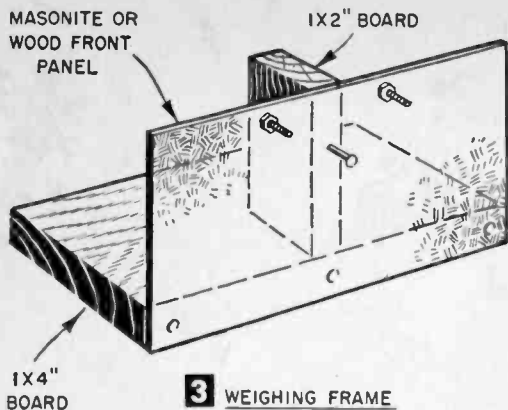

How to Make A Balance. Figure 5 shows a balance constructed on the weighing frame with a ruler as the beam and a nail as the pivot. The hooks are made of iron wire. Cut the pieces of wire that you use for hooks to equal length before you bend them. Place them equidistant from the hole in the center of the ruler, and then adjust the position of one of the hooks slightly till balance is achieved. Place a spacer about 1 in. long (a thread spool or several washers) on the nail between the perforated Masonite board and the ruler to limit side motion.

To use the balance, place the unknown weight on one of the hooks. Known laboratory weights are attached to the other hook till balance is achieved.

You can obtain accurate but inexpensive weights in this way: Get a number of small boxes (metal, wood, plastic or cardboard—Aspirin boxes, small plastic prescription tubes, and even small bottles work fine). Attach hooks made of iron wire to them, and load them to the desired weight with tacks, nails, screws, BB's, etc. Solder hook ends to metal cans or metal bottle tops, pass

To calibrate the spring scale, first record the zero point ruler reading. Then apply a known weight (a pound box of rice or barley for example) and record the reading. If you are going to calibrate directly on a piece of paper instead of using a ruler, simply mark the zero and the known weight points. A spring's stretch is proportional to the applied force within its elastic limit. If a 1-lb. force stretched the spring 1 in., 2 lbs. of force will stretch it 2 in. In other words, you can compute the "spring constant" by dividing the known weight by the change in length. Then, to get the weight of an unknown object, you simply multiply the change in spring length by this constant. If you placed a piece of paper on the frame for direct reading, you simply put additional marks where they should be and label them. Unfortunately, low quality springs have a large amount of "hysteresis"—they remember that they were stretched and don't return to their original zero position. This is why the balance is more popular for laboratory use.

TABLE A—LABORATORY WEIGHTS

CLASS M—High precision lab primary made of, or plated with tarnish-proof material
 CLASS S—Same precision as M; restriction on material relaxed
 CLASS S-2—Lower tolerance weights for general lab and student use

DENOMINATION	TOLERANCE	
	M, S (in mg)	S-2 (in mg)
100 g	0.5	2.5
50 g	0.3	1.5
20 g	0.2	1.0
10 g	0.15	0.75
5 g	0.15	0.75
2 g	0.10	0.50
1 g	0.10	0.50
500 mg	0.05	0.25
200 mg	0.05	0.25
100 mg	0.05	0.25
50 mg	0.03	0.15
20 mg	0.03	0.15
10 mg	0.02	0.10
5 mg	0.02	0.10

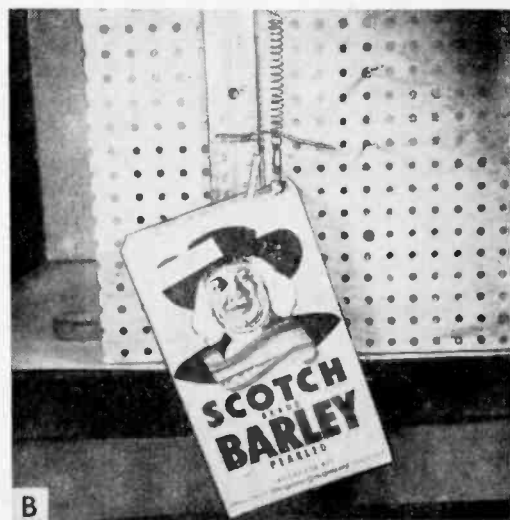
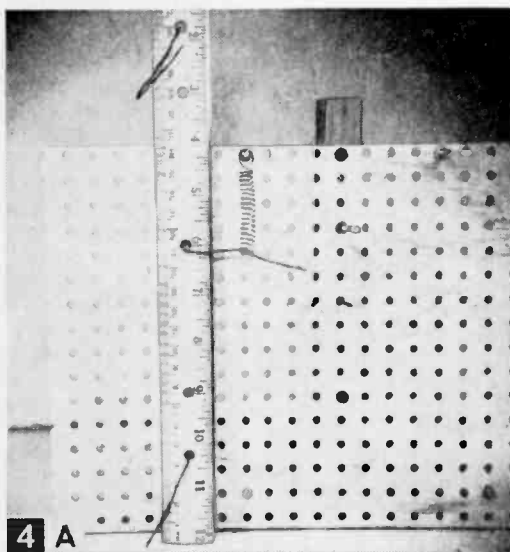

Rough spring scale on weighing frame.

them through plastic and cork, bending them over after passage. Or, load the weights into aluminum foil.

For your smaller weights, use washers, and machine screw nuts, trimming them to weight by filing them down if they're over weight, or building them up with solder or metal foil if they're under weight. They don't require individual hooks since you can slip them over the balance hooks.

Perhaps you raised your eyebrows at the statement "load them to the desired weight." Obviously, you need a standard. Use the weights and balances you have in your high school science department. Don't expect to be permitted to use an analytical balance, however. A trip balance will be sufficient.

Another way to calibrate your own weights is to use a single known weight, and apply the torque equilibrium principle of static mechanics.

Torque Equilibrium Principle. A body at rest

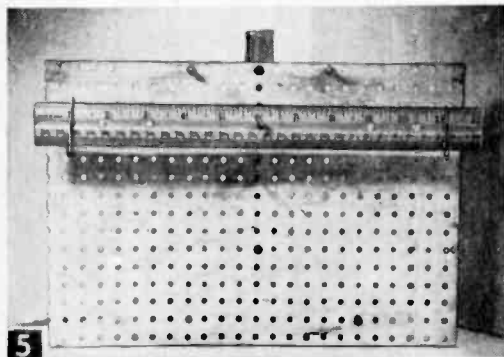

Simple balance on weighing frame.

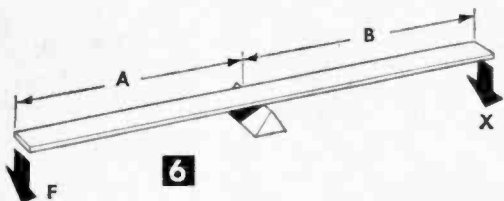

is in static equilibrium. For a body to be in static equilibrium, the vector sum of the forces on the body must be zero; and the vector sum of the moments about any point in the body must be zero.

The second relationship is the one with which we will be most concerned in connection with the torque balance to be described next.

The terminology of the second condition for equilibrium may sound a bit complicated. Actually it isn't. We are concerned with a simple first class lever. A first class lever has the pivot or fulcrum between the applied forces as shown in Fig. 6. Condition two simply states that for the lever of Fig. 6 to be in equilibrium, the force F times the distance A must equal the force X

times the distance B . This assumes the lever to be weightless.

But, there's a way to eliminate the weight of the ruler from the problem. The ruler is reasonably homogeneous and uniform. Therefore its center of gravity, the point at which its weight may be considered to be concentrated, is at its midpoint. If the fulcrum is placed at the midpoint of the ruler, the force due to the ruler's weight passes through the fulcrum. The lever arm is therefore zero, and the torque due to the ruler's weight is zero.

The balance described earlier can be used as a torque balance simply by making the hooks slide along the ruler. Or the ruler may be suspended at its midpoint from a wire hook as shown in Fig. 1. Balance can be achieved between a known weight and an unknown weight placed on the weight-hanging hooks by moving the hooks. Then the unknown weight X is equal to the known weight F times the distance A divided by distance B .

You can calibrate your own laboratory weights with only one weight available by following a simple procedure. For the sake of example, we'll assume you have a 1-lb. box of rice or barley available as a standard.

Assume you want to make a 500 gram weight. The 1-lb. weight is equal to 2,200 grams. It's apparent that you'll need more lever arm for the smaller weight. Therefore, the 500 gram weight should be placed nearer an end of the ruler. The centimeter calibrations are easier to use mathematically than the inch calibrations. The center of gravity of a 12-in. ruler is near the 15.2 centimeter (cm) mark. A good choice for the 500 gm. weight lever arm distance is 15 cm. from the center of gravity of the ruler.

Next, compute the lever arm distance for the 1-lb. (2200 gm.) weight. This distance is $(500 \times 15)/2200$ or 3.4 cm. If the center of gravity of your ruler is at 15.2 cm., the 500 gm. weight should be placed at 15.2 plus 15 or 30.2 cm. The 1-lb. weight should be placed at 15.2 minus 3.4 or 11.8 cm.

Remember, the weight you're making is built up till the meter stick is balanced on the pivot. When this occurs, your weight is 500 grams, or reasonably close to this value. The 500 gram weight may be used as the standard to make a 300 gram weight in the same way. By following this procedure successively you can make a complete set of weights.

You can make a more accurate torque balance by using a longer beam. The small distance of one of the weights from the lever arm in the example just cited is very critical and it is difficult to locate accurately. An error of, say, 0.2 cm. would not be nearly as serious in a 15 cm. measurement as it would be in a 3.4 cm. measurement.

But, if you do use a longer beam, remember that it should be stiff enough not to bend, it should be straight, and it should have uniform dimensions.

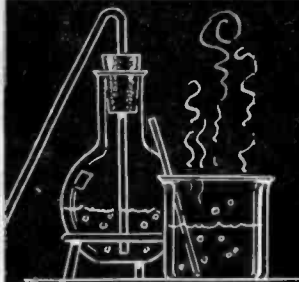

Magic in CHEMISTRY in Magic



◀ Prove you're a man to be reckoned with—and the only man who can make the gal in the photo (Fig. 1) blush. Prepare her for the test by painting her cheeks with phenolphthalein solution (from the drug store), and be sure the cheeks are slightly moist when you perform the trick. Ordinarily this solution is colorless, but when a finger (yours) moistened with household ammonia is brought near it, the reaction of the fumes with the solution causes it to turn pink. When the ammonia evaporates, the cheeks lose their color.



▶ Whoosh goes this miniature volcano (Fig. 2) you've made from a small, pointed mound of ammonium dichromate (from chemical supply houses or large photographic stores). Just center the chemical on an asbestos pad (for heat protection) and light the tip with a match (Fig. 2A). When burning starts, turn out the room lights. In darkness the burning chemical looks like a miniature volcano, complete with sparks and lava-like material tumbling down its sides. When the lights flash on again your audience will see that a mountain of green powder (chromium sesquioxide) has replaced the little heap of ammonium dichromate.



◀ Show your guests you can cool a bottle sans refrigerator and sans ice (Fig. 3). All you need are a large fruit juice can, a turkish bath towel, 1 lb. of common photographic hypo, water, and a couple of rubber bands (Fig. 3A.) Wrap and rubber band the folded towel around and under the can; then pour in 1 qt. of the coldest water you can get. Dissolve the hypo in it by rapid stirring, and insert the bottle. Bottle temp. should drop about 25°F. Later, after the moment of glory, bottle hypo solution for later photographic use.

Make your friend's name turn into a caricature of himself (Fig. 4). Fortify yourself ahead of time by drawing the caricature in invisible ink made by mixing a pinch each of potassium iodide and cornstarch in a tablespoon of water, then heating for several minutes to dissolve the starch. Next, write the name with any ink that can be removed with ordinary ink remover, but dilute 1 part ink into 15 parts of water (Fig. 4A).

It's a whiff of chlorine gas in the jar that does the trick. It bleaches the ordinary ink and releases the brown-colored free iodine in the invisible ink. To make the chlorine, cover the bottom of the jar with sodium hypochlorite bleach, such as Chlorox or Linco, and then add a little hydrochloric acid. Lay a square of stiff cardboard over the jar to confine the gas while it is being generated, and don't inhale the gas.

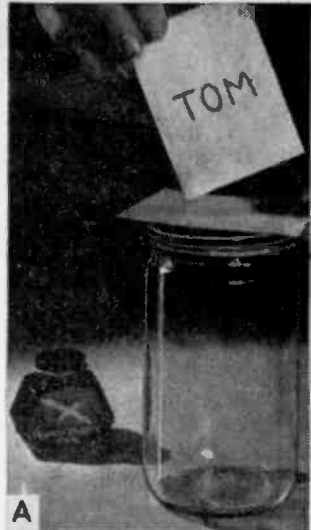

Want to make an ink with which you can write a message that is invisible in humid weather but which turns blue when the weather is fair—and the fairer the bluer (Fig. 5)? Just dissolve a few crystals of cobalt chloride in a little water. Write the message with a blunt instrument, and apply plenty of solution (Fig. 5A). Invisible when even slightly moist, the writing appears whenever the weather is dry enough, or the paper is dried artificially under an electric light.

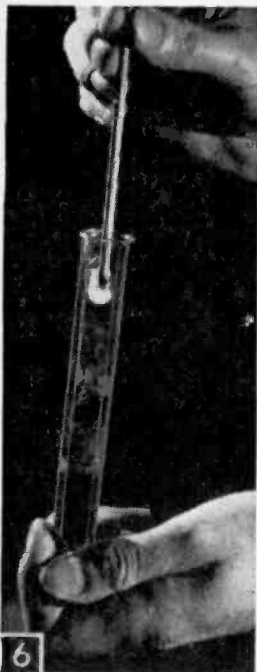
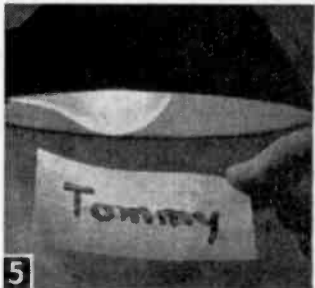

Show the folks how pure oxygen facilitates combustion (Fig. 6). Pour about an inch of hydrogen peroxide into a test tube, and add a few grains of powdered manganese dioxide which acts as a catalyst to liberate the oxygen. After a few seconds, insert into the upper part of the tube a wood splinter or a piece of cord with a spark at its tip. Instantly, the spark will burst into flame. A small piece of steel wool, heated red hot, will burn brightly if lowered into the tube.

You can bring a dozing audience (someone else's, naturally, not yours) to quick attention by changing wood alcohol to that evil-smelling gas, formaldehyde (Fig. 7). Customarily used in water solution to preserve biological specimens and to harden photographic film, the gas is made commercially by oxidizing methyl, or wood alcohol by means of heat and a surface catalyst. You can do this, however, by immersing a test tube containing a teaspoonful of the alcohol in hot water. When alcohol warms, heat a 1/4-in. coil of bare copper wire in a gas flame and plunge it into the alcohol vapor. The copper causes the vapor to unite with oxygen from the air and from the film of oxide on itself, and the smell of wood alcohol changes into the pungent odor of formaldehyde.



DIAL-A-FLASH

(Continued from page 18)

blue, yellow, magenta and cyan, a greenish blue) for only 75 cents (see materials list for source).

A polarizing filter should be added to these. In the remaining holes you can add other experimental filters, or various light-balancing and color-compensating filters used in color photography (see Kodak's data booklet titled *Photography Through the Microscope* for more information about their uses).

The larger disc assembly is fitted with a series of stepped neutral density filters. These are grey filters which transmit varying amounts of light and are used to control the flash intensities to obtain proper exposures.

Your photo supply store can probably obtain a set of neutral density filters for you. To save money, try making your own by simply exposing black-and-white film to varying amounts of white light. Here's how I made mine:

A camera loaded with Verichrome Pan film (any film would do) was pointed at a piece of white cardboard illuminated evenly with flood lamps. A meter reading taken from a standard grey card held over the white cardboard indicated that the "correct" exposure was $\frac{1}{25}$ th second at $f/8$. Keeping the shutter speed set at $\frac{1}{25}$ th, successive

frames on the roll of film were exposed to the white card while the camera diaphragm was closed down one stop after each exposure (i.e. $f/3.5$; $f/4$; $f/5.6$; $f/8$; $f/11$; $f/16$; $f/22$). The film was developed to gamma 1.0.

Two-inch squares of these neutral density filters are mounted in tonal sequence in the larger filter disc. For convenience, they should be identified by ND (Neutral Density) numbers—i.e. ND-0 (open hole, no filter); ND-1, the lightest filter; ND-2, the next lightest, etc. These numbers are marked on the edge of the disc where they can be seen on the sections projecting from the front panel. Note that the ND numbers are *not* placed in front of the filters they represent, but on the diametrically opposite sides of the disc. The color and polarizing filters can be similarly identified with labels.

You can obtain a reasonably accurate idea of the relative light transmissions of the ND filters by placing an exposure meter on the light hole at the top of the box and reading the light values as you switch from one filter to the next. Illuminate with your regular microscopic lamp. Using a Science & Mechanics exposure meter and a 100-watt light source, I obtained the following readings on scale 1 of the meter: ND-0, 29; ND-1, 26; ND-2, 23; ND-3, 20; ND-4, 16.5; ND-5, 11; ND-6, 8; ND-7, 6.5.

You can, if you wish, extend the ND grey scale further by exposing additional film less for still lighter filters and more for darker filters. Admittedly, these filters aren't as precisely density-graded as are standard commercial filters, but they serve very well after you calibrate their relative light transmissions.

Incidentally, the polarizing filter can be used alone or in combination with the ND filters for further flexibility in light control. For example, the polarizing filter alone gave an S&M meter reading of 22; in combination with the ND-7 (darkest) filter the meter reading dropped to 3.5.

In fact you can eliminate the use of ND filters by using two polarizing filters—one in the disc and the other placed just above the light hole in the large box. Rotate the top polarizing filter to obtain an infinite number of transmission levels (with my system, readings ranged from 18.5 to 4.5 on the No. 1 range of the S&M meter).

Remember that color filters too reduce light transmission by varying amounts, depending on color and density of filters used.

(Continued on page 96)

KODAK "M" FILTERS

Filter No.	Color	Use
38A	Blue	Increase contrast in faintly stained yellow or orange preparations. Increase resolution of fine detail.
45A	Blue-Green	Used when highest resolving power is desired, as in the study of diatom structures.
66	Light Green	Contrast filter for use with pink- and red-stained preparations.
58	Green	Contrast filter for use with faintly stained pink or red preparations.
15	Deep Yellow	For increasing contrast in blue preparations; better observation of insects details by reducing contrast between preparation and background.
22	Yellow-Orange	Uses similar to No. 15.
25	Red	Contrast filter for preparations stained with methylene blue, methyl green, etc.



Classified MARKET PLACE

For Information on Classified ads—to be included in our next SCIENCE EXPERIMENTER—write C. D. Wilson, Mgr., Classified Advertising, SCIENCE EXPERIMENTER, 505 Park Ave., New York, N. Y. 10022.

ADDITIONAL INCOME

SECRETS — Stock Market Success. Send One Dollar. Whitmore, Box 1393, Evanston, Ill. 60204.

AUTHOR'S SERVICE

WANTED Writers! Short stories, articles, books, plays, poetry. Will help place, sell your work. Write today, free particulars! Literary Agent Mead, Dept. 22A, 915 Broadway, New York 10, N. Y.

BIG MAIL

YOUR Name Listed with 1000 Mailers, Publishers, Importers, etc. Our mailing each month \$1.00. Dixie Mailers, King, North Carolina.

BOOKS & PERIODICALS

DO It Yourself and Technical Books for Radio, TV, Hi-Fi. Top Numbers Only. Send for Free List and Bargain Catalogue. Indian River Book Shop, Indian River, Michigan 49749.

BUSINESS OPPORTUNITIES

I MADE \$40,000.00 a Year by Mailorder. Helped others to make money! Start with \$10.00—Free Proof. Torrey, Box 3566-T, Oklahoma City, Okla. 73106.

FREE Book "990 Successful Little-Known Businesses." Fascinating! Work home! Plymouth-911-W, Brooklyn, N. Y. 11218.

FREE Report, "Businesses You Can Launch At Home." Immediate earnings! Wyman Enterprises, B-50, Congers, N. Y. 10920.

BUY IT WHOLESALE

TRAIN Sets—\$1.36, Recorders—\$6.70, Pistols—\$5.74, Walkie-Talkies, Binoculars, Cameras. Buy From American, European, Japanese Wholesalers. Exciting Details Free. Enterprises, Box 160-K-4 Jamaica, New York 11430.

EARTHWORMS

BIG Money Raising Fishworms and Crickets. Free Literature. Carter Farm-O, Plains, Georgia.

EDUCATION & INSTRUCTION

YOUR F.C.C. first class license (electronics, broadcasting)—prepare by correspondence or resident classes. Then continue, if you wish, for A.S.E.E. Degree. Free catalog. Grantham Engineering Institute, 1505 North Western Ave., Hollywood, Calif. 90027.

ELECTRONIC EQUIPMENT

COUPON Book—Special offers from various firms, to members of Electronic Experimenters' Club. Dues \$2.00 or write for further particulars. Box 5332-EB, Inglewood, Calif. 90310.

FIREARMS, AMMUNITION & EQUIPMENT

SILENCERS: Rifles, Pistols. Details Construction Operation \$1.00. Gunsco, Soquel, Calif. 95073.

FLORIDA LAND

FLORIDA Water Wonderland—Home, cottage, Mobilesites. Established area, \$590.00 full price, \$9.00 a month. Swimming, fishing, boating. Write: Lake Weir, Box MG-38, Silver Springs, Florida AD 6-1070 (F-1).

FOR INVENTORS

PATENT Searches—48 hour airmail service. \$6.00, including nearest patent copies. More than 200 registered patent attorneys have used my service. Free invention protection forms. Write Miss Ann Hastings, Patent Searcher, P. O. Box 176, Washington 4, D. C.

FOR SALE—MISCELLANEOUS

BARGAINS Our Business. Catalog 10¢ Refundable. Tojocar, 2907-E West 39th Place, Chicago, Ill. 60632.

GOVERNMENT SURPLUS

JEEPS From—\$52.50, Typewriters From—\$4.15, Cars From—\$31.50. Walkie-Talkies, Guns, Airplanes, Boats. Typical "As Is" Bid Bargains From Uncle Sam. Tremendous Variety. Exciting Free List. Write: Enterprises, Box 402-K7, Jamaica, New York 11430.

HOME WORKSHOP SUPPLIES

MAKE \$100.00 Formica Counter Tops with few dollars material. Complete instructions \$1.00—Build Cabinets like Professionals, with new manual. "Cabinet-making Made Easy." \$2.00—Jaaps, 126 Seventh North, Hopkins, Minn. 55343.

HYPNOTISM

NEW concept teaches you self-hypnosis quickly! Free literature. Smith-McKinley, Box 3038, San Bernardino, Calif.

INVENTIONS WANTED

WE either sell your invention or pay cash bonus. Write for details. Universal Inventions, 298-E, Marion, Ohio.

MAILING LISTS

MAILING Lists most all kinds 1000 \$5.00. Free folder. Your circulars mailed \$4.00 1000. Dixie Mailers, King, N. C.

OFFICE EQUIPMENT & SUPPLIES

OFFSET, Letterpress, Varytypers, Typewriters, Mimeograph, Multigraph Machines, Bargains. DixieGraph, King, North Carolina.

PATENT SERVICE

PATENT Searches, \$6.00. For free "Invention Record" and "Important Information Inventors Need," write: Miss Hayward, 1029D Vermont, Washington 5, District of Columbia.

PATENT Searches—48 hour airmail service. \$6.00, including nearest patent copies. More than 200 registered patent attorneys have used my service. Free invention protection forms. Write Miss Ann Hastings, Patent Searcher, P. O. Box 176, Washington 4, D. C.

PETS—DOGS, BIRDS, RABBITS, HAMSTERS, ETC.

MAKE big money raising rabbits for us. Information on 25¢. Keeney Brothers, New Freedom, Penna.

PROFITABLE OCCUPATIONS

INVESTIGATE Accidents. Earn \$750.00 to \$1,500.00 monthly. Car furnished. Expenses paid. No selling. No college education necessary. Pick own job location in U. S., Canada or overseas. Investigate full time Or earn \$844 hour spare time. Men urgently needed now. Write for Free information. Absolutely no obligation. Universal, CMH, 6801 Hillcrest, Dallas 5, Texas.

MAKE Mail Order pay. Get "How To Write a Classified Ad That Fails." Includes certificate worth \$2.00 toward classified ad in S & M. Send \$1.00 to C. D. Wilson, Science & Mechanics, 505 Park Ave., New York, N. Y. 10022.

SONGWRITERS

POEMS Wanted for musical setting and recording. Send poems. Free examination. Crown Music, 49-SC West 32, New York 1.

RADIO & TELEVISION

McGEE Radio Company. Big 1966 Catalog Sent Free. America's Best Values. Hi-Fi, Amplifiers, Speakers, Electronic Parts. Send Name, Address and Zip Code Number to McGee Radio Company, 1901 McGee Street, Dept. RTV, Kansas City, Missouri 64108.

FREE Catalog. Electronics parts, tubes. Wholesale. Thousands of items. Unbeatable prices. Arcturus Electronics-RT, 502 22nd St., Union City, N. J. 07087.

TELEVISION Servicing Course, complete, latest edition. Special \$3.00. Satisfaction guaranteed. Supreme Publications, 1760 Balsam, Highland Park, Illinois 60035.

BEGINNERS All Wave Radio Kit, tube and transistor included \$3.00. Ekeradio, Box 131, Temple City, Calif.

IT'S Supercallfragilisticexpialdocius! Free information about Kit-of-the-Month Club and new catalog: Etched Circuit Boards, Radio Books. Exclusive items. Leader Enterprises, Box 44718KS, Los Angeles, 90044.

TELEVISION troubles spotted in minutes! Repair all makes and models this easy expert way. No Book theory. A real "work bench" simplified method. Used by "pros" throughout the industry. Write, specifying black/white, or color. National Technical Research Labs., 6430 So. Western Ave., Whittier, Calif.

DIAGRAMS, service information, Radio \$1.00, Television \$1.50. Beltman, 1760 Balsam, Highland Park, Illinois 60035.

TREASURE FINDERS—PROSPECTING EQUIPMENT

NEW supersensitive transistor locators detect buried gold, silver, coins. Kits assembled models. \$19.95 up. Free catalog. Relco-A30, Box 10563, Houston, Texas 77018.

DIAL-A-FLASH

(Continued from page 94)

If you have a sensitive exposure meter fitted with a small probe (such as one of the S&M meters) you can eliminate much work and worry about relative light transmissions by reading light intensities off the ground glass viewing screen of your camera.

Aside from these suggestions, it would be pointless to talk more about proper exposures because there are too many variables. The intensity of your flash may be stronger or weaker than the one discussed here, and

your whole optical system may be markedly different.

The best approach is to run a series of test exposures while keeping full records of filter combinations used, type of lighting (transmitted or overhead), type and speed of film, development times, microscope objectives and eyepieces, bellows extension if any, etc. This information will soon enable you to judge exposures accurately.

Assuming that you work these problems out methodically, there is one sure conclusion: the Dial-a-Flash will enable you to get pictures you never got before. ■

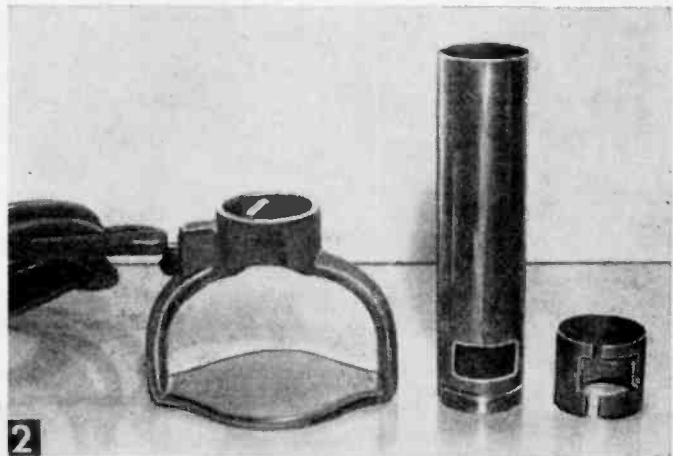
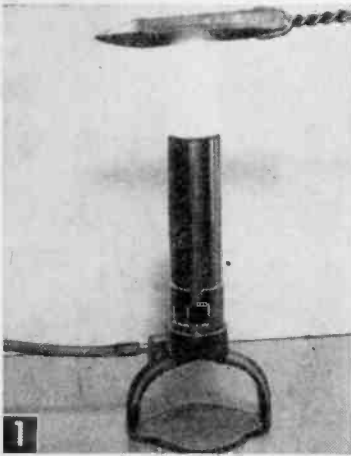

Tire Pump Bunsen Burner

ALL the "works" you need to make a heavy duty Bunsen burner for those big science project heating jobs is contained in an old hand tire pump equipped with a 1¼-in. cylinder (Fig. 1).

Take apart the piston, ball valve in the base, and the barrel from the base. Cut the tube onto two pieces, the threaded end 8 in. long and a 1¼-in. section. Lay out for air-intake openings and cut out as in Figs. 2 and 3. Next cut the air regulator and bend in to form a stop. Slide over barrel, making sure it turns freely.

If necessary, redrill the air outlet hole in the pump base with a ⅛-in. drill. Cut a piece of ⅛-in. copper tubing, file a slight taper on one end, coat end with gasket compound and force into the hole in the pump base. Bend up the tubing so the jet is centered in the tube, and cut off ¼ in. above the top of the base. Plug-solder end of tube, and bore a hole with a No. 54 drill for an orifice. Remove tube, coat tapered end with gasket compound and as-

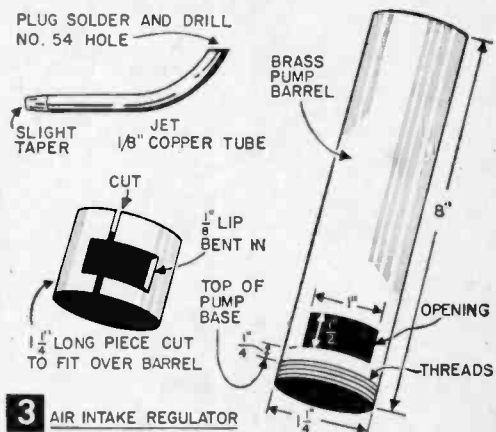

semble. With natural gas or a mixture of natural and manufactured gas, it may be necessary to increase the size of the orifice.

—ROBERT MICALS

S&M's SUPERSENSITIVE DARKROOM METER



You get your money's worth when you own an S&M A-3 Supersensitive Darkroom Meter.

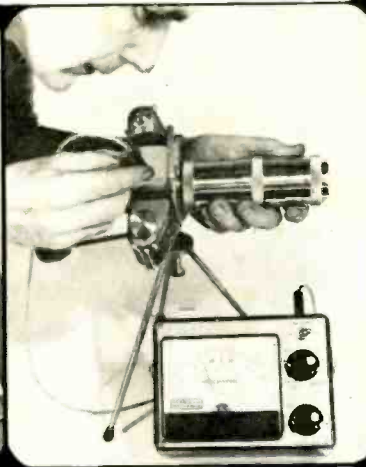

U.S. Camera says,
"The meter is a
marvelously sensitive
and accurate
instrument."

\$36.95 in Kit form
\$41.95 Factory-assembled
\$ 5.00 Sturdy carrying case

This Model A-3 Meter is named the "Darkroom Meter" because it has been so widely accepted for reading enlarger easel exposures. It has earned a reputation as a precision instrument in color studio photography, copy work, portraiture, and available light photography. You can use it with movie cameras and with single lens reflex cameras. The A-3s are also used for ground glass exposure readings with microscopes, telescopes and can even be set up for use as a densitometer.

An exclusive feature of this versatile instrument is its standard plug-in probe assembly with three foot flexible cable. This probe utilizes the newest Clairex Corp. CL-505L cadmium sulfide photocell—the best grade available today—balanced for color, and the complete range of exposures from dim available light to full bright sun light. Its field of view is 43 degrees, equal to normal camera lens angles.

The meter is supplied with a 5-inch, easy-to-read computer with four-range selection and EV-EVS-LV settings to give F stops from .7 to 90 and list exposure time from 1/15,000 second to 8 hours.

The 4½-inch dial of the meter is self-illuminated with built-in battery lamps. You read on 4 sensitivity ranges, therefore the meter dial and selector switch give you an equivalent of 18 inches of total dial space for reading accuracy. The paper speed control knob is used to set sensitivity to match the various grades of printing papers. The meter sensitivity is sufficient to detect the light of a match 10 feet away.

This S&M Light Meter is supplied with a probe holding bracket for darkroom work. An accessory easel probe ¾-inch (see photo) is recommended for use with high speed enlarging papers. The standard ¾-inch diameter probe can be used to read a ½-inch circle on the viewing glass of many SLR's. To read a smaller target through the lens of Exactas, Practicas, etc., order the ¾-inch diameter probe which has a ¼ wide photocell.

Whether you buy the S&M A-3 Meter as an easy-to-assemble kit, or completely factory-assembled, you can be sure you have the advantage of owning a rugged and dependable instrument. A complete manual tells you step-by-step how to assemble the instrument, how to use it for profitable photography and how to keep it working right for years

Use the coupon below to order your meter today. Satisfaction guaranteed!

SCIENCE & MECHANICS—KIT DIVISION
505 Park Avenue / New York, N.Y. 10022

Dept. SE-784A

Please send the S&M, A-3 Supersensitive Darkroom Meter as I've indicated below. I understand that if I am not satisfied, I may return the meter within 10 days for a complete refund.

Add 10% for Canadian and foreign orders. N.Y.C. residents add 5% for sales tax.

- | | |
|--|---|
| _____ \$36.95—in kit form | _____ \$6.50—Easel Probe |
| _____ \$41.95—factory assembled | _____ \$6.50—¾-inch Miniature Probe |
| _____ \$ 5.00—carrying case | _____ Enclosed \$3.00 deposit, |
| _____ Check or money order enclosed,
ship post-paid | _____ Ship COD, plus postage & COD
charges |

Name (PLEASE PRINT) _____
Address _____
City _____ State _____ Zip _____

American Basic Science Club's Master Lab... a HOME SCIENCE LAB AND COURSE

You Get ALL the Following Equipment in 9 Monthly Kits

ELECTRICAL LAB

All the equipment for basic electrical experiments with Wheatstone Bridge (measures resistance), Magnetizer and De-magnetizer, Thermocouple, Potentiometer, Continuity Tester, Extension Voltmeter, Selenoid Coin Tossor, Electromagnetic Relay, Neon Lamp, Galvanometer, Induction Coil, Resistors, Chemicals and Electrodes for Plating and Electrolysis.

FOR SAFETY a step-down Isolator Transformer provides required current.



(Available as a Separate Unit for \$8.95 Postpaid)

STROBE LIGHT

A Neon Lamp that flashes at intervals you can synchronize with the speed of rotating or vibrating objects in order to "freeze" their motion to permit close study and checking frequencies and RPM. Flashes are timed by a high speed Oscillator. Operates on the Master Lab DC Power Supply. (When bought as a separate unit uses a 90 V. Battery that is included in unit price.)

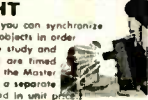

(Available as a Separate Unit for \$7.95 Postpaid)

PHOTOELECTRIC RELAY

Crystal Filter, Electronic Amplifier, Relay, large Condensing Lens in Cabinet Mount. Features automatic "on-air-off" or holding circuit operation. Sensitivity Control, Plug-in Outlet for controlled circuit. Use for alarms, counters, etc. Operates on 115V AC. A basic unit for many exciting experiments.



(Available as a Separate Unit for \$8.95 Postpaid)

ANALOG COMPUTER

Electronic Computer multiplies, divides, calculates powers, roots, logarithms. Set up the problem on the scales of two linear potentiometers and find the answer by listening for the null point on the third potentiometer. More accurate, educational, and practical than similar computers that sell for several times the price. Easy to assemble. Complete with Headphone.

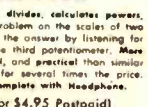

(Available as a Separate Unit for \$4.95 Postpaid)

LIGHT AND OPTICS LAB

Exciting optical projects. Set up a study of light. Equipment includes: Five Precision Lenses, Prism, Polarizing Filter, Diffraction Grating, Mirror, Telescoping Tubing, Lens Mounts, Tube Holders and Brackets. All the parts and instructions to build a Microscope, Camera Obscura, Camera Lucida, Polaroscope, Photometer and many other optical devices.



(Available as a Separate Unit for \$6.95 Postpaid)

PHOTOGRAPHY LAB

A PRECISION 35MM ENLARGER... horizontal type with twin condensing lenses and 3" F11 projection lens. Produces quality enlargements up to 8" x 10". Contact Print Frame takes negatives up to 3 1/2" x 4 1/4". 3 Plastic Developer Trays, Neon Safelight, Thermometer, Film Clips, Developing Chemicals, Printing and Enlarging Paper and Darkroom Hand-book. Make quality enlargements for 6c. Make prints for only 2c.

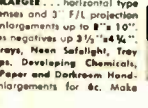

(Available as a Separate Unit for \$9.95 Postpaid)

RADIO LAB AND COURSE

SHORTWAVE AND BROADCAST RADIOS. 3-tube regenerative circuit. Uses 115V AC House current. Complete with headset. CARBON MICROPHONE and 2-stage AUDIO AMPLIFIER. RADIO TRANSMITTER for code or voice.



(Available as a Separate Unit for \$17.80 Postpaid)

DC POWER SUPPLY

Changes regular 110-120V AC to the direct current required for electronic projects and experimenting. Consists of a Power Transformer, Vacuum Tube Rectifier, 20/20MFD Capacitor Filter Circuit and a Patentmeter Voltage Selector. Dial Control for 0 to 55V. A solid state Power Supply that eliminates the need of expensive multi-volt batteries.



(Available as a Separate Unit for \$6.95 Postpaid)

PHOTOMICROGRAPHY LAB

Projection-Type Camera takes and prints pictures of subjects mounted on microscope slides. Enlarges up to 100 times. Takes the place of microscope, camera and printer. No other equipment needed. Includes: Developing Trays, Chemicals, Paper, Microscope Slides and Safe Light. Uses standard size of regular roll film.



(Available as a Separate Unit for \$7.95 Postpaid)

SLIDE PROJECTOR

Has interchangeable projection assemblies — one for standard 35MM slides, and the other, with greater magnification, for microscope slides. Comes with 140 watt GE Projection Lamp. Large Twin Condensing Lenses for extra brightness, sturdy Steel Housing with inner chimney and baffle for cool operation.



(Available as a Separate Unit for \$6.95 Postpaid)

LIGHT TRANSMITTER-RECEIVER

The TRANSMITTER consists of a Light Source, a Modulating Reflector Diaphragm and an Optical Projection System. The RECEIVER is a Two-Stage Audio-Amplifier, controlled by a Photo-electronic Cell that catches the projected light beam and causes the original sound waves to be reproduced in the headphones.



(Available as a Separate Unit for \$14.95 Postpaid)

ATOMIC ENERGY LAB

ATOMIC CLOUD CHAMBER WITH PROJECTOR ILLUMINATOR. See the vapor trails of alpha and beta particles, and of cosmic rays. SPECTROSCOPE. Shows exploding stars in easy-to-read scale. ELECTROSCOPE — metal housed with Scale and Magnifying Viewer. Measures background radiation and tests sample sources. SAFE RADIOACTIVE MATERIALS. Alpha Source in handy container and Uranium Ore. Full instructions and explanations open up the fascinating field of nuclear physics.



(Available as a Separate Unit for \$6.95 Postpaid)

SPECTROSCOPE

Analyze spectra of glowing gases. See and identify the Fraunhofer Lines. A quality instrument featuring an easy-to-read built-in scale and a powerful equidispersion system for a bright spectrum. Equipment includes Alcohol Burner and a 2 Watt Neon Spectral Lamp. Full instructions cover theory and use.



(Available as a Separate Unit for \$5.95 Postpaid)

ULTRAVIOLET LAMP

140 watt filter type UV LAMP. Heavy metal cabinet, 6 Foot Cord, Rotary Switch. Produces dazzling color effects with invisible black light. Has many uses in the fields of Mineralogy, Crime Detection and Science. Accessories include Invisible Ink, Trace Powder, Fluorescent Crayons.

SURVEYOR'S TRANSIT

A practical Transit. 6X erect image telescope with Range Finder Reticle for measuring remote distances and heights. Vernier reading for both horizontal and vertical scales. Leveling Head with Thumb Screw Adjustment and Spirit Level. Clamps under head hold wooden legs of Tripod. (Legs not included.) Instructions cover elementary surveying, range-finding.

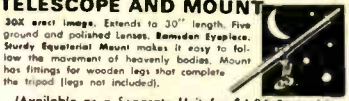

(Available as a Separate Unit for \$5.95 Postpaid)

TELESCOPE AND MOUNT

30X erect image. Extends to 30" length. Five ground and polished lenses. Ramsden Eyepiece. Sturdy Equatorial Mount makes it easy to follow the movement of heavenly bodies. Mount has fittings for wooden legs that complete the tripod (legs not included).



(Available as a Separate Unit for \$4.95 Postpaid)

WEATHER STATION

A REMOTE READING ANEMOMETER AND WIND-VANE... Flashing Neon Lights on indoor indicator board show wind speed and direction. Operates on less than 1 cent per month. Safety Power Cord makes all connections safe. 150 ft. of Lead-in Wire. Plus — Air Tank Barometer with 4 ft. Indicator Column. Sling Psychrometer measures relative humidity. Rain Gauge measures rainfall to 1/100 inch. ALSO Cloud Chart, Weather Map and Forecasting Manual — a complete set-up for amateur meteorology.



(Available as a Separate Unit for \$7.95 Postpaid)

9 KIT MASTER LAB Includes ALL the Equipment for ALL the Above...only \$37⁵⁵

SEND \$2⁰⁰ WITH ONLY COUPON

PAY \$3⁹⁵ PLUS POSTAGE FOR EACH OF THE 9 KITS... ONE-A-MONTH

CANCEL ANY TIME YOU WISH — MONEY BACK IF NOT DELIGHTED

MULTI-USE DESIGN — A MASTER LAB FEATURE

All the above equipment, as separate units, adds up to over \$14000.

How can the 9 kit Master Lab have it all for only \$37⁵⁵ ?

Multi-use design is the answer. For example: The Slide Projector quickly and easily converts into the Photo-Enlarger, Spectroscope, Cloud Chamber Illuminator. Similarly, the Transit Head doubles as a Telescope Mount. Such multi-purpose design makes possible an all-science lab at an unheard-of low price. Multi-purpose design is used only where it is advantageous, and not for such applications as the permanently-mounted weather instruments, where it would not be practical.

KIT-A-MONTH — OR ALL AT ONCE Get Master Lab on either plan (see coupon). You may start with the Kit-A-Month plan, and at any time get the balance of the 9 kit series in one shipment by sending \$3.95 for each of the unshipped kits.

SEPARATE UNITS ALL GOOD BUYS You can order any of the individual units and be sure that it is a quality item and the best value in its field. The Master Lab, however, is the "buy of buys" and every science-minded person should try it.

NO EXPERIENCE NECESSARY — IT'S EASY! IT'S FUN!

You will enjoy the easy-to-use equipment and the exciting learn-by-doing course. The 9 instruction manuals and the 6 auxiliary text books are expertly written and clearly illustrated. Over 490 pages. Over 280 illustrations. A real science course for a solid science background.

ACCLAIMED BY EDUCATORS

Everyone interested in science should have your enjoyable kits. You are doing a wonderful job.

Allan T. Ayers, Physics Dept., Jamestown High School, Jamestown, N. Y.

FREE with first kit! MYSTERY SHOCK BOX
Yours to keep even if you return the kit for full refund

KIT-A-MONTH...THE EASY WAY TO A WONDERFUL LAB!

* You take only as many kits as you wish — no obligation.

* You may return any kit and receive full refund.

There's "No Risk" assurances because we know.....

.....you'll be amazed and delighted. The first kit will convince you that you want the Master Lab.

Send \$2 today — get your first kit on its way!

All Orders on 10 Day Approval — Your Satisfaction or Your Money Back

- Start sending me the MASTER LAB in 9 monthly kits. I enclose \$2.00 and will pay \$3.95 plus COD postage on receipt of each kit. I may cancel unshipped kits at any time.
- Send me complete MASTER LAB (all 9 kits) in one shipment. I enclose \$37.55 Full Payment, Postage Paid.
- Send me only the _____ Unit. I enclose \$ _____, Full Payment, Postage Paid.

Name _____
Address _____
City & State _____ (ZIP CODE _____)

AMERICAN BASIC SCIENCE CLUB, INC.
501 East Crockett St., San Antonio, Texas 78202

A SPACE AGE HOBBY... EXCITING — REWARDING!