

# INSTALLING



# HIFI

# SYSTEMS

JEFF MARKELL and  
JAY STANTON



GERNSBACK LIBRARY BOOK No. 86

\$3.20  
(in U. S.)

Installing

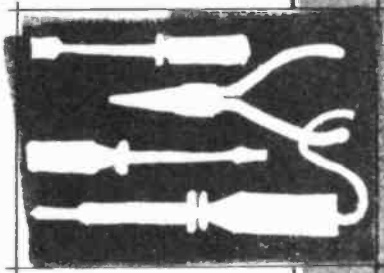

Hi-Fi  
Systems

By Jeff Markell and Jay Stanton

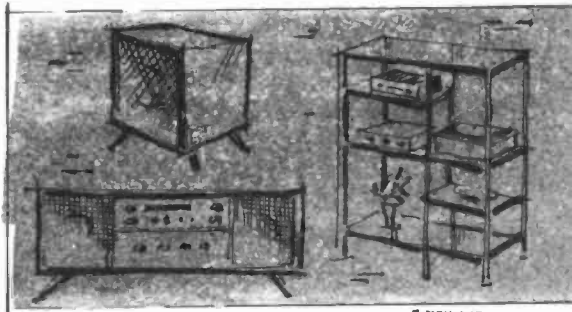
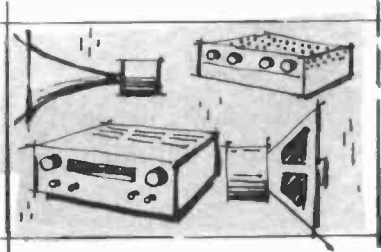

GERNSBACK LIBRARY, Inc.,  
New York 11, N. Y.



© 1960 Gernsback Library, Inc.  
All rights reserved under Universal,  
International and Pan-American  
Copyright Conventions.

Library of Congress Catalog Card No. 60-14659

# contents

chapter

page

1

## **High-fidelity systems**

7

Monophonic sound reproduction systems. "Monaural" system. Achieving presence. Perspective and sound-source spatial distribution. Binaural reproduction. Stereophonic reproduction. Binaural system. Stereo installation problems. Other sonic perspective systems. Limitations. The installer and system types.

2

## **Client needs and preferences**

15

Esthetics of appearance. Understanding the client's tastes. Functionality. Flexibility for future modification. Types of modifications. Advance electronic provisions for modification. Advance cabinet provisions. Advance room provisions for modification. Explaining factors to the client. The installation decision.

3

## **Legal and insurance considerations**

31

Government regulations. Federal tax requirements. Federal, State and Municipal taxes. Building electrical and health codes. Private dealings. Originating a business. Liability. Purchases. Avoiding lawsuits. Sales. Collection problems. Warranty. Liability and insurance.

4

## **High-fidelity system components**

41

Components. System elements. Tuners for hi-fi systems. Am-Fm tuners. All-wave receivers. Television sound channels. Pickups and tone arms. Tone arms and turntables. Record changers. Tape recording and playback equipment. Preamplifiers. Power amplifiers. Reproducers.

5

## **Electrical and electronic interconnections**

57

Power-line frequencies. Primary electric supplies. Power connections. Total power drain. Interconnection problems. Interconnecting transformerless receivers. Control adjustments. Remote stereo control unit. Cable and wire considerations. Using coaxial shielded wire. Speaker wiring requirements.

6

## **Environment and electronic equipment**

65

Regional climatic conditions. Temperature effects. Acceptable temperature ranges for equipment. Effects of heat on components. Humidity effects. Vapor pressure. Climate. Using heater elements. Local ambient factors. Chemical corrosion problems. Using aerosol lacquer sprays. Tropicalization.

7

## **Noise and interference**

75

Eliminating sources of hum. Ground loops. Problems of shock hazard. Curing hiss problems. Excessive signal input. Man-made interference and external electrical noise. Using low-pass rf filters. Filter cutoff frequency. Electronic and acoustic feedback.

chapter		page
8	<b>Acoustic factors</b> Speakers. Speaker enclosures. Infinite baffle. Reflex baffle. Horns. Room acoustics. Speaker placement. Reverberation time. Absorbency vs frequency. Optimum reverberation time. Sound transmission. Diffraction. Reflection. Echo. Standing waves. Sound transmission in solids. Direct conduction. Structural resonance.	85
9	<b>Solving acoustic problems</b> Room acoustics. Excessive reverberation. Room surfacing materials. Echoes and standing waves. Insufficient reverberation. Object resonances. Structural resonance. Sound leakage. Air transmission. Sound transmission through solids. Transmission by direct conduction. Enclosure and speaker factors. Speakers. Enclosures.	107
10	<b>Esthetic appeal</b> Elements of design. Static and dynamic lines. Regular and irregular shapes. Form. Proportion. Color. Design expressed in style. Functional differences. Importance of decorative detail. Specific styles. Modern. Contemporary. Traditional. French styles. English styles. American styles.	123
11	<b>Achieving esthetic effects</b> How does the room look? Locating the hi-fi. Optimum location for speakers. Style. Space limitations. Differences between built-in or free-standing units. Size. Shape and proportion. Color and texture. Appearance and functionality.	149
12	<b>Construction of cabinets and built-in furniture</b> The installer's point of view. Style and construction. New materials and methods. Plywood or solid lumber. Basic types of plywood construction. Plywood grades. Face veneers. Wood species. Plastic surfacing materials. Hardware. Other materials. Joints. Fastenings. Finishing.	163
13	<b>Preparing cabinets for installation</b> Equipment cabinets. Speaker cabinets. Repairs. Hardware. Loose or open joints. Loose legs. Other structural defects. Finish retouching. Scratches. Depression injuries. Burning-in. French polish. Burns. Cracked, crazed or alligatored finish. Stains. Refinishing.	187
14	<b>Structural factors</b> Basic construction. Materials and methods used in building. Wood frame. Plank and beam construction. Masonry construction. Steel frame. Reinforced concrete. Typical construction details. Basic types of windows. Doors. Interior wood frame and masonry partitions.	207

# introduction

**N**EVER before in the history of the musical art has it been possible for so great a listening audience to enjoy the riches of the world's musical literature. Through the medium of recording and reproduction, this availability extends also to spoken drama, to poetry and, indeed, to all of the accumulated art and wisdom of mankind that can be expressed in sound. Today, within a range of cost that excludes practically no one, this whole area of human culture can be enjoyed in the privacy and comfort of the home, in public forums and gathering places, and even in moving vehicles.

More and more people have come to realize that money spent for high-fidelity equipment continues to yield a return in pleasure and satisfaction long after the cost has been forgotten. Indeed, it is difficult to think of any other item in the average home that continues to please as much after the initial "newness" has worn off.

In view of this, it hardly seems necessary to stress the importance of a good, well-thought-out installation in achieving the overall satisfaction that even a modest high-fidelity system can give.

Yet the writers' experience over the years indicates that many buyers and users of hi-fi are getting less satisfaction than their equipment can provide, simply because the fundamentals of good installation were not understood or were ignored in favor of economy or visual decor. This book was written to make available in a single source the fundamentals of hi-fi installation, in a form neither too difficult for the nontechnical nor too superficial

for the professional. We believe the information given will be applicable to the overwhelming majority of installation problems, although, of course, it is not meant to replace a textbook on acoustic engineering.

Thoughtfully applied, the information given here can prevent costly errors in installation and even in the buying of equipment for a specific application. Indeed, it is likely that, in many existing installations, some modification of the installation along the principles presented here will probably result in a performance improvement worth a good deal more than the modest cost of this book. It is with this hope that we offer this result of our combined experience in the fascinating field of sound reproduction.

JEFF MARKELL  
JAY STANTON

# high-fidelity systems

ONCE upon a time, a music lover who wanted to play records in his home merely waltzed into a furniture or appliance store, said, "Sell me that phonograph over there, the one with the vermillion doors," went home, plugged his purchase into the wall socket, and voilà!, music (of a sort) permeated his premises. There was no muss, no fuss, no installation problem. Unfortunately, often there was not very much real music either, at least not for the discerning ear used to the sonorous basses, the bite of real brass tone, the tinkle of the triangle and the kwis-s-shhh! of a pair of 16-inch cymbals in the concert hall. Frequency range was low (which often mercifully concealed some screeching upper-harmonic distortion); dynamic range was modest; hum, scratch and wow were abundant, and pickups wore shellac records into spirals of black thread in heaps of gray groove dust — unless the abrasive in the shellac wore down the stylus first.

The advent of high-fidelity reproduction of recorded sound changed this simple picture drastically. Confined at first to a small, dedicated group of technical and musical aficionados who built their own equipment with loving care, the taste and demand for at least tolerable quality in home reproduction were given a mammoth boost by a number of factors. Among these were the musical film "Fantasia" co-starring Stokowski, Deems Taylor and Mickey Mouse (a most unlikely and unusual trio); the introduction of plastic materials without abrasive content for pressings, and the development of the L-P record by Columbia Records. Since these primitive early times (primitive, at least, for the average music lover who was not also an electronics engineer), there has been a steady advance in the art of recording and reproducing sound. Today, the quality of reproduction in even a



modest home can substantially exceed that available to even the wealthiest 15, or even 10 years ago. In fact, the art has grown, improved and proliferated into different techniques so rapidly that the major decision for the modern music lover may well be between competing *techniques* of recording and reproduction rather than between items of equipment. The improved quality of reproduction is great from the point of view of the consumer, but the diversity in recording and playback techniques adds somewhat to the problems of the installer, be he do-it-yourselfer choosing and putting in his own system or a full-time professional advising clients and making complete installations. Before we get into the nut-and-bolt details of installation problems, it will be helpful to have an overall look at basic techniques of recording and reproducing sound currently of commercial importance.

### **Monophonic sound reproduction systems**

The old standby of sound reproducing systems and still the most popular is the misnamed "monaural" system. It is misnamed because monaural, in a fairly literal translation, means "one-eared" or "one-heard," whatever *that* is. Monophonic is preferable. Actually, monaural refers to the recording of music, with the output of all microphones used for picking up the program mixed into a single composite signal (Fig. 101) and amplified through the same amplifying stages. The amplified signal is then applied to a single recording transducer, which puts the signal on the recording medium (tape, disc, or motion-picture sound track) as a single signal. When reproduced, the recorded program plays back as a single signal. This single signal may be reproduced as a sound wave by a single speaker or by many speakers, either clustered or widely spaced, or even by headphones. But no matter how it is reproduced, the program is still heard as a single signal, and the apparent source will be the general area of the reproducer.

However, even in the monophonic technique, advances have been made in achieving a more spacious, concert-hall effect, as well as in reducing distortion and increasing dynamic range. In the best monophonic systems, a respectable feeling of presence and immediacy can be achieved by use of reproducers consisting of a considerable number of good speakers, so arranged physically that the "listening-through-a-knot-hole effect" that a single small speaker often produces is substantially removed. A good monophonic system, using a fairly large total radiating surface distributed over an area perhaps 6 or 8 feet wide and 4 feet high, and with two or more good squawkers and tweeters properly positioned

and phased with the woofer assembly, can still compete in overall listener satisfaction with most good stereo systems, in the opinion of the authors. This is not to say that stereo does not have some-

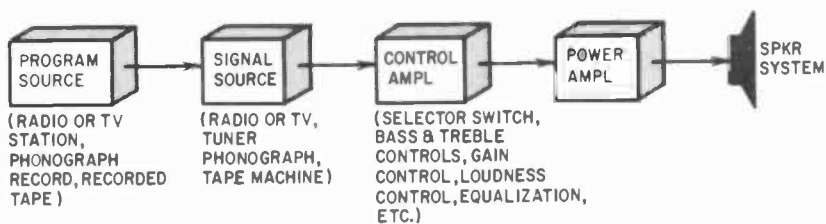

Fig. 101. *Essentials of a monophonic reproduction system.*

thing special to offer, for it does have. But plenty of stereo systems now installed and operating don't provide anything like the advertised effect of spatial location, perspective and presence actually possible in the present state of the art. And, in direct comparison with many a simple stereo system, a monophonic system of the sort described will need no apologies.

### **Perspective and sound-source spatial distribution**

Experiments in reproducing music in a way to give the same effect of spatial perspective and distribution of the sources of sound that a listener at the live performance hears, were carried out very early in the development of the audio art, so early that they are not easy to trace and date. Some of the most basic research and experiments were conducted by the Bell Telephone Laboratories as far back as 1933. In an historic experiment, music and other audible program material were performed on the stage of the American Academy of Music in Philadelphia, picked up by separate microphones, transmitted over separate telephone lines to Constitution Hall in Washington, D.C., and there reproduced through separate speakers.

Properly speaking, the system used in this early experiment was of a type that is now called stereophonic. Another experiment made in the preceding year used two separate microphones and audio channels, and reproduced the separate signals in two separate earphones mounted to form a single headset. Such a system differs somewhat from the type used in the Academy of Music experiment. It is called a "binaural" system, although this, too, is a misnomer in its way, as we shall see.

### **Binaural reproduction**

The term binaural (which might be better written "bi-aural"),

has come into general acceptance in the audio field as meaning a method of reproduction in which two complete audio channels are provided, with complete separation of the channels from the two microphones to the two ears of the listener. A direct translation would be "two-eared," but, since most people listen to *any* kind of sound system with both ears, the term is not accurate without some explanation. As now used, the important distinguishing feature of a binaural system is that *none* of the signal entering the left microphone reaches the right ear of the listener, and *none* of the right-microphone signal reaches the left ear (Fig. 102).

In practical applications, this can be done effectively only by using a separate earphone for each of the listener's ears, with earphone cushions that provide a very effective seal against sound leakage. Because of these requirements, binaural systems have so far had a limited popularity, since most people find the wearing of headphones physically distracting and visually unesthetic, especially for the length of time required for a symphonic performance. An approximation of the binaural effect can be produced by mounting two small speakers in the wings of a well-padded wing chair, but the effect is limited to the occupant of the chair, and the low-frequency response of small speakers suitable for this application is limited.

From the installer's point of view, the rare occasion when he is called on to install a pure binaural system is practically a holiday, for the problems of speaker placement and room acoustics vanish when only headphones are used for listening. From the user's point of view, this characteristic of the binaural system removes any possibility of an irate neighbor or spouse (if he happens to like loud music at 3:00 am), and it also cuts the cost of high-quality reproduction drastically. This is true because of the low cost of the highest quality headphones compared to quality speakers, and the very low power requirements for headphone reproduction.

### **Stereophonic reproduction**

Of the various means of providing an effect of spatial distribution in the apparent source of the sound, the "stereophonic" method is by far the most popular. The term is generally accepted in the audio field as meaning a system of recording and reproduction in which the audible program is picked up by two separate microphones and recorded as two distinct sound signals.

In playback, the two separate signals from the recording medium are picked up and amplified separately, and reproduced through two separate speaker systems (Fig. 103). The two speaker systems are so positioned that the sound signal picked up by the microphone at the right, as seen by an observer facing the sound source, is reproduced through the speaker at the right, as seen by the listener facing the speakers in his living room. Similarly, the signal picked up by the left microphone in the recording studio is reproduced through the speaker at the left in the stereo reproduction setup.

This scheme closely resembles the binaural method, but there are significant differences, some of which are obvious while others

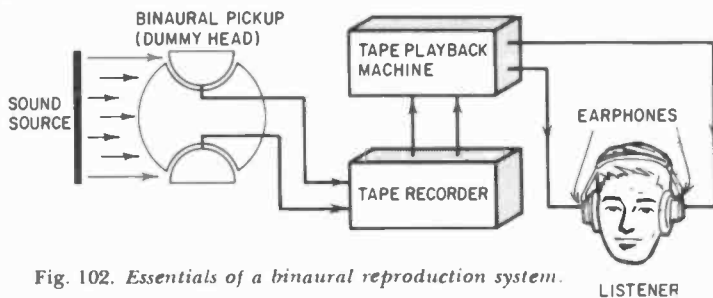

are rather subtle. The unesthetic aspects of wearing headphones are removed, along with the physical discomfort and the restricting effect of the headphone cords. The apparent sound source is given a stable orientation in the room instead of turning with the headphones when a listener turns his head, an effect some listeners find weird. However, the portion of the room in which the maximum stereo effect is heard is fairly limited, and *complete* separation between the sound signals at the ears of the listener is impossible in a practical situation. To be more specific, some of the sound from the right speaker always reaches the left ear of the listener, either directly or by reflection from the walls of the room, and vice versa. Also, the sound-absorbing and/or reverberant qualities of the listening room now enter the picture, in ways that may either enhance or conflict with the best stereo effect.

In spite of these complicating factors, a good stereo system, properly installed, can give a very realistic effect of presence and sonic perspective. The result is particularly good for sound sources that were distributed over a large stage, or moved about on the stage during the recording session. Thus, a symphony orchestra presenting a selection in which a phrase played by the string

section at one side of the stage is answered by a following phrase from the reeds at the other side can be reproduced by a stereo system with a startlingly realistic effect. Similarly, an actor speaking lines while walking across the stage is heard by the listener as apparently crossing the room from one side to the other as the lines are spoken.

All in all, stereo appears to be on its way to dominance in the high-fidelity field, although it is unlikely that the monophonic type of system will ever entirely disappear. From the installer's point of view, stereophonic systems usually pose the more difficult problems. This is true because of the necessity for achieving the full stereo effect, in addition to satisfying the other requirements, such as visual appeal, full frequency range under room conditions, and freedom from echo, standing wave, and sound leakage difficulties. In almost any home listening-room situation however, the skilled installer can accomplish the desired result without serious trouble. The toughest problems arise when the stereo effect must be achieved in a large public room, such as a restaurant dining room. There, some compromises must be made, and it is certain that the effect will not be good in all parts of the room. Such systems are rare however, and a careful explanation of the physical limitations of stereo to the client will usually prevent misunderstanding.

### **Other sonic perspective systems**

It is unlikely that the average installer of hi-fi systems will encounter any type other than those already mentioned. Nevertheless, there are some other schemes for producing the sonic perspective effect, in which the apparent position of the source of the reproduced sound corresponds to the position the sound source occupied with respect to the recording microphones. It is worth knowing about some of these other methods, because they are an aid to understanding the general sound principles involved, and also because they may become more common in the future, particularly for large public rooms.

One method used occasionally for sound reinforcement at large outdoor concert shells and similar places is called the "curtain-of-sound" method. A row of microphones, usually at least four and often six or more, is spaced across the front of the stage. Each is connected to a separate amplifier which drives a separate speaker positioned with its back to the microphone, so that its output is directed to that portion of the audience directly in line with the microphone and the center of the sound source (such

as a symphony orchestra). If the microphones and speakers have approximately similar pickup and radiation patterns, the effect for the audience can be very good to excellent. Such a system practically eliminates the typical public-address-system effect that many simpler sound reinforcement systems give. Yet it makes it possible to present the program at a high enough average sound level to cover a very large audience effectively, despite the inevitable ambient sound from outside sources, such as aircraft overhead.

However, because of the number of separate channels involved, it is very unlikely that the curtain-of-sound idea will be used in recording and playing back sound programs.

Another system that has found limited usage is called coded stereo. It has been used in "road-show" presentations of some motion pictures in which the sound track was of special interest, as in the case of "Fantasia." In this system, a single audio signal is usually recorded, but the playback system has two, three or more amplifiers and speaker systems. All amplifiers are fed the audio signal, and the speakers are dispersed across the stage, usually behind a sound-transparent screen or curtain. In addition to the sound program on the recording medium, coded signals that control the gain of each amplifier are recorded. These signals are usually a sine wave at a frequency below the audible range, around 12 to 15 cycles, or perhaps 20. The coding can be arranged to control the gain of the various amplifiers in such a way that the sound of a marching band, for example, is heard at first only in the speaker at stage right. As the volume gradually rises (controlled by the coded signals), the next amplifier and speaker to the left are brought into action and, as this channel level rises, the output of the first one is reduced. The apparent source of the sound can thus be caused to move across the stage to correspond with the natural movement of a marching band.

The system can be quite effective for certain kinds of programs, (such as the marching band), but it cannot produce the effect of a duet between separate instruments located at two different points on the stage, since only a single audio channel is actually used. It is unlikely that a private installer will encounter such a system professionally, since they are practically limited to special shows that carry their own crew of sound technicians.

### **The installer and system types**

Practically all installation work at present involves one or the other of the monophonic and stereophonic types of system. Essentially, a monophonic system is simpler, both because less



Fig. 103. Basic stereo system consists of stereo program source, dual control amplifier, power amplifiers and two speaker systems. More speakers may be used, but placement is critical. (Photo: Allied Radio Corp.)

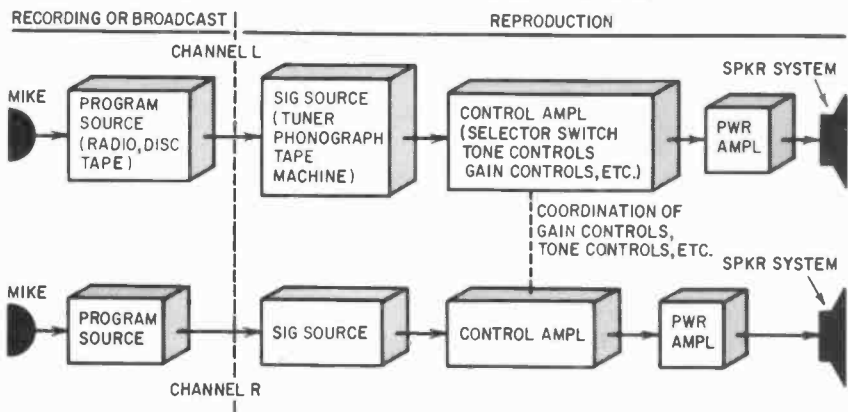

equipment is involved and because the acoustic factors are less complex. In making a monophonic installation, however, it is well to double-check the possibility that the client will want stereo at some time in the future. If so (and the present trend is in that direction), it may be possible to simplify the later job by a little forethought, such as running an extra pair of speaker wires from the amplifier position to the probable speaker location.

# client needs and preferences

SEVERAL factors are involved in determining an individual client's needs and preferences concerning his hi-fi system. You may be able to sell him on something he doesn't *need*, but you'll have a terrible time selling him something he doesn't *want*. That his taste with regard to the sound he wants is primary, goes without saying. But almost as important is his taste regarding the appearance of the finished installation. Function and esthetics will not often mesh well without some careful fitting, and here is where your ingenuity will be required. You've got to come up with the answers within the limitations of the client's budget, space and taste. This is not always easy to accomplish.

## Esthetics of appearance

The tremendous importance of styling and eye appeal to the salability of any product today is obvious to anyone dealing with the general public. That an item like a woman's blouse is sold primarily on the basis of style is news to no one. But for those of us in technical fields, it is still easy to forget the extent to which the purchaser of such a utilitarian object as an automobile is influenced by "sculptured metal" and "decorator-styled upholstery." Manufacturers of every household item from a toaster to an automatic washer spend millions on the superficial appearance of their products.

It is a safe bet that they do not do this capriciously, or with an altruistic desire to make the world a prettier place in which to live. They do it because they've found it sells merchandise. It



turns out that a product that functions adequately and also looks attractive is easier to sell than one that functions just as well or even better, but lacks the attractive appearance (Fig. 201).

It is wise for anyone handling hi-fi installations to take serious note of this fact; many, perhaps most clients, will be just as concerned with the final appearance of the installation as with its performance. Since the enjoyment of hi-fi reproduction is primarily a recreational activity, the equipment is usually installed in living or recreational areas, where appearance counts heavily, whether the installation is commercial or residential. The operators of a restaurant, hotel or country club, in contracting for a commercial hi-fi installation, will be just as finicky about how the thing looks as the individual home owner.

That the total system presents a pleasing appearance becomes doubly important in view of its durability. It is going to be around far too long to be tolerated if it is ugly.

### **Understanding the client's tastes**

People differ widely as to what they find pleasing to look at. On the one hand, it would be pretty dull if they didn't, but on the other, this presents the installer with a considerable problem. He already has a number of technical considerations to contend with to get optimum performance from the system. In addition, he's got to handle these questions within the framework of the client's taste as to appearance of the finished product.

So you've got to start by finding out how the client *wants* things to look. Your first tipoff will be the general type and style of furnishings he already has. You're certainly not going to suggest a French Provincial breakfast room to house a system in an otherwise Modern room, or vice versa. Certainly, you also don't want to make the slightly less obvious mistake of recommending a Hepplewhite cabinet to go in a Directoire room. You are going to need at least a nodding familiarity with the more important furniture styles (these will be discussed in Chapter 10).

The client (and his wife), are likely to have a good bit to say as to what they want. The problem won't be getting them to talk — it will be to decipher what they mean from what they say. The public, bless them, are our customers, and we are not going to knock them. However, many times, they don't entirely know what they are talking about. Just because somebody says he has American Colonial furniture, don't be sure it's not Georgian until you've seen it. His understanding of blonde color and yours may

be quite different. His identification of cabinet woods may or may not be accurate.

It is wise to build up a small file of photographs or drawings of different furniture styles and designs to have handy when discussing this aspect with a client. You can save both yourself and the client much time and avoid misunderstanding if you're able



Fig. 201. *The bare speaker system (a), and its finished counterpart (b). It is easy to see which one will have more sales appeal. (Stromberg-Carlson Co.)*

to pull out a picture and ask him, "Is it like this?" It won't take a huge file to do the job. Two or three pictures each, of eight or ten major styles correctly identified, will pay you many times over for the slight expenditure of time it will take to assemble them.

From time to time, you'll come across timid souls who are afraid to tell you what they want or, perhaps, are unable to decide. When you do, you have a problem because, obviously, you cannot find out what a person wants before he himself knows.

The best you can do with timid types is try to reassure them that they have a perfect right to like whatever they do, regardless of what you or anyone else thinks. And you are not fooling them one bit.

As for the chap who really doesn't know what he wants, if you can't get anywhere by showing him various things (trying to find

one he likes), take the opposite approach. Try to find out what he does *not* like, and narrow the field that way. In any event, don't let this foggy fellow discourage you unduly. He's really the most difficult customer to deal with. Don't waste too much time on him until he has started to clear the haze in his own mind by himself.

### **Esthetics, and all that**

Here we've been blithely using the word esthetics as if we knew it had the same meaning for both of us. More than likely, this isn't so. Therefore, it's up to us to clarify what we mean by it, at least for purposes of the present discussion. In the philosophical sense, of course, esthetics is the general study of the science of the beautiful in any or all situations or manifestations. Obviously, this is too broad a meaning for our immediate purposes. In the present instance, we use the word esthetics to mean the sum of the aspects of style, design and individual taste that add up to make a particular installation visually pleasing in its surroundings and to its owner.

To understand the esthetic preferences of your prospective clients well enough to work with them, you are going to need at least a smattering of design theory and to be on a first-name basis with at least a few styles of furniture and interior decor. You can work with someone whose taste agrees with your own, by feeling. But the only way you can work with someone of differing taste is by applying knowledge.

Chapters 10 and 11 provide the necessary basic information in the esthetic area, as well as some practical hints to its application.

### **Functionality**

It is not just difficult, it is impossible, to divorce esthetics and functionality in the case of a hi-fi installation. In the overwhelming majority of cases, the installation is placed in a living or recreational area where appearance is paramount, while at the same time the equipment being installed imposes certain requirements to function properly.

It is inevitable, then, that conflicts will arise between functional and esthetic considerations. The manner in which the installer handles these conflicts is critical to the client's eventual satisfaction and, therefore, requires careful judgment.

If you have a client who wants the sound of a pair of 15-inch woofers to emanate from a space the size of a water glass, you're in an impossible situation, and that's that. But fortunately, most



Fig. 202. *Large speaker systems may require extensive furniture rearrangement. Book-shelf-size enclosures avoid this problem.* (Allied Radio Corp.)

esthetic vs. functional conflicts are susceptible to some sort of compromise solution that will be satisfactory all around, if you have the wit to think of it.

This brings us back again to your understanding of your client. If you have asked him the right questions about how he wants to use his system, you will not only have a good deal of information to help you in suggesting solutions<sup>9</sup> to conflicts of interest, but you should also be able to avoid a lot of problems before they ever get started.

For example, if a client has just redecorated at considerable expense, does a great deal of business entertaining and will use the system largely for background music to the clinking of high-ball glasses, you'll likely suggest one of the more compact speakers rather than a bulky one (Figs. 202 and 203) that would be difficult to locate in the room without disturbing existing arrangements. If he inquires about a larger reproducer, tell him that you aren't recommending one because there is no place to put it without upsetting the room, and he doesn't need anything bigger anyway. Your conscience should be clear. Of course, you should be sure you haven't overlooked any possibility before making the recommendation.

Unfortunately, the function-vs-esthetic conflicts often cannot be entirely avoided. Then you have to sit down with the client and try to solve them.

Perhaps madam cannot understand why that big piece of cloth in front of the speaker cabinet can't be the same material as her

drapes. The need for high-frequency transmission gives you a good answer — use it; tactfully, of course. If she's still adamant, perhaps you can add a finished panel on the upper part of the baffle board, and bring the tweeter through that directly. Or maybe she will countenance some way of mounting the tweeter separately (Fig. 204).

You probably will not do yourself any good in the long run if you go along with an arrangement that is functionally really bad merely to make one sale, but don't try to be a complete purist about the sound, either. Remember, that unless this is *strictly* a music room, these folks are going to be using it for other purposes, too. After you've done your installation and gone, they have to live with it, so set things up to interfere as little as possible with other activities that go on in the room.

Here again, ask enough questions to get a reasonably clear idea of how the room is used and by whom before you make recommendations. If there are going to be small children toddling about the place a good deal, you may want to recommend that all controls be made inaccessible enough to discourage their interest completely. If teenagers will frequently roll up the rug and use the system for dance music, keep the system off the rug. If the lady of the house is totally uninterested in technical matters but will be the one who uses the system most, keep the controls as simple as possible. If one of the children likes to play rock-and-roll after dinner while Dad sits in his favorite chair to read the paper, see to it that the main speaker system is a good deal more than 6 inches from his left ear.

Fig. 203. *Bookshelf-size enclosures can be incorporated in custom cabinet installations.*  
(Acoustic Research, Inc.)



Another matter that occasionally requires attention is the functional consideration of the client's physical condition. We once had an installation for a man who, while in good physical condi-

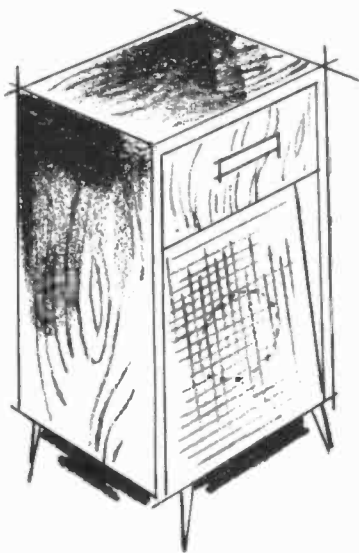

The grille cloth that is used may clash with the enclosure style or with the type of wood that is used. Also, it may not be in harmony with the style of adjacent decorative pieces or other furnishings. Finally, and possibly most important, the grille cloth may interfere with the high-frequency part of the sound. One solution is to mount the tweeter behind a small finished panel. Only the woofer is behind the cloth.

Using a separately-mounted tweeter may reconcile the conflicting demands for good high-frequency transmission from the speaker and the decorative scheme of the room.

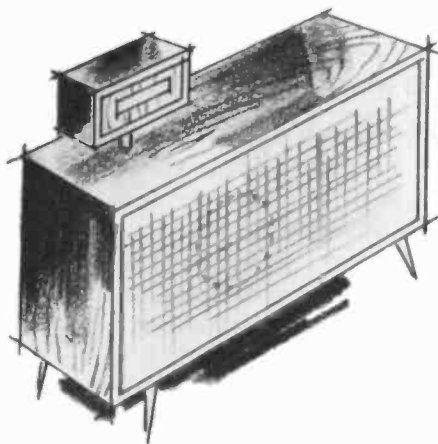

Fig. 204. *If the grille cloth is acoustically bad, find a way to get the tweeter clear of it.*

tion, happened to be both tall and heavy. It was a considerable effort for him to bend down to reach low controls. We set things up so that he could see and operate everything from a standing position. We'd hate to have to operate his system very much, it's too high for us, but it's fine for him. If we hadn't done it that way, he would have had a legitimate gripe.

Very often, people of advanced years have the same trouble when it comes to bending over to reach controls. There is seldom good reason for them to have to, and it is up to you to see that they don't.

You'll be a lot less likely to overlook this consideration in the case of a person with a visible physical disability. It may take a bit of ingenuity to work things out so that he can operate his equipment with a minimum of inconvenience or discomfort (Fig. 205) but, if you don't have a little ingenuity, you should have stuck with servicing crystal sets, anyway.

Another fellow who needs special attention (and he'll ask for it), is the one who has no problem except a personal croquet of some sort. He insists on being able to operate his set from his easy chair, or he wants his controls on a panel that slants back because he is convinced this will somehow simplify his life. His whims may not seem particularly vital to you at first, but be assured — they are. The reasons he gives for wanting things a specific way may not have a basis in anything that remotely resembles logic, but again remember he's the one who will live with the installation. You cannot go along with something that will seriously detract from performance without endangering your own integrity and reputation, but other than that, he is entitled to whatever he wants.

### **Flexibility for future modification**

Fairly often, the client contemplates some sort of future modification to his system at the time of the initial installation. If so, he is hardly likely to be in a position to specify to the installer the necessary technical provisions that should be made to facilitate these later modifications.

Whether specific later changes are in mind or not at the time of initial installation, it is up to the installer to suggest (in the light of his knowledge of equipment) such steps as seem advisable to protect the client from unnecessary complications if and when he decides to make changes.

More often than not, the installer who gives adequate thought to this question not only does his client a favor, but also himself. If the purchaser is happy with the results of his original installation, you are likely to be called back to make any modifications he might want. At this point, *you'll* have to pick up where *you* left off.

Most modifications of earlier installations are going to be in the direction of expansion. This means additional components and

is, therefore, not the sort of business you'll want to discourage.

### **Types of modifications**

At the moment, the monophonic-to-stereo conversion is among the most important forms of system expansion, and will undoubtedly continue for some time. As of this writing, the most



*Fig. 205. Arranging equipment for use by a person with a physical liability will require a little extra thought. (Heath Co.)*

commonly available stereo is in the form of discs. However, the rate of research and development in FM multiplex indicates that in a fairly short time, stereo broadcasts of this type will be regularly available.

An increasingly comprehensive library of stereo tapes is appearing, and a high percentage of the newer tape machines are equipped to play back stereo, if not record it. Thus, a thoroughgoing stereo conversion can be a job of decidedly interesting magnitude.

The addition of signal sources that were not part of the original installation is another very common modification. Here, you're most likely to run into things such as adding radio to a phono-only system, or adding tape to a radio-phono. On occasion, you'll



get the job of piping TV audio into the system, or even arranging for audio to accompany home movies.

You can convert a monophonic system to stereo by adding the second channel — another preamp, amplifier and speaker system. Then by this time you know the disadvantages. You have two of everything to adjust. You have to move leads around to reverse channels or phase, play mono material or play one channel through both amplifiers. Time you started looking for a way out!

You won't have to look far. To cut down on the handling problem, try a stereo adapter. Several of these units are on the market. Their cost — and what they can do — varies considerably, so decide which one gives you what you want commensurate with what you (or your customer) can afford to spend before you make any choice.

With any of these units hooked up the control problem is greatly simplified. Now you have but one volume control, and it regulates both amplifiers simultaneously and equally. You also get a balance control for matching the outputs so the output from both speakers is equal.

Some units (Fig. 206) provide for channel reversal, while others also include phase reversal. Best of all, some can be used as remote controls (attached by wire leads) that can be kept by the arm of a chair so you can adjust volume and balance from your favorite listening position.

Sounds wonderful, doesn't it? Well a little bad comes with the good. It bears an ugly name — insertion loss. Most adapters are passive units and resistances in these units can reduce the level of the signal passing through them — usually as much as 3 to 9 db. If the adapter you get cuts the signal level too much, you may have to keep your amplifiers' gain unreasonably high, introducing additional and unwanted distortion as well as lowering the signal-to-noise ratio. Be sure the adapter you get is suited to the amplifiers.

Adapters come in many forms. Some are adapters and nothing more. Others are remote-control units as well, and one incorporates a preamp that is used for the second channel.

The enlargement of speaker systems can involve anything from the addition of a single tweeter to a complete replacement. Enlarged speaker systems, in most instances, involve enlarged cabinetry, and this in turn often raises space and placement problems. You're not likely to get a 7-cubic-foot box in a space formerly occupied by a 2-footer. Or have you noticed this?

Running remote speakers to other rooms is a refinement that is

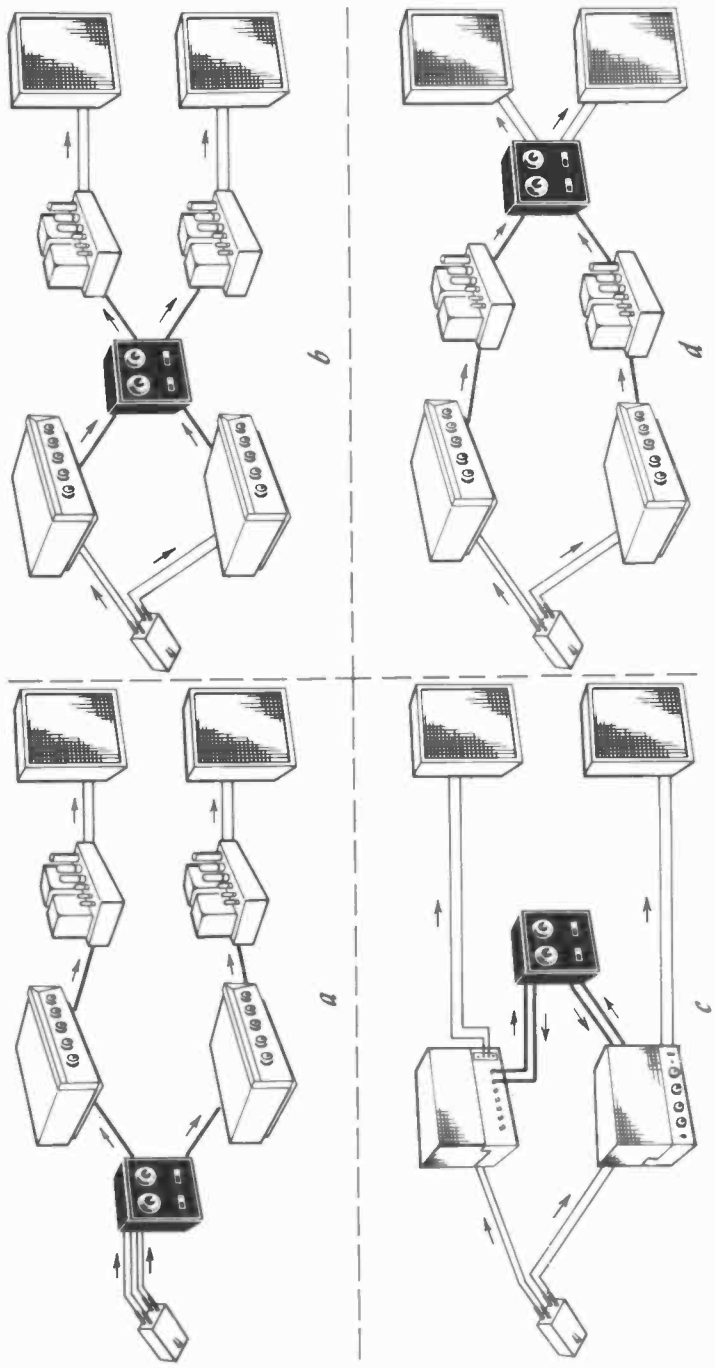

Fig. 206. Various stereo adapters can be used in different ways. A single adapter cannot be used in all the arrangements illustrated. They are limited to one or two of those shown. (a) Between the cartridge and the preamps. (b) Between the preamps and the amplifiers. (c) With combinations (preamp and amplifier in one unit). Tape-output jack connects to tape-monitor jack. (d) Between the amplifiers and the speakers.

becoming increasingly popular, and for good reason. Why *not* have your music follow you around the house if you choose? In most cases, the remote speaker systems will be considerably smaller than the main system. This is logical since they are not intended for the same kind of listening.

### **Advance electronic provisions for modification**

Spare inputs on amplifier, preamplifier or tuner (whichever is the main control center for the system) are a must in providing in advance for future expansion of the system. This is seldom a problem, since these components are normally manufactured with enough spare inputs to accommodate any additional signal sources you're likely to want.

Reserve amplifier power to provide for future enlargement of the speaker system or the addition of remotes is not as easy. First, you have to decide how much reserve power you should provide, and then, you have the job of convincing the client that he ought to buy something that is bigger (and therefore more expensive) than what he needs at the moment. The mere suggestion of such an idea requires diplomacy, if he is not to get the idea that you are trying to raise the cost on him, and thus start to mistrust you entirely.

Straight AM-FM tuners do not differ in cost very much from the stereo models, so here you shouldn't have too much trouble. In fact, soon you probably won't be able to find a new nonstereo AM-FM tuner, even if you want one. A majority of the current tuners also have inputs for FM multiplex.

With regard to changers, or turntables and arms, it is foolish to handle any equipment that isn't adaptable for stereo, whether it is going into an installation that is stereo initially or not. Perhaps you should not give a man a stereo cartridge until he is ready for it, but give him a changer or transcription arm that is already wired for stereo. On tape machines, too, stick with the ones that offer a stereo playback, at least.

In connection with future modifications, there is another thing that many tend to forget when making an installation. If at some point you've got a nasty place to fish wiring through — a floor, a wall, or a ceiling perhaps — why not fish a *spare* pair through while you're at it? Then, if you ever have to come back again, you won't have that rotten job to do twice. There's more on this subject in Chapter 5.

### **Advance cabinet provisions for modification**

First and foremost, the provision to make in a cabinet in allow-

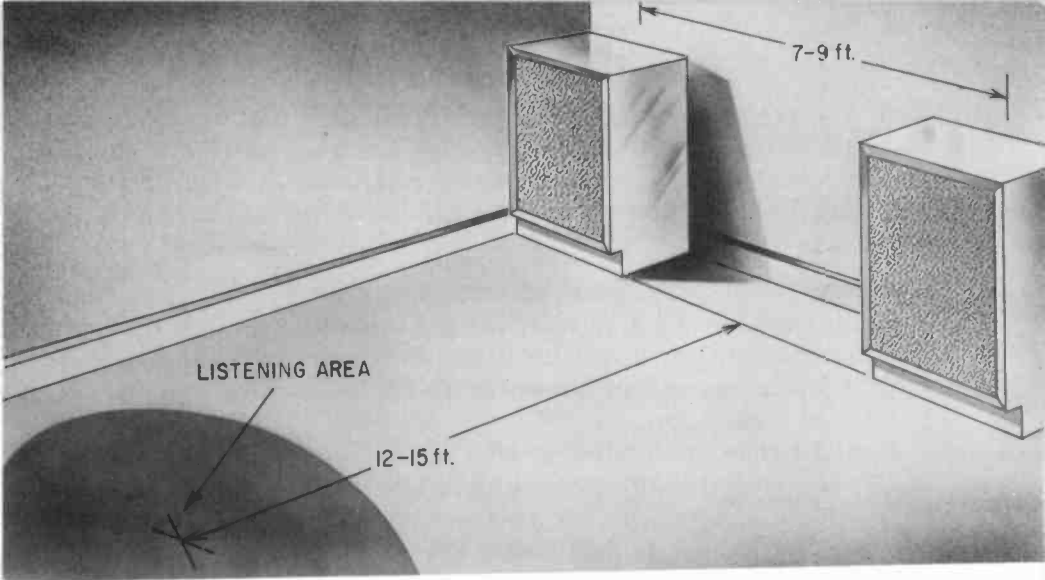

Fig. 207. If stereo installation is imminent, make things easier for yourself (and your customer) by placing the main monophonic speaker system in the position it will ultimately occupy as a stereo speaker. Placement of stereo speakers will vary with room shape and size and types of speakers used.

ing for future system expansion is some spare space. Empty space as such, however, is of no value unless it is placed and shaped so as to be usable.

The shape, location and access to a space intended for a future stereo tuner will not be the same as that required for a tape machine. Suppose your original installation includes stereo phono, tuner, preamplifier and amplifier. What is the next most likely step? Tape, of course! So, if you have left a full square yard of  $\frac{1}{4}$ -inch control panel space, what earthly use is it going to be? As our British cousins would say, ruddy little.

By the same token, if you have enough space to garage a car, but it's at the bottom or the back, with nothing left on the control panel, what happens if the next logical step is to put in a tuner?

No great acuity is required to see this kind of thing. The only trick is to remember it at the right time.

Another good thing to remember: *never* glue in control panels, record-player mounting boards or even internal mounting shelves for tuners or amplifiers. It's a devil of a job to get such things out once they've been glued in. You can very readily make a hopeless mess of the cabinet trying to do so, and it's unnecessary.

Screws will hold such parts admirably and are easy to remove.

Don't glue baffle boards or backs in speaker cabinets, either. If you have a revision in the speaker system, chances are you'll

have to make some new holes in the baffle board (try doing this without taking it out!). Even if there are no changes of the speaker system, grille cloth gets tired after a while. Try merely changing the grille cloth on a baffle board you've glued in. You'll never glue one again!

### **Advance room provisions for modification**

As the installer of a hi-fi, there is not a great deal you can do in this department, but there is a little. How much you can do is largely dependent on how imminent modifications are at the time of original installation.

If at the time of installation of a monophonic setup, a stereo conversion is clearly intended within a few months, you might as well plan your stereo speaker placement now (Fig. 207) and put the speaker system that goes in initially as one side of the stereo arrangement. But if a stereo conversion is planned only for some vague and remote future time, you may as well arrange the best monophonic setup you can and not worry about the stereo. By the time you get back for the conversion, the room may well have been completely redecorated. Accessibility of controls is partly a matter of cabinet design and room placement.

When suggesting possible room locations for the operational parts, try to think ahead to what will happen to the convenience of operation as that control panel later gets filled up, or the storage compartment at the bottom of the cabinet becomes great with tape machine.

### **Explaining factors to the client**

This is transparently one of the most important parts of any installation job for a simple reason. If the client does not understand the various factors we've been discussing, then he doesn't understand what you are selling. If he doesn't understand what you're selling, he's not likely to buy.

Adequate explanations are particularly important in dealing with people who have never before had true hi-fi. They will have heard about hi-fi from a variety of sources. But without any first-hand experience, they are bound to have a mixed bag of information and misinformation that will have to be sorted out and the waste matter disposed of.

You'll probably never get light on all of the curious dark superstitions held by some of your clients, but most of the more important ones will readily show themselves, like "Why do you have to play it so *loud* all the time?" or "I don't *ever* have to change a diamond needle?"

Some of these superstitions are going to seem pretty ludicrous to the trained technician, but don't let the client know this. They are still a serious business to him until they have been dispelled and, you've been elected to do the job.

If he's been asking some particularly naive questions and seems inordinately blockheaded about understanding the answers, try thinking how unintelligent you might appear if asked to grapple with the technicalities of *his* field. This usually helps you to find a bit more patience.

There are also a few other questions you might usefully ask yourself. One is, have you adequately and correctly analyzed the client's situation? You should have checked this carefully before you opened your mouth in the first place. It is vitally important that he feel confident you know what you are talking about. Be sure you have taken all factors into account before you make recommendations, because nothing will shake his confidence faster than catching you seriously off base.

Have you sized up your man properly? Are you telling him about the things that interest *him* in a manner he can understand? Suppose you've got a fellow who knows nothing whatever about electronics, and cares even less? But he happens to know and appreciate music well. A big pitch about the difference in frequency response and distortion between hi-fi and non-hi-fi will pass by him. However, if you can show him that reeds will sound reedier, brasses brassier and strings stringier, he's more likely to be interested.

The fellow who will use a system primarily for background music while entertaining, and who neither knows nor cares about either the electronic or the artistic aspects of the performance, won't be impressed by either approach. But he might possibly be interested in its being simple to operate, that it requires little attention while running, and that he can expect a lot of running time before he'll need any servicing.

When you are proposing compromises with what you would consider an ideal system because of space, usage or esthetic reasons, be sure to tell him why. You don't want him to talk with a friend and get the idea that either you don't know what you are about, or are giving him a fast shuffle.

Again, the fellow whose system will be used to provide background music should have a changer, and it should not be difficult to show him why. For equally good reasons, the golden-eared musicologist should be strongly steered away from the changer.

## The installation decision

When your explanations are completed and all questions answered, it is time for the decision. Bring him to it. As many sales have been lost by too much talking as by too little. There is certainly no rule you can go by as to when to stop the talk and close the deal. This is something that only experience can teach you, if you don't already know.

It is a good idea to sit down periodically and go over in your mind the jobs you got and the ones you didn't, and try to figure out why the results were as they were in each case. Gradually, you'll find that you are handling potential customers better and better, and what's more important, getting a higher percentage of the jobs you go after.

We will have more to say in Chapter 3 about the form the paperwork should take when completing a sale, but this will be from the point of view of avoiding legal problems. Regardless of the legal considerations of terms and conditions, you don't want any later confusions or misunderstandings about details and specifications, so get them all written down, dated and signed. It's awfully easy to just plain forget, a month later, an exact detail like the color of a wood finish. It may seem so simple at the time as to be impossible to confuse, but *don't you believe it*. Both of you will have a lot of other things on your minds in the meanwhile. Play safe. Refer to a specific sample in writing, and both of you keep a copy. If any subsequent changes are made, write them down and attach them to the original specs. Nine times out of ten, these precautions will have been unnecessary but the tenth one could be a real bone-crusher.

# legal and insurance considerations

**T**HERE are several reasons why no book on hi-fi installation work can be considered complete without some discussion of legal considerations. One of them is that ignorance of the legal factors involved may lead you to incur legal liability for some staggering sums of money, whether you are in the business of installing hi-fi or are just putting in a system for yourself. Do we need to go into any *other* reasons?

The law of the land is written and interpreted in ways that are sometimes mysterious and frequently totally incomprehensible to the layman, which means anyone not trained in law, regardless of how much he knows in other fields. This is partly because the law, like Topsy, "jest growed" and partly because law, like medicine, has "mysteries" which the specialists have felt it would be unwise (and unprofitable) to share with the lay public. Entering upon an installation job with all the ethics and good faith in the world can nonetheless expose you to legal obligations and liabilities you never dreamed of. Or the same job may place others in positions of legal liability to you. When this happens, it still may be necessary for you to have some legal guidance to insure that you do not surrender your rights by default.

What we are doing in this chapter is pointing out the more important general areas in which legal problems can arise in connection with installations. Some of these areas will be of concern to you only if you are in business doing installations, while others will concern you even if you are merely installing a system for your own personal use.



For specific advice on how to protect yourself from legal difficulties (as well as solutions for any that do crop up), you should consult your lawyer and your insurance agent. Your accountant can often assist you in these matters, as well.

If you don't have a lawyer, get one, particularly if you are going into business. Have a good, long session with him before you start, and let him explain to you in some detail the various legal pitfalls you should be on guard against. If you pay careful attention, you won't need to see him again until a claim arises, and that could be years.

Any claims or controversies that do develop can be classified in two basic categories. One includes all matters relating to government regulations — Federal, state or local. The second covers all questions of private dealings — between buyers and sellers, employers and employees, and liabilities to third parties.

### **Government regulations**

All of us are more familiar than we'd like to be with the fact that the Federal government taxes our personal incomes. But if you set up a business, this is just the beginning of the ways in which Government will come into your life.

To stay with taxes for a bit, as soon as you take on help you'll have to deduct Federal and perhaps state income tax from their wages and send it to the right place, at the right times, along with the right forms. In many cases, you'll have to make another deduction under the Federal Insurance Contributions Act (Social Security). This time you get taxed an amount equal to the employee's tax when you send it in. In addition, you may have to fuss with a Federal or a state unemployment tax and disability insurance.

If you are not thoroughly familiar with the Federal requirements regarding withholding of taxes from employee wages, send to the District Director of Internal Revenue in your area, requesting a copy of *Circular E*. This circular will give you information explaining which employers and employees are subject to which taxes, what constitutes "wages" under the law, how to compute the taxes from the wages, and various other happy bits of incidental intelligence. If you remain puzzled by some points, consult your lawyer or accountant, before you make some mistakes and thereby incur penalties or interest that your pocketbook will find unwelcome. Similar help can be obtained for state and local tax questions.

In doing hi-fi installations, you are not likely to run afoul of

Federal agencies other than the Treasury Department unless you violate wage and hour laws. Your lawyer can tell you whether they apply to your operation.

Some states have income taxes, unemployment insurance taxes, corporate taxes, or unincorporated business taxes, and the like, so you'd better find out from your lawyer or accountant whether any of these things exist in your state and, if so, how they affect you. Also, have them check whether there are any other state agencies that would have jurisdiction over any aspects of your business. Of course, if you are setting up a corporation, this will have to be done by your lawyer through the appropriate state office.

In addition to Federal and state taxes, you may be subject to municipal taxes of various sorts. In New York City, for example,

CUSTOMER'S RECEIPT			
DATE	JOB NO.	MAKE	MODEL
RECEIVED (for shop service)			
PER _____			
SERVICE TECHNICIAN			

CUSTOMER'S RECEIPT			
DATE	JOB NO.	MAKE	MODEL
RECEIVED (for shop service)			
PER _____			
SERVICE TECHNICIAN			

Fig. 301. When equipment is pulled for work in the shop, give the customers a receipt.

there is a real estate tax on the owner of a property, and an occupancy tax on one who rents premises for business purposes. In addition, there is a gross business tax if your business grosses more than \$10,000 a year, and there is also a city sales tax. Other cities may have some or all of these taxes, or some others of different kinds. Thus, the tax situation in your municipality requires investigation.

In addition to taxing powers, your municipality will have a building code, an electrical code and health regulations that will affect what you can do in and to a building when making an installation. If, and only if, you are doing an installation for your

own use in your own private home, these regulations will not apply. But when you are working in a multiple dwelling, a commercial structure, a public building or someone else's private home, they *will* apply.

Building, electrical and health codes vary considerably from one place to another. So to be safe, you've no choice but to look up the ones for your particular locality.

An unincorporated business, whether proprietorship or partnership, may require registration with the county clerk or other

LANE'S RADIO SHOP  
GI 3-6661  
130 Jefferson Ave.  
New London  
DO NOT REMOVE

Date \_\_\_\_\_  
Served By \_\_\_\_\_  
Tubes \_\_\_\_\_  
\_\_\_\_\_  
\_\_\_\_\_  
Fuses \_\_\_\_\_  
Adj: \_\_\_\_\_  
\_\_\_\_\_  
Misc. \_\_\_\_\_  
\_\_\_\_\_

Fig. 302. Adhesive tags attached to equipment that has been serviced aid the technician on the next service call and are good advertising.

public official. This will avoid the complications that could arise if two firms in similar types of business in the same locality inadvertently choose the same name.

Although we have tried to mention the main areas in which installation work could bring you in contact with Government regulation or authority, we don't purport in these few pages to have covered them all. Naturally, very little of our discussion on Government regulation applies to the individual doing his own personal installation, but if you are a professional, we hope we've stimulated you to investigate these matters thoroughly (if you haven't already).

### Private dealings

The vast majority of litigation choking up the courts all over the country results from claims and disagreements arising in various ways out of private dealings. And the monumental number of private disputes that actually reach trial is small compared with the number finally settled out of court. A lawsuit of any kind,

whether settled in or out of court, will certainly cost you time and possibly a substantial amount of money. Therefore, a suit is to be avoided whenever possible, and a substantial number of the suits that do arise could be avoided if one or both parties used a bit more foresight.

While there are many suits, particularly in the area of accident claims, that reasonable caution could not, or did not prevent, proper insurance can minimize most of the serious dangers.

Keeping good records is good business, helps avoid lawsuits. If you must pull the hi-fi system for repairs, give your customer a receipt (Fig. 301) but make sure the receipt is filled-in properly. No one, let alone an audiophile, likes to see precious (and possibly expensive) equipment disappear into the unknown, without some tangible proof of transfer. Putting a gummed label (Fig. 302) inside the equipment (after repair) gives you a capsule review if and when you get the same job again. Psychologically, from a customer's relations viewpoint, it's a good gambit.

Let's look now at some of the ordinary types of transactions out of which disagreements resulting in litigation can crop up.

### **Originating a business**

The fellow who sets up an unincorporated business wholly-owned by himself need go through no elaborate legal procedure. Once he has complied with the Federal, state, and local regulations that apply to him, he can consider himself technically in business. He doesn't need extensive business premises, equipment or stock to be legally in business. But before he does any jobs, he'd better have adequate liability insurance because, as the sole proprietor of an unincorporated business, he is *personally liable* for *any* claims made against the *business*. If someone has an accident on his premises, or if there is an accident on someone else's premises involving his installation, tools or equipment, he can be sued. And if a sizable judgment is secured against him, he can be thoroughly wiped out if he's not adequately insured.

When two or more go into business in the form of an unincorporated partnership, they should first, be sure of each other, and second, they should have a complete and thorough partnership agreement drawn. A lot of old friendships have broken apart under the strain of a loosely drawn business partnership.

Remember, too, that in an unincorporated partnership, *any* or *all* of the partners are personally liable under the law for the actions of any or all of the others. Translation: one of the boys can get the business in a fix that will ruin all of you.

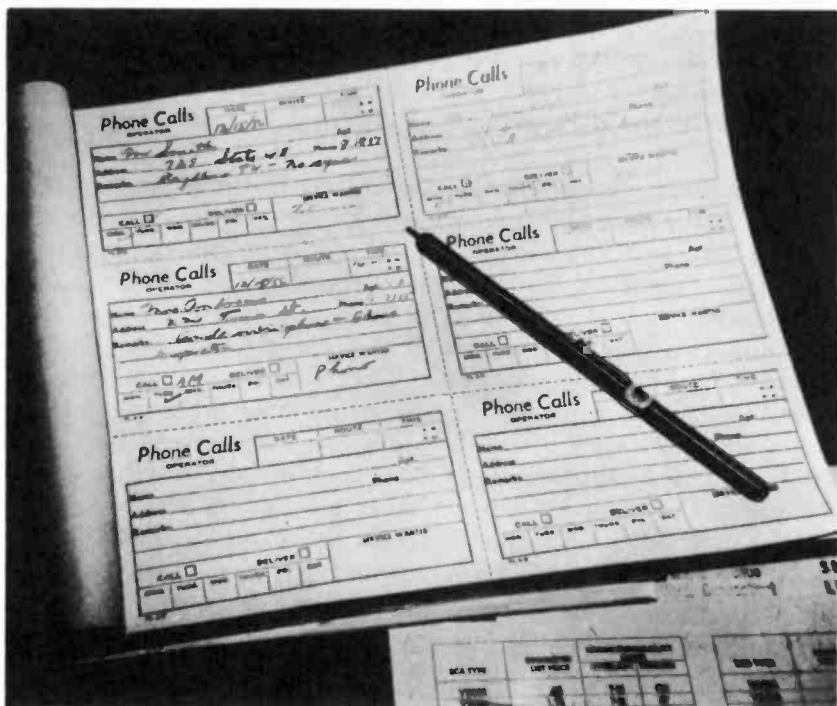

Fig. 303. Requests for service are listed in the phone call book.

One major reason for incorporating a small business is to eliminate the danger of personal liability for business obligations.

Except where improper actions on the part of an officer can be shown, civil suits and judgments against an incorporated business can be leveled only against the corporate entity and not against individuals. Translation: one of the boys can run the corporation or himself broke, but your personal holdings outside of the corporation (your house, car, bank account, etc.) are safe.

### Purchases

Of course, the easiest way to avoid litigation in connection with your purchases is to pay your bills more or less on time. But now and then you'll have a reason, other than lack of cash, that seems a valid cause for withholding payment. The question then is will your reason hold up legally.

Suppose you pick up the phone and order 23 standard gilhickies and 3 standard fozzles. You don't confirm it in writing and neither does the supplier, who subsequently sends you 23 fozzles and 3 gilhickies. Are you stuck because *he* got the order backward?

Generally not, if you return the incorrect order and let him correct it. However, now suppose you ordered a couple items that he had to make up specially for you, and he *did* confirm in writing but you failed to notice on the confirmation that he had the order backward. Are you stuck *this* time with a load of stuff that you don't want? Unfortunately, yes!

The worst of it is, you've only yourself to blame. If *you* had sent a written confirmation of your telephone order, you'd be in the clear. And while we're at it, keeping records of phone calls for service (Fig. 303) is also a good habit.

At least 75% of the problems in connection with purchases can be eliminated by the use of clear, complete written orders stating quantities, specs, terms, delivery dates and method of shipment.

Speaking of shipment, a lot of troubles arise relating to merchandise damaged in transit. If the terms of sale include delivery by the supplier, he may not be directly liable for transit damage, but he *will* have to claim and collect for it from the carrier. But when the terms are FOB some point at which the supplier delivers the merchandise to a carrier, his responsibility ceases at that point and *you'll* have to claim against the carrier for any subsequent damage.

## Sales

There is little question that the major legal problem in connection with sales is going to be collecting. Only after every other possible means has been tried and has failed should you sue for collection. A suit is expensive, time-consuming and not at all good for your public relations.

Unless you are particularly unlucky, you won't have to sue very often. Nevertheless, at the time a sale is consummated, you should protect your position in the event that you later have a collection problem. When you take an order, write down everything in detail, e.g., model numbers, colors, delivery date, terms, and prices. On anything over \$100, have the customer sign the original of the order (which you keep) and give him a carbon copy. If there are any changes in the order prior to delivery, confirm these in writing and have the customer initial a copy and return it to you (Fig. 304.)

A good deal of the trouble and delay over collections develops because the customer thinks he didn't get what he ordered, either in kind or in quality, so he becomes reluctant to pay. If the original order was well-written, reference to it will readily clarify such points.

MASTER SERVICE CARD											
CUSTOMER			ADDRESS				CITY		APP.	PHONE	
R. SMITH			1001 HENS HAW ST				N. L.		7254	91-3-6661	
CUSTOMER EQUIPMENT INFORMATION											
UNIT NO.	EQUIPMENT	MAKE	MODEL	WE SOLD		WARRANTIES EXPIRES			SERVICE CONTRACT		
				DATE	PRICE	PARTS	PER YEAR	REPAIRS	STARTS	ENDS	
1	TELEVISION										
2	TELEVISION										
3	HOME RADIO										
4	AUTO RADIO										
5	PORTABLE RADIO										
6	Radio	Model: 1	Preamp	5/17/59	74.95						
ACCESSORIES		<input type="checkbox"/> V. H. ADAPTOR		<input checked="" type="checkbox"/> F. M. TUNER		<input type="checkbox"/> RECORD CHANGER					
BUILT IN FEATURES		<input type="checkbox"/> V. H. F.		<input type="checkbox"/> F. M.		<input checked="" type="checkbox"/> RECORD CHANGER					
SERVICE INFORMATION											
UNIT NO.	SERVICE DATE	JOB NO.	SERVICED BY		PIECES BY	DELIVERED BY	INSTALLED BY	PRINCIPAL PARTS REPLACED	TOTAL PRICE	P. T. U.	
			IN HOME	IN SHOP							
6	4/21/60	88579	Cy					Two Tubes	18.50	45	

Fig. 304. Master service card shows all work performed for each customer.

Try to make delivery on the date promised. Delivery on time doesn't mean you'll get paid on time, but at least your customer is encouraged in the right direction. And if your customer isn't home when delivery is made, a short note on your business card (Fig. 305) is proof against future grumbling.

## Warranty

Any standard hi-fi components you purchase for an installation will carry a factory warranty of some kind. If you are doing your own personal installation, this is as much warranty as you get, and you'll get a different one on each component.

When you are doing an installation professionally, you do not have to warranty the components beyond the manufacturer's warranty but whether you state it or not, your own work legally carries an implied warranty. By purporting to be a professional, which you've done by taking the job in the first place, you are expected to do work of at least average professional quality. If you don't, you can be required to make good.

By the way, if you or your customer putter around inside a component during the period of the factory warranty, you are very likely to void that warranty, so be very careful yourself and be sure to warn him on this score.

## Liability and insurance

Whether you are a home owner, a professional installation man

or merely a tenant living in someone else's building, the various kinds of personal injuries and property damage for which you can conceivably be held liable would probably gray your hair instantly if you were aware of the complete list. Better than 70% of all the lawsuits tried in the civil courts throughout the country are claims for damages arising out of personal injuries.

There is no earthly way you can insure yourself against people instituting liability suits against you, but you certainly *can* insure yourself against the consequences of such suits. The way to find out what kinds of liability insurance you should carry, and how much, is by conferring with a qualified insurance agent. Various individuals and various businesses will each have different risks and, therefore, different liability insurance requirements.

Of the commoner forms of liability coverage, we'll mention a few. If your agent recommends one we haven't noted, go by what



Fig. 305. If the customer is not at home, a card left in the door shows that you were there.

he says. He knows your circumstances and needs — we don't. And we wouldn't dare make recommendations if we did!

If you are in business and have as many as *one* employee, you should have Workmen's Compensation coverage. In many states you have no choice, since it is required by law. But required or



not, carry it! All you need is one serious accident and that employee could clean you out right down to your shoelaces.

Your agent can also advise you regarding nonoccupational disability coverage. This is an additional form of protection for employees.

Depending upon the type and extent of your business operations, a number of additional coverages available protect you against liability claims from customers and from what are called "third parties." A third party is someone not directly involved in a transaction with you, who may be injured while you are pursuing the normal course of your business. Owners', landlords' and tenants' liability, manufacturers' and contractors' liability, and storekeepers' liability are common forms of such coverage. Each covers a different range of risks so find out whether you need any of them, or perhaps something else entirely.

You'd also do well to find out whether you should carry comprehensive personal liability on yourself, your family and your home.

A happy thought in connection with insurance is that your insurance company will defend you legally against any claims or suits for liabilities covered in your policies, making it unnecessary for you to go to any personal expense to defend such claims.

To repeat what we said at the outset of this chapter, we have not attempted to give you any legal advice whatsoever. If, however, we have run a cold chill or two down your spine sufficient to send you scuttling off to your attorney, accountant or insurance agent, we have succeeded admirably in our purpose, which has been to induce you to take the necessary steps to protect yourself.

# high-fidelity system components

THE various types of manufactured hi-fi system components pose few serious technical problems from the installer's point of view. Nevertheless, it is useful to have an overall picture of just what may be encountered, and what may be anticipated as later additions to a system before you begin. Right away, it becomes desirable to clarify a few definitions before going into details. For our purposes, a hi-fi *system* is defined as meaning the entire collection of equipment that makes up the installation, even though all the various units that make up the whole may never be in operation at once. Thus, a simple system (Fig. 401) might con-

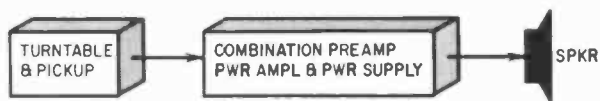

Fig. 401. *The simplest form of a single-channel high-fidelity system contains just three components: the record player, the preamp-amplifier combination and the speaker system. For many installations, this is all that will be required.*

sist of a turntable with its associated tone arm and pickup, a preamplifier, a power amplifier and power supply (either as one unit or separate), a speaker in its enclosure and the cabling necessary to connect these components in the proper manner.

A *component* we define as any single unit of equipment, such as a preamplifier or record changer, that forms one of the building blocks of a system. This will simplify the discussion both here and in more complex matters taken up later. While we're at it, we may as well define the word *part*, also. This word gets abused often, so we'll use it to mean a specific part of a component or system

that is not usually further subdividable, such as a vacuum tube, pickup, resistor or speaker.

### System elements

Before we go on to detailed consideration of the various components that may be combined into a hi-fi system by the installer, it will be useful to consider a more versatile system than that of Fig. 401 and a fairly elaborate stereo layout.

The system shown in Fig. 402 contains 7 components that are

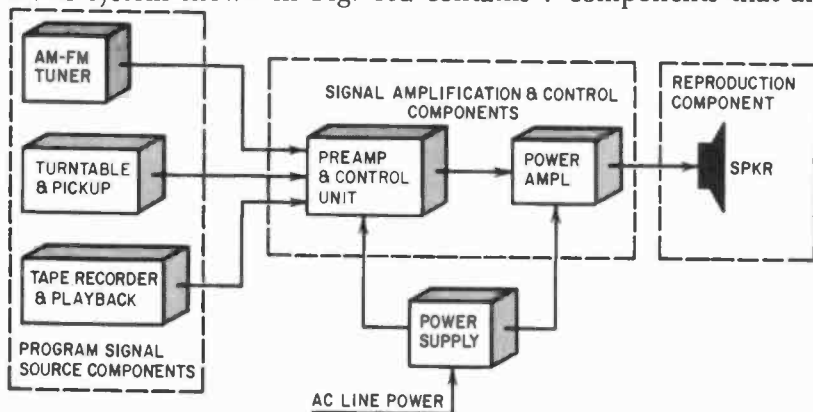

Fig. 402. Greater listening variety is afforded by using several different program sources and a flexible preamplifier. The control section of the preamp will perform a variety of switching functions, while use of a separate power amplifier makes for easy replacement for future expansion of system.

classifiable into 3 categories that will be recognized in all hi-fi installations. The three boxed at the left in the illustration are sources of program signals to be reproduced. Since the signal from such sources is not strong enough to drive the reproducer directly, and also usually requires some frequency response correction, it goes next to the components in the center box. Here, a switching circuit permits selection of the desired program signal, and equalizing networks and tone control circuits afford the needed adjustment of frequency response. Finally, the prepared signal is raised to the desired power level and applied to the reproducer, where the electrical signal is converted into sound waves and radiated into the listening area.

It doesn't necessarily follow that all monophonic systems are simple and stereo systems complex. The interconnections for the various components of a monophonic setup can be somewhat extensive. Fig. 403 shows a monophonic arrangement.

Regardless of how simple or elaborate a system is, it contains at least one component in each of the three categories mentioned,

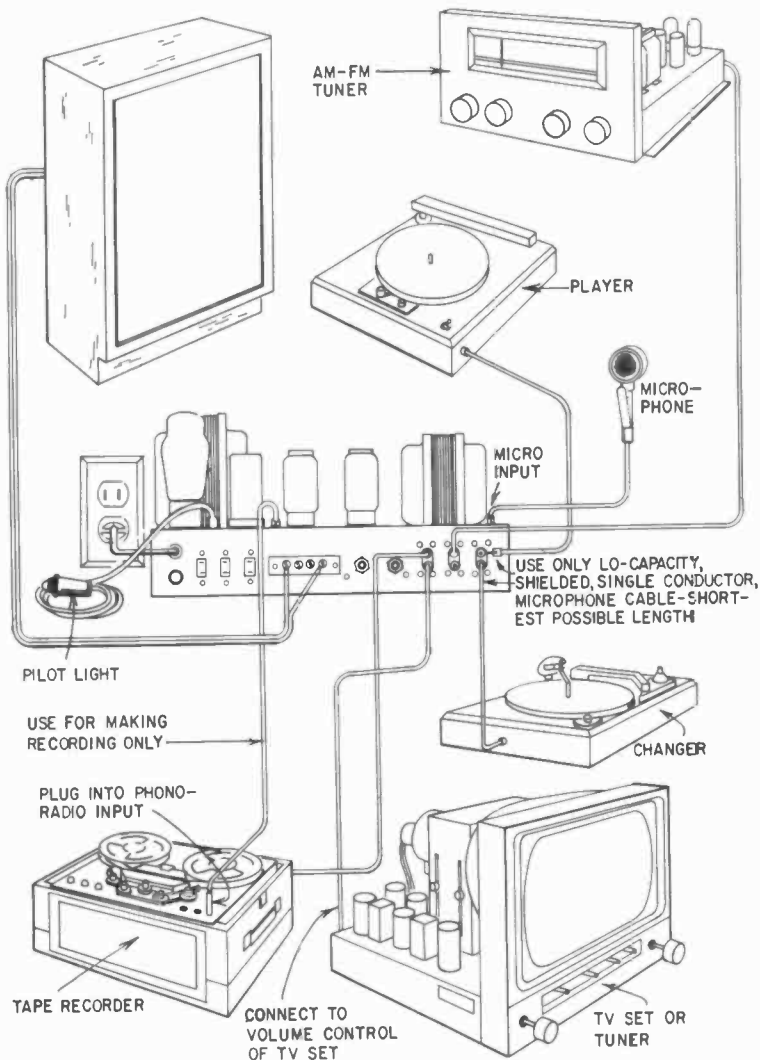

Fig. 403. A truly flexible preamp section should have many inputs, both high- and low-level, tapped speaker outputs of several impedances and a constant-level output for tape recording. Make primary connections between program sources and amplifier with low-capacitance coaxial cable. Keep cable length as short as possible—preferably 18 inches or less. And when wiring, be on the lookout for a hot chassis. Avoid interconnecting transformerless TV sets.

and two or more components are often combined in a single assembly. For example, the system shown in Fig. 401 has the pre-amplifier, power amplifier and power supply combined in a single

assembly. Many modest hi-fi installations use this combination type of component, particularly if space is at a premium. On the other hand, in elaborate installations such as the stereo system of Fig. 404, several components not often encountered may be found, such as resistance-capacitance frequency-divider networks. In this stereo setup, the FM and AM tuners are shown as one mechanical assembly, although they must be independently tunable to be usable for stereo. The preamplifier and control units for the right and left channels are shown this way also.

### **Tuners for hi-fi systems**

In order that high-fidelity broadcasts may be reproduced in the home with something like the quality of sound that the artists create in the studio, a radio receiving unit of somewhat special characteristics is needed at the receiving end. In a few cases, such a receiver may be a very elaborate component built into a cabinet with its own power amplifier and speaker. However, the most popular hi-fi component for this purpose is a specialized unit called a tuner. The name derives mainly from the fact that it tunes in the desired station while excluding undesired ones, amplifies the signal, demodulates the audio signal from the station carrier, and delivers the demodulated audio signal at a low power level to the next component in the reproduction chain, usually the preamplifier. A representative tuner is shown in Fig. 405.

Tuners may cover the regular broadcast band of amplitude-modulated stations only, the frequency-modulation band only, or both. The last variety may be so constructed that only one of the two bands may be received at a time, or so designed that any station on either band may be tuned in simultaneously, but independently. This type is rapidly gaining in popularity, since it makes possible reception of stereo programs from those stations using the simultaneous AM and FM system of stereo broadcasting.

### **All-wave receivers**

The all-wave receiver, once very popular, was so-called because it could receive the regular American broadcast band (550 to 1600 kc) and one or more high-frequency (shortwave) broadcast bands. These receivers fell from popularity for some years, but are now experiencing a renewal of listener interest, and you may occasionally find it necessary to integrate one into a hi-fi system.

Some receivers of this type are not very satisfactory as a high-fidelity signal source without modification, due to sideband cutting in the if amplifier, restricted frequency range in the audio

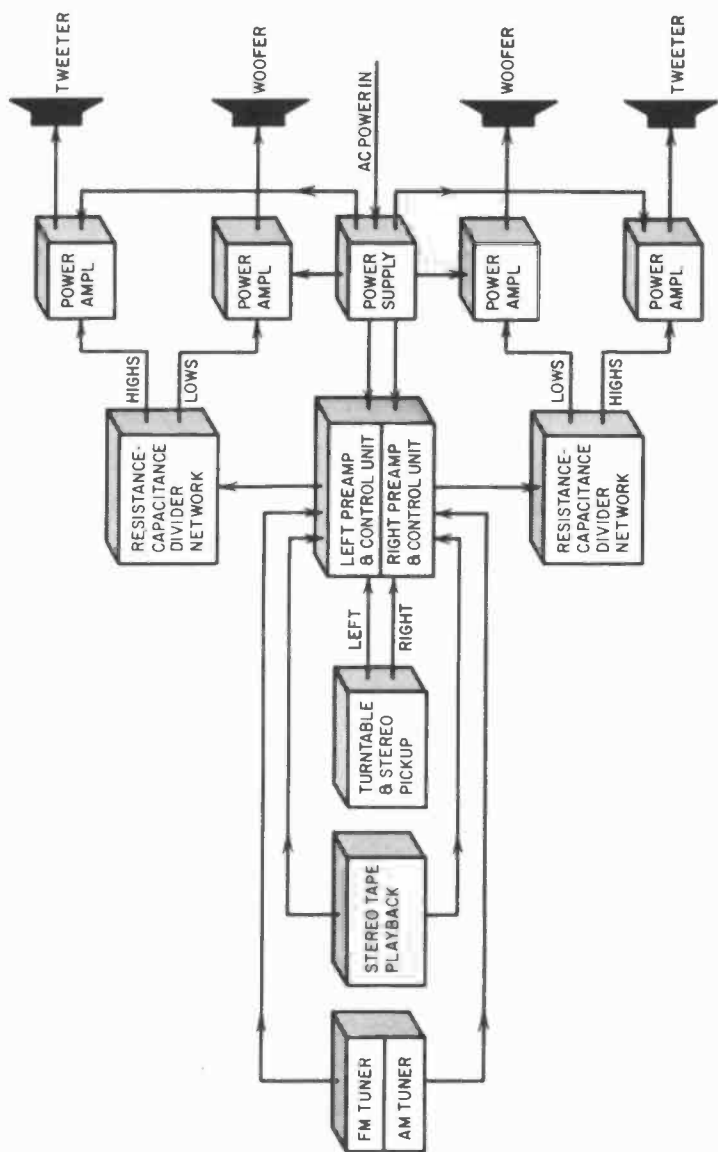

Fig. 404. A stereo system with several program sources demands a preamp control section with many switching functions.

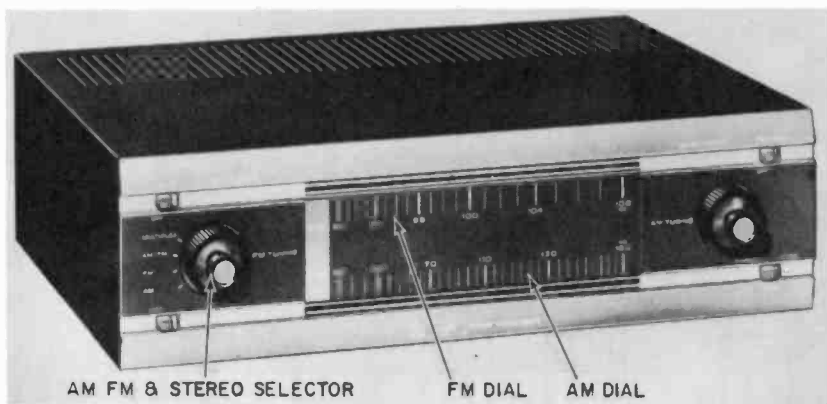

Fig. 405. This unit is a stereo tuner having separate AM and FM tuning units. (Allied Radio Corp.)

section or excessive hum and noise. Others, however, offer variable if selectivity to meet the varying receiving conditions, and good-to-excellent audio channels. A number of US and foreign stations broadcast fine music programs with the world's best artists live or on recordings. Such programs, when coupled into a good hi-fi system (where some compensation can be made with the tone controls of the preamplifier to correct, at least partially, for high and low audio-frequency deficiencies in the receiver), can be very enjoyable, since they are unusually free of breaks for commercials. Several representative receivers of this type are shown in Fig. 406.

### Television sound channels

In a good many cases, the less said about piping the sound output of a TV set into a hi-fi system, the better off everyone concerned is going to be. While TV stations are theoretically able to provide a high-quality sound signal over the sound FM carrier, a good many of them don't. They know quite well the quality of the average TV receiver's audio section, and the capabilities of the puny little 5-inch speaker inside the rattly metal cabinet. Once in a while, though, you'll get a client with a TV set providing a passable audio signal from the detector, and once in a while TV stations will broadcast the Philharmonic. In such cases, piping the detector output into an input of the hi-fi preamplifier may be fully justified, particularly in a full custom installation, where the TV set can be integrated into the overall setup right from the start.

### Pickups and tone arms

Perhaps the most critical element in the reproducing chain

between the wiggly groove in the record surface and the strains of the Philharmonic emanating from the reproducer is the pickup or

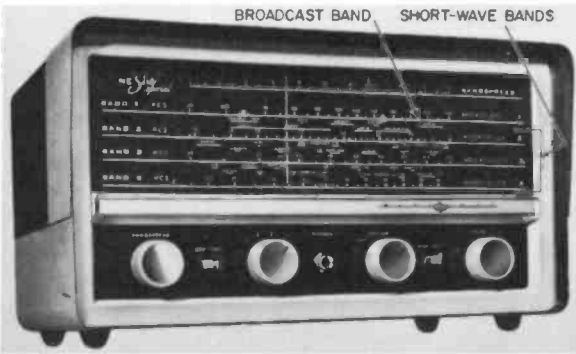

Fig. 406. All-wave receivers of the type used by hams and short-wave enthusiasts can be incorporated as a program source in a high-fidelity system. (Upper photo: Allied Radio Corp. Lower photo: National Radio Co., Inc.)

cartridge. Few consumer items require such excellence in design and manufacture, or such a combination of delicacy and ruggedness.

All pickups do essentially the same job. They convert the small departures of the record groove from a perfectly smooth spiral path in the record material into an audio-frequency electrical signal almost the exact electrical equivalent of the signal applied to the cutting head in the studio. Such a device for converting one form of energy into a precise equivalent in another form (in this case mechanical to electrical) is called a transducer. Modern pickups (Fig. 407) are greatly improved over their predecessors of 10 or even 5 years ago, thanks to concentrated research effort in the industry in response to continued public support of the hi-fi market.



No one transducer principle has so far shown itself to be outstandingly superior for solving the pickup problem. At present, excellent pickups operating on piezoelectric, variable-reluctance, electrodynamic and frequency-modulation principles are avail-

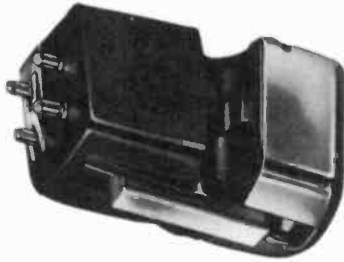

Fig. 407. Example of a typical stereo cartridge.

able, and the use of magnetostriction and the strain gauge (variable resistance) principles is by no means dead. The principal problem this variety of pickups presents to the installer is that of making sure the pickup is working into the optimum load impedance in the preamplifier input circuit, and that the ambient conditions are not such as to injure the unit or degrade the quality of reproduction. Piezoelectric pickups employing Rochelle salt as the sensitive element are soon damaged by extremely humid or dry conditions (fortunately, not in the range found in the average living room), and by even short exposures to temperatures above 115° F. Unfortunately, *this* can be a snag, since the rising air column over power or rectifier tubes in a hi-fi installation can easily exceed this limit.

Piezoelectric pickups using a ceramic element such as barium titanate are relatively immune to humidity and temperature problems, but provide a lower electrical output for a given groove modulation.

Electrodynamic and variable-reluctance pickups are usually more troubled by strong hum fields such as may exist around some turntable motors or exposed ac wiring in the room. Iron turntables may also cause trouble with such pickups, either through hum induction or a change of stylus pressure because of magnetic attraction. The ribbon type of electrodynamic pickup is somewhat more delicate mechanically than some other types, although all good pickups should be handled carefully.

Pickups in which the frequency of an rf oscillator is modulated

by action of the vibrating stylus are somewhat susceptible to direct electrical interference, and also to an extent by drift of the basic oscillator resting (no-modulation) frequency, although this problem has been much reduced in recent years.

All pickups employ a certain amount of mechanical damping



Fig. 408. *A wide variety of pickup arms is available for manual turntables. This type of arrangement gives best record reproduction and longest record life. (Stromberg-Carlson Co.)*

to smooth the response, particularly at the two principal resonances that wall in the audio range. Improvements in damping materials in recent years have substantially reduced the effects of age and high ambient temperature and low humidity on pickup damping blocks. However, these effects should not be forgotten, particularly if a good, but old pickup, is a part of an installation. In particular, any pickup using natural-rubber damping blocks should be regarded with suspicion if it is more than a year or so old, or has been exposed to high temperatures.

### **Tone arms and turntables**

The partners of the pickup in the act of transducing the record groove wiggles into an electric signal are the tone arm that holds the pickup, and the turntable or record changer that spins the disc. Both these elements of a hi-fi system are equally important, but the tone arm has a more direct and intimate relationship with the pickup. Tracking error, stylus pressure and the arm and record material resonances are directly affected by the design of the arm and its interaction with the pickup in operation. For this reason, some makers have developed arms specifically for use with a certain model pickup. In general, best results with these pickups will be obtained by sticking to the recommended combination. A number of excellent tone arms are available, however, (Fig. 408) that permit a wide range of adjustment to suit various pickups, and have acceptably low pivot friction and satisfactory resonance characteristics. The installer must give the same careful consideration to the maker's recommendations for mounting, leveling and similar matters as he does to any other part of the installation process. An error of 1/16 inch in placement of the tone-arm turning center with respect to the center of the record

spindle can cause a significant increase in tracking error, particularly with short pickup arms.

The turntable itself is a critical element in the reproduction system, particularly in a system good enough to really reproduce hum and rumble if they are present in significant amounts. It is



Fig. 409. Record changers currently available have many features formerly found only in professional-quality equipment. This model has an adjustable weight on the tone arm and a handle for manual operation. (Webcor, Inc.)

difficult to design and manufacture a mechanical drive that affords the exceptional constancy of angular velocity, acoustic quietness, and freedom from vibration required of even a good monophonic turntable. When these stiff requirements are aggravated by the additional requirement that *vertical* vibration also be held to a very low level to afford good stereo reproduction, the problem becomes acute.

Good turntables *are* manufactured, but to achieve high quality throughout a production run is expensive. From the installer's point of view, making the cutout and installing and leveling the table and the tone arm are the chief concerns. Bear in mind, however, that the greatest care in this process can be nullified by a sloppy bearing fit in the drive mechanism of a spanking new turntable.

### Record changers

The installer must face the fact that record changers are going to be around for a long time, even though the vibration, rumble, wow and various other ills that afflict them are usually much more prominent than in straight turntables. In typical changers (Fig.

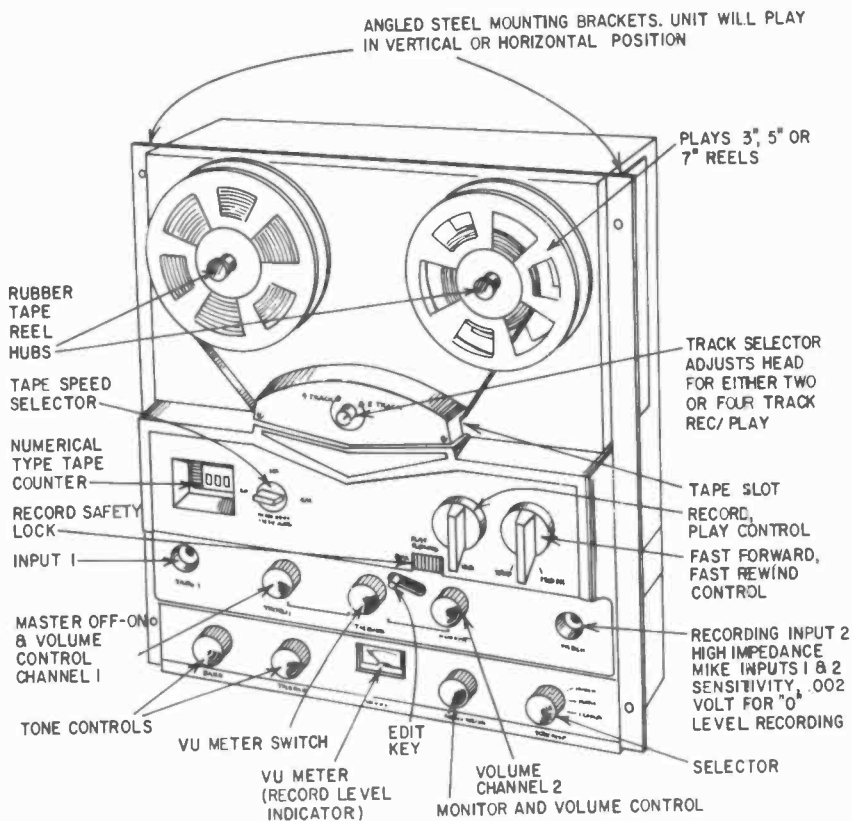

Fig. 410. Stereo tape recorders are becoming highly versatile and complex. The home-model tape deck shown here will record and play back two stereo channels and will play back pre-recorded four-track tapes. (Webcor, Inc.)

409) in the popular-price range, such factors are not intolerable, but must be given the same attention recommended in connection with turntables. When the equipment is tested after installation, take special care to check for excessive rumble and other objectionable characteristics. If this is not done, the installer may be blamed for something beyond his control. Fortunately, reputable makers are always willing to correct a condition in an individual unit that does not meet their published performance figures.

The cutout template, mounting instructions, clearances above and below the mounting board, and other necessary specific information for a given changer are provided in the manufacturer's literature, usually in a sheet or pamphlet accompanying the

equipment. Follow the instructions carefully. Overlooking a single point, such as removal of inconspicuous packing or hold-down ties used for protection in shipment, can lead to an exasperating waste of time later.

### **Tape recording and playback equipment**

The use of tape recorders and tape players has not shown quite the phenomenal growth of disc high fidelity. Nevertheless, it continues to increase, particularly among audio hobbyists and the wealthier general hi-fi audience. Such equipment (Fig. 410) comes in a large variety, from completely self-contained midget portable units powered by batteries to large, rack-mounted professional equipment. Of course, the tape playback signal from *any* type can be put into an input of the hi-fi preamplifier and reproduced over the system. But you'll hear some pretty weird sound if the proper frequency compensation is not provided, and impedance matching and noise can be problems, too.

Many tape machines come complete with preamplifiers for recording and playback that provide the correct compensation for the tape heads used in the machine. With such equipment, the installer's problems are considerably simplified, as these preamplifiers usually afford the requisite sensitivity for microphone input, and an audio output level about equal to that of a good tuner. However, beware the noise, hum and interference-pickup troubles of a low-priced tape machine played through a good-quality hi-fi system. The proud owner will hear things he never dreamed was on the tape of his inexpensive little portable when listening to it on the small built-in speaker.

The actual installation of tape equipment is no more difficult than putting in a turntable or changer, but remember that the controls of a tape machine will be used a lot more often than those of some other parts of the system. For this reason, it should be positioned for convenience. Fumbling with half-visible knobs and threading tape reels deep in the recesses of a cabinet is a chore that will cause the customer to remember you with displeasure.

### **Preamplifiers**

Of all the hi-fi components, probably more genuine advance in design has been achieved in preamplifiers than in any other. This opinion may sound surprising, but it is based on considerable field experience. Even some relatively inexpensive modern preamps offer features that were well-nigh unattainable 10 years ago.



Fig. 411. Preamplifiers must perform many functions in a stereo system. Complex switching systems take some of the brainwork out of operating the rig, but a customer can be frightened by "all those knobs" if he doesn't understand their purpose. (Upper photo: Electronic Instrument Co. Lower photo: Altec Lansing Corp.)

This has come about partly through improvements in circuitry, but more because of advances in the design and manufacture of vacuum tubes, resistors and capacitors, and the advent of printed circuits, transistors and other semiconductor devices. In representative preamps now available (Fig. 411), hum, noise and instability are well below the tolerable maximum limits for good performance with the other components of a system.

In addition, modern preamps provide a far greater and more precise control over frequency response, input switching and impedance for various input devices than was formerly available. For the installer, preamplifiers are usually an easy item to handle. The main consideration is to position the unit so that manipulation of the controls is easy and convenient, and the input and output connections are protected from accidental detachment.

### Power amplifiers

Modern power amplifiers leave very little to be desired, as far as performance is concerned, and definitely provide more clean watts per dollar than was ever before available in good-quality audio. This has come about partly through the development of



*Fig. 412. The power amplifier is your hi-fi system's workhorse: (a) a typical single-channel amplifier and (b) a stereo power amplifier. Both units must be used with appropriate preamplifiers. (Upper photo: Heath Co. Lower photo: British Industries Corp.)*

new tube types, such as the 6551, KT88 and others, and partly because of wider availability of really good output transformers. Oddly enough, the most important feature of the celebrated Williamson amplifier was the relatively tough specification written for the output transformer. Only with a transformer of such superior frequency and phase characteristics was the amount of negative feedback used by Williamson feasible. As to the use of feedback itself, this was common in high-quality professional audio equipment even during the mid-30's.

For the installer, power amplifiers are most likely to be of concern when considering ventilation, heat radiation, size and weight factors. Since adjustment of the power amplifier is seldom re-



*Fig. 413. An integrated stereo system is frequently very bulky and may require extensive rearrangement of living room furniture. (Bogen-Presto Co., A Division of the Siegler Corp.)*

quired, it can be located in the less accessible part of a cabinet or shelf, but don't slight the air circulation problem. The run of signal and power wiring should be inconspicuous, and it is well to hold the length of cable from the power amplifier to the reproducer to a reasonable minimum. But, in the average home, this is not likely to be a critical factor (Fig. 412).

### **Reproducers**

The speaker and cabinet or enclosure combination that makes up the reproducer is one of the most critical elements in any hi-fi system. The reproducer is a transducer in that it converts the electrical signal provided by the power amplifier into sound waves radiating into the listening area. Other things being equal, dollars and care expended on the transducing elements in the hi-fi chain (the pickup and reproducer) will show more net return in quality than if spent anywhere else. For the installer, some caution is in order if the job calls for putting speakers into an enclosure that is a part of the structure of the building. The factors involved are discussed in later chapters. It is enough now to remember that they warrant respect.



Where the enclosure is a free-standing cabinet, the job is usually straightforward, even though the speaker is to be put into the cabinet as part of the job. Usually the maker's literature on the cabinet and speaker will provide any necessary details, such as

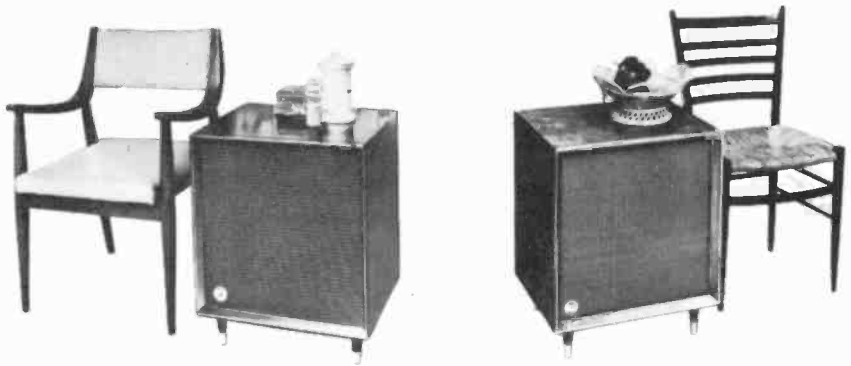

Fig. 414. To avoid major reorganization of the living room, smaller speakers, conveniently placed, can act as end tables. Be sure to insulate porcelainware and other knick-knacks against vibration. (R-J Audio Products, Inc.)

the required size of the mounting-board hole. If the enclosure is a completely assembled unit, the problem resolves itself into one of placement for the desired acoustic and visual effect (Fig. 413). The run of cable to the power amplifier can usually be handled inconspicuously along the upper edge of the baseboard, under a rug or even under the floor if there is a basement.

The trend in enclosures toward smaller, completely assembled units (Fig. 414), has been sparked in part by the modest dimensions of many modern homes and apartments. From the installer's viewpoint, this simplifies the job still further, since placement atop a bookcase or even on a shelf in an existing piece of furniture is entirely practical.

# electrical and electronic interconnections

**W**HILE most connections required between the various units of a hi-fi system are simple and self-evident, a little care expended in making them properly will avoid a host of troubles later. Probably the best place to start is with connections to the power source, which brings up the matter of the primary power available. The bulk of installations in the US are supplied with 60 cycle, 115-volt ac, with one side of this line firmly grounded to the household water line at or near the electric service entrance.

## Primary power sources

However, 50-cycle ac is supplied in a few parts of the country, and a few buildings in some cities are supplied with 25-cycle ac. Most 60-cycle equipment will operate on 50-cycle ac, but, of course, synchronous motors will run slower by one-sixth their nominal speed. Most manufacturers can supply the required size of motor pulley to make the turntable run at the proper record speed, and will do so without charge, if requested. In Los Angeles, for example, for years certain areas of the city had 60-cycle current, while adjacent areas had a 50-cycle supply. A stock of both sizes of motor pulley solved that problem.

Unfortunately, 60-cycle equipment usually will *not* operate satisfactorily on 25-cycle current. There is seldom enough primary inductance in the power transformer, for one thing, and it will merrily overheat and go West in a cloud of smoke not long after you plug it in, if it doesn't blow a fuse somewhere. Yes, it's *possible* to buy a rotary converter that will run on 25-cycle power and deliver 60-cycles for the equipment, but such units are both

expensive and hard to find. Luckily, you're not likely to get many clients who have 25-cycle supply to contend with any more.

But 120-volt dc is quite another thing. A few areas in relatively large cities like New York still have this current supply, a relic of the days when there was competition between utilities for the same service area. Suitable converters for running ac equipment from such a supply are standard catalog items, and constitute the only practical solution when the client does not wish to convert his entire house or apartment to ac. Such a changeover in current supply is feasible in many dc areas now, but a client may balk at the expense involved in also changing over every last refrigerator, vacuum cleaner, food mixer, and other dc motors he may have acquired over the years.

### **Dc power sources**

In house trailers and yachts, the primary electric supply when not hooked up to the utility line in some more or less permanent location may be 6.3-, 12.6-, 25.2- (nominally called 24) or 32-volt direct current supplied by storage batteries, or by a gasoline-driven generator across which the batteries are floated. For any of these supplies, dc-to-ac conversion units can be obtained, as in the case of 120-volt dc utility power. The 32-volt system is particularly common on isolated farms generally located too far from utility lines for service.

With *all* unusual current supplies, the important thing is to find out what it is, and which pole, if either, is grounded. Don't forget about it when you are making the installation, either; you can burn out a good ac soldering gun readily on a 120-volt dc supply. This applies to signal generators and other contraptions having power transformers, too, and even to soldering irons having thermostatic heat controls. If you are unfamiliar with such jobs, the trusty, self-contained multimeter and extreme caution are your best allies.

Another easy-to-use tester is the neon type mounted on a pair of test leads. There are two tiny rods inside the bulb. If the line voltage is ac you will note a glow around both rods. If the line voltage is dc, the glow will appear around just one of the rods. It only takes a second to make the test, and at the same time get the assurance that power is being delivered to the outlet.

In connection with dc supplies and converters, a final word is necessary. Not all converters are suited to use where the output frequency, and to an extent the waveform, are fairly critical, as is the case with a hi-fi system. Be sure the converter ordered is of

a type meant for the kind of service you have in mind, or you may have a very unhappy client on your hands.

### Power connections

While a lot of equipment can just be plugged into the wall socket and snapped on, a little thought in a hi-fi setup will often result in greater operating convenience. Arranging the line connections so that a single switch applies current to the main amplifier, preamp and turntable motor, is an example (Fig. 501). The nature of the system and the client's wishes will govern, but the final setup should take into account the noise, interference and safety factors discussed in Chapter 7.

If the hi-fi setup includes quite a number of units, so that the

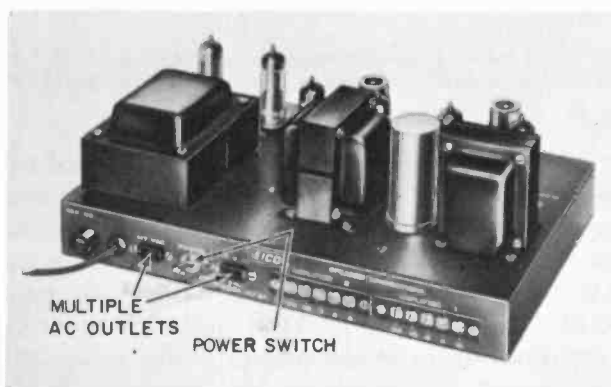

Fig. 501. Convenience ac outlets are usually provided on power amplifiers. This model has one switch-controlled outlet and one receptacle that is always turned on. (Electronic Instrument Co.)

total power drain is a few hundred watts, it is well to check the fusing of the branch line from which it will be supplied, as well as the other loads that may be connected. A TV set and a toaster may be all it takes to insure a succession of blown fuses.

### Interconnection problems

In a straightforward hi-fi setup that includes only units that have transformer-type power supplies, the interconnections of tuner, preamplifier, power amplifier, phono and tape inputs, AM-FM antennas, speakers and so on are usually only a matter of having cables with the right connectors for the application (Fig. 502).

Now and then, however, the question will arise of applying the output of a so-called ac-dc device to an input of a hi-fi system. These units should actually be described as "transformerless"

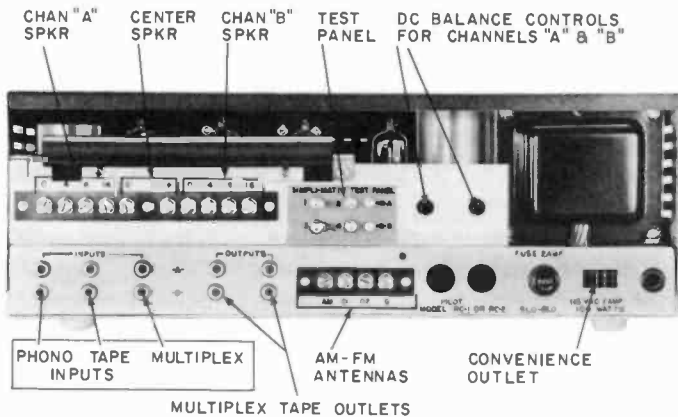

Fig. 502. A stereo pre-amp-amplifier combination has many input and output terminals for greater versatility. (Pilot Radio Corp.)

electronic items, since they were originally developed in an effort to cut the manufacturing cost of table-model radio receivers by eliminating the relatively expensive iron-cored transformer and choke of the older form of power supply. Indeed, a good many ac-dc sets won't play satisfactorily on the 120-volt dc utility supply still found in some parts of New York and a few other cities.

The usual difficulty in interconnecting such units with regular ac units is to avoid connecting the hot chassis of the ac-dc unit to the chassis of the preamplifier. At best, this is makeshift and potentially unsafe because of shock hazard, unless certain measures are taken. At worst, it can also bring in severe hum and noise problems, and the result very seldom justifies the effort required to achieve it.

The reasons for this state of affairs are not hard to find. For one thing, the quality of reproduction provided by all but a very few ac-dc receivers leaves much to be desired. Since the unit is an economy item, designed and manufactured to meet a price, it is inevitable that some quality sacrifices have been made in the design. Since the maker wants to get by with a minimum amount of power supply filtering, the low-frequency response is deliberately sacrificed so that the hum and ripple won't be too audible. And to get the maximum possible gain from the usual five tubes, all grid and load resistors of the usual two audio stages are of the maximum permissible value. This insures that the high-frequency response will also droop rapidly above the mid-range. Yes. It is

possible to modify such a receiver to provide much better performance, but the effort and expense are seldom, if ever, justified.

### **Low-fi and hi-fi**

If your client *insists* on piping the output of some five-tube midget radio into the system in lieu of a good AM tuner, the wisest course is probably to replace the output transformer in the ac-dc receiver with a fairly good one that has a 500-ohm winding in addition to and completely separate from the voice-coil winding. Run a coaxial line from the 500-ohm winding to a suitable input of the preamplifier, and hope for the best. Sometimes, only the use of a transformer with a balanced 500-ohm winding, with the center-tap grounded, will get rid of persistent hum and ripple troubles.

### **Overloading**

Don't forget the possibility of overloading the input circuit of a preamplifier or power amplifier with the output from a tuner or TV receiver sound channel. Chapter 7 discusses methods of coping with such a situation. Most tuners made for hi-fi installations have a potentiometer in the output circuit, perhaps located on the rear chassis apron as a screwdriver-operated control. This is usually the most convenient way of adjusting the level of several input sources to provide substantially uniform level when switching the preamplifier from one input source to another.

Usually, it will be best to adjust the master volume control of the hi-fi system to a setting that provides the *maximum* loudness that will be required from the system, taking the output of the pickup as the signal source. Without changing the master setting, switch the preamplifier to each of the other signal input channels in turn, and set the level to about the same value by adjusting the *output* control of the signal-source device, such as the FM tuner. By this means, the risk of overdriving the preamplifier is avoided, and switching from input to input will not require frantic grabs at the master volume control.

If your installation problem is that of converting from mono to stereo, consider the use of a remote-control unit (see page 24).

For a completely new installation, however, the flexibility of mono *and* stereo operation can be controlled directly at the preamplifier. In one commercial unit switching facilities are combined on one simplified, convenient control to enable the listener to select instantly any desired mode of operation. The preamplifier has a special selector switch, choosing stereo normal,

stereo reverse, either channel separately or either channel monophonically through both outputs (see Fig. 503).

### Cable and wire considerations

Most interconnections between units of a hi-fi system must be made with coaxial shielded wire of the type called microphone cable or cord. This is required because signals are still at a relatively low level (up to a volt or so) until they reach the input of the power amplifier. Cords fitted with many combinations of connectors for such use are now commercially available already made up, and can be a great time and labor saver in an elaborate system. When a line must be made for a specific use, use extra care in cutting and stripping, for a single strand across the signal path can cause an exasperating scratching noise and be very hard to locate.

### Speaker wiring

As to speaker wiring, consider two requirements sometimes overlooked. If the line is longer than 10 or 15 feet, use No. 16

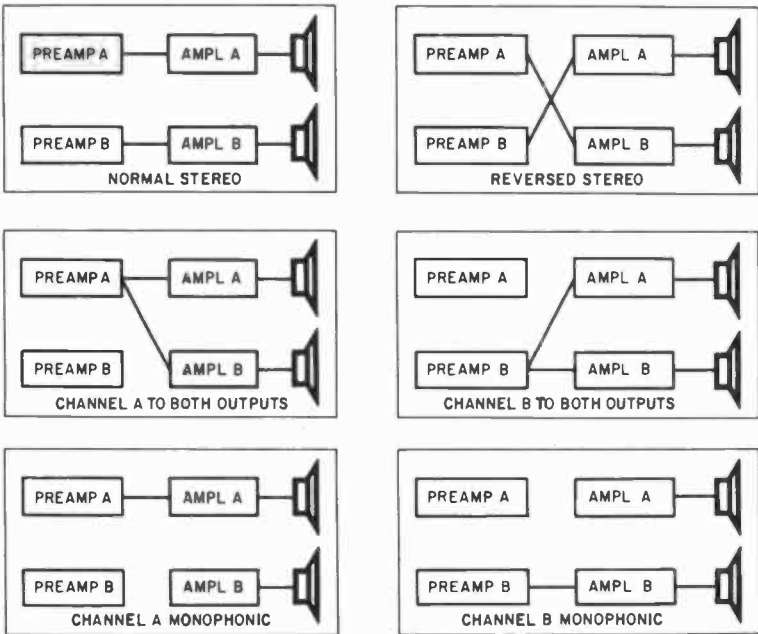

Fig. 503. For new stereo installations where no conversion is involved, the pre-amplifier is usually provided with switching facilities for selecting a wide variety of operational modes.

(Allied Radio Corp.)

wire (at least) and preferably No. 14, if the speakers are supplied directly at voice-coil impedance. The makers of hi-fi amplifiers go to great trouble to provide a good damping factor in the amplifier, and this can be considerably reduced by excessive resistance between the amplifier output and the voice coil. In some cases, it may also be necessary to run the speaker line in an outer shield braid to prevent feedback or crosstalk into telephone or intercom lines. This is more likely in installations in public rooms like a hotel lounge, but should not be forgotten in a residence installation if several lines must run near each other.

### Multiplex adapters

In most stereo systems, chances are that FM radio multiplex will be added at some future date, so you might as well make some provision for a multiplex adapter. The adapter will be about the size of a medium-size power amplifier, and you can

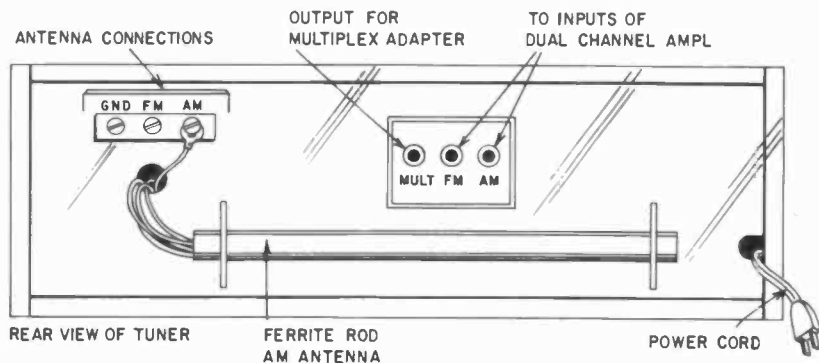

Fig. 504. FM-AM tuner usually has three outputs. The FM and AM outputs are usable as is. FM and multiplex outputs are connected to the multiplex adapter if one is used.

allow some space for it at the rear of the cabinet. The only controls on the unit are of the semi-permanent type. Set them once and you won't have to change them again until the missus decides to move some furniture around.

When installing the multiplex adapter, there will be four cables to connect: two from the tuner (the straight FM output and the output labeled "multiplex" in Fig. 504) to the adapter, and two from the adapter to the inputs of the stereo amplifier. The adapter is fully compatible so you won't have to make any changes in the wiring for monophonic listening as long as the stereo preamp has suitable switching functions.



### **Stereo realism**

When you adjust the channel separation control, use your customer as the “guinea pig”, having him tell you when the separation and stereo effect suit *him* (or his wife) the best. This method helps avoid future callbacks and complaints about the “realism” of the stereo effect. This is a case where you cannot depend on your own ears to guide you, especially since you’ll be crouched behind or alongside the cabinet making the adjustments, instead of in the optimum listening area.

# environment and electronic equipment

**T**HE very best butter is no good as a lubricant for a watch, as Lewis Carroll aptly pointed out, nor will dunking the timepiece in a pot of hot tea do much to improve its timekeeping performance. Similarly, the environment in which high-fidelity equipment is to operate can have drastic effects on its performance and service life. This includes all parts of the system, even such usually overlooked items as cabinets and interconnecting wiring. Usually, the environmental conditions such as temperature, humidity and vibration that affect a hi-fi installation are not very rigorous, since they are essentially those of ordinary human habitations. However, there are always certain local spots in a home or business establishment (such as a shelf over a radiator) where environmental conditions are bad for electronic gear and other hi-fi equipment. And, of course, there are special problems arising from regional climatic conditions that also require forethought if the installation is to give satisfactory, trouble-free service for the period of time the owner has a right to expect. The material in this chapter will aid installer and owner alike in understanding the effects of environmental influences, and in avoiding mistakes that can impair the performance and shorten the service life of the equipment.

## **Temperature effects**

Electronic and electrical equipment manufactured for sale to the general consuming public, such as broadcast receivers, hi-fi amplifiers, record changers and the like, are designed to give

satisfactory service in temperatures ranging from perhaps 32° to 120°F. The temperature in most living rooms will stay well inside this range (barring a failure of the heating plant during a Montana winter), in which case it's not likely that the family will gather in the living room for a session of Bach on records anyhow.

Unfortunately, this is not the whole story. Electronic equipment that uses vacuum tubes develops a good deal of heat itself, and this heat must be allowed to escape. If this is not done, the temperature of some parts will exceed the safe operating value, resulting in drastically reduced service life, if not something worse.

It's worthwhile to consider a few specific aspects of the effects of temperature. Electrolytic capacitors are used extensively for power supply ripple filtering, and for bypassing and decoupling separate amplifier stages at low frequencies. At temperatures of 32°F and below, the capacitance of electrolytic capacitors drops sharply and the internal impedance rises. For this reason, equipment that has been stored in subzero temperatures should be allowed to warm to room temperature, or at least to 40°F or so before it is operated. Turning on the equipment while it is still cold may or may not damage it because of excessive ripple voltage, depending upon the design and the actual temperature.

At high ambient temperatures of 120°F and over, such capacitors show a serious increase in leakage current, which causes the internal temperature to rise still further, causing more heat. Under extreme conditions, this action can cause a runaway effect such that the capacitor fails within a matter of hours or even minutes. Electrolytic capacitors have even been known to explode because of internal pressure from the vaporized electrolyte. Even when the temperature is not so extreme, the useful life of such capacitors will be reduced as much as 30% to 50% if they must operate at the extreme upper end of their temperature range. The steady loss of electrolyte by evaporation that results causes a gradual reduction in effective capacitance. This is the main reason that the hum level of some hi-fi amplifiers shows a noticeable increase after some months or years of operation.

Fig. 601 shows a below-chassis method of mounting electrolytics. These are kept away from the tubes (biggest source of heat) and the transformer, all of which are above the chassis. The metal mounting plate also acts as a heat baffle against any small amount of heat supplied by the resistors.

Solid-state devices such as semiconductor diodes, transistors

and power rectifiers are all subject to some reduction in their performance ratings as temperature increases. In this respect, silicon and germanium devices are usually somewhat superior to selenium, but all have high-temperature limitations. Most manufacturers' ratings of current and voltage for selenium rectifiers

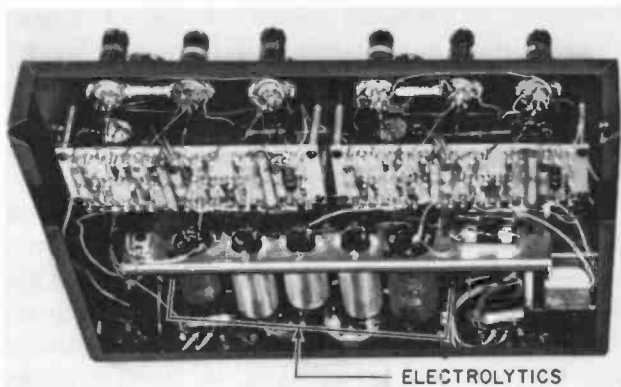

*Fig. 601. Heat and age are the biggest enemies of electrolytic capacitors. Avoid excessive heat in amplifier design by keeping the electrolytic cans as far away from the tubes as possible. In this amplifier, the chassis itself separates the tubes and the filter capacitors. (Harmon-Kardon, Inc.)*

are established to provide a satisfactory service life at temperatures up to 95°F. For ambient temperatures above this, some derating from the catalog specification is advisable. This derating is the concern of the equipment designer rather than the installer. However, the installer can help the owner to get the full expected service life from his equipment by proper care in the installation, and by explaining the life-reducing effects of excessive operating temperatures.

In general, the most serious effects of high temperature on such devices is to cause the back resistance to decrease, the noise in amplifying devices to increase, and the service life to be reduced. Fortunately, the lowest temperature likely to be encountered in service or even in storage has no serious effect on semiconductor devices.

Devices using Rochelle salt and similar crystalline materials, such as pickups, microphones and headphones, are all rather vulnerable to temperatures well above 115°F. This is true whether they are in use or are merely stored. Furthermore, the effect of high temperature on such devices is not reversible. Once overheated, the crystal element is permanently damaged. Since the temperature of a pickup arm exposed to direct sunlight

through a window can easily rise to 130° or 140° or so (as, for example, in southerly parts of the US), it is clear that the point cannot be overlooked in installation.

*Ceramic* devices will be unharmed by temperatures well above the boiling point of water, and are therefore not likely to be damaged even if accidentally stored on top of a hot radiator. Needless to say, other parts (such as plastic) *may* be damaged by such treatment, even if the active element is not.

Wax-coated or impregnated devices are not seriously affected by low temperatures, although some capacitors show a substantial reduction in capacitance at temperatures of -20° or -30°F. The effect is temporary and disappears as the part warms again, so it is not of concern even when equipment is stored. However, *high* temperatures will cause wax to melt and run off wax-dipped parts, and out of nonsealed transformers and chokes that have wax-dipped windings. A certain amount of this is almost certain to occur, particularly in older equipment, but it is undesirable, because it reduces the protection from moisture. The trend in modern electronic parts is toward encapsulating in an epoxy resin (Fig. 602) instead of wax dipping, but the practice is more costly and not always used, particularly in inexpensive equipment.

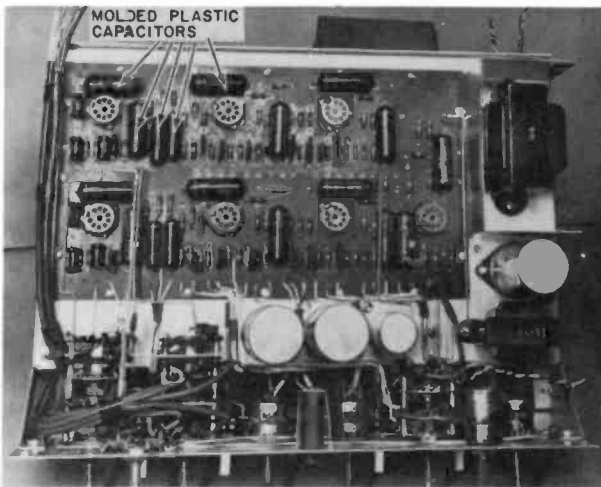
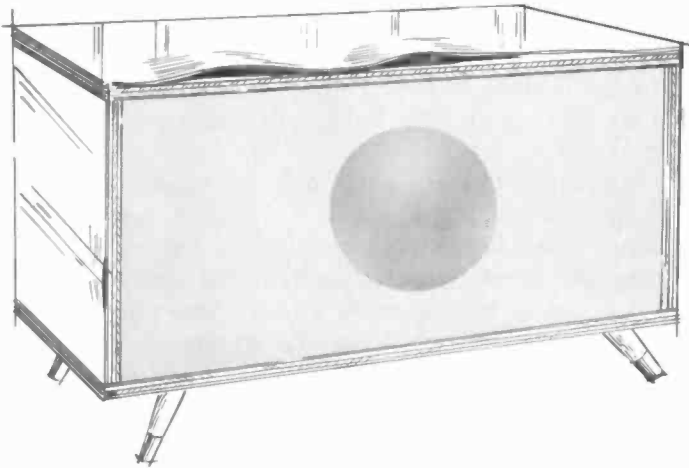

Fig. 602. Wax-dipped capacitors are susceptible to heat damage, and the trend now is toward the use of molded plastic capacitors in locations near the tubes. (Lafayette Radio Corp.)

Vacuum tubes are also susceptible to damage from high

ambient temperature when operating, although they can be safely stored at any temperature likely to be encountered in a warehouse or stockroom. Tubes working near their rated plate dissipation are most likely to be damaged by excessive ambient temperature. In most equipment, these include the power output stages of hi-fi amplifiers, and the rectifier tubes in power supplies. The usual result of excessive temperature is shortened tube life due to early development of a gassy condition, heater-to-cathode leakage, or warped and possibly shorted grids. All these conditions are likely to be progressive, causing increased plate current which generates more heat, accelerating the breakdown process.

In addition to the effects in the tubes themselves, the heat generated by power and rectifier tubes can seriously affect other



*Fig. 603. Veneer has a tendency to peel or buckle along the edges of the cabinet. This is usually due to extreme conditions of heat and moisture.*

components close to them. Electrolytic capacitors are frequently mounted close to the rectifier tube for wiring convenience, thereby guaranteeing a shortened service life for the filter capacitor. Needless to say, such a piece of equipment will be more susceptible to damage by operation in a high ambient temperature than a unit of more conservative design.

Even cabinets and enclosures are susceptible to heat damage if the condition is extreme and lasts for a long time. Thus, the end of a cabinet positioned too near a radiator or other heating element may suffer blistering or peeling of the exterior finish, and

eventual separation of the plies if made of plywood. Even solid wood cabinets may warp or crack (Fig. 603.)

In general, the installer's concern with temperature effects is to make the installation in such a way that the equipment performs normally and gives normal service life. This usually boils down to a few simple precautions. The first of these is to insure that the electronic equipment has adequate ventilation. If these units are mounted in a closed cabinet, do not depend on the doors being left open when the equipment is in use. Make sure there are adequate ventilating openings at the rear of the cabinet, *both top and bottom*. These openings may be screened inside with pieces of copper mesh (this is advisable), but they should be of adequate size to make good use of the chimney effect produced by the heat from the tubes. Openings at the top of the cabinet can best be made in the back near the upper edge. Bottom openings may be either in the back piece (if used) near the bottom edge, or in the bottom of the cabinet itself, in some cases. If the holes can be located directly below the main source of heat, so much the better.

Where one unit of equipment must be positioned above another, try to prevent putting two sources of heat in a direct vertical line. Thus, if the power amplifier must go on a shelf directly over the power supply, position the units so the power output tubes are at the opposite end of the cabinet from the rectifier tube. If this is not done, the stream of hot air (often as hot as 140° or 150°F) from the lower unit will cause the upper one to overheat.

Fig. 604 shows how simple it is to avoid problems caused by heat. If double shelves are used, make sure the spacing between them is ample. A single shelf, completely exposed, is ideal. Note the louvers in the units, provided for heat escape. They serve a function. Don't cover them with decorative materials.

It should not be necessary to mention the undesirability of mounting electronic equipment above a radiator or similar heat source, but we'll do it, anyhow. Don't let the fact that the thing is cold in summer tempt you, either. When the steam is put on in the fall, your satisfied client may be changed into an irate plaintiff in a small-claims court. In a really tight installation, where the available space for the equipment simply cannot provide adequate ventilation, do not hesitate to take up with the client the idea of adding a small, quiet fan or blower to pull or push air into or out of the cabinet. Its cost is small, both to buy and to operate,

and it will usually save its price in extended service life for the other equipment.

### Humidity effects

Moisture is the deadly enemy of most electrical and electronic devices, because it severely degrades certain electrical properties, particularly insulation resistance. In parts that are not hermetically sealed, it is almost impossible to prevent high atmospheric



*Fig. 604. The simplest and most effective way to provide adequate ventilation is by placing components on open shelves. Be careful not to obstruct vents and louvers in component cabinets. (H. H. Scott, Inc.)*

humidity from ultimately having an adverse effect. This is particularly true for equipment that does not run continuously, but is instead turned on only for certain periods of the day. This alternate heating and cooling causes circuit parts to “breathe,” because their internal materials usually have a vapor pressure that changes considerably with temperature. Thus, the dielectric wax impregnation of paper capacitors will develop enough pressure to cause some vapor leakage at the seal around the electrode lead in inexpensive capacitors. Then, when the equipment is shut off and cools, the wax vapor pressure inside drops, causing



a partial vacuum inside that tends to suck in outside air, with whatever moisture it contains.

The same sort of thing goes on in electrolytic capacitors, only more so, because they must be provided with a vent anyhow, to prevent the internal vapor pressure from exploding them. Even transformers are not immune to the breathing effect unless hermetically sealed, which is expensive. When electronic equipment not meant for tropical service is taken to regions where temperatures and humidity are both high, transformer windings carrying direct current have been known to corrode completely within a few years. The combined effects of the breathing action, high humidity and electrolytic corrosion caused by the dc potential do this.

For the installer, the humidity factors in ordinary home or business premises consist mainly of avoiding locations where the humidity is excessive, such as a poorly ventilated basement or an area used part-time for drying clothes. Even leaking steam from a radiator valve can cause a nasty local condition if it gets directly into the cabinet containing the equipment, to say nothing of its effect on the furniture!

### **Climate**

The effects of climate on the installer's task are primarily due to the temperature and humidity factors, which obviously vary considerably from region to region. Thus, it is unlikely that an installer in Albuquerque will be much concerned with humidity problems, but one in New Orleans or Tallahassee definitely will be. In climates where humidity runs high a good deal of the year, the use of a heating element in the cabinet, or even in each unit of electronic equipment, may be advisable. It should be connected so that it is turned off when the equipment is turned on, and vice-versa. This action keeps the air within the enclosure warmer than the ambient atmosphere, thereby keeping the *relative* humidity lower and holding the breathing effect to a minimum. Careful precautions against the hazard of fire caused by the heating element should be taken.

Usually, as little as a pair of 60-watt electric bulbs mounted low down in the cabinet will suffice to prevent an excessive rise of humidity within the enclosure after the equipment has been shut down. If a heating element is to be put inside the electronic units, it will naturally have to be smaller than a light bulb.<sup>1</sup>

<sup>1</sup> The type of resistive heater element made by the Damp-Chaser Corp., (P.O. Box 520, Hendersonville, N.C.) is a suitable commercial item. See Fig. 605.

## Local ambient factors

Some localities will differ enough in ambient conditions from the surrounding country to require special consideration. Thus, an installation in a home right on the beach may meet humidity and salt-atmosphere conditions quite different from those found even a mile or so inland. *Don't* make the mistake of thinking the difference does not matter. Firms doing large-scale television installing have long since learned that twin-lead transmission lines must be of a special type, or must be covered with vinyl sleeving to prevent salt deposits from stealing too much signal. You will need the same precaution for an FM antenna, particularly in an area where signals are medium-to-weak because of distance.

Some other local conditions such as the presence of a large chemical plant discharging corrosive fumes, or an industrial plant generating heavy radio interference or causing line voltage fluctuations, can also make trouble for the installer. Electrical problems arising from such a situation are dealt with in Chapters 5 and 7. Chemical corrosion problems can be so variable in nature that they cannot be anticipated in a book of this sort. The main point is to find out if such a situation exists, and investigate the protective measures already adopted by other organizations in the area. In a location plagued by smelter fumes, for example, you will undoubtedly find that appliance dealers and others in similar businesses have already had to investigate solutions to the corrosion problem. The use of aerosol lacquer sprays to protect exposed metal parts is one example of measures sometimes required by local conditions.

## Tropicalization

A number of manufacturers make a separate line of hi-fi and radio equipment for export or overseas use. Usually, the design has been modified to make it more resistant to temperature and humidity effects, and perhaps also to the growth of tropical fungi that seem to take an unholy delight in invading apparatus not designed for warm, humid climates. This entire set of measures is referred to by the Armed Forces as *tropicalization*. If you are advising a client who lives in such a climate—and this includes the Gulf Coast, Florida and the lower Atlantic seaboard—the possibility of getting tropicalized equipment should be called to his attention. The difference in cost is usually small in terms of percentage of the total, and it will usually be saved within a couple of years in reduced maintenance cost.

The use of fungus-inhibiting lacquer to improve the resistance of equipment not tropicalized at the factory is also possible, but has serious pitfalls. For one thing, it is hard to get it on the part of the equipment where you want it without also covering switch



*Fig. 605. Humidity problems may necessitate use of a resistive heating unit to protect certain components against excessive moisture. This unit is designed especially for use in closed cabinets. If cabinet is tightly sealed, the manufacturer recommends drilling several small holes to allow ventilation. (Dampp-Chaser, Inc.)*

contacts and other parts where you definitely *don't* want it. And hardly anything is more exasperating than trying to clean contacts of a receiver range switch that have been inadvertently sprayed with sticky lacquer. If you try such measures, use masking tape and Kraft paper to protect the things you don't want to lacquer. This should include the exposed contacts of connectors, even if they are not currently required. One of the authors once spent a frantic half-hour before a remote broadcast trying to find the trouble in a remote-pickup setup, only to discover that someone had carefully lacquered *all* the microphone input connectors on the amplifier chassis.

# noise and interference

**N**OTHING is more annoying to the installer than to wire good equipment and hear bad sound come out. Assuming that the equipment is of reasonable quality, in good condition and properly connected, the trouble is probably due to some sort of noise or interference getting into the signal channel, where it is amplified along with the desired program.

This is not a troubleshooting handbook, therefore we will (with a few exceptions) refrain from dealing with the correction of troubles *within* a single unit of equipment, such as an amplifier. The aspects of noise and interference treated here are those that arise from external causes, such as diathermy equipment, nearby radio transmitters and power lines. Incorrect connections between units, such as might occur in the course of wiring an installation, are also discussed.

## Hum

Hum is seldom a problem in any single unit of good manufactured equipment, but it can show up when several units are interconnected into a complete system.

Incidentally, by hum we mean the fundamental power-line frequency or one or more of its higher harmonics. Thus, for a 60-cycle supply line, this would mean a 60-, 120-, 180-, or 240-cycle signal in the output with no program input.

If hum shows up, disconnect the preamplifier and all other units supplying the signal to the power amplifier, and check the output again with only the power amplifier running. If the

preamp and power amplifier are built as an integral unit, remove the last tube in the signal path *ahead* of the stage where the overall feedback loop begins (if there is such a feedback loop in the unit). If the hum persists with only the power amplifier on, try adjusting the hum bucking control (if the unit has one). Such controls are often found misadjusted after shipment or stockroom storage. Also try reversing the position of the power-cord plug at the wall socket, and the addition of a direct ground from the power amplifier chassis to a water pipe or to the metal box containing the electric outlet in the wall. If none of these measures removes the hum, try replacing the tubes in the power amplifier one at a time. A tube can become defective because of shock or vibration, even when the equipment is not in service, although it happens rarely.

If the hum disappears with all units disconnected, (except the power amplifier) reconnect the preamplifier only and turn it on. If the hum returns, look at the settings of the controls. With the bass control at the flat setting and the volume control turned to its lowest setting, hum and hiss should be little more than barely audible when listening within a foot or so of the speaker in a fairly quiet room. If the noise level is acceptable with the volume control at minimum but comes up when the control is advanced, the hum or hiss is coming from an early stage. With some types of input connector, hum may be excessive with the gain of the amplifier at maximum and nothing connected to the input. Try shorting the input, or shielding it with an appropriate cable connector mated to the chassis connector.

By following these general procedures with each unit as it is connected into the system, the unwanted noise can usually be traced to the source, whether it be in the preamplifier, AM or FM tuner, pickup or other input signal source.

### **Ground Loop**

One frequent cause of a fairly low-level but hard-to-locate hum is the condition called a ground loop. Hum from this cause shows up only when two or more units are connected together into a system. It arises when there is a fairly strong 60-cycle ac induction field present in the room (this condition is extremely common), and there are *two or more* ac ground connections to the hi-fi system. What often throws the installer off the track and into a head-scratching frenzy is the fact that frequently, at least one of the ac ground paths is a hidden one, perhaps through the

capacitance between the power-transformer primary winding and the core, which is usually grounded to the chassis. A look at Fig. 701 will show how the hum voltage arises. When the power

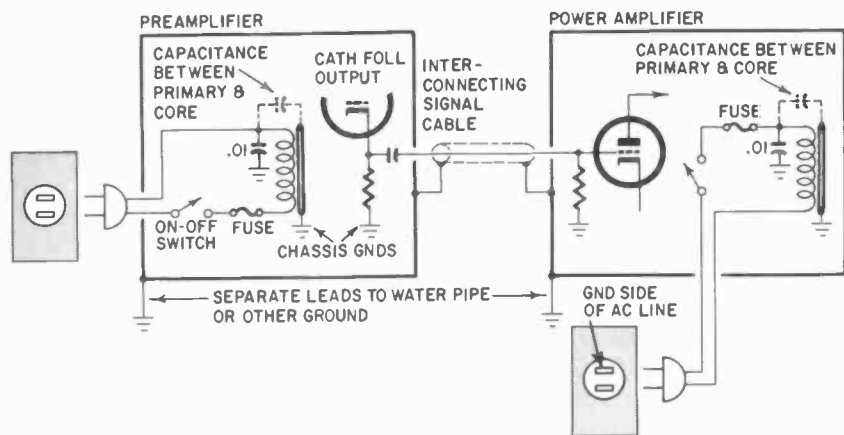

Fig. 701. Hum can arise in a system because of ground loops through interconnecting cables.

amplifier and preamplifier are at some distance from each other and plugged into separate wall outlets, hum can arise because of the large closed loop formed by the interconnecting signal cable, the two chassis and the power line itself. Note that even one or two millivolts of signal developed across the impedance of the interconnecting cable shield will appear as a signal at the input to the power amplifier.

The closed loop can be formed in any of the several ways shown in the drawing: through the primary-to-core capacitance of the transformers, the noise-bypass capacitors often wired from one side of the primary to ground, or even through the capacitance of the secondary (not shown). In all cases, the remedy is the same: get rid of the closed loop in which the induced voltage appears. One effective way to do this is to plug one unit into a convenience outlet on the other. In most cases, this is most convenient because it permits turning both units on and off together.

Another step is advisable for safety reasons, and often necessary, anyhow, to eliminate stubborn traces of hum. This is to make sure that the power-cord plugs are inserted in the wall sockets with such polarity that *both* the noise bypass capacitors across the transformer primaries are effectively connected from the cold (grounded) side of the ac line to the unit chassis. If this is not

done, the chassis of the unit concerned will be at line voltage above ground through the noise bypass capacitor, and will therefore be a shock hazard. The risk of shock with the reversed connection can be removed by providing a direct, solid ground from the chassis to the conduit or metal shell of the ac outlet box.

However, this brings in the possibility of hum pickup again, and there is no assurance that the ground wire will not be disconnected accidentally when furniture is moved for cleaning, reviving the shock hazard. A recent (and laudable) trend among appliance makers has been toward the use of a 3-wire power cord, with a 3-pronged plug that automatically grounds the device when the plug is inserted in a wall socket of a matching type. Unfortunately, this type of cord and plug is not yet widely used in the audio industry, probably because of some inertia, and the fact that most household electrical outlets are still the ordinary 2-pronged type.

If the client will authorize the slight additional expense, replacement of the standard power cord on a piece of equipment with a new cord of the 3-wire type, complete with a 3-pronged plug, is a very good solution. Even if the wall socket is not of the 3-hole grounding kind, a simple adapter can be inserted that has an exterior pigtail attached to its grounding socket. This pigtail is permanently grounded under the screw holding the cover plate on the outlet box, and the adapter is left in place even when the equipment is unplugged. The only joker here, of course, is the assumption that all outlet boxes are grounded. They should be, but this doesn't mean that they are. You can check easily enough with the help of a test lamp or ac voltmeter. Attach one lead to the plate. Insert the other lead into one, then the other, prong of the outlet. If you get no indication, the plate isn't grounded.

If this procedure is not acceptable to the client, he may agree to a change of the power-cord plug to the type having one of the flat prongs wider than the other. In properly wired household electrical outlets, the grounded side of the 115-volt ac line is wired to the wider of the two slots in the receptacle. If the plug is wired to the cord in such a way that the hot side of the line goes directly to the on-off switch in the equipment, the unit will definitely be safe when the switch is in the "off" condition.

One solution to the shock hazard problem in cases where a direct ground is not feasible is to clip out the noise bypass capacitor entirely. This usually reduces the shock hazard to negligible proportions, even when no direct chassis ground is

provided, since the capacitance from transformer primary to core is very much smaller than the .01 or .005- $\mu$ f capacitor often included for noise suppression. If noise trouble is encountered, a choke-and-capacitor-type line filter installed at the wall socket, with the case and ground terminal solidly grounded to the ac conduit or box, is the best solution to both the shock and noise problems.

## Hiss

Little can be said here about curing hiss problems, since they usually indicate a defective resistor in an early stage of a high-gain system and, as such, are a troubleshooting problem inside the unit. Heater-to-cathode leakage in a preamplifier tube may cause

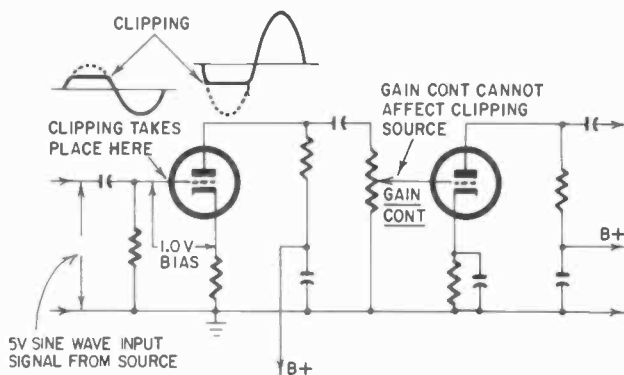

Fig. 702. Overdriving the grid of a low-level stage generates distortion that cannot be corrected by adjustments in later stages.

hiss, but it is almost invariably accompanied by a generous helping of hum, except in those rare cases where the preamp heaters are supplied with dc. Nevertheless, it is worth trying a tube change if hiss is excessive.

In some otherwise good preamplifier designs, a 1/2-watt carbon resistor will be found in the plate or grid circuit of an early stage. Sometimes these cause no trouble, but all that's needed to make many of them a prolific source of hiss is a little too lengthy application of the soldering iron during assembly.

## Overdriving

Overloading is another of those words that doesn't fit very well the idea it's meant to convey. As commonly used, it means that the amplitude of the input signal applied to a given circuit point exceeds the amplitude that the stage can amplify linearly.



A better word to describe this condition might be overdriving. Such overdriving results in clipping of one or both peaks of the signal wave and plenty of distortion, even though every unit in the system is in perfect shape (Fig. 702). Usually it arises when a high-output device such as a crystal pickup of an FM tuner is connected to a preamplifier input meant for a low-level input. Backing down the gain of the preamplifier will do no good, for the gain control is seldom between the input and the first grid, which is where the clipping takes place. Obviously, reducing the gain at a point beyond the source of the distortion cannot cure the trouble.

The answer, of course, is to knock down the input signal to a level that the stage can handle. At one demonstration of a specially-built preamplifier for the Audio Engineering Society, half the program was presented with raucous distortion while some of the better brains of the industry frantically switched tubes and examined pickups through jeweler's loupes. You guessed it; the specially-built preamplifier output was overdriving the input to the power amplifier all the time. A hastily inserted pad knocked the 5-volt output of the preamp down to the 1 volt or less the power amplifier was designed to take, and all was serene again, although the blushes took some time to subside.

### **Man-made interference and external electrical noise**

It is customary in electronic work to distinguish between noise and interference in some manner, although the distinction is often not an easy one to make. For our purposes, we can treat as interference all electronic disturbances that are deliberately generated to perform some desired function in some service (such as transmissions in mobile radio) but which also get into the equipment used by other services in such a way as to interfere with the normal functioning of that service. This broad definition is made necessary by the present extremely varied use of electrical and electronic equipment, and the certain expansion of such use in the future.

Signals generated by radio transmitters, electronic heating equipment used by doctors and by industry, and even signals generated internally in television and other receivers, can sometimes interfere in hi-fi and public-address equipment. This may seem a bit weird, since the interfering radio transmissions are made on frequencies far above the audio range. The culprit turns out to be our old friend nonlinearity, which comes about because

of overdriving somewhere, the same process previously described.

Almost without exception, this overdriving and the resulting nonlinear operation that results in interference, occur in the first stage of a high-gain amplifier, although the interfering signal may be picked up on the transducer supplying the normal input signal to such a stage, or on the interconnecting cable, even if it is of the shielded type. Once the interfering signal reaches the grid at sufficient amplitude, the process is simple. Whenever the grid is swung by the interfering signal into a voltage region where the plate waveshape is not a faithful linear reproduction, detection takes place, just as in the detector of any radio receiver. Any modulation on the interfering signal will now be heard through the hi-fi or PA system with a degree of clarity that can be both startling and embarrassing.

The remedy in most cases is simple in principle and may require either or both of two expedients. The first is to prevent

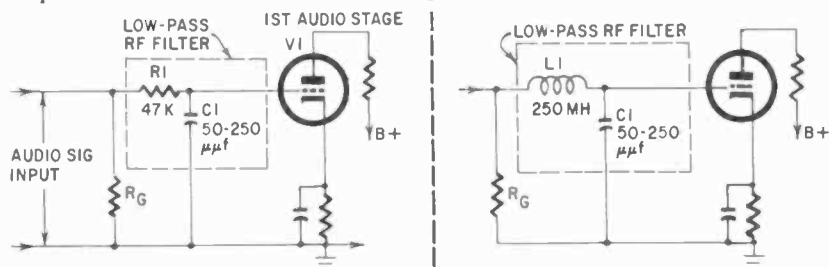

Fig. 703. A low-pass rf filter at the input grid will solve many interference problems.

the offending signal from entering the hi-fi equipment, and the second is to bypass it to ground before it can reach the grid of the first tube. Preventing the signal from entering the equipment can usually be accomplished by thorough shielding of all input signal sources (such as a phono pickup or tape-recorder playback head), with a shield that has a very low impedance path to ground for rf voltages. Unfortunately, this is sometimes easier said than done, particularly in areas where the interfering signal is very strong. The difficulty arises in trying to shield the transducer effectively without interfering with its normal function. Often, the most complete shielding that can be practically provided will still permit a certain amount of interference pickup to occur. Fortunately, the insertion of a simple low-pass rf filter *as near the grid of the tube as possible* will usually remove the last traces of the interference that the shielding does not keep out.

## Filters

Suitable filter configurations are shown in Fig. 703. The cutoff frequency of such a filter should be well above the audio-frequency range for most kinds of interference. A cutoff even as high as 100 kilocycles is usually just as effective as a lower cutoff and obviates any fear that high-frequency response will suffer.

It is necessary to mention one type of interference that definitely *cannot* be removed by such a filter: interference from the horizontal oscillator frequency of a nearby television receiver, which occurs at 15,750 *cycles* and innumerable harmonics thereof. A great many TV receivers unfortunately have little or no provision to prevent radiation of this interference. If you can get at the offending set, a grounded shield placed around the tube and tuned circuit of the horizontal oscillator and as much of the yoke wiring as possible, may help considerably. Shielding the pickup or other input device at the hi-fi set will also help, and a line filter between the wall ac outlet and the power cord for the hi-fi may also improve things. It may also be necessary to install a shield braid over the power cord itself, grounded at the wall end and to the power supply chassis.

Only as a last desperate measure should a low-pass filter that cuts off *below* 15,750 cycles be installed, because this definitely *does* impair the high-frequency response which is one of the features of hi-fi equipment the customer pays good money to get.

In connection with interference from radio transmitters, particularly those operated by radio amateurs, it is important to bear in mind that *all* radio services are licensed by the FCC and have a legal right to operate. Owners and operators of licensed radio equipment and services are required by law to cooperate in eliminating interference, but this does not mean they are required to suspend operation. Almost invariably, even the most stubborn and difficult interference problems can be solved by cooperation between the parties concerned.

It is necessary to mention one other way in which interference can arise (although it is too large a subject to be covered here). When the signal feeding the hi-fi system is the audio output from an AM or FM tuner or other type of radio program receiving equipment, the tuner itself may experience direct radio-frequency interference on the channel to which it is tuned. This may arise from a number of causes. If the offending signal is entering in this manner, it may be necessary to consult a book devoted en-

tirely to the subject of interference elimination to solve the problem.

### **Electronic and acoustic feedback**

By *feedback*, we mean here *unwanted* feedback in a hi-fi system, often regenerative, which can cause drastic distortion and even oscillation of the whole system. Unwanted feedback of the electronic or electrical sort can occur when output and input cables are laid close to each other for a distance, or when one or both lines are not shielded. The remedy is usually just a matter of providing adequate separation of *all* inputs from all outputs, and perhaps the addition of shielding to the speaker line, with the shield grounded to the power amplifier chassis (but *not* to a building ground at the other end!). This latter expedient is more likely to be required in systems using a very powerful power amplifier, run at high level, and perhaps an unshielded 500-ohm output line feeding distant speakers.

Acoustic feedback refers to actual sound vibrations, sometimes through the air but more often through solid materials like the wood cabinets. The output of the speaker reaches some sensitive part of the equipment by one of the phase shifts involved and proceeds to ruin reproduction. The two most likely places for the vibration to re-enter the system are through a vacuum tube at the input (where the gain following the stage is very high), or through the phono turntable, the material of the record, and the pickup itself.

Heavy mechanical vibration of the preamplifier chassis can cause the grid-to-cathode spacing of a tube to vary with the vibration and thus inject an electrical signal equivalent to the vibration waveform into the signal path. In a tube with loose mica spacers or some similar defect, this effect will be much more severe, which is why some tubes that seem perfect when tried in a tester free of vibration give bad results in actual service. Assuming that no defective tube is found, the only remedy is to provide vibration isolation between the acoustic output and the place where the vibration is re-entering the system. This may mean putting padding under one or more electronic units (but don't block the paths for ventilation), removing them to another cabinet, or even mounting the speaker and its enclosure on shock mounts. The direct airborne sound from the speaker will seldom vibrate even the most sensitive tube hard enough to cause this kind of feedback, unless the amplifier is right in front of the speaker cone, where it has no business to be.

Without doubt, the most common cause of acoustic feedback is vibration from the speaker enclosure traveling through a solid path to the turntable, where the vibration can actuate the pickup to inject the feedback signal at the point in the whole system where the following gain is usually highest. Here again, the solution is to provide isolation in the solid path. This may be done by means of foam rubber or similar padding under and behind the speaker enclosure, the turntable base or both. When both are housed in the same cabinet, the problem may be a little more severe, but even here sufficient isolation can usually be attained to prevent trouble. Stereo systems seem to be more prone to this difficulty than straight monophonic systems, probably because of the sensitivity of the stereo pickup to a vertical component of motion as well as horizontal.

If you suspect that a small amount of acoustic feedback is causing distortion, but the feedback is not great enough to make the fact a certainty, it is advisable to make the following test: monitor the output of the amplifier with a good pair of headphones bridged across the speaker line, while the speaker load and an equivalent resistor dummy load are alternately switched across the output. If, when the speaker is connected, the suspicious sound increases on large low-frequency sounds like the thump of a bass drum and disappears when the resistor is acting as the load, you've got acoustic feedback.

# acoustic factors

**I**t's easy to get so immersed in the electronic end of things that we forget momentarily the simple truth that all hi-fi systems, in reality, are acoustic devices. In the fullest sense of the term, acoustics is the study of sound in all its manifestations and in relation to all types of materials — gases, liquids and solids.

In a high-fidelity sound reproduction system, electrical energy is first converted by the speaker and its associated enclosure into sound waves in the air of the listening area. It is here at the transducing element, where the conversion is made, that our concern with acoustics begins. Except in occasional outdoor installations, this sound is then propagated in the more or less enclosed space of a room. The room thus is the source of our second group of acoustic considerations. Getting the program to sound right in the area where it is wanted, and keeping it confined to that area only, are the two major acoustic problems that concern the installer.

It should hardly be necessary to add that the user is just as much concerned with this end result as the installer, or rather more so, as he is going to live with the system for a reasonable time. This chapter discusses the basic acoustic factors that affect the installation, while the following chapter explains how to deal with some of the more common difficulties you may encounter in practical work.

## Speakers

At the present state of the art, a wide variety of speakers and enclosures is available; so great a variety that several volumes would be required to cover the subject adequately.

Since, for our purpose, acoustics begins with the speaker, let's make it clear right now that you cannot get good sound from a poor speaker or from any multiplication of poor speakers. We tried it years ago. The idea was that since cheap speakers are so

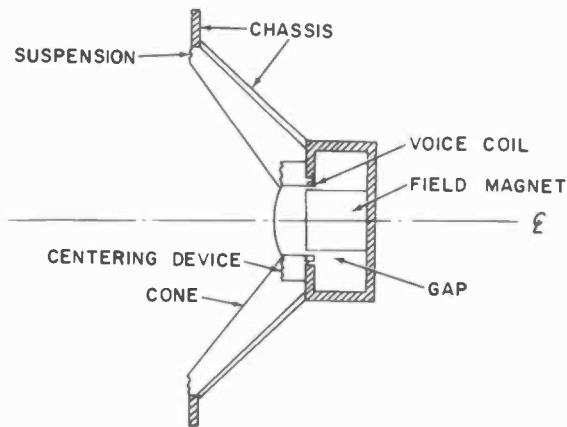

Fig. 801. *Cross-section of a typical cone type speaker.*

nonuniformly relative to each other, at a frequency where one was bad some others would be good. This worked out a little like making an omelet with only a few bad eggs in the lot, although the analogy is not perfect. Suffice to say, it didn't work out that way, although it is true that with a great deal of doctoring and cut-and-try experimenting, it is possible to get such an arrangement to sound passable.

You may well ask, then, what constitutes a good speaker? The answer requires that we classify speakers according to the frequency range and power they are expected to handle. A tweeter or speaker that is to be good for high frequencies has very different requirements from a woofer or low-frequency speaker.

At present, most speakers are of the permanent-magnet type, although electrostatic, piezoelectric and possibly corona-discharge (ionization) types, bid fair to become of increasing importance in the future.

Most woofers are cone-type direct-radiator speakers basically similar in cross-section to Fig. 801. Since they handle the greater part of the audio load in terms of power, they should be ruggedly constructed. A powerful magnet of generous size is required to provide the magnetic flux necessary to give good control of the

voice-coil motion. The cone must be light, but sufficiently stiff to move as a unit over a wide range of frequencies. And the suspension must be flexible enough to permit free movement of the cone, but yet not introduce spurious effects of its own.

All in all, making a good speaker is a reasonably complicated job, which is why they are not cheap.

A good tweeter need handle only a small fraction of the power required of a woofer but, it must be even more precise. Think, for example, of the diaphragm of the horn tweeter shown in Fig. 802 generating a complex waveform at a frequency of 15,000

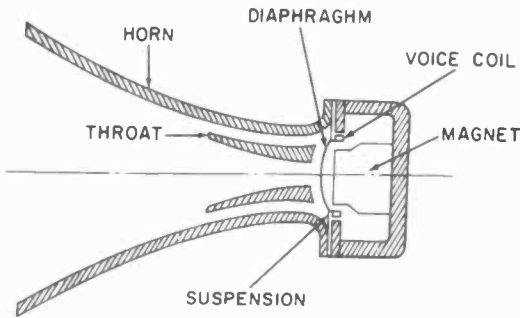

Fig. 802. *Cross-section of a horn tweeter.*

cycles. A rather staggering order of engineering and production skill is required to make this possible. For this reason, a good tweeter isn't cheap either, even though it may physically be comparatively small.

### **Speaker enclosures**

A speaker enclosure is an acoustical device whose basic purpose is to improve the low-frequency response of the speaker. Even the best speakers will give poor performance at low frequencies if they are not enclosed or coupled to the air in some way. The reason is that as soon as the frequency is reduced to a point where half of the wavelength of the sound in air is about equal to the sound path from the back to the front of the speaker, the back wave, being  $180^\circ$  out of phase with the front wave, starts to cancel it. The speaker is still generating sound waves, but the back wave and front wave reach the listener at the same time and cancel. So they don't do you any good. Therefore, you've got to help the speaker along by eliminating or controlling that back wave, if you're to get respectable reproduction at the low-frequency end of the sound spectrum.



## Infinite baffle

The simplest way to get rid of trouble with the back wave is to eliminate it entirely. This is the thinking behind the infinite baffle.

A truly *infinite* baffle is something that exists only in theory, but there are two ways of approximating its effect in practical installation work. One is the well-known trick of mounting a speaker in a hole in a wall between two rooms (Fig. 803). By isolating the back wave from the front wave, the wall in which the speaker is mounted becomes effectively an infinite baffle. Cancellation of the front wave by the 180° out-of-phase back wave at low frequencies is eliminated. The speaker is now free to respond smoothly down to its resonant frequency. At this point, it peaks and then drops off quite rapidly. Very satisfactory low-frequency response can be obtained in this way, provided that the speaker has a reasonably low resonant frequency to start with. Of course, response can be carried well below resonance also, but some tricks are required.

## Efficiency

There is some small objection to this method because it is inefficient, since the entire back wave is thrown away unless the room *behind* the speaker is also a listening room. Considering the excess power available in contemporary amplifiers, however, we don't consider this objection as very serious, but there's another objection that *is* serious: the majority of people do not have a room available for the back side of the speaker.

Fortunately, there is another way of approximating an infinite baffle — the use of a large, fully-enclosed cabinet with a hole only for the speaker. By large, we mean a cabinet of the order of 5½ cubic feet for an 8-inch speaker, 8 cubic feet for a 12-inch speaker, or 10-cubic feet for a 15-inch speaker. Such cabinets must be solidly constructed with plenty of internal battens to control panel resonances, and *plenty* of padding to control standing waves and absorb the back-wave energy.

With this arrangement, the inefficiency objection remains. The cabinet must be so large as to be unwieldy for many residential applications but, if you reduce its size, you'll raise the resonant frequency of the entire speaker system and thus lose part of the bass end. However, it's an excellent enclosure method if you have the room space for it.

## Reflex baffle

The phase inverter or reflex baffle provides a way of reducing the overall size of the speaker enclosure while at the same time increasing efficiency and boosting the bass response below the resonant frequency of the speaker. This is accomplished by means of a tuned port which enables you to utilize a portion of the back wave at low frequencies. Fig. 804 is a chart which, with the accompanying text, will assist you in determining port sizes for reflex enclosures. As an installer, you are not expected to be an

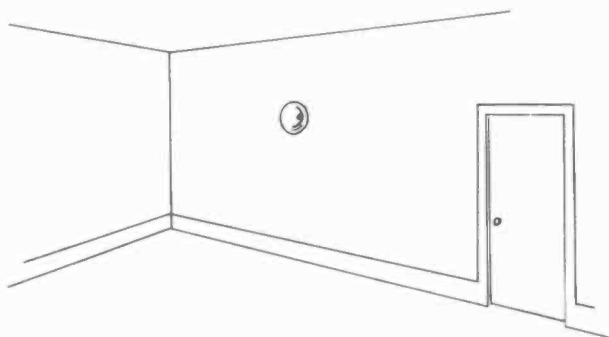

Fig. 803. *Approximation of an infinite baffle by mounting in the wall between two rooms.*

acoustical engineer, so don't hang yourself by your thumbs trying to monkey with cabinets and ports already specified and engineered by a manufacturer for his speakers. We imagine his engineers know what they are about. Specify only ports when you have to.

Even if enclosure size is no object, you might want to use a reflex, rather than an infinite baffle, in the event you or your client has chosen a speaker that has excellent mid- and high-range response but is a bit weak at the low end. The reflex may allow you to boost the low end enough to bring the overall response into a more pleasing balance.

## Horns

According to Paul Klipsch, one of the foremost horn engineers and designers in the field, a horn should not properly be called an enclosure. It is a housing that is at the same time an integral part, albeit an extension, of the speaker itself. To the installer, this means you do *not* under any circumstances fiddle with the insides of a horn. If you like a particular speaker in a particular horn, use it "as is." If you don't like certain exterior aspects

such as grille cloth, legs, molding or color, you can change these things. But do nothing that will alter the *interior* arrangements in any way. The chances are 110 to 0 that any such alterations will be detrimental to the performance.

### **Other speaker housings**

The acoustic facts of life underlying the three types of speaker housings mentioned have given rise to a number of patented speaker enclosures and complete speaker systems. Many of these enjoy considerable popularity by virtue of providing respectable sound in a compact package. Such enclosures and systems, like horns, should not be tampered with internally by the installer, if best results are to be obtained.

### **Room acoustics**

Assuming that, by whatever means, you have a speaker and housing operating satisfactorily together, the sound must still move through the room to the listener's ears. The room itself can acoustically favor, hinder or distort the propagation of the desired sounds. By the room, we mean the room *and* all the enclosed furnishings. This means upholstery (chairs and sofas), drapes, floor coverings, cabinets and tables, as well as areas of smooth plaster, glass, wood or tile in floor, walls and ceiling. For, as we shall see, changing some of these can substantially alter the room acoustics for better or for worse.

### **Speaker placement**

To give the room a fighting chance to do well for you, begin by making a determined effort to locate the speaker system or systems in acoustically favorable positions. Such positions are diagrammed in Chapter 11. In that chapter we will remind you to remember acoustics when dealing with esthetic problems, and here we must remind you of the reverse. Remember all the way through your consideration of acoustic matters that an installation that performs beautifully, but has to look badly to do it, will still be a monumental failure with just about all of your clients.

At times, you may have to compromise on speaker location for esthetic reasons, but merely because a speaker is not in the ideal spot for a given room doesn't necessarily mean that you have an acoustic calamity on your hands.

A speaker that is not located in the optimum place in a room will probably give poor sound distribution to parts of it. But this does not mean that it must provide *bad* sound in terms of causing

echoes, standing waves or any type of acoustic distortion. These problems involve other factors in addition to speaker placement.

**Reverberation time**

When a speaker starts to produce sound in a room, it does not instantly reach full intensity, due to the fact that sound travels through air at a finite velocity (approximately 1,100 feet per second) and therefore takes a finite time to reach the room limits. As the waves of sound radiating from the speaker spread out into the room, they are partially absorbed and partially reflected each time they strike a wall, floor, ceiling or some object in the room. Each wave is reflected many times before it is ultimately dissipated. Full intensity is reached when the amount of sound energy being absorbed equals the amount being produced by the speaker.

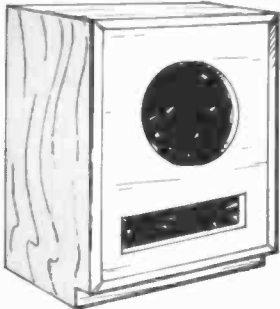

Fig. 804. Graph shows the relationships between the resonance of reflex enclosures, port area, and cabinet volume. The reflex cabinet at the right is built in the traditional shape.

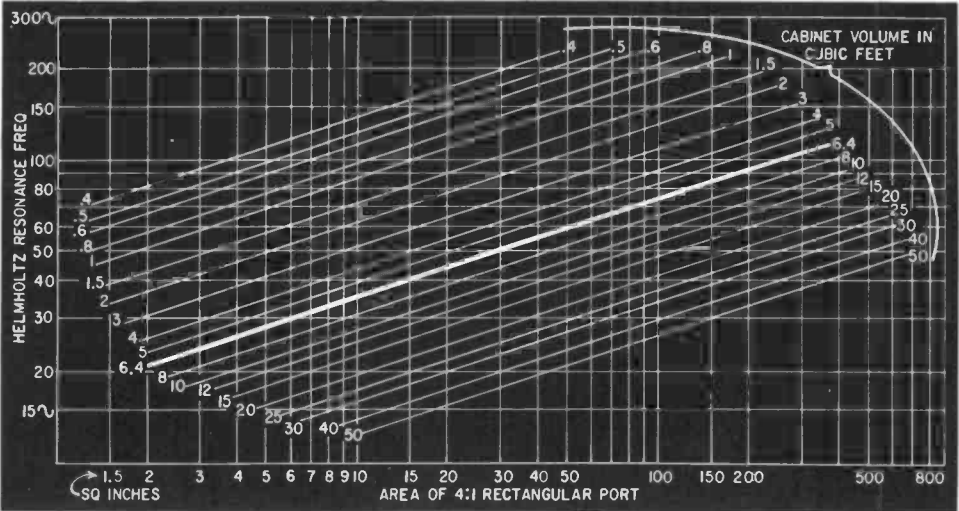

Fig. 805 shows in very abbreviated form, and in two dimensions only, the path of a given point on a sound wavefront as the wave goes bouncing about in a room. The thinning of the line with each reflection indicates the partial absorption of the sound each time it strikes something. In reality, a sound would bounce many more times in a room than can be shown conveniently in the drawing, before being absorbed entirely.

When the speaker stops producing sound, the energy already bouncing about in the room will require a finite time before it is absorbed and dissipated, just as a finite time was required to build it up. This time, specifically the period required for

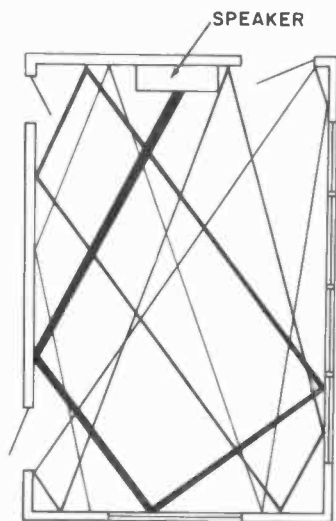

Fig. 805. Path of a pencil of sound in a room from source through various reflections to ultimate dissipation.

the sound to decay to one-millionth of its original intensity, is termed the reverberation time of the room.

### Absorption

The reverberation times of rooms will vary somewhat with differences in size (cubic volume) and with the absorptiveness of the interior surface and contents. For example, an acoustic tile ceiling or a carpeted floor will absorb *more* of the sound hitting them and reflect *less* than a smooth plaster ceiling or a bare hardwood floor. As surface absorption is increased, the number of reflections necessary to absorb a given amount of sound energy

fully is decreased, thus shortening the reverberation time.

Let's take another example. Room A and room B have interior surfaces of the same materials and in the same proportions, but room B is half again as large as A (Fig. 806). The same *number* of reflections will be required to absorb fully a given sound in both rooms. But in B, the *distances* and therefore, the *time between reflections* is longer, *increasing* the reverberation time.

If the reverberation time in a listening room is too short because there is too much highly absorptive material in the room,

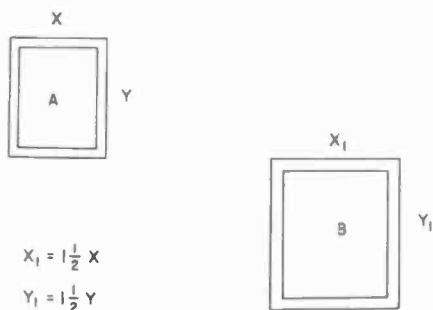

Fig. 806. When two rooms are identical except for size, the larger will have a longer reverberation time because of the larger air paths the sound must travel.

reverberation dies out very rapidly, and a very dull, flat and unrealistic acoustic effect results. On the other hand, when a room has too *long* a reverberation time, unpleasant hangover effects will be noted due to a long-period echos and standing waves.

Thus, it is entirely possible to have an excellent hi-fi system correctly installed technically and in perfect working order that can produce only a very unsatisfactory sound in a particular room, purely because of room acoustics.

### Absorbency vs frequency

Thus far, in discussing reverberation time, we have considered sound without regard to differences in frequency. This could be misleading, because any given material will absorb differing amounts of sound energy at different frequencies. A typical carpet, for instance, will absorb about three times as much at 2,048 cycles as it will at 128. And at 4,096, it has better than four times the absorption at 128 cycles.

Generally, absorption will increase in any material as the fre-

quency goes up. Not only does absorption increase with frequency but the *rate* of its increase also slopes up as frequency rises. The curves of absorption coefficients relative to frequency increase will vary for different materials, and they won't necessarily be smooth curves, either. Some may have flats or dips here and there, but the *general* direction of such curves can be depended upon to move up with rising frequency.

This partly explains the common problem of getting adequate dispersion of highs in a listening room. Not only are highs difficult to spread as they emanate from the speaker, but they are also the first things to be absorbed by the room and therefore, won't readily spread out by reflection either. If a room is live enough to disperse highs well by reflection, it will very likely be intolerably reverberant at mid- and low-frequencies. On the other hand, a very dead room with extremely low reverberation time will be one in which you won't hear any highs very well unless you keep your ear pretty close to the center axis of the speaker system.

### **Optimum reverberation time**

As we have noted in the previous discussion, if the reverberation time in a given room is too short or too long, the reproduction of music in that room will be impaired by acoustics, regardless of the quality of the reproducing system. Hence, it might be helpful if we could compute or measure the actual reverberation time of a room and compare this with some sort of absolute optimum for its cubic volume.

Unfortunately, the available methods for either measuring or computing reverberation time accurately are sufficiently complex to suggest that the installer will do well to avoid them. These are jobs which should be done by an acoustical engineer if considered essential and, if you are doing a sound system in an auditorium, it may very well *be* essential. However, the average residential installation will not require elaborate analysis.

Sabine, one of the pioneers in architectural acoustics, used only his ear as a detector, and a stop watch for time measurements. For most of your purposes this method, plus an educated look at the room and furnishings, will be good enough.

Make it a standard procedure to look over any room in which you are planning an installation with a thought to acoustics. Suppose you see a fairly large room, say 18 x 30 feet, with lots of glass and smooth plaster, a bare tile floor, very thin and few drapes, and a few light, modern upholstered pieces. You have

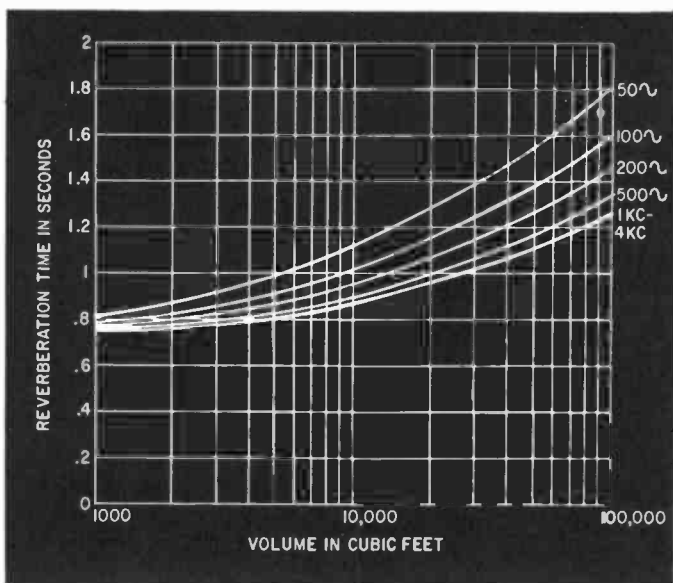

Fig. 807. Reverberation time of a room versus room volume is a function of frequency. (Modified from Harry Olson's Musical Engineering, McGraw-Hill Book Co., Inc.)

good reason to suspect at once that the room may be too reverberant. Now, try a single sharp clap of your hands at various spots in the room and listen carefully to the rate of decay of the echo each time. If the clap rings on stubbornly, your suspicion is taking on substance.

### Making reverberation measurements

If you want to make a rough reverberation measurement, hook up an audio oscillator ahead of an amplifier and speaker. Then, with ear and stopwatch, check the reverberation time at a few frequencies, perhaps 100, 500 and 1,000 cycles. If you come up with times around 2 seconds or greater, you have too long a reverberation time.

### Reverberation vs room volume

The graph of Fig. 807 gives the optimum reverberation time for rooms as a function of room volume for a few selected frequency ranges. Note that the optimum time differs at different frequencies, but note also that the curves don't start *really* to fan out until the room volume gets well over 10,000 cubic feet.



Unless you're doing a lot of theaters and auditoriums, you won't deal with many rooms over 10,000 cubic feet.

### **Live and dead rooms**

A room that is too dead (not *enough* reverberation time) is a bit more difficult to spot in advance without instruments. Fortunately, its deleterious effects are also far less painful. What with echoes, standing waves and various spurious resonances winging about, a room that is too live produces some very positive types of unpleasantness, while a dead room produces effects primarily of a negative nature. Highs just disappear, the mid-range loses brilliance and clarity due to loss of the upper overtones, and bass tones tend to degenerate into a series of dull thuds.

Very often, visual inspection will tip you off to a room that later proves to be too dead. Thick carpeting, lots of heavy drapes, extensive well-stocked bookshelves and plenty of heavy, upholstered furniture should make you suspicious. The clapping trick doesn't help you much here, except to confirm your suspicions by giving you no ring.

Both excessive liveness and excessive deadness in a listening room are bad, but of the two, we tend to find excessive liveness the more objectionable, due to the positive nature of the aberrations it introduces. Suggestions regarding the alleviation of both of these conditions will appear in Chapter 9.

### **Miscellaneous object resonances**

An ill-assorted polyglot group of miscellaneous grunts, groans, squeaks, rattles, buzzes, whistles and rumbles occasionally appears to plague owner and installer subsequent to an installation. They are usually intermittent, and often seem at first to appear and disappear at random. Then, you'll begin to notice that they are associated with specific frequencies as they recur in the program material coming through the system.

They are not in the speaker box, because they come from somewhere else in the room, and at times they can be quite troublesome to run down.

We don't know where you might find them, but perhaps we can help you by giving you a few examples of some we've run across.

Often, a double-hung window will rattle in its frame at a particular frequency, while another window in the same room will rattle at a different frequency. Closet and cabinet doors, although clear across the room, are common offenders in the same way. Piano strings will sometimes vibrate sympathetically at all

sorts of odd frequencies. And, occasionally, a slight vibration set up in a shelf is enough to cause bric-a-brac to rattle.

We recall one case when at odd intervals a beautiful, clear bell like tone would ring out through the room. It was always the same tone, and it was usually frightfully out of key with the program at the moment, which didn't make sense. After much head

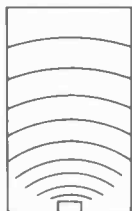

*a*

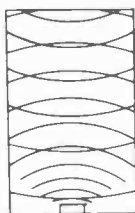

*b*

Fig. 808. (a) Sound waves traveling through a room, and (b) reflected from the end wall.

scratching, we finally ran down the cause. A moderately sharp transient at a particular frequency caused a shelf inside a cabinet to vibrate. This in turn caused a piece of crystal glassware on the shelf to tap against a piece next to it, producing a lovely, clear ring. It was excellent quality crystal. Naturally, slightly separating the pieces on the shelf stopped the ringing.

This was a particularly troublesome one to track down because it appeared only on transients and not when the frequency was generated steadily. But most object noises will give themselves away if you plug an audio-frequency generator into the system and sweep through the whole band very slowly with the gain pretty well up. When you hear an extraneous noise, diddle the frequency up and down a bit until you've got it at the point that produces the worst noise. Then, leaving the generator and system running as is, poke about the room until you locate the cause of the noise.

It's not a bad idea to make a routine noise check with the generator at the completion of all installations, and point out to the client any noises you uncover. This way, you'll forestall any possibility of the system being blamed for nonexistent defects.

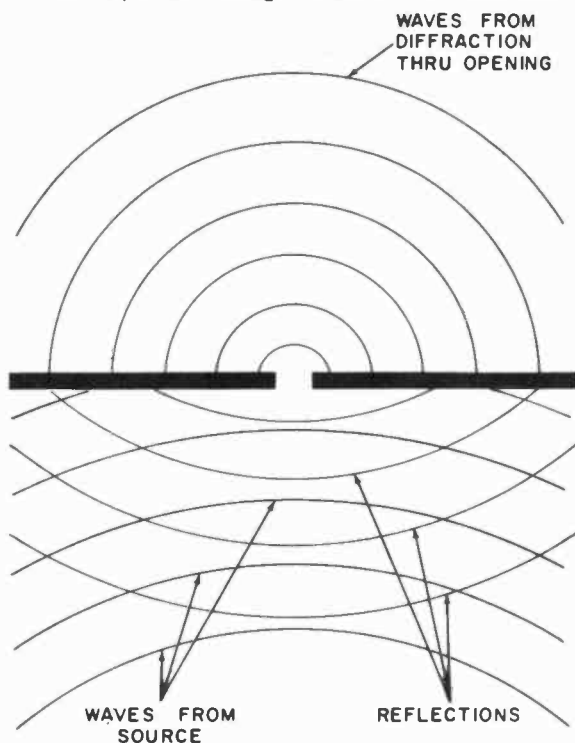

Fig. 809. *Diffraction of sound through a small opening.*

The question is now up to the client as to what he wants done to correct the fault, and what he's willing to live with.

### **Sound transmission**

More than a few pleasant relationships between neighbors, or between landlords and tenants, have been strained if not shattered after hi-fi has entered the picture. Yet, usually, most of the strain can be avoided by a little understanding of sound transmission.

Since the sound you hear in your listening room is transmitted from the speaker through the air to your ear, it is not difficult to understand that it will continue to travel via air through any openings in the room such as windows, doors, etc. and thus be transmitted to adjacent areas. But sound transmitted through

solid media — walls, floors and ceilings — is not as readily expected or understood, and it's a darn sight harder to control.

### Sound transmissions in air

The same physics that gives us the sounds we want to propagate in air also goes on to produce a spate of effects we definitely don't want. Fortunately, a little understanding of what is happening will provide some clues to the control of the undesirable effects.

Fig. 808-a shows progressively the movement of a sound wave from a speaker out into a room. In Fig. 808-b, we see it reflected

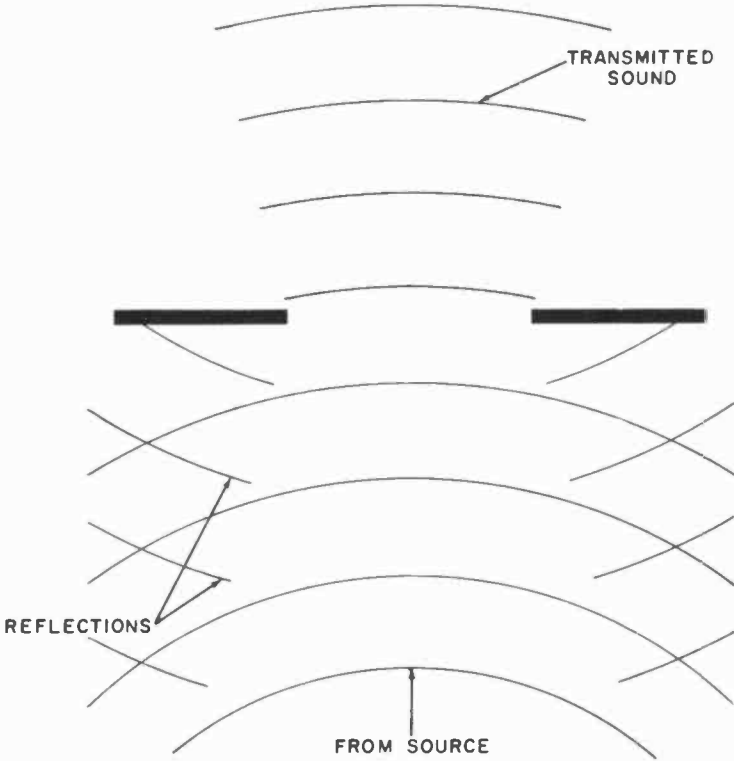

Fig. 810. *Transmission of sound through a large opening.*

from the end wall. As we noted in discussing reverberation, part of the sound striking the wall is lost in the wall and part reflected into the air, to travel until it strikes another obstacle where the process is repeated.

If, however, there is an opening in the end wall, some of the sound will be transmitted through the opening into the adjoining

area. The amount and character of this transmission will vary, depending upon the size of the opening relative to the wavelength of the sound.

### **Diffraction**

If the size of the opening is small relative to the wavelength, as in Fig. 809, the sound passing through will spread out in all directions. But since the *amount* of sound energy that can pass through the opening is small, the *intensity* of the sound transmitted to the adjoining space will also be small.

When sound changes direction by passing an obstacle, the process is defined as diffraction, which is exactly what is happening here. The sound struck the opening from a single direction but is proceeding from it in all directions.

When, as in Fig. 810, a sound encounters an opening that is *large* relative to the wavelength, the results are quite different. It passes through with no loss in intensity, but note that this time it does not spread out in all directions but rather it bends only moderately around the edges of the opening. This is what happens when higher-frequency sounds pass through an open door or window.

If you ever heard of a case where someone across the street complained of noise in an apartment, while the fellow downstairs wasn't disturbed in the least, you now know why.

### **Reflection**

In the same way that the size of an *opening* relative to wavelength will vary the way sound is transmitted through the opening, the size of an *object* relative to wavelength will affect its reflection of sound and its shadowing effect on the area behind it.

When an object is *small* relative to wavelength, as in Fig. 811, the sound waves bend around it by diffraction, and meet again in a relatively short distance. The object, therefore, casts a very slight sound shadow and does not reflect such a sound appreciably.

Fig. 812 shows how conditions change when the object is large relative to wavelength. It now reflects a substantial portion of the sound striking it and casts a sizable sound shadow. This explains why lows will go around a chair placed in front of a speaker system while the highs won't.

If, instead of being perpendicular to the path of the sound striking it, a reflecting surface is angled (Fig. 813), the deflected sound will bounce off at an angle equal to that at which it struck. Such a reflecting object will also cast just as dandy a sound shadow

as one that is perpendicular to the sound source.

### Echo

An echo is merely a sound that has traveled the scenic route via reflection, and arrives at the ear with sufficient delay to give the impression of being distinct from the sound wave that reached the ear directly from the source. For a well-developed echo, the

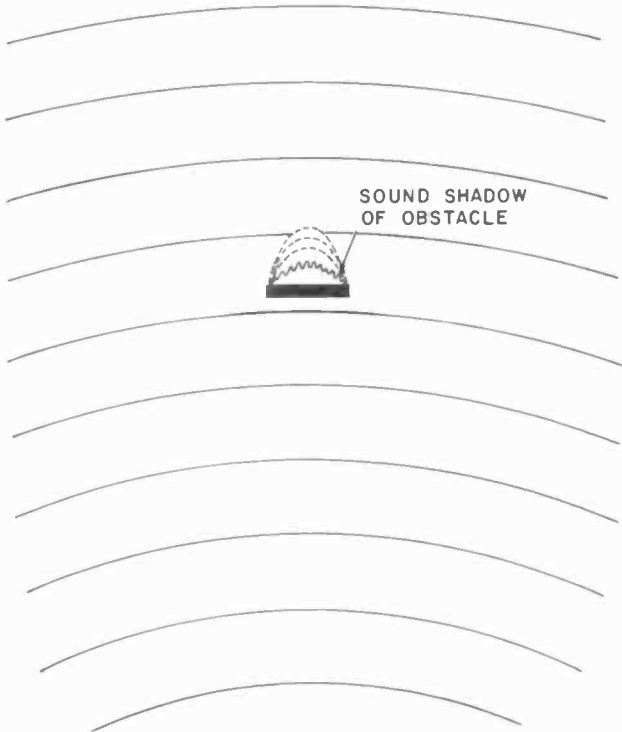

Fig. 811. Sound will readily diffract around an obstacle that is small relative to the wavelength.

sound must bounce off a rather highly reflective surface or surfaces, so that the echo arrives at the listener's ear without too much loss in intensity relative to the direct sound.

A multiple echo is a series of individual echoes traveling along paths of different lengths and therefore reaches the listener with differing time delays.

Severe echo is seldom a problem in the average living room, but can become quite serious in auditoriums, meeting halls or dance halls, and various commercial and industrial areas.

### Standing waves

Another type of undesirable acoustic effect produced by re-

flection is termed a stationary or standing wave. A normal sound wave is progressive in nature, moving continually outward from

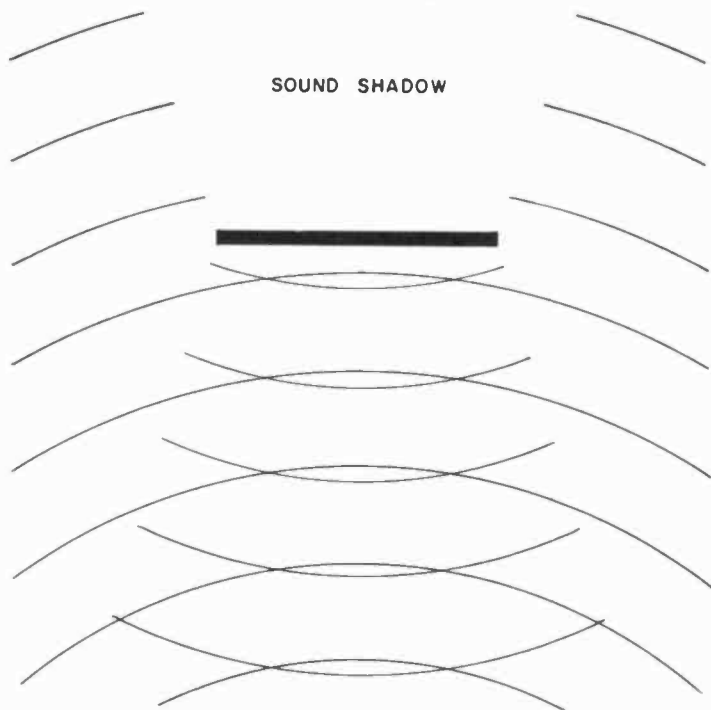

Fig. 812. A large object reflects sound and casts a sound shadow.

its source. A standing wave is merely the result of a reflected sound wave combining with the direct wave from the sound source.

For a very simple case to illustrate the principle of standing wave formation, consider that a steam whistle is suspended before a vertical cliff at a distance of 100 feet. When compressed air is fed to the whistle, it generates a continuing sound that has a wave length of, say, 10 feet. Along the path leading from the whistle perpendicularly to the cliff, sound will travel straight to the cliff and be reflected straight toward the whistle. Thus, as soon as the sound has had time to reach the cliff and return to the whistle, a steady condition will exist in which sound waves are moving in both directions over the same path. The wave-length of the sound being 10 feet, it is easy to see that at a point on the sound path 5 feet from the cliff, the direct wave and reflected wave will be in phase and will reinforce each other,

causing the sound pressure to be almost double its normal value. (If no energy was lost at the reflecting surface, the pressure would be doubled.) This reinforcing effect will be found at all points in the sound field where the direct and reflected wave are exactly

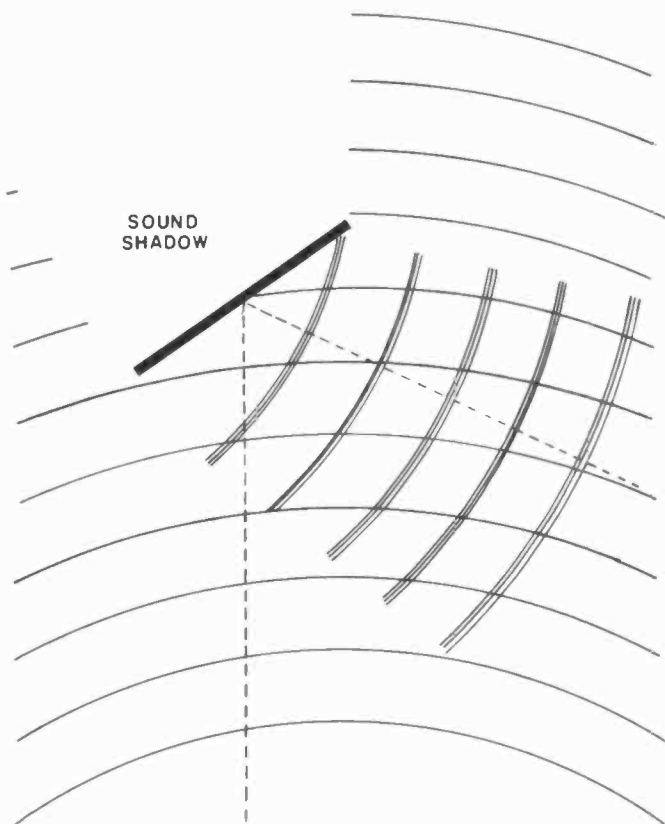

Fig. 813. *Effect of sound striking an angled reflecting surface.*

in phase. On the direct path between source and reflector in this case, the in-phase points would be at 5 feet from the cliff, 15 feet, 25 feet and so on. But at points 10 feet, 20 feet, 30 feet and so on, the direct and reflected waves will be exactly *out* of phase and would almost completely cancel each other. Since these maximum- and minimum-intensity points remain stationary, although the direct and reflected sound waves that combine to produce them continue to move back and forth as usual, they are called standing waves.

In large auditoriums and even in outdoor stadiums, standing-



wave patterns frequently occur, particularly when the audience is sparse, permitting large areas of hard surface to reflect the sound waves without the absorbing effects of human bodies and clothing. This may result in "dead" spots where announcements or music are badly distorted or almost inaudible, if the sound system is not carefully installed to minimize such standing-wave effects.

However, in homes and *small* auditoriums, standing waves are seldom a problem and, in auditoriums built since the advent of amplified sound, the acoustics are usually taken into account when the building is first put on the drawing board, so that such effects are minimized.

### **Sound transmission in solids**

Sound can be transmitted not only through air but also through solid media. This fact turns up to plague the installer in the form of sounds that are generated in the desired listening area, picked up in turn by the walls, floor or ceiling, only to emerge in areas where they are *not* wanted.

The intensity of such transmission, and therefore the extent of the disturbance it causes in other people's lives, is governed by three factors. One is the power of the source; the second is the type of construction used in the building; and the third is the manner in which the sound is picked up by the structure.

Sound can be transmitted into solid media in two ways, first via air and second by direct conduction. As we noted when discussing reverberation and reflection, when a sound wave propagated in air strikes a wall, part of the energy is absorbed by the wall and part is reflected by it. Of the energy absorbed by the wall, some is dissipated in the wall but part is also transmitted through it to the air beyond (Fig. 814).

The amount of sound actually absorbed and dissipated in the wall is termed transmission loss, and is measured in decibels. Although there are occasional exceptions, it will usually be true that the heavier the materials and the thicker the wall, the greater will be the transmission loss.

### **Direct conduction**

A speaker mounted in a wall will conduct energy directly into the wall through its frame. A speaker enclosure standing directly on a bare floor can do the same thing; that is, conduct some sound vibration directly into the floor. Such direct conduction won't radiate very well from the wall or floor, but it can travel astonish-

ing distances through a building. As we shall see in Chapter 9, except at very low frequencies and very high power, direct conduction for our purposes can be fairly well controlled.

There is one other circumstance under which direct conduction

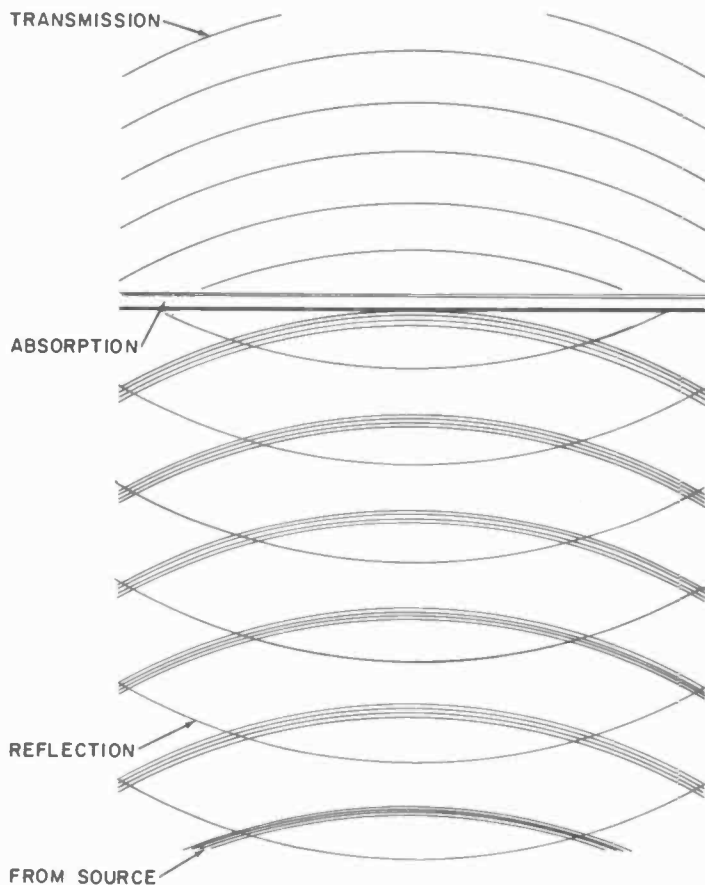

Fig. 814. Effect of a partially reflecting, partially absorbing and partially transmitting wall.

becomes hard to control, and that is at frequencies that cause parts of the room, walls or floor to resonate.

### Structural resonance

In the same way that a speaker cone, a speaker box or a piano string has a resonant frequency or frequencies, so will a wall or a floor. In fact, it may have several and, depending on the construction, it may resonate very freely. This is an aspect of construction that might never bother anyone until a hi-fi set is in-

troduced. But then it can cause quite a disturbance in places adjacent to the listening area, as well as some pretty undesirable effects there, too.

While structural resonances won't often cause the most blatant of your acoustic problems, they'll be among the most difficult to correct if they're bad enough to require correction. However, the situation is never hopeless, and some means for dealing with this and other difficulties are discussed in the next chapter.

## solving acoustic problems

WHEN acoustic problems arise in connection with a hi-fi installation, their solution may require control measures ranging from the trivial to the monumental, depending on the nature of the difficulty. What you do in desperate cases will depend a good deal on how far the client is able or willing to go, for almost *any* acoustic difficulty can be overcome if expense and trouble are not obstacles. Unfortunately, the authors have never yet encountered an installation where these factors did not enter the picture in *some* form, so everything discussed here must be weighed against these twin influences and explained fairly to the client, so he understands just what he's being asked to decide.

In all cases where a really serious acoustic problem must be solved, it is best to evaluate it carefully, dope out a proposed remedy and submit a cost estimate to the client along with your statement of the trouble and your proposed solution. After that, the decision is up to him. *Don't* go ahead and do the job and *then* bill him for it unless you have a specific contractual agreement stating that you are to proceed in that way, or you will very likely wind up not getting paid, and with a lost client to boot.

The reason for this caution is partly psychological. If the client hears the system only after you've cured the trouble, he may very well take the attitude that "that's the way it *should* sound, so why should I pay extra?" It is far better to demonstrate just what the problem is and get his okay before attempting corrective measures. Another reason for the suggested procedure is that most professional installers are not fully trained professional acoustic en-

DRAW DRAPES (HELP CONTROL TOTAL ABSORPTION)

ROUGH-TEXTURED ACOUSTIC-TILE WALL



SOUND ABSORBENT MATERIAL (UPHOLSTERED CHAIR, RUGS,  
THROW CUSHIONS)

Fig. 901. A large drape can be very effective as a sound absorber when placed opposite the speaker. Placed behind or alongside the speaker, the drape will damp reflected sound waves, thus helping to deaden a room that is too "live". (Photo Klipsch and Associates, Inc.)



gineers, to say nothing of the average "do-it-yourselfer" making his own installation. And if the problem is a really nasty one, say a resonating floor or a tissue-paper apartment-house wall leaking sound into the next tenant's quarters, it may take an acoustic engineer and the architect to solve it to everyone's satisfaction.

In the examples discussed in this chapter, we have tried to indicate about how far a competent installer should go in dealing with acoustic troubles. However, individual cases can pose unforeseeable problems and, in cases where the solution looks doubtful, you should not hesitate to suggest to the client that an acoustical engineer be called in. This recourse is likely to be justified only in fairly large and elaborate installations, such as in public places, institutions or the mansion of a very well-to-do client.

### Room acoustics

Once the sound leaves the speaker and travels out into the air, it is at the mercy of the environment. This environment may consist of anything from a very modest living room or bedroom to a large auditorium, or even an outdoor stadium or amusement park, for many businesses and public gathering places have begun to recognize the appeal of high-fidelity reproduced music. For our purposes, we will limit the discussion to acoustical problems arising in small- to medium-sized rooms, up to perhaps the size of the dining room of a modest restaurant.

As we saw in Chapter 8, room reverberation time can cause trouble in sound reproduction if it's either too long or too short. If you are a professional installer, what you can do about it will depend entirely on what the client is willing to let you do. If you're doing your own personal installation, you are perhaps freer. But then, your wife may give you less latitude than a client would.

However, regardless of what is done or by whom, it must be considered in the light of room appearance and functionality, as well as acoustics. If the best acoustic treatment for a particular situation would impair the usefulness or appearance of the room, it's *out* and that's that. Try the next best thing. Don't ever lose sight of the room as a whole, and the living that goes on in it in favor of a single aspect. Hi-fi may be your full-time business, but to your client it is a part-time recreation.

### **Excessive reverberation**

A room that is excessively reverberant (too live) is a room containing too much surface area that is highly reflective to sound. In its simplest terms, the solution to this problem is to provide enough area of high absorption to increase substantially the rate at which sound energy will be used up in the room.

A number of materials will help to do this. Some, such as carpets or drapes, are commonly used in interiors for their decorative effect, and incidentally, happen to be helpful acoustically. Others are acoustic materials designed solely to provide certain sound-controlling properties.

When trying to increase absorption in residential or commercial spaces where appearance counts heavily, do as much as possible with commonly-used decorative materials. Laying a substantially wall-to-wall carpet, particularly with underpadding, will add a large amount of absorption to a room that has a bare hardwood or tile floor. Often, this in itself is enough to bring reverberation time back within tolerable limits. A number of small throw rugs are not as effective as one large carpet. The larger the carpet and the deeper the pile, the more effective it will be. A carpet with an underpad will be more effective than one without, and the underpad is a good thing anyway as it increases the service life of the carpet. Once a heavy carpet with underpadding is down, there is very little else you can do with the floor to control sound in the room.

A rough-textured wall surfacing — rough plaster, textured paper, or fabric — will provide better absorption than smooth painted plaster, but not very much. The amount of improvement will vary with the coarseness of the texture and the softness of the surface, a coarse fabric being about the best thing short of acoustic plaster or acoustic tile.

A large drape or lined tapestry can work wonders, particularly if it is on the wall directly opposite the speaker. (Fig. 901). The heavier and thicker the drapery material, the more effectively it

will absorb sound. The efficiency of even a heavy material will be perceptibly increased if a lining is added, and further increased with interlining. As with a carpet, the larger the area of the drape, the more you can expect it to accomplish. Acoustically, a wall-to-wall drape will do the best job and, fortunately, esthetically it is

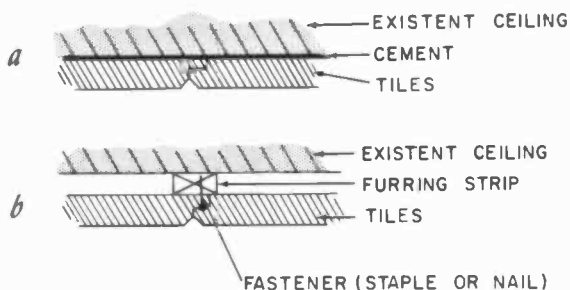

Fig. 902. Installation of acoustic tile (a) by cementing directly to ceiling, (b) by attaching to furring strips.

often easier to get a satisfactory effect this way than with partial draping. When a drape is not acceptable as a permanent feature of the room decor, it can be hung on a track that permits it to be run back to the corners when desired.

It is customary for some people to take carpets up and drapes down in the summer and put them back in the fall. If you hit a client like this in the summer, his reverberation problem will very possibly be solved by the normal fall replacement of these items. Of course, what he can do in the summer is a nasty question, unless he has a reasonably-isolated private home and can leave the windows open so some sound energy can escape that way.

The old-style, large, overstuffed chairs and sofas were far better absorbers than the light, slim, trim modern ones, but there's nothing much you can do about that either, unless you revamp the listening room as a replica of grandma's parlor. This is not a solution that will appeal to many.

If normal decorative materials simply won't do an adequate job of reducing the reverberation time, you've no choice but to turn to specific acoustic materials and devices. There are, of course, a few people who would *rather* put acoustic tile on the ceiling than a carpet on the floor. They just don't like carpets.

An acoustic ceiling is fine as an absorber, but it involves much more labor than laying a carpet, even the wall-to-wall type. Quite a variety of patterns and textures is available in acoustic tiles.



Their coefficients of absorption also vary somewhat with different patterns, thicknesses and methods of mounting. But you needn't worry much about that unless you have a really *fearful* reverberation problem, in which case you probably need an acoustic engineer anyway.

The two most common ways of installing acoustic tile, shown in Fig. 902, are by cementing directly to the ceiling or by nailing or stapling to furring strips which have, in turn, been nailed to the ceiling. The furring-strip method is the better of the two acoustically since the coefficients of absorption are somewhat higher with this mounting than when tiles are applied directly to the ceiling. Also, the furring-strip method generally results in a better looking job, as the strips tend to bridge any irregularities in the ceiling surface, producing a smoother-looking surface upon completion.

If you are feeling energetic and would like to install an acoustic tile ceiling for yourself, either of the methods just mentioned are fine and will be within your capabilities. In addition, there are a half dozen other methods that we will not enumerate, as they should be handled by a contractor.

If, for some reason, an acoustic tile ceiling is undesirable, there is always acoustic plaster as an alternate possibility. While it will exhibit a rough surface texture compared with ordinary plaster, it will allow you to eliminate the patterns of acoustic tile, which may not be acceptable to your client. Acoustic plaster should be put up by a contractor familiar with the use of the material, as it must be handled differently from ordinary plaster.

Acoustic plaster can also be used to deaden walls as well as ceilings but, since it is nowhere nearly as hard as regular plaster, it can be readily chipped by kids, pets and carelessness. So you'll need to take extra precautions not to damage such a wall inadvertently, and the whole matter should be made clear to the client.

### **Echoes and standing waves**

Seldom will any sound path in even the largest rooms considered in this book be long enough to permit a genuine echo to show up, even if the room is fairly live. One of the authors once lived in a suite of rooms on the ground floor of an enormous old mansion that had, as a feature of the entrance hall, a huge circular staircase that began in a cavernous basement and rose through all four floors of the structure to an equally cavernous attic. When the double doors of the suite were open, a drummer's "rim shot" or other short transient sound resulted in *three* distinct echoes; one

from the basement, one from the end of the hall, and one from the ceiling of the hall. A single loud chord of organ music gave practically the effect of a short scherzo movement, and an orchestral selection suggested a parade in which several bands at varying distances along the route were playing the same selection. Closing the doors solved the problem very neatly.

It's unlikely you will have to grapple with a real echo problem. When you do, it's nine chances out of ten the trouble occurs because of a *very* high ceiling, a reflective wall at the far end of a very long room, or a long, hard-surfaced hall or corridor opening directly into the listening room. If the trouble is due to a very high reflective ceiling, making the walls and floor more absorptive will help some, particularly the wall directly opposite the speaker. This is cheaper than treating the ceiling and is worth trying with some jury-rig drapes, such as blankets hung up. Also try relocating the speakers. If they are centered in a long wall of the room, repositioning them in a corner adjacent to the main listening area may make a considerable improvement. Hanging tapestries high up on the walls will also help, but this brings in a decorator problem which should be discussed with the client.

As a last resort, the ceiling may be covered with acoustic tile; but this not only alters the decor, it costs like original sin if scaffolding is required to do the job. One other solution, and in some cases the best, is a heavy drape cut to cover the ceiling, and hung from metal tracks at each end in such a way that it can be drawn back or pulled across to cover the reflecting area, at the client's convenience. Such an installation in a splendid old California mansion solved a severe echo problem without permanently hiding a very beautiful ceiling fresco.

Standing-wave trouble is somewhat more common, since it does not depend on a long sound path. It usually crops up in symmetrical rooms that are rather live, particularly when there are few door or window openings or other wall irregularities, and little absorptive furniture. Standing waves make themselves apparent by producing dead and live spots in the room, particularly at certain frequencies. If you find, when feeding the audio oscillator through the system, that certain frequencies in the lower middle range (say from 100 to 1,600 cycles or so) are heard very weakly at certain points in the room and very strongly in others, you've got standing waves. Even the deadest room will show some standing waves if you search for them hard enough, but usually *only* very live rooms show the effect strongly enough to require corrective measures.

Two technical expedients will solve almost all standing-wave difficulties. These are relocation of the speaker in the room, and the addition of some absorbing material in a suitable place. Placing a speaker dead center in any wall of a symmetrical room is particularly bad, and should be avoided, if at all possible. In or near a corner is much better on several counts, and somewhat off center of the narrowest wall of the room may be almost as good. The absorbing material, if used, should go on the wall opposite the speaker, and on either *adjacent* wall, if more is required. Carpeting a bare floor will also help, and the addition of a large item of furniture or two in the room will at least alter the standing-wave pattern, and will often reduce the strength of such waves substantially.

### **Insufficient reverberation**

Insufficient reverberation means excessive sound absorption; i.e., a dead room. Both cause and cure are just the opposite of the excessive-liveness condition previously discussed. Somehow, you have to get rid of some highly absorptive areas and replace them with highly reflective ones.

On floors, for example, the area of carpeting should be reduced as much as possible. Better yet, remove the carpet entirely. If the floor under the carpet is in such hopeless condition that sanding and refinishing won't produce a satisfactory result, a wide variety of flooring tiles in asphalt, linoleum, rubber and vinyl is available to produce a good-looking floor that is also highly reflective. If you're the energetic type, this is also a job you can expect to do satisfactorily yourself, if you care to save a few dollars.

If the ceiling is smooth plaster, leave it alone. You won't be able to do anything better with it. If some misguided experimenter has tiled it with acoustic tile, you'd best not try to remove it. Getting the tiles *down* and repairing the ceiling afterward is a major project. Besides, it may be needed there to control sound leakage into the room above, or vice-versa. Some types of tile lose part of their absorptiveness with a heavy coat of paint, so you might see if that helps. But otherwise, look elsewhere to increase reflectivity.

If the ceiling has been treated with acoustic plaster, a thin coat of regular plaster on top will greatly increase reflectivity, but again, don't try to knock the whole business down. It becomes a very sloppy job.

When you get to the walls, the idea is to bare as much smooth plaster, paneling or what have you as possible. Where there are wall-to-wall drapes, try to cut them down to a narrow strip on

either side of the windows. If madam won't hear of this, at least get rid of the linings and interlinings, if any, and leave the drapes open as much as possible when playing music. Sometimes, when madam won't go along with eliminating or reducing the area of drapes, she'll at least permit switching to a lighter material. Fine! Every little bit helps. Sell her on the lightest and gauziest material you can.

At times, when the lady insists on keeping the drapes, you can at least get her to part with the valences. Even this is a small step



Fig. 903. *Loose display pieces of china, ashtrays and other knickknacks tend to rattle, but the noise will stop when a piece of felt padding is inserted under the offending member.* (Harmon-Kardon, Inc.)

forward. And don't overlook the possibility of getting wall drapes rehung on tracks, so they can be drawn back to expose wall area when music is to be played.

You will also make a bit of progress if you can get some of the larger overstuffed upholstered pieces cut down or removed. This isn't easy, but perhaps you can at least get the aprons off the ones on legs, so a little air can pass under them.

Generally, you'll have your troubles in getting very far toward livening a room that is too dead because such a room is likely to be furnished in a fairly plush period style. By the time you've removed enough absorptive material to help matters appreciably, you've probably ruined the decorative effect. If that's the problem, all you can do is take out what little you're allowed, crank up the gain and treble controls, and hope for the best.

## Object resonances

As indicated in Chapter 8, these are elusive little devils and, what's worse, they are often difficult to stop even after you've located them.

Buzzes and rattles caused by ashtrays, china, vases and bric-a-brac are comparatively simple to control. A felt pad or a doily under the offending piece will usually stop the trouble. If you don't want the pad to be visible, simply cut a felt pad to the shape of the bottom of the piece to be padded and cement it on with Duco or something similar (Fig. 903).

A rattle in a casement window is generally pretty simple too. A strip of self-adhesive sponge neoprene gasketing will do the trick nicely, and will also serve as a very effective dust and weather seal at the same time. The same trick will often work on hinged closet and cabinet doors when the door is rattling against an inside stop strip.

Where a hinged door is rattling on its catch, moving the strike plate in, sometimes as little as 1/16 inch, will stop the noise. If a cabinet has bullet catches on its doors and they rattle, there's no point fooling with the bullet catch. Add a spring-clip type catch inside and you can get a good positive hold on the door.

Cabinets with sliding doors that rattle are *really* a problem because, even if you can manage to fill up the grooves enough to stop the rattle, you'll find that now the doors bind. Nylon glides are now being made for such doors that will prevent rattles. Remember them if you're planning to build some sliding-door cabinets, but they won't help you with an existing one that's giving trouble. One scheme that will help is to glue a piece of fairly soft felt to the *front* surface of the *rear* door, in the middle of the edge that is hidden behind the front door when both doors are closed. If this felt is carefully trimmed with a razor blade to just the right thickness, it will usually stop the rattle without causing an intolerable amount of friction when the doors are opened.

Double-hung windows that rattle are also a nasty problem, for the same reason as sliding doors. If you get them tight enough to stop the rattle, you're likely to need a hydraulic jack to open and close them. Sometimes, weatherstripping consisting of a wood or metal molding with a felt edge, if properly installed, will stop these rattles and still let you open and close the windows (Fig. 904). You may have to keep renewing the weatherstripping as the felt wears down.

So many kinds of objects can resonate and rattle we couldn't

possibly mention them all if we spent the rest of our lives at it. In a good many cases, you're just going to have to swear and sweat until you can locate them, and then do the best you can to think of something that will shut them up. If it's any encouragement, about 90% are easy. It's the last 10% that starts you talking to yourself.

### Structural resonance

Aha! We now come to the most persistent villain in the sound picture, particularly in buildings of certain modern low-cost types of construction. Many of them compare to older structures as a cracker box compares to a bank vault and, when a really good hi-fi installation is cranked up a bit in one of them, weird things can happen. One of the most common and most aggravating is for an

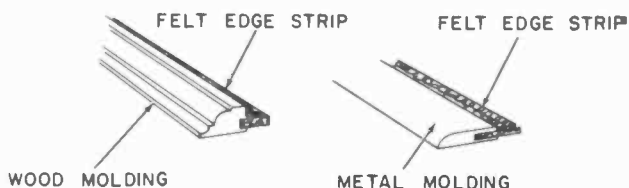

Fig. 904. The installation of felt-edged weather strips around a double-hung window will often help control resonance rattles.

entire wall, floor or ceiling to be highly resonant at some frequency in the middle or low range of audio frequencies. Whenever this note comes along in the music, it booms out like the trumpet of doom, and maybe sets the dishes rattling in the kitchen, or the dog howling in the yard. Even notes an octave or two below it or adjacent semitones will excite it, and the sound will be heard on the other side of such a wall just about as well as in the listening room. Since few musical compositions consist of a single tone and harmonics thereof, the effect in the next room is even more aggravating than would be the case if the whole program leaked through on an equal footing.

Sometimes, relocating the speaker will help, particularly if the offending surface is the wall opposite the speaker, but this is seldom the complete answer. On a floor, a heavy rug will help, and the addition of a heavy piece of furniture as near the middle of the floor as the lady of the house will permit will substantially alter the frequency of the annoying resonances. On a wall, a heavy drape may help some if the frequency is fairly high. At low frequencies, the drape will not absorb enough energy to do the job. A large, heavy cabinet shifted back against the offending wall

may be the most effective expedient. Don't forget that if this is possible, you can enhance the effect by cutting a large piece of builder's deadening felt to fit the back of the cabinet, and tacking it on so that it forms a deadening layer between the back of the cabinet and the surface of the wall. The felt must come into solid contact with the wall, or most of the effect will be lost.

In houses of the popular dry-wall type of construction, one or more of the gypsum board panels may be excited into lively vibrating when the music is loud. In an interior wall, filling the space between the two wall surfaces with the type of insulating material that is meant to be poured or blown in by an air hose may do the trick. This can often be put in through one small hole cut in the panel near the ceiling. Be *very* careful how and where you make the hole, and how you patch it and replace the flap of wall paper or repaint the seam. Often, it's better to work from the room adjacent on the other side of the wall, if it is a closet or storage room. Outside walls will usually already have insulation between the surfaces, so this treatment won't work there. Even resonant ceiling panels can be controlled in this fashion, if you can find a convenient way to introduce the insulation.

Another point to remember is that where structural resonances show up, it is particularly important to isolate the entire speaker enclosure carefully from solid contact with the structure. A thick foam-rubber pad under the whole bottom of the enclosure, and a similar pad on the back if it normally touches the wall, are strongly recommended.

### **Sound leakage**

When the sound of the reproduced program leaks out of the listening area into places where it's not wanted (say the nursery or a neighbor's apartment), something must be done to confine it or soak it up. The method used depends greatly on the manner in which the leakage occurs.

### **Air transmission**

Most people with hi-fi systems whom we've dealt with are rather decent sorts, but nevertheless, *most* of the air-transmitted sound that gets into areas where it is not wanted and inconveniences innocent bystanders results from the hi-fi owner being careless, thoughtless or just an inconsiderate pest. A fellow who'll simply close his windows and doors when he wants to crank up his system fairly loud has stopped most of the noise that might disturb someone else.

But most is by no means all. There are various other ways by which air-transmitted sound can get out to go wandering. Heating, ventilating and air-conditioning ducts can provide dandy passages through which sounds may travel astonishing distances. The factors determining where and how far sounds will travel in such a duct system become rather complicated. The size of the main ducts and the number and location of branch ducts, bends, vanes, and dampers as well as the positions of dampers, will affect how far sound will travel and where it will come out. If your sound is bothering someone by traveling through a duct system, the best solution is to call in an engineer qualified to specify the type and location of baffles to control it. If *your* sound travels through the ducts, other sounds probably do, too. Possibly you and the fellow

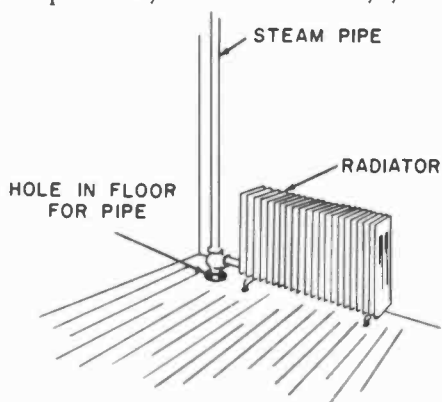

Fig. 905. An oversize hole around piping through which sound diffraction might occur.

you're bothering can enlist the support of some of your neighbors to approach the owner of the building and have proper controls inserted for the entire system. After all, one day someone else in the building may put in a hi-fi, at which time you're liable to be on the receiving end.

On occasion, overly generous steam or water pipe holes through a floor or wall (Fig. 905) permit sound to pass through the excess area of the opening and diffract into the adjoining space. No sizable amount of sound energy can pass through this kind of opening, but often the pipe itself helps, and the total may be bothersome. Check to see if there's a loose hole around a pipe.

### Sound transmission through solids

If you'll refer to Chapter 8, Fig. 814, you'll see the sound en-



ergy being radiated into a room breaking up into three components. One stays in the room, a second is absorbed by the wall and the third goes *through* the wall into the adjoining space. The last is the component we're concerned with now.

This kind of transmission often means real trouble, because it indicates that the basic construction of the wall is too flimsy. If it's a wood or metal frame partition with inside air spaces, you will get some relief by having rock wool blown into the air spaces, but this is a sizable job too. Covering *both* wall surfaces with acoustic tile will also help, if other considerations make this practicable.

An extensive cabinet treatment that attaches securely to the wall (Fig. 906) will increase the wall mass and thus help matters, but often this is not feasible unless more cabinet space is useful and it is permissible to locate it on that particular wall.

### **Transmission by direct conduction**

When your speaker is mounted in a free-standing cabinet, this kind of trouble is usually easy to control. It usually happens because the enclosure is standing directly on a bare floor with no soft material intervening. Get some carpet under it and the situation will be markedly improved. Where there is carpet *already* under it and you've still got excessive transmission, simply isolate it further by using rubber mounts under the legs or base. And don't forget about padding between the back and the wall.

One stubborn case was not gotten under control until the entire enclosure was suspended on shock mounts from a bracket on the wall. But this was a particularly odd case of combined conduction transmission and structural resonance.

A speaker mounted directly *in* a wall can produce the most horrible combinations of conduction transmission and structural resonances on record. And the worst of it is that there is no way of effectively shock-mounting the speaker or the baffle board without leaving some nice, short, direct paths for the back wave to come right around in front where it will ruin the bass response. You may just have to pull the speaker out of the wall, completely enclose the back in an infinite-baffle arrangement, and sink the whole works in the wall, with some padding between enclosure and supports.

### **Enclosure and speaker factors**

In a book devoted primarily to installation, it should be possible to assume that all the equipment is in good order and working

properly, including the speaker and enclosure. Alas! Would that it were true, but 'taint. Even the best speaker may be damaged in shipment or storage, and the same applies to enclosures. Before we abandon consideration of acoustic problems, it's necessary to say a few words, none of them kind, about certain *equipment* troubles that may fool you into thinking they are really acoustic.

## Speakers

A speaker with a torn cone or with an off-center or out-of-round voice coil will often give out with a ratty, scratchy sound that will make you think something in the room is vibrating, unless you scrunch down and jam your trusty analytical ear right into the grille cloth. Dirt or packing material in the voice-coil air gap (it can still happen in some speakers) will also produce a scratchy

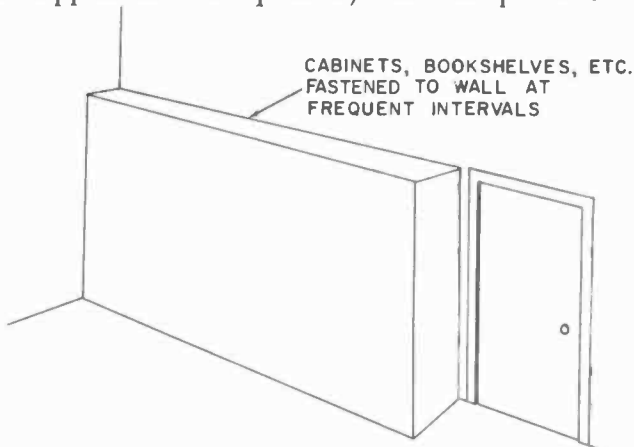

Fig. 906. *An extensive cabinet treatment securely attached to a wall will add considerable mass, enough to damp most of the wall resonance.*

noise. It can be removed by putting some 60-cycle (for convenience) signal into the voice coil and blowing some air through the gap. If you use a compressed air hose, be *very* cautious. A slug of water or a metal particle in the stream will make a neat hole in the cone that few will appreciate. Even an excessive squish of air may tear something. If the speaker is actually defective, repair or replacement is the only course.

If you are mounting the speakers themselves in a built-in enclosure or in a wall, don't even open the boxes until you are actually ready to fasten the speakers into place. That means you have not only finished the carpentry or whatever is required, but you've thoroughly cleaned up the shavings, plaster chips and other

loose stuff that might conceivably get into the speaker mechanism. And it should go without saying (but won't here) that you must phase speakers properly in multiple-speaker assemblies. The dry-cell test applied to the voice coil leads to see if they all jump forward or backward together is tried and true. And to get tweeter and woofer to pump together at the crossover frequency, put in that frequency with your oscillator, and try the effect of reversing connections to *either* the woofer *or* the tweeter, but not both. The connection that gives the loudest response at the crossover frequency is the right one.

### Enclosures

The best enclosure can occasionally let out a raspy buzz at certain frequencies. This means that *something* that should be held firmly in place, isn't. It could be the speaker itself (try the screws), the baffle board (try the screws), an internal partition or stiffening batten (try the screws and glue joints) or the back (try the . . . but you get the idea). Even screws that look and feel tight may stop the buzz if they're given another quarter-turn. In cabinets that seem to have too few screws too far apart, particularly those holding the back on, don't hesitate to add some more, if you trace the buzz to the offending member.

In horns and some other enclosures, internal structural members may be loose because of a poorly made or damaged glued joint. Reglue if possible, or add a glue block or two and maybe a couple of screws. And don't forget the possibility that the whole enclosure may be rattling against the wall or floor if there's no intervening padding.

One other odd-ball cabinet trouble is worth mention, not because it's very common, but because it may drive you out of your mind if you're unprepared for it. We've hit it three times in some 8 or 9 years ourselves. The first time, a cabinet buzzed atrociously at high volume, particularly on organ music. Everything inside and out was gone over practically with a microscope. No dice. *Everything* was sound and tight, but it buzzed. Switch speakers, it buzzed. Finally John Karlson suggested tapping the buzzer all over with a rubber-headed mallet. Eureka! There was the buzz, *inside* the wood of one panel forming the box. It was a loose part of a knot in one of the core plies of the fir plywood from which the enclosure was constructed. Sneaky, eh? We drilled a little bitty hole from the inside, injected some sticky stuff, let it set, and killed the buzz for keeps.

# esthetic appeal

UNFORTUNATELY, individual tastes in decor are far less predictable than the functional performance of electronic parts. There is, therefore, no simple set of rules that will enable you always to produce a completely charming installation. Nevertheless if you will absorb what follows you will be able to do better than average, and you may avoid some embarrassing and costly errors.

Several factors make up the visual appeal (or lack of it) in a given object. Some have to do with the design or style of the thing itself as a single entity, while others concern its relationship to its surroundings. This chapter is concerned with the first category while the next chapter deals with the second.

Keep in mind as we discuss design and style of installation housings that they can, in fact, exist only in relation to *some* sort of surroundings, and therefore should never be considered as ends in themselves.

But what are the specific factors within an individual object that tend to make it pleasant or unpleasant to the eye? Although we are referring primarily to cabinets or built-in constructions intended to house hi-fi equipment or speakers, the same factors apply to many other objects.

One such group we shall consider under the general heading of design; the other as elements of style. Design is the broader of the two terms, encompassing elements basic to the development of all styles. The elements of design are line, shape, form, proportion, color and texture. These are the raw materials from which

styles are formulated. Style results when they are used to create distinctive combinations of form, proportion and decorative detail that are accepted as beautiful and useful by the society for which they were created.

Beautiful and useful. We know fairly well what "useful" means. But what is "beautiful"? The greatest artists and philosophers have pondered that one, and the fact that their conclusions have varied so widely convinces us that you and we are not likely to get much closer to the cosmic verity than they did. The fellow who said that "beauty lies in the eye of the beholder" got pretty close, except that we'd go a couple of inches further and say that beauty is also in the mind of the beholder. This is the only simple and logical explanation for the fact that a number of historical styles, in concept quite at variance with each other, remain popular in this country at the present time.

Two other key factors that have repeatedly and profoundly influenced the development of styles throughout history are the materials and technologies available at different times and places. While the scope of the present volume does not permit a discussion of the many fascinating and curious effects of these influences, they are mentioned in passing to explain a number of seeming oddities that you may encounter. One of these is the Early American Colonial style discussed later in this chapter.

Design, then, provides the basic elements from which styles are made, and a style in turn expresses the concept of the beautiful held by a particular group of people at a particular time. In any individual, this personal concept of beauty is what the esthetic appeal of an object touches, if it touches anything.

Merely because a particular style of design fails to excite you does not condemn it for someone else, and vice versa. Hence, it is necessary for you to be knowledgeable enough to understand another person's taste, even though you may heartily disagree with it.

### **Elements of design**

Probably if you had a nickel for every time you've been exposed to ads trilling about the "sweeping lines" or "flowing contours" of some thunderingly ordinary product, you would be able to retire instantly and live in comfort, nay luxury, for the rest of your days.

For all of the times you've run into the word "line" used in this connection, you may never have come across its meaning to an artist. In design, line is the basic element from which the more complex constructions, shape and form developed and on which

they are based. Line is a man-made abstraction. It practically does not exist in nature. As you look across the room, there is no line where that chair ends and the wall behind it begins. The chair just ends, and your subjective visual perception supplies the line.

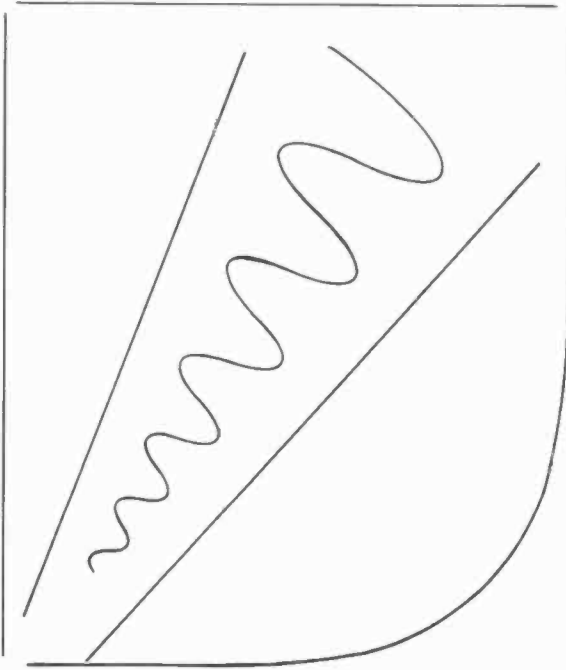

Fig. 1001. *There are only two types of lines; straight and curved.*

Lines, like words, are abstractions that can be used when referring to and thinking about *things*. As such, they are one of the primary tools used by the designer.

The ad man's product has form, proportion, color and texture, but it hasn't had any lines since it left the drawing board. The reason for emphasizing what may seem a semantic distinction is that so often a design may appear beautiful on paper and grisly when built, because the other factors just mentioned were not adequately considered.

### **Lines**

There are only two kinds of lines; straight and curved (Fig. 1001). You'll qualify for a solid gold Cadillac and a lifetime supply of pickled kumkwats if you can think of a third. And don't

try to ring in broken lines, since they are merely groupings of straight or curved lines.

Horizontals and verticals are called static lines, while any diagonal in between is called dynamic (Fig. 1002). To the designer, there is an important distinction here that is not so vital to the layman. The static line is at rest visually. The dynamic line isn't, and requires visual balancing to avoid an unpleasant effect. In the design of hi-fi housings, and furniture in general for that matter, dynamic lines are not common, so don't worry about them.

Curved lines, too (Fig. 1003), are divided into two classes. One is the class of regular curves. This includes the circle, the oval, the

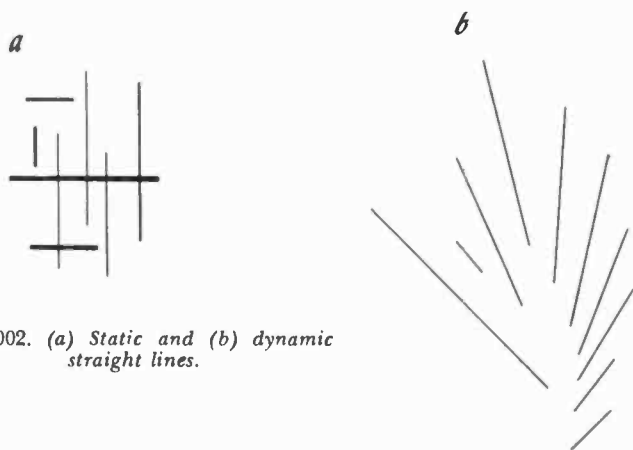

Fig. 1002. (a) *Static* and (b) *dynamic* straight lines.

spiral, and regularly repeated types, such as a wave or scallop. All other curves fall in the remaining category of irregular or "free-form" curves.

Since most hi-fi cabinets are made of wood, and wood comes in straight panels, planks and timbers, the judicious use of curves in the design can help greatly to reduce the linear monotony inherent in the material itself. But these curves must be introduced in a way that conforms to the nature of the material. To curve the main panels of a cabinet is extremely difficult. But curving the edges of such a panel is comparatively simple.

## Shape

Lines are used in various combinations to develop shapes, as may be seen in Fig. 1004. Shapes or planes can be regular or irregular, depending on the lines of which they are composed. A few lines such as the circle, the oval and some free-form curves (Fig. 1005) are both lines and shapes at the same time, since they return

on themselves and thus delineate a complete area and separate it from its surroundings.

The shape that will concern you most is the rectangle, since it is

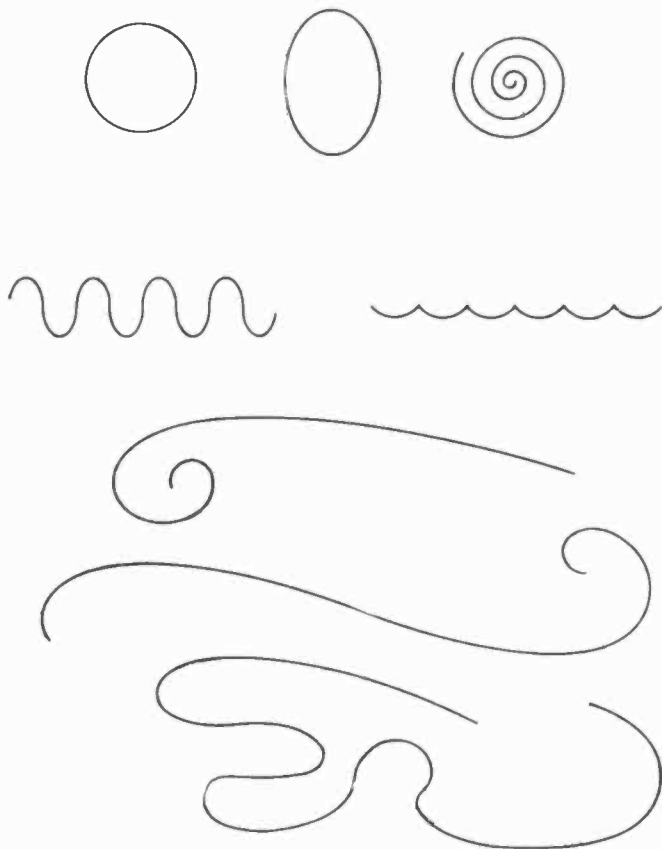

Fig. 1003. Various types of regular and irregular curved lines.

combinations of this one that result in the three-dimensional forms of most cabinets. The circle, the oval, the diamond and many other shapes appear in the decorative detailing of various styles of design, and as such they are usually among the identifying characteristics of specific styles.

### Form

Form, then, results from the combining of shapes into three-dimensional objects. The commonest, although not by any means the only form for hi-fi cabinets is rectangular, as shown in Fig. 1006. The corner speaker (Fig. 1007) is certainly not a rare de-



parture from this form, and there are many others possible.

For hi-fi purposes, the form a cabinet will take is dictated partly by the conventions of the particular style to which you wish to

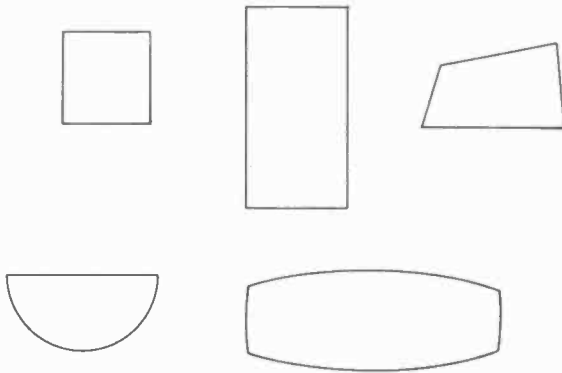

Fig. 1004. Shapes are plane areas fully enclosed by lines.

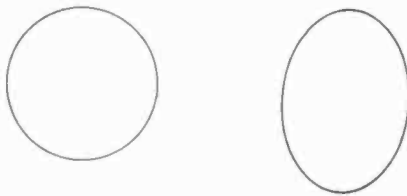
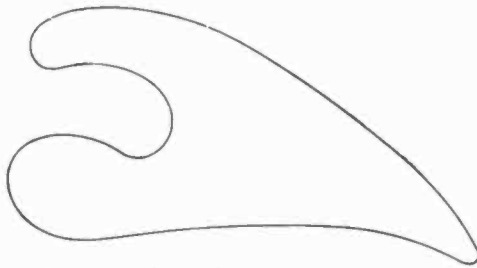

Fig. 1005. The circle, the oval and some free-form curves are both lines and shapes simultaneously.



conform and partially by the requirements of the equipment that is to go inside. To mount equipment so that it can be conveniently operated in period style cabinets, it is often necessary to waste some inside space. After all, Sheraton didn't know hi-fi was coming, so he could hardly plan for it.

If you must change the height, width or depth of a cabinet

relative to the other dimensions, you will inevitably change the form. Minor changes of an inch or so are not likely to cause trouble, but if you need to make a change of half a foot, be very careful. You might end up with a form that is not at all good for the style you are using. In general, the more folksy styles like Early Colonial or Provincial will put up with more pulling and hauling than the sophisticated, formal styles, such as Hepplewhite or Sheraton. And with Modern, you can be pretty free.

### Proportion

Questions of proportion deal with relationships sometimes with-



Fig. 1006. *Rectangular form for speaker enclosure.* (Design by Jeff Markell.)

in a form, and other times between forms. Within a form (Fig. 1008), proportion refers to the relationship of height to width, to depth, and to the heights and widths of doors, drawers or drop fronts relative to each other and to the overall piece.

Between two or more forms, proportion still relates to heights, widths and depths relative to each other, but these relationships properly fall in the province of the next chapter and will be discussed there.

Within a single form, an infinite variety of proportional relationships are possible, but, in cabinet and furniture work, experience has shown a range in which the most generally satisfactory ones will fall. Let's look at a few examples and you'll begin to see what we mean.

At one end of the scale, the simplest proportion of width to height to depth for a cabinet is 1:1:1 or a cube (see Fig. 1009-a). No matter what you do, this is an uninteresting and ugly proportion. There is no contrast. Remember all the table-model TV sets of a few years ago that were practically cubes? That's one reason they were so ugly. Fig. 1009-b shows a 2:1:1 ratio. This is a considerable improvement, but you can't go too far in varying



Fig. 1007. *A corner speaker enclosure of nonrectangular design.* (Design by Jeff Markell.)

just one dimension as in Fig. 1009-c. This shows 3:1:1 which is getting disproportionately long. Fig. 1009-d (3:2:1) is getting better, and Fig. 1009-e (3:2:1½) is the best yet.

Now, what does all this indicate? Unfortunately, we know of no simple set of rules that will apply to all cases, but the following will apply to a goodly number:

1. Preferably, no two dimensions should be the same (let alone three).
2. The largest dimension should be at least double the smallest.
3. The largest dimension should not be more than double the middle one.
4. The difference between dimensions should increase as the dimensions increase (3:2:1 is not as good as 3:2:1½).

The proportioning of cabinet fronts (doors, drawers, etc.) is dictated by the equipment to be housed. One hint: if the inside



Fig. 1008. *Some of the proportional relationships that exist in a cabinet.* (Raynes and Rhine, Inc.)

spaces are going to be *very* irregular (Fig. 1010), don't let them show through on the front. Put on a pair of matching doors to hide the whole thing, and let it go at that.

### **Color**

In a built-in installation where the housings are to be painted to match the wall, there is no color problem other than the accurate mixing of the paint. A competent painter can do this.

With free-standing furniture, the color must be appropriate to the style. Check the colors that were used for the style you are working with, and stick closely to them. A trained designer or decorator can successfully make departures from these colors, but your chances aren't too good, so why risk an embarrassing failure?

You are not likely to have much to do with color determination anyway. The other furniture in the room has probably dictated both the style and color to be used. Your problem is more likely to be one of getting a finisher to match the color of the other furniture correctly. Don't make him guess! Get a door or a drawer from one of the pieces to be matched. Madam won't like this much, but generally she'll go along with it if you explain that this is the

only way you can guarantee a sufficiently accurate match for her to be happy with the end result.

### Design expressed in style

Variations in form, proportion, color and decorative detail supply the primary distinctions between the various furniture styles. For our purposes, functional differences are rare and unimportant. Granted, occasionally one encounters a piece, say an Early Colonial "dry sink", that performs a function not found anywhere in other

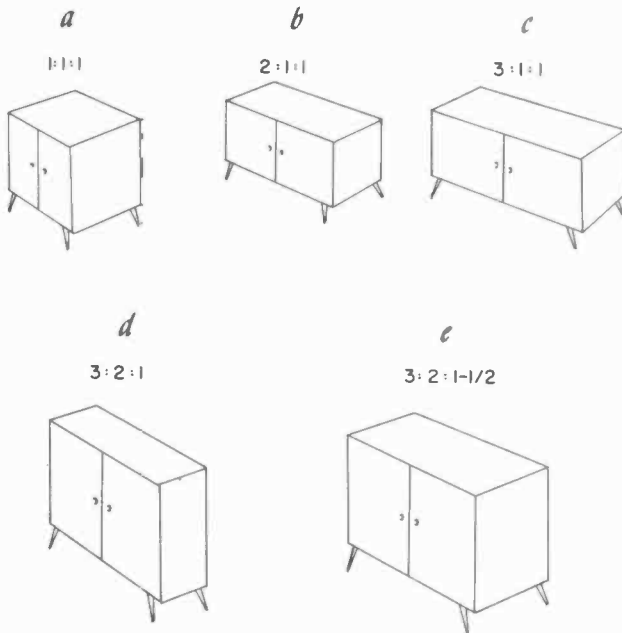

Fig. 1009. The same volume of enclosed space can look quite different, depending on the proportions of the enclosing form.

styles. For example, Sheraton never produced any piece with the same function for the good and sufficient reason that his clientele had no need for it.

But a chest of drawers, be it Sheraton, Directoire, Regency or Early Colonial, performs essentially the same function in essentially the same way, regardless of style. The differences that distinguish them stylistically from one another lie in variations in the use of design elements.

Form and proportion can enter into the delineation of style in several ways. The turning, fluting or curving of a leg is a matter of form. The height of a leg relative to its thickness and the height

of a leg relative to the height of the cabinet are matters of proportion. Whether a cabinet has legs or a base, whether the top overlaps the sides or comes flush, whether the front is flat or curved, the relation of overall height to length; these are all matters of form and proportion. The manner in which they are handled will vary in typical ways from one style to another.

### **Decorative detail**

Hardware, inlay work, moldings, beading and carving are all part of the decorative detailing of furniture. The amount, kind

*Fig. 1010. Irregular internal subdivisions shown with dashed lines. Such regular rectangular forms look better with irregular subdivisions hidden.*

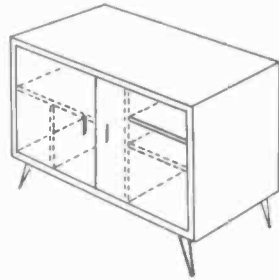

and placement of such detailing is highly significant in the determination and quality of styling. Fig. 1011 shows a variety of details from several styles.

The type of decoration is so important to the determination of style that you could take a basic cabinet and, by merely changing the decorative details, come up with very accurate reproductions of at least a half dozen or more different styles. Variation of the doors alone (Fig. 1012) is very effective.

### **Specific styles**

The number of furniture styles that have been developed in just Western Europe and the United States is pretty staggering without considering the rest of the planet. However, the ones, outside of Modern and Contemporary, that remain sufficiently popular in the United States to warrant consideration here, were all developed during a period extending roughly from 1700 to 1820. Styles from both before and after that period are now quite rare.

We'll discuss first Modern and Contemporary styling, then the eight most important styles from the period just mentioned. Once you are acquainted with these styles, you'll find that 95% of the time you are on familiar ground.

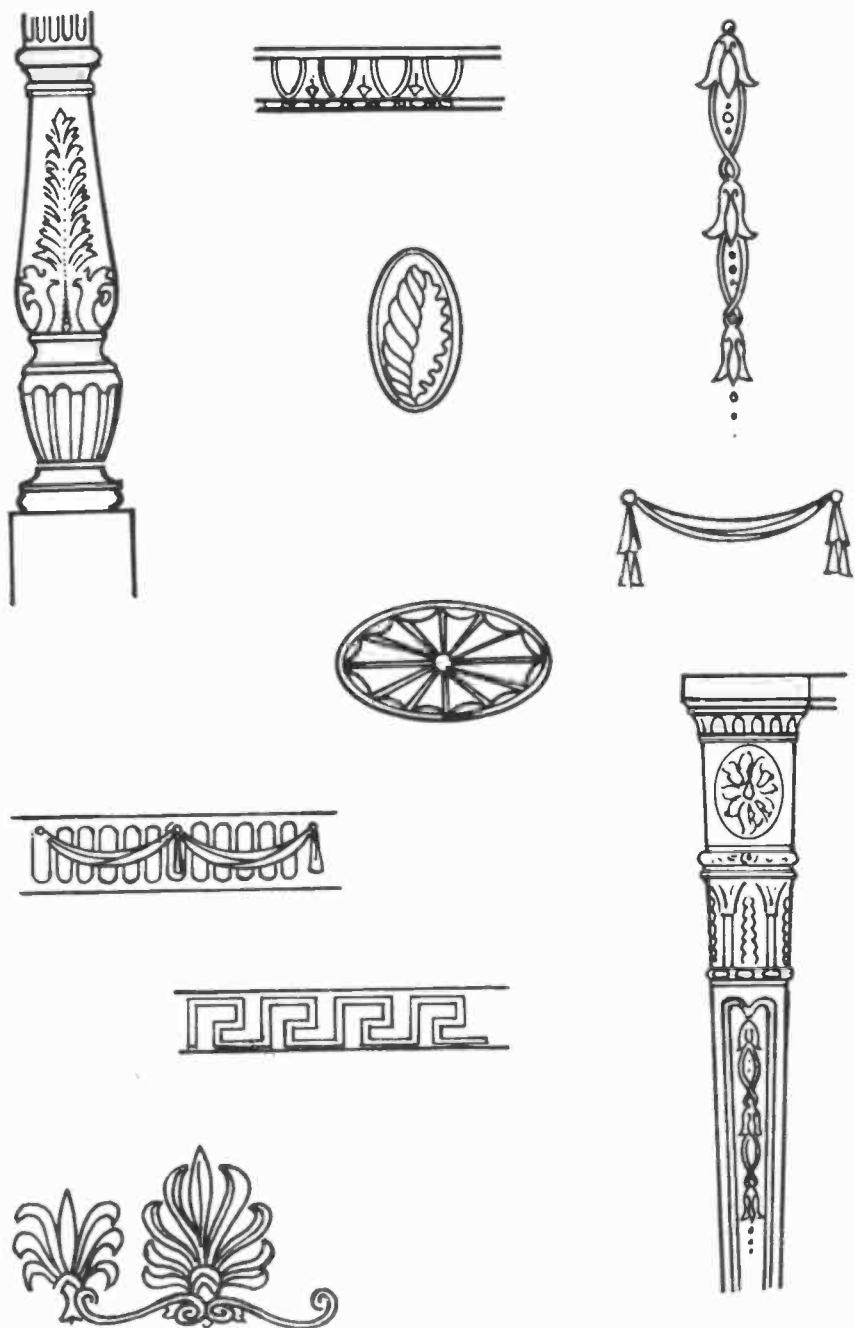
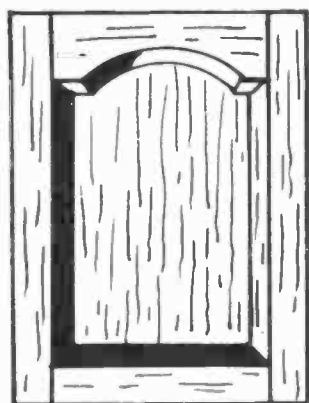
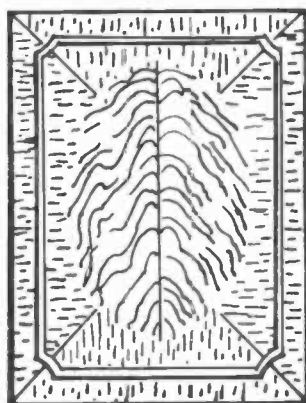

Fig. 1011. A few decorative details from various styles.



a



b

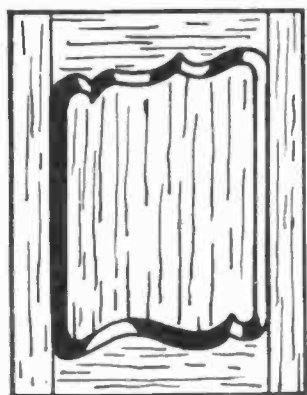

c

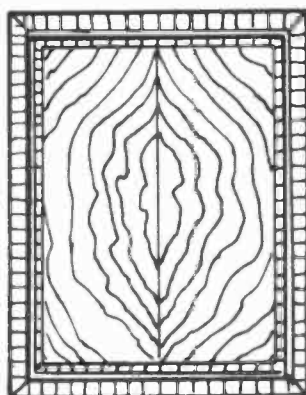

d

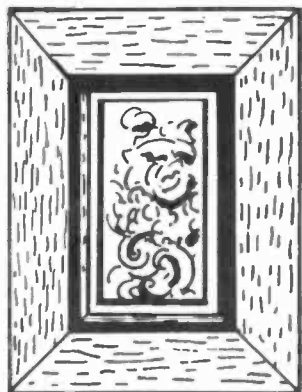

e

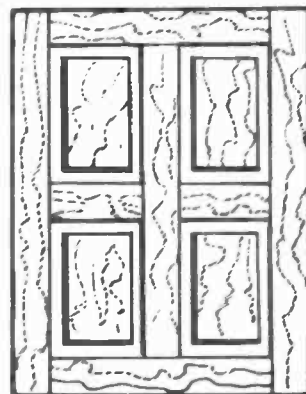

f

Fig. 1012. Some typical panels: (a) Jacobean English, (b) Hepplewhite, (c) French Provincial, (d) Sheraton, (e) Louis XIV and (f) American Colonial.



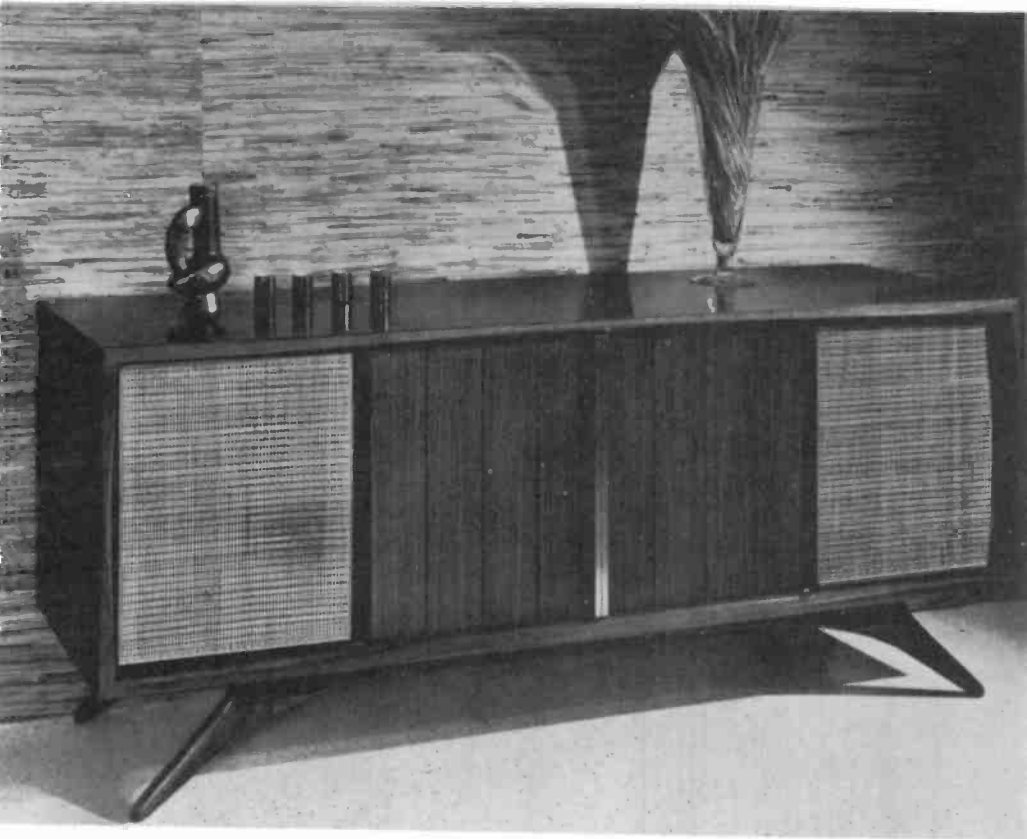

Fig. 1013. *Modern cabinets like this one are characterized by lack of decorative detail and highly functional appearance. (Grosfeld House.)*

## Modern

This is, of course, the style of the present day, of our time, and as such is in a state of constant change and development. This makes it a good deal more difficult to define and analyze than the styles of the past. They are neatly pickled in the formaldehyde of history and will stand still while we study them. Modern won't.

However, we can identify some general characteristics of Modern cabinets that will enable you to distinguish them readily from any in the historical styles. The most striking feature of Modern is the extreme sparseness and simplification of decorative detail. Fig. 1013 shows an example of this. Carved floral and classical motifs have entirely disappeared, and inlay work is virtually non-existent. What little does appear is of the simplest kind and usually on doors only.

Some critics of the style have attributed this disappearance of ornamentation to a lamentable lack of imagination on the part of the designers. We do not agree. We find in it an accurate reflec-

tion of aspects of our contemporary ways of thinking and living. Whether these ways are good, bad or indifferent is not the point.

Ornamental design has been replaced by a strong emphasis on natural wood grains and colors, and the use of contrasting materials and textures (Fig. 1014). As a result, a number of woods and other materials, some natural and some synthetic, not previously used in furniture, have made their appearance.

A highly distinctive feature of Modern styling is the introduction of asymmetrical design. Most period furniture was designed so that starting with a vertical line down the middle, either side of a

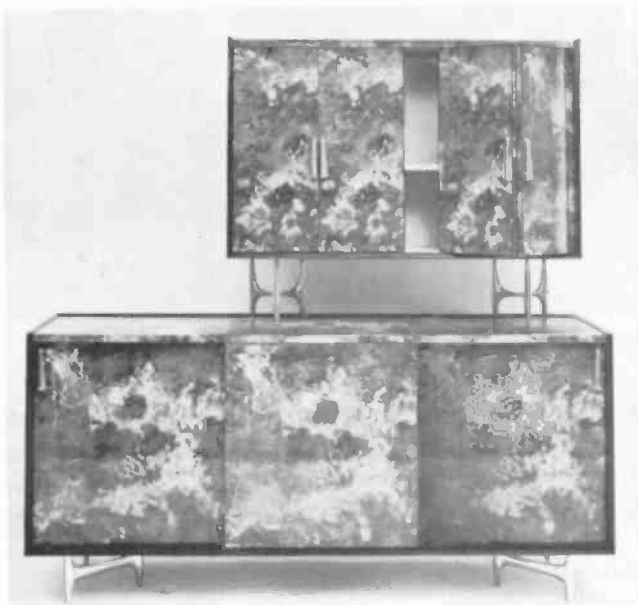

Fig. 1014. *Highly contrasting wood grains and colors can offset lack of ornamentation.* (Charak Furniture Co.)

cabinet would be a mirror image of the other. In Modern (Fig. 1014) this bilateral symmetry is often ignored, if not purposely avoided.

Modern cabinets are generally raised off the floor on legs to give a feeling of lightness. Staining or bleaching of woods is relatively uncommon, in keeping with the emphasis on natural colors, and finished surfaces of a satin or dull texture are preferred over a high gloss.

### **Contemporary**

It is often difficult not only for the layman, but even for the professional, to draw a sharp line between Modern and Contem-



Fig. 1015. *Contemporary style generally reflects some period influence. Here the reference is classical. (John Scalia, Inc.)*

porary styling. The most important, but not always the most obvious difference, is that Contemporary designs will always contain some reference, veiled or otherwise, to a period influence. In Fig. 1015, this reference is classical, but beyond that we're too cowardly to attempt an identification, while Fig. 1016 shows a readily visible Chinese influence.

Contemporary styling adheres to bilateral symmetry in design and employs more decorative detailing than Modern. Cabinets will more often run down close to the floor on 2- to 4-inch-high bases. Coloring of woods by bleaching and staining is more common, and there is a good deal more use of high-gloss finishes.

Unfortunately, in hi-fi and TV, a great deal of uninspired, if not downright incompetent Contemporary design, has been used in abortive attempts to arrive at a "universal compromise" that will fit satisfactorily with many styles of decor. Too often the result has been cabinets that esthetically don't really fit well with anything, not even themselves. It usually requires a bit more effort to work out something that really fits with a given decor than to settle for a "universal compromise", but the improvement in the finished job is worth the trouble (Fig. 1017).



Fig. 1016. *Chinese influence is fairly obvious in the modern installation above. (Harmon-Kardon, Inc.) Oriental reference is somewhat more subtle in the contemporary piece shown below. (Charak Furniture Co.)*

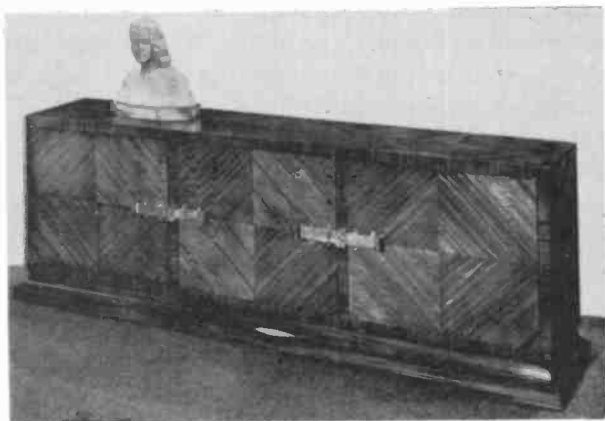

### **Traditional**

Like Modern and Contemporary, Traditional and specific period styles are not always easy to distinguish from each other, particularly if the period piece is a reproduction. Modern reproductions



Fig. 1017. *The simple and unadorned lines of modern furniture are especially adaptable to interiors that do not have any particular period influence.* (Harmon-Kardon, Inc.)

of period pieces usually involve some simplification of decorative detail and a consequent loss of some identifying characteristics.

The simplest distinction between Traditional and specific period pieces is, unfortunately, one that won't help much until you're reasonably well-acquainted with period styles. The distinction is that a Traditional piece will have characteristics of more than one style.

As with Contemporary, a good deal of hi-fi and TV cabinetry has been done in Traditional style in an attempt to bridge gaps and blend styles, with something less than brilliant results. Eclectic design mixing styles in a single cabinet is most difficult, but many manufacturers would rather wrestle with that problem than the problem of stocking several distinctive styles.

### **French styles**

At the beginning of the period we are going to discuss, from 1700 to 1820, the only style that was of any importance to the French was that of the court of Louis XIV. It is of no importance to us. Why? Because it was a pompous, flamboyant, heavy, ornate design that has fallen completely out of favor and is virtually unused



Fig. 1018. *French Provincial* is a simplified version of the highly ornate court styles of Louis XIV. Compound curves as illustrated above are especially typical of this style. (Furniture Craftsmen.) The lower photo illustrates how some types of high-fidelity equipment blend with *French Provincial*. (Harmon-Kardon, Inc.)



today. So has the lighter and more subtle style of his successor, Louis XV.

However, during this period, a style was developing in the outlying districts of the country that is of importance today — French Provincial. The provincials wanted very much to ape the court style but, since the country bourgeoisie just couldn't afford to go whole hog, the result was necessarily a simplified version. Fig. 1018 shows examples. If you will note the compound curves of aprons and tops, the inset panels in the doors, and the reverse-curved cabriole legs blending into the curves of the bottom of the apron, you are not likely to confuse this style with any other. The enforced relative simplicity of ornamentation and the resulting graceful forms are the features that have enabled Provincial furniture to survive, while the overornamented and rather vulgar court prototypes have disappeared.

By the time of Louis XVI, the court style had become quite frivolous and dainty, in keeping with the empty-headed, feeble court that supported it. With the lopping of Louis' head, both the style and Louis came to a sudden end.

The style of the Directoire that followed was a complete contrast (Fig. 1019). The Greco-Roman ideals of the time produced a style of classical dignity and restraint. The graceful curvilinear forms of the court style are gone, but so is the ostentatious overornamentation. Directoire was sober and self-conscious, but not yet self-important. The application of flat pilasters or fluting reminiscent of classical columns was common. These and simple geometric shapes form the main decorative effects. The profuse rococo floral patterns of the court are entirely eliminated. Simple rectangular forms without decorative moldings or carving are the order of the day. Some ornamentation appears in the hardware, but again it is largely geometric.

The Directoire ends with the rise of Napoleon and, as a result of his influence, the Empire style appears (Fig. 1020). What was a moderate self-consciousness in the Directoire becomes self-importance in the Empire. Napoleon was a somber and rather pompous little guy, and his style reflects this. It has become heavier and more ornate. While the classical influence remains, it seems to have become more Roman than Greek. Although the veneer work stays basically geometric, it has become more complicated and purely ornamental brass work or ormolu has been added. The Empire style, like Napoleon and his appointed aristocracy, lacked the grace and subtlety of the old hereditary nobility. But, while



Fig. 1019. Like the French Revolution that caused it, the Directoire style is completely opposed to the ornateness of Louis' court. Directoire presents a square appearance and an almost Spartan simplicity. (John Scalia, Inc.)

it may at times have become pretty bombastic, the Empire never became weak, effeminate or just plain silly, as the Bourbons did both before and after Napoleon.





Fig. 1020. *Empire style retains the basic squareness and simple lines of Directoire, with some small added ornamentation and brassware. The heavy stumplike legs add a feeling of massiveness to the piece. (Grosfeld House.)*

After the fall of Napoleon and the end of the Empire, French furniture design falls into a decline that it is kinder not to trace. It rests in well-deserved obscurity.

### **English styles**

In England, the best and most important styles were the work of individual designers — rather a contrast with France, where the styles were the result of the work of groups of designers, none of whose names are readily discovered.

The first of the important English stylists was Thomas Chippendale. He was actually more of an adapter than an original designer, in that the most striking characteristics of his styles were based on the Louis XV style in France and the Queen Ann style that preceded him in England. In cabinets, his style was a bit heavy and over-ornamented by contemporary standards. Consequently, his pieces as reproduced today (Fig. 1021) are simplified versions of the originals.

If you should run into an original, the apron at the base of the cabinet will be richly carved, and there will be little or no inlay work. The curves of the top and front as shown are typical Chippendale, as is the general proportioning. On smaller cabinets with legs, Chippendale commonly used a curved or cabriole leg heavily carved and often terminating in a carved ball- and claw-foot.

Elaborate carving as a form of decoration virtually disappeared after the time of Chippendale until it was reintroduced in the



Fig. 1021. Simplified versions of Chippendale are still being manufactured today, although this style enjoyed a far greater popularity several decades ago. (Schmiegl and Kotzian, Inc.)

Victorian era, a time when design of all kinds in England reached a nadir seldom equalled anywhere at any time.

After Chippendale, furniture design in England had its

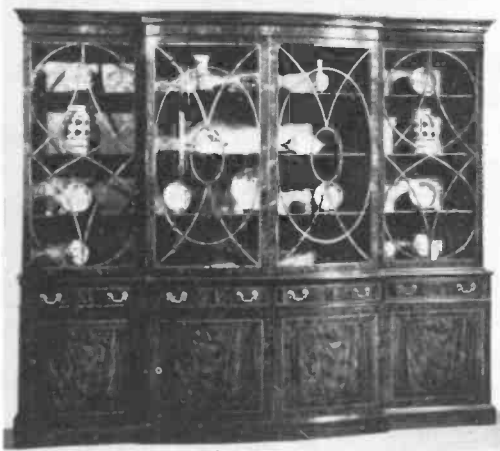

Fig. 1022. Hepplewhite is another important English furniture style. Note the use of ovals in the design. (John Scalia, Inc.)

Golden Age in the styles of Hepplewhite and Sheraton. In the hands of these great designers, English styling reached heights of refinement and delicacy that have never been equalled, let alone

surpassed. Although the overall styles of these two designers were quite distinct, their cabinets were sufficiently similar to make it fairly difficult to distinguish one from the other readily. This is



Fig. 1023. Sheraton is closely related to Hepplewhite, and it is often difficult to distinguish one from the other. Characteristic of Sheraton are the contrasting wood-panel inlays. (John Scalia, Inc.)

particularly true of contemporary reproductions where minor simplifications of characteristic detailing, which are common, can greatly cloud the issue. Both men had a strong feeling for wood



Fig. 1024. Derived from Empire, English Regency style is bombastic and elegant. (John Scalia, Inc.)

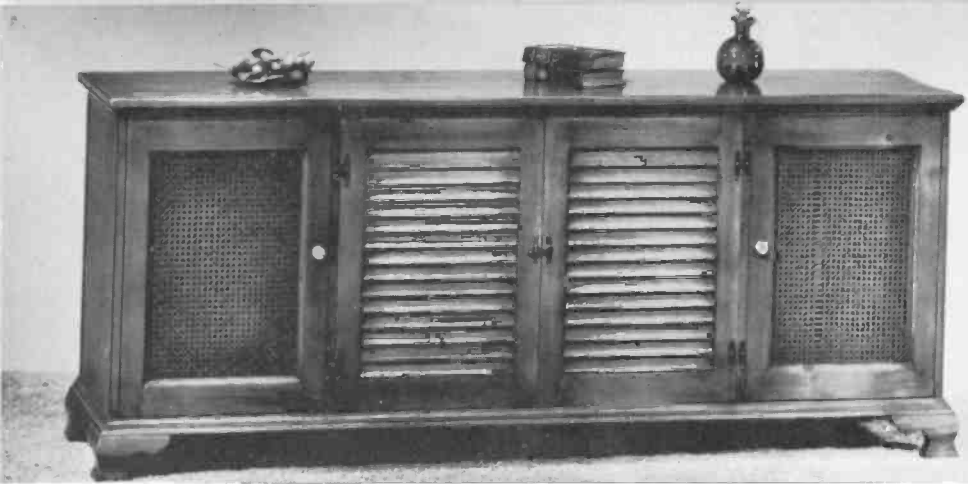

Fig. 1025. *The only completely American style is Early Colonial, frequently called Early American. Dating from the late 1600's, Early American embodies simplicity and functionality. The curved short legs are just about the only concession to stylization. (Furniture Craftsmen.)*

and the beauty of wood grains, a subtle eye for proportion and great restraint in their approach to decoration. Hepplewhite (Fig. 1022) tended to use the oval in his decorative motifs more often than Sheraton, and was inclined toward a slightly larger proportion of width to height in his overall dimensioning.

Sheraton (Fig. 1023) preferred rectangular motifs in his inlays, and for them, liked somewhat more contrasting woods and grains than Hepplewhite. Sheraton's proportioning was narrower and higher than Hepplewhite's and he often emphasized this by using elaborate pediments on the tops of his high pieces.

The fact that it is a bit difficult to distinguish the cabinets of these two styles from one another also means that it is not terribly important, particularly for hi-fi housings, to be able to do so. As long as you can tell that a given piece is Hepplewhite or Sheraton and not something else entirely, you're all right.

After Hepplewhite and Sheraton, the influence of the Empire of France became felt in England in the form of the Regency style.

English Regency (Fig. 1024) begins to reflect a bombast akin to that of the Empire, and in the process necessarily loses some of the very sophisticated gracefulness of Sheraton and Hepplewhite. But Neo-Classicism was rampant throughout Europe, and England was not immune.

The English, however, did manage to avoid the depths of vulgar pomposity occasionally reached by those across the Channel. The previous finesse in decorative detailing also slumps somewhat in Regency design, but it does not become really clumsy. Regency represents to us a definite retreat from the high point of Hepplewhite and Sheraton, but it is not yet a rout.

The real disaster occurs later in the Victorian period, and when it came it was of monumental proportions. The best thing that can be said of Victorian furniture is absolutely nothing, and the best thing we can think of to do with it is try to forget it ever happened.

### **American styles**

It comes as rather of a shock to many Americans to discover that throughout most of our national history, our furniture styles at any given time have been merely rehashes of those current in England 10 to 20 years earlier.

The very early period of colonization was an exception. At that time, the American colonists developed of necessity a definite style of their own, albeit based on Jacobean English prototypes.

The conditions of frontier living required furniture that served functions not needed in civilized England. These pieces had to be invented. The materials available and the general level of craftsmanship also differed from the homeland, all of which contributed to the development of a local provincial style in keeping with local needs and conditions.

Fig. 1025 shows examples of this style. Pine was the most common material, although birch, maple and fruitwoods were also used. Simple, straight cabinet lines, doors with plain rectangular inset panels, short, heavy curved legs and very sparse decoration were typical.

As the colonies grew, this style faded into a welter of copies of English and occasionally French styles. Nothing indigenously American reappears until modern times, and whether our Modern styling is American or International is a moot question.

Remember that we haven't pretended to cover *all* of the furniture styles you'll ever encounter. But the styles covered will constitute more than 90% of the furniture you'll see. Going out and seeing examples of these styles in the wood will be a great help toward getting the styles firmly fixed in your mind once and for all. A local museum or books on furniture will help with this familiarizing process. Once you've done this, you will be in a far better position to tackle the problems involved in relating a hi-fi cabinet to the rest of the furnishings in the room where it is to be placed.

# achieving esthetic effects

**T**HE function of the installer of a hi-fi system is patently not that of an interior decorator. But woe in big bunches will betide him who is fool enough to ruin the esthetic effects that the lady of the house has gone to great pains to achieve, with or without the help of a decorator.

It matters not a bit whether you are your own sole customer or whether you are doing installations as a business; milady will insist that you show enough understanding of her decorating ideas to make the system fit well with the rest of the room.

## **How does the room look?**

Before you can make final recommendations on components, particularly speakers, and certainly before you can offer any suggestions regarding housings, inspect the room in which the system will be placed. You are looking for a number of specific things, so take a tape measure and make copious notes and even sketches. You won't remember everything and there is no reason to try.

First, can you identify the style of furniture? It is highly likely to be one of those mentioned in the preceding chapter. Remember, it is far easier to identify style if you have seen the actual pieces of furniture rather than photographs or drawings alone.

Make a note of the style, the wood, and whether the finish is gloss or satin. In the case of period pieces, see whether they are originals or reproductions. You might be asked to put the hi-fi components in the original antique (by someone who doesn't know that to do this you'll have to drill holes). She'll cheerfully lynch you if she doesn't find this out until after it's been done.

If you can't identify the style, you've no choice but to ask. Monsieur may or may not know, but madame will.

Next note the colors of walls, carpets or flooring and drapes, as well as furniture. Sooner or later you'll run up against the old problem of grille cloth color, so be prepared.

Various architectural features are worthy of attention. After you've measured and noted the overall length, width and height of the room, take the sizes and locations of doors, windows, ells, alcoves, fireplaces and any other structures that might either be useful or troublesome. This includes service outlets — electrical, heating and air conditioning. In dwellings, the associated piping or conduit for these services is generally concealed, but in a sales-room, restaurant or nightclub, some of it might be in the open.

The sizes and locations of the existing pieces of furniture are the next things to note. Some equipment will probably have to go where *they* aren't, hence you'll need to know where they are. At this point, sketch a rough floor plan that will show where the furniture is, and also the spots that are vacant and in which equipment housings could be placed — if they are any such spots. The lady of the house probably has very definite ideas as to where you may or may not be allowed some space, so try to have an alternative or two in mind in case the one place you've picked is already pre-empted for some other purpose.

Some of the activities for which the room is normally used may knock out other possible locations for the system, so find out what these activities are. In the process, you'll begin to see what routes are most frequently taken into, through and out of the room. This information is also useful. You don't want a swinging door or a pullout drawer to open in the middle of a midget Pennsylvania Turnpike. It will be banged up in no time, and maybe some equipment with it.

### **Locating the hi-fi**

Your examination of the room, plus the answers to your questions about its use, should supply you with the information necessary to formulate sensible suggestions as to the placement of the hi-fi. Speakers, particularly for stereo, are more difficult to locate than the other parts, if they are to both look and function well. The tuner, amplifier and such don't care functionally where they go in the room. So long as the user doesn't have to crawl under the sofa or jump a barbed-wire fence to reach the controls, you can be guided *almost* entirely by esthetic considerations in locating

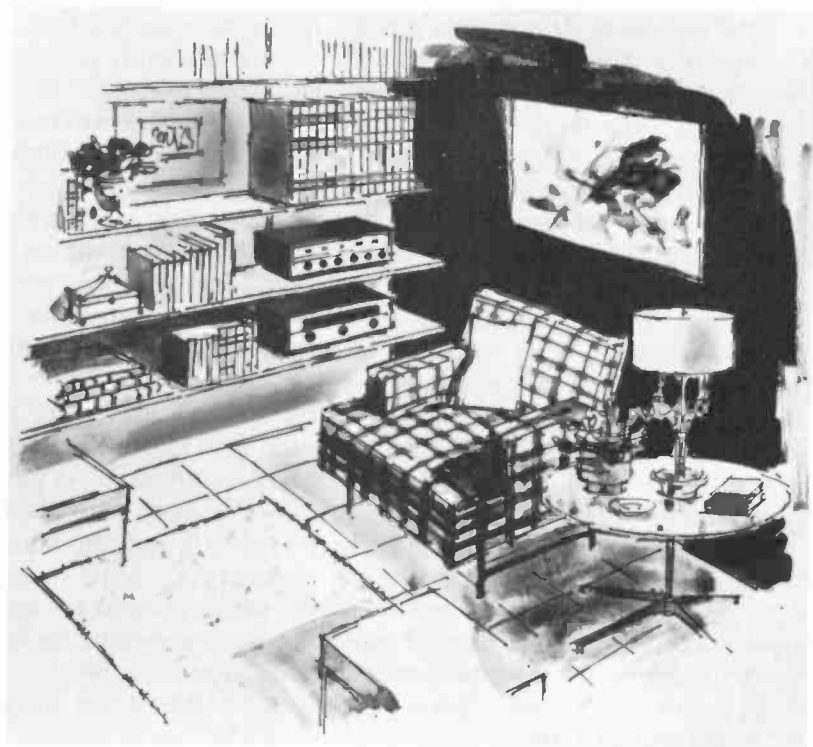

Fig. 1101. *Placing equipment in out-of-the-way corner will keep it out of harm's way when pint-size cowboys and Indians are racing through the house.*  
(Harmon-Kardon, Inc.)

them. We say "almost" because, for one thing, there is some specific minimum cubic volume required to house these parts. Also, you don't want to place them where an economy-sized Lone Ranger in hot pursuit of evil-doers will be likely to sideswipe them. Furthermore, if as mentioned in Chapter 2 your client has a physical disability, the convenience of operation may require some special consideration with regard to location (Fig. 1101).

From a purely esthetic point of view, you can locate a small- to moderate-size equipment cabinet practically anywhere in the room where there is enough wall space for it. Style will not enter into your location considerations as long as the style of the equipment cabinet matches the style of the other wood pieces in the room. Size, however, should enter into your location thinking. A cabinet that goes over 3 feet in any dimension is getting big. The bigger it is, the more important its location becomes esthetically. A piece 6 or 8 feet long is likely to be *the* important cabinet in



the room and, as such, requires a place of importance at or near the center of a wall. If it is pushed off toward a corner, it is liable to throw the whole room off balance.

Very large cabinets can be placed well toward the corners of a room only in certain types of very modern decorative treatments, and then only by someone who knows exactly what he's doing.

It is also a good general rule to avoid placing a new equipment cabinet alongside of an existing cabinet. If the new one differs a good deal from the old one, it will just look as though you were trying to match them and failed. The only time you can place a new cabinet alongside an existing one is when the new one is an exact match — the same style, model and manufacture.

But equipment cabinets are comparatively simple to locate. If you'll observe the points mentioned thus far, and can manage to stay away from the radiators, you can stay out of trouble. As you doubtless know, placing an equipment cabinet in front of or close to a radiator will raise hob with both the cabinet and the components. Excessive heat can ruin the glue joints in a cabinet, warp the panels, blister the veneer and wreck the finish. And as for the components, the combination of the heat they generate themselves plus additional external heat can cook them to a fare-thee-well. If you've read Chapter 6 you will remember that it has much more to say on this subject.

Your more difficult location problems will arise in connection with speakers, particularly in stereo installations. Time and again, esthetics will indicate one solution and acoustics another. Neither can be entirely ignored without inviting trouble.

But let's consider monophonic speaker locations first, since they are much easier. A corner speaker obviously has to go in a corner (Fig. 1102). In an average rectangular room, you have four possibilities. In an L-shaped room, there are two good locations and one fair one (Fig. 1102). If, in either case, none of these corners can be made available because of doors, windows, radiators or something else that got there first, just forget about using a corner speaker. That's all!

Acoustically, there are two optimum locations in a rectangular room, and two in an L-shaped one (Fig. 1103). If you can't get exactly on one of these spots because of esthetic or functional reasons (windows, radiators and so on), don't worry. A few feet off to one side or the other won't drastically affect performance, but can make a big difference esthetically. A single rectangular reproducer crowded off close to a corner usually doesn't look well

(it can't be hidden behind a chair like an equipment cabinet) and, what's more, it won't function well either. For appearance, you may occasionally be tempted to position a reproducer in the

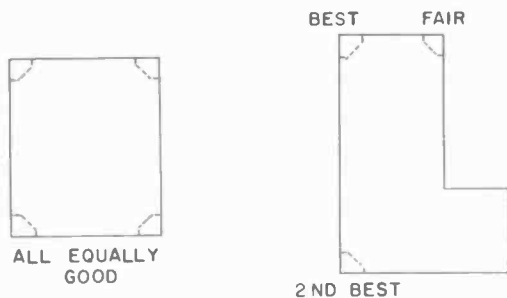
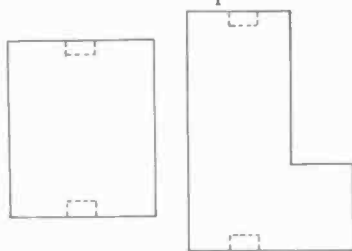

Fig. 1102. Possible locations for corner speakers in rectangular and L-shaped rooms.

middle of a long wall instead of a short one. While this doesn't absolutely assure disaster, you *are* departing sharply from the best acoustic practice, so avoid this solution where at all possible.

Fig. 1103. Optimum locations for reproducers in rectangular and L-shaped rooms.



The esthetic effect of stereo reproducer locations will depend on which of the four possible types of stereo speaker arrangements you use. Or, to put it the other way around, you've got four types of stereo speaker arrangements from which to choose one that will look well in the room.

Occasionally, you'll be able to place a pair of matched speaker systems and enclosures where you want them on a short wall, so that they'll look well with the other furniture and incidentally provide a maximum true stereo listening area in the room (Fig. 1104). All too often though, this cannot be done without seriously disrupting the decor of the room. So you'll have to try one of the other methods.

Very often you can find one location for a large full-range reproducer system that will look fine, but you can't possibly work in two. A way out of this dilemma is to use the one full-range speaker for a common bass, plus the mid-range and high end of

stereo channel 1, and add a little bookshelf-type enclosure for the mid- and high-ranges of stereo channel 2 (Fig. 1104-b).

There are times when no amount of head scratching can alter the sad fact that two reproducers of any description are not visually acceptable in the room. This leaves no choice but to put them both in one enclosure. Granted that acoustically this isn't the best method, still it will save the day many times when there is no other way out of the appearance problem.

The fourth type of stereo reproducer arrangement is often an esthetic monster, but occasionally an acoustic necessity. The mid-

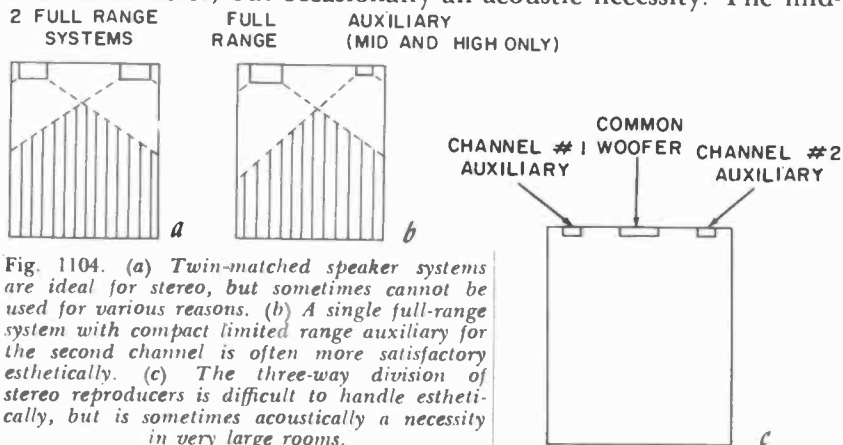

Fig. 1104. (a) *Twin-matched speaker systems are ideal for stereo, but sometimes cannot be used for various reasons.* (b) *A single full-range system with compact limited range auxiliary for the second channel is often more satisfactory esthetically.* (c) *The three-way division of stereo reproducers is difficult to handle esthetically, but is sometimes acoustically a necessity in very large rooms.*

dle and upper frequencies of stereo channels 1 and 2 are fed to two widely-spaced, limited-range reproducers, while the bass ends of both channels are lumped together in a common center woofer. When the shortest wall of a room gets to be 20 or 30 feet long, even the best matched twin speaker systems are likely to give you the feeling that the fellows who sit in the center of the orchestra didn't show up for work. The common center woofer will fill up the apparent acoustic hole, but visually you now have *three* reproducers to contend with. Unless you can sink something into the wall this is a pretty miserable situation, but fortunately one you won't encounter very often.

## Style

Location is a very important factor, but far from the only one to be considered if you are to produce a visually satisfactory installation.

The style of the hi-fi housings is a primary factor with many clients. In general, where possible, the best and simplest thing to do is to make the hi-fi housings conform with the predominant

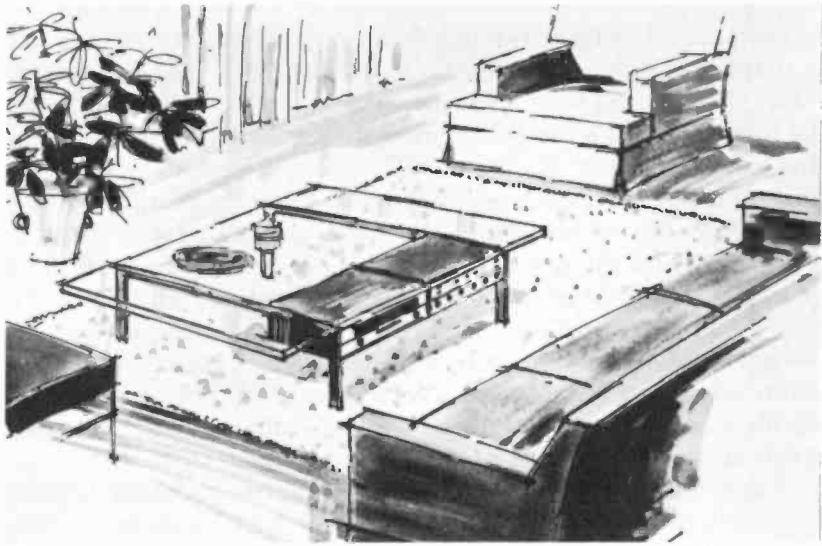

Fig. 1105. Sometimes it is possible to add hi-fi components without changing or upsetting existing decor. (Harmon-Kardon, Inc.)

style in the room (Fig. 1105). Unfortunately, this isn't always possible.

Sometimes the space limitations are such that a cabinet that matches the styling of the existing furniture and which has enough room inside for the equipment simply won't fit in the room. On other occasions, the existing furniture may be in a style that was perfectly reasonable in cost when it was originally purchased 35 years ago, but today can be matched only on custom order at a great deal higher cost than the owner is willing to pay. Another possibility is the room that is furnished entirely in original antiques, and the owner doesn't want to mix any ersatz with them.

All of these situations present styling problems. In the first two instances, there is a choice of either working out something that will blend closely with the styling of the existing furnishings, or doing something that contrasts pleasingly with the present decor. Such a contrast must be sharp enough so that it can't possibly look as if you were trying to match and failed. A well-done contrast can add a lot of interest to the room as a whole, but it's tricky to do. There are no rules for it either, because so much depends on the specific circumstances, but we do suggest that before you try, browse through some back issues of the better house and home magazines for illustrations showing how the professionals do it. You are bound to get some very good ideas this way.

When you try to blend, stay as close as possible to the originals

in every detail. The wood and finish color shouldn't be too hard to match. The decorative detailing — molding, beading, carving, inlay (if any), and legs — will be more difficult. Believe it or not, the hardware will often be the most difficult of all to match. Many times furniture manufacturers will have special runs of hardware made for their exclusive use. This will never turn up in a hardware store. If you can locate the manufacturer of the furniture with which you are trying to blend, there is a faint possibility of getting some hardware from him, if the furniture isn't too old.

If a room is furnished entirely in original antiques and the owners want to keep it that way, give them internal dimensions you need and let *them* look for a cabinet. They'll have very definite ideas as to what they want. Also, the chances are they know much more about furniture than you do.

If they suggest installation in an antique they already have, be *certain* they understand fully what you'll have to do to it. They are liable to prefer that you tear a big hole in the wall, rather than make the tiniest hole in their valuable cabinet.

### **Built-in or free-standing?**

The example discussed above is one of those in which a built-in installation may be the only solution.

There are others. You have doubtless seen, as we have, beautifully decorated rooms in which it just is not possible to add another cabinet without destroying an excellent esthetic effect. And probably none of the existing pieces can be removed, because each has a definite purpose. Building in the cabinetry is the only sensible solution (Fig. 1106).

There are also instances when, although there may be space for additional cabinets, the owner simply as a matter of taste doesn't *want* any more. In such a case, don't argue. Building in is again indicated.

Before proceeding further, let's be sure we're clear on what building in means. To many, the phrase suggests chopping a hole in a wall, sinking the equipment in that hole and then facing it off so that the installation ends up approximately flush with the original surface. This is one way, but an installation is just as thoroughly built-in if it is attached *to* the wall (Fig. 1107) as when it is literally sunk *in*.

The essential differences between a built-in installation and free-standing furniture is that the built-in is fixed in position and becomes an integral part of the room while the furniture type can be freely moved about.

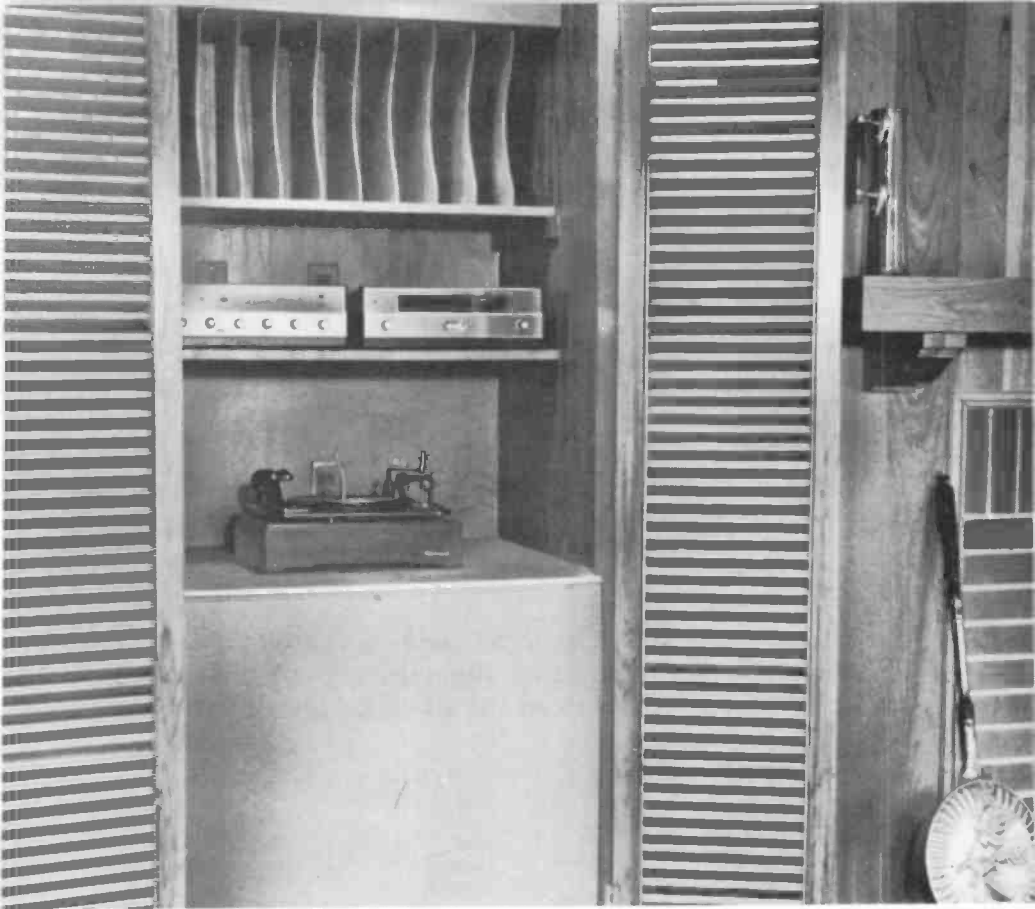

*Fig. 1106. When an installation will obviously clash with decor, building-in and hiding the system is sometimes the only possible arrangement. (Harmon-Kardon, Inc.)*

The immovable nature of the built-in type of housing raises important considerations. If madam gets tired of having it where it is, there's nothing she can do to move it without incurring considerable trouble and expense. Thus, all concerned should go to extra pains to be certain that the location and design of built-in housings are such that they'll wear well visually and functionally.

Since built-in installations generally look best when a fairly extensive wall treatment is done (Fig. 1108), it is possible to combine a number of other facilities in such a treatment along with housing the hi-fi. Bookshelves, record storage, bar, general utility storage, desk, TV and so on can be provided, eliminating the need for a number of separate pieces of furniture. In small rooms or even in larger rooms where wall space is severely limited by large or numerous openings for windows and doors, building in cabine-

try may well be the *only* feasible method of providing, in a visually satisfactory way, all the needed facilities desired.

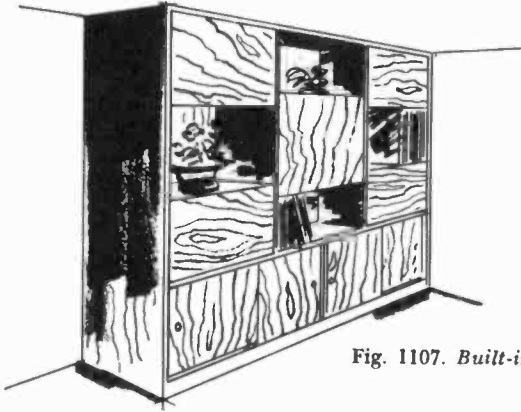

Fig. 1107. Built-in installation on a wall rather than in it.

Sooner or later you'll run into a good many cases where building in the installation is the logical thing to do. But merely because it is logical doesn't always mean you can go ahead. In rented prem-

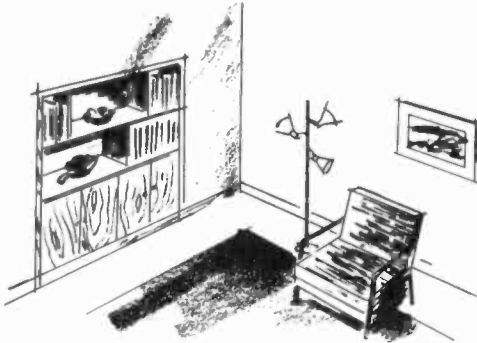

Fig. 1108. Built-in installation sunk into a wall.

ises, the tenant is not going to be allowed to cut holes in the wall without special authorization, and he's often not allowed to fasten anything to it. Fortunately, it is possible to achieve a built-in look with cabinets that are actually free-standing.

This is done (Fig. 1109) by building a number of what are called "modular cabinets." These can be placed on top and alongside of each other until, if you like, you've covered a whole wall.

This is a very good trick because, while it gives the impression of a built-in job, it gets around all the major disadvantages of actually building in. First, the home owners are not inconvenienced by dirt, noise and strangers in the house while the job is

being done, as the heavy work is all done in the shop. Second, a landlord cannot complain, because his building is not affected in any way. Third, if changes become desirable after a time, it is a

*Fig. 1109. Cabinets can be grouped to achieve a built-in look although they are actually free standing. In this case seven separate cabinets are used all completely independent of each other.*

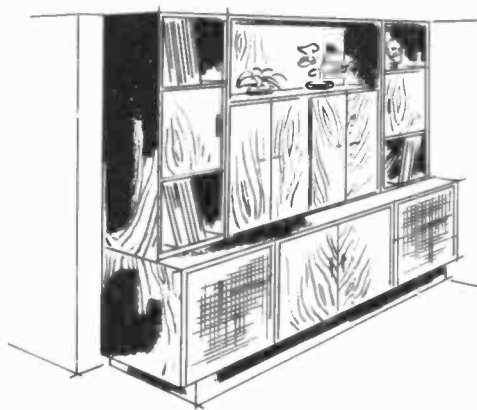

simple matter to remove as many modules as necessary and replace them with different ones. Fourth, the owners are not forced to write off the whole setup if they move. They can take it with them and certainly will salvage some parts for use in their new quarters. And last, but far from least, the installer is freed from the risk of

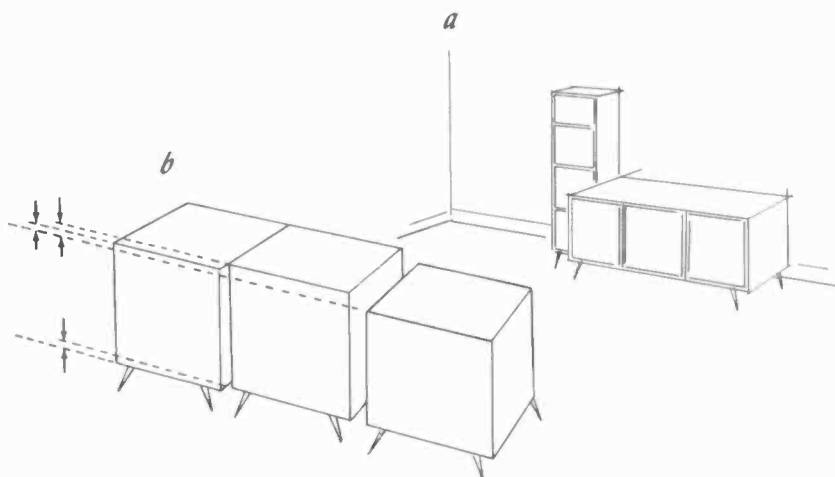

*Fig. 1110. (a) Gross errors in proportion will be obvious to the most casual observer. (b) It is the more subtle errors that will catch you unaware.*

running into unexpected problems after he has ripped a gaping hole in somebody's wall.

There are no hard and fast visual rules as to when to favor built-



in housings over free-standing and vice versa because there are too many instances when either approach could produce happy results. At such times, the choice boils down to a matter of the owner's taste, or other considerations (some of which have been mentioned) that have little to do with appearance.

## Size

Size and location are intimately connected with one another in achieving a desirable visual effect. The off-balance feeling that can result from a too-large cabinet placed too far into a corner has already been mentioned, but the converse is also true. Imagine a cabinet of standard 30 inches height but only 18 inches wide placed at the center of a 20-foot wall. It's going to look ridiculous because it's much too small.

How can you judge size? The first determinant must be the minimum internal cabinet volume required by the components you are housing. The actual part sizes, plus an allowance for ventilating air and an allowance for thicknesses of wood, will give you the irreducible minimum external size. This can then be adjusted upwards as necessary to fit the esthetic requirements of the room and location.

Always start with the components and end on the esthetic considerations. An interior decorator might not work this way, but you should.

Having settled the matter of minimum size, how do you know where to stop in the other direction? This isn't as easy to determine.

Except when the hi-fi is to supply the major cabinetry in the room, the largest pieces already in place are your guide. The hi-fi certainly shouldn't get any bigger than they are, and preferably, it should be enough smaller to avoid competing with them in importance.

When the hi-fi is to provide part or all of the major cabinetry, then the scale of the room itself should be considered. Built-in and semi-built-in jobs can successfully take up an entire wall. But free-standing furniture should always have enough open wall space around it to make it look truly free-standing and uncrowded. Again, we can't give you any specific measurements to guide you but, as the wall gets bigger and the cabinets get bigger, so should the amount of open space. If, for example, you find that 3 feet of clearance at either side of the cabinets on a 15-foot wall looked all right, you can be sure that 4 to 5 feet will be needed to get a similar effect on a 25-foot wall.

## Shape and proportion

As we've seen in Chapter 10, these factors are basic to the visually esthetic effect of an individual piece of furniture, and they are equally basic to its relationship with its surroundings. In a room furnished with long, low modern pieces, one narrow tall one is going to look incongruous. Also, the long, low look will itself seem not low but squashed if held too consistently in a room with 15-foot ceilings. The shape and proportion of individual pieces of furniture must relate to each other and to the room, if a satisfactory overall effect is to be achieved.

The most common errors in the handling of shape and proportion are not the gross ones. It doesn't require much training or thought for almost anyone to see at once that a bookcase 8 inches deep, 6 feet high and 2 feet wide will not look well alongside a cabinet 2 feet deep, 2½ feet high and 6 feet long (Fig. 1110). But it is fairly easy to fumble into a situation where there are three modest-sized cabinets along one wall, separated from each other, each okay in itself, but in a grouping they just don't come off visually, even though they ought to. It then becomes apparent that someone, when purchasing and placing these cabinets, failed to notice that each differs in height from *both* of the others by a mere couple of inches. The difference isn't enough to look intentional, but it's quite enough to look like what it is — a goof.

A roomful of furniture, all of the same height can be pretty monotonous visually. A good interior designer will often introduce intentional variations in a room to prevent this monotony. Two requisites are necessary to the success of such an effect. First, the level from which variation is made must be firmly established by repetition and, second, the variations must be sufficiently great to make it clear that they are intentional. It generally takes more than one variation to produce a good effect, but use restraint. Too many will destroy the reference level. Then, you'll be worse off than when you started.

In built-in jobs, proportioning troubles often arise from a tendency to subdivide the fronts excessively. It may seem at first thought as though a separate little door for every little thing that is inside would make for convenient operation. Perhaps so, but the resulting front gets to look like a patchwork quilt. So steel your flinty heart against this engaging temptation and keep all the doors large enough and few enough to be in scale with the overall size.

## **Color and texture**

Cabinet color will seldom be a problem. In most instances, the color will be dictated by that of the other wood pieces in the room. Finish texture will be determined the same way. You would not put a high-gloss cabinet in with a lot of satin-finished wood or vice versa.

The speaker grille cloth will give you trouble. Many times, no matter how carefully you explain the necessity of using a cloth that is reasonably transparent acoustically, Madam won't go along with anything you've got.

It is well worth while to build up a really complete sample collection of all the truly correct grille cloths available. With such a collection in hand, you'll get the lady's approval of one of them (however reluctantly) in more cases than you might expect.

But for those times when none of them will do, figure you've done your best and retire in confusion to let her come up with her own choice. Unless it is so hopelessly heavy that you won't be able to push any highs through it even with the treble cranked all the way up, let it go.

Even though one of the standard grille cloths may look perfectly dandy for this room in your eyes, remember that color is a highly subjective thing. The owner who is not entirely pleased with the appearance of a system is sometimes never entirely pleased with the sound either, even though there's nothing wrong with it.

So don't put up too strong a fight on this issue. You've got tone controls on the preamplifier and there's nothing in the criminal code against using them.

## **Appearance and functionality**

The sort of thing we've just been talking about is a case in point. You'll encounter others where appearance and function requirements are at odds.

The reason we've spent two chapters discussing matters of visual esthetics is that in residential and commercial hi-fi installations, appearance cannot be ignored in favor of acoustic and other functional considerations. Obviously, you can't ignore function for appearance either, but you are less likely to try that.

These inevitable conflicts between appearance and functionality are nothing to be afraid of, but they will require that you keep your wits about you to arrive at a workable compromise, and compromise you will. Any decision regarding an installation that entirely disregards either factor is bound to be a bad one.

# construction of cabinets and built-in furniture

**W**HETHER you're a professional technician installing hi-fi equipment as part of your regular work, or a do-it-yourself sturdily coping with your own installation problems, you need to know some fundamental things about cabinets and built-in furniture. If you don't, sooner or later the lack will cost you — merely in miserable sound reproduction if you're lucky, in expensive damage to furniture if you're not. Even if you never expect to build so much as a rabbit hutch from scratch, a modest knowledge of furniture construction will enable you to get better sound from an installation and avoid wasted time and costly errors. And, if you're a home owner specifying what you want in your own setup, it will help you to explain what you want and to get it.

## **The installer's point of view**

You probably won't be called on actually to build the furniture that houses the hi-fi equipment, although in many cases you may be asked to make recommendations as to what sort of cabinet to buy or have built. You certainly will be required to fit the various components of the system into the available cabinetry and spaces, subject to the client's preferences where function permits a choice. And you probably will make all the holes for intercomponent cabling and ventilation, and perhaps also mount the speaker or speakers, pad and brace the enclosing box, and so on.

## **Style and construction**

Ideally, as we have seen in Chapters 10 and 11, the styling of furniture intended to house hi-fi equipment should be planned

so as to place it in a definite relationship to the furnishings that will surround it. Excellent theory, but before we can install any equipment the theory must be translated into tangible objects; the actual furniture. In other words, the styling ideas will have to take form via available methods in available materials before you'll have the physical spaces in which to do an installation.

This may sound like a roundabout way of saying something very elementary. It is not. If you have seen, as the writers have, many ideas that were beautiful on paper but couldn't be built practically, you'll readily agree.

Style and construction are, then, directly dependent on each other. You cannot laugh off the fact that so much authentic period furniture is still around by blaming it on pure snobbery or nostalgia. A great deal of it was put together by people who knew how to fuse design ideas, materials and construction methods into objects that were structurally sound and eminently capable of serving the purposes for which they were intended.

Hi-fi furniture, particularly the speaker enclosure, is required to serve purposes for which the furniture of no prior period was intended. It is necessary then, to suit the materials and construction methods to the use.

We are fortunate in having at hand materials and technologies that were not available to our predecessors, and for hi-fi purposes it's a good thing that this is so. We need them. As an example, for both equipment and speaker enclosures, modern plywood is a vastly more reliable material for large panels than the solid lumber of former times, even if solid lumber were available in wide stock any more.

When working with modern or contemporary styles, you'll have much more flexibility in choosing both materials and construction methods than is possible in period reproduction. In any of the highly developed period styles, both the materials used and the manner in which the various parts were joined was very thoroughly standardized. If, in making a reproduction, you stray very far from the materials and methods used in the originals, the feeling of authenticity will quickly be lost.

But in the variations of modern styling, neither materials nor methods are standardized. In fact, one of the most interesting aspects of Modern is that it has been so highly experimental, and that so many new materials and methods have been introduced.

This is not by any means an unmixed blessing. The correct use of methods and materials that have previously withstood the test

of time gives one a reasonable assurance that they will do so again. But the use of new methods and materials does not always provide the same guarantee.

The choice of materials and construction methods to be used is thus primarily influenced by two factors. First, they must be appropriate to the styling of the design and, second, they must be appropriate to the use. As an example, we shall see a bit further

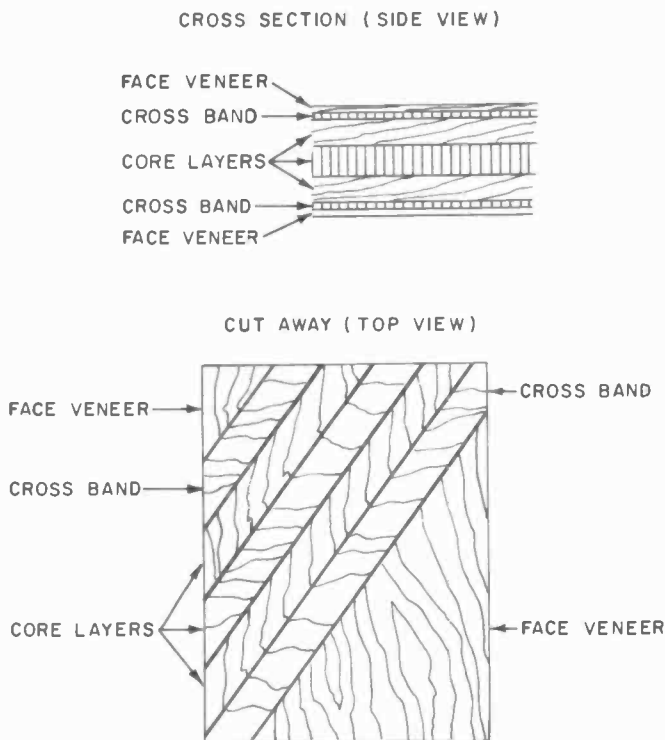

Fig. 1201. Details of veneer-core plywood construction.

on why a large speaker enclosure constructed with butt joints and fastened with nails is bound to produce trouble, while an equipment enclosure built this way could be reasonably satisfactory.

### Plywood construction

Whether your hi-fi housings are free-standing furniture or compartments built into a wall, the basic construction material will be wood.

Wood comes in one of two forms; either as plywood or as solid lumber. Lumber needs no explanation, but plywood does. There

are two basic types of plywood construction; veneer core and solid core. One good reason for knowing one from the other is that they differ appreciably in cost.

Veneer core consists of a number of thin layers of wood laid one on top of the other with the grain of each layer running at right angles to that of the last one, as shown in Fig. 1201. The various layers are sodidly glued together under heavy pressure to form the final panel. The construction illustrated is typical of a  $\frac{3}{4}$ -inch-thick panel. Other thicknesses are obtained by increasing or reducing the number or thickness of the various layers.

Solid-core plywood is made by laying, edge to edge, strips of solid lumber, generally 3 inches wide, and then gluing on cross-band veneers and face veneers, as shown in Fig. 1202.

Of the two constructions, solid-core results in the better material for cabinet purposes, but it is also more expensive.

The main advantages of solid-core are that it is more stable, that is, it resists warpage better, and there is far less tendency for the face veneers to transfer surface ripples from the grain of the core material. These surface ripples are often difficult for the nonprofessional at woodworking to detect in the raw panel, but they'll show up when the piece is finished, particularly if a high-gloss finish is used.

Where the job calls for the best, be sure to specify the use of solid-core plywood for all large surface areas and you'll avoid some possible trouble getting the final finish to the desired degree of smoothness. By the same token, where cost is primary, change over to veneer-core and save something on the material. The fact that solid-core is better doesn't mean that veneer-core is a poor, weak or unreliable material. Quite the contrary.

### **Plywood grades**

While construction is one major factor in the ultimate cost of plywood, there are also two others. One is the grade of surface or, more properly, face veneers; the other is the species of wood.

Face veneers are graded according to the uniformity of grain and color and the presence or absence of various imperfections such as knots, pinholes, splits, mineral streaks and other flaws.

A panel that is good one one face only, specified G1f, costs a good deal less than G2f, which is good on both faces. Here is where intelligent specification of materials can hold down cost without detracting from the appearance or structural soundness of the finished product. The outside surfaces of a speaker cabinet are readily visible and therefore require a good face veneer, but

the inside surfaces certainly don't. For such uses, G1f is just as good as G2f, and cheaper. The mounting board of a speaker enclosure is usually covered with grille cloth and *neither* face is visible. Obviously then, plain fir plywood is fully adequate.

Differences in construction or wood species in a panel of given thickness will result in minor differences in the stiffness of the

CROSS SECTION (END VIEW)

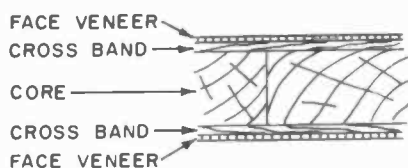

CUTAWAY (TOP VIEW)

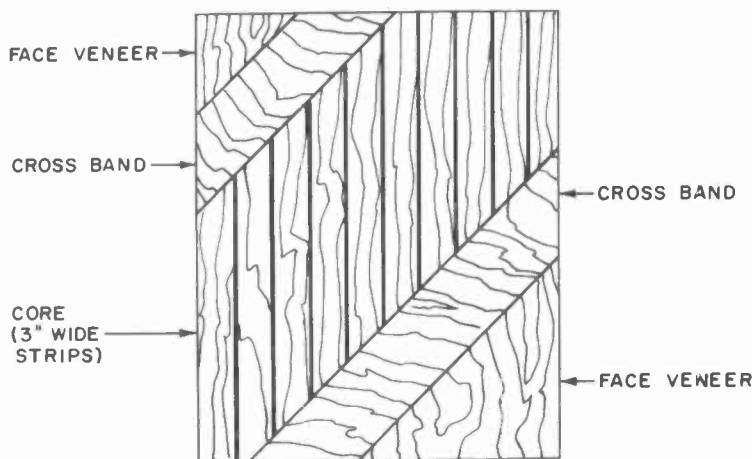

Fig. 1202. Details of solid core plywood construction.

resulting panel and in the acoustic coefficient of absorption of its surface. However, these differences are so slight that there is no practical value to be gained from considering them.

As a general rule, style permitting, specify that plywood rather than solid lumber be used for all large panel areas in hi-fi cabinets, whether intended for equipment or speakers. Plywood is more resistant than solid lumber to the vibration in a speaker enclosure and to the heat in an equipment cabinet. In addition, it is far easier to maintain uniformity of grain and color with plywood.



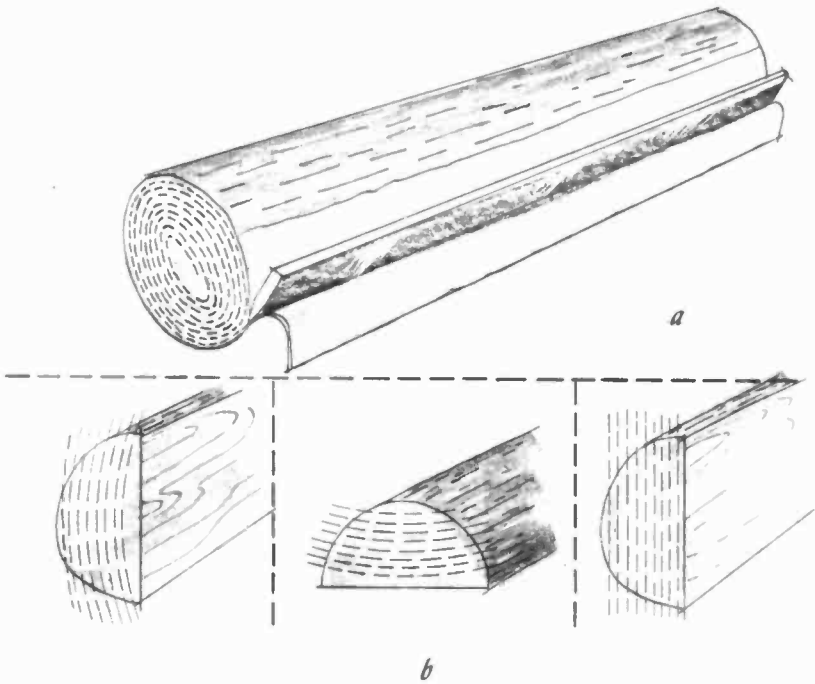

Fig. 1203. A rotary cut (a) gives more attractive graining than the plain slices (b).

Moldings, bases and legs must be in solid lumber, and any internal cleats or glue blocks should be also. An exact match in graining between parts made of plywood and others made of solid wood is very difficult, even though both are of the same species. This results from the fact that the plywood maker can and often does cut through the log on a curve when making his veneers in order to expose beautiful graining figures. These do not appear when the log is sawed straight as is necessary when cutting solid lumber. Fig. 1203 shows examples of these differences in grain.

Even though an *exact* match in grain between solid and plywood parts is unlikely, a little care in the selection of adjoining pieces that will show can keep the differences well within the range of acceptability. Remember also that a good deal can be done in finishing to smooth out differences that seem quite strong while the wood is still raw. A good deal more care must be taken when selecting lumber to be finished in the natural wood color than is necessary if the piece is to be stained or bleached. These latter processes are far more effective in obscuring minor material variations than a natural finish.

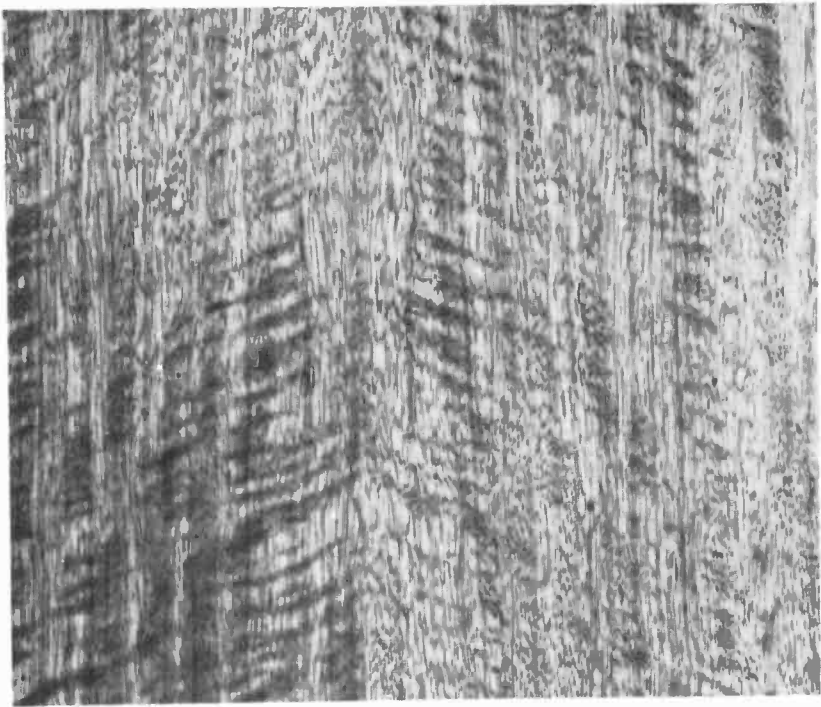

Fig. 1204. *African mahogany has a rather pronounced grain and enjoys fairly wide usage.* (Hardwood Plywood Institute.)

### Wood species

Contrary to popular belief, the species of wood chosen for a hi-fi cabinet will not have much effect on its construction or durability. It will, though, have a very large effect on the appearance. This is why it is so important to use a species and finish color appropriate to the style.

The great English styles, Chippendale, Hepplewhite and Sheraton, used largely mahogany and occasionally walnut. French Provincial was generally in birch or fruitwoods. Early American furniture was largely pine. To reproduce a Sheraton piece in birch, or a French Provincial piece in oak, just wouldn't make sense.

To give even a moderately complete background in the various furniture styles and the wood species employed in making them would require a book by itself. Fortunately for our purpose, detailed information in this area is quite unnecessary.

But you should at least know and be able to identify the four major hardwood species used in present-day cabinet work. You



*Fig. 1205. Walnut is an attractively grained wood that is very popular with furniture makers. It is beautifully colored, very durable and easy to work with. (Hardwood Plywood Institute.)*

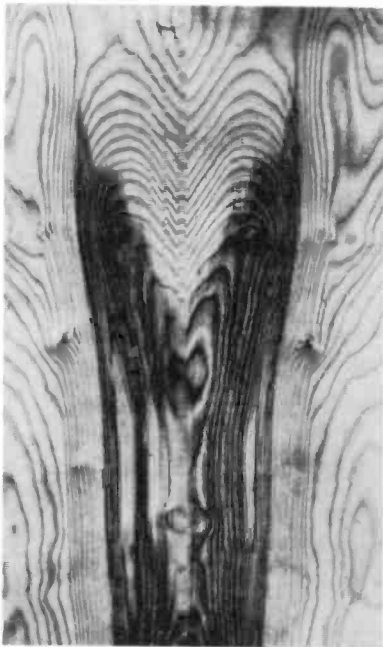

*Fig. 1206. If a natural blond wood is needed, birch is just about the finest, in spite of the difficulties of working with it. (Hardwood Plywood Institute.)*

are very likely to have to change or add a control panel or changer mounting board in an existing cabinet from time to time. If you know these four species of wood, you'll be equipped to deal with at least 90% of such cases, since at least that percent of the furniture you'll encounter will be made of one of these woods.

The four species concerned are mahogany, walnut, oak and birch. Mahogany is by far the most widely used. Technically, mahogany is a name that covers an extensive group of closely-related tropical woods. There are at least 37 in the group, but only two that need concern us — the African and Honduras mahoganies.

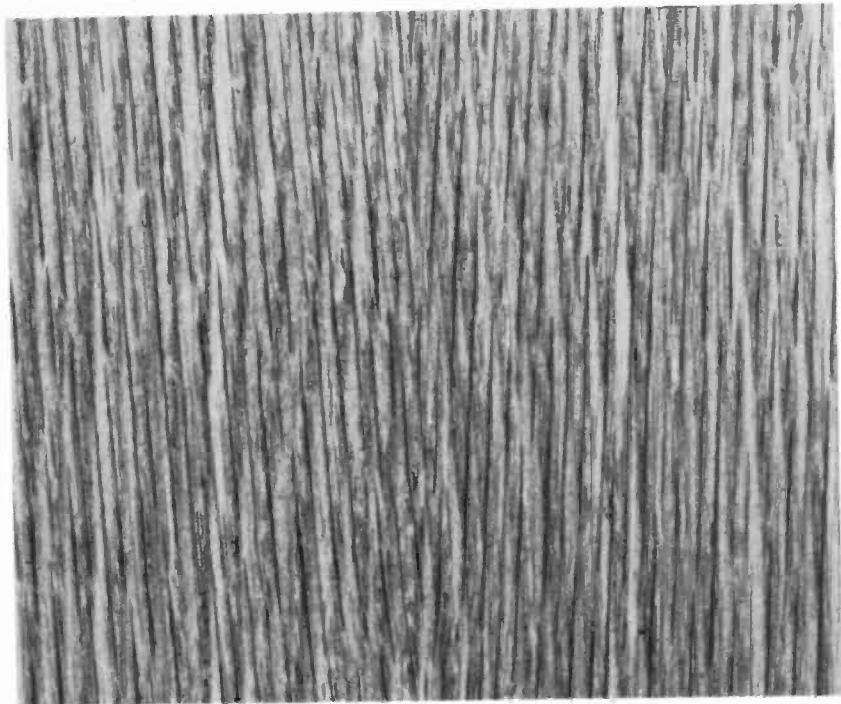

Fig. 1207. *The even grain lines of comb-grain oak make it a very popular wood for furniture. (Hardwood Plywood Institute.)*

African mahogany (Fig. 1204) is a small-pored, close-grained wood of medium hardness. The grain figure consists of long straight stripes alternating light and dark that fade into each other at their edges. This type of figure is called a ribbon stripe and is characteristic of the mahoganies.

Honduras mahogany is very similar to African mahogany except that the ribbon stripe is not quite as pronounced, nor as even. Also, the pores of Honduras are somewhat coarser. African

is the preferred variety but Honduras is less expensive, an undeniable attraction.

Walnut (Fig. 1205) is an extremely beautiful and popular wood. It also is of medium hardness, with a very fine pore structure. However, it has a far *more* pronounced and active graining figure than the mahoganies, and is preferred by many for this reason. Large swirling figures interspersed with areas of narrow pencil stripes are characteristic of this wood.

The swirl in the figure of walnut is the source of much of the beauty of the wood, but also can cause some nasty problems when



*Fig. 1208. A gentle swirl in the graining figure is an identifying feature of plain sliced oak. (Hardwood Plywood Institute.)*

matching. If you want to match a new control panel or door to an existing walnut cabinet, you may have some trouble finding a piece of wood with the correct grain and color for the job, so try to avoid such a problem if you can.

Birch is naturally a blond wood, although it is often stained to resemble mahogany or walnut. It is very hard, dense and extremely small-pored. Its hardness makes it very strong and durable, but by the same token more difficult to work than mahogany or

walnut (in the solid lumber form at least). The graining figure swirls in a manner resembling walnut (Fig. 1206). This figure is very subdued if the wood is left in its natural color, but becomes more pronounced with staining. Stained birch has often been used to imitate walnut because the wood itself is less expensive. You might get fooled once by birch-stained walnut, but it won't happen twice. It is not that good an imitation.

Oak is another very hard, dense, heavy and durable wood. Aside from its tremendous durability, the attraction of oak as a furniture wood is a bit baffling. It is difficult to work because it is so hard, and it also has a very coarse pore structure, making finishing more of a chore. Comb grain or rift oak (Fig. 1207) has a very regular even pattern of narrow pencil stripes, making matching problems pretty negligible, an undeniable advantage over walnut. Plain sliced oak (Fig. 1208) is characterized by gently swirling figures less pronounced than those of walnut. One of the most beautiful figures to be found in any wood is that of quartered oak. It consists of longitudinal lines contrasted with strong radial lines called crossfire as shown in Fig. 1209.

In addition to the hardwoods mentioned thus far, two soft woods are worth remembering. Probably you know both of them already. If you've done any installing you are bound to have used some fir plywood. This is a very useful material, so don't look down on it. If you are using anything else for concealed parts like baffle boards, backs and internal partitions in speaker enclosures, you're wasting money on materials. If you have a piece of walnut left over from building the speaker box, don't use it for the baffle! That wouldn't be too bright. You can use fir and save that walnut. It might make a couple of player mounting boards when you need them.

The other soft wood to remember is knotty pine. You'll run into it a good deal in dens and playrooms, where it is used as paneling. If you have to build an installation into such a room, you may be stumped for a while unless you remember that knotty pine is available in plywood sheets for use where you require pieces larger than can be obtained in the form of solid lumber.

For surfaces where a good deal of abuse can be expected, don't forget the decorative possibilities available in plastic surfacing sheets such as Formica, Micarta, Nevamar, Textolite, Pionite and the others. These materials are obtainable in a variety of excellent wood grains, and also solid colors, although you might not think so after seeing the ghastly patterns commonly-used for the count-

ers of one-arm lunches. These materials can be worked with ordinary woodworking tools and can be applied with a special contact cement to surfaces already in place.



Fig. 1209. Quartered oak displays one of the most beautiful and complex graining figures to be found in wood. (Hardwood Plywood Institute.)

## Hardware

Outside of fastenings, the hardware items most commonly required by the hi-fi installer are drawer slides, lid supports, hinges and knobs or pulls.

The drawer slides commonly used in hi-fi work are either 13

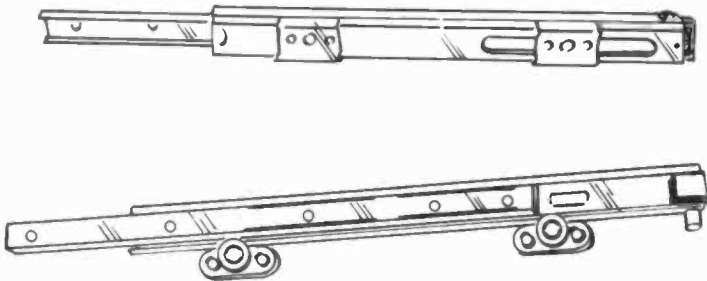

Fig. 1210. Tape recorders and record players are frequently mounted on pull-out drawers. Two types of drawer slides that will do the job are shown here. Be certain that the slides you select will support the drawer and its equipment when fully extended.

inches long with a 9-inch traverse or 15 inches long with an 11-inch traverse. They are rated to carry 40 to 50 pounds a pair. Two

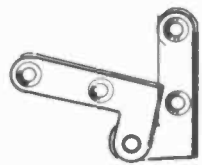
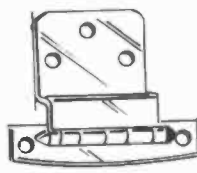
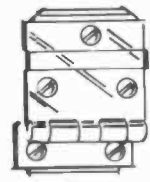
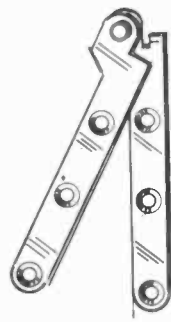
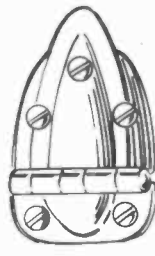
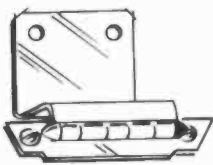
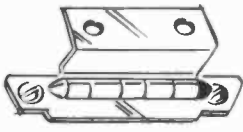
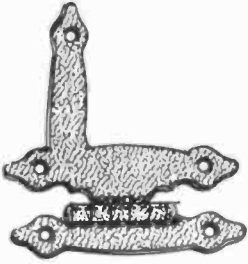
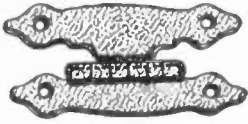

Fig. 1211. Hinges come in a wide variety of shapes, but their selection is largely just a matter of taste.



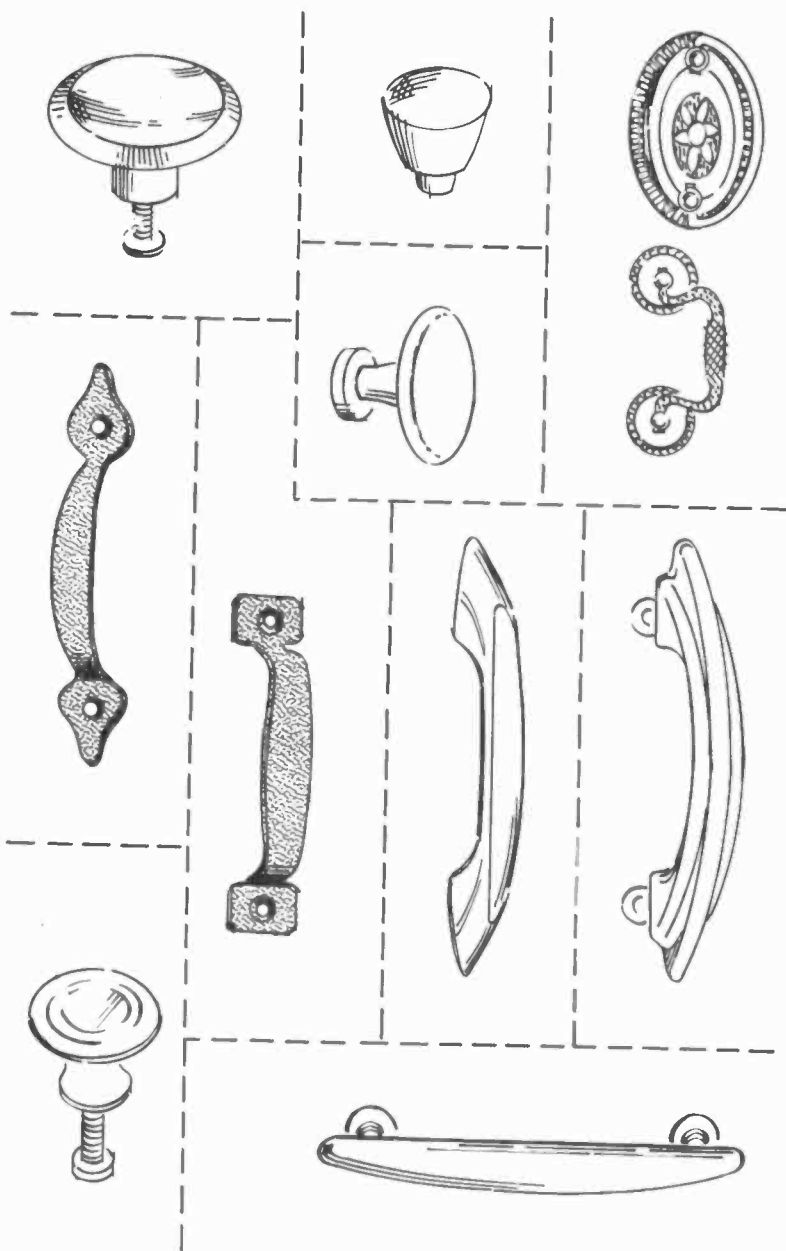

Fig. 1212. Carefully select knobs and drawer pulls to match decor and furniture styling. A catalog or store display will be a helpful guide in making a selection.

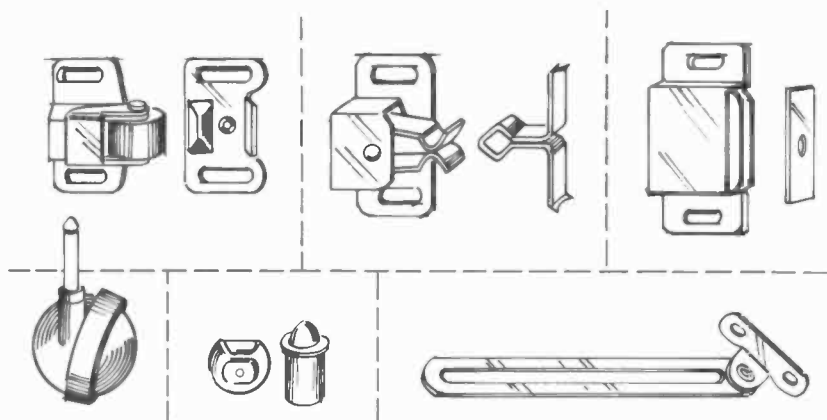

Fig. 1213. Legs, catches and casters will probably be encountered before you're through with the installation. Here again, browsing through a catalog or a store display will be helpful.

basic types are made. One is the side mount, intended to be attached to the sides of the cabinet; the other is the undercarriage slide intended to be attached to a shelf underneath the drawer (Fig. 1210). Try to use each as intended, otherwise the weight-carrying capacity will not be as rated.

In case you have a big load such as a large tape machine to be put in a pull-out drawer, very-heavy-duty slides can be obtained, with weight-carrying capacities up to 200 pounds a pair. In some localities you may have trouble finding these types in stock anywhere, but they can be ordered.

About lid supports, nothing much need be said except to be sure you use one strong enough to stand up under constant use. We recommend that with all moving hardware, lid supports, slides, and hinges, that any error be on the side of using material that you know is *too* heavy for the job. The capacity of exhilarated people at a party to overload such devices is astonishing, to say nothing of the onslaughts of healthy children.

Fig. 1211 shows a few of the many hinges available. Here, the problem is often to find one that is strong enough without being too conspicuous. The piano hinge is, of course, the strongest, but it shows all the way along the door. The butt and Soss hinges are of about equal strength, and the Soss has the advantage of being completely invisible when the door is closed. Remember this when you are tempted to use a pivot hinge, the weakest of the lot, merely because it is inconspicuous.

Knobs and pulls (Fig. 1212) are of such infinite variety that your best bet is not to get embroiled in suggesting anything. Send

the lady of the house down to a well-stocked hardware place and let her pick out what she wants.

There are various other pieces of hardware often used on hi-fi cabinets, but as an installer you will have very little to do with them. However, you should at least know what they are when you see them, so a few of the more common ones are illustrated in Fig. 1213.

### Other materials

You won't very often manage an installation without having to contend with grille cloth. The best cloths to use from a hi-fi functional viewpoint are woven specially for the purpose from monofilament plastic yarns. The big snag here is finding a pattern that

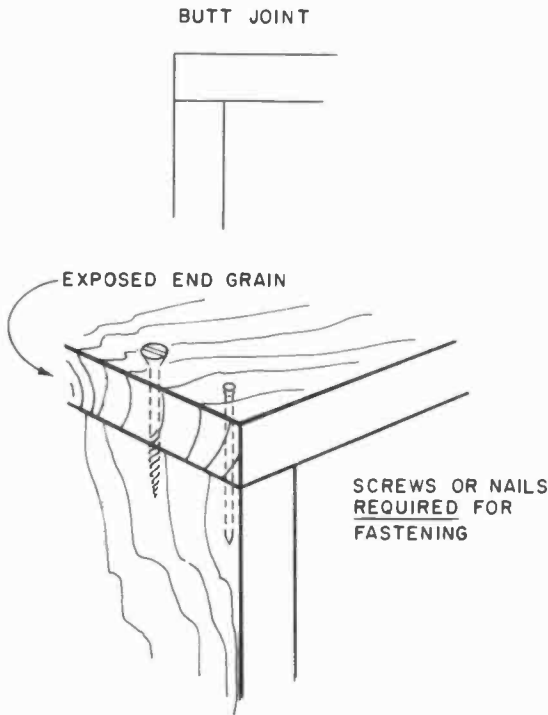

Fig. 1214. The butt joint is one of the simplest ways of joining two pieces of wood.

will satisfy esthetic requirements without being functionally bad. This is not always possible. From time to time, you'll have to settle for something that is acoustically less than ideal but, after all, why is there a treble boost on the preamplifier if not to be used?

For padding the inside of speaker enclosures a good many materials have been used such as felt, rock wool, Kimsul, cotton waste or fiberglas. We generally prefer fiberglas in the form of flexible blanketing. It gives the best absorption for the cubic volume occupied, and is very easy to handle. You can cut it to

#### SHOULDER BUTT JOINT

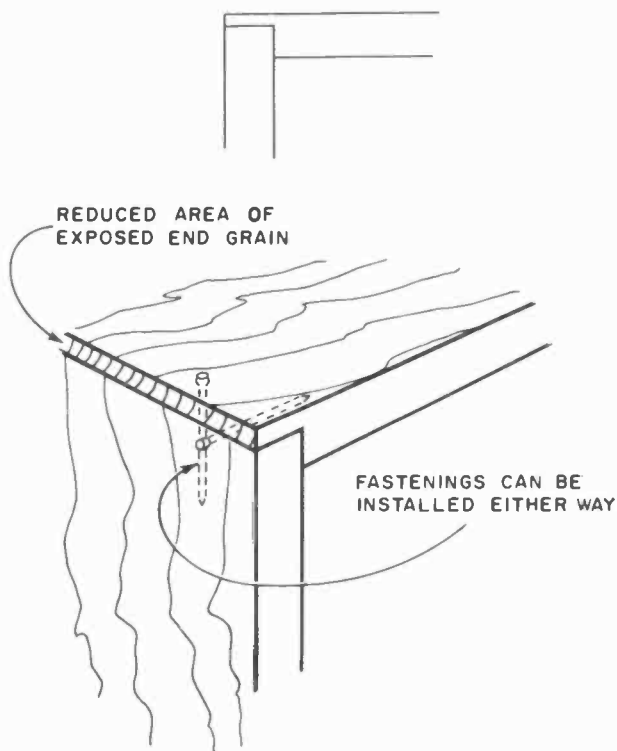

Fig. 1215. *Stronger than the plain butt joint, the shoulder butt joint has less exposed end-grain surface and is thus easier to finish.*

size with a pair of large scissors and staple it in place. Incidentally, it is said you can actually sharpen a pair of scissors this way.

### Joints

Since most of your installations are going into cabinets of one sort or another, you'd best know a bit about how they are put together. Then, if alterations or new construction such as added internal shelves are needed, you'll know what can be done and what cannot.

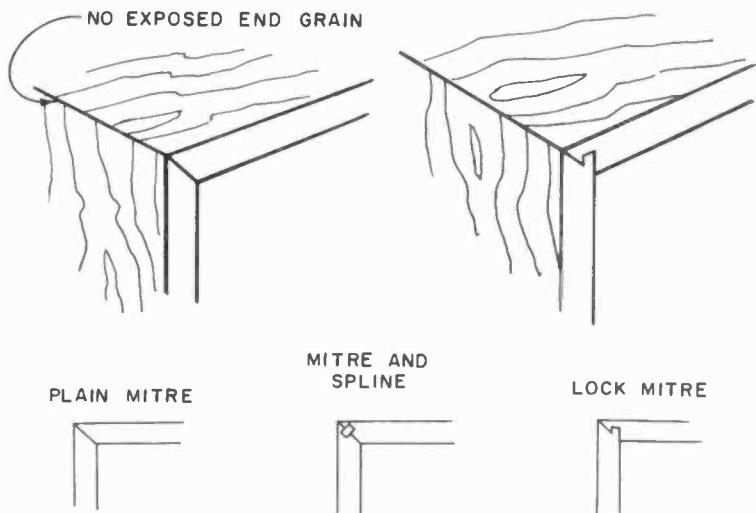

Fig. 1216. Mitre joints are relatively easy to cut, although using a shaper will result in a smoother and tighter fit. Using a spline strengthens the mitre joint. Even better is the lock mitre but for this you must use a shaper.

There are a number of ways of jointing a cabinet, depending on the tools available, strength required and appearance and cost factors. The least expensive joint, the simplest one and the one requiring the least equipment is the butt joint (Fig. 1214). All that is needed to make a decent butt joint is a smooth, straight cut on the ends of the pieces to be joined. One piece is placed so as to overlap the end of the other, and they are then fastened together with glue and either nails or screws. It is an easy joint, but has two disadvantages. It is the weakest of the various joints, and it leaves the end grain of the overlapping piece exposed. This is often esthetically undesirable.

The shoulder butt is a considerable improvement over the plain butt (Fig. 1215). It is a bit more complicated but not much, considerably stronger and much better-looking. It is made by notching out the end of the overlapping piece, then setting the end of the piece to be overlapped into the notch. The only problem is to cut the notch in the overlapping piece accurately. This can readily be done with a table saw, swing saw or router. But it is pretty difficult to do by hand.

The best joints to use for cabinet work are the several variations of the mitre (Fig. 1216). They make the cleanest, strongest and most professional-looking joints. The plain mitre reinforced with a glue block is the simplest but least desirable of the mitres. If

the inside can be seen, the glue block doesn't look so great, and without it, the joint is considerably weaker. The two best variations are the mitre and spline, and the lock mitre. They are the strongest joints you can use, and the best-looking. The plain mitre, or the mitre and spline joints, can be made with nothing more than a table saw if it is accurate, but a lock mitre requires a shaper equipped with the proper knives. This isn't a joint you are likely to make yourself, but it is a good one to specify if you are having some cabinet work done.

The joints mentioned thus far are for outside corners. If fixed internal partitions are required, there are a couple of ways of

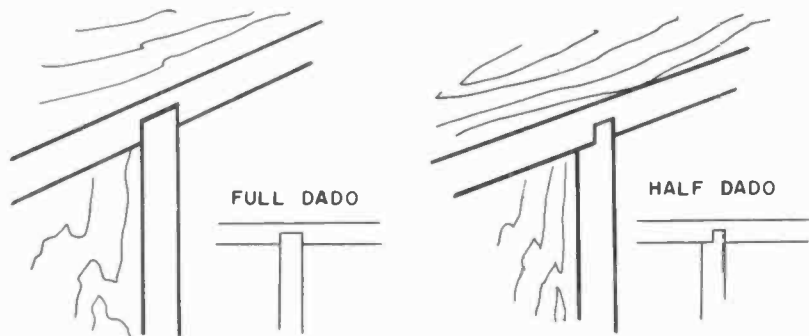

*Fig. 1217. Use a dado or half dado for interior partitions or shelves. The half dado, while requiring more work than full dado, does not weaken cabinet side panels as much.*

doing it. One way is to butt them as shown in Fig. 1214. The other way is to slip the partition into a half or a full dado, illustrated in Fig. 1217. This is the method of choice if you are building a cabinet, but if you have to install a partition in an existing cabinet it's a devil of a job to cut the dados to receive the partition. It can be done quite readily with a portable router. If you don't have one, it probably wouldn't cost very much to have a cabinetmaker come in and do that part of the job.

Two other joints that you'll encounter from time to time are the doweled joint and the mortise and tenon (Fig. 1218). They are found most often in legs and bases and in the frames of doors with inset panels. Neither of these is a joint you should try for yourself. Leave them to a cabinetmaker. As we shall see in the next chapter, you can often repair one if it is loose, but don't try to make one from scratch unless you are sure you know what you're doing.

## Fastenings

A large number of fastenings can be used in connection with the furniture end of installation work. Some you have been using for a long time, but others may not be as familiar. Fig. 1219 illustrates several types of nails. The cut nail (a) is presented only to caution you never to use it for anything around a cabinet. It is a flooring nail. The common or flat head nail (b) and the finishing nail (c) you probably know. The common nail holds better, but the finishing nail is less conspicuous. The spiral shank or screw-tight nail (d) and the anchor-fast (e) you may not know. These can be used where you need better holding power than you

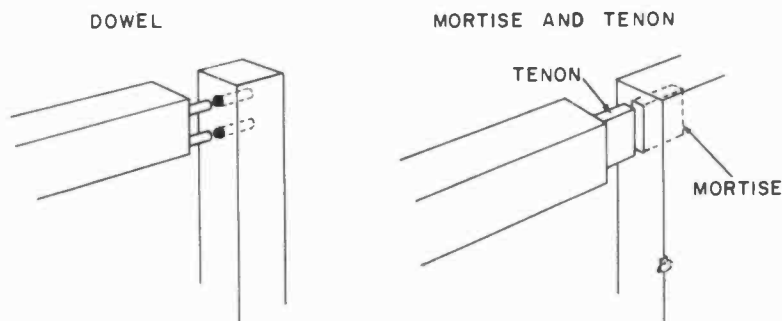

Fig. 1218. (a) The dowel joint requires precise alignment of holes. (b) A mortise-and-tenon joint also requires exact cutting and shaping, but is much stronger than a doweled joint. A hole is frequently drilled through the mortise and tenon and plugged with a dowel for added rigidity.

get with an ordinary nail, but where you don't want to drive screws. The anchor-fast is reported to have even better holding power than a screw of comparable size. This can be a great little time and labor saver when assembling a speaker enclosure that requires a lot of screws. But don't anchor-fast the back or the baffle board into place. It may take a crowbar and sledge hammer if you ever have to get them out.

The three types of wood screws in Fig. 1220 will all be familiar but, for your own good, use them properly. Nothing looks cheaper and less professional than a flat-head screw that isn't countersunk, unless it's an oval head with no finishing washer.

You won't use bolts (Fig. 1221) much in connection with cabinets, but (again!) when you do, use the right ones. Don't attach a wrought-iron rod to the side of a cabinet with a flat-head bolt when the holes are not countersunk. And don't attach a brass

rod with a chrome-plated bolt. Muff enough such details and the whole job begins to look slovenly.

Two fasteners you ought to know about in case you ever have to hang a cabinet or counter on a wall are rawl plugs and toggle bolts (Fig. 1222). Rawl and other similar plugs consist of either a fiber or metal plug used with a wood, sheet-metal or machine screw to fasten things to plaster, brick, masonry, concrete or cinder block. A hole is drilled in the wall of the size required to receive the plug, using either a carbide masonry drill or a star

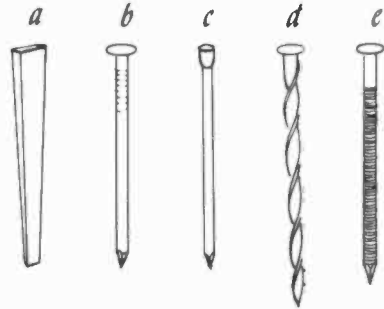

Fig. 1219. Types of nails include (a) cut nail, (b) common nail, (c) finish nail, (d) screw-tight nail and (e) anchor-fast nail.

drill. The plug is inserted in the hole and the appropriate screw is driven into the plug to complete the fastening.

The toggle bolt is used where there is internal open space inside the wall, as in a wall with wood or metal lath underlying a plaster surface. The toggle bolt is installed by drilling through into the internal air space, then inserting the toggle bolt with its wings folded. When the wings come clear into the internal space, they spring open behind the lath, permitting the fastening to be completed by tightening up on the external end of the bolt. This

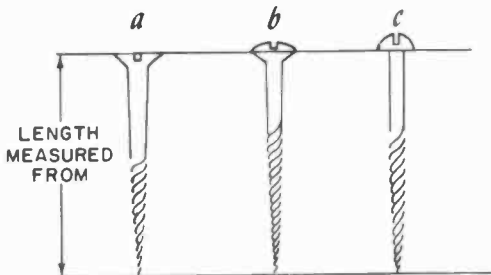

Fig. 1220. Commonly used wood screws are: (a) flat head, (b) oval head and (c) round head.

makes an extremely simple and very positive fastening, as a sizeable hole would have to be torn in the wall for the fastening



to break out. *Caution:* Be sure the unit you are mounting in this fashion is ready to go into place permanently. If you have to back out the screws to remove it, the wing nuts will fall down inside the wall and you will have to put in new ones in order to finish the job.

## Finishing

No discussion of the furniture aspects of hi-fi installation is complete without reference to furniture finishing. While it's unlikely that you'll finish an entire cabinet, you may very well need to finish a new control panel, mounting board, drawer or other part involved in a cabinet revision. Also, you are bound to run

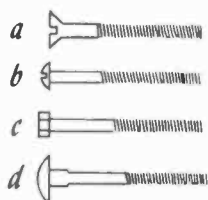

Fig. 1221. Bolts that may be needed for long reaches: (a) flat head, (b) round head, (c) hex head and (d) carriage bolt.

into cabinets that need scratches or nicks retouched, a procedure covered in the next chapter. For these reasons it's helpful to know how the original furniture finish was done.

To say that the final sandpapering of the raw wood is *the* most important part of finishing would be an exaggeration, but only a slight one. It is *impossible* to get a really good finish on wood if the surface has not been adequately prepared. This means a really thorough sanding with papers as fine as 4/0 or even 6/0, depending on the kind of wood. The softer the wood, the finer the final paper. Most of this work can be done nowadays by machine. Fig. 1223 shows two types of acceptable portable machines. One is a belt sander and the other an oscillating sander. The oscillating types are okay if they have a straight back-and-forth movement, but stay away from those with an orbital movement, as part of their cycle takes them *across* the grain of the wood, and sanding for a furniture finish, should always be done *with* the grain only. *Never* use a disk sander for furniture work, for the same reason.

Once the final sanding is completed, the actual finishing begins with the precoloring of the wood, except in those cases where the wood is to be finished in its natural color. To darken the natural color, you use stain; to lighten it, you bleach. Staining is quite simple and reliable; bleaching is not. If you need a blond color, why not use a wood that is blond to begin with? There are plenty of them. In addition to birch, there are limba, avodire, primavera

and chen chen, to name a few. If for some reason it is absolutely necessary to bleach, go to a reliable finishing materials supplier for the materials and follow the instructions to the letter.

If staining is needed, there is no real problem except to get the color right. While quite a number of colors are available as standard mixtures, the exact color you need may not be among them. You can make up the color you need by thinning or mixing the standard colors. If you can take along a sample of the final color you need, your dealer can be very helpful in suggesting what and how to mix to get it.

Wood stains are of three types: alcohol, water and oil base. You are not likely to use alcohol stains. Again, if you tell the dealer what type of wood is to be stained, he'll be in a position to make a useful recommendation. In general, oil stains do not penetrate the wood as readily as water stains. Thus, on a very hard wood such as oak, you'll have better luck with the water type. On medium-hard woods like walnut or mahogany, either oil or water stains can be used. However, on very soft woods like pine, fir or

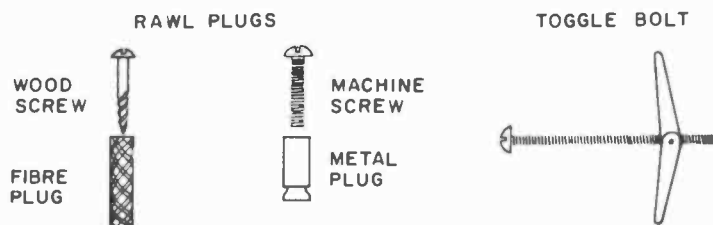

Fig. 1222. Use rawl plugs or toggle bolts when fastening anything to masonry.

poplar, you can control an oil stain more readily to avoid inadvertently getting the color too dark.

After staining, the next step is filling. This is done with a paste wood filler, the purpose being to fill the numerous tiny pores in the wood so that the final finish coats will go on smoothly. As with stains, fillers come in a variety of standard colors, which can in turn be mixed or toned to approximate more closely the color of the stained wood. On occasion, interesting effects are obtained by contrasting the color of the filler with that of the surrounding stained background.

After filling, the finish is built up by sealing with either shellac or lacquer, then applying two or more, usually more, final coats of either varnish or lacquer. Preferably, shellac should not be used for final coats as it is too soft.

Final coats are done best with a spray gun, as this method results in a smoother surface than can be obtained by brushing. Spraying is also a great deal faster; consequently, it is the method used in finishing all commercially-built cabinets.

After the last finish coat, the better grades of furniture are rubbed down to produce the degree of sheen desired. The resulting finish can vary from a dull, satiny texture to a mirrorlike high gloss, depending on the abrasives used for the rubbing. The very dull finish requires nothing more than a rubdown with 6/0 steel wool, while the very high gloss is produced with the aid of a special rubbing compound. Various other abrasives will result in textures in between.

After rubbing, the finish should be protected with a coat of good quality paste wax before the piece is put into service. Liquid waxes are all right for maintenance, but the original protective coat should be paste wax.

Since the very dull oil finish, particularly on walnut, is so popular these days, you might like to know how this is done. It is very simple. Linseed oil is used, heated to improve penetration. The oil is brushed on, then allowed to stand for about 20 minutes, after which the excess is wiped off and the piece is allowed to stand overnight. The process is repeated about three times to complete the initial oiling. From then on re-oiling is needed only once in 3 to 6 months.

What with woods, hardware and other materials, joints, fastenings and finish, we have covered the more important elements that go into the making of a hi-fi cabinet as it comes to you for an installation. There is much more to this subject than could possibly be included in a single chapter. If you are interested in obtaining more information, the subject is treated much more thoroughly in a previous book *Hi-Fi Furniture*, by one of the present authors. This book is No. 79 in the Gernsback Library series.

# preparing cabinets for installation

**B**EFORE you put so much as a single cabling hole into a cabinet or other housing for the hi-fi components, there are a few things to be double-checked. It may sound silly, after all those cautions about measuring and fitting, but — will the components fit in the cabinet space?

This question is not nearly as ridiculous as it sounds, for a couple of things can happen to cause unhappy crowding or an outright impossible space problem. For one thing, people sometimes change their minds about components and order something that is physically bigger, *after* they've selected a cabinet big enough to hold everything they originally had in mind. Or they may even add another unit, without remembering that the cabinet ordered has no unallocated space left. Check to make *sure* everything will go in before you do anything to make an exchange for a larger-size cabinet impossible.

If the cabinet was made to order, perhaps to your own measurements, did the cabinetmaker misconstrue your figures, say taking inside measure (IM) as outside measure (OM)? If he did or you failed to indicate plainly inside or outside measurement, you may find yourself the not-very-proud owner of a cabinet you hadn't planned on buying. Again, before you cut any holes, make sure you can get everything into the furniture in a functional arrangement.

The main structural panels of almost all cabinets will be  $\frac{3}{4}$ -inch thick, very likely of a finish-veneered plywood. Any main horizontal or vertical partitions will also probably be of this thick-

ness (Fig. 1301). Any internal shelves for supporting tuners, amplifiers and such will probably be  $\frac{1}{2}$ -inch plywood (Fig. 1302), although the turntable or changer cutout board should be  $\frac{3}{4}$  inch. When you're sure there hasn't been a foulup in the size and

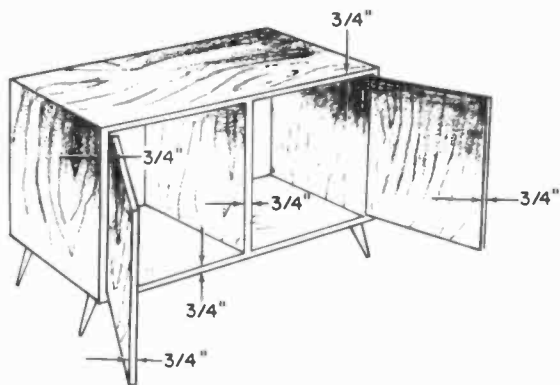

Fig. 1301. In good quality cabinets, the main structural panels should be of  $\frac{3}{4}$ " stock.

capacity of the cabinet or other enclosure, give it (or them) a very thorough inspection. It doesn't matter whether the cabinet is new or used, for equipment or speaker, nor whether it was originally built for hi-fi use or not; check it over carefully.

If it is a new cabinet, look for finish defects or evidence of transit damage, such as scratches, crushed corners, sprung joints or pressure marks. Check also the fit and smooth operation of moving parts such as doors, drawers, lids and all hardware.

In the case of a cabinet that you are supplying as part of the job, it is your responsibility to have any defects corrected. The manufacturer is responsible for any defects that existed when the piece left his plant but, as we have seen in Chapter 2, he is not generally responsible for transit damage, except when the merchandise is delivered by his own employees.

Where shipment and delivery were in the hands of a common carrier, the claim for damages is made against him and usually must be filed by you.

If a new cabinet was purchased by the client and turned over to you for installation, you have no responsibility whatever for any defects or damage occurring before it reached your hands. However, you do have a definite responsibility to report to him immediately anything that is wrong. You certainly don't want to be blamed for damage you didn't cause, and you will be, if you

don't start at an early date getting him interested in blaming somebody else.

A used cabinet should be gone over quite as thoroughly as a new one, if not more so. A used cabinet is bound to have some defects, so here you want to be particularly careful not to get blamed for any of them. Preferably, get the client to inspect the piece with you, list what you find and get him to initial the list. This way, if there is any question later on, you are protected.

On a used cabinet, you are looking for the same defects as on a new one, plus use and age defects. By use defects we mean such

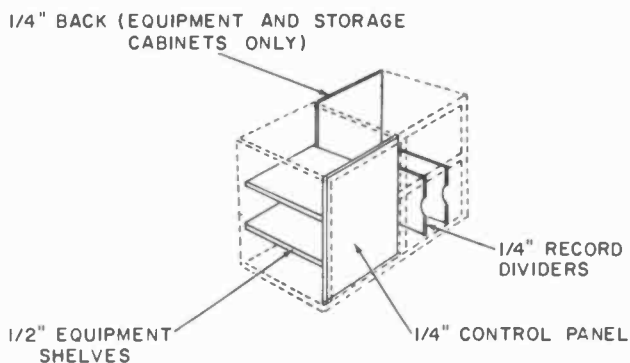

Fig. 1302. Cabinet panels that will normally be less than  $\frac{3}{4}$ " thick.

things as nicks and scratches, burns, water or beverage stains and damaged hardware. Age defects include loose joints, loose or blistered veneer, loose legs and cracked, crazed or alligatored finish.

Later on in this chapter we'll discuss various cabinet defects in more detail, explain which ones you can repair, which ones a professional should repair for you, and which ones justify discarding the cabinet entirely.

But first, let's look at the various cutting, fitting, altering and adapting operations that may be necessary to prepare a cabinet for an installation.

### Equipment cabinets

The first necessary step in connection with preparing an equipment cabinet is in making the cutouts. The control panel must be cut for the tuner or preamplifier controls, the mounting board must be cut for the record player, and you may need special holes for cabling and ventilation.

The handy-dandy tools you ought to have for these operations are a decent electric drill with an assortment of wood bits, and

some sort of a saber saw. If you want to do it the hard way, you can use a bit and brace for the holes, and a keyhole hand saw for the cutouts.

The type of bit to use in your electric drill, particularly for holes  $\frac{1}{2}$  inch in diameter and up, is the sort shown in Fig. 1303,



Fig. 1303. When drilling holes  $\frac{1}{2}$ " in diameter or larger, use a wood bit of this type. (Millers Falls Co.)

rather than regular twist drills. Twist drills will tear and splinter the back of the panel where the drill comes out a good deal more than a wood bit made with a rim cutter of one sort or another.

When drilling holes larger than  $\frac{1}{4}$  inch in diameter, always

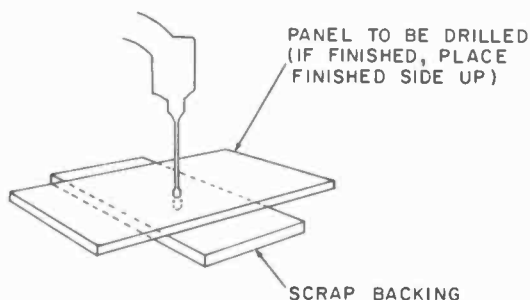

Fig. 1304. When drilling larger holes, always back up the work with scrap wood to reduce splintering on the other side.

back up the panel with a piece of scrap wood (Fig. 1304). This will greatly reduce the splintering of the back side of the piece being drilled.

If you must drill holes bigger than 1 inch in diameter, forget the bits and switch over to a hole saw or a fly cutter (Fig. 1305). You can make holes up to  $2\frac{1}{2}$  inches in diameter with a hole saw and up to 5 inches in diameter with a fly cutter, using nothing more than a  $\frac{1}{4}$ -inch electric drill, hand-held. We don't recommend this procedure however, if you can possibly mount the drill so you can use it like a drill press, or better yet, use an actual drill press for the job. With these devices, you'll get a much cleaner hole if you've a good, firm stationary mount for the drill that drives them.

When drilling holes in a finished panel, always drill with the finished side up so that, if there is any splintering where the drill goes through, it will be on the inside where it is not visible.

A variety of saber saws are on the market (Fig. 1306) but most of them have one thing in common. They cut on the "up" stroke.

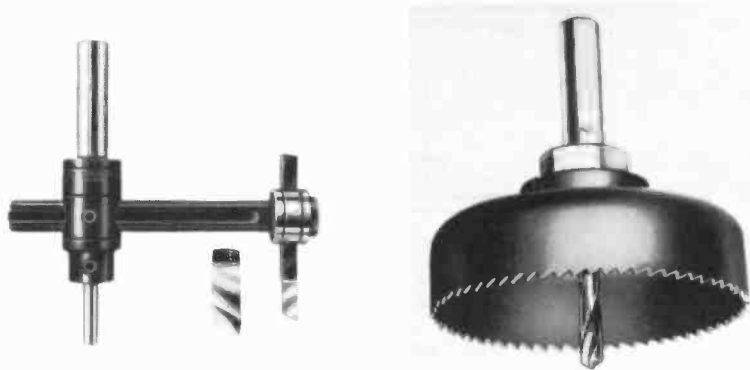

Fig. 1305. For extra-large holes, (a) an adjustable circle cutter or (b) a hole saw can be used. (The Stanley Works.)

This means that the face that is up when you are cutting is the face that will be subject to the most chipping and splintering.



Fig. 1306. A sabre saw is used for curved or irregular cuts such as turntable mounting boards, (see Fig. 1307). (Porter-Cable Machine Co.)

Therefore, whenever possible, try to keep the finished side *down* when doing a cutout with a saber saw, the *opposite* of the procedure recommended when drilling. And don't put the good face on a surface that will damage it while you're cutting it.



Did we mention that before you start to make a cutout you should remove the panel from the cabinet? Well, you should. It is very much easier to work on it, and we're firm believers in doing everything the easiest way possible. This is why we said in

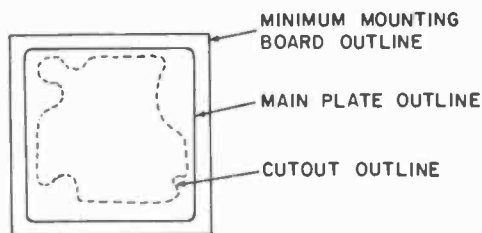

Fig. 1307. A typical record player template will show three outlines: (1) the outline of the minimum size for the mounting board, (2) outline of the record player main plate and (3) outline of the cutout to be made for the record player. Be sure you use the right outline for your cutout.

Chapter 12 that panels that will require cuts should never be glued into a cabinet, until they've *been* cut.

Unless you are going to mount a piece of equipment in some

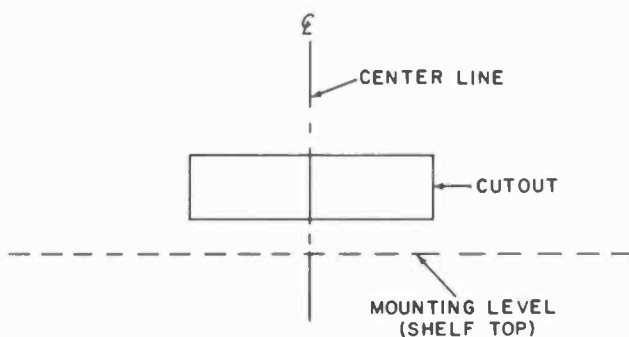

Fig. 1308. Typical tuner or amplifier template. The spacing between the mounting shelf and cutout is fairly critical.

manner other than that intended by the manufacturer, you won't have any problem of figuring out what and where to cut.

The maker almost always supplies a template that shows the size, shape and location of all necessary holes. Almost always these templates are full size, so you can just tape them to the panel and proceed.

Locating the template on the panel initially is the only thing that might give any trouble. Be sure to center the changer or turn-

table templates by the outline of the machine rather than by the outline of the cutout (Fig. 1307). With tuners or amplifiers, if you locate the line showing the mounting level correctly, everything else will fall into place (Fig. 1308).

Often, when tuner and preamplifier are stacked in the same compartment (Fig. 1309), it is necessary to insert a mounting shelf to hold whichever one is to be on top.

Plain old 1/2-inch fir plywood is excellent for this. The shelf is

Fig. 1309. When a separate tuner and amplifier are "stacked", it is best to insert a 1/2" plywood shelf to support the upper unit.

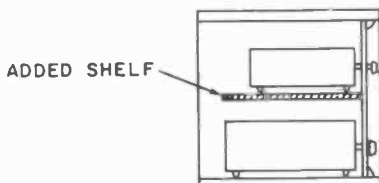

easily fixed in place by merely screwing a pair of 3/4-inch-square cleats to the sides of the cabinet. Just screw them in; *don't* glue them. If the components are ever changed, you might need to move the shelf up or down to accommodate the new parts.

If you have occasion to mount a record player drawer in a cabinet, the simplest and least expensive way to do it is to get one of the manufacturer's own bases for the machine, and mount it on a set of drawer slides. At times, the standard base won't fit, or you cannot get one in a color that is even remotely like what you need, so you'll have to make a drawer. This is very simple. All you need is a frame with a mounting board on top (Fig. 1310), which is in turn mounted on slides.

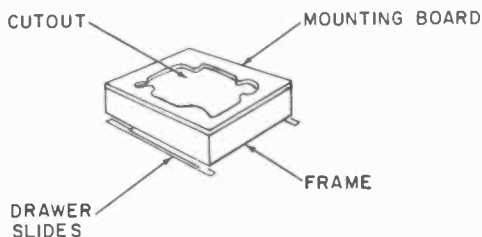

Fig. 1310. Complete record player mounting drawer. Slides can be mounted on sides or bottom, depending on cabinet design.

The chance that you will have to supply doors or lids for an installation is pretty slight, but what's worse is that you might be confronted with a cabinet like that in Fig. 1311. It is a perfectly good cabinet, but if it's to house hi-fi, it has to be completely

fitted out inside. This isn't as frightening a job as it might appear at first. This might be done in a number of ways, depending on the equipment involved.

Fig. 1312 shows the same cabinet with a horizontal shelf for mounting equipment, control panel and molding, record player drawer and storage compartment. Fig. 1313 is the plan for this alteration.

The first step is to take the back and the doors off the cabinet. You won't do any work on the doors, but it's better to take them

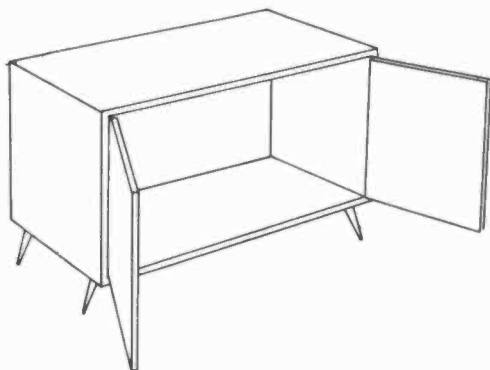

Fig. 1311. *Standard storage cabinet before fitting out for hi-fi equipment.*

off so they won't be flapping around in your way and get damaged while you are working. The back gets cut down to the height of what will be the top of the horizontal shelf. Now the shelf goes in and is secured with cleats to the sides of the cabinet. Note that

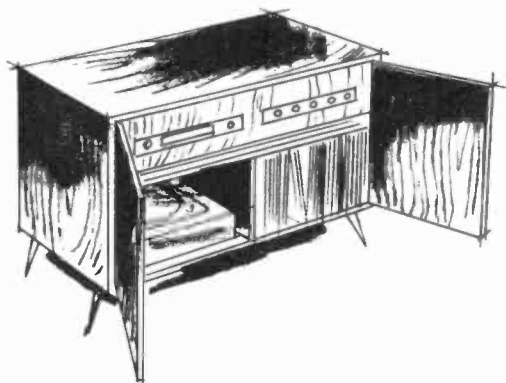

Fig. 1312. *Cabinet shown in Fig. 1311 now fitted out with hi-fi equipment.*

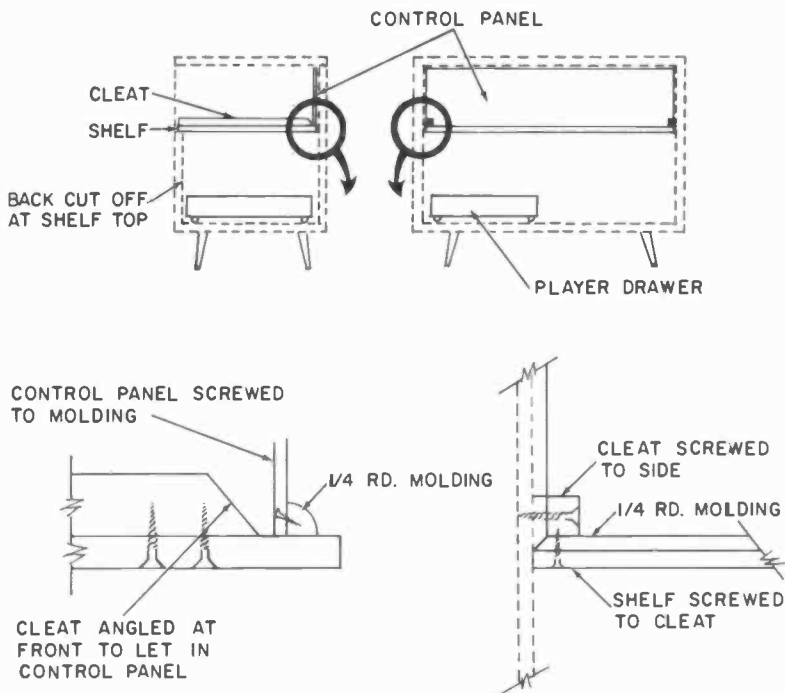

Fig. 1313. Details of alterations necessary to fit ordinary storage cabinet for use as hi-fi equipment cabinet.

the cleats are *above* the shelf. This is not the strongest way to mount the shelf, but it hides the cleats and, under average conditions, it will be plenty strong enough. If the equipment is so large that you won't have space enough for it between the cleats, you'll have to place the cleats under the shelf. But the idea is to hide them, if you *can*.

The molding around the inside front part of the upper compartment is installed to form a frame for the control panel. This molding is glued in, but the control panel isn't. Remember?

The record player drawer may be a standard manufacturer's base set on tracks, or you may make it up specially for the job as conditions dictate. You may or may not choose to separate the storage compartment from the player with a partition.

Apply a bit of finish to the front edge of the shelf, the molding and the control panel, and you're all set, except for reinstalling the back and the doors.

Be sure before you replace the back to make a hole behind the record player to pass the leads out. And don't be timid. Make that

hole big enough to pass the power cord *with its plug* attached. As long as you keep it low enough, it won't show from the front.

In nine out of ten such ordinary examples, you'll have provided adequate ventilation for the tuner and other components by merely leaving the back of the upper compartment open. But the tenth time, you may be working with equipment that runs a bit hot. If so, either cut a large rectangular hole in the shelf under each component or perforate the entire shelf with a series of 1½-inch round holes (Fig. 1314). This will allow air to circulate up from the compartment below, around the parts and out the back.

Ventilation is really quite simple in a free-standing cabinet where the back is not finished and goes against a wall. But if the back *is* to be finished and will be visible as in a room divider, it is another story.

Getting ventilating air *in* is not too difficult. You can usually bring it up from underneath the components through intake holes in the mounting shelf. The trick is to get it *out* again without making the back or the top look messy.

If the cabinet is high enough so that the top is above eye level, it's easy. Just cut an outlet slot in the top. This is *too* easy to happen often.

Usually the top is below eye level and visible. In that case, forget the top and concentrate on the back. Once in a while on a modern job, you can get away with a solid-color perforated masonite back. It should be mounted on a snap-in frame so that there'll be no screw heads left showing. But generally, the client won't go along with it anyway. The lady of the house will also greet a plain perforated or expanded metal grille without visible enthusiasm. You might evoke something closer to a smile with a snap-in frame covered with grille cloth and possibly a decorative metal grille on top of the cloth. Another possibility is a snap-in frame with louvers. This can be finished to match the rest of the cabinet, and can be a very satisfactory solution indeed.

Ventilation can raise problems in built-in installations also. Again, you're more likely to have trouble locating outlets than intakes. You'll still be able to cut intakes through the mounting shelf in most cases.

The outlets will depend on whether the installation is built against the wall and attached to it or sunk into the wall. If it is sunk in, try to arrange outlets into the air spaces between the wall studs. This isn't ideal but it's usually adequate, if you can screen the openings. Another way is to put a louvered area above the

equipment on the front as an outlet. Occasionally, a baby electric fan is needed in the equipment compartment to supply enough air circulation.

If the housing is built against the wall, louvers in front above the equipment are still good, or perhaps you can put louvers in a side and vent out that way.

With both types of built-in housings, you can often cut holes into compartments adjoining the equipment on one or both sides and help yourself somewhat this way.

With furniture-finished cabinets, it is a good idea to make a standard practice of lining the inside top and sides of compartments housing heat-producing units (like amplifiers) with thin

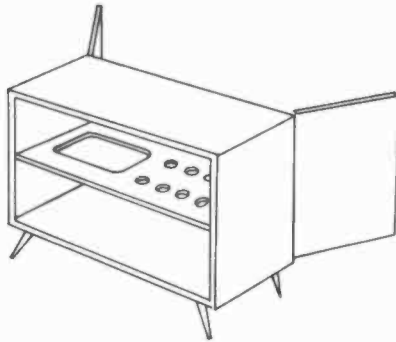

Fig. 1314. *Equipment mounting shelf with air intake holes.*

sheet asbestos or ordinary kitchen aluminum foil. Very often, the finish over and around tuner - amplifier compartments will discolor or crack long before the finish on the rest of the cabinet lets go. Lining the compartment inside will afford a sizable degree of protection.

Granted doing the actual work isn't quite as simple as reading these few paragraphs, but at the same time, it really is not beyond the capability of anyone with average coordination and a moderately firm intent to complete the job.

### **Speaker cabinets**

Cabinets that were manufactured as speaker enclosures will not require preparation prior to installation unless you plan to mount in them different sizes or numbers of speakers than the manufacturer intended. If so, you'll have to add adapter panels, or remove the baffle board, take off the grille cloth and recut to suit your requirements.

To recut the holes, your friend the saber saw comes in handy again. You might get hoodwinked into cutting a hole for a 15-inch speaker in  $\frac{3}{4}$ -inch plywood by hand with a keyhole saw once. You're not likely to let it happen a second time.

The only way you could get into any real work on a speaker cabinet would be if you have to adapt a cabinet that wasn't built for the purpose.

This kind of alteration is really much simpler than an equipment adaptation. When revising an existing cabinet into a speaker enclosure, stay with the principle of either an infinite or a reflex baffle. You are unlikely to make a successful horn out of something that wasn't meant for such use.

Fig. 1315 shows a common type of sliding-door storage cabinet and the same cabinet revised into a bass-reflex speaker enclosure. This revision is particularly simple since no new exposed wood is required, and therefore, no finishing is involved.

The plan for the job is shown in Fig. 1316. The step-by-step

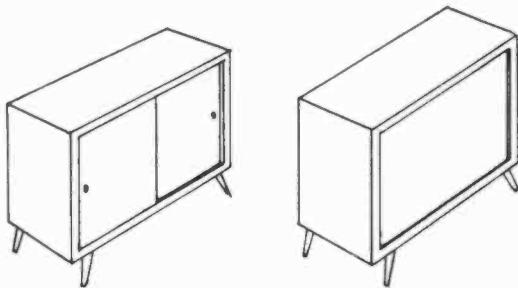

Fig. 1315. *Common type of sliding-door cabinet, and the same converted into a speaker cabinet.*

procedure is as follows: First, remove the doors and the back. Install the  $\frac{3}{4}$ -inch-square cleats all around the inside front and back, set in from the edges as shown to allow for the thickness of the front and back panels that will be screwed to them. Put in the four front-to-back corner reinforcing blocks with glue and screws. Cut the baffle board, stain the front black and staple the grille cloth in place.

The baffle board is installed by screwing through the front cleats from *inside*. This way the screw heads won't show.

Cut and fit the back, install by screwing to the back cleats, and you're all set.

Port size is determined on the basis of cubic volume of the particular enclosure and the resonance of the speaker. Tuning a

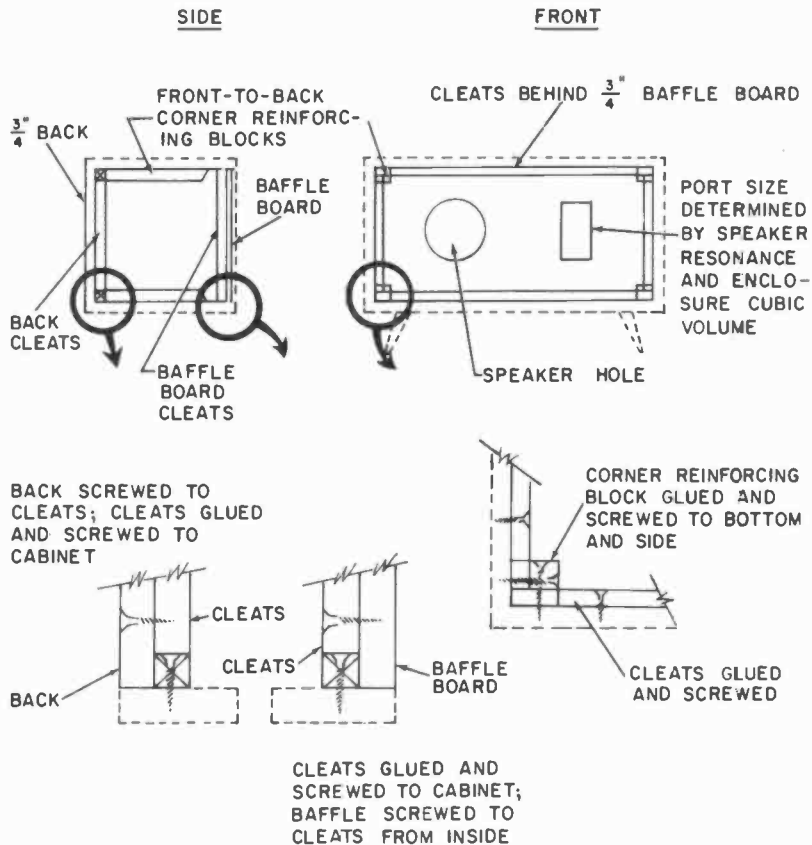

Fig. 1316. Details of conversion in Fig. 1315. New construction is shown with solid lines.

reflex cabinet *really* accurately becomes rather complex. However, by correct use of a chart (see Fig. 804), you can get pretty close, close enough for most purposes.

Compute as accurately as possible the internal cubic volume of the enclosure in cubic feet. Then find out from the manufacturer's specifications what the resonant frequency of the speaker should be.

On the chart in Fig. 804 (page 91) find the intersection of the cabinet volume with the resonant frequency. From here drop a vertical to the bottom of the chart, and you'll have the answer of the port area in square inches.

Note that speaker diameter has nothing to do with the case—only the speaker resonance is important.

The port shape doesn't seem to be at all critical, but generally



it is kept rectangular because this is the easiest way to figure the area accurately.

To make an infinite baffle out of the same enclosure, merely forget about the port entirely and thoroughly pad the whole interior.

In either case, some internal padding should be included. An infinite baffle is usually padded on all interior surfaces except the baffle board itself. The reflex would get padding on either top or bottom, one side and the back. We prefer Fiberglas blanket for this purpose, but other materials can be used.

A cabinet that is to house a large and powerful speaker, say 12 inches and up, should be braced or battened inside to reduce panel resonances. If the manufacturer left them out, you put

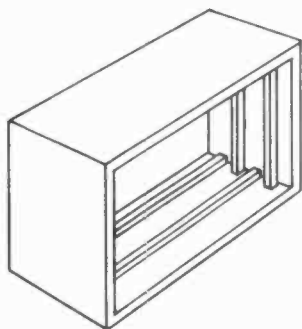

Fig. 1317. Add internal battens to large speaker enclosures to reduce panel resonances.

them in. They can be made of  $\frac{3}{4} \times 2$ -inch stock and should be edge-glued and screwed in place as in Fig. 1317. It is just as well if they are *not* evenly spaced.

With really large enclosures, 10 cubic feet and up, it is often desirable to cross-brace them inside with three 2 by 4's, top to bottom, side to side and front to back. The purpose is the same as battening to reduce panel resonances.

## Repairs

Since with a new cabinet either the manufacturer or the carrier is responsible for any damage or defect, let one of them correct it or pay for having it corrected by a professional.

A used cabinet is another story. Here, you can often pick up a few extra dollars by repairing an old veteran so it can be put back in service.

## Hardware

On used cabinets, it is commonplace to find loose, bent or broken hardware of some sort. The best thing to do with it is

throw it out and replace it with new hardware. Only in the case of genuine antique hardware that cannot be replaced nowadays should repairs be attempted. Such antiques can be fairly valuable so, if there is anything more than a mild bend to be repaired, give the job to a qualified metal worker. With all due respect to your own skill, you've a chance of hopelessly mangling the thing.

Loose hardware is a cinch. Probably all that has happened is that the screws holding it have stripped their threads in the wood. Take the screws out, fill the holes with plastic wood and redrive the screws just until the heads are flush. *Don't overdrive them!* Let the plastic wood harden thoroughly, and your hardware will be tight again.

### Loose or open joints

This kind of problem can arise either from simple failure of the glue line, or warpage in the panels resulting in enough strain

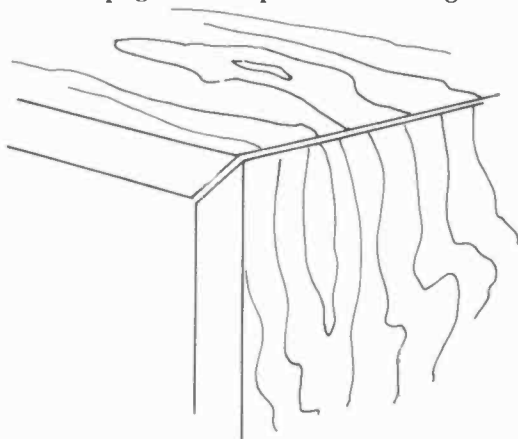

Fig. 1318. *Open joints can often be repaired successfully.*

to spring the joint open (Fig. 1318). To repair it, first scrape as much of the old glue out of the joint as possible, using a sharp thin-bladed knife. Squeeze new glue into the joint (a squeeze glue container helps), and apply plenty of pressure to hold the joint closed while the new glue hardens. The ideal way of applying this pressure is with cabinetmaker's pipe or bar clamps.

Here is a simple trick for applying very respectable pressure without them (Fig. 1319). Run a heavy rope around the cabinet. Place L-blocks and padding under where it touches the corners, otherwise you'll crush or mar them when you take up on it. Now slip a bar through the rope and start twisting it like a tourniquet.

You'll be pleasantly surprised at what a powerful squeeze you can get this way.

### Loose legs

Since a majority of legs these days are secured with hangar bolts to metal plates on the bottom of the cabinet, a good many cases of loose legs can readily be cured by merely twisting the leg tighter into the plate. Sometimes, though, the leg is loose because the hangar bolt has stripped its threads in the leg or the leg has split. The stripped thread can be repaired by taking the bolt out, inserting plastic wood, and running the bolt back in the same as for stripped screw threads. The split leg can be repaired with glue

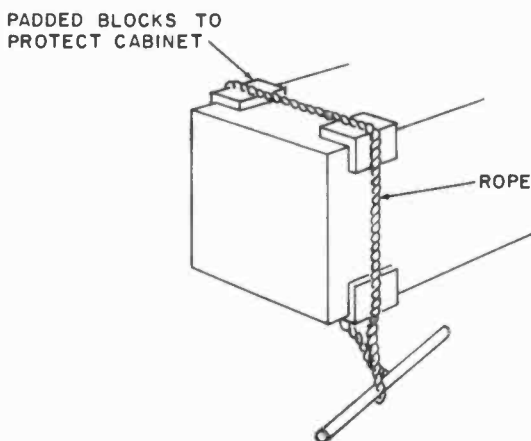

Fig. 1319. Rig for applying pressure to joints when no clamps are available.

and pressure, but in either case no repair is as good as replacing the leg. If you cannot find a leg that matches, this may mean replacing *all four* legs, but a set of legs isn't very expensive and then you'll have something you can rely on.

### Other structural defects

There are various other structural defects you might encounter in a cabinet, depending on the style and construction methods used. In styles where they are used you might find loose doweled or mortise-and-tenon joints. A molding could be loose or broken, a panel could be split, veneer can loosen and peel, and internal partitions can come unglued.

Nine out of ten of these miscellaneous ailments can be cured with glue and pressure. Often, a bit of retouching of the finish is needed afterward.

Remember always to scrape away the old glue when regluing anything that has let go. Don't use nails for repairs if you can possibly help it. They look bad, and they don't hold well anyway. If you have to use nails on a part that will be seen, be sure, at least, that they are finish nails (see Chapter 12). In places that are not seen, you can use screws to your heart's content or, if you're lazy, use anchor-fast nails — they'll hold just as well.

### **Finish retouching**

This isn't anything you're going to *want* to do, but it's a handy thing to be able to do. You can actually save yourself a tremendous amount of time and aggravation, not to mention expense, if you can take care of minor retouching jobs yourself. This will require a small kit of materials, and a bit of practice, but it is nothing to be afraid of.

A finishing material supplier can assemble for you a kit of the materials you'll need. Following is a list of things that ought to be included:

- Alcohol lamp and burn-in knife
- or
- Electric burn-in knife
- Stains (6 or 8 assorted colors)
- Shellac sticks (6 or 8 assorted colors)
- 4/0, 6/0, and 8/0 Garnet papers
- 6/0 steel wool
- Shellac
- Denatured alcohol
- Lacquer thinner
- Rubbing compound
- Linseed oil
- Powdered pumice
- Paste wax
- Soft rags and cheesecloth
- Small sable touchup brush

Perhaps this looks like a fair number of items, but they are all small. You don't need very much of any one thing. Transferring the liquids to 2- or 4-ounce medicine bottles that can be readily refilled will help to keep the whole kit down to a very modest size and weight for easy portability. Now, with a kit in hand, let's look at some of the more common finish defects and injuries to see what can be done about them.

### **Scratches**

You won't find a piece of furniture that has ever been used

without also finding some scratches on it. There may be only the fine hairline scratches that are the inevitable result of normal use, or there may be some fairly deep ones resulting from accidents or abuse.

The minor scratches can be quickly polished out with rubbing compound. It is amazing how tired a cabinet can look when there is nothing wrong with it beyond a multitude of little hairline scratches in the finish. And the extent to which a bit of rubbing compound can help you spruce it up in 15 minutes' time is even more amazing. Rubbing compound is for a gloss finish. For satin or dull finishes, use pumice and oil or 4/0 to 6/0 steel wool, depending on how dull you want the end result to be. These days the duller finishes are very much in favor, which is nice because they are lots easier to work with than gloss.

Really bad scratches won't come out with mere rubbing. They'll have to be French-polished and then rubbed. There are also commercially formulated scratch-fixing liquids available if you care to look into them.

### **Depression injuries (nicks, dents, scars, gouges, crushes, etc.)**

With these kinds of damage, the injured area has either been crushed in or some material has been torn out. However, they all have one thing in common: the injury lies below the level of the surrounding surface.

Either burning-in or French polishing will be required to fill the affected area back up even with the surface around it. But before this can be done, any splinters, chips of old finish or foreign material must be removed from the spot, and any exposed raw wood stained to match the surrounding color.

### **Burning-in**

Here is where shellac sticks are used with either the alcohol lamp and palette knife, or electric burn-in knife.

Heat the palette knife over the lamp until when you touch it to the shellac stick a bit of shellac will soften and come off on the knife. Knife the shellac into the hole to be filled and repeat the process, filling the hole a little at a time with shellac until you are back even with the surrounding surface. We're assuming you're using a shellac stick of an appropriate color for the job. That's why you've got an assortment of colors.

Once the hole is filled up, if the repair is a bit bumpy on top, you can smooth it off with the warm knife before giving it a little French polish and rubbing out to complete the repair.

## French polish

French polishing is a bit more tedious than burning-in, but sometimes it is preferable, particularly if the injury is wide and shallow rather than narrow and deep.

First, make a small pad of cheesecloth or gauze about  $1\frac{1}{2}$  inches square and about 20 layers thick. Wet it with white shellac so that it's soggy, but *not* dripping. Now pull the corners together to make a round-ended pad and apply a few drops of linseed oil. Rub the shellac into the damaged area with a brisk motion. Use very little pressure at first. In a few seconds, as the shellac starts to harden, gradually increase the pressure to about what you'd expect to apply when polishing hard wax. Keep rewetting the pad and repeating the process until you've built the shellac in the injured area up to the desired level. Now rub off with compound, pumice or steel wool, whichever will give you the right texture to match the surrounding surface, and you're through.

## Burns

Burns are really just another type of depression injury. The only difference is that there will be charred wood and blistered or discolored finish around them that must be scraped away before you can start repairing. This can be done with any small sharp knife. After all the charred material is scraped away, you'll have to decide whether to repair by burn-in or by French polish. A fair rule of thumb is that if the hole is  $\frac{1}{8}$  inch deep or less, use French polish, if deeper, do a burn-in.

## Cracked, crazed, or alligatored finish

These names describe the appearance of different kinds of overall deterioration of a finish. They each look a little different from one another and the causes differ, but to you they all mean the same thing. Hands off!

If you must handle one of these conditions on a commercial basis, call in a professional finisher. If it's something of your own that you want to fool around with, that's another story. An overall French polishing will help tremendously if the finish isn't entirely shot. Or you could try one of the commercial scratch-fixing preparations, followed by an overall French polish. Occasionally, a cracked or crazed finish will respond to nothing more than a good rubdown with linseed oil.

## Stains

The milky stains left in a finish by water or beverages can often

be removed by merely rubbing out with compound, pumice or steel wool, whichever is appropriate to the texture of the finish. If you don't get results pretty quickly this way, switch to chemical methods. Dampen a rag or pad very lightly with ammonia (or lacquer thinner for lacquer finishes) and brush it lightly and quickly over the stained area. If your pad is too wet or you're not quick enough, you could take the finish clean off the area, so be careful. If you *do* goof, you'll have to French polish the spot to get some finish back on it.

### **Refinishing**

This is another operation that you should not try to do yourself on a commercial job. Call in a professional.

Again, if it is personal, you can't get hurt if the results are bad, so go ahead if you want to.

Refinishing involves exactly the same steps that were taken in applying the original finish with one difference, and it is a big one. You've got to get the old finish off! This requires a liberal supply of paint remover and a good deal of careful scraping. Once the old finish is off, wash the piece down thoroughly with turps or benzine, and sandpaper it as if it were new.

From here on, use the same procedures as for a new piece. You can expect just as good results if you did a complete job getting the old finish off, *and* sanded down well afterward.

## structural factors

**Q**UESTIONS often arise relating to the structure of a building in which an installation is being made. Very often, they have little or nothing to do with electronics, yet must be answered if a satisfactory installation is to be completed. They usually fall into one of two categories: those relating to running the interconnecting wiring between the various units of the system; and those connected with the placement and physical mounting of the equipment.

The first category includes the physical routing of antenna transmission lines, remote speaker lines and signal lines to components separate from the main installation. If you must run leads through walls, floors or ceilings, it is well to know what your drill is heading into. You could heat a client to the boiling point pretty rapidly by boring a neat  $\frac{3}{8}$ -inch hole in a hot-water pipe or radiator steam line, and you'd give yourself a reasonably hot fist if you put the drill into a concealed ac power cable. By picking a bad spot for your hole, there is also the gloomy possibility that you'll be there till next Michaelmas trying to get through 6 inches of reinforced concrete with a steel I beam in the middle of it.

The second category includes those questions you'll need to answer if you're doing a built-in installation, whether it is to be sunk in or attached to the wall. Either way, you'll need a shrewd idea of how the wall is built and what is likely to be inside it, if anything.

Purely electronic questions such as hum pickup, electrical interference or undesired rf shielding due to the building are not the province of this chapter. Chapter 7 explains how to deal with them.



## Basic construction

A bewildering array of materials and methods is used in building construction today. If the basic construction principles used were actually as varied as external appearances suggest, the subject really *would* be a hopeless morass. But fortunately, this isn't so.

In spite of our vaunted technology we are still putting up most of our buildings on the basis of mechanical principles that have been in use for a very long time. In fact, if we keep at it long enough, we may even catch up with the ancients and figure out exactly how Maya architects cut hard rock so well without hard steel tools, or how the Arch of Ctesiphon was really built.

This is by way of encouraging you to look for basic similarities underlying surface variations. We'll discuss some of the constructions in common use today but, if you encounter one that doesn't seem to conform to any of them, look for it to be a variation or combination rather than something out of deep left field.

## Wood frame

In the country as a whole, there are more wood frame buildings standing than all other types of construction put together. The vast majority of private homes are built this way, and so are a good many smaller commercial and industrial structures.

Fig. 1401 shows one type of wood framing (a method called balloon framing) which is part of the framing for a two-story residence. There are several other ways of working out light wood framing, but they are sufficiently similar so that for our purposes this one will do to illustrate the group.

This frame starts with the sill which is laid level on top of the foundation, and bedded in cement. The corner posts and studs rest on the sill and support the plate that runs horizontally across their tops. This plate in turn supports the roof beams or *rafters*. The floor beams or joists for the ground floor also rest on the sill while the joists for upper floors are held on girts or ribbons that are carried on or attached to the studs.

Do you see these short pieces labeled firestop wiggling along more or less horizontally between the studs? If the void in the wall between studs isn't filled with insulation, they'll be there. Their name explains their purpose, but to you they mean that you cannot fish cables inside the wall from ceiling to floor because they'll be in the way, unless the wall hasn't been closed yet. In that case, you can readily drill through them. Fishing leads laterally between wall surfaces is obviously also out of the question once the walls are closed, because of the studs.

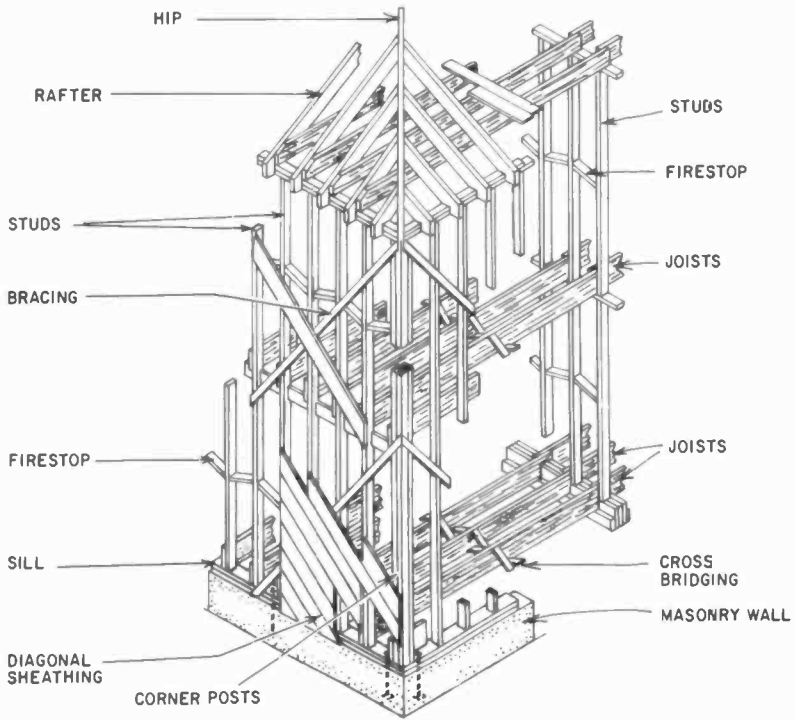
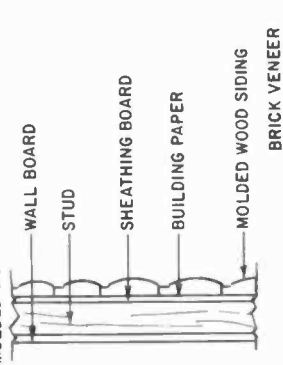

Fig. 1401. Balloon framing, one of several similar types of light wood framing for residential and small commercial structures. (Architectural Graphic Standards.)

Note that the floor beams or joists run the same way on the upper floor as on the ground floor. This means that if you need to know which way they run upstairs, you can look in the basement or crawl space under the ground floor to find out. The joists of upper floors will of course be hidden from direct view by the ceilings under them.

Both the exterior and interior finish of wood-frame walls can be treated in a variety of ways. Fig. 1402 shows a few. It makes very little difference whether the exterior walls are finished in shingle, siding, paneling, brick veneer or what have you. The only types you need to give second thought to are straight stucco and stucco with half timbers. In such cases, the stucco *may* be on metal lath. The lath could constitute quite an effective shield even though the frame is wood. If so, it may be necessary to give the tuner an outside antenna.

In this type of construction, metal lath under the plaster of



WALL BOARD  
STUD  
SHEATHING BOARD  
BUILDING PAPER  
MOLDED WOOD SIDING  
BRICK VENEER

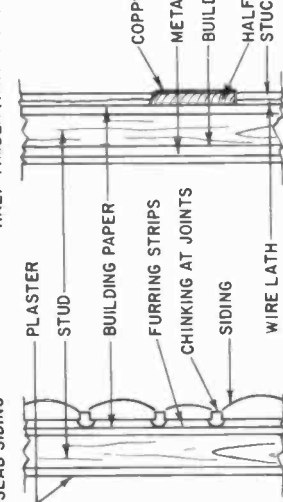

PLASTER  
STUD  
BUILDING PAPER  
FURRING STRIPS  
CHINKING AT JOINTS  
SIDING  
WIRE LATH

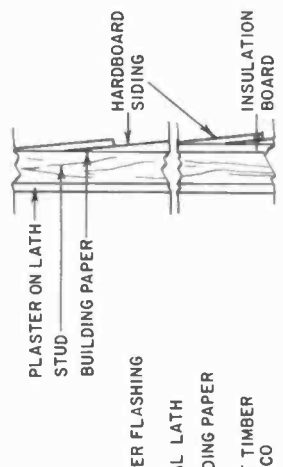

PLASTER ON LATH  
STUD  
BUILDING PAPER  
HARDBOARD SIDING  
INSULATION BOARD

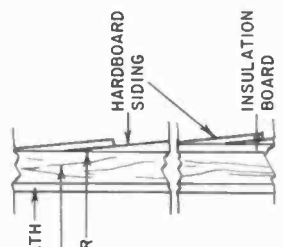

PLASTER ON LATH  
STUD  
BUILDING PAPER  
HARDBOARD SIDING  
INSULATION BOARD

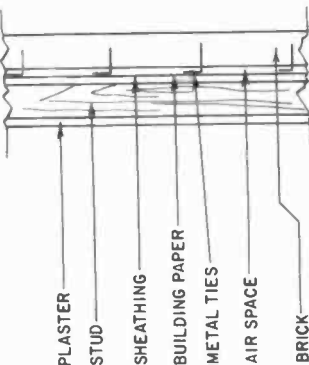

PLASTER  
STUD  
SHEATHING  
BUILDING PAPER  
METAL TIES  
AIR SPACE  
BRICK

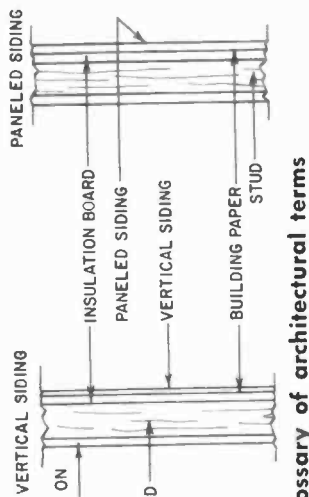

INSULATION BOARD  
PANELED SIDING  
VERTICAL SIDING  
BUILDING PAPER  
STUD

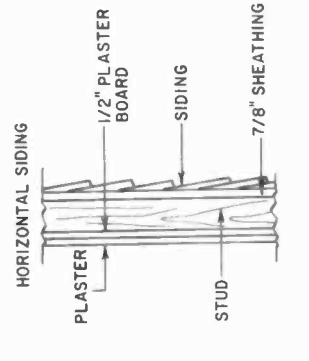

PLASTER  
STUD  
1/2" PLASTER BOARD  
SIDING  
7/8" SHEATHING

## glossary of architectural terms

**Anchor:** metallic belt built into masonry to hold facing materials  
**Blocking:** fit with or mounted on blocks  
**Bracing:** collection of timbers, metals, etc., used to support portions of the framework  
**Casement:** hinged window sash  
**Flashing:** sheet metal coverings protecting joints and junctions of roofs with walls or chimneys  
**Furring:** thin strips of board that provide level lathing or plastering surface  
**Header (or header block):** brick or building stone positioned lengthwise across a wall

**Hip:** line of juncture of two sloping roof sides  
**Jamb:** vertical framework members of door or window  
**Joist:** main timbers that form a base for fastening floorboards and laths  
**Lath:** thin, narrow wood strips used as a basis for plastering  
**Lintel:** horizontal piece laid across the top of door or window jombs  
**Masonry:** stonework  
**Mullion:** wood or metal, vertical separating strip between the panes of a window  
**Rafter:** supporting timber holding roof covering

**Sheathing:** covering or outer layer of metal, wood or other material  
**Shingles:** overlapping thin pieces of wood, asbestos, etc. used for covering roofs and sides of houses  
**Siding:** boarding, metal, or composition forming the sides of a timber building  
**Sill:** horizontal piece of member beneath a window, door, or other opening  
**Stool:** window sill  
**Stud:** vertical supporting timber in building walls  
**Veneer:** thin sheet or layer of fine-grade covering material

◀ Fig. 1402. Various typical interior and exterior finishes for wood-frame walls. Any interior can be used with any of the exteriors. (Architectural Graphic Standards.)

interior walls is not common, but on occasion it is used. So it is possible you could have a wood frame with wood exterior finish and *still* have metal lath in the wall under the interior plaster causing rf shielding. An outdoor antenna is again a possible requirement, particularly for FM or TV reception at medium or greater distances from the transmitter.

### Plank and beam construction

A relatively recent development in small-home building is plank and beam construction. This method substitutes a few large structural members in place of the many small members used in conventional wood framing. The sheathing, roofing, and flooring boards are beefed up so that they really become structural members. Fig. 1403 shows a comparison between plank and beam

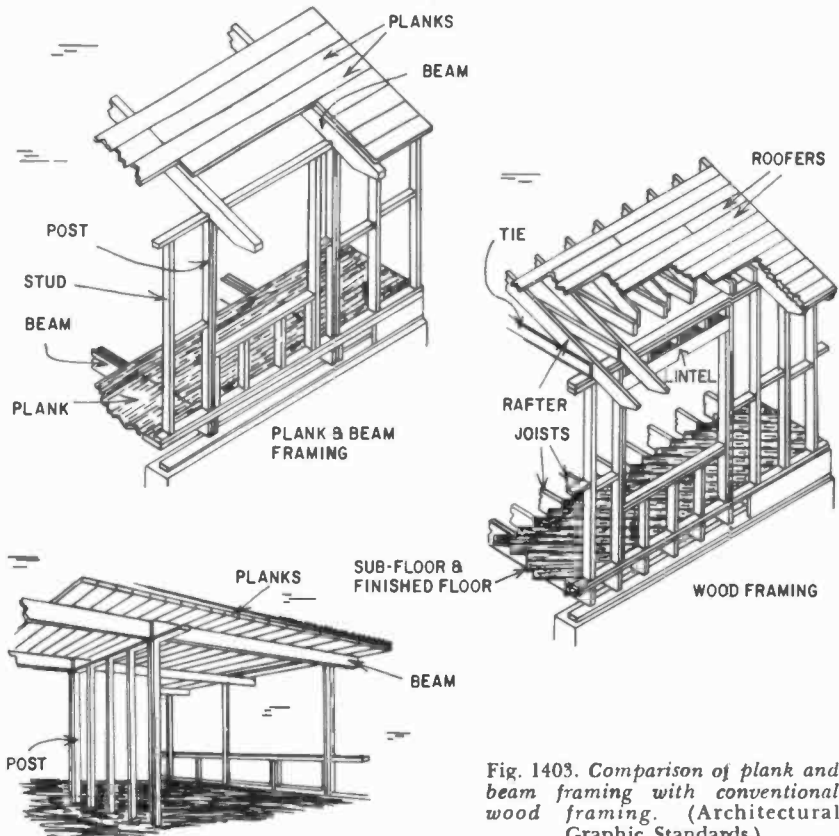

Fig. 1403. Comparison of plank and beam framing with conventional wood framing. (Architectural Graphic Standards.)

framing and conventional wood framing. Due to the smaller number of parts required, the assembly time needed on the job can be cut down, reducing labor costs and the bad-weather hazard. Interior finishing labor can also be reduced, giving additional savings.

Take note in Fig. 1403 of how the window opening is framed in each case. If you have occasion to sink built-in installation into a wood-frame wall or partition, you should frame in the area to be occupied by the system just the same as if it were a window area, as shown. This way, you don't destroy the structural integrity of the wall, and at the same time you provide yourself with a frame within which the construction necessary to house the equipment can be secured.

If you need to secure something to a wood-frame wall, the most positive method is to drive good hefty wood screws into the studs. The problem is to find the studs! Normal spacing is 16 inches center-to-center, so try this first. Measure out from a corner 16 inches. Tap the wall with a padded hammer, and somewhere between 16 and 17 inches you should be over the center of the first stud. You should get a fairly solid thunk when you're on it, and more of a hollow boom when you're off it. Tap a few inches off on either side of where the stud ought to be, then tap for the stud. If there is a definite difference in sound, you're probably on it. But, to be sure, test by running a very small drill in where you think you've spotted the stud. If it goes in more than an inch and still seems to be in something solid — you're okay.

If you can't find anything at or near 16 inches, you must have some nonstandard spacing on your hands, so start at 12 inches from the corner, and tap your way out to 24 inches. It's *got* to be somewhere in there.

When the first stud is about 16 inches, the rest will conform. But if the first one was not 16 inches, check carefully for the second one. If the second one is 16 inches from the first, the odd ball was just at the end. When the second one isn't spaced 16 inches, but matches the first, that spacing probably remains uniform. However, don't trust it. Tap for every stud you need to find.

### **Masonry construction**

In a general way, masonry construction covers the use of such familiar materials as brick, stone and the various kinds of building blocks: concrete block, clay tile, and gypsum or cinder blocks. In some cases, masonry walls are homogeneous; that is, one material only is used, while at other times two materials are sandwiched

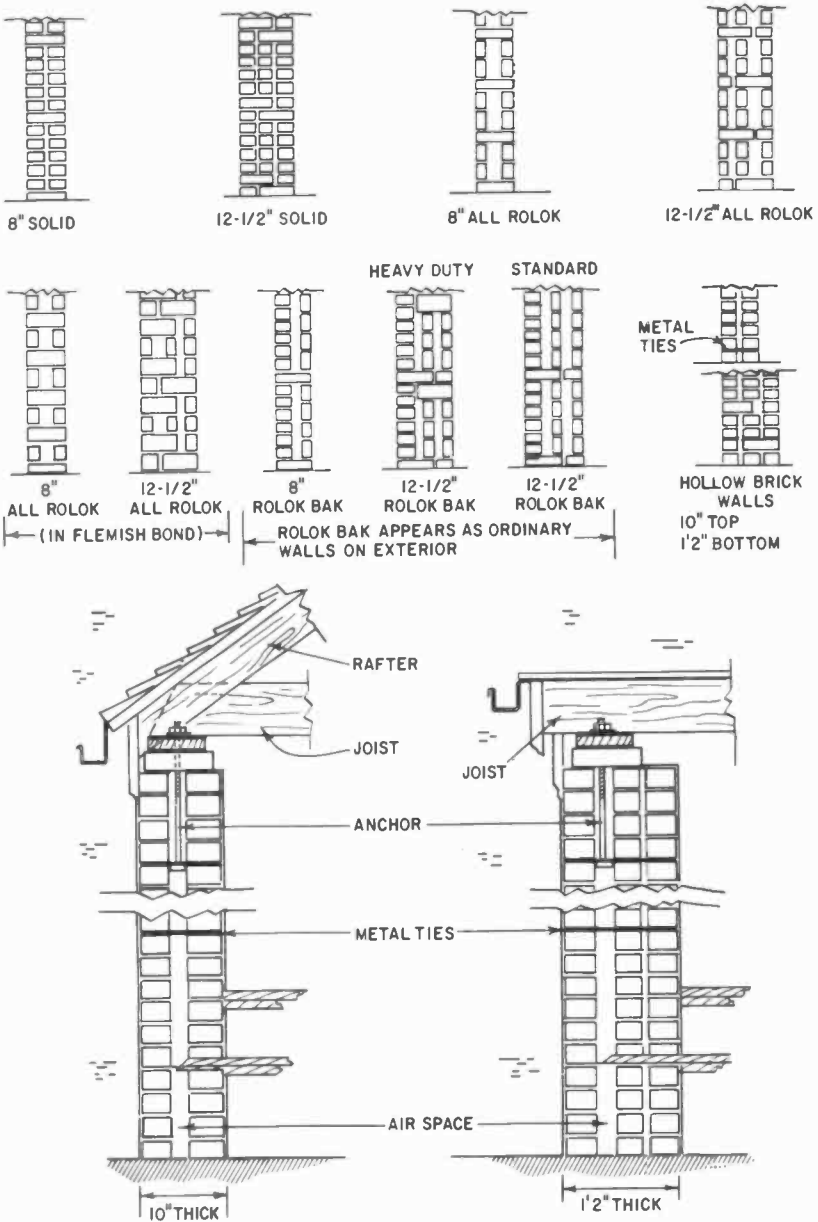

Fig. 1404. Various types of solid and hollow brick wall constructions. (Architectural Graphic Standards.)

together to make up the full thickness of the wall.

In Fig. 1402, we have already seen one example of such a sandwich in the use of brick veneer on a wood-frame wall. This brick-

work is certainly masonry, regardless of the fact that it is a surface veneer on top of a wood-frame construction.

The difference is that in a construction that is entirely masonry, there is no wood frame in the walls. Fig. 1404 shows cross sections through several types of walls made entirely of brick. Note that some are solid and others hollow. If there is a way of telling by surface inspection whether the inside of a brick wall is solid or hollow, we haven't heard of it. To you it doesn't matter anyway. You're not going to fish lines through the inside of the wall, even

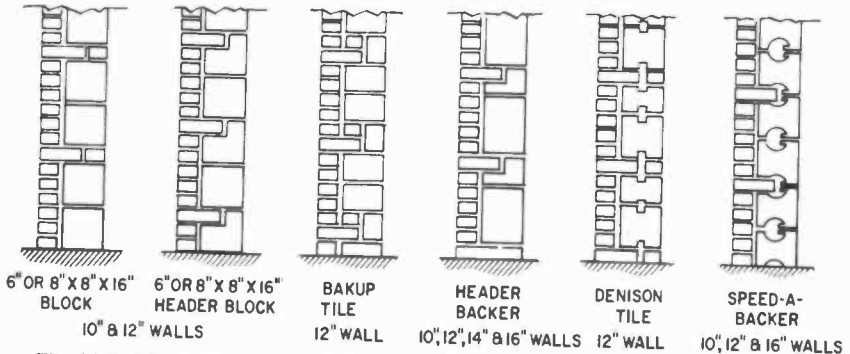

Fig. 1405. Walls utilizing brick backed with concrete block or clay tile. (Architectural Graphic Standards.)

if it is hollow. And if you are thinking of piercing a hole of any size bigger than perhaps 1 inch through a brick wall, it can sometimes be done, but call in an architect or a structural engineer to work it out for you. Do *not* attempt to work it out yourself!

If you have occasion to hang something fairly heavy on an all-brick wall, or merely wish to attach a built-in unit to such a wall, you'll do well to use some type of expansion plug. Toggle bolts are not a good idea because, even if you know the wall is of hollow construction, you can't tell when you'll hit the hollow and when you'll hit a bonding course from the other side.

While brick can be used by itself to form a wall, it is often used in combination with concrete blocks or clay tiles. Fig. 1405 shows cross-sections of some of the various constructions possible. If you can just manage to find out which material was used for the backing blocks (concrete or clay), then the actual internal configuration won't matter for your purposes.

In concrete blocks, expansion plugs will hold perfectly well, so you needn't waste time and effort poking about to locate the voids in them. But you'll do well to avoid expansion anchors and to use toggle bolts in clay tiles. And take care to load the toggle bolts

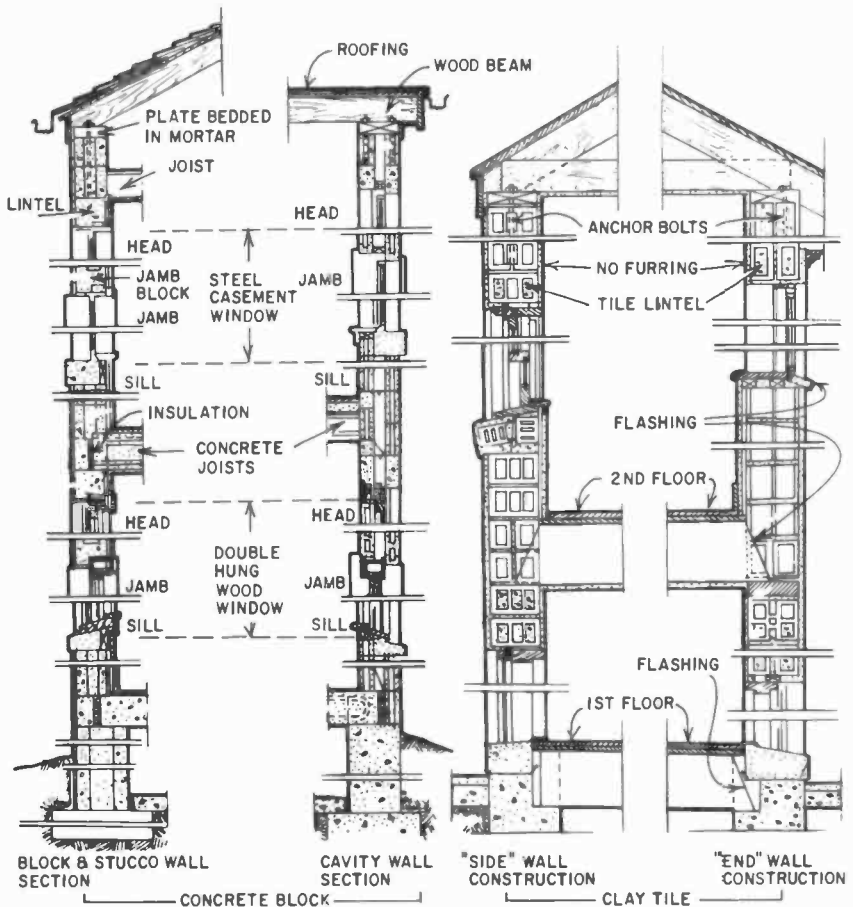

Fig. 1406. Typical sections of concrete block and structural clay tile walls. (Architectural Graphic Standards.)

rather lightly. Clay tiles are designed to stand up under the kind of compression loading they get as a part of the wall, but not much of the kind of lateral pull they'll get from a toggle bolt.

Concrete block or clay tile can perfectly well be used by themselves without brick facing. Fig. 1406 shows sections of such walls. They will often carry an exterior coat of stucco for appearance.

Obviously the absence of the exterior layer of brick is not going to change the fastening considerations regarding these walls one bit.

In combination walls of brick with block or tile and in walls of block or tile alone, observe the same caution about piercing large holes as you would in an all-brick wall. Get an architect or an engineer to plan the job.



Probably the first type of construction to come to mind at the mention of the word masonry is stone. Like brick, stone is sometimes used alone to form a wall, and at other times either as a

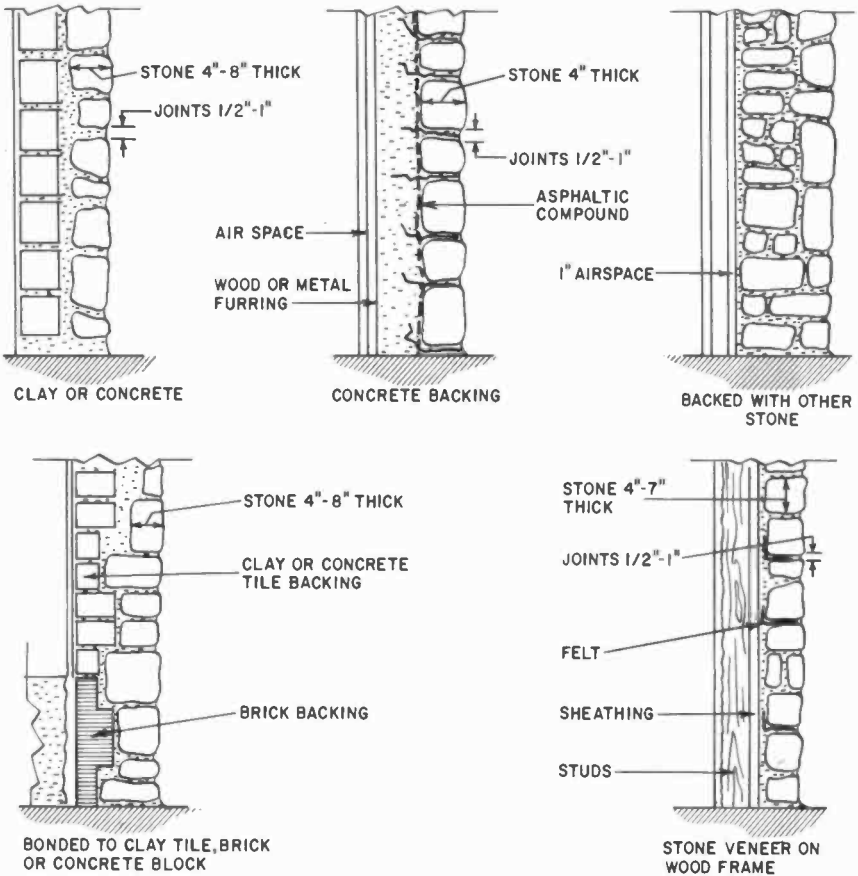

Fig. 1407. Common methods of using stone. (Architectural Graphic Standards.)

veneer over wood-frame construction or in combination with concrete block or clay tile. Fig. 1407 shows some of the ways stone can be used.

When you do run into stone work, it isn't going to change your life any. Most of what you have to do with a wall is related to the backing, and the majority of the stone you'll encounter will be backed with either wood frame, clay tile or concrete block. You know how to deal with them.

If you do have to attach something directly to stone, use expansion plugs the same as for brick, but be prepared to have a

harder time making holes for the expansion anchors in stone. At times you'll run into some brutally hard stone. Then the carbide drill turned by a powerful, *slow-speed* hand drill is the installer's

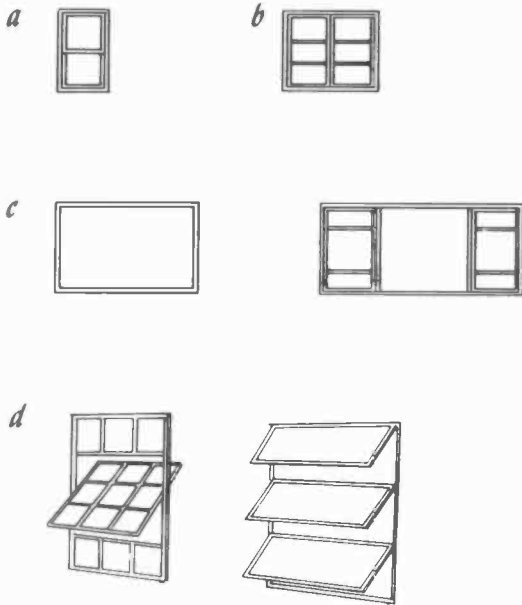

Fig. 1408. Common window types: (a) sash, (b) casement, (c) picture and picture with side casements and (d) projected and awning.

best friend. (And give it *heavy* feed pressure.) Or you may find it expedient to put the holes for the anchors in the mortar *between* stones wherever possible.

### Steel frame

Nowadays if a building is planned to be of really significant size, only two methods of holding it up are worth serious consideration. One of these is steel-frame construction.

You've doubtless seen the bare steel frames of office buildings under construction, at least from a distance. If you examined a number of them closely, you'd see wide variations in the structure of the members forming the frame, but the underlying principle remains the same. The entire weight of the building and its contents is carried by the structural steel. This takes a good deal of steel, and steel is frequently an *rf* shield. The frame in itself might not be too bad, but by the time steel floor beams, studs and

metal lath have been added, the shielding can become pretty complete. Add exterior curtain walls of aluminum paneling, and you have a pretty good screened room. The only real solution is an outdoor antenna, which may present difficulties in a large apartment building.

### Reinforced concrete

Here again, as with steel framing, the structural details can vary quite widely, but the basic method remains the same. A

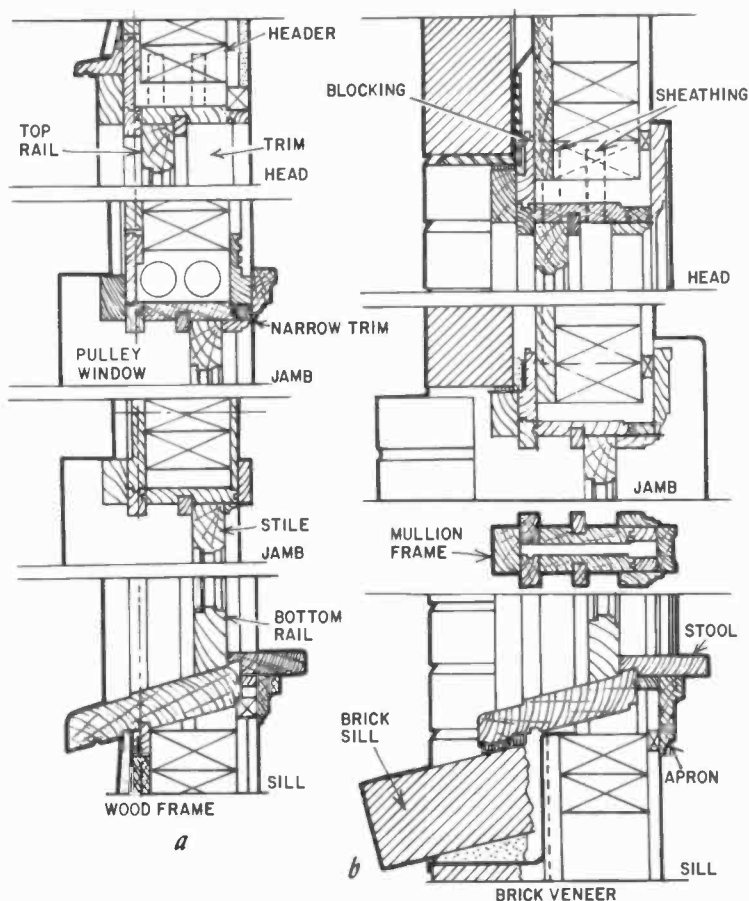

Fig. 1409. Installation details for double-hung wood sash windows in (a) wood frame and (b) brick veneer. (Architectural Graphic Standards.)

series of reinforced concrete columns support each floor, which is, in turn, essentially a continuous reinforced concrete slab.

Variations in size and placement patterns of the reinforcing bars depend on the sizes, uses and expected stresses.

In any event, it's also possible in this kind of construction to encounter shielding problems. The outside antenna is again likely to be required.

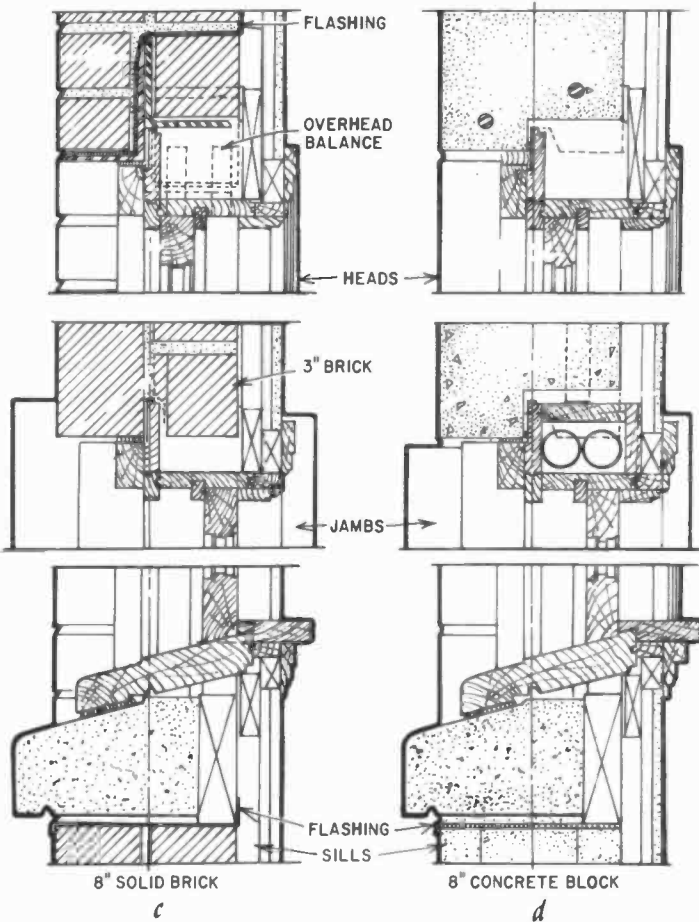

Fig. 1409. (continued) Details of double-hung wood-sash windows (c) solid brick and (d) concrete block. (Architectural Graphic Standards.)

### Typical construction details

Regardless of how a building is built, it must have doors and windows, floors and interior partitions. These are things you'll have to work through and around in installation work, so we'd better see how these things are normally handled.

## Windows

The basic types of windows are: first (and most common), *double-hung sash*; second, *casement*; third, *single- or double-glass picture*; and fourth, *projected or awning* types (Fig. 1408). The old type that swings horizontally on a center pivot and the sliding types are so uncommon they are hardly worth mentioning.

All the common types are available in three materials: wood, aluminum and steel. And any of them can be mounted in any of the constructions we have discussed; wood frame, masonry, steel frame or reinforced concrete. In practice, wood windows are

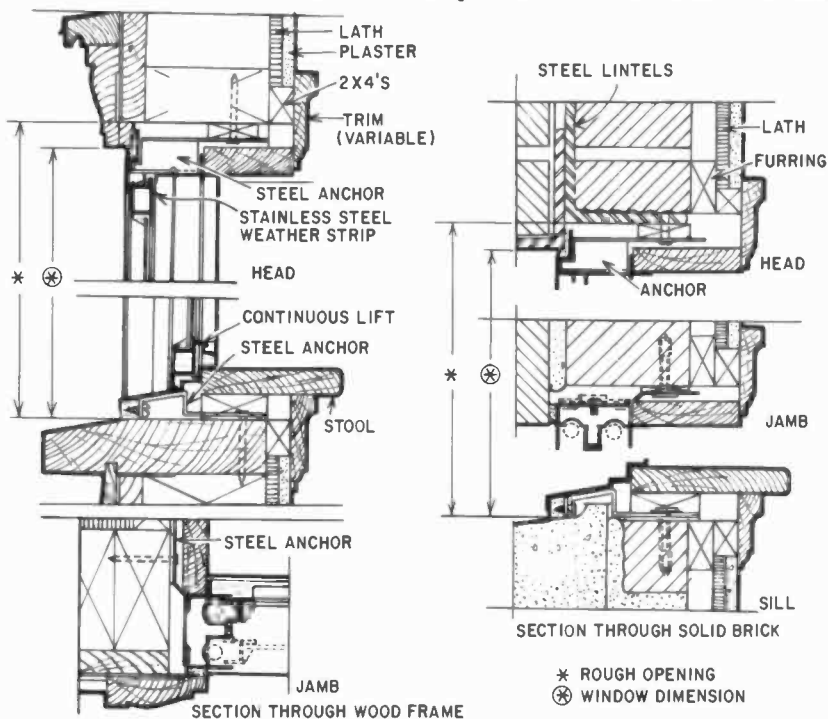

Fig. 1410. Aluminum double-hung sash windows in wood-frame and brick constructions. (Architectural Graphic Standards.)

seldom used in steel-frame or concrete buildings. Steel sash windows are not as common as wood or aluminum ones.

Fig. 1409 shows details for double-hung wood sash windows in wood frame, brick-veneer, solid-brick and concrete-block constructions. Fig. 1410 shows aluminum double-hung sashes in wood frame and brick.

Fig. 1411 shows a wood casement in wood frame, and an aluminum casement in brick.

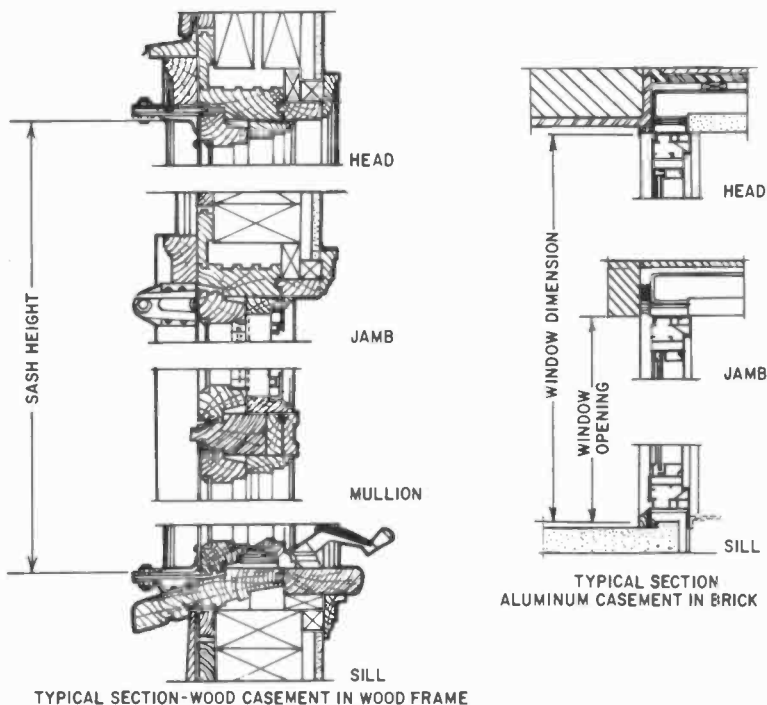

Fig. 1411. Wood casement window in wood-frame construction and aluminum casement in brick construction. (Architectural Graphic Standards.)

Fig. 1412 shows steel casement used in various ways. There is neither space nor need to illustrate all the possible permutations and combinations you may encounter. From the viewpoint of installation work, a window is an opening in the structure of a wall that you may use to get through to the outside with a transmission line. The window details shown will cover the vast majority of those you'll see.

To make a hole for leads through the apron from the inside, start it just under the stool, and aim to come out just under the sill on the outside by angling your drill somewhere between  $10^\circ$  and  $15^\circ$  (Fig. 1413). The hole should always be angled down as it goes out to prevent water entering from outside through it. After the leads have been run through, caulk the outside end of the hole as an additional precaution.

As you can readily see from the window-sill details, not all windows will permit you to do this. That's why we've shown so many. If you can't get the hole through properly, don't put it through at all. Either open the window and lay in a piece of flat

lead on which the window can close or, if this won't work, get outdoors somewhere else entirely.

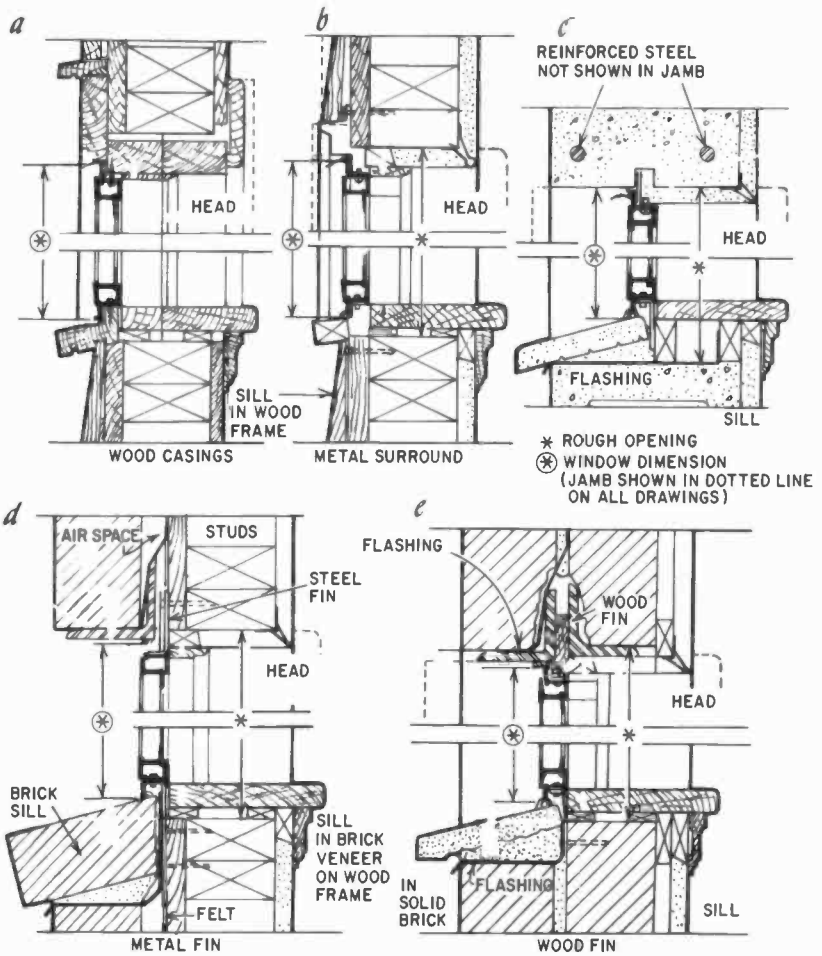

Fig. 1412. Steel casement windows: (a and b) wood frame construction, (c) concrete block or structural tile construction, (d) brick veneer on wood frame and (e) solid brick construction. (Architectural Graphic Standards.)

## Doors

In installation work, a door is usually a nuisance around which you have to run a wire. Fig. 1414 shows a detail of a typical interior door and frame. For our purposes, exterior doors are essentially similar.

If a door has wood trim, there is no problem getting a line around it by running up one side of the trim, across the top and down the other side. But if you've metal trim or no trim or

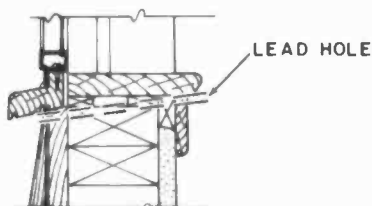

Fig. 1413. Section of window sill showing hole for leads in dashed lines. (Architectural Graphic Standards.)

madam considers a line up, across and down unsightly, there is another way. You can run the line straight across the bottom of the door opening. Unfortunately, this is usually done by the lazy method of stapling it alongside the door saddle. We consider this method dangerous, and therefore unsatisfactory. The door saddle should properly be removed, grooved to accommodate the line, and replaced with the line passing under it and thus covered.

A line stapled right alongside a door saddle does get *some* protection but, if you think about it for a moment, you'll agree it's

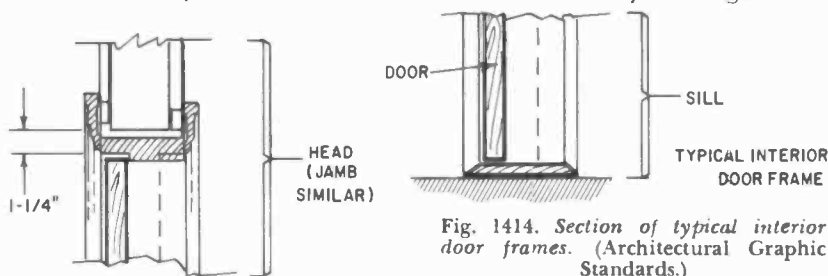

Fig. 1414. Section of typical interior door frames. (Architectural Graphic Standards.)

really not much, certainly not enough for a permanent installation.

### Interior partitions

The interior partitions in wood-frame structures are pretty sure to be wood-frame construction also. Stud spacing will be the same as for exterior walls, normally 16 inches on centers. Fig. 1402, showing cross-sections of frame walls, gives a variety of interior finishes as well as exterior. Either one or both sides of an interior partition wall may be finished in any of the various ways shown.

To attach something to such a wall, follow the same procedure as for attaching to an exterior frame wall. If you make an opening in which to flush-mount something, be sure you plan to frame it in with a header and sill just as if it were a window opening in an exterior wall. And check where the power wiring and plumbing seem to be going, before you decide finally on the location and size of the opening.

Wood-frame partitions will be found not only in wood-frame



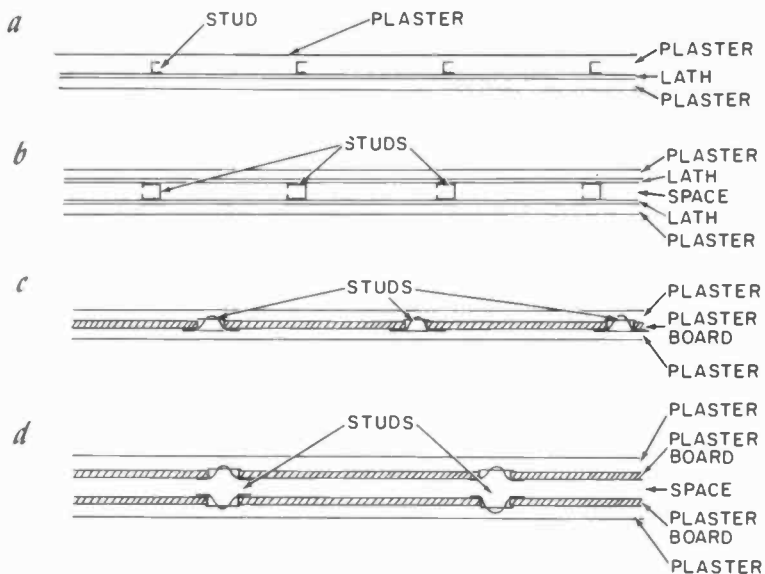

Fig. 1415. Interior partitions: (a) solid with metal studs and lath, (b) hollow with metal studs and lath, (c) solid with metal studs and plasterboard and (d) hollow with metal studs and plasterboard.

buildings, but also in a good many masonry structures: brick, concrete block and so on. The obvious reason is that they are cheaper and easier to put up than masonry partitions.

Where masonry interior partitions are used, they will be made of light building blocks: concrete, cinder or clay tile. Brick is very seldom used for this purpose.

Outside of the fact that masonry interior partitions are generally made of thinner blocks than are exterior walls, both masonry and wood-frame partitions are constructed in basically the same way as exterior walls. But there are several types of metal-stud and metal-lath partitions in use that do not resemble any type of exterior wall.

Fig. 1415 shows four of them. In Figs. 1415-a and -c, the solid types, are essentially similar to each other, as are -b and -d, the hollow ones. Methods for attaching to such partitions are obvious: in solid walls, use expansion plugs; in hollow types, use toggle bolts. If you want to hang a cabinet completely unsupported except by the wall on any of these types of partitions, don't do it unless all you are hanging is one of the little half-pint speaker systems. These partitions won't take much of this kind of load. Not that they'll fall down, but they won't hold fastenings as well as some of the other types.

# Other GERNSBACK LIBRARY Books

- 44—BASIC RADIO COURSE. Describes the action of radio circuits in a quick-to-grasp manner. Hard cover. 176 pages. \$2.25
- 45—RADIO TUBE FUNDAMENTALS. The first low-priced book to give a complete understanding of radio tubes. 96 pages. \$1.00
- 47—RADIO & TV HINTS. Hundreds of short-cuts. The hints and kinks in this book are practical, and can be put to work by you. 112 pages. \$1.00
- 48—HIGH FIDELITY. Audio design, construction, measurement, techniques. Complete section on building amplifiers. 128 pages. \$1.50
- 49—RADIO AND TV TEST INSTRUMENTS. Build CRT circuit analyzer, CRT tester, 3 inch scope, portable marker generator, etc. 128 pages. \$1.50
- 50—TV REPAIR TECHNIQUES. Service TV in the home; high-voltage troubles, CRT circuit difficulties, TVI, intercarrier buzz, etc. 128 pages. \$1.50
- 52—THE OSCILLOSCOPE. Waveforms, sweep systems, typical scopes, alignment techniques, tests, measurements, experiments. 192 pages. \$2.25
- 53—RADIO-CONTROL HANDBOOK. Radio control for planes, boats, trucks, tractors, etc. Practical construction ideas. 192 pages. \$2.25
- 54—PROBES. Crystal-demodulator, voltage-doubler, low capacitance, high-voltage, isolation, transistorized and direct probes. 224 pages. \$2.50
- 55—SWEEP & MARKER GENERATORS FOR TV and Radio. Complete theory and use of sweep and marker generators. 224 pages. \$2.50
- 56—HIGH FIDELITY CIRCUIT DESIGN. Feedback, drivers, inverters, attenuators, equalizers, speaker systems. Hard cover. 304 pages. \$5.95
- 57—The V.T.V.M. Supplies full information on the theory and practical operation of the vacuum-tube voltmeter. 224 pages. \$2.50
- 58—MAINTAINING HI-FI EQUIPMENT. Instruments; circuits; diagnosis; distortion; pickups; turntables; equalizers; tuners. 224 pages. \$2.90
- 59—SERVICING RECORD CHANGERS. Detailed drawings show how to make repairs. Full servicing information. 224 pages. \$2.90
- 60—RAPID TV REPAIR. Alphabetical listing of hundreds of TV troubles — symptoms and specific information on repair. 224 pages. \$2.90
- 61—TRANSISTOR TECHNIQUES. How to work with and test transistors; measurements; practical building projects. 96 pages. \$1.50
- 62—TV—IT'S A CINCH! Snappy conversational style with hundreds and hundreds of drawings helps you breeze through TV. 224 pages. \$2.90
- 63—TRANSISTOR CIRCUITS. Over 150 practical circuits, using transistors only. A guide for the experimenter. 160 pages. \$2.75
- 64—UNDERSTANDING HI-FI CIRCUITS. Explains how modern audio circuits work and what you can expect from them. 224 pages. \$2.90
- 65—SERVICING COLOR TV. How to repair color receivers. Illustrated with photos, drawings and troubleshooting charts. 224 pages. \$2.90
- 66—BASIC AUDIO COURSE. Fundamental audio concepts; describes microphones, equalizers, amplifiers, speakers, enclosures. 224 pages. \$2.75
- 67—ELEMENTS OF TAPE RECORDER CIRCUITS. Complete coverage of the electronic portion of tape recorders. 224 pages. \$2.90
- 68—TV AND RADIO TUBE TROUBLES. Service TV and radio receivers by understanding tube troubles. Recognize symptoms quickly. 224 pages. \$2.90
- 69—ELECTRONIC HOBBYISTS' HANDBOOK. Scores of practical circuits for the hobbyist. Parts lists on construction projects. 160 pages. \$2.50
- 70—ELECTRONIC PUZZLES AND GAMES. Build and design them. Dozens of projects which need no special parts or tools. 128 pages. \$1.95
- 71—AUDIO DESIGN HANDBOOK. Each chapter covers a separate section of an audio system, from preamp to speaker. 224 pages. \$2.90
- 72—OSCILLOSCOPE TECHNIQUES. Derivation and interpretation of waveforms. Hundreds of photographs of actual traces. 224 pages. \$2.90
- 73—AUDIO MEASUREMENTS. Test equipment and all phases of audio measurement from basic amplifier to microphone. 224 pages. \$2.90
- 74—MODEL RADIO-CONTROL. Coders, transmitters, receivers, power control, servos, transistors. Theory and construction. 192 pages. \$2.65
- 75—TRANSISTORS—THEORY and PRACTICE. Theory, equivalent circuits, amplifiers, oscillators, tests and measurements. 160 pages. \$2.95
- 76—SERVICING TRANSISTOR RADIOS. Fundamentals, types of construction, testing, stage-by-stage servicing procedures. 224 pages. \$2.90
- 77—GUIDE TO MOBILE RADIO. Industrial and railroad radio, selective and remote systems, maintenance and licensing. 160 pages. \$2.85
- 78—RAPID RADIO REPAIR. Fix radios quickly and easily. Separate sections deal with receiver types, servicing techniques, troubles. 224 pages. \$2.90
- 79—DESIGNING & BUILDING HI-FI FURNITURE. Fundamentals of design, woods, tools, professional finishing, polishing and retouching, furniture styles, placement. 224 pages. \$2.90
- 80—STEREO... HOW IT WORKS. Complete coverage of stereo, discs, tapes, multi-channel, installation, pseudo-stereo. 224 pages. \$2.90
- 81—PRINTED CIRCUITS. Designing and making printed circuits, repairs, subminiaturization, applications. 224 pages. \$2.90
- 85—HOW TO GET THE MOST OUT OF YOUR VOM. Basic meter, kits, accessories, measurements, servicing. 224 pages. \$2.90
- 90—HI-FI MADE EASY. Audio explained for the layman in easy-to-understand form. Profusely illustrated. 224 pages. \$2.90