

Barbara Bant

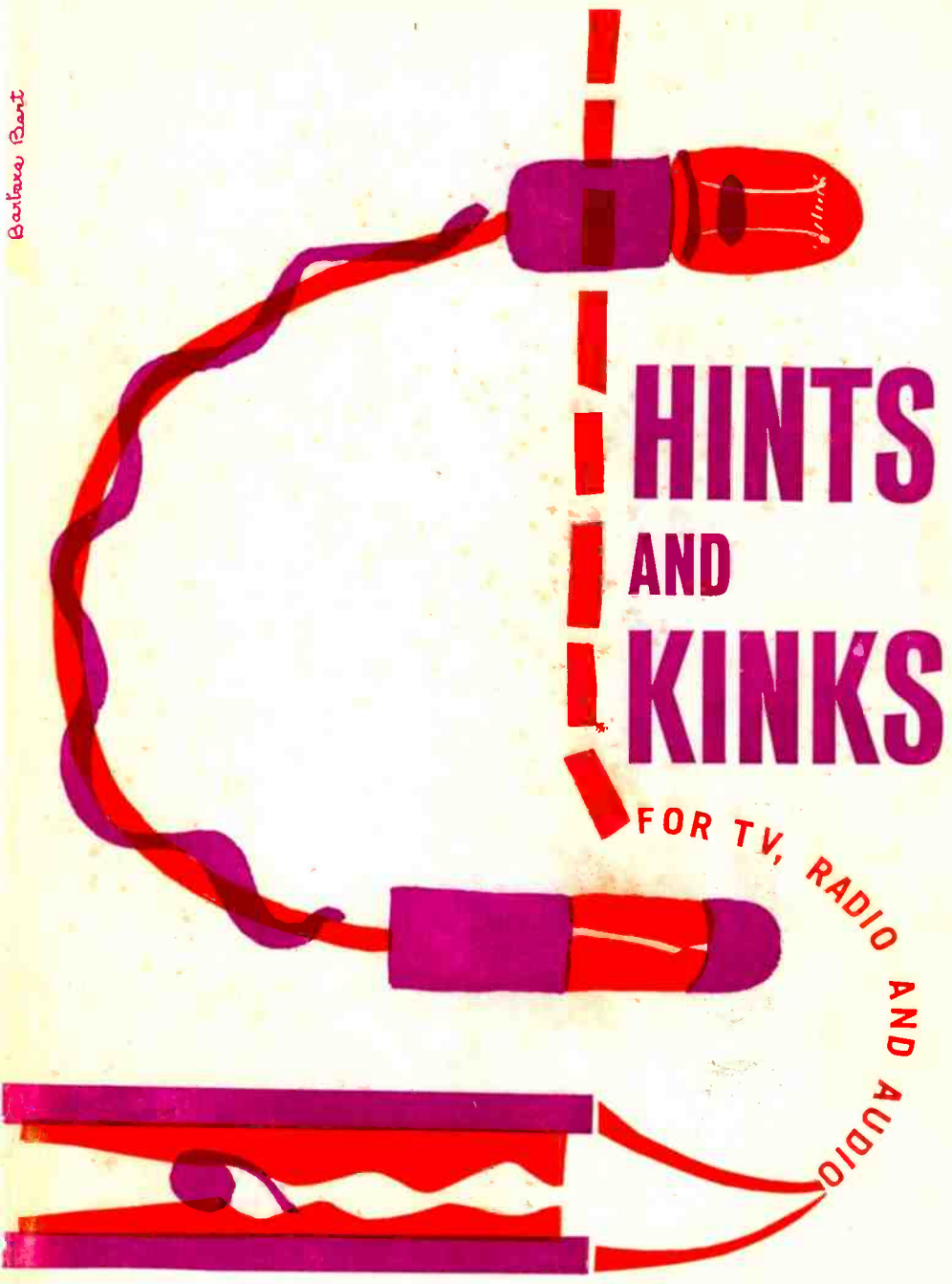

HINTS AND KINKS

FOR TV, RADIO AND AUDIO

EDITED BY MARTIN CLIFFORD



GERNSBACK LIBRARY NO. 103

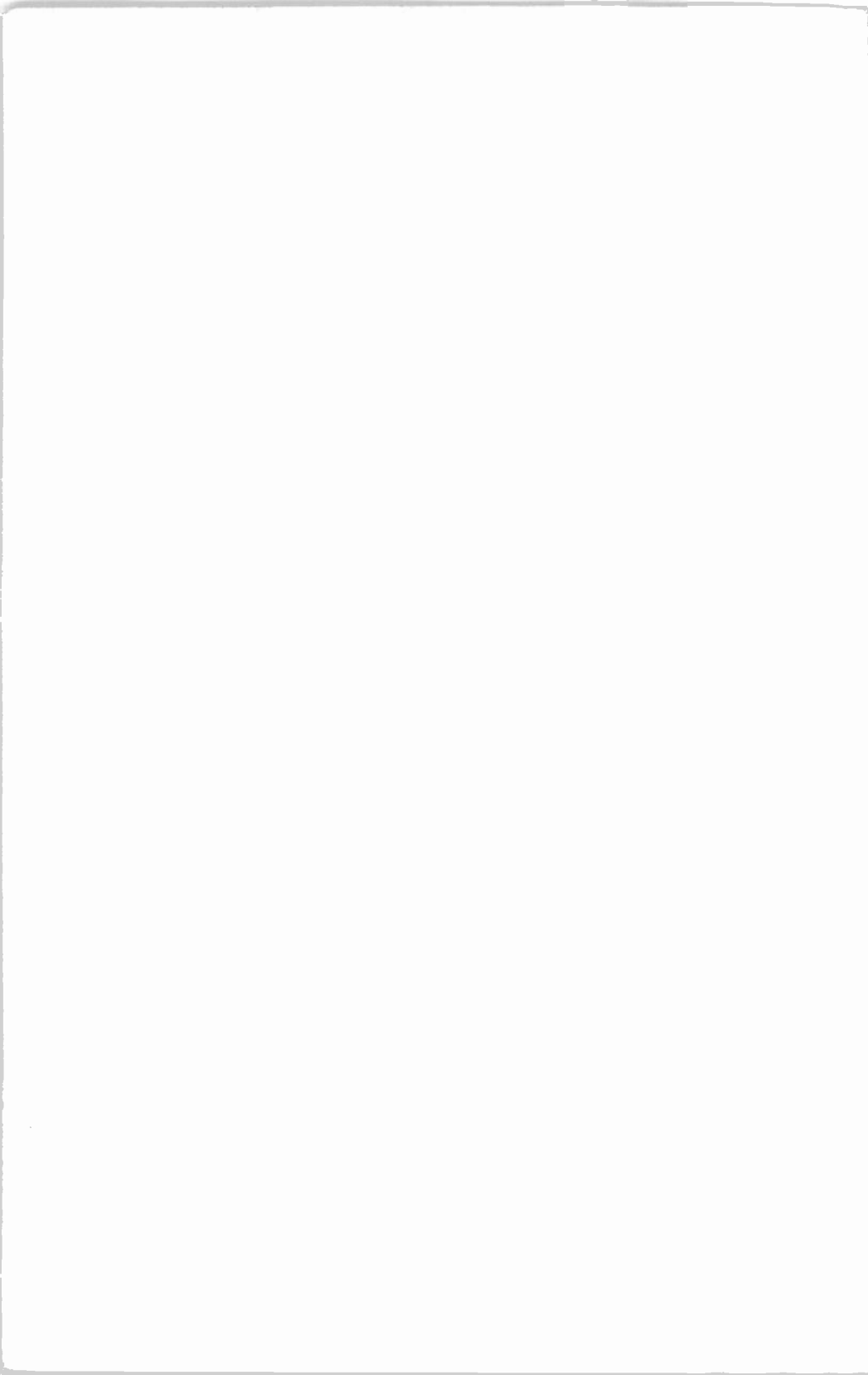

\$2.35
(in the U.S.)

Hints & Kinks
for TV
Radio
Audio

Edited by MARTIN CLIFFORD

In cooperation with

The Editors of RADIO-ELECTRONICS Magazine

GERNSBACK LIBRARY, INC.
NEW YORK 11, N. Y.



© 1961 Gernsback Library, Inc.
All rights reserved under Universal
International, and Pan-American
Copyright Conventions.

© 1956, 1957, 1958, 1959, 1960, 1961 Gernsback Publications, Inc.
Library of Congress Catalog Card No. 61-18400

CONTENTS

Chapter INSTRUMENTS

7

1

Test-lead storage. Protect your meter. Making first-class panels. Shock absorbers. See-through probe guards. Test-lead extensions. Cooling hot jacks. Nonmagnetic meter case. Versatile Variac. Brighten meter scales. Handy test adapter. Polarized marker pips. Home-made cable connectors. Double clips are useful. Resistance-box modification. Phone-tip adapter. Universal test-lead hint. Measure high resistances. Improving capacitor bridges. Easy connections for tip jacks. Vom in a shaving bag. Battery reminder. Clamp saves plug. Painting etched panels. Renew panel markings. Probe saver. Vtvm measures resistance. Peak-reading probe. High-wattage substitution box. Pocket continuity tester. Combination vtvm probe. Feet protect test sets. Banana plug to tip jack. Easily made test prods. Sawtooth generator.

TELEVISION

27

2

Tv servicing aid. Knob breakage. Second-anode connector. Insulate line splices. Crt coating. Installing tv antennas. Easy wire measuring. Protect tv-fm lead-ins. High-voltage discharger. Tent for lightning arrester. Standoff mount. Blown high-voltage fuses. Lucite scratches. Isolation transformer. Uhf installation kink. Standoff for sloping roofs. Electrostatic-focus crt's. Fuse puller. Vertical sync tracer. Don't forget tube shields. Mask-removal tool. Dual control assembly. Rustproofing hardware. Crt cleaning aid. Sticky yokes. Handy holder. Shock-absorbing ride. Foil foils intermittents. Tv lead-in splices. Bonding straps. Tv antenna alignment. Aiming antennas. New "magic antenna". Cleaning plastic safety glass. Splicing tv lead-in. Check 'em hot. Fuse holder for spares. Socket trouble. Faster installation. Diode-triode tubes. Video peaking. Filters can be dangerous. Filter capacitors. Use an atomizer. Screw eyes for tv safety. Plastic tape kink. Toolkit cheater holder. Noisy volume controls. Testing at top of socket. Plastic tv knobs. Parts substitution in dogs. Don't use a heat lamp. Glove fingers insulate clips. Mast measures lead-in. Intermittent-short detector. New tv line cord. Simple service calls. High-voltage gloves. Bad tubes can be useful. Compound fills holes. Fuse-clip burnisher. Emergency antenna connector. Liquid metal service aid. Reduce nuisance calls.

RADIO

49

3

Knob from toothpaste-tube cap. Replacing selenium rectifiers. Mounting speaker transformers. Boost fringe reception. Earpiece repair. Insulate electrolytics. Straighten component leads. High-Q if transformers. Timing service jobs. Fast auto radio service. Adding a rear-seat speaker. Slipping dial cords. Spaghetti in a tube. Extra life for defective pots. Damaged tuning slug. Volume-control switches. Vials hold batteries. Power-transistor sockets. Freeing if coil slugs. Substitution speaker. Soldering hint. Fusing transistors. Signal-seeking tuners. Test for hot chassis. Dial-stringing aid. A low-resistance ground. Duplex signal tuning. Auto speaker switching. Rechargeable battery repair. Transistor rectifier. Transistor mounting clips. New line cord. Extra heat sink for power transistors. More room in auto radios. Simplify mounting problems. Heat-sink insulator. Battery protection. Rectifier tests. Receiver calibration. Telephone antenna. Grommet protects transistors. Dial-cord restringing. Transistor life saver. Loopstick tracking.

CONTENTS

Chapter

AUDIO

67

4

Anchoring amplifier cover. Plug adapter. Hum suppression. Audio test rig. Tape-splicer cleaning. Examining phono stylus. Control guides. Timing tape recorders. Speaker repairs. Recorder cleaning kink. Rubbing voice coil. Erratic record players. Changer stylus skips or sticks. Improve portable record players. Tape recorder kink. Recorder mike stand. Service syringe. Record changer hum. Storing recorded tapes. Simple feedback connection. New flock for turntable.

SHOP HINTS

77

5

Mat on the bench. Kit-building kink. Coil insulation. Double-duty Allen wrench. Transistor socket mount. Keep jumpers untangled. Pencil-iron tinning. Universal vise. Top-of-toolbox vise. Solar-cell precaution. Twist drill covers. Inexpensive panel bearings. Soldering-iron holder. Penicillin syringes. Stay-put trouble light. Screwdriver modification. Soldering tip. Gun carries own sander. Sticky relay cure. Thumb screw wrench. Tube carrier. Clothespin eases prod handling. Phillips screwdrivers. Danger—high voltage. Handy bending brake. Emergency contact plug. Solder dispenser. Splicing stranded wire. Enlarging holes in plastic. Handy heat sink. Hanger tops for tubes. Keeping the iron clean. Pop-up toolbox. Hole shrinking. Soldering-iron rest. Sharpening a punch. Handy file. Liquid metal anchors wire. Drilling thin metal. Can opener is service tool. Handy reamer. Soldering cast iron. Wire-terminal identifiers. Turning tough screws. Reduce line-cord fraying. File cleaning kink. Wire stripper. Stuff that plug. Mirror holder. Soldering-tool maintenance. Spare iron tips. Custom tips. Penny for your tape. Soldering vise. Soldering phone tips. Screw-cutting jig. Inverted cartons mark empties. Chalk prevents file clogging. Heat-conductionless soldering. Tube holder. Portable wire rack. Chassis drilling. Solder loop anchors wire. Toolkit flux dispenser. Spaghetti insulates solder. Soldering the unsolderable. Color-code those tools. Chassis-punch care. Pencil-iron rest. Soldering-iron cleaner. Another third hand. Handy tap stand. Tool for technicians. Handy bench gadget. Bowl-cover service aid. Mini-Gator clips. Jeweler's saw cuts control shafts. Cutting miniature shafts. Toolbox storage kink. Soldering pad. Hacksaw blade repair. Service bench aid. Soldering aid. Hand grinder solves problems.

MISCELLANEOUS

111

6

Novelty blinker. Relay operating kink. Drinking-straw spaghetti. Locking battery nuts. Hint for experimenters. Tape protects chemicals. Corkscrew for tight cap. Christmas tree lights. Solderless connectors. Use a ballpoint pen. Drop-cloth pockets. Handy connecting stand. Temporary wire wrapping. Low-voltage neon flasher. Attractive panels. Experimental connectors. Standoff posts to suit. Improve relay sensitivity. Grommet aids gun lamp removal. Spaghetti for miniature circuits. Transistor kink. Colorful panels. Light-bulb resistors. Fast plug connections. Stripping short harnessed wires. Loop oiler. Simple uhf antenna. Experimental coils. Service light holder. Nichrome elements. Phone-plug switch. Tube tapper and wire pusher. Wing-nut driver.

INDEX

125

INTRODUCTION

TO THE AVERAGE, nontechnical person, a paper clip is exactly that. There is no urge, need or motivation for changing the paper clip into anything else. But not the service technician! To him it is a challenge. He sees it, not only as a paper clip, but as a screwdriver, a hex nut holder, and (when straightened) as a fine tool for poking around the remote inside of a radio or TV chassis.

The paper clip is just a sample. Whatever the technician sees and touches becomes grist for his mill. A grommet becomes a tube tapper or an instrument support. Stripped insulation becomes spaghetti. A pair of wooden boards become a tool for straightening wires. Steel wool becomes a soldering tip cleaner. And so it goes. Bottles originally intended for the medicine cabinet, kitchen utensils and garden tools are given a chance at survival. Instead of being thrown away, they serve new and useful purposes.

There is an important point to remember here. The modification of odds and ends isn't just a mental exercise. Most often, necessity gives birth to new ideas, and the technician (and the experimenter and the hobbyist) are forced to use every object, every little item that comes to hand.

Ideas, though, are not always easily come by. That is why we have compiled this book. Here you will find hundreds of suggestions, all of them tried and tested, that you can use in working on radio and TV receivers, on audio amplifiers. Here are the gimmicks and the gadgets that have proved their worth on test instruments and in the shop.

The hints and kinks in this book have been carefully culled from those that appeared in the pages of Radio-Electronics Magazine. So many technicians made contributions that space limitation just does not permit listing their names. Our thanks go to them just the same.

That a hint or kink appears in these pages does not mean that no change is possible. Adopt the idea for your own purposes or adapt it for your special needs.

MARTIN CLIFFORD

To Sarah

test-lead storage

IN MOST SERVICING SHOPS the problem of where to keep test leads not in use is not solved satisfactorily. Leads are usually left in a drawer or on the bench, resulting in time-consuming untangling before they can be hooked to an instrument and used again.

A few minutes' work can end this problem. Take a piece of wood or metal about 2 inches wide (as shown in Fig. 101) and long enough to accommodate the number of leads on your bench. Mark off $3\frac{3}{4}$ -

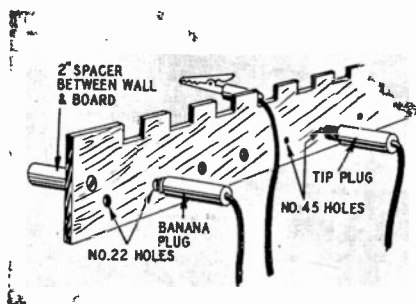

Fig. 101. Simple arrangement for solving test-lead storage problem.

inch divisions along the top edge and saw notches $\frac{1}{2}$ inch deep. These notches accommodate leads with alligator clips, meter probes and coaxial fittings. Below these slots drill a series of No. 22 and No. 45 holes — the No. 22 holes for banana plugs and No. 45 holes for tip plugs.

Mount the board or metal strip on the wall behind your bench, about 5 feet above the floor, on 2-inch spacers.

Incidentally, peg board can be used instead of wood but isn't recommended, since the holes in pegboard make matters somewhat confusing.

shock absorbers

Shock-absorbing pads for delicate electronic instruments, record changers, motors, etc. can be made from ordinary discarded garden hose. Cut a section of the hose into small pieces. Drill or punch a small hole through the center of each section as shown in the photos, Fig. 102.

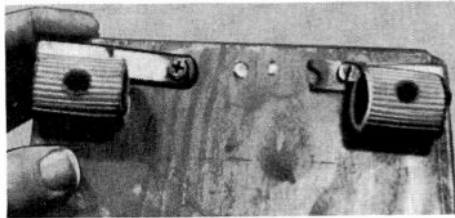
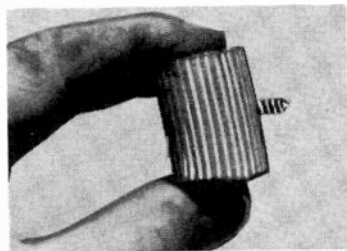

Fig. 102. *Does the garden hose leak? Don't throw it away. Small sections of it make fine shock absorbers.*



These holes are for the attaching screws or bolts. If more convenient, the pads can be permanently fastened to small wooden blocks that are attached to the equipment. In addition to stopping vibration, these pads will keep a motor (for example) from creeping on a smooth surface.

protect your meter

On outside service calls vacuum-tube voltmeters are subjected to jarring and rough handling that often damages the bearings or other parts of the meter movement. Meter movements that are lightly damped are especially susceptible to damage by sudden jarring or bumping. You can avoid ruining an expensive vtvm in this manner by making a simple modification. Wire a spst toggle switch directly across the meter terminals without disturbing the original circuit. With the switch closed, the moving coil of the meter is shorted and sudden jars or bumps will barely move the needle.

To make this modification, first disconnect the meter movement and remove it from the tester. This prevents possible damage from vibration. Drill a hole for the toggle switch as close as practicable to the meter mounting position. Avoid damaging the tester components with the drill. Mount the toggle switch and replace the meter in the panel; then wire the switch directly across the meter terminals and the revision is complete.

If the power switch is mounted near the meter and there is sufficient space on the panel, mount the meter shorting switch next to it. As an alternative, replace the on-off switch with one having an extra set of spst contacts so that turning off the power shorts the meter movement and vice versa. This will eliminate the necessity of turning the meter shorting switch on and off for transporting and testing.

This simple modification is applicable to practically any meter and should cut down the cost of equipment upkeep.

making first-class panels

If you would like the appearance of that pet project to be all that it should, here is a practical way to get the panel lettering.

1. Make a full-scale drawing of the required lettering on a sheet $\frac{1}{2}$ inch larger than the panel all around. This original may be a pasteup — letters or designs cut from catalogs, etc., and glued to the sheet. The edges of all such patches must be given a coat of white ink.
2. Get a very black, high-gloss negative photostat of the drawing.
3. Cement the photostat to the panel and trim off the edges.

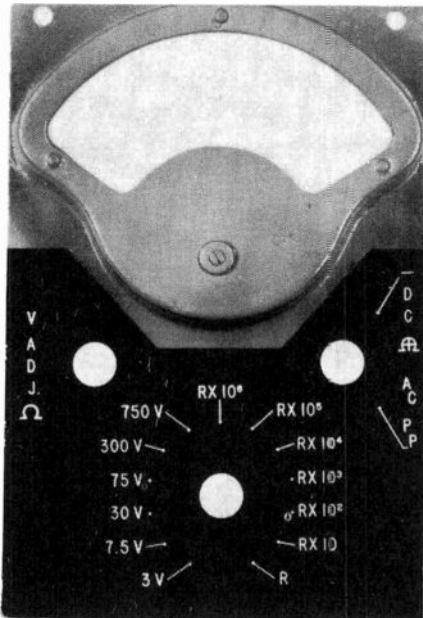

Fig. 103. *Photostat gives meter professional appearance.*

The photo in Fig. 103 shows the results on a panel that has received this treatment — fully commercial in appearance. Three protective coats of clear floor varnish make it durable too.

see-through probe guards

If your test probe doesn't have finger guards to keep the tips of your fingers out of hot circuits, make some from clear polystyrene plastic. Cut two 1¼-inch discs (see Fig. 104) from a clear sheet of ⅛-inch plastic and drill a hole in the center of each to accommodate the barrel

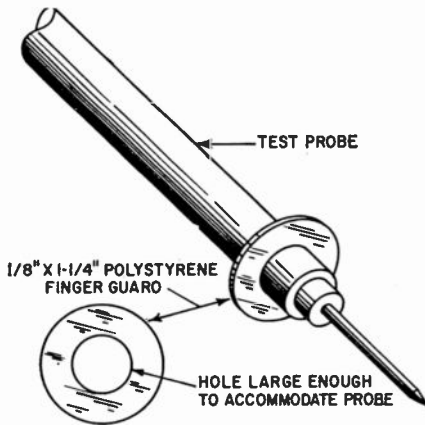

Fig. 104. A finger guard is necessary protection on a test probe.

of your test probes. Slip the guards in place as shown. If they don't fit snugly, apply a daub of service cement to hold them in place. These see-through finger guards won't hamper your vision when testing in cramped circuits and will keep your finger tips safe.

test-lead extensions

Here are three wire extensions that are useful with phone-tip type test prods. You can form them from plastic-covered bell wire but any insulated No. 20 or No. 22 solid-copper wire can be used. Bend a hook on

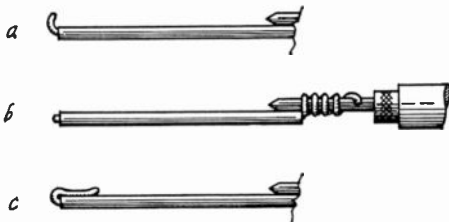

Fig. 105. Increase the usefulness of your test prods with these extensions.

the end of one (Fig. 105-a) and it can be hung on leads and socket lugs. Leave 1/64 inch of bare wire extending beyond the spaghetti (Fig. 105-b) and it is handy for taking readings down under a jumble of wires. Fig. 105-c shows an extender that has its end bent into a clip.

The prod tip against the spaghetti of the extender holds the extension firmly in place but it's better to put a rubber band over the prod tip and pigtail of the extender to be sure.

cooling hot jacks

It is customary, for reasons of economy, to use plug-in meters in many types of commercial and amateur electronic equipment, particularly in circuits that need only occasional adjustment. Where one side of the circuit is at ground potential, the conventional two-circuit jack and plug is electrically satisfactory and entirely safe.

Where both sides of the circuit are above ground, the jack ferrule (bushing) and frame are customarily insulated from the metal panel by insulating washers. Failure or omission of these washers has costly consequences, as many builders can testify. Even more serious, in many installations, is the danger of touching the hot jack bushing and something grounded at the same time. This results in a shock, the danger from which depends upon the voltages involved. Use of bright red insulating washers, as is done in some military installations, while plainly indicating the danger does not remove it.

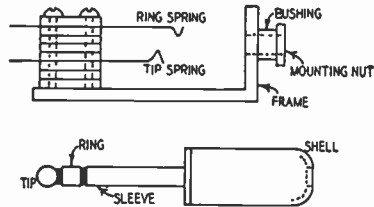

Fig. 106. *Three-circuit phone jack and plug minimize shock hazard.*

In a wide variety of equipment, the hot-bushing danger can be entirely eliminated, at negligible cost, by use of three-circuit telephone jacks and plugs, an entirely standard communication item, constructed as shown in Fig. 106. The plug has three conducting elements—the tip, ring and sleeve; the jack has springs to contact the ring and tip. The sleeve contact is made with the jack bushing. Telephone type plugs are so constructed that short circuits on insertion and removal are practically impossible.

By connecting the two hot leads of the meter to the tip and ring of the plug and the two hot circuits to be monitored to the corresponding jack spring, the ferrule is always electrically cold — at ground potential — and danger from shocks is minimized.

The same type of jack and plug is useful for connecting dual shielded leads quickly. Experience shows that telephone type three-circuit components will stand 350 volts continually in ordinary environments and about 250 volts in high-humidity locations.

nonmagnetic meter case

Mounting meters in iron cases for bench use can cause errors unless the instrument is specially calibrated. As much as 10% error may be noted between readings in and out of an iron case, because of magnetic shunting.

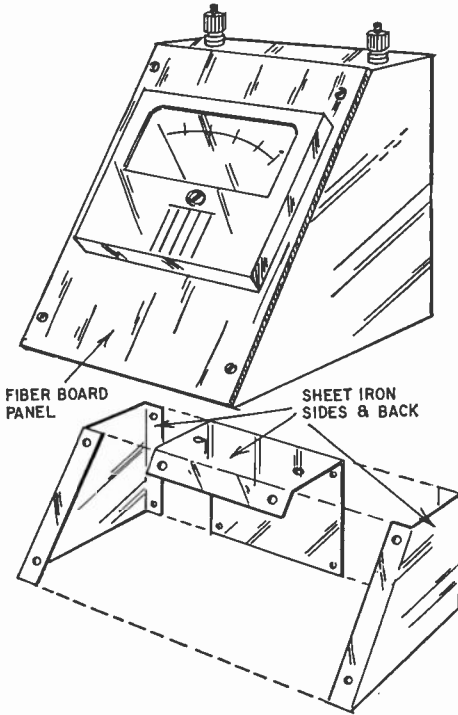

Fig. 107. Meter case uses nonmagnetic front panel.

Satisfactory meter cases (as shown in Fig. 107) can be made with sheet-iron sides and backs if the front panel is nonmagnetic. A piece of fiberboard attached to the metal frame with screws or rivets will make an ideal mount.

versatile variac

To get a range of 0–250 volts with a 0–135-volt Variac, connect

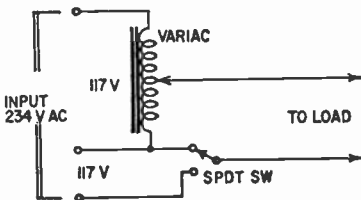

Fig. 108. Using Variac with three-wire system.

the Variac and load to the 117/234-volt three-wire system with a spdt switch as shown in the diagram in Fig. 108. Depending on the switch position, the Variac covers 0–134 or 117–234 volts.

brighten meter scales

Meter and instrument scales ultimately get dull and dirty-looking. Cleaning is difficult because of soft, easily scratched surfaces, and the printing or lithographing.

There is only one satisfactory way of cleaning meter faces, but it really does a good job.

Obtain some drawing cleaning powder from a stationery store or one that deals in engineering drawing supplies. Then sprinkle the

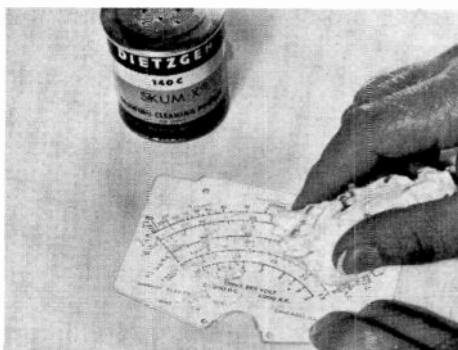

Fig. 109. *Cleaning powder makes meter scales look like new.*

meter face with the powder and rub with a rotary motion using a soft cloth or piece of paper toweling (see Fig. 109). A second application may be necessary.

The result will be a beautifully and uniformly clean instrument dial.

handy test adapter

Here is an easy way to measure voltages at the tube sockets from the top of the chassis. Run a length of bare copper wire through a piece of spaghetti tubing and twist a loop in one end to fit pins on miniature

Fig. 110. *Test adapter is easy to make.*

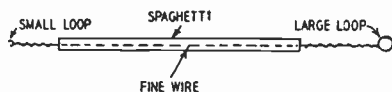

sockets and a loop on the other end to fit pins on octal or other tube types. See Fig. 110. Remove the tube from the socket. Scratch the pins with a knife to remove film and corrosion, place the loop over the correct pin and then follow it with a paper washer (see Fig. 111) to

hold the loop in place and insulate it from accidental contact with the chassis.

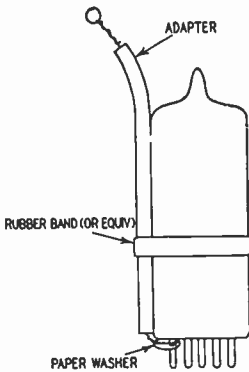

Fig. 111. Test adapter mounted on tube.

A miniature test clip or a test prod measures the voltage at the other end of the adapter. A rubber band clamps the adapter to the tube and prevents it from shorting to the chassis.

polarized marker pips

To minimize waveform distortion and simplify identification of markers, it is often desirable that a marker generator provide positive- or negative-going pips on the curve displayed on the scope. The circuit diagram in Fig. 112 shows an easily constructed addition to the output circuit of most marker generators to provide positive, negative

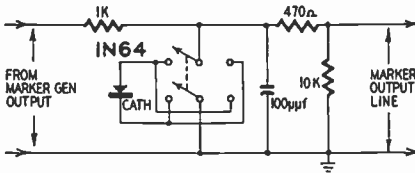

Fig. 112. Circuit for supplying polarized marker pips.

and bipolar pips at the flip of a switch. The diode clips and removes the positive or negative peaks of the marker signal, depending on the switch setting. The switch is a dpdt lever, toggle or slide type with spring return to the open center position.

home-made cable connectors

When a plug and socket connector of the seven- or nine-pin variety is not readily available... you can make one out of two miniature sockets and an ordinary paper clip. Cut the clip into 1/2-inch lengths, insert in the tube end of one socket and solder in place. This makes the male plug. The other socket of course is the female connector.

double clips are useful

Fastening two ordinary test clips together makes them into "twin-clips" and their usefulness around the shop is greatly improved. They can be used for making fast temporary connections, for increasing or decreasing the value of components by connecting them in series or parallel, or for clipping a test prod to a wire or terminal. You can also use the clips to hold a part reminder or note to a chassis.

To fasten two clips together, simply cut off the wire supports at the rear of each clip, remove the screws and use just one screw to fasten both clips together. Twin clips are also sold commercially, but are not always obtainable.

Here is another suggestion. Try connecting them with about an inch of flexible wire between clips. This makes them much more versatile.

resistance-box modification

Some resistance substitution boxes have separate selector switches for high- and low-resistance ranges but only a single set of output

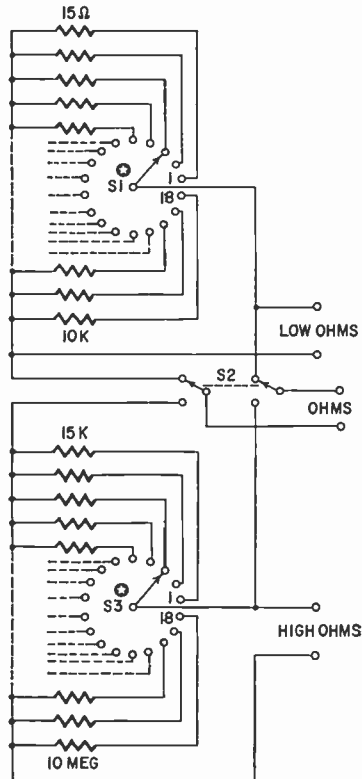

⊙ S1 & S3 ARE SIMPLIFIED DRAWINGS OF 18 POINT RANGE SWITCHES IN EICO 1100

Fig. 113. Modification of resistance box allows use of low and high ranges at same time.

vtvm ground to a water-pipe ground and the difficulty will clear up.

If you choose to build your own high-ohms probe, remember that the insulation in the probe construction must be maintained unusually high to avoid leakage and inaccurate indication.

improving capacitor bridges

Many capacitor bridges use an electron-ray tube as a null or balance indicator. The shadow is not sharp enough and the tube is not sufficiently sensitive to permit matching capacitors as closely as required in some applications. You will find that capacitors can be matched much more accurately by connecting a vtvm between the grid and cathode of the indicator and using the voltage swing to indicate balance.

easy connections for tip jacks

This simple adapter comes in handy for instruments or in experimental work when various components must be temporarily connected to tip jacks. To make this adapter, simply push the lug end of a No. 30 Mueller alligator clip into the sleeve of a phone tip and run a little solder in to make a solid connection.

The photo in Fig. 117 shows how a capacitor can be quickly connected to a tip jack. You can also connect resistors, diodes, transistors, etc., in the same way.

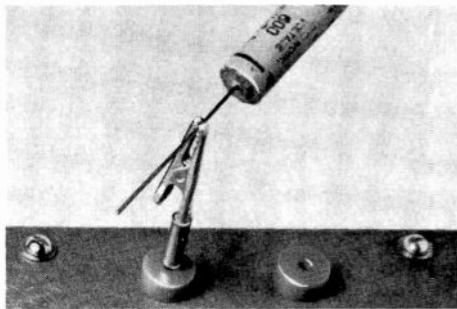

Fig. 117. Adapter for connecting components to tip jacks.

If you prefer to use a larger alligator clip, simply force the sleeve of the phone tip into the sleeve of the clip and run a little solder around the joint.

vom in a shaving bag

Whenever a service technician is called to repair a set in the customer's home, his reputation is hanging in the balance. The appearance of his test equipment can leave either a good or bad impression on the customer, depending on the shape the instrument is in. Obviously a vtvm or vom

with a cracked meter face or a badly scratched case isn't going to leave as good an impression as one having a new appearance. To keep your vom or vtvm looking new, store it in a travel-type shaving bag. (See Fig.

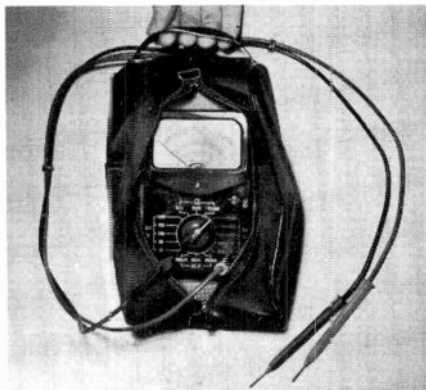

Fig. 118. *Carrying bag protects instrument.*

118.) You'll find there's generally plenty of space in the bag for test leads and that you don't actually have to remove the meter from the bag to use it. The convenient handle makes it easy to carry too.

battery reminder

Because of the small current required, the average multimeter will continue to work even after the internal battery may have started to leak and corrode nearby components.

You can lose an expensive meter this way. Form the habit of taping a note on the face of the instrument every time you replace the batteries. Have it say: "Replace Battery Dec. 25," or whatever date is a safe 6 months from installation date.

clamp saves plug

Ever step accidentally on a phone plug and feel its bakelite handle

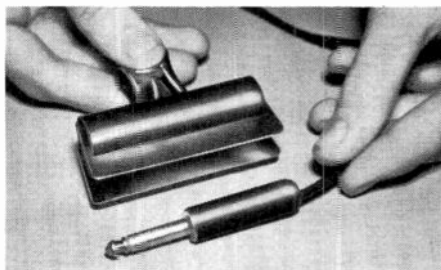

Fig. 119. *Protect your phone plugs with paper clamp.*

crush under your weight? Why let a costly accident such as this happen when you can easily prevent it by slipping a large paper clamp over the plug? Fig. 119 will give you the general idea. Other types of electrical connectors can be protected like this, too.

painting etched panels

Repainting electronic equipment with control markings etched on the metal panel is quite a problem. Many shun this type of work because of the time spent in "picking" the recessed letterings, which are usually numerous. Here is a simplified method of repainting this type of panel with a minimum of effort and with simple and inexpensive equipment.

To start with, you will need a paint sprayer or a hand type insecticide sprayer with a good pump. This is imperative if you want a fine spray finish. You will also need a stiff brush, a few sticks of writing chalk, paint thinner and, of course, quick-drying enamels of the desired shades.

In repainting etched panels, start with the etched letters. Give the inside of the letters a thin coat of the desired color using a stiff brush to apply the paint. Use jabbing strokes. Next, wipe off paint smears on the panel's surface with a rag wet with paint thinner. Do not use too much thinner or you will flood the etchings. Allow the paint to dry completely (this is absolutely necessary) before you tackle the whole panel surface. If quick-drying lacquer or enamel is used in the operation, the repainting can be completed the same day. Here's where the real problem comes in. How do you prevent paint from smearing the nice job you made on the etched lettering? Very simple! Get out those sticks of blackboard chalk and, with the panel laid flat on a table, rub particles of chalk into the etched letters to fill the depressions completely. Wipe off excess chalk that gets on the panel's surface, being careful not to scratch out the chalk that is in the etchings. Now you are ready to spray.

Fill up the sprayer with the desired paint and spray it on the whole panel surface. Allow the paint to dry completely. When dry, restore the markings by picking them with a stiff brush. The thin paint coating breaks loose easily under the pressure of the stiff brush. The loosened particles of chalk may then be blown out of the depressions and clear, neat letters remain.

renew panel markings

Here is another technique you can use to perk up the depressed (or recessed) markings typical of many instrument panels. These markings can be easily restored to a brand-new appearance.

Buy a china marking pencil. They come in several colors. Red and white are best for electronic instruments.

Warm the instrument panel slightly under a 100-watt electric lamp and rub the pencil over the panel markings to fill the letters. Rub off any excess on the panel with a piece of tissue paper. This technique also works on engraved name plates.

probe saver

An ordinary clip type broom or tool holder fastened to the side of the vtvm case or a nearby spot on the bench makes a convenient holder for the high-voltage probe (or any other probe) and protects its plastic shell from damaging contact with other tools on a crowded bench.

vtvm measures resistance

The vtvm is an ideal instrument for measuring resistances as high as 100,000 megohms with an accuracy of a few percent. All you need, in addition to the vtvm, is an external power supply delivering approximately 100 volts or more.

Connect the unknown resistance in series between the power supply and the meter and calculate the value from the formula

$$R = \frac{(V1 - V2) \times R_m}{V2}$$

where R is the unknown resistance in megohms, V1 the supply voltage, V2 the voltage read on the meter with R in series with one of the leads and R_m the input resistance of the meter in megohms.

Meter reading (V2) 50 volts	Unknown resistance (R) megohms
50	11
33	22
20	44
10	99
5	209
4	264
2	539
1	1,089
0.5	2,189
0.3	3,652
0.2	5,489
0.1	10,989

The table gives sample values of V2 and R when V1 is 100 volts and R_m is 11 megohms. Multiply the meter readings in the table by 2 when V1 is 200 volts, by 3 when V1 is 300 volts and so on.

Another method of checking large-value resistances was described earlier on page 17 under the heading of "measure high resistance".

peak-reading probe

Demodulator probes used with oscilloscopes to observe waveforms prior to detection (such as in the video if stages) may be converted to peak-reading probes for use with a voltmeter.

A schematic of a typical demodulator probe is shown in the diagram, Fig. 120. A capacitor is placed across the output, making it a peak-reading probe for use with the meter. The shunting (added) capacitor may

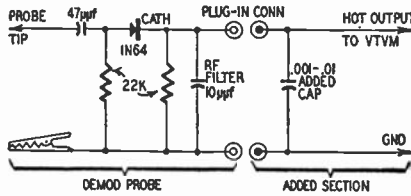

Fig. 120. Simple modification makes demodulator probe into peak-reading unit.

be enclosed in a shield with terminals to match the output terminals of the probe—a plug-in arrangement. The output of the capacitor may be provided with terminals for the meter.

high-wattage substitution box

Resistor substitution boxes are invaluable in service and design work. However, most are rated at 1 watt, which limits their usefulness. A higher-wattage unit can be constructed with only twelve 10-watt resistors. It will supply resistances from 25 to 72,075 ohms in 25-ohm steps. See Fig. 121.

All resistors are in series and each one has a spst switch across it, allowing any resistor to be inserted or removed from the circuit.

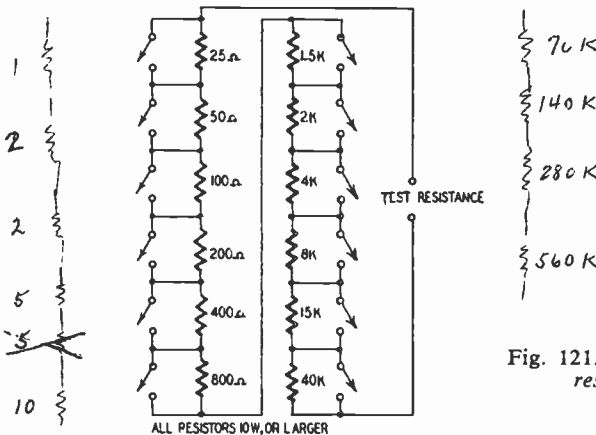

Fig. 121. Circuit of the high-wattage resistor substitution box.

Simple addition will show what resistors to insert to get the desired value. The minimum power rating is 10 watts, becoming proportionately greater when two or more resistors are in series.

The complete unit can be built in a standard 4 x 8 x 2-inch chassis with a bottom plate to make a compact and handy instrument.

pocket continuity tester

This little tester is easily shoved in a toolbox or pocket and provides a fast means of making simple troubleshooting tests. The few components are mounted on a piece of asbestos shingle pressed snugly into a clear plastic case.

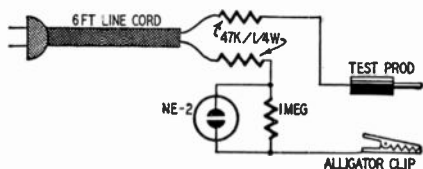

Fig. 122. Continuity tester uses few parts, is easy to construct.

The heart of this handy device (Fig. 122) is a NE-2 neon lamp. It is wired across a 1-megohm resistor, while a $\frac{1}{4}$ -watt 47,000-ohm resistor is in series with each side of the line to minimize shock hazard. One test prod and one alligator clip provide easy testing.

combination vtm probe

Many popular electronic vtm's have separate probes or test leads for ac volts and resistance measurements and another set for dc voltage. Fig. 123 shows how a dc/ac-ohms probe can be used for all measure-

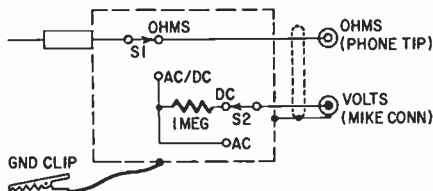

Fig. 123. Single probe measures ohms, ac and dc volts.

ments. Two built-in switches select the desired function. When S1 is set to OHMS, the circuit is completed straight through to the OHMS terminal on the meter. Switching to AC-DC connects the probe tip directly to the VOLTS terminal on the meter when S2 is on AC and through a 1-megohm resistor when set on DC.

The housing is $1\frac{1}{8}$ -inch inside diameter aluminum tubing with machined plastic or fiberboard inserts in the ends. The cable can be two-conductor shielded cable or two-conductor coax such as RG-22/U.

Construction and operation can be simplified by replacing S1 and S2 with a three-position single-pole slide switch connected as in Fig. 124. The output connectors are selected to match those on your vtm.

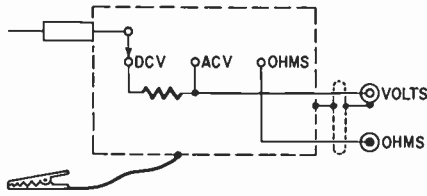

Fig. 124. Slide switch simplifies probe construction.

feet protect test sets

You will find that a piece of 1/2-inch foam rubber cemented on the bottom of your test instruments greatly reduces the amount of jarring and jolting that they take while being moved around. It also tends to reduce the chance of cracking a case and to lengthen the life of the instrument.

banana plug to tip jack

In electronic service and experimental work, it is sometimes desired to fit banana plugs to tip jacks. To do this, some kind of an adapter is needed. One solution to the problem is shown in the photo, Fig. 125.

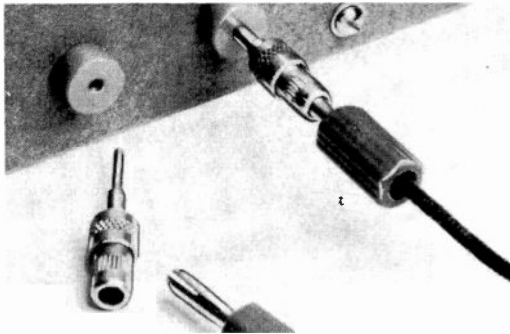

Fig. 125. Adapter for inserting banana plugs into tip jacks.

Simply buy a couple of solderless tip plugs and use them as adapters. You will find the openings on the back ends of the solderless plugs just the right size to receive banana plugs.

easily made test prods

Need a pair of test prods? Here's how you can make them easily from some heavy-gauge insulated solid copper wire and some plastic tubing. First, select a piece of heavy-gauge insulated solid copper wire and a length of plastic tubing that will fit snugly over the wire. Cut the wire

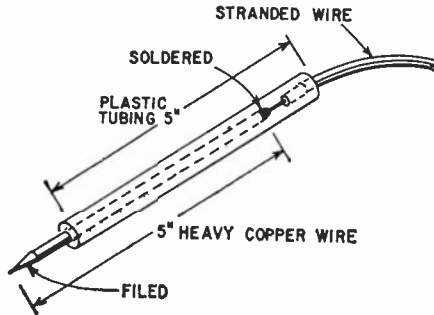

Fig. 126. *Heavy copper wire and some tubing, and you have a test prod.*

and tubing into 5-inch lengths. Solder a longer piece (about 3 or 4 feet) of insulated stranded wire to each solid piece for test leads. (See Fig. 126.) Next, place some service cement on the solid wires and insert them into the lengths of tubing with 1 inch of the solid wire extending from the business end of each prod. Then cut the insulation from the short extending wire and file the end to a point. Finally, fasten the desired type of clips or connectors to the opposite ends of the test leads and the prods are ready for use.

sawtooth generator

Most electronic technicians and experimenters have had, at one time or another, a need for a sawtooth-wave source, variable in frequency and amplitude. It usually is needed when there is neither time nor inclination to construct one "from the ground up." However, if you own a scope, there is a very easy and inexpensive way to provide just such a source.

The diagram in Fig. 127 shows a partial circuit of a typical oscilloscope with the modification shown in dashed lines. The only parts necessary are an insulated pin or banana jack and a 0.25- μ f 600-volt capacitor. The jack is mounted in the front panel near the ground post on the horizontal amplifier side of the panel. Insulate the jack from the panel. The capacitor connects the jack to the plate of the horizontal amplifier tube. The frequency is controlled by the COARSE and FINE FREQUENCY scope controls and the amplitude by the HORIZONTAL GAIN control.

A cable can be made up by using a length of coaxial line long enough to suit the needs of the user with appropriate lugs, clips and plug attached.

In use, there will be no discernible depreciation in the performance of the scope by making this modification, provided the cable is disconnected from the scope when it is not being used as a sawtooth source.

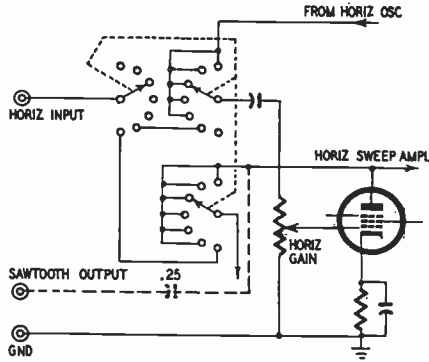

Fig. 127. Modification permits scope to be used as a sawtooth generator.

A very practical use for this modified equipment is in determining whether the trouble in the horizontal sweep section of a TV receiver lies in the oscillator or output stage. By disconnecting the horizontal drive trimmer and the coupling capacitor from the grid of the output tube (be sure the grid resistor is left connected) and feeding the sawtooth wave into the grid, a few voltage checks on the output and damper tubes will reveal if the output stage is functioning normally. If it is, then it can be assumed that the trouble lies in the horizontal oscillator section.

tv servicing aid

A SELF-GENERATING photocell and a 10-ma meter make a useful aid when adjusting ion-trap magnets (beam benders) without pulling the TV chassis. Mount the meter and photocell on opposite ends of a 12-inch supporting rod or strip with a suction cup to hold the assembly

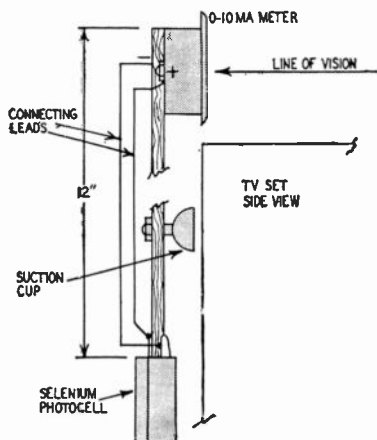

Fig. 201. This gadget will help you adjust ion trap for maximum screen brightness.

so the meter projects above the cabinet and the photocell is in front of the picture tube as shown in Fig. 201. The meter and cell are wired in series and polarized so the meter reading increases as the raster gets brighter. An International Rectifier Corp. type A-15 selenium cell was used but any similar type with high output will do.

knob breakage

A major cause of excessive knob breakage on TV set channel selectors is oil or grease. Oil or grease on a polystyrene knob weakens it, making it easy to damage. Even the vapors from lubricants can do this.

So be sure that polystyrene knobs do not touch oil or grease and that

knob shafts are carefully cleaned before the knobs are installed. Of course, knobs not made from polystyrene plastic will not be affected.

second-anode connector

A wire plate or grid cap of the type shown in Fig. 202 is easily con-

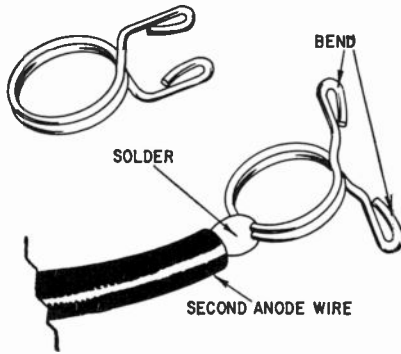

Fig. 202. Spring-metal plate connector works fine as second-anode clip.

verted to a second anode connector for a picture tube. Just bend the ends back as shown in Fig. 202 and solder the high-voltage lead to it.

insulate line splices

When you must splice a length of ribbon TV lead, it's best not to tape the splice. Tape will cause appreciable signal loss when it becomes wet

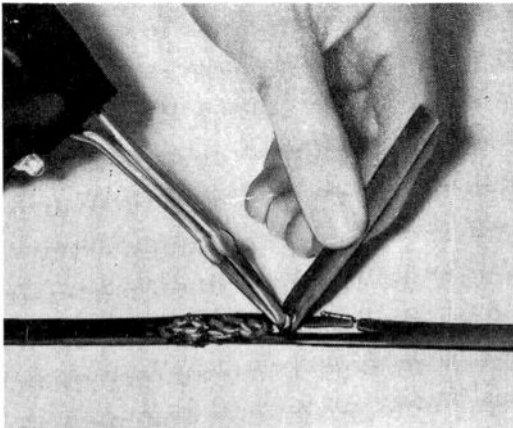

Fig. 203. When splicing twin lead, melt in some insulation from a bit of spare line.

with rain. Instead, take a spare piece of the line and cover and fill in the gap between the conductors with melted insulation as shown in Fig. 203. This is probably the best low-loss insulating technique devised. There is much less chance of upsetting line impedance with this insulating technique.

crt coating

Occasionally a service technician will discover a TV set whose picture tube has a defective aquadag coating. A CRT in this condition offers a poor ground connection to the ground return spring, sometimes resulting in arcing that disturbs vertical sync, causes noise specks in the picture, and a noisy discharge when the voltage builds up enough to arc to the chassis. This is not uncommon, but does present an evasive type of fault that is often overlooked. Often, this trouble occurs only on particularly damp days, when the moisture content of the air permits a high-voltage discharge through the air at the surface of the tube, between the coating and chassis.

To remedy this situation, simply paint the peeled surface of the picture tube with one or more coatings of *Carbon X*, a liquid solution commonly used to touch-up noisy volume controls. In a matter of minutes the *Carbon X* dries into a thin conductive coating around the ground spring and eliminates the arcing. This solution can even be used to completely renew the conductive coating on the outside of the CRT.

installing tv antennas

An ordinary galvanized iron bucket and a hank of ¼-inch sash cord or clothesline come in handy when installing TV or FM antennas on a

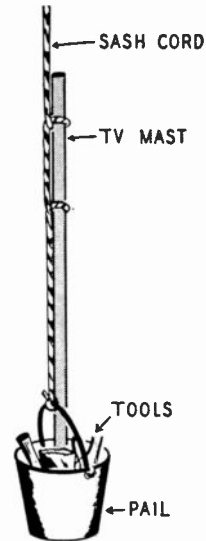

Fig. 204. Getting the stuff up on the roof is much easier when this idea is used.

roof. In the bucket you can keep two end wrenches, a hammer, oil can, sandpaper, a paper bag of assorted nuts and bolts, pliers, screwdriver, cutters and any other tools you may need. Stick one end of the mast in the bucket and throw a couple of half-hitches of line around the other end. Carry the line to the roof and haul away. See Fig. 204. It's easy to hoist antennas in cartons this way too.

Always keep your tools in the bucket. It is easy to lose them if you lay them on a roof.

easy wire measuring

When a do-it-yourself customer comes to the shop for a length of TV lead-in or other wire, do you usually measure out the right amount with a yardstick or tape measure? Unless only a very short length is needed, that's doing it the hard way. It's easier if you measure a length of your shop floor and mark it off at 1-foot and ½-foot intervals with colored paint. Use red paint for 1-foot intervals; yellow or green for ½-foot marks. Using this giant yardstick to measure wire will save you time and effort.

protect tv-fm lead-ins

Salt in the atmosphere in coastal areas can quickly ruin the performance of TV and FM antenna lead-ins. To prevent this, merely enclose the line in the smallest available type of plastic hose. Be sure to seal the top of the hose at the point where the lead-in enters.

As an alternative you can use plastic tubing or spaghetti. These are available in suitable lengths and diameters but lightweight plastic garden hose is easier to obtain and frequently less expensive.

high-voltage discharger

You can make an efficient device for discharging the stored-up potential from the high-voltage section of a television set from an old test prod, a nail and an alligator clip.

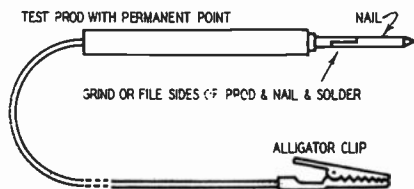

Fig. 205. It isn't the shock—it's the surprise that hurts. Discharge picture tubes and capacitors.

If the test prod is of the replaceable-tip type, it is a simple matter to replace the original tip with a 1½- or 2-inch nail (with head removed,

of course). If the tip is not removable, simply solder a nail to it. See Fig. 205. An alligator clip is attached to the other end to complete the device.

The discharger is simple to use. First, fasten the alligator clip to any ground point on the TV chassis. Then, with the test prod, ground the high-voltage lead at the point where it fastens to the picture tube. The length of nail may be pushed under the rubber cup (if present), thus contacting the picture-tube button. If the set uses a voltage-doubler circuit, discharge both capacitors as an added precaution.

tent for lightning arrester

The moisture that collects on a TV's lightning arrester during wet weather tends to short the TV signal and impair reception. When it is mounted on the outside of a window sill or any other place where it is exposed to the weather, it's a good idea to tack a transparent plastic tent over it. Cut the tent from an old plastic bag or some other plastic material.

standoff mount

Many TV antennas are well installed mechanically and electrically except at the place where the lead-in comes off the roof and down the side of the house.

Sometimes the lead-in is run through a hose or tubing and sometimes it touches the edge of the roof (metal in many cases). But if a wood bracket is used (like the one shown in Fig. 206), the lead-in can clear

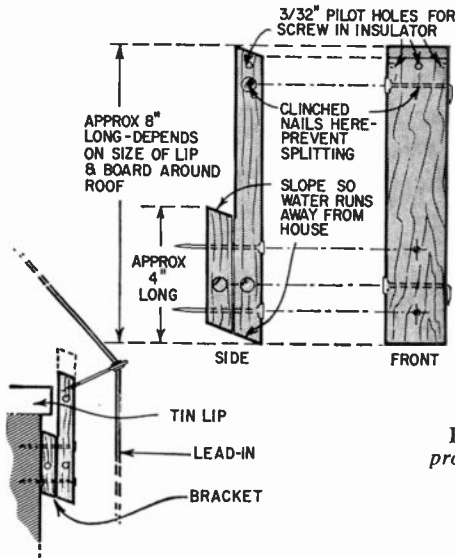

Fig. 206. Suggestion for a more professional tv antenna installation.

the roof by 6 inches or any desired amount. Make the brackets of 1 by 3/4-inch white pine or other soft wood. It is quicker to make up a dozen

wood to a strip of tin (see Fig. 208). The standoff is screwed into the wood block. The remainder of the metal strip goes under the shingles, where it is nailed down.

electrostatic-focus crt's

These picture tubes are designed to be self-focusing despite variations in the voltage applied to the focus electrode of the tube. However, focus can sometimes be improved by trying the various voltages found throughout the chassis on the focus electrode.

fuse puller

In many TV receivers the high-voltage fuse is located in the high-voltage cage and to technicians with big hands can sometimes prove to be a slippery article.

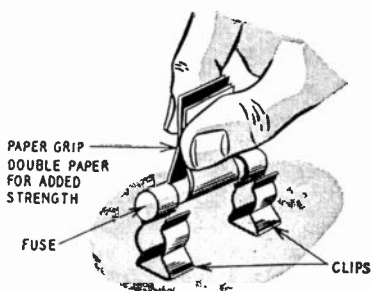

Fig. 209. Just a small strip of paper
—and out pops the fuse.

You can beat this problem by slipping a piece of heavy, brown paper (Fig. 209) around the fuse for a handle or grip as in the diagram.

Cut a strip just wide enough to fit between the fuse clips—about $\frac{3}{4}$ x 5 inches. The fuse can be easily pulled or replaced using this paper handle. Keep a couple in your tool kit.

vertical sync tracer

When it is inconvenient to use a scope for tracing vertical sync-pulse troubles, this handy little gadget, made from a pair of headphones and an extra test prod, can stand you in good stead. The sketch in Fig. 210 is self-explanatory: one lead of the headphone goes to the prod itself while the other side goes to a sheet of aluminum foil wrapped around the handle. The whole business can then be wrapped with a plastic insulating tape for safety in use. Only one direct connection is made to the circuit under test, thus avoiding loading the circuit. The return is through “body capacitance.”

When the probe is touched to an output portion of a functioning vertical oscillator, a distinctive 60-cycle click or thump will be heard, the frequency of which should vary as the hold control is manipulated.

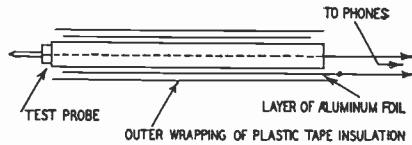

Fig. 210. You can find the reason for loss of vertical sync in a matter of minutes.

In those sets which have a normal raster and picture, but will not stand still vertically, loss of sync is indicated. It is in these cases that we can use this tool to good advantage. Start at the point of sync take-off, whether it be the video detector or the last video if stage. At this point you should be able to hear a decided click or thump of the sync pulse so long as the blanking bar appears on the picture. Then touch the inputs and outputs of all tubes, capacitors, resistors down through the sync separator, the sync amplifiers, and clippers, even the integrator until you find the points between which the pulse disappears.

Just one word of caution. Often you will find a sync pulse on both sides of a blocking transformer when the fact is that the coupling coil is open. You can check to see if the click is sync or generated pulse by twiddling the hold control. If generated, the frequency will vary. Many times, as you follow the sync pulse through the chain, it does not disappear, but becomes weaker, due to a faulty tube or component.

don't forget tube shields

Forgetting to replace tube shields can cause a lot of trouble. Interference beats in the picture, if oscillation, degraded picture, distorted sound and critical fine tuning can result. Proper placement of tube shields in the tuner, pix if strip and audio if are especially important. Check grounding springs for good contact between tube shields and chassis.

dual control assembly

When replacing dual controls in a TV set with a unit assembled from a control kit, use a little lubricant between extension shafts before fastening the sections together. Some controls have a tendency to be rough when first put together. The lubricant corrects the condition.

rustproofing hardware

To keep the bolts and nuts used in an antenna installation from rusting, coat them with plastic rubber before putting up the antenna. You will find that this weatherproofing prevents rust and makes the antenna easier to dismantle when the customer decides to buy a new one. It's a real help in salt-water climates too.

mask-removal tool

Do you carry a plumber's force cup in your toolbox to ease the removal of a TV's safety mask? Many technicians do. A force cup works

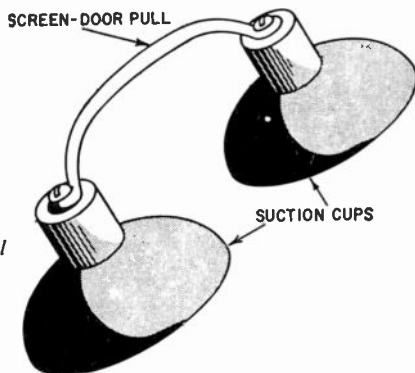

Fig. 211. A pair of small suction cups will lift the TV safety mask right off.

well, but it wastes a lot of valuable space in your toolbox. For a smaller unit, try the simple gadget shown in Fig. 211. It's just a couple of car-rack suction cups attached to a screen-door handle.

crt cleaning aid

Many TV house calls are for a familiar trouble—a dim picture due to a heavy coating of dirt on the CRT and safety glass. Most technicians rely on the customer to provide the cleaning materials for this job, but all too often none are readily available.

You can solve this problem by equipping your tube caddie with a plastic spray bottle, such as used for deodorants, filled with a 10% solution of ammonia and water. The tops of most spray bottles are easily removed for quick filling.

This handy applicator makes the job of cleaning CRT's and safety glass an easy job.

sticky yokes

Occasionally a yoke will stick to the neck of a picture tube so tightly that it seems nothing will dislodge it. Don't yield to the temptation of using a hammer or pipe wrench. Instead, pour a liberal quantity of rubber cement thinner or benzine along the neck of the tube from the socket end. This usually does the job without affecting the insulation or enamel on the wire. Caution: rubber cement thinner and benzine are extremely inflammable.

handy holder

A small corrugated cardboard box with a double rim at the top (Fig. 212) is extremely useful in making TV repairs or adjustments. The tubes

can be removed from the radio or TV and their prongs easily speared into the "sockets" of the double thickness of the corrugated cardboard. They may be placed in the same relative position as they are in the TV



Fig. 212. Corrugated cardboard box is neat method for keeping parts and tubes handy.

and, of course, need not be marked. The interior of the box is useful for small parts, extra tubes, etc. By cutting down the height of the box you can make the necessary double thickness rim for it from the material you trim off.

shock-absorbing ride

When you have to deliver a TV to a customer over a rough country road, rest the set on a partly pumped-up inner tube placed on the floor in the back of your service truck. The inner tube will absorb all of those rough jolts that could otherwise jar something loose and cause trouble. Carry one of these TV cushions and you can be sure the set will still be in operating condition when you reach your destination. For console radio-TV-record player combinations, use two inner tubes.

foil foils intermittents

Does that thermal intermittent have you baffled because it has jumped back into its hiding place now that you have removed the chassis from its cabinet? Here may be the answer to your problem. Wrap all suspected tubes with aluminum foil, and set the chassis on a sheet of foil tacked to the bench. The aluminum foil will reflect dissipated heat, hasten set warmup and help ferret out the defective component.

This kink often works where soldering iron, heat lamp and hair dryers fail.

tv lead-in splices

To save yourself that extra trip back up on the roof when repairing or installing a TV antenna—be careful when you tape any lead-in splices. Taping the connection is where you are most likely to get into trouble.

The 300-ohm ribbon line is usually made up of a number of strands of fine copper wire. The first thing an installation man usually does when starting to make a splice is to cut and trim the wire ends so they are of the proper length, using, of course, his diagonal cutters. Next, comes the joining and twisting together the ends of the lead-in. Now you reach for the roll of electrical Scotch tape. You fish in your pocket for the wire cutters. Finding them you snip off a few inches of tape and begin to wrap . . .

The first wrap around is the one that counts because, if you haven't been paying attention, there is a good chance that the adhesive surface of the tape has picked up at least one strand of the fine copper wire nipped from the lead-in when we were matching our ends; transferred so innocently from the jaws of the diagonals! You can guess the rest. That strand can cause a first-class short.

bonding straps

If you need some bonding straps right away but none can be found in the shop, why not use the shield of a section of coax?

First, measure off the desired length of coax cable. Next, with a razor blade, slit the coax lengthwise and remove the outer covering. Then, pull the inner conductor out of the shield and store it for future use. Next, attach alligator clips to both ends and pull the copper shield through your fingers to flatten it and your inexpensive bonding strap is complete.

tv antenna alignment

To do a rapid one-man job of aligning a TV antenna, loosen the clamps on the mast, and tie a long length of clothesline to each end of the crossarm.



Fig. 213. Some clothesline will help you solve the problem of orienting the TV antenna when you do the job alone.

Drop the line down over the roof (see Fig. 213) bring into a window near the set, then through the window and into the room. Line up the antenna by working the two clotheslines, then retighten the mast clamps.

aiming antennas

A trouble light in the form of a long extension cord is a simple aid in aiming a TV antenna during installation. Poke the light out a window where it can be seen by the man on the roof.

The person watching the screen image flashes the light fast if the

antenna is way off and slows the flashing to a stop as the correct orientation is reached.

new "magic antenna"

Some owners of portable television sets, or any larger sets with rabbit-ear antennas, will find a greatly increased signal by doing the following:

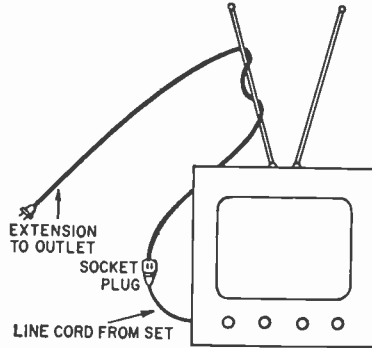

Fig. 214. *Heavy-duty extension cord increases signal pickup.*

Plug your set into a heavy-duty extension cord rather than directly into a wall outlet and loop the extension cord around one of the antenna poles as illustrated in Fig. 214. Be sure to use a heavy-duty extension cord. Ordinary household cords do not give a boost to reception.

cleaning plastic safety glass

A little penetrating oil applied with a soft cloth does an effective job of cleaning fogged plastic safety glass on TV sets. Be sure to wipe it off thoroughly afterwards.

splicing tv lead-in

Although it's not generally recommended practice to splice a TV lead-in, sometimes it is necessary (especially on extra-long runs). If you have

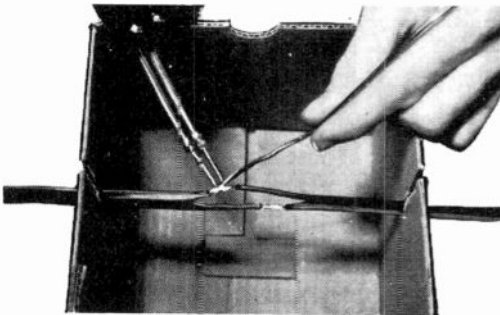

Fig. 215. *Cardboard box is helpful when splicing twin lead up on a roof.*

to splice a joint on a windy day and don't have a torch along, soldering on a rooftop can be difficult. The wind, together with the voltage drop in a long electric cord, robs the soldering iron of its heat.

To solve this problem, try using a cardboard box as a wind shield. The slits cut in the side of the box, as shown in Fig. 215, hold the lead firmly for easy soldering.

check 'em hot

When checking tubes in a TV set with a parallel heater circuit, you can save a lot of time if the set is left on during the job. Do this safely by using any *one* of the following methods:

Remove all low-voltage rectifiers.

If the set is a selenium rectifier type, remove the plug-in fuse resistor.

Remove the high-voltage fuse.

Remove the high-voltage rectifier or rectifiers.

The rest of the procedure consists of setting up the tube checker, removing a tube and plugging it immediately into the checker. You can then check the tube without waiting for it to warm up.

fuse holder for spares

A snap-on fuse holder (Fig. 216), the kind used when replacing a pigtail fuse with an ordinary tubular fuse, makes a good holder for a

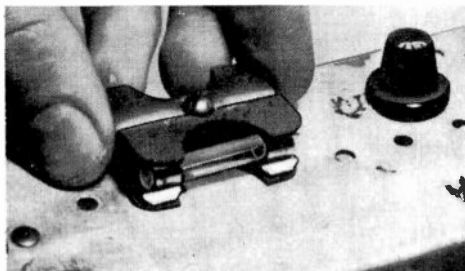

Fig. 216. Snap-on fuse holder keeps spares until needed.

couple of spare fuses. Simply cement the holder to a vacant spot on the chassis and snap a couple of spares into it.

socket trouble

Many times, particularly in older television sets, certain intermittents can be traced to poor socket contacts. This trouble can usually be detected by rocking or twisting each tube while the set is in operation. Correction, usually rather simple, consists merely of bending or tightening the socket contacts while the tube is removed.

In the case of molded sockets, a sharp-pointed instrument or tool, forced from above between the metal contacts and the molded plastic,

will usually bend the contacts sufficiently to restore the socket to normal operation. A well-pointed nail mounted on a stick or an old test prod (the kind that uses steel phono needles) will usually serve very adequately as the instrument or tool.

Contacts of wafer sockets must be adjusted or bent from underneath with either long-nose pliers or a screwdriver.

faster installation

To facilitate chassis deliveries, when the picture tube is carried separately from the chassis, spray a light coat of some nonmetallic paint over the ion trap before pulling the set off the bench. This makes relocating the ion trap much quicker when replacing the set in its cabinet.

diode-triode tubes

Do not discard a defective duo-diode triode tube while the triode section is still O.K. Instead, mark the tube to indicate its condition (diode weak, triode O.K.) and save it for use in one of the many amplifiers or FM and TV receivers that use only the triode section.

video peaking

Some power resistors have just enough inductance for plate loads in video amplifiers and are simpler than noninductive resistors plus separate peaking coils. This is often true of 10- and 20-watt sizes from 2,000 to 6,000 ohms. Power resistors below 2,000 ohms may have too much inductance.

filters can be dangerous

Much publicity has been given to the dangers involved in handling picture tubes but little has been said about some of the other dangers involved in TV servicing—such as exploding filter capacitors.

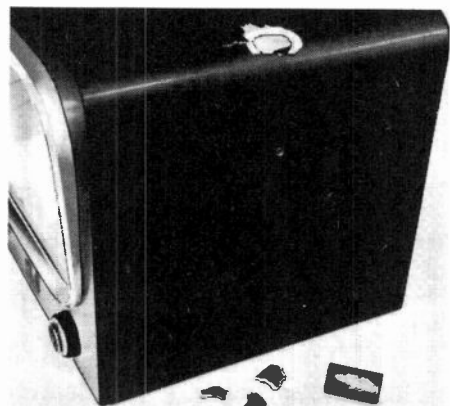

Fig. 217. Exploding filter capacitor is dangerous.

Fig. 217 should serve as a word of caution to those who would short a fuse in a set or substitute a much larger fuse than that recommended by the manufacturer. The condition shown was the result of some unknown person's substituting a jumper wire for a fuse resistor.

This capacitor "let go" with such force that it pierced not only the case, but the Celotex ceiling of the repair shop as well.

Pity the poor guy who might have been leaning over this set at the time of the explosion! Let this serve as a lesson to all service technicians to be more careful—the set you save may be your own.

filter capacitors

A defective filter capacitor is suspected whenever a radio or TV receiver has loud hum. The usual method for locating the bad unit is to place a test filter capacitor across each unit in the set, one at a time. When the hum is eliminated, the bad capacitor has been found.

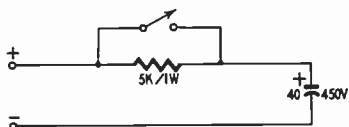

Fig. 218. Filter test unit does not disturb circuit.

Instead of placing a test capacitor directly across each suspected unit, try using this testing aid that includes a 40- μf capacitor and 4,700- or 5,000-ohm resistor with a cutout switch as in Fig. 218. The unit is placed across the suspected capacitor with the switch open. The resistor limits the charging current into the test capacitor and eliminates costly burnouts of pilot light and rectifier tube in ac-dc receivers. After a second or two, when the capacitor is almost fully charged, the switch is closed. Another advantage of using this testing aid is that the suspected unit is usually not disturbed by the test. This avoids the annoying experience of temporarily healing an intermittent capacitor which then is difficult to locate until it becomes defective again.

use an atomizer

Not generally recognized as such, one of your most useful shop tools could be an old-fashioned throat atomizer. Keep one filled with contact cleaner on the shelf and, whenever a set comes in with dirty controls or switch contacts, put it to work.

It's especially helpful when you encounter an erratic switch-type tuner. Rather than disconnect and dismantle the whole front end, spray a mist of cleaner through the vent holes and have a like-new tuner in 10 seconds.

screw eyes for tv safety

Many TV service technicians leave the backs off their own sets to facilitate repair work. A less dangerous method, but one that lets you

remove the back without running for a nutdriver, is to use screw eyes to hold the back on. This permits rapid and easy removal, yet it keeps the children away from dangerous voltages.

plastic tape kink

Before you go outdoors to splice TV lead-in in cold weather, put a roll of electrician's plastic tape in an inside pocket to keep it warm. You will find the warm tape sticks better than cold, and that a warm roll goes farther because it has more stretch inch per inch.

toolkit cheater holder

A spring type broom clip (see Fig. 219) attached to the underside of the cover of your tool box makes a handy cheater-cord holder. By keep-

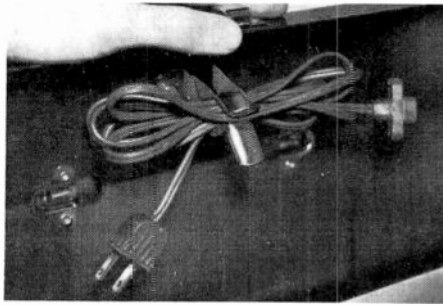

Fig. 219. Cheater cord never around when you need it? Try this little holder to keep it handy for you.

ing the cord in this handy holder, there's no danger of losing it. What's more, it's always within an arm's reach when needed.

noisy volume controls

Sometimes what sounds like intercarrier buzz is caused by a dirty volume control. Cigarette lighter fluid will clean it. However, this stuff is inflammable even though it isn't toxic like carbon tet.

testing at top of socket

The tips of ordinary test prods won't fit into the pin holes of miniature tube sockets. This is a definite handicap when you want to check voltages from the top of the chassis rather than from underneath. To overcome this handicap, file or grind the ends of your prods to fit. You'll have to make them smaller and more pointed.

plastic tv knobs

The TV technician installing a chassis in the cabinet after an initial

repair job often finds the plastic knobs so worn that they refuse to stay on the knurled shafts. Attempts to shrink the plastic with a soldering gun usually result in a messy, loose knob. At best, some technicians jam the knobs on the shafts, using wood or plastic tape to provide the necessary grip. These methods are sometimes effective, but not very permanent. An alternative method that *works* calls for simply slipping the proper type of insulating spaghetti tubing into the oversize knob hole, using a little cement to hold it in place, then fitting the knob on the shaft.

Walsco Flexitube spaghetti, a polyethylene type, or Alphlex PVC-105 seem best for this purpose. Either can be purchased in various sizes.

parts substitution in dogs

When working on an exceptionally tough "dog" where the only recourse is to change parts one after another until the bad one is tagged, you can use a simple method to keep track of what's going on. On a blank piece of paper sketch in the base diagram of the tube in the circuit in question and then draw each component as it is checked. In this way you will know that each part that has been drawn in is known good and all missing components are still in doubt.

don't use a heat lamp

Instead of using a heat lamp to make an intermittent set act up, use a soldering pencil. The disadvantage of a lamp is that it heats too large an area, making it difficult to localize the component which is changing value greatly or opening or shorting because of heat.

Lay the point of the iron on suspected components, plate and cathode parts first because they carry the greatest current; screen resistors and bypass capacitors next. Grid resistors rarely get hot so skip them. Leave the hot tip on each component long enough to heat it, but not enough to ruin it, meanwhile watching the screen. The system works fine! It's important to wait for each component to cool after testing before trying the next part.

mast measures lead-in

Ever wish for an easy way to measure the length of TV lead-in used for an antenna installation? It's pretty difficult to use a tape measure. Next time don't use a tape measure or estimate the amount of lead-in used—be sure, do it the easy way with a 5- or 10-foot section of mast. This way you won't overcharge or undercharge for the amount of wire used.

intermittent-short detector

Solder a 0.5- to 2-amp auto light bulb across a burned-out fuse and insert it into the fuse clips of a TV set that is burning out fuses. Intermittent shorts are located by watching the bulb while jarring suspected components.

glove fingers insulate clips

When you have to insulate test clips that will be connected to live circuits and there aren't any insulating jackets handy, cut insulating covers from the fingers of old rubber gloves and slip them over the clips. Make

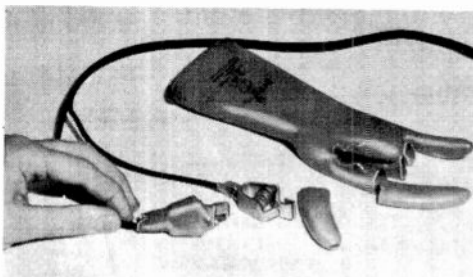

Fig. 220. Don't throw away those old rubber gloves. There's plenty of insulating life left in them.

a small hole in the tip of the glove's finger to slip it over the test lead. You may have to stretch the covers some to get them to fit over large size clips like the ones in Fig. 220.

new tv line cord

When replacing a TV power cord, you can do a neat job by cutting the old cord off the rivets with a pair of side cutters. Heat the end of the new cord in boiling water for a few minutes. This makes it easy to slip over the existing rivets with the aid of a fine screwdriver.

simple service calls

How many TV service calls have you made where the only trouble was the set's line cord pulled from its wall outlet? Carry some spring type clothespins in your toolkit and, whenever you make such a call, ask the customer for permission to nail a clothespin to the wall near the outlet to hold the cord in place. It only takes a minute so don't charge for the service.

This promotes good customer-technician relations and at the same time lets you plug your service—plainly stamped on each pin could be your name, address and phone number.

high-voltage gloves

When you have to reach into the high-voltage circuit of a TV set to remove tubes or discharge capacitors, you will find it wise to wear rubber gloves to avoid getting bitten by the high voltage. When rubber gloves (Fig. 221) aren't available, ask the customer to lend you a plastic food

bag. Although the bags are only a few thousandths of an inch thick, you will find that they can save you from receiving an uncomfortable shock that could prove fatal.

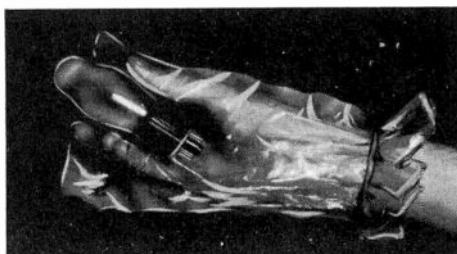

Fig. 221. If you must feel around inside the TV set with the voltage on, try protecting yourself.

bad tubes can be useful

Don't discard useless tubes! If the mixer section is good, old converter tubes, with the oscillator's grid pin removed, substitute in the tuner of a set being aligned. With no oscillator, there is no danger of spurious markers on the if trace.

A set of tubes with just heater pins left intact make it easy to put any stage temporarily out of action in a series set on the bench.

compound fills holes

When installing antennas on roofs, it is handy to carry a tube of calking compound in your toolkit to fill holes made by guy-wire anchors, and in window sills where a lead-in feeds through. The compound is more convenient to carry than tar since it comes in a tube like toothpaste and just one squeeze fills most holes.

fuse-clip burnisher

Clean and brighten the metal clips of tubular fuse holders with a 1½-inch wide strip of fine abrasive cloth (Fig. 222) wrapped around the ¼-inch shank of a screwdriver. The abrasive cloth is held in place with plastic tape. The fuse-size shank is an almost perfect fit and just a few

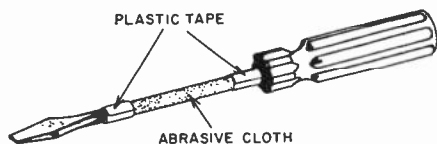

Fig. 222. Burnish fuse clips to avoid high resistance caused by corrosion.

turns of the handle makes fast work of burnishing the clip's inner surfaces. You will always come across a few really bad cases of high contact resistance due to slip corrosion, so make it a habit to clean fuse-clip contacts every time you replace a tubular fuse.

emergency antenna connector

If you are fresh out of antenna connectors for TV or radio, you can quickly make a satisfactory substitute from a spring type clothespin. Drill a small hole in each handle end of the clothespin and to these holes, by means of small machine bolts, fasten ordinary paperclips with their ends

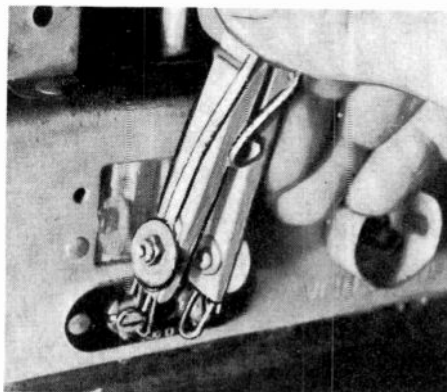

Fig. 223. A pair of paper clips, a spring-loaded clothespin, and you have yourself a TV antenna connector.

projecting about $\frac{1}{2}$ inch as in Fig. 223. Fasten antenna leads to the other ends of the paper clips and the device is complete. To use, merely squeeze the clothespin together at the top and place it between the antenna connections on the TV. It saves time and trouble.

liquid metal service aid

Ever attempt to replace a back on a TV set only to find the screw holes stripped and too enlarged for the screws?

Whenever you encounter a minor problem of this type, just reach into your toolkit for the tube of liquid metal that you should always carry. Now available at most hardware stores, the liquid plastic powdered-metal compound is very handy for many minor service problems. It dries hard like metal and can be used to mend wood, plastic, porcelain, glass and all kinds of metals. It can be drilled, filed, sanded, sawed and painted. Don't try to use it for solder joints designed to pass electricity, though—most of these compounds are pretty good insulators!

a resistor. By stocking these 150-ma silicon diodes you will eliminate the necessity of stocking an assortment of selenium rectifiers for tube-type radios.

mounting speaker transformers

When you fit a new output transformer onto an old speaker, the mounting holes are rarely in the same place and, if you are not careful, you can spend a lot of time getting it on firmly. Stop fiddling around with it. Cut a narrow strip of metal just long enough and wide enough to

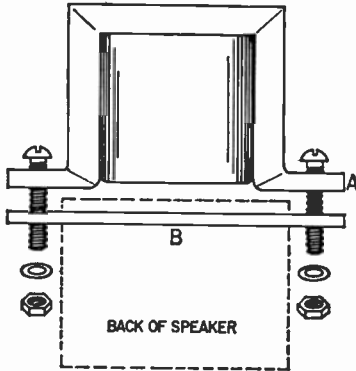

Fig. 302. Easy way to mount speaker transformers.

cover the transformer mounting lugs. Drill two holes to match those on the replacement transformer. Now slip the metal strip through the square mount at the back of the speaker and mount the transformer on top, securing it with two small nuts and bolts. The sketch in Fig. 302 is easy to follow.

boost fringe reception

The small five-tube receiver in fringe areas needs a little boost for good reception. The schematic in Fig. 303 shows how to supply it. Very little cost or time is involved. The only parts needed are some hookup wire and a small variable capacitor.

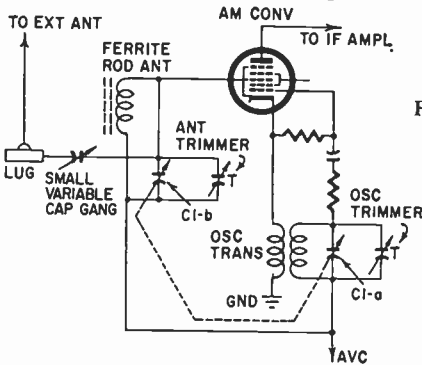

Fig. 303. Tuned antenna increases signal pickup.

Connect the little trimmer to the antenna section trimmer of the receiver's gang, and the other end to a floating lug located on the outside of the receiver.

Tune in a station and connect a wire from the floating lug to a metal window frame or any type of an antenna that is not grounded. Adjust the added variable capacitor (use a knob on its shaft), and the receiver will all but jump from its stand. The knob prevents body capacitance from affecting the capacitor setting.

earpiece repair

Some of the transistor radio earpieces have rubber ear inserts. After being used for a while, the ear insert gets sticky and the rubber eventually "rots" away. When this happens you have to get a new insert. You can make your own by simply obtaining a plastic cap like those on the plastic squeeze bottles that glue comes in. Drill a 5/32-inch hole in the small end of the cap. Then slip it over the earpiece knob. If the cap slides off the knob, sand the knob lightly and apply a small amount of glue.

insulate electrolytics

Many subminiature electrolytic capacitors do not have insulated cases. However, such insulation is often needed when the capacitor is used for interstage coupling, for example, and when the positive terminal is grounded and the case is hot. Also some have a metal case that is not connected to *either* terminal but must be insulated from the chassis to prevent noise.

A satisfactory solution to this problem *without covering capacitance and voltage markings* is to coat the capacitor with polystyrene coil dope. The coil dope should be thin enough to drip slowly. If it is too thin the coating will be too thin and if too thick it will be impossible to make a neat job. Use polystyrene coil dope thinner to get the right consistency. To apply, simply dip the capacitor in the coil dope and hold it under a 60-watt lamp for about a minute while rotating it with the fingers to obtain an even coat. Then hang it from a convenient support until dry.

straighten component leads

Here is a way to straighten that bent and twisted lead on resistors, capacitors and other components. After getting the lead as straight as possible with a pair of pliers or your fingers, place it between two blocks of wood. Roll the top block back and forth a few times and the lead will be straight as new. Works on insulated wire too.

high-q if transformers

Many experimenters do not like to use extremely high-Q if transformers in their receivers since they usually tend to make the if stages

form into insulating spaghetti in about 30 minutes. Once dry, the liquid latex rubber possesses about the same insulating qualities as latex rubber. It won't ever dry out and become brittle. If one coat of the insulation doesn't seem adequate, apply a second coat about 15 minutes after the first.

extra life for defective pots

Defective potentiometers are usually open or very erratic near one end of the resistance strip—ordinarily the low end. This makes them useless as volume controls. But there is still plenty of life in the other end of the strip for experimental work and some construction projects. Simply cut the lug off the defective end and use the other two lugs to obtain a variable resistor.

damaged tuning slug

Did you ever butcher the end of the brass screw of a tuning slug in an FM tuner? And then did you try to reslot the screw? Needless to say such attempts don't succeed too often.

Here is a technique you can try, though. First file the damaged end smooth. Then file a flat surface about $\frac{1}{4}$ -inch from the end, making that part of the stud half-round. Now an alignment tool with a recessed blade can be slipped over the flat end (as in Fig. 307) making it possible to turn the slug.

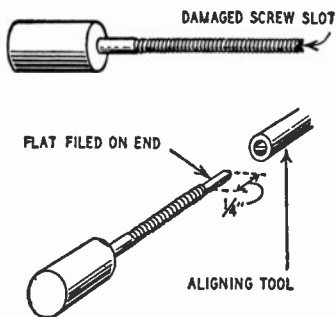

Fig. 307. File screw end so it can be turned by alignment tool.

Note that the flat end of the stud will find a snug fit in the tool or that part of the recessed head between one side of the blade and the wall of the tool itself. With this arrangement it is virtually impossible for the alignment tool to slip off or damage the end of the slug.

volume-control switches

When selecting switches to be mounted on volume controls, it is better to order double-pole, instead of the single-pole, units. The double-pole switches cost no more and are more versatile. They can be used to replace single-pole, double-pole or single-pole types with dummy lug.

vials hold batteries

Small plastic vials that are used as containers for five and dime store items can be made into ideal battery holders for compact transistor circuits. The vials are a perfect fit for penlight batteries and are very easily fitted with screw contacts at either end for voltage pickup.

The screw terminals at either end can be tightened to hold the batteries very securely in the case, thus assuring positive contact at all times.

power-transistor sockets

It's easy to make sockets for power transistors. Just take a new 7- or 9-pin tube socket, straighten the little hook at the bottom of a pin, and push it through the hole. This way you can take out as many pins as you need. Take the pins you have removed and solder them to the end of the wire you want to connect to the transistor's base or emitter, and push it on. For a neat and short-free job you can pull a piece of spaghetti over the joint of pin and wire. If you have only used tube sockets, break one with a hammer or pliers to free the pins.

freeing if coil slugs

Quite often trying to touch up the if alignment of an auto radio becomes a major job because one or two slugs refuse to budge. Usually, this is caused by wax the manufacturer drops into the core to keep vibration from affecting the receiver's alignment. Trying to force the slug may damage it, the coil or the alignment tool.

Most auto radio if slugs require a hex alignment tool and, as these tools are nonmetallic, they cannot be used to apply heat to the slug. Placing the receiver under a heat lamp will eventually soften the wax, but this needlessly subjects many parts to extreme temperatures.

An easy way to soften the wax holding an if slug is to heat an Allen wrench of the proper size with a soldering iron and insert it into the slug opening. This not only provides maximum transfer of heat but also provides a means of starting the slug.

substitution speaker

This little inexpensive substitution speaker permits you to check the audio circuits of most radio and TV sets without using the set's speaker.

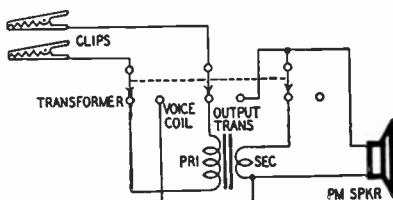

Fig. 308. *Easy-to-build substitute speaker.*

You need a small PM speaker with matching output transformer for pentodes (a 4-incher will do), a three-pole double-throw switch and a cabinet about 7½ inches wide, 7 inches high and 3 or 4 inches deep.

Wire the switch, speaker and test leads together as shown in Fig. 308. Now you can select either a direct connection to the voice coil or to the primary of the output transformer. Insulated clip leads are used for connecting to the set under test. You can mount the unit test speaker under a shelf above the bench with the leads hanging on a hook. In this way, it is out of the way yet available for instant use.

soldering hint

Ever ruin a transistor or other expensive component by overheating its leads when soldering it into a circuit? To eliminate this difficulty and speed soldering, hammer the solder flat before bringing it into contact with the joint to be soldered. This permits the solder to melt more readily, thus reducing the time the iron need be held in contact with the joint. This hint works equally well with both solid and rosin-core roll solder.

fusing transistors

The resistance of a fuse protecting class-B transistors can cause distortion if the drop across it, as current increases, affects bias as well as

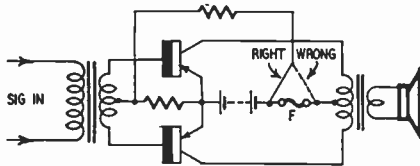

Fig. 309. Fuse can affect bias of transistor circuit.

collector voltage. Lower idle current can be used if the bias bleeder, whose resistance limits the base-to-emitter current, is fed from ahead of the fuse as shown in Fig. 309.

signal-seeking tuners

In the far reaches of the woods or for that picnic with the girl friend, you might like to have some music. It may be available in the car radio but the Signal-Seeking Tuner just won't latch onto such a weak signal. The automatic tuner keeps right on seeking, skipping over signals too low to actuate the trigger mechanism that shuts it off.

A remedy is to increase the pickup so that enough signal exists to kick the seeking mechanism off. Adding metal to the antenna is one method. A wire may be connected to the tip of the antenna and run to the radiator ornament. A clip will facilitate attachment to the antenna or the wire may be simply wrapped around. A piece of fiber or wood

with a couple of holes in it will insulate the added wire from the ornament.

In case nothing else is handy you can run the antenna to a nearby fence post, tree or other object. In some instances good results can be obtained merely by pushing the wire into the soil. The entire ground acts as an antenna because the tires insulate the vehicle from the ground.

test for hot chassis

Did you ever *slide* your finger tips or the back of your hand or your arm *lightly* over the surface of the cabinet or chassis of a connected ac-dc radio and feel the very rapid vibrations as the skin was rubbing over the surface? You were feeling the alternating pulsations of the house current because the chassis was on the hot side of the line. The vibrations can no longer be felt when the power plug is reversed in the outlet, thus putting the chassis on the grounded side of the line. You may have noticed this effect many times but has it occurred to you to use it as a quick test for a hot chassis? This effect is more pronounced in some radios than in others, and the skin on the back of the hand or on the arm is usually more sensitive than the finger tips. If you can feel the vibrations, you can use this trick as a reliable test for a hot chassis. It is sometimes desired to make a quick hot-chassis test when connecting other pieces of ac equipment to ac-dc radios. For example, when using an ac-dc radio as a tuner with a hi-fi amplifier, or when feeding the tuner of one radio into the amplifier of another radio, etc.

dial-stringing aid

A thick paste made by mixing powdered rosin and carbon tet is handy to have around when restringing dial cords. Where the dial cord is likely to slip off the drum or pulley before the job is completed, use a small gob of the paste to hold it in place. When the job is completed, use carbon tet to remove the paste. The rosin left on the cord will minimize the slippage in the future and make for a more positive hold.

a low-resistance ground

A good ground is useful on many electronic devices—a necessity on dx radios. Where rain is infrequent, or the soil may be dry for other reasons, some kind of automatic soil moistener is needed. Such an attachment is easy to make. Into one end of a 5- or 6-foot length of common $\frac{1}{4}$ -inch galvanized pipe drive a steel plug. This can be made out of about 3 inches of $\frac{1}{2}$ -inch diameter rod. The diameter should be ground down to about $\frac{3}{16}$ inch for $\frac{3}{4}$ inch of its length so that it can be driven firmly into the piece of pipe up to the shoulder and leave about $2\frac{1}{4}$ inches projecting. Next, grind this projection to a blunt point and drill a $\frac{1}{8}$ -inch hole right through the pipe just above the top end of the plug. This is a drain hole.

Drop a $\frac{3}{16}$ -inch hexagon-head machine screw into the opposite end

of the piece of pipe. It should just slide in to make a driving head and protect the end of the pipe from mushrooming. Drive the pipe into the earth where the ground lead is desired. Drive carefully so as not to bend the pipe. Leave about 6 inches projecting above the dirt level. Fill the pipe with a solution of copper sulphate in water. This deposits copper film on the inside of the pipe where the galvanizing may not be so good and also increases the conductivity of the soil near the bottom of the pipe where the solution leaks out through the two holes.

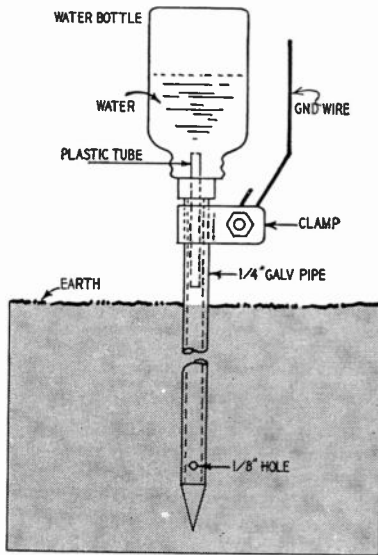

Fig. 310. *Technique for obtaining a good ground connection.*

Fasten the ground wire to the pipe by a clamp. The ground is now ready for use but the earth must be kept moist by pouring more water into the pipe. This can be made automatic by taking a bottle that holds around a half-pint or so and drilling a hole through its cork so that a 2½-inch length of ¼-inch outside diameter plastic tube can be forced in. Fill the bottle with water, put in the cork with the tube, invert into the pipe ground and the water will automatically feed into the pipe and thus keep the ground at the lower end moist and of low resistance. A sketch of the arrangement is shown in Fig. 310. The bottle should be filled once a month.

duplex signal tuning

Duplex signal positioning is an attractive feature, easily installed on most communications receivers, that enables the ham or SWL to switch from one side of the phone QSO to the other and eliminates tuning back and forth across the dial.

The procedure to follow is this: Install at some convenient spot on the receiver front panel a 1.8–8.7- μmf miniature variable capacitor with

dial plate and knob. Near by on the panel install a toggle, lever or slide-type spst switch. Wire the switch in series with the grid side of this midget variable as shown in Fig. 311. The stator plates go to ground or B minus. In most sets the midget capacitor is wired directly across the bandspread and main tuning capacitors.

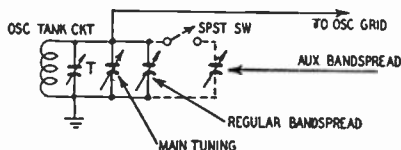

Fig. 311. *Simple modification permits duplex signal tuning.*

With the duplex signal positioning switch open, tune in a QSO. Only phone bands below 50 mc are recommended. Get station A and then wait until the conversation is turned over to station B. When station B takes over, flip the duplex positioning switch closed and tune in station B. Now the bandspread capacitor is handling station A. And your miniature variable with duplex switch closed will take care of station B. Actually, this same switching can be done with relays operated by the carriers. When station A cuts its carrier, station B is automatically switched over.

Remember that frequency lowers as capacitors mesh. Therefore it is advisable when spotting your stations on the dial to allow sufficient down-frequency coverage so that the complete spectrum of the phone band being used can be covered on the miniature. It sometimes takes practice to become accustomed to this new method of lining up your stations. But soon you will be more than satisfied with the ease with which you will be able to switch quickly from one side of the QSO to the other.

As might be expected, additional wire and other capacitances effect a slight change in the receiver oscillator settings. This may be amply compensated for by readjusting the receiver oscillator trimmer.

So long as the part of the band to be covered when using duplex positioning is below 50 mc, there is only slight rf loss in the receiver when, for instance, station B is a bit down the band from station A. Phone bands are comparatively narrow and the rf circuits are fairly broad so tracking and sensitivity will not suffer too much. This method of tuning works best when both stations are S7 or better.

auto speaker switching

While installing a rear-seat speaker in a car, you will generally require a three-way switch of the type usually used in these setups. However, you can use a spdt switch with a center off position that is less expensive and works. See Fig. 312.

When the switch is in the center (off) position, the speakers are in series and the power divides between them. Throwing the switch in one direction shorts the front speaker and full power is applied to the one

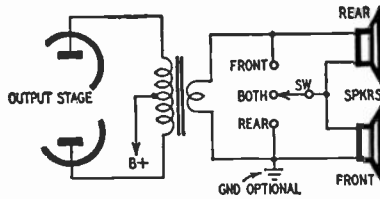

Fig. 312. Method of switching front and rear speakers in auto.

in the rear. In the opposite direction, the rear speaker is shorted and the front speaker receives full power.

rechargeable battery repair

Don't throw away your rechargeable 9-volt transistor radio battery if it works intermittently or goes dead suddenly. Internal acid leakage can corrode the wire connections inside the battery. Remove the top plate and the battery case, and solder in new leads. After resealing with cellophane tape, the battery may be as good as new.

transistor rectifier

Everyone knows that a junction transistor is made up of two rectifiers, but few have tried it for rectification purposes. Actually, the base-collector junction is very efficient when used as an ac rectifier.

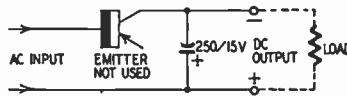

Fig. 313. High-power transistor makes suitable rectifier.

The circuit is shown in the diagram, Fig. 313. The transistor is any high-power p-n-p transistor, such as a 2N256 or 2N301. Load currents and voltages are shown below. In these tests the transistor junction was compared with that of a low-voltage (25-volt) selenium rectifier.

Ac volts	Load (ohms)	Load Current (ma)	
		Transistor	Selenium
12	12.5	600	500
10	8.	600	520
6	8.	350	280

If you find yourself without a high-current rectifier for a sudden experiment, try a transistor. Even a damaged unit may still be suitable as a rectifier. For example, it is quite possible that dead short may occur between emitter and base, without affecting the other junction. Under this condition, it is still possible to use the collector-base junction.

transistor mounting clips

Many transistors have pigtail leads and are usually soldered into a circuit. However, while this is fine for a 5-cent resistor or 10-cent capacitor, it is hardly recommended for a delicate unit that can cost several dollars, especially in experimental work where circuits are changed often. Not only do the leads become messed up after several solderings and unsolderings, but there is always the chance of heat damage.

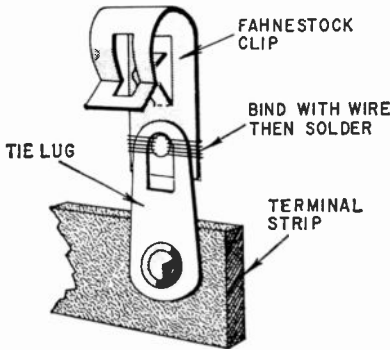

Fig. 314. Fahnestock clips supply easy and quick way for mounting transistors.

To avoid these problems and protect your investment in transistors, fasten three Fahnestock clips to the lugs of a three-lug terminal strip. The clips are firmly bound to the lugs with short pieces of wire (Fig. 314) and soldered together. Circuit leads are then soldered to the clips and the transistor leads are inserted in them after all soldering is completed.

new line cord

When a set is received for servicing, you may find a new line cord has been spliced to the old one close to the chassis. Obviously, the old line cord wore out and the owner spliced a new one on, not considering himself capable of connecting the new cord directly into the set's wiring. However, this is a useful extra service the technician can perform. It takes only a couple of minutes to disconnect the old line cord from the set, cut the splice and wire the new cord in instead.

extra heat sink for power transistors

The popular types of power transistors have metal cases and are intended to be bolted to a metal chassis or other sheet of metal, which acts as a heat sink to absorb some of the transistor heat. However, there is no provision for drawing off heat from the top of the transistor. It's a

good idea to tape a copper coin (Fig. 315) or iron washer to the top of the transistor as a secondary heat sink.

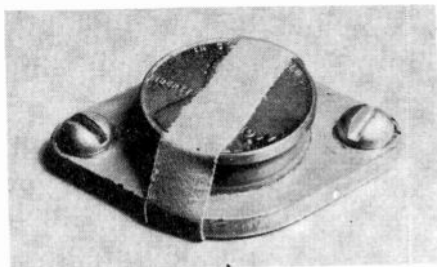

Fig. 315. Washers or coins can be used to supplement existing heat sink.

more room in auto radios

Many radio amateurs use their car radios with converters as mobile shortwave receivers. When so used, it is sometimes desirable to add noise limiters or extra if amplifiers to the receiver. This is usually difficult as space inside these radios is limited. However, with some sets, there is a way out. Some auto radios have the speaker mounted in the same case with the chassis and often have a large cutout in the chassis to accommodate the speaker frame. If the speaker is removed from the radio's case and mounted elsewhere in the car, a small subchassis can be mounted in this cutout, allowing room for any desired additional circuits.

simplify mounting problems

Mounting radio parts such as transformers is a cinch if you have a tube of Duro plastic aluminum or steel (Fig. 316) at hand. You can literally

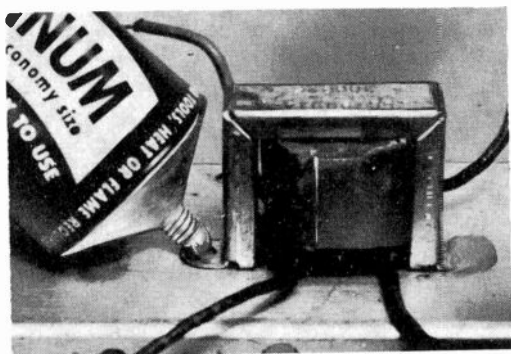

Fig. 316. Use plastic aluminum or steel for quick mounting of transformers.

solder or weld the part to the metal chassis without ever plugging in a soldering iron. And once dry, the liquid metal forms a strong bond between part and chassis.

heat-sink insulator

When commonly recommended materials are not readily available for insulating a transistor from a heat sink, an excellent substitute is varnished cambric.

It can be found around most service shops, particularly in the high-voltage cages of discarded TV sets. It has excellent insulation qualities, can be cut to any shape with a pair of scissors and has fine heat-conducting ability. Be sure to coat the cambric with silicone grease before using it.

battery protection

Use fingernail polish to coat the positive poles of extra flashlight cells carried in your tool kit. The polish insulates the cells so they don't lose their charge when stored among tools. When you are ready to use a battery, peel off the polish.

rectifier tests

Like the tubes they replace, selenium rectifiers gradually grow weak. In TV sets a common symptom of a weak selenium rectifier is insufficient width (sometimes also height). Ac-dc radios with weak rectifiers often cut off when an appliance such as a refrigerator or an oil burner goes on.

Selenium rectifiers can be checked by ohmmeters and selenium rectifier testers, but there is no check as positive as direct substitution. The rectifier need not be removed or unsoldered to check it. All that is needed is to parallel an equal-size (or larger) unit across its terminals, observing polarity, of course. If it is inconvenient (as in some sets) to get across both terminals, the first and last heat dissipating plates will do equally well. A pair of test leads with color-coded alligator clips on one end and corresponding color-coded test prods on the other makes a handy and useful test unit. A good selenium rectifier is inserted in the clips. If the original unit is O.K., little or no improvement will be noticed. In sets with two selenium rectifiers replace both units if improvement is noted as each is bridged. When checking radios, reduce the line voltage with a Variac or similar control until the set cuts off. When a defective rectifier is shunted with the test unit, the set will come to life, then go off again when the test unit is removed.

With selenium rectifiers that are shorted or have developed a high reverse current, the nose will be the best test. The sickening odor of spoiled eggs common to this type of failures is easily detected.

receiver calibration

A good receiver must be properly calibrated whether it is calibrated directly in frequency or a dial number. Dial calibration requires stable secondary standards plus some way of determining whether you are tuned to an even or odd harmonic. By itself, a 100-kc oscillator is not adequate for this purpose. The least expensive way to identify harmonics is to add

a 200-kc crystal oscillator with a trimmer capacitor across the crystal. (See Fig. 317.) Once a zero-beat setting is established, turning the trimmer slightly higher or lower lets the operator distinguish between odd and even harmonics of 100 kc. Tuning a receiver to even harmonics produces

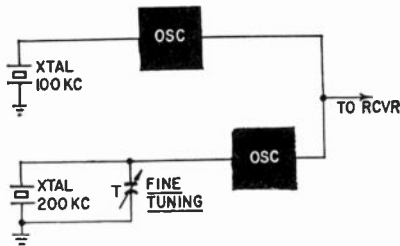

Fig. 317. A pair of crystal oscillators can be used for receiver calibration.

an audio tone while odd harmonics give off only an rf signal. Be careful not to overload the receiver, for too high an output fed into a non-linear amplifier will produce unwanted beat frequencies.

telephone antenna

Many a technician has encountered the landlord who would not stand for an outdoor antenna. A simple solution to this problem is to take a 10-foot length of insulated indoor antenna wire and wrap one end into a 4-inch coil of about 6 turns. Place this coil under the base of a desk telephone and fasten the other end to the antenna terminals of the AM receiver.

The electrostatic or capacitive coupling between the coil of wire and the phone base transfers rf signals picked up by the external telephone lines to the lead-in and on to the AM receiver.

grommet protects transistors

To protect a transistor from blows that are likely to injure it internally, slip a rubber grommet over the transistor's case (Fig. 318). The grommet makes a protective bumper that wards off damaging blows. Grommets are available that will fit almost every round or oval transistor.

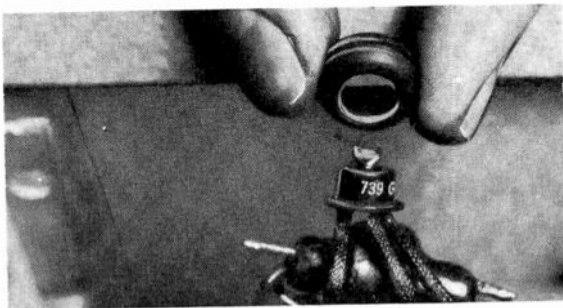

Fig. 318. Grommet makes rubber bumper for transistor.

dial-cord restringing

It's no cinch to restring a dial mechanism because the dial cord has a tendency to slip off the various pulleys as restringing progresses. This can be prevented by tacking the cord in place on each pulley with a small glob

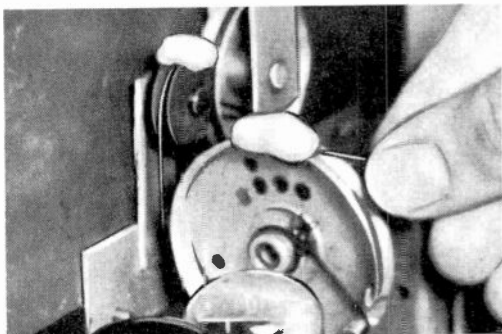

Fig. 319. Modeling clay keeps slipping dial cord in place during restringing.

of modeling clay (Fig. 319) until the tension spring has been fastened. This holds the cord securely and is easy to remove once the dial has been restrung.

transistor life saver

Before you start to solder a component into a radio, TV or other electronic device disconnect the power cord, external ground or any test

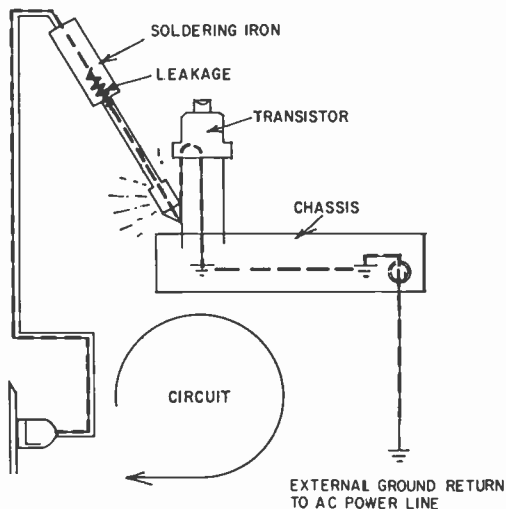

Fig. 320. Soldering-iron leakage can ruin transistor.

equipment before you touch your soldering iron to a solder junction. Just the normal, capacitive-current-leakage from the element to the tip may be sufficient to ruin a transistor. Of course if there happens to be a defect in the iron, a leakage current could ruin other components (electrolytic capacitors in particular) by having as high as 120-volts applied across them. The leakage path, in either case, as shown in Fig. 320, is from the power line, through the iron's tip, through the transistor to chassis ground and completed through the external ground. A piece of test equipment with an ac-dc power supply or a transformer supply with a leaky primary winding or line surge capacitor can be equally destructive.

loopstick tracking

Ferrite-core antennas are used almost exclusively in transistor radios. If one is replaced, it may need adjusting for satisfactory tracking.

The sketch in Fig. 321 shows the usual circuit and the physical connections to the antenna. Tracking is adjusted by removing turns from

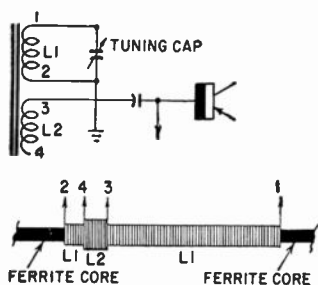

Fig. 321. *Loopstick replacement in transistor radio may require adjustment for satisfactory tracking.*

the long coil (L1) at the end away from the secondary coil (L2). Turns should not be removed from terminal 2, since mutual coupling to the low-impedance transistor coupling coil (L2) may be upset. Take off turns at lead 1 a few at a time.

anchoring amplifier cover

IF THE COVER of your amplifier chassis is held by spring clips be very careful when anyone else is to lift the unit. The chances are they'll get a grip on the cover and you'll hear a crash as the amplifier hits the floor! The fastening shown in Fig. 401 was installed after two such accidents. While the amplifier managed to survive, there's no sense in its being subjected to another shock test.

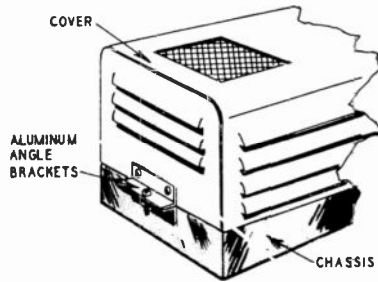

Fig. 401. Aluminum angle brackets keep the cover and chassis joined securely.

Fasten pieces of aluminum angle stock to the cover and chassis at each end. They form flanges that may be bolted together, and also serve as handles for lifting. Keeping the bolts tight tends to have a beneficial effect, too—it discourages knob twisters from disturbing critical screw-driver adjustments under the cover!

plug adapter

With the increasing popularity of miniature mike connectors, an adapter is needed to connect a standard phono plug quickly and easily to a miniature mike jack.

The photo, Fig. 402, shows the extreme simplicity of the adapter. It is merely a miniature mike connector with the setscrew and cord protecting spring removed. The miniature mike connector fits on the mini-

ature mike chassis unit in the usual manner and the standard phono pin plugs onto the end of the mike connector, making a snug fit.

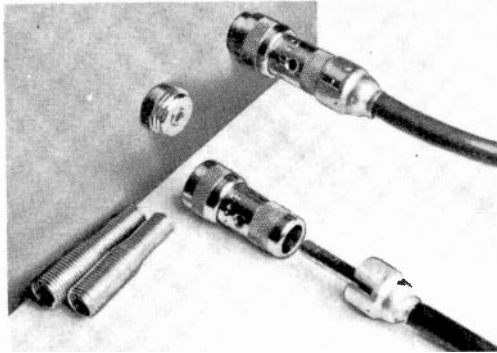

Fig. 402. Adapter for connecting standard phono plug to miniature mike jack.

When you push the phono plug onto the end of the mike connector, the pin on the phono plug contacts the eyelet in the front end of the mike connector. This makes a good temporary connection as long as you don't pull too hard on the phono cord.

hum suppression

There are several effective, but not too well known, ways of suppressing hum. Basically they consist of injecting into the circuit a voltage 180° out

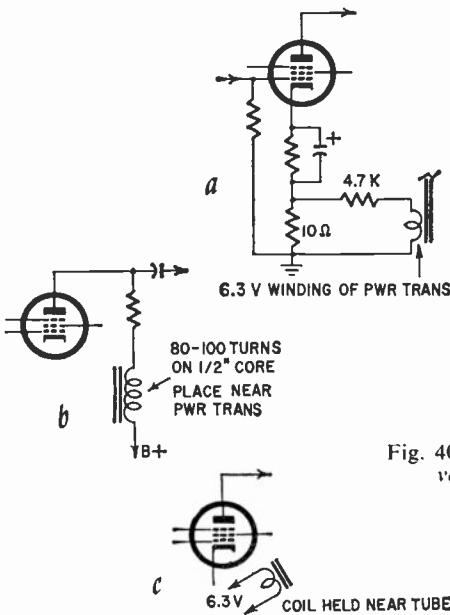

Fig. 403 Three hum-bucking voltage techniques.

of phase with the hum voltage. Fig. 403-a shows how some voltage from the power transformer is fed to the cathode of one of the tubes—usually a preamplifier. If the hum increases, reverse the connections on the heater winding. The value of the 4,700-ohm resistor can be increased or decreased for fine adjustment.

Fig. 403-b shows a small coil of approximately 80 to 100 turns wound on a ½-inch core which can be placed in either the plate, grid or cathode circuit and held near the power transformer and rotated until the hum diminishes.

The arrangement in Fig. 403-c is used for tubes with heavy heater-current drain. The coil is 500 turns of fine wire wound on a ½-inch core. The coil and core of a 6-volt ac relay should work nicely.

audio test rig

To save a trip to the shop with an audio chassis, use this simple audio test rig—turntable, capacitor substitutor and output unit, as shown in Fig.

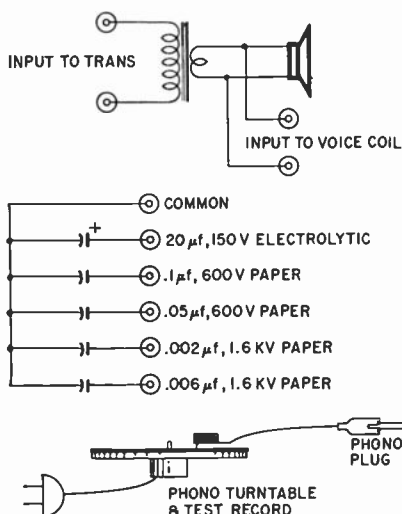

Fig. 404. Audio test rig for home servicing.

404, built into a carrying case. It lets you check for a variety of common faults in the home and speeds servicing time.

tape-splicer cleaning

One of the hardest cleanup jobs the tape-recording fan runs into is that of removing the tiny bits of magnetic tape that get stuck in the hinge of the splicer where they are likely to be caught in the splicing tape. The solution to the problem is simple. Just use a small magnet (you can salvage one from an ion trap) to pick the scraps of tape out of the

splicer (Fig. 405). The tape, of course, is magnetic and is attracted to the magnet. A word of caution: Demagnetize the splicer occasionally to avoid damaging valuable recordings.

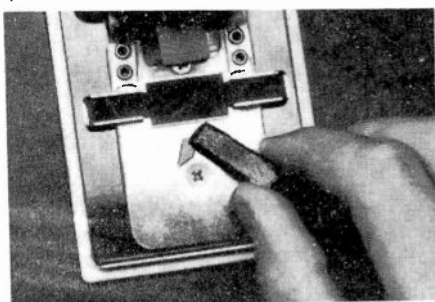

Fig. 405. Small magnet removes tape scraps from splicer.

examining phono stylus

If you want to examine the point of a phono stylus and don't have a microscope, you can use the viewfinder on a small folding camera. Just hold the stylus close to the small lens in the front of the finder and look in at the top. You will find that the viewfinder makes a powerful magnifying glass for examining tips of recording and playback styli.

When using the viewfinder on the larger folding cameras, it may be necessary to unscrew the front lens and hold it in your hand to bring the stylus into focus. This is not necessary with vest-pocket models. In either case, shine a strong light on the stylus tip while examining it.

control guides

Potentiometers with short, slotted shafts are frequently used for preset adjustments in commercial and home-constructed equipment. Adjusting

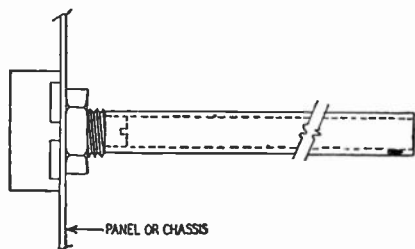

Fig. 406. Short length of tubing works as guide for screwdriver adjustment.

these may sometimes be difficult if the shaft is closely surrounded by other components. A guide consisting of a suitable length of ¼-inch-diameter vinyl tubing (Fig. 406) or insulating spaghetti slipped over the short shaft stub permanently will guide and insulate the screwdriver.

timing tape recorders

Maintaining correct speed of tape machines is a point often overlooked by home recordists. The oversight is justified, however, because the recordist seldom—if ever—has occasion to play his tapes on any machine except his own. Hence, no variation in pitch or tempo is detectable. If he buys a new recorder or makes tapes for use on other machines, he is likely to be dismayed to find the original tapes either too fast or too slow. The same applies in the reproduction of commercial pre-recorded tapes.

Here is a simple method of determining the actual operating speed of a recorder: Use a piece of blank tape carefully measured and cut to a length five times the rated speed of your recorder, adding an extra ¼ inch for splicing purposes. (For instance, a 7½-ips recorder requires a total length of 37¾ inches.) Make sure both ends are square. Overlap the ends of this strip ¼ inch, make a diagonal cut and splice in the usual manner.

Thread this loop into the recorder so that it can run continuously without obstruction. Switch to MICROPHONE-RECORD, turn recording gain about half open and thump the microphone once with your finger. Stop the recorder immediately so that this thump will not be erased when the loop begins to repeat its run.

Now set the recorder in playback position. Synchronize a stop watch or the second hand of your wrist watch with the first thump and count the total number occurring within a 120-second interval. This count, divided by a factor X (shown in table) gives the actual operating speed of your recorder.

$$\text{Actual speed} = \frac{\text{Thumps in 120 sec}}{X}$$

<u>X</u>	<u>Rated speed of recorder</u> (ips)
1.6	15
3.2	7.5
6.4	3.75
12.8	1.875

If the recorder is running true, you should count 24 thumps. Assuming a rated speed of 7.5 ips, a count of 23 would indicate an actual speed of 7.19 ips. A count of 25 would indicate 7.81 ips. Both these figures represent an approximate 5% deviation from the ideal—which means that

musical pitch is raised or lowered by less than a half tone. To many people this is hardly detectable, if reproduction is from a prerecorded tape. However a critical listener might be disturbed by this slight change of pitch and tempo. If your recorder deviates as much as 2 counts per 120 seconds, this represents an approximate 10% error, which is serious.

If a timing loop isn't long enough to clear all obstructions on the recorder, it may be made twice the ordinary length (but do *not* double the extra $\frac{1}{4}$ inch added for splicing). In this case divide the factor X by 2 for determining actual speed.

If you are interested only in measuring 15- and 7½-ips tapes, the tape may be made 60 inches long. Then a 15-ips tape will give 30 thumps and a 7½-inch one 15 thumps each 120-second period. X then is equal to 2 in each case.

speaker repairs

When the voice-coil lead on a speaker breaks close to the cone at a point that cannot be reached from the rear with a soldering iron, cut a V (not a triangle) in the cone over the spot where the lead is to be soldered.

Bend the point of the V outward and insert the soldering iron into the opening to make the repair. Bend the V-flap back, match the edges and apply cone cement to form a solid seam over the cut. If you are careful, the repair can be made without noticeably changing the speaker's response.

recorder cleaning kink

Tape recording enthusiasts who take pride in keeping their recorder in tip-top running condition will be interested to know that an empty plastic squeeze bottle (Fig. 407) makes a handy addition to a tape recordist's

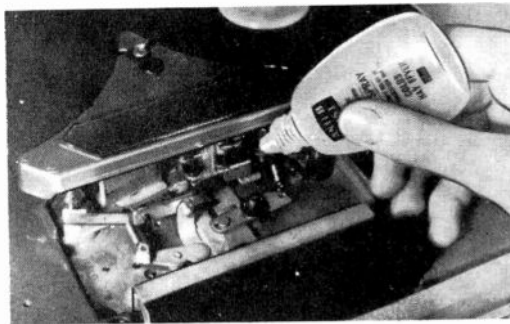

Fig. 407. Plastic squeeze bottle is useful blower.

cleaning and lubricating kit. It makes a handy miniature air gun for blowing metallic dust particles from a recorder's mechanism. To make the air gun work more efficiently, pry out the neck plug and remove the inside spray tube. Then replace the plug.

rubbing voice coil

One of the most common causes for speaker replacement is a voice coil that rubs the pole piece and causes distortion. This is usually due to the cone shrinking or stretching unevenly and exerting more pull on one side of the voice coil. There is a way to make temporary repairs that enable the customer to use his set until a replacement is obtained.

Use a razor blade to cut completely around the cone just above the voice coil terminals and then slightly flex the voice coil to return it to its correct centered position. Now, all that is necessary is to close the incision with genuine (nonshrinking) speaker cement.

erratic record players

Slippage in the friction-drive mechanism of rim-driven phono turntables often causes erratic and unsatisfactory performance in record players. If this condition cannot be corrected with normal service adjustments, paint liquid nonslip compound on the inner rim of the turntable, the edge of the rubber-tired drive wheel and on the metal shaft that engages and drives it. The stick type nonslip compound is not nearly as effective as the liquid on record players but it is very good for use on dial cords.

changer stylus skips or sticks

There are three things to check when you run into this problem. First is stylus pressure. Too light and the stylus skips; too high and it may skip. Next is a worn stylus or one that is clogged with dirt or lint. A tone arm that does not pivot freely or whose movement is limited by tight pickup leads can also cause record skip.

improve portable record players

Many "economy" portable record players are now in use. Most are owned by teenagers who need all the volume they can get while dancing. To get sufficient volume the gain control must be fully advanced, but often this is still not quite enough, especially after the pickup's output drops because of aging.

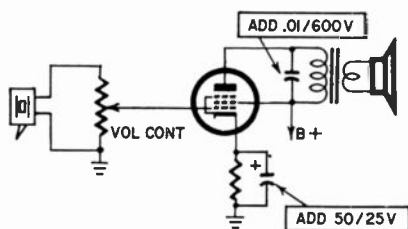

Fig. 408. Adding cathode bypass increases gain.

These record players feature a one-tube audio amplifier which is stripped to the basic essentials, as is shown in the schematic in Fig. 408. But for less than a dollar, gain and quality of reproduction of such an amplifier can be greatly improved. Simply connect a 50- μf 25-volt electrolytic across the cathode resistor. This increases gain by eliminating the degeneration in the cathode circuit. Any advantage that an unbypassed cathode may have in reducing distortion is offset by the small speaker these record players have.

To improve the quality of reproduction, connect a .01- μf 600-volt capacitor across the output transformer's primary. This eliminates most of the record surface noise, acting as a tone control, and prevents saturation of the output transformer by high frequencies. Today's hi-fi records really contain plenty of high frequencies. Be sure to use a 600-volt capacitor as one of lower voltage may short due to the high peak voltages generated by the transformer's inductance.

tape recorder kink

If you have ever picked up a tape recorder by its carrying handle while reels of recording tape were still on the spindles, you'll remember how the reels of tape slipped off and fell crashing to the floor in a tangled mess. You can take measures to keep it from happening again. Before

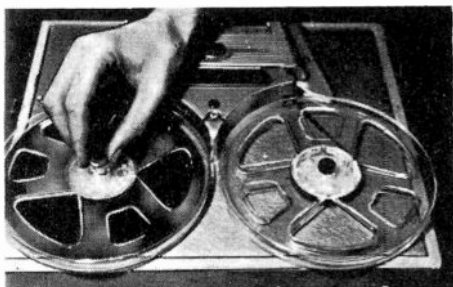

Fig. 409. Grommets keep spindles from flying off.

handling the recorder when there are reels of tape on the spindles, slip a tight-fitting rubber grommet (Fig. 409) over each spindle. This keeps the reels of tape from slipping off.

recorder mike stand

The tape recording enthusiast who has no stand-mounted mike can easily mount his hand-held mike on a base removed from a discarded electric desk fan. Mount it as shown in Fig. 410, by making a loop from TV ribbon line, punching a hole near either end, and fastening the loop to the fan base with a machine screw and washers. (You have to space the holes in the loop and determine its length for a snug fit by wrapping the

lead around the contour of your individual mike.) Once you have the lead fastened in place on the base, all you need do is to force fit the mike into the loop's opening. Using the base as a stand, you can quickly mount or dismount the mike and angle it up or down for good sound pickup.



Fig. 410. Base of old fan can be used as support for mike.

service syringe

A little gadget you should carry in your tool kit is handy as a service syringe. It's a plastic squeeze bottle with a length of small-diameter insulating spaghetti added as a far-reaching nozzle (Fig. 411). Use the



Fig. 411. Plastic bottle with added nozzle gets lubrication into tight spots.

tool as an oil can to apply oil to the drives of phonos and tape recorders. It might even be used to apply cleaner to noisy controls. There are probably many other uses.

record changer hum

Rubber washers are generally used between the motor mounting bolts and the changer base. If the rubber hardens or if the bolts are tightened

excessively, motor vibration can be transferred to the changer's frame and thence through the turntable to the record and needle, causing hum. If the hum stops when you short the pickup terminals with a screwdriver while the needle is resting on a stationary record (speed selector in neutral), motor vibrations are the probable cause. Examine the motor mounting and replace the rubber washers if necessary.

storing recorded tapes

Do you have reels and reels of tape, but no safe place to keep them? A look around the kitchen will solve the problem—empty potato-chip cans. They are about 7¼ inches in diameter and about 10 inches high—good for holding twenty 7-inch reels. Smaller cans for smaller reels can also be obtained and are very convenient.

simple feedback connection

You can add inverse feedback to an audio amplifier, radio, TV set or small phonograph in a very simple manner. Just disconnect the plate load resistor of the first audio tube from B-plus and connect it to the plate of the output tube. Thus, that resistor now serves as both a plate load and a feedback resistor. The degree of feedback can be changed by changing the value of this resistor—lower values for more feedback.

new flock for turntable

Have you ever tried to pry the C washer off the spindle on a record player only to have the screwdriver slip and run a gash across the face of the turntable? With a little time and patience such an accident can be remedied with no one the wiser.

First scrape some flocking off the rim of the turntable with a penknife. In most cases the turntable is set down in a well and the rim is out of view. Next, carefully apply some general-purpose cement to the gash and brush on some of the flocking. If this is done neatly, once the cement is set you will never know the difference.

mat on the bench

YOU CAN USE a rubber utility mat on the bench in your shop for a number of odd jobs. It makes a handy pix-tube pad when you have to lay a chassis on its side and a catch-all for screws, nuts and other small parts removed from a set. When you have to empty a box of parts to find one of the value you need, pour them out on the mat. After you get the right one, the mat is folded and the parts easily poured back into their container. Can't you think of some other uses for one of these mats on your bench?

kit-building kink

When building electronic devices from kits, you can save yourself considerable time and get more enjoyment out of the hobby if you sort out all the small components (resistors, capacitors, etc.), and lay them

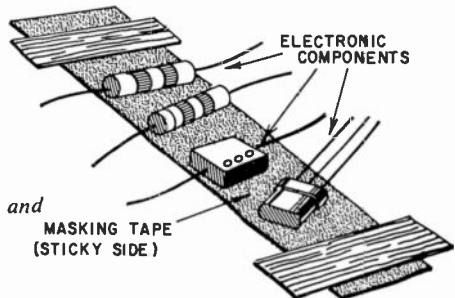

Fig. 501. Masking tape keeps parts and hardware safely at hand.

out in an orderly manner on a strip of masking tape (as shown in Fig. 501) taped sticky-side up to the bench top. Small easily lost hardware can be safely held in the same manner for easy selection.

coil insulation

Sometimes the experimenter, constructor or ham operator winding a coil or small transformer finds himself up against it for a suitable cambric, paper or cloth to insulate the windings. This problem can often be solved by resorting to the common plastic bag, found in the cupboard, tucked away in a corner of the refrigerator or wrapped around the shirts you just had dry-cleaned.

The average plastic bag is thin, resilient, lightweight, moisture-resistant and tough. When this plastic is used in low-wattage units, it provides very satisfactory insulation. At the same time, readily available as it is, it costs you nothing.

double-duty allen wrench

To get at Phillips-head screws in cramped quarters, grind one end of an Allen wrench to fit the screw slots. Pocket-sized, such a screwdriver will loosen the most stubborn screw, and its unaltered end can be used for the regular Allen setscrews.

transistor socket mount

A mount for transistor sockets will simplify many-experimental transistor circuit layouts. Such a unit can be made from a terminal board. Drill a hole in the center of the board (Fig. 502). Put the socket in the hole and cement it in place. Then connect the socket pins to the board terminals. The extra board terminals make convenient tie points for associated components.

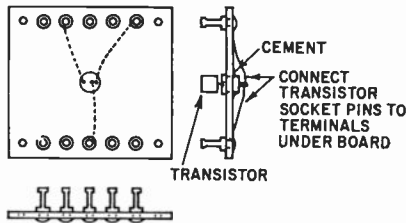

Fig. 502. Terminal board supplies mount for transistor socket.

keep jumpers untangled

Almost every service technician uses jumpers, and they are usually all tangled up when not in use. An easy way to keep this from happening is to hook one clip on the other (Fig. 503) before hanging up the jumper. Now any number of jumpers can be hung on the same nail with little chance of entanglement.



Fig. 503. Simple way of keeping jumpers untangled and ready for use.

pencil-iron tinning

When a file is used on the screw-on tip of a pencil iron preparatory to tinning, there's a good chance of loosening the heating-element barrel that

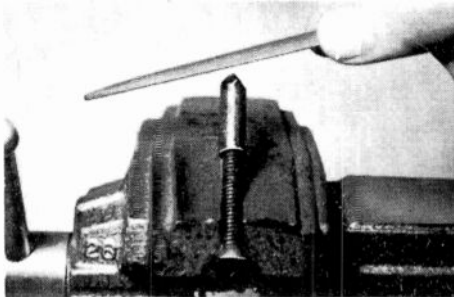

Fig. 504. This method of filing an iron tip won't damage the heating element.

the tip screws onto. Rather than chance this possibility of ruining the heating element, unscrew the tip and screw it onto a bolt or screw clamped in a vise as shown in Fig. 504.

universal vise

For work on devices that are hard to hold in just the right position—such as a small chassis—you can use a panoramic tripod head. A small angle bracket is welded to a C-clamp, and a hole tapped for $\frac{1}{4}$ -20 thread to fit the tripod screw. A same-size machine screw is used to fasten the

soldering-iron holder

When you need both hands free for a soldering job, this simple holder (Fig. 509) is good to have around. It consists of a spring type broom clip

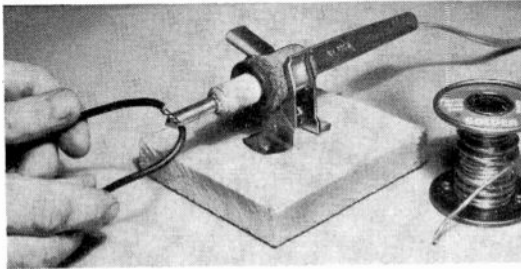

Fig. 509. *Spring-loaded broom clip has a new job.*

fastened to a block of wood. A hole drilled in the base lets you hang the whole works on a nail driven into the shop wall, when the holder isn't in use.

penicillin syringes

Ask your doctor to save empty disposable penicillin syringes for you. They are convenient containers and applicators for oil, contact cleaner and other service chemicals. The syringes take up very little space in the tool kit and are handy for forcing liquids into hard-to-reach spots.

stay-put trouble light

If you use a trouble light like the one shown in Fig. 510, you know just how difficult it is to make it stay put on a flat surface. Keep the light

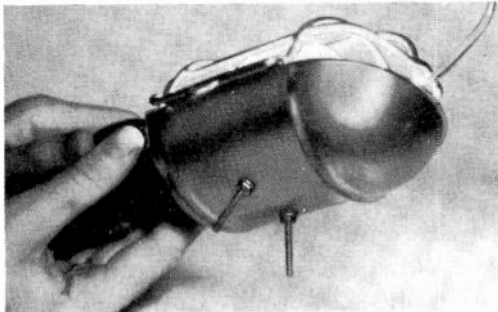

Fig. 510. *A pair of feet keep the lamp from rolling.*

from rolling out of position by adding a couple of legs. Drill two holes through the reflector and insert a 1¼-inch long machine screw in each.

screwdriver modification

When working on electronics gear, you sometimes encounter screws in out-of-reach places accessible only to an offset screwdriver. You will

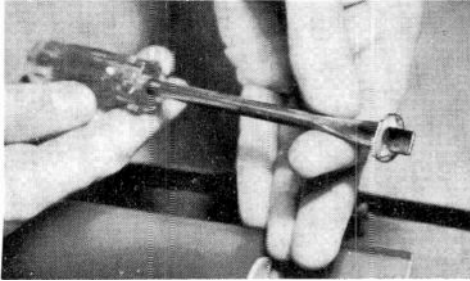

Fig. 511. *Metal washer makes screwdriver an offset type.*

always have an offset driver handy if you convert a regular screwdriver by soldering a metal washer to the blade near the tip as shown in Fig. 511. File two edges of the washer flat like the tip of a screwdriver.

gun carries own sander

When soldering, a little sandpaper or other form of abrasive is often needed for cleaning wire tips, lugs, etc. A small square of sandpaper taped to the side of your soldering gun (Fig. 512) can save you much wasted time and needless steps hunting for sandpaper when in the midst of a soldering job. Tape a piece to your gun now, before you forget!

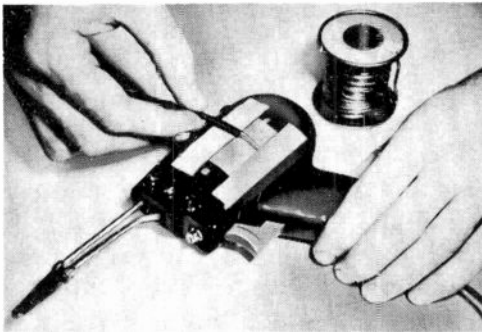

Fig. 512. *Strip of sandpaper is always handy when taped to side of gun.*

sticky relay cure

If the moving armature of a relay touches the pole piece after it has pulled in, the relay may not release the armature at the prescribed dropout current or voltage across it.

The cure is *smooth* insulating material cemented to either the pole piece or the armature. Use varnished cambric, Mylar, etc. Cellophane tape is good in an emergency but crinkles with age.

Be sure to remove any surplus adhesive as the relay may be even more sticky if the surface is not smooth.

soldering tip

Some of the tips used with the Ungar soldering pencil are small copper rods screwed into the main copper body. The performance of these tips depends on heat conduction into the tip. A simple way to improve this is to flow a little solder into the joint between tip and body, making a much better conductor than the mere physical contact normally obtained.

thumb screw wrench

An effective tool to tighten or loosen thumbscrews quickly can be made from a discarded socket wrench. For this purpose a cheap socket is pre-

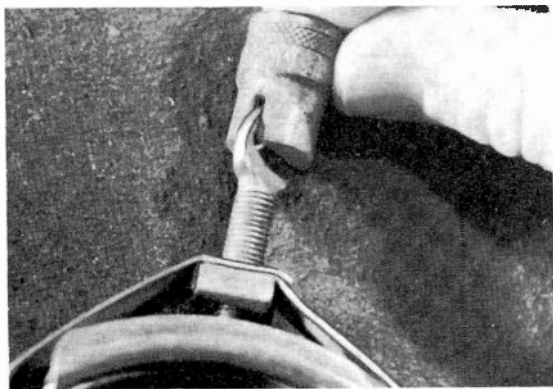

Fig. 513. *Old socket wrench makes fine tool for thumbscrews.*

ferred since it is made of soft steel which can be readily cut. Saw a rather deep, wide slot in the socket (Fig. 513) and it can be used with a socket-wrench speed handle. It will save a lot of time and turning effort.

tube carrier

Plastic flower boxes are available in various sizes, and may be used as lightweight durable carriers for shop equipment. Tubes which are kept on hand for use as trial tests may be handily stored and transported to and from the test bench in such a box. The box in the photo (Fig. 514) is about 28½ inches long and 6½ inches wide at the top and about 6 inches deep.

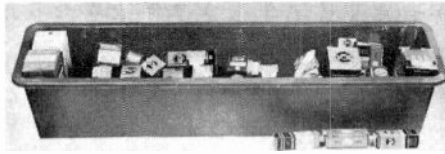

Fig. 514. Use plastic flower box for carrying tubes and tools.

clothespin eases prod handling

By attaching your test prods to the legs of a wooden spring type clothespin with rubber bands as shown in Fig. 515, you will be able to handle them much more easily. Since both prods are attached to each other,

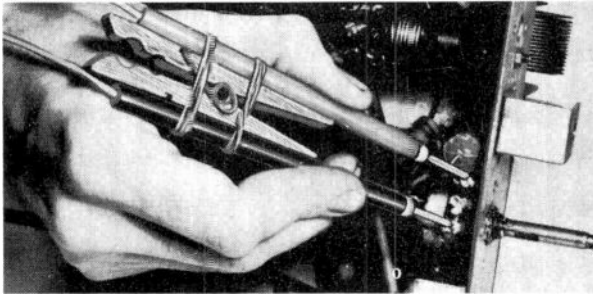

Fig. 515. Spring-loaded clothespin and a pair of test prods make unique tool.

you can handle them single-handed. Just a squeeze puts the tips closer together to touch test points only a short distance apart. You will find this clothespin-and-prod arrangement a real convenience once you get used to working with it.

phillips screwdrivers

Occasionally, use a triangular file on the head of your Phillips screwdrivers to remove nicks and burrs. This lets them get a tight grip and prevents stripping the screw heads.

danger—high-voltage

While high-voltage indicator lamps are useful, one is apt to get used to seeing them lit and make the wrong move anyway. A blinker lamp will do a much better job of keeping one's subconscious informed that lethal high voltage is on. A very simple neon-lamp blinker can be made and

installed in less than 1/2 hour using only one capacitor, three resistors and a 1/4-watt neon lamp.

The value of resistance shown in Fig. 516 is about right for a 1,250-volt supply and produces about one blink per second. This resistance must be

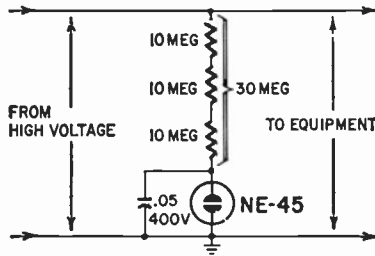

Fig. 516. *Blinker flashes constant reminder of high voltage.*

adjusted according to the voltage of the power supply being used and the desired blink rate.

If the neon light glows steadily, the resistance is too low. Use a clear-glass jewel.

handy bending brake

Making neat bends in thin sheet metal for an odd-sized chassis or cabinet is usually a difficult job for the average constructor who does not have a bending brake. Here is a way to simplify this problem.

Have a lumber yard cut three pieces of wood 17 inches long, 4 inches wide and 1 inch thick and then run the saw down the center of the 1-inch side. Make the slot 1 inch deep in one piece, 2 inches deep in another and 3 inches in the last. The saw blade should be approximately 3/32 inch thick.

To use these improvised brakes, simply insert the edge of the metal to be bent into the proper slot (1, 2 or 3 inches, depending on the depth of the bend) and then slowly make the bend to the required angle. You can make neat bends with very little effort. If you have the tools, you can make these brakes yourself from scrap lumber.

emergency contact plug

There are times when the constructor, experimenter or ham needs a small male plug and matching receptacle with five, six, or seven pins. He is usually stumped until he can get to the local distributor or order one by mail. Here is a substitute.

Take a miniature tube socket, preferably one of the molded types, and insert in each prong hole a 1-inch length of No. 20 solid copper wire. Extend these wires until they go down through the socket. Solder the

extruding ends to socket lugs, allowing sufficient solder to flow in and around wires where they extend through the prongs so that they are firmly held in place to form the male plug prongs. Trim and bend for proper alignment and insertion. You now have an emergency male plug that will pass for the best.

solder dispenser

A small medicine bottle or five and dime store plastic vial makes a handy solder dispenser for the toolkit, convenient and easy to use. Just wind a coil of solder around a pencil or other form, and drop it into the bottle. Punch a small hole in the bottle's lid and thread the solder out through it. Pull out more solder as needed while soldering.

splicing stranded wire

When splicing two stranded wires, some technicians simply wrap the severed ends around each other before taping. A slight tug on such a splice pulls it apart, often causing blown fuses and service callbacks.

A better method is first to tie the bared ends with a tight square knot

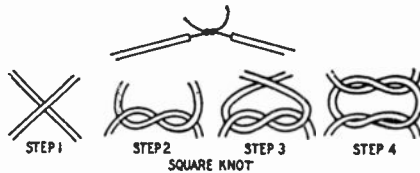

Fig. 517. Proper method of splicing keeps wires firmly joined.

(see Fig. 517) and then wrap the ends around each other before taping. This splice will resist all efforts to pull it apart—even to the breaking point of the wire.

enlarging holes in plastic

If a hole in plastic has to be made larger (such as plastic bosses) to hold a larger self-tapping screw, try this simple method. Start the larger screw in the original hole—just a few turns are sufficient. Then apply heat from a soldering gun to the screw. Before the screw cools, turn it into the soft plastic. Apply more heat and continue until the hole reaches the desired size. Leave the screw in the plastic until it has cooled. When cool, slowly and carefully remove the screw. Now you have a fresh hole large enough to hold the larger self-tapping screw.

handy heat sink

An ordinary metal hinge (Fig. 518) with a small machine screw and wing nut through a pair of its mounting holes makes a dandy heat sink

when you have to solder or unsolder a heat-sensitive component from a circuit. Just unscrew the wing nut a little way, slip the sink over the com-

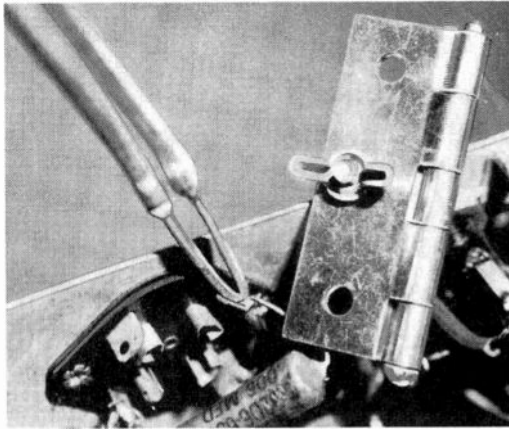

Fig. 518. Combination of metal hinge, machine screw and wing nut makes a heat sink.

ponent's lead and tighten the nut again. This is much easier than using pliers—particularly if the soldering job happens to be a three-handed one.

hanger tops for tubes

Those tubes of radio-TV servicing chemicals that lay around on the bench and eventually become punctured won't if you hang them up out of the way. Remove the tube's original cap and screw a cup hook (Fig.

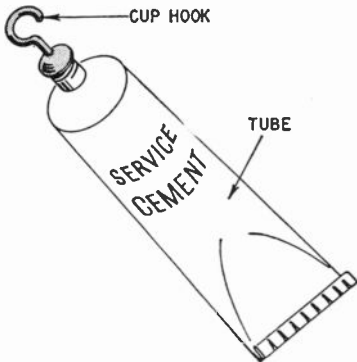

Fig. 519. Service cement never around when you want it? Put a cup hook on one end and hang it up as though it were a tool.

519) into the opening. This way you can hang the tubes on brads driven into the edge of a shelf or the service bench.

keeping the iron clean

Keep the tip of your soldering iron clean and free of scale by occasionally holding it against a revolving wire brush. The stiff wire bristles of the brush remove all traces of scale and solder. Then the iron can be readily tinned.

pop-up toolbox

Your toolbox with its lift-out tray will be handier with the modification shown in Fig. 520, which raises the tray automatically when the lid is opened. Mount the front of the tray with swinging levers of sheet metal

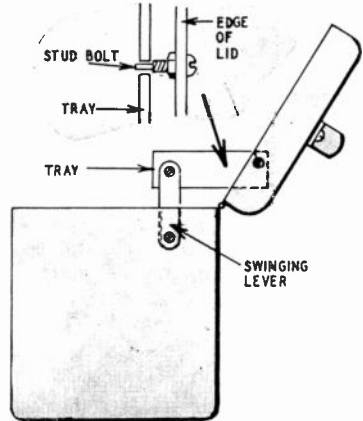

Fig. 520. Tray lifts automatically when tool-box cover is raised.

at each end. Determine the dimensions by trial. Support the tray's back edge with studs through the lid, located to project through holes in the tray.

hole shrinking

After tightening and loosening a self-tapping screw several times, the threads on the tapped metal become loose. This also happens when machine screws are used with tapped holes in sheet metal. To make the hole tight again, just shrink it!

Sheet metal can be compressed into the hole by center punching. Six or so sharp punches with a prick punch around the hole and about $\frac{1}{8}$ inch away does for most cases. Hold a hammer against the other side so that the metal does not bend if it is thin. If six punches do not do the job, try more or punch the same holes again.

soldering-iron rest

When working with miniature soldering irons, you must be careful to conserve their heat so they will be hot enough to bring the work quickly to soldering temperature. Thus, it is a good idea to avoid using a conventional stand or stone slab as a rest while using the iron. These dissipate

the heat from the iron so it will not be hot enough when picked up again. Try using a holder that isolates the iron from heat sinks.

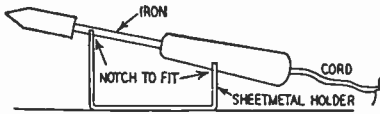

Fig. 521. *Miniature soldering-iron holder doesn't rob iron of heat.*

You can use a piece of asbestos or bend a holder from sheet metal as shown in Fig. 521. This holder is shaped so its contact with the iron is limited and restricted to parts where heat is low.

sharpening a punch

Eventually a chassis punch loses its keen edge and doesn't cut as efficiently as it should. If you have a dull punch resharpen it by laying the punch and die ring on an oil stone and slowly rotating them with a circular motion, using moderate pressure. Don't rock the punch up on edge while sharpening or you will get an uneven cutting edge.

If you don't have an oil stone, a piece of very fine sandpaper tacked to a perfectly flat surface will do the job nicely.

handy file

Often at the bench or in the field you want to dress up a soldering job but don't have a file handy. Also solder will clog a file and make it lose its effectiveness. An excellent, cheap substitute for a metal file is an emery board. They are available in packs of 10 at any drug or variety store. Try using one next time you have a mike or phone plug you want to dress up after soldering.

liquid metal anchors wire

When you need some sort of clamp to keep a long insulated wire positioned correctly, Duro plastic aluminum or steel can be used as liquid

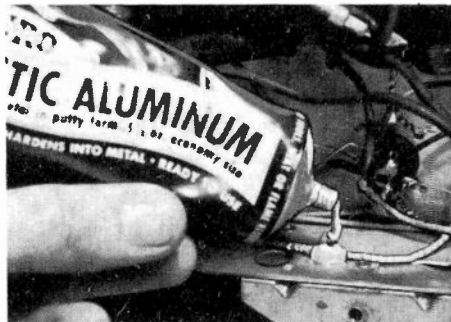

Fig. 522. *Plastic metal holds wires in place.*

metal for making wire anchors. Apply the liquid to the wire and to a spot on the chassis as shown in Fig. 522. The liquid will dry metal-hard and hold the wire securely in place.

drilling thin metal

When drilling thin metal, brace it so it won't bend by using a soldering iron to stick on a blob of solder at the site of the center punch mark.

The diameter of the solder should be slightly smaller than the drill used and 1/16 inch thick. The solder easily gives way to the drill and holds it there until the hole is started.

Even more accurate drilling is possible if the top of the solder is flattened by filing.

can opener is service tool

Although a beer-can opener may be considered standard equipment for thirsty radio-TV service technicians, its usefulness to the nondrinking technician as a service tool should not be underestimated. You can use one as a tube lifter for stubborn tubes (don't use it with the set turned on for it might short the base pins). You can also use its sharp point for opening solder-clogged terminal eyes. The point is also handy for making holes in wood siding for starting screw-in standoff insulators. If kept in a toolkit along with other tools, a can opener will undoubtedly solve many other service problems.

handy reamer

For enlarging holes drilled in a chassis, the technician and radio builder will both find that a plumber's burring reamer with a T-handle like the

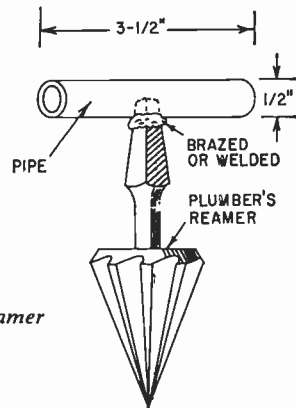

Fig. 523. Section of pipe added to plumber's reamer makes a new tool for the technician.

one shown can't be beat. It's a cinch to use in close quarters and its large diameter makes it more versatile than the usual T-handle reamer. Drill a hole in the pipe large enough to accept part of the reamer's shank (Fig.

523) then braze it in place. You are sure to find this modified reamer a handy addition to your bench tools.

soldering cast iron

Speed soldering to cast-iron, galvanized-iron or steel components by removing the hair bristles from the tin-handled brush commonly used to spread liquid flux and replacing them with a bundle of fine copper wires from a piece of stranded cord.

Connect the positive side of a 3-volt battery to the brush handle and the negative to the work. Then use the copper brush to spread the flux (cut muriatic acid or paste Nokorode flux) on the work.

This lends a thin plating of copper, and soldering becomes easier and goes faster.

wire-terminal identifiers

When you have to unsolder and remove a wire lead or a number of leads from a terminal in an electrical circuit, mark the terminal and the wire with a short length of colored plastic soda straw. (Fig. 524). By

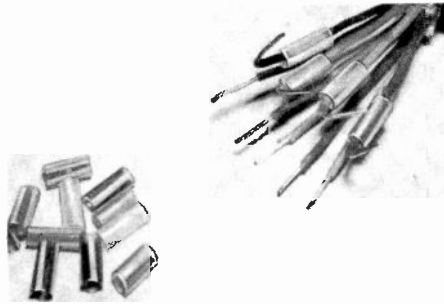

Fig. 524. Colored plastic soda straws help identify wires.

slipping these “identifiers” over each wire and terminal, using corresponding colors, you will always be able to resolder the wires to their correct lugs. Keep a container full of the colored identifiers on your bench for instant use whenever they’re needed.

turning tough screws

In cramped quarters on a chassis where it’s difficult to turn a screw with an ordinary screwdriver, use a blade from an interchangeable screwdriver set chucked in a tap wrench. This tool will not only enable you to turn screws in inaccessible places, but the T-handle gives better leverage on other jobs.

reduce line-cord fraying

The line cord on your soldering iron will have a longer life if you keep

it from fraying. Just wind a coil spring around the line cord for a distance of several inches (Fig. 525). Then force the end of the spring inside the soldering iron's handle.

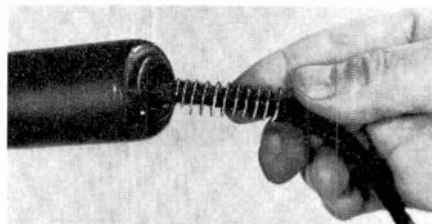

Fig. 525. *Coil spring keeps soldering-iron line cord from fraying.*

file cleaning kink

When files are used on soft materials such as plastic, aluminum, solder, copper and brass, the flutes have a tendency to become clogged with filings. This makes it almost impossible to clean fine smoothing files with an ordinary file card or wire brush, as the large bristles cannot reach deep enough into the gullets where the filings are imbedded. A small gob of modeling clay pressed firmly against the file will, however, remove the filings and restore the file's bite.

Kit builders, experimenters, service technicians and others who work with files will find this kink especially useful.

wire stripper

To make a wire stripper, file or grind the sharp point of a puncture type can opener flat, and make a V-notch in the center of the tip. Grind or file the whole tip, including the bottom of the V to the thickness of a

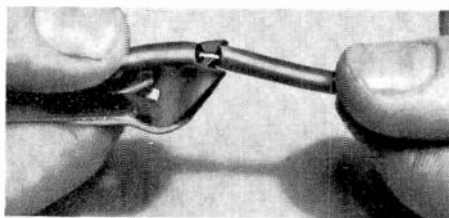

Fig. 526. *A little work and the can opener becomes a wire stripper.*

knife-blade edge (Fig. 526). To use the stripper, place the wire in the notch, put your thumb over the end of the wire and pull the opener toward the wire's end, while holding the wire with your other hand.

stuff that plug

Broken plugs and loose dangling wires at the ends of appliance cords are old-hat to the electrical-appliance repairman. Although it is true that breakable bakelite plugs are no longer part of newly purchased electric appliances, they are still used for replacements and are still found on older units.

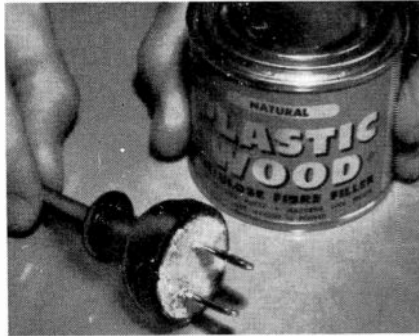

Fig. 527. *Plastic wood strengthens plug, keeps line cord from working loose.*

When one of these bearing the older type plug comes in to the shop for repair, stuff it with plastic wood (Fig. 527) before the appliance is allowed to leave the shop. Once the wood stuffing has set, it's next to impossible to pull the cord from the plug. What's more, the stuffing supports the plug's outer shell, reducing the chance of its breaking should the plug be stepped on.

mirror holder

An inspection mirror carried in a toolbox usually breaks in no time at all. Put it safely out of the way by attaching a fuse holder to the inside

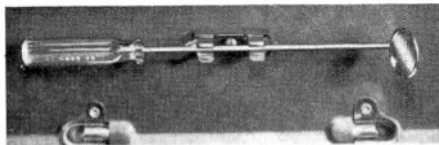

Fig. 528. *Fuse holder keeps inspection mirror out of harm's way.*

of your toolbox lid as shown in Fig. 528. The mirror snaps into the clips of the fuse holder.

soldering-tool maintenance

In addition to keeping your soldering gun's tip tinned, check to see if the screws or nuts that hold the tip in place are tight. Loose screws or nuts mean a poor electrical contact and reduced tip temperature and soldering efficiency. If you work with an iron, do you ever take time out to unscrew the tip or loosen the setscrew (if yours has one) and remove the tip? If this isn't done occasionally, the tip may become frozen in place and very difficult to remove. Should that happen, soak the tip in ammonia to loosen it. (Watch those fumes—they can be very unpleasant!)

spare iron tips

It's no cinch to keep track of those spare tips for a pencil soldering iron. You often spend several minutes searching through your tool assort-

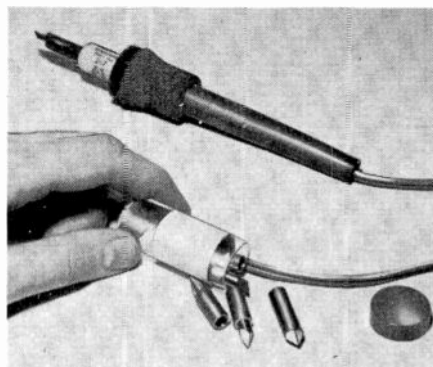

Fig. 529. Spare tips can be kept in vial taped to line cord.

ment to find the needed tip. A small plastic vial taped to the iron's power cord (Fig. 529) makes a handy storage place for the spare tips.

custom tips

Low-wattage pencil type soldering irons are handy, but every so often their relatively short tips may not penetrate far enough into crowded chassis corners. Since most of these irons have screw-in tips, it is easy to make your own special tips at low cost.

Buy several lengths of small-diameter copper rod and an inexpensive die to cut the thread used in the tip end of the heating element of your iron. Clip off a length of rod to suit the job, run a thread $\frac{1}{4}$ inch long on one end and file the other to the tip shape best suited to the joint being soldered.

An added bonus arises from the fact that the longer tip also radiates more heat to the air, and thus provides a slightly gentler tip for delicate printed-circuit boards.

chalk prevents file clogging

When those fine-cut jeweler's files favored by the radio-TV technician are used on solder, aluminum, brass, copper, plastic and other soft materials, the teeth tend to become clogged and dull the file's bite. Prevent

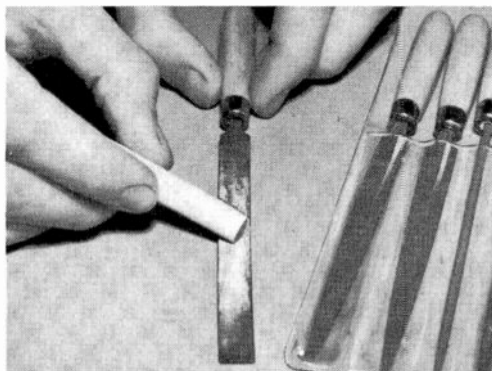

Fig. 534. *Chalk rubbed on files keeps teeth from getting clogged.*

this by rubbing the file with ordinary blackboard chalk just before it is used. See Fig. 534. The chalk dust keeps the filings from adhering.

heat-conductionless soldering

When you have some small work that has to be soldered, it's practically impossible to clamp the work in a vise, as the metal jaws drain off most of the heat. Avoid this difficulty by using a wooden clothespin clamped

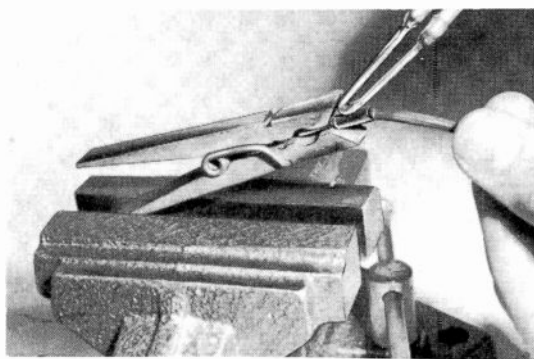

Fig. 535. *Clothespin clamped in vise is ideal for holding small parts during soldering.*

in the vise (Fig. 535) to grip the work. Wood has a much lower heat-conduction factor than metal, so the clothespin jaws won't drain the heat.

tube holder

Most technicians have a stock of bench tubes that are used exclusively for testing. When a bad tube is located by substitution, the bench test

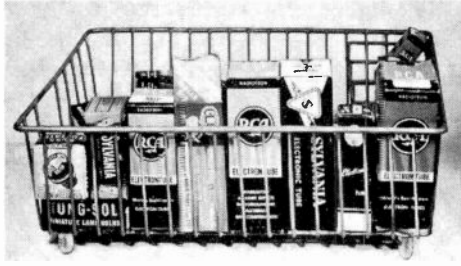

Fig. 536. Dish drainer keeps bench tubes all together and at hand.

tube is returned to its carton and a new tube from the technician's stock is installed in the set. To keep these bench tubes on hand and not all over the bench, try using an ordinary dish drainer, as in Fig. 536.

portable wire rack

Here's a handy little box (Fig. 537) holding six spools of wire which you can carry right to the job or from one bench to another in the lab. The wire can't get tangled and the six ends are always protruding from the top, ready for use.

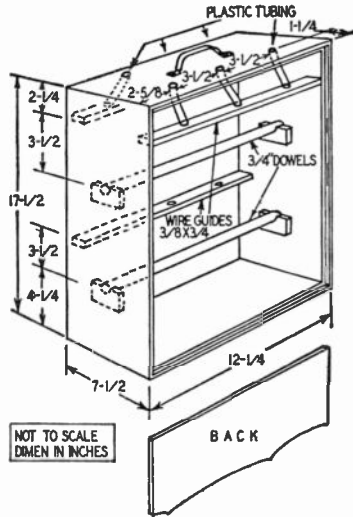

Fig. 537. Wire rack carries six spools, keeps wires from tangling.

The box is easy to build, having $\frac{1}{2}$ -inch sides, top and bottom. A rabbet all the way around allows the $\frac{1}{4}$ -inch plywood front and back

panels to set in flush. The front one is nailed in place, while the back one is clipped in place. Two $\frac{3}{4}$ -inch hardwood dowels hold the wire spools, and the wire is fed up through the wire guides.

The wire from the bottom spools comes up through the holes in the lower wire guide and then is threaded through the top guide and out through the top. Between the top wire guide and the top of the cabinet are six lengths of heavy plastic tubing of $\frac{5}{32}$ inch inside diameter and $\frac{9}{32}$ -inch outside. This serves as a brake to prevent the wire from being pulled too fast and to keep it from falling back after cutting. The holes in the lower guide are $\frac{1}{4}$ -inch in diameter and those in the upper guides and top are $\frac{5}{32}$ -inch with a $\frac{9}{32}$ -inch counterbore to hold the tubing in place.

Brass eyelets can be pressed in the holes in the top. Six turns of No. 14 music wire springs, 1- to $1\frac{1}{2}$ -inch in diameter, are placed between the spools to keep tension on them and to prevent one from turning another. Four of these springs are required. A coat of gray paint, a handle on top and four rubber feet complete the cabinet.

chassis drilling

When holes are drilled in the metal chassis of electronics gear, there is always the danger of the chips falling in unwanted places, causing short circuits and other troubles.

To prevent this, always magnetize the drill so that it will attract and hold the particles. If the chassis is of a nonmagnetic material such as aluminum, make a dam out of putty or clay around the spot where the hole is to be drilled to catch the chips.

Incidentally, the clay or putty also works well in removing metal chips from a magnetized drill.

solder loop anchors wire

When you need a tiny wire clamp to hold a long insulated wire posi-

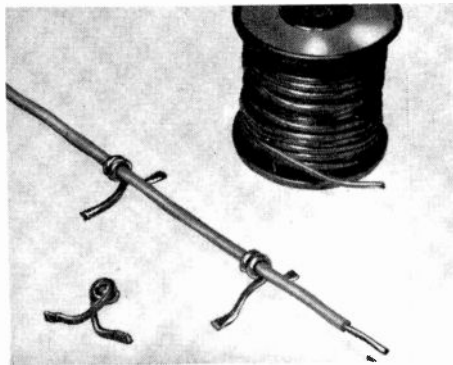

Fig. 538. Short strips of wire solder keep wires in place.

tioned correctly in electronics gear, make standoff clamps (Fig. 538) by twisting short lengths of wire solder around the conductor several times, and tack-solder the ends to the chassis. The wire lead stays put with this arrangement, and it is particularly useful in critical circuits of mobile electronics gear subject to mechanical shocks and vibration.

toolkit flux dispenser

Is your toolkit overcrowded? If you carry a large can of soldering flux, why not exchange it for a smaller one? Next time you are in a department store, buy one of those small plastic vials used as containers for screws and other hardware. Empty the vial of its contents, fill it with flux and drill a small hole in the lid. Whenever you need a bit of soldering paste, just push the end of the solder or wire lead into the hole.

spaghetti insulates solder

When you have to solder live electric wires, avoid the possibility of getting a shock when the solder touches the joint by insulating it with a length of spaghetti. By slipping the insulation over the solder, you will avoid the unpleasant experience of receiving an unnecessary jolt.

soldering the unsolderable

A rather simple soldering technique¹ now makes it possible to solder a wide range of materials previously joined only by ultrasonic processes.

The technique requires, in addition to the usual soldering materials, only a hand grinder with an abrasive grinding wheel of medium grit. To solder such "unsolderable" materials as stainless steel, aluminum, ceramics and glass, the grinder is turned on and the abrasive wheel (preferably preheated by grinding metal or by applying heat with a torch) is brought to bear on a soft solder, such as Wood's metal or 40-60 lead-tin. The soft solder melts and flows onto the surface of the wheel; the solder-loaded wheel is then applied to the surface to be soldered until a slight amount of abrasion has taken place, using the pressure one would ordinarily use in grinding. The heat generated by the friction again melts the solder, which flows onto the freshly abraded surface and forms a positive bond. The surface of the other material is also given this treatment if it is not ordinarily tinned with solder alone. After this tinning operation, the soldering process is performed in the usual manner with standard 50-50 lead-tin solder. Soldering flux or surface cleaning is unnecessary. Pieces to be joined with this technique need not be of the same material—metals, ceramics, soft glass and Pyrex can be soldered in any combination desired.

color-code those tools

If you have trouble keeping the tools you carry in your toolkit from getting mixed up with bench tools in the shop, mark the toolkit ones

¹Developed by University of California Chemistry and Metallurgy Laboratory.

with bands of bright-colored cellophane tape. See Fig. 539. If you have ever unloaded your pockets on the bench at the end of a busy day and neglected to put the contents back in your toolkit for use the next day, you'll truly appreciate this kink. The tape is more durable than paint so

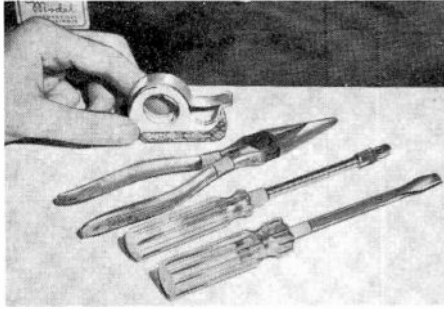

Fig. 539. *Bright-colored cellophane tape helps identify tools.*

it won't wear off with frequent handling. If you have more than one kit of tools you want to keep separate, use two colors of tape.

chassis-punch care

To the electronics builder, a chassis punch is probably as useful as his soldering gun or his own two hands. And like most all other shop tools, a chassis punch requires a certain amount of care if it is to lead a long useful life.

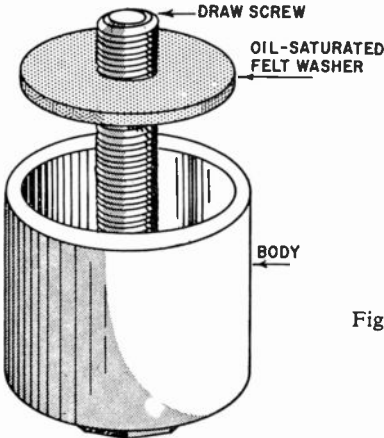

Fig. 540. *Felt washer, saturated with oil, increases life of chassis punch.*

To protect your punches cut felt washers from an old felt hat, saturate each with oil and slip one over each draw screw as shown in Fig. 540. The rest of the punch is assembled and used just as before. The oil keeps

the parts lubricated, makes the punch work easier, and deters rust. A chassis punch is relatively expensive, so give yours the care they so rightly deserve.

pencil-iron rest

Sometimes the correct place to put a pencil iron on the bench is hard to find. One excellent solution is to use a discarded 1B3 tube. Break away the glass envelope from the metal cap and skirt. Then drill a hole in the bench large enough for the cap to be inserted in and you have a perma-

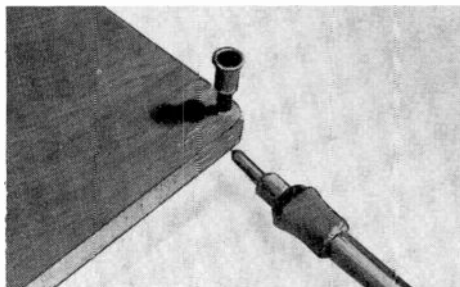
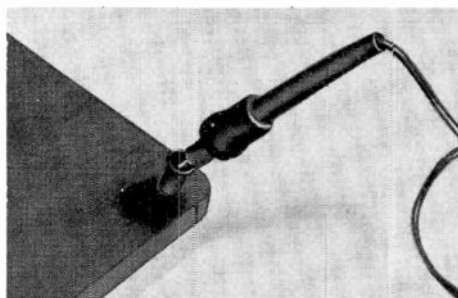

Fig. 541. Need a holder for a pencil iron? Plate cap of a 1B3 will work very nicely.



nent iron holder that will never be in the way (Fig. 541). With the tip of the iron inserted as the heating element, it can also be used as a miniature solder pot for multiple tinning operations, etc.

soldering-iron cleaner

To make a handy soldering-iron-tip-cleaner (Fig. 542) roll up a length of 2-inch wide wire screen and force-fit it into the bakelite base of an old octal tube. When the cleaner isn't in use, store it in an old octal tube socket attached to the top of your spool of solder.

Another soldering-iron cleaner you can make consists of a piece of fine screening tacked to a scrap piece of wood. See Fig. 543. Wiping the iron's tip across the screen occasionally removes excess drops of solder and crust from the tip efficiently.

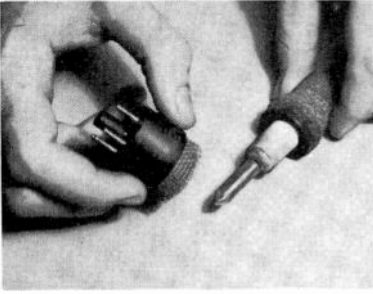

Fig. 542. *Wire screen rolled up into tube base is iron-tip cleaner.*

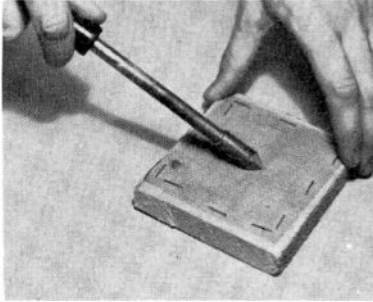

Fig. 543. *Another way of cleaning soldering iron tips—tack a bit of screening on a flat board.*

another third hand

Many service technicians have devised a third hand for holding parts while they are being soldered. Here is another method. Plug the center of your spool of solder with a cork to which you have screw-fastened a

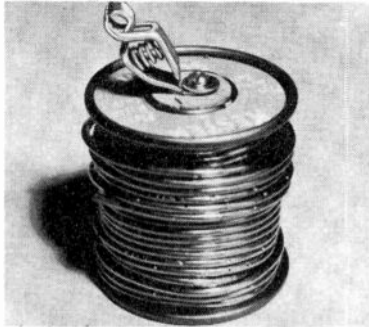

Fig. 544. *Need a device for holding parts? Try this technique.*

test clip as shown in Fig. 544. The clip provides that often needed third hand and can be transferred from one spool of solder to another as solder spools are emptied.

handy tap stand

Before you decide to discard an empty spool that once contained hook-

up wire, consider making it into a handy stand for holding taps. Drill holes of appropriate size through the upper flange (Fig. 545) to accept

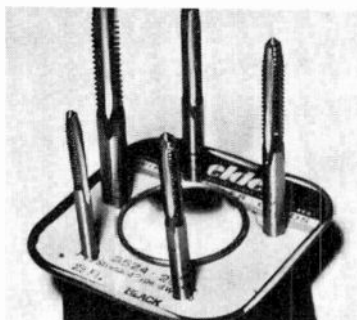

Fig. 545. Discarded spool makes holder for taps.

the taps, then rest them in the holes. Or, if you need a small twist-drill stand, make it in the same way.

tool for technicians

A pair of ordinary gas pliers can be turned into an extremely useful tool for the electronic technician by grinding off a goodly portion of the ends of the jaws as shown in the photograph, Fig. 546. When altered, the pliers will still hold a pin or similar part securely and can be turned

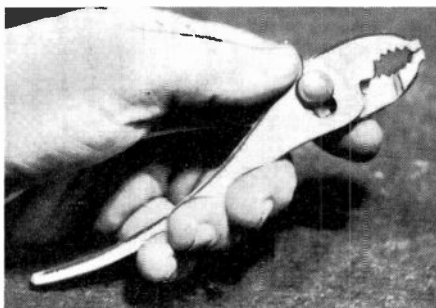

Fig. 546. Modified gas pliers make special tool.

easily in close quarters. The wide portion of the jaws will hold tubing, tighten larger bolts and nuts of the TV and radio chassis as well as do the work of special pliers. Add a rubber band to the handles and you will have a small vise for holding small parts to be soldered or adjusted.

handy bench gadget

Here's a mighty handy gadget that you will find many uses for on the bench in your service shop. It consists of a large paper-clamp screw and wing nut fastened to a metal base taken from a discarded desk fan. In addition to being a handy service-light holder as shown in the photograph,



Fig. 547. Paper clamp and old metal base join forces to make handy vise.

Fig. 547, it is just as handy as a soldering-iron holder and a vise for holding parts while they are being soldered or tested. By loosening the wing nut, it can be angled to several different working positions. It is a very flexible "tool" and should make a welcome addition to any service bench.

bowl-cover service aid

Your toolkit for house calls should contain, among other things, several sizes of plastic bowl covers as shown in Fig. 548. They come in mighty handy as bags for holding screws, knobs and other hardware removed

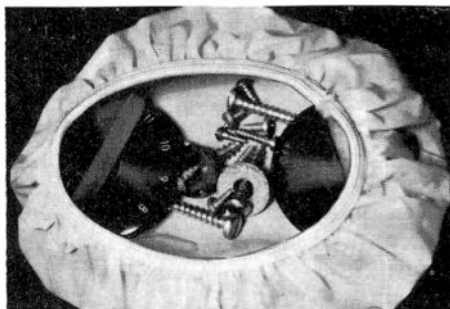

Fig. 548. Plastic bowl covers are handy for holding hardware.

from a set, as well as being handy slip-on protective covers for guarding against accidental speaker-cone punctures when transporting a chassis to the shop for repair. You should find them very useful.

mini-gator clips

Mini-Gator clips, not much larger than a transistor, are ideal for fast setups of experimental transistor circuits (Fig. 549). Unlike other clips, these easily hang onto the smallest transistor leads without sliding along or slipping off.

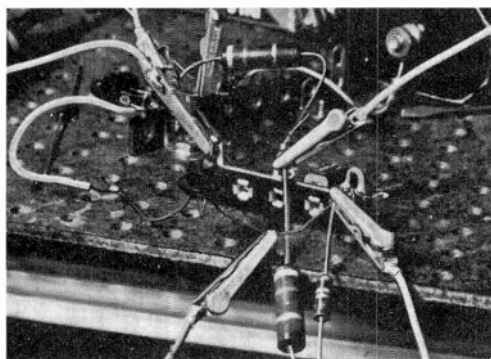

Fig. 549. Working with transistors or sub-miniature parts? Try Mini-Gator clips for holding to leads.

Small sections of flexible stranded wire with Mini-Gators on each end can be used for hurry-up wiring of breadboard circuits. Lead lengths of 3 to 6 inches seem to be the most useful.

Insulating sleeves available for these clips guard against accidental shorts.

jeweler's saw cuts control shafts

The photo shows a jeweler's saw being used to cut a control shaft to length. The fine teeth of this saw make sharp, even cuts without binding and jamming to the extent experienced with a common hacksaw.

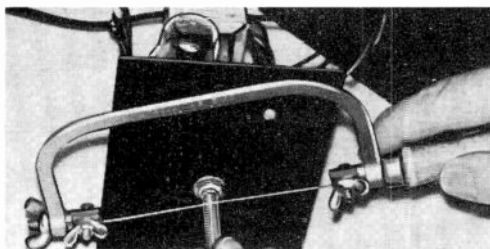

Fig. 550. Use a jeweler's saw for cutting control shafts.

The control can be cut after it has been mounted without excessive vibration that might loosen the mounting nut. The subsequent hazard of

moving the loose control and damaging wiring is also eliminated.

In sawing, hold one hand on the shaft as shown. This prevents any tendency toward binding.

cutting miniature shafts

Subminiature controls used in transistor equipment have $\frac{1}{8}$ -inch-diameter shafts. These shafts can be cut to length in less than a second using an AMP type screw-cutting and terminal tool.

Insert the shaft into the 8-32 or 10-32 screw-cutting opening and squeeze. The shaft will cut off clean as a whistle without any burrs or distortion.

toolbox storage kink

Don't let that unused space in the lid of your toolbox go to waste. Drill a couple of small holes near either end and attach a screen-door

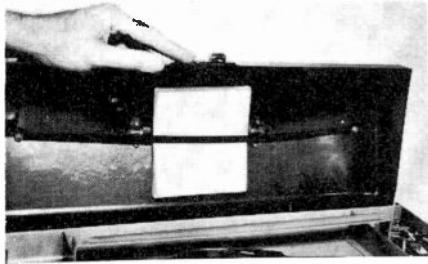

Fig. 551. Screen-door spring helps put underside of tool-box lid to use.

spring to the underside, as in Fig. 551. Now you can use this additional space for storing sandpaper packs, diagrams, service data or other small items.

soldering pad

An asbestos shingle tacked to one corner of the workbench makes an excellent spot on which to "park" a hot soldering iron. It prevents scorching the bench top and is a handy pad for use when soldering small parts together.

hacksaw blade repair

Many service technicians have discovered that the spiral-(drill-) blade hacksaws work more efficiently than standard types for cutting control shafts and other odd sawing jobs. They have only one drawback—the blades are rather thin and tend to break off easily near either end.

When a blade breaks near the end, it can be easily restored to a usable length with a ring type terminal lug, as shown in the drawing, Fig. 552. Put the end of the blade into the lug as you would a wire, flatten the lug

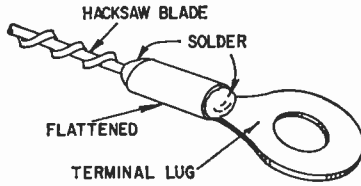

Fig. 552. Ring type terminal lug helps salvage spiral type hacksaw blades.

and solder to strengthen the joint. You can make several repeated repairs in this way until about only half the blade remains.

service bench aid

In the course of servicing electronic equipment, line power is often connected and disconnected many times. Most service technicians do this by withdrawing and inserting the line-cord plug. This soon becomes a nuisance as the plug usually falls to the floor when it is withdrawn. Using the power switch on the unit being serviced sometimes opens only one side of the line which doesn't completely isolate the unit from the power line.

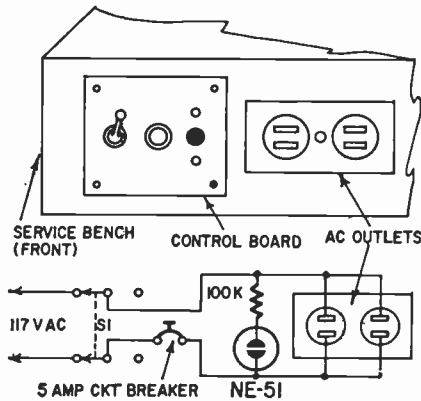

Fig. 553. Outlet control board is handy for turning line power on and off.

You can solve this problem by making an ac outlet control board and mounting it next to the ac outlet on your service bench. This control

board includes a dpdt switch, pilot light and circuit breaker. With a flick of a finger, you can completely disconnect the unit being serviced from the power line. The pilot light indicates when the power is on, and the circuit breaker will prevent blowing the main fuses should there be a short in the unit being serviced.

The circuit and details of the control board are shown in the diagram, Fig. 553. You will find it practical to construct the control board on a 4-inch square of aluminum. Needless to say, this unit will make servicing much faster and safer.

soldering aid

You can hold a wire still while you tin its tip by using a spiral of solder wrapped around a heavy tool such as a pair of pliers, as shown in

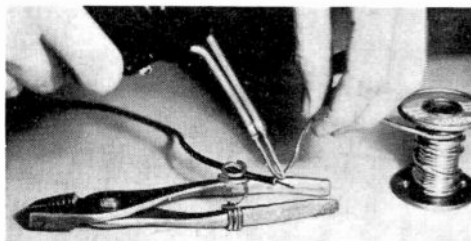

Fig. 554. Try this kink for keeping wire steady while soldering.

Fig. 554. Small parts can be held the same way. Try this “second-hand” idea sometime.

hand grinder solves problems

An electric hand power tool can be the solution to many electronic service problems. For example, a small wire brush chucked in the tool can reach down in deep among parts and wires to clean a lug that's otherwise nearly impossible to get at. Also, you can drill holes in hard-to-get-at places easier than you could with a hand drill. Every time you have to tin your iron's tip, you can put the wire brush to it and do the job in just a few seconds. Obviously, there are a dozen and one other handy time- and frustration-saving uses for one around the bench.

♦ 6 ♦ MISCELLANEOUS

novelty blinker

TWO NEON LAMPS that blink on and off will delight children when used as the eyes of a Santa Claus, jack-o'-lantern or any similar toy. They can also be used in making eye-catching window displays. The circuit in Fig. 601 is a form of gas-tube multivibrator using a pair of

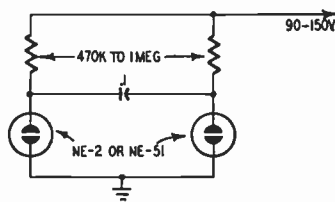

Fig. 601. *Double blinker adds novelty to toys or window display.*

NE-2 or NE-51 neon lamps operating from a supply delivering 90 to 150 volts dc. This voltage can be supplied from inexpensive batteries or a small line-operated power supply. The flashing rate can be adjusted as desired by varying the value of the capacitor.

relay operating kink

Try using an incandescent lamp instead of a resistor in series with the coil when operating a relay on higher than rated coil voltage. The surge current of the cold lamp operates the relay very smartly and the smaller hot current holds it. The holding current can be less than would close the relay, if the lamp has a second or two to cool between opening and reclosing.

A 12-volt, 80-ohm relay in series with a 120-volt 15-watt lamp on 112 volts dc can be reclosed immediately, but a 7-watt lamp operates it satisfactorily only if it is not reclosed too quickly.

To use the connector, simply insert the leads of transistors, resistors and capacitors between the grommet and the inside edge of the washer.

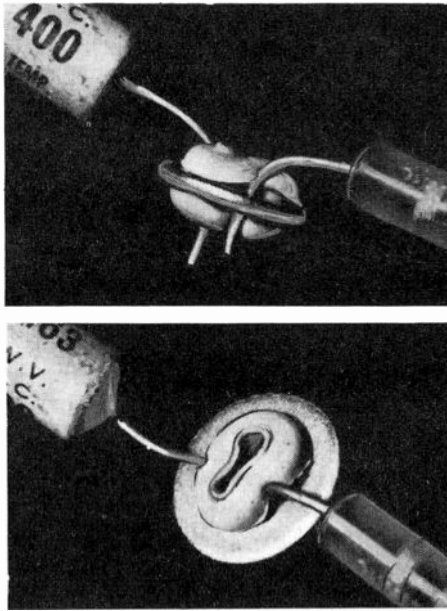

Fig. 604. *Need solderless connectors? Try this idea!*

To use tube sockets, potentiometers and parts which do not have leads, solder a length of solid wire to each terminal so they may be used with this connector.

use a ballpoint pen

Technicians will have frequent need for the handy items that can be made from the sleeve of a plastic (or metal) ballpoint pen. An insulating sleeve of any length up to 5 inches (Fig. 605-a) can be made from the sleeve of a discarded plastic pen. Insulators for electrical testing prods are another possibility.

Run the ends of a length of string through a ballpoint-pen sleeve, and the resulting loop at one end of the barrel will make a holder for a screw or bolt (Fig. 605-b) that must be inserted into an almost inaccessible hole on a TV chassis. For somewhat similar use, insert a straightened-out paper clip in such a sleeve (Fig. 605-c) and use it to get a drop or two of light oil to a normally inaccessible spot.

Convenient-size bushings and insulated feet for any lightweight chassis are other items that can be made in a minute from these handy sleeves. For insulating feet, thread the inside of the sleeve for a proper-size screw.

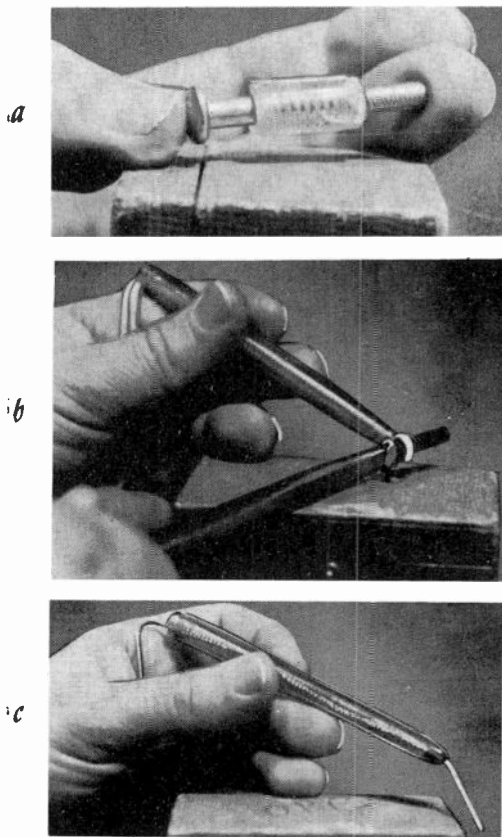

Fig. 605. Ballpoint-pen sleeving has variety of uses.

drop-cloth pockets

Have your wife sew a pocket into each corner of your drop cloth. Use them to store a set of dusting cloths, sponges and other cleaning items. This is an especially good idea if your caddy or toolkit happens to be a bit overcrowded. Snap fasteners on the pockets will keep the contents from falling out.

handy connecting stand

With this simple device, fixed capacitors, fixed resistors, germanium diodes, etc. can be quickly connected or disconnected in experimental circuits without damaging their leads. Germanium diodes may be easily and rapidly reversed by simply turning the diode around in the clips.

As shown in the photo, Fig. 606, drill two 3/16-inch holes about 2½ inches apart in a block of wood or plastic and force the sleeve of a "60

series" Mueller alligator clip into each hole. It's a good idea to put a little all-purpose cement into each hole before mounting the clips. Wire leads connected to the screw terminals on the clips go to the experimental circuit.

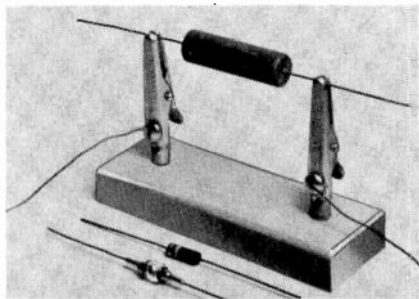

Fig. 606. *Pee-wee clips make handy mounts for small parts.*

temporary wire wrapping

Ever try to remove rubber or plastic electrician's tape from a temporary wire splice? Chances are, after several minutes of tugging away at the tape trying to get hold of the end, you just clipped the wire to remove the splice. To keep this from happening the next time you wrap a temporary splice, fold over a short length of the tape (about $\frac{1}{2}$ inch) back onto itself to form a tab that's easy to grab when it comes time to remove the tape.

low-voltage neon flasher

While it is generally considered that about 75 volts is needed to flash a neon bulb, it is possible to obtain a test flash with 1.5 volts by using the arrangement shown in Fig. 607. The bulb flashes each time the test prod is lifted to break the circuit. The bulb element that flashes is the positive terminal.

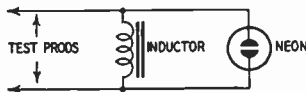

Fig. 607. *Iron-core coil helps flash neon bulb when using low-voltage source.*

Look around in your junkbox for any small iron-core inductor. If you have a horizontal blocking oscillator transformer, use the primary winding. If you want to make a vest-pocket tester, rewind the coil on a $\frac{1}{4}$ x 4-inch iron core.

The counter-emf of the coil steps up low voltages when the test prod is lifted from the low voltage circuit, causing the bulb to flash.

attractive panels

Professional-looking panels for home-built equipment are easy to make from white Formica, often used on table and counter tops. Available in small pieces at hardware and lumber stores, this material is dirt-proof, scratch-resistant and easily worked with ordinary hand tools. The smooth white surface gives the equipment a modern look and takes black decal lettering for easy control identification.

If shielding is a problem, mount the Formica panel directly over a regular metal panel or simply back the plastic panel with aluminum foil.

experimental connectors

Old tube sockets can be taken apart and their contacts used as connectors for temporary experimental hookups. Just break the insulator away with pliers and the contacts will fall free. See Fig. 608. Solder wires

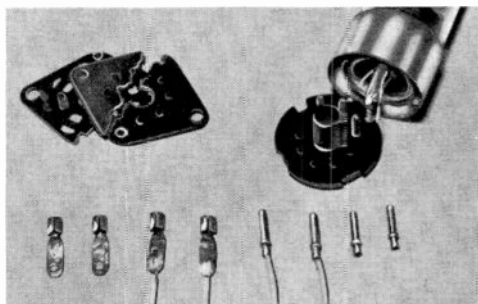

Fig. 608. *Don't throw away those old sockets. They can be salvaged for connectors.*

to the contacts and use them for making fast temporary connections to tube base pins or standard phone tips. Also use tube base pins removed from old tube bases as male connecting plugs.

standoff posts to suit

Have you ever needed a threaded standoff post of special length, but didn't have the necessary lathe facilities to make it? Well, here is how you can solve that particular problem.

3/16-inch outside diameter brass tubing has a 1/8-inch bore which corresponds to a hole just a bit smaller than a No. 30 drill. By squeezing the tube near the ends ever so slightly the bore can be worked down enough to be threaded with a 6-32 tap. Almost any tool, a vise, pliers, etc., can be used to squeeze the tubing.

improve relay sensitivity

Many factors affect the sensitivity of a relay, and most cannot readily be altered without major rebuilding. To get a great improvement, try adjusting the relay armature and contacts. The spring tension on the relay armature has an appreciable affect on sensitivity. Tension should be adjusted to the absolute minimum required to operate the relay. Spring tension is usually adjusted by bending the metal tab to which it is anchored. Sometimes the original spring has to be replaced by a lighter one that has less tension. The spacing of the relay contacts also affects its sensitivity. They should be set to the absolute minimum clearance, in the open position, that prevents arcing. Much more current is required to close a relay than to keep it closed because the magnetic flux is denser near the coil core. To increase sensitivity further, the clearance between the armature and the coil core, in the closed position, should be the absolute minimum that keeps them from touching. After these adjustments are made, the relay will be as sensitive as possible without changing the coil and core design.

grommet aids gun lamp removal

If the "spot light" of your soldering gun has ever blown, you know just how hard it is to remove it for replacement. It is difficult to get a good hold on the small, slick glass envelope to unscrew the bulb. However, the task is much easier if you take a small rubber wire feed-through grommet (Fig. 609) and press it tightly against the bulb's smooth envelope.

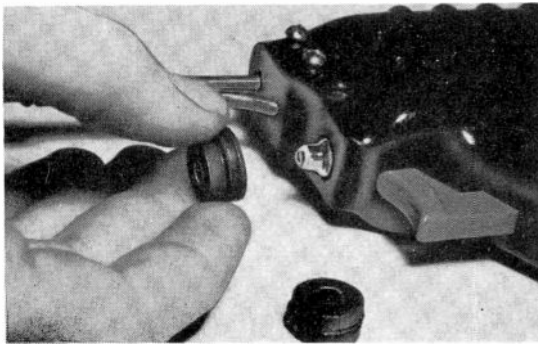

Fig. 609. Having trouble getting the light out of your soldering gun? Try a grommet.

spaghetti for miniature circuits

In miniature circuit construction the experimenter uses component leads to a greater extent than in conventional-size construction projects. Transistor leads usually are soldered directly to other components in the circuit.

Leads of miniature components and transistors are smaller than those on more conventional-size parts and, if the builder uses standard spaghetti for insulation, the leads become hard to work with.

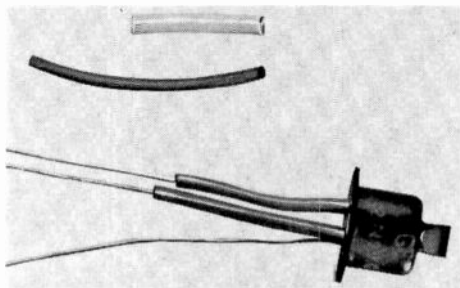

Fig. 610. *Make your own spaghetti. Use the plastic insulation of No. 22 hookup wire.*

You will find that the plastic insulation you strip off No. 22 hookup wire is ideal for insulating spaghetti in miniature circuit work. See Fig. 610. Save the insulation you strip off hookup wire for use as spaghetti in miniature circuits. This spaghetti is flexible and small enough to do credit to miniature circuits.

transistor kink

Electronic experimenters who use transistors to build one circuit, then tear it down to build another and so on, soon find that their transistors are not built to take that sort of harsh punishment. Excessive heating of the leads while soldering and unsoldering them eventually destroys the inner elements. To prevent this, the experimenter should wire his transistors into the bases of old octal tubes and make them into convenient plug-in units. (Two transistors can be wired into one hole.) This arrangement extends the component's life, saves money and is convenient too.

colorful panels

Plastic bathroom wall tiles make economical and colorful panels for small radios, test apparatus and other small electronic gear. These Styron tiles come in a variety of colors and designs and, when used with plastic-covered cabinets, many beautiful color combinations can be worked out. The photo (Fig. 611) shows a $4\frac{1}{4} \times 4\frac{1}{4}$ -inch red marble plastic tile (Homart P-23, Sears Roebuck) used as a panel on a wood cabinet covered with *Con-Tact*, a self-adhesive plastic material that has a black walnut grain. *Con-Tact* is available in many colors and designs and is ideal for covering radio cabinets.

Plastic tiles are made by several manufacturers and can be purchased

in small quantities. The Styron (poly-styrene) tiles have low-loss properties and can be used for uhf gear. The tiles are not as rugged as thicker polystyrene would be, but you will find that they are quite serviceable.

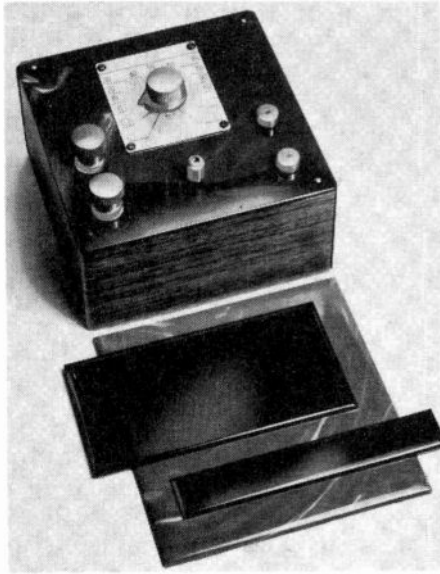

Fig. 611. Plastic wall tile makes attractive panel.

light-bulb resistors

In an emergency, electric light bulbs can be used as resistors. They also come in handy for breadboard layouts since they can dissipate heavy wattages and are easily mounted. The table compares the resistance of various bulb sizes (wattages) at normal operating temperature with the cold resistance measured with an ohmmeter. Since the operating temperature depends on the current in amperes through the bulb, the actual ohmic value in any given application varies accordingly.

LIGHT-BULB RESISTANCE
(117 VOLTS)

Bulb Size (watts)	Cold Resistance (ohms)	Operating or Hot Resistance (ohms)	Operating or Hot Current (amps)
7	220	2060	0.058
15	125	960	0.121
40	24	360	0.332
60	17	240	0.500
75	13	192	0.625
100	9	144	0.832
150	6	96	1.210

fast plug connections

When experimenting with speaker hookups and other temporary connections involving the use of a standard two-conductor phone plug, considerable time can be saved by fastening No. 2 or No. 3 Fahnestock clips to the plug's screw terminals as shown in Fig. 612. Don't use this

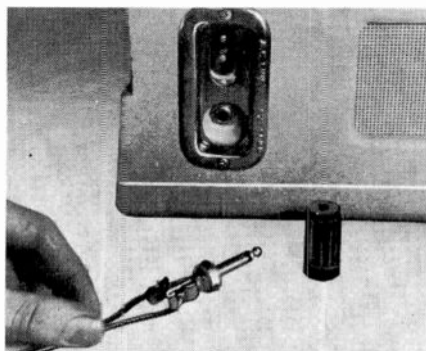

Fig. 612. *Fahnestock clips on plug's screw terminals make it convenient to connect and disconnect leads.*

sort of convenience hookup when high voltages are involved, unless you intend being extra cautious to avoid getting bit by voltages at the exposed clips.

stripping short harnessed wires

Here's how to use automatic wire strippers to strip short lengths of wiring harness. Simply loop a piece of scrap wire around the cable and grip this scrap with one set of jaws and the short lead with the stripping jaws.

loop oiler

A small narrow loop of thin wire makes an excellent oiler for carrying a small amount of oil into a tight spot and not elsewhere. Such a device may be made from a strand of wire soldered to a heavier piece of wire. The loop should be rather small—not more than about five wire diameters across or the oil will not form a film.

In practice, the loop picks up a drop of oil from the nozzle of an oil can. It is touched to the joint to be lubricated and twisted slightly so the oil flows on the part from the loop.

simple uhf antenna

Short vertical antennas are often used for field-strength meters and for various uhf experiments. Since supporting clamps and insulators are

often inconvenient and cumbersome, you can use glass jars with plastic caps to support and insulate the antenna rods.

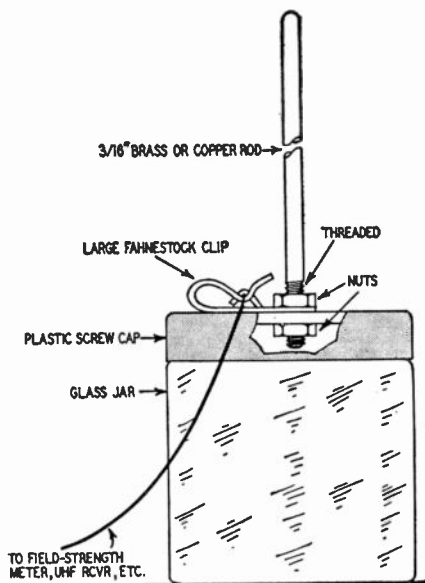

Fig. 613. Glass jar is support for uhf antenna.

Brass or copper rods $3/16$ inch in diameter and up to 4 feet long can be supported by a 3-inch diameter jar without tipping. The rod is threaded at the bottom so it can be fastened to the jar cap with two hexagon nuts as shown in the illustration, Fig. 613. A Fahnestock clip or soldering lug can be clamped between the top nut and cap for connecting to the antenna. The jar can be held in the hand and moved around without serious body-capacitance effects.

If a jar with a metal cap is used, scrape the enamel off the top of the cap and solder the rod directly to it. Before soldering, make a small loop in the end of the rod and bend it at right angles to the rod. This provides a broader base for the rod and a greater area for soldering.

service light holder

No technician's toolkit is complete without some sort of trouble light for illuminating the dark corners of a chassis. To save space in the toolkit, many technicians carry a small penlight, but often you will find jobs where an extra hand is needed to hold the light. Solve this problem by screw-fastening two spring clothespins back to back. With the light clamped in the jaws of one pin and the jaws of the other pin clamped to a pair of pliers or other heavy tool, you will find that the light can be angled to nearly any position with very little difficulty.

experimental coils

This method of winding makes it easy to change the number of turns on experimental coils. Wind the coil with a thin strip of plastic or Bakelite between the winding and core. Anchor the ends with one turn around

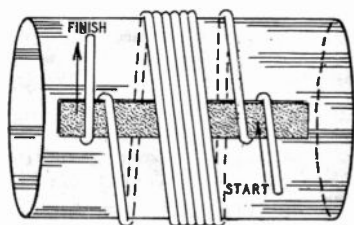

Fig. 614. *Technique for changing number of coil turns.*

the strip as shown in the drawing. After the exact number of turns has been determined, the ends can be anchored with a drop of cement and the leads soldered to lugs or pins on the form. See Fig. 614.

nichrome elements

When the nichrome element in an electrical appliance breaks, twist the ends of the broken section together in a loose joint. Then sprinkle a little borax over it and turn on the juice. The resulting spark will fuse the connection and save the element.

phone-plug switch

A push-switch arrangement for use with meters or headphones can be made by replacing the little insulating washer behind the tip of a phone

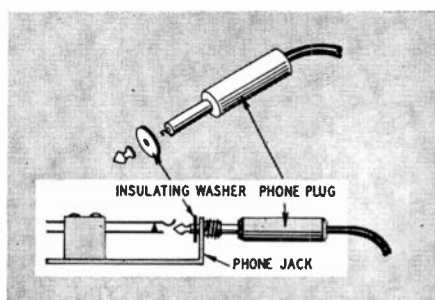

Fig. 615. *Modified phone plug becomes push switch.*

plug with a larger one. Of course the tip has to be screwed back on after the plug is inserted into its jack. Complete removal of the plug is prevented, but there is enough movement to break and make connections.

tube taper and wire pusher

Two, three or four rubber grommets placed on a 7- or 8-inch dowel section make a handy tube taper. Form a dimple in the other end of the dowel with a small twist drill. The dimple stops the dowel from

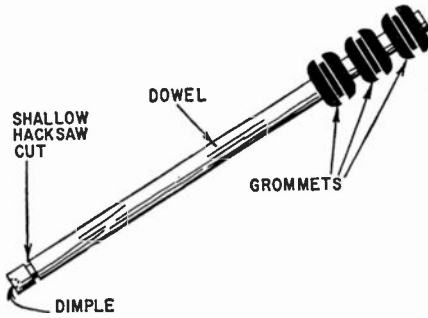

Fig. 616. *A few grommets plus a dowel and you have a tube taper.*

slipping off lug and wire ends when it is used as a pusher to dress lugs, etc.

Ring the dimpled end with a shallow hacksaw cut to be used for pushing leads into better dress. See Fig. 616.

INDEX

A

Absorbers, Shock	8
Adapter:	
Handy Test	13
Phone-Tip	16
Plug	67
Adding A Rear-Seat Speaker	52
Aiming Antennas	38
Allen Wrench, Double-Duty	78
Amplifier Cover, Anchoring	67
Anchoring Amplifier Cover	67
Antenna:	
Connector, Emergency	47
New Magic	39
Simple UHF	121
Telephone	64
Antennas, Aiming	38
Antennas, Installing TV	29
Assembly, Dual Control	36
Atomizer, Use an	42
Audio Test Rig	69
Auto:	
Radio Service, Fast	52
Radios, More Room in	62
Speaker Switching	59

B

Bad Tubes Can Be Useful	46
Ballpoint Pen, Use a	114
Banana Plug to Tip Jack	24
Batteries, Vials Hold	55
Battery:	
Nuts, Locking	112
Protection	63
Reminder	19
Repair, Rechargeable	60
Bearings, Inexpensive Panel	81
Bench, Mat on the	77
Bending Brake, Handy	86
Blade Repair, Hacksaw	108
Blinker, Novelty	111
Blown-High-Voltage Fuses	32
Bonding Straps	38
Boost Fringe Reception	50
Bowl-Cover Service Aid	106
Bridges, Improving Capacitor	18
Brighten Meter Scales	13
Burnishers, Fuse-Clip	46

C

Cable Connectors, Home-Made	14
Calibration, Receiver	63
Can Opener is Service Tool	91
Capacitor Bridges, Improving	18
Capacitors, Filter	42
Carrier, Tube	84
Cast Iron, Soldering	92
Cathode-Ray Tube (see CRT)	
Chalk Prevents File Clogging	98
Changer Stylus Skips or Sticks	73
Chassis:	
Drilling	100
Punch Care	102
Test for Hot	57
Cheater Holder, Toolkit	43
Chemicals, Tape Protects	112
Christmas Tree Lights	113
Clamp Saves Plug	19
Cleaning Aid, Crt	36
Cleaning Plastic Safety Glass	39

Clips:

Double, are Useful	15
Glove Fingers Insulate	45
Mini-Gator	107
Clothespin Eases Prod Handling	85
Coating, Crt	29
Coil Insulation	78
Coil Slugs, Freeing IF	55
Coils, Experimental	123
Color-Code Those Tools	101
Colorful Panels	119
Combination VTVM Probe	23
Component Leads, Straighten	51
Compound Fills Holes	46
Connector, Second-Anode	28
Connectors, Experimental	117
Connectors, Solderless	11:
Contact Plug, Emergency	86
Control Guides	70
Control Shafts, Jeweler's Saw Cuts	107
Cooling Hot Jacks	11
Corkscrew for Tight Cap	113
CRT:	
Cleaning Aid	36
Coating	29
Electrostatic-Focus	34
Custom Tips	95
Cutting Miniature Shafts	108

D

Damaged Tuning Slug	54
Danger-High-Voltage	85
Dial:	
Cord Restringing	65
Cords, Slipping	53
Stringing Aid	57
Diode-Triode Tubes	41
Discharger, High-Voltage	30
Dogs, Parts Substitution in	44
Double Clips are Useful	15
Double-Duty Allen Wrench	78
Drilling, Chassis	100
Drilling Thin Metal	91
Drinking-Straw Spaghetti	112
Drop-Cloth Pockets	115
Dual Control Assembly	35
Duplex Signal Tuning	58

E

Earpiece Repair	51
Easily Made Test Prods	25
Easy Connections for Tip Jacks	18
Easy Wire Measuring	30
Electrolytics, Insulating	51
Electrostatic-Focus Crt's	34
Emergency Antenna Connector	47
Emergency Contact Plug	86
Enlarging Holes in Plastic	87
Erratic Record Players	73
Examining Phono Stylus	70
Experimental Coils	123
Experimental Connectors	117
Extensions, Test-Lead	10
Extra Heat Sink for Power Transistors	61
Extra Life for Defective Pots	54

F

Fast Auto Radio Service	52
Fast Plug Connections	121
Faster Installation	41

Feedback Connection, Simple	76	Installation, Faster TV	41
Feet Protect Test Sets	24	Installing TV Antennas	29
File:		Insulate Electrolytics	51
Cleaning Kink	93	Insulate Line Splices	28
Clogging, Chalk Prevents	98	Insulation, Coil	78
Handy	90	Insulator, Heat-Sink	63
Filter Capacitors	42	Intermittent-Short Detector	44
Filters Can Be Dangerous	41	Inverted Cartons Mark Empties	97
Flux Dispenser, Toolkit	101	Iron Tips, Spare	95
Foil Foils Intermittents	37	Isolation Transformer	32
Freeing IF Coil Slugs	55		
Fringe Reception, Boost	50	J	
Fuse:		Jeweler's Saw Cuts Control Shafts	107
Clip Burnisher	46	Jig, Screw-Cutting	97
Holder for Spares	40	Jumpers Untangled, How to Keep	78
Puller	34		
Fuses, Blown High Voltage	32	K	
Fusing Transistors	56	Keep Jumpers Untangled	78
G		Keeping the Iron Clean	89
Generator, Sawtooth	25	Kit-Building Kink	77
Glove Fingers Insulate Clips	45	Knob Breakage	27
Gloves, High-Voltage	45	Knob from Toothpaste-Tube Cap	49
Grommet Aids Gun Lamp Removal	118	Knobs, Plastic TV	43
Grommet Protects Transistors	64		
Ground, Low-Resistance	57	L	
Guides, Control	70	Lead-In, Mast Measures	45
Gun Carries Own Sander	83	Leads, Straighten Component	51
Gun Lamp Removal, Grommet Aids	118	Light-Bulb Resistors	120
H		Lightning Arrester, Tent for	31
Hacksaw Blade Repair	108	Lights, Christmas Tree	113
Hand Grinder Solves Problems	110	Line Cord:	
Handy:		Fraying, Reduce	92
Bench Gadget	106	New	61
Bending Brake	86	New TV	45
Connecting Stand	115	Line Splices, Insulating	28
File	90	Liquid Metal Anchors Wire	90
Heat Sink	87	Liquid Metal Service Aid	47
Holder	36	Locking Battery Nuts	112
Reamer	91	Loop Oiler	121
Tap Stand	104	Loopstick Tracking	66
Test Adapter	13	Loudspeaker (see Speaker)	
Hanger Tops for Tubes	88	Low-Voltage Neon Flasher	116
Hardware, Rustproofing	36	Lucite Scratches	32
Harnessed Wires, Stripping Short	121		
Heat:		M	
Conductionless Soldering	98	Making First-Class Panels	9
Lamp, Don't use a	44	Marker Pips, Polarized	14
Sink for Power Transistors, Extra	61	Mask Removal Tool	36
Sink, Handy	87	Mast Measures Lead-In	44
Sink Insulator	63	Mat on the Bench	77
High-Q IF Transformers	51	Measure High Resistances	17
High Voltage:		Metal, Drilling Thin	91
Danger	85	Meter:	
Discharger	30	Case, Nonmagnetic	12
Fuses, Blown	31	Protect Your	8
Gloves	45	Scales, Brighten	13
High-Wattage Substitution Box	22	Mike Stand, Recorder	74
Hint for Experimenters	112	Miniature Circuits, Spaghetti for	118
Holder:		Mini-Gator Clips	107
Handy	36	Mirror Holder	94
Mirror	94	More Room in Auto Radios	62
Soldering-Iron	82	Mount, Standoff	31
Tube	99	Mounting Clips, Transistor	61
Hole Shrinking	89	Mounting Problems, Simplify	62
Holes, Compound Fills	46	Mounting Speaker Transformers	50
Home-Made Cable Connectors	14		
Hot Chassis, Test for	57	N	
Hot Jacks, Cooling	11	Neon Flasher, Low-Voltage	116
Hum, Record Changer	75	New:	
Hum Suppression	68	Flock for Turntable	76
I		Line Cord	61
IF Coil Slugs, Freeing	55	"Magic Antenna"	39
IF Transformers, High-Q	51	TV Line Cord	45
Improve Portable Record Players	73	Nichrome Elements	123
Improve Relay Sensitivity	118	Noisy Volume Controls	43
Improving Capacitor Bridges	18	Nonmagnetic Meter Case	12
Inexpensive Panel Bearings	81	Novelty Blinker	111

O	
Oiler, Loop	121
P	
Pad, Soldering	108
Painting Etched Panels	20
Panel Bearings, Inexpensive	81
Panel Markings, Renew	20
Panels:	
Attractive	117
Colorful	119
Making First-Class	9
Painting Etched	20
Parts Substitution in Dogs	44
Peak-Reading Probe	21
Peaking, Video	41
Pencil-Iron Rest	103
Pencil-Iron Tinning	79
Pencillin Syringes	82
Penny for Your Tape	96
Phillips Screwdrivers	85
Phone:	
Plug Switch	123
Tip Adapter	16
Tips, Soldering	96
Phono Stylus, Examining	70
Plastic:	
Enlarging Holes in	87
Tape Kink	43
TV Knobs	43
Players, Improving Portable Record	73
Plug:	
Adapter	67
Clamp Saves	19
Connections, Fast	121
Stuffing a	94
Pocket Continuity Tester	23
Pockets, Drop-Cloth	115
Polarized Marker Pips	14
Pop-Up Toolbox	89
Portable Wire Rack	99
Pots, Extra Life for Defective	54
Power-Transistor Sockets	55
Probe:	
Guards, See Through	10
Peak-Reading	21
Saver	21
Prod Handling, Clothespin Eases	85
Protect TV-FM Lead-Ins	30
Protect Your Meter	8
Punch Care, Chassis	102
Punch, Sharpening a	90
R	
Reamer, Handy	91
Receiver Calibration	63
Reception, Boost Fringe	50
Rechargeable Battery Repair	60
Record:	
Changer Hum	75
Players, Erratic	73
Players, Improving Portable	73
Recorded Tapes, Storing	76
Recorder:	
Cleaning Kink	72
Kink, Tape	74
Mike Stand	74
Recorders, Timing Tape	71
Rectifier Tests	63
Rectifier, Transistor	60
Reduce Line-Cord Fraying	92
Reduce Nuisance Calls	48
Relay:	
Cure, Sticky	84
Operating Kink	111
Sensitivity, Improve	118
Renew Panel Markings	20
Replacing Selenium Rectifiers	49
Resistance-Box Modification	15
Resistance, VTVM Measures	21

Resistances, Measure High	17
Resistors, Light-Bulb	120
Restringing Dial Cord	65
Rubbing Voice Coil	73
Rustproofing Hardware	35

S

Safety Glass, Cleaning Plastic	39
Sander, Gun Carries Own	83
Sawtooth Generator	25
Scales, Brighten Meter	13
Scratches, Lucite	32
Screw-Cutting Jig	97
Screw Eyes for TV Safety	42
Screwdriver Modification	83
Screwdrivers, Phillips	85
Screws, Turning Tough	92
Second-Anode Connector	28
See Through Probe Guards	10
Selenium Rectifiers, Replacing	49
Shafts, Cutting Miniature	108
Service:	
Aid, Bowl-Cover	106
Bench Aid	109
Calls, Simple	45
Jobs, Timing	52
Light Holder	122
Syringe	75
Tool, Can Opener as a	91
Sharpening a Punch	90
Shaving Bag, VOM in a	8
Shock Absorbers	18
Shock-Absorbing Ride	37
Short Detector, Intermittent	45
Signal-Seeking Tuners	56
Signal Tuning, Duplex	58
Simplify Mounting Problems	62
Slipping Dial Cords	53
Sloping Roofs, Standoff for	33
Socket:	
Mount, Transistor	78
Testing at Top of	43
Trouble	40
Solar-Cell Precaution	80
Solder:	
Dispenser	87
Loop Anchors Wire	100
Spaghetti Insulates	101
Soldering:	
Aid	110
Cast Iron	92
Heat-Conductionless	98
Hint	56
Iron Cleaner	103
Iron Holder	82
Iron, Keeping a Clean	89
Iron Rest	89, 103
Iron Tinning	79
Pad	108
Phone Tips	96
The Unsolderable	101
Tip	84
Tool Maintenance	95
Vise	96
Solderless Connectors	113
Spaghetti:	
Drinking-Straw	112
for Miniature Circuits	118
in a Tube	53
Insulates Solder	101
Spare Iron Tips	95
Speaker:	
Adding a Rear-Seat	52
Repairs	72
Substitution	55
Switching, Auto	59
Splices, TV Lead-In	37
Splicing Stranded Wire	87
Splicing TV Lead-In	39
Stand, Handy Connecting	115
Stand, Soldering-Iron	89

Standoff:			Transistor: (Cont.)	
for Sloping Roofs	33		Rectifier	60
Mount	31		Socket Mount	78
Posts to Suit	117		Sockets, Power	55
Stay-Put Trouble Light	82		Transistors, Fusing	56
Sticky Relay Cure	84		Transistors, Grommet Protects	64
Sticky Yokes	36		Trouble Light, Stay-Put	82
Storing Recorded Tapes	76		Tube:	
Straighten Component Leads	51		Carrier	84
Stranded Wire, Splicing	87		Holder	99
Straps, Bonding	38		Shields, Don't Forget	35
Stringing Aid, Dial	57		Tapper and Wire Pusher	124
Stripper, Wire	93		Tubes, Diode-Triode	41
Stripping Short Harnessed Wires	121		Tubes, Hanger Tops for	88
Stylus, Examining Phono	70		Tuners, Signal-Seeking	56
Stylus Skips or Sticks	73		Tuning Slug, Damaged	54
Substitution Box, High-Wattage	22		Turning Tough Screws	92
Substitution Speaker	55		Turntable, New Flock for	76
Suppression, Hum	68		TV:	
Switch, Phone-Plug	123		Antenna Alignment	38
Switches, Volume-Control	54		Antennas, Installing	29
Switching Auto Speakers	59		-FM Lead-Ins, Protect	30
Sync Tracer, Vertical	34		Lead-In Splices	37
Syringe, Service	75		Lead-In, Splicing	39
Syringes, Penicillin	82		Servicing Aid	27
			Twist Drill Covers	81
T			U	
Tap Stand, Handy	104		UHF Installation Kink	33
Tape:			Universal Test-Lead Hint	16
Protects Chemicals	112		Universal Vise	79
Recorder Kink	74		Use a Ballpoint Pen	114
Splicer Cleaning	69		Use an Atomizer	42
Tapes, Storing Recorded	76		V	
Telephone Antenna	64		Variac, Versatile	12
Temporary Wire Wrapping	116		Versatile Variac	12
Tent for Lightning Arrester	31		Vertical Sync Tracer	34
Test:			Viols Hold Batteries	55
Adapter, Handy	13		Video Peaking	41
for Hot Chassis	57		Vise:	
Lead Extensions	10		Soldering	96
Lead Hint, Universal	16		Top-of-Toolbox	80
Lead Storage	7		Universal	79
Prods, Easily Made	25		Voice Coil, Rubbing	73
Rig, Audio	69		Volume-Control Switches	54
Sets, Feet Protect	24		Volume Controls, Noisy	43
Tester, Pocket Continuity	23		VOM in a Shaving Bag	18
Testing at Top of Socket	43		VTVM Measures Resistance	21
Thumb Screw Wrench	84		VTVM Probe, Combination	23
Tight Cap, Corkscrew for	113		W	
Timing Service Jobs	52		Wire:	
Timing Tape Recorders	71		Anchored by Liquid Metal	90
Tip Jacks, Easy Connections for	18		Pusher and Tube Tapper	124
Tip, Soldering	84		Rack, Portable	99
Tool for Technicians	105		Splicing Stranded	87
Toolbox, Pop-Up	89		Stripper	93
Toolbox Storage Kink	108		Terminal Identifiers	92
Toolkit Cheater Holder	43		Wrapping, Temporary	116
Toolkit Flux Dispenser	101		Wrench, Thumb Screw	84
Tools, Color Coding	101		Y	
Top-of-Toolbox Vise	80		Yokes, Sticky	36
Tracking, Loopstick	66			
Transformer, Isolation	32			
Transformers, High-Q IF	51			
Transformers, Mounting Speaker	50			
Transistor:				
Kink	119			
Life Saver	65			
Mounting Clips	61			

Printed in the United States of America



BE SURE TO READ THESE OTHER GERNSBACK LIBRARY BOOKS

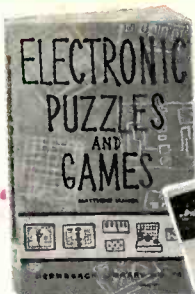

ELECTRONIC PUZZLES and GAMES by Matthew Mandl. Build your own projects with simple, inexpensive materials. Easy-to-understand and easy-to-construct! No special electronic knowledge needed. G/L No. 70. 128 pages. **\$1.95**



HI-FI MADE EASY by Norman H. Crowhurst. Learn all about high-fidelity in a simple, quick-to-learn way. Written so that you can understand it. Filled with hundreds of amusing, yet informative sketches. G/L No. 90. 224 pages. **\$2.90**

MODEL RADIO-CONTROL by Edward L. Safford, Jr. Want to know more about this fascinating hobby? Learn how to put together a complete radio-control system of your own. Control planes, boats, toy cars and trucks at a distance. G/L No. 74. 192 pages. **\$2.65**



ELECTRONIC HOBBYIST'S HANDBOOK by Rufus P. Turner. Scores of circuits for planning, designing and building amplifiers, oscillators, intercoms, door openers and numerous other hobbyist's projects. Also covers safety and shop practice. G/L No. 69. 160 pages. **\$2.50**

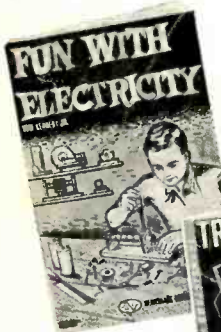
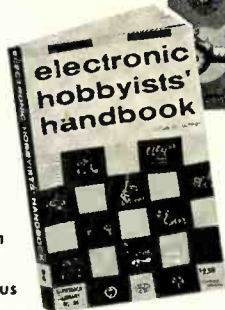

FUN WITH ELECTRICITY by Tom Kennedy, Jr. Build and learn! A unique introduction to electricity plus shop projects that make learning fun. Ideal for the practical hobbyist or student. G/L No. 83. 128 pages. **\$2.65**

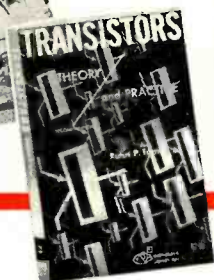

TRANSISTORS—THEORY and PRACTICE (Second Edition) by Rufus P. Turner. Learn how transistors work, how to use them in circuits, how to get the most out of them. Theory written so you can understand it —circuits explained so that you can follow them. G/L No. 75. 160 pages. **\$2.95**

**GERNSBACK
LIBRARY
INC.**
154 West 14th Street
New York 11, N. Y.

Use the Gernsback Library book way of getting more knowledge and more enjoyment out of electronics. You can increase your understanding and enjoyment of high fidelity, build your own projects, use the latest circuits. Learn every phase of electronics. All of this—and more, in Gernsback Library books,