

POWER SUPPLIES

THEORY AND TROUBLESHOOTING

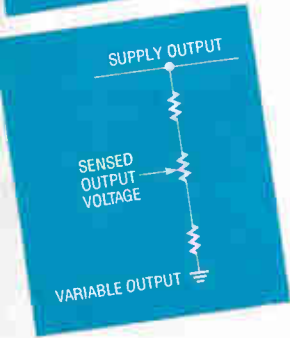

By Sam Wilson
 Edited by the ISCET Staff

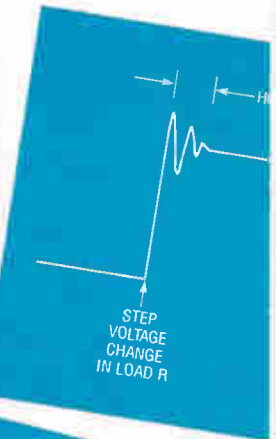
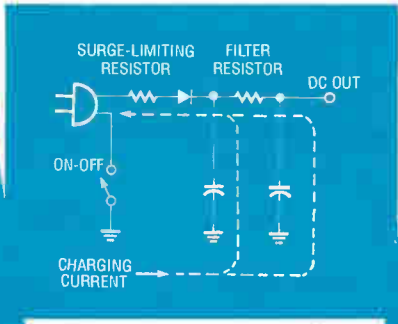
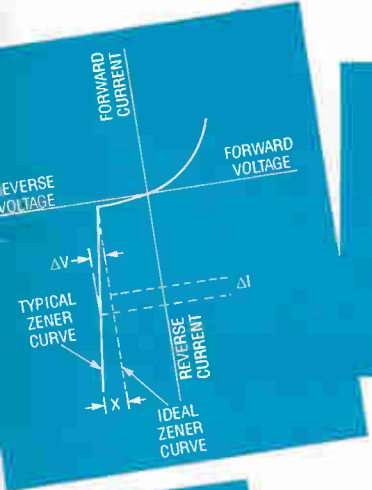
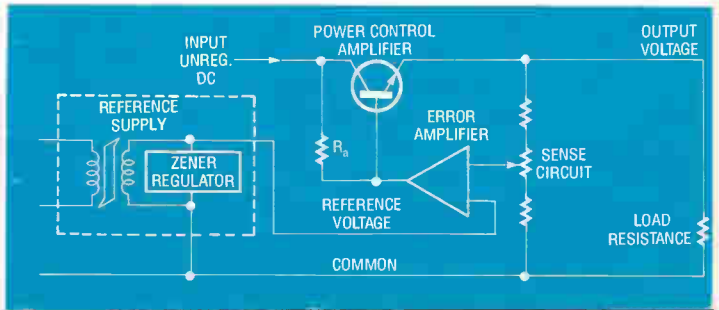

Sam Wilson's Vita

J.A. Sam Wilson has a diploma from Capital Radio Engineering Institute, a Bachelor's Degree from Long Beach State College in California and a Master's Degree from Kent State University in Ohio. He also has three diplomas from correspondence schools.

He has 20 years experience as an instructor and professor. He has taught at Kent State University, Colorado State University and several proprietary schools. In 1984 he was selected as Technician of the Year by the International Society of Certified Electronics Technicians.

Sam Wilson was the director of Technical Publications for NESDA (National Electronics Service Dealer Association) for five years and was a CET Test Consultant for ISCET (International Society of Certified Electronics Technicians) for eight years.

In 1986 he was on a lecture tour taking the subjects of microprocessors and computers to technicians who had an expertise in other fields of electronics. The lectures were given in Texas, Kansas, Oregon, Washington and Louisiana.

Wilson holds a patent on a portable transcutaneous electrical neural stimulation (TENS) unit and a disclosure letter at the patent office on a laser acupuncture unit. He is presently a full-time freelance technical writer and consultant.

Sam has a Radio Amateur General License (WA8RMS), a lifetime First Class Commercial FCC License with a Radar Endorsement and a Journeyman Certified Electronics Technician (CET) rating in Consumer Electronics.

POWER SUPPLIES THEORY AND TROUBLESHOOTING

By Sam Wilson
Edited by the IS CET Staff

There are six things that every technician needs to know and needs to have for troubleshooting and repairing power supplies. They are:

1. The right test equipment
2. A knowledge of how power supplies work
3. A logical approach to troubleshooting
4. Knowledge of a few "tricks-of-the-trade"
5. The right tools and training for replacing faulty components
6. Experience

Items 1, 2, 3, and 4 are the main thrust of this material and they are covered in this booklet. Obviously, Item 5, tools and training, cannot be supplied in any booklet. Also, I've never found a way to provide experience (Item 6) in a text.

I get a lot of letters as a result of my articles in *ES&T* magazine. Among other things, technicians send reports of their experiences. I have put many of their practical ideas into this material. However, there is really no substitute for jumping in and actually doing the work.

TEST EQUIPMENT

Of course, you need a good volt-ohm-milliammeter (VOM) and that an oscilloscope is very useful. A proper set of probes for both is a must.

There are two pieces of equipment that are sometimes overlooked: A good regulated DC bench supply and a good substitute load resistor. Maybe you don't think of them as being test equipment, but, make sure you have them on your bench before you start troubleshooting modern power supplies.

I would like to *suggest* that you invest in a good commercial DC power supply with built-in meters and adjustments. That is easy for me to say, but I know the reality is that some of us may not have the money to invest in such a supply at this time. In that case, put it on your list as a necessary future addition to your bench. Then, build a good regulated supply that you can use in the meantime.

I have included the schematics diagram for two good, yet inexpensive regulated power supplies in Appendix A. Both circuits are easy to build. Be sure to mount the regulators on a heat sink! That gives the power supplies maximum current capability! All of the information for the home-made supplies is from by Texas Instruments.

The 1N4022 diode in the LM317 illustration isn't always shown in books and articles, but consider it to be an essential part of the supply. Although not shown in the illustration, it would be a good idea to include that diode with the LM350 circuit.

Suppose, for example, that the +48V in the LM317 is switched off and, at the same time, the 25 microfarad output capacitor is fully charged to 25V. That puts a positive voltage at V_{out} and a lower positive input DC voltage. That reverse voltage across the LM317 can destroy it if the diode is not present! However, under the reverse-voltage condition the diode conducts and places a short-circuit (nearly) across the regulator.

Also shown in Appendix A is a circuit using the LM350. It has a higher current rating of 3 amperes.

Both of the regulators in Appendix A will automatically begin to shut down when the output current rating is exceeded. The regulators use a fold-back current circuit. In other words, the output voltage will start to decrease as the output current starts to exceed the current rating. That decrease in voltage can destroy some types of circuits. (For example, TTL circuits, 5V memories, etc.) For that reason I strongly suggest that the power supply voltage be monitored at all times during troubleshooting.

Don't be misled by the simplicity of the circuits in Appendix A. Both supplies have current limiters and heat sensors to shut the supply down in case of an overload.

It would be a good idea to build several bench-supply circuits so you can substitute all of the voltages into a system that has several outputs.

A substitute load resistance makes it possible to operate the supply you are troubleshooting when it is disconnected from the system. It is not a good idea, and in some cases it is definitely unwise, to operate a system power supply without a load resistance. There is often a minimum idling current requirement for a regulated power supply. That is especially true of regulated DC supplies that use an integrated circuit-regulator. Loss of the idling current can be destructive to the supply and especially to a supply output circuit.

Examples of substitute load resistor circuits are shown in Appendix B. The illustration also shows how a bipolar power transistor can be used as a substitute load resistance in DC circuits. A Darlington pair (Figure 40) is especially well suited for this application. It can handle high currents but uses a relatively low current for base control.

A VFET can also be used as a substitute load resistance. As with the bipolar transistor circuit shown, the enhancement-type VFET requires a forward bias. So, the VFET circuitry is similar to the one shown in Appendix B for the bipolar transistor. It would be a good idea to calibrate the variable resistors for current capability in one-half ampere steps.

Besides using power transistors or series and parallel resistors, another choice is to use a 3-legged regulator mounted on a heat sink.

A combination isolation transformer and adjustable AC power source is a test instrument that will save you many hours of troubleshooting time and make your bench safe. The version made by Sencore (PR57 Powerite) has an AC voltmeter and AC ammeter so you can monitor the input power to a system you are troubleshooting.

With this equipment you can start with a low-input power to the system being serviced. Then, increase the power while you monitor the voltage and current. If the current starts to increase rapidly you can shut down before any damage is done.

An LCR (Inductance, Capacitance, Resistance) meter can be very useful for evaluating power supply chokes and transformer windings as well as capacitor and resistor values.

The rated capacitance of an electrolytic capacitor is often given with a tolerance of +100%, -50%. Some have even wider tolerances. A measurement of the actual capacitance value of an electrolytic capacitor does not give much useful information.

A meter that measures the ESR (Equivalent Series Resistance) of electrolytic capacitors is an inexpensive and very useful piece of test equipment. ESR is NOT the same as series resistance! Actually, ESR is the equivalent of the combined series resistance and leakage resistance of an electrolytic capacitor.

Many ohmmeters that are part of a VOM cannot accurately measure resistances that are less than few ohms. That is a measurement that is very useful when searching for shorted transformer turns. There are many do-it-yourself circuits available for converting your VOM for making low-resistance measurements.

An *in situ* tester is a very valuable troubleshooting instrument for locating faulty transistors in hard-wired power supply regulators and other electronic systems. The term *in situ* means the tester can test a transistor while it is connected into a circuit. You'll not find these testers offered for sale by instrument manufacturers, so, make your own. The schematic diagram for an *in situ* tester is in Appendix C. The tester outputs a tone when testing a good transistor.

I have a small desk fan that originally operated on two 1.5V dry cells. I use one-half of a center-tapped 6.3V filament transformer and a bridge rectifier to run it because I can never remember to buy batteries.

It has a lot of uses. For example, I use it to blow the smoke away from me when I am soldering. I also use it to move air past a load resistance or power transistor (See Appendix B) when used as a substitute load resistance across a power supply output.

AN OVERALL VIEW

When you first begin to troubleshoot any electronic system it is a good idea to start with a complete visual inspection. Look for evidence of overheating, burned components, loose wires, defective plugs and connectors, cold solder joints and any other obvious faults. Make the necessary repairs before proceeding. Also, check for a blown fuse or a tripped circuit breaker.

When troubleshooting any electronic system the first measurement should be the power supply [or battery] output terminal voltage. If the power supply output voltage is not correct, fix that problem first. In some cases—such as a low DC output voltage—repairing the power supply will also fix other problems in the system. As will be discussed in more detail later, it is usually necessary to check the output voltage (or, terminal voltage) when the supply is under load.

Let's stop here and make sure we are talking about the same thing when we talk about a power-supply load. The power-supply load is the current delivered by the power supply. When we say the supply is "under a heavy load" we mean it is delivering a lot of current. The load resistance is the resistance the load current flows through.

If the power supply output voltage is not correct it can cause some other part of the system to stop operating properly. You can waste a lot of time working in a section that seems to be defective when the real problem is in the power supply.

I remember working on an early television receiver that always went out of horizontal sync whenever the power supply voltage was low. If you didn't know that you could spend a lot of time troubleshooting in the horizontal sync section and not solve the problem.

In some modern systems a low [or, high] power supply voltage can destroy a complete circuit, or, components in a circuit. As an example, suppose a technician is troubleshooting in a circuit that is made with TTL logic gates. The technician discovers that several of the gates have been destroyed, so, those gates are replaced. After replacing the gates the circuit is energized and the new gates are destroyed. The real problem was an incorrect power supply voltage.

Of course that seldom happens to experienced technicians, but it does help to explain why the power supply voltage—and sometimes the power supply current—should be investigated as a first measurement in troubleshooting.

This leads to an important rule regarding equipment servicing: Whenever you have made repairs in any system, try to find out what caused the failure before you energize the system again!

The term "power supply" is another term that needs to be reviewed. In many cases that circuit does not actually supply power for operating an electronic system. Instead, it modifies and controls the amount of power delivered to the system from a DC or AC power [line voltage] source. However, looking from the electronic system toward the power supply, that power supply can be considered to be the power source.

POWER CONVERSION

An important part of power supply technology is the power conversion. Power supplies usually incorporate one or more types of power conversion and it is a good idea to start by reviewing this section of the power supply.

There are four possible power conversions and they are illustrated in Figure 1. They are: AC to AC; AC to DC; DC to AC; and, DC to DC.

AC-to-AC Conversion

In the AC-to-AC conversion (Figure 1) a power transformer or some other form of transformer is used. A transformer can be used in the following ways:

- Step voltage up or down
- Step current up or down
- Isolate two circuits (as with an isolation transformer)
- Pass one frequency or range of frequencies and, reject all others (as with an RF transformer)
- Match one impedance to a different value of impedance (as with an interstage coupling transformer)

Remember, whenever the voltage is stepped up in a power transformer the current is automatically stepped down and *vice versa*.

Isolation transformers are a very important part of the work bench in electronics because some equipment is still in use that can prove lethal under the right conditions. That equipment is usually prefixed by the term "AC/DC." In the older systems it is possible to plug that type of equipment into a socket and put the chassis of the equipment at a high-level AC voltage. That is, the chassis is connected to the hot lead of the power cord instead of the ground lead. You do not want the chassis of an AC-DC system connected to the hot side of the AC power line as shown in Figure 2. This can happen, for example, if some energetic home handyman has replaced the plug and/or line cord incorrectly. Even worse, the polarized receptacles on the test bench may be wired incorrectly!

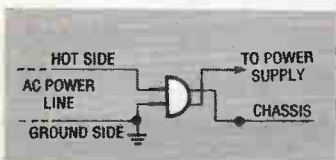

Figure 2

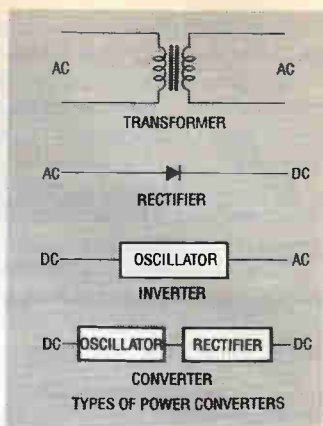

Figure 1

Modern AC/DC equipment has a polarized plug but it is still a good idea to use an isolation system circuit. An isolation transformer does not convert the voltage from one level to another. Instead, it has a one-to-one turns ratio between the primary and secondary windings. Its only purpose is to isolate the equipment on the bench from the AC power line.

When you are investing in an isolation transformer

it is a good idea to put a little more money with the investment and purchase a variable isolated AC power supply with current and voltage meters. This not only isolates the AC/DC chassis for safety reasons but it also permits a technician to determine how much current is being drawn by the system and how much voltage is being applied.

If you have some older AC/DC equipment on your bench for servicing it would be a good idea to change the plug to one that is polarized. Charge the customer for this service. After all, the customer pays you for your expertise, and, preventing accidental death comes well within the range of a technician's capability.

Autotransformers—often referred to by the trade name “Variac”—are *not* isolation transformers! However, they can be used in the primary circuit of a non-variable isolation transformer to adjust the output voltage to the bench. Some commercial output transformers—like the Sencore type—have an adjustable built-in isolation transformer along with the desired metering.

The second power conversion shown in Figure 1 is a rectifier. Rectifiers “convert” AC power to DC power by limiting the flow of current in one direction only. The theory of rectified by diodes is familiar to even novice technicians.

DC-to-AC Conversion

The third method of power conversion is called an inverter and it is illustrated in Figure 1. It “converts” DC to AC. Remember that every oscillator circuit in electronics is a device that changes DC to AC. A DC power source is required to operate the electronic oscillator and the AC output from an inverter is the result of the oscillation.

DC-to-DC Conversion

A device that “converts” DC to AC is properly referred to as an *inverter*. Do not confuse it with the *converter* illustrated in Figure 1. In a converter the DC is changed from one level to a higher DC level. [Resistive voltage dividers are used to change both AC and DC voltages to a lower voltage value]. A transformer can be used to step up the voltage in a converter. The transformer steps up the AC or pulsating DC voltage. The secondary voltage is rectified and the higher level DC is delivered to the output.

The converter is interesting because it uses three different forms of power conversion that can be built into one unit. The three forms are DC-to-AC, AC to a higher level of AC, and, AC-to-DC.

There are many modern power supplies in operation today that utilize several methods of power conversion. For example, a UPS (Uninterruptible Power Supply) is often used in computer systems to prevent the loss of computer memory in the event of a power failure. The UPS uses a heavy duty battery [such as a lead acid battery] as the source of power. That power must be changed to AC by an inverter.

In the design of the UPS, the AC output must have a very accurate 60 Hertz frequency and must be a pure sine wave. That is why the UPS often incorporates a crystal-controlled frequency, a countdown circuit from a high frequency to 60 Hertz, and, a wave shaping section.

No matter how complicated the electronic power supply design, it will utilize at least one of the methods of power conversion shown in Figure 1.

NOTES ON UNREGULATED POWER SUPPLIES

A battery is an example of an unregulated DC supply. A simple AC-to-DC rectifier supply is another example of an unregulated supply.

An AC-to-DC unregulated supply has no way of maintaining output voltage and/or current at a constant level. It is sometimes called a *brute force power supply*. An example is

POWER SUPPLIES THEORY AND TROUBLESHOOTING

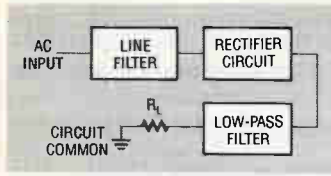

Figure 3

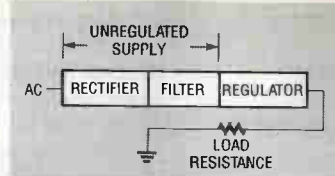

Figure 4

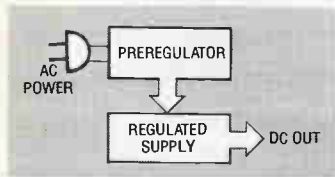

Figure 5

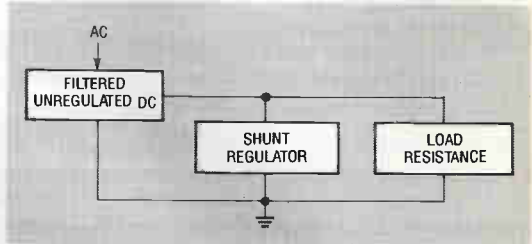

Figure 6

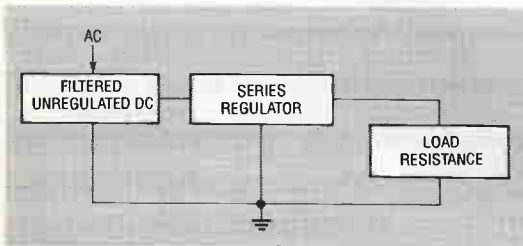

Figure 7

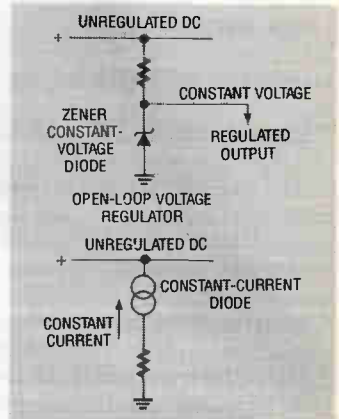

Figure 8

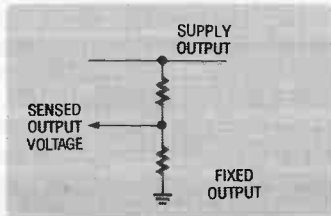

Figure 9

shown in block diagram of Figure 3. Since it is unregulated, changes in load will result in terminal voltage changes. In this way the supply behaves like a battery.

When an electronic system operates from an unregulated supply it can be assumed that small changes in the supply output voltage or current will not cause trouble in the system. For example, the normal voltage drop at the output terminals of a battery should not cause damage in battery-operated equipment.

Percent regulation is a measure of how well an unregulated supply holds its output volt-

age when its output current changes. It is calculated using the following equation:

$$\% \text{ Regulation} = [(\text{No-load voltage} - \text{full-load voltage}) / (\text{full-load voltage})] \times 100$$

where: No-load voltage is the output voltage of the supply with its output terminals open; and, Full-load voltage is the output voltage with its output terminals connected to the normal load resistance of the supply.

Example: The output voltage of an unregulated supply is 25 volts when there is no load resistance connected across its terminals. When the supply is under full load its terminal voltage is 20V. What is the percent regulation?

Solution: $\% \text{ regulation} = [25 - 20] / [20] \times 100 = 25\%$

A low value of percent regulation is desirable. Percent regulation is not a term used with regulated supplies.

Unregulated supplies are usually designed to deliver a specific (rated) voltage at a specific (rated) amount of current. To work properly they must be operated at their specified load, or, range of output currents. In most cases you cannot effectively troubleshoot this type of supply thoroughly unless it is under load!

NOTES ON REGULATED POWER SUPPLIES

All electronically-regulated power supply systems have an unregulated power supply as part of their circuitry. (See Figure 4.)

A pre-regulator is a form of regulator that is connected ahead of the major regulator. This is shown in Figure 5. A typical example is a regulating transformer. Failure of the pre-regulator to provide a steady output voltage can make it impossible for the major regulator to properly perform its job!

Figure 6 shows the connection for a *shunt regulator*. In this circuit the regulator current is in parallel with the supply load. Usually you will see this type of regulator used in circuits where the power supply must deliver a high current.

Figure 7 shows the connection for a *series regulator*. In this case the output current flows through the regulator. As a result, this type of regulator is not usually required to pass a very high current.

There are two methods of obtaining voltage and/or current regulation: *open loop* and *closed loop*. With an open-loop regulator there is no feedback circuit. The output depends upon a device that delivers a constant voltage (like a Zener diode) or a constant current (like a

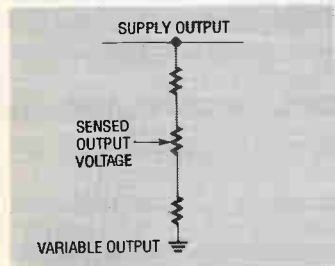

Figure 10

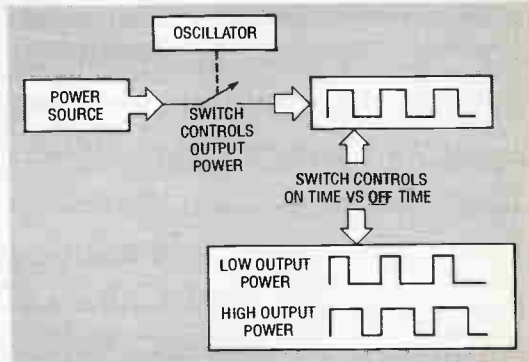

Figure 11

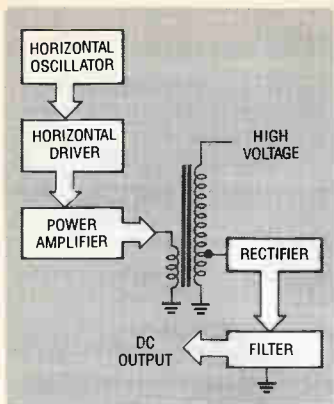

Figure 12

The *switching regulator* shown in Figure 11 is switched on and off by an oscillator circuit. The "on" time is controlled by the feedback circuitry. That, in turn, controls the power supply output. Observe the waveforms for low and high output power for switching regulators as shown in Figure 11.

A *scan-derived supply* is a special case of a switching supply. As shown in Figure 12, it uses the horizontal oscillator to obtain the switching. This type of supply may or may not be regulated.

GENERAL PROCEDURES FOR TROUBLESHOOTING ALL TYPES OF SUPPLIES

It would be a mistake to troubleshoot any type of supply regulator and not take the complete power supply circuit into consideration. Suppose, for example, that a certain supply does not deliver any output voltage. In addition to the regulator circuit, likely causes are a defective transformer or filter inductor.

The arrows on the block diagram in Figure 13 show sections where a supply can become defective. Any of these can be a source of trouble in a regulated power supply.

The problem of troubleshooting power supplies is made a little bit easier by the fact that many of the circuits are common to all types of supplies. You don't have to learn new circuits and new techniques for these every time you troubleshoot a new supply.

We will now look at some common supply circuits indicated by the arrows in Figure 13. The following discussion includes both theory and troubleshooting techniques.

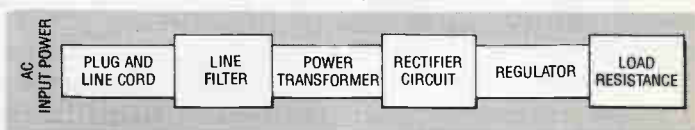

Figure 13

POWER SUPPLIES THEORY AND TROUBLESHOOTING

The AC Power Line

Power line problems can occur in both regulated and unregulated supplies.

Don't take the input AC power for granted. There are several types of line voltage problems to consider. The line voltage can be below the standard 120 volts. Also, it could be above 120 volts but that doesn't create as much of a problem. The incorrect line voltage can be for a short term or a long term.

Some regulator circuits will drop out when the line voltage is low. That can be a cause of no output voltage from the supply.

By far the most serious problem with the AC power line is voltage spikes, often called *transients*. Those spikes can pass through rectifiers, regulators, and filters and get into the circuitry at the supply output. The result can be insulation or dielectric breakdown, loss of timing in digital systems, and/or a breakdown of operation in any part of the system, and, noise in the system out-

put. This is a very difficult problem because the damage may be already done by the time the technician sees the system. Also, the system may be taken into a shop where there are no line transients and the technician might overlook that possibility.

Here are some suggestions. Always keep the line transient problem in mind—especially if there are components that show signs of insulation breakdown. It might be a good idea to go to the location and look for machinery and other possible causes of transients. In extreme cases you might consider adding a line voltage transient filter such as Transorb™ to make sure there won't be a call back. I know there are technicians who believe talking to the customer about problems is a waste of time. However, the customer may be helpful in locating possible sources of line transients.

Nearby lightning strikes can induce highly-destructive line transients in the AC power line. I've never talked to anyone who knows what to do about that other than using some kind of transient protective device such as an MOV™ (Metal-Oxide Varistor). That is always a good idea for your bench AC line—especially in states like Florida where there is a lot of lightning.

The Plug Could Be The Problem

Don't forget to look at the plug! Start with a good visual inspection. This is especially true if some well-meaning handyman has been at work. Remember that the plug in modern equipment is polarized. In other words, it is designed to assure that the ground side of the power line goes to the preferred ground side in the circuit. In some cases the equipment would work with the plug reversed, but some undesirable effects are likely

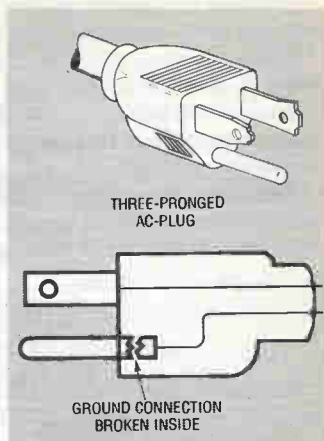

Figure 14

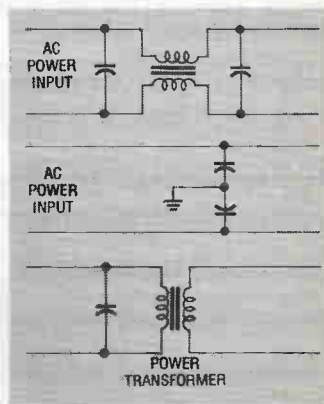

Figure 15

to occur. If it is an AC/DC system there can be lethal voltages on the chassis or other places where you don't expect them.

A second undesirable effect of an improperly polarized input is the likelihood of electrical noise being introduced into the system.

Figure 14 shows a problem that was very difficult to find. The ground connection of the plug was broken internally. This is a safety connection and the customer was without the protection built into the system. There was no symptom to give the technician any hint that there was a problem. However, if someone had been injured or killed you can imagine who would get the blame!

Some types of variable transformers used to adjust the line voltage on the bench are made with autotransformers. They give no isolation between the primary and secondary windings! Don't assume those types serve as isolation transformers!! Check them out!!

GOOD WORKBENCH PRACTICE
Equip your workbench with an isolation transformer!
The life you save may be your own!!!

Line Filters

Transient voltage spikes can destroy components, integrated circuits and surface mount devices before an eye can blink. Beyond that, they can produce annoying noise in a system.

Examples of line filters that can be used to get rid of this problem are shown in Figure 15. They are all examples of low-pass filters. The capacitors short the undesired transients across the line or to ground. Inductors pass the 60-Hertz, power-line frequency but offer a high opposition (reactance) to the high-frequency transients.

Line filters will not protect against the high-voltage spikes created by lightning. Those types require the line protectors mentioned earlier.

Line filters are one of the most neglected parts of any power supply. Even when they are not working properly they may not cause any immediate problem with system operation. So, they don't get the attention they deserve.

One way to check these filters is to test each component separately. If you are lucky enough to have an LCR tester the components are easy to test. At the very least, use an ohmmeter to make sure the capacitors are not leaky or open. Make sure the coils have equal resistance values. Sometimes you can determine if the coils have shorted turns by giving them a close visual inspection. Look for evidence of overheating.

You should make it a habit to check these filters every time you troubleshoot a power supply.

Problems with Power Transformers

The most common symptoms of trouble in a transformer are: overheating, low output

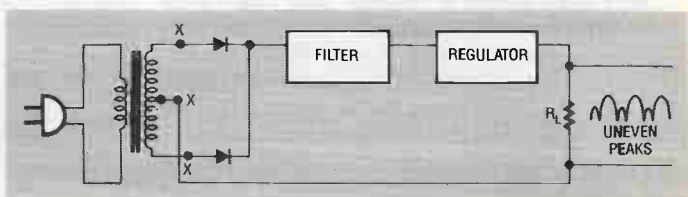

Figure 16

voltage, or, high output voltage.

Be sure to measure the transformer output voltage when it is delivering power to the supply circuit, or, artificial load. In other words check it when the supply is under full load. If there are a few shorted turns in the primary or secondary windings they may show up when you measure voltages while the transformer is working.

Resistance checks of primary and secondary windings are usually next to useless unless the manufacturer has supplied the required resistance values. You cannot determine the turns ratio of a transformer using resistance measurements because different wire sizes are used for the primary and secondary windings. Use the ratio of the output voltage to input voltage (V_{out}/V_{in}) to determine the secondary-to-primary turns ratio. You may need to know the turns ratio if you have to order a replacement power transformer.

When a transformer is used in a full-wave rectifier circuit, like the one in Figure 16, shorted turns in one half of the secondary winding can cause excessive ripple in the output. The resulting waveform—shown in the illustration—is difficult to filter. However, if the supply has a stiff electronic regulator it may smooth out this ripple problem.

So, if you suspect a shorted turn, disconnect the supply from the regulator at the points marked with an "X." Connect an artificial load resistance (see Appendix B) across the outputs to ground. Then, using an oscilloscope, look at the waveform across the output terminals.

Here are two important points to remember about transformers with a few shorted turns in the windings:

- Shorted turns in the primary winding will cause an increase in the secondary voltage.
- Shorted turns in the secondary winding will cause a decrease in the secondary voltage.

The reason for these changes in voltage is that the shorted turns change the transformer turns ratio.

Remember, an uneven waveform in the rectifier output may be caused by a defective diode. Therefore, if you get the uneven waveform be sure to scope each of the transformer windings (under load) separately.

When you replace a transformer pay attention to the dot notation on the schematic drawings of the circuit and on the symbol (See Figure 17.) They tell which leads have signals that are in phase. Phase isn't always important, so you don't always see the dots on schematic diagrams. When they are included you can assume it is an application that requires the phase notation be followed for correct replacement.

Transformers may have a braided bare wire coming from inside the case. That wire is the connection for the Faraday shield. (See Figure 17.) Its purpose is to reject transient voltages on the line from entering the supply via capacitive coupling between the primary and secondary windings. As with the line filter, don't neglect this shield. It should be connected to a good ground point. However, if the supply has a floating chassis (not grounded) it doesn't do any good to ground the shield to the chassis. Connect it to the power lead that goes to the outside ground. Always check this connection when the system is in for servicing.

Much of the equipment made today has a power transformer that is rated at 50 to 60 Hertz. The reason for that is that some European countries use a 50-Hertz power line instead of the 60 Hertz we are familiar with in this country. A question that sometimes arises:

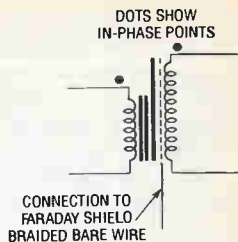

Figure 17

If the transformer is rated at 60 Hertz only, can it be operated on 50 Hertz?

The answer is that it is not a good idea. The reason being that the lower frequency will see a lower primary winding impedance. That can cause the primary winding current to be too high! In some cases that high current can be destructive to the transformer and equipment it heats up. If a customer asks that question, check it out and, if necessary, replace the transformer with one that is rated from 50 to 60 Hertz.

A remote possibility is that some 400-Hertz equipment will come across your bench. That would be a rare situation because the power plugs would not (ordinarily) match. However, you should never overlook the innovative genius of the home handyman and the merchandising moxie that is characteristic of flea markets.

Equipment that operates on 400-Hertz power is usually from aircraft and military equipment. The 400-Hertz lines are preferred in aircraft because they permit a lower weight due to the reduced magnetic iron circuitry for the core!

Regulating Transformers

Some transformers are designed to operate as *pre-regulators*. Two types are made: *self-saturating* and *ferro-resonant*. The schematic symbols often used for these transformers are shown in Figure 18. Unfortunately, some manufacturers have slightly modified these symbols. However, you should still be able to determine the type of transformer by comparing their symbols to those in Figure 18. Regulating transformers are sometimes listed by trade names like Paraformer. (See Appendix D.)

The *self saturating* type is designed so that the magnetic circuit—that is, the core—goes into saturation when the transformer input AC current approaches the rated value. When saturation occurs there can be no further increase in the secondary voltage. That results in the squared tops of the secondary waveform shown in in Figure 18.

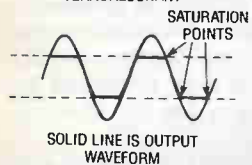
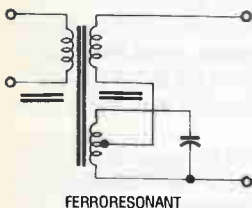
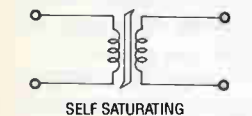

OUTPUT WAVEFORM FOR BOTH TRANSFORMERS

Figure 18

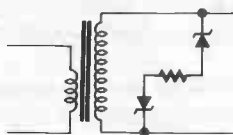

Figure 19

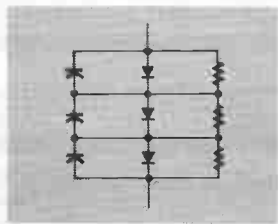

Figure 21

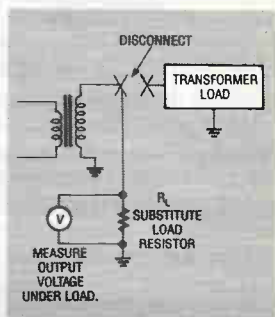

Figure 20

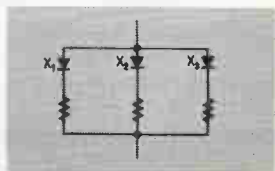

Figure 22

This is an example of a case where a low power-line voltage can disrupt the proper operation of a system. These transformers will not work properly unless the primary-winding current is high enough to drive the transformer core into saturation!

Since the primary-winding current depends (among other things) upon the impedance reflected from the secondary winding, it follows that the transformer replacement must be an exact duplicate of the original! If you do not use the exact replacement the complete power supply, including the electronic regulator (if it exists) may not perform properly.

If you try to operate a self-saturating transformer without a load it will not regulate the secondary voltage!

The *ferro-resonant transformer* shown in Figure 18 also works on the idea of saturating the magnetic core. However, in this case the core is driven into saturation by the circulating current in a resonant LC circuit.

There is a circulating “flywheel” current in the LC circuit during normal operation. Just before the magnetic field in the core reaches saturation on each half cycle of AC input, the flywheel current in the LC circuit adds enough current (and magnetic flux) to drive the core well into saturation. That squares off the tops of the secondary waveform and limits the secondary voltage.

Every time you troubleshoot a power supply with this type of transformer you should always check the inductance and capacity in the LC circuit. You can do this by “scoping” for a near sine wave voltage across the capacitor. (Watch out for high voltages!)

Failure of the LC resonant circuit can result in failure of other circuits in the supply. As with the self-saturating transformer, always use a replacement that has the exact same voltage and current ratings.

Figure 19 shows another way of making a regulating transformer. The zener diodes limit the secondary voltage on both half cycles. The result is a secondary voltage that has the same squared-off (amplitude-limited) waveform as the other regulating transformers. Failure of a zener diode may seriously overload the transformer. At the very least, you will get a blown fuse or burned out surge-limiting resistor (to be discussed later.)

If the output waveform is OK you can assume the zener diodes are OK.

If you get a power supply on your bench that shows evidence of transformer overheating, never energize it to see where the supply is smoking! Disconnect the transformer secondary-winding circuits. Connect a substitute load resistor across the secondary winding then energize it. If the transformer smokes you have two jobs to do: Replace the transformer and find the possible cause of an overload that might have occurred.

Of course, there may not be an overload that caused the transformer failure. However, after the transformer has been replaced it is a good idea to connect the output circuit(s) to a bench power supply one-at-a-time.

For the following test you can usually estimate the current by using the fuse rating. The secondary-winding voltage is usually known from the replacement transformer specifications, or, by measuring it.

When making the transformer test shown in Figure 20, disconnect the transformer at the output leads. Using the rated secondary RMS current (I) and voltage (V), calculate the value of the power resistor: $R = V/I$. Estimate the resistor power rating by using $P = V \times I$. Then double that value.

I know experienced technicians will write and say they don't have time for all that. If the transformer looks OK and smells OK it is seldom bad, so, better to wrap it up as done. There's a lot to be said for that because—after all—you have to make a living. However, technicians without a lot of experience may not want to trust their judgment about energiz-

ing a circuit with a replaced transformer. Always keep in mind the fact that a circuit can be destroyed by an incorrect DC voltage.

Rectifiers

If you are working on power supplies you already know how the rectifier circuits work. If you need to review the rectifier voltage ratings, I have put them in Appendix E. That information can be useful if you have to replace a diode and you don't have the specifications.

Remember that you can replace a rectifier diode or bridge with one having a higher voltage and/or current rating. Never use a replacement with lower ratings.

If there is one open diode in a bridge or 2-diode full-wave rectifier, but the other diode(s) are OK, you will get an output waveform that is very difficult to filter. That results in a high-output ripple that seems to indicate a defective filter. Before you take the filter apart, use your oscilloscope to look at the rectifier output waveforms.

Remember that a transformer can cause the same symptom, so, check the transformer before you squawk the rectifier circuit.

Rectifier diodes might be connected in series or parallel to accomplish a specific purpose. Knowing that purpose tells you something about the supply. For example, they are connected in series to increase the PIV (Peak Inverse Voltage) rating of the rectifier. Series-connected diodes usually mean you are working with a high-voltage power supply. Be careful!

If rectifier diodes are connected in parallel the objective is to get a higher current-carrying capacity.

Figure 21 shows a typical series connection for diodes. The resistors assure that the reverse voltage across each diode is the same.

There is always a small amount of reverse current through a diode that is reverse biased, so each diode has a reverse voltage across it. The reverse resistances of the diodes are usually not equal, so, the reverse voltages across the series-connected diodes are not equal.

In fact, the reverse voltage across one of the diodes can exceed its PIV rating. That higher reverse voltage can destroy the diode.

The resistors across the series-connected diodes assure equal distribution of the reverse voltage across the diodes. This assumes that the resistors have equal resistances. If one of the diodes has been destroyed be sure to check the resistances of those parallel resistors!

In addition to the reverse resistance, a reverse-biased diode has a junction capacity. As with the reverse resistances, the reverse-biased capacities can be unequal. The higher reverse voltage is always across the lowest capacity value. That can happen with a different diode than the one with the highest reverse resistance. The capacitors across the diodes assure equal distribution of reverse voltages across the junction capacities.

You may read that there are other purposes to the resistors and capacitors. The purposes given here are the purposes stated by the manufacturers. They are in the best position to know!

The capacitors are not there just to bypass high-voltage transients around the diodes, but, they will do that. Having said that, remember that it is those transient (spike) voltages that are most likely to damage all components.

Not all high-voltage supplies have the reverse-voltage protection shown in Figure 21. Some have only the resistors, some have only the capacitors, and, some have no extra protection. The line filters discussed earlier are very important for protecting the diodes in the rectifiers.

POWER SUPPLIES THEORY AND TROUBLESHOOTING

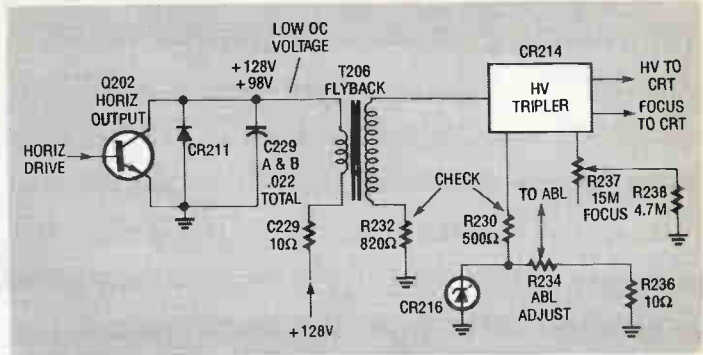

Figure 23

Figure 22 shows how diodes are connected in parallel. It takes a forward voltage of about 0.7 volts across a silicon diode to get it into conduction. That voltage is not written in stone! Some will conduct with less voltage than others. Suppose diode X1 in Figure 22 conducts when there is 0.6 volts across it; and, diode X2 doesn't conduct until there is 0.8 volts across it. Clearly, once diode X1 starts to conduct there is no chance for the other one to get started. This condition is known as "current hogging".

The low-values of resistance in series with the diodes assure that there is enough voltage drop across each branch to start the opposite diode(s).

As with the line filters, the components in series and parallel-connected diodes are often neglected when the power supply is being serviced. The few minutes it takes to check them can prevent a costly call back or reservicing job.

There are many packaged rectifier circuits on the market - too many to handle in one monograph. For example, rectifier circuits come in a sealed plastic package with only two leads. For those cases you can't test the individual components. Testing these units is usually for a GO/NO GO evaluation. Even if you could test individual components you couldn't replace them. These packages are tested as a single unit. Treat them as a single diode.

Figure 23 shows an example of the use of a packaged rectifier circuit (CR214). The high-voltage tripler in this illustration comes as a single unit. The illustration was taken from an article by Homer Davidson in *Electronic Servicing and Technology* magazine.

In a typical troubleshooting problem there was insufficient high voltage to the CRT. The horizontal output transistor Q202 was OK but the collector voltage on Q202 measured only 98 volts instead of the required 128 volts. When the packaged high-voltage tripler was disconnected from the secondary the collector voltage of Q202 rose to the required 128 volts. This very important troubleshooting problem (introduced by Homer Davidson) is a very good example of transformer loading. Any loading on the secondary winding of a transformer is reflected back into the primary winding! So, if the secondary winding is drawing too much current the primary winding will be loaded as described in the above procedure.

The tripler is replaced as a unit and Homer Davidson suggests checking and/or replacing R232 and R230 for possible destruction due to overload.

An important thing can be learned from this troubleshooting problem. Packaged doublers and triplers can go bad in such a way that they draw excessive current and load down

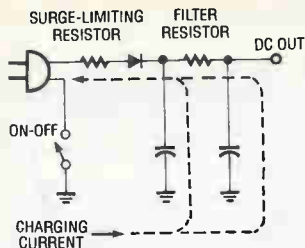

Figure 24

the trans-
former primary winding.

Surge-limiting Resistors

When the power supply in Figure 24 is first energized, the charging current for the filter capacitors—especially the input capacitor—can be amperes high. That will sooner or later destroy the diode. The reason destruction takes time, and a number of on/off cycles, is that the duration of high current is short. However, the diode life will be shortened without the surge-limiting resistor. Its job is to limit the diode current while the capacitor is being charged. That way the diode is protected.

The power rating of the surge-limiting resistor is important. With a serious output circuit overload, or a very leaky filter capacitor, the resistor can act like a fuse. Never replace it with a resistor that has a higher power rating! If the manufacturer specifies a surge-limiting resistor—use an exact replacement! If the surge-limiting resistor is burned out check the power supply filter and output circuit carefully.

One way to do that is to connect an ammeter (or, milliammeter) across the terminals of the surge-limiting resistor. The resistor must be removed for this test even if it looks good. Multiply the surge-limiting resistance value by the square of the current.

$$P = I^2R$$

Then, determine if the resistor that was in the circuit has enough power rating to handle the amount of power calculated. In other words,

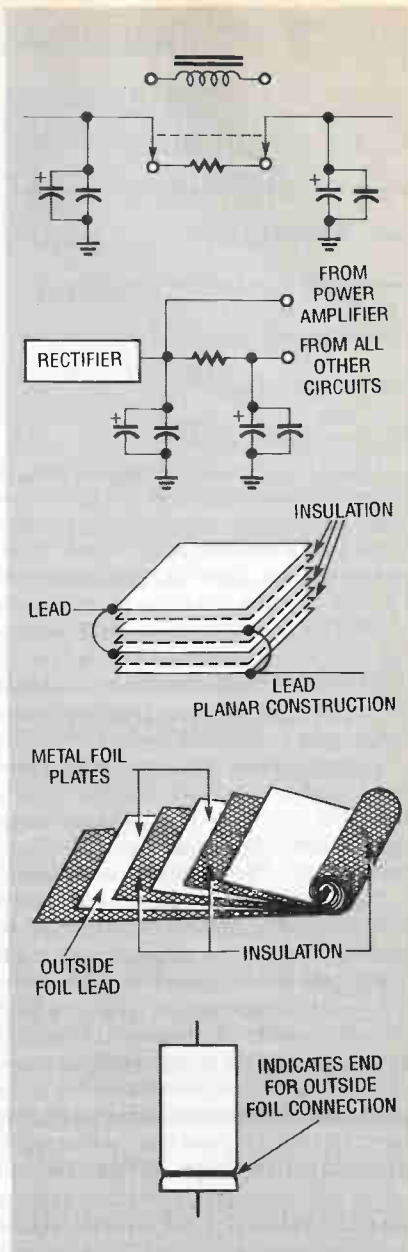

Figure 25

is the power rating of the surge-limiting resistor higher than the actual power dissipated? If yes, replace the resistor and run the equipment for at least a half hour. Is the resistor getting too hot? If so, better check the load circuit.

Let me suggest a very valuable test instrument—a temperature probe. Touching a component to see if it is too hot can lead to very annoying burns. With a little experience you will quickly learn the range of measured temperatures that are characteristic of operating components.

Be especially sure to check the electrolytic capacitors for leakage. As mentioned before, an ESR meter is best for this test.

You may have to disconnect the output circuits of the power supply to find out why the surge-limiting resistor burned out. The ohmmeter is used to locate short circuits, but many current branches may hamper the search for the short circuit. Disconnect all of the supply outputs. Then, connect them one-at-a-time and watch for overheating of the surge-limiting resistor.

Better still, leave the resistor out and the milliammeter connected, and, watch for excessive supply current. If the replacement surge-limiting resistor is overheating, or, there is excessive current, your trouble can be a defective filter capacitor, bad diode, or some problem in the output circuit. After you correct the problem be sure to replace that overheated resistor!

Rectifier Output Filters

A filter is the next stage after the rectifier. It is often a pi network made with two capacitors and a resistor. An inductor may be used in place of the resistor. Both versions are shown in Figure 25. The advantage of the inductor is that there is practically no DC voltage drop across it, so, more of the supply voltage is available for the output circuit. Also, there is very little power loss in the coil. The disadvantages are higher, greater space requirement, and, the possibility of electromagnetic interference.

At one time the coil was located in a speaker. In that application it was often called a “hum bucking” coil. The coil served two purposes: provide the magnetic field for speaker operation; and, filter the pulsating rectifier current. You may still run across one of these if you service older systems. Their higher cost has resulted in the use of permanent magnet speakers and resistors as filters.

As shown in the second circuit of Figure 25 the power amplifiers in a system are connected so that their high currents do not flow through the filter resistor or inductor. Power amplifiers are not sensitive to voltage changes. So, the less-filtered pulsations do not affect their operation. Also, they require a high current for their operation.

The overall result is that the filter resistor can have a lower power rating when the power amplifier is connected directly to the rectifier cathode. In another version a different supply (with less filtering) is used for the power amplifier. The filter resistor (or, the filter inductor) can be checked with an ohmmeter.

The electrolytic filter capacitors in the second circuit of Figure 25 are shown with low-capacity, non-inductive capacitors across their terminals. Those non-inductive filters are made with the planar instructions. They are sometimes needed because there is a certain amount of self inductance in an electrolytic capacitor. As shown in Figure 25, it is caused by the

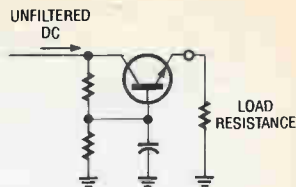

Figure 26

POWER SUPPLIES THEORY AND TROUBLESHOOTING

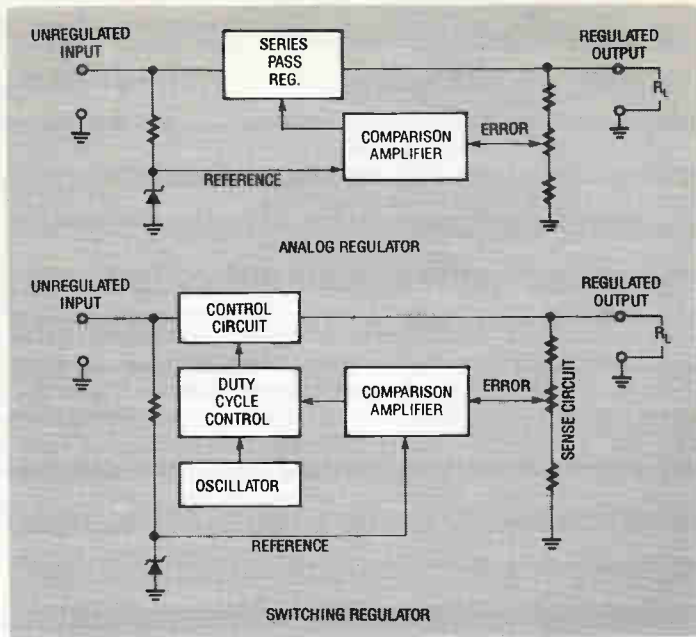

Figure 27

act that the filter capacitor plates are coiled in order to get as much plate area for a given volume.

The small bypass capacitors must be non-inductive types. Never replace these capacitors with types that have self inductance!

The small parallel capacitors make it possible to ground any spike voltages that may have sneaked through the input circuitry. They are likely to be neglected when the supply is being serviced. The reason is that if one of them is open it will not affect the performance of the supply when it is being operated on the workbench. However, if it is returned to service without working bypass capacitors, undesirable transient signals can be passed on to the output circuit of the supply.

Take a few minutes to test those bypass capacitors. Remember to use the right replacement if the capacitor is defective.

Again, the best way to test electrolytic capacitors is to measure their Equivalent Series Resistance (ESR). ESR measures the combined parallel leakage resistance and the series resistance.

Instead of a pi filter, some supplies use an active filter. In this case the word "active" means that an amplifier is used. Figure 26 shows an example. This circuit is also called a *capacitor multiplier* or *electronic filter*.

Actually, the circuit of Figure 26 is an example of a stiff (tightly regulated) open-loop voltage regulator. It behaves like a very high value capacitor is being used for a filter.

You will know that the active filter is not working properly if there is too much output

ripple voltage, or, no DC voltage at the output. Measure the ripple voltage with your oscilloscope input set to AC. The manufacturer's specification will tell you what the ripple rating is supposed to be. If those specifications are not available, compare the ripple with another similar circuit. The allowable ripple depends upon the type of output circuit. That is why the value of ripple cannot be given here.

When a good voltage regulator follows the rectifier in a power supply there may be only a single grounded capacitor to serve as a filter. That capacitor often has a very high capacity of 1000 microfarads or more.

If your ESR meter can't evaluate an electrolytic capacitor with a capacity that high, at least use an ohmmeter to look for excessive leakage. It would be better to try an electrolytic capacitor known to be good.

All of the circuitry and components discussed up to this point make up an unregulated supply. Regulated supplies use an unregulated DC source to supply the regulator.

CLOSED-LOOP REGULATOR CIRCUITS

There are two types of closed-loop regulator circuits that are popular at this time: *analog regulators* and *switching regulators*. The best way to study them is to start with the individual circuits that are used in their construction.

An Overall View of Closed-Loop Regulator Systems

Figure 27 shows a block diagram of an analog regulator; and, a block diagram of a switching regulator. Observe that they are both closed-loop systems. A most important difference between them is in the fact that an oscillator is required for the switching regulator. Another important difference is that the analog regulator uses a continuous bias control to maintain a constant output voltage. The switching regulator usually makes use of a pulse width modulator for the same purpose.

The switching regulator is not the only power supply that uses an oscillator. Inverter and converter circuits have oscillators. Uninterruptible power supplies and scan-derived supplies also use oscillators.

There are some advantages of the switching regulator over the analog type:

- Power supplies are more efficient when they are switched on and off as opposed to continuous duty.
- Since the frequency associated with the on/off switching is higher than the 60-Hertz or 120-Hertz ripple frequency of most analog supplies, the ripple is easier to filter. That, in turn, means that smaller and less costly components can be used in the filtering circuitry. It also means that the complete switching regulator can be built into a smaller package.

The disadvantages of the switching regulator are:

- There is a higher cost in the design and in the manufacturing because of the more complicated circuitry.
- As a rule the switching regulator is more difficult to troubleshoot. That can mean more delay in getting the circuit back into operation.

Because of the switching circuitry and the associated switching transients, switching regulators are noisier than analog types. Transient filters must be used if the noise is a problem.

A brief review of the operation of individual circuits follows.

CIRCUITS COMMON TO ALL CLOSED-LOOP REGULATORS

Refer again to the analog regulator in Figure 27. A good way to analyze analog and switching regulators is to start with the circuits that are common to both. Be sure you know how to recognize the circuits common to all regulator circuits, and know how to troubleshoot them!

Think about this: a closed-loop voltage-regulated power supply compares the power supply output voltage with a reference voltage. If the two voltages are the same no corrective action is needed. If the voltages are not the same the regulator will adjust the output voltage to make them the same.

Regulator Circuits

In high-priced regulated supplies the reference voltage is obtained from a separate supply. However, in most regulator circuits it is usually made with an open-loop regulator using a zener diode in series with a resistor.

The output voltage of the regulator circuit must be sensed so that it can be compared with the reference voltage. So, you can expect to find a sense circuit in regulators. Figures 8 and 9 show examples. In a typical sense circuit, the sense voltage is lower than the supply voltage.

There has to be a voltage comparator in a closed-loop regulator circuit. It compares the sensed voltage with the reference voltage. Refer again to Figures 8 and 9.

There has to be a control component. In an analog regulator it is a power amplifier that can be used to adjust the output voltage if a corrective action is needed. It is often called the *series pass amplifier*.

All of these things are needed in an analog closed-loop voltage or current regulator circuit. There may be a protective device or protective circuit. A fuse or circuit breaker is an electro-mechanical protective device. An electronic crowbar circuit may be used as a very fast, non-mechanical, protective circuit. The purpose of the protective device or protective circuit is to prevent a wrong output voltage and/or current from destroying components in the load circuit. Any of these circuits or components may be the cause of a regulated supply not working properly!

OPERATION OF THE ANALOG VOLTAGE REGULATOR CIRCUIT

Refer again to the analog regulator in Figure 27. The output voltage is sensed and compared with a reference voltage. If there is a difference in the two voltages that difference is amplified and fed back to control the conduction of the series-pass transistor.

There is a limit to the amount of amplification that can be used in the regulator. Too much feedback will cause oscillations and a condition known as "hunting". Figure 28 shows the output of a supply that has too much feedback amplification when there is a step-voltage change in the input. The complete supply becomes an oscillator for a brief time. You can easily recognize the oscillation frequency because on an oscilloscope display, it is higher than the normal ripple frequency.

If the feedback amplification is not high enough the supply will be slow to respond to change in the supply voltage. The supply is said to have a poor slewing capability. In that case the output voltage of a regulator can undergo undesirable transient voltage changes because the regulator is not fast enough to prevent them.

The amplified difference between the sensed and reference voltages is inverted and delivered to the base of the series-pass transistor. So, if the sense voltage is higher than the

reference voltage the forward bias on the transistor is reduced. On the other hand, if the sensed voltage is lower than the reference voltage the forward bias on the transistor is increased. You can consider the series-pass transistor as being a voltage-operated resistor.

A decrease in the power amplifier bias control voltage increases the resistance of the power amplifier. This positions the variable-resistor arm and lowers the supply output current. The reduced current lowers the voltage across the output load resistance. The overall result of the operation just described brings the output voltage back to the required value.

The bias control voltage decreases the resistance of the power amplifier when the output voltage is too low.

OPERATION OF THE SWITCHING REGULATOR

Refer again to Figure 27. Unlike the analog regulator which has a continuous output voltage control, this type is switched on and off to regulate the output power. The on time is controlled by the duty cycle control. That, in turn, controls the power supply output. Observe the waveforms for low and high output power shown in Figure 29.

As with the analog regulator, the output voltage is sensed and compared with the reference voltage. The difference voltage (if it exists) is amplified and used to control the duty cycle of the pulse control circuit. As shown in Figure 29, the RMS value of the voltage or current is higher for a higher duty cycle. That translates to a higher power supply DC output voltage for higher pulse RMS values.

The oscillator delivers pulses to the duty cycle control circuit. Note that the oscillator output is not changed by the control signal. The change in duty cycle occurs inside the control circuit in this version of the switching regulator. Using a signal or variable voltage to control the duty cycle is called *pulse width modulation*, or, PWM.

The overall result is that a rise in the output voltage above the required voltage causes a decrease in the duty cycle of the pulses. The result is a lowering of the RMS value and corresponding lowering of the output voltage back to the required value.

If the output voltage goes below the required value the duty cycle of the pulses is increased. That results in the output voltage rising to the required value.

If you are troubleshooting a switching regulator that has no output, one of the first steps is to scope the oscillator output. If there is no oscillator signal the system cannot operate.

As with the analog regulator, the output of the unregulated supply should be one of your first measurements when troubleshooting an electronic system. If the preliminary tests don't work, open (or, defeat) the loop and test the circuits one-at-a-time. Start with the oscillator.

The oscillator in a switching regulator will be some kind of relaxation oscillator—often a multivibrator.

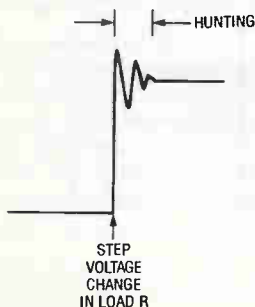

TROUBLESHOOTING ANALOG REGULATORS

Think about this again: An analog regulated power

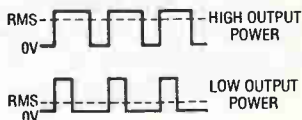

Figure 28

Figure 29

POWER SUPPLIES THEORY AND TROUBLESHOOTING

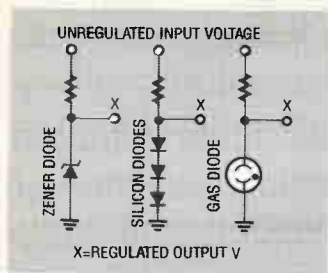

Figure 30

supply compares the output voltage with a reference voltage. See Figure 27. If the two voltages are the same no corrective action is needed. If the voltages are not the same the regulator will automatically adjust the output to make them the same.

There has to be a *reference voltage* somewhere in the regulator.

The output voltage must be sensed so that it can be compared with the reference voltage. So, you can always expect to find a *sense circuit* in the regulator.

There has to be a *voltage comparator* to match the sensed voltage against the reference voltage.

There has to be a *control circuit* that can be used to adjust the output voltage if a corrective action is needed.

All of these things are needed in an analog voltage regulator circuit. There may also be a *current regulator* in the regulator section of the supply. Finally, there may be a *protective circuit* to prevent the output voltage and/or current from being the wrong value.

Any of these circuits may be the cause of an analog regulated supply not working properly! So, locate these circuits and test them when you begin to work on the supply. Some

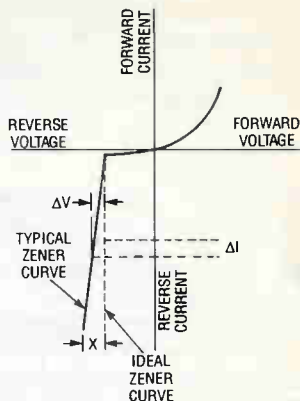

Figure 31

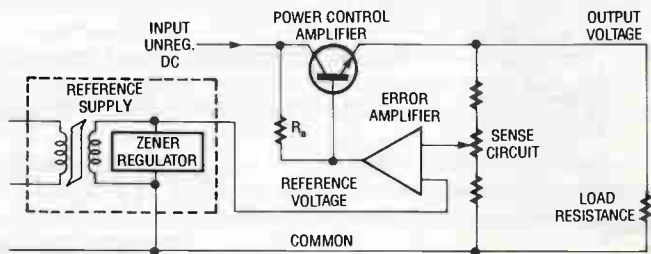

Figure 32

methods of doing that are discussed in the following paragraphs.

The Reference Circuit

It is customary to use an open-loop regulator to obtain a reference voltage. At one time neon lamps were used to obtain a reference voltage. Today the favored component is a zener diode. An example is shown in Figure 30. The reference circuit is connected across the DC voltage source at some point in the regulator near the output.

The voltage across the zener diode is nearly constant even through the DC input voltage may vary over a limited range. Also, limited changes in the value of load resistance will not seriously affect the voltage across the zener diode and load resistance.

Figure 31 shows a typical zener diode characteristic curve. Observe that the voltage is not precisely constant. When there is a small change in current (ΔI) through the zener diode, there is an accompanying slight voltage change (ΔV).

The problem created by ΔV is magnified by the fact that the zener reference circuit gets its voltage from the DC source, and, that is the voltage the closed-loop regulator is supposed to regulate. Furthermore, changes in the regulator load current can slightly affect the voltage across the zener diode.

To get around the fact that the zener circuit output voltage is not precisely held to a constant value, expensive laboratory supplies often are designed with a separate supply as a reference source. This is shown in Figure 32.

You may wonder why the separate zener reference voltage is made with a pre-regulator (such as a constant-voltage transformer). Why not just use the pre-regulator in the circuit of Figure 27? Although that is done in some supplies, the answer is in the cost. The lower power requirement in the reference translates to less expensive pre-regulator transformers.

If you have a variable AC voltage source on your bench—such as an autotransformer (Variac)—it is a good idea to measure the zener voltage when the AC input voltage is varied from 100V to 125V. (The manufacturer may specify a wider range of input voltages.) The zener voltage should be constant—or, very nearly constant—when the AC voltage is varied over that range.

You can replace a zener diode with one that has a higher power rating. Of course, the voltage rating must be the same. Never use one with a lower power rating; and, never try to get a higher power rating by connecting zener diodes in parallel.

SENSE CIRCUITS

There are two types of sense circuits that may be used in regulated power supplies: *voltage sense* and *current sense*. Both types are shown in Figures 33 and 34.

Voltage Sense Circuit

The reference voltage must be compared with the power supply output voltage, or, with a voltage that is proportional to the output voltage. The supply output voltage is usually sensed by a resistive voltage divider circuit like the one shown in Figure 33.

The variable resistors used in some sense circuits have a nasty habit of opening at the contacts. That makes it impossible for the regulator to work. Make a mental note to make sure the variable resistor is operating smoothly—even though it is not the source of the trouble you are working on.

Current Regulation

Figure 34 shows the basic circuit for current regulator. This circuit is often used in con-

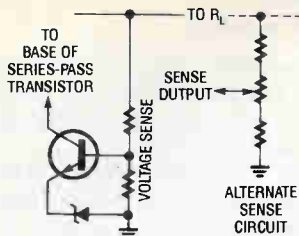

Figure 33

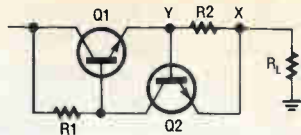

Figure 34

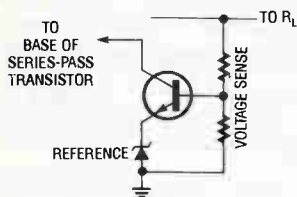

Figure 35

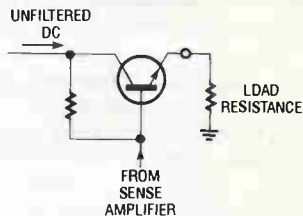

Figure 36

junction with a voltage regulator. All of the load current is delivered to point (x). There it splits with part of it flowing through R_2 and Q_1 . Resistor R_2 is a low value of resistance used to sense the load current. Assuming electron current flow, point (x) will be negative with respect to point (y). That makes the base of Q_2 positive with respect to its emitter. The amount of positive forward bias depends upon the amount of load current through R_2 .

The collector current of Q_2 flows through R_1 and sets the bias voltage on the base of Q_1 .

If the load current tries to increase, Q_2 conducts harder and that, in turn, decreases the forward bias on series pass transistor Q_1 . The result is that the current through Q_1 decreases and returns the load current to the rated value.

A decrease in the load current will increase the forward bias on Q_1 and return the load current to its rated value.

Voltage Sense Amplifier Circuit

Figure 35 shows a typical sense amplifier. The sense voltage and the reference voltage are compared in a voltage *sense amplifier* circuit. If the two voltages are the same there is no corrective action taken. If the sense voltage is higher or lower than the reference the closed-loop circuit adjusts the output of the supply until those voltages are matched.

In order to get a well-regulated supply it is necessary to amplify the difference between the sensed and reference voltage. That way the regulator can take action for very small change in the output of the supply. That is why a sense amplifier is used. (It is sometimes called a *difference amplifier*.)

Operational amplifiers have a differential amplifier input so they can be used as sense amplifiers. Another advantage of using an operational amplifier is its high gain. The high gain makes the regulator very sensitive to small changes in output voltage.

You have to be careful when you troubleshoot any of the types of sense amplifiers. It

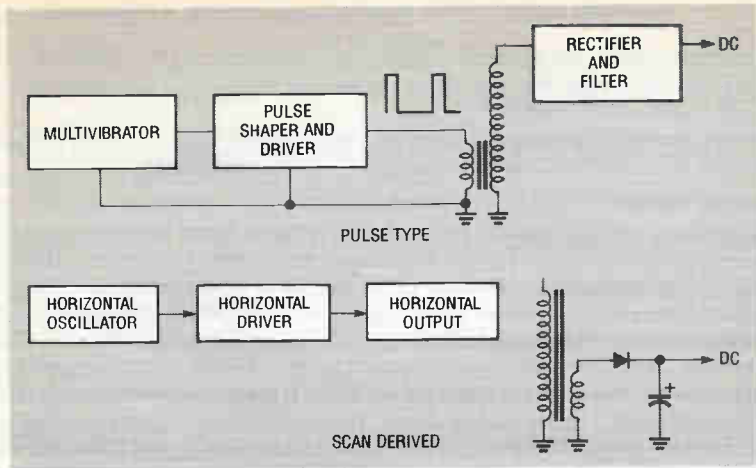

Figure 37

might seem that an obvious approach would be to open the load resistance to produce a rise in the output voltage. Then, check the output of the sense amplifier to see if it reacts to the increased voltage at the output. That would be a very bad practice!

The Power Amplifier

The power amplifier controls the output current and voltage of the supply. See Figure 36. As with all electronic components that get very warm, the power amplifier is a very likely problem in a supply when the symptom has an incorrect output voltage. Because of its high operating temperature, the defect is likely to be catastrophic. In other words, when it becomes defective it is completely destroyed.

A quick check for a defective power transistor is to measure the emitter-collector voltage. It should be about one volt. Due to its internal construction a short circuit between the emitter and collector is a likely source of power amplifier failure.

A high voltage across the power amplifier is another indication that it is defective. A higher-than-normal temperature (due to an internal short circuit) is also a clue to a defective amplifier.

You have to be very careful when replacing a power amplifier. In most applications the transistor case must be isolated from the supply chassis. Silicon grease is usually required to insure that the heat from the transistor is transferred to the heat sink.

A problem that can occur with replacement is that the technician over-tightens the stud. That causes an internal stress and early loss of the replacement amplifier. On the other hand if the amplifier is not sufficiently tightened there will be a poor thermal and/or electrical connection. That will also cause an early loss of the replacement transistor.

At one time it was recommended that a torque wrench be used to tighten the stud. Unfortunately, few technicians had the necessary torque wrench. Today, the studs are tightened by using the "feel" of the wrench. Fortunately, there is a wide allowable tolerance.

TROUBLESHOOTING SWITCHING REGULATORS

Compare the two regulator circuits in Figure 27 and observe that the switching regulator has three additional circuits: a startup circuit, an oscillator circuit and a duty cycle circuit. (The power amplifiers are very similar.)

Therefore, the troubleshooting discussion for analog regulators also apply to switching regulators. Only three additional circuits need to be discussed separately.

The Startup Circuit

If the oscillator gets its operating voltage from the output of the switching regulator it is obvious the circuit cannot get started. There is no output voltage unless the oscillator is working; and, the oscillator cannot work unless there is an output voltage.

The *startup circuit* is sometimes called a *kickstart*. It supplies voltage to the oscillator until the output of the regulator can take over.

The startup circuit is powered by a DC input from the unregulated DC supply. If there is no output from the regulator make sure the oscillator is producing an output signal. If not, look for the DC input from the startup circuit. The startup circuit is diode switched. When the circuit is first energized a portion of the unregulated voltage forward biases a diode. That applies a DC operating voltage to the oscillator. Once the regulator output goes above the voltage providing the forward biasing, the diode is reverse biased and the unregulated voltage is disconnected from the startup circuit.

If there is a DC input to the startup circuit, but no DC output when the system is first energized, concentrate on the startup circuit.

The Oscillator Circuit

Energize the oscillator from a bench supply to make sure the regulator has not been shut down by a crowbar circuit. If the oscillator doesn't work with an input from the bench supply, concentrate on the oscillator circuit.

The Duty Cycle Control

Vary the sense input and see if there is a change in duty cycle. The best way to do that is to disconnect the sense circuit. Vary the sense input to the comparison amplifier using a variable output bench supply.

If there is no change in the output of the comparison amplifier or duty cycle control concentrate on those circuits.

One of the best ways to troubleshoot the three circuits just mentioned is to make careful voltage measurements. Consult the schematic diagram of the system for typical measurement values.

Remember that, as with analog regulators, you have to open (or defeat) the feedback loop to troubleshoot the switching regulator.

PULSE-OPERATED AND SCAN-DERIVED SUPPLIES

Pulse-Operated Type

There are some power supplies that are closely related to switching types, but, they deserve a separate classification. They can be called *pulse supplies*. They include the scan derived and chopper types.

An important feature of these supplies is that they utilize *Faraday's Law of Electromagnetic Induction*.

Clearly stated, the amount of induced voltage (V) in a coil at any instant of time can be increased by increasing the number of turns of wire in the coil. Also, it can be increased by in-

creasing the rate at which the magnetic field is moving across the coil. (In textbook terms the magnetic flux lines are said to be "cutting across" the turns of wire in the coil.)

In the example of Figure 37 the *current* in the primary winding has a pulse waveform. That represents a rapid change of current in the primary, and, a rapidly changing magnetic field (do/dt) around the primary winding. That rapidly changing field cuts across the secondary winding and produces the high secondary voltage.

So, the high secondary voltage of the transformer in Figure 37 is produced by a large number of turns and a rapidly changing magnetic field around the primary.

In practice, the current in the primary winding can be high and cause a rapidly changing flux to cut across the secondary.

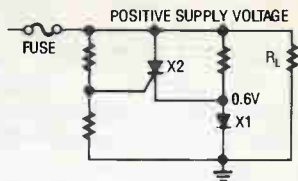

Figure 38

Scan-Derived Type

Figure 37 also shows the principle parts of a scan-derived power supply. A relatively few turns of wire in the low-voltage winding of the flyback transformer is used to produce a secondary AC voltage. That voltage is rectified to produce the scan-derived DC supply voltage.

Here are some important advantages of the scan-derived low-voltage power supply over other types:

- The frequency of the sweep is approximately 15,750 Hertz. That makes the ripple of the supply easier to filter. So, smaller and lower-cost components can be used in the low-pass ripple filter.
- The sweep is available from the horizontal sweep section. Therefore it is not necessary to use a separate oscillator as in some switching regulators.
- Compared to using a power transformer operated from the 60 Hertz power lines, a few turns of wire on the flyback transformer is a much less costly and less bulky way to get the voltage for operating the low voltage supply.
- The fact that the supply uses a rapidly-changing sawtooth current rather than sine waves makes it a more efficient supply.

If the scan-derived supply is delivering too much current (because of a defect in the low-voltage output circuitry) the high current can affect the magnetic circuit in the flyback transformer. That, in turn, will seem to indicate there is something wrong in the horizontal scanning circuit or in the high-voltage circuit.

Before you tear into the flyback transformer circuits, use your oscilloscope to check the waveform of the voltage delivered to the scan derived supply. Any change in the amplitude or shape of the pulse means there is something wrong.

As a further check, disconnect the circuits that get their low voltage from the scan-derived supply winding. Use your bench supply to deliver the required voltage and current to the disconnected circuits. If the circuit works, the trouble is in the flyback transformer. If the circuits that receive their voltage from this supply don't work with the bench supply you know the trouble is in one of those sections.

I will get letters if I don't warn you that there are some mighty *High Voltages* around the flyback transformer. Don't try to 'scope those high voltages unless you are sure your oscilloscope can handle them.

Chopper Supplies

In the period between the 1930's and middle 1950's the tube-operated car radios could not operate directly from the battery. Toward the end of that period some of the radios operated with tubes that used 12V for the plates, but, the most important step to using the car battery for a "B" supply was the introduction of the transistor.

Returning to the problem of the earlier days—that is, the problem of operating vacuum tube equipment from the car battery—there were two approaches.

Early Chrysler cars used a *dynamotor* (mounted in the trunk) to get the necessary high voltages. A dynamotor is a DC motor and DC generator mounted on the same shaft. The motor operated directly from the car battery and the generator delivered the higher voltage needed for operating the tube receivers.

A more common method was to use an electromagnetic vibrator—sometimes called a chopper—to convert the battery DC to a pulsating DC. The pulsating DC voltage could be stepped up in a transformer, rectified and filtered, and used as a "B" supply for the tube plates.

Although those supplies are no longer needed for car radios there is still an important application for them. The most difficult voltages to measure are *zero volt* and very low voltages! Meters are not usually sensitive enough to measure those voltages.

One method that does work is to chop the voltage, amplify the resulting pulse, then measure the higher voltage. The instruments made that way are calibrated to indicate the very low voltages.

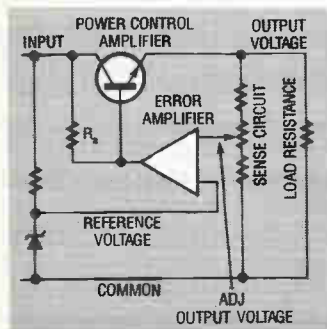

Figure 39

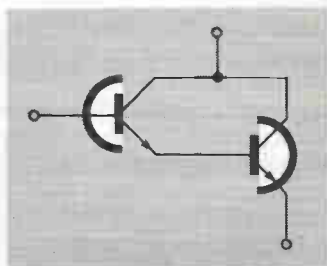

Figure 40

The inverters and converters are chopper supplies, but, they usually use electronic oscillators in place of electromechanical vibrators.

Electromechanical vibrators and choppers are similar to the mechanism that operates door bells. Instead of a clapper that strikes the bell, the moving part is used for switching contacts.

RF Power Supplies

The RF power supply also utilizes Faraday's Law. A high-frequency oscillator supplies a rapidly changing current (and flux) to the primary winding. A high secondary voltage is the result. Except for the high voltages involved, the operation is similar to transformer supplies operated from the 60-Hertz power lines.

The supply is a form of inverter if the output is AC, and, it is a form of converter if the out-

put is DC.

CROWBAR PROTECTION

Serious damage can result from an excessively-high voltage delivered to an integrated circuit. Surge-limiting resistors or fuses will not protect the circuit because they are too slow. In other words, the damage is already done by the time they get into operation.

The *crowbar circuit* in Figure 38 is fast enough to protect most circuits. There are many variations of the circuit.

Diode X_1 puts a positive voltage of about 0.7V on the cathode of SCR X_2 . So, the DC supply voltage must be high enough to raise the gate above 0.7V before the SCR can conduct. The reason for keeping the cathode above the common voltage is so that noise signals and transient voltages will not accidentally kick the SCR into conduction. However, crowbar circuits may have the SCR cathode connected directly to common.

If the voltage across the load resistance goes above its rated value the gate of the SCR activates the crowbar circuit.

The conducting SCR puts an immediate short circuit across the power supply output. The resulting high short-circuit current may be used to blow the fuse or trip a circuit breaker. So, check the crowbar circuit before replacing the fuse.

REVIEW AND ADDITIONAL NOTES ON TROUBLESHOOTING

Some of the theory and troubleshooting procedures will now be reviewed and extended.

Manufacturers sometimes supply troubleshooting flow charts that are designed to lead you through a maze of measurement steps. The troubleshooting material in this monograph should NOT be substituted for the manufacturer's procedures.

Experienced technicians will not agree with all of the techniques described here. Two technicians may troubleshoot a circuit in different ways that depend upon their choice of instruments and procedures.

I have made it a point to describe procedures that are safe and with the least possible damage to equipment. This monograph is a starting point if there is no manufacturer information available.

I have not incorporated speed into the procedure. That is best obtained with experience.

Always keep in mind the troubleshooting technique called the *statistical method*. Experienced technicians know that there are certain components that are very likely to fail before others.

For example, the components that get hot during normal operation are often more likely to fail than other, cooler, components. The power amplifier in a regulator is a likely suspect. Be sure to check the power amplifier for emitter-to-collector shorts. That's a common problem.

If you are working on the same system most of the time you should keep notes on often-encountered troubles. At a seminar conducted with technician members of the Kansas Electronics Association (KEA) there was unanimous agreement on the benefit of keeping a notebook. The technicians record troubles in various systems.

Closed-loop regulators often require special procedures. The output voltage of the regulator depends upon the control input; and, the control input depends upon the output voltage. If there is a problem anywhere in this closed loop it will cause changes in all of the other sections. In most cases it is useful to open that loop or defeat the loop. Then, troubleshoot the circuits one-at-a-time. See Figure 39.

A bipolar transistor is a current-operated device. An increase in emitter-base current causes an increase in collector current; and, a decrease in collector current occurs when the emitter-base current decreases.

Even though the bipolar transistor is current operated, its operation is often described on the basis of voltage. The assumption is that an increasing or decreasing voltage corresponds to an increasing or decreasing current.

An SCR (and TRIAC) also operates on the basis of current. A gate current can produce an anode current if the proper cathode-to-anode voltage is present.

One disadvantage of current-operated amplifiers is that they require input-signal power [$V \times I$] for their operation. In an analog regulator that means a decrease in operating efficiency.

There are voltage-operated, power-control devices that do not require much current on their signal input electrodes. An example is the VFET. Despite the obvious advantage of voltage-operated power control devices they have not been used extensively in regulator circuits at this time. That situation could change in the near future.

The Darlington amplifier of Figure 40 is a very popular power-control device in modern regulator systems. It has the advantage of being a power amplifier with a relatively high beta. Darlington amplifiers are usually put in the same case so their operating temperatures will be the same.

You could fill an encyclopedia with variations of the circuits I have discussed in this monograph.

For example, I gave the familiar 2-resistor and 3-resistor versions of the sense circuits. However, in switching supplies there is often a separate winding on the output transformer that is used to sense the output voltage.

The power "amplifier" in a switching supply is often a high-current SCR. Its low cost and ability to switch high-current pulses makes it a good choice for that job.

I gave the symbols for regulating transformers; but, I have seen many circuits with that type of transformer represented with a standard transformer symbol. You can't tell it is a regulating transformer unless you read the small print.

Stiff regulators make it possible to reduce the complexity of the filter circuit. For that reason, a high ripple content in the output voltage may indicate a defective regulator circuit rather than a filter problem.

A key feature of a startup circuit is a DC voltage obtained by rectifying the AC power. That resulting DC voltage supplies the oscillator to get the switching regulator working. As soon as the DC output of the switching supply is obtained, the line-rectified DC is removed.

The series-pass power transistors discussed in this monograph were NPN types. Always be alert to the fact that a PNP transistor can be used for that job. (As mentioned before, you may also encounter an SCR used for power control.)

Identifying the Types of Problems in System Supplies

An article by Jim Smith of Sencore that appeared in *Electronic Servicing & Technology* magazine describes some of the difficulties in servicing power supplies that are an integral part of an electronic system. Here are the difficulties as described by Jim Smith.

First, it is tough to tell if there is really a problem or whether the fuse or circuit breaker is simply opening too soon.

Second, most problems cause the protective device to open as soon as the power is applied which makes it tough to make any circuit measurements. You can't just jumper across the fuse or circuit breaker without risking extensive damage to other components and circuits that are

drawing too much power.

Third, it is often tough to tell whether the problem is in the power supply or the load connecting to the output.

By using an isolated AC power supply with current and voltage meters you can start applying power to the defective system starting with a low AC voltage and keeping your eye on the current. You know how much current should be allowed by the current rating of the fuse or circuit breaker. If the current starts to rise rapidly with a fixed rate of increase of voltage you know it is not just a premature tripping of the circuit breaker or blowing of the fuse.

The next step is to operate the equipment with a lower voltage (and especially a lower current) then use your voltmeter to troubleshoot the power supply and output circuitry.

You should never disconnect the sense lead in a regulator with the power supply energized! That would cause the supply to immediately try to recover. That, in turn, can cause a destructive overshoot.



APPENDIX A

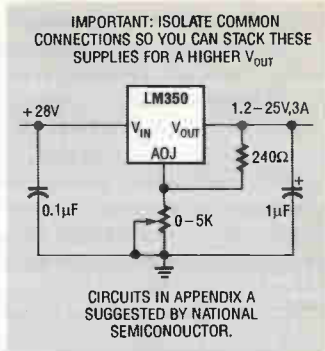
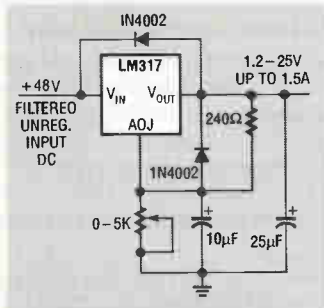

These excellent regulators are designs suggested by National Semiconductor. They appear in their *Voltage Regulator Handbook*. Important: See text discussion before constructing the circuits!

APPENDIX B

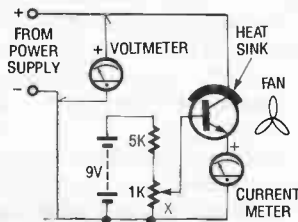
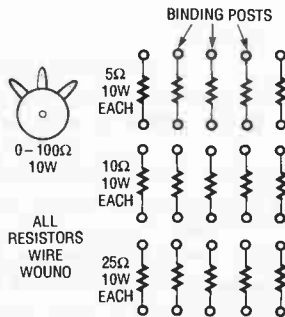

Examples of substitute load resistor circuits. At bottom a bipolar power transistor is used as a substitute load resistance in DC circuits.

APPENDIX C

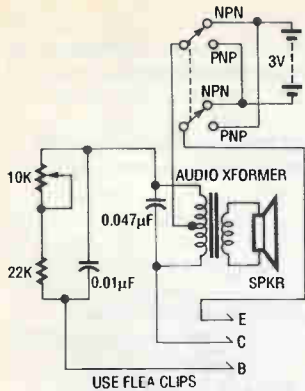

Schematic diagram for an *in situ* tester. The tester produces a tone when a good transistor is added to the circuit.

Stance of the secondary. This modulation can be achieved only by transferring electrical power from the primary to the secondary. This power in turn sustains the secondary oscillations and delivers power to the load. It is this unique parametric power transfer mechanism that makes the Paraformer™ a revolutionary new component. (Courtesy of Wanless Electric Co.)

APPENDIX D

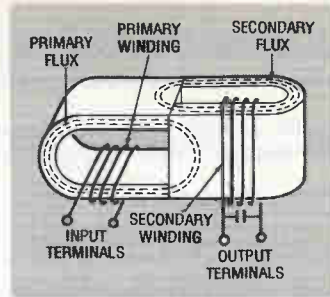

Note that the geometry of the transformer above is such that the primary flux does not link the secondary winding and that the secondary flux does not link the primary winding. (Accordingly, the classical flux coupling is zero). However, note that the primary flux does modulate the reluctance associated with the secondary flux and hence the primary does modulate the inductance of the secondary.

APPENDIX E

SINGLE PHASE RECTIFIER CIRCUITS-

DESIGN CONSIDERATIONS FOR BATTERY OR CAPACITIVE LOADS & RESISTIVE OR INDUCTIVE LOADS.

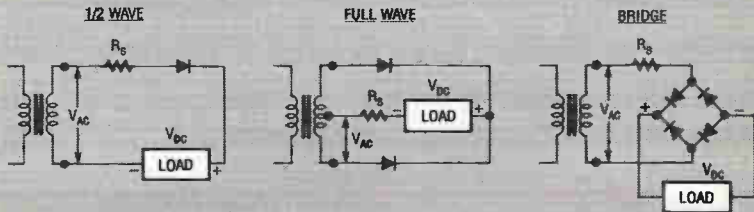

RIPLLE FREQUENCY	F		2F		2F	
OUTPUT WAVEFORM NO LOAD						
RESISTIVE OR INDUCTIVE LOADS	$V_{AC,RMS} = 2.2 V_{DC}$ $I_{AC,RMS} = 1.6 I_{DC}$	MIN. PIV. = 1.4 V_{RMS}	$V_{AC,RMS} = 1.1 V_{DC}$ $I_{AC,RMS} = 0.79 I_{DC}$	MIN. PIV. = 2.8 V_{RMS}	$V_{AC,RMS} = 1.1 V_{DC}$ $I_{AC,RMS} = 1.1 I_{DC}$	MIN. PIV. = 1.4 V_{RMS}
CAPACITIVE OR BATTERY LOADS	$V_{AC,RMS} = 1.0 V_{DC}$ $I_{AC,RMS} = 2.3 I_{DC}$	MIN. PIV. = 2.8 V_{RMS}	$V_{AC,RMS} = 0.85 V_{DC}$ $I_{AC,RMS} = 1.2 I_{DC}$	MIN. PIV. = 2.8 V_{RMS}	$V_{AC,RMS} = 0.85 V_{DC}$ $I_{AC,RMS} = 1.7 I_{DC}$	MIN. PIV. = 1.4 V_{RMS}

QUIZ

Completion of this quiz has a value of 1 Educational Hour (0.1 CEV) toward upgrading your IS CET Certificate. Please fill in or circle the correct answer. Note: Some multiple-choice questions have two answers and are so indicated.

1. What are the six things every technician needs to know and needs to troubleshoot and repair power supplies?

a _____ b _____ e _____

c _____ d _____ f _____

2. What is the purpose of the 1N4002 diode in the LM317 schematic diagram below?

- a. Surge protection
- b. Protect LM317 from reverse voltage
- c. Current limiter
- d. Shorted load protection

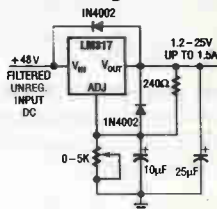

3. What are the four types of power conversion?

a _____ b _____ c _____ d _____

4. What type of regulator is required for high current?

- a. Series regulator
- b. Shunt regulation
- c. Both a and b above
- d. None of the above

5. Why should you not use a 60-Hertz transformer in a 50-Hertz circuit?

- a. Does not make any difference
- b. Lower primary winding current
- c. Overheating
- d. Higher secondary voltage

6. What type of transformers can be used as pre-regulators? (Select 2 answers.)

- a. Autotransformer
- b. Self-saturating
- c. Any power transformer
- d. Ferro-resonant

7. What possible problems could cause this waveform? (Select 2 answers.)

- a. Defective diode
- b. Shorted load
- c. Shorted turns in the transformer
- d. Open turns in the transformer

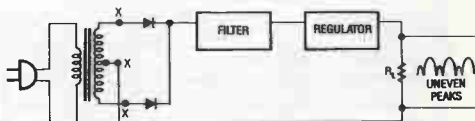

8. What is the purpose of the resistors in the diagram below?

- Prevent over-heating of the diodes
- Shunt RF
- Assume reverse current across each diode is the same
- Assure reverse voltage across each diode is the same
- Not discussed in text

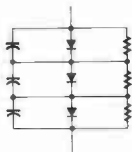

9. What is the purpose of the resistors in the diagram below? (Select 2 answers.)

- Bleed resistors
- Current limiting
- Prevent current hogging
- All of the above

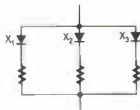

10. What is the purpose of the surge-limiting resistor in the diagram below? (Select 2 answers.)

- To protect the first capacitor
- To protect the load
- To protect the diode
- To limit current during startup

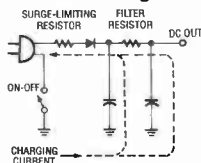

11. Why do you connect the power amplifiers before the filter resistor in the diagram below? (Select 2 answers.)

- Power amplifiers are not voltage sensitive
- No particular reason
- Power amps draw high current
- Cost is less

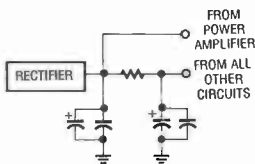

12. What does ESR measure?

- Internal resistance
- Equivalent Series Resonance
- Parallel leakage resistance and the series resistance
- Equal Source Resistance

13. What are some of the advantages of a switching regulator over an analog regulator? (Select the incorrect answer only!)

- Efficiency
- Easier troubleshooting
- Smaller components
- Easier to filter

14. What type of power conversion supply uses an oscillator? (Select 2 answers.)

- AC to AC
- AC to DC
- DC to AC
- DC to DC

15. What circuits have to be in a closed-loop regulator?

- a. Control component
- b. Sense
- c. Voltage comparator
- d. Series-pass regulator
- e. All of the above

16. What type of regulators are shown in the diagrams below?

- a. Open and closed loop
- b. Closed loop
- c. Open Loop
- d. None of the above

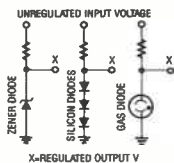

17. What additional circuits are needed for a switching regulator over an analog regulator?

- a. Startup, oscillator, comparison amplifier
- b. Startup, oscillator, sense
- c. Startup, oscillator, duty cycle
- d. All of the above

18. Which of the following are pulse supplies? (Select 2 answers.)

- a. Analog voltage regulator
- b. Chopper
- c. Scan derived
- d. Closed-loop regulation

19. What is the purpose of the "crowbar" circuit?

- a. Protection
- b. Increase voltage to the load
- c. Increase current to the load
- d. Decrease voltage to the load

20. What is the best tip to troubleshoot a closed-loop regulator?

(Refer to the diagram below.)

- a. Remove the power control amplifier
- b. Open or defeat the loop
- c. Remove the load
- d. All of the above

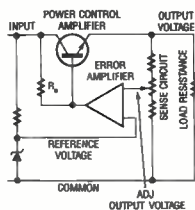

Answers: 1. Right test equipment, knowledge of how a power supply works, logical approach to troubleshooting, knowledge of a few tricks of the trade, the right tools and training for replacing faulty components and experience—not necessarily in the order given; 2. b, 3. AC to AC, AC to DC, DC to AC and DC to DC—not necessarily in the order given; 4. b; 5. c; 6 b and d; 7. a and c; 8. d; 9. c; 10. c and d; 11. a and c; 12. c; 13. b is the incorrect answer; 14. c and d; 15. e; 16. c; 17. c; 18. b and c; 19. a; 20. b.

The International Society of Electronics Technicians is located at 2708 West Berry Street, Fort Worth, Texas 76109-2356. (Telephone: 817-921-9101, FAX 817-921-3741) Write for information on becoming a Certified Electronics Technicians or upgrading your current CET status.

Enter A World Of Excitement with a Subscription to **Popular Electronics**[®]

Get the latest electronic technology and information monthly!

Now you can subscribe to the magazine that plugs you into the exciting world of electronics. With every issue of Popular Electronics you'll find a wide variety of electronics projects you can build and enjoy.

Popular Electronics brings you informative new product and literature listings, feature articles on test equipment and tools—all designed to keep you tuned in to the latest developments in electronics.

So if you love to build fascinating electronics, just call toll free the number below to subscribe to Popular Electronics . . . It's a power-house of fun for the electronics enthusiast.



Save **55%**
Off The Regular
NEWSSTAND
Rate

1 yr \$18.95 2 yrs \$36.95

Basic Subscription Rate — 1 yr/\$21.95; 2 yrs/\$42.95

FOR FAST SERVICE CALL TODAY

1-800-827-0383

(7:30 AM-8:30 PM—EASTERN STANDARD TIME)

GET THE LATEST ADVANCES IN ELECTRONICS

WITH A SUBSCRIPTION TO



Electronics Now gives you exciting articles like:

- Buyer's Guide to Digital Oscilloscopes
- Build A Scanner Converter
- Single-Chip Voice Recorder
- Build A MIDI Interface for your PC
- Troubleshoot Microprocessor Circuits
- Build A High-Power Amplifier for your Car
- Add Music On Hold to your Phone
- All About Binaural Recording
- VGA-to-NTSC Converter

Electronics Radio Combined with **Electronics.** **NOW**

ENJOY THE WORLD OF ELECTRONICS EACH MONTH!

Subscribe to the best electronics magazine—the one that brings you the latest high-tech construction projects, feature articles on new technology, practical troubleshooting techniques, circuit design fundamentals, and much more.

Electronics Now looks to the future and shows you what new video, audio and computer products are on the horizon. What's more you'll find helpful, monthly departments such as Video News, Equipment Reports, Hardware Hacker, Audio Update, Drawing Board, Computer Connections, New Products, and more. All designed to give you instruction, tips, and fun.



FOR FASTER SERVICE CALL TODAY
1-800-999-7139

SUBSCRIBE TODAY

Just fill out the order card in this magazine and mail it in today.