

Be a Radio Technician

As a civilian or member of the Armed Forces, Radio offers you opportunities for better pay and valuable, intelligent service to your Country. Start learning Radio quickly, right in your own home, in spare time—through the time-tested, well known N.R.I. Course.

Shortage of Trained Radio Technicians Already Serious

Since new Radios are no longer being made, the service and repair of existing receivers is vitally necessary work. But many of the leading Radio Servicemen in every community are now in the Army, Navy or Marines. This means beginners must get ready fast to take over the great volume of important, highly paid Radio work which must be done.

Radio factories, working to produce over TWO BILLION dollars worth of Military Radio equipment, need more trained men at good pay and overtime. Civilian Radio jobs are also open to men who can meet Civil Service requirements, in the Army Signal Corps, and the Army Air Force as civilian maintenance men and instructors.

All these great civilian demands for Radio Technicians are ADDED to urgent calls by the Army and Navy for MORE Radio Technicians to accept attractive assignments of duty with good chances for advancement in rank and pay.

Learn Radio by the Tested, Practical N.R.I. Method

When you learn Radio with N.R.I., you follow a plan based on over 25 successful years of teaching Radio. You study a Course prepared by Radio experts who are also teachers.

You learn Radio by the method which has put hundreds of men on the road to success. From my students and graduates, working in every field of Radio, I get letters telling me of money they are making—honors they are winning—service they are rendering to their country because of N.R.I. Training.

N.R.I. Will Help You Get a Quick Start

From your first N.R.I. Lesson, you will find practical, money making information. Within a



few months, you can be ready to do many kinds of Radio work. It's up to YOU. N.R.I. will cooperate, help you make rapid progress. These days, some students complete four or five lessons a week. We will help you do as well or better.

As an example of how quickly N.R.I. helps you get ready, I want to point out that by the time you finish 12 lessons you should be familiar with Power Supplies, Radio Frequency Amplifiers, Detectors, Oscillators, and important circuits in a Radio receiver and transmitter. There is no wasted time in N.R.I. training.

Mail the Coupon for Sample Lesson and Free Book

Act Today. Mail coupon now for Sample Lesson (Getting Acquainted with Receiver Service), and my 64-page book "Win Rich Rewards in Radio." Both books are FREE. They give you an idea of what my Course is like, point out Radio's opportunities, show you letters from men I trained, telling what they are doing and earning. Find out what Radio offers you. MAIL COUPON in an envelope or paste on a postcard—NOW.

J. E. SMITH, President
National Radio Institute

Dept. 4FR-3 Washington, D. C.

GERNSBACK'S EDUCATIONAL LIBRARY No 8

RADIO for BEGINNERS

10 CENTS

By HUGO GERNSBACK



RADIO PUBLICATIONS, 25 WEST B'WAY - NEW YORK, N.Y.

J. E. Smith, President, Dept. 4FR-3
National Radio Institute, Washington, D. C.
Send me FREE, without obligation, Sample Lesson and 64-page book "Win Rich Rewards in Radio" which tells about Radio's spare time and full time opportunities and how I can earn at home for them. (Write plainly)

Name..... Age.....
Address.....
City..... State..... 4FR-3

Suggest A Good Book Title

WIN TEN DOLLARS!

SINCE 1908, the name Gernsback has been synonymous with scientific and radio literature. Since that time, many millions of Gernsback magazines and books have been distributed and read by people all over the globe.

Recently, Hugo Gernsback decided to place upon the market a new, popular priced series of books under the name of **GERNSBACK'S EDUCATIONAL LIBRARY**. It is the intent of the publisher to continuously add books to the library, from time to time, under various titles. These books will cover a great many subjects, which will not necessarily be restricted to radio or science, but which will encompass many other arts.

It is Mr. Gernsback's plan to have all the books of uniform size. Their price being extremely low, everyone will ultimately be able to possess the entire library, especially since they are purchased piece-meal as the books are published.

Don't forget either, that Gernsback books and magazines always have given you your full money's worth. The present series of books again proves this. Never in the history of technical publishing have you been able to buy so much for so little money. The answer to this is in turning out a greater number of books and in large quantities.

In bringing out new books, we want your help. Perhaps you have an idea for a certain book title (subject for a new book) that you think we should publish in one of these 10c volumes. If you have such an idea, communicate it to us; we will pay \$10.00 for each new book title which we accept. If you submit more than one title, write each one on a separate sheet of paper. In case of a tie, identical prizes will be paid to the contestants.

Address all letters to

RADIO TITLE EDITOR

RADIO PUBLICATIONS
25 West B'way NEW YORK City.

PRIZE WINNERS

ALFRED CETTIE

4115 Midvale Avenue
Seattle, Wash.

Title: **ALL ABOUT AERIALS,**
Book 4

RUDY RUZICKA

3441 California Avenue
St. Louis, Mo.

Title: **BEGINNERS' RADIO DICTIONARY,** Book 5

KENNETH WARNER

R. F. D. No. 2
Burbank, Ohio

Title: **HOW TO READ RADIO DIAGRAMS,** Book 7

CLYDE SORRELL

504 North 10th Street
Rockyford, Colo.

Title: **RADIO FOR BEGINNERS,**
Book 8
(Watch the List Grow)

Copyright 1938, by H. Gernsback.
Printed in U.S.

Radio for the Beginner

By **HUGO GERNSBACK**

Chapter I

HISTORIC

THE true art of radio was unquestionably discovered by Heinrich Hertz, a German professor, living at Frankfort. His first technical papers on his epoch-making invention were published in 1887. Hertz was the first to send electric waves through space by means of an electric spark. His apparatus was simple; he had an electric spark coil that made intermittent sparks, and by proper arrangement of this station, he could receive sparks at a distance by the simple arrangement of cutting a single wire hoop and leaving a small gap. Between the two free ends, small sparks jumped whenever sparks were made to jump on his spark coil a few yards away.

Guglielmo Marconi, an Italian youth, read of these experiments and being gifted along these lines, he duplicated Hertz's experiments. Soon his mind conceived the idea of using the invention for transmitting intelligence over a distance. He en-

deavored to send a message without wires over miles where Hertz used yards. Instead of the wire hoop, Marconi devised and used a more sensitive apparatus. He found that an instrument called the coherer was enormously sensitive to the new electric waves, and soon was transmitting signals for many hundreds of yards on the estate of his father in Italy. By diligent labor he increased this distance and shortly was telegraphing without wires across the English channel. Not many years later, he transmitted the letter "S" in telegraphic code across the Atlantic by means of wireless.

Radio telephony, contrary to popular opinion is not a new invention either. It was first invented by Valdemar Poulsen, the "Danish Edison." Instead of using a crashing spark at his sending station, he used a silent electric arc, with certain adjuncts.

Chapter II

WAVE ANALOGIES



What is a radio wave? It is not any different physically than a sound wave or a wave in the ocean. If we throw a heavy stone in a still lake, it makes a splash. This wave rapidly extends in the form of circles, as shown in Fig. 1.

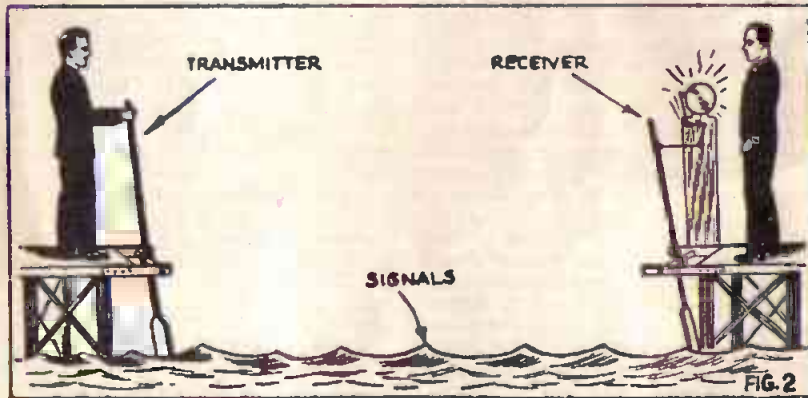

The analogy between water waves and radio waves can be carried a step further. We have seen how waves may be produced; now let us study how they may be received.

Take, for instance, a tank of water 20 or 30 feet in length. At the two opposite ends, platforms have been built, as illustrated in Fig. 2. On one of these platforms a large paddle has been arranged, so that a person may operate its handle. Now, if the paddle is moved back and forth, a series of waves extending in all directions from this source of creation will be formed. The waves spread further and further away from the paddle in concentric rings until their strength is completely expended. In this instance the tank is small, and the waves are sufficiently powerful to reach

the opposite end, where the other platform is built.

On the other platform, located at the other end of the tank, we have a smaller paddle, on the handle of which a hammer has been arranged to strike a gong. It is obvious that the waves moving the paddle will cause the gong to ring, informing the operator on that platform that the operator on the other platform is moving the paddle and creating waves on the surface of the water. By skillful manipulation of the larger paddle, it is possible to cause the smaller paddle to ring the bell periodically, as desired; and if a series of signals has been pre-arranged, the operator with the larger paddle may communicate certain information by properly operating its handle. This represents both the transmitting and receiving stations of the wireless telegraph, the larger paddle being the transmitter, and the conducting medium being the water, while the smaller paddle is the receiver. It is exactly so in radio. If, by means of certain electrical apparatus connected to an aerial, we excite this aerial electrically, waves are set up in the space exactly as water waves are set up on the lake. Radio waves, just as do the water waves, branch out in all directions. With the water waves this is not so true. A true water wave, as we know, is carried along only upon the surface of the water. A few feet below the water and immediately above the water, no water waves are found. A better analogy would be sound waves. Take, for instance, a church bell. By giving it a blow with a hammer, we excite this bell. Sound waves

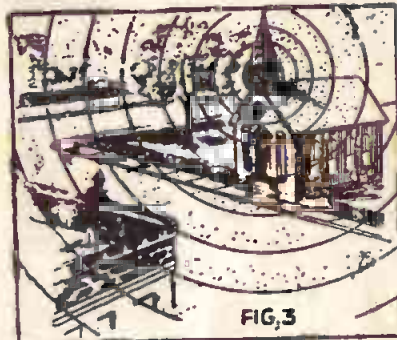

are set up in the air in all directions from the bell. Whether you are on the street level, 100 feet below, or in a building on the same level as the bell—in all these positions you will clearly hear the ringing of the bell (Fig. 3). The sound waves are propagated in every direction in the form of waves, invisible to the eye, but "visible" to the ear. These waves are exactly of the same shape as are the ocean waves or water waves, with the difference that the sound waves go out in the air in the form of spheres. In other words, the first sound wave leaving the bell would be a sort of invisible globe all around it. The wave rapidly spreads out, becoming larger and larger, always remaining, however, in the form of a sphere. If the sound waves did not go out in the form of spheres, it would not be possible for us to hear them in all directions as we have seen in Fig. 3.

Sound waves that leave a bell branch out, above, below, sideways; in fact in all directions. It is exactly

so in radio. The aerial of the broadcasting station, or other radio transmitting station radiates as does a bell. Both are transmitters of waves.

We can hear a bell even if windows are closed. The invisible sound waves pass through the window panes. Radio waves do exactly the same thing, except that they pass through solids far better than do sound waves. Radio waves even pass through mountains, providing these mountains do not contain ores or other metallic substances. Radio waves also pass through the water just as sound waves do. But, as we all know, the farther away we go from a ringing bell, the more difficult it is to hear it. The reason is that the original wave, as we increase the distance between ourselves and the bell, becomes larger and larger and soon covers a tremendous area. Finally there comes a point where we no longer can hear the bell.

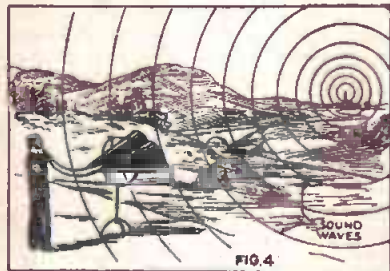

If, now we were to take two horns and point them in the direction of the bell, as shown in Fig. 4, and apply the ear pieces to our ears, we would be able to hear the bell again, although without these appliances, we would not be able to hear

it at all. The reason is that the vibrations that reach our ears normally are too weak to be intercepted by our small ears. By enlarging our ears, as shown in Fig. 4, we intercept many more weak sound waves, and these waves, all being collected into our ears—bunched together, so to speak—are sufficient to impress the diaphragm in the ear. This holds true in radio as well. If we have a transmitting station, or a broadcasting station, we can hear it only up to a certain distance with a given apparatus. If we take a small aerial which we can liken to a normal ear, we can use it only for a given distance, let us say 25 miles. If we move this aerial 30 miles away from the radio broadcasting station we can no longer hear it. The case here is exactly as with the sound waves. The radio waves now have to cover much larger areas, and there are not enough waves, so to speak, to leave any impression upon our small aerial. If, however, we were to double or triple the size of the aerial, we would do physically the same thing as we were doing when we attached the two horns to our ears. By having a larger or increased aerial with more wires, we would, by means of this, intercept more waves than we could with a small normal aerial; consequently with such an aerial we could hear the broadcasting station again, even though we were removed 35 miles from it. The analogy between the sound wave and the radio wave holds pretty true, all the way through. Of course, in radio we have other means to bring in the signals even if we are removed still greater distances. It would not al-

ways be practical to make the aerial tremendously large in order to hear greater distances, also we would not expect to hear our bell 20 miles away by means of even large horns. We would have to devise some other more sensitive means to hear the bell, and there are such means at hand today in super-sensitive electrical microphones which magnify the very weakest sounds. So too in radio it is not necessary to build a larger and larger aerial, the more we remove ourselves from the broadcasting or transmitting station. Instead, we use more sensitive apparatus which will magnify the sounds in an electrical manner, so that we can hear the station even though we are removed thousands of miles from it.

Let us now return to our stone which we dropped into the water. If we were to place our eye on a level with the water, and someone was to throw a stone into a quiet surface of water, what would we see? Fig. 5 shows this. Any water wave is composed of two distinct parts, the crest and the trough. In other words, the water first comes up, then dips below the original surface, then up again above the original surface etc. In our illustration, we have shown in dotted lines the original surface of the water. The disturbance of the stone has caused the water to expand into waves. Now then, the wave length is that portion which extends from crest to crest. In Fig. 5 we see what a wave length consists of. It starts at the top of the crest, covers the trough and again up to the crest. This is exactly one wave length, be-

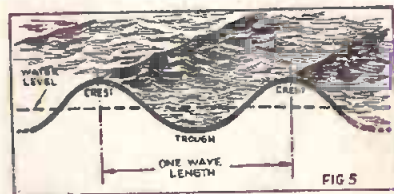

cause it embraces the total make-up of one complete wave.

In radio we have the same sort of waves, and these waves go out into space in all directions, as we have learned before. In radio we can make a wave length from a fraction of one meter up to several thousand meters and over. This all depends upon the apparatus we use.

RADIO TELEGRAPH AND RADIO TELEPHONE WAVES

In radio telegraphy we simply hear the plain wave in our telephone receivers. If the operator in the transmitting station presses his key, groups of waves are sent out into space as long as the key is depressed. At the receiving side we hear the waves making a buzzing sound for the length of time that the key is depressed at the sending station. If the key is pressed down for a second, we hear a buzz for a second. If the key is depressed for two seconds we hear the buzz for two seconds, and by means of this buzzing sound the telegraphic signals are reproduced. Usually a code such as the Morse or the Continental is used. For instance, a short buzz will be the letter "E" while "SOS" would stand for the following ----- (a short dash being a short buzz, a long dash being a long buzz).

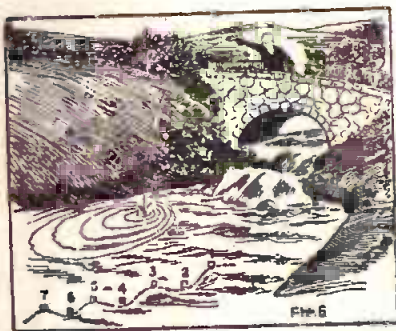

In radio telephony (broadcasting) however, we have a different and more complicated action. In the first place, we hear sounds, words, and music exactly as they are produced at the broadcasting or transmitting station. Two distinct things happen. The aerial is made to send out a radio wave that is continuous. This wave cannot be heard by the human ear with ordinary receiving apparatus. It is what is technically called C.W. or Continuous Wave. It is also used to carry along the human speech. At this point we must resort again to our water wave. Suppose we throw a stone into a river. At the same time that the stone is thrown we also throw a cork into the water, at the same spot. What happens? The cork is carried along by the current as shown in Fig. 6. First we see the cork in position 1. A little later we see it in position 2. Still later in position 4 as shown on the dotted lines. The cork, therefore, is carried along by the wave as well as by the current. As the waves progress, the cork progresses

also. Exactly the same thing happens when the human speech is impressed upon the radio carrier wave. By certain means too technical to go into here, the vibrations made by the voice are carried along upon the carrier wave, exactly as the cork is carried upon the water wave. At the receiving side we only hear the words or music, for the reason that the carrier wave is inaudible. Hence, nothing but the words or speech are heard by us in our loud speakers.

Radio waves travel with the speed of light, namely, the enormous speed of 186,000 miles per second. We, therefore, can understand that if a message is sent out anywhere on our globe, it will be received at any place almost instantaneously; the greatest distance that a radio wave or a message could travel would be 12,000 miles, for the reason that the circumference of the earth is 24,000 miles. You will see, therefore, that a radio wave would travel around the earth at the rate of almost eight times in one second.

POPULAR MISCONCEPTION AS TO RADIO WAVES

Many people have an idea that radio waves broadcast by a transmitting or broadcasting station, change their form as they are sent out into space. The length of the wave never changes between the transmitting and the receiving stations.

It stands to reason that if all stations were to send at exactly the same wave length, we would get nothing but a jumble.

Suppose you have six pianos in one room, which are all tuned alike;

if we have six players sitting down at the pianos and each hits the same key, we will only hear that one note, let us say A. You could not possibly detect it if five were striking the key A, because all of the players are transmitting on the same sound wave length which transmits only the note A. Suppose, however, that one operator is striking the key A while another strikes the key E. We can immediately eliminate one or the other, and by a little concentration of our ear, we can hear either

A or E. In other words the two pianos are now transmitting at different sound wave lengths, the wave length of E being different from the wave length of A, and vice versa. It is exactly so in radio, only we have better means in radio because we can tune out entirely one station or another by means of tuning appliances so that we can hear either one at will. That is the reason why different transmitting stations send on different wave lengths.

Chapter III TRANSMITTING General

There are several ways of transmitting by radio; the oldest and historical method is shown in Fig. 7. Here we have an ordinary spark coil such as is used in automobiles, a few dry cells, a key and the so-called spark gap which may consist of wire nails or better two zinc balls. Every time we press the key a spark jumps across the open space in the spark gap. By connecting one end of an aerial to the ground, which may be a water pipe, or a steam radiator, radio waves are sent out into space. We might compare this to a string held between two nails and plucked with the finger, when we would hear some sort of noise.

Just exactly as a manufacturer of a piano knows what the sound wave

length of the longest string of his piano is, so the radio engineer will know on what wave length a given aerial will send.

Roughly speaking, an aerial 100 feet long will give a wave length of about 140 meters, while an aerial 200 feet long will give a wave length of exactly twice the length of the shorter one or 280 meters.

Suppose, with our little outfit shown in Fig. 7, we wish to send out a wave length of a thousand meters; we could do this by making an aerial 833 feet in length. That however, would not be practicable because not in all instances could we find that much room for the aerial.

We, therefore, resort to another means, and we build an aerial in-

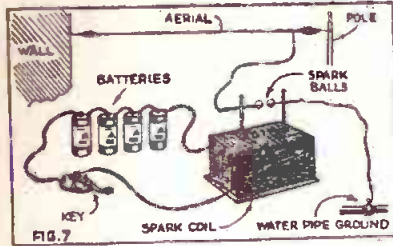

doors which we attach to the original aerial—a sort of sending tuning coil, which we show in Fig. 8. This tuning coil is the same wire which we use for the aerial, wrapped around a frame or tube, as shown in Fig. 8. This coil means simply the additional wire which is necessary to lengthen our aerial in order to make it long enough to give us our thousand meters. By means of the slider, which runs up and down the wire convolutions, we now have the means of changing the wave length merely by adding more or less wire. If this is not entirely plain, take a violin as an example. When the violinist wishes to transmit a certain sound wave he plucks his string first without touching his hand to it. As he presses down on the string, he automatically makes it shorter and shorter, and the

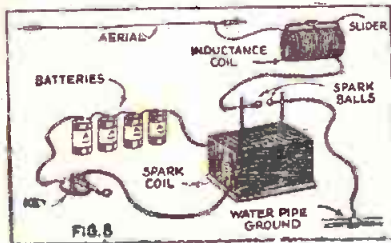

further down his fingers slide, the higher and higher the note becomes. He does here exactly the same thing as the slider does on our sending tuning coil, that is, he changes his sound wave length. Fig. 9.

In other words, if he wants a long sound wave he slides his finger down the small end of the violin, and if he wants a short sound wave, he slides his finger towards his chin. This changes the sound wave length in exactly the same way as our sending coil changes the radio wave length. Both are fundamentally the same.

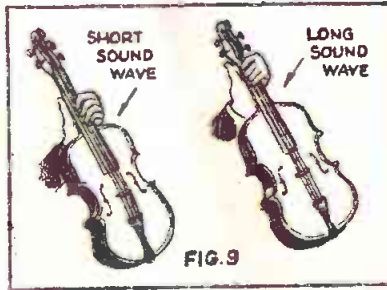

When Marconi first rigged up his little sending station, as shown in Fig. 7, he naturally could only send out radio telegraphic signals. Every time he pressed the key, radio waves were sent out. When he pressed the key for a second, a buzzing noise was heard for a second in the distant receiving telephone receivers. If he pressed the key for two seconds, a buzzing sound for two seconds was heard. By this means the telegraphic code is made up. At the present time, the Continental code is used almost exclusively, and today, as in Marconi's time, when

the operator at his transmitter presses down his key for a short duration, this is interpreted as a dot at the receiving side, and when he presses his key down for a longer period this becomes a dash on the other end. By means of dots and dashes, the telegraphic code is made up.

In Fig. 7, we showed a simple sender. Of course, it goes without saying that soon after Marconi started his experiments, more complicated sending apparatus was designed.

There are now many different transmitters in use, as for instance, the vacuum tube which may be used for transmitting. This has the advantage of giving rise to what is called continuous waves; this is made clear by the diagram shown in Fig. 10A. When we press the key of the old Marconi outfit, we send out into space radio waves which have somewhat the form shown in Fig. 10A. These waves start with a high pitch, as we might say, and die out rapidly. This happens a great many thousand times each second, but these waves are not continuous. They are small wavelets, as we might term them, which are disrupted and do not form a continuous line. Look at Fig. 10B; this is what we might term a continuous wave and is a wave which is sent out by a vacuum tube transmitter such as is now used universally at broadcast stations. As long as the sending set is transmitting, a continuous wave is sent out into space which does not vary. It does not take a technical mind to know that the waves sent out, as shown

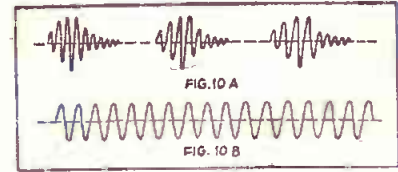

in Fig. 10B, must be better and clearer than the interrupted waves sent out in Fig. 10A. This is the day of the Continuous Wave commonly called C. W. It is the Continuous Wave that makes broadcasting possible.

Let us make a comparison again, which can be easily understood, and which may serve to make the interrupted wave and the Continuous Wave clear in our minds. Take a number of pipes as shown in Fig. 11A; one person stands at one end and another at the other end. One talks into this interrupted pipe, which may be 100 feet long, and as will be readily seen the person at the other end will have a great disadvantage in hearing the speaker because the pipe, being interrupted so many times, breaks up the speech. This is the analogy for spark waves. Now turn to Fig. 11B; here we have a long pipe the same as we use in our speaking tubes,

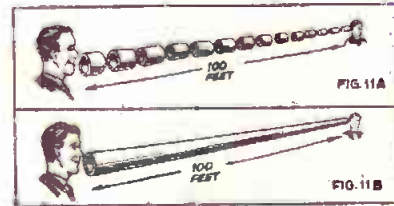

which is free from interruptions, and is continuous all the way through. You can readily understand why the person at the other end will have no trouble in hearing what the speaker says, for the reason that the pipe is continuous all the way

through. This continuous long pipe stands for a continuous wave. This of course, is not a strict analogy, but may serve to implant in the reader's mind the difference between an interrupted spark wave and a continuous wave.

Chapter IV

RECEIVING

General

No matter what receiving station you have, it can receive either radio telegraphy or radio telephony. The receiving station has the exact counterpart in your ear, which receives any and all sound and noises that are floating about in the air. So it is with the radio receiving station; with it you can hear, if properly adjusted, any and all disturbances that are flung out into space by the various broadcast stations. Receiving instruments are becoming more and more sensitive for which reason we can hear the sending station further and further away. If we have a broadcast station which is sending out a band concert, and if we were to use Marconi's first instrument, the coherer, for receiving purposes, it would not be possible for us to receive this concert at all because Marconi's coherer is totally unsuited to receive broadcast radio music. After Marconi's coherer came the auto-coherer a somewhat more sensitive instrument. With such an

instrument a broadcasting station could possibly be heard five to ten miles, but no further. Next came the crystal detectors; with a good one we may hear the broadcast station at a distance of 25 miles or more. Still later came the audion or vacuum tube. This instrument, being enormously more sensitive than a crystal detector, at once increased the range up to a thousand miles and over.

How do we get more sensitive radio receivers? A single vacuum tube is only able to detect radio signals for a given distance. By adding more vacuum tubes, more "stages" as we call them in radio parlance, we step up the faint signals until finally a radio signal that could not be heard at all with a pair of telephone receivers, and a crystal detector, will roar out of the loud-speaker with ear-splitting strength. If conditions are not right, for instance, if our insulation is bad, or if the adjustments of the appara-

tus are not correct, we will hear the signals faintly, and often not at all. Receiving radio waves is not any different from receiving light waves. If you go to the opera you would not think of using the opera glass unless it was properly adjusted—tuned—to your particular eye. You also would not have the lenses covered with finger marks. You know in advance that you would not see much of the opera if you were to do that. The same thing holds true of your receiving set. We must have perfect insulation; all metal parts that carry the current must make good contact—all parts must be perfectly adjusted. Only in this case will the receiving be 100 per cent., or rather approaching it, because we have not as yet reached the stage where we can receive 100 per cent.

We have mentioned before that radio waves pass as readily through a stone wall as through the air. It, therefore, does not surprise us that we can have a modern radio receiver in our library without an outdoor aerial at all and the waves will be received just as well as if the radio set was stationed on top of the roof or out in the yard. This is true only if the detecting apparatus of the set is very sensitive, otherwise we will not be able to detect the waves, although they are there.

As a general thing, it has been found in receiving that the higher up our receiving aerial is, the better we can receive. It also has been found that one can receive further with a given receiver over water than over land. Roughly speaking, one can hear twice as well over water as over land.

Presence of steel buildings also tend to cut down the receiving range. Thus, for instance, if a crystal of moderate sensitivity is located in the heart of the New York downtown district, we will hear practically nothing from the neighboring broadcast stations, unless of course the aerial extends above the buildings. All these facts should be borne in mind when erecting a good receiving station.

Another point to be remembered is that reception during the night time as a rule is better than during the day. The reason for this is that during the day time the sun's rays ionize the air, which means that the sunlight makes the air partly conductive. That cuts down the receiving range as well. It is not a rare occurrence that distant stations are heard twice as far during the night time as during the day.

STATIC

A few words as to this greatest nuisance that the radio man has to contend with. Static disturbance is nothing but atmospheric electricity. We are not bothered much with static in the winter time, but during the months of May, June, July, August and September, there is plenty of it, particularly, if we have an aerial extending up into the air. Static makes itself heard in our receivers in a sort of irregular noise that cannot be controlled today. Very often we hear sharp clicks in our receivers which vary up to a loud roar particularly when a thunder storm is approaching. Sometimes the air, even on a perfectly clear day, is so highly charged with

electricity that if we bring the lead-in from our aerial, close to the ground wire, small sparks will jump from the aerial to the ground, proving conclusively that static electrici-

ty is collecting upon the aerial. These static noises so far have not been corrected, as no way has been found to weed out or entirely tune out these disturbances.

Chapter V

RECEIVING INSTRUMENTS

The earliest instrument for detecting radio waves was the coherer. This was a rather complicated little instrument, and one that was difficult to keep adjusted. Furthermore, it was not at all sensitive, compared with the detecting instruments of today.

One of the earlier detectors, still in use today, is the crystal detector. Dunwoody was perhaps the first man to use such a crystal, viz., carborundum. This particular crystal is seldom used today.

Another of the early detectors, which has almost entirely vanished from the radio picture is the silicon detector. Silicon is a manufactured substance, which is a by-product of the electric oven in the manufacture of abrasives; it is a cousin to carborundum. Silicon is a hard rock-like substance of a dark silver-gray color. A small piece of silicon broken from a larger piece by means of a hammer or in a vice, about $\frac{1}{4}$ inch by $\frac{1}{4}$ inch, is first imbedded into a soft solder. The idea of this pellet is that contact is made on five sides with the metal, which is simply cast around the silicon, and

the crystal part of this round pellet is afterwards placed in contact with the contact member as shown in Fig. 13.

The galena and other common crystals of today are similarly mounted. The contact member to the silicon detector is nothing but a piece of brass, which is not very sharp at the end, but rather blunt. The amount of pressure upon the pellet is varied by a spring. In detectors of this kind, not every point of the silicon is equally sensitive. Some points are very sensitive while others are not. Some of the sensitive points require more pressure than others. All this is found out by experiments. The silicon detector is quite sensitive; it was the first detector invented that required no battery whatsoever to detect radio signals, and for that reason was a favorite instrument with early experimenters. The silicon detector had also the great advantage in that it was not easily "knocked out," as most other detectors are, nor did it burn out easily. When connected, as in Fig. 12, a set of receivers of at least 1,000 ohms should be used

for best results. A 75-ohm receiver, such as is used in house phones, should never be used in connection with radio waves. The results are very poor.

Soon after the silicon detector was invented, Greenleaf W. Pickard, the inventor of the silicon detector, invented a host of other detectors all of which use a native mineral crystal, such as, for instance iron pyrite, copper pyrite, bornite, etc. All of these detectors are used similarly to the silicon detector, the crystal being cast into a soft metal in pellet form. This pellet is used in the same way as the silicon detector; sometimes a sharp brass contact point is used with some minerals and at other times a fine wire is used, which latter is termed a Catwhisker. Such a detector is shown in Fig. 13. This detector uses as a sensitive member the mineral or crystal known as the iron pyrite. As with all other crystal detectors, no battery is used in connection with it. In this detector no sharp point is used, but rather a fine wire catwhisker. A catwhisker is a piece of fine wire about No. 26 or No. 28 B & S gauge phosphor bronze. This is usually attached to some sort of handle or other adjusting means so that the pressure of the wire upon the surface of the mineral may be varied.

One of the most sensitive and most widely used detectors is made of Galena, a lead ore of which there are different grades. It is known under many trade names as well. A good piece of galena is probably as sensitive as any crystal yet discovered, but it is not stable. A cat-

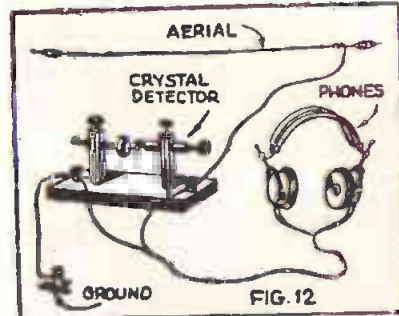

whisker, as explained above, is used with the galena crystal and the amount of pressure has to be found by experiment. Ordinary galena is not sensitive on every spot, but there are certain grades which are equally sensitive over the entire surface; this is known as Argentiferous Galena, which means that it is silver bearing. On the other hand not all argentiferous galena is equally sensitive, and there is no hard and fast rule about it. It must be found by experiment. A good connection for the crystal is shown in Fig. 26. No battery is used with galena, and as a matter of fact a battery will destroy the usefulness of it by burning out the sensitive points. With galena, a fine brass wire No. 24 or No. 26 B & S gauge is used; a stiff gold wire of the same dimension may also be used, as it is non-oxidizing.

All crystals are sensitive only if absolutely clean, and their usefulness becomes destroyed immediately upon being handled with bare fingers.

Although we have stated a little further back that most crystal de-

ectors have the sensitive mineral embedded in a metal pellet, the amateur or experimenter does not always require this, and Fig. 13A shows several simple home-made detectors. The illustrations are so self-explanatory, that no further details need be given. Base boards may be of wood, hard rubber or any good insulator. As will be seen in these illustrations, the detector mineral is clamped by simple holding devices; anything that will hold the crystal down so that it will not move, and at the same time make good contact with it, may be used. The catwhisker wire is best, a No. 24 or No. 26 B & S brass gauge, or phosphor bronze wire. It may be straight, or coiled in pig-tail fashion, either will work equally well. The clever experimenter can change the design to suit his own individual tastes, and the chances are that the device will work well. The trouble with most mineral detectors is that their adjustment does not keep for any length of time. Jars, or static surges in the aerial will cause the detector to become inoperative, after which it must again be adjusted.

We now come to a vastly differ-

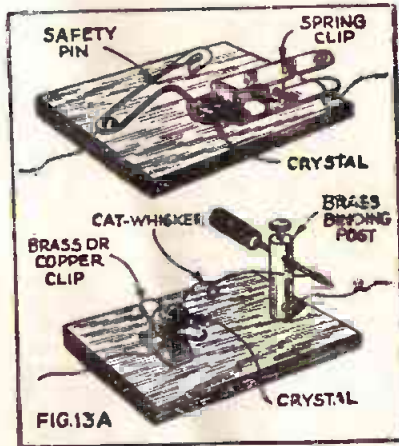
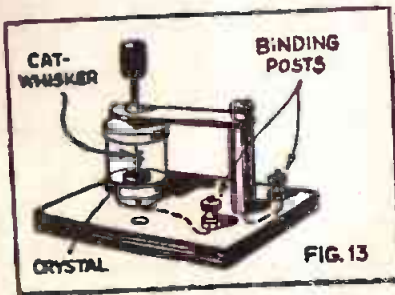

ent sort of detector, namely the Audion, or as it is commonly called, the "Vacuum Tube." This detector works upon an entirely different principle from any of the former ones described, and is in general use today for reasons which we shall learn presently. Fig. 14 shows a standard vacuum tube where we have the filament, which is the same as that used in an incandescent lamp; this is heated by means of a battery of from two to six volts or by means of current from the house lighting lines. We next have the grid which may be in the form of a gridiron or a spiral, it making little difference which. Opposite the filament and with the grid in the middle, we find the plate, usually a small piece of nickel or other metal. The connection of the simplest audion is shown in Fig. 15. If we make the plate positive with respect to the filament, we find that

highly charged electrical particles called "electrons" travel constantly from the filament to the cold plate.

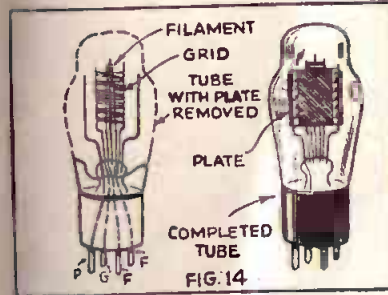

It was soon found that the vacuum tube acted as a sort of valve for the electrical current, allowing the high frequency currents as they came over the aerial to travel in one direction in a vacuum tube but not in the other. In this respect the vacuum tube is the same as a crystal detector, which also acts as a valve, permitting currents to pass one way only.

The vacuum tube was first invented by Dr. Fleming, to whom belongs the honor of using it first as a detector for radio. He was using only a two-element tube, viz., an exhausted bulb containing a filament and a plate. Dr. Lee De Forest conceived the idea of introducing a third electrode into the tube, as explained above. The purpose of this electrode which he called the grid serves only to control the flow of the electrons attracted by the cold plate. It is the grid that makes the vacuum tube the exceedingly sensitive apparatus that it is. Making the grid alternately positive and nega-

tive varies the amount of current that flows from the hot filament to the plate, decreasing, and even stopping it entirely. The grid simply acts as a gate valve which controls the plate current. The curious thing about the grid is that it uses no great amount of power. A modern vacuum tube is exhausted to a very high degree, because it was found that unless the vacuum was perfect, the sensitivity of the tube was very poor. It is not necessary here to go into a very technical discussion of the vacuum tube, as we are merely interested in its functioning. The study of the vacuum tube, however, is a science in itself today, and for that reason it can only be treated generally here. We must, however, add that the vacuum tube is far more sensitive than other detectors, particularly when used in connection with other vacuum tubes. It was found, for instance, that this was the case when several tubes

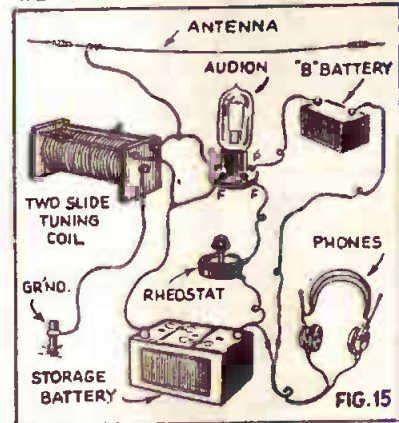

were coupled together; this gives us the so-called two-step or three-step amplifier, which will be discussed later on. The idea of these amplifiers is for each to step up the exceedingly weak current received from the first tube. By means of such a stepping up process, it is possible to bring in signals over tremendous ranges, a thing impossible to do with any other detector known at this time.

Tuning Devices

We have seen in previous chapters that each radio wave-length is dependent upon the length of wire of each aerial. If it were possible to make all aerials of exactly the same length and capacity, and if all stations were transmitting at exactly the same wave-length, we would not need any tuning devices. Unfortunately this is not the case. When we install an aerial, we cannot always make it of the length or capacity which we desire, but are hampered by physical and geographical limitations. In other words, our aerial is usually a compromise. On the other hand, the various transmitting stations all send on different wave lengths and, for that reason, many different tuning devices are used. One of these, and the oldest, is the Tuning Coil, shown in Fig. 16. This is nothing but an aerial wound upon a cardboard tube or other circular or square piece of insulating material. The tuning coil is simply an extension of the aerial. Even though we have an aerial which is only 100 feet long, by attaching more wire to it in the form of the tuning coil, we thereby lengthen the aerial. The tuning coil, as shown in the illus-

tration, is simply an insulated wire wrapped upon a cardboard tube, its size is immaterial. Tuning coils may be made in almost any size, from the smallest one wound upon a pencil, to the largest, as big as a barrel. The more wire we use, the more wave-length our tuning coil will be able to absorb, so to speak. Of course, in practice tuning coils are built for a certain capacity, all depending upon what it is to be used for. If, for instance, we have but a little aerial and wish to receive from stations having a wave length of say 650 meters, a small coil about 6 inches long and 2 inches in diameter and wound with No. 24 B & S gauge wire will do nicely. The purpose of the slider is simply to add more or less wire to the aerial; it is but an adjustment. It goes without saying that the slider of the tuning coil must touch the wire, as otherwise no connection would be made. In Fig. 16, we show the simplest connection for a tuning coil. This, as will be seen, duplicates the connection of the crystal detector. We have here merely added the tuning coil in order to tune the circuit. By means of this tuning coil, it now becomes possible to tune out unwanted stations merely by moving the slider back and forth and so connecting more or less wire to the aerial. For instance, if two stations are sending at the same time, by moving the slider backward and forward it becomes possible to tune in or out the unwanted station, and listen only to the one we desire to hear. In Fig. 17, we show the same tuning coil, but with two sliders. The two sliders are somewhat of an improvement, for

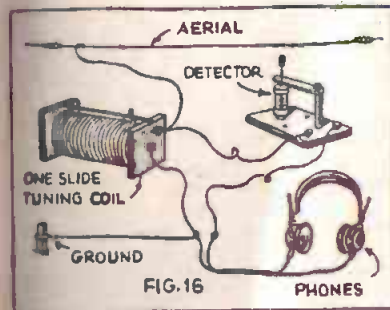

the reason that better tuning is accomplished with them.

Loose Couplers

The Loose Coupler, Fig. 18, is another form of tuning coil and this instrument, which was formerly used a great deal, is really one of the best tuning devices known. Instead of using just one coil, as for instance the tuning coil just described, a loose coupler uses two coils—one sliding into the other without touching. The loose coupler is an electrical transformer, as it has been found

that if a radio current traversed one coil, another tuning coil standing close by would be affected, although no wire touched the first coil. This is termed an "inductive effect." In other words, the energy is radiated from one coil to another, the same as a stove radiates heat to objects that are close to it.

As we just mentioned, the loose coupler is a transformer. The current that comes in over the aerial in the form of radio waves is a high frequency current. By that we mean that waves swing back and forth very rapidly. It is the purpose of the loose coupler to change this

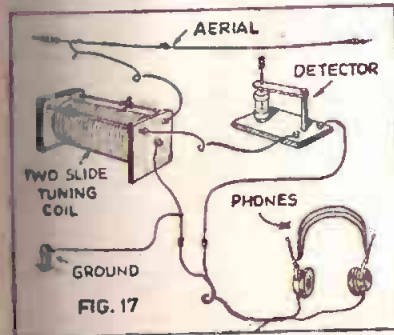
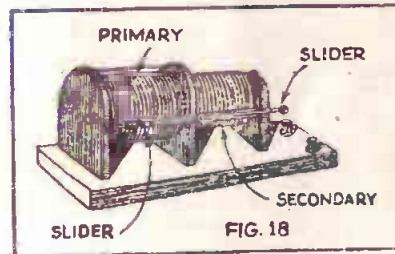

energy into a more suitable form. We again take recourse to an analogy. In Fig. 19 we show, by means of a lever action, the principle of the transformer. We are all familiar with the lever action whereby a man who weighs only 150 lbs. can raise a weight of 1000 lbs. by means of the lever. Is he getting something for nothing in this case? Certainly not! You cannot get free energy, but the experiment in Fig. 19 simply shows that force plus time may be transformed into something else. In this case the man

who weighs 150 lbs. is the force and the time is the interval that it takes him to reach from point A to point B. The two added together are sufficient to raise the 1000 lb. weight, the distance from C to D. The longer the lever arm L, the more weight we can raise. Archimedes told us that "give him a long enough lever he could raise the earth from its hinges." Always providing that he has a sufficiently long lever and a fulcrum, or point of rest which is shown at F in Fig. 19. Summing

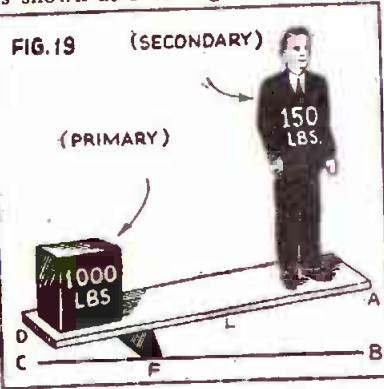

up, we understand now that by means of a small weight we are able to lift a much heavier one.

This analogy holds with our loose coupler, which we have shown in Fig. 18. The loose coupler has two coils; the primary, which is usually the outer tube, is always wound with a coarser wire, while the inner tube is wound with a finer wire. As in the tuning coil we have a slider upon the primary, or if we do not use a slider we may have taps (con-

nections) taken at every few turns of wire, if we so desire. On the secondary also, we may have a slider or taps brought out, both of which are the same. The inner tube is made to slide back and forth upon sliding rods so that the degree of coupling, as we call it, may be changed. If the inner tube, called the secondary, is pushed into the outer tube, which we call the primary, we have a complete electrical lever system, as shown in our analogy Fig. 19. The energy that comes into the primary is now raised exactly as the weight is raised by means of a lever, and we get a marked effect from the secondary. The more we pull out the secondary tube, the less our lever action becomes. It is as if the man in Fig. 19 were to move down to the point F where it would become impossible for him to raise the weight at all, or even to budge it. By using the loose coupler, we do not get something for nothing any more than if we raise a stone we perform no work.

Reverting back to Fig. 18, the tubes of the tuning coil may be of cardboard, hard rubber or composition, or any good insulating material. No steel or iron should be used in the construction of a good loose coupler. Its size is immaterial providing the proportions are right, this being determined by experiment. The important part is that the secondary must come as close as possible to the primary. In other words, the diameter of the two tubes must be so that the secondary tube, when moved inside the primary will take up the entire air space without, however, touching the outer tube. The closer the two

windings come together, the better it is. In Fig. 20, we show the simplest connection for a loose coupler, crystal detector and phones. Very good results are had with this circuit, and the loose coupler is particularly efficient for tuning out interference to a certain degree. It gives what is called sharp tuning, because if two stations operate at a close wave length, let us say one at 360 meters and another at 320 meters, the loose coupler will give very good results by reason of its sharp tuning.

The Vario-coupler shown in Fig. 21 is a development of the loose coupler. In this instrument we have an outer tube wound with a heavy wire, while the inner tube which rotates upon its axis is wound with a finer wire.

In a radio circuit, in order to do fine tuning, we must often take recourse to the condenser which instrument is used to do just what its name implies, viz., condensing the electric current. This is perhaps

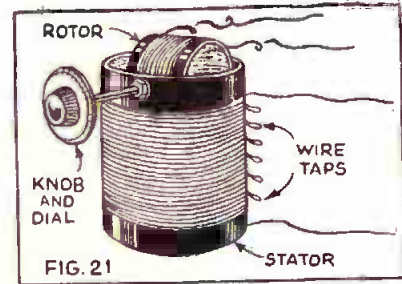
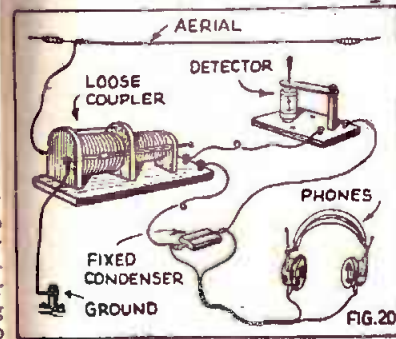

not exactly accurate, for there is no condensing done in radio work, but rather storing of energy.

Consider Fig. 22. Here we have a spring which we compress by means of a weight. As soon as we take the weight away, the spring returns to its original position. What have we done? We have simply stored energy into the spring. The electrical condenser is used in exactly the same way, viz., to store electrical energy. However, that is not its only purpose. Just as the spring may be used for other purposes besides that of storing mechanical energy, so the electrical condenser may be used for other purposes also.

A condenser is a capacity or a vessel in which electrical energy is stored. The simplest form of electrical condenser is shown in Fig. 23, where we have a metal plate A, a glass plate B, and another metal plate C. By means of this arrangement, we may store electrical energy upon the surfaces, of glass plate B. The larger we make the metal plates, the more electrical energy may be stored.

The form shown in Fig. 23, is

used in many condensers today. The metal plates A and C may be any form of metal, such as, for instance, tin or metal foil, while the glass plate B may be replaced by a piece of paraffin paper. In other words, any good metallic conductors may be used if coupled with a good insulator. The better the insulator, the better the condenser will be and the greater its electrical capacity. In the commercial condensers, paraffin paper, varnished silk, sulphur, sealing compounds, or mica, is usually used. In Fig. 24, is shown

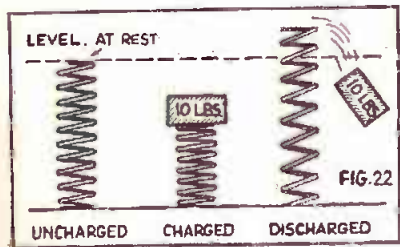

a simple condenser; this is also shown opened up. It is made by rolling together two strips of tinfoil between several strips of paraffin paper. The whole, when rolled together and assembled, becomes the finished condenser. By rolling it together, it takes up less room. In radio work, where fine regulation is required, we make use of still another condenser, as shown in Fig. 25. This condenser, instead of being fixed, is variable. As will be seen there are a number of plates which are usually made of brass, zinc or aluminum, which mesh into each other to a more or less degree. The more plates we have and the closer

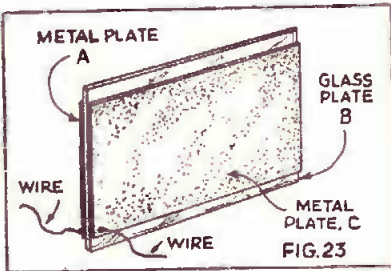

they come to each other, the higher will be the capacity of that condenser. For certain purposes we need only a small condenser of a few plates, while in others we need a larger one of a great many plates. It is just like having a small spring and still another very large one. Both have their uses, and both are very necessary, all depending upon what work they are required to do. In Fig. 26, we show the simplest elementary connection, where we have a crystal detector, a tuning coil without a slider, a pair of phones and a telephone condenser. This is a peculiar connection because in it we wish to show that we can tune by means of the condenser. As will be seen in this tuning coil, we do not use any slider by which the

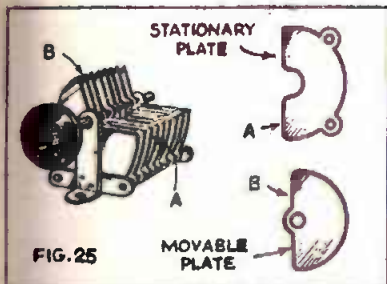
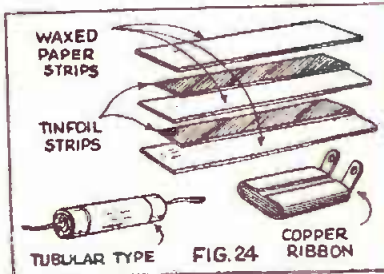

length of the aerial may be changed, which would thus change the wave length. This is performed entirely

by the variable condenser. When we adjust the latter, we also change the relation of the tuning coil, and in fact are changing the wave length until a point is found where the signals come in best. This is a finely balanced circuit, and the amount of wire on a little tuning coil should be in direct relation to the condenser. In other words, if there is too much wire on the tuning coil and the capacity of the condenser is small, we cannot do much tuning. For the best results, as for instance for receiving broadcast music on a wave length of 360 meters, we could

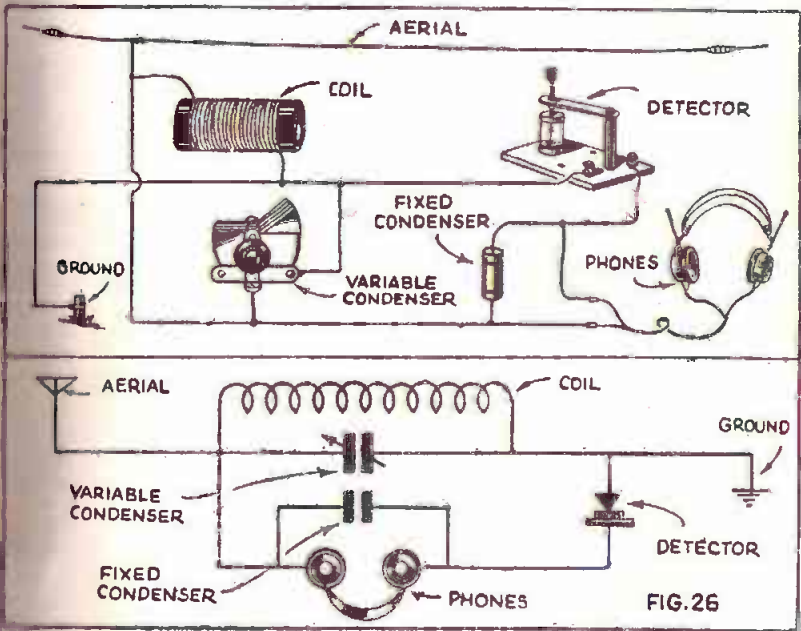

use a small coil, one inch in diameter, wound with about 70 or 80 turns of No. 18 enamel wire, while the condenser should be of the commercial variety known as a 23-plate condenser. Then, all we have to do is simply adjust the condenser until the signals are heard best.

In this illustration, we also see where the phone condenser is located. This phone condenser stores the energy of the circuit, and discharges it into the telephone receivers which enables us to hear the signal more loudly.

The two forms of condensers shown here are of course not the only ones, as many more types of either fixed or variable condensers are made.

VACUUM TUBE ACCESSORIES

We have learned something about the vacuum tube which was described previously in this article, and in Fig. 15 we have shown the simplest connection of an audion detector. There are, however, a number of other auxiliary instruments used in vacuum tube systems which give certain refinements.

The vacuum tube, when it is used singly, acts as a detector and detects the signals the same as a crystal detector. Also, we might state here, that the crystal detector is a better rectifier "valve" than the vacuum tube.

With a crystal detector, or in the ordinary single vacuum tube circuit, the incoming signals act upon the phones and we hear the signals with a certain strength. Let us now consider the vacuum tube and the incoming signal. We may indeed, by certain means boost up the very weakest of signals and amplify or

magnify it a hundred or a thousand or a million times its original strength. It is just as if you take a piece of film such as is used in a moving picture theatre and examine it with your eye. The figures are so small that you can hardly distinguish them. The regular film which is about the size of a postage stamp here stands in our analogy as a single vacuum tube. We can, however, take that film, and by using a powerful light enlarge the little picture (no larger than a postage stamp,) by projecting it upon the screen. We thereby amplify or magnify the original picture several thousand times. We can amplify or enlarge it a million times if necessary all depending upon the amount of light we put behind a film and the distance from the screen. This is graphically shown in Fig. 27.

We may do precisely the same thing with a vacuum tube, but we must use additional energy, the same as in our film where we use energy (the electric current which produces the light) to project the film upon the screen. In other words, we can take the detector tube and enlarge the original small and weak signal, and boost it up until the sound comes out loud from a loudspeaker, which in our analogy stands for the moving picture screen. The electrical connections for a vacuum tube amplifier are shown in Fig. 28. This is what is called technically a two-step amplifier. We show this connection simply because without it, it is almost impossible to bring home the meaning of the vacuum tube auxiliary instruments with which the reader is as yet unfamiliar. In this

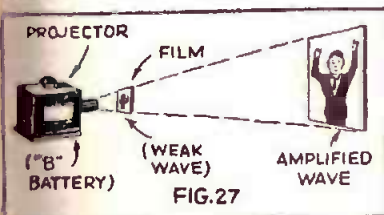

circuit we have, as before, the aerial, the ground, the variable condenser, the blocking or phone condenser and several other instruments as well. We find for instance, that several transformers are used, viz., what is technically called the Audio Frequency Transformer.

AUDIO FREQUENCY TRANSFORMER

This transformer (E in Fig. 28),

consists of just an iron core upon which is first wound a coarse wire termed the primary, and on top of this a finer wire termed the secondary. The ratio of these transformers is usually such that, electrically speaking, the value of the secondary is from three to ten times as much as that of the primary. The audio frequency transformer is in principle the same as the loose coupler, which we studied before, and the purpose of the audio frequency transformer is to transform the energy from a low level to a high one. The purpose of this transformer, as shown in Fig. 28, is to 'boost up the weakest signals, transforming them into stronger ones. The transformer by itself could never accomplish this, and in order

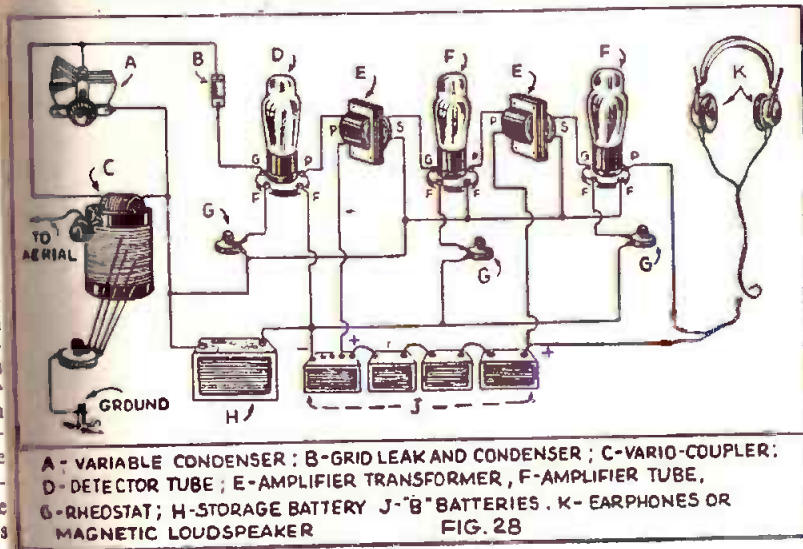

A - VARIABLE CONDENSER ; B - GRID LEAK AND CONDENSER ; C - VARIO-COUPLER ;
D - DETECTOR TUBE ; E - AMPLIFIER TRANSFORMER , F - AMPLIFIER TUBE .
G - RHEOSTAT ; H - STORAGE BATTERY J - "B" BATTERIES . K - EARPHONES OR
MAGNETIC LOUDSPEAKER

to make the lever action work perfectly, we take recourse to a battery which is connected to the transformer and with the vacuum tube, as shown. By means of this additional electrical energy we are now in a position to boost up and relay the weak signal. In this connection, we have shown first a detector tube, while the other tubes are amplifier tubes. By this we mean that the first tube receives the signal, while the other tubes are merely used as pumps to boost up the electrical energy until the signal finally comes from the phones so loudly that if we connect the phones with a loud speaker, loud signals or music will issue from it. The battery used in this case is a so-called "B" battery, or high voltage battery which has been found necessary to aid in boosting up the weak signals. As a rule batteries anywhere from 24 to 300 volts are used, all depending upon the circuits.

It should be understood that the audio frequency transformer is used only to boost up the weak signal as it leaves the first detector tube. It is not in the province of this transformer to do anything save amplify the signal which is detected by the detector tube.

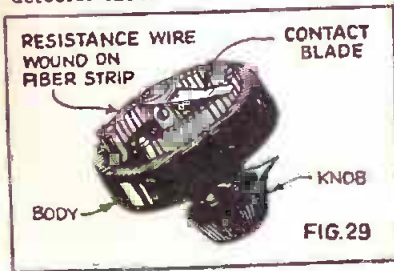

RHEOSTATS

In Fig. 28, we also find another new instrument, the Rheostat, shown in detail in Fig. 29. This is simply an electrical resistance and is used solely to increase or decrease the glowing of the vacuum tube filament. When signals are received, it has been found that the filament must glow at a certain intensity. Some signals come in best when the filament is burning very brightly, while with other tubes the signals come in best when the filament is only a cherry red.

GRID LEAK

In Fig. 28 we have another newcomer, which is termed the Grid Leak, and its condenser. It has been found that when the grid condenser is used, as shown in the illustration, the signals will come in about twice as well as if none was used. However, this condenser alone would not be sufficient, for the reason that the accumulation of electrons, which are highly charged electrical particles on the grid of the vacuum tube, would interfere with the normal working of the tube. We must provide a means to let the surplus electrons leak out without, however, letting them out too quickly. It is as if we had a boiler under which a constant fire was maintained. In order to provide a remedy, we install a safety valve. This valve is used for the purpose of giving off the surplus steam and so keep the boiler free from harm. It is the same with the vacuum tube. While of course, the vacuum tube would not burst, even if we did not use the grid leak, electrically speaking, the tube would not function properly. Hence, the grid leak, which is a

sort of safety valve to let the surplus accumulation of electrons run off. The grid leak is nothing but a very high resistance, sometimes millions of ohms high. It may consist of only pencil lines drawn across a piece of stiff Bristol board; these pencil lines are but slight electrical conductors, but the resistance is enormous. It suffices, however, to allow the surplus electrons to leak off. There are various ways and means to make grid leaks, and a popular form is shown in Fig. 30. Here we have a piece of cardboard or fibre upon which is traced a fine line in India ink. This line acts the same as a pencil line. The whole is enclosed in a tube to prevent moisture or dust from settling upon the grid leak. Connections are made on the ends by metal clips. Fig. 30 shows a grid leak and condenser combined as two instruments, which are usually used in conjunction. The grid leak condenser is small and is similar to a telephone blocking condenser, and the grid leak is traced by means of India ink upon a piece of fibre; the whole is enclosed in waxed paper.

RADIO FREQUENCY TRANSFORMER

In Fig. 28 we have learned about the audio frequency transformer. We know that this transformer amplifies static and also other disturbances, as well as the signals. For that reason it is not possible to use many such transformers, or, technically termed, many steps of audio amplification. If we use more than three such transformers and their respective vacuum tubes, additional noises are all amplified, and the

amount of noise which we get in the phones is tremendous. For that reason, we take recourse to what is termed a Radio Frequency Transformer. The radio frequency transformer may consist of only two windings, one adjacent to the other on a cardboard tube. The simplest form is shown in Fig. 31. The wire used on this is usually exceedingly fine, No. 24 B & S wire, or even thinner. The two windings act upon each other by induction, and do not make connections physically. A radio frequency stage amplifies the

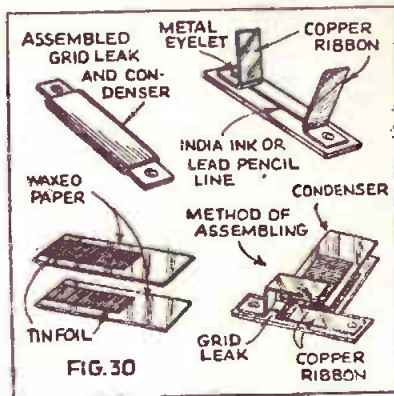

weak signals as they are coming in over an aerial. The radio frequency transformer steps up these weak signals, amplifying them and passing them on to the detector tube. We now get the net result, with the detector tube in a position to detect already fairly strong signals which may then be amplified in the audio frequency amplifiers, and boosted up further by a second or a third transformer, if so desired.

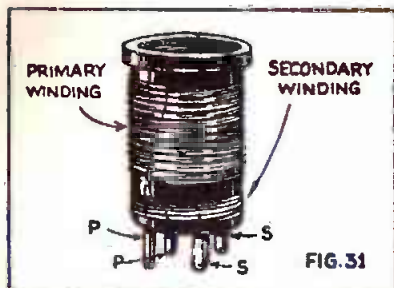

FIG. 31

To resume and in a few words, we may say that the radio frequency transformer boosts up the very weak radio frequency currents so that the detector gives maximum results, whereas the audio frequency boosts up the audible signals. The radio frequency transformers, in other words, amplify signals that would be lost otherwise, while the audio frequency transformers give volume to signals which are already audible.

TELEPHONE RECEIVERS

In order to receive signals or broadcast entertainment by ear, we use a telephone receiver, of which

two simple types are shown in Fig. 32; this consists of the following: First we have a powerful magnet which attracts to it a thin iron diaphragm which is clamped tight like a drum head along its outer edge. Upon the magnet are mounted two pole pieces around which are wound many thousand turns of exceedingly fine wire, almost as fine as the human hair.

Ordinarily when no current is sent into the telephone receiver, the diaphragm is pulled down somewhat to the pole pieces, although it must never touch them. If it does, no sound will be received. If, however, a weak electrical current passes through these spools the diaphragm will either be pulled down more if the current is in the right direction, or if the current is in the wrong direction, it will weaken the magnetism on the pole pieces. In this case, the diaphragm is not attracted. These little variations make the diaphragm vibrate more or less. These vibrations are passed on to the air, and the air vibrating in unison with the dia-

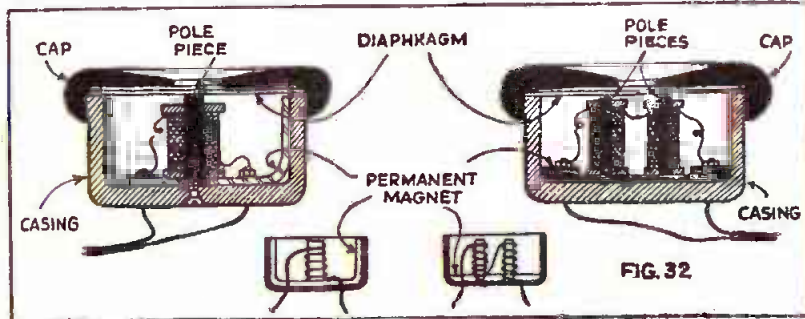

FIG. 32

phragm is changed into sound waves, which are sent on to our ear, where we hear them.

LOUD SPEAKERS

The dynamic loud speaker, now so widely used, works upon a principle where a small coil, through which the received current flows, is influenced by a powerful electro-magnet. It is another case of boosting up the sound which is received from the last amplifier tube. Such tone amplifiers can throw the voice or music over distances of one-half mile and more, and if a person stands in front of one of these giant horns, the amount of sound that issues from it is simply terrific. Of

course, not all tone amplifiers work so loudly. Those made for home or parlor purposes do not use so much current, and therefore do not give so much power. There are a number of types of tone amplifiers, but most of them work along the same electro-magnetic lines, and if they do not use the outside electric current in order to create a strong electro-magnetic field, they either use strong magnets to accomplish the same result, or necessitate the use of a high tension current in the amplifier. Such tone amplifiers are nothing but transformers or relays, transforming or relaying a weak sound into a loud one.

Chapter VI TUNING

In former chapters we learned something about tuning; this is nothing but resonance. We all know the experiment of standing near the piano and singing a certain note into it; when we reach the correct or fundamental note, the piano begins to sound that particular note in sympathy. We may then say that we are in tune with that particular string which sounds in our ears. Likewise in radio, we make use of a similar system, except that we use electrical tuning instead of acoustical tuning. Tuning consists as a rule in merely attuning our aerial electrically to the same length as the aerial, that is transmitting to us. In other words, if a broadcasting station is transmitting on a wave of 360 meters, we must attune our aer-

ial to the same wave, namely, 360 meters. If we have an aerial which is 260 meters long, electrically speaking, it stands to reason that we must add 100 meters to this aer-

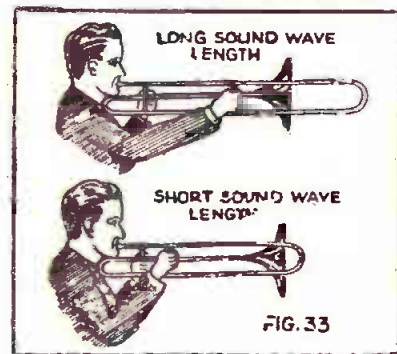

FIG. 33

ial in order to receive the wave at all. We have learned in other chapters how this may be accomplished. If we have a receiving outfit, all we have to do is move the slider of our tuning coil backward and forward until the signals come in at maximum strength. When that point is reached, we know that our aerial, electrically speaking, must be 360 meters long. We have also seen in Fig. 26 that we need not have sliders on the tuning coil in order to tune. We may use a condenser for tuning purposes because its electrical equivalent is the same as a tuning coil slider. By adding more or less capacity to the condenser and therefore to the tuning coil, we changed the electrical value of the tuning coil, and also its wave length. This is not literally true, technically speaking, but we must use this language to bring home the meaning.

We therefore learn that we may tune either by lengthening the aerial with additional wire, or by using a capacity or condenser in connection with a wire coil. Both, if correctly apportioned, give the same results. Before we can receive signals, or amplify them, it is of the greatest importance that we tune in to the right wave length. An aerial must be in electrical sympathy with the sending station before we hope to receive signals. In Figs. 17 and 26, we have shown the elemental methods of tuning. Of course, there are many other ways of tuning, all of which, however, are along the same principles as those just enumerated.

Perhaps an analogy in tuning will not be amiss here, and we have a particular analogy that covers tun-

ing nicely. Take the musical instrument, the trombone shown in Fig. 33. You all have seen this instrument, as nearly every orchestra boasts of one or more. It is known by all of us that while the musician blows into the mouth piece, he varies the length of the trombone by moving the sliding member back and forth. If he wants to get a deep note, he pulls the sliding member almost all the way out, and this gives him a long sound wave. If he wishes a high note, he must have a short sound wave. This means that he must push the sliding member all the way in. It is literally, as well as scientifically, true that the lengthened trombone gives a long wave length, while the shortened trombone gives a short wave length. These are, of course, sound waves with which we have to do here. In radio we do exactly the same thing in tuning. When we wish a long wave length, we must add more wire or its equivalent to the aerial. If we want a short wave length we must either have a short aerial or subtract some wire from the aerial. The reader should remember that in order to decrease the wave length of an aerial, all that is necessary is to put a condenser in series with the aerial, which actually decreases the wave length; it does not increase it as some people seem to think. The variable condenser, therefore, gives us the best practical means to decrease the wave length; this point is quite important to remember. Suppose you have a long aerial, say 200 feet, in connection with a small tuning coil, or suppose you have a short aerial and live on the tenth floor of an apart-

ment house. The only available ground would be the water pipe. This water pipe, however, would be so long that it would add extra meters to your wave length, and something must be done to decrease it, if you wish to receive signals sent out from a broadcast-

ing station operating on a short wave length of 360 meters. The only way you could then tune in would be in the former case of the long aerial, to put a variable condenser in the aerial circuit, or in the other case where you have a long ground to interpose the condenser in the ground lead.

Chapter VII

AERIALS, LOOP AERIALS, GROUNDS

An aerial is used to intercept radio waves; that is its sole function in the receiving set. It does not amplify or make the signals come in clearer by itself. Hundreds of different aerials have been invented, and there is hardly anything in this field that has not been tried out. An aerial, properly speaking, is an elevated wire that is well insulated, and is usually placed outside of the building or house.

An aerial can be made of most any metallic wire, but the best material is copper wire. A still better wire to use is a stranded wire, which is composed of several copper or phosphor bronze wires twisted together. As a rule, we may say that the larger the wire, the better it is for radio purposes. Very thick wires, as a rule, cost much and are very heavy, and therefore are not very practicable. A No. 14 B & S gauge wire is a standard as used today and gives excellent results. For radio broadcast reception it has been found that a single wire

50 feet long gives excellent results. Illustrations 34 and 35 show such a type of aerial.

Unless you wish to go to a great deal of inconvenience, make your lead-in of the same wire as the main aerial. This may be done very simply with a single wire aerial, for the reason that no soldered connections are necessary. This is also shown in Fig. 34 and Fig. 35. The next things to consider are the insulators, which are quite important. The insulator serves to insulate the aerial, and unless we use good ones, a great deal of energy will be dissipated uselessly. We show in Fig. 36 various types of insulators that may be used. One of the simplest is the ordinary porcelain cleat, but when this type is chosen, an unglazed cleat should be avoided. Insist upon getting a glazed cleat which is a better insulator. When using cleats, put them in tandem, two or three strung in a row, as shown. The more insulators we add, the better the insulation.

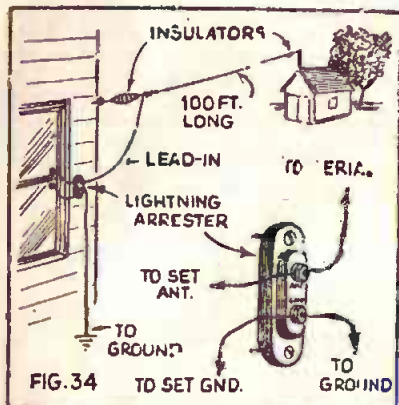

FIG. 34

It is, however, hardly necessary to use more than three in a row. We next have the small spool insulators, which are very good and may also be strung in pairs, or sets of three. Various other types are shown.

When putting up an aerial, it should be remembered always that the aerial proper must be at least a foot away from all buildings, barns, trees and the like. In other words, it should be away from all objects.

The height of the aerial is often important. It should always be placed at least 20 to 30 feet above the ground.

As a rule, an aerial in the country may be stretched from the attic window to a flagpole, or if such is not at hand, a barn, garage, or even a tree could be made use of. If a tree is used, some means must be had to compensate for the swaying of the tree. Such a method is to have a pulley attached to a tree by means of a rope; the end of the

aerial is then run over this pulley and a fairly heavy weight secured to the open end. As the tree sways back and forth, more or less aerial rope is paid out or taken in, and a good compensation is thus had. The weight may be 50 to 100 pounds.

When an aerial is erected in the city, let us say on an apartment house, it should be at least 10 feet above the roof, particularly if the apartment has steel construction.

LEAD-IN

The lead-in is that part of the aerial that goes into the building or house to establish connection with the instruments. In a single-wire aerial, the lead-in is simply the aerial wire itself leading into the house and thence to the receiver. The lead-in wire should be of the same size as the aerial. In other words, about No. 14 B & S wire. It should be insulated at the point where it nears the building, or if this is not possible in the case of a single-wire aerial, the lead-in is strung on insulators, the wire being always at least 2 inches away from buildings,

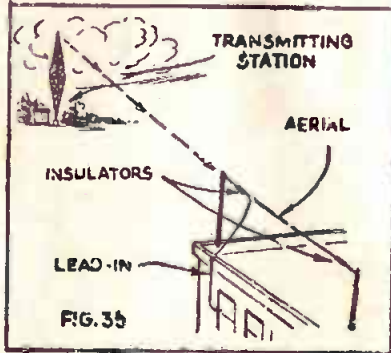

FIG. 35

walls, etc., until it reaches the points where actual entrance is made into the building.

We now come to an aerial which is entirely different from those of which we have spoken before. We refer to the loop aerial, which is shown in Fig. 37. It should be understood that a loop aerial is hardly, if ever, used in connection with a crystal set. It is used almost exclusively with a vacuum tube set, where it serves several purposes. In the first place, it does away with the ground connection. Secondly, the loop aerial may be made in any size from a few inches square up to 20 feet square. The loop aerial is highly directive; by that we mean that it will only receive with maximum intensity if the loop is turned in the direction of the coming signals. This is shown clearly in Fig. 38. Here we see how an ordinary loop aerial is placed in a building and we also see how the waves are propagated from a distant sending station. It will be found that the signals are strongest when the loop

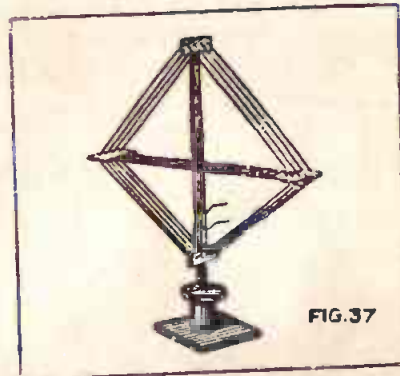

FIG. 37

points exactly in the direction from which the waves are coming.

GROUNDS

In radio, in connection with the usual aerial, it becomes necessary to use a ground, which as its name implies, is a connection made with the earth. Fig. 39 shows the simplest and perhaps the best. It is simply a wire fastened to the cold water pipe, which is found in almost every house and apartment. In order to make a good connection, we use a ground clamp, as shown in Fig. 39. By means of some clamping arrangement, which differs for every ground clamp, a strong mechanical connection is made. The ground wire is then fastened to the screw or binding post attached to the ground clamp. The ground wire need not be insulated. An ordinary bare No. 14 B & S wire will do nicely; in other words, the same wire which we use on an aerial may be used. It is not necessary to run the ground wire on insulators, as is done with the aerial

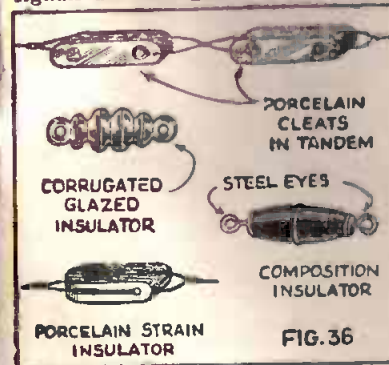

FIG. 36

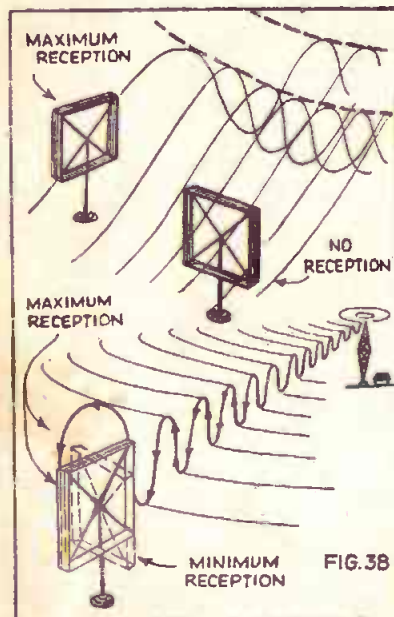

FIG. 38

lead-in, but it may be attached to the wall by means of nails which serve the purpose equally well. Of course, the ground wire should not be longer than is absolutely necessary. If it is not possible to find a cold water pipe, a radiator pipe may

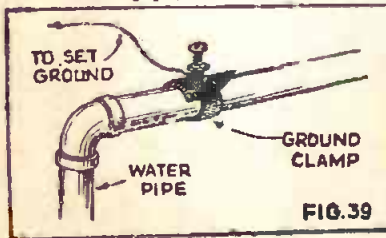

FIG. 39

be used, although the results may not be as good as from the cold water pipe. It is against the law to connect a ground to a gas pipe, and it should therefore never be done.

When we are out in the country, for instance, when camping, it is not always possible to have a water pipe, and in that case we have to establish contact with Mother Earth direct. This is usually accomplished by driving a metal rod into moist earth, as is shown in Fig. 40.

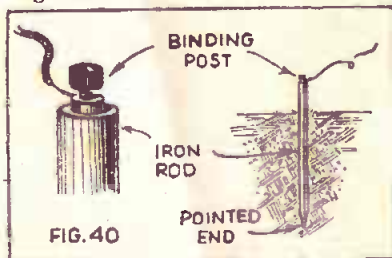

FIG. 40

LIGHTNING ARRESTERS

The properly installed aerial, when used with a lightning arrester, is the best protection a building or house could have against lightning. The aerial is a lightning conductor itself, and will actually protect the house, and will never endanger it if properly installed.

The lightning arrester itself is nothing but a small spark gap either in a vacuum or in the atmosphere, which gap breaks down when a current of a few hundred volts strikes the aerial. Instead of going through the instruments which have a high resistance, the current travels directly to the ground, which has a low resistance. Secondly, the instruments are not damaged.

GERNSBACK'S EDUCATIONAL LIBRARY:

No. 1	No. 2	No. 3	No. 4
How To Make Four Doerle Short Wave Sets	How To Make The Most Popular All-Wave 1- and 2-Tube Receivers	Alternating Current for Beginners	All About Aerials



No. 9

Simple Electrical Experiments

No. 5	No. 6	No. 7	No. 10
Beginners' Radio Dictionary	How To Have Fun With Radio	How To Read Radio Diagrams	Television



10c.
EACH

BOOKS ARE ALL UNIFORM
Every book in the GERNSBACK'S EDUCATIONAL LIBRARY has 32 pages—with illustrations varying from 80 to 68 in number. Each title volume contains over 15,000 words. POSITIVELY THE GREATEST 10c VALUE IN RADIO BOOKS EVER OFFERED TO THE PUBLIC.

Order books by number—remit by check, money order, cash or unused U. S. Postage Stamps. Books are mailed POSTPAID.

RADIO PUBLICATIONS . 25 WEST B'WAY - NEW YORK, N.Y.