

GERNSBACK'S EDUCATIONAL LIBRARY N° 6

HOW TO HAVE FUN WITH RADIO

10
CENTS

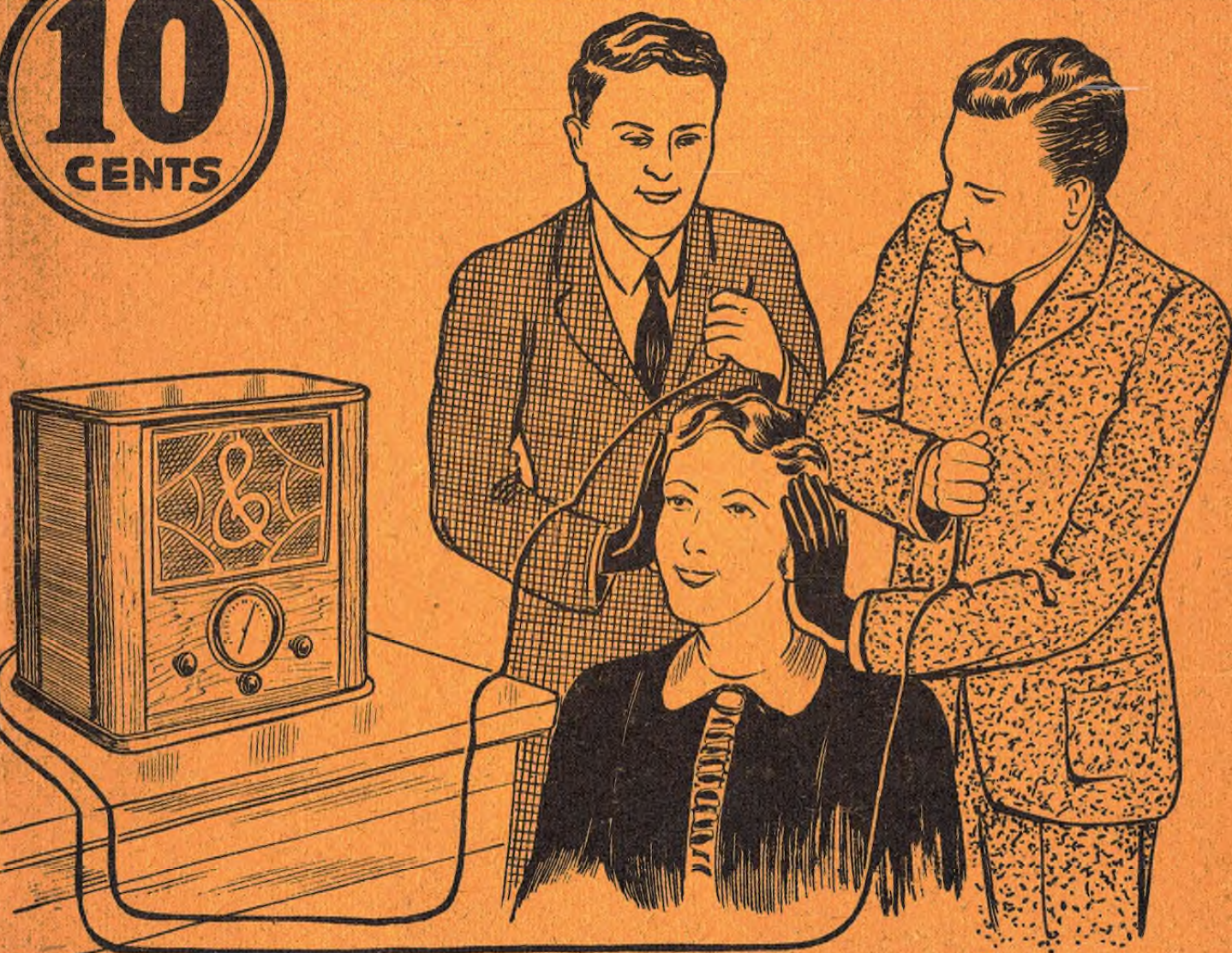

RADIO PUBLICATIONS, 25 WEST B'WAY, NEW YORK 7, N. Y.

Suggest A Good Book Title

WIN TEN DOLLARS!

SINCE 1908, the name Gernsback has been synonymous with scientific and radio literature. Since that time, many millions of Gernsback magazines and books have been distributed and read by people all over the globe.

Recently, Hugo Gernsback decided to place upon the market a new, popular priced series of books under the name of GERNSBACK'S EDUCATIONAL LIBRARY. It is the intent of the publisher to continuously add books to the library, from time to time, under various titles. These books will cover a great many subjects, which will not necessarily be restricted to radio or science, but which will encompass many other arts.

It is Mr. Gernsback's plan to have all the books of uniform size. Their price being extremely low, everyone will ultimately be able to possess the entire library, especially since they are purchased piece-meal as the books are published.

Don't forget either, that Gernsback books and magazines always have given you your full money's worth. The present series of books again proves this. Never in the history of technical publishing have you been able to buy so much for so little money. The answer to this is in turning out a greater number of books and in large quantities.

In bringing out new books, we want your help. Perhaps you have an idea for a certain book title (subject for a new book) that you think we should publish in one of these 10c volumes. If you have such an idea, communicate it to us; we will pay \$10.00 for each new book title which we accept. If you submit more than one title, write each one on a separate sheet of paper. In case of a tie, identical prizes will be paid to the contestants.

Address all letters to

RADIO TITLE EDITOR

RADIO PUBLICATIONS
25 West B'way NEW YORK City.

PRIZE WINNERS

ALFRED CETTIE

**4115 Midvale Avenue
Seattle, Wash.**

Title: **ALL ABOUT AERIALS,**
Book 4

RUDY RUZICKA

**3441 California Avenue
St. Louis, Mo.**

Title: **BEGINNERS' RADIO DIC-**
TIONARY, Book 5

KENNETH WARNER

**R. F. D. No. 2
Burbank, Ohio**

Title: **HOW TO READ RADIO**
DIAGRAMS, Book 7

CLYDE SORRELL

**504 North 10th Street
Rockyford, Colo.**

Title: **RADIO FOR BEGINNERS,**
Book 8
(Watch the List Grow)

Copyright 1938, by H. Gernsback
Printed in U.S.

INTRODUCTION

NO matter how much entertainment you get from your radio receiver, it is capable of providing still more fun.

With it you can make records, burglar alarms, perform magic tricks, and practical jokes; in fact, you can do dozens of things that never occurred to you before. And they do not damage the radio in any way. Fifteen such pastimes with radio sets and equipment are given in this book. If you are the typically inventive young American, each will suggest many more.

Before proceeding with the various stunts described and illustrated in this volume, there are several things you must know.

First, all of the stunts described will work only on radio sets employing three or more tubes — the more tubes the better.

Second, **disconnect the radio before doing any work on it.** If it is a battery set, disconnect the "A", "B" and "C" batteries. If it is an electric set, pull its plug out of the wall socket.

Third, check your work carefully before you reconnect the batteries or plug in the set. If you make a mistake, you are likely to damage the set, the tubes, or both.

Fourth, wherever fixed condensers are specified use those that have a high enough rated voltage. If the condenser

is to go across 110 volts, use a condenser rated at a **working** voltage of at least 200. Remember that working voltage and peak voltage do NOT mean the same thing; a condenser with a rated **peak** voltage of 200 is likely to blow out when connected across a 110-volt line. In short, always look at the **working** voltage of the condenser and choose one that is rated considerably above the voltage at which it will be used.

Fifth, do your work neatly. A carelessly done job never works as well as a carefully performed one.

Sixth, make sure that you have good connections wherever there is supposed to be contact. Remove insulation and scrape wires bright before connecting them.

Seventh, if you solder connections (which is the best way to make them) use rosin core solder. While it is easier to solder with acid core solder, joints made with it will corrode unless the work has been done by an expert.

With those few suggestions in mind, go ahead with the various experiments in the book. You will find them both entertaining and instructive.

If you have the average accumulation of radio parts, it is unlikely that you will have to buy anything. If not, parts specified in the following pages average but a few cents each in cost, and are readily obtainable in any locality.

TALKING NEWSPAPER

WHEN voices and music come from a newspaper tossed casually onto a chair—well, the shock is almost too much for a nervous man. It's good for a lot of laughs, and it is easily done, too—in a number of ways.

Perhaps the simplest is to make a condenser-type loud speaker out of the paper. This is done by taking two sheets of tinfoil (the kind that comes in packs of cigarettes will do, but larger pieces are better) and soldering long leads to them.

The newspaper is placed upon a chair, and one piece of foil laid loosely between two pages. The other piece of foil is similarly laid between the **very next** two pages, so that only one thickness of newspaper separates the two pieces of foil. (Fig. 1.)

It is best to have the foil good and smooth. It may be flattened by laying it on top of a perfectly flat desk or table, and covering it with a piece of paper. The rounded part of the bowl of a tablespoon is then rubbed firmly over the paper; which must be held so that it cannot crumple. The way to do this is to hold the spoon in the right hand and to use the left to hold the paper flat. If you always rub **away from** the left hand, the paper will not crinkle. Fig. 2A shows how this is done.

The connection of the wires to the tinfoil is likewise easily made. You cannot solder to tinfoil satisfactorily; it melts too readily. Therefore, crumple

one corner of the foil and wind the scraped end of the wire around it, as shown is Fig. 2B.

Finally connect the primary of a step-up transformer, such as an old audio frequency transformer, across the output of the set. Connect the two wires from the foil to its secondary, and tune-in a program. The paper will talk. If it tends to rattle too much, lay a thin magazine on top of it. This will reduce the rattle and the volume.

Another type of talking paper can be made of an old headphone unit. For this one, best results will be had by soaking a sheet of newspaper in water to which a little glue has been added, in order to stiffen it. The paper must then be hung up to dry—if you lay it down to dry, it will stick to the surface upon which it rests.

While it is drying, remove the cap from the headphone and cut away the center part, as shown in Fig. 3, leaving just enough at the rim to hold the diaphragm. This must be done with considerable care in order to avoid cracking the cap which would make the unit worthless.

When this job is done, and the paper has dried, the paper is attached to the center of the diaphragm with a drop of sealing wax, which may be taken from the top of a discarded "B" battery (some "A" 1½-volt cells are also sealed with wax). If no sealing wax is available, a small lump of beeswax or cobbler's wax—about the size of a grain of rice—will do as well.

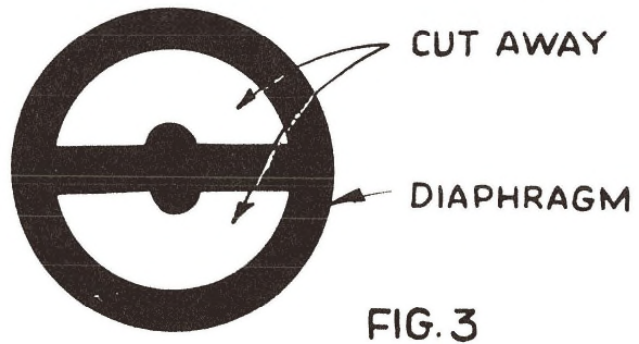
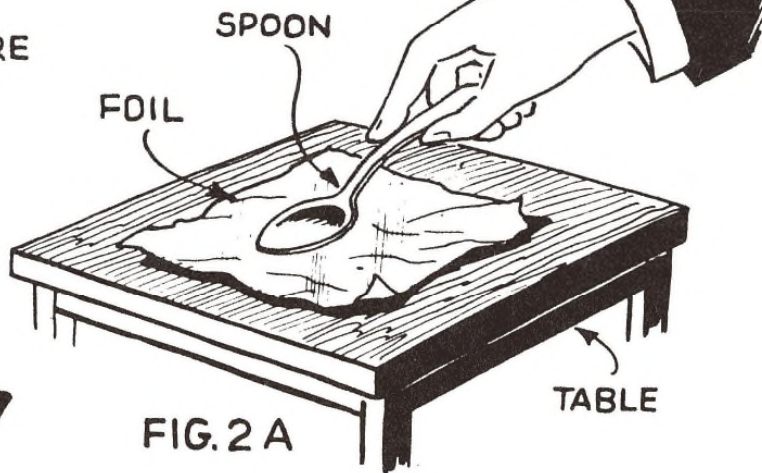
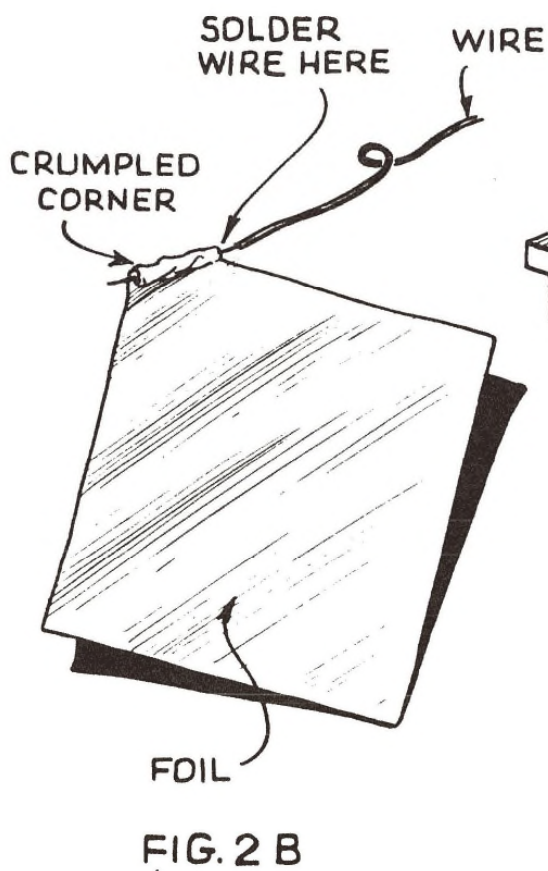
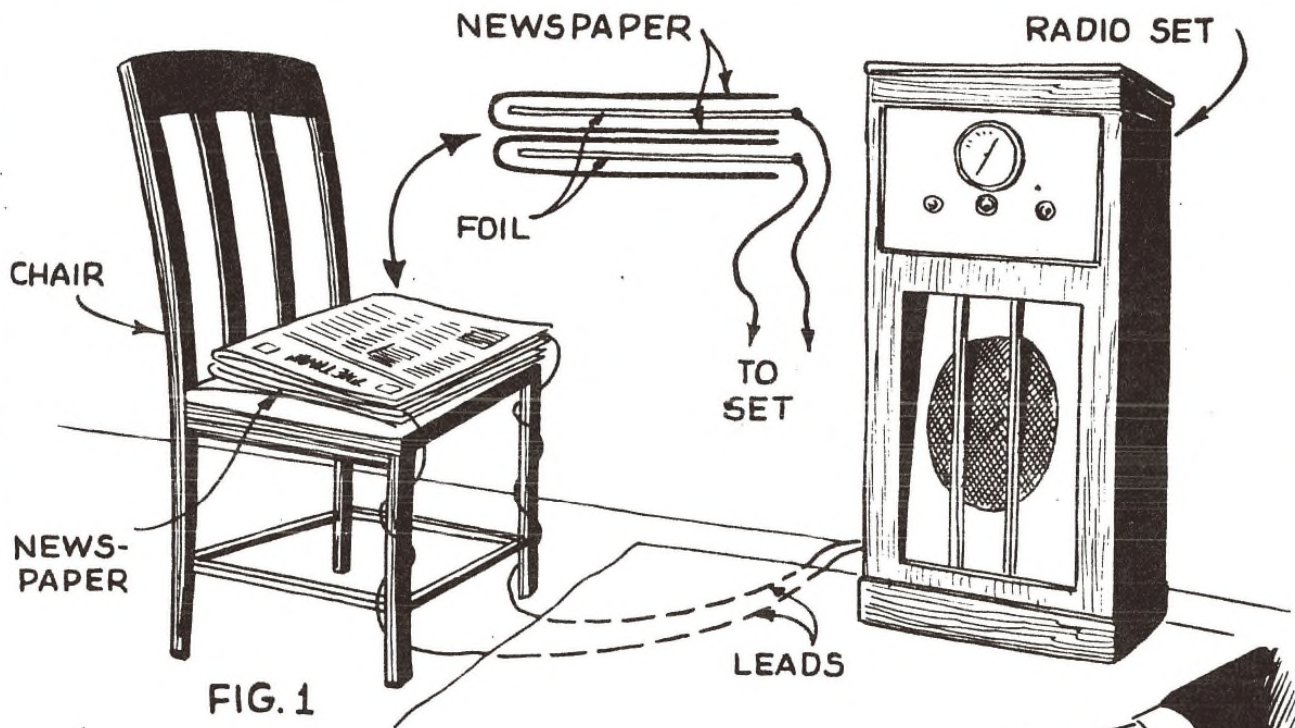

TALKING GLOVES

A CUTE stunt for parties is to let your guests hear music apparently coming from your hands. To do this, you will require an assistant, an old audio transformer and a pair of kid gloves.

The regular output transformer or loud speaker is disconnected from your radio set, and the primary of the old audio transformer is connected in its place, as shown in **Fig. 4A**. If the set has push-pull output, either use a push-pull output transformer, as in **Fig. 4B**, or connect a pair of 250,000 resistors across the primary of your old transformer, as **Fig. 4C** indicates.

From the secondary of this transformer, run a pair of leads with bared ends.

You and your assistant next put on one glove each. The gloves must fit tightly, so the palms are stretched out when your hands are held open.

You each now grasp one end of the wires, as shown in **Fig. 5**, and place your gloved hands tightly over the ears of the person to whom the demonstration is being given, making sure that the gloves actually touch the ears. If the subject is a girl, have her pull her hair out of the way first. **Fig. 5** shows how the hands are held.

If a station is tuned in on the radio, the subject will hear it as loudly as though he had a pair of phones on his ears. The reason is that you have made yourself into part of a condenser-type loud speaker.

Your hand, and that of your assistant, act as two plates of a condenser;

the palms of the gloves are the dielectrics which, in this case, serve as diaphragms. And the head of the subject, between these two diaphragms, acts as a third plate, carrying the charge between the two outer ones. The leather diaphragms vibrate because of the audio frequency current in the secondary of the output transformer, and so give forth sound waves, just as does the vibrating diaphragm of a loud speaker.

There is one caution to observe. The radio set of today often has quite a bit of power in its output stage. You and your assistant are therefore advised not to touch each other, and not to touch the subject with anything other than the leather of the gloves. If you are not careful about this, one or all of you will receive a shock which, while not dangerous, will be decidedly unpleasant. For the same reason, you are cautioned against touching any other metal, or any grounded objects, including the radio set, while you are holding the bare end of the wire in your hand.

If no gloves are available, the experiment can be performed with two sheets of good, stiff writing paper, which you and your assistant press against the subject's ears with your bare hands, while you hold the wires from the set in your other hands. You may have to try several kinds of paper before you strike upon the sort which affords the best results; the right paper will work as well as gloves.

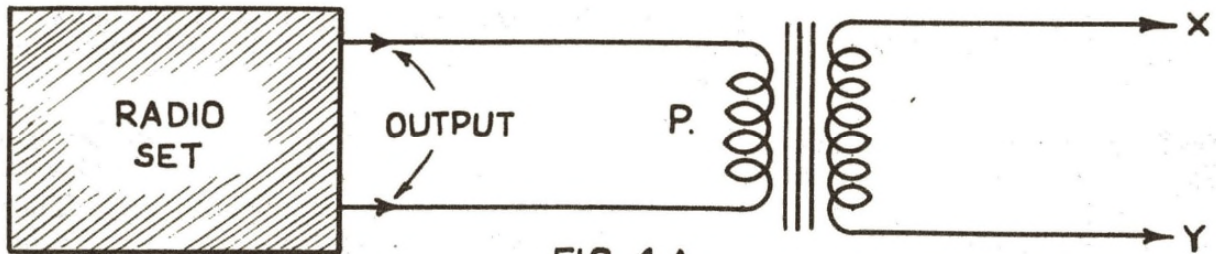

FIG. 4 A

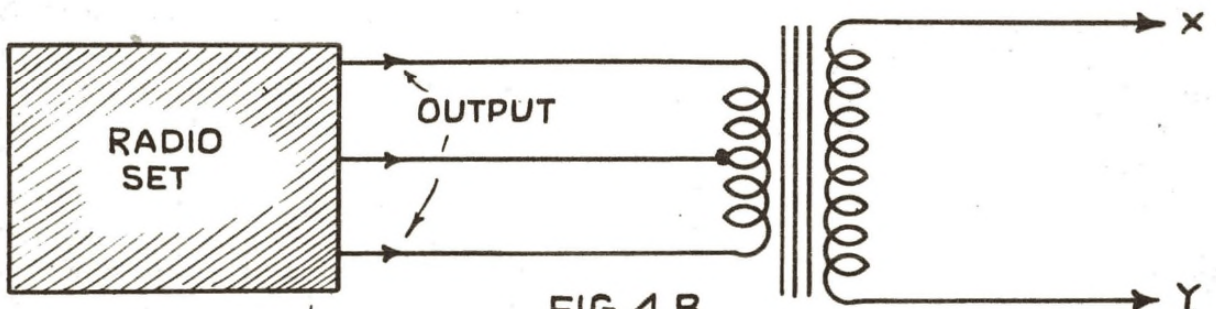

FIG. 4 B

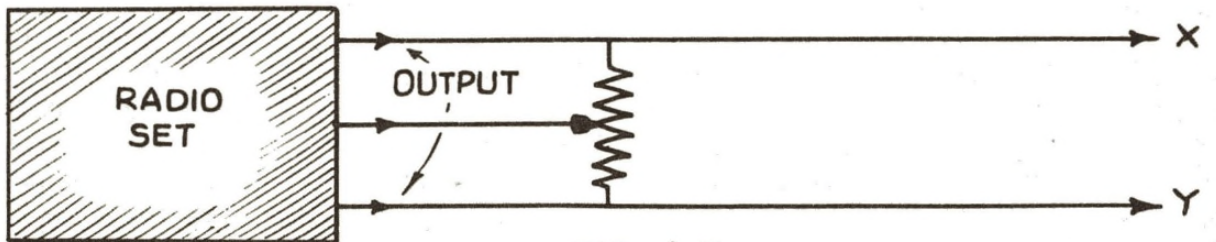
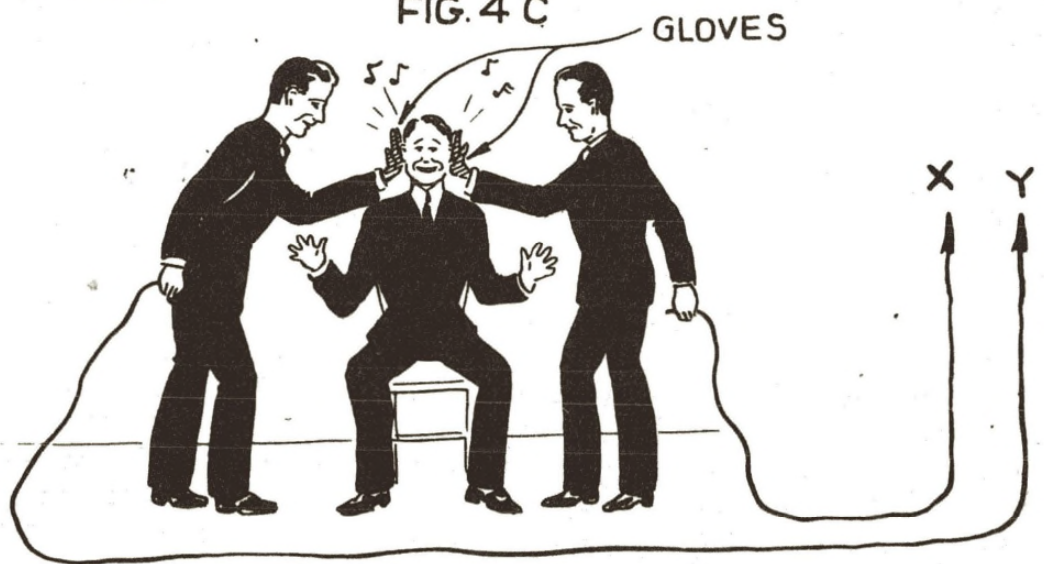

FIG. 4 C

FIG. 5



RADIO "ELECTRIC CHAIR"

IN some New York night clubs, the "hot seat" is a practical joke, which makes even the most dignified patron leap wildly to his feet. A stunt of this sort can be built to work in conjunction with your radio set. It is harmless, and affords plenty of fun to all but its victims. But they get their amusement when they have undergone the ordeal and can see someone else get caught.

The device looks most innocent when built into the cushion of an ordinary chair. No one suspects upholstery, though metal furniture, or furniture with specially installed metal contacts, does arouse marked suspicion in the ordinary home.

As the comparatively low voltages of a radio set's output will not penetrate as many layers of cloth as there are in the average person's clothing, a better means of contact must be made. These are little brushes of fine copper wire, fastened point upward inside the cushion. The way in which the wire is looped and wound, then cut to afford points, is seen in Fig. 6A. The wire should be no thicker than No. 28, and bare wire is preferable.

Make six of these brushes and connect them as Fig. 6B shows, arranging them under the covering of the cushion, as pictured. The arrangement given will assure contact.

Before sewing the brushes fast in place, press the ends of the wire bristles upward through the fabric, twisting them slightly from side to side, to help them through. When the sewing has been finished, and the cushion closed

again, the ends of the bristles must be cut off not more than 1/32 inch above the surface of the cushion. There are three reasons for this: (1) it will make them less noticeable; (2) it will make them stiffer, so that they can penetrate the clothing more easily; (3) it will make them less likely to prick the victim and give the joke away.

The connections may be made in either of two ways. The best is to use an old audio transformer, Fig. 7A, with its primary connected to the output of the set and its secondary to the brushes. This affords more voltage. The other means is merely to connect the brushes across the loud speaker, as shown in Fig. 7B. This second method should be used only with battery-operated sets — NEVER with electric sets, for it might be dangerous.

In order to know how much of a shock to give, try the circuit on yourself. Start with the volume control turned low; the volume control will regulate the degree of shock if the first-mentioned connection is used. If you use the second connection, put a 400-ohm potentiometer across the output, as in Fig. 7B, for use as a regulating device.

Shocks can be given from a set's output in a number of ways, the connections always being made as described above. **It is absolutely essential to use the transformer when playing around with sets operated from house lighting lines.** Without it, the shock would be painful if not dangerous — and fun ceases where pain begins.

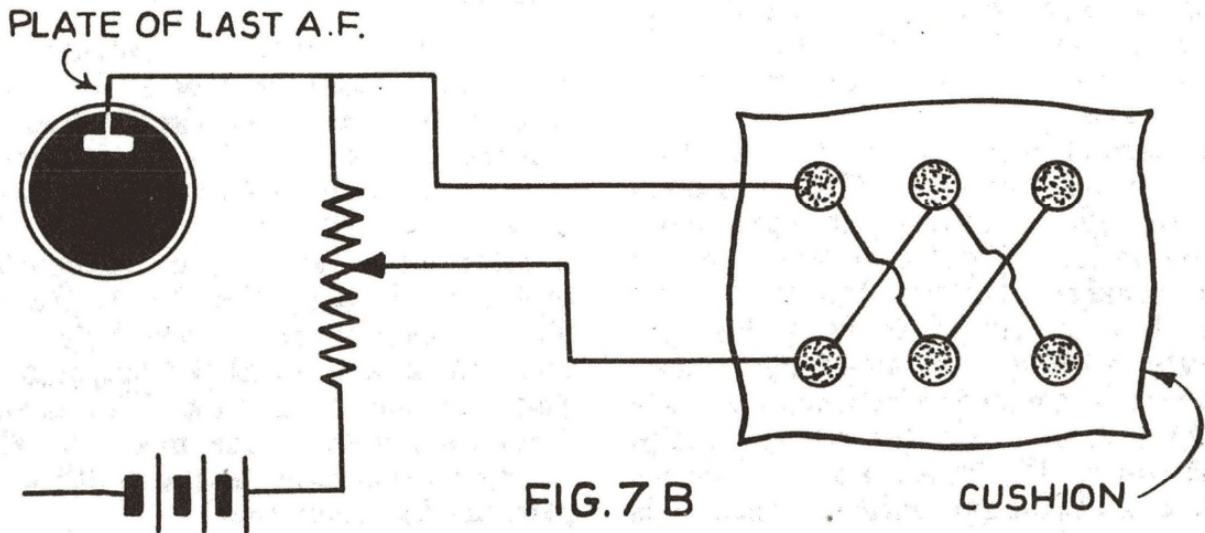
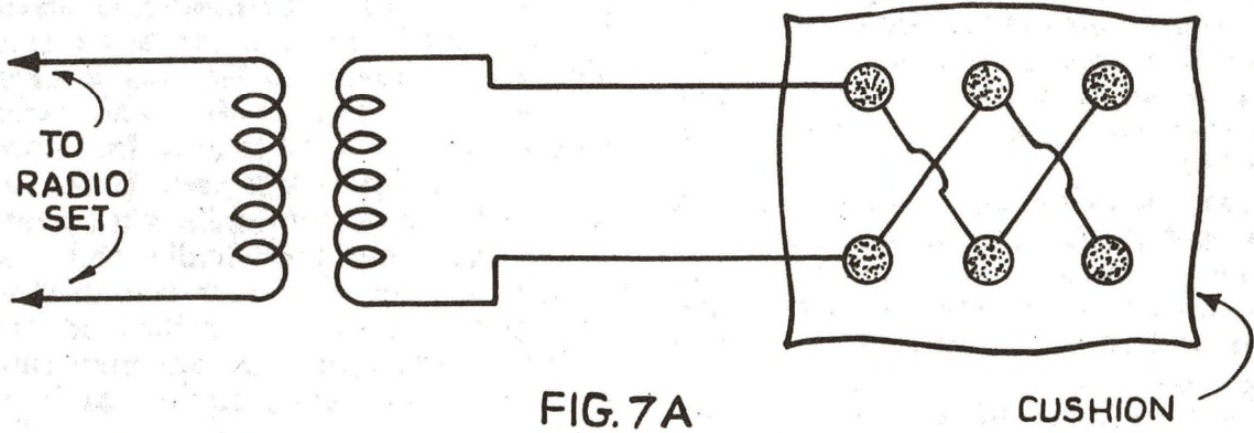
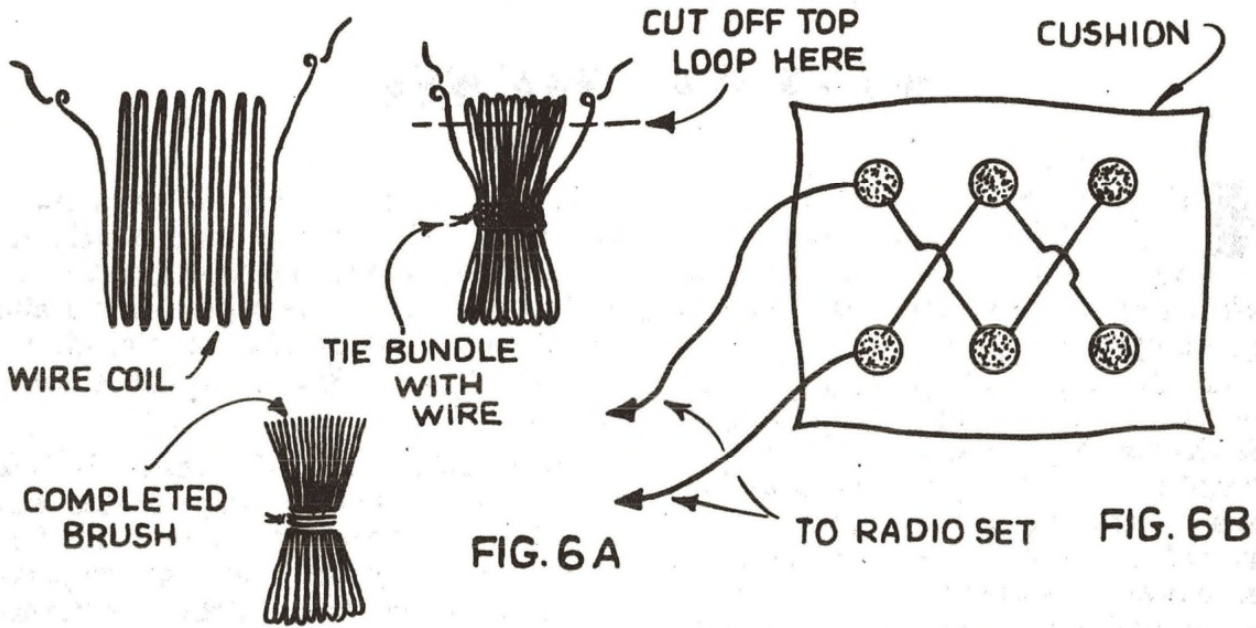

VISUAL MUSIC

HAVE you ever actually seen the music that comes out of your radio set? It isn't hard to do, at all — and without any costly oscilloscope equipment, either.

You can either make it paint patterns in sand, or make a lamp glow with rhythmic pulsations.

Simplest of all is the mechanical means of making a voice pattern. To make the necessary device, all you need is a dynamic speaker — the one in your set will do — and a piece of rubber tissue, obtainable from any drug store. The speaker is mounted with its cone pointing upward, and the tissue stretched tightly across it, as shown in Fig. 8.

About a half-teaspoonful of common table salt is then poured onto the center of the membrane, and the set is tuned-in with moderate volume. Different audio tones will set up vibrations of varying frequencies in the diaphragm, causing the salt to form rapidly changing patterns, as Fig. 9. If the salt fails to move, increase the set's volume; if it tends to fly off the diaphragm, reduce the volume.

Somewhat more elaborate is the neon light "music viewer". This is simply a neon light, connected to the output of the radio set either in place of the loud speaker, or in addition to this unit. If it is desired to have the light operate without accompanying sound, it is merely connected between the plate of the last tube and the power supply, as shown in Fig. 10A. You will notice that a 10,000-ohm variable resistor is

connected in series with the neon tube; this is to reduce the voltage sufficiently to avoid damaging the tube. Start operating with the set at good volume and all of the resistance in the circuit, reducing it until the tube lights satisfactorily.

Somewhat more elaborate is the system used when the loud speaker and the "music viewer" are to be used simultaneously. This calls for the employment of an old audio frequency transformer, with the tube connected across its secondary, the primary being connected in parallel with the loud speaker, as shown in Fig. 10B. The series resistance permits the tube to be turned off while the speaker is used. If the resistance is closed, both units will operate at the same time. Incidentally, this connection will afford better results than the direct connection outlined in the previous paragraph. A 1-watt neon tube will prove satisfactory as well as inexpensive.

To see the music as patterns, you will need a scanning disc and a motor. The motor may be an electric fan, with the blades removed. The disc is punched with a number of holes arranged in a spiral, as shown in Fig. 11. The number of holes used is unimportant, and depends upon the size of the disc. The distance from the first hole to the last hole should equal the height of the plate in the neon tube. The distance from each hole to the next one along the spiral should equal the width of the plate in the neon tube.

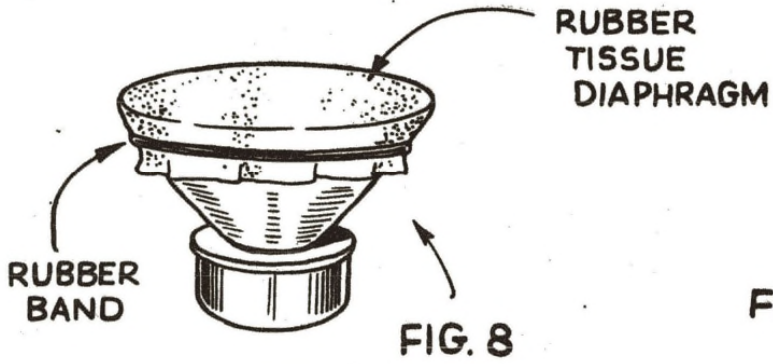

PLATE OF LAST AUDIO

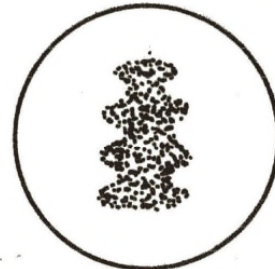
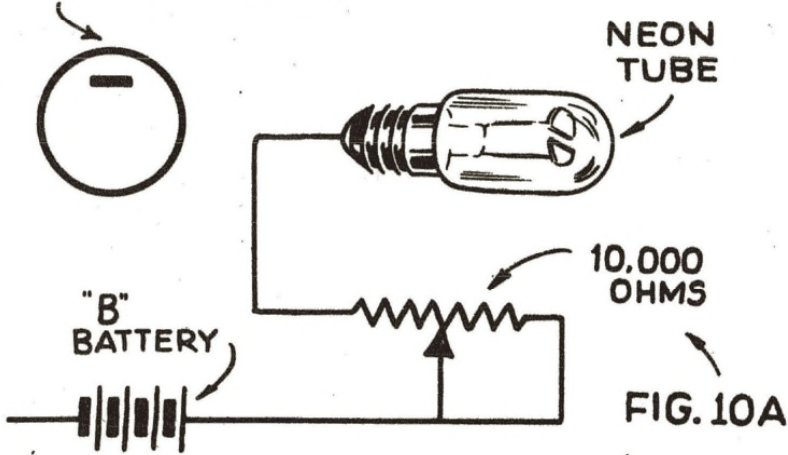

FIG. 9

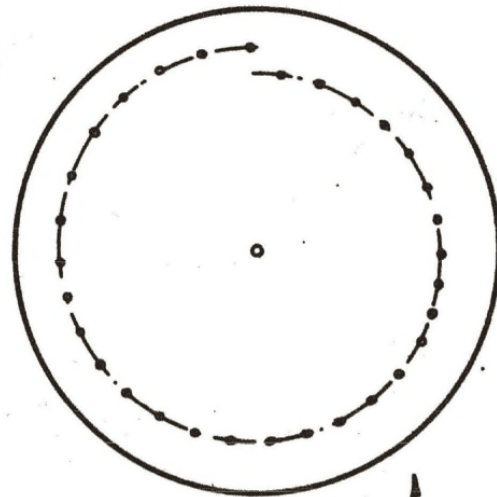
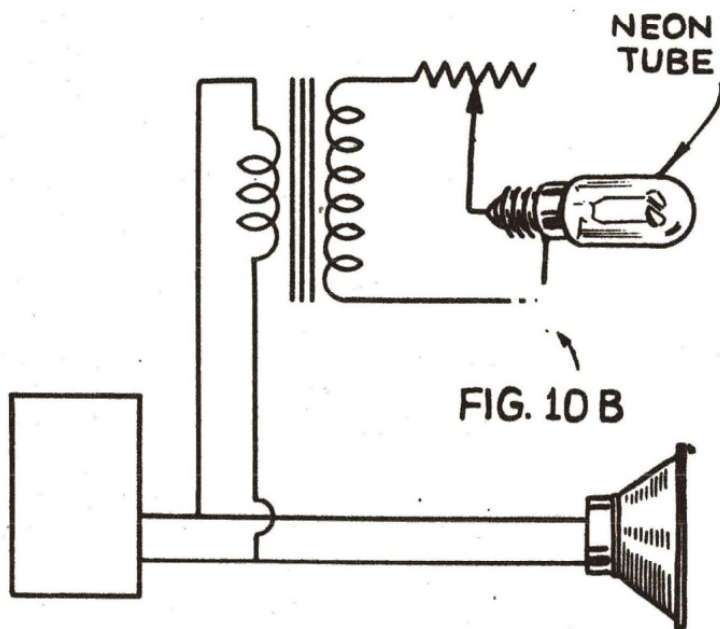
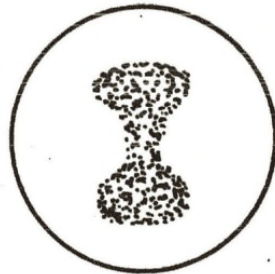

FIG. 11

DANCING TO "SILENT MUSIC"

ONE of the finest novelties that can be offered at a radio party is silent music — heard only by the dancers, but inaudible to anyone who is off the dance floor, or not provided with a pair of head-phones. Nor are their concealed wires run to the phones; they would become entangled. The phones are connected to nothing whatever except to the dancers themselves, who are free to move about the floor.

The loud speaker is removed from the set, and an old head-phone, (with the cap and diaphragm removed, to silence it) is connected in its place. If no phone is available, the primary or secondary of an old audio transformer may be used instead, as may an audio frequency choke, or even a 25,000-ohm resistor. **Fig. 12** shows the connection.

The prime requisite of this outfit is a network of tinfoil strips, or other conductive medium, concealed under the rug. This may be made of strips of any metal foil about three or four inches wide, laid as shown in **Fig. 13**. Notice that the spaces between the strips must not be greater than the width of the strips themselves.

Should you find it difficult or costly to secure the necessary foil, window screening, preferably of bronze or copper, may be used. Even one-inch mesh chicken wire will do, though it is not so good, and larger mesh gives even poorer results.

One end of an insulated wire is connected to the metal, the wire's insulation being carefully removed where the con-

nection is made. The other end of this wire is connected to one side of the set's output, as shown in **Fig. 12**. You will have to test it out with the connection first on one side of the output and then on the other, to determine which affords the best results.

In order that the music be heard, each of the dancers must wear a radio head-set. One end of the phone cord is taped back; the other end is slipped under the wearer's ring or bracelet, so that it makes good contact with his or her body. **Fig. 14** shows this detail. No other connection to the phone is necessary, nor need the dancers carry any additional apparatus.

With an assistant wearing the phones in this way, and standing on the rug, try both connections for the network, as previously suggested. Also try a ground lead on the other side of the output, but be very sure to have a .1 mfd. condenser, rated at least 600 working volts. in series with the ground, to avoid blowing out the set.

All wires should be insulated and well concealed, to make the operation more mysterious.

You will notice several things when dancing to "silent music" First, the sound will be practically inaudible when you step away from the metallic network concealed under the rug, but when you approach within three or four feet of it, the music will become louder and louder, reaching its maximum when you are standing upon the rug.

A switching system may be installed.

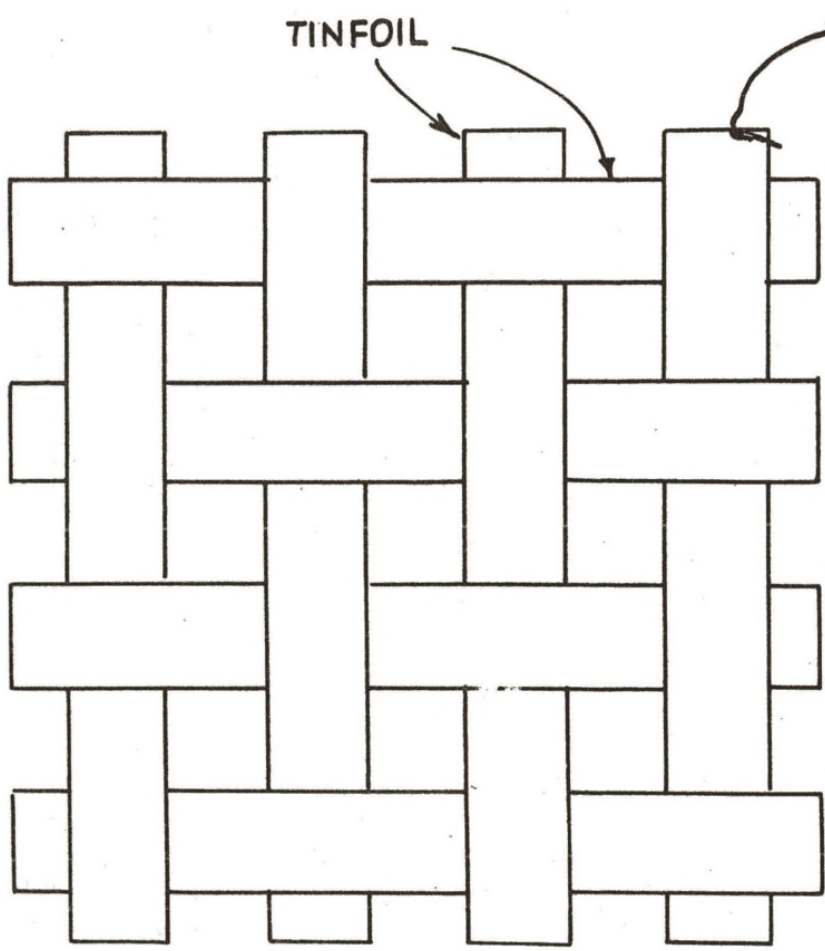
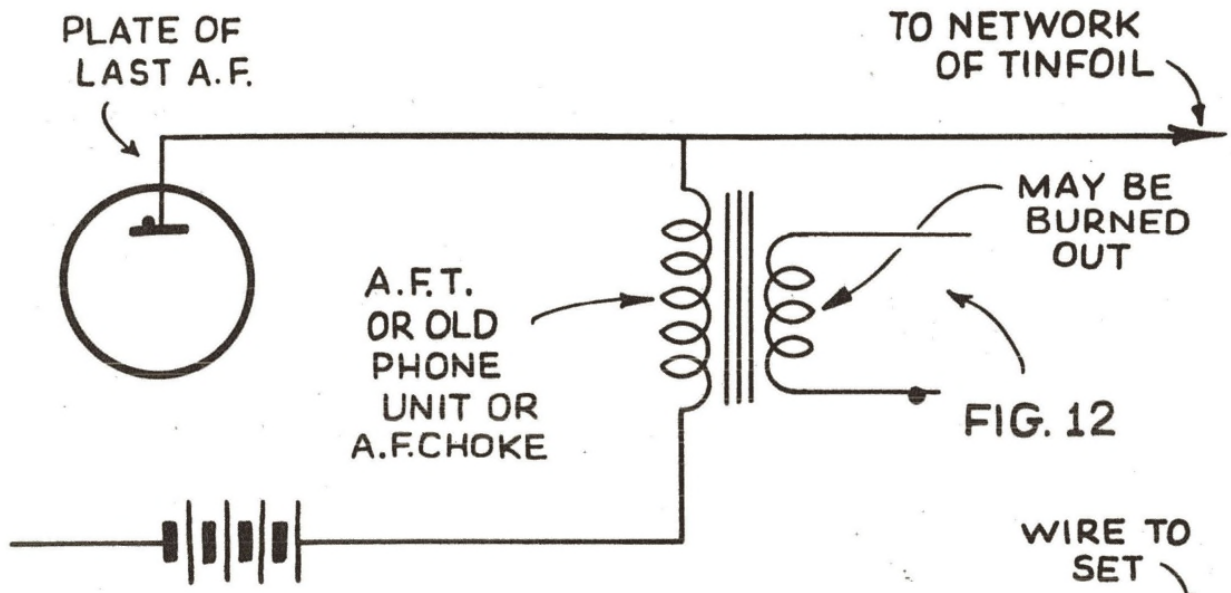

MUSICAL AND TALKING GADGETS

IF course you can make an object with a large vibratable surface talk, as is told when describing the Talking Door, Stunt No. 11.

But you can also make a number of other objects talk, too — and without the use of any speaker unit, either. The principle involved is that of the condenser-speaker, just the same principle as was used to make the talking gloves (Stunt No. 2) and one of the talking newspapers (Stunt No. 1). There is also another principle which may be employed — but more about that subsequently.

You can make a pie-tin talk and sing quite well, when it is simply lying upon the kitchen table or other large, flat metal surface, supported by bits of paper. A transformer is also required, connected as shown in Fig. 15, where you will see that its primary is connected across the set's output, while its secondary is connected to the pie-tin and to the table top. The wire leading to the table may be easily concealed by running it up one of the table legs. Most kitchen tables are enameled, and if that is the case with yours, the enamel will serve as the dielectric of the condenser. If the metal surface is bare, however, you will have to supply insulation, which needs only be a sheet of thin, dry paper, somewhat larger than the pie-pan, laid between it and the surface upon which it rests.

When you were operating the talking gloves, your hands were the plates of the condenser-type speaker; they did not vibrate. The sound came from the

dielectric — the gloves — which vibrated as the electrical tension to which they were subjected. In the case of the pie-tin on the enameled metal-top table, the table top and enamel, being heavy, could not vibrate, but as charges were produced across the two plates of the condenser, the lighter plate (the pie-tin) vibrated. The bits of paper under its edge (Fig. 15) are to permit it to vibrate without rattling against the table top; if it still rattles, use thicker paper. Also make sure that the connection to the pie-tin is tightly soldered as looseness will cause intermittent operation and rattling.

Should you care to carry the experiment further, you can use two pie-tins with paper between them, as in Fig. 16A, or even a whole stack of such tins, separated by paper. Fig. 16B shows how this may be done.

For a novelty, singing chokes and transformers are often amusing, and they are very easily made from discarded parts. If you have an old audio transformer, with either one or two good windings left on it, it can be used very nicely.

Simply loosen the screws or clamps which hold the laminations of the core together, and remove one of the wedges which may be used to hold the windings tightly to the core, as indicated in Fig. 17. Then connect the good winding of the transformer in place of the speaker, as in Fig. 18, and tune-in a station. An audio frequency choke coil, if similarly treated, will work in the same way.

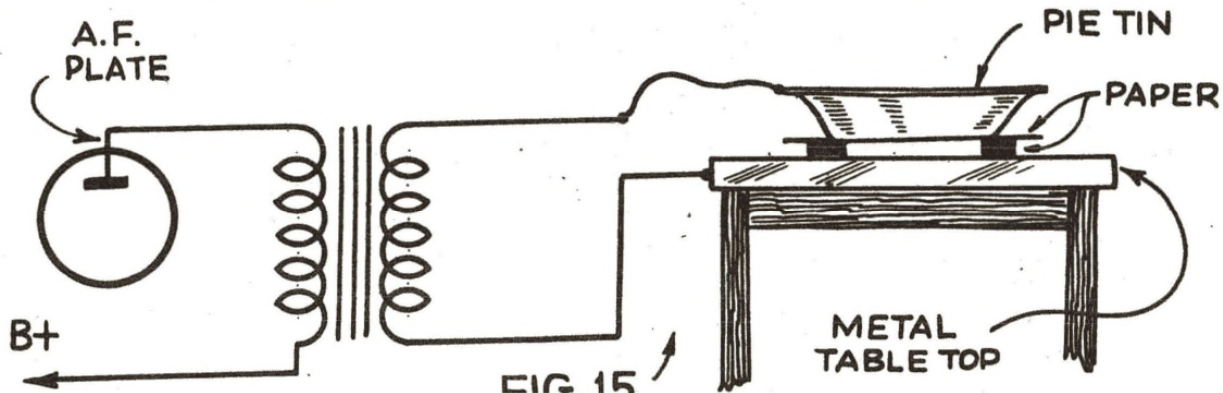

FIG. 15

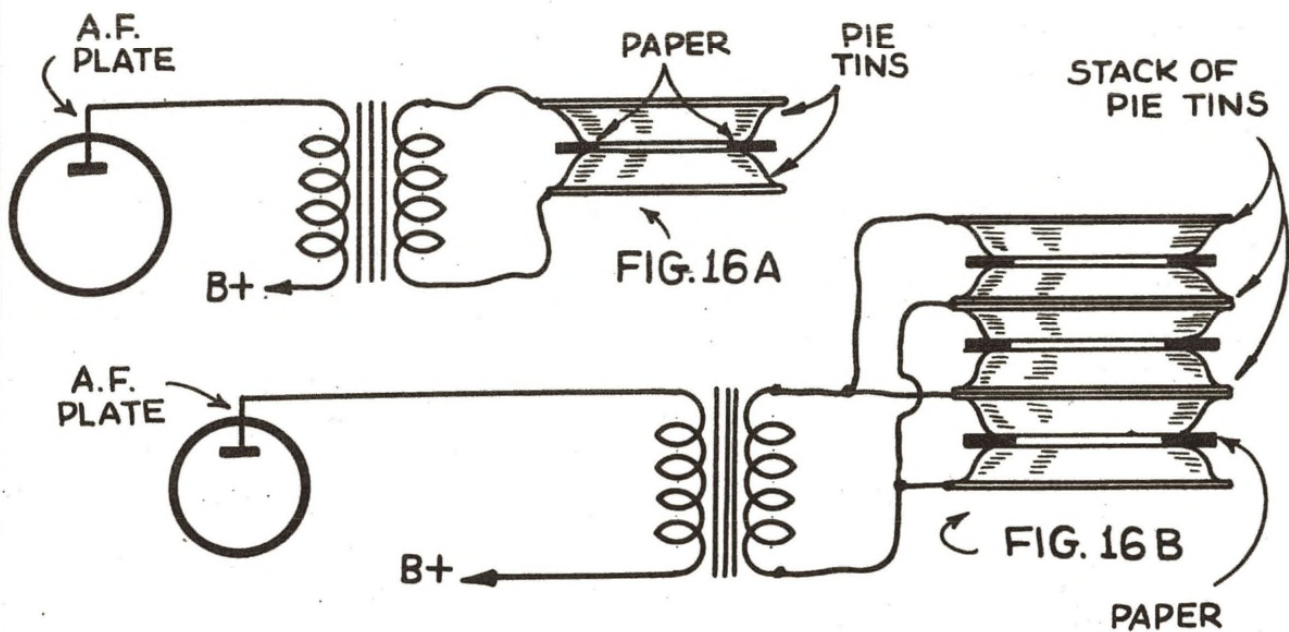

FIG. 16A

FIG. 16B

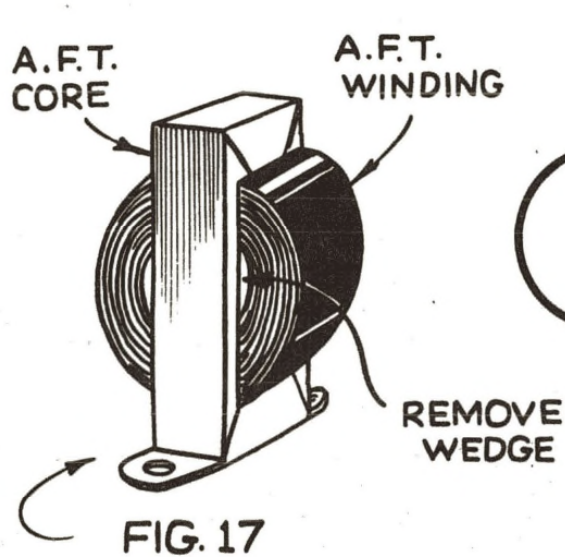

FIG. 17

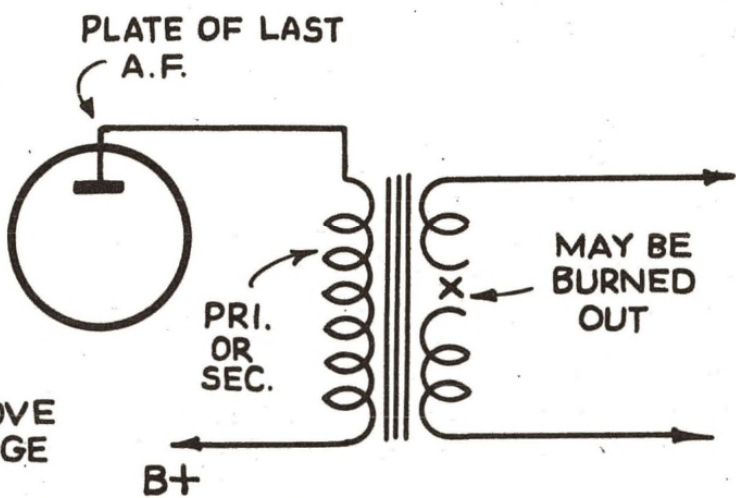

FIG. 18

THE RADIO DANCER

A DOLL that dances in time to the music of your radio set is a novelty that takes but a few hours to construct, yet affords endless hours of amusement.

It can be made from an old head-
phone, but gives better action if an old armature-type loud speaker unit is employed instead. This is the sort of unit which employs an armature between the pole-pieces of a magnet. Attached to the armature is a light rod, which drives the speaker diaphragm directly.

This unit is to be removed from the speaker and mounted on the inside of a strong cardboard or light wooden box, in such a way that the end of the drive rod projects about $1/32$ of an inch through the bottom. The hole for this rod should be at the exact center of the bottom of the box, and should be about an inch in diameter, to give the rod perfectly free play.

With your soldering iron, you next put a bit of solder on the end of the rod. You then secure a brand new 8-inch tin pie-plate, choosing one which has an absolutely flat bottom, and which is as smooth as glass on the inside. Place a drop of solder on the exact center of the bottom, taking care not to apply enough heat to warp the pan. Center the pan on the drive rod, as shown in Fig. 19, supporting it around the edge with bits of cardboard, so that it is spaced evenly from the box all around, and apply your iron to the center, to melt the solder, thus soldering the pan to the drive rod. If you put a thin scrap of aluminum over the place where you hold the iron, it

will prevent marring the inside of the pan. The aluminum will not take ordinary solder, and so may be removed as soon as the solder under the pan has set.

Next make a ring of cardboard, the outside diameter great enough to fit neatly on the top of the pan. The width of the ring should be about $1\frac{1}{2}$ inches. It is then glued or cemented on top of the pan.

Its purpose is to keep the little dancers from getting too close to the edge of the pan, where they would be less active.

You must finally buy or make the little celluloid dancers; about 2 inches tall, as that is the largest size that will be satisfactory.

Cement two of them together, as shown in Fig. 20, remembering that they must be at least an inch apart in order to have stability. You must also add feet, as the drawing indicates. These feet must be small, to reduce friction. Pieces of quill tooth-pick, cemented to the celluloid with nail polish, give very good results, and the wider apart you space them, the less likely the dancers are to fall.

If you do not wish to buy your dancers, you can make a solo performer easily out of a small cork. It must have three feet, arranged like a tripod and may be dressed or decorated in any way that strikes your fancy. But it must not weigh more than about $\frac{1}{2}$ ounce.

Connect the speaker unit to the output of your radio set and make sure the pan is absolutely level. The dancers will then move about.

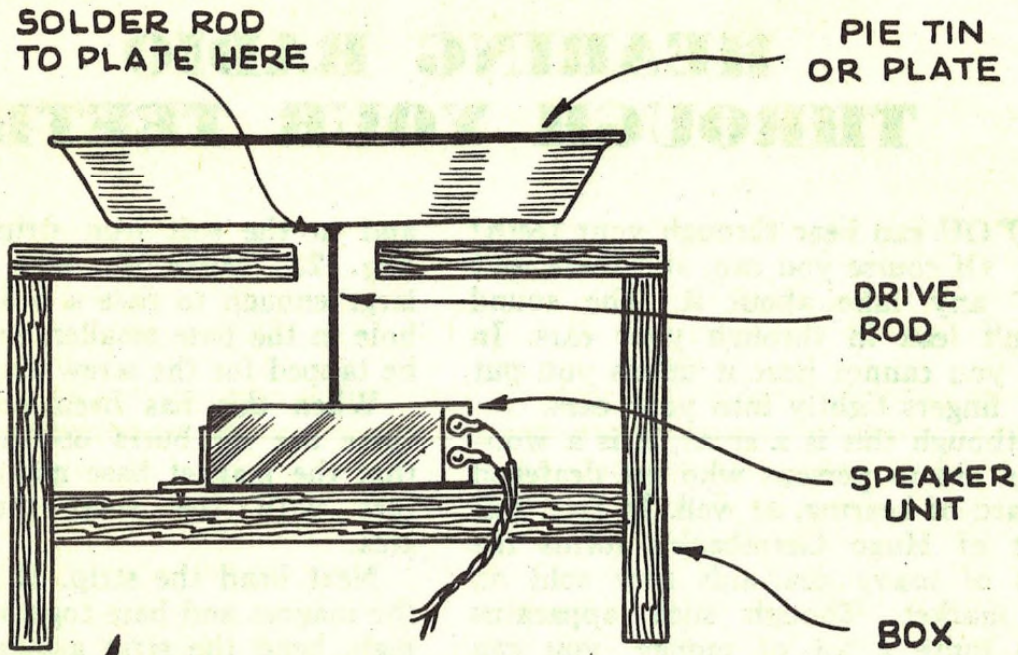

FIG. 19

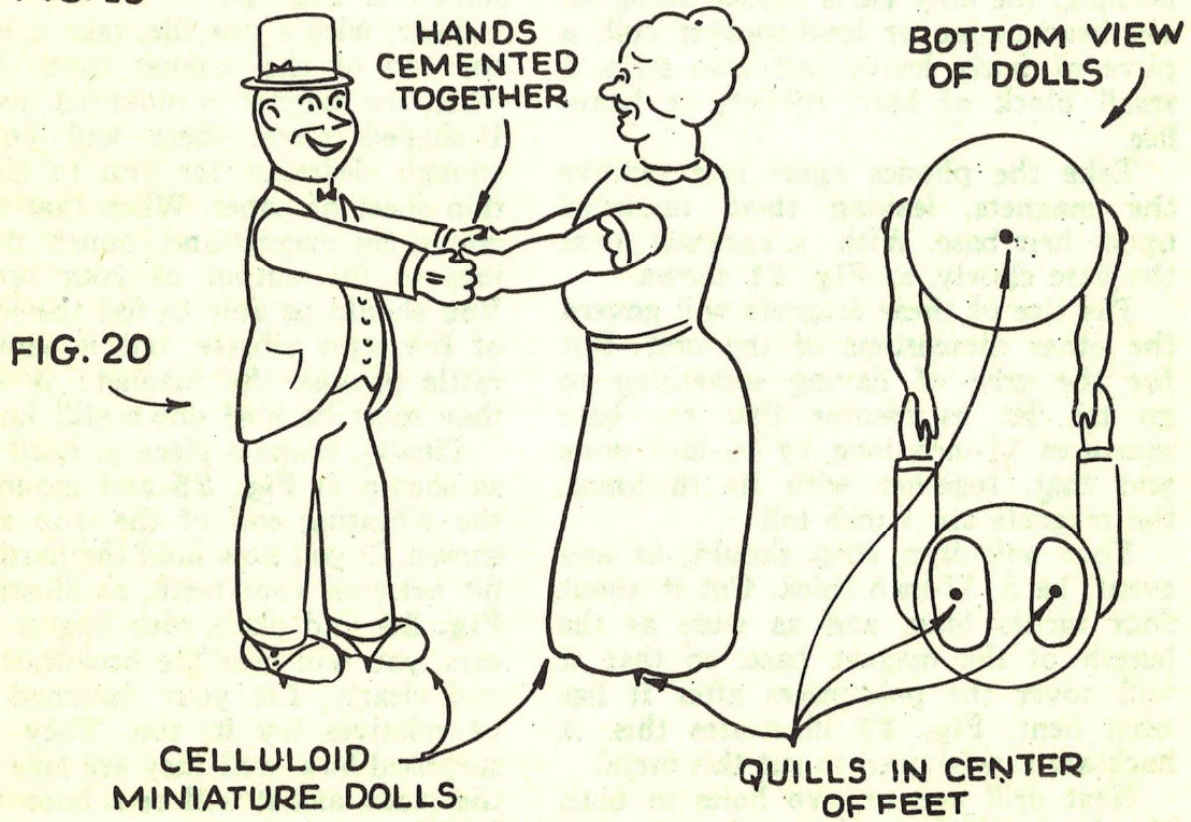

FIG. 20

HEARING RADIO THROUGH YOUR TEETH

YOU can hear through your teeth! Of course you can, and there isn't any fake about it. The sound doesn't leak in through your ears. In fact, you cannot hear it unless you put your fingers tightly into your ears.

Although this is a stunt, it is a wonderful aid to persons who are deafened or hard-of-hearing, as well. In fact, this stunt of Hugo Gernsback's forms the basis of many deaf-aids now sold on the market. Though such apparatus costs quite a lot of money, you can build the unit yourself for next to nothing, the only parts needed being an old head-phone or loud-speaker coil, a piece of fairly heavy soft iron strip, a small block of hard rubber, or bakelite.

Take the phones apart and remove the magnets, leaving them mounted upon their base. With a hacksaw, trim the base closely, as Fig. 21 shows.

The size of these magnets will govern the other dimensions of the unit. But for the sake of having something to go by, let us assume that the base measures $\frac{3}{4}$ -inch long by $\frac{1}{2}$ -inch wide and that, together with its thickness, the magnets are 1-inch tall.

Your soft iron strip should, in any event, be $\frac{3}{32}$ -inch thick. Cut it about four inches long, and as wide as the length of the magnet base, so that it will cover the pole-pieces after it has been bent. Fig. 22 illustrates this. A hacksaw can be used to cut this metal.

Next drill one or two holes in both the base which supports the magnets

and in the soft iron strip, as seen in Fig. 23. Make the hole in the strip large enough to pass a 6-32 screw; the hole in the base smaller, so that it may be tapped for the screw threads.

When this has been done, see that there are no burrs on the holes, and that the magnet base makes good contact with the strip throughout its area.

Next bend the strip. If, as was said, the magnet and base together are 1-inch high, bend the strip around a piece of one inch pipe, holding it in a vise, as shown in Fig. 24.

Now, with a fine file, take a little off the top of the magnet cores, so that when the magnet is mounted inside the U-shaped piece, there will be about enough clearance for you to slip in a thin sheet of paper. When that is done, mount the magnet and connect its windings to the output of your radio set. You should be able to feel the long end of the strip vibrate, but it should not rattle against the magnet; if it does, they must be filed down still farther.

Finally, shape a piece of hard rubber, as shown in Fig. 25 and mount it on the vibrating end of the iron strip, as shown. If you now hold the hard rubber bit between your teeth, as illustrated in Fig. 26, and place your fingers in your ears, you will hear the broadcast loudly and clearly. Let your deafened friends or relatives try it, too. They will be surprised how well they are able to hear the radio, and it will be a boon to their families.

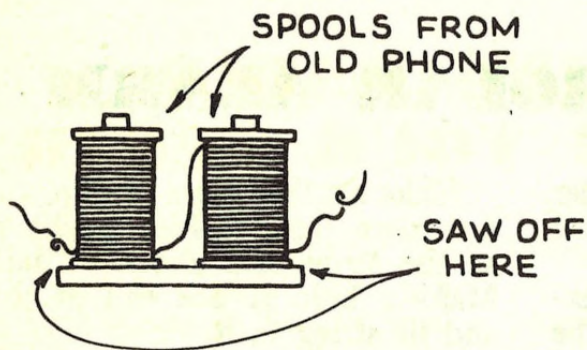

FIG. 21

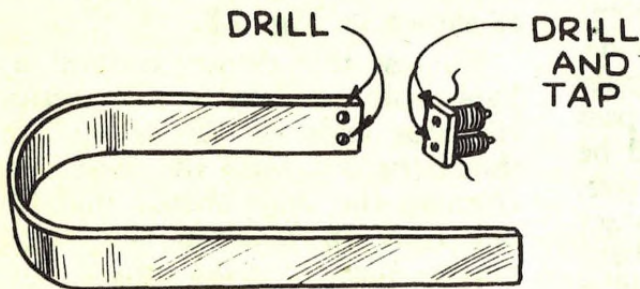
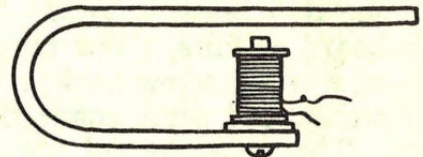
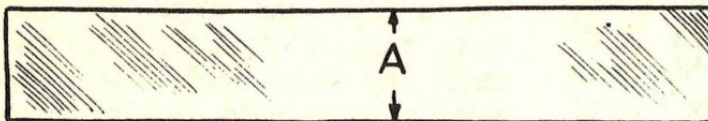
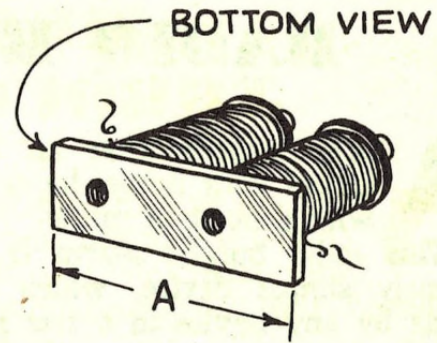

FIG. 23



FIG. 25

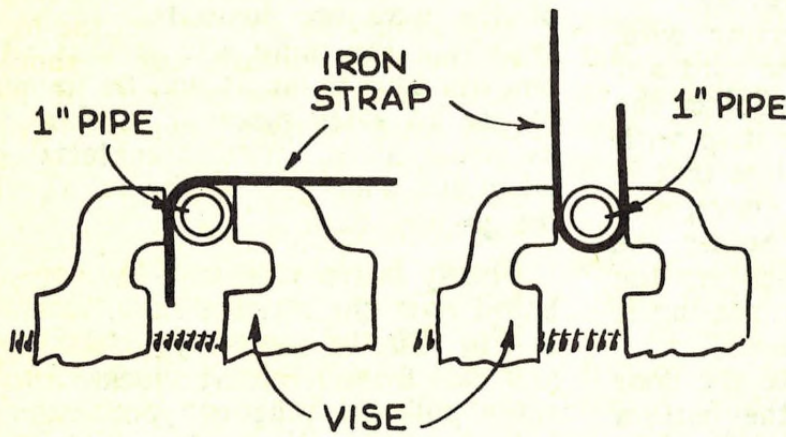
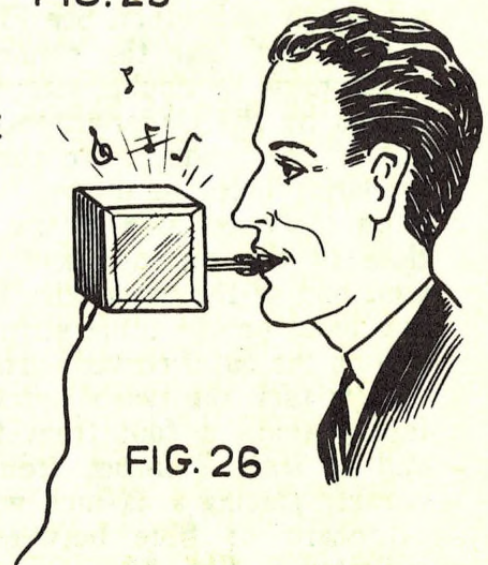

FIG. 24



RADIO BURGLAR ALARM

A FEW seconds after an intruder enters your home, he is greeted with a burst of music.

This radio burglar alarm is an extremely simple device, which can be made by any novice in a few minutes' time and with scrap materials found in the workshop. All the materials you need are a few inches of any spring metal — brass is good — a little cardboard or fibre, a few tacks, a thin piece of wood, a screw hook, a foot or two of string, and some connecting wire.

The strips are cut about an inch and a half long, and of any convenient width, from $\frac{1}{2}$ inch to 1 inch wide. Each has two holes that in the upper piece need only be big enough to pass the tacks; those in the other should be enlarged to about three times that size, so that the tacks will not make contact with them. The two strips are then bent slightly, so that when they are held a little apart at one end, the other ends will touch each other. See Fig. 27.

You next take the connecting wire, which must be double electric cord approved by the Underwriters. Solder the end of one conductor to the strip with the larger holes, as shown. Note that it is on the outer side of the curve, and close to the punched end. Solder the same end of the other wire between the two holes on the other strip, putting it also on the outer curved surface.

Now tack the two strips to the door frame, about a foot from the bottom and at least 2 inches from the door opening placing a $\frac{3}{4}$ -inch wide strip of cardboard or fibre between them as indicated in Fig. 27.

Make another piece of fibre (or wood, not more than $\frac{1}{8}$ -inch thick) as wide as the strips and about an inch long. Make a hole at one end of this piece and tie string to it.

Put the screw hook in the door frame about 2 inches below the strips. Put the little piece of wood or fibre between the ends of the strips, to keep them from making contact, loop the string under the screw-hook, which should be pointing downward, and bring the string over to the door, which is closed, tacking it an inch or two from the edge, as shown in Fig. 28.

To test this device, connect a flashlight bulb and battery in series with the free ends of the wire. The light should be out, until the door is opened. Opening the door should pull the plug out from in between the strips, permitting them to make contact and causing the bulb to light. When the apparatus tests successfully, the two free ends of the wire are connected across the switch in the radio set, so that either one can turn it on. It will be necessary to use an extra piece of cardboard to keep the alarm switch's contacts open when you want to turn the set off while the guarded door is open.

Finally fasten a piece of fibre or cardboard over the alarm switch, as shown in Fig. 29, to protect yourself, family and pets from receiving shocks. And always pull the plug of your radio set before setting the alarm switch, or touching it in any way. **NEVER TOUCH IT WHILE THE SET IS PLUGGED IN!**

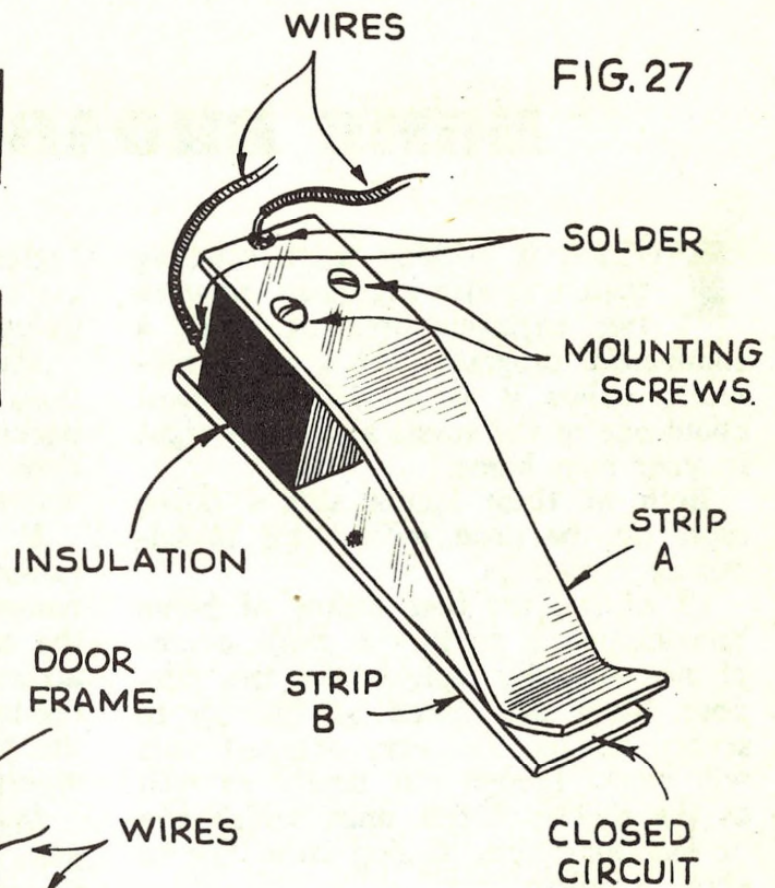
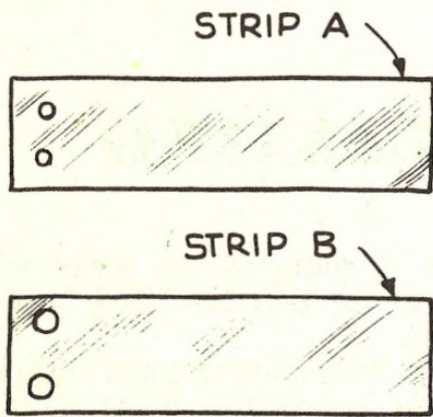

FIG. 27

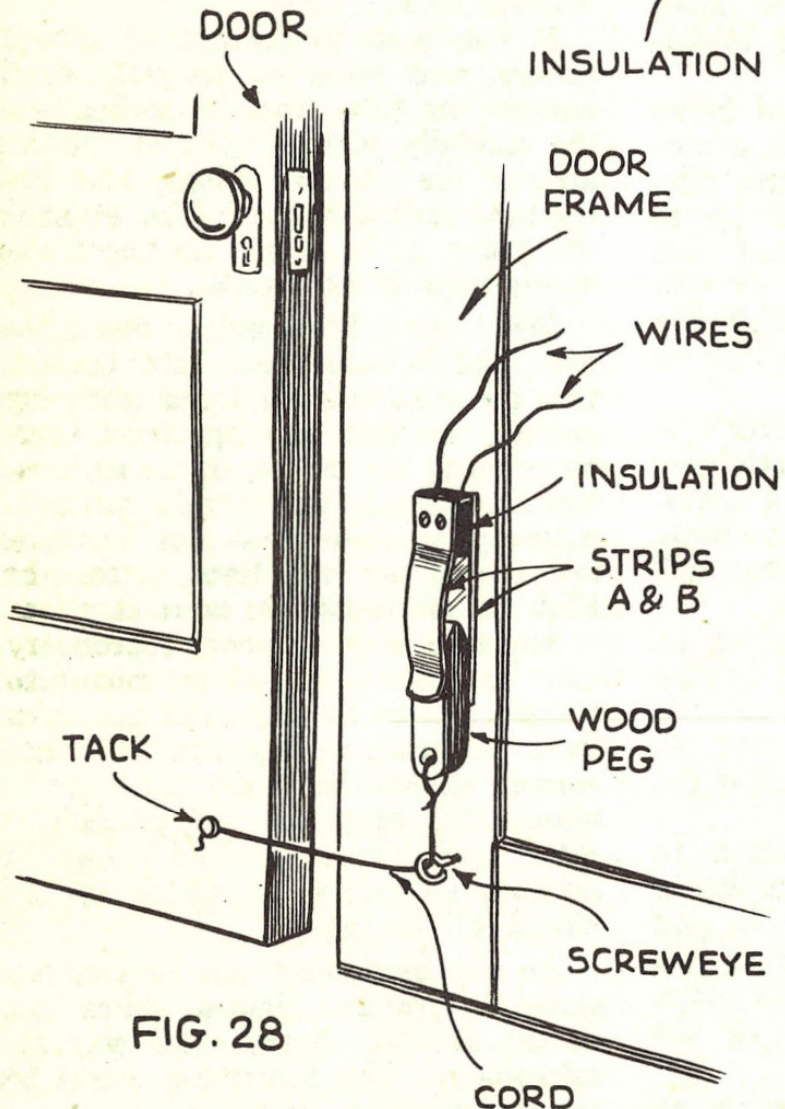

FIG. 28

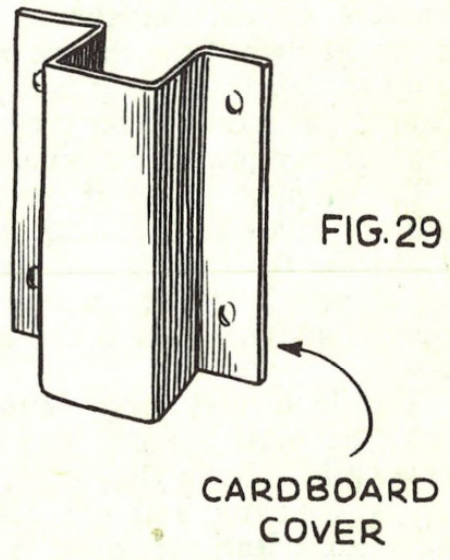

FIG. 29

HOME BROADCASTING

THERE is nothing more startling than a sudden argument between two engineers breaking in on a commercial program over a major network, unless it is a radio comment about one of the guests at a party right in your own home.

Both of these stunts and a dozen more can be done with home broadcasting apparatus.

Of course, the best means of home broadcasting is to buy a small microphone, especially designed for this purpose. They are priced at 10c up to several dollars. The very cheapest ones will work, though not nearly as well as the slightly better ones, which can be had for prices ranging from 50c to about a dollar.

If no expenditure, however small, is desirable, an old headphone, preferably of the Baldwin type though not necessarily so, can be used. It will give more volume, but much poorer tone, than will a moderately priced microphone.

The simplest means of connecting an ordinary home broadcasting microphone is between the control grid and cathode (or filament) of the detector tube. In superheterodynes, this is the second detector.

This is a very easy connection to make, as most modern sets employ a screen grid tube in that stage. The grid cap is removed, and one side of the microphone lead connected in its place, the other being run directly to the chassis.

Sometimes, however, the set is so designed that the microphone works

better if connected in series with the plate of the detector. This, however, is unusual.

Most microphones come with instructions for connecting. Many of them are packed with small adapters, to permit their connection to the prongs of the detector tube.

If you wish to connect to a tube's prongs, and have no adapter, simply remove the tube from its socket, wind the carefully scraped ends of the wire around the correct prongs, and press the tube back into place. Fig. 30 shows the prong positions for the most commonly used detector tubes.

Many home broadcasting mikes have little pushbuttons built into them, so that the mike may be permanently connected, and put into operation simply by pressing the button. If no such button is present, any toggle switch or momentary contact switch connected into one of the mike leads, as shown in Fig. 31, will serve the same purpose.

Much better microphone reproduction can be had if a special microphone transformer and a single-cell battery are used, as shown in Fig. 32. This transformer should have an impedance of about 200 ohms in the primary, to match the microphone and a high impedance secondary, to match the grid circuit of the tube.

An old headphone can be connected across the grid and filament (or cathode) of the detector in the same way as a microphone. This sometimes works better if connected across the primary of the first audio transformer.

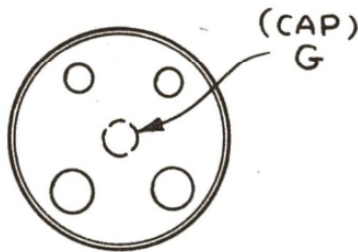
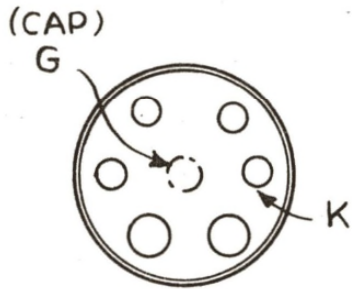
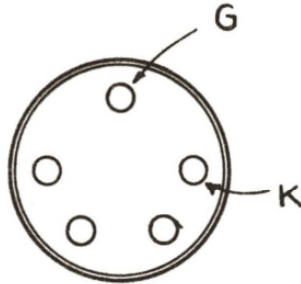
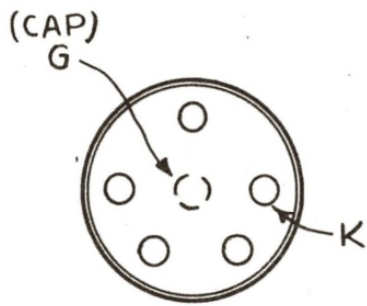

BOTTOM VIEW OF SOCKETS

FIG. 30

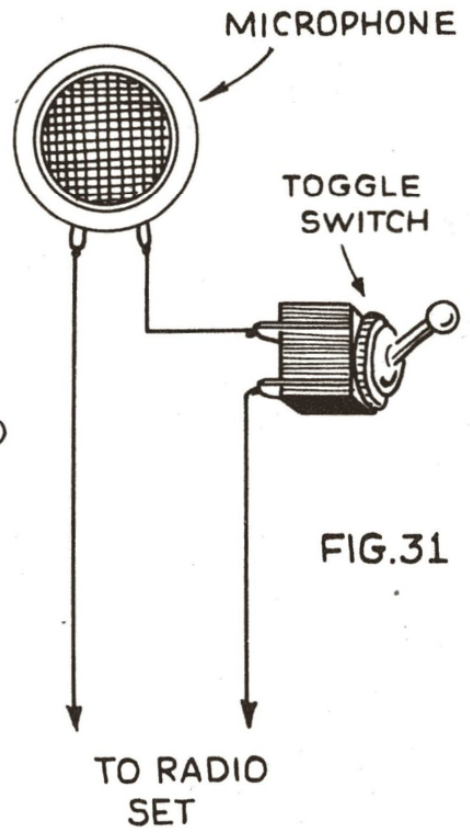

FIG. 31

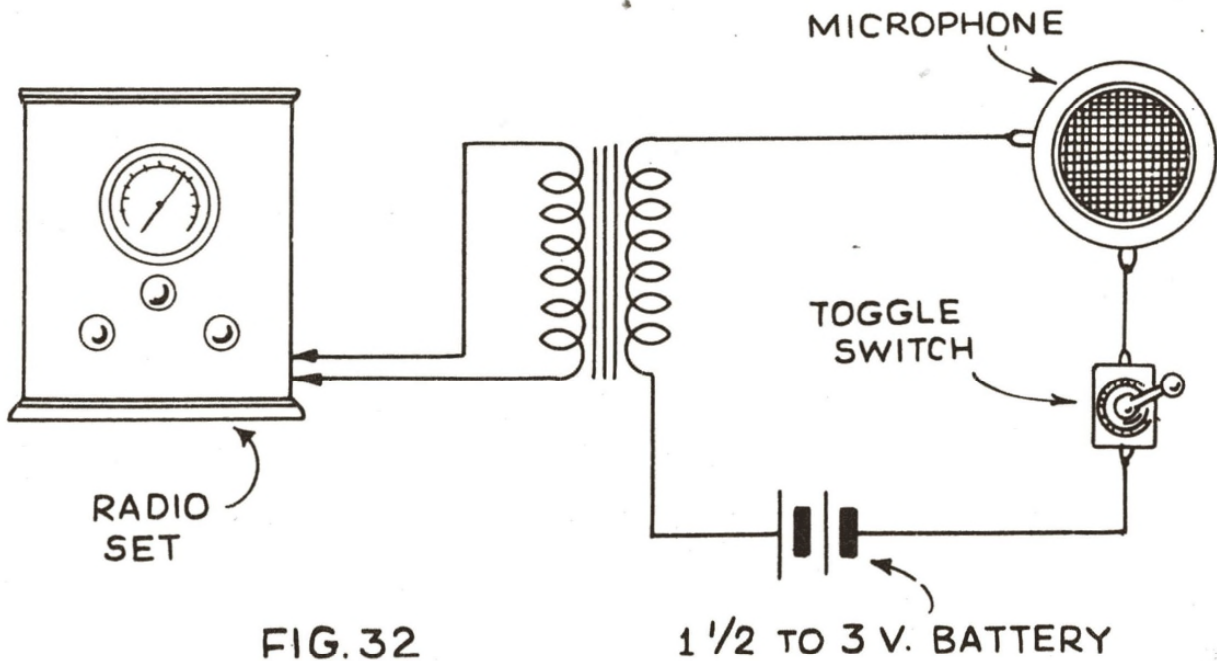

FIG. 32

1 1/2 TO 3 V. BATTERY

THE DOOR THAT TALKED

SUPPOSE you were alone in a room — no radio set and no people with you — and all of a sudden, the door began talking to you. That's one of the effects you can make with an old speaker unit, of the type described in Stunt Number 7.

It can be rigged up in such a way that the sound comes only when the door is shut, or only when it is open, or regardless of whether it is open or closed. All three methods will be described here.

In order to work best, the door must have a fairly thin panel — the thinner it is, the better the result will be.

A brass screw is driven into the middle of the panel at about eye level on the inner side of a closet door. The speaker unit is mounted on a board and located so that the end of its drive rod comes even with the screw, and the board is fastened to the frame (not the panel) of the door, after the rod has been cut off so that it just fails to touch the head of the screw by about the thickness of a piece of paper. It is then soldered fast.

Two very thin insulated wires, such as No. 24 enameled, are connected to the binding posts of the speaker unit, and these are concealed on the underside of its mounting strip until they reach the point where the panel is set into the door frame. Fig. 35 shows the whole set-up.

The wires are concealed in this crack and are brought up to the top of the door.

If it is desired to have the music stop when anyone opens the door to see where the sound is coming from, these wires are terminated at a pair of screws high on the hinge side of the door frame, as in Fig. 35. These two screws make contact with another pair of screw heads driven directly opposite them in the door jamb. Best contact will be had if strips of spring brass are placed under the screw heads and bent over as in Fig. 34. The two screws in the door jamb are connected to the output of the radio set.

To make this work so that the music continues irrespective of whether the door is open or shut, the fine wires from the unit are merely left with sufficient slack so that the door can be opened without putting strain on them. The connection is thus maintained unbroken no matter whether the door is open or shut. See Fig. 35.

To make the door cut off the sound when it is closed, simply tack one piece of spring brass to the door jamb and the other to the edge of the door frame, so they will short the speaker, when the door is closed. Connect one of the leads to one of the brass springs, the other lead to the other spring.

The finishing touch on the job, whichever one you do, is a small medicine cabinet, with its back cut away. This can be one of the sort with a mirror front, as sold at the 10c store. It is attached to the same board that mounts the speaker units which it conceals from view. It is nailed shut.

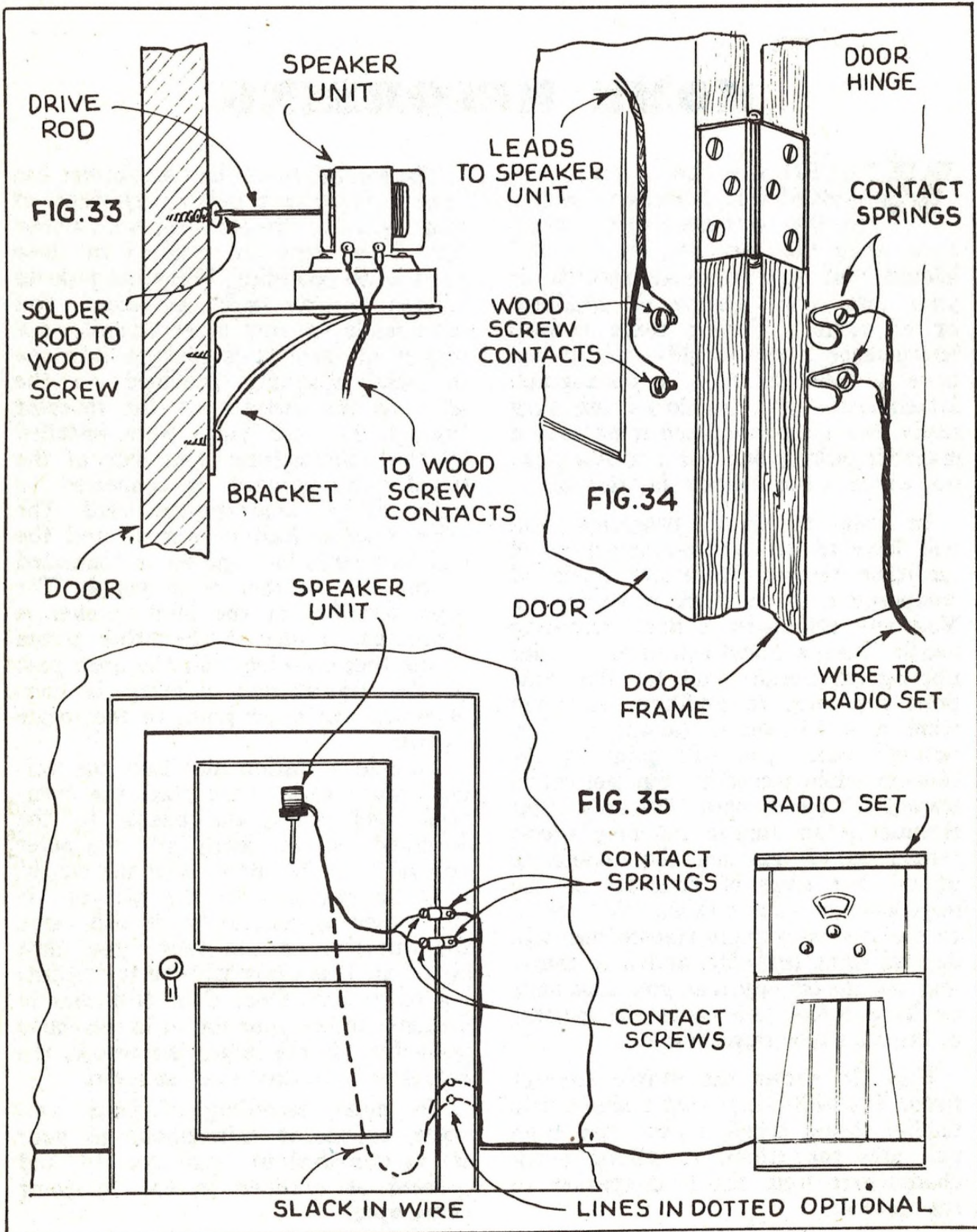

HOME RECORDING

WOULD you like to make records of your favorite programs, so that you can listen to them even when they are not on the air? Would you like to make records of your own voice singing or speaking, or of yourself playing some musical instrument? If you would—and if you have a radio set with a phonograph attachment—you can do all this very easily. But the phonograph must have a magnetic pick-up and not a crystal pick-up, which is too delicate for the job.

In order to record programs, you will have to use a pre-grooved home recording record. These are made of composition, or celluloid or aluminum. You will also need a home-recording needle. These are sold just as are regular phonograph needles and for the same price per card. In addition, you will want a small weight (about 4 to 6 ounces) which you will hang on the pick-up while recording, but not while playing the record back. The only other essential is an output matching transformer, which matches the impedance of the last stage of your set to the impedance of your pick-up. Very often an old low-ratio audio transformer will do this work perfectly, and it is therefore well to try any that you may have on hand before you go to the expense of buying a new transformer.

Fig. 36 shows the simple connections. You will notice that a single-pole double throw toggle switch has been put into the circuit to afford quick change-over from the loud speaker to the recorder.

The secondary of the transformer has been brought to a pair of tip-jacks, as most pick-ups are provided with phone tips. These tips are inserted in these jacks when recording. When the pick-up is used to play back the records you have made (or any other records, as a matter of fact) it is plugged into the tip-jacks originally provided on the set—to the adapter on the detector tube, if no such jacks were installed by the manufacturer. One side of the transformer primary is connected to either of the loud speaker leads. The other speaker lead is opened, and the end that leads into the set is connected to the arm of the toggle switch. The open terminal of the loud speaker is connected to one of the other points of the toggle switch, and the open post of the transformer primary is connected to the other point of the toggle switch.

Tune-in a station and turn the volume fairly high. Then start the turntable and lower the needle in the weighted pick-up gently into the outer groove. Fig. 37 shows how the weight may be attached to the pick-up. If the weight is too heavy, it will cause the turntable to run slow; you must lighten it. It is inadvisable to try recording on records more than 10-inches in diameter unless your motor is extremely powerful, for the larger the record, the harder it is to turn at even speed.

To make recording of your own voice, connect a microphone to your set as described in Stunt No. 10, and proceed as outlined in the foregoing paragraphs.

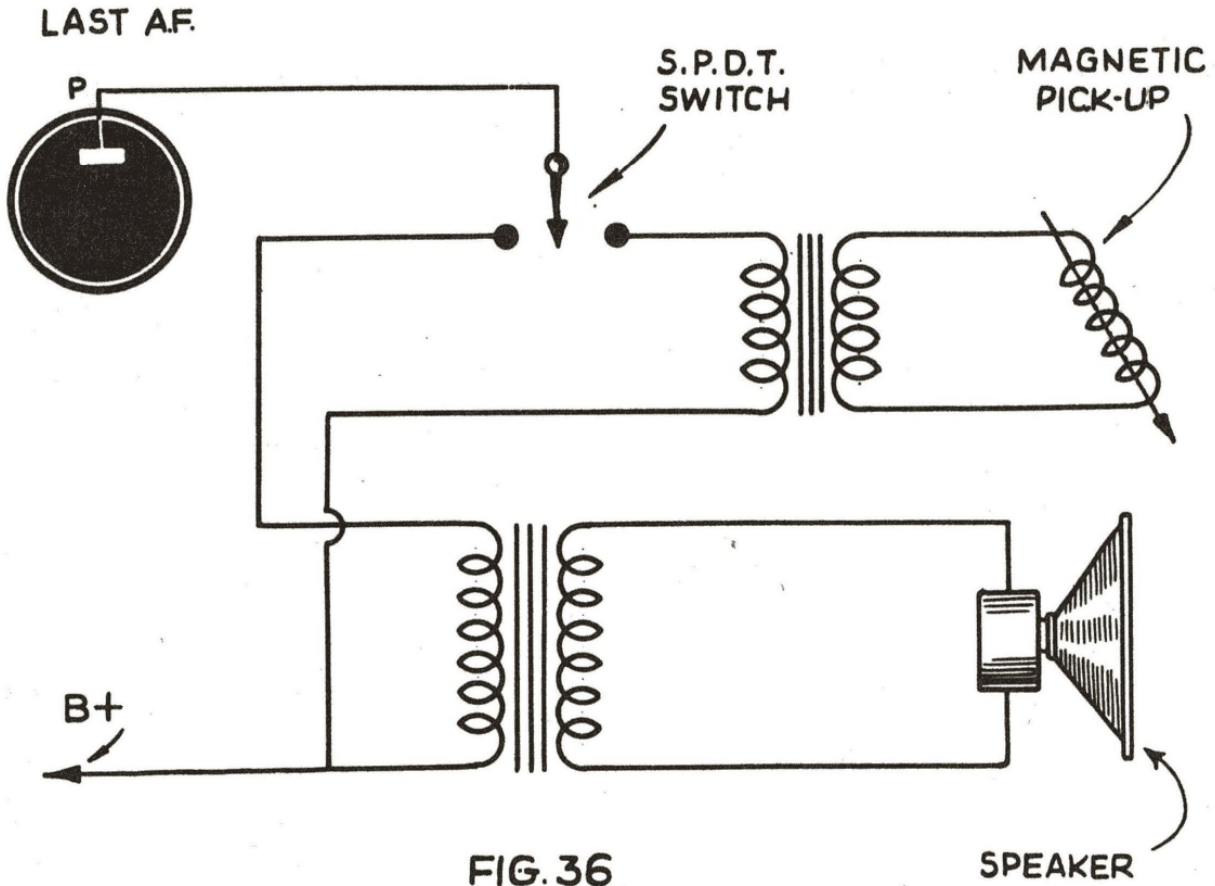

FIG. 36

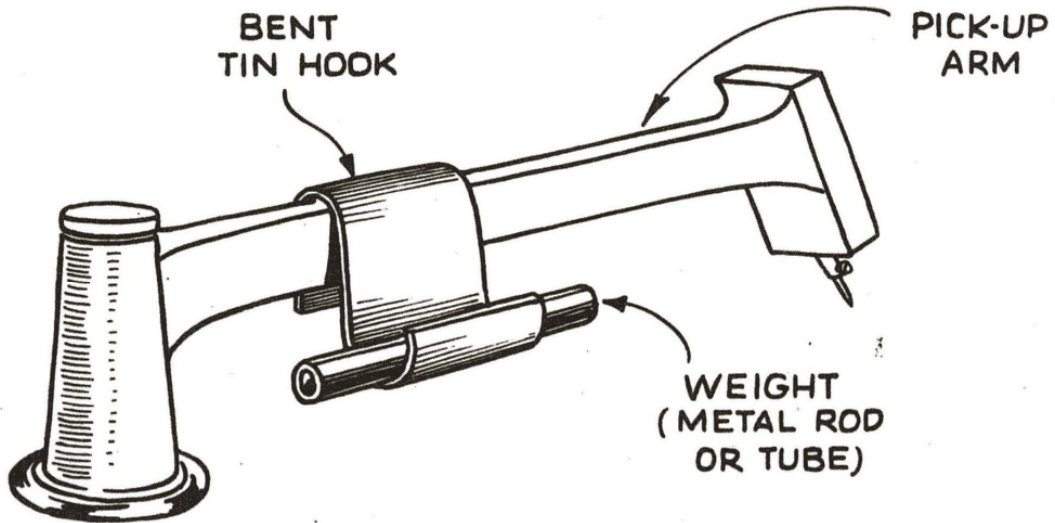

FIG. 37

MAKING A REAL TELEPHONE WITH RADIO

A REAL telephone between any two rooms in your house—a phone in which either “station” can call the other “station”—and each of which may both talk and listen—can be built out of a pair of old headphones or, better, two pair. Not only does the telephone work as described, but it can be used to let the persons in both rooms listen to the programs coming in over the radio set, also, as shown.

All the equipment needed for the telephone is a pair of old phones, a couple of bells and dry-cells, a length of three-conductor wire, a pair of push-buttons and a pair of single-pole, double-throw knife switches, which will be rebuilt as shown in Fig. 38.

The usual handle is removed from the switch arm, which is shaped into a hook, to serve for a support for the phones when they are not in use. The other two contacts are removed and replaced with stiff brass strips, so arranged as to limit the hook's travel to about $\frac{1}{2}$ -inch. A bracket is attached to hold a spring which pulls the hook to the upward position when the phones are removed from it. The switch arm must make firm contact with the upper strip when the phones are removed, yet the spring must not be so strong as to prevent good contact between the arm and the lower strip when the phones are in use. A rubber band will make a satisfactory spring.

These switches are mounted at convenient spots in the rooms which are to be linked by telephone. Near each is

mounted one electric bell and one push-button, and a battery is placed wherever conveniently near. For the average home, one dry-cell at each station will be enough, but if long lines are used, or if the wires are quite thin, the number of batteries at each station must be increased to two, three or more.

The connections are simple, as shown in Fig. 39. Taking one station at a time, the wiring is done as follows: One side of the phone cord is connected directly to wire A-A linking the two stations. The other terminal of the phone cord is connected to the upper blade B of the rebuilt knife switch. The lower blade C of the knife switch is connected to one terminal of the bell. The other terminal of the bell is connected to one side of the push-button and to the second wire linking the two stations. The arm of the knife switch is connected to the other terminal of the battery and to the third wire linking the two stations.

The second station is connected in exactly the same way, but you must be sure that the wire which connects to the bell at one station also connects to the bell in the other; that the wire which connects to the switch at one station also connects to the switch at the other; and that the wire which connects to the phone in one station also connects to the phone at the other.

Put a friend at either station while you go to the other and test it with him.

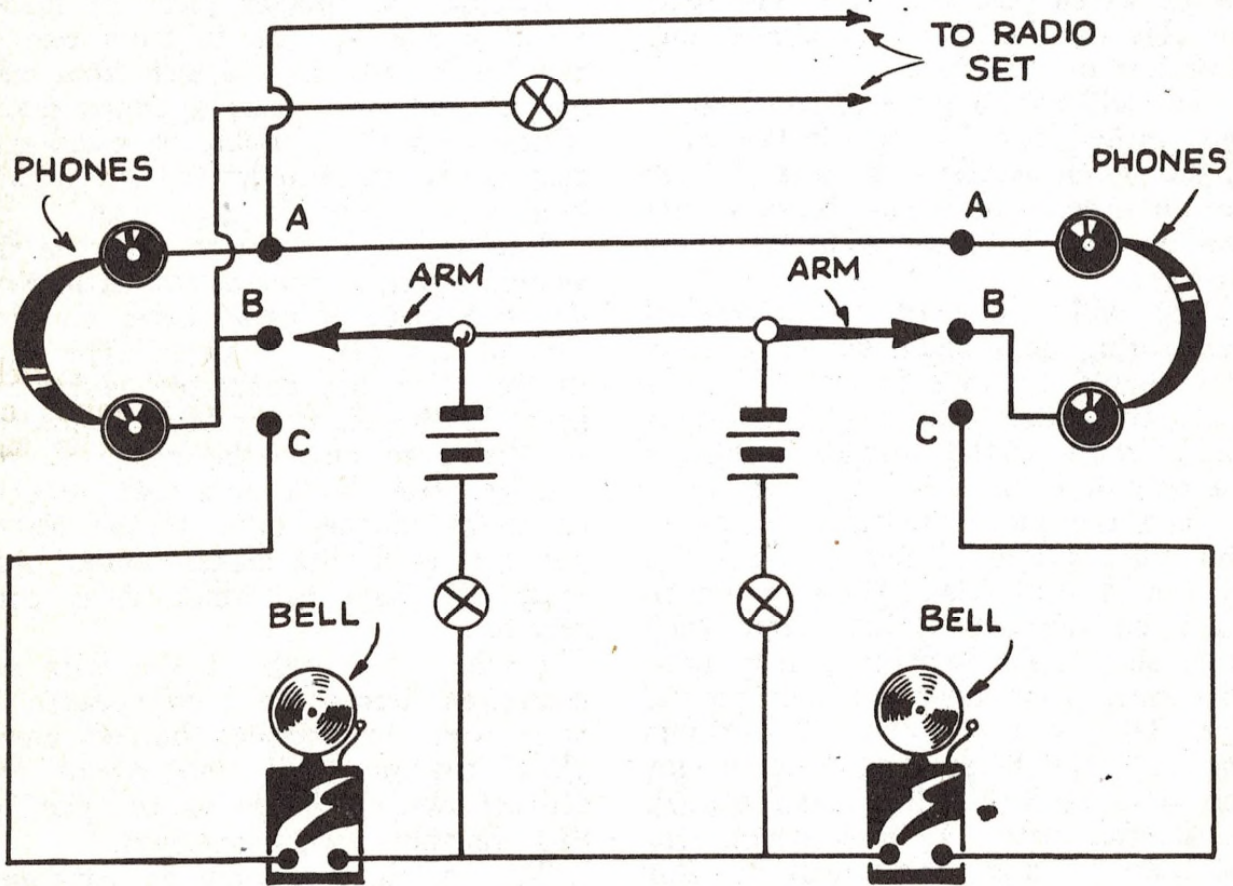
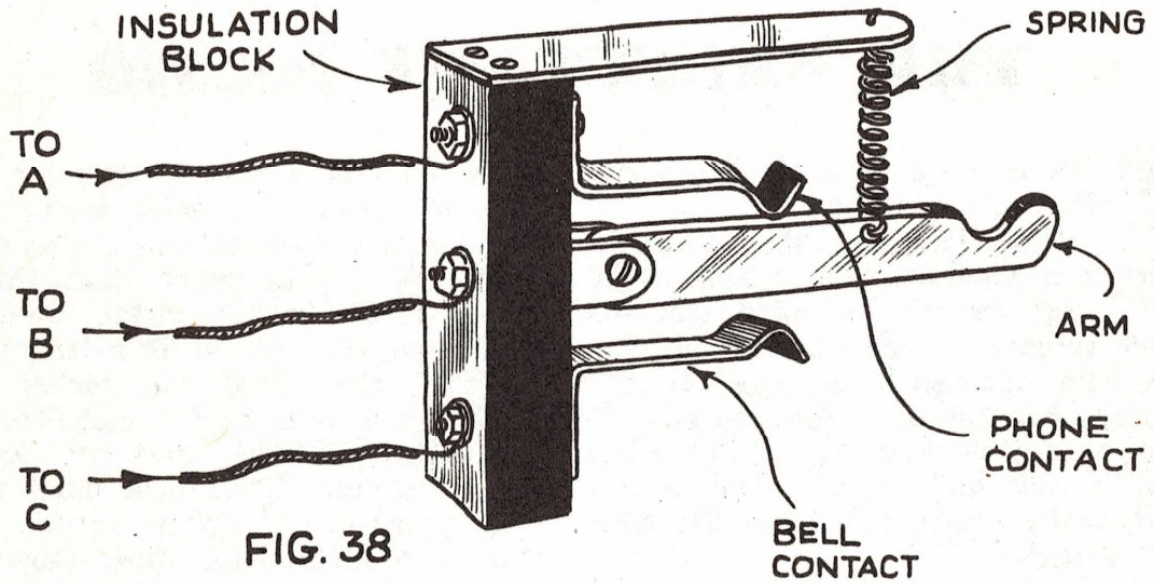

THE RELUCTANT RADIO

THIS is a simple trick which can afford plenty of fun.

The effect is that your guest tunes in a program, but as soon as he gets it satisfactorily adjusted and sits down to enjoy it, the set stops playing. The trick can also be arranged in such a way that the set stops working as soon as anyone goes near it, or when anyone calls out "Stop!" This is not really voice control; it is, as has been said, a trick.

The heart of the device is a special switch which you will make. The parts for this can be found in almost any junk box or workshop.

You will need a piece of panel about four inches long by two inches wide. If this is not available, a piece of cigar box or other light wood the same size will do, but the panel is better, being stronger.

You will also need two pieces of light spring metal about six inches long. One should be four inches wide, the other, two inches wide. Four small bolts and a length of thin insulated wire are the only other parts you will require.

Take the piece of panel or wood, and mark a line $\frac{1}{2}$ -inch in from one of the 4-inch sides. Make a punch mark on the line $\frac{3}{4}$ -inch from each end; then make another punch mark $1\frac{1}{2}$ inches from each end, also on the line. That will give you the centers for the four holes needed to mount the metal. Drill these holes large enough to accommodate the bolts which will be used to hold the metal to this piece.

Next place this piece on the larger

piece of spring metal, with the edge nearest which the holes were drilled flush with one of the 4-inch edge of the metal. With your punch, mark the two outer holes on the metal, using the piece you have drilled for a template.

Mark the metal $1\frac{1}{8}$ inches from each 6-inch edge, and 1 inch from the punch-marked edge, and cut out the piece between. Then drill holes where the punch-marks were made, using the same drill. **Fig. 40A** shows the detail.

Taking the smaller piece of metal, make a line $\frac{1}{2}$ inch in from one of the 2-inch ends, and $\frac{3}{8}$ inch from each end of this line, make a punch mark. Check with the template to make sure these holes center under the two middle holes and, if they do, drill them.

You are now ready to assemble the switch, which is done as shown in **Fig. 41**, one piece of metal being on each side of the piece of panel. The ends of the wires are connected under the heads of the bolts, one being connected to the large plate, the other to the smaller plate. Make sure that none of the bolts touches both of the plates, and that each wire makes contact only with the plate to which it is connected.

If the other ends of the wire are connected across the loud speaker of your radio set, pressing the two metal plates together will short-circuit the speaker, causing the set to stop playing. **Fig. 42** shows this connection.

The switch may now be concealed under the cushion of a chair. Sitting on it stops the set.

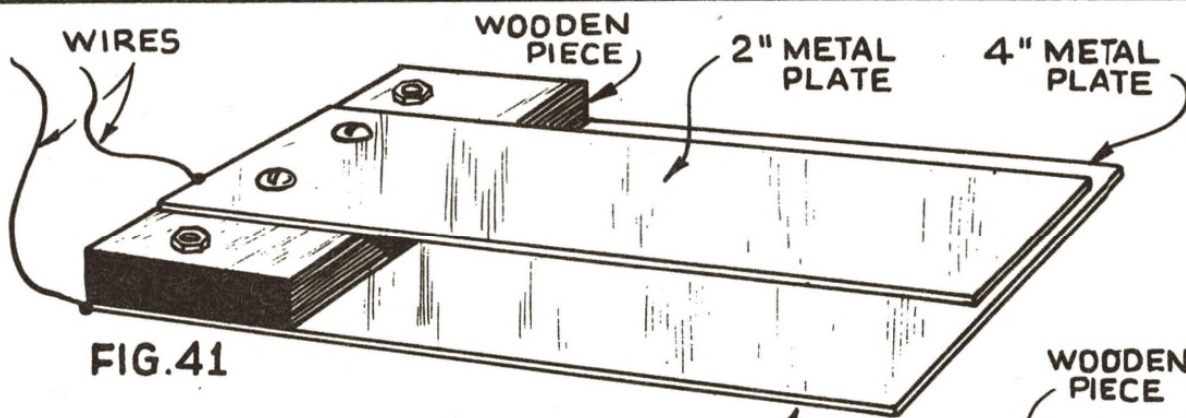

FIG. 41

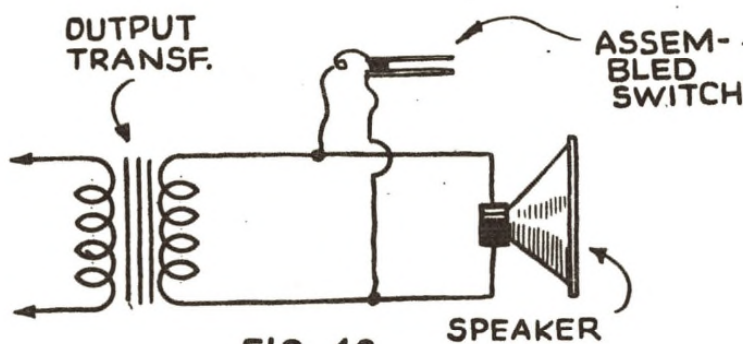

FIG. 42

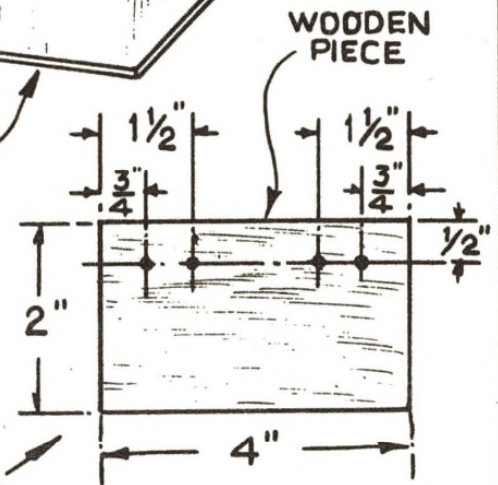

FIG. 40

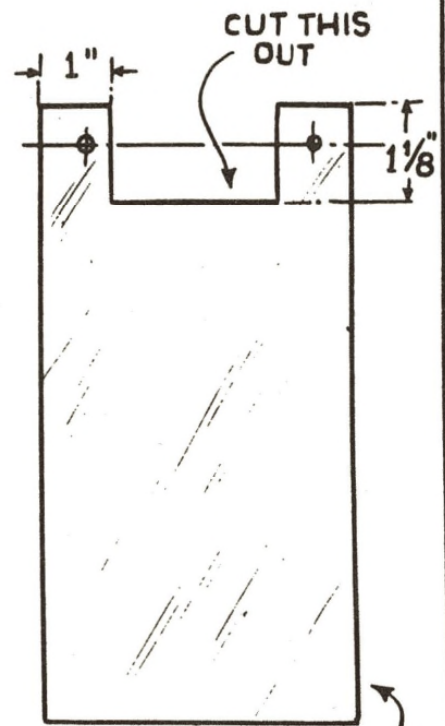
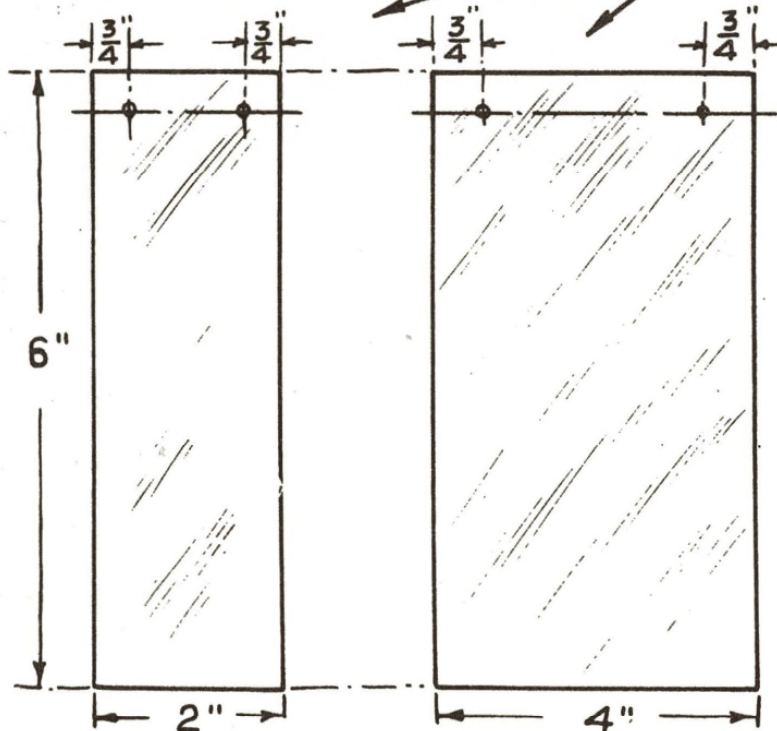

FIG. 40A

A "NO-POWER" RADIO SET

EVERYBODY expects a radio receiver which uses tubes to require some sort of power — either from batteries or from the electric light lines. Therefore, a set which apparently has no connections at all, yet which has all its tubes lit and operates a loud speaker, is something of a marvel.

It is easy for your visitors to see that there are no power lines connected to the set, for it stands upon a box made of glass, which can be seen through from all sides. And they can tell that the receiver is not battery-powered, for it is a standard midget chassis, with no room for concealment of batteries. Its antenna is strung between two uprights mounted a few inches from the chassis, on the board which supports it. The ground is a tiny flower-pot full of earth, standing beside the set. Fig. 43 shows the general set-up.

The secret of the set's operation lies in the glass case. It is carefully made, with neatly fitted corners, and the wires which supply the set's power are not visible, being No. 28 tinned wire sunk in the cement at the inner side of the joints between the rear glass and the side glasses. Even if colorless cement is used, the wires will be invisible, even to close inspection in good light. Thin foil strips may be used too, as shown in Fig. 44.

The glass box is mounted, top and bottom, in grooves cut into wooden boards, and these grooves serve well as a means of concealing the ends of the power line, which are brought through the bottom board and soldered to the

ends of a regular lamp cord, after which it is taped.

The other ends of these fine wires are brought up through the grooves in which the top of the glass is mounted. The regular line cord of the set is disconnected and these fine wires, insulated with "spaghetti tubing" are connected in its place, as Fig. 43 shows.

If the set is one which has a built-in ground, no further attention to that detail is necessary, but if it needs a separate ground, this is secured by attaching a .1 mfd. fixed condenser between the set's ground post (on the under side, where it won't show) and one side of the power line. The antenna connection is made as shown in Fig. 45, and the flower-pot is added merely as a gag—you don't really need it at all.

The set is fastened to the top board by means of two long screws run through the chassis, and so positioned that they will not interfere with any of the parts of the set.

In putting this job together, the task will be much simplified if a certain order of procedure is followed.

(1) Prepare all parts, including the grooved boards.

(2) Connect the fine wire leads under the chassis and screw the chassis to the upper board. Also the condenser-ground, if needed.

(3) Drill holes for the wires in the upper board; bring the wires through these holes.

(4) Put cement into the grooves of the upper board and along the edges of

FIG. 43

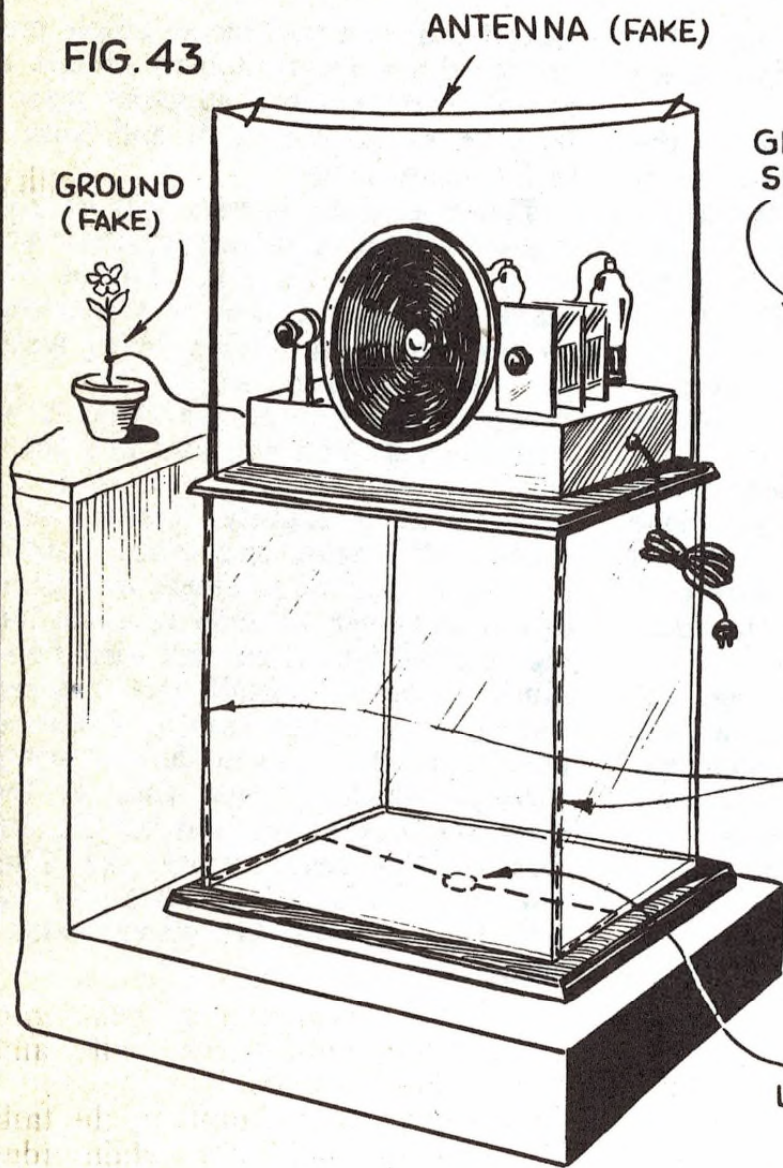
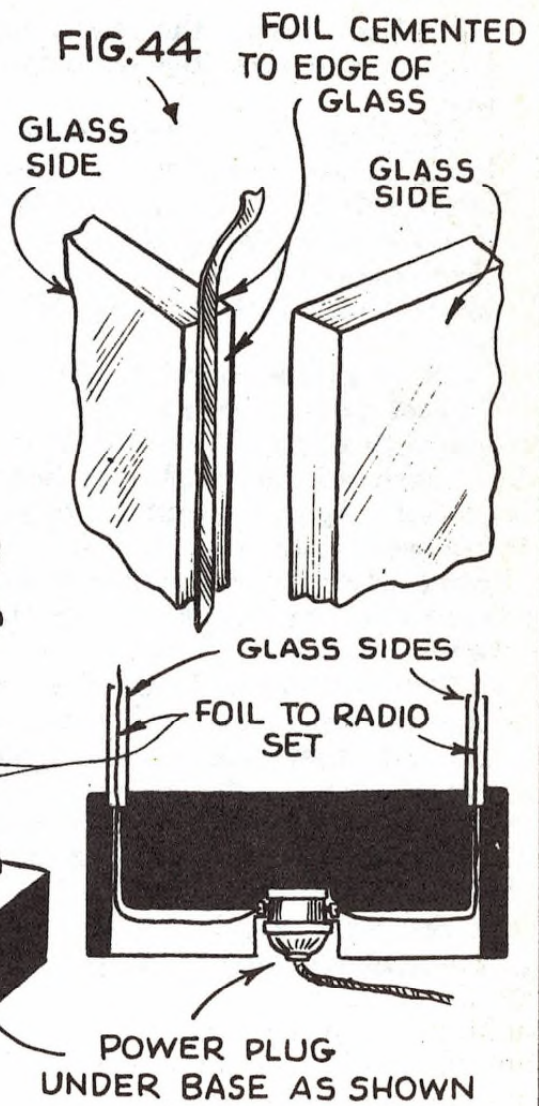
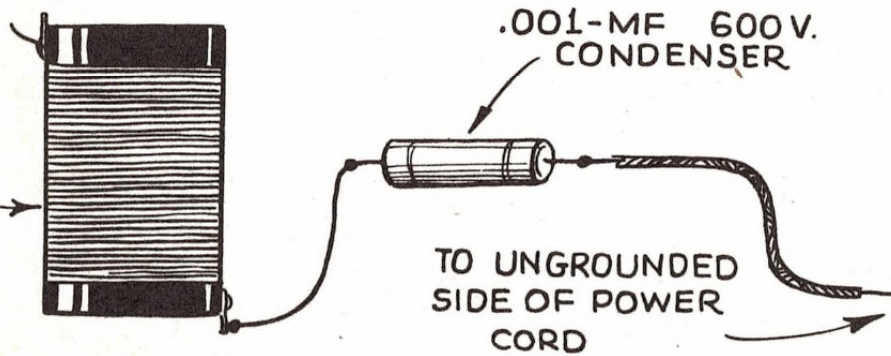

FIG. 44



ANTENNA COIL OF SET

FIG. 45



the glass. Insert the glass into the grooves, and press the wires into position.

(5) Drill all necessary holes in the lower board, including a recess in its under side for connections. Put cement in its grooves, bring the wires through their holes and put this board in place. Make connections on under side of this board.

(6) Add the antenna, the "ground" (flower pot) and any other touches you may desire.

When all the work has been done, the set may be plugged in. If you have followed instructions carefully, it will work as well as it would if it were connected to the power lines in the usual way.

You will notice, in the drawing, that the antenna lead-in is coiled around the post that supports the midget antenna. These posts may be made from lengths of dowel stick, inserted into holes drilled in the board and glued fast. The important part of the antenna is really the lead-in, for by using a No. 22 insulated wire in a not-too-widely

spaced coil, you will secure ample pick-up for the average modern midget receiver. These antenna supports may be from $\frac{3}{8}$ to $\frac{3}{4}$ -inch thick, and from 18 to 24 inches long.

The most difficult part will be making a neat job of concealing the wiring in the angle of the glass. This is most easily done if the wire is straightened by being hung up with a heavy weight on its end over night, first. The straighter the wire is, the easier it will be to hide it. You will also find that it stays in place best if you wait until the cement is slightly "tacky" before pressing the wire into place. Position it with a pair of tweezers or the end of a screwdriver, in order to avoid leaving finger-prints. You will also find it much easier to install this concealed wiring if you are careful about the position of the holes in the end boards, through which it must pass. If these holes are located precisely at the inner side of the angle where the glasses join, there will be comparatively little trouble in putting the wires neatly in place.

Radio Lesson FREE

See how I train you at home to
BE A RADIO TECHNICIAN



J. E. SMITH
President

Mail Coupon for a 32-page sample lesson FREE. It shows how N. R. I. trains you for Radio at home in spare time. I'll also send my 64-page book, "WIN RICH REWARDS IN RADIO," which describes many fascinating Radio jobs.

Future Looks Bright for Trained Radio Technicians, Operators

The Radio Repair Business is booming. Profits are large and future prospects are bright. Broadcasting Stations, Aviation Radio, Police Radio, Loudspeaker Systems, Radio Manufacturing, all employ trained Radio men at good pay. Also think of the NEW jobs that Television, Frequency Modulation, Electronics, other Radio developments promise for the future. You have a real opportunity. I will train you to be ready to cash in when amazing Radio developments are released for unlimited use.

My Method Helps Many Make \$5, \$10 a Week EXTRA While Learning

Many N. R. I. students start to fix Radios in spare time while learning. Learning from illustrated N. R. I. lessons and building and testing circuits with Radio parts I send makes you "old friends" with Radio before you know it. You run your own spare time shop, get practice fixing Radios, get paid while training.

Find Out What N.R.I. Can Do For You

MAIL COUPON NOW for FREE sample Lesson and 64-page illustrated book. If you want to jump your pay — Mail Coupon AT ONCE!

J. E. SMITH, President. Dept. 6AV4
National Radio Institute, Washington, D. C.

Sample 32-Page Lesson Shows How You Start to Learn These Vital Subjects

How superheterodyne receivers work.
Three reasons why Radio tubes fail.
Electrodynamic loudspeaker: How it works; Replacing damaged cone; Re-centering voice coil; Remedies for open field coil.
Output transformer construction, repair.
Gang tuning condenser: Construction of rotor, stator; How capacity varies.
I. F. transformers—What they do, repair hints.
How to locate defective soldered joints.
Inside story of carbon resistors.
Paper, electrolytic, mica, trimmer condensers.
How condensers become shorted, leaky.
Antenna, oscillator coil facts.
Power transformer: construction, possible troubles.
Installing power cord.
Combination volume control, on-off switch.
Tone controls.
Dial lamp connections.
Receiver servicing technique: Checking performance; Testing tubes; Circuit disturbance test; Isolating defective stage; Locating defective part.

MAIL THIS COUPON

J. E. SMITH, President. Dept. 6AV4

National Radio Institute, Washington, D. C.

Send me FREE, without obligation, Sample Lesson and 64-page book "Win Rich Rewards in Radio" which tells about Radio's spare time and full time opportunities and how I can train at home for them. (Write plainly.)

Name Age.....

Address

City..... State..... **472**