

Coyne **TECHNICAL DICTIONARY**

TELEVISION • RADIO • ELECTRICITY • ELECTRONICS

4000 TERMS, EXPRESSIONS, WORDS, ABBREVIATIONS

A Handy, Concise, Authentic Reference Book containing over 4,000 Television, Radio, Electrical, Electronic and Radar terms, abbreviations and symbols. For Servicemen, Students, Experimenters, and Beginners.

A Coyne P U B L I C A T I O N

DISTRIBUTED BY: Howard W. Sams & Co., Inc., Indianapolis 5, Ind.

World Radio History

[Faint, illegible handwritten text, possibly bleed-through from the reverse side of the page.]

CTB 100
\$200

COYNE TECHNICAL DICTIONARY

**4000 Terms, Words, Expressions used in
TELEVISION — RADIO — ELECTRICITY
and ELECTRONICS**

A Handy, Complete Authentic reference handbook containing over 4000 terms, abbreviations, symbols, expressions used in the TELEVISION, RADIO, ELECTRICAL and ELECTRONICS fields.

Written by Harold P. Manly and edited by the Technical Staff of COYNE ELECTRICAL SCHOOL the COYNE TECHNICAL DICTIONARY is a valuable ready-reference aid to technicians, students or anyone else interested in the above subjects. Every effort was made to present the definitions in the most simple easy-to-understand terms.

In addition to the 4000 word dictionary this book also has a quick-reference DATA SECTION at the back of the book. This Data Section includes formulas, tables, tube characteristic charts, symbols, wiring diagrams and other on-the-job reference data.

●
Published by:
Educational Book Publishing Division
COYNE ELECTRICAL SCHOOL
CHICAGO 7, ILL.

●
Distributed by:
HOWARD W. SAMS & CO., INC.
2201 E. 46th St.
INDIANAPOLIS 5, IND.

**COYNE
TECHNICAL DICTIONARY
OF
4000 TERMS USED IN
TELEVISION · RADIO · ELECTRICITY · ELECTRONICS**



A Handy, Concise, Authentic Reference book containing over 4000 TELEVISION, RADIO, ELECTRICAL, ELECTRONICS and RADAR terms, abbreviations, and symbols.

This book was prepared by the TECHNICAL STAFF of COYNE ELECTRICAL SCHOOL as an aid to technicians, students or anyone else employed or interested in the above subjects.

A special DATA section of valuable formulas, tables, charts, etc., can be found in the last section of the book.



PREPARED BY
TECHNICAL STAFF
COYNE ELECTRICAL SCHOOL

**COYNE ELECTRICAL SCHOOL — CHICAGO
1955**

Copyright 1955 by
COYNE ELECTRICAL SCHOOL
500 South Paulina Street
Chicago, Illinois

All rights reserved. This book or any parts thereof may not be reproduced in any form without written permission of the Coyne Electrical School.

Printed in United States of America

FOREWORD

WITHIN the past few years the fields of Electricity, Radio, Television and Electronics have made great advancements. This advancement has brought many NEW words, terms, expressions and symbols. Electrical and Radio-TV workers are being confronted with these new expressions daily and have found the need of an up-to-date, handy-size technical dictionary greater than ever before.

Furthermore, Radar for thousands of Industrial uses brings other new words, terms and expressions that the Electrical and Radio-TV worker will have to know to understand his work.

We are now in a new Electronics Era and with it comes still more new words and terms. This book includes definitions and data on Electricity, Radio, Television, Electronics and Radar.

This handy dictionary and data book was developed and prepared by the Technical Staff of the Coyne Electrical School. **Being a flexible pocket size you can always carry it with you.** It is especially helpful for:

1. FOR THE STUDENT OR "BEGINNER"

The knowledge of the exact meaning of Electrical, Radio-TV and Electronics and Radar terms and symbols will prove valuable to the "beginner," student, an experimenter, or anyone else who is interested in these fields. This book will also be valuable to anyone who is employed by an Electrical or Radio-TV company in any capacity—salesmen, stenographers, clerks, etc., included.

2. FOR THE "OLD TIMER" OR EXPERIENCED ELECTRICIAN AND RADIO-TV MAN

The experienced Electrician and Radio-TV technician also has need for an authoritative and reliable dictionary to serve as a reference guide on the precise meaning of the many new

terms and expressions in his field. **He also has great need for the data covered in the last section of this book.**

This dictionary is condensed so that as many definitions as possible could be included in a book of this size—yet every word is fully defined.

We consider the symbols used in Electrical, Radio-TV and Electronics a very necessary part of a dictionary of this kind, so you will find those fully explained in the latter part of this book.

The data that has been selected for this book has been “hand picked” from dozens of special files on material for reference on the job. Any Electrical or Radio-TV worker cannot be expected to carry all the data he needs in his head.

All words in the dictionary portion are arranged in one continuous alphabetical order. Hyphenated words are treated as single words—while abbreviations are handled as though their letters formed a word.

Every effort has been made to enable you to find the information you need **QUICKLY**.

So whether you are a “beginner” or an “old timer” in Electrical or Radio work, this dictionary should be in your pocket or tool box as an aid when you must be sure of the exact meaning of a word.

R. A. SNYDER, *General Manager*
Educational Book Publishing Division
Coyne Electrical School

TABLE OF CONTENTS

1. Dictionary of 4000 words, terms, abbreviations and expressions in Radio, Television, Electricity, Radar and Electronics.....	1-114
2. Data Section	115-153
Interior Wiring	116
Industrial Wiring	117
Insulation Table	118
Voltage Drop in Conductors.....	119-120
Voltage Drop Graphs.....	121
Diameters, weights, resistance—copper wire.....	122
Motor Wiring Data.....	123
Load Data, single and 3 phase.....	124
Number of conductors in conduit or tubing.....	125-126
Wiring Diagrams: DC Motor, Transformer, Ammeter, voltmeter connections.....	127-129
Power Factor Correction.....	130
Decimal and Metric equivalents, voltage estimating data	131
Conversion tables	132
Identifying code letters on AC Motors, Grid Bias resistor calculations	133
Copper sensitivity—electronic formula.....	134
Allowable current carrying capacity.....	135
Important data in AC Machinery.....	136-137
Factors on tube inter-changing.....	139-140
Tube data charts 14 inch to 30 inch.....	141-149
Test Tables, electrolytic and non-electrolytic.....	150
Chart, inductive reactance at high frequencies....	151
Chart, alignment for inductance, capacitance, and frequency resonance	152
Chart, alignment for capacitive reactance, frequency and capacitance.....	153

A

- A.—** (A negative or A minus.) Symbol used to designate the point in a circuit to which the negative terminal of the filament supply is to be connected.
- A+.** (A positive or A plus.) Symbol used to designate the point in a circuit to which the positive terminal of the filament supply is to be connected.
- A Battery.**—The battery (often a single dry cell) used for supplying heating current to the filaments of radio tubes.
- ABK.**—Airborne search radar.
- AB Power Pack.**—A combination of batteries or devices in a single housing, used to supply potentials for receivers, especially portable sets.
- Abscissa.**—The horizontal distance of a point to the right or left of a vertical line passing through zero. The abscissa is a horizontal line drawn from the zero vertical line to the point to be located.
- Absolute Unit.**—A unit of measurement that has been determined according to fixed physical properties such as length, weight, time, etc.
- Absorption of Condenser Charge.**—The property of some dielectrics in condensers which prevents quick receiving or quick loss of the condenser's charge.
- Absorption Dynamometer.**—A testing machine in which the power generated by the unit being tested is absorbed and gotten rid of in the dynamometer by friction, heat, etc.
- Absorption Marker.**—A dip produced on an oscilloscope frequency-response trace by attenuation of sweep signal voltage at the marked frequency.
- A. C.**—An abbreviation for "alternating current."
- A.C. Receiver.**—A receiver designed to operate only from an a.c. power source. Power packs of these sets invariably employ a power transformer, for stepping the a.c. line voltage up and down.
- A.C.-D.C. Receiver.**—A receiver which will operate either from an a.c. or d.c. power source. It does not have a power transformer.
- Accompanying Sound.**—The television sound signal transmitted in the same channel as the received picture signal.
- Achromatic.**—Without color. A picture consisting entirely of black, white, and intermediate shades of gray.
- Acoustic.**—Pertaining to sound.
- Acoustic Feedback.**—Transfer of sound waves from a loudspeaker to any previous part, such as a microphone, in the same amplifying or broadcasting system. It can cause howling and overloading of tubes.
- Acoustic Resonance Device.**—A device which is resonant to the frequency of received signals.
- Active Lines.**—Periods during which the electron beam exists or is active in a television camera tube or picture tube, and is either scanning or else reproducing the lights and shades of the picture.
- Accumulator.**—A storage battery.
- Acid Proof Paint.**—A paint that resists the action of acids, especially the sulphuric acid used with storage batteries.
- Acid Proof Wire.**—Wire having insulation that resists the action of acids.
- Acoustic Synchroniser.**—An instrument which tells when two alternating current devices are in phase by the sound or lack of sound in the instrument.
- Active Component.**—The average power of an alternating current in watts, divided by its voltage.
- Active Conductor.**—A conductor in which electromotive force is acting or is induced, or in which current is flowing.
- Active Current.**—The part of an alternating current that is in phase with the e. m. f.
- Active E. M. F.**—The electromotive force that is effective in producing a current in an alternating circuit. At any instant it is the difference between the impressed voltage and the counter e. m. f.
- Active Material.**—The material which fills the spaces in the grids of storage battery plates and which changes during charge and discharge of the battery.
- Active Plate.**—The element or plate in a primary battery that is dissolved by the electrolyte during the production of current.
- Aceylic Machine.**—A direct current motor or generator in which the electromotive force in the armature conductors maintains the same direction at all times, a unipolar machine.
- Adapter.**—Any device used for changing temporarily or permanently the terminal connections of a circuit or part.
- Adder.**—In a color television receiver, an amplifier and associated circuits that combine chrominance and luminance signals to produce and amplify color primary signals which go to picture tube input circuits.
- Adjacent Sound.**—A television sound signal transmitted in the channel immediately lower in frequency than the channel to which the receiver is tuned. A resulting beat frequency is 1.5 mc higher than the video intermediate frequency of the receiver.
- Adjacent Video.**—A television video carrier frequency in the channel immediately higher in frequency than the channel to which the receiver is tuned. A resulting beat frequency is 6.0 mc lower than the video intermediate frequency of the receiver.
- Adjustable Ceiling Fixture.**—A bracket supporting electric lights from a ceiling in such a way that the lamps may be moved.

Adjustable Condenser

A.I.E.E.

- Adjustable Condenser.**—A condenser whose effective size and capacity may be adjusted, a variable condenser.
- Adjustable Conduit Attachment Fixture.**—An adjustable lamp fixture which may be attached to conduit or pipe by clamps.
- Adjustable Coupling.**—A driving connection which allows changing the position of a driven shaft with reference to the driving shaft; often used for driving ignition devices on automobile engines.
- Adjustable Resistance.**—A resistance whose value may be adjusted, or a resistance arranged so that more or less of it may be inserted in a circuit.
- Adjustable Speed Motor.**—An electric motor whose speed may be adjusted to any desired point within its range and which tends to run constantly at this speed when adjusted.
- Adjustable Thermostat.**—A thermostat which may be adjusted to act at different temperatures.
- Admedium Lampholder.**—A lampholder having a nominal screw diameter of $\frac{1}{4}$ inch.
- Admittance.**—The measure of ease with which an alternating current flows in a circuit. The reciprocal of impedance. Measured in micromhos (mhos.).
- Advance Resistance Wire.**—An alloy of copper and nickel used for heating units or where there is much heating and cooling of the wire.
- Aerial.**—The antenna.
- Aerial Circuit.**—Conductors or wires supported in the air as distinguished from underground systems.
- Aerial Mast.**—The vertical support for the antenna.
- Aerial Switch.**—A switch that connects the antenna either with the ground or with the receiving or transmitting set.
- Aerometer.**—An instrument for measuring the weight of gases.
- Aetna Material.**—An insulating material adapted for use in strain insulators because of its mechanical strength.
- A. F.**—An abbreviation for "audio frequency."
- Ageing of Magnet.**—A gradual loss of magnetism that takes place following the magnetizing of a permanent magnet. It is rapid at first, but becomes slower and slower.
- Ageing of Transformer.**—A gradual loss of efficiency that takes place in a transformer due to changes in the iron of the core.
- AGL.**—Aircraft gun laying; radar for plane-to-plane fire control.
- Agonic Line.**—An imaginary line through points on the earth at which a compass needle points to the true north.
- AI.**—Aircraft interception.
- Aided Tracking.**—A system for tracking a signal in azimuth, elevation, or range or all variables together, in which a constant rate of motion is maintained by mechanical means. Operator adjusts an error voltage.
- A radar term.*
- A. I. E. E.**—An abbreviation for "American Institute of Electrical Engineers."
- Air Blast Transformer.**—A transformer cooled by forced circulation of air around its core and windings.
- Air-cell A Battery.**—A non-rechargeable wet-cell battery which usually is built to deliver 2 volts, for use chiefly in battery-operated home radio receivers. Its carbon electrodes are porous and absorb oxygen from the air during use. Rated life in normal radio use is 500 to 1500 hours, depending upon battery size and current drain.
- Air Condenser.**—A condenser using air for the dielectric between its plates.
- Air Cooled Transformer.**—A transformer cooled by natural circulation of the air around its heated parts.
- Air Core.**—A term used to describe coils or transformers which have no iron in their magnetic circuits. Air-core construction is used chiefly in r.f. circuits.
- Air Dielectric.**—The value of air as a dielectric is taken as 1, and the value of other dielectrics are based on a comparison with the value of air.
- Air Gap.**—The air space between magnetic poles, between armature core and field magnet, or between the ends of conductors.
- Air Insulation.**—The use of air as an insulator, with or without additional insulation of other materials.
- Air Magnetic Circuit.**—The part of a magnetic circuit that passes through air, or the air gap.
- Air Resistance.**—The resistance through an air gap in an electric circuit. This term is sometimes used for air gaps in magnetic circuits.
- Air Space.**—The air-filled distance or space between two parts.
- Airplane Dial.**—Popular name for a circular-shaped radio receiver dial with a rotating pointer, resembling the dials and pointers of airplane instruments.
- Airplane Spark Plug.**—An ignition spark plug having a number of cooling flanges on its shell; used in airplane engines.
- Aligning Tool.**—An essentially non-metallic screwdriver or socket wrench used for adjusting the trimmer condensers and adjustable coils which are provided in radio receivers for aligning purposes or for pre-setting push-button tuners.
- Alive.**—Carrying an electric current or voltage.
- Alkaline Battery.**—A storage battery whose electrolyte liquid is alkaline rather than acid. Edison Battery.
- Alligator Clip.**—A long-nose clip with spring-controlled meshing jaws used

All-metal Type Tube

Alternation

- on test leads for making quick temporary connections.
- All-metal Type Tube.**—A vacuum tube having a metal envelope instead of a glass envelope. Electrode connections are made through glass beads fused into the top and bottom of the metal envelope. The octal bakelite base is designed to take eight equally spaced terminal prongs, but some of the prongs are omitted on tubes having less than eight terminals.
- Alloy.**—A metal composed of two or more metals or of metals and other materials melted together in order to produce some desired result in the alloy.
- All-wave Antenna.**—A receiving antenna designed to pick up stations reasonably well over a wide range of carrier frequencies including short-wave bands as well as the broadcast band. It may be a single doublet antenna or a combination of two or more doublets.
- All-wave Receiver.**—A receiver capable of receiving stations on all of the commonly used wavelengths in short-wave bands as well as the broadcast band.
- Alpha Particle.**—The composite nucleus of a helium atom, two protons and two neutrons. The name originally referred to alpha radiation from naturally radioactive substances like uranium and radium, later recognized to be fast moving nuclei of ordinary helium gas.
- Alphaduct.**—A flexible conduit made of heavy canvas covered with weather-proof compound and fibre cord.
- Alternating Arc.**—An arc light operated with alternating current.
- Alternating Current.**—An electric current which reverses its direction of flow at regular intervals, many times each second.
- Alternating Current Circuit.**—An electric circuit carrying alternating current.
- Alternating Current Generator.**—A generator producing alternating current.
- Alternating Current Instrument.**—An instrument which measures or records the various values of alternating current such as voltage, amperage, phase, frequency, etc.
- Alternating Current Magnet.**—An electromagnet whose windings carry alternating current. Its ends have no constant polarity as with a direct current in the winding.
- Alternating Current Motor.**—An electric motor operated by alternating current.
- Alternating Current Rectifier.**—A device which delivers pulsating direct or one-way current when alternating voltage is applied. The action may be electrical, chemical, or mechanical.
- Alternating Current Resistance.**—The total loss of electrical energy (watts) that takes place in an alternating current circuit. It is greater than the ohmic resistance.
- Alternation.**—One-half of a cycle of alternating current, during which the current rises from zero to maximum value and returns to zero.
- Alternative Discharge.**—A high voltage discharge that takes place across a comparatively high but short resistance in place of going through a lower resistance of greater length.
- Alternator.**—A generator which produces an alternating current.
- Aluminized Screen.**—A television picture tube phosphor screen on the inside of which is deposited an extremely thin layer of aluminum. Beam electrons penetrate the coating and reach the phosphors. The aluminum acts somewhat like a mirror to reflect outward through the face plate most of the phosphor illumination which otherwise would go back inside the tube.
- Aluminum.**—A white, non-corroding metal of very light weight often used for electrical conductors. Its resistance is higher than the resistance of copper and a larger wire must be used to carry a given current.
- Aluminum Cell Lightning Arrester.**—A lightning arrester employing plates of aluminum in an electrolyte. The high voltage of the lightning breaks down the thin insulating film that forms on the plates and a conducting path is formed through the cell for escape of the lightning to ground.
- Aluminum Cell Rectifier.**—An electric cell containing plates of aluminum and plates of iron or lead in an electrolyte of ammonium phosphate. Current can pass only from the iron or lead to the aluminum.
- A. M.**—Amplitude modulation. Also written as a-m or AM.
- Amalgam.**—An alloy of mercury with another metal.
- Amalgamate.**—To combine mercury with another metal, as on the surface of battery electrodes or plates.
- Amateur.**—Any person who operates and experiments with short-wave transmitters as a hobby rather than for profit.
- Amateur Bands.**—Bands of frequencies assigned exclusively to radio amateurs by the Federal Communications Commission.
- Amateur Operator.**—A person holding a valid license issued by the F.C.C. authorizing him to operate licensed amateur stations.
- Amateur Station.**—A radio station used by an amateur for personal communication with other amateurs.
- Amateur Station Call Letters.**—Identifying call signal assigned to a licensed amateur operator to identify his station. Amateur calls in a given country begin with a one or two-letter prefix (W or N for U.S., and

K for U.S. possessions), followed by a location-indicating numeral and two or more additional letters.

Amber.—A kind of resin which can be strongly electrified by friction.

Ambroin.—A moulded insulating material adapted to withstand high temperatures.

American Morse Code.—A dot-and-dash code which is commonly used for telegraphic communication over wires. It differs considerably from the International Morse Code which is used in radio.

American Wire Gauge.—The gauge generally adopted and used for measuring the size of wires in the United States.

Ammeter.—An instrument which measures and indicates the number of amperes flowing in an electric circuit.

Ammeter Shunt.—A low resistance conductor placed in parallel or shunt with an ammeter so the greater part of the measured current flows through the shunt, only a small part of the total flow going through the ammeter itself.

Ammonia.—A gas, usually dissolved in water, making ammonia water, which is an alkali and used for neutralizing or preventing damage from acids.

Amorphous.—Having an irregular grain rather than being formed in crystals.

Amortisseur Winding.—A damper winding.

Amp.—Ampere

Amperage.—The strength of electric current in amperes.

Ampere.—The practical unit for measurement of electric current; the electric current that flows through a circuit having a resistance of one ohm when the pressure is one volt.

Ampere Balance.—An ammeter which balances the attraction and repulsion of two currents against a weight to measure the current.

Ampere-Foot.—A unit for measuring drop of pressure in wires. A current of one ampere flowing through one foot of conductor.

Ampere-Hour.—A measure of quantity of electricity; the quantity that flows through a circuit in one hour when the flow is one ampere.

Ampere-Hour Efficiency of Storage Battery.—The ratio of the number of ampere hours secured from the battery on discharge to the number of ampere hours required to charge the battery.

Ampere-Hour Meter.—An instrument which measures, and indicates or records the number of ampere-hours passing through the circuit.

Ampere-Hour Meter Regulation.—A form of regulation used with automobile battery charging generators. The duration and amperage of the charge is controlled by movement of an ampere-hour meter.

Ampere-Minute.—A measure of current quantity; the quantity flowing through a circuit in one minute when the rate is one ampere.

Ampere-Second.—A measure of current quantity; the current flowing through a circuit in one second when the rate is one ampere. One coulomb.

Ampere-Turn.—A measure of the magnetic strength of a coil or magnet. One ampere flowing through one full turn of the winding equals one ampere-turn. It is also a unit for measuring magnetomotive force.

Ampere-Turn.—A unit of magnetizing force, equal to the number of amperes of current multiplied by the number of turns of a winding in which it flows.

Amplification.—The process of increasing the strength (current, voltage or power) of a signal. Amplification can be provided by transformers and tuned circuits as well as vacuum tubes.

Amplification Factor.—A vacuum tube rating indicating the theoretical maximum increase in signal strength which can be provided by a given tube.

Amplifier.—A device consisting of one or more vacuum tubes and associated parts, used to increase the strength of a signal.

Amplifier Triode.—An amplifier tube.

Amplifier Tube.—An electron tube used for amplification.

Amplify.—To increase in strength.

Amplitude.—The maximum departure of an alternating current or voltage from its zero value, as measured in either direction from zero.

Amplitude Modulation.—The common system of radio broadcasting, in which the deviation in frequency above and below the assigned carrier frequency value is equal to the frequency of the sound wave being transmitted, and the amplitude of the transmitted signal varies in accordance with the instantaneous amplitude of the sound wave being transmitted. Abbreviated as a.m., or a-m or AM.

Analogous Pole.—A positive pole produced in certain substances when their temperature is increased. The substances are pyro-electric.

Analogy.—A similarity in action between two different things such that one may be more easily understood by comparison with the other.

Analyzer.—A test instrument used for checking radio parts and circuits. It sometimes includes a special plug-in system which can be inserted in a tube socket to extend the socket terminal to the instrument for convenience in making measurements.

Anchor.—A metal piece set into the ground for the purpose of holding the end of a guy wire.

Anchor Pole.—A short pole to which guy wires are attached.

Anchor Rod

Anchor Rod.—A rod attached to an anchor for holding a guy wire.

Anchored Filament.—A lamp bulb filament attached to a solid support at one or more points in its length.

Angle.—In alternating current work, an electric angle is a distance along the wave or part of a cycle, measured in degrees, each complete cycle being divided into 360 degrees.

Angle of Dip.—The angle at which a magnetic needle inclines toward the center of the earth when the needle is freely suspended at its center.

Angle of Lag.—The angle through which motor brushes are shifted against armature rotation to make up for armature reaction which changes the position of the magnetic field. The distance measured in degrees that the current lags behind the voltage in an A. C. circuit. An angle whose tangent is equal to the ratio of the inductive to the ohmic resistance.

Angle of Lead.—The electrical angle, in degrees, by which current leads applied voltage in a capacitive circuit. Also the angle through which generator brushes are shifted with armature rotation to compensate for armature reaction.

Angle Socket.—A lamp socket standing at a right angle to the fixture.

Angstrom Unit.—A unit of wave-length for light and other similar radiations. Equal to a length of one ten-billionth of a meter.

Animal Electricity.—The electricity produced in the body of an animal.

Anion.—The gas or other substance produced at the positive electrode in electrolytic action.

Anneal.—To soften by the use of heat.

Annealed Steel.—Soft steel which does not become a permanent magnet.

Annunciator.—An electrically operated signal consisting of a pointer, a drop, a lamp, etc., connected to a switch or push button operated to call attention to a certain room or place.

Annunciator Wire.—Insulated soft copper wire formed of a single conductor.

Anode.—In an electron tube or an electrolyte, the internal element or electrode toward which electrons flow within the tube or electrolyte, and from which they pass to an external source of voltage. The plate of a radio tube. In an electric source, the terminal away from which electrons flow inside the source, and at which they enter from external circuits.

Anomalous Magnet.—A magnet having consequent poles.

Ant.—Antenna.

Antenna.—A metallic structure or an arrangement of conducting wires or rods used for picking up or radiating radio waves. Also known as an aerial.

Antenna Capacity.—The capacity of the conductors forming the antenna.

Antenna Coil.—That coil in a radio receiver through which the antenna

Antenna Inductance

current flows. This coil is usually directly connected to the antenna and ground terminals inside the set.

Antenna Inductance.—The inductance of the conductors forming the antenna.

Antenna Ground.—The connection of the antenna circuit to ground, usually controlled by the antenna switch.

Antenna Gain.—The ratio between signal voltage delivered by a given antenna to a transmission line or receiver, and voltage from the same signal under the same conditions delivered by a reference antenna, which usually is a straight half-wave dipole cut for resonance at the frequency of measurement.

Antenna Impedance.—Impedance of an antenna at a specified frequency, usually at the frequency for which the antenna is resonant because of its length. At this frequency the inductive and capacitive reactances balance, leaving only high-frequency losses or resistance to act as impedance.

Antenna Switch.—The switch which connects the antenna to the receiving or the transmitting set or else connects the antenna to ground.

Antenna Wave Length.—The fundamental or natural wave length of an antenna, due to its own capacity and inductance.

Anticathode.—The substance in a vacuum tube against which the rays from the cathode strike and produce X-rays.

Anti-Induction Cable.—Cable sheathed and grounded or electrically protected in some way to reduce induction. A stranded cable with the conductors arranged to reduce mutual induction between them.

Antimony.—A metal used for alloying with lead in the manufacture of storage battery parts in order to increase the strength and resistance to the action of acid.

Antinode.—A point on a resonant line at which direct and reflected waves or charges combine to form maximum amplitude.

Anti-Parallel Feeding.—A parallel connection in which one side of the source is connected to the parallel circuit at one end, while the opposite end of the parallel circuit is connected to the other side of the source. Current flows in the same direction along both sides of the parallel part of the circuit.

Anti-TR Switch.—A spark gap and transmission line combination which prevents radar echoes from feeding into transmitter.

Aperiodic Circuit.—A circuit in which there are no oscillations and in which the current dies away without reversal, that is, a circuit which has no period.

Aperiodic Current.—A current having no continued alternations or periods. Current such as induced in an induc-

Aperture Mask

tive circuit whose resistance is so great as to cause more or less rapid decrease from initial maximum to zero.

Aperture Mask.—The shadow mask in a color television picture tube.

Apparent Electromotive Force.—The voltage measured by its effect on the current through a circuit.

Apparent Resistance.—The impedance.

Apparent Power.—The product of volts and amperes in an alternating-current circuit whose voltage and current are not in phase, in a circuit containing inductance, capacitance or both. Measured in volt-amperes.

Appliance.—Stationary or portable power-consuming equipment such as heating devices, cooking devices, and small motor-driven equipment.

Arago's Disc.—A disc of non-magnetic metal which, when rotated under a magnetic needle, causes the needle to turn or rotate with the disc.

Arc.—An electric discharge across a gap in a circuit. It causes a bright light or glow, the arc light.

Arc Characteristic.—The relation between the current through an arc and the voltage across the arc.

Arc Cutout.—A device for short circuiting an arc lamp.

Arc Lamp.—A lamp producing light from an electric arc.

Arc Lamp Carbon.—A rod of carbon or of copper-covered carbon from the end of which the arc is formed in an arc lamp.

Arc Light Generator.—A constant current generator adapted to furnish current to an arc lamp circuit.

Arc Light Projector.—A device for throwing illuminated pictures or figures on a screen with light secured from an arc lamp.

Arc Rectifier.—See mercury arc rectifier.

Arc Welding.—Welding of metals with heat from an electric arc. Two separate electrodes may be used for forming the arc, or the arc may be made between one electrode and the metal to be welded as the other.

Arcing of Brushes.—Sparks occurring through a conductor; measured in square inches, circular mils, square at the contact between a brush and its commutator or slip ring.

Area of Battery Plate.—The number of square inches on one side of a storage battery plate.

Area of Conductor.—The size of a section in centimeters, etc.; the cross sectional area.

Argon.—A colorless, odorless, inert gas which forms a part of the air. It is used in the bulbs of certain types of rectifiers.

Argon Bulb Rectifier.—An alternating current rectifier using a bulb with a tungsten filament and filled with argon gas through which the current can pass in only one direction.

Armature.—Usually the movable portion of a magnetic circuit, such as

Armature Air Gap

the rotating section of a generator or motor, the pivoted iron portion of a magnetic loudspeaker, or the spring-mounted iron portion of a buzzer or relay.

Armature Air Gap.—The air gap between a generator or motor armature and the face of the pole shoe, or the air gap between the end of the magnet and its armature.

Armature Band.—A band of wire or sheet metal placed around a motor or generator armature to prevent the windings from being displaced by centrifugal force.

Armature Bar.—An armature conductor formed of heavy copper rods or bars in place of wire windings.

Armature Binding Wire.—Wire holding the windings and conductors of generator and motor armatures in place.

Armature Bore.—The space between pole shoes in which an armature rotates.

Armature Circuit.—The current path through armature windings from brush to brush.

Armature Coil.—A coil of wire placed on the armature of a generator or motor, part of the armature winding.

Armature Core.—The iron cylinder or ring on which, or in which, armature windings are carried.

Armature Current.—The current through the armature and commutator of a generator or motor. It does not include the current through the field windings unless they are in series with the armature.

Armature End-Play.—The distance which an armature shaft is allowed to move endwise in its bearings.

Armature Heating.—The heating of an armature caused by resistance in the conductors, by eddy currents in the iron, by friction, etc.

Armature Interference.—Counter electromotive force.

Armature Loop.—An armature coil.

Armature Pocket.—Armature slot or groove which has a comparatively small outside opening.

Armature Pole.—A magnetic pole formed on an armature.

Armature Reaction.—The effect of the magnetism produced in an armature by its windings, on the magnetism of the fields of the machine, resulting in a magnetic field which is a combination of the two effects.

Armature Resistance.—The resistance of the commutator or slip rings and the armature windings of a generator or motor from brush to brush.

Armature Shaft.—A shaft on which the armature core is carried and which is supported by the bearings of the machine.

Armature Slot.—A slot or groove in an armature core for holding the armature windings or coils.

Armature Spider.—Metal parts which hold the armature core discs securely to the armature shaft and tightly

Armature Stand

- together.
- Armature Stand.**—A device in which an armature is supported by its shaft while work is being done on the armature or commutator.
- Armature Tape.**—An insulating tape frictioned on only one side; used for armatures, field coils, etc.
- Armature Tester.**—Any instrument adapted for locating faults in armature windings or armature circuits.
- Armature Tooth.**—The metal projecting between the slots or grooves of an armature core.
- Armature Tunnel.**—The cylindrical space between pole shoes in which the armature rotates, the armature bore.
- Armature Varnish.**—Insulating and heat resisting varnish adapted for use on armatures and field coils.
- Armature Winder.**—A machine for winding armature coils in their slots or for winding the coils on forms.
- Armature Winding.**—All of the wire placed on the armature of a generator or motor. It includes the active conductors, the end connectors, the commutator leads, etc.
- Armored Cable.**—Conductor cable having a woven or spirally wound metallic covering over its insulation so that it is protected against mechanical injury. B.X.
- ARL.**—Lightweight radar range finder.
- Array.**—All the elements of a complete antenna system, including whatever dipoles, reflectors, and directors are used. A name usually applied to two or more bays.
- Artificial Ground.**—A grounding electrode consisting of a metal plate, pipe or rod buried in the earth.
- Artificial Magnet.**—A permanent magnet which has been magnetized by the effect of electromagnets or other permanent magnets, as distinct from a natural magnet.
- Asbestos Insulated Wire.**—Wire whose insulation is protected against high temperatures by a covering of asbestos.
- Asbestos-Mica.**—An insulating material made of asbestos and mica moulded by being mixed with shellac.
- Aspect Ratio.**—In television, a numerical ratio equal to picture width divided by picture height.
- A-Scan.**—An indicator with a horizontal or vertical sweep, giving range only.
A radar term.
- Associated Sound.**—Same as accompanying sound.
- Assurance Factor.**—The ratio of the voltage at which an electrical part is operated to its maximum safe voltage.
- Astatic.**—An iron or steel piece which does not act as a magnetic compass or assume a certain direction or position.
- Astatic Couple.**—Two magnet needles placed with positive and negative

Astatic Galvanometer

- poles near each other so that their magnetism is neutralized as far as its causing the couple to take a definite position north and south is concerned.
- Astatic Galvanometer.**—A galvanometer in which the moving element includes an astatic couple.
- Astatic Meter.**—A meter built with a moving element containing an astatic couple.
- Astatic Needle.**—An astatic couple.
- Asynchronous.**—Not Synchronous, not in phase or in step.
- Asynchronous Motor.**—An alternating current motor whose speed is not synchronous with the supply current.
- Atmosphere.**—The pressure of the air; a pressure of one atmosphere is equal to 14.7 pounds to the square inch.
- Atmospheric Absorption.**—The part of the radiated energy lost through atmospheric conductivity.
- Atmospheric Electricity.**—Electricity passing through or between the air and the clouds.
- Atmospheric Interference.**—Crackling and hissing noises reproduced in the radio loudspeaker due to electrical disturbances occurring in the atmosphere surrounding the earth; these disturbances radiate electro-magnetic waves which are picked up by antenna systems of receivers. Also called static interference, and particularly noticeable during thunderstorms.
- Atom.**—One of the elemental particles into which all matter is divided. An atom has a nucleus consisting of electrons and protons, with additional electrons revolving around the nucleus. Each of the 94 known elements has a different number and arrangement of electrons and protons in its atoms.
- Atom.**—The smallest elemental particle which exists by itself, and is not further divisible by chemical means. Consists of a positive nucleus around which move a number of negative electrons depending on the kind of element.
- Atomic Number.**—An integer characteristic of each chemical element, telling how many protons are in the atomic nucleus and also how many electrons are in the atom outside the nucleus.
- Atomic Interrupter.**—An interrupter that can be adjusted to vibrate over a wide range of frequencies.
- Attachment Plug.**—A screw plug inserted in a lamp socket and from which wires run to an electric device to be attached to the circuit.
- Attenuation.**—Reduction in the strength of an electrical impulse.
- Attraction.**—The effect between magnetized bodies, or between a magnet and iron or steel, by which they are drawn together.
- Attraction of Current.**—An attraction between the magnetic fields surrounding conductors carrying cur-

Audibility

- rent.
- Audibility.**—The degree of strength of received signals.
- Audible.**—Capable of being heard by the human ear.
- Audio Amplifier.**—A vacuum tube device which increases the voltage and power of an audio frequency signal. It may be a separate piece of equipment or a section in a radio receiver.
- Audio Frequency.**—A frequency corresponding to an audible sound wave. The extreme limits of audio frequencies vary with the individual and are from about 20 cycles to about 20,000 cycles per second.
- Audio Transformer.**—An iron-core transformer used for the dual purpose of coupling together two audio amplifier circuits and changing the value of an audio signal.
- Audio Oscillator.**—An oscillator which generates audio frequency voltages.
- Audion.**—A vacuum tube detector.
- Aurora Borealis.**—A glow sometimes seen in the northern sky at night and thought to be caused by electricity.
- Antodyne Reception.**—Production of beats of audible frequency in the current of the receiving set.
- Automatic Annunciator.**—An annunciator which resets its indicators to their off position when a new call comes in.
- Automatic Bass Compensation.**—A special resistor and condenser circuit used in some radio receivers to make low audio frequency notes sound more natural at low volume control settings. The circuit automatically compensates for the poor response of the human ear to weak low-frequency sounds.
- Automatic Circuit Breaker.**—A circuit breaker operated by the current in the circuit to be broken.
- Automatic Door Switch.**—An electric switch operated by the opening or closing of a door.
- Automatic Drop.**—A device which closes a circuit, such as for a burglar alarm, and keeps it closed until re-set.
- Automatic Flasher.**—A device which automatically turns the current for an electric sign on and off.
- Automatic Focusing.**—A method of electrostatic focusing in television picture tubes. The focusing anode is internally connected through a resistor to the cathode, and requires no external focusing voltage.
- Automatic Frequency Control.**—In television receivers, a tube circuit in which combine voltages from the output of a sweep oscillator and from a synchronizing source, such as sync pulses, to produce a correction voltage which, applied to the oscillator, increases or decreases its frequency as may be required for proper timing with the synchronizing voltage. In a sound radio receiver, a control circuit that synchronizes r.f. oscillator frequency with carrier frequency of a received signal; often used with au-

Automatic Phase Control

- tomatic tuning systems.
- Automatic Gain Control.**—In a television receiver, a circuit supplying variable negative biasing voltage to change amplification in the i.f. amplifier, the video amplifier, or both. This amplification is decreased while received carrier signals are strong, and increased while they are weak. Similar to automatic volume control in sound radio receivers.
- Automatic Phase Control.**—In color television receivers, a tube circuit similar to that for automatic frequency control in monochrome receivers, but maintaining both frequency and phase of the 3.58-mc color oscillator synchronized with the burst signal.
- Automatic Record Changer.**—An electric phonograph which automatically plays a number of records one after another. Some types play only one side of each record, while others are arranged to turn each record over and play both sides.
- Automatic Regulation.**—Regulation of the current or voltage of an electric device through the effects of its own action rather than by manual operation.
- Automatic Spark Advance.**—Control of ignition spark timing by means of a governor operated by the speed of the engine.
- Automatic Telephone System.**—A system in which the connections between subscribers are completed by automatic switches without an operator.
- Automatic Time Switch.**—A switch operated at certain hours by clockwork.
- Automatic Tracking.**—Servo mechanism tracking.
A radar term.
- Automatic Tuning.**—An electrical, electro-mechanical or mechanical system which tunes a radio receiver automatically to a predetermined station when a button or lever is pushed.
- Automatic Volume Control.**—A radio circuit which automatically maintains the output value of a radio receiver constant within limits while the carrier signal picked up by the antenna is varying in amplitude over a wide range. It is used in practically all modern receivers, for it minimizes annoying fading of distant stations and prevents blasting when tuning suddenly from a weak station to a strong station.
- Automatic Volume Expansion.**—A special audio circuit which increases the volume range of a radio program or phonograph record by making the weak passages weaker and making loud passages louder.
- Automobile Battery.**—A storage battery adapted for use in electric automobiles. A storage battery adapted for use in starting and lighting systems of gasoline automobiles.

Automobile Fuse

- Automobile Fuse.**—A small glass-enclosed fuse for use in the lighting and battery charging circuits of automobiles.
- Auto-Starters.**—A motor starter employing a tapped auto-transformer for applying a reduced voltage to the motor during a period of speed acceleration, after which full line voltage is applied to the motor.
- Auto-Transformer.**—A transformer in which part of the primary winding serves also as the secondary, or in which part of the secondary winding is also in the primary circuit. Some of the energy transferred from the input to the output is through the conductive connection, with the remainder transferred by induction.
- Auxiliary.**—Something extra which is used in emergency or for certain special purposes.
- Auxiliary Circuit.**—Circuits not regularly used for power, light, etc., but used for control purposes, for instruments, etc.
- Auxiliary Spark Gap.**—A small gap placed in the high tension circuit of an ignition system, connected in series between the secondary winding of the ignition coil and the spark plug.
- Auxiliary Switch.**—A switch operated by the action of some other part.
- Average Efficiency.**—The efficiencies at a number of different times or places added together and divided by the number, to obtain the average.
- A.V.C.**—Automatic volume control.
- Average Value.**—A voltage or current found by adding together a large number of instantaneous values and dividing by the number of values. In an alternation of sine wave form the average value is 0.636 times the maximum value.
- Aviation Channels.**—Frequency bands assigned to aviation service for radio communication between aircraft and ground stations. These bands are both above and below broadcast band frequencies.
- A. W. G.**—An abbreviation for "American Wire Gauge."
- AYD.**—Airborne altimeter equipment.
- Azimuth Stabilized PPL.**—The presentation of the radar signals on a PPI tube so that north (magnetic or true) is always at the top of the tube.

B

- b.**—A symbol for susceptance, in mhos.
- B.**—U. S. Navy prefix to identify identification equipment. As ABK, etc.
- B.**—A symbol for magnetic flux denigrator.
- B⁻.**—(B negative or B minus.) Symbol used to designate the point in a circuit to which the negative terminal of the plate supply is to be connected.
- B⁺.**—(B positive or B plus.) Symbol used to designate the point in a circuit to which the positive terminal

B.A.

- of the plate supply is to be connected.
- B. A.**—An abbreviation for "British Association."
- Back Emf.**—Same as counter emf.
- Background Noise.**—Noise heard along with a received radio program, due to atmospheric interference or to circuit conditions.
- Back Porch.**—In a composite television signal, the portion of the black level during horizontal blanking intervals which precedes each horizontal sync pulse. It is part of the pedestal.
- Back Pitch.**—The distance between two sides of a coil and measured in slots, coils or coil sides at the back of the armature.
- Back Turns of Armature.**—The demagnetizing turns of an armature winding.
- Back Swing.**—A portion of a pulse in which the voltage shifts in the direction opposite to that of the main body of the pulse, and occurs at the end of the main body of the pulse.
- A radar term.*
- Baffle.**—A wood, metal or composition horn or flat surface used with a loudspeaker to increase the length of the air path from the front to the back of the loudspeaker diaphragm, thereby reducing interaction between sound waves produced simultaneously by front and back surfaces of the diaphragm. A baffle thus serves to direct the sound produced by a loudspeaker and improve the fidelity of reproduction.
- Bakelite.**—A phenolic compound having high electrical resistance, used as an insulating material in the construction of radio parts such as panels, coil forms, tube sockets, etc.
- Bakelite-mica.**—A fibre-like insulating material.
- Balance Controls.**—In a color television receiver using a three-gun picture tube, adjustments for picture tube screen grid voltages for the purpose of proportioning relative intensities of the three electron beams for required strengths of primary colors.
- Balance Coil.**—An auto-transformer connected to the middle wire of a three wire system.
- Balance Indicator.**—An instrument that indicates when the load on two sides of a three wire system is balanced or out of balance.
- Balanced Armature Unit.**—An electromagnetic sound-producing device used chiefly in magnetic loudspeakers. It has a small moving iron armature which is surrounded by windings carrying audio currents. The armature is pivoted between the poles of a permanent magnet. Variation in the audio current cause corresponding changes in magnetism, making the armature rock back and forth. A diaphragm coupled to the armature produces sound waves.
- Balanced Load.**—An evenly divided load on the two sides of a three wire

- system.
- Balanced Transmission Line.**—Two side-by-side conductors connected to the two parts of a dipole antenna and to the receiver input terminals. Signal electron flow is simultaneously equal and opposite in the conductors. Distinguished from an unbalanced or coaxial transmission line.
- Balancer Set.**—In a three wire system, generators electrically connected in series and mechanically direct connected with the neutral or intermediate wires attached between the generators.
- Balancing Resistance for Generators.**—A resistance used to control the voltage of generators connected in parallel with each other.
- Ballast Lamp.**—A lamp bulb with an iron wire filament connected in series with the "A" battery to control the filament voltage by the resistance of the iron.
- Ballast Resistor.**—A special type of resistor used in radio apparatus to compensate for fluctuations in a.c. power line voltage. It is usually connected in series with the power supply to the receiver or amplifier. The ohmic value of a ballast resistor increases automatically with increases in current through it, thereby tending to maintain essentially constant current despite variations in line voltage.
- Ballast Tube.**—A ballast resistor mounted in an evacuated glass or metal envelope. This construction improves the automatic voltage regulating action by reducing radiation of heat from the resistor element.
- Ball Cord Adjuster.**—A ball with two holes through which a drop cord is passed for the purpose of adjusting the cord's length.
- Ballistic Galvanometer.**—A galvanometer which measures electrical quantities, coulombs, ampere minutes, etc.
- Band.**—In radio, frequencies which are within two definite limits and are used for a definite purpose. Thus, the standard broadcast band extends from 550 kc. to 1600 kc.
- Bandpass Amplifier.**—The chrominance amplifier in a color television receiver.
- Bandspread Tuning Control.**—A small variable condenser connected in parallel with the main tuning condenser of a short-wave receiver to provide more accurate tuning.
- Band Switch.**—A switch which simultaneously changes all tuning circuits of a radio receiver or transmitter to a desired band of frequencies.
- Bank of Lamps.**—A number of incandescent lamps connected in series or parallel, usually employed for resistance.
- Bank of Transformers.**—A number of transformers connected to one or more circuits in common.
- Bar Generator.**—A type of signal generator that delivers frequencies corresponding to several color or chrominance signals of various hues or color phases. The colors appear as bars or bands on the picture tube of a color receiver.
- Bar Magnet.**—A straight magnet with poles at opposite ends.
- Bar Wound Armature.**—An armature whose conductors are of copper rods or bars rather than of wires.
- Barkhausen Oscillation.**—High-frequency oscillation in television horizontal output amplifier tubes and circuits. Causes a ragged, dark, vertical line at the left on the picture tube viewing screen.
- Barrage Reception.**—A system which neutralizes interfering waves of great strength and allows receiving in spite of them.
- Barreter.**—An instrument for measuring the current in telephone circuits.
- Barreter.**—A device using variations of resistance caused by changes in heat due to a current in a conductor. The changes in resistance affect the receiving instrument.
- Bass.**—Low audio frequencies.
- Bass Control.**—A manually-adjusted control provided on a radio receiver for the purpose of emphasizing the loudness of the bass notes in a radio program.
- Bass Compensation.**—Any means of offsetting the natural drop in the response of the human ear to low audio frequencies at low volume levels.
- Bass Response.**—The ability of a loudspeaker to handle low audio notes, or the sensitivity of the human ear to low audio notes.
- Bath.**—The electrolyte used in electroplating.
- Battery.**—A number of similar parts working together. Usually, a number of electric cells, either primary or storage cells, connected together to secure a desired voltage or amperage from the combination.
- Battery Acid.**—Pure sulphuric acid suitable for use in storage battery electrolyte.
- Battery Ammeter.**—An ammeter used for measuring the current flowing into or out of a battery.
- Battery Box.**—The box or case in which the several cells are held to form an electric battery.
- Battery Capacity.**—The amount of discharge, measured in ampere-hours or in watt-hours, that may be secured from a battery.
- Battery Carbon.**—Carbon used for an electrode in a primary cell.
- Battery Carrier.**—The support or framework carrying a complete storage battery.
- Battery Case.**—The battery box.
- Battery Cell.**—A single cell which, with others like it, forms an electric battery. Usually applied to storage battery cells.
- Battery Charger.**—An alternating cur-

Battery Charging Cable

rent rectifier suited for use in charging storage batteries with the rectified direct current.

Battery Charging Cable.—Acid resisting cable suitable for use around storage batteries having acid in their electrolyte.

Battery Charging Plug.—A plug connector inserted into a socket to complete the connections for charging the storage batteries of electric vehicles.

Battery Charging Rectifier.—An alternating current rectifier suitable for use in charging storage batteries usually for batteries of only a few cells.

Battery Charging Rheostat.—A rheostat inserted in a direct current, constant voltage, battery charging circuit to regulate the amperage of charge.

Battery Connector.—A lead link used to connect the terminal of one battery cell to the terminal of an adjacent cell in the same battery.

Battery Copper.—A piece of copper shaped for use as an electrode in primary electric cells.

Battery Cover.—A protecting cover to be placed over a storage battery to prevent entrance of dirt into the cells and to prevent accidental short circuits between the terminals and connectors of the cells.

Battery Cradle.—A battery carrier.

Battery Current.—Current secured from a storage battery or a primary cell.

Battery Discharger.—An adjustable resistance or rheostat allowing current to flow through it from a storage battery in discharging the battery for testing purposes or during processes of repair.

Battery Electrode.—One of the elements inserted in the electrolyte of an electric cell and by means of which the current enters or leaves the cell.

Battery Electrolyte.—The liquid in which the electrodes of an electric cell are placed and through which the battery current passes between the electrodes.

Battery Filler.—A syringe used for adding water or electrolyte to the cells of storage batteries.

Battery of Generators.—A number of generators connected together in series or in parallel and furnishing current to a single circuit.

Battery Hold-Down.—A small piece of wood, hard rubber, or celluloid which prevents the separators between storage battery plates from rising out of the electrolyte.

Battery Hydrometer.—A hydrometer adapted for testing the specific gravity of storage battery electrolyte to indicate the condition of the battery's charge.

Battery Ignition.—An ignition system for internal combustion engines. It cells as the source of current. Usual-

Battery Insulator

ly used with a generator to re-charge the battery when it is of the storage type.

Battery Insulator.—A separator.

Battery Insulator.—A device for maintaining the proper distance between the edges of plates in a storage battery cell.

Battery Jar.—The container holding the plates and the electrolyte of a storage battery or primary cell.

Battery Jar Spacer.—A piece of wood or fibre placed between the jars or cells of storage batteries to fill extra space in the battery electrolyte.

Battery Liquid.—Battery electrolyte.

Battery Mounting.—Fastening devices which prevent a battery from moving about in its carrier.

Battery Oven.—A heating oven into which storage batteries are placed for the purpose of softening their sealing compound when the cells are to be opened.

Battery Paint.—An acid-resisting paint with an asphaltum base used on storage batteries and battery carriers.

Battery Plate.—A plate which forms an electrode in a battery cell.

Battery Polarization.—The formation of the gases hydrogen and oxygen on the plates of a battery during charge and discharge. The polarization is due to electrolytic action.

Battery Receiver.—A receiver which uses batteries as a power source.

Battery Resistance.—The internal resistance of an electric cell or a series of cells forming a battery. The resistance through the electrodes and the electrolyte.

Battery Solution.—Storage battery electrolyte.

Battery Steamer.—An apparatus for introducing steam into the cells of a storage battery for the purpose of softening the sealing compound when the cells are to be opened.

Battery Still.—A still for distilling water to be used in storage battery cells.

Battery Syringe.—A syringe used for adding water or electrolyte to the cells of a storage battery.

Battery Terminal.—A terminal through which current enters or leaves a battery.

Battery Turntable.—A small rotating platform on which storage batteries are placed while work is being done on them.

Battery Vise.—A vise in which storage batteries are clamped while their plates or jars are being removed.

Battery Voltage.—The voltage between the terminals of a battery.

Battery Water.—Distilled water or other water pure enough for use in the electrolyte of storage batteries.

Bay.—A single set of antenna conductors, consisting of one dipole, with associated reflectors and directors if has a storage battery or primary

Bayonet Base

used. Two or more similar bays constitute an array.

Bayonet Base.—A type of tube and lamp base having two projecting pins on opposite sides of the smooth cylindrical base; these engage in corresponding slots in the bayonet shell socket.

Bazooka.—A terminating device used to convert an unbalanced line to a balanced line.

B Battery.—A battery having many small cells connected in series, used for supplying d.c. voltages to the plate and screen grid electrodes of radio tubes used in battery-operated equipment.

Beacon.—Automatic transmitter operated by a radar signal to enable an aircraft to determine its azimuth and range with respect to the beacon.

Beam Cutoff.—In a television picture tube or cathode-ray tube, the condition with which control grid potential is so negative with respect to cathode potential as to prevent electron flow in the form of a beam.

Beam Power Amplifier Tube.—A special type of vacuum tube designed for use in the output stage of a radio receiver. Deflecting electrodes concentrate the electrons into beams to give high power output along with desirable operating characteristics.

Beam Width.—Width (angle between $\frac{1}{2}$ power intensities) in azimuth of the effective radiation from an antenna.

Beat.—Audible vibrations from regular interference between two sets of waves not quite in unison.

Bearing Loss.—The loss of power through friction of the bearings in an electric machine, determined with the brushes removed and with no current in the windings.

Beat Frequency.—The frequency obtained when signals of two different frequencies are combined and rectified. The beat frequency is equal in numerical value to the difference between the original frequencies.

Beat Frequency Oscillator.—An audio frequency oscillator whose output is obtained by combining and rectifying two known higher-frequency signals which are generated by or obtained from separate circuits.

Beat Reception.—Production of audible beats in a receiver by the combination of two currents having different frequencies.

Bedsprings.—Broadside array with flat reflector.

A radar term.

Bee's Wax.—Wax from the honeycomb of the bee, used for mixing with other waxes and oils for insulating compounds.

B Eliminator.—An a.c. power pack which converts a.c. power line voltage to the pure d.c. circuits of radio tubes, thereby eliminating the need for B batteries.

Bell Ringing Transformer

Bell Ringing Transformer.—A small transformer attached to the house lighting circuits and furnishing current at low voltage for operating door bells.

Bell Shaped Magnet.—A cylindrical permanent magnet, open at one end and along two sides, used in certain types of magnetos.

Bell Wire.—A common term for the cotton-covered B. & S. No. 18 copper wire used for making doorbell and thermostat connections in homes.

Bench Charge for Battery.—The charge given an automobile storage battery when it has been removed from the car and placed on the charging bench.

Bending.—In a television picture, curvature to either the left or right of lines which should be vertically straight. Usually occurs at and near the top of pictures.

Bent Gun Ion Trap.—A television picture tube ion trap in which initial bending or deflection of both ions and electrons results from only part of the electron gun being in line with the tube axis, while the remainder is at an angle. Requires a single external magnet.

B-H Curve.—A curve showing the relations between the applied magnetomotive force and the flux density produced in a given grade or kind of magnetic material.

Bias.—The fixed voltage applied between the control grid and cathode electrodes of a radio tube. Also called C bias.

Bias Cell.—A tiny 1-volt or $1\frac{1}{4}$ -volt cell used singly or in series to provide a negative C bias voltage for a vacuum tube amplifier circuit. It will last indefinitely if not overloaded.

Bichromate Cell.—A primary electric cell using zinc and carbon for electrodes and bichromate of potash and sulphuric acid for electrolyte. Used for large currents of short duration.

Bi-Metallic Wire.—Copper clad steel wire or aluminum clad steel wire combining strength with fair electrical conductivity.

Binding Post.—A screw terminal for connecting the ends of wires to electrical parts or circuits.

Bipolar.—Having two magnetic poles, one north and the other south. Two-pole.

Birmingham Wire Gauge.—A wire gauge often used in telegraph and telephone work.

Black-and-white.—In television, the same as monochrome. Not related to color.

Black Face Tube.—A television picture tube in which unilluminated phosphors of the viewing screen are of rather dark gray shade, to lessen reflections from light sources in front of the tube.

Black Induction.—The effect produced by the demagnetizing turns on an armature.

Black Lead

Black Lead.—Graphite, a form of carbon.

Black Level.—The steady level of television carrier current or voltage while not modulated by any of the signals. The base or starting value above which rise the synchronizing and equalizing voltages of the television signal.

Black Oxide of Manganese.—A chemical compound used as a depolarizer in dry cells.

Blacker Than Black.—In a composite television signal, any voltage on the sync pulse side of the black level, not on the picture signal side. Such voltage cuts off or blanks the electron beam.

Blanking Bars.—Dark vertical or horizontal areas or strips with portions of a television picture above and below or to the left and right of the dark bars. A bar extending up and down represents horizontal blanking intervals between picture lines, while a bar from side to side represents vertical blanking between fields or frames.

Blanking Signal.—The portion of a television signal that blanks or extinguishes the electron beam in the picture tube of the receiver while the beam is being blanked in the camera tube at the transmitter.

Blasting.—Overloading of an amplifier or loudspeaker, resulting in severe distortion of loud sounds.

Bleeder Current.—A current drawn continuously from a power pack to improve its voltage regulation or to increase the voltage drop value across a particular resistor.

Bleeder Resistor.—A resistor which is used to draw a fixed bleeder current value from a power pack.

Blocking Condenser.—Any condenser used in a radio circuit to block the flow of direct current while allowing a.c. signal currents to pass.

Blocking Oscillator.—A relaxation oscillator in whose grid circuit a capacitor is charged to make the control grid so highly negative as to cut off or block plate current. Each cycle of oscillation begins when the grid capacitor loses enough charge through any grid circuit resistance to reduce negative grid voltage to a value that allows resumption of plate current.

Blocking Oscillator Driver.—Circuit which develops a square pulse used to drive the modulator tube and usually contains a line controlled oscillator (blocking) to shape pulse into square waves.
A radar term.

Blooper.—Slang term applied to a regenerative receiver which radiates a signal when improperly tuned.

Blow.—To "blow-out" a fuse, to burn out a wire, etc.

Blow-Out Magnet.—A strong permanent or electromagnet for reducing or deflecting the arc between electrodes or contacts.

Blue Beam Magnet

Blue Beam Magnet.—A small permanent magnet, movement of which alters the direction of the electron beam for blue phosphor dots in a three-gun color television picture tube. It is a convergence adjustment.

Blue Gun.—In a three-gun color television picture tube, the electron gun whose beam strikes phosphor dots emitting the blue primary color.

Body Capacity.—The capacity existing between the human body and a piece of radio apparatus.

Bolometer.—An instrument for measuring slight changes in temperature by the change of resistance caused in a conductor.

Bond.—A connection between metallic parts which makes them a continuous electrical conductor.

Bonding.—Connecting the metal housings and shields of radio parts together or to the chassis with heavy wire so they will be at the same potential (usually ground potential).

Bonding Resistance of Rail.—The total resistance of the rail bond and its joints.

Boosted B-voltage.—In the d.c. voltage supply system of a television receiver, a direct voltage to which has been added the potential of pulses in the damper tube circuit. After filtering, the power supply positive potential is increased by 50 or more volts.

Booster.—One or more high-frequency amplifying stages constructed in a separate unit for connection between a television or u.h.f. antenna and the receiver for increasing the strength of carrier signals.

Booster.—A generator in series with a circuit for the purpose of increasing the circuit voltage.

Booster Converter.—A combination of a converter and an alternating current generator used for controlling the voltage in a circuit.

Booster Transformer.—A transformer connected to a circuit for the purpose of raising the circuit voltage or overcoming the line drop in voltage.

Bootstrap Driver.—Vacuum tube circuit used to produce square pulse which drives modulator tube. Duration of pulse is determined by pulse-forming line. Circuit is called bootstrap driver because voltages on both sides of the pulse forming line are raised simultaneously with voltages in the output pulse but their relative difference (on both sides of the pulse forming line) is not affected by the considerable voltage rise in the output pulse.
A radar term.

Bound Charge.—An electric charge which remains on an insulated conductor due to the effect of another nearby charge of opposite polarity.

Box Connector.—An attachment for fastening the ends of cables to panel boxes.

Box Rheostat.—A rheostat of large

Braided Wire

capacity with its resistance arranged in compact form.

Braided Wire.—Flexible wire composed of small strands woven or braided together.

Brake Horsepower.—The actual power, measured by some form of dynamometer attached to the machine being tested.

Branch Circuit.—The portion of a wiring system that extends beyond the final overcurrent device (fuse, cut-out or circuit breaker) that protects the circuit. The portion of the circuit leading to lamps, appliances and other power-consuming equipment.

Branch Cutout.—A fuse block protecting a branch circuit.

Braun Tube.—A form of X-ray tube used for examining the wave form of high frequency alternating currents.

Break.—An open circuit.

Break-up.—Incorrect colors resulting from rapid motion of objects in color television pictures.

Break Wheel.—A wheel having metal pieces set into its rim at various points through which a circuit is completed when the points come underneath a brush or contact.

Breaking Down of Insulation.—Failure of insulation so that current passes through it. Caused by too high voltage, by cracks and holes, or by rotting and decay.

Bridge.—A Wheatstone bridge.

Bridge Circuit.—Two parallel paths connected between a common source of potential, with each path divided into two parts at intermediate junction points, and with an indicating element such as a galvanometer bridged from one of these junctions to the other. The four parts into which the paths are thus divided are called the arms of the bridge. The arms contain various kinds of circuit elements, usually such as have resistance or impedance.

Bridge Rectifier.—A type of full-wave rectifier which employs four rectifying elements in the four arms of a bridge circuit. Current during one alternation is carried by two elements which are in opposite arms of the bridge.

Bridging Set.—A telephone set designed for connection to its circuit in parallel.

Brightness Control.—In a television receiver, the control which varies the average illumination of the reproduced image.

Brightness Signal.—The luminance signal in color television.

Britannia Joint.—A wire joint in which the two ends are laid side by side and fastened with a separate binding wire.

British Thermal Unit.—The amount of heat that increases the temperature of one pound of water one degree Fahrenheit.

Broad Band Amplifier

Broad Band Amplifier.—An amplifier providing satisfactory gain throughout a frequency range having a large ratio of highest to lowest frequencies. An example is the television video amplifier, which may handle frequencies from 60 cycles to four megacycles per second.

Broad Band Antenna.—A television antenna capable of satisfactory pickup for carrier signal energy throughout a wide range of channel frequencies, usually in both bands of the very-high frequency range or over the entire ultra-high frequency range.

Broadcast.—A radio transmission intended for reception by the general public.

Broadcasting.—A general term applying to the radiation of radio waves carrying programs intended for public interest, education, or entertainment.

Broadcast Band.—The band of frequencies between 550 kc. and 1600 kc., to which are assigned all standard broadcast stations operating in the United States.

Broadcast Station.—A radio station used for transmitting programs to the general public.

Broad Tuning.—A condition wherein two or more stations are picked up at one setting of a receiver tuning dial, due to lack of selectivity in the tuning circuits.

Bronze.—An alloy of copper and tin, much used for conducting parts in switches, etc.

Brown & Sharpe Wire Gauge.—Same as the American wire gauge.

Brush.—A conductor, of metal or carbon, that rests against the moving surface of a commutator or slip ring for the purpose of allowing current flow between the two parts.

Brush Contact Loss.—The voltage drop across the contact between a brush and the commutator or slip ring.

Brush Discharge.—A faint glowing discharge between pointed spark gaps or electrodes carrying high voltage. It takes place at a voltage slightly below that which will cause a spark or disruptive discharge.

Brush Friction Loss.—The power lost in an electric machine through friction of its brushes on the commutator or slip rings. It is the difference between the power required to drive the machine idle with the brushes in place, and the power required to drive it with the brushes removed.

Brush Holder.—The part of a generator or motor that supports the brushes so that they may slide or pivot in following the commutator or slip ring surface.

Brush Lag.—The distance that motor brushes are moved against armature rotation to overcome the effect of armature reaction.

Brush Lead.—The distance that generator brushes are moved with armature rotation to overcome the effect

Brush Pig Tail

of armature reaction and improve the commutation.

Brush Pig-Tail.—A short length of flexible wire between a brush and the circuit to which the brush is connected. It avoids taking current through the joints of the brush holder.

Brush Pressure.—The pressure of the end of the brush on its commutator or slip ring. Measured in ounces or pounds per square inch.

Brush Rigging.—All of the parts that support the brushes and brush holders in a generator or motor.

Brush Rocker.—A support for brushes and their holders which allows the position of the brushes to be shifted around the commutator ring.

Brush Yoke.—A framework or plate supporting the holders for two or more brushes.

B. & S.—An abbreviation for "Brown & Sharpe" wire gauge. It is the same as the American wire gauge.

B-Scan.—Presentation in which signal appears as a bright spot with azimuth angle as the horizontal coordinate and range as the vertical coordinate.

A radar term.

B. T. U.—An abbreviation for "British Thermit unit," a measure of quantity of heat.

Buck.—To oppose.

Bucking.—Opposing one action by another of similar kind but opposite in effect.

Bucking Coil.—A winding or coil on an electromagnet or a field winding which opposes the magnetism produced by the main winding.

Buckling.—Twisting or warping of storage battery plates.

Buffer.—Any part or circuit used to reduce undesirable interaction between radio circuits.

Buffer Condenser.—A condenser connected between the anode and cathode of a cold-cathode rectifier tube to reduce voltage surges which might affect following parts in the apparatus.

Buffer Stage.—An amplifier stage used to prevent feed-back of energy from a power stage to a preceding stage.

Bug.—A semi-automatic code transmitting key in which movement of a lever to one side produces a series of dots, and movement to the other side produces a single dash.

Building Up of Generator.—The effect of the residual magnetism in the field magnets of a generator by which production of voltage is started in the rotating armature before the field windings are fully excited.

Built-in Aerial.—An aerial which is an integral part of a radio receiver. It may be a loop aerial, a power line connection or a sheet of metal mounted in the receiver cabinet.

Bulb.—The glass part of an incandes-

Bunched Cable

cent lamp in which the filament is carried.

Bunched Cable.—A cable containing a number of separate conductors.

Bunsen Cell.—A primary electric cell using zinc and carbon for electrodes. It will deliver a large current.

Burn-Out.—Melting through of an electrical conductor due to the heating effect of an excessive current.

Burning Rack.—A framework in which storage battery plates are supported while they are being joined to their plate straps.

Burst.—A color television synchronizing signal consisting of not less than eight sine-wave cycles at a frequency of 3.579545 cycles per second occurring once during each horizontal line period while there are horizontal sync pulses, and appearing on the back porch of the pedestal. The burst signal originates from the master oscillator of the transmitter, and is used in the receiver for synchronizing phase and frequency of the color oscillator.

Burst Gate.—In a color television receiver, a tube which passes burst signals to color oscillator control circuits but is held at plate current cutoff during other portions of the composite color signal. The tube is gated to pass only burst signals.

Burst Oscillator.—The color oscillator.

Burst Pedestal.—Average amplitude of burst sine waves, or zero burst signal voltage, considered with respect to the horizontal blanking pedestal.

Bus Bar.—A heavy rod or bar of copper, brass, or bronze carrying one of the main circuits on a switchboard or between distributing points.

Bushing.—An insulating sleeve for protecting a conductor where it passes through a hole.

Busway.—A protective enclosure for buses, which are conductors formed by bars or rods of large cross section.

Butt Joint.—A joint formed by bringing the ends of two wires in contact and joining them by soldering, brazing or welding.

Buzzer.—An electromagnetic device in which attraction of an armature by an electro-magnet interrupts the current flow; a spring then pulls the armature back, closing the circuit again so that the process repeats itself and creates a buzzing sound.

Buzzer Test.—Use of a vibrating buzzer to make high frequency impulses while testing the adjustment of a crystal detector.

B.W.G.—An abbreviation for "Birmingham Wire Gauge."

BX.—Flexible metal conduit used to protect power line wiring in buildings and in high-power radio apparatus.

B. X. Conductor.—An electric cable covered with a spirally wound steel strip for mechanical protection.

By-Pass Condenser.—A condenser used

B-Y Signal

to provide a low-impedance path for radio or audio signals around a resistor or between a circuit terminal and ground.

B-Y Signal.—A blue-minus-Y or blue-minus-luminance color television signal which is a component of the chrominance signal. When combined with a plus luminance (+Y) signal, the result is the blue primary color signal.

C

C.—Letter used to designate a condenser, a grid bias voltage, or the centigrade temperature scale.

C.—(C negative or C minus.) Symbol used to designate the point in a vacuum tube circuit to which the negative terminal of the grid bias source is to be connected.

C+.—(C positive or C plus.) Symbol used to designate the point in a vacuum tube circuit to which the positive terminal of the grid bias source is to be connected.

Cabinet.—An enclosure for switches, fuses and wire connections, designed for either surface or flush mounting and having a frame or trim on which are hung swinging doors.

Cable.—A stranded conductor (called a single-conductor cable) or a combination of conductors insulated from one another (called a multiple-conductor cable).

Cable.—A conductor composed of a number of separate conductors, a stranded conductor.

Cable Box.—An enclosure in which joints and connections are made between cables for different circuits.

Cable Clamp.—A round clamp for attaching cables to their supports.

Cable Clip.—A half-round clamp for holding a cable against a flat surface.

Cable Core.—The conductors inside a cable.

Cable Grip.—A device which grips around the cable that is to be pulled into position.

Cable Head.—A small cable box.

Cable Shield.—A piece of metal which protects a cable where it passes through an opening.

Cadmium.—A metal sometimes plated on a steel chassis to improve its appearance and prevent rusting.

Cadmium Meter.—A voltmeter whose scale is marked with the readings employed in making a cadmium test of storage battery plates.

Cadmium Test.—A test of the individual condition of charge or discharge of the negative and positive plates in a storage battery. A piece of cadmium is used as a neutral electrode from which voltage readings are made to either the positive or the negative plate groups.

Calibrate.—To compare the readings of a measuring instrument with some fixed standard or with another instrument and note or correct any

Calibration Marker

variation from the correct readings.

Calibration Marker.—Same as range marker.

A radar term.

Call Letters.—Government-assigned identifying letters for a radio station.

Cam.—An irregular-shaped rotating or sliding part used to convert rotary motion to linear motion, or vice versa. Used extensively in mechanical push-button tuning systems.

Cam Type Regulation.—A form of constant voltage regulation for direct current generators in which a cam on the armature shaft operates a pair of contacts controlling resistance in the shunt field circuit.

Cambric Tape.—Tape made of cotton treated with linseed oil.

Canal Rays.—Positive rays passing through the cathode of an X-ray tube when it is perforated.

Candelabra Lampholder.—A lampholder having a nominal screw diameter of $\frac{1}{2}$ inch.

Candle-Foot.—The amount of light from a standard candle one foot away.

Candlepower.—A unit of intensity of light from a source; equal to the intensity from a standard candle.

Canopy.—A cover for the part of an electric fixture that enters a wall or support.

Caoutchouc.—Rubber gum.

Capacitance.—The ability to receive or carry a charge of electricity, the ratio between the charge and the voltage that causes it. Measured in farads or microfarads.

Capacitive Circuit.—A circuit containing more capacitive reactance than inductive reactance.

Capacitive Coupling.—A coupling with which energy transfer results from potential difference across the reactance of a capacitor which is common to the two coupled circuits.

Capacitive Reactance.—The reactance which a condenser offers to a.c. or pulsating d.c. It is measured in ohms, and decreases as frequency and capacity are increased.

Capacitive Time Constant.—The time during which a capacitor initially charged to any voltage loses approximately 63.2 per cent of initial charge through circuit resistance. Equal, in seconds, to the product of capacitance in microfarads and circuit resistance in megohms.

Capacitor.—Condenser.

Capacitor.—A condenser or an electrostatic condenser.

Capacitor Motor.—A split-phase motor in which a capacitor or capacitors displace part of the current in phase from the remainder in order that the motor may be self-starting on single-phase supply current.

Capacity.—The electrical size of a condenser, determining the amount of electrical energy which can be stored

Capacity of Coil

in a condenser by a given voltage. In radio work, capacity is measured both. It comes ahead of the inductance component.

in microfarads (mfd.) and micro-microfarads (mmfd.); 1 mfd. is equal to 1,000,000 mmfd.

Capacity of Coil.—The electrostatic capacity of the conductors in a coil to carry a charge of electricity like the charge of a condenser. All circuits have a certain amount of such capacity.

Capacity Component of Spark.—The part of a spark caused by discharge of the electrostatic capacity of a winding or of a condenser, or by

Capacity of condenser.—The amount of electricity, the electric charge, that a condenser will receive and hold. Measured in farads or microfarads.

Capacity Ground.—Using a capacity, a condenser, in place of the ground. Capacity of conductors may also be used.

Cap and Cone Insulator.—An insulator for carrying electric railway cables. It is made of two parts, a cap on top and a cone underneath.

Carbon.—One of the elements, much used in electrical work for making brushes, electrodes, contacts, etc. It is a fair conductor and withstands heat and sparking.

Carbon.—An element used in the construction of radio parts such as resistors, dry cells, and microphones.

Carbon Arc Lead Burning.—Lead burning with an arc formed between a rod of carbon and the lead to be melted.

Carbon Arc Welding.—Welding with an arc formed between two carbon electrodes or between a carbon and the metal being welded.

Carbon Battery Plate.—A carbon electrode used in several different types of primary electric cells.

Carbon Brush.—A current-carrying brush made of carbon, of carbon and graphite, or of carbon and copper.

Carbon Cell.—A primary electric cell in which the carbon is consumed in the production of current. No practical form has yet been devised.

Carbon Contact.—A circuit breaking contact made of carbon. It resists the effects of sparking and heating.

Carbon Disc.—A piece of carbon used in a rheostat to produce resistance.

Carbon Filament Lamp.—An incandescent electric lamp using a filament of carbon. It is not as efficient as lamps with tungsten filaments, but the carbon is not so easily broken. An old style of lamp.

Carbon Holder.—The part of an arc lamp that carries the carbons.

Carbon Pile Regulator.—A resistance composed of pieces of carbon arranged to be held loosely or tightly together, thus increasing or decreasing the resistance through them for controlling the voltage or current through a circuit.

Carbon Resistor

Carbon Resistor.—A resistor made of carbon particles and a ceramic binder molded into a cylindrical shape, with leads attached to opposite ends.

Carbon Rheostat.—A rheostat whose resistance is composed of pieces of carbon that are pressed more tightly together to reduce the resistance, and allowed to separate to increase the resistance.

Carboning a Lamp.—Inserting fresh carbon in arc lamp.

Carbonize.—To turn some other material into carbon. Making the threads for lamp filaments into carbon.

Carborundum.—A compound of carbon and silicon used in crystal form to rectify or detect radio waves, as in a crystal detector.

Carrier.—A current, voltage or radio wave having the assigned frequency of a radio station. When no sounds are being transmitted, such as during pause between portions of a program, only the unmodulated carrier signal is present in the transmitting and receiving system.

Carrier Color Signal.—The chrominance signal.

Carrier Frequency.—The frequency of the original unmodulated radio wave produced by a transmitter. In the case of a broadcast station, the carrier frequency must be maintained within a few cycles of the frequency value assigned to that station by the Federal Communications Commission.

Cartridge Fuse.—A fuse enclosed in a tube of fibre or glass so that there is no exposed flash when the fuse burns out.

Cascade Amplification.—The use of two or more electron tubes, each one of which amplifies the waves received from the tube preceding it in the circuit.

Cascade Connection.—Sending the current from one electrical unit through another unit to produce some desired effect.

Cascade Control.—Control of motors connected together. Concatenation control of motors.

Cascade Converter.—A motor combined with a rotary converter, the armature of the converter receiving current directly from the secondary of the motor.

Cascade Amplifier.—A radio-frequency or very-high frequency amplifier consisting of two triodes, usually in a single envelope. Input, as from an antenna coupling, is to the grid of the first triode. The second, operated as a grounded grid amplifier, has signal input to its cathode from the plate of the first triode. Advantages are high gain, low noise factor, and freedom from oscillation.

Catenary Suspension.—Supporting electric trolley wires with a system of cross wires.

Cathode.—The electron-emitting electrode of a radio tube. Thermionic

vacuum tubes employ heated cathodes; the heat is either supplied indirectly by a filament located inside the cathode or is supplied by current flowing through the cathode itself. In this latter case, the cathode is also the filament.

Cathode Follower.—An electron tube whose plate is grounded through a capacitor of low reactance at signal frequencies, with signal input between control grid and plate by way of ground, and with signal output from across a resistor connected from cathode to ground, which means that output is from between plate and cathode. There is no amplification, but always some loss of signal voltage between input and output. Provides high input and low output impedance, with wide frequency response.

Cathode Rays.—The rays that come from the vacuum tube cathode connected to the negative of the source. When they strike a solid substance in the tube, they produce X-rays.

Cathode Ray Tube.—A special type of vacuum tube in which a beam of electrons is directed at a fluorescent screen by an electron gun, producing a green or white glow on the screen at the point of impact. The beam passes between electrostatic deflecting plates or electromagnetic deflecting coils which can make it bend enough to produce any desired pattern or picture on the screen when the proper varying voltages are applied to the deflecting system.

Cathode Ray Tuning Indicator.—A small cathode ray tube used in radio receivers to indicate when a station is tuned in accurately.

Cathode Ray Oscilloscope.—A test instrument using a cathode ray tube to make visible the wave form of a varying current or voltage.

Cation or Cathion.—The substance produced at the terminal connected to the negative of the source in electrolytic action.

Catwhisker.—A small, sharply pointed wire used in crystal detector to make contact with a sensitive point on the surface of the crystal.

Cavity Resonator.—A metallic enclosure or chamber within which is air or a vacuum, and in which are produced electromagnetic waves that oscillate at a resonant frequency determined by the shape and dimensions of the chamber. The action is similar to that of an inductance and a capacitance in the ordinary resonant circuit, but higher frequencies may be attained with less dissipation of energy.

C Battery.—The battery used for supplying a negative C bias to the control grid of a vacuum tube.

C Bias.—An applied voltage used to bias the control grid of a vacuum

tube negative with respect to the cathode.

Ceiling Button.—A porcelain insulating piece for attaching drop cords to a ceiling.

Cell.—A single unit capable of serving as a d.c. voltage source. A primary cell, such as a dry cell, cannot be recharged when exhausted. A secondary cell, such as the cell of a storage battery, can be recharged when exhausted by passing a current through it in the reverse direction.

Cell Connector.—A connection between the terminals of two adjacent cells.

Cell Cover.—A cover that closes the top of the jar in a battery cell.

Cell Tester.—A voltmeter connected across a resistance through which a discharge from a storage cell is taken while the cell voltage is read.

Cell Vent.—An opening through a cell cover out of which may escape the gases caused by electrolytic action.

Cellular Metal Floor Raceway.—A raceway formed in the hollow spaces of cellular metal floors, together with suitable fittings, forming a passage-way for electric conductors.

Celluloid.—A material made from gun-cotton and oil. It forms a good insulator but takes fire easily.

Celluloid Separator.—A storage battery plate separator made of celluloid.

Cementation.—The formation of small quantities of lead sulphate in storage battery plates as they dry after manufacture. The sulphate binds the materials firmly together.

Center of Distribution.—The point in a system of distributing circuits at which the supply or feeder is connected.

Centering Control.—In a television receiver, a control used to shift the entire reproduced image on the screen. The horizontal centering control moves the image horizontally in either direction, while the vertical centering control shifts the image up or down.

Centering Diode.—A clamping circuit used in some types of PPI indicators.

Centiampere.—The one hundredth part of an ampere.

Centigrade.—The European scale of temperature in which 0 is the temperature of melting ice and 100 is the temperature of boiling water at sea level.

Centimeter.—In the metric system of measurements, a unit equal to one-hundredth of a meter, or approximately .39 inch. There are 2.54 centimeters in one inch.

Central Station.—A generating plant centrally located in a town for supplying power and light.

Centrifugal Cutout.—A cutout in which the contacts are thrown open by centrifugal force and are closed by a spring or by gravity.

Ceresin.—A kind of wax used in insu-

lating compounds.

Chain.—In radio, a network of radio stations connected together by special telephone lines so that all can broadcast simultaneously a program originating at a key station.

Chain Reaction.—Any reaction, nuclear or chemical, in which the process continues by virtue of the action of one of the products to cause the reaction to continue. Example: Uranium fission is caused by a neutron, and the fission process releases more neutrons which can cause more fissions.

Chain Winding.—An alternating current armature winding whose diagram appears like a chain.

Channel.—The range or band of frequencies within which are the carrier and sidebands for signals of a radio, television, or other transmitter. Also, the path or all circuits designed to carry some particular kind of signal, although other signals may travel more or less incidentally in the same path.

Characteristic.—The ability of an electrical device to produce certain results, a description of how it performs under certain conditions.

Characteristic Impedance.—Impedance of a transmission line as determined by the ratio of inductance to capacitance in any length. Since both factors increase or decrease together as the line is lengthened or shortened, the ratio remains constant. Consequently, this impedance depends only on design or structure of the line and is not altered by length or by frequency.

Charge.—A quantity of electrical energy held on an insulated object. The electrical energy stored in a condenser. The act of supplying electrical energy to a metal object, to a condenser, or to a storage battery. When an object has more electrons than normal, it has a negative charge. When an object has less electrons than normal, it has a positive charge.

Charging.—Sending a flow of current through a storage battery to bring the plates into condition to cause a flow of current on discharge.

Charging Current.—The direct current used for charging a storage battery.

Charging Fuse.—A fuse connected in the charging circuit of a storage battery.

Charging Rate.—The number of amperes flowing through a storage battery being charged.

Charger.—A device used to convert alternating current into a pulsating direct current which can be used for charging an exhausted storage battery.

Chassis.—The metal framework on which the parts of a radio receiver or transmitter are mounted. Also used to designate the completed piece of radio equipment before it is mounted in a cabinet.

Choke Coil.—A coil used to limit the flow of alternating current while allowing direct current to pass. R.F. choke coils have air or pulverized iron cores, while a.f. choke coils and filter chokes have iron cores.

Choke Flange Joint.—Nonrigid connection between two wave guides and containing an L shaped cavity.

A radar term.

Choke Joints.—Wave guide joints designed for low losses.

A radar term.

Chroma.—Color quality which is determined only by hue and saturation, without reference to brightness or luminance. The word may be used also as referring only to saturation.

Chroma Control.—A color television control that alters the saturation of colors in reproduced pictures.

Chromaticity.—The quality of a color which depends only on hue and saturation, not on luminance or brightness.

Chromatron.—A type of single-gun color television picture tube. The Lawrence color tube.

Chromic acid cell.—A primary electric cell using two carbons and a zinc between them as electrodes. It will deliver large currents.

Chrominance.—The manner in which a color differs from a gray of equal brightness or luminance, chrominance then referring to the color quality of a tone whose brightness, considered alone, is the same as that of some particular gray shade. The word commonly is used in referring to those portions of a color television signal or picture which depend only on hue and saturation, not on brightness.

Chrominance Amplifier.—In color television receivers, the amplifier section that contains wave filters passing only chrominance signal frequencies and the burst frequency, not the entire range of luminance frequencies. It is between the chrominance detector and the color demodulators.

Chrominance Channel.—Any path or any circuits primarily intended to carry only chrominance signals.

Chrominance Signals.—Color television signals which represent only hue and saturation, not luminance or brightness. Components of a chrominance signal include I- and Q-signals, or include B-Y and R-Y signals.

CIC.—Combat information center.

Circuit.—A complete path over which an electric current can flow.

Circuit Breaker.—A device for automatically opening a circuit in case of over-current in this or another circuit, and sometimes for opening the circuit in case of under-voltage.

Circuit Closer.—An automatic device mechanically or electrically operated to close a circuit under certain conditions.

Circular Loom.—A flexible insulating tubing to be slipped over a wire or cable for additional protection.

Circuit Voltage.—The greatest effect-

- tive difference of potential between any two conductors in the circuit considered.
- Circular Mil.**—A unit of cross sectional area of conductors; equal to the area of a circle having a diameter of one mil or 1/1,000 inch.
- Circular Mil Foot.**—A unit of conductor size commonly used in specifying resistance. It is equal to a portion of the conductor having a cross sectional area of one circular mil and a length of one foot.
- Circular Scanning.**—Axis of the RF beam rotates through 360 deg. in single plane.
A radar term.
- Circulation of Electrolyte.**—The movement of the liquid electrolyte between the plates of a storage cell by which the acid strength is maintained at uniform value through all parts of the electrolyte.
- Clamping Circuit.**—Circuit which clamps either amplitude extreme of a wave form to a given reference level.
A radar term.
- Clark Standard Cell.**—A primary electric cell formerly used as a standard of voltage. It uses electrodes of zinc and mercury.
- Class A Amplifier.**—An amplifier in which the relation of grid bias to grid signal voltage is such that plate current flows at all times, never decreasing to zero.
- Class AB Amplifier.**—An amplifier in which the relation of bias to grid signal voltage is such that plate current does not flow during the entire cycle, but flows during more than half of the cycle.
- Class B Amplifier.**—An amplifier in which the relation of grid bias to grid signal voltage is such that plate current flows for more than half, but for less than the whole cycle. The grid bias is equal approximately to the cutoff value for the tube.
- Class C Amplifier.**—An amplifier in which the relation of grid bias to grid signal voltage is such that plate current flows during less than one-half of each cycle. The grid bias is greater than the cutoff value for the tube.
- Clearance Space.**—The space between any electrical or mechanical parts depended on for insulation or for mechanical separation. The air space between an armature and the pole shoes.
- Cleat.**—Pieces of insulating material, usually porcelain, fibre, or glass, with which wires are attached to flat surfaces.
- Cleat Knob.**—A small round insulator around which a wire is twisted to hold a conductor in position.
- Climber.**—A sharp spike that may be attached to the shoes for catching in wood poles to climb them.
- Clip.**—A small spring-type clamp having any of several different designs, used for making a readily removable connection to a terminal.
- Clipper.**—A diode with plate or cathode so biased that applied voltages in excess of a predetermined amplitude are conducted to B-minus or ground, leaving only a selected maximum amplitude. A triode operated with such element voltages as to deliver in its plate circuit only voltage up to a predetermined maximum amplitude regardless of applied control grid voltages.
- Clockwise Rotation.**—Rotation in the same direction that the hands of the clock travel, right-handed rotation.
- Close Coupling.**—Coupling with which the coefficient is 0.5 or more, or in which resistance or reactance common to the two circuits is large, and causes relatively great transfer of signal energy.
- Closed-Circuit.**—An electric circuit that is complete and through which current may flow when voltage is applied.
- Closed-Circuit Battery.**—A primary electric cell adapted for use on circuits which are closed most of the time or all of the time, cells which will deliver a steady flow of current.
- Closed Coil Armature.**—An armature whose windings form closed circuits in themselves, the usual form of armature.
- Closed Magnetic Circuit.**—A magnetic circuit formed entirely of iron or steel all the way around. Some devices having a very small air gap are also said to have closed magnetic circuits.
- Closed Magnetic Core.**—A core made up entirely of iron or steel through which magnetism flows.
- Club Footed Magnet.**—An electromagnet of U-shape having a winding near one pole.
- Cluster.**—An electrical fixture carrying two or more lamps.
- CM.**—Centimeter.
- Coax Dry Load.**—A sand-carbon mixture in cable to act as dummy load.
- Coaxial Cable.**—A two-conductor cable in which one conductor is a flexible or non-flexible metal tube and the other is a wire centrally supported inside the tube by insulators.
- Cobalt.**—A metal that is slightly attracted by magnets.
- C-O-D Indicator.**—An instrument used in automobile battery charging circuits which reads "Charge, Off, and Discharge."
- Code.**—A system of dot and dash signals used in the transmission of messages by radio or wire telegraphy. The International Morse Code (also called the Continental Code) is used everywhere for radio telegraphy. The American Morse Code is used commonly for wire telegraphy.
- Code Recorder.**—An instrument which makes a permanent record of code

Coefficient

messages received by radio or otherwise.

Coefficient.—A number which indicates the rate or amount of change in some condition, such as resistance, that is brought about by other changing conditions.

Coefficient of Mutual Induction.—The flux affecting two circuits having mutual induction on each other.

Coefficient of Self-Induction.—The inductance of a given circuit.

Coelectron.—An atom of matter which has lost a negative electron, leaving the coelectron positive.

Coercive Force.—The magnetizing force that must be applied in an opposite direction to completely demagnetize a piece of iron or steel that has been magnetized.

Coherer.—Conductors between which a connection is made or resistance reduced by the coherence or drawing together of metal parts. The coherence is caused by the received waves, and the reduction of resistance allows audible signals to be produced.

Coil.—A number of turns of wire wound on an iron core or on a coil form made of insulating material. A coil offers considerable opposition to the passage of alternating current but very little opposition to direct current.

Coil Box.—A box containing two or more separate induction or ignition coils.

Coil Form.—The tubing or solid object on which a coil is wound. It can have any shape and can be made from any insulating material, such as paper, cardboard, fiber, bakelite, a plastic or ceramic materials, or wood.

Cold Cathode.—A cathode which does not depend upon heat for electron emission. The cold cathode of a photo-electric tube emits electrons when exposed to light, while in a type BH rectifier tube the electrons are pulled out of the cold cathode by a sufficiently high voltage applied to the pointed anode.

Coil Pitch.—In armature windings, the number of slots between the slot containing one side of a coil and the slot containing its other side.

Collector Brush.—A brush taking current from a collector ring.

Collector Rings.—Continuous metallic rings on a rotating member, against which bear stationary brushes to allow current flow between the rotating and stationary parts of the equipment.

Color Carrier.—The composite color television signal.

Color Carrier Reference.—Phase of the burst signal.

Color Code.—Any system of colors used to specify the electrical value of a radio part or identify terminals and leads.

Color Difference Signal.—A color tele-

Color Gate

vision signal representing one of the primary colors with reference to hue and saturation, but without reference to brightness or luminance or minus these latter qualities. B-Y, R-Y, or G-Y signals.

Color Gate.—In a single-gun sequential system of color television, a tube circuit which passes a signal for one primary color to the electron gun only while the beam is striking a phosphor for that particular color.

Color Grid.—In the Chromatron single-gun color picture tube, a structure having many thin wires arranged side by side immediately back of the phosphor screen. Alternate wires are connected together, and when the groups are made of opposite polarity their fields focus the deflected electron beam away from green phosphor strips and onto either red or blue strips.

Color Killer.—In a color television receiver, a tube circuit which biases to plate current cutoff some or all of the chrominance amplifier tubes while monochrome signals, not color transmissions, are received. Helps prevent appearance of color in monochrome pictures.

Color Oscillator.—In a color television receiver, the oscillator which operates at the chrominance subcarrier or burst frequency of 3.579545 megacycles. This oscillator is synchronized in frequency and phase with the transmitter master oscillator, and furnishes a continual subcarrier frequency required for demodulators in the receiver.

Color Phase.—Phase relation of a chrominance signal or any of its components, as I, B, B-Y, R-Y, to the burst signal voltage whose phase is considered as the reference. Color phase determines the hue to which a given signal is related. The phase of chrominance signals shifts during picture reception.

Color Sync Signal.—The burst signal in color television.

Colpitts Oscillator.—A high-frequency oscillator circuit in which a single inductor is tuned by two capacitances in series with each other and across the ends of the inductor. One capacitance is in the plate circuit and the other in the grid circuit of the tube, thereby providing feedback. As employed in television tuners, the capacitances consist wholly or in part of stray, distributed, and tube capacitances.

Comb Lightning Arrester.—A lightning arrester having the gap formed by metal teeth opposed to each other.

Combination Current.—Several currents of different kinds carried in one circuit.

Combination Fixture.—A lighting fixture for both gas and electric lamps.

Combination Switch.—In automobiles, a switch that controls both the lights and the ignition; or the lights, the ignition and the starter.

Come-Along Clamp.—A clamp to be

- caught around a cable or wire when the cable is to be pulled into position.
- Commercial Efficiency.**—The efficiency expected from an electric device in ordinary service.
- Communication Receiver.**—A receiver designed especially for reception of code or voice messages transmitted by short-wave radio communication services.
- Commutating Machine.**—Motors, generators and converters using commutators.
- Commutating Pole.**—An Interpole.
- Commutating Pole Converter.**—A converter fitted with interpoles for improving commutation.
- Commutating Pole Generator.**—Generators fitted with interpoles to improve commutation.
- Commutating Rectifier.**—An alternating current rectifier using a commutator and brushes to send impulses of one polarity into one side of a circuit and impulses of opposite polarity into the other side of the circuit.
- Commutating Switch.**—A switch arranged to change the voltage in a circuit.
- Commutation.**—The act of changing the alternating current from armature windings into direct current through the action of the commutator and brushes. Commutation is said to take place at the brushes.
- Commutator.**—A ring of insulated copper segments connected to the windings of an armature, and on which bear brushes which connect the armature windings to the outside circuits. A generator commutator and brushes change the induced alternating current of the armature to direct current in the output. A motor commutator changes the direction of applied direct current so that currents in the armature conductors flow as required to produce the turning effect.
- Commutator Air Blast.**—A current of air directed toward the contact of the brush end on a commutator to reduce the sparking.
- Commutator Bar.**—One of the small pieces of copper that go to make up a commutator, a commutator segment.
- Commutator Cement.**—An insulating cement used for fastening the segments and insulation of commutators.
- Commutator Compound.**—A compound applied to the surface of a commutator to assist in giving the copper a smooth polish and improve the brush contact.
- Commutator Ripple.**—Small pulsations in the voltage and current taken from a direct-current generator.
- Compass.**—A small magnetic steel needle pivoted at its center so that it is free to swing into line with the earth's magnetism, the ends pointing to the magnetic north and south poles.
- Compatibility.**—Descriptive of a color television system which permits reproduction of color transmissions as monochrome pictures on typical unaltered black-and-white receivers, also reproduction of monochrome transmissions as black-and-white pictures on color receivers.
- Compensated Machine.**—A generator or motor with series field windings on the face of the pole shoes for the purpose of reducing the effect of armature reaction.
- Compensating Coil.**—The series winding of a compound wound generator or motor.
- Compensating Magnet.**—A permanent magnet placed near the needle of a compass for the purpose of overcoming external magnetic fields and letting the compass indicate the true direction.
- Compensating Transformer.**—A transformer used with telephone or telegraph circuits to excite conductors which neutralize the inductive effect of nearby power lines.
- Compensating Winding.**—A field winding carried in slots of the field poles of generators and which reduces the effect of armature reaction.
- Compensator.**—A balancer.
- Compensator.**—An auto-starter, which see. Also an auto-transformer, which see.
- Complementary Colors.**—Two colors which, combined in suitable proportions, cause the visual sensation of white. Some complementary pairs are red and cyan, green and magenta, blue and yellow.
- Component.**—A part of anything, a part which may be varied or adjusted and which then alters some result. A part of the whole. For example; in a pulsating current, which is the whole current, there are two components or parts. One component is a direct current and the other is an alternating current, the two flowing together to form pulsating current.
- Composite Color Signal.**—All of the color television signal transmitted by amplitude modulation. Includes the luminance signal, chrominance signal sidebands, burst signal, also horizontal, vertical, and equalizing pulses together with blanking. Accompanying sound is not included.
- Composite Television Signal.**—All of a monochrome television signal transmitted by amplitude modulation. Includes picture signals, blanking, and horizontal, vertical, and equalizing pulses. Sound is separately transmitted.
- Composited Circuit.**—In telephone work the use of each of the two wires in a metallic circuit as one side of two other circuits which are completed through ground.
- Compound Catenary.**—Supporting elec-

Compound Circuit

tric trolley wires from cross wires which are in turn supported by other cross wires.

Compound Circuit.—A series circuit including more than one current consuming device and one source.

Compound Field Winding.—A field winding composed of both shunt and series coils acting together or against each other. On a common magnetic circuit, the winding connected in series with the load. The series winding affects operation of the device in accordance with the total current which flows in this winding.

Compound Magnet.—A permanent magnet consisting of several similarly shaped single magnets in close contact and with like poles together.

Compound Magnet.—A permanent magnet made up of several similarly shaped smaller magnets. Its strength is slightly greater than a one-piece magnet of equal size.

Compound Synchronous Converter.—A converter with a compound winding which maintains an approximately constant voltage.

Compounding.—The effect of the series winding in a compound wound generator or motor. In a generator it may maintain constant voltage or it may slightly raise or lower the voltage with increase of load. In a motor it may maintain practically constant speed or may allow the speed to drop slightly with increase of load.

Compound-Wound Generator.—A direct-current generator having a compound (series and a shunt) winding for its field. The output voltage remains fairly constant when there is a varying load.

Compound-Wound Motor.—A direct-current motor having a compound (series and shunt) winding for its field. The operating speed decreases with increase of load.

Concatenation Motor Control.—A method of controlling alternating current motors so that they may be run at either their normal full speed or at half speed on the same current.

Concentrated Acid.—Pure sulphuric acid, undiluted with water, for use in storage battery electrolyte.

Concentric Cable.—A cable having a center conductor surrounded by a number of spirally wound conductors.

Condenser.—A radio part consisting of two conducting surfaces separated from each other by an insulating material such as air, oil, paper, glass or mica. A condenser is capable of storing electrical energy. In radio circuits, condensers are used to block the flow of direct current while allowing alternating and pulsating currents to pass. The electrical size or capacity of a condenser is specified in microfarads and micro-

Condenser Capacity

microfarads.

Condenser Capacity.—The amount of electric charge a condenser will receive and hold. Measured in farads and microfarads.

Condenser Charge.—The electricity held in the plates of a condenser.

Condenser Dielectric.—The insulating material between the plates of a condenser; usually mica, paper, glass or air.

Condenser Plate.—One of the conductors in a condenser or the whole number of conductors that are connected together on one side of the circuit.

Condensite.—A phenol base insulating material which is moulded to shape.

Condensive Load.—In alternating current work, a load whose current leads the voltage by a certain phase angle.

Condensive Reactance.—The reactance caused by a condenser. See reactance.

Conductance.—A measure of the ease with which a substance conducts electricity measured in ohms. Conductance in ohms is equal to the reciprocal of the resistance in ohms.

Conduction Current.—The current passing through a conductor as distinct from the slight amount of electricity that moves in an insulator when voltage is impressed on the insulator. See displacement current.

Conductivity.—The ability of a material to carry electric current.

Conductivity Bridge.—A resistance bridge or Wheatstone bridge arranged to measure conductivity in mohs.

Conductor.—Any substance in which a difference of voltage between two points causes current to flow between these points. One or more wires carrying a single current.

Conductor.—A wire or other metal structure which provides a path for electric current between two points. A conductor is thus a material which offers little opposition to the continuous flow of electric current.

Conduit.—A metallic enclosure for conductors, which protects them from mechanical injury and at the same time forms a support and guide for the wires.

Conduit Box.—A box between the ends of lengths of conduit and in which connections are made between the conductors.

Conduit Bushing.—A threaded sleeve which screws over the end of a conduit to hold it in a conduit box.

Conduit Bushing Adapter.—A threaded sleeve which allows the use of small conduit with larger fittings or large conduit with smaller fittings.

Conduit Coupling.—A metal piece that screws over the end of a conduit and into which another length of conduit can be screwed to hold conduits end to end.

Conduit Elbow

Conduit Elbow.—A threaded metal sleeve with its two ends bent at an angle so that lengths of conduit may be joined at this angle.

Conduit Rodding.—Pushing a number of jointed rods through a length of conduit so that a conductor may be drawn through after them.

Conduit Wiring.—Wiring carried in conduits and conduit fittings.

Condulet.—Any one of a great variety and number of attachments and fittings for use with conduit in forming joints in different positions and angles, and in attaching circuits and lighting fixtures to the conduit wiring.

Cone.—The conical-shaped paper or fiber diaphragm of a magnetic or dynamic loud-speaker.

Conical Antenna.—A dipole antenna consisting of two or more pairs of symmetrically arranged conductors radiating approximately sideways from a common center at which is the gap to which are connected the conductors of a transmission line. It is a broad band antenna.

Conical Scanning.—Scanning in which antenna tilt angle is fixed so that the axis of the rf beam generates a cone with a vertex angle usually of 5 to 10 deg.

A radar term.

Connected Load.—The sum of the continuous ratings of all current consuming devices connected to the circuit.

Connector.—A short conductor used to electrically connect one terminal in a circuit to another terminal in the same or a different circuit.

Connector Plug.—A plug and socket which, when pushed together, complete a current path or circuit.

Connector Switch.—A telephone exchange switch that automatically makes the connection with the called line.

Consequent Pole.—A magnetic pole formed along the body of a magnet, not at the ends, by bringing together two poles of the same size, or by winding the coil of an electromagnet in such a way that a pole is produced along the body of the magnet as well as at its ends.

Console.—A large radio receiver cabinet, designed to rest on the floor rather than on a table.

Consonance.—Agreement of the natural period in the primary of a condenser with the period of the incoming current, resonance in the primary circuit.

Constant Amperage Regulation.—Control of a generator to cause it to give a current of unchanging amperage regardless of its speed above the minimum required for the current.

Constant Current.—An unchanging rate of flow or amperage in a circuit.

Constant Current Distribution.—A circuit having its parts in series.

Constant Current Generator.—A gen-

Constant Current Motor

erator having constant amperage regulation.

Constant Current Motor.—A motor operating with changing voltage according to the load but with an unchanging amperage or current.

Constant Current Regulator.—A regulator that causes a generator to maintain an unchanging amperage with changes in speed.

Constant Current Transformer.—A transformer whose secondary current remains practically unchanging with change of load as long as the primary voltage remains the same.

Constant Luminance.—Descriptive of color transmission and reception with which chrominance signals affect only color or hue. They do not affect luminance or brightness, which is controlled only by the luminance signal.

Constant Potential.—Constant voltage, an unchanging voltage under various conditions of speed and load.

Constant Potential Distribution.—A circuit having the current consuming devices connected in parallel so all receive the same voltage.

Constant Potential Generator.—A generator maintaining an unchanging voltage with changes of speed or load.

Constant Potential Rectifier.—An alternating current, battery charging rectifier which maintains a constant voltage in the charging circuit regardless of the load or of the condition of charge of the batteries in the circuit.

Constant Potential Regulator.—A constant voltage regulator.

Constant Potential Transformer.—A transformer in which the ratio of the secondary voltage to the primary voltage remains practically the same with all loads.

Constant Speed Motor.—An electric motor which maintains a practically constant speed.

Constant Speed Regulation.—Regulating the output or voltage of a generator by using a governor to maintain a constant speed above that at which the governor commences to act.

Constant Voltage Regulator.—A regulator that causes a generator to maintain an unchanging voltage with changes in speed and in load.

Contact.—A point through which current flows to another contact or conductor when they are held together and at which the circuit is opened when the contacts are separated.

Contact Detector.—A detector which depends on the resistance of a contact such as in the coherer. The crystal detector and thermoelectric detector, are examples.

Contact Drop.—The drop in voltage across the contact between two parts carrying electric current.

Contact Point.—A piece of metal or carbon in contact with another simi-

Contact Potential

- lar or different piece, between the two at which electric current is carried. Metal contacts are made of copper, silver, platinum, tungsten, etc., to resist the effect of the arc formed when they break a current.
- Contact Potential.**—A potential difference produced by two different metals which are in contact.
- Contact Rail.**—The third rail of an electric railway, the rail which carries one side of the circuit for the motors in the cars.
- Contact Rectifier.**—Two substances, as a metal and an oxide, which, when in contact, permit current to flow through the contact much more readily in one direction than in the other. The combination will act as a rectifier.
- Contact Resistance.**—The resistance across the contact between two parts carrying electric current.
- Contact Sparking.**—Sparking that takes place between contact points as they break a circuit.
- Contact Voltage Regulator.**—A transformer in which the number of active turns in the windings may be adjusted to alter the voltage ratio.
- Connector.**—A magnetically operated switch for opening and closing circuits carrying large currents.
- Continental Code.**—Same as the International Morse Code. Used universally for radio telegraphy.
- Continuous Current.**—A direct current of constant value, without appreciable rise or fall.
- Continuous Duty.**—A type of service in which an electric machine or device operates at substantially constant load for an unlimited period.
- Continuous Rating.**—The rating at which an electric device can operate steadily without overheating or other damage or danger.
- Continuous Wave.**—An undamped series of waves which continues with a constant amplitude.
- Contrast Control.**—In a television receiver, a manual control which adjusts the range of brightness between highlights and shadows of the reproduced image.
- Control Grid.**—That electrode in a vacuum tube which has the most effective control over the plate current passed by the tube. The control grid is usually the electrode nearest to the cathode.
- Control Panel.**—An exposed or enclosed upright panel carrying switches and other controlling, measuring and protective devices for electrical machinery or equipment.
- Control Switch.**—A switch controlling the circuits through circuit breakers or other switches which are magnetically operated.
- Control Transmitter.**—Selsyn.
- Controlled Rectifier.**—A gas-filled or mercury-vapor rectifier tube with which there is control of the por-

Controller

- tion of each rectified alternation during which current flows through the tube. Thus it is possible to vary the output current.
- Controller.**—A switching or current control device, or a group of such devices which govern the time or manner in which power is delivered to motors or other electrical devices to which the controller is connected. A controller usually is capable of varying the speed, power, torque, acceleration, or other operation of a machine, as well as its starting and stopping.
- Conventional Current.**—The older, but erroneous, concept that electricity flows toward points in a circuit which are positive, and away from those which are negative. There is no electricity of this nature. The only actual flow in conductors is of electrons, which move away from points which are negative (having a surplus of electrons) and toward points which are positive (having a deficiency of electrons). The electrons themselves are negative charges.
- Convergence.**—In three-gun color television picture tubes, the coming together of the three electron beams at openings in the shadow mask, followed by their divergence or spreading to reach phosphor dots of the three primary colors.
- Convergence Coils.**—Three electromagnets carrying currents which produce fields for convergence of electron beams in three-gun color television picture tubes.
- Converter.**—That section of a superheterodyne radio receiver which changes incoming modulated r.f. signals to a lower frequency known as the i.f. value; the converter section includes the oscillator and the first detector. Also, a device, usually rotary, changing electrical energy from one form to another, as AC to DC.
- Coolidge Tube.**—An X-ray tube using a tungsten filament operating at high temperature and having high penetrative power.
- Copper.**—The metal most commonly used for electrical conductors.
- Copper Bath.**—The electrolyte used for copper plating with the electrolytic process.
- Copper-Clad.**—Copper covered steel or iron used to combine the mechanical strength of steel or iron and the electrical conductivity of copper.
- Copper Loss.**—The power lost in overcoming the resistance of conductors or transmission lines.
- Copper-Oxide Rectifier.**—A rectifier made up of discs of copper coated on one side with cuprous oxide. The discs allow direct current to flow in one direction but allow very little current flow in the reverse direction.
- Cord.**—An insulated flexible cable of stranded wire.
- Core.**—The iron or steel through which magnetism flows in electrical devices

Core Gap

- using electromagnetic action.
- Core Gap.**—The air space between an armature and its magnet pole.
- Core Iron.**—A grade of soft iron suitable for use in magnet cores or in the cores of fields, transformers, etc.
- Core Loss.**—The power lost in an electric machine because of the electromagnetic effects with current in its windings. It is the difference between the power required to drive the machine with the windings excited and the power required to drive it with no current in the windings. The loss is due to both the eddy currents and the hysteresis.
- Core Pin.**—A pin or plug of non-magnetic material placed in the core of a magnet to prevent sticking of the magnet armature.
- Core Transformer.**—A transformer whose core forms a single continuous magnetic circuit or path, without divisions or branches, and with only one path for the magnetic flux.
- Cored Carbon.**—An arc light carbon with a soft or cored center.
- Corkscrew Rule.**—When a right-handed screw is turned in the direction of magnetic flux lines around a conductor, the screw tends to move lengthwise in a direction opposite to that of electron flow in the conductor.
- Corner Reflector Antenna.**—A u.h.f. receiving antenna consisting of almost any form of half-wave dipole, back of which is supported a reflector made of many separate conductors lying parallel to the dipole, arranged in two planes that come together at a corner directly behind the dipole. The planes may meet at various angles, but commonly are at 90° to each other.
- Corona.**—An electrostatic discharge causing a violet light around conductors carrying high voltage. It occurs just before the voltage rises high enough to cause a spark or a steady brush discharge.
- Correction Thermometer.**—A thermometer having two scales and used for testing battery electrolyte. One scale shows the temperature in degrees while the other scale shows the number of points of specific gravity that should be added to or subtracted from the apparent reading to give the true gravity.
- Corrosion.**—The formation of copper sulphate (verdigris) on copper, brass, and bronze parts from the action of acid fumes. The formation of lead sulphate on the grid of storage battery plates.
- Cosecant Squared Beam.**—Radar beam pattern designed to give approximate uniform signal intensity from distant and nearby objects. Beam is generated by a spun barrel reflector. Intensity varies as the square of the cosecant of the elevation angle.
- Cotton Covered Wire.**—Wire having an insulation of spirally wound cotton.

Cotton Enameled Wire

- Cotton Enameled Wire.**—Wire insulated with enamel and covered with cotton.
- Cotton Sleeving.**—A sleeve or tube woven of cotton and slipped over wires in generators, motors, coils, etc., for insulating purposes.
- Coulomb.**—A unit of electric charge, or of the quantity of electricity. It is equal to, 6,280,000,000,000,000 electrons or to the quantity of electricity passing during one second in a circuit wherein the rate of flow is one ampere.
- Counter Circuit.**—Circuit which receives uniform pulses representing units to be counted and produces a voltage in proportion to their frequency.
- A radar term.*
- Counterclockwise Rotation.**—Rotation in a direction opposite to the hands of the clock, left handed rotation.
- Counter Electromotive Force.**—A voltage or electromotive force which opposes the normal or impressed voltage in a circuit and which tends to send current in the opposite direction. In a circuit containing self-inductance, a voltage produced by changes of current and which at every instant opposes the change of current that produces the voltage.
- Counter E. M. F. Cells.**—Cells connected to a large storage battery with their polarity opposing the main battery polarity and used to regulate the output and voltage of the battery with changes in load and condition of charge.
- Counterpoise.**—Wires placed below the antenna wires in order to overcome the effect of a poor ground or to allow operation with no ground connection.
- Countersink.**—To ream, drill or cut a conical depression around a hole for a flat-head screw, so that the screw head will be flush with the surface of the work.
- Coupler.**—A device for producing radio frequency energy in one circuit from radio frequency energy in another circuit by the effect of one circuit on the other.
- Coupling.**—A transfer of signal energy from one circuit to another by means of resistance, reactance, or impedance common to both circuits. Potential difference caused by electric energy in one circuit is also in the second circuit. Coupling may be by means of resistors, capacitors, impedances formed by tuned inductors, by mutual induction, or by various combinations.
- Cowl Lamp.**—A lamp placed on the cowl or dashboard of an automobile to light the instruments mounted on the cowl.
- Cradle Dynamometer.**—An electric dynamometer consisting of a generator armature connected to the shaft of a machine being tested and a field structure hung in a cradle so that

- the torque is measured by the magnetic pull between armature and field.
- Cranking Capacity of Battery.**—The ability of a storage battery to operate an electric starter for cranking engines of certain sizes. Measured according to the piston displacement of the engine.
- Crazer in Positive Carbon.**—The cup that forms in the end of the positive carbon of an arc lamp.
- Creeping of Electrolyte.**—Movement of battery electrolyte up onto the cell covers and terminals due to capillary attraction.
- Creeping of Wattmeter.**—A slow movement of a wattmeter that takes place when there is no flow of power or lightning current. It is due to incorrect adjustment of the windings.
- Critical Current.**—The amperage which is just sufficient to produce some certain result, as a given degree of heat, etc.
- Critical Damping.**—Damping of an electrical measuring instrument such that its needle returns to zero without moving back and forth across zero.
- Critical Resistance.**—The resistance in a circuit at which proper functioning of connected electrical devices is prevented.
- Critical Speed.**—The speed of an electric machine at which a certain result takes place, usually at which the counter electromotive force equals the impressed voltage.
- C.R.O.**—Cathode ray oscilloscope.
- Crookes Tube.**—A vacuum tube used for the production of X-rays.
- Cross.**—An accidental connection of one circuit to two or more other circuits. A short circuit usually results.
- Cross Arm.**—A horizontal arm attached to a pole to support the wires carrying current.
- Crosshatch Pattern.**—A number of vertical and horizontal lines produced on the viewing screen of a television picture tube by voltages from a pattern generator connected at antenna terminals or at some following amplifier input. Lines may be light on a dark background or dark on a bright background. Used during adjustments for linearity and size.
- Cross Magnetizing.**—The effect on the magnetic field of a generator or motor caused by armature reaction.
- Cross-over.**—A crossing of two trolley wires arranged to keep the trolley wheel on the wire.
- Cross Sectional Area.**—The size of a part measured by a surface that would be exposed by cutting straight through it across the length, at right angles to the length. This area is measured in square inches, square centimeters, circular mils, etc.
- Cross Talk.**—Inductive interference between telephone circuits.
- Crow-Foot Zinc.**—A primary cell zinc electrode having several extending arms.
- Crystal.**—Usually a small, flat piece of quartz so shaped or ground as to exhibit the piezo-electric effect. Used for maintaining within close limits the frequency of oscillators employed in various radio and electronic instruments, such as signal generators.
- Crystal Control.**—Use of a quartz crystal to maintain operation of a radio station at its assigned frequency within the limits prescribed by law.
- Crystal Detector.**—A detector utilizing a crystal such as silicon or galena in contact with a pointed wire to rectify an incoming radio signal. Used in crystal receivers.
- Crystal Diode.**—A rectifier consisting of a small piece of germanium, silicon, or certain other minerals, on one of whose surfaces rests a point on the end of a small wire. There is small resistance to electron flow from crystal to wire, large resistance to opposite flow. The crystal is the cathode, the wire is the anode. Germanium crystals are used at frequencies to several hundred megacycles, silicon crystals to several thousand megacycles.
- Crystal Filter.**—A highly selective tuning circuits employing a quartz crystal, sometimes used in the i.f. amplifier of a communications receiver to improve selectivity so as to permit reception of a desired station even when there is strong interference from other stations on nearby channels.
- Crystal Pick-up.**—A type of phonograph pick-up in which the needle movements bend or twist a Rochelle salt crystal element and cause the crystal element to generate an audio frequency voltage corresponding to the recorded sound waves.
- Crystal Set.**—A radio receiver which uses a crystal detector for signal rectification, and has no vacuum tubes.
- C-Scan.**—Type of presentation in which signal appears as a bright spot with azimuth angle as horizontal coordinate and elevation angle is vertical coordinate.
A radar term.
- Cumulative Compound Winding.**—A compound winding in which the magnetic effects of the series and shunt portions are in the same direction; in which the series winding assists the shunt winding.
- Current.**—The movement of electrons through a conductor. Current is measured in amperes, in milliamperes and in micro-amperes.
- Current Coil.**—A coil or winding carrying all the current in a circuit and affected by changes of amperage.
- Current Consuming Device.**—Any part that requires electric current for its operation, such as lamps, motors, heaters, etc.
- Current Density.**—The current or the number of amperes passing through

Current Limiting Reactor

a conductor when measured according to the size of the conductor. Measured in amperes per square centimeter or per square inch.

Current Limiting Reactor.—A reactance coil attached to alternating current generators or motors to limit the amount of current through a short circuit.

Current Ratio of Transformer.—The ratio in amperes of the effective primary current to the effective secondary current of a transformer.

Current Regulator.—A regulator which limits or controls the amperage of a generator.

Current Strength.—The amperage of a current.

Current Tap.—A socket plug designed to carry a lamp and at the same time allow current to be taken from the same socket to another circuit.

Current Transformer.—An instrument transformer whose primary winding is in series with a current-carrying conductor, and whose secondary is connected to a meter or other device which is to be actuated by conductor current and changes of current.

Cut-In.—To connect an electric part to a circuit, or to connect two circuits together.

Cutler Feed.—Resonant cavity at the end of a wave guide, feeding energy to reflector of spinner assembly.

Cutout.—An insulating mounting which provides connections for fuses. Also a magnetically operated relay.

Cutout Box.—A box in which are mounted cutouts, fuses, and fuse blocks.

Cutout Relay.—A reverse current cutout operated by an electromagnet.

Cutting Head.—That part of a sound recorder which cuts or embosses on a disc, the irregular grooves corresponding to the wave form of the sounds being recorded.

Cutting Lines of Force.—Movement between magnetic lines of force and conductors, by which electromotive force is caused in the conductors. Electromagnetic induction.

C.W.—Continuous wave.

Cycle.—One complete series of changes in an alternating current or voltage, including one maximum amplitude in each polarity, intervening instants of zero potential, and accompanying intermediate changes. A cycle may commence at zero, go through maximum in one polarity, back through zero to maximum in the opposite polarity and again to zero. A cycle, or in the time period of one cycle, may commence also at a point of any polarity and direction of change, and continue until there is return to the same polarity and direction of change.

Cylindrical Armature.—A drum armature.

Cylindrical Face Plate.—A television picture tube face plate which curves on the outside from side to side but

D.

is straight from top to bottom. The shape is approximately that of part of a cylinder having large radius.

D

D.—A symbol for electrostatic flux density.

Damped Current.—An alternating current having diminishing amplitude.

Damped Needle.—In an electric measuring instrument, a needle that quickly comes to rest.

Damped Wave.—A wave that diminishes rapidly and ceases.

Damper Tube.—In television receiver circuits for horizontal deflection, a diode that conducts upon reversal of polarity during the first cycle of oscillation at a frequency determined by inductance and capacitance in the deflection circuit. Conduction current loads the circuit and removes enough energy to cause a smooth decrease of sawtooth current to zero, instead of continued oscillation.

Damper Winding.—Copper pieces so placed in the pole faces of alternating current machines to reduce hunting.

Damping.—Causing the needle of an electric measuring instrument to come to rest quickly.

Damping.—A reduction of intensity or amplitude of the waves.

Damping of Instrument.—The degree of damping is determined according to the time it takes for the pointer of an instrument to come to rest, according to the number of swings the pointer makes back and forth, and according to the distance beyond the true reading to which the pointer swings.

Damping Coll.—A coil used to cause the needle of a galvanometer to quickly return to zero.

Danell Cell.—A primary electric cell using copper and zinc for electrodes. Used on closed circuit work.

Dark Trace Tube.—A CRT with screen composed of a halide of sodium or potassium, the traces of which may be enlarged by projection.

D'Arsonval Meter Movement.—The commonest movement employed in precision direct current measuring instruments. It consists essentially of a small coil of wire supported on jeweled bearings between the poles of a permanent magnet, with a spiral spring holding the coil and the attached indicating pointer at the zero position on the meter scale. When the current to be measured is sent through this coil, the magnetic fields of the coil and magnet interact to cause rotation of the coil and pointer.

Dash Board Instrument.—An ammeter, voltmeter, or current indicator suitable for mounting on the dash or cowl board of an automobile.

Dash Pot.—A cylindrical chamber containing oil, air or other fluid in which moves a plunger attached to

some part in which it is desired to avoid sudden changes of position.

b.—Abbreviation for decibel.

b. C.—An abbreviation for "direct current."

b. C.—An abbreviation for "double contact."

b. C. C.—An abbreviation for "double cotton covered" wire.

b. C. Component.—In a television picture signal or video signal, the average value of signal voltage with respect to cathode potential. This average determines overall instantaneous level of illumination in pictures. The d.c. component may be considered a direct potential continually varying during picture signals.

b. C. Convergence.—Same as static convergence.

b. C. Receiver.—A receiver designed to operate from a d.c. power line, such as from the 110-volt d.c. lines still being used in older sections of some cities.

b. C. Restoration or Reinsertion.—An automatic control in signal input circuits of television picture tubes, for replacing the d.c. component after the video signal has passed through a capacitor to leave only alternations on a zero axis.

beat Beat.—An instrument whose pointer comes immediately to its true reading without swinging back and forth.

beat Coil.—An armature coil which is not connected in the armature circuit of the windings but which is required in order that there may be the proper number of coil sides in each slot.

beat End.—The end of a wire to which no electrical connection is made, the end used for supporting the wire. The part of a coil or winding that is not in use.

beat end Eye.—A metal eye threaded at one end to attach to a rod and holding a cable in the loop of the eye.

beat Ground.—An accidental ground of low resistance through which most of the current can escape from a circuit.

beat Load.—A resistance used for applying a load to a generator or a circuit for testing purposes.

beat Spot.—A region in which signals from certain radio stations are poorly received.

beat Turn of Armature.—A conductor of an armature winding which is moving with the direction of field flux and which generates no electromotive force because it is not cutting through the lines of force.

beat Wire.—A wire in which there is no electric current or voltage.

beat Bridge.—A Wheatstone bridge having ten separate coils of each resistance value.

beat-Ampere.—One-tenth of an ampere.

Decibel.—The logarithmic ratio of one a.c. or audio power to a reference power level or to some other specified power. Also the logarithmic ratio of one a.c. voltage or current to another when both are measured across equal impedances.

Declination.—The difference between the position of a compass needle and the true position of geographical north and south.

Declinometer.—An instrument for measuring the declination of a compass needle.

Decoder.—In color television receivers, the section that includes demodulators, matrixes, and other circuits which recover primary color signals from chrominance signals.

Decohere.—Separation of the particles in the tube of a coherer.

Decrement.—The damping factor of a wave.

Decremeter.—An instrument that measures the reduction of current in proportion to changes of adjustment. It shows the strength of the induced current caused by changes in capacity and inductance.

De-energize.—To stop current from flowing in a circuit or an electrical part.

Definition.—In television pictures, the degree to which fine details are reproduced. Other things being equal, definition increases with increase of the range of higher video frequencies received, amplified, and applied to the picture tube.

Deflagrator.—An electric cell capable of giving a very high current output because of low internal resistance.

Deflection.—Bending of the electron beam in a television picture tube after the focused beam leaves the electron gun. Horizontal deflection causes the beam to trace picture lines, while vertical deflection allows formation of fields and frames.

Deflection Angle.—The total angle through which the electron beam in a television picture tube is bent or deflected horizontally, vertically, or diagonally. Horizontal deflection seldom exceeds 85° and diagonal deflection 90°.

Deflection Method.—Making electrical measurements and tests according to the deflection or readings of the pointers of measuring instruments in place of by causing the pointers to rest at zero.

Deflection of Magnetic Needle.—Movement of a compass needle caused by magnetic fields or currents other than those of the earth.

Deflector of Lamp.—A device for directing the rays from a lamp in a certain direction.

Degeneration.—A type of feedback which reduces signal strength. Degeneration is the opposite of regeneration.

Delayed A.V.C.—An automatic volume control circuit which does not begin

- to act until signals reach a certain strength. It permits reception of weak signals even though they are fading at times, whereas normal a.v.c. tends to make weak signals weaker.
- Deka-Ampere.**—Ten amperes.
- Delay Distortion.**—Color television picture distortion occurring when time for passage of signals through various signal channels is not the same at all frequencies.
- Delay Line.**—Inductance and capacitance concentrated in a small unit through which signals travel more slowly than in ordinary circuits. The purpose is to retard a signal in the circuit containing the delay line and thus maintain its phase relation to other signals delayed in passing through a different path. Employed in the luminance signal channel and sometimes in the I-signal channel of color television receivers.
- Delta Connection.**—A three-phase connection with which the phases may be represented as connected together in the form of a triangle, with the line conductors connected to the corners of the triangle between adjacent phases.
- Demagnetization.**—Causing the magnetism to disappear from a magnet. An electromagnet is demagnetized by stopping the current through its winding or by reversing the current. A permanent magnet is demagnetized by heating, by hammering, or by the effect of another magnet.
- Demagnetizing Turns of Armature.**—The turns of armature windings which produce a magnetic flux opposing the main magnetic field of the machine.
- Demand.**—The amount of electric power required from a circuit or from a generator.
- Demand Factor.**—The ratio of the maximum demand of a system, or part of a system, to the total connected load of the system or the part of the system considered. The maximum watts actually used at any time, divided by the total wattage of all equipment connected to the system.
- Demand Meter.**—An instrument which measures and indicates the maximum demand.
- Demodulation.**—The process of rectifying or detecting a modulated radio signal in order to remove the carrier and obtain the desired audio or picture signal.
- Demodulator.**—A color television receiver circuit employing diodes, triodes or pentodes to produce color primary or color difference signals from variations of phase and amplitude in an applied chrominance signal with reference to an applied color oscillator signal. Chrominance phase varies demodulator output polarity, while chrominance amplitude varies output amplitude. Also the f.m. sound detector of a television or f.m. receiver; in this case a ratio detector or a discriminator.
- Density.**—The number of anything per unit of cross sectional area or per unit of volume. For example, flux density means the number of magnetic flux lines per square inch of cross section of magnetic circuit.
- Density of Charge.**—The amount of electricity in or on a conductor of given size.
- Density of Current.**—The number of amperes passing through a certain measured cross sectional area of a conductor.
- Density of Electrolyte.**—The proportion of acid in the electrolyte of a storage battery in relation to the water.
- Density of Field.**—The number of magnetic lines of force or the flux passing through a certain cross sectional area of a field.
- Depolarize.**—To remove the gas that collects on the plates of an electric cell when charging or discharging, or on the plates in an electrolytic cell.
- Depolarizer.**—A material placed in an electric cell to absorb or remove the gases caused by polarization and reduce the internal resistance of the cell by their removal.
- Derived Circuit.**—A parallel or shunt circuit securing its current from another circuit.
- Detector.**—In a television or radio receiver, an electron tube or crystal diode which rectifies a modulated carrier or intermediate-frequency signal voltage and delivers the signal carried as modulation by the higher frequency. A demodulator. A radio receiver detector delivers audio signals.
- Detector Tube.**—An electron tube used as a detector.
- Deuteron.**—The nucleus of heavy hydrogen atoms which occur in nature as about 1/5000 of ordinary hydrogen. It is the simplest composite nucleus known, consisting of one proton and one neutron.
- Deviation Factor.**—The difference between an alternating current wave and a true sine wave.
- Dextrorsal.**—A right handed winding.
- Dextrorsal Helix or Solenoid.**—A coil wound right-handed, in a clockwise direction looking at the end.
- Diacritical Current.**—The amount of current in a coil or winding which will cause a flux in the core equal to one-half the flux of saturation.
- Dial.**—Any means for indicating the value to which a control knob has been adjusted. Tuning dials of broadcast band receivers indicate the frequency to which the receiver is tuned, either in kilocycles directly or in kilocycle values having one zero removed; sometimes the wavelength in meters will also be indicated.
- Dial Cable.**—The braided cord or flexible wire cable used to make a tuning knob control the position of the

- pointer or dial which indicates the frequency to which a radio receiver is tuned.
- Dial Light.**—The pilot lamp which illuminates the tuning dial of a radio receiver.
- Diamagnetic.**—Having permeability less than that of air or a vacuum. Diamagnetic substances supported in air are repelled by a magnet.
- Diameter of Commutation.**—The diameter or distance through a commutator from brush to brush.
- Diaphragm.**—A thin, flexible metallic or non-metallic sheet which vibrates when struck by sound waves as in a microphone, or which produces sound waves when moved back and forth at an audio rate, as in a headphone or loudspeaker.
- Dinthermy Interference.**—Television picture interference caused by medical apparatus and producing a herringbone pattern.
- Dichroic Mirror.**—A surface which reflects certain colors or wavelengths of light while allowing other colors to pass through. Used in some television cameras.
- Dielectric.**—Any insulating material, but usually one having such exceedingly high electrical resistance as to effectively prevent flow of any current through it. A dielectric used between conductive plates in a condenser receives and retains the electric charge of the condenser. Air, mica, glass and paper are common dielectrics.
- Dielectric Absorption.**—The charge that is retained in a condenser after the first discharge and that will cause a second discharge.
- Dielectric Constant.**—The dielectric constant of a material is the ratio of the capacitance of a condenser using that material as its dielectric to the capacitance of a condenser otherwise similar but having air or a vacuum for the dielectric. The increase of capacitance caused by using the material instead of air for the dielectric.
- Dielectric Current.**—The current that apparently passes through the dielectric of a condenser in an alternating current circuit.
- Dielectric Hysteresis.**—A loss that occurs between charge and discharge of a condenser similar to the loss due to hysteresis in magnetizing and demagnetizing a magnet.
- Dielectric Power.**—The ability of a dielectric to allow induction through its body, its ability to "bind" the opposite charges in a condenser.
- Dielectric Resistance.**—The resistance of a dielectric to electric potential.
- Dielectric Strain or Stress.**—The strain or pressure under which a dielectric is placed by the difference in potential of the opposite charges in a condenser, or the voltage in a conductor.
- Dielectric Strength.**—The ability of an insulating material to resist electric potential or voltage. Measured in the number of volts required to puncture a given thickness.
- Difference of Potential.**—The difference of voltage or pressure between two points.
- Differential Booster.**—A booster generator in a battery charging system so connected as to maintain a practically constant voltage.
- Differential Compound Winding.**—A compound winding in which the magnetic effects of the series and shunt portions act in opposite directions; in which the series winding opposes the shunt winding so that the field strength is proportional to the difference between the two effects.
- Differential Electromagnet.**—An electromagnet in which part of the turns in its winding may be made to oppose the other turns.
- Differential Field Winding.**—A field winding in which the series coil opposes the shunt winding.
- Differential Galvanometer.**—A galvanometer using two coils which oppose each other in their action.
- Differential Generator.**—A generator whose series field winding opposes the effect of the shunt field winding to limit the maximum amperage.
- Differential Motor.**—A direct current motor in which the series field winding opposes the shunt field winding to secure fairly constant speed.
- Differential Selsyn.**—A selsyn in which both rotor and stator have similar windings that are spread 120 deg. apart. The position of the rotor corresponds to the algebraic sum of the fields produced by the stator and rotor.
- Differential Winding.**—A winding or coil which opposes the action of another winding or coil.
- Differentiating Filter.**—A capacitor in series and a resistor shunted across a two-conductor line, or two or more such combinations. Applied voltage having sudden changes of potential produces at the filter output a series of brief, sharp, pulses of voltage which may be called spikes or pips. The capacitive time constant is short in relation to periods of applied voltage changes.
- Diffusion of Electrolyte.**—The spreading through the active material of storage battery plates of the electrolyte so that all parts of the material are acted upon.
- Diffusion of Magnetic Flux.**—Leakage of field flux.
- Dimmer Coil.**—A coil of resistance wire that may be connected in series with a lamp to reduce its amount of light.
- Diode.**—A vacuum tube having two electrodes, one being the cathode and the other the plate or anode. A diode allows electrons to pass in only one direction, from the cathode to the anode.
- Dip.**—The angle at which a magnetic needle turns toward the earth's cen-

Diphase Alternator

- ter when the needle is freely suspended.
- Diphase Alternator.**—An alternating current generator producing two currents a quarter cycle apart.
- Diplex Telegraphy.**—Transmission of two messages in the same direction at the same time without interference.
- Diplexer.**—A coupling system which allows a radar and a communication transmitter to operate simultaneously or separately from the same antenna. Not to be confused with the duplexer.
- Dipole Antenna.**—An antenna in which carrier waves induce positive and negative electric poles or charges, or north and south magnetic poles, at the same instant on opposite sides of the antenna. The usual form is a half-wave dipole.
- Dipping Needle.**—A magnetic needle arranged to dip or incline toward the earth when magnetically attracted.
- Direct Connected.**—Two or more electric machines mechanically connected so that they rotate at the same speed, usually having their shafts connected end to end.
- Direct Coupling.**—The use of a conductor to connect two circuits together and provide a direct path for signal currents.
- Direct Current.**—An electric current that flows always in the same direction in its circuit. The current may be steady or of constant value, or it may vary in strength, or there may be intervals of no current, but so long as current that does flow always moves in the one direction it is a direct current.
- Direct Current Converter.**—A converter changing a direct current of one voltage to a direct current of another voltage.
- Direct Current Generator.**—A generator delivering direct current.
- Direct Current Instruments.**—Measuring and indicating instruments suitable for use only with direct currents.
- Direct Current Magnet.**—An electromagnet whose winding carries direct current, giving the magnet constant poles.
- Direct Reading Galvanometer.**—A galvanometer indicating amperes or volts directly on its scale without the necessity of calculating the values from the position of the pointer.
- Direction Finder.**—A special type of radio receiver employing a highly directional loop antenna so as to permit determining the direction from which radio waves are arriving.
- Direction rectifier.**—A rectifier which supplies a direct voltage varying in magnitude and polarity with the magnitude and relative polarity of an ac selsyn error voltage.
- Directional Antenna.**—A type of antenna which receives signals with great

Directional Selectivity

- er strength from one direction or from two opposite directions than from any other points of the compass.
- Directional Selectivity.**—The effect produced in a receiving antenna by waves of given strength from a certain angle of best reception to the average effect by waves of the same strength coming from all directions.
- Directive Sending.**—Control of the position of the transmitting antenna to favor reception at receiving stations within a certain angle of the compass.
- Director.**—A conductor, usually straight, supported parallel to a dipole antenna on the side toward which received signals approach, not conductively connected to the dipole. Reradiation of signal waves from director to dipole reinforces signals approaching from the director side.
- Disc Armature.**—A generator or motor armature having its coils carried on a flat disc in place of on a cylindrical drum.
- Discharge.**—A passage of electricity from a source.
- Discharge Recorder.**—An instrument which makes a record of all discharges through a lightning arrester.
- Discharge Resistance.**—A resistance connected across circuit breaking contacts to avoid arcing when the contacts open. Part of the current is taken through this resistance.
- Discharger for Battery.**—A resistance or rheostat used for allowing a storage battery to discharge for purposes of testing its performance.
- Disconnecter.**—A switch for opening high voltage circuits. It is opened only with a light load in the circuit.
- Discriminator.**—In a frequency modulated radio receiver, the tube and circuit which change the frequency modulation into variations of voltage at audio frequency, serving the same purpose as the second detector in an amplitude modulated superheterodyne receiver.
- Displacement Current.**—The slight amount of electricity that moves in an insulator when a voltage is impressed on it. (See conduction current.)
- Display.**—A CRT screen and dials which present the information obtainable by the radar set; for example, range, azimuth, elevation.
- Disruptive Discharge.**—A sudden discharge of electricity through the air or an insulator, usually producing a spark.
- Distortion.**—Improper reproduction of a sound or television radio program due to changes occurring in the wave form of the intelligence signal somewhere in the path it takes through the transmitting and receiving system or through an amplifier system.
- Distortion of Field.**—A path of magnetic lines of force or flux other than

Distributing Box

in direct lines from pole to pole of magnets.

Distributing Box.—A box in which the branch circuits are connected to mains, and mains to feeders, through cutouts and switches.

Distributed Capacity.—Capacity distributed between conducting elements such as wires, as distinguished from capacity concentrated in a condenser. Usually used to specify the small capacity existing between the turns of wire in a coil.

Distributing Frame.—In telephone work, the structure at which junctions are made between the inside and outside wires for the exchange.

Distributing Station.—A sub-station.

Distribution.—Dividing the supply current between a number of branch circuits leading to different points

Distribution Panel.—A panel or switchboard on which connections are made between main supply circuits and branch lines.

Distribution System.—A system of branch lines used in cities to supply the various consumers with light and power.

District Call Box.—A small magneto operated by a crank to call messengers by a signal transmitted to a telegraph office.

Diurnal Load.—The daytime load or demand on an electric system.

Divided Magnetic Circuit.—A magnetic circuit including more than one complete path through which the flux passes.

Dome Lamp.—A small electric lamp inside the top of an automobile.

Door Lamp.—A lamp so placed that it lights the door and steps of an automobile when the door is opened.

Door Switch.—A switch operated by opening and closing a door.

Dot Generator.—A pattern generator whose signal voltage produces, on a television picture tube, regularly spaced bright dots or small rectangles on a dark background for use in convergence adjustments. Also a generator producing dark dots on a light background.

Double Antenna.—An antenna system with an insulator inserted at its exact center, with one lead of a two-wire transmission line connected to each half of the antenna at this insulator.

Double Armature.—An armature having two separate windings with two commutators but with only one core.

Double-Break Knife Switch.—A switch breaking two contacts at the same instant.

Double-Button Carbon Microphone.—A carbon microphone employing two buttons or containers for carbon granules, one on each side of the diaphragm, so as to secure a push-pull action which gives increased signal output.

Double Cone Insulator.—A hollow in-

Double-Contact Lamp

ulator, large at the ends and small at the center, with the conductor passing through it.

Double-Contact Lamp.—A lamp whose base and socket are designed for use on a two-wire system, with both sides of the circuit insulated.

Double Conversion.—A system of super-heterodyne reception with which carrier signals are reduced in frequency by beating them with one oscillator frequency in one mixer, then are reduced to the receiver intermediate frequency by beating again with a second lower oscillator frequency in a second mixer. Employed in some u.h.f. converters and tuners.

Double Cotton Covered.—Two layers of cotton covering a conductor.

Double Current Generator.—A generator furnishing both direct current and alternating current from the same armature.

Double-Deck.—Two electric machines, usually a generator and motor, mounted one above the other.

Double Filament Lamp.—An incandescent lamp containing two separate filaments, one for low candlepower, the other for full candlepower.

Double-magnet Ion Trap.—A television picture tube ion trap designed to require two magnetic fields, with two external permanent magnets to furnish the fields.

Double-Pole.—Descriptive of a switch or other device connected in both sides of a circuit, or controlling both sides of the circuit at one time.

Double Pole Switch.—A switch which simultaneously opens or closes two separate circuits or both sides of the same circuit.

Double Reduction.—A drive operating through two sets of gears, belts, or chains so that the total reduction in speed is equal to the product of the two reductions.

Double Silk Covered.—A conductor covered with two layers of silk insulation.

Double-Throw Switch.—A knife switch whose blades are pivoted at the center of the switch and arranged to make contact with connections at either one end or the other of the switch so that a circuit may be completed through either of two paths.

Doubly Re-entrant Winding.—An armature winding that forms a complete closed circuit after including half the conductors.

D. P.—An abbreviation for "double-throw," applied to switches.

D. P. S.—An abbreviation for "double-pole snap switch."

D.P.S.T.—An abbreviation for "double-pole single throw."

D. P. D. T.—An abbreviation for "doublepole double throw."

Drain.—A term used to indicate that current is being taken from a voltage source.

Drive.—Peak-to-peak value of a video signal voltage applied between con-

Driver

- trol grid and cathode of a television picture tube. Also the signal voltage applied to the grid input of any amplifier tube.
- Driver.**—A stage of amplification used to feed or drive a final stage of amplification for the purpose of making the final stage operate at maximum efficiency.
- Drive-Through.**—A drive arrangement using a shaft of one machine extended at both ends so that it may be driven from one end and drive a second machine from the other end.
- Drop.**—The voltage drop developed across a resistor due to current flow through the resistor.
- Drop Annunciator.**—An annunciator whose signals are registered by small metal pieces which drop out of position when released by a magnet.
- Drop Wire.**—The connection from the outside line to the building.
- Drop of Potential.**—A decrease of electric potential or voltage from place to place in a circuit carrying current.
- Drum.**—An armature winding placed on a cylindrical or drum-shaped armature core. The two sides of any one coil are always under poles of opposite polarity.
- Drum Controller.**—A controller utilizing a drum switch as its principal element.
- Drum Switch.**—A switch whose circuit-connecting parts are fingers held by spring pressure against contact surfaces or segments carried on the outside of a cylinder or part of a cylinder which is rotated to effect control.
- Dry Battery.**—A number of dry cells connected in a series or parallel circuit to increase their voltage or amperage in the circuit.
- Dry Cell.**—A type of primary cell in which the electrolyte is in the form of a paste rather than a liquid. Dry cells are used extensively in radio batteries.
- Dry Cell.**—A primary cell having a zinc outer can as its negative electrode, a central carbon rod as its positive electrode, and a liquid electrolyte of a small quantity of sal ammoniac and zinc chloride held in an absorbent lining and in a mass of powdered graphite and manganese dioxide, these latter two materials being the depolarizer. The cell is sealed. Its voltage is approximately 1.5.
- Dry Cell Connector.**—A short length of insulated flexible wire with a metal terminal at each end. Used for making connections between the separate cells forming a dry battery.
- Dry Electrolytic Condenser.**—An electrolytic condenser in which the electrolyte is a paste rather than a liquid, to permit using the condenser in any position without danger of the electrolyte leaking out.
- Dry Storage.**—Storage of a storage battery while it is not in use by re-

Dry Storage Battery

- moving the electrolyte from the cells, or by removing the plates and keeping them in a dry condition.
- Dry Storage Battery.**—A storage battery whose electrolyte is in a semi-solid form.
- D.S.C.**—Double silk covered insulation on a wire.
- D-Scan.**—Presentation combining B and C types. The signal appears as a bright spot with azimuth angle as the horizontal coordinate and elevation angle as the vertical coordinate. Each horizontal trace is expanded slightly vertically by a compressed time sweep to facilitate separation of signal from noise and give a rough range indication.
A radar term.
- Dual Channel Sound.**—A television receiver sound system with which sound intermediate frequency is taken to a sound i.f. amplifier from a point preceding the video detector, and is amplified at this frequency until reaching the sound demodulator. The sound channel is separate, in whole or in part, from the video i.f. channel.
- Dual Ignition.**—An internal combustion engine ignition system arranged to use either magneto current or battery current as the source.
- Dual Magneto.**—A magneto arranged to handle either its own armature current or the current from a battery as the electric source, sending either current through the same interrupter and distributor on the magneto.
- Dummy Antenna.**—One or more resistors, capacitors, or inductors connected to approximately duplicate electrical characteristics of an antenna when the dummy is used between a signal generator and receiver during servicing.
- Duo-lateral Coil.**—An open-work coil whose successive layers are staggered with reference to each other.
- Duplex Cable.**—A cable made of two wires insulated from each other and both carried in an outside insulation.
- Duplex Ignition.**—A system of magneto ignition in which battery current and magneto current can be sent through the primary circuit at the same time.
- Duplex Telegraphy.**—A telegraph circuit operated in two opposite directions at the same time.
- Duplex Winding.**—An armature winding having two simple windings or wound with two conductors in hand.
- Duplex Wire.**—A cable containing two separate conductors in one outside cover.
- Duplex Wound Armature.**—A double wound armature.
- Duplexing Assembly.**—Combination of TR switch, and sometimes an anti-TR switch, with transmission lines.
- Duralumin.**—An alloy of aluminum which is comparable in strength and hardness to soft steel. It contains 95.5 parts aluminum, 3 parts copper, 1

- part manganese and .5 part magnesium.
- Dustproof.**—So constructed or protected that an accumulation of dust will not interfere with satisfactory operation.
- Dust-Tight.**—So constructed that dust will not enter the enclosing case.
- Duty Cycle.**—That portion or percentage of the total time during which an electrical device carries current, or the number of operations during a given period of time. A duty cycle may be specified as so many seconds or minutes during a longer time, or as a percentage of a longer time.
- DX.**—A slang expression for distance, used chiefly in connection with reception of distant radio stations.
- Dynamic Convergence.**—In a three-gun color television picture tube, convergence of the electron beams at openings which are away from the center of the shadow mask. Convergence of the deflected beams.
- Dynamic Loudspeaker.**—A loudspeaker in which the diaphragm or cone is attached to a small coil mounted so it can move within a constant magnetic field. Audio frequency currents flowing through this coil (called the voice coil) make it move in and out, thereby causing the diaphragm to reproduce sound waves. The magnetic field is produced by a permanent magnet in p.m. dynamic loudspeakers, and by an electromagnet in electrodynamic loudspeakers.
- Dynamometer Instrument.**—A meter whose pointer is attached to a current-carrying coil, the field of which acts with that of stationary coils carrying the same current to rotate the first coil and move the pointer.
- Dynamotor.**—A rotating device acting both as motor and generator, used to change a d.c. voltage to an a.c. voltage or to a higher d.c. voltage. It is used chiefly for portable and mobile operation of radio transmitters and P.A. amplifiers from storage batteries.
- Dynamic Electricity.**—Electric current.
- Dynamo.**—While it might mean either a generator or a motor, this term usually refers to a generator.
- Dynamometer.**—A device for testing and measuring the torque or driving power of machines.
- E**
- E.**—A symbol for volts, electromotive force.
- E.**—Commonly used symbol for voltage.
- E. M. F.**—An abbreviation for "electromotive force."
- Earth.**—A connection to the earth; the earth considered as a common part of all electrical circuits. The word earth has the same meaning as "ground."
- Earth Antenna.**—Wires placed near the earth. Their capacity acts as a ground.
- Earth Current.**—An electric current passing through the ground or earth.
- Ebonite.**—Black hard rubber.
- Echo Box.**—A high Q resonant cavity which receives RF energy through a pickup antenna during the transmitted pulse and reradiates this energy through the same antenna immediately after the pulse. The reradiated energy is picked up by the radar set. Since this energy from the echo box dies off exponentially it will appear on an A-scope indicator as a flat-topped pulse, resulting from the saturation of the receiver by the high energy reverberal coordinate.
- Eddy Current Loss.**—The power used in generating eddy currents which do no useful work.
- Eddy Currents.**—Circulating currents induced in conducting materials by varying magnetic fields. They are undesirable because they represent loss of energy and cause heating. Eddy currents are kept at a minimum by employing laminated construction for the iron cores of transformers.
- Edging.**—Incorrect added coloring at edges or boundaries of differently colored areas in television pictures.
- Edison Base.**—The standard screw base used for ordinary electric light bulbs in this country.
- Edison Battery.**—A form of storage battery using plates of nickel peroxide and iron with an alkaline electrolyte of potassium hydrate.
- Edison-Lalande Cell.**—A primary electric cell using electrodes of copper oxide and zinc in an alkaline electrolyte of caustic soda solution.
- Edisvan Lamp Base End Socket.**—A bayonet lamp base end socket.
- Edisvan Connector.**—A plug connector built like a bayonet lamp base and socket.
- Effective Current.**—That value of alternating current which will cause the same heating effect as a given value of direct current. For sine wave alternating currents, the effective value is approximately seven-tenths of the peak value.
- Effective Electromotive Force.**—The difference between the impressed voltage and the counter electromotive force or counter voltage.
- Effective Resistance.**—The resistance to alternating current. It includes the ohmic resistance and all other electrical and inductive losses.
- Efficiency.**—The ratio of energy output to energy input, usually expressed as a percentage. A perfect electrical device would have an efficiency of 100%.
- Elastance.**—The opposite of capacity in a condenser, the opposition to taking an electric charge, "electrostatic resistance." The reciprocal of the capacitance of a condenser.
- Elasticity.**—Similar to electric resistivity, but applied to electrostatics. It is the specific elastance, the elas-

Electralloy

- tance of a centimeter cube of the substance measured.
- Electralloy.**—A soft iron alloy used for radio chassis construction.
- Electric or Electrical.**—A word used to describe anything having to do with electricity in any form.
- Electric Amalgam.**—An amalgam used in machines which produce frictional electricity.
- Electric Attraction.**—The attraction for each other possessed by bodies or conductors carrying an electric charge or an electric current.
- Electric Balance.**—A Wheatstone bridge.
- Electric Brake.**—A brake used for stopping an electric motor. A braking effect caused by allowing the motors of electric cars to act as generators.
- Electric Breeze.**—The brush discharge at the end of a pointed conductor which carries a high voltage or an electric charge.
- Electric Candle.**—A small arc lamp with its two carbons placed side by side so that the arc forms across their ends.
- Electric Charge.**—The electricity on the surface of a conductor.
- Electrical Degree.**—One of 360 equal parts into which an alternating cycle may be divided, or of which one cycle is considered to be composed.
- Electric Eel.**—An eel which can give an electric shock.
- Electric Energy.**—The ability of electricity to perform work, to develop power.
- Electric Eye.**—A phototube or a photocell.
- Electric Field.**—A region in space surrounding a charged object. Lines drawn to represent the direction in which the electric field will act on other charged objects are called electric lines of force. A moving electric field, such as that associated with electrons in motion or with a radio wave, is always accompanied by a moving magnetic field.
- Electric Fluid.**—A term once used to mean electricity.
- Electric Furnace.**—A heating furnace using electric current, in the form of an arc, a resistance, or a transformer, as its source of heat.
- Electric Glow.**—The corona.
- Electric Heater.**—A heater using resistance wire made hot by a flow of current through it.
- Electric Horsepower.**—Horsepower measured in watts, 746 watts equal one electrical horsepower.
- Electric Potential.**—Voltage, pressure.
- Electric Spectrum.**—The light from an electric arc or spark separated into its various colors and parts by a glass prism.
- Electric Thermometer.**—A device for indicating temperature by the change of resistance caused by changes in

Electric Unit

- heat of a conductor.
- Electric Unit.**—Any of the units used to measure electricity, such as the volt, the ampere, etc.
- Electric Wave.**—A passage of electricity through the air over long distances.
- Electric Welding.**—Welding metals with heat produced by an electric current as in arc welding, spot welding, etc.
- Electrical Metallic Tubing.**—Thin-walled light-weight steel tubing used similarly to rigid conduit for carrying and protecting insulated electric wires.
- Electrical Series.**—The various pairs of materials which, when rubbed together, produce frictional electricity.
- Electrical Sheet.**—Thin sheet steel or sheet iron from which are made the laminations or layers for cores in generators, motors, transformers, etc.
- Electrical Transcription.**—A disc recording of a complete program, as contrasted with a phonograph record which ordinarily contains only a single musical selection. Transcriptions are made to permit broadcasting of a particular program at any desired time by any number of stations.
- Electrician.**—One who works at the repair, upkeep, or installation of electrical devices.
- Electricity.**—The electrons, protons, and other particles which are electric charges or which carry electric charges in the atoms of matter and which, when separated, exhibit electrostatic effects while at rest and electrostatic, magnetic and electromagnetic effects while in motion. Electricity is a form of energy which may be converted from or into other forms of energy such as chemical, heat, radiant, or mechanical energy.
- Electrification.**—To make anything operate by electricity.
- Electrochemistry.**—The science that deals with actions and effects which include both electrical and chemical changes at one time or which depend on each other.
- Electrode.**—A conductor at the surface of which electricity enters or leaves a gas or a liquid into which the conductor extends. One of the elements of electronic tubes, one of the plates of a storage cell, or any conductor serving a generally similar purpose.
- Electrodynamie.**—Relating to the electric current, electricity in motion. Relating to the actions and effects of magnetism and induction.
- Electrodynamie Loud-Speaker.**—A dynamic loudspeaker in which the constant magnetic field is produced by an electromagnet. The coil of this electromagnet is known as the field coil.
- Electrodynamie Induction.**—Production of an induced current in a conductor by change or movement of a mag-

Electrodynamometer

netic field or the conductor. Includes self-induction, mutual induction, and electromagnetic induction.

Electrodynamometer.—A current measuring instrument operating by the attraction and repulsion of electric currents in conductors.

Electrokinetic.—Relating to electricity in motion.

Electrolier.—A hanging type of electric lamp fixture.

Electrolier Switch.—A switch controlling the lamps in an electrolier.

Electrolysis.—The effect of electric current in chemically separating the elements of a liquid through which it flows. The elements are released as gases or else are deposited on electrodes.

Electrolyte.—The liquid or chemical paste which is used between the electrodes of a dry cell storage battery or electrolytic condenser.

Electrolytic.—Relating to electrolysis.

Electrolytic Cell.—The combination of the container or jar, the electrodes, and the electrolyte used for electrolysis.

Electrolytic Condenser.—A fixed condenser in which the dielectric is a thin film of gas formed on the surface of one aluminum electrode by a liquid or paste electrolyte.

Electrolytic Decomposition.—Decomposition or separation of an electrolyte by electrolysis.

Electrolytic Detector.—A detector which allows current through it in only one direction due to electrolytic action in an electrolyte.

Electrolytic Generator.—A low voltage generator for operating electrolytic cells.

Electrolytic Interrupter.—An interrupter formed by two electrodes in an electrolyte. The gas which alternately forms and disappears at one electrode interrupts the current.

Electrolytic Lightning Arrester.—A lightning arrester formed of electrolyte in which are electrodes which become covered with an insulating film that is quickly broken down by the high voltage of a lightning discharge.

Electrolytic Rectifier.—An aluminum cell rectifier.

Electrolyzer.—An electrolytic cell.

Electromagnet.—A coil of wire, usually wound on an iron core, which produces a strong magnetic field when current is sent through the coil.

Electromagnetic Attraction.—The attraction between opposite poles of electromagnets.

Electromagnetic Brake.—A car wheel brake operated by electromagnets.

Electromagnetic Cutout.—A reverse current cutout or an overload or underload cutout operated by an electromagnet.

Electromagnetic Deflection.—Vertical and horizontal deflection of the electron beam or beams in a television

Electromagnetic Field

picture tube or a cathode-ray tube by varying magnetic fields produced by currents of sawtooth waveform in pairs of coils. Pairs for vertical and for horizontal deflection are in a yoke around the picture tube neck.

Electromagnetic Field.—A magnetic field produced by electromagnets.

Electromagnetic Flux.—The flux or magnetic lines of force produced by electromagnets.

Electromagnetic Focusing.—Focusing of the electron beam in a television picture tube by magnetic field lines running lengthwise of the tube axis, produced by direct current in a focusing coil outside the tube neck.

Electromagnetic Induction.—Production of electromotive force in conductors by relative movement between conductors and magnetic lines of force from other conductors, electromagnets, or permanent magnets. Movement may be of the conductors, the field lines, or of both at once.

Electromagnetic Repulsion.—The repulsion between like poles of electromagnets.

Electromagnetic Units.—Units by which electromagnetic effects are measured.

Electromagnetic Vibrator.—A contact type of interrupter operated by an electromagnet.

Electromagnetism.—The science which deals with the actions and effects of electricity and magnetism with each other.

Electrometallurgy.—The production of metals by the action of electric current on substances containing the metals.

Electrometer.—An instrument for measuring very small potentials or voltage.

Electromotive Force.—The force produced within a generator, battery, or other source of electric energy which causes movement of electrons in a connected electric circuit. It is measured in volts.

Electron.—A small active particle of negative electricity. Some electrons are closely associated with atoms of matter, while others, called free electrons, move readily between atoms under the influence of electric or magnetic fields. It is the movement of electrons through a conductor which constitute an electric current.

Electron Emission.—The ejection of electrons from the surface of a material into surrounding space due to causes. In a thermionic vacuum tube, electron emission from the cathode is produced by heat from the filament.

Electron Gun.—In a cathode-ray tube or television picture tube, the cathode, the control grid and the first and second anodes; these being the parts that produce the electron beam and direct it against the fluorescent screen.

Electron-Ray Tube.—A tube which indicates visibly on a fluorescent target

Electron Theory

the effects of changes in control voltage applied to the tube. It is used chiefly as a tuning indicator for radio receivers. Sometimes called a "magic eye".

Electron Theory.—The theory that electrons form a part of the atoms in all forms of matter and all the elements, that every atom consists of a positive center around which rotate negative electrons that may be detached from the atom under certain conditions, leaving the atom positive.

Electronegative.—Having a charge of negative polarity. The negative electrode of an electric cell.

Electron Tube.—Any partly-evacuated, completely-evacuated or gas-filled tube used to control the flow of electrons in a circuit. Vacuum tubes, phototubes, mercury vapor rectifier tubes, cathode ray tubes are all electron tubes.

Electronic Control.—The control of a machine or device by apparatus employing electron tubes.

Electronic Voltmeter.—A vacuum tube voltmeter.

Electronics.—The science and art which deals with the flow of electricity or electrons through vacuums and gases confined within the envelopes of tubes or tanks. Radio, television, and associated arts are branches of electronics. Industrial electronics deals with the use of electronic tubes in manufacturing, processing, and in other industrial and commercial fields.

Electrotherapy.—Medical electricity.

Electrophorus.—An insulating disc and a metallic plate which, when placed together and the disc electrified by friction, produce opposite electric charges on the two elements when separated.

Electroplating.—The plating of metals by depositing them on one of the electrodes in an electrolytic cell.

Electropolar.—Having magnetic poles or having positive and negative electric charges.

Electropositive.—Having a charge of positive polarity. The positive electrode of an electric cell.

Electroreceptive Device.—A device or part that uses the power of electric current for its operation, something that consumes electric power.

Electroscope.—A device which shows the presence of very small amounts of electricity or potential.

Electroze.—A hard, moulded insulating material.

Electrostatic.—Pertaining to the forces and effects of electrons or electricity while at rest; to electric charges, electric fields, lines of electric force, condensers, and dielectrics.

Electrostatic Capacity.—The ability to receive and retain an electric charge. The capacity of a condenser, measured in microfarads or farads. Capacitance or permittance. The symbol

Electrostatic Deflection

is C.

Electrostatic Deflection.—Horizontal and vertical deflection of the electron beam in a cathode-ray tube by electrostatic or electric fields of varying strength and polarity formed between internal deflecting plates. Deflection is toward a plate instantaneously positive, and away from the opposite plate which is instantaneously negative.

Electrostatic Discharge.—A discharge or passage of electricity between bodies which are carrying electric charges.

Electrostatic Field.—The space in which electrostatic effects take place around a conductor carrying an electric charge.

Electrostatic Focusing.—Focusing the electron beam in a television picture tube or cathode-ray tube by electron lenses formed by points of equal potential in gaps between a focusing anode on both sides of which are parts of an accelerating anode or second anode. Adjustment of focus is by altering the voltage of the focusing anode with respect to the cathode, which also means with respect to the accelerating anode.

Electrostatic Galvanometer.—A galvanometer which operates by the effect of two electric charges on each other.

Electrostatic Generator.—A machine which generates electricity by friction or by electrostatic induction.

Electrostatic Grid.—A grid which exercises control of an electron stream by variations of potential difference between this grid and the cathode of a tube in which the grid is an element.

Electrostatic Induction.—The production of an electric charge by moving a conductor into an electrostatic field.

Electrostatic Machine.—An electrostatic generator producing electric charges by friction.

Electrotherapeutics.—The use of electricity in curing disease.

Electrothermal.—Relating to the actions of electricity and heat on each other.

Electrotype.—A printing plate made by depositing metal on a form by means of electric current in an electrolytic cell.

Electrum.—An old name for amber.

Element.—One of the essential internal parts or electrodes of an electronic tube. The plate, grid, cathode and other parts associated with electron flow.

Element of Battery.—The positive and negative plates of an electric cell or battery.

Elevator Control Cable.—A very flexible cable used for making electrical connections to elevators.

Emergency Set.—A transmitting set operated from an auxiliary electric source when the regular source is not in operation.

Emissivity.—The rate at which heat is radiated from a body.

Empire Cloth.—An insulating cotton or linen cloth coated with linseed oil.

Enamelled Wire.—Wire coated with an insulating layer of baked enamel.

Enclosed Arc Lamp.—An electric arc carried inside a glass bulb in the lamp.

Enclosed Fuse.—A fuse enclosed in a tube of glass or fibre to prevent contact of the arc with inflammable vapors.

End Cell.—One of the several cells used with large storage batteries for the purpose of regulating the battery's voltage on charge or discharge.

End Play.—The distance that a shaft or a part mounted on a shaft can move freely in a line with the shaft's length.

End Thrust.—The thrust that is exerted endwise or in line with a shaft.

Endodyne Reception.—Use of a second set of waves which, acting with the received waves, produce beats within the audible range of vibrations.

Endosmose.—The flow of a liquid through a porous substance caused by the passage of an electric current through the porous substance.

Energize.—To cause a magnetic material, such as a magnet core, to become magnetized or magnetic. To send current through a circuit or through a winding or coil.

Energy.—The ability to do work, or to cause movement against an opposing force when utilized in suitable equipment. Energy exists in bodies that are in motion, in bodies such as springs that are in a strained position, in electromotive force, in chemicals, and in heat. Energy existing in one form may be changed to energy existing in other forms; as when chemical energy in a battery changes to electromotive force.

Entrance Switch.—A switch connected in a circuit where the wires enter a building.

Envelope.—The glass or metal housing of a radio tube.

Equalizer.—A connection between generators in parallel which equalizes their voltage and current.

Equalizing Charge.—A charge given to a storage battery for the purpose of bringing all cells to their maximum gravity, after which the electrolyte density is adjusted in all cells.

Equalizing Pulses.—In a composite television signal, a series of six pulses, each of half the time duration of a horizontal sync pulse, preceding and following each complete serrated vertical pulse. Equalizing pulses allow alternate picture fields to begin with a full line and with a half line for interlaced scanning.

Equator of Magnet.—A point midway between the opposite poles of a magnet.

Equipotential.—At the same electric voltage or pressure.

Escutcheon.—The ornamental wood, metal or plastic framework for a radio dial, tuning indicator or other panel-mounted part in a radio receiver or amplifier.

Ether.—The medium which is supposed to fill all space, and through which radio, heat, and light waves are supposed to travel. Its existence has not yet been definitely proved.

Excite.—To magnetize or cause a magnetic flux in the field magnets of generators or motors by sending current through their windings.

Exciter.—A small generator for supplying direct current to the field windings of an alternator. Sometimes refers to an oscillator.

Exciting Current.—The field current of a generator or motor, or the current through the winding of an electromagnet.

Excitron.—One form of grid-pool tube, which see.

Expanded Scope.—A magnified portion of a given type of CRT presentation; for example, P¹.

Explosion-Proof.—Enclosed in a case which is capable of withstanding an explosion of a specified gas or vapor within it, and of preventing the ignition by sparks, flashes or explosions of that gas or vapor surrounding the enclosure.

Extended Pole Piece.—A pole piece or pole shoe having one tip extended around the armature farther than the other tip.

Extension.—A flexible cable used to connect a lamp or other electric device to a socket from which current is secured.

External Armature.—An armature in the form of a ring that rotates around the outside of the field magnets in a generator or motor.

External Circuit.—All of the wires and conductors which are outside the source.

External Magnetic Circuit.—The part of the magnetic circuit that is outside of the magnet coil or winding.

Extra Current.—A current produced by self-induction.

F

F.—An abbreviation for "frequency," cycles per second.

F.—Fahrenheit. Scale of temperature.

F.—U. S. Navy prefix to designate shipborne fire control radar. Examples: FC, FD, FH, etc. Designation later changed to Mark III, Mark IV, Mark VIII, etc.

Face Plate.—The transparent or semi-transparent glass front of a television picture tube, through which is seen the phosphor illumination forming pictures.

Facsimile.—A system of radio communication in which photographs, drawings, handwriting, and printed matter of any kind are transmitted to receivers which feed into facsimile recorders.

- Facsimile Recorder.**—An instrument which reproduces on paper the illustration, writing or printed matter being transmitted by a facsimile system.
- Factor.**—Any value or condition that affects or changes a result. In $2 \times 3 = 6$ the numbers 2 and 3 are factors, and changing either one would change the result.
- Fading.**—An essentially regular rise and fall due to variations in transmission conditions along the path taken by the radio waves from the transmitting station to the receiver.
- Fading.**—It is due to atmospheric conditions.
- Fahnestock Clip.**—A spring-type terminal to which a temporary connection can readily be made.
- Fahrenheit.**—The temperature-measuring system generally used in the United States in which 32 degrees is the temperature of melting ice and 212 is the temperature of boiling water at sea level.
- Fall of Potential.**—The drop of voltage between different points in an electric current.
- False Resistance.**—The resistance effect of counter electromotive force.
- Fan Antenna.**—A name sometimes applied to a conical antenna.
- Fan Motor.**—A small electric motor.
- Farad.**—The basic unit of capacity, but too large for practical use. The microfarad, equal to one millionth of a farad, is a more practical unit for radio work. An even smaller unit, the micro-microfarad, is also used in radio; it is equal to one millionth of a microfarad.
- Faradic Current.**—A current produced by induction.
- Farm Lighting Plant.**—Small generator driven by gasoline engine.
- Fault.**—Any trouble in an electric circuit; a short circuit, or an excessively high resistance.
- Fault Finder.**—A resistance bridge used to determine the location of faults in telegraph or telephone circuits.
- Faure Plate.**—A storage battery plate made by filling the spaces in a grid with pastes of active material.
- F.C.C.**—Federal Communications Commission. A commission appointed by the President of the United States and given licensing and regulating authority on matters dealing with wire and radio communications in the United States and its possessions.
- Feedback.**—Transfer of energy from one point in an electrical system to a preceding point, such as from the output back to the input.
- Feeder.**—Any conductors of a wiring system between the service equipment, or the generator switchboard of an isolated plant, and the over-current devices that protect branch circuits.
- Feeder Panel.**—A panel or unit of a switchboard at which connections are made to a feeder.
- Ferro-Manganese.**—Containing iron and manganese in an alloy.
- Ferro-Nickel.**—Containing iron and nickel in an alloy.
- Fibre.**—A hard, tough material of rubber-like structure.
- Fibre Cleats.**—A piece of fibre used to fasten conductors to flat surfaces.
- Fibre Conduit.**—Conduit or insulating tubing made of moulded fibre.
- Fibre Cored Cable.**—A stranded cable having a piece of fibre running through its center. Used for carrying large alternating currents.
- Fidelity.**—The faithfulness with which part or all of an electrical system delivers an exact reproduction of the input signal wave form.
- Field.**—Every alternate horizontal line of a television picture, as scanned during 1/60 second. One field begins with a full line from the upper left-hand corner, the next with a half line beginning midway across the top. The two sets of alternate lines complete the scanning for one picture, taking a time of 1/30 second and forming one frame. With 525 lines per frame, there are 262½ lines per field.
- Field.**—1. Magnetic or electromagnetic field; the space in which appear the magnetic lines of force around a magnet or an electromagnet. 2. Electrostatic field; the space between two opposite electric charges, in which appear electrostatic lines of force.
- Field Coil.**—The winding or conductor around the field magnets of generators, motors, etc. In an electrodynamic loudspeaker, the coil which produces the constant-strength magnetic field.
- Field Distortion.**—A change in the path followed by lines of force from a straight path or the shortest path between poles. The change of field path caused by armature reaction.
- Field Flux.**—The lines of force passing through a magnetic field or magnetic circuit.
- Field Form.**—A line or curve which shows the amount of field flux at different armature conductors in an armature circuit.
- Field Frequency.**—In television systems employing interlaced scanning, this term refers to the number of times per second the frame area is fractionally scanned.
- Field Intensity.**—The magnetizing force or flux density. The rate at which the magnetomotive force or magnetic potential changes along a magnetic circuit, measured at certain distances. Measured in ampere-turns per centimeter of length of the magnetic circuit.
- Field Magnet.**—The permanent magnet

Field Pole

or electromagnet which supplies a magnetic field in a generator, motor or other electrical equipment.

Field Pole.—One of the ends of the field magnet between which an armature of a generator or motor rotates.

Field Rheostat.—A rheostat connected in the field circuit of a generator or motor for controlling the generator voltage or the motor speed.

Field Strength.—The strength, usually measured in microvolts, of a radio or television carrier-frequency signal derived from an antenna. Absolute field strength, in microvolts per meter, is that induced in a standard dipole antenna one meter long. Relative field strengths, in microvolts, are those induced in any antenna or at the input to a receiver by carrier signals in various channels.

Field Strength Meter.—A meter which indicates field strengths directly. Consists essentially of tuner, i-f amplifier, and a detector whose output goes directly or through an amplifier to a d.c. meter.

Field Winding.—A field coil, or all of the coils on one field pole.

Filament.—The resistance wire through which filament current is sent in a vacuum tube to produce the heat required for electron emission. When electron emission is from the surface of the filament wire itself, the filament is also serving as the cathode. When the filament merely supplies heat to a separate cathode electrode, we have a heater-type or indirectly-heated tube.

Filament Battery.—The battery whose current heats the filament in the electron tube, the "A" battery.

Filament Cathode.—A filament which is heated by flow of current in it, and which acts as an electron emitting cathode at the same time.

Filament Circuit.—The complete circuit over which filament current flows from the A battery, filament winding or other filament voltage source to the filaments of radio tubes and pilot lamps.

Filament Current.—The current supplied to the filament of a vacuum tube for heating purposes.

Filament Rheostat.—A rheostat connected between the filament of the electron tube and the "A" battery.

Filament Switch.—The switch that connects the "A" battery to the filaments of the electron tubes.

Filament Voltage.—The voltage value which must be applied to the filament terminals of a vacuum tube in order to provide the rated value of filament current.

Filament Winding.—A separate secondary winding provided on the power transformer of a radio receiver or other a.c.-operated apparatus for use as a filament voltage source.

filings Coherer.—A coherer tube using filings.

Film Cutout

Film Cutout.—A thin piece of insulating material between the electrodes of a lamp. This insulator burns through when the filament breaks, thus completing the circuit through the dead lamp to others in the same circuit.

Filter.—A resistor, coil, condenser or any combination of these parts which is used to block or attenuate alternating currents at certain frequencies while allowing essentially unimpeded flow of currents at other frequencies or of direct current. Thus, the filter in a radio power pack is a coil, condenser and resistor combination which receives a pulsating direct current having many a.c. components, but delivers an essentially pure and constant direct current.

Filter Choke.—A coil used in a filter system to pass low frequency currents or direct current while limiting or blocking the flow of higher-frequency alternating or pulsating currents.

Filter Condenser.—A condenser used in a filter system to permit passage of higher-frequency currents while limiting or blocking the flow of lower-frequency currents and direct current.

Finder Switch.—A telephone exchange switch which automatically connects the circuit over which a signal is coming.

Fine Tuning.—A control for varying the frequency of the r.f. oscillator in a television tuner, usually by means of an adjustable capacitor, to make this frequency such as beats correctly with a received carrier frequency to produce intermediate frequencies employed in the receiver.

Fire Alarm Telegraph.—The telegraphic system through which alarms of fire are transmitted.

First Audio Stage.—The first stage in the audio amplifier of a radio receiver. Audio signals are fed into this stage by the detector of a t.r.f. receiver, and by the second detector of a superheterodyne receiver.

First Detector.—That stage in a superheterodyne receiver in which the incoming modulated r.f. signal and the r.f. signal from the local oscillator are combined to produce the i.f. signal.

Fish Paper.—A strong paper used for insulation.

Fish Wire.—A flat steel wire used for pulling conductors through conduits and raceways.

Fitting.—A part such as a bushing or locknut which is intended to perform some mechanical function, rather than electrical, in a wiring system.

Fixed Condenser.—A condenser having a definite capacity value which cannot be adjusted.

Fixed Resistor.—A resistor having a definite ohmic value which cannot be adjusted.

Fixture Wire.—Insulated wire suitable for passing through the tubes of electric fixtures.

Flaming Arc.—An enclosed arc using carbons containing various minerals which, in burning, give the flame different colors or shades of color.

Flaming of Arc.—The production of a flame in place of a steady arc between the electrodes of an arc lamp.

Flaming Discharge.—A continuous bright discharge between the ends of an induction coil's secondary circuit when a large primary current is being used.

Flushed Filaments.—A carbon filament that has been made of uniform size by heating it in a gas which contains carbon.

Flusher.—An automatic or electrically operated switch that turns the lamps in an electric sign on and off at regular intervals.

Flashing Over.—Sparking that occurs at the edge of a generator brush away from which the commutator is traveling and by means of which currents jump over one segment to the brush resting on an adjacent segment.

Flat.—A flat or low spot on a commutator.

Flat-Compound Generator.—A compound wound generator whose windings are proportioned to give a constant voltage under various loads and speeds.

Flat Top Antenna.—An antenna whose conductors run parallel with the earth's surface.

Fleming's Rules.—Rules in direct current work for determining the direction of a conductor's motion through a magnetic field, the direction of the lines of force, and the direction of current flow through the conductor. The rule for generators is: Hold the thumb, the forefinger and middle finger of your right hand so they are at right angles with each other. Then your thumb points in the direction of the conductor's motion, your forefinger points in the direction of the lines of force, and your middle finger points in the direction of current through the conductor.

The rule for motors is: Hold the thumb, the forefinger and the middle finger of your left hand so they are at right angles with each other. Then your thumb points in the direction of the conductor's motion, your forefinger points in the direction of the lines of force, and your middle finger points in the direction of current through the conductor.

Flexible Cable.—Cable made up of stranded or woven conductors.

Flexible Conduit.—Conduit made of fabric and insulating compound.

Flexible Metal Conduit.—A hollow tube formed by spirally wound metallic strips, within which are placed insulated electric wires for protection

and support.

Flip-flop.—In color television, shifts of color phase.

Floating Battery.—A storage battery connected in parallel with a generator and the current consuming devices so that the battery can either receive a charge or can supply any extra current above the generator's output that may be required in the circuit.

Flood Lights.—High candlepower lamps with reflectors which direct the light onto objects to be strongly lighted.

Floor Insulator.—An insulator carrying a conductor through a floor.

Flow.—Passage of electricity through a circuit as electric current. Passage of magnetic lines of force through a magnetic circuit as flux.

Fluorescent Lamp.—A form of lamp which emits visible light when fluorescent material (phosphors) on the inside of the lamp tube are struck by streams of electrons passing between electrodes in the ends of the tube.

Fluorescent Screen.—A coating of chemical material which glows when bombarded by electrons. In a cathode ray tube, the coating is on the inside surface of the evacuated glass envelope of the tube.

Flush Receptacle.—An electric lamp socket which mounts against a flat surface.

Flush Switch.—A push button switch that is set into a wall so its surface is flush with the wall surface.

Fluxmeter.—An instrument for measuring and indicating the magnetic flux density in a field.

Flux.—The magnetic lines of force in a magnet or in a magnet and its magnetic field. The flux, in magnetism, is similar to the current in electric circuits, since both terms refer to a flow.

Flux Density.—The number of magnetic lines per square inch or other unit of cross section of a magnetic circuit consisting of iron, steel, air or other material at a point where the flux density is measured.

Flyback Period.—A period or interval during which the scanning beam in the television camera is extinguished or is blanked while the controls which move the beam return to the conditions at which the following trace is to be made over the picture image.

Flyback Power Supply.—A system of producing high voltages for television picture tubes. High potential pulses are induced in a horizontal output transformer winding by sudden reversals of sawtooth currents in deflecting coils, these reversals occurring during beam retrace or flyback periods. Pulse voltage is increased by autotransformer action, then rectified and filtered.

Flywheel Effect.—Continuation of oscillatory current at nearly constant frequency in a resonant circuit dur-

- ing intervals between applied signal energy. The effect is due to slow loss of energy when the resonant circuit has a high Q-factor.
- F.M.**— Frequency modulation. Also written as f-m or FM.
- Focus.**—The position of a lamp with reference to its reflector so that the beams of light are thrown in straight lines in one direction.
- Focusing Control.**—In a cathode ray oscilloscope or television system, the control which adjusts the size of the visible spot produced at the screen by the electron gun in a cathode ray tube.
- Folded Dipole.**—An antenna whose dipole element consists of two or more side-by-side conductors spaced apart and conductively connected together at their outer ends. At the center of one conductor is a gap for connection of a two-wire transmission line. Inherently a broad band antenna.
- Folded Picture.**—Overlapping of part of a television picture over the remainder, either vertically or horizontally.
- Foot-Candle.**—A unit of illumination affecting a surface. It is the degree of illumination produced by a luminous flux of one lumen per square foot of surface area.
- Foot-Pound.**—A unit of work or of energy. The work done or the energy expended in lifting a mass of one pound vertically against the force of gravity through a distance of one foot.
- Force.**—That which changes the speed or motion of anything, either to cause motion, to increase or decrease the speed, to stop motion.
- Forced Alternating Current.**—A current whose frequency and damping are equal to the frequency and damping of the exciting e.m.f.
- Forced Oscillations.**—Causing the induced current in a circuit to have the same period as the inducing or received current.
- Form Factor.**—The ratio of the effective value of one-half a cycle of alternating current its mean average value.
- Form Wound.**—A winding built up on a form to the proper shape before being installed in its working position on an armature, field pole, coil core, etc.
- Forming of Battery Plates.**—Changing the materials in storage battery plates after manufacture into the active materials, peroxide of lead and sponge metallic lead, by passing a current through the cells.
- Foucault Currents.**—Eddy currents.
- Four-Pole.**—Having four magnetic poles, two positive and two negative in direct current work. Controlling four different current conductors or circuits.
- Four-Way Switch.**—A switch used in a circuit that permits a single lamp to be controlled from any of three or more positions. The switch has four terminals which alternately are joined together in different pairs.
- Fractional Pitch.**—An armature coil between the sides of which there is a number of slots not exactly equal to the pole pitch or number of slots per pole of the machine.
- Frame.**—In television, one complete scanning of every part of the field of view being transmitted.
- Frame Frequency.**—In television, the number of times per second the frame area is completely scanned.
- Framing Control.**—In television, a general term applying to any of the control knobs used for adjusting the centering, width and height of the reproduced image.
- Free Alternating Current.**—The current caused by an electromagnetic disturbance in a circuit having capacity and inductance.
- Free Electrons.**—Those electrons which are free to move between the atoms of a material when acted upon by electric or magnetic forces.
- Free Magnetic Pole.**—A magnetic pole so far removed from the action of an opposite pole that it acts as if it were free from the effect of the other pole.
- Frequency.**—The number of complete cycles per second which an electric current, a sound wave or a vibrating object undergoes. Frequency in cycles is equal to the velocity divided by the wavelength.
- Frequency Changer.**—A motor-generator set driven by alternating current of one frequency and generating current of another frequency.
- Frequency Compensation.**—Any circuit modifications or added elements which extend to higher and lower frequencies the range in which there is satisfactory response or amplification of an amplifier, or which make for more uniform response over a wide range of operating frequencies.
- Frequency Converter.**—A circuit or device which changes the frequency of an alternating current. Thus, the oscillator and mixer-first detector stages make up the frequency converter of a superheterodyne receiver.
- Frequency Distortion.**—A type of distortion which occurs when a circuit or device amplifies or transmits unequally the different frequencies it is handling.
- Frequency Indicator.**—An instrument which indicates when two alternating currents are in phase, or of the same frequency.
- Frequency Meter.**—An instrument for measuring and indicating the frequency or cycles of an alternating current.
- Frequency Modulation.**—A system of radio transmission and reception with which sound or other signals modulate carrier voltages or currents by varying the frequency but not the amplitude of the carriers. The extent

Frequency Response

Fuse Block

- of frequency change, called deviation, is proportional to strength or amplitude of the modulation, while the number of frequency changes per second is proportional to frequency of the modulating signal. The average or unmodulated carrier frequency is called the center frequency.
- Frequency Response.**—A graph or curve showing relative gains of an amplifier at all frequencies within its normal operating range, or showing relative outputs of a speaker or other device at various operating frequencies. Input power, voltage, or current is maintained constant at all frequencies.
- Freya.**—German early-warning radar set.
- Friction Tape.**—Tape filled with some adhesive compound. It is a good insulator for low voltage.
- Frictional Electricity.**—Electricity or an electric charge produced by the friction of one material on another.
- Frictional Machine.**—A machine for producing frictional electricity; a static machine.
- Fringing.**—Same as edging in color television pictures.
- Front End.**—The tuner of a receiver.
- Front Porch.**—In a composite television signal, the portion of the black level which, during horizontal blanking intervals, precedes each horizontal sync pulse. A part of the pedestal.
- Frying of Arcs.**—A sputtering sound in an arc lamp caused when the carbons are too close together.
- F-Scan.**—A single signal only, appearing as a bright spot. Azimuth error angle (relative bearing) appears as the horizontal coordinate, elevation angle as the vertical coordinate.
- Full-Magnetic Controller.**—A controller in which electromagnets perform all of the basic functions, such as closing and opening the line circuit, reversing, retarding, and accelerating the controlled machine.
- Full Pitch.**—An armature coil between the sides of which there is a number of slots exactly equal to the pole pitch or number of slots per pole of the machine.
- Full-wave Rectifier.**—A rectifier which allows alternations of both polarities in an applied alternating voltage to produce pulses of one-way or direct current flowing the same direction in the output circuit.
- Fuller Cell.**—A primary electric cell sometimes used in small telephone exchange switchboards.
- Fundamental Units.**—Units dealing with length, with time, or with size or weight, from which all other units are derived.
- Fuse.**—A strip or wire of metal which, when it carries an electric current greater than the capacity or rating of the fuse, will become so heated by the excess of current as to melt or burn out. The fuse is connected in the circuit to be protected against

- overcurrent, and melts to open the circuit when overcurrent exists in the circuit. A fuse sometimes is called a cutout. Other overcurrent protective devices include automatic relays and circuit breakers.
- Fuse Block.**—A piece of insulating material designed to carry fuses and their connections.
- Fuse Box.**—A covered box in which fuse blocks and fuses are carried.
- Fuse Clip.**—A spring clip to hold the end of a cartridge fuse.
- Fuse Cutout.**—A fuse which burns out to disconnect or "cut out" a circuit attached to it.
- Fuse Link.**—An unenclosed fuse.
- Fuse Panel.**—A panel on which fuses and their connections are mounted.
- Fuse Plug.**—A fuse carried in a screw plug which can be inserted in a socket like a lamp socket.
- Fuse Strip.**—A fuse in the form of a thin flat strip rather than wire.
- Fuse Wire.**—A fuse in wire form.
- G
- G.**—A symbol for mho, meaning conductivity.
- "GA." Coil.**—A coil wound with separated layers having air space between each layer to improve the capacity and inductance over solidly wound coils.
- Gain.**—In an amplifier stage or system, the ratio of output voltage, current or power to input voltage, current or power. Usually expressed in decibels.
- Galeno.**—Lead sulphide, a shiny bluish gray mineral often used as the crystal in a crystal detector.
- Galvanic.**—An old word meaning voltaic. (See voltaic.)
- Galvanic Taste.**—A rather sour taste produced when the ends of conductors carrying low voltage are touched to the tongue.
- Galvanometer.**—An instrument for measuring small currents or voltages. A meter which indicates the presence, flow, or direction of small currents, usually on a scale having arbitrary numbers rather than in standard units such as milliamperes.
- Gamma.**—The relation between range of gray tones reproduced in a television picture and the range of picture voltage changes in the applied video signal. Measured as the tangent of the angle formed between a zero line and a characteristic curve relating picture tones to signal variations.
- Gang Switch.**—Two or more rotary switches mounted on the same shaft and operated by a single control.
- Gang Tuning Condenser.**—Two or more variable tuning condensers mounted on the same shaft and operated by a single control.
- Gas Amplification Factor.**—The number of times that the current in a gas-filled phototube is increased over the current which would flow in an otherwise similar vacuum phototube operated under like conditions.

Gas-Filled Lamp

Gas-Filled Lamp.—An incandescent lamp whose bulb is filled with nitrogen and argon gases which permit operating the filament at higher temperatures than in vacuum lamps.

Gas-Filled Tube.—An electronic tube into which, after evacuation, has been admitted a small quantity of some inert gas such as argon, helium, neon or xenon. Ionization of the gas, which occurs at and above certain applied voltages, permits a greatly increased tube current and a small voltage drop in the tube.

Gas Lighter.—A device for lighting a gas flame with an electric spark.

Gasoline-Electric.—A driving and speed control mechanism including a generator driven from a gasoline engine and one or more motors driven by the generator, with or without a storage battery in the circuit.

Gassing.—The production of hydrogen and oxygen gases at the plates in an electric cell during discharge, or during charge of a storage cell or passage of current through an electrolytic cell.

Gated Automatic Gain Control.—Same as keyed automatic gain control.

Gated Beam Tube.—A five element electron tube in which plate current may be varied from zero to maximum by small variations of control grid voltage, with only slight further increase of plate current when the grid is made still less negative, or positive. Used as an i.m. sound demodulator, also in instruments for producing pulsed voltages of various forms.

Gating.—Maintaining plate current of an electron tube at cutoff except during a limited portion of the operating cycle, thus permitting the tube to become conductive (to open the gate) only when grid, screen, or plate voltage is made such as to cause or allow conduction. Usually a pulsed voltage is applied to plate, screen, or grid to open the gate.

Gauge Lamp.—A small lamp for lighting the instruments on the dash or cowl of an automobile.

Gauss.—A measure of flux density, one maxwell per square centimeter.

Gauze Brush.—A current collecting or carrying brush made of copper wire gauze, woven or coiled.

GCA.—Ground control of the approach of an aircraft to an airfield.

GCI.—Ground control of interception. The technic that is accomplished by coordination between a land-based radar set and fighter aircraft equipped with their own radar sets.

GCL.—Ground control of the landing of aircraft.

Geissler Tube.—A partial vacuum tube in which is a small amount of some gas which emits various colors of light when a current passes through the tube.

Gelatin Battery.—A storage battery in which the electrolyte is in jelly or semi-solid form.

Generator

Generator.—A rotating machine which converts mechanical energy into electrical energy. Also, a radio device or circuit which develops an a.c. voltage at a desired frequency when energized with d.c. or low frequency a.c. power.

Generator Busbar.—A switchboard busbar to which generators are connected.

Generator Cradle.—The mounting for a generator. It is generally adjustable as to position.

Generator Efficiency.—The ratio of the power it takes to drive a generator to the electric power of the current generated.

Generator Loss.—The loss of power between that required to drive a generator and the power generated. It is made up of both the electrical and mechanical losses.

Generator Output.—The number of amperes secured from a generator, or the number of watts secured.

German Silver.—A resistance alloy containing copper, nickel and zinc.

Getter.—An alkali metal introduced into a vacuum tube during manufacture and vaporized after the tube has been evacuated, to absorb any gases which may have been left by the vacuum pump. The silvery deposit on the inside of the glass envelope of a tube, usually near the tube base, is the result of getter vaporization.

Ghost Image.—In television, an undesired duplicate image appearing a fraction of an inch to one side of the desired image, due to reception of a reflected signal along with the signal coming directly from the television station. The remedy involves using a directional receiving antenna adjusted so it will receive signals coming over only one path.

Gilbert.—A measure of magnetomotive force, magnetic potential. One gilbert is the magnetomotive force that sends one maxwell of flux through a magnetic circuit having a reluctance of one oersted.

Gimbal.—One of the supports for a ship's compass which allow it to remain horizontal with movement of the ship.

Gimmick.—A small capacitance formed by winding a bare wire around an insulated wire, or by winding two insulated wires together, so that insulation acts as dielectric and the wire conductors as plates of a capacitor.

Girder Armature.—An H-armature or shuttle armature.

GL.—Gun laying. Information supplied by GL equipment (range, bearing and elevation) is used to direct guns and to control their firing.

Glass Separator.—A storage battery plate separator made of glass or of glass wool.

Glass-Type Tube.—A vacuum tube or gaseous tube having a glass envelope or housing.

Glow Lamp

Glow Lamp.—A gaseous tube having a glass envelope through which can be seen a glow due to ionization of the molecules of gas. Neon gas gives a red glow, mercury vapor gives blue, and argon gas gives a light purple glow. Also called glow tube.

Glow Tube.—A cold-cathode gas-filled electronic tube containing only a cathode and an anode as elements. Used as a voltage regulator and as a protective tube at the potentials which causes ionization or breakdown and a resulting increase of tube current.

Gold-Leaf Electroscope.—An electroscope in which a small piece of gold leaf is moved by the electrostatic force.

Goniometry.—Locating the position of a transmitting station by the use of a direction finder.

Government Broadcasting.—Broadcasting done officially by various departments of the national government.

Gram.—A unit of weight in the metric system. One pound is equal to 453.59 grams. See metric system.

Gramme Ring Armature.—A ring armature.

Graphite.—A form of carbon which is an excellent conductor.

Gravity Meter.—A meter whose pointer is held at zero by gravity rather than by a spring.

Gravity Battery.—The generally used type of Daniell cell.

Gravity Drop.—An annunciator drop which is caused to fall by the force of gravity.

Green Gun.—In a three-gun color television picture tube, the electron gun whose beam strikes phosphor dots emitting the green primary color.

Greenfield Conductor.—A flexible cable covered with a spirally wound piece of metal for mechanical protection.

Grenet Cell.—A bichromate cell from which the zinc is removed when the cell is not in use.

Grid.—The metal framework of a storage battery plate, in the spaces of which the active material is carried. An electrode mounted between the cathode and the anode of a radio or electronic tube to control the flow of electrons from cathode to anode. The grid electrode is usually either a cylindrical-shaped wire screen or a spiral of wire through which electrons can readily move.

Grid Bias.—Another term for C bias, which is the voltage used to make the control grid of a radio tube negative with respect to the cathode.

Grid Clip.—A spring clip used to make an easily removable connection to the cap terminal located at the top of some radio tubes.

Grid Condenser.—A small fixed condenser inserted in the grid circuit of a vacuum tube.

Grid-Glow Tube.—A cold-cathode gas-filled electronic tube with one or

Grid Leak

more control electrodes or grids which regulate the instant at which current flow commences. Used somewhat similarly to thyatron, but with smaller amounts of power, as in safety controls and similar applications.

Grid Leak.—A resistor of high ohmic value, used to connect the control grid to the cathode in a grid leak-condenser detector circuit.

Grid-Leak-Condenser Detector.—A type of detection in which a.f. potentials developed across a grid resistor by the flow of grid current through that resistor result in plate current changes at the desired audio frequencies. This type of detector is identified by the presence of a grid leak and grid condenser in the grid circuit.

Grid-Pool Tube.—A tube or tank having a mercury pool cathode, one or more anodes, and a control electrode or grid which regulates the instant at which current flow commences.

Grid Pulsing.—A circuit arrangement of the RF oscillator in which the grid of the oscillator is biased so negatively that no oscillations take place even when plate voltage is applied to the tube and pulsing is accomplished by removing this negative bias through the application of a positive pulse on the grid.

Grid Return.—The lead or connection which provides a path for electrons from the grid circuit or C bias battery to the cathode.

Grille.—An arrangement of wood or metal bars placed across the front of the loudspeaker in a radio receiver for protective purposes and to enhance the design of the cabinet.

Grille Cloth.—A loosely woven cloth stretched behind the loudspeaker grille of a radio receiver to keep dust and other foreign matter out of the loudspeaker diaphragm. Sound waves travel unimpeded through this cloth.

Grommet.—A special washer, made of rubber or other insulating material, used to prevent a wire from touching the sides of a chassis hole through which the wire is run.

Ground.—The earth when employed as a conductor or as a point of unvarying potential. Any conductor providing an electrical connection between circuits or electrical equipment and the earth. The metallic portions of a support or framework when employed as a conductor for portions of electric circuits.

Ground Antenna.—An antenna laid on the ground or buried in the ground in place of being supported in the air.

Ground Circuit.—A circuit completed through ground, through the earth, or the metal parts of electrical units.

Ground Clamp.—A metal strap or clamp used for making a good electrical connection to a ground rod or grounded pipe. The clamp has a screw terminal or soldering lug to

- which the ground wire of a radio receiver can readily be attached.
- Ground Detector.**—A voltmeter connected between a circuit and ground to indicate when accidental grounds occur.
- Ground Indicator.**—An instrument which indicates when an accidental ground connection exists in a circuit.
- Ground Plate.**—A piece of metal buried in the earth or attached to a metal framework to provide a connection to ground in electric circuits.
- Ground Return.**—A part of a circuit from electro-receptive devices back to the source which is made wholly or in part through the ground.
- Ground Return.**—Radiation which is reflected from the ground and is returned as an echo to the radar set.
- Ground Return Circuit.**—In telegraph and telephone circuits, a circuit completed through the earth as one conductor.
- Ground Suppressor.**—A device which automatically grounds a circuit on which there is an accidental short circuit or ground.
- Ground Wire.**—The conductor leading from a current consuming device to a ground connection.
- Ground Waves.**—Radio waves which travel along the surface of the earth instead of going up into the sky.
- Grounded Field.**—A field winding, one end of which is connected to ground.
- Grounded Neutral.**—A grounded neutral wire in a three-wire circuit.
- Grounded Primary.**—A primary circuit of an induction coil or other electric device which is completed through ground connections.
- Grounding Brush.**—A small brush used for making a ground connection from a moving part, such as the metal of an armature core.
- Grounding Conductor.**—A wire or other conductor used to connect electrical equipment or one of the conductors in a wiring system with ground or with a grounding electrode buried in the earth.
- Group of Battery Plates.**—All of the negative plates or all of the positive plates in a storage cell or primary electric cell.
- Grove Cell.**—A primary electric cell using zinc and platinum for electrodes. Otherwise similar to the Bunsen cell.
- Group Frequency.**—The number of sparks per second.
- Growler.**—An iron core with a winding through which alternating current or pulsating direct current is passed while the core of an armature or a coil is placed across the ends of the growler core. Acting as a transformer, the growler then shows whether short circuits exist.
- G-Scan.**—A single signal only, appearing as a bright spot on which wings grow as the distance to the target is diminished. Azimuth angle appears as the horizontal coordinate, elevation angle as the vertical coordinate. This has been referred to as Mark VI indication.
- A radar term.*
- Guillemin Line.**—The network used in high level pulse modulation in generating a nearly square pulse with steep rise and fall.
- A radar term.*
- Gutta-Percha.**—A material similar to rubber.
- Gutter.**—A trough or recess for wire leads and wire splices in a cabinet or box.
- Guy Wire.**—A wire used to brace the mast or tower of a transmitting or receiving antenna system.
- G-Y Signal.**—A green-minus-Y or green-minus-luminance color-difference signal in television. When combined with suitable proportions of a plus luminance (+Y) signal, the green primary color results.

H

- H.**—A symbol for magnetic field intensity, or for magnetizing force.
- H Armature.**—An armature of which a cross section through the core has somewhat the form of the letter H, with two opposite slots for carrying a single loop of windings.
- Half-Inch Spark Plug.**—A spark plug whose shell has a half-inch tapered pipe thread.
- Half-wave Dipole.**—An antenna whose conductors extend approximately in line from side to side over a total distance equal to very nearly half of the wavelength at which the antenna is series resonant. Inductance for resonance is proportional to conductor length, and capacitance to conductor diameter or to the number of conductors side by side. All commonly employed television and f.m. radio antennas are half-wave dipoles of one form or another.
- Half-wave Rectifier.**—A rectifier allowing alternations of only one polarity in applied alternating voltage to produce pulses of one-way or direct current in the output.
- Hand Advance.**—Advance and retard of internal combustion ignition devices by hand operated controls.
- Hand Regulation.**—Control of current or voltage by hand operated devices.
- Hard-Drawn Copper Wire.**—A hard grade of copper wire having good mechanical strength.
- Hard Fibre.**—A highly compressed and rather brittle grade of fibre.
- Hard Rubber.**—Rubber that has been vulcanized until very hard. It is used for insulation.
- Hard Tube.**—An electron tube having a high degree of vacuum.
- Hardened Battery Plate.**—A storage battery plate in which the active material has been made hard and non-porous by excessive sulphation.
- Harmonic.**—A multiple of any particular frequency. Thus, the second har-

Harmonic Distortion

monic of a fundamental frequency would be equal to two times that fundamental frequency.

Harmonic Distortion.—Another name for wave form distortion.

Harmonic Selective Ringing.—Ringing certain subscribers on a party telephone line by having the ringers adjusted to respond only to a certain frequency of current.

Hartley Oscillator.—A vacuum tube oscillator circuit identified by a tuned circuit which employs a tapped winding connected between the grid and plate of the vacuum tube, with the tap going to the cathode.

Hazardous Locations.—Locations in which special types of electrical equipment and devices are required to insure safety. Places where flammable materials are stored other than in original containers, where dust may become combustible or explosive, where dust and dirt collect in such quantities as to cause overheating, and where combustible materials are handled, manufactured, stored or used.

Hazeltine Licensed.—Radio apparatus which uses Hazeltine patents under a licensing agreement with the Hazeltine Corporation.

Headphone.—A small telephone receiver, held against an ear by a clamp passing over the head, used for private reception of radio programs or for reception of signals which are too weak to provide loudspeaker volume. Headphones are usually used in pairs, one for each ear, with the clamping strap holding them both in position.

Heater.—A filament used in a vacuum tube only for the purpose of supplying heat to an indirectly heated cathode.

Heater Cathode.—An indirectly heated cathode. A cathode which is insulated within the tube from its separate heater element.

Heat Loss.—The loss of power due to increased resistance in heated conductors.

Heat Run.—Running a generator, motor, transformer or other electrical device to find the amount of heating that takes place under certain conditions.

Heating Unit.—The part of an electric heating device which carries the resistance elements in which the heat is developed.

Heaviside Layer.—A layer of ionized gas which scientists believe exists in the region between 50 and 400 miles above the surface of the earth, and which reflects radio waves back to earth under certain conditions. Also called the Kennelly-Heaviside layer.

Heavy Water.—A water whose molecules consist of the heavy hydrogen isotope, deuterium, in combination with oxygen. The formula is D_2O instead of H_2O .

Hecto-Ampere.—One hundred amperes.

Helical Scanning

Helical Scanning.—The scanning motion in which a point on the RF beam describes a distorted helix. The antenna rotates continuously about the vertical axis while the elevation angle changes slowly from the horizontal to the vertical.

A radar term.

Helix.—A coil formed by a single-layer spiral winding, usually with no iron in the core space.

Henry.—The unit for measuring inductance. A circuit has an inductance of one henry when a current which changes at the rate of one ampere in a second produces a pressure of one volt in the circuit.

Heptode.—A high-vacuum electronic tube containing seven elements or electrodes.

Herringbone Pattern.—An interference pattern on television pictures, appearing as closely spaced V-shaped or S-shaped lines in a horizontal band over a limited vertical area of the picture.

Hertzian Wave.—Radio Wave.

Hexode.—A high vacuum electronic tube containing six elements or electrodes.

High-Fidelity Receiver.—A receiver capable of reproducing audio frequencies in a range from 50 to about 8,000 cycles or wider without serious distortion. A receiver which approaches the goal wherein the reproduced program cannot be distinguished from the original studio program.

High-frequencies.—In radio and other electronic applications, frequencies from 3,000 kilocycles to 30 megacycles. The name often is used for any radio frequency in excess of about 15 kilocycles.

High Frequency Alternator.—An alternating current generator capable of producing high frequency current.

High Frequency Cable.—A conductor made up of a number of separately insulated wires or conductors.

High Frequency Circuit.—A circuit carrying high frequency current. High frequency circuits are distinguished by the values of their inductances and their capacities.

High Frequency Coil.—An induction coil giving discharges at high frequency due to the oscillating discharge of the condenser.

High-frequency Compensation.—Means for extending the range of a broad band amplifier to higher frequencies, usually with one or more inductors, called peakers, in amplifier grid and plate circuits. The peakers resonate with circuit capacitances at a frequency just lower than the desired high limit.

High Frequency Current.—An alternating or pulsating current whose cycles or whose pulsations run into hundreds of thousands per second.

High Frequency Resistance.—The resistance of conductors to the flow of

- high frequency current which passes along on the outside of the conductors. This resistance is many times greater than the resistance of the same conductor to a flow of direct or low frequency current.
- High-Frequency Trimmer.**—In a superheterodyne receiver, the trimmer condenser which controls the calibration of a tuning circuit at the high-frequency end of a tuning range.
- High Potential.**—High voltage, usually above 500 or 550 volts.
- High Rate Discharge.**—A discharge of a storage battery at a number of amperes great enough to be equivalent to its heaviest possible duty in service.
- High Resistance.**—A resistance considerably above the resistance that ordinarily exists in a circuit or part of a circuit.
- High Tension.**—High voltage, voltage of a thousand or more.
- High Tension Magneto.**—An ignition magneto in which high tension current for the spark plugs is produced directly in the windings without an outside induction coil.
- Hinge Coupler.**—A coupler in which one winding may be moved toward or away from the other on a pivot or hinge.
- Hissing Arc.**—A noise caused in an arc lamp when the carbons are too close together.
- Hold Control.**—In a television receiver, an adjustment that varies free-running frequency or unsynchronized frequency of a horizontal or vertical sweep oscillator, so that oscillating cycles may be started by sync pulses of a received signal.
- Hold-Down for Battery Separator.**—A small piece of wood, hard rubber, etc., placed above the tops of storage battery plate separators to keep the separators in place.
- Holding Coil.**—In a relay or contactor, a separate coil which is energized by operation of the relay or contactor, and which holds the relay pulled in after the original operating circuit is opened.
- Holding Contacts.**—On a relay or contactor, an additional pair of contacts which operate with the relay or contactor and complete a circuit which maintains current in the coil so that the unit remains in an operated position after the original operating circuit is opened.
- Holding Magnet.**—An electromagnet used to hold parts upon which work is being done.
- Hole.**—In transistors, an atom temporarily having fewer than its normal number of electrons, thus acting as a positive charge. Holes disappear where atoms regain electrons, reappear where other atoms lose electrons, and the holes seem to move from place to place.
- Holtz Machine.**—A machine for producing frictional electricity or electric charges.
- Homopolar Generator.**—A generator in which the armature conductors revolve between two or more poles of the same polarity instead of passing from a pole of one polarity to a pole of the opposite sign.
- Homopolar Magnet.**—A magnet having its two poles concentric.
- Hook Switch.**—The switch on a telephone instrument which is closed when the receiver is removed from its hook.
- Honeycomb Coil.**—A coil wound in such a way that there are open spaces between the wires, making it something like a lattice work.
- Hook-Up.**—A diagram giving circuit connections for a radio-receiver, amplifier or transmitter.
- Horizontal Candlepower.**—The candlepower of a lamp measured in a horizontal distance from the source of light.
- Horizontal Oscillator.**—In a television receiver, the oscillator that uses the horizontal synchronizing and blanking signals to produce voltages which, when amplified, operate the deflecting plates or coils in the picture tube.
- Horizontal Phase Control.**—An adjustment for varying the waveform of parabolic current or voltage in the horizontal convergence system, for three-gun color picture tubes.
- Horizontal Polarization.**—Transmission of electromagnetic carrier waves whose electrostatic lines of force are horizontal or parallel to the earth surface, while magnetic lines of force are vertical. Television carrier waves are horizontally polarized.
- Horizontal Sync.**—Synchronization or correct timing of horizontal deflections of the electron beam in a picture tube with respect to horizontal sync pulses in a received television signal.
- Horn Gap.**—A gap in a lightning arrester. The width of the gap is narrow at one end and widens toward the other end.
- Horn of Pole Piece.**—The curved and pointed edge of a pole piece.
- Horsepower.**—A unit of power which is equal to work being done at the rate of 550 foot-pounds per second or 33,000 foot-pounds per minute.
- Horsepower-Hour.**—A measure of work performed, one horsepower for one hour.
- Horseshoe Magnet.**—A magnet whose core is shaped like a horseshoe.
- Hot.**—A word used to mean that a conductor is carrying current or voltage.
- Hot-Cathode Tube.**—A vacuum or gaseous tube in which the cathode is heated to provide electron emission.
- Hot Wire Meter.**—A current-indicating meter whose pointer is allowed to move across the dial when a wire inside the meter is heated and expanded by the measured current flow-

ing through this wire.

Hot Wire Wiring.—An expression used in marine electrical work to designate the use of a special armored cable, the covering of which is made by the "hot process."

Howl.—An undesirable audio frequency oscillation occurring in a radio or amplifier system, due either to electrical or acoustic feedback.

Howler.—A device for causing a howling noise in the receiver of a telephone to attract attention to the phone when the receiver has been left off the hook.

H. P.—An abbreviation for "horsepower."

H-Scan.—A modification of B-Scan. Signal appears as a bright line the slope of which is proportional to the sine of the angle of elevation. Azimuth appears as the horizontal coordinate, and range as the vertical coordinate.

A radar term.

Hue.—The visual color sensation resulting from particular wavelengths of light, without reference to brightness or to vividness of the color. For example: pink, rose, cerise, vermilion, and others all are of red hue, although differing in other qualities. Hue, in color television, depends on phase relations between chrominance signals and reference phase of the burst signal.

Hue Control.—In a color television receiver, an adjustment that varies phase of chrominance signals with respect to that of the burst signal, thereby altering hues in reproduced pictures.

Hum.—A low and constant audio frequency, usually either 60 to 120 cycles, heard in the background of a received radio program. A defective filter condenser in an a.c. power pack is a common cause of hum in a radio receiver.

Humming.—In a transformer, a noise due to movements between the laminations of the core caused by the cycles of current when the sheets are not securely fastened together. In a generator, a noise caused by the sudden passage of the armature coil from under the edge of the pole piece. It is reduced by placing the armature slots at an angle with the axis.

Hunting.—Regular increase and decrease in speed of generators, motors and converters.

Hydraulic Analogy.—A comparison of the action of electricity to the action of water for the purpose of making clearer explanation of the electrical actions.

Hydroelectric.—Relating to the generation of electricity from water power or hydraulic power.

Hydrometer.—A weighted hollow bulb with an extended graduated stem which when partially immersed in a liquid, sinks to a level such that the

specific gravity of the liquid is indicated on the stem.

Hydrometer Jar.—A jar or vessel in which a liquid is placed for measuring its specific gravity with a hydrometer.

Hydrometer Syringe.—A glass syringe in which is a hydrometer and into which may be drawn liquid whose specific gravity is to be measured.

Hyper Frequencies.—Frequencies which usually are considered to be in the range of between 1,000,000,000 and 100,000,000,000 cycles per second. Microwaves.

Hysteresis.—In the iron or steel of a magnetic circuit energized by a coil winding, the lag of magnetic flux behind the rate at which current increases in the coil, and the lag in reduction of flux behind the rate at which coil current decreases. There is a similar effect or similar lag of electrostatic flux in a dielectric with changes of voltage which produce the flux.

Hysteresis Curve.—A curve which shows the relation between the magnetizing force applied to iron or steel and the amount of magnetism produced by that force.

Hysteresis Loop.—A double hysteresis curve showing the rise and fall from zero through the complete cycle and back to zero. The area enclosed by the curves, or loop, indicates the hysteresis loss.

Hysteresis Loss.—The work or power required to reverse the direction of magnetism in iron or steel.

I

I.—An abbreviation commonly used to designate current.

Icosonoscope.—A form of cathode-ray tube used in the camera of a television transmitter. The tube contains a mosaic or an area covered with photo-sensitive globules on which the image is focused, also a conductive plate and a collector which receives electrons emitted by the sensitive globules.

I-demodulator.—The demodulator of a color television receiver in which combine the chrominance signal and voltage from the color oscillator to recover the I-signal.

I. E. C.—An abbreviation for "International Electrotechnical Commission."

I.F.—Intermediate frequency.

IFF.—Identification of friend from foe. System used in conjunction with radar for distinguishing between friendly and enemy aircraft or surface vessels.

I. H. P.—An abbreviation for "indicated horsepower."

Idle Coil.—A part of a winding in which no current flows or in which no electromotive force is produced.

Idle Voltage of Battery.—The voltage of an electric battery when it is

neither discharging nor being charged, when it is neither acting as a current source nor as an electro-receptive device.

Igniter.—A device placed inside the cylinder of an internal combustion engine for the purpose of breaking a circuit to produce an ignition spark in the cylinder.

Ignitor.—The electrostatic grid or control electrode of an ignitron.

Ignitron.—A tube or tank having a mercury-pool cathode and an ignitor electrode which controls the instant at which ionization and current flow commence during each cycle of applied alternating potential. Used for control, and for controlled rectification, of large amounts of power such as employed in welding, mining, transportation, electrochemistry and electrometallurgy.

Ignition Battery.—A storage battery or primary battery used as a source of ignition current. It is required to deliver only a small current.

Ignition Breaker.—An ignition interrupter.

Ignition Coil.—An induction coil used for producing a high tension current which jumps the gap in spark plugs of internal combustion engines.

Ignition Distributor.—A rotating device which receives current from an ignition coil or any high tension source and distributes it to the spark plugs in the various cylinders of a multi-cylinder internal combustion engine.

Ignition Generator.—A battery charging generator which has an attached ignition interrupter and distributor; used on automobiles.

Ignition Interrupter.—A device which breaks the circuit of the primary winding of an induction coil or low tension winding of a magneto in order to produce high tension current by induction. (See interrupter.)

Ignition Lock.—A lock which prevents closing of the ignition circuit on an automobile; used for theft protection.

Ignition Relay.—An ignition vibrator which may be cut into or left out of an ignition circuit.

Ignition Spark.—The electric spark taking place inside the cylinder of an internal combustion engine for the purpose of igniting the gas mixture.

Ignition Switch.—A switch in the primary circuit of an ignition system for turning the ignition on and off.

Ignition Timer.—A rotating contact maker which alternately completes and opens the primary circuit of an ignition system to operate ignition coils at the proper time. Also called a commutator.

Ignition Timing.—Adjusting or setting an ignition interrupter or distributor to cause the spark to take place at the correct instant in the cylinder of

an internal combustion engine.

Ignition Vibrator.—Two contacts in the primary circuit of an ignition coil which are separated by the magnetism in the coil core and which act as an interrupter.

Image.—An interfering signal whose frequency is twice the I.F. frequency of receiver.

Image Dissector.—A cathode ray television pickup tube. Construction and operating principles are different from those of the iconoscope, but serves essentially the same purpose of converting a scene into corresponding electrical impulses.

Image Impedance.—Characteristic impedance.

Image Ratio.—The ratio of the strength of a signal to its image. Used to indicate selectivity of a receiver.

Impedance.—Opposition to flow of alternating current measured in ohms. The opposition which results from any combination of resistance, inductive reactance and capacitive reactance, or any two of these factors.

Impedance Coil.—A coil whose impedance limits the current in an alternating circuit or protects devices in the circuit against excessive current.

Impedance Coupling.—A connection of the plate circuit of one tube to the grid circuit of another tube through an impedance coil.

Impedance Factor.—The ratio of the alternating current impedance in a circuit to the ohmic resistance in the same circuit.

Impedance Triangle.—A right-angled triangle with which, when the lengths of the sides adjacent to the right angle are proportional to the resistance and to the net reactance of a series circuit. The length of the hypotenuse is proportional to the impedance of the circuit.

Impregnated Cloth.—Cloth which has been impregnated, not only coated, with varnish or oil to give it high electrical resistance.

Impressed Voltage.—The voltage or pressure coming from an electric source and acting at the terminals of a circuit or electric device.

Impulse.—A momentary increase in the current or voltage in a circuit.

Impulse Starter Coupling.—A device which stops the rotation of a magneto armature during a part of a revolution of the driving shaft, then suddenly releases the armature so that a quick change of magnetism is caused through the armature windings to produce a good spark at low speeds of the driving shaft.

Impurities in Battery.—Metals or organic compounds in the electrolyte of a storage battery which either cause grid corrosion or cause local action on the plates. They include iron, copper, various acids, etc.

Incandescent Lamp.—An electric lamp

- in which light is produced by the white-hot temperature of the filament in which heat is produced by current flowing against the resistance of the filament.
- Inclination Compass.**—A magnetic compass needle supported so that it may incline or dip toward the earth.
- Inclined Coil Meter.**—A voltmeter or ammeter including a coil and an iron vane both inclined to the axis of the pointer.
- Increment Key.**—A key or switch used to increase the current in a telegraph line.
- Incremental Tuner.**—A television tuner in which inductors for resonating antenna, r.f. amplifier, and r.f. oscillator circuits are continuous or in small sections or coils connected in series. Rotary switches for channel selection contact taps on the inductors to provide that portion of total inductance required for any given channel, or may short circuit all of an inductance except that required for a given channel.
- India Rubber.**—Soft rubber much used as an insulating covering for conductors.
- Indicated Horsepower.**—Horsepower determined by figuring from the dimensions, or the movement of parts of an engine or from its indicator diagram, rather than by actual test.
- Indicating Switch.**—A snap switch showing the words "Off" and "On" through its cover, depending on the position of the switch.
- Indicator Gate.**—A rectangular voltage to the grid or cathode circuit of an indicator cathode ray tube to sensitize it during the desired portion of the operating cycle.
A radar term.
- Indirect Lighting.**—A lighting system in which the light from the lamps is directed against a light colored surface from which it is reflected and diffused into the space to be lighted.
- Indoor Antenna.**—A receiving antenna system located entirely inside a building, either under a rug, around the walls, or in the attic.
- Induced Current.**—Current caused by mutual or electromagnetic induction.
- Induced Electromotive Force.**—Voltage produced by mutual or electromagnetic induction.
- Induced Magnetism.**—Magnetism produced from the action of electric currents or by the action of other magnets.
- Induced Voltage.**—A voltage produced in a circuit by changes in the number of magnetic lines of force which are linking or cutting through the conductors of the circuit.
- Inductance.**—That property of a coil or other radio part which tends to prevent any change in current flow. Inductance is effective only when varying or alternating currents are present; it has no effect whatsoever upon the flow of direct current. Inductance is measured in henrys.
- Inductance Coil.**—A coil inserted in a circuit for the purpose of increasing the circuit's inductance.
- Inductance Coil.**—A coil whose inductance may be adjusted to permit tuning.
- Inductance Component of Spark.**—The part of an electric spark which is caused by inductance, as distinguished from the capacity component caused by the capacity of the circuit and condenser. The inductance component follows the capacity component.
- Induction.**—Electromagnetic induction is the production of an emf or voltage in a conductor which moves through a magnetic field and cuts across the lines of force, or when the magnetic field is moved across the conductor. Magnetic induction is the production of magnetism in a piece of iron or steel by magnetic lines of force from another magnet.
- Induction Alternator.**—An alternating current generator with stationary armature and stationary fields, but with a rotating inductor for changing the magnetic flux.
- Induction Balance.**—An instrument which measures the inductance of a substance by the sound produced in a circuit into whose field the substance is moved.
- Induction Coil.**—A coil having an iron core and two windings, in one winding of which a high voltage current is induced by changes of current strength in the other's winding, the changes causing an increase and decrease of magnetic field from the core.
- Induction Furnace.**—An electric furnace whose heat is secured from the secondary of a transformer.
- Induction Generator.**—An alternating current generator with rotating armature or rotating field and driven at a speed greater than the synchronous speed.
- Induction Machine.**—Motors, generators, converters, etc., having two sets of windings (field and armature) one of which rotates with reference to the other.
- Induction Meter.**—Alternating current meters operating with two sets of coils, one a current coil, the other a voltage coil.
- Induction Motor.**—An alternating current motor in which energy from stationary windings is transferred to conductors on the revolving rotor by electromagnetic induction, and in which the rotor receives no current through any conductive connections such as brushes and a commutator or slip rings.
- Induction Voltage Regulator.**—A transformer in which the relative position of the primary and secondary windings may be changed to alter the voltage ratio.

Inductive Circuit

Inductive Circuit.—A circuit containing more inductive reactance than capacitive reactance. A circuit containing many devices having iron core coils and windings, such as induction motors.

Inductive Coupling.—A form of coupling in which energy is transferred from a coil in one circuit to a coil in another circuit by induction. Magnetic lines of force produced by the flow of current through one coil cause an a.c. voltage to be induced in the other coil.

Inductive Load.—In alternating current work, a load whose current lags in phase behind the voltage across the load.

Inductive Reactance.—Reactance due to the inductance of a coil or other part in an alternating current circuit. Inductive reactance is measured in ohms, and is equal to the inductance in henrys multiplied by the frequency in cycles, times the number 6.28; inductive reactance therefore increase with frequency.

Inductive Resistance.—The apparent resistance caused by self-induction in a circuit.

Inductive Retardation.—The slowing up of a telegraph signal by the induction of the circuit.

Inductive Time Constant.—Time for current in an inductor or a circuit containing inductance to increase from zero to 63.2 per cent of its final value, measured from the instant at which voltage is applied to the inductor or circuit.

Inductive Winding.—A winding used for producing induction.

Inductivity.—The ability or capacity of a circuit or coil for induction.

Inductometer.—An instrument for measuring and indicating the induction in a circuit.

Inductor.—A coil, with or without an iron core, which opposes changes of current by its property of self-inductance.

Inductor Generator.—An alternating current generator in which the flux is changed by movement of an inductor.

Inductor Magneto.—A magneto having stationary windings through which changes of flux are caused by rotation of an inductor.

Industrial Controller.—A rheostat used for starting or for controlling the speed of electric motors.

Infinity Plug.—In a Wheatstone bridge, a plug whose removal leaves an open circuit, an infinitely high resistance.

Infra-Red.—Radiation at wavelengths longer than those of visible light, but not so long as those of microwaves. Wavelengths longer than 7,000 Angstrom units.

In Phase.—Descriptive of alternating currents or potentials, or both, whose zero values occur at the same instants and whose maximum values

Initial Voltage

are in the same direction. When two periodically varying quantities pass through corresponding values at the same instant, they are "in phase."

Initial Voltage.—The voltage that just causes the appearance of a corona around an electric conductor.

Input.—The power required to operate any electric device, all of the power consumed in such a device.

Inside Wiring.—The part of the wiring inside of a house or building.

Installation.—A complete set of electrical apparatus with all its conductors and parts.

Instantaneous Value.—The voltage, current or other value at some instant of time in a circuit wherein the voltage or current is continually changing, as with alternating current.

Instrument Lamp.—A lamp used to light the instruments on an automobile dash or cowl, or the lamp used to light instruments on a switchboard.

Instrument Transformer.—A transformer through which meters or other devices are connected to power lines wherein the voltages or currents are greater than permissible in the connected instruments.

Insulate.—To place a non-conductor or insulator around a conductor to prevent current from leaving the conductor at its insulated parts.

Insulating Bushing.—A ring of insulating material through which a conductor passes.

Insulating Cement.—Cements or glues made from materials that are insulators, wax, resin, shellac, varnish, etc.

Insulating Compound.—A combination of insulating waxes, etc., which is melted and poured around parts to be insulated.

Insulating Joint.—A threaded coupling for holding an electroliner on a gas pipe and at the same time insulating it from the pipe.

Insulating Varnish.—Varnish used to treat insulating material or to cover parts, such as coils and windings, that are to be insulated. The varnish is applied as a liquid and dried by baking.

Insulation.—Any material which has a sufficiently high electrical resistance to permit its use for separating one electrical circuit, part or wire from others. Cotton, silk, baked enamel, mica, porcelain, rubber and bakelite are a few of the common insulating materials used in radio.

Insulation Resistance.—The resistance of an insulator to a voltage tending to send current through it.

Insulator.—A part made of insulation in a form suitable for supporting electrical conductors or for separating them electrically from other conductors.

Integrating Filter.—One or more resistors in series and one or more inter-

- vening shunting capacitors in which successive pulses of applied voltages cause cumulative increase of charge and voltage of capacitors. Used in television receivers for building up from serrated vertical sync pulses a voltage that causes the sweep oscillator to begin each cycle. The time constant is long in relation to period of applied pulses.
- Integrating Instrument.**—A measuring instrument which records the total quantity of energy, power, or electricity which passes in a circuit during a period of time.
- Integrating Wattmeter.**—A meter which measures and records watt-hours or kilowatt-hours.
- Intelligence Signal.**—Any signal which conveys information, such as voice, music, code, television pictures, facsimile photographs, diagrams, written and printed matter, etc.
- Intensity Control.**—A saturation control in a color television receiver.
- Intensity of Current.**—Amperage, the number of amperes flowing in a conductor of given size.
- Intensity of Field.**—Field flux, the number of lines of force passing through a field of given size.
- Intercarrier Beat.**—An interference pattern on television pictures, caused by the 4.5-mc beat frequency of an intercarrier sound system getting through the video amplifier to signal input circuits of the picture tube.
- Intercarrier Buzz.**—A 60-cycle buzzing sound, not a hum, occurring in television receivers employing intercarrier sound. Caused by amplitude modulation of the 4.5-mc sound signal from various faults in received signals or in receiver operating adjustments.
- Intercarrier Sound.**—A television receiver sound system with which both the sound and the video intermediate frequencies pass together from tuner to a video detector, sound detector, or both. The intermediates beat in the detector to produce a difference frequency, always 4.5 megacycles, which retains f.m. sound modulation. Distinguished from dual channel sound.
- Intercommunication System.**—An amplifier system which provides two-way communication between two or more rooms in a building. Each station in the system contains a microphone and loud-speaker usually combined as a single dynamic unit; a headphone or telephone receiver is sometimes provided also for private reception of messages. The stations may be connected to each other by wire cables, or may receive and transmit messages through the electric wiring system in the building.
- Inter-Electrode Capacity.**—The capacity which exists between two electrodes in a vacuum tube. Although this is usually a very low value, it becomes extremely important when tubes are operated in ultra-high frequency circuits.
- Interference.**—Any electromagnetic waves, carrier signals, or internally produced voltages which mar the clear and undistorted reception of radio programs or of television pictures or sound.
- Interference Filter.**—A device used between source of interference and a radio to attenuate or eliminate noise. Generally consists of a capacity and inductance which offers a high impedance to noise impulses.
- Interior Wiring.**—All of the wiring inside of a house or building.
- Interlaced Scanning.**—In television, a type of scanning to which every other line of the image is scanned during one downward travel of the scanning beam, and the remaining lines are scanned during the next downward travel of the scanning beam.
- Interleaving.**—In color television, transmission of separated chrominance and luminance signals within the same range of video frequencies. Luminance signal amplitudes concentrate around harmonics of the horizontal line frequency, while chrominance amplitudes concentrate around harmonics of the color subcarrier frequency. Harmonics of one kind occur midway between those of the other kind throughout the frequency range; consequently the chrominance and luminance signals remain separated.
- Intermediate Frequency.**—In a superheterodyne receiver, the frequency to which all incoming carrier signals are converted before being fed into the intermediate frequency amplifier.
- Intermediate Frequency Amplifier.**—That section of a superheterodyne receiver which is designed to amplify signals with high efficiency at a predetermined frequency called the intermediate frequency of the receiver.
- Intermediate Frequency Transformer.**—A transformer used at the input and output of each i.f. amplifier stage in a superheterodyne receiver for coupling purposes and for providing selectivity.
- Intermediate Lampholder.**—A lampholder having a nominal screw diameter of 21/32 inch.
- Intermittent Current.**—A current that starts and stops at regular intervals.
- Intermittent Rating.**—The rating of an electric machine at which it may be operated with loads lasting a comparatively short time, between which there are periods of rest or of light loads.
- Intermittent Reception.**—A type of radio receiver trouble in which the receiver performs normally for a time, then becomes dead or distorts the programs with the process repeating itself.
- Internal Armature.**—An armature which rotates inside the field poles.
- Internal Circuit.**—The circuit inside of an electric source, between its termi-

Internal Discharge

- nals.
- Internal Discharge.**—A discharge that takes place directly between the plates of a storage battery without passing through the external circuit attached to the battery.
- Internal Resistance.**—The resistance of conductors inside some electrical equipment or device; the resistance of the device or equipment measured between its terminal connections. The resistance of conductors through which currents flow inside a battery, generator or motor.
- Internal Short Circuit.**—In a storage battery, a short circuit between plates of opposite polarity due to defects in the separators, to high sediment, etc.
- Internal Wiring.**—The wiring inside of an electric device, the internal circuits.
- International Morse Code.**—The code used universally for radio telegraphy, and also used for wire telegraphy in some European countries. It is also known as the Continental Code.
- International Units.**—The legal units of electrical measurements which were adopted by law after being recommended by the International Electrical Congress at Chicago in 1893. These units include the ohm, the ampere, the volt, the coulomb, the farad, the joule, the watt, and the henry.
- Interpole.**—Small additional poles carrying a series winding for improving commutation.
- Interrogator Responder.**—A unit in the identification system which consists of a transmitter interrogator and receiver response operating on IFF frequencies and synchronized with some type of radar equipment. The receiver is designed to receive the signal from the IFF equipment on the ship or plane interrogated and apply that signal to the radar indicator.
- Interrupter.**—A device which automatically opens and closes a circuit many times a second, causing a pulsating current in the circuit.
- Interrupter Arm or Lever.**—The arm or lever carrying one contact of an interrupter and which is moved to separate the contacts.
- Interrupter Cam.**—A cam which acts to open, or to open and close, the contacts of an interrupter.
- Interrupter Contact.**—The point, of metal or carbon, at which the circuit is broken in an interrupter.
- Interrupter Gap.**—The distance by which the interrupter contacts are separated from each other when at their greatest opening.
- Interrupter Spring.**—The spring which closes the contacts in an interrupter after they have been opened by the cam.
- Interrupter Timing.**—Ignition timing.
- Invar.**—A nickel steel used for resist-

Inverse Feedback

- ance wires.
- Inverse Feedback.**—Intentional negative feedback or degeneration, introduced in an amplifier or single vacuum tube stage for the purpose of reducing distortion, thereby permitting greater power output.
- Inverse Ratio.**—An increase of one value with decrease of another.
- Inverted Converter.**—A synchronous converter for changing direct current to alternating current.
- Inverted L Antenna.**—The conventional antenna used for broadcast reception, having a long horizontal portion suspended between insulators, with the single wire lead-in connected to one end of the horizontal portion.
- Inverter Tube.**—A phase inverter.
- Ion.**—An atom or molecule which has fewer or more electrons than normal. A positive ion is one which has lost electrons, and a negative ion is one which has acquired more electrons than normal.
- Ionization.**—Separation of portions of an electrolyte into its chemical elements by electrolysis. An action whereby atoms or molecules of gas in an electronic tube are converted into electrically charged ions which are attracted by charged electrodes. Ionization makes a gaseous tube more conductive than an equivalent vacuum tube.
- Ion Trap.**—A means for separating relatively heavy ions from the electron beam in the electron gun of a television picture tube. Utilizes the fact that an electrostatic field deflects both ions and electrons, while a magnetic field bends the electron beam but has little effect on ion direction. Bending or tilting all or part of the electron gun may provide initial deflection for both particles, with a magnetic field controlling direction of the electrons.
- Ion Trap Magnet.**—One or more small permanent magnets with pole pieces, mounted outside the neck of a television picture tube to provide magnetic fields for ion trap action in the electron gun.
- IR Drop.**—A technical expression sometimes used to designate the voltage drop developed across a resistance by the flow of current through the resistance.
- IR Loss.**—The power consumed by the heating effect of a current passing through a conductor.
- Iron Clad.**—A magnetic structure or circuit which almost completely surrounds its coils or windings.
- Ironclad Armature.**—An armature whose windings or coils are surrounded by the iron of the core.
- Iron-Core Coil.**—A coil having iron inside its windings. The iron is usually in the form of laminations, but it may also be pulverized iron mixed with a binding material.
- Ironclad Magnet.**—An electromagnet

having a sleeve or tube of iron around the outside of its winding as well as a core inside.

Ironclad Solenoid.—A solenoid surrounded by an iron cover and operating a plunger in the solenoid.

Iron-Core Transformer.—A transformer in which iron makes up part or all of the path for magnetic lines of force traveling through the transformer windings.

Iron Loss.—The power which is dissipated as heat in a magnetic circuit due to eddy currents and hysteresis.

I-Scan.—Used to depict range and direction for a system with a conically scanning antenna. Signal appears as a bright circular segment with radius proportional to range. The circular length of the segment is inversely proportional to the error of aiming this system and its position indicates the bearing of the target. True aim results in a complete circle. Also referred to as RTB indication.

I-Signal.—The "in-phase" portion of the chrominance signal in color television. The plus I-signal side bands center at 57° electrical degrees from the reference or burst signal phase.

Insulantite.—A high-quality insulating material used in the construction and mounting of radio parts, particularly those employed in ultra-high frequency circuits.

Isolated Electric Plant.—An apparatus including a battery charging generator and a storage battery, or a constant voltage generator without a battery, which is used to furnish light and power in isolated places such as farms and country homes, or wherever central station current is not available.

Isolating Switch.—A switch intended only for disconnecting its circuit from a source of power after the circuit has been opened and current stopped by some other means.

Isolation Diode.—A diode used to pass signals in one direction through a circuit but which prevents signals and voltages from being transmitted in the opposite direction.

Iterative Impedance.—Characteristic impedance.

Isolator for Battery Plates.—A device which holds the edges and corners of storage battery plates apart from each other independently of the separators.

Isotope.—A variety of atom or nucleus characterized by atomic weight as well as atomic number. Example: All uranium atoms have atomic number 92, but those of the light isotope have atomic weight of about 235 while those of the heavy isotope have atomic weight of about 238.

J

Jablochkoff Candle.—The electric candle.

Jack.—A plug-in type spring terminal widely used in radio apparatus for

temporary connections. A connection is made to a jack simply by plugging into it a probe or plug attached to a flexible insulated wire or cable. Some jacks have extra contacts which are opened or closed when the probe is inserted, thereby giving automatic switching action.

Jamming.—Intentional transmitting of radio waves in such a way as to interfere with reception of signals from another station.

Jar for Battery.—The container for the electrolyte in a battery cell.

Jigger.—A transformer in the antenna circuit between the antenna and the detector.

Joint.—A permanent soldered connection or semi-permanent screwed or clamped connection in an electric circuit.

Joint Resistance.—The resistance across a joint; or the combined resistance of two conductors in series or parallel.

Joule.—A unit of electrical energy or of work, equal to the energy transferred by a power rate of one watt continuing for one second. The work done by sending one ampere of electricity through a resistance of one ohm for one second.

J-Scan.—A modification of type A in which the time sweep produces a circular range scale near the circumference of the CRT face. The signal appears as a radial deflection of the time trace. No bearing indication is given.

A radar term.

Jump Spark.—An electric spark caused to jump through the gap between two conductors by a voltage high enough to overcome the gap's resistance.

Jump Spark Ignition.—Internal combustion engine ignition by means of jump sparks as distinguished from the spark in a make-and-break system.

Jump Spark Distributor.—An ignition distributor in which there is no direct contact between the rotor and the segments, but in which the high tension current jumps a gap of a few thousandths of an inch between these parts.

Junction Box.—A box in which branch circuits are connected to mains.

K

K.—Letter used to designate the cathode of a radio tube.

K.—A symbol for dielectric constant.

KC.—Kilocycle.

KW.—Kilowatt.

Kaolin.—A kind of porcelain or china used for insulators.

Kathion.—A cation.

Keep-Alive.—An auxiliary electrode in the TR switch, to which a negative dc potential is applied. The keep-alive is turned on before the main rf power, and furnishes sufficient ions

Keeper of Magnet

for almost instantaneous discharge across the main gap with small leakage power to the crystal.

A radar term.

Keeper of Magnet.—A piece of iron placed across the poles of a magnet while the magnet is not being used.

Kennelly-Heaviside Layer.—A layer of ionized gas supposed to exist in the region between 50 and 400 miles above the surface of the earth. It reflects radio waves back to earth under certain conditions, making possible long-distance reception.

Kenotron.—A vacuum type hot-cathode rectifier tube in which there are no control grids. Kenotron rectifiers operate with currents which usually are no more than one ampere, but may operate at very high voltages.

Kerite.—An insulation material having a rubber base.

Key.—A lever-type switch designed for rapid opening and closing of a circuit during transmission of code signals.

Keyed Automatic Gain Control.—A system of television gain control with which negative d.c. potential for grids of controlled tubes is obtained by filtering plate voltage pulses from an a.g.c. tube. This tube is held at plate current cutoff except while peaks of positive horizontal sync pulses act on its grid, whereupon there are pulses of plate voltage. Prevents a.g.c. voltage from being affected by signal noise pulses occurring at other times than sync pulses.

Keying.—Same as gating, in an electron tube.

Key Switch.—A switch operated by a special key.

Keyless Lamp Socket.—A lamp socket in which there is no key or switch for turning the lamp on and off.

Kicking Coil.—A choking coil.

Kilampere.—One thousand amperes.

Kilocycle.—One thousand cycles but commonly interpreted as 1,000 cycles per second.

Kilovolt.—One thousand volts.

Kilowatt.—One thousand watts.

Kilowatt-Hour.—A unit of electric energy. The energy transferred by a power rate of one kilowatt continuing for a time of one hour.

Kinescope.—A cathode ray tube developed by the Radio Corporation of America and used in television receivers for the purpose of reproducing on a screen the scene originally televised.

Kirchoff's Current Law.—A fundamental electrical law which states that the sum of all the currents flowing to a point in a circuit must be equal to the sum of all the currents flowing away from that point.

Kirchoff's Voltage Law.—A fundamental electrical law which states that the sum of all the voltage sources acting in a complete circuit must be equal to the sum of all the voltage drops in that same circuit.

Klystron

Klystron.—A tube employing cavity resonators and velocity modulation of an electron stream flowing from a heated cathode to a collector acting as an anode. The alternate bunching and spreading out of electrons as they reach the output side of the tube act as a varying current. The klystron is used as an oscillator or as an amplifier at hyper frequencies or microwaves.

Knife Switch.—A switch in which one or more flat metal blades, each pivoted at one end, serve as the moving parts. The blades are usually of copper; when the switch is closed, they make contact with flat gripping spring clips and complete the circuit.

Knob.—A radio part, usually round but sometimes having a pointer or other position-indicating means, which is attached to the end of a control shaft to make it easier to rotate the shaft with the fingers.

Knob-and-Tube Wiring.—Interior wiring with which the conductors are carried on knobs in exposed places and through porcelain tube insulators when passing through walls and partitions.

K-Scan.—A modification of type A-scan for aiming a double lobe system in azimuth (elevation). A horizontal (vertical) time sweep is displaced slightly in the direction of the antenna lobe in use. The signal appears as a double vertical (horizontal) deflection of the time sweep with the ratio of amplitudes indicative of the error in aiming.

A radar term.

L

L.—An abbreviation for "length."

L.—The letter commonly used on circuit diagrams and in formulas to designate an inductance or coil.

Lag.—Coming after something else that is related; as the magnetic lag (hysteresis), lag of a phase, etc.

Lag of Brushes.—The distance that motor brushes are moved against armature rotation to make up for the effect of armature reaction.

Lag of Phase.—An alternating current whose maximum value comes after the maximum of a second alternating current of the same frequency is said to lag in phase with reference to the first current.

Lagging Coil.—A small coil with an adjustable resistance used in induction meters to cause the correct current in the voltage coil of the meter.

Lagging Current.—An alternating current whose zero values and maximum values in a given direction occur later than the zeros and corresponding maximums of the alternating voltage in the same circuit. Such a current as exists in an inductive circuit.

Laminated.—A type of construction widely used for the cores of iron core transformers, choke coils, electro-

Lamp Bank Resistance

Lead

- magnets, motors and generators. It involves building up the desired shape of core with thin strips of a magnetic material such as soft iron or silicon steel. This construction relieves eddy currents.
- Lamp Bank Resistance.**—A resistance composed of a number of incandescent lamps in a circuit.
- Lamp Bulb.**—An incandescent electric lamp.
- Lamp Bulb Adapter.**—A threaded sleeve for insertion in a lamp socket of one size so that a lamp with a smaller base may be used in the socket.
- Lamp Bulb Base.**—On an incandescent lamp, the metal part that fits into the socket and which carries the contacts for electrical connection to the circuit.
- Lamp Bulb Efficiency.**—The ratio of the candlepower of a lamp to the watts required to light it.
- Lamp Connector.**—A plug and socket or a screw plug on the base of an electric lamp for the purpose of making electrical connection with the circuit.
- Lamp Cord.**—A twisted flexible cord or small cable containing two insulated conductors.
- Lamp Deflector.**—A device for turning the rays of light from a lamp reflector downward.
- Lamp Dimmer.**—A device, such as a special lens, or a resistance in the circuit, so arranged that the amount of light from a lamp may be temporarily reduced.
- Lampholder.**—A screw shell device for receiving the screw base of an incandescent lamp bulb or other part with a similar screw base, and for making electrical connections to the part thus held. Often called a lamp socket.
- Lamp-Hour.**—The electric power which operates a lamp for one hour.
- Lamp Lens.**—The glass which protects the open side of a lamp reflector.
- Lamp Reflector.**—A reflector, usually of parabolic section, placed back of an electric lamp to direct the light rays in a certain direction.
- Lap Winding.**—An armature winding in which the two ends of any one coil lap over each other at their connections to the commutator.
- Lap Wound Armature.**—An armature having a lap winding.
- Lapel Microphone.**—A small microphone which can be attached to a lapel or pocket by means of a clip.
- Lava.**—A hard, dense, stone-like insulating material.
- Lavite.**—A glass-hard insulating material which will withstand very high temperatures.
- Lawrence Color Tube.**—A single-gun color television picture tube. A Chromatron tube.
- Layout.**—A diagram indicating the placement of parts on a panel or chassis.
- Lead.**—A soft metal that is not readily oxidized nor attracted by acids. It is generally used in making parts of storage batteries having an acid electrolyte.
- Lead-Acid Battery.**—A storage battery using plates of lead peroxide and sponge lead in an electrolyte of sulphuric acid and water; the most common form of storage battery.
- Lead Burning.**—The process of joining lead parts in storage battery work by melting the parts together.
- Lead (Pronounced leed).**—Short lengths of wire through which current is carried to and from an electrical device.
- Lead of Brushes.**—The distance around the commutator that generator brushes are moved with armature rotation to make up for armature reaction.
- Lead of Phase.**—An alternating current whose maximum value comes before the maximum of a second alternating current of the same frequency, is said to lead the second current in phase.
- Lead-In.**—The conductor connecting the antenna with the receiving or transmitting set.
- Lead-in Insulator.**—A porcelain tube inserted in a hole drilled through an outer wall or window frame of a house. The lead-in wire of the antenna is run through this tube.
- Leading Current.**—An alternating current whose zero values and maximum values in a given direction occur before the zeros and corresponding maximums of the alternating voltage in the same circuit. Such a current as exists in a capacitive circuit.
- Leading-in Wires.**—The wires through which a circuit is brought into a building.
- Leak.**—A loss of current through a short circuit or an accidental ground.
- Leakage.**—Undesirable flow of current through or over the surface of an insulating material. This term is also used to describe magnetic flux which wanders off into space without doing useful work.
- Leakage Drop.**—A drop of voltage due to a short circuit or an accidental ground.
- Leakage Flux.**—That portion of the total magnetic flux which does not link all of the turns of wire in a coil or transformer and is consequently wasted.
- Leakage Resistance.**—The resistance of a path taken by leakage currents. Thus, the leakage resistance of a condenser is the normally high resistance which it offers to the flow of the direct current.
- Leclanche Cell.**—A primary electric cell of which the ordinary dry cell is a modification. It uses carbon and zinc for electrodes and may be used on either open or closed circuits.

Left-Hand Rule

Left-Hand Rule.—A method of showing the relative directions of magnetic field flux, current flow in a conductor, and motion of the conductor through the field. The motor rule. Extend the thumb, forefinger and middle finger of the left hand so that they are at right angles, each to the others. When the forefinger points in the direction of flux (north pole to south pole) and the middle finger in the direction of conductor current, the thumb points in the direction that the conductor is moved.

Left-Handed Helix or Solenoid. — A sinistrorsal helix or solenoid, one wound left handed looking at the end.

Left-Hand Rule for Electron Flow.—If electron flow rather than conventional current flow is considered in the foregoing left-hand rule, conductor motion is opposite to the direction in which the thumb points.

Left-Handed Rotation.—Rotation in a direction opposite to that of the hands on a clock.

Legal Ohm.—The international unit for one ohm of resistance.

Leyden Jar.—A form of condenser consisting of a glass jar which acts as the dielectric, coated inside and outside with tin foil which acts as the conductive plates.

Lifting Magnet.—An electromagnet designed to lift and convey heavy iron and steel parts from place to place.

Light.—A form of radiant energy emitted by and flowing away from luminous bodies such as the sun and various kinds of lamps. Light is visible radiant energy, or is radiant energy which causes the visual sensation in our eyes.

Light Load.—A load on a circuit which is less than the normal or average load.

Lighting Battery.—A storage battery designed and proportioned to deliver a current large enough for use in lighting circuits.

Lighting Line.—One of the conductors in a circuit supplying current to electric lamps.

Lighting Outlet.—In a building wiring system an outlet intended for direct connection of a lampholder, a lighting fixture, or a cord that carries a lampholder.

Lighting Transformer.—A transformer which reduces voltage to a value suitable for operating electric lamps.

Lightning Arrester.—A protective device used to sidetrack directly to ground a discharge of lightning which strikes a radio receiving or transmitting antenna.

Lightning Rod.—A conductor extending from the earth to the highest point on a building or other structure so that lightning discharges will be carried harmlessly to ground through the conductor.

limiter. — In a frequency modulation

Limiting Voltage

radio receiver, a tube circuit which eliminates any amplitude modulation which may have affected the carrier wave and leaves only the frequency modulation.

Limiting Voltage. — The voltage at which a spark or disruptive discharge starts to take place.

Line.—One of the wires in a circuit, or both sides of a circuit.

Line Cord.—A two-wire cable terminating in a two-prong plug, used to connect a radio receiver to an a.c. or d.c. wall outlet. Sometimes this cord also includes a resistance wire used for the purpose of reducing the line voltage to the value required by the series-connected filaments of the tubes.

Line Drop.—Voltage drop which occurs in a conductor or a line due to flow of current in the line resistance.

Line Filter.—A device inserted between the line cord plug of a radio receiver and the power line to block noise signals which might otherwise enter the receiver from the power line. It contains one or more choke coils and condensers.

Line of Force. — An imaginary line which indicates the direction in which magnetism flows between magnet poles or around conductors carrying a current or an electric charge. A unit in which magnetic flux is measured.

Line of Induction.—A line of force. Sometimes applied to lines of force passing through a magnetic material.

Line Insulator.—An insulator used to carry an overhead wire.

Line Reactance.—The reactance in the lines outside of a power station, between the station and the points at which power is used.

Line Resistance.—The resistance in the lines outside of a power station.

Line Starter.—A motor starter which applies full line voltage to a motor immediately upon operation of the starter.

Line Voltage.—The voltage existing at a wall outlet or other terminals of a power line system. In the United States, the line voltage is usually between 115 and 120 volts, but may vary at times as much as five volts above and below these limits.

Lineman.—A man who works on the outdoor parts of power, lighting, telephone or telegraph circuits.

Linearity.—Shapes and relative positions of lines and objects in a television picture in relation to their shapes and positions in the original televised image. Non-linearity means displacements, crowding, or stretching horizontally, vertically, or both ways.

Linearity Control.—Any television receiver service adjustment for altering the waveform of sawtooth currents or voltages employed for deflection of the electron beam, thus cor-

Link Fuse

- recting for non-linearity which results from distorted sawtooths.
- Link Fuse.**—An unenclosed fuse.
- Listening Cam.**—In a telephone switchboard, a switch that allows the operator to listen to conversation between subscribers.
- Litharge.**—Monoxide of lead, a lead compound used in the manufacture of active material for storage battery plates.
- Litz Wire.**—A conductor built up of small insulated wires woven together into a tubular form with a hollow center. Has lower resistance to high frequency currents than solid wire or stranded wire.
- Load.**—Lamps, motors, heaters, or any other energy-consuming or power-consuming equipment connected to a battery, generator or a circuit supplying power and energy. The load might be measured in watts, watt-hours, ohms of resistance, amperes, volts, or any other unit which would indicate the size or magnitude of the load.
- Load Control.**—Control of a generator's output effected by changes in the load in its circuit.
- Load Curve.**—A curve plotted to show the changes in load or current demand in a circuit over a period of time.
- Load Factor.**—The ratio of the average power consumed to the maximum power, in any given time.
- Load Test.**—A test of an electrical device operating with its normal load.
- Loading Coil.**—A coil which is inserted in a circuit for the purpose of adding inductance and inductive reactance to the circuit.
- Lobe Switching.**—Directing an rf beam rapidly back and forth between two positions. Used for accurate direction finding.
- A radar term.*
- Local Action.**—A discharge between different parts of a single plate in a storage battery. It is caused by impurities in the electrolyte which deposit on the plates.
- Local Current.**—An eddy current.
- Local Oscillator.**—In a radio or television tuner, the r.f. oscillator that delivers a frequency for beating with received carrier frequencies for production of intermediate frequencies.
- Localized Capacity.**—Capacity concentrated in a small space, such as in a condenser, as distinct from distributed capacity in a long conductor or coil.
- Lock Torque.**—The torque or turning effort exerted by an electric motor which is prevented from rotating but which is receiving current.
- Lodestone.**—A kind of iron ore that is naturally magnetic.
- Log.**—A list of radio stations. A record of stations with which a radio transmitter has been in communication; amateur radio operators are required

Logarithmic Decrement

- by law to keep this log. A detailed record describing the program being broadcast each minute of the operating day by a broadcast station. A record of the meter readings which are required by law to be taken at regular intervals in a broadcast transmitter and in certain other types of transmitters.
- Logarithmic Decrement.**—Decrement.
- Logging.**—Making a record of the exact dial setting at which a radio station is received, or making a written record of any other essential data in connection with radio equipment.
- Loktal Tube.**—A small-size glass radio tube having a special base, construction which locks the tube firmly in the corresponding special 8-prong loktal socket. Loktal tubes are used chiefly in midget a.c.-d.c. receivers and in auto radios.
- Long Shunt.**—In a compound wound machine, a connection of the shunt winding so that its current passes also through the series winding.
- Long Waves.**—Wave lengths longer than the longest broadcast band wave length of 545 meters. Long waves correspond to frequencies between about 20 kilocycles and 550 kilocycles.
- Loop.**—A two-wire circuit or a multiple circuit.
- Loop Antenna.**—An antenna consisting of one or more complete turns of wire. It may be built into a radio receiver cabinet or separately mounted, and is usually tuned to resonance by a variable condenser. Loop antennas are used extensively in radio direction-finding apparatus.
- Loop Feeder.**—A feeder which follows along a circuit and distributes the voltage more evenly at different points.
- Loop Test.**—A test for locating accidental grounds on telephone or telegraph lines by the use of a resistance bridge with the faulty line connected in one side of the bridge.
- Loose Coupling.**—Coupling in which the coefficient is decidedly less than 0.5, or in which resistance, reactance, or impedance common to the coupled circuits is so small as to allow only limited transfer of energy.
- Losses.**—Energy which is dissipated before it accomplishes useful work.
- Loudspeaker.**—A device for converting audio frequency signals into sound waves.
- Louver.**—A type of loudspeaker grille construction in which sloping slats or equivalent parts of a molded plastic cabinet hide the loudspeaker yet allow sound waves to emerge unhindered. Also spelled *louvre*.
- Low Frequency.**—An alternating or pulsating current having a small number of cycles per second or impulses per second, usually less than two hundred of either.
- Low-frequency Compensation.**—Means

Low-Frequency Padder

for extending the range of a broad band amplifier to lower frequencies, usually by suitable plate circuit decoupling, small reactance in a blocking capacitor, and a suitable grid resistor for the second tube.

Low-Frequency Padder.—In a super-heterodyne receiver, a semi-adjustable condenser which is placed in series with the oscillator tuning circuit to control the calibration of the circuit at the low-frequency end of the tuning range.

Low-Loss Construction.—A type of radio part construction involving the use of insulating materials which maintain their insulating characteristics at high radio frequencies.

Low-Potential System.—A low voltage system, usually one operating at less than 600 volts.

Low Tension.—Low voltage.

Low Tension Coil.—A coil which makes use of self-induction in a single winding to produce a spark at an igniter.

Low Tension Magneto.—A magneto which generates current at a low voltage, which then is changed to high voltage or high tension current in an induction coil or is passed through a low tension coil to produce current for make-and-break ignition.

Low Tension Winding.—In a transformer or induction coil, the primary winding which carries the lower voltage current.

Low Voltage Release.—A device which opens the supply circuit when the voltage drops below a certain point and which again closes the circuit when the voltage comes back to normal.

L-Scan.—A modification of type A-scan for aiming a double lobe system in azimuth (elevation). A vertical (horizontal) time switch indicates range. The signal from the left (lower) lobe appears as a horizontal (vertical) deflection to the left (downward); the signal from the right (upward). The ratio of signal amplitudes is indicative of the error in homing. British Mark IV.
A radar term.

Lug.—A small strip of metal placed on a terminal screw or riveted to an insulating material to provide a convenient means for making a soldered wire connection.

Lumen.—A unit of luminous flux. The luminous flux which falls upon one square foot of the internal surface of a hollow sphere or ball at the center of which is a point source of light whose intensity is one candle-power. The luminous flux reaching one square foot of a surface whose illumination is one foot-candle.

Luminance.—A word which, when used with reference to color television, has the same general meaning as brightness.

Luminance Channel

Luminance Channel.—In color television, the electrical path or circuits intended primarily for carrying luminance signals, although other signals may flow in parts of the path.

Luminance Signal.—In color television, the signal that controls brightness but not coloring, and whose frequency range extends high enough, to about 4.0 megacycles, for reproduction of fine details in pictures. By itself, the luminance signal is capable of producing a monochrome picture.

Luminosity.—In illumination, the brightness of a color when compared with white.

Luminous Flux.—The rate of flow of visible light energy from a source of light. The flux may be the total flow in all directions, or may be specified as the flow occurring in a certain direction or region. Measured in lumens.

M

M.—A letter sometimes used to indicate that a particular resistance value is to be multiplied by 1,000. Thus, 50M would mean 50,000 ohms.

M.—A symbol for resistance in meg-ohms.

M.—A symbol for henrys, measuring mutual induction.

MA.—Milliampere.

m. f. d.—An abbreviation for "microfarad."

M. M. F.—An abbreviation for "magnetomotive force."

M. P. H.—An abbreviation for "miles per hour."

Machine Ringing.—In telephone work, ringing by means of electrically-operated contacts.

Magic Eye.—An electron-ray tube, which see.

Magnet.—A piece of iron or steel which has the property of attracting other pieces of magnetic material such as iron, and has the property of attracting or repelling other magnets.

Magnet Armature.—An iron or steel piece which is attracted to a permanent magnet or an electromagnet.

Magnetic Blowout.—A magnet whose field is at right angles to the path of an arc in the gap between separated conductors. The arc, which is equivalent to an electric current, is deflected out of the gap and is so lengthened as to be extinguished.

Magnet Charger.—A powerful electromagnet used for magnetizing permanent magnets, a re-magnetizer.

Magnetic Circuit.—A complete path for magnetic lines of force. It always includes the permanent magnet or electromagnet which is producing the magnetic lines of force.

Magnet Coil.—The coil or winding of an electromagnet.

Magnet Core.—The iron center of an electromagnet.

Magnet Steel.—Steel suitable for making permanent magnets. Tungsten steel is the kind generally used.

Magnet Winding. — The conductor wound around an electromagnet.

Magnet Wire. — A soft single-conductor wire insulated with enamel, cotton or silk, and used for the windings of electromagnets, induction coils, field and armature coils, transformers, choke coils, relays, etc.

Magnetic. — Pertaining to magnets or magnetism.

Magnetic Attraction. — The attraction between two magnets or between a magnet and iron or steel.

Magnetic Axis. — The center line through the core of a permanent magnet or an electromagnet, also this center line extended through a straight magnetic field.

Magnetic Battery. — A compound magnet.

Magnetic Brake. — A brake operated by electromagnets but using friction for retarding the motion of the parts.

Magnetic Bridge. — An instrument which measures magnetic reluctance and permeability.

Magnetic Clutch. — A clutch whose parts are drawn together by electromagnets.

Magnetic Compass. — A compass using a small piece of magnetized steel to indicate north and south.

Magnetic Compensator. — A magnet so placed with reference to a ship's compass that it causes the compass to indicate true north and south.

Magnetic Contactor. — A device operated by an electromagnet to close and open contacts in a circuit.

Magnetic Couple. — The two attractions of the earth's north magnetic pole and its south magnetic pole which together act to turn a magnetic needle.

Magnetic Coupling Transformer. — A jigger.

Magnetic Cutout. — A reverse current cutout operated by an electromagnet.

Magnetic Cycle. — The rise and fall of magnetism in an iron core, from zero to maximum of one polarity, to maximum of the opposite polarity, and back to zero.

Magnetic Deflection. — Electromagnetic deflection.

Magnetic Degree. — The 360th part of the angle included between a pair of field poles in an electric machine.

Magnetic Density. — Flux density in a given cross section of a magnetic field.

Magnetic Dip. — The turning of a magnet needle toward the earth.

Magnetic Equator. — An imaginary line around the earth at which a magnetic needle has no dip but remains horizontal. It is near the geographical equator.

Magnetic Explorer. — A solenoid connected to a galvanometer and used to determine the strength of a magnetic field.

Magnetic Fatigue. — A gradual increase of the hysteresis loss in magnetic

material in which changes of flux are long continued.

Magnetic Field. — A region in space surrounding a magnet or a conductor through which current is flowing.

Magnetic Flux. — Total number of magnetic lines of force acting in a magnetic circuit.

Magnetic Focusing. — Electromagnetic focusing.

Magnetic Force. — See magnetomotive force. This term may also mean the attraction between magnetic poles.

Magnetic Friction. — Hysteresis. This term may also mean the effect of a magnetic field on a conductor moving through it, which requires an effort to move the conductor.

Magnetic Gear-Shift. — In an automobile, a device for shifting the transmission gears by plunger magnets.

Magnetic Induction. — Magnetism produced in a magnetic material by bringing the material into a magnetic field or by producing a magnetic field through the material.

Magnetic Inertia. — Hysteresis.

Magnetic Intensity. — Flux density.

Magnetic Lag. — The difference between the rate of increase in magnetizing force and the magnetism produced by the force, the amount by which the magnetism is behind the magnetizing force.

Magnetic Leakage. — Lines of force which do no useful work because of passing outside of the working field.

Magnetic Limit. — The heat at which a magnetic material cannot be magnetized.

Magnetic Lines of Force. — Imaginary lines used for convenience to designate the directions in which magnetic forces are acting throughout the magnetic field associated with a permanent magnet, electromagnet or current-carrying conductor.

Magnetic Linkage. — The magnetism which affects two different electric circuits or which is produced by one circuit and affects another circuit.

Magnetic Loudspeaker. — A loudspeaker consisting essentially of a permanent magnet, a pivoted armature which is mechanically connected to the diaphragm or cone, and a coil which is connected to the output stage of a radio receiver or other apparatus. Interaction between the permanent magnetic field and that developed in the armature by the coil results in movement of the armature and production of sound waves by the diaphragm.

Magnetic Material. — Materials which are useful in electrical work because they readily carry magnetism or become magnets. Iron and steel in their different forms are the only important magnetic materials.

Magnetic Meridian. — A circle whose plane lies in line with the magnetic north and south.

Magnetic Moment. — The strength of

Magnetic Needle

one magnet pole multiplied by the distance between two poles.

Magnetic Needle.—A small permanent magnet used to indicate north and south or to incline toward the earth due to the earth's magnetism.

Magnetic Pick-up.—A phonograph pick-up consisting of a permanent magnet, one or two coils, an iron armature and a core structure so arranged that movement of the phonograph needle in the record groove varies the amount of magnetic flux passing through the coils, thereby inducing audio frequency voltages in the coils.

Magnetic Pinion Shift.—Movement of the pinion of an automobile electric starting motor by means of a plunger and solenoid.

Magnetic Polarity.—Identification of magnetic poles according to the direction of lines of force; the north pole being the one at which lines issue from the magnet, and the south pole the one at which they re-enter the magnet.

Magnetic Pole.—The part of a magnet at which magnetic lines of force leave or enter the magnet.

Magnetic Potential.—Magnetomotive force.

Magnetic Repulsion.—The repulsion between like magnetic poles.

Magnetic Resistance.—Reluctance.

Magnetic Saturation.—The greatest number of lines of force or the greatest flux density that a magnetic material will carry under given conditions.

Magnetic Screen or Shield.—A body of soft iron through which magnetism is carried so that it will not affect some part which would otherwise be in the magnetic path.

Magnetic Shunt.—A piece of iron or steel adjustably located in the field of a magnet for the purpose of deflecting some of the flux from the gap and of thus regulating the field strength in the gap between the magnet poles.

Magnetic Spark Plug.—An ignition spark plug containing an electromagnet which separates contacts between which a spark is produced.

Magnetic Starting Switch.—An automobile starting switch whose contacts are closed by an electromagnet.

Magnetic Switch.—A switch operated by an electromagnet.

Magnetic Tick.—A faint sound caused in iron or steel which is being magnetized or demagnetized.

Magnetic Unit.—Units in which magnetic quantities and values are measured.

Magnetic Vane Meter.—An ammeter or voltmeter having two pieces of soft iron which measure electricity by the repulsion produced between the two pieces when magnetized.

Magnetic Whirl.—The magnetic waves which start from a conductor carry-

Magnetite

ing electric current.

Magnetite.—Magnetic oxide of iron, lodestone.

Magnetism.—A property of the molecules of certain substances chiefly iron and steel, by which motion of electrons in the atoms and between them produces a magnetic field or magnetic lines of force in and around the substance.

Magnetisation.—A magnetic condition of a substance.

Magnetization Curve.—A curve showing the relation in a magnetic circuit between the magnetizing force (H) in ampere-turns and the flux density (B) measured in magnetic lines of force per unit of cross sectional area of the circuit. A BH curve.

Magnetize.—To cause anything to become a magnet.

Magnetizing Force.—Magnetomotive force per inch or other unit of length of a magnetic circuit. Ampere-turns per inch of circuit length.

Magneto.—A small generator with permanent magnet fields which generates current for ignition in internal combustion engines and which is driven by the engine.

Magneto Base.—A mounting of non-magnetic metal on which a magneto is supported.

Magneto Breaker.—An interrupter attached to and driven from a magneto armature shaft.

Magneto Cover.—A waterproof cover for a magneto.

Magneto Distributor.—An ignition distributor attached to and driven by a magneto.

Magneto Generator.—The combination of a direct current battery charging generator and a magneto so that both are driven by a single shaft but so that they are electrically separate.

Magneto Ignition.—Internal combustion engine ignition using a magneto as its source of current.

Magneto Interrupter.—An interrupter attached to and driven from the armature shaft of a magneto.

Magneto Mounting.—The fastenings and base for holding a magneto on an engine.

Magneto Rotor.—The revolving mass of iron in an inductor magneto.

Magneto Timing.—Connecting the armature shaft of a magneto to the driving shaft from the engine in such a relation to each other that the ignition spark is produced at the right instant in the engine cylinders.

Magnetometer.—An instrument for measuring and indicating the amount of magnetic flux.

Magnetomotive Force.—The total force which causes magnetic flux or magnetic lines of force to appear in a magnetic circuit. Measured as the number of ampere-turns of the coil or winding in which the force arises. Magnetomotive force in a magnetic

circuit is similar to electromotive force in an electric circuit.

Magnetron.—A vacuum tube in which electrons emitted from a central filament may be deflected in greater or less degree by a varying magnetic field produced externally to the tube. Electrons may or may not reach the plate which is around the filament, depending on the instantaneous strength of the magnetic field. Used as an ultra-high frequency oscillator.

Main.—A supply line to which circuits are connected through switches or cutouts.

Make-and-Break Ignition.—Ignition in internal combustion engines from a spark produced by the separation of current carrying contacts carried inside the engine cylinder.

Make-Induced Current.—A current produced by induction when a circuit is completed. It is less than the break-induced current when the circuit is broken.

Manganese Steel.—An alloy steel containing manganese, which makes the metal non-magnetic.

Man-Made Static.—High-frequency noise signals which are produced by sparking in electrical apparatus or power lines and picked up by radio receivers, with the result that buzzing and crashing sounds are heard along with a desired radio program.

Manual Controller.—A controller in which all the basic functions (starting, stopping, reversing, speed changing, etc.) are performed by hand operation of the controller.

Manual Cutout.—A reverse current cutout operated through a mechanical connection to some hand operated switch, such as the ignition switch or the starting switch.

Manual Pinion-Shift.—A shifting mechanism for automobile starting motor pinions which is operated by foot or by hand.

Manual Ringing.—In telephone work, ringing done by the operator with a key.

Manual Telephone System.—A system in which the connections between subscribers are made by hand.

Manual Tuning.—Tuning a radio receiver to a desired station by rotating the tuning control knob by hand.

Mariner's Compass.—A compass in which a card showing the directions is turned by being attached to two compass needles. The form of compass used for guiding ships.

Marker Generator.—A signal generator furnishing oscillator voltage for producing beat-frequency marker pips, or containing an absorption circuit for producing breaks or dips, on the frequency response curve of an amplifier or receiver displayed on an oscilloscope. Frequencies on the curve are identified from tuned frequencies of the generator.

Mask.—A frame, usually ornamental,

mounted in front of a television picture tube to limit the area of viewing screen visible from outside the cabinet.

Master Service.—Service conductors and equipment for a group of buildings under one management.

Master Switch.—An electric switch that controls other parts or contactors which in turn operate electric devices.

Matching.—Connecting two circuits or parts together with a coupling device in such a way that the impedance of either circuit will be equal to the impedance existing between the coupling terminals to which that circuit is connected.

Matching Diaphragm.—A window consisting of an aperture (slit) in a thin piece of metal, placed transversely across the wave guide; used as a matching device. The orientation of the slit (whether parallel to the long or short dimension of the wave guide) determines whether it is respectively capacitive or inductive.

A radar term.

Matching Stub.—A short piece of resonant line connected at the antenna end or receiver end of a transmission line for the purpose of adding enough inductive or capacitive reactance to match impedances of antenna, receiver, or line at a limited range of frequencies.

Matrix.—In color television receivers, a group of resistors through which the luminance signal combines with signals from the demodulators to form color primary signals, or sometimes a G-Y color difference signal. Each matrix feeds to a color amplifier or to a picture tube grid-cathode circuit.

Matrixing.—Combining or mixing chrominance signal components and the luminance signal in resistance networks of color television receivers for production of color primary or color-difference signals.

Maximum Demand.—The greatest load that is called for from a system in a given period.

Maximum Demand Meter.—An instrument which registers the greatest amperage that has been flowing in a circuit within a given time.

Maximum Undistorted Output.—The maximum audio power output which a radio receiver or audio amplifier will deliver without having more than 10% total harmonic distortion. Tests have shown that this amount of distortion is not ordinarily noticeable or objectionable.

Maximum Value.—The greatest value reached by an alternating voltage or current during any instant in the cycle.

Maxwell.—A measure of magnetic flux or number of lines of force. One maxwell is the flux sent through a magnetic circuit whose reluctance is one oersted by a magnetomotive

force of one gilbert.

Mayday.—The international distress call for radiotelephone communication. It is derived from the French pronunciation of "M'aidez," meaning "Help me."

Mazda Lamp.—A vacuum or gas filled incandescent lamp with a tungsten filament.

MC.—Megacycle.

McNally Tube.—A local oscillator tube. A single cavity, velocity modulated tube, the frequency of which may be controlled over wide ranges by electrical methods.

Mean Horizontal Candlepower.—The average candlepower through the luminous center of a lamp in a horizontal plane.

Mean Spherical Candlepower.—The average candlepower of a lamp measured in all directions from its center of illumination.

Medium Lampholder.—A lampholder having a nominal screw diameter of one inch.

Meg.—Megohm.

Megacycle.—One million cycles per second.

Megger.—An instrument for measuring the resistance of insulation in megohms.

Megohm.—A resistance of one million ohms.

Mercurial Contact.—A device in which a circuit is completed or broken by the expansion and contraction of mercury with changes of temperature.

Mercury.—A heavy, silvery-colored metal which is liquid at ordinary room temperatures. When heated, it gives off a vapor which is highly conductive when ionized.

Mercury Break.—A device which breaks a circuit by withdrawing a conductor from a pool of mercury to which the other side of the circuit is connected.

Mercury Interrupter.—A high speed interrupter making contact between mercury and a solid metal. It is usually motor driven.

Mercury Vapor Lamp.—A lamp in which a small quantity of mercury is vaporized by the heat of an electric discharge through argon gas, after which flow of current through the mercury vapor produces light.

Mercury Vapor Rectifier Tube.—A rectifier tube containing a small amount of mercury. When the filament or heater-type cathode is heated, mercury vapor is produced, and the resulting ionization of the mercury vapor molecules gives a much higher plate current than would be obtained in an equivalent vacuum type rectifier tube.

Mesh Connection.—Connections in armature windings which produce closed circuits.

Messenger Wire.—In electric railroad work, a wire used to support trolley wires or feeders.

Metal-backed Screen.—An aluminized screen in a television picture tube.

Metal Conduit.—Iron pipe used for carrying electric wiring.

Metal Cone Tube.—A television picture tube having a cone-shaped metal shell, instead of glass, between the glass face plate and glass at the forward end of the tube neck.

Metallic Arc.—A direct current arc lamp using electrodes of copper and iron oxide.

Metallic Circuit.—A circuit completed entirely through metal, with no part grounded.

Metallic Filament.—An incandescent lamp filament made of tungsten, tantalum, or other metal.

Metalized Resistor.—A resistor made by depositing a thin film of high-resistance metal on the surface of a tube or rod made of glass or other insulating material. Leads are attached to opposite ends of the unit.

Metal-Type Tube.—A vacuum or gaseous tube having a metal envelope or housing, with electrode connections being made through glass beads fused into the metal envelope. Usually called all-metal tube.

Meter.—The unit of length in the metric system; one meter is equal to 3.28 feet. An instrument used for making electrical measurements. A voltmeter measures voltage; an ammeter or milliammeter measures currents; a wattmeter measures power; an ohmmeter measures resistance.

Metric Spark Plug.—A spark plug by depositing a thin film of high-resistance metal on the surface of a tube or rod made of glass or other insulating material. Leads are attached to opposite ends of the unit, whose shell has a straight thread measured in millimeters. It is about a half inch in diameter.

Metric System.—The decimal system of measurement, based on the meter for length and the gram for mass. All units are tenths, or multiples of ten, of the other units in a given class.

MH.—Millihenry.

Mho.—The unit in which conductivity is measured, the reciprocal of an ohm.

Mica.—A transparent flaky mineral which splits readily into thin sheets and has excellent insulating and heat-resisting qualities. It is used extensively to separate the plates of condensers, to insulate electrode elements of vacuum tubes, and for many other insulating purposes in radio apparatus.

Mica Condenser.—A condenser which employs sheets of mica as the dielectric material which insulates adjacent plates from each other.

Mica Dielectric.—Thin sheets of mica used for the dielectric in a condenser.

Mica Spark Plug.—A spark plug whose center electrode is insulated from

the shell with mica.

Mica Undercutter.—A tool which cuts the mica insulation between commutator segments below the surface of the copper.

Micantite.—Small pieces of mica cemented together into a sheet.

Micro.—A prefix meaning one millionth.

Microampere.—The one-millionth part of an ampere.

Microfarad.—A unit of capacity equal to one millionth of a farad. The microfarad is the capacity unit most commonly used in radio work. It is abbreviated as mfd.

Microhm.—A resistance of one one-millionth of one ohm.

Micro-Microfarad.—A unit of capacity equal to one millionth of a microfarad, and abbreviated as mmfd.

Microphone.—A device which converts sound waves into corresponding audio frequency electrical energy. It contains some form of flexible diaphragm which moves in accordance with sound wave variations. This movement, in turn, generates a minute voltage which is fed to the input of an amplifier where it is amplified many times. There are several types of microphones available, but they all operate on the above principle. **Carbon Microphone.**—A microphone in which loosely packed carbon granules complete the electrical circuit between two terminals. The resistance of this circuit varies in accordance with variations in the pressure exerted on the granules by the sound-actuated diaphragm. In a single-button carbon microphone, the granules are on only one side of the diaphragm. In a double-button carbon microphone the granules are on both sides of the diaphragm, giving a push-pull action which greatly increases the resistance change produced by a given diaphragm movement.

Condenser Microphone.—A microphone in which the diaphragm serves as one plate of a condenser. Sound waves move the diaphragm in and out, causing the capacity of the microphone and the current through it to vary in accordance with the sound waves. **Contact Microphone.**—A microphone designed to pick up mechanical vibrations directly and convert them into electrical impulses. It is used chiefly with string, wind, and percussion musical instruments, and is simply strapped or clamped to the housing of the instrument. **Crystral Microphone.**—A microphone depending upon the piezoelectric effect, or voltage produced in Rochelle salt crystals when subjected to mechanical stress such as that caused by sound waves. Two types are in use today, the sound-cell type and the diaphragm type. **Dynamic Microphone.**—A microphone in which the diaphragm moves a voice coil back and forth in a constant magnetic

field, causing audio currents to be induced in the coil. A small dynamic loudspeaker is often made to serve also as a dynamic microphone, particularly in two-way intercommunication systems. **Velocity or Ribbon Microphone.**—A microphone in which a thin, light-weight ribbon of duralumin alloy serves as the diaphragm. This ribbon is mounted in a powerful fixed magnetic field. Audio frequency voltages are induced in the ribbon when it is moved back and forth through the magnetic field by sound waves.

Microphone Pre-Amplifier.—An audio amplifier which amplifies the output of a microphone sufficiently so that the audio signal may be sent over a transmission line to the main amplifier. Sometimes, particularly with condenser microphones, this microphone amplifier is mounted right on the microphone stand or in the microphone housing itself.

Microphone Button.—A button-shaped container filled with carbon particles. When attached to the diaphragm of a microphone, the resistance between the terminals of the button varies in accordance with movements of the diaphragm.

Microphone Stand.—A table or floor-type stand used to support a microphone in a desired position.

Microphone Transformer.—The iron-core a.f. transformer which couples the microphone to a microphone amplifier, to a transmission line, or to the input circuit of the main audio amplifier.

Microphonic.—A condition in which mechanical movement of some radio part other than a microphone causes corresponding variations in circuit current. A radio tube is microphonic if a ping-pong sound is heard in the loudspeaker when the side of the tube is tapped with a finger; the tapping is then setting the internal elements into vibration. If sound waves from the loudspeaker are producing this vibration of tube elements, the sound will be sustained as a howl.

Microvolt.—The one-millionth part of a volt.

Microwaves.—Wavelengths which usually are considered to be in the range of between $3/10$ and $3/1000$ of a meter. Hyper frequencies.

Mike.—A microphone.

Mil.—The one-thousandth part of an inch.

Mil-Foot.—A measure of the size of conductors; a conductor one foot long having a cross sectional area of one circular mil.

Mile-Ohm.—A resistance of one ohm in a length of one mile of conductor.

Milky Electrolyte.—Electrolyte having a milky-white appearance due to the presence of large quantities of oxygen bubbles coming from the positive plate surface.

Milli

- Milli.**—A prefix meaning one thousandth.
- Milliammeter.**—A measuring instrument which measures current flow in milliamperes.
- Milliampere.**—An electric current of 1/1000 of an ampere.
- Millihenry.**—One-thousandth of a henry; a unit of inductance.
- Millimeter.**—A metric unit of length equal to one thousandth of a meter. One millimeter is approximately equal to one twenty-fifth of an inch.
- Millimicron.**—A unit for measuring wavelength of light, equal approximately to one twenty-five-millionth of an inch.
- Millivolt.**—A unit of voltage equal to one thousandth of a volt.
- Millivoltmeter.**—A voltmeter calibrated to read in thousandths of volts.
- Mineralae.**—A kind of insulating compound.
- Miniature Lamp.**—An incandescent lamp using the smallest size of screw base.
- Minus Color Signal.**—A color television chrominance or luminance signal differing in phase by 180° from a plus signal. A plus luminance signal inverted between grid and plate of a tube becomes a minus luminance signal. Example: A yellow signal is plus, while the signal for the complementary color of blue is minus, and differs in phase by 180° from yellow.
- Mirror Backed Screen.**—An aluminized screen in a television picture tube.
- Mirror Galvanometer.**—A galvanometer which indicates by the movement of a small spot of light reflected from a mirror attached to the moving element.
- Mitis Iron.**—A magnetic steel containing aluminum as an alloy.
- Mixed Highs.**—The color television luminance signal or brightness signal, whose frequencies extend high enough in the video range for reproduction of fine details in pictures.
- Mixer.**—A control which permits combining the output signals of two or more microphones or other a.f. signal sources in any desired proportion before these signals are fed to the input of the main a.f. amplifier. Also, the stage in a superheterodyne receiver in which the incoming modulated r.f. signals are mixed with the local oscillator signals to produce the i.f. signal.
- MM.**—Millimeter.
- Mobile Station.**—A radio station operated in a movable location such as on an automobile, fire truck, railway train, ship or airplane.
- Moderator.**—A substance such as carbon, beryllium, or heavy water used for slowing down neutrons by means of elastic impacts of the neutrons with atoms of the moderator.
- Modulated Amplifier.**—The r.f. stage in a transmitter at which the intelligence signal is made to modulate the r.f. carrier signal.

Modulated Wave

- Modulated Wave.**—A radio wave which varies either in frequency (frequency modulation) or in amplitude (amplitude modulation) in accordance with the wave form of the intelligence signal being transmitted.
- Modulation.**—The process of varying the frequency or the amplitude of an r.f. carrier signal in accordance with the wave form of the intelligence signal being transmitted.
- Modulator.**—The final audio stage in a radio transmitter. It feeds the intelligence signal into the modulated amplifier stage, where the signal is made to modulate the r.f. carrier signal.
- Mogul Lampholder.**—A lampholder having a nominal screw diameter of 1½ inches.
- Molecule.**—The group of atoms which constitutes the smallest particle in which a compound or material can exist separately.
- Moment.**—Any effect that produces motion.
- Moment of a Magnet.**—See magnetic moment.
- Monel Metal.**—A natural alloy of nickel and copper used for resistance.
- Monkey Chatter.**—Garbled speech or music heard along with a desired program. This type of interference occurs when the side frequencies of an adjacent-channel station beat with the desired station signal.
- Monochrome.**—Descriptive of a picture reproduced from a black-and-white transmission, the picture appearing in black, white, and shades of gray, but having no coloring. The strict meaning is a picture all of a single hue, but with differences of saturation and brightness.
- Monochrome Channel.**—In color television receivers, an electrical path intended to carry monochrome signals.
- Monochrome Signal.**—A television signal that controls only luminance or brightness of pictures, not chrominance or colors.
- Monocyclic Alternator.**—An alternating current generator producing two currents at the same time, one for lighting and the other for power.
- Monocyclic System.**—A system of three-wire alternating current distribution. Between two wires a higher voltage can be obtained than between either of these wires and the center wire.
- Monoscope.**—A special type of cathode ray tube which produces television picture signals corresponding to the design or picture which has been printed on its screen. This tube is used in television picture signal generators to provide a satisfactory signal source for television receiver test purposes during those times when no television station is on the air.
- Morse Code.**—A system of dot and dash signals used in the transmission of messages by radio or wire telegraphy. The International Morse Code

- (also called the Continental Code) is used universally for radio telegraphy, while the American Morse Code is used only for wire telegraphy.
- Mosaic.**—The photosensitive globules on their insulating mounting in the tube or Iconoscope of the television camera. The camera lens system focuses the image on the area of the mosaic.
- Motor.**—A machine which changes electric energy into mechanical power.
- Motor-Brush Starting Switch.**—An arrangement used in some automobile starting motors by which lifting one or more brushes of the commutator opens the starting circuit, while letting them drop onto the commutator causes the motor to operate.
- Motorboating.**—Regeneration occurring at audio frequencies in a radio receiver or audio amplifier, resulting in put-put-put sounds resembling those made by a motorboat.
- Motor-Circuit Switch.**—A switch that will open the maximum operating overload current of a motor, the switch being rated in horsepower which is the same as that of the motor.
- Motor Converter.**—A cascade converter.
- Motor Efficiency.**—The ratio between the power in watts supplied to an electric motor and the mechanical horsepower produced by the motor.
- Motor-Generator.**—An electric motor driving an electric generator for the purpose of transforming voltage or current or changing A. C. to D. C. or vice versa.
- Motor Starter.**—A hand-operated or magnetically operated contactor or heavy-duty switching device for opening and closing the circuit feeding a motor or motors as the motors are stopped and started.
- Motor Transformer.**—An inverted converter.
- Motoring of Generator.**—Operating a generator as a motor for the purpose of learning its probable ability to generate.
- Moulded Insulation.**—Any insulating material that may be formed to shape in a mould while moist or while heated.
- Moulded Mica.**—Insulating material made of small pieces of mica held together with a cement.
- Moulding.**—A strip of material, wood or steel in which are grooves to receive and carry electric wires.
- Moving Coil Meter.**—A current-actuated electric meter consisting of a permanent magnet between the poles of which is suspended a wire coil through which flows all or part of the current to be measured. The coil is mounted between end bearings and to it is attached the indicating pointer. The coil and pointer are moved by reaction between the magnetic fields of the permanent magnet and of the current-carrying coil.
- M-Scan.**—A modification of type A-Scan for accurate range finding. A horizontal time sweep is displaced stepwise slightly vertically. The signal appears as a vertical deflection of the time sweep. An auxiliary device for controlling the phase of the signal or the step is used to bring them into coincidence, at which point the device registers range.
A radar term.
- MU.**—Amplification factor.
- Multi-Meter.**—A test instrument having provisions for measuring voltages and currents, as well as resistance. It usually consists of one or sometimes two meters provided with the necessary number of scales, and a range-selecting switch which places a meter in the correct circuit for a particular measurement. Also known as a multimeter, multiple-purpose tester or voltohm-milliammeter.
- Multiphase.**—Of more than one phase, polyphase.
- Multiple.**—A parallel connection of several parts.
- Multiple Arc.**—A parallel or multiple connection.
- Multiple Arc Lamp.**—An arc lamp designed for connection in parallel or multiple across a circuit, in place of in series with other arc lamps.
- Multiple Circuit.**—A circuit having several parts in parallel.
- Multiple Drum Winding.**—A lap winding of an armature.
- Multiple Images.**—Alternate bright and dark lines following closely at the right of sharp changes of shading in television pictures, with successive image lines diminishing in distinctness. Caused by damped oscillations affecting the video signal.
- Multiple Key.**—A key controlling more than one circuit.
- Multiple Series.**—A multiple or parallel connection of two or more series circuits.
- Multiple Series Condenser.**—An adjustable condenser whose parts may be placed in series or in parallel.
- Multiple Telegraphy.**—A system in which two or more messages are carried at the same time over one circuit.
- Multiple Transformer.**—A transformer whose primary is connected in parallel with the supply circuit.
- Multiple Unit System.**—Control of the motors in two or more cars of a train from a single master controller in one of the cars.
- Multiple Voltage System.**—Connection of current consuming devices in series so that their total voltage requirement equals the voltage of the current supply.
- Multiplex Telegraphy.**—A telegraph circuit used for carrying one or more messages in both directions at one time; a duplex or a quadruplex circuit.
- Multiplex Wave Winding.**—An arma-

Multiplier

- ture wave winding having more than two paths in parallel.
- Multiplier.**—A resistance which, when connected to a voltmeter, allows the meter to measure higher voltages than those shown by its scale.
- Multipolar.**—Usually refers to an electric machine having more than two poles, the two-pole types being called bipolar or two-pole.
- Multi-Speed Motor.**—An electric motor which can be run at several definite speeds.
- Multivibrator.**—A relaxation oscillator employing two triodes. Feedback may be capacitive from the plate of each triode to the grid of the other, or else may be through a common cathode resistor. Time between successive oscillations is determined by discharge rate of capacitors in one or both grid circuits; the discharge occurring through resistors to cathodes or ground. A commonly used sweep oscillator in television receivers.
- Mush Coil.**—A coil whose winding is not applied in regular layers and turns.
- Mutual Inductance.**—The property of circuits which permits the action of mutual induction in them.
- Mutual Induction.**—Production of a varying or alternating emf in one circuit by movement across its conductors of field lines arising in another nearby circuit in which the current is varying.

N

- N.**—A symbol for speed, revolutions per second or minute.
- N.**—An abbreviation for "number."
- N.**—A symbol for the north seeking pole of a magnet, its positive pole.
- N. B. S.**—Abbreviation for the "National Bureau of Standards." Generally applied to the standard units of resistance.
- N. E. C.**—Abbreviation for "National Electric Code"; a set of instructions and rules published by the National Board of Fire Underwriters and generally adopted by light and power companies as the basis of their own rules for installation.
- N. H. P.**—An abbreviation for "nominal horsepower."
- Natural Frequency.**—Resonant frequency corresponding to inductance and to stray and distributed capacitances in a circuit or part, not to intentional tuning.
- Natural Magnet.**—See lodestone.
- Neck.**—A small part of a field core between two larger parts.
- Needle.**—A straight magnetized piece of steel, hung at its center and free to swing north and south or up and down the pointer in a compass. That part of a phonograph pick-up which converts the variations in the record grooves into mechanical movements which are in turn converted into audio frequency signals by the pick-up element. The needle must be carefully shaped to follow faithfully the high-frequency variations in the grooves without causing excessive record wear.
- Needle Electrode.**—An electrode or conductor of needle shape used in medical work.
- Needle Point.**—Fine sharp points used in a spark gap, as distinct from blunt or ball shaped points.
- Negative.**—Having more than a normal quantity of electrons. Descriptive of a point in a circuit away from which electrons flow to other points relatively positive. Conventional current flow is opposite to electron flow.
- Negative Bias.**—The use of a voltage which makes the control grid of a radio tube negative with respect to the cathode.
- Negative Brush.**—A generator brush through which current enters the armature. On a motor it is the brush through which current leaves its armature. Any brush on the negative side of a circuit.
- Negative Charge.**—A charge of electricity of negative polarity. The charge on that plate of a condenser connected with the negative side of the source. The electrical condition of a body on which are more than the normal quantities of negative electrons, so that the body has more negative electricity than has an uncharged or neutral body.
- Negative Conductor.**—A conductor attached between the negative side of an electrical source and the negative side of a current consuming device.
- Negative Electricity.**—Electricity at lower pressure or potential than the pressure in another part of a circuit.
- Negative Electrode.**—The terminal of a source away from which electrons flow into external circuits. Conventional current flow is opposite to electron flow.
- Negative Element.**—In a battery or cell, the plates from which electrons flow to external circuits. Conventional current flow is opposite to electron flow.
- Negative Feedback.**—Degeneration, causing a reduction in signal strength.
- Negative Feeder.**—The feeder connected to the negative terminal of a generator or motor.
- Negative Lead.**—A negative conductor.
- Negative Peaking.**—Addition of a brief pulse at the negative end of sudden reversal of polarity in a sawtooth wave. The peak may be added by a fixed or adjustable resistor in series with the capacitor whose charge and discharge produce the sawtooth.
- Negative Plate.**—In a battery or cell; the plate through which current enters the battery or cell. In a lead-acid battery, the sponge lead plate.
- Negative Pole.**—In a magnet; the pole at which the lines of force from the outside field are assumed to re-enter

Needle Electrode

Negative Post

- the magnet. The south pointing pole of a compass needle.
- Negative Post.**—A negative terminal.
- Negative Potential.**—An electric potential caused by an excess of electrons at the point considered. The electrons are negative charges.
- Negative Side.**—The parts in a circuit between the point from which the current leaves the current consuming devices and the point at which the current re-enters the source.
- Negative Sign.**—The minus sign (—). It stands for a negative conductor, the negative pole of a magnet, or a negative terminal.
- Negative Terminal.**—The terminal of a source from which electrons pass to external circuits. On an external device the terminal connected to negative of the source. Conventional current flow is opposite to electron flow.
- Negative Transmission.**—In television transmission, modulation of the carrier in such manner that peaks of sync pulses are at maximum amplitudes both sides of zero, while the white level of picture signals is at minimum amplitudes. The method used in the United States and elsewhere, but not everywhere.
- Negative Wire.**—A negative conductor.
- Neon.**—An inert gas used in neon lamps and in tubes employed for the detection of electrostatic fields around high voltage conductors. A pure gas sometimes used in electronic tubes. It produces a characteristic red glow when ionized.
- Neon Glow Lamp.**—A neon-filled gaseous tube having a glass envelope through which can be seen the characteristic red glow of neon when ionization occurs during operation of the tube.
- Neptunium.**—A chemical element not known to occur in nature. Atomic number is 93 and atomic weight is 239. Formed by radioactive decay of uranium-239 which emits a B-particle (high energy electron) to become neptunium-239.
- Net Reactance.**—The difference between the ohms of inductive reactance and the ohms of capacitive reactance in a circuit. If inductive reactance is the greater, the difference is considered to be positive reactance, and if capacitive reactance is the greater the difference is considered to be negative reactance.
- Network.**—An electric circuit in which the parts cannot be classified as connected in series, in parallel, or in series-parallel, but in which the connections are of some special nature suited to the purpose for which the circuit is to be used.
- Neutral.**—Having electric or electrostatic potential intermediate between the potentials of other associated parts in a circuit; positive with reference to some parts while negative with reference to others. Sometimes refers to zero potential, neither posi-

Neutral Density Faceplate

- live nor negative.
- Neutral Density Faceplate.**—A television picture tube face plate of glass tinted to absorb part of light and allow the remainder to pass. Light passing outward from the viewing screen goes through the glass but once, while external light reflected from the screen passes twice and suffers greater absorption.
- Neutral Relay.**—In telegraphy, a non-polar relay.
- Neon Lamp.**—An electric lamp made with a lighting element of rare oxides, operating in air. The lighting element is a non-conductor when cold and requires a heating element to start the lamp in operation.
- Neutral Conductor.**—A conductor acting as either positive or negative, depending on which of the other conductors in a three-wire circuit it is attached to.
- Neutral Ground.**—A ground, earth or metal, that acts as either positive or negative to conductors.
- Neutral Line.**—A line drawn through the positions around a generator or motor armature at which the conductors are cutting no lines of force in the field.
- Neutral Point.**—The point on the commutator of a generator or motor which is connected with conductors passing the neutral line of the armature. A point on a magnet midway between the positive and negative poles of the magnet.
- Neutral Position.**—The position of the brushes in a generator or motor at which they show the least sparking. It is near the neutral point on the commutator.
- Neutral Pole.**—The point on a magnet midway between the positive and negative poles of the magnet.
- Neutral Terminal.**—A terminal, usually on the source, acting as either positive or negative to two other terminals, one of which is positive, the other negative.
- Neutral Wire.**—A neutral conductor.
- Neutralization.**—A term used in radio to describe any process which balances out or prevents an undesirable effect such as oscillation.
- Neutralizing Tool.**—A small screwdriver or socket wrench, constructed partly or entirely from non-metallic materials, and used for making neutralizing or aligning adjustments in radio receivers. It eliminates the body capacity effects which would affect the accuracy of the adjustments if an ordinary metal wrench or screwdriver were used.
- Neutron.**—A basic constituent particle of atomic nuclei. It has no electric charge.
- Nichrome.**—An alloy of nickel, iron and chromium which has a high resistance per unit volume and is capable of withstanding high temperatures. It is used extensively in the construction of wire-wound resistors, as

Nickel

well as in the heating elements of soldering irons and other electrical heating appliances.

Nickel.—A silvery white metal, one of the elements. Nickel does not readily oxidize and it is used in the majority of resistance alloys.

Nickel-Iron Battery.—The Edison storage battery in which two of the elements used are nickel and iron.

Nickel Silver.—A resistance wire material made of copper, zinc and nickel.

Nickel Steel.—An alloy of steel containing a percentage of nickel. Used for electrodes because of its resistance to heat and oxidation.

Nitrogen Lamp.—An electric lamp made with a tungsten filament carried in nitrogen or some other inert gas. It gives a whiter light than the vacuum lamp because the filament can be run hotter with the same deterioration than when in a vacuum.

Node.—A point on a resonant line at which direct and reflected charges or waves balance to leave zero or minimum amplitude.

Noise.—In radio, a term used chiefly in connection with interfering sounds heard along with desired programs.

Noise Filter.—A device which is inserted between a wall outlet and the power cord plug of a radio receiver to block noise interference which otherwise might enter the receiver.

Noise Limiter.—A special radio circuit which limits the effects of interfering noises by cutting off all noise peaks which are stronger than the highest signal peak being received.

Noise Silencer.—A special vacuum tube circuit which can be introduced into superheterodyne receivers to reduce the effects of static and man-made interference noises. Its chief value is in short wave communication receivers.

Noise-Reducing Antenna System.—An antenna system in which the only part capable of picking up signals is the antenna proper, this being erected high enough to be out of the noise-interference zone. The lead-in is a special shielded cable or twisted two-wire line which can pass through the interference zone without picking up noise signals.

Noisy Picture.—A television picture affected by interference from electric fields or pulse voltages such as would cause noise from a sound radio receiver.

Nominal Horsepower.—The rated power of a motor, engine, etc.

Nominal Rating.—Not meant to be taken as the exact and invariable meaning. The ordinary rating of a device under normal conditions, but from which there may be a variation with a change of operating conditions.

Nominal Voltage.—The voltage at which an electrical device is designed to operate.

Non-Arcing Lightning Arrester.—A

Non-Arcing Metal

lightning arrester having its electrodes made from non-arcing metals.

Non-Arcing Metal.—Metal, such as zinc and cadmium, between electrodes of which an arc quickly dies out.

Non-Conductor.—Any material which offers very high opposition to the flow of electricity. An insulating material.

Non-Inductive.—So designed or constructed that effects of self-induction cancel in two parts of a circuit or device to leave little or no self-inductance.

Non-Inductive Load.—In an alternating current circuit; a load whose current is in phase with the voltage on the load.

Non-Inductive Winding.—A winding so arranged that it produces little or no induced current, has no self-induction or mutual induction.

Non-Magnetic.—Not having magnetic properties, such as the ability to become a magnet or to attract and repel iron and steel. All materials except iron, steel, nickel and cobalt are non-magnetic.

Nonmetallic Sheathed Cable.—Wire or cable enclosed within and protected by a covering of insulating compounds and fabric braids in layers providing fair mechanical strength. Used for some building wiring where this cable is permitted.

Non-Metallic Surface Extension.—Two individually insulated conductors attached to a fabric or other flexible support, or two conductors in a single insulating flexible support, or some equivalent arrangement designed for easy fastening to walls or other exposed building surfaces.

Non-Metallic Waterproof Wiring.—A multiple-conductor rubber-sheathed cable used for exposed wiring in wet locations where exposed to mildly corrosive fumes or vapors.

Non-Polar Relay.—In telegraphy, a relay operating with the change of current regardless of the direction or polarity of the current.

Non-Polarized.—Not having magnetic poles. A piece of iron or steel that is non-magnetic.

Non-Reactive Load.—In alternating current work, a load whose current is in phase with the voltage across the load.

Non-Sinusoidal Wave.—An alternating current wave whose form does not correspond with a sine wave.

Non-Synchronous.—Not in phase.

Normal.—The usual condition, or average amount. Such as normal voltage or normal current.

Normal Sulphation of Battery.—The formation of sulphate of lead in intimate combination with the active materials of battery plates during discharge. It is the part of the sulphate which is changed back to active material by charging.

North Pole.—The pole of a magnet,

No-Voltage Release

from which lines of force leave the magnet. The north seeking pole. The positive pole.

No-Voltage Release.—A switch held in a closed or operating position by an electromagnet, and released when voltage across the magnet winding drops to a predetermined minimum value.

N-Scan.—A combination of type K and M-Scan.

A radar term.

NTSC.—National Television System Committee.

Numerator.—The number written above the line in a fraction, denoting how many of the parts or divisions are taken. (See denominator.)

O

Obsolescence-Free.—Not liable to become out of date because of new developments or new inventions. A term applied particularly to tube testers and other test instruments.

Octal Base.—A type of tube socket base having eight equally-spaced prongs and a central aligning key. When some of the prongs are not needed, they are omitted without changing the positions of the remaining prongs.

Octal Glass-Type Tube.—A glass tube having an octal base.

Oersted.—A measure of magnetic reluctance, or resistance to the flow of magnetism. One oersted is the magnetic resistance that allows one maxwell of flux to pass through a magnetic circuit when the magnetomotive force is one gilbert.

Ohm.—The unit of electrical resistance. The resistance of a device is one ohm when a d.c. voltage of one volt will send a current of one ampere through that device. The Greek letter omega is commonly used to represent ohm.

Ohmic Drop.—Potential difference due to flow of direct current through resistance.

Ohmic Value.—The resistance in ohms which a part or circuit offers to the flow of direct current.

Ohmmeter.—A test instrument which measures and indicates directly the resistance of a part or the resistance between any two points in a circuit. It consists essentially of a milliammeter in series with a suitable d.c. voltage and suitable series or shunt resistors.

Ohm's Law.—A fundamental electrical law which expresses the relationship between voltage, current, and resistance in a direct current circuit, or the relationship between voltage, current and impedance in an a.c. circuit. The three forms of the law in each case are given below, in which E is the pressure in volts, I is current in amperes, R is resistance in ohms and Z is impedance in ohms.

D.C. FORMS

A.C. FORMS

$$\begin{aligned} E &= I \times R \\ I &= E \div R \\ R &= E \div I \end{aligned}$$

$$\begin{aligned} E &= I \times Z \\ I &= E \div Z \\ Z &= E \div I \end{aligned}$$

Ohms-Per-Volt.—A sensitivity rating for meters. It is obtained by dividing the resistance in ohms of any meter range by the full scale voltage reading of the meter at that range. The higher the ohms-per-volt rating, the more sensitive is the meter.

Oil Circuit Breaker.—A high voltage circuit breaker whose contacts open in a bath of oil which puts out the arc.

Oil Switch.—A switch whose contacts break in an oil bath.

Oil Transformer.—A transformer which is insulated by a bath of oil. The oil circulates and cools the heated parts of the transformer while acting as an insulator.

Oiled Cloth.—Cotton or muslin cloth treated with linseed oil to increase its insulating strength.

Oiled Muslin.—Cotton cloth filled with insulating varnish.

Oiled Paper.—Paper treated with linseed oil or varnish to make it a good insulator.

Okonite.—A special rubber insulation used on wires.

Oldham Coupling.—A driving connection made of three parts, two of which have ridges or keys while the third, placed between them, has grooves or keyways. It slips apart readily and gives some flexibility to the drive.

Ombibus Bar.—A busbar.

One-Wire.—Pertaining to parts and connections used in circuits having one side grounded, requiring but one separate contact in the devices.

Open Circuit.—An incomplete circuit, one broken at any point, so that current does not flow through any part of it.

Open-Circuit Battery.—A primary electric cell suitable for use only on circuits which are open most of the time, which operates only for short intervals.

Open-Circuit Voltmeter.—A voltmeter which measures voltage without allowing any current to flow through it. It operates by the electrostatic charges produced.

Open Coil Armature.—An armature in which the ends of one coil are not connected to the ends of other coils at the commutator segments and are therefore open circuited except when connected to the brushes.

Open Delta Connection.—A connection of two transformers so that they form only two sides of a "delta" or triangular connection, in place of the three sides with three transformers in a regular delta connection.

Open Half-wave Line.—A half-wave resonant line whose conductors are not connected together at the far end. Acts like a parallel resonant

Open Link Fuse

- circuit at the resonant frequency.
- Open Link Fuse.**—A fuse that is not enclosed in a tube of fibre or glass.
- Open Machine.**—An electric machine whose housing or framework is open for ventilation.
- Open Quarter-wave Line.**—A quarter-wave resonant line whose conductors are not connected together at the far end. Acts like a series resonant circuit at the resonant frequency.
- Open Wiring.**—Insulated wires supported on knobs, cleats, and other suitable insulating forms, without additional enclosure or protection.
- Operator.**—A person whose duties include the adjustment, maintenance and operation of radio transmitting equipment.
- Opposite Phase.**—A phase difference of 180 electrical degrees, or a difference of one-half cycle.
- Ordinate.**—The vertical distance of a point on a curve above or below the horizontal base line for the curve. The ordinate is a line drawn from the base vertically to the point to be specified.
- Orientation.**—Rotating the dipole and other conductors of an antenna about the supporting mast, or inclining them, to secure maximum pickup of signal energy or rejection of interference, as may be desired.
- Oscillating Current.**—An alternating current caused by electromagnetic action in a circuit having inductance and capacity, but whose resistance is below the critical resistance.
- Oscillating Discharge.**—A series of discharges from a condenser. They grow less and less in volume.
- Oscillation.**—A condition whereby high-frequency currents are generated in a circuit.
- Oscillator.**—An electronic tube or other device without rotating parts which produces alternating voltage and current when direct-current power is applied. In common forms of electronic oscillators, other than relaxation types, grid voltage is varied by energy feedback from the plate circuit to cause saturation and cutoff of plate current thus producing alternating current and voltage in the plate circuit.
- Oscillograph.**—An oscilloscope.
- Oscilloscope.**—A test instrument which shows visually on a screen the wave form of a varying current or voltage.
- Out of Phase.**—Descriptive of alternating currents or voltages between which there are phase differences of any degree. Any currents or voltages which are not "in phase".
- Outboard Bearing.**—A bearing on the extreme end of a shaft, so that a gear or pulley is between the bearing and the machine.
- Outlet.**—A set of terminals from which electric power may be obtained. Thus, power at the a.c. line voltage may be obtained from a wall outlet

Outlet Box

- in a building connected to an a.c. power system.
- Outlet Box.**—A box at which the concealed wiring in a building is exposed for attachment of devices and fixtures.
- Output.**—The useful electrical energy delivered by a radio receiver, a.f. amplifier, electrical generator, or any other signal or power source.
- Output Control.**—Controlling the amperage or voltage of a generator.
- Output Impedance.**—The impedance as measured between the output terminals of a radio device, receiver or amplifier at a definite frequency or at a predominant frequency in the audio range which the device is a handle. For maximum efficiency, the load impedance should match or be equal to this output impedance.
- Output Meter.**—A meter connected to the output of a receiver or amplifier for the purpose of measuring variations in output signal strength.
- Output Stage.**—The final stage in a receiver or a.f. amplifier. In a radio receiver, the output stage feeds the loudspeaker directly. In an a.f. amplifier, the output stage may feed into one or more loudspeakers, a transmission line, or a cutting head in the case of a sound recording system.
- Output Transformer.**—An iron-core a.f. transformer used to provide efficient coupling between the output stage of a radio receiver or a.f. amplifier and its load.
- Output Tube.**—A tube designed for use in the output stage. It is a power amplifier tube, whereas the other tubes in a receiver are usually voltage amplifier tubes.
- Overcompound.**—To proportion a compound winding in a generator so that it slightly increases the voltage with an increase of load.
- Overcoupled Transformer.**—A tuned high-frequency transformer in which coupling is close enough to cause peaks of secondary voltage at two different frequencies when both windings are separately resonant at another frequency in between. Coupling usually is by means of inductive or capacitive reactance, not by mutual induction.
- Overcurrent Device.**—A protective device, such as a fuse or circuit breaker, which acts almost simultaneously to open a circuit when current in that circuit exceeds a certain predetermined value.
- Overdischarge of Battery.**—Discharge of a storage battery after its voltage has fallen to the low practical limit, a harmful discharge.
- Overflowing of Battery.**—Adding water to storage battery cells to bring the electrolyte high enough so it overflows when gassing commences.
- Overhead Line.**—The wiring which is carried on elevated poles, as distinguished from underground wiring.

Overheating of Battery.—Heating of the electrolyte and plates of a storage battery to such a point that the plate material is softened and so that the separators are charred by the hot acid.

Overload.—A load in amperes greater than an electric device or circuit is designed to carry or to operate with.

Overload Circuit Breaker or Switch.—A circuit breaker arranged to open when the current exceeds a certain value for which the breaker is set.

Overload Device.—A protective device, such as a thermally operated or heat-operated switch, that acts to open a circuit when an excessive load and excessive current have continued for long enough to bring temperature of the circuit wires nearly to the danger point.

Override.—Making an automatic gain or volume control system inoperative by connecting from the a/c or a/vc circuit bus to B-minus or ground a fixed voltage, usually from a dry cell battery.

Overrunning Clutch.—A driving clutch which locks a drive in one direction, but which releases when an attempt is made to reverse the direction. It uses a ratchet and pawl or some form of wedge.

Overshoot.—An excessive potential attained by a portion of the main body of a pulse. Compare Back Swing.

A radar term.

Over-Sulphation of Battery.—Production of such a quantity of sulphate of lead in a storage battery that all of this sulphate cannot be reduced to active material by re-charging. It is caused by overdischarge or by undercharge.

Overvoltage.—The additional voltage required for electrolysis with some metals as electrodes above the voltage required with other metals.

Own Ship's Course Bus (O.S.C.).—The cable which feeds the output of a selsyn generator controlled by the ship's gyro compass to the radar set for producing indication of true bearing.

Ozokerite.—An insulating wax.

Ozone.—A form of oxygen produced by electric discharges or sparks passing through air.

P

P.—A letter used to designate power, the plate electrode of a tube, or the primary winding of a transformer.

P.A.—Public address.

P. D.—An abbreviation for "potential difference."

P. B. X.—An abbreviation for "private branch (telephone) exchange."

Padder.—In a superheterodyne receiver, the trimmer condenser placed in series with the oscillator tuning circuit to control the receiver calibration at the low-frequency end of a tuning range.

Panel.—A sheet of metallic or non-metallic material on which the operating controls of a radio device such as a receiver, transmitter, or p.a. amplifier are mounted.

Panel Box.—A box containing the switches and cutouts through which a branch circuit is supplied.

Panel Cutout.—A fuse cutout for mounting in a panel box.

Panelboard.—An enclosed panel or panels carrying buses, switches, over-current devices and other control elements in various combinations for the control of lighting, heating or power circuits or relatively small capacity such as used in individual buildings or sections of buildings.

Pantograph (Radar).—System for transmitting and automatically recording data from CRT to a remote point.

Paper Condenser.—A fixed condenser employing foil plates separated by paraffined or oiled paper.

Parabolic Current or Voltage.—Current or voltage whose strength is varied in time with vertical and horizontal deflection of the electron beam in a three-gun color television picture tube, for the purpose of maintaining convergence at openings in the shadow mask away from its center.

Parabolic Reflector.—A form of curved reflector, which, with the light at a position called the focus, sends all the reflected rays straight in one direction.

Paraffin.—A wax-like material used for insulating purposes.

Paraffined Paper.—Paper treated with paraffin to improve its insulating properties.

Parallax.—In reading an instrument having a pointer, the difference between the pointer's apparent position on the scale when looked at from an angle, and the true position when looked at from straight in front of the pointer.

Parallel Connection.—A connection of two or more circuits or parts between the same terminals of a source or current-supply circuit so that the same voltage difference is applied to all parts so connected and so that the current through each is proportional to the overall voltage and the resistance of the individual parts. The total current is equal to the sum of the currents in all the connected circuits or parts, and the total resistance or the effective resistance of all the parts in parallel is less than the individual resistance of any one of them.

Parallel Resonant Circuit.—A tuning circuit consisting of a coil and condenser connected in parallel. At resonance, it offers a high impedance, so that a large value of signal voltage is developed across it at the frequency to which it is tuned.

Parallel-Series.—Another name for mul-

- tiple series.
- Paramagnetic.**—Materials which are attracted by a magnet. Iron, steel, nickel and cobalt are paramagnetic. Capable of being magnetized. Having a permeability greater than that of air or a vacuum.
- Parasitic Element.**—A reflector or a director used with a dipole antenna.
- Parasitic Oscillation.**—High-frequency oscillation in inductance and capacitance not intentionally tuned to resonance at the oscillating frequency.
- Party Line.**—A single telephone circuit to which are connected two or more subscriber's sets.
- Paste Joint.**—The joint around the leading-in wires of a lamp bulb.
- Pasted Plate.**—A storage battery plate made by filling the holes in a metal grid with pastes of the active materials. A Faure plate.
- Pattern Generator.**—A signal generator for television servicing, producing on the viewing screen of the picture tube a series of horizontal lines, vertical lines, or both at the same time. The lines may be dark on a bright background or bright on a dark background.
- Peak.**—The maximum instantaneous value of a varying voltage or current.
- Peaker.**—A small fixed or adjustable inductor for high-frequency compensation in broad band amplifiers. Peakers in plate and grid circuits resonate with stray and distributed capacitances to increase impedance and gain at the higher frequencies.
- Peak Factor.**—The ratio of the maximum value of an alternating current to its effective value.
- Peaking Control.**—An adjustable resistor in series with a capacitor in a sawtooth circuit, for varying the negative peaking.
- Peak Load.**—The greatest load on an electrical system or circuit in a certain period of time.
- Peak Power.**—The average power during a period when the power is at a maximum.
- Peak-to-peak Voltage.**—Total potential difference between maximum voltage amplitudes in opposite polarities of any alternating or varying waveform. Equal to positive peak amplitude plus negative peak amplitude.
- Peak Value.**—Same as maximum value, which see.
- Peak Voltage.**—The highest voltage attained in a circuit in a given period.
- Peenat Tube.**—A small size electron tube designed to operate with a smaller current than the standard tubes.
- Pear Push.**—A small push button switch hanging from a drop cord and enclosed in a pear shaped piece of insulation.
- Pedestal.**—In the waveform of a composite television signal, the black level which appears as a horizontal line during each horizontal blanking period, with a horizontal sync pulse extending from the pedestal. The pedestal includes front and back porches.
- Pencil Mixer.**—A form of crystal mixer.
- Pendant Switch.**—A small push button switch attached to a circuit by a hanging flexible cord.
- Pentode.**—A vacuum tube having five electrodes. Ordinarily these will be the cathode, control grid, screen grid, suppressor grid and anode.
- Period.**—The length of time required for one complete cycle of alternating current or voltage. As an example, the period for 60 cycles per second is 1/60 second.
- Period of Instrument.**—The time it takes the pointer of an instrument to make a swing from zero, one way, then the other, and back to zero.
- Periodic Current.**—An alternating current or a pulsating current.
- Periodic Duty.**—A type of service in which there are alternate periods of load and no load, with the load well defined and repeating in a uniform manner.
- Permalloy.**—An alloy of nickel and iron which has very great permeability.
- Permanent Magnet.**—A hard steel magnet which keeps its magnetic strength for long periods of time with little change.
- Permanent Magnet Centering.**—Vertical or horizontal shifting of average deflection of the electron beam, and of complete pictures, on the viewing screen of a television picture tube by means of magnetic fields from permanent magnets mounted around the neck of the tube.
- Permanent Magnet Dynamic Speaker.**—A moving coil speaker with its field supplied by a permanent magnet.
- Permanent Magnet Focusing.**—Focusing of the electron beam in a television picture tube by means of field lines from one or more permanent magnets usually located around the tube neck. Adjustment of external magnets is by rotating them around the neck or by shifting them lengthwise.
- Permatron.**—A gas-filled hot-cathode electronic tube in which the starting of ionization and current flow is controlled by an electromagnetic field. The tube is a controlled rectifier, used similarly to a thyratron.
- Permeability.**—A measure of the ease with which magnetic flux or magnetic lines of force may be established in a magnetic circuit. The ratio of the number of flux lines produced by an electromagnet coil having a core of iron or steel to the flux produced by the same coil with no core other than air. The reciprocal of reluctance.
- Permeability Curve.**—A curve showing the relation between the magnetizing force in ampere-turns and the magnetic flux produced in a given magnetic material.

Permeability Tuner

Permeability Tuner.—A television or radio tuner in which the channel selector or tuning dial moves the cores of inductors for tuning the antenna, r.f. amplifier, and r.f. oscillator circuits.

Permeability Tuning.—Tuning of radio by means of adjustable iron-core inductance in place of tuning condenser.

Permeameter.—An instrument which tests the permeability of iron and steel.

Permeance.—The ability of a material to carry magnetic flux or lines of force. The opposite of reluctance.

Permittance.—The electrostatic capacity of a condenser.

Permittivity.—The dielectric constant, the permittance through a centimeter cube of a dielectric. This is an electrostatic unit similar to conductivity in speaking of electric currents.

Peroxide of Lead.—A lead compound used in the manufacture of storage battery plates. In a charged lead-acid cell it forms the principal part of the positive plate.

Perveance.—A numerical value representing the ability of a diode detector to rectify or demodulate high-frequency signals with little loss of signal voltage. Corresponds roughly to conductance. High-perveance refers to small voltage drop in the detector.

Petticoat Insulator.—An insulator having the shape of a cone on the outside and hollow for some distance up the inside.

Phanotron.—A gas-filled or mercury-vapor type of rectifier tube with a hot cathode and with no control grid. Phanotrons handle much larger currents than handled by kenotrons, but the working voltages are lower, usually no higher than about 20,000 volts.

Phantom Circuit.—In telephony and telegraphy, a circuit one side of which is made through the two conductors forming one other metallic circuit, and the second side of which is made through two metallic conductors of still another two-wire circuit.

Phantom Line.—The additional "invisible" circuit through which some of the messages in multiple telegraphy and telephony take place.

Phantom Cable.—A cable used for one side of a phantom circuit.

Phantoplex Telegraphy.—A telegraph system operating with an alternating current phantom circuit completed over the conductors of a direct current circuit.

Phase.—The point or position to which an alternating current wave has increased toward maximum from the position of zero potential. It is a part of an alternating current cycle measured from the zero point. It is measured in degrees, one complete

Phase Advancer

cycle being divided into 360 degrees. To be "in phase" means that the maximum points of two waves come at the same instant. "Out of phase" means that the maximum points do not come together.

Phase Advancer.—An electric machine used in connection with induction motors, but whose current is not in phase with the motor. The motor's pulling power is improved by the effect of the phase advancer.

Phase Angle.—The time difference between alternating currents or voltages. The number of electrical degrees or the fraction of a cycle by which maximum amplitudes in either polarity occur before (angle of lead) or after (angle of lag) the maximum amplitudes of the same polarity in the other current or voltage. Usually refers to voltages or currents having the same frequency.

Phase Control.—A hue control in a color television receiver.

Phase Controller.—A phase advancer.

Phase Detector.—An instrument which indicates when two alternators are in step or synchronized.

Phase Detector.—A tube and associated circuits in automatic phase control or frequency control systems, in which combine an oscillator output waveform and a controlling waveform such as that of sync pulses to produce a correction voltage applied to the oscillator. Oscillator frequency is increased or decreased as required to keep it synchronized with frequency or with both frequency and phase of a controlling voltage.

Phase Difference or Displacement.—The difference between corresponding points on the waves of two alternating currents having the same frequency. It is measured in degrees of the cycle expressed as angles.

Phase Inverter.—A tube, usually a triode, in which changes of plate load signal voltage are of opposite instantaneous polarity to changes of grid signal voltage. An alternating or varying signal applied to the grid circuit is displaced by 180° electrical degrees in the plate output.

Phase Meter.—An instrument for indicating the phase difference between two alternating currents.

Phase Modifier.—A device which corrects the lag of alternating currents.

Phase Shift Circuit.—A combination of inductance, capacitance, and resistance, or any two of these quantities, in which the phase of output current and voltage is altered with respect to that of input current and voltage.

Phase Shift Control.—A method of control of current flow in thyratrons and ignitrons. The instant at which ionization and current flow commences is varied by changing the phase difference between the anode potential and the control grid potential.

Phase Splitter.—A color television re-

Phase Splitter

celver tube acting as a phase inverter to deliver from its plate circuit a color signal 180° out of phase with a signal at the grid, and from its cathode circuit a signal in phase with that at the grid. Plus and minus color signals are obtained when either kind of signal is applied to the grid.

Phase Splitter.—A device which divides a single phase current into parts from which an induction motor can start itself. Also, a device for dividing a multi-phase current into currents of different phases for different circuits.

Phasing Links. — Between bays of a stacked antenna, connections of such electrical properties and so connected that signals from all bays are in phase at the transmission line.

Phillips Screw.—A screw having an indented cross in its head in place of a slot.

Phono-Electric Wire. — A very strong copper-alloy wire.

Phonograph.—A device for converting mechanical vibrations into sound waves. **Electrical Phonograph** — A phonograph in which the motor derives its power from an electrical source. **Mechanical Phonograph**—A phonograph utilizing a hand-wound type of mechanical motor.

Phonograph Connection.—A set of two terminals sometimes provided at the back of a radio receiver for making connections to a phonograph pick-up. The terminals connect to the input of the a.f. amplifier. This connection permits use of the entire audio amplifier and loudspeaker to reproduce phonograph records.

Phonograph Oscillator.—An r.f. oscillator arranged for modulation by the output of a phonograph pick-up, so that the resulting modulated r.f. signal can be fed to the antenna and ground terminals of a radio receiver. This permits using the entire receiver (rather than just the a.f. amplifier) for amplifying and reproducing phonograph records.

Phonograph Pick-Up.—A device which converts variations in the grooves of a phonograph record into corresponding audio signals. It consists essentially of a needle which converts record groove variations into mechanical movements, and a crystal, dynamic or photoelectric system which converts these mechanical movements into the audio signals.

Phonoplex Telegraphy.— A system which uses the regular telegraph circuit for carrying high frequency telegraph circuits at the same time.

Phosphor. — Any fluorescent material used for the screen in a cathode-ray tube, an X-ray viewing screen, or a fluorescent lamp. The phosphor becomes luminous when struck by a stream or beam of electrons.

Phosphor Bronze. — Bronze containing phosphorus to increase its strength.

Phosphor Dot

Phosphor Dot.—In a three-gun color television picture tube, one of three phosphor areas, on the order of 0.014 inch diameter, which comprise each group of dots for emission of the three primary colors.

Phosphor Strip.—In a single-gun television picture tube, a very narrow band of phosphor for one primary color, extending all the way across the phosphor plate or viewing screen.

Photo cell.—This name nowadays is used chiefly for photoconductive and photovoltaic cells, but formerly included also the photoemissive cell or phototube.

Photoconductive Cell.—A device utilizing the property of selenium by which its electrical resistance varies with changes of visible light striking the selenium or the cell.

Photoelectric Cell.—A photocell.

Photoemissive Cell. — A phototube which see.

Photometer. — An instrument which measures the amount of light from a source or which compares the light from different sources.

Photophone.—An arrangement using selenium's change of resistance with changes of light to transmit messages.

Phototube.—A vacuum tube or a gas-filled tube with an anode and with a cold cathode covered with caesium or other substances which emit electrons when reached by visible light or by infra-red or ultra-violet radiation. When a potential difference is maintained between anode and cathode of a vacuum phototube the current is almost exactly proportional to the radiant energy reaching the cathode. In the gas-filled phototube the current increases more rapidly than does the radiant energy.

Photovoltaic Cell. — A device which changes radiant energy, such as that of visible light, into the energy of electromotive force without any chemical or mechanical changes occurring in the cell at the same time. Barrier layer cells consist of two dissimilar substances, such as a metal and an oxide, at whose contacting surface appears the emf and potential difference when light reaches this contacting surface. Earlier types of photovoltaic cells contained two electrodes immersed in a liquid electrolyte, with the emf appearing at the contacting surface between an electrode and the electrolyte.

P³¹L.—Expanded PPI presentation.

Picture Element.—In a television system, the smallest portion of a picture or scene which is individually converted into an electrical signal and transmitted.

Picture Frequency.—In television, the number of complete pictures which are scanned and transmitted in one second.

Picture Tube.—In a television receiver.

the cathode-ray tube on whose screen is reproduced the scene being scanned at the television transmitter.

Piezo-Electric Effect.—A property of crystals of quartz and some other substances by which their form or dimensions are varied by application of potential differences to opposite faces. The original dimensions and manner of cutting of the crystal determine the frequency of applied voltage at which the crystal is resonant and vibrates most freely, this being the frequency which will be maintained within very narrow limits in a suitable resonant circuit containing the crystal.

Pigtail.—A flexible connection between a stationary terminal and a part or terminal which has a limited range of motion.

Pig-Tail of Brush.—See brush pig tail.

Pile.—In atomic energy applications, any arrangement involving lumps of fissionable material such as uranium, together with moderator, so arranged as to utilize the neutrons well enough to result in a chain reaction.

Pillar Post of Battery.—The terminal of a battery cell to which all of the plates of one group are connected by their plate strap.

Pilot Brush.—A small brush used for learning the difference in voltage between various points on a commutator.

Pilot Cell.—In a storage battery; one cell from which specific gravity and voltage readings are taken to indicate the condition of charge of the whole battery.

Pilot Lamp.—A small electric lamp connected to a circuit so that lighting or extinguishing of the light indicates the flow of current in the circuit and whether other electrical devices or lamps are operating.

Pinch Effect.—The electromagnetic effect of currents in conductors by which they tend to contract the conductor's size around and to make it longer.

Pincushion Effect.—Outward extension of corners and inward curvature of sides, top, and bottom of television pictures.

Pincushion Magnets.—Small permanent magnets, adjustable in position, used near the yoke around the neck of a television picture tube for preventing pincushion effect.

Pip.—A term used to designate a signal or special marker on the A-scope type of presentation.

A radar term.

Pitch of Armature Winding.—The number of slots between the one that carries one side of a coil on an armature and the slot carrying the other side of the same coil.

Pitch of Poles.—The distance from the center of a pole of one sign to the center of the adjacent pole of opposite sign in a generator or motor.

Plante Battery Plate.—A lead storage battery plate on which the active materials, peroxide of lead and sponge lead, are formed by electrical action in the cell rather than by applying pastes as in a Faure plate.

Plastie.—A general term used in connection with any of the black or colored materials used for molding radio receiver cabinets, control knobs, tube bases, sockets, and the insulating portions of many other radio parts. It is an excellent insulating material and has a natural smooth glossy surface which requires no finishing or polishing operations after molding.

Plate.—The anode in a radio tube. It is usually at a high positive potential with respect to the cathode, and therefore attracts the electrons emitted by the cathode.

Plate Circuit.—A circuit including the plate voltage source and all other parts connected between the cathode and plate terminals of a radio tube.

Plate Condenser.—A condenser formed of plate conductors with the dielectric between them.

Plate Current.—The current flowing through the plate circuit of a radio tube and between the plate and cathode inside the tube. The electrons which make up the plate current always flow in the direction from the cathode to the plate.

Plate Press.—A device for applying pressure to storage battery plates for the purpose of straightening them out flat or for compressing the elements so they will fit into a jar.

Plate Puller.—A device for grasping the plates or elements of a storage battery and pulling them from the jars without damage.

Plate Pulsing.—A circuit arrangement of the rf oscillator in which the plate voltage is normally reduced to such a low value or completely removed, so that no current flows to the plate and no oscillations occur. A pulse equal to the full plate voltage is then introduced in series with the plate. Oscillations begin and last for the duration of the pulse.

Plate Rheostat.—A rheostat whose resistance is mounted on plates of insulating material.

Plate Strap.—A flat piece of lead to which all plates of one polarity are attached in a storage battery cell.

Plate Supply.—The voltage source used in a vacuum tube circuit to place the plate at a high positive potential with respect to the cathode. The plate supply voltage is always higher than the actual plate voltage, because of the voltage drops across resistance in the plate circuit.

Plate Voltage.—The d.c. voltage existing between the plate and cathode terminals of a radio tube.

Plating Dynamo.—A direct current generator delivering a current of heavy

Platinum

- amperage, used in electroplating.
- Platinum.**—A silver-white, non-corrosive metal having a very high melting point and much used for making contact points which separate to break a circuit.
- Platinum-Iridium Alloy.**—Platinum to which iridium has been added to increase the hardness of the resulting alloy.
- Pliotron.**—A vacuum type hot-cathode tube in which there is a cathode, one or more anodes or plates, and one or more control grids. The name pliotron is applied to industrial and commercial types of triodes, tetrodes and pentodes. Pliotrons are used as amplifiers and as oscillators.
- Plug.**—A connecting device at the end of a flexible cord, used for making an instantly-removable connection to a corresponding terminal jack or outlet.
- Plug Fuse.**—A fuse so mounted as to screw into its holder.
- Plug Switch.**—A switch that completes a connection between a socket attached to one side of the circuit and a metal plug that pushes into the socket.
- Plug-In Coil.**—A coil having as its terminals a number of prongs arranged to fit into a socket mounted on the radio chassis. With this arrangement, the tuning range of a receiver or transmitter can be changed simply by pulling out one coil and inserting another in the socket.
- Plunge Battery.**—A battery in which one electrode in each cell is arranged to be raised from or lowered into the electrolyte when the battery is to remain idle or be used.
- Plunger Magnet.**—A solenoid with an iron core or plunger which is moved lengthwise in the solenoid winding by the magnetic effects of current in the winding.
- Plutonium.**—A chemical element not known to occur in nature, having the atomic number 94 and atomic weight of 239, formed by radioactive emission of a B-particle from neptunium-239.
- P.M.**—Abbreviation for permanent magnet.
- Pneumatic Rodding.**—A method of conduit rodding in which the rods are forced through the conduit by means of compressed air.
- Pocket Meter.**—A small voltmeter or ammeter mounted in a case similar to a large watch case.
- Polar Diagram.**—A graph showing by curves or lobes relative pickup ability of an antenna for carrier signals coming horizontally from various geographical directions or from various points around a circle at whose center is the antenna. Distances from the center to polar curves are proportional to percentages of maximum pickup.
- Polar Duplex Telegraphy.**—Use of a

Polar Relay

- telegraph instrument built with a polarized relay which is operated by currents in one direction but not by currents in the opposite direction.
- Polar Relay.**—A relay operated when the direction of its current changes.
- Polarity.**—In a radio part or circuit, the quality of having two opposite charges, one negative and the other positive. In a magnetic circuit or part, the quality of having two opposite poles, one North and the other South.
- Polarity Changer.**—Any device which changes the direction of the polarity in a circuit or changes the polarity from the terminals of a source.
- Polarity Indicator.**—An instrument which indicates the positive and negative ends of a circuit. Some devices use a voltmeter movement, others use chemicals in liquids which change color.
- Polarization.**—The formation of gases on the plate surfaces in electric batteries. The gases are formed from the electrolyte by the electrolytic action and form a partial insulator on the plates.
- Polarized.**—1. A polarized bell or relay is one whose armature is a permanent magnet and which operates in accordance with the direction of current through its windings. 2. Marked, colored, or otherwise identified for the correct connection of positive and negative wires, grounded and ungrounded wires, or other conductors.
- Polarized Armature.**—A magnet in which the end attracted by the magnet core has a definite magnetic polarity so that it is attracted only when the magnet end is of the opposite polarity.
- Polarized Relay.**—A relay using a polarized armature.
- Polarized Vane Meter.**—A meter in which the moving iron part is polarized.
- Pole.**—In magnetic parts, the magnetic pole. In electric currents, the positive or negative terminal.
- Pole.**—One end of a magnet. One electrode of a battery.
- Pole Armature.**—An armature whose coils are placed on pole pieces standing out from a center, or arranged around the inside of a circle and pointing toward the center.
- Police Calls.**—Broadcasts or calls made by police radio stations. Many modern single-band receivers are capable of picking up police radio stations operating on frequencies between 1626 kc. and 1712 kc. (just beyond the high-frequency end of the broadcast band).
- Pole Changer.**—A device which acts to rapidly change the polarity or direction of current flow through a circuit so that the current may be used to operate signalling devices.
- Pole Climber.**—See climber.

Pole Piece

Pole Piece.—On a field magnet or an electromagnet, the end that forms one of the magnetic poles. The separate piece attached to field structures for the purpose of forming magnetic poles.

Pole Pitch.—The number of armature slots per pole.

Pole Shoe.—A curved piece that conforms to the curve of an armature and which is attached to a field pole in a generator or motor.

Pole Strength.—The number of lines of force, the flux, passing through a magnetic pole.

Pole Tip.—The edges of the field magnet cores toward which, and away from which, the armature rotates.

Polyphase.—Having two or more alternating currents and potentials acting at the same time in a system or apparatus. Two-phase or three-phase, as distinguished from single-phase.

Polyphase Alternator.—An alternating current generator producing currents of more than a single phase.

Polyphase Circuit.—Alternating current circuits carrying more than a single phase of current.

Polyphase Current.—A current in which there are two or more different phases.

Polyphase Generator.—A polyphase alternator.

Polyphase Motor.—Any motor which operates from a supply current of more than one phase, as from a two-phase or a three-phase system.

Polyphase System.—All the circuits connected to a polyphase alternator and in which are currents of different phases.

Polyphase Transformer.—A transformer under a polyphase system.

Polyplexer (Aircraft).—A system for combining the operations of both duplexing and lobe switching in certain radar equipments.

Polyrod Antenna.—An antenna in which the radiating element is a rod of polystyrene. Similar to the action of a leaky wave guide.

Pool Tube.—A mercury arc rectifier in which the cathode is a pool of mercury. There is no grid or other current-control element in the tube.

Porcelain.—An insulating material made from clays and sand, moulded and baked. It has high resistance and withstands heat quite well.

Porosity of Battery Plate.—The normal condition of material in a battery plate which allows the electrolyte to penetrate or diffuse through exceedingly small pores.

Porous Cell.—A porous jar used in some forms of primary electric cells having two different electrolytes for the two electrodes.

Portable Appliance.—An appliance to which current is furnished through a flexible cord and attachment plug, permitting the appliance to be moved and connected to various

Portable Instrument

sources.

Portable Instrument.—Any electrical instrument mounted in a case so that it may be carried from place to place and with terminals to which temporary testing connections may be made.

Portable Receiver.—A completely self-contained radio receiver having the loudspeaker, all necessary batteries, and a loop antenna built into a compact carrying case. Terminals are sometimes provided for external antenna and ground connections.

Portable Magnet.—An electromagnet used for lifting or holding.

Position Control.—A centering control for a television picture tube or a cathode-ray tube.

Positive.—Having fewer than a normal number of electrons. The deficiency of negative electrons leaves the charge or potential positive. Descriptive of a point in a circuit toward which electrons flow from other points relatively negative or having a relative excess of electrons. Conventional current flow is opposite to electron flow.

Positive Brush.—A generator brush through which current leaves the armature. A motor brush through which current enters the armature. Any brush connected in the positive side of a circuit.

Positive Charge.—A charge of electricity of positive polarity. The charge on a condenser plate connected to the positive side of a source. The electrical condition of a body which has less than the normal quantity of negative electrons, so that the body has less negative electricity than one which is uncharged or is neutral.

Positive Conductor.—A conductor attached between the positive side of an electrical source and the positive side of a current consuming device.

Positive Electricity.—Electricity at higher pressure or potential than the pressure in another part of a circuit.

Positive Electrode.—The terminal of a source toward which electrons flow from external circuits. Conventional current flow is opposite to electron flow.

Positive Element.—In a battery or cell, the plates toward and into which electrons flow from external circuits. Conventional current flow is opposite to electron flow.

Positive Feedback.—Regeneration, causing an increase in signal strength.

Positive Feeder.—The feeder connected to the positive terminal of a generator or motor.

Positive Lead.—A positive conductor.

Positive Plate.—In a battery or cell; the plates from which current leaves the battery or cell. In a lead-acid battery, the peroxide of lead plate.

Positive Post.—A positive terminal.

Positive Potential.—An electric potential caused by a deficiency of negative electrons, or by fewer electrons

Positive Sign

than would correspond to a neutral condition at the point considered.

Positive Sign.—The plus sign (+). It stands for a positive conductor or the positive pole of a magnet.

Positive Terminal.—The terminal of a source to which electrons flow from external circuits. On an external device, the terminal connected to the positive of the source. Conventional current flow is opposite to electron flow.

Positive Transmission.—A method of television signal transmission with which modulation of carrier waves is such as to place peaks of sync pulses at minimum amplitudes, with the white level of picture signals at maximum amplitudes. Not used in the United States.

Positive Wire.—A positive conductor.

Post Bulder.—A metal form placed around a battery cell terminal so that the terminal may be built in larger or higher by the addition of melted lead.

Post-deflection Focusing.—In a single-gun system of color television, employing potentials on the wires of the color grid to direct the vertically and horizontally deflected beam onto phosphor strips for red and blue primaries. The beam travels to green strips when the wires are at equal potentials.

Potential.—Electromotive force, pressure or voltage. A characteristic of a point in an electric circuit determined by its electric charge in comparison with the charge at some other reference point, thus making the point considered more positive or more negative than the reference point.

Potential Coil.—A coil or winding, the current through which is affected by changes of voltage in the circuit to which it is connected.

Potential Difference.—The difference in electrical pressure or voltage between two points in a circuit. The potential difference causes a flow of current.

Potential Gradient.—The rate of change of potential with respect to distance between two points. For example, a potential difference of 100 volts in a space of 2 inches means a gradient of 50 volts per inch.

Potential Regulator.—A transformer in which the amount of induction may be adjusted to control the voltage.

Potential Transformer.—An instrument transformer with its primary connected between opposite sides of a line or between points having a potential difference, and with its secondary connected to a meter or other device which is to be actuated by the potential difference of the line.

Potentiometer.—A resistance unit having a rotating contact arm which can be set at any desired point on the resistance element. The total

Potter Oscillator

available voltage is applied to the fixed end terminals of the resistance element, and the output circuit is connected between the movable contact and one end terminal. Rotating the movable contact thus varies the proportion of the total voltage which is transferred to the output circuit. The volume control of a receiver or p.a. amplifier is generally a potentiometer.

Potter Oscillator.—A multivibrator with which feedback or coupling between the two triodes is by means of single cathode resistor common to both. Widely used for vertical and horizontal sweep oscillators in television receivers.

Poulsen Arc.—A producer of high frequency waves for use in radio telegraphy and radio telephony. The arc is made and broken with sufficient rapidity to produce a radio frequency wave.

Power.—The rate at which electrical energy is delivered and consumed. Electrical power is measured in watts.

Power Amplifier Stage.—An audio amplifier stage which is capable of handling a relatively large amount of audio power without distortion. An r.f. amplifier stage in a transmitter which serves primarily to increase the power of the r.f. carrier signal.

Power Circuit.—A circuit supplying current to electric motors or other devices using electric power for industrial work.

Power Factor.—The ratio of the voltage and current, or volt-amperes, that do useful work in an alternating-current circuit or alternating-current equipment to the total voltage and current, volt-amperes, flowing in the circuit. In circuits containing much inductance or much capacitance in addition to their resistance the total current is more than the current that produces useful power, consequently— circuits have relatively low power factors. In circuits containing only resistance all the current and voltage do useful work, consequently the ratio is one-to-one or is unity, this being the highest possible power factor.

Power Factor Correction.—The addition of capacitance to an alternating-current circuit containing a great deal of inductance, so that the capacitive reactance balances out a large portion of the inductive reactance, thus lessening the amount of current that does no useful work and making a higher power factor for the circuit. Inductance might similarly be added to a circuit containing excessive capacitance.

Power Factor Meter.—A form of wattmeter which directly indicates the power factor of a circuit.

Power Level.—The amount of electrical power passing through a given point

in a circuit. Power level can be expressed in watts, in decibels, or in volume units.

Power Level Indicator.—An a.c. voltmeter which is calibrated to read in terms of audio power level.

Power Loss.—The power, measured in watts, that disappears in transmitting current through a circuit.

Power Pack.—The power supply unit of a radio receiver, amplifier, transmitter, or other radio apparatus. Its function is to convert the available power line or storage battery voltage to the values required by filament grid and plate circuits.

Power Output Tube.—A radio tube especially designed for use in the a.f. output stage of a radio system. It is capable of handling much greater current than the ordinary amplifier tube, and hence delivers high output power.

Power Transformer.—A transformer used for handling current of large power. An iron-core transformer having a primary winding which is connected across the a.c. power line, a high-voltage secondary winding for the power pack rectifier tube, and one or more low-voltage secondary windings which supply the required a.c. voltages to the tube filaments.

Power of Alternating Current.—The average value of the power in watts through a complete cycle.

PPI Scan.—Plan position indicator. The sweep is a radius of the tube face (from center of face), and moves around through 360 deg. It gives azimuth by direction of the radial line, and range by the distance of the signal from the center of the screen.

A radar term.

Practical Unit.—Units of electrical measurement that are generally employed in practical work. They include the volt, ampere, ohm, coulomb, joule, watt, farad, and henry.

Precision Instrument.—An electric measuring instrument, ammeter, voltmeter, wattmeter, etc., in which the variation from the actual values is very small.

Precision Sweep.—A small portion of a normal sweep, usually 2,000 yards, selected and expanded over the entire screen in order to permit precise range measurements.

A radar term.

Preselector.—That circuit or r.f. amplifier stage in a superheterodyne receiver which amplifies the incoming modulated r.f. signal before it is converted to the i.f. signal by the oscillator-mixer-first detector section.

Press Board.—A smooth, hard, fibre-like paper sometimes used for insulation.

Pressure.—The force being exerted. It does not necessarily cause motion or do work. Electric force is measured in volts. It is the electromotive force or potential.

PRF.—Pulse recurrence frequency.

PrI.—Primary.

Primary.—The part of any electrical device, or the circuit, attached directly to the source, as distinguished from secondary which means parts depending on the primary in place of directly on the source. Also, a source that produces electricity for something else as mechanical or chemical action. First in order of time, placement, development or importance.

Primary Cell.—A voltaic cell or battery cell in which, when current is produced, the chemicals of the cell elements are consumed or changed to such forms that they cannot be restored to their original active condition by sending a reverse current through the cell, thus making the cell useless after having delivered a certain number of ampere-hours of electricity.

Primary Circuit.—A circuit connected directly to a source.

Primary Coil.—An induction coil which produces a spark by the effect of self-induction in its windings.

Primary Colors.—Three bands of wavelengths from the visible spectrum which are employed by themselves and in combinations to form all colors or hues for color television. The blue primary includes wavelengths from deep violet to greenish-blue, the green primary from blue-green into yellowish-green, and the red primary from yellow and orange to deep red.

Primary Current.—The current which flows from the source in a primary circuit.

Primary Winding.—In an electrical device, the winding which receives current from the outside circuit. The input winding of a transformer. It can be identified by the fact that r.f., a.f. or power line alternating current or pulsating d.c. is sent through this winding.

Primary Wire.—In ignition work, wire having a large conductor with comparatively little insulation, suitable for use with low voltage primary current.

Priming Spark Plug.—An ignition spark plug having a pet cock or other opening through which liquid fuel may be put directly into the cylinders of an engine.

Printed Wiring.—Circuit conductors formed by thin copper strips bonded to a sheet of insulation. The conductors are formed by a photoengraving process, or by eating away unneeded portions of an original all-over copper coating. Capacitors may be formed by conductors on opposite sides of the insulation, which acts as dielectric. Resistors may be formed by suitable carbon compositions. Conventional pigtailed resistors and capacitors, as well as other circuit components, may be soldered to printed conductor connections at eyelets or posts in the insulation.

Private Broadcasting

Private Broadcasting.—Broadcasting by an individual or an organization licensed to send entertainment and similar features.

Prony Brake.—A brake which bears on a drum or pulley driven by the machine being tested and arranged so that the brake pressure may be changed. The pull required to prevent rotation of the brake is measure of the torque of the machine being tested.

Proportional.—A change of one value in accordance with change in another value.

Protective Reactor.—A reactance which limits the current through a circuit when conditions are abnormal.

Proton.—A basic constituent particle of atomic nuclei, having a positive charge numerically equal to that of the negatively charged electron and a mass about the same as that of the neutron. The proton itself is the nucleus of ordinary hydrogen atoms.

P-Scan.—See PPI-scan.

Public Address Amplifier.—An audio amplifier capable of supplying sufficient audio power to loudspeakers for adequate sound coverage of public gatherings.

Public Address System.—A complete system for reproducing voice and speech with adequate volume for large public gatherings. It includes one or more microphones, a powerful audio amplifier with suitable power supply, and a sufficient number of loudspeakers to give coverage of the auditorium, stadium or other large space. Most installations also include a phonograph which may or may not be of the automatic record changer type.

Public Broadening.—Broadcasting of information of general interest by semi-public institutions.

Pulling.—Same as bending in television pictures.

Pulsating Current.—A current which changes in value but not in direction. It can be considered as a direct current combined with a smaller value of alternating current. It is usually an intermittent direct current.

Pulse.—A momentary sharp change in a current or voltage.

Pulse Transformer.—A special transformer designed to have a frequency response suitable for passing a pulse without materially altering its shape.

Puncture.—Breaking through an insulator by a high voltage current.

Puncture Test.—Testing insulation by gradually raising the voltage difference between ends of conductors on opposite sides of the insulation or connected to other conductors between which the insulation lies.

Purity.—In color television, production on the picture tube viewing screen of each primary color unadmixed with another primary, as results when the electron beams in a three-gun tube strike only a phosphor for one pri-

Purity Adjustment

mary color at one time. There is impurity or contamination when a beam strikes phosphors for two or more primary colors at the same time.

Purity Adjustment.—Variation of position of a purity magnet, or of current in a purity coil, in color television receivers.

Purity Coil.—In a color television receiver, an electromagnet whose field alters the direction of the electron beams so that each beam strikes only the phosphor for one color at a time.

Purity Magnet.—In a color television receiver, a permanent magnet or set of magnets whose function is the same as that of a purity coil.

Push Button.—A form of switch which is closed by pushing on a button and is opened by a spring.

Push-Back Hook-Up Wire.—Tinned copper hook-up wire covered with a loosely braided cotton insulation which can be pushed back from the end of a wire length with the fingers to expose sufficient bare wire for a connection. Radio men use this type of wire almost exclusively for experimental and repair work.

Push-Button Tuner.—A tuning unit which automatically tunes a radio receiver to a station when the button assigned to that station is pressed. In electrical automatic push-button tuning, the button actuates switches which connect a set of pre-adjusted trimmer condensers into the receiver tuning circuits. In electromechanical automatic push-button tuning, the button controls the starting and stopping circuits of a small motor which rotates the regular gang tuning condenser of the receiver. In mechanical automatic push-button tuning, pressure on the button is transferred by a lever or cam system into a force which rotates the gang tuning condenser to the correct position for the desired station.

Push-and-Pull Switch.—A switch to which is connected a small button which is moved in and out to open or close the switch.

Push-pull Amplifier.—An amplifier employing two triodes, pentodes, or beam tubes, with their grid signal voltages applied in opposite phase, producing plate signal voltages of opposite phase which combine in a center-tapped output transformer primary to form a single signal voltage. Direct plate currents in the transformer are equal and opposite, cancelling their d.c. magnetic effects. Distortion due to second and other even harmonics generated in the push-pull stage, also hum due to power supply ripple, are greatly reduced.

Push-pull Oscillator.—An oscillator employing two triodes with a tuned parallel resonant circuit between their plates. Oscillatory voltage from each plate is fed back to the other grid through capacitors on each side of the circuit.

Pyro-Electricity.—Electricity developed

Pyromagnetic

In certain materials by unequal heating and cooling of different parts.

Pyromagnetic.—Pertaining to the action and effects of heat and magnetism on each other.

Pyrometer.—An instrument for measuring and indicating high temperatures.

Q

Q.—An abbreviation for "quantity" of electricity, coulombs or ampere-hours.

Q-demodulator.—The demodulator of a color television receiver in which combine the chrominance signal and voltage from the color oscillator to recover the Q-signal. Oscillator voltage is 90° out of phase with that furnished to the I-demodulator in the same receiver.

Q-factor.—The ratio of inductive or capacitive reactance to high-frequency resistance or total energy loss in an inductor, capacitor, or entire circuit. A circuit or component having small losses has a high-Q.

Q-signal.—The quadrature component of the chrominance signal in color television. The plus Q-signal sidebands center at 90° from the I-signal, and at 147° from the reference or burst signal phase.

Q Signal.—One of the three-letter abbreviations in the International List of Abbreviations, used to represent complete sentences in radio telegraphy. When the question form of the sentence is intended, the code signal for an interrogation mark is sent after the abbreviation. Thus QRM means "I am being interfered with," and QRM? means "Are you being interfered with?"

Quadded Cable.—A phantom cable.

Quadrature.—Having a phase difference of one quarter of a cycle.

Quadrature Circuit or Filter.—In a color television receiver, a combination of inductor and capacitor, or a tuned transformer, which shifts the phase of part of the color oscillator output for use in one of the color demodulators.

Quadrupolar.—Having four poles.

Quadruplex Telegraphy or Telephony.—A telegraph or telephone circuit used for sending two messages in each direction at the same time.

Quantity.—Electrical quantity is the amount of current passing through a circuit in a given time, or the amount of electric charge in conductors. It is measured in coulombs or in ampere-hours, ampere-minutes, etc.

Quarter Phase.—Two-phase, diaphase.

Quartz Crystal.—A small piece of quartz so shaped and ground as to exhibit the piezo-electric effect, and to be suitable for frequency control.

Quenched Spark Gap.—A spark gap in which the total length of the gap is divided into a number of small spaces so that the points are kept cool by the additional metal employed.

R.

R

R.—An abbreviation for "resistance," ohms.

R. F.—An abbreviation for "radio frequency."

R. P. M.—An abbreviation for "revolutions per minute."

Raceway.—Any enclosure designed for and used only for holding wires, cables or bus-bars; includes all types of conduit, whether of metal or of insulating material, and all similar wire channels.

Racing of Generator.—Excessive speed of a generator caused by a quick drop in load.

Racing of Motor.—Excessive speed of motor due to a light load or no load, or to excessive applied voltage.

Racon.—A radar beacon.

Radar.—The detection, location and observation of stationary or moving objects which are at a distance from the point of observation. High frequency radiation from the radar transmitter is reflected or scattered from a ship, airplane, building, or any other object in which the conductivity or the dielectric properties are appreciably different from those of the air or other surrounding medium. The reflected radiation is detected with the aid of cathode-ray devices having fluorescent screens at the receiver, which is placed rather close to the transmitter. Time intervals are related to distances, and positions on the screen are related to location of the observed object.

Radiant Flux.—In illumination, the radiation with reference to the electrical energy or power.

Radiation.—The process wherein the transmitting antenna system of a radio station converts the modulated r.f. output of the transmitter into radio waves which travel away from the station through space.

Radiation Pattern.—A diagram showing how well an antenna system radiates or picks up radio waves in various directions.

Radio.—Communication by means of radio waves. Also, a receiving set capable of picking up radio waves and reproducing the intelligence they convey. This intelligence may consist of speech, music, code signals, writing, printed matter, diagrams, photographs, motion pictures, actual scenes, etc. In space radio, which is the conventional form, radio waves are transmitted through space. In wired radio, the radio waves are guided by conductors.

Radioactive Material.—Any substance which gives off positively or negatively charged particles, as radium.

Radioactive Rays.—The particles given off by radioactive materials. Negatively charged particles are called beta rays, positively charged atoms are called alpha rays.

Radio Beacon.—A stationary radio

Radio Broadcasting

transmitter which sends out special identifying signals continuously. Radio receivers on ships at sea and on aircraft in flight can tune to a radio beacon to determine their direction and position with respect to the beacon location.

Radio Broadcasting.—A one-way transmission of voice and music to anyone within receiving range of the radio station.

Radio Compass.—A radio direction finder used chiefly in marine and aircraft radio stations for navigational purposes.

Radio Control.—The control of moving objects such as airplanes, automobiles, ships, torpedoes, etc., by means of signals transmitted over radio waves from the transmitter location to special radio receiving equipment in the object being controlled.

Radio Frequency.—Any frequency in the radio spectrum above the highest audible frequency, which is about 20,000 cycles. This term is also used in connection with radio parts designed for use at frequencies higher than the audio frequency range. Abbreviated r.f.

Radio Frequency Amplifier.—A vacuum tube amplifier stage to provide amplification at radio frequencies. In a t.r.f. receiver, all stages ahead of the detector are r.f. amplifier stages. In a superheterodyne receiver, the amplifier stage sometimes used ahead of the first detector (in the pre-selector) is an r.f. amplifier stage.

Radio Frequency Choke.—A choke coil designed to have high impedance at radio frequencies, so that it limits or blocks the flow of r.f. currents.

Radio Frequency Transformer.—An air-core or pulverized iron-core, transformer used in r.f. circuits.

Radio Metal Locator.—A radio instrument which indicates the presence of metal within its operating range by a change in meter reading or a change in a tone signal heard in headphones. Used for determining positions of buried pipe lines, buried metal objects, metal objects concealed in the clothes of prisoners, metal objects imbedded in logs about to be sawed, deposits of metallic minerals, etc.

Radio Meteorograph.—A combination meteorograph and radio transmitter carried aloft by an unmanned gas-filled rubber balloon and so designed that it will transmit back to earth radio signals which can be interpreted in terms of the pressure, temperature and humidity at regular intervals during the ascent of the balloon into the stratosphere. When the balloon bursts, the instrument is lowered to earth by a parachute.

Radiometer.—An instrument which indicates the presence of rays of light or of heat by their causing rotation of small vanes in a vacuum bulb.

Radio Prospecting

Radio Prospecting.—Use of radio equipment to locate mineral or oil deposits.

Radio Receiver.—An instrument which amplifies radio frequency signals, separates the r.f. carrier from the intelligence signal additionally in most cases, then converts the intelligence signal back into the original sound waves.

Radiosonde.—A radio meteorograph.

Radio Telegraphy.—Radio communication by means of the Internal Morse Code.

Radio Telephone Transmitter.—A transmitter capable of sending voice and music, as contrasted to a radiotelegraph transmitter which can send only code.

Radio Telephony.—Two-way voice communication between two or more stations by means of radio waves.

Radiotrician.—A trained radio serviceman.

Radio Wave.—A combination of electric and magnetic fields varying at a radio frequency, and capable of traveling through space at the speed of light. It is produced by feeding the output of a radio transmitter to the transmitting antenna, and may carry modulation.

Radome.—A general name for radar turrets which enclose antenna assemblies.

Rail Bond.—A conductor connecting two adjacent railway rails for including them in a circuit.

Raintight.—So constructed or protected that exposure to a beating rain will not cause entrance of water into the enclosure.

Random Wound.—A winding having varying numbers of turns per layer and varying numbers of layers, in which a regular order of winding is not observed.

Range Mark.—A mark on the CRT screen which indicates distances from the radar set of the various echoes appearing on the screen of the CRT.

Range of Instrument.—The greatest value that an electrical measuring instrument will measure or indicate.

Rapid Scanning.—The use of narrow beams in the horizontal plane, scanned 10 cycles per second or higher for application to gun-laying radar.

Raster.—Luminous traces over all of the viewing screen of a television picture tube, caused by horizontal and vertical deflection of the electron beam while no pictures are reproduced.

Rated Candlepower.—The candlepower that a lamp should give with a current of a certain voltage and ampereage flowing through it.

Rating.—The operating limit in ampereage, voltage, power, heat, etc., of an electrical device. The word rating is often used in the sense of capacity.

Ratio.—The relation of one number of value to another, such that a change

Ratio Detector

of one necessitates a change of the other in order to preserve the same ratio. The ratio of 2 to 4 is the same as the ratio of 3 to 6, the ratio being 1 to 2 in both cases. Ratios can be written as fractions, all three of the above ratios, $2/4$, $3/6$ and $1/2$ having the same value.

Ratio Detector.—A demodulator for frequency-modulation sound signals. Consists of two diodes with plate of one and cathode of the other connected to outer ends of a center-tapped input transformer secondary, and remaining cathode and plate to a paralleled capacitor and resistor or to pairs of capacitors and resistors. Signals in the transformer primary induce quadrature voltages in the tuned center-tapped secondary, also in-phase voltage in a third winding connected between the center tap and the previously mentioned capacitors and resistors. Audio output is from the circuit of the third winding. Widely used in television sound systems.

Ratio of Transformer.—The ratio of the number of turns in the primary winding of a transformer to the number of turns in the secondary winding.

R.C.A. Licensed.—Manufactured under a licensing agreement which permits use of patents controlled by the Radio Corporation of America.

RCM.—Radar counter measures.

RDF.—Radio direction finding. British abbreviation for radar.

Reactance.—Opposition offered to the flow of alternating current by the inductance or capacity of a part. Reactance is measured in ohms, and depends upon the frequency of the alternating current as well as upon the electrical value of inductance or capacity. A condenser has capacitive reactance, and a coil has inductive reactance. The letter X is used to designate reactance.

Reactance Factor.—The ratio of the resistance to alternating current to the ohmic resistance of a conductor.

Reactance Coil, Reactive Coil, or Reaction Coil.—A choke coil.

Reactance Tube.—A triode or pentode in whose plate-cathode circuit are a capacitor and resistor connected across an oscillator tank circuit. Alternating plate current may be made to either lag or lead oscillator voltage, providing the effect of either added inductance or capacitance. When correction voltage from an a.f.c. or a.p.c. system is applied to the reactance grid, inductive or capacitive effect of plate current alters oscillator frequency to synchronize it with control signals in the a.f.c. or a.p.c. system. Used also in sweep generators and other applications for varying the frequency of an oscillator.

Reaction Key.—A key which opens and closes a circuit with a very slight movement.

Reactive Component or Current.—The

Reactive Factor

part of a current that does no useful work, because its phase is one quarter of a cycle different from the voltage.

Reactive Factor.—In an alternating current, the ratio of the reactive component to the total volt-amperes.

Reactive Load.—In alternating current work a load whose current is not in phase with the voltage across the load.

Reactor.—A coil of insulated wire, with or without an iron core, connected in a circuit to add inductive reactance to the circuit.

Receiver.—The part of a telephone set which changes the current impulses into sound through use of a diaphragm.

Receiver Attenuation.—A television receiver i.f. amplifier frequency response providing 50 per cent of maximum gain at the video intermediate frequency, approximately zero gain at 0.75 mc higher frequency, and 100 per cent gain from 0.75 mc below the video intermediate to the lowest amplified video frequency. The response is required with vestigial sideband transmission to compensate for double strength of carriers to 0.75 mc below and above the video carrier, and single strength at other frequencies.

Receiver Gating.—Applying operating voltages to one or more stages of intermediate frequency amplification in a receiver during that part of a cycle of operation when reception is desired.

Receiving Antenna.—Antenna used for receiving radio signals.

Receiving Apparatus.—Electrical devices which consume power for their operation.

Receiving Circuit.—A circuit or arrangement of conductors suitable for use in connecting apparatus for receiving radio waves.

Receiving Set.—All of the parts used for receiving radio messages.

Receptacle.—A device which holds or supports and at the same time makes electrical connections to a lamp-holder, lamp base, cord plug, or other attachment device.

Receptacle Outlet.—An outlet equipped with one or more receptacles intended to receive attachment plugs or cord plugs, not with receptacles of the screw type.

Reciprocal.—The reciprocal of a number is equal to 1 divided by that number. The reciprocal of 4 is $1/4$.

Record Player.—A motor-driven turntable and a crystal or magnetic phono pick-up used for converting a phonograph record into audio frequency signals. These signals must be fed into the audio section of a radio receiver or into a separate audio amplifier for additional amplification before they can be reproduced as sound waves by a loudspeaker. When the amplifier and

- loudspeaker are built into the same cabinet with the record player, the combination is generally called an electric phonograph.
- Recorder.**—An instrument which makes a permanent record of a varying electrical signal. Thus code messages are recorded on paper tape by a code recorder. Music and voice are recorded on discs or other materials by a sound recorder. Pictures and printed matter transmitted by radio are reproduced on paper by a facsimile recorder.
- Recording Instrument.**—An electric measuring instrument which makes a record of the values it measures.
- Recovery Time.**—(1) Of receiver: The time required for the receiver to recover to half sensitivity, after the end of the transmitted pulse. (2) Of TR switch: Time required after an rf pulse has fired the gap in the TR switch, for the received signal to reach half its maximum amplitude.
- A radar term.*
- Rectified.**—Direct current which has been produced from alternating current by a rectifier.
- Rectifier.**—A device that delivers one-way or direct current when supplied with alternating voltage.
- Rectifier Efficiency.**—The ratio of the power of the direct current delivered by a rectifier to the power of the alternating current going into the rectifier.
- Rectifier Meter.**—A moving coil direct-current meter equipped with a rectifier which changes alternating current or voltage to be measured into direct current or voltage which will operate the meter and cause it to indicate.
- Rectifigou.**—A gas-filled hot-cathode rectifier tube used chiefly for battery charging at low voltages. Similar to a Tungar.
- Red Gun.**—In a three-gun color television picture tube, the electron gun whose beam strikes phosphor dots emitting the red primary color.
- Red Lead.**—Peroxide of lead, used in storage battery plates.
- Re-Entrant Armature Winding.**—An armature winding which forms a closed circuit.
- Reference Phase.**—The phase of the burst signal voltage in a color television receiver, and of master oscillator voltage at the transmitter.
- Reflections.**—Carrier waves reflected from conductive and semi-conductive surfaces to a television antenna. They cause ghost images in pictures.
- Reflector.**—A conductor mounted parallel to an antenna dipole, on the side opposite the direction from which desired signals approach. Signal emf's induced in the reflector cause reradiation to the dipole, thus increasing strength of desired signals. Reflector and dipole are not conductively connected.
- Regeneration.**—A method of securing output from an amplifier by feeding a part of the amplifier output back to the amplifier input in such a way that reinforcement of the input signal is obtained. With this arrangement, a signal may pass through the same amplifier over and over again, with an increase in strength each time.
- Regeneration Control.**—A rheostat, potentiometer, or variable condenser which is used in a regenerative receiver to control the amount of signal which is fed back from output to input in the regenerative detector stage.
- Regenerative Braking.**—Using the motors of electric cars or locomotives as generators for braking purposes. The generated current is returned to the power circuit.
- Regenerative Detector.**—A vacuum tube detector in which international feedback of r.f. energy from the plate circuit to the control grid circuit produces regeneration.
- Regenerative Receiver.**—A radio receiver which employs controlled regeneration to increase the amplification provided by a vacuum tube stage (usually the detector stage).
- Regulating Cell.**—An end cell.
- Regulating Resistance.**—Resistance that may be inserted in the field circuit or the main circuit of a generator for the purpose of regulating the generator's output.
- Regulation.**—The change in voltage which occurs between a condition of no load and one of full load or rated load in a transformer, generator, or other source. If the decrease or difference is divided by the voltage at rated load the resulting fraction is the ratio of regulation, and this fraction multiplied by 100 is equal to the percentage regulation.
- Regulator.**—A device for controlling the amperage or voltage, or both amperage and voltage, from a generator.
- Relative Permeability.**—The ratio of the magnetic permeability of one material to another, or the ratio of permeability under different conditions in the same material.
- Relaxation Oscillator.**—An electron tube oscillator whose operating frequency is determined by rate of charge and discharge in a capacitor-resistor network, not by resonance in a tuned inductor-capacitor circuit.
- Relay.**—An electromagnetic device which permits control of current in one circuit by a much smaller current flowing in another circuit.
- Relay Magnet.**—A telegraph instrument which operates the circuit in a local office by the effect of the incoming current on the relay.
- Relay Regulator.**—In automobile battery charging systems, the combination of a reverse current cutout and a regulator in a device using a single

Reluctance

- magnet for both actions.
- Reluctance.**—A measure of the total opposition of an entire magnetic circuit to the production of magnetic flux in the circuit. Equal to magnetomotive force divided by magnetic flux, or to ampere-turns divided by the number of lines of flux in the circuit.
- Reluctivity.**—A measure of the opposition of a material to the production of magnetic flux in it. The reciprocal of permeability of the material. Equal to magnetizing force divided by flux density, or to ampere-turns per inch of circuit length divided by the number of magnetic lines per square inch of cross section.
- Remagnetizer.**—A powerful direct current electromagnet used for magnetizing the permanent magnets of magnetos.
- Remote Control.**—Control of electric motors or other devices through switches operated by electromagnets whose circuit is completed from a switch at some distant point. Operation of radio transmitting or receiving equipment from a remote point.
- Renewable Fuse.**—A plug fuse or cartridge fuse in which the burned out fuse may be replaced with a new piece.
- Repeater.**—A device which reproduces the signals from one telegraph circuit in another telegraph circuit.
- Repeating Coil.**—In telephone work, a transformer of one-to-one ratio.
- Repulsion-Induction Motor.**—An alternating-current motor with two windings on the rotor, one of which may be a squirrel cage or modified squirrel cage, while the other is similar to that of a repulsion-start induction motor. The commutator and brushes are used during starting, but practically no current flows in them at full speed.
- Repulsion Motor.**—An alternating-current motor in which turning of the rotor results from the repulsion between magnetic fields induced by supply current in stator windings and other fields induced in the rotor windings. Supply current is connected only to the stator windings. The rotor has a commutator and brushes, with the brushes short circuited on each other.
- Repulsion of Charges.**—The effect by which two conductors, having charges of the same polarity, repulse each other.
- Repulsion of Magnets.**—The effect by which two magnet poles of the same polarity repel each other.
- Repulsion-Start Induction Motor.**—A type of alternating-current motor that starts as a repulsion motor and, after coming up to speed, runs as an induction motor. The changeover is made by an automatic switch, usually located inside the motor housing and operated by centrifugal force.

Residual Charge

- Residual Charge.**—The additional discharge that may be secured from an apparently discharged storage battery after it has had a period of idleness without discharge.
- Residual Discharge.**—A discharge from a condenser after the first or initial discharge has been allowed to escape.
- Residual Magnetism.**—The magnetism that remains in a piece of iron or steel when the magnetizing force is removed; as after the current stops flowing through the winding of an electromagnet.
- Resin.**—A vegetable material often mixed with waxes to form insulating compounds that are harder than the waxes themselves. A soldering flux.
- Resistance.**—The opposition which a device or material offers to the flow of direct or alternating current. The opposition which results in production of heat in the material carrying the current. Resistance is measured in ohms, and is usually designated by the letter R.
- Resistance Alloys.**—Various metals made by melting two or more metals together into an alloy having high resistance and suitable for use in resistance units or heating units.
- Resistance Balance or Bridge.**—A Wheatstone bridge.
- Resistance Coil.**—A coil of high resistance wire which may be inserted in a circuit to reduce the current flow.
- Resistance Coupling.**—A coupling method with which a single resistance or paralleled plate and grid circuit resistances are common to input and output or to plate and grid circuits. A blocking capacitor of low reactance keeps d.c. plate voltage from the following grid, but allows alternating signals to pass.
- Resistance Dimming.**—Lessening the amount of light from electric lamps by inserting resistance in their circuit.
- Resistance Drop.**—The voltage drop caused by the resistance in a circuit.
- Resistance Loss.**—The power in watts required to overcome the resistance in a circuit or in an electric device.
- Resistance Wire.**—Wire having high electrical resistance and at the same time able to withstand repeated heating and cooling.
- Resistivity.**—The resistance in ohms through a centimeter cube of the material, the specific resistance. Measured in ohm-centimeters.
- Resistor.**—A part which offers resistance to the flow of electric current. Its electrical size is specified in ohms or megohms, (one megohm equals 1,000,000 ohms). A resistor also has a power-handling rating in watts, indicating the amount of power which can safely be dissipated as heat by the resistor.
- Resolution.**—Ability of a camera lens or equivalent device to form images of fine detail. The word may be used as the equivalent of definition in tele-

Resonance

vision pictures.

Resonance.—The condition in a circuit whose inductive reactance and capacitive reactance are equal, allowing them to completely balance or neutralize each other and leaving only the resistance of the circuit to oppose flow of current in it.

Resonance Transformer.—An arrangement of a generator, transformer, and secondary condenser to reduce the impedance of the primary circuit so that resonance exists.

Resonator.—A circuit that responds to oscillations in another circuit.

Resonant Charging Choke.—In modulators, denotes the inductor, which with the effective capacitance of a pulse-forming network, is used to set up an oscillation of a given charging frequency.

Resonant Frequency.—The frequency which produces resonance in a coil-condenser tuning circuit. In a series resonant circuit, the largest current flow occurs at the resonant frequency. In a parallel resonant circuit, the largest voltage is developed across the circuit at the resonant frequency.

Resonant Line.—Two conductors running side by side and separated by air or other insulation. Often a piece of transmission line. Has the properties of resonant circuits at frequencies for which electrical length of line is a quarter or a half wavelength. Has parallel resonance when a half-wavelength long and open at its far end, or when a quarter-wavelength long with conductors shorted at the far end. Has series resonance when a half-wave long with ends shorted, or when a quarter-wave long with ends open. Used for tuning at very-high and ultra-high frequencies.

Resonant Line Tuner.—A television tuner in which lengths of resonant line tune the antenna, r.f. amplifier, and r.f. oscillator circuits. The channel selector moves shorting contacts to make the lines shorted quarter-wave types at various channel frequencies.

Resting Frequency.—The assigned carrier frequency of a radio station which employs the frequency modulation system of broadcasting. The resting frequency is radiated only during intervals when no sound waves are being transmitted.

Retardation Coil.—A choke coil used in telephone circuits for lessening interference between different circuits.

Retarding Disc.—The copper or aluminum disc in wattmeters. It is mounted between the poles of a magnet in order to slow down the rotation of the motor armature in the meter.

Retentivity.—The ability of a magnetic material to resist loss of its magnetism, to retain some lines of force even with the magnetizing effect removed.

RETMA.—Abbreviation for Radio-Elec-

Retrace Blanking

tronic-Television Manufacturers Association.

Retrace Blanking.—Making the control grid of a television picture tube so negative with respect to the cathode during vertical retrace intervals as to prevent appearance of retrace lines. Voltage pulses for blanking are derived from vertical sweep oscillator or deflection circuits.

Retrace Lines.—Narrow, bright, sloping lines which appear on a television picture when brightness is turned too high in relation to contrast, or on a raster under most conditions. The lines result from zig-zag upward travel of the electron beam during vertical retrace periods.

Retrace Period.—The time during which the blanked scanning beam in a television tube returns to its starting point on the field.

Return Circuit.—The part of a circuit through which current returns from a current consuming device to the source.

Reverse Current Circuit Breaker.—A circuit breaker which opens a circuit when the current starts flowing in an opposite direction.

Reverse Current Cutout.—In automobile battery charging systems, an automatic switch that opens the circuit between battery and generator when the generator's voltage is below the voltage necessary to charge the battery. In automatic cutouts, operated by an electromagnet, a small flow of reverse current is required to open their contacts.

Reversed Battery Plate.—A battery whose polarity and active material have been reversed by too long continued discharge in series with other cells, or by charging in the wrong direction.

Reversed Series Generator.—In a compound wound direct current generator, such a connection of the field circuits that the series field opposes the shunt field to limit the maximum output of the generator.

Reversing Key or Switch.—A switch having one moving part that may be moved one way to send current through a circuit in one direction and moved a short distance the other way to reverse the direction of the current.

R.F. Power Supply.—A high-voltage power supply with which output of an oscillator operating at several hundred kilocycles is stepped up by a high-ratio air-core transformer to voltage required for second anodes in television picture tubes or cathode-ray tubes, then rectified to furnish high-voltage direct current.

Rheostat.—A resistance unit which can be varied in ohmic value so as to control the flow of current in the circuit of which it is a part.

Rheostat Regulation.—Control of a generator's output or a motor's speed by an adjustable rheostat connected in their field circuit or their arma-

Rhombic Antenna

- ture circuit.
- Rhombic Antenna.**—An antenna consisting of four straight conductors of equal lengths supported to form a parallelogram of diamond shape whose plane is parallel to the earth surface. Signal takeoff is from a gap at one of the corners in line with carrier wave travel. A type used for u.h.f. reception.
- Rhumbatron.**—A type of cavity resonator, which see.
- Ribbed Armature.**—An armature having slots in the core for carrying the armature coils.
- Right-Hand Rule.**—A method of showing the relative directions of magnetic field flux, motion of a conductor through the field, and of current which thus is induced in the conductor. The generator rule. Extend the thumb, forefinger and middle finger of the right hand so that they are at right angles, each to the others. When the forefinger points in the direction of magnetic flux (north pole to south pole) and the thumb points in the direction of conductor motion, the middle finger points in the direction of induced emf and current in the conductor.
- Right-Hand Rule for Electron Flow.**—If electron flow rather than conventional current flow is considered in the foregoing right-hand rule, electron flow is opposite to conventional current flow.
- Right Handed Helix or Solenoid.**—A dextrorsal helix or solenoid, one wound clockwise looking at the end.
- Right Handed Rotation.**—Rotation toward the right, in the same direction that the hands of a clock rotate.
- Rigid Metal Conduit.**—Piping or heavy tubing of mild steel having pipe-thread ends and used with similarly threaded fittings for the enclosure and support of insulated wires in an electrical system.
- Rim-Drive.**—A method of driving a phonograph or sound recorder turntable with a rubber-covered wheel which is in contact with the rim of the turntable. The wheel is powered by an electric motor.
- Ring Armature.**—An armature whose core is in the form of a hollow ring with the winding around the ring.
- Ring Side or Wire.**—In telephone work, the conductor connected to the ring side of the jack.
- Ringer.**—The electromagnets which ring the bell for a subscriber's telephone.
- Ringings.**—Damped oscillation in inductance and capacitance not intentionally tuned to the oscillating frequency. The oscillatory circuit is shock excited by variations of some other voltage. A cause for multiple images on television pictures.
- Ripple.**—An alternating current component which is present in the output of a d.c. voltage supply such as a power pack or d.c. generator.
- Riser.**—In house and building wiring, the wires running vertically from one floor to another.
- R.M.A.**—Radio Manufacturers Association, an organization of leading manufacturers in the radio industry. Its work involves standardizing sizes and designs of radio parts, standardizing of color markings on parts (such as the R.M.A. color code for resistors and condensers) and standardizing of radio terms and definitions.
- R.M.A. Color Code.**—A standard method of designating resistor values by colored markings. The code is given at the back of this book.
- R.M.S.**—Root mean square value, which is the effective value of an alternating current. It corresponds to the equivalent direct current value which will produce the same heating effect. Unless otherwise specified, alternating current values are always r.m.s. values.
- Rocker Arm.**—A brush holder which may be moved by a handle to change the position of the brush on the commutator.
- Rodding a Conduit.**—Pushing a series of connected rods through a conduit so that a conductor may finally be drawn through by the rods.
- Roentgen Rays.**—Same as X-rays.
- Roller Contact.**—An electrical contact between moving parts which is made through a small roller connected to one part and resting on the surface of the other part.
- Root Mean Square Value.**—The effective value of an alternating current.
- Rosette.**—A small two-piece insulator in which connection is made between wiring and drop cords attached to the wiring.
- Rosette Cutout.**—A rosette in which there is a fuse.
- Rosin.**—A kind of resin made from turpentine.
- Rosin-Core Solder.**—Solder which has as its core the correct amount of rosin flux for effective radio soldering work. The rosin is released automatically as the solder is applied to the heated joint.
- Rotary Beam Antenna.**—A highly directional short wave receiving or transmitting antenna system mounted on a high pole or mast in such a way that it can be rotated to any desired positions either manually or by an electric motor drive.
- Rotary Converter.**—A converter having one armature with slip rings and a commutator, used to change an alternating current to a direct current or a direct current to an alternating current. A synchronous converter, which see.
- Rotary Current.**—A polyphase or multiple current.
- Rotary Discharger.**—A device having rotating electrodes between which a radio telegraph spark passes.

Rotary Field Motor.—An induction motor.

Rotary Phase Converter.—A converter which changes the number of phases of an alternating current to a different number of phases, but which does not change the frequency or cycle of the current.

Rotary Spark Gap.—A device in which several electrodes mounted on a wheel are rotated past a fixed electrode producing spark discharges periodically.

Rotary Switch.—A switch operating different circuits by rotating its contactor around a center to make connections with the various contacts.

Rotating Field.—A magnetic field produced by a multi-phase current.

Rotary Spark Gap.—A spark gap formed with two electrodes between which is a toothed wheel rotated by a motor.

Rotor.—In a generator, motor or other electric machine having a rotating member, the member that rotates. A word used chiefly when referring to alternating-current machines.

Rotor.—The movable winding in a variable inductance coil.

Rotor Plates.—The movable plates of a variable condenser. They are usually connected directly to the metal frame of the condenser.

RTMA.—Abbreviation for Radio-Television Manufacturers Association.

Rubber.—A natural gum from certain trees. After preparation in various ways it is used in electrical work for insulation of wires and cables, and in the form of hard rubber for general insulation work.

Rubber Covered Wire.—Wire whose outside insulation is made of rubber.

Rubber Separator.—A storage battery plate separator made of perforated hard rubber sheets. It is often used in connection with wood separators.

Ruhmkorff Coll.—An induction coil producing high voltage secondary current.

Running Free.—The condition of an electric motor running without a load.

Running Torque.—The torque or turning power of a motor measured while the motor is running.

R-Y Signal.—A red-minus-Y or red-minus-luminance color television signal. When combined with a plus luminance (+Y) signal the result is the red color primary signal.

S

S.—A letter sometimes used to designate the secondary winding of a transformer.

S. A. E.—An abbreviation for "Society of Automotive Engineers."

S. A. E. Spark Plug.—A spark plug whose shell has a straight thread $\frac{3}{4}$ of an inch in diameter with 18 threads to the inch. Also called a $\frac{3}{4}$ -18 spark plug.

S. C.—An abbreviation for "single contact."

S. C. C.—An abbreviation for "single cotton covered" wire.

S. C. E.—An abbreviation for "single cotton covered enameled" wire.

S. S. C.—An abbreviation for "single silk covered" wire.

S. P.—An abbreviation for "single-pole."

Safety Fuse.—The usual form of fuse which breaks a circuit when there is excessive current.

Safety Gap.—Two electrodes connected across the positive and negative sides of a circuit, between which a spark can pass when the voltage becomes high enough to damage other parts in the circuit.

Sal Ammoniac Battery.—A primary electric cell using sal ammoniac in solution for its electrolyte.

Sallient Pole.—A magnetic pole at the end of the iron part of a magnet. See also consequent pole.

Sapphire.—A gem used in the tips of high-grade phonograph needles and in cutting needles used with sound recorders.

Saturable Reactor.—An iron core reactor on which are two windings. One winding carries direct current which may be varied to control the degree of saturation of the core. The other winding carries alternating current to which the reactance is varied by the changing degree of core saturation. Thus the unit provides an adjustable reactance and impedance for an alternating-current circuit.

Saturation.—Descriptive of the proportion of white mixed with a pure color or hue. Low saturation means a preponderance of white, as in light red or pink, while high saturation means little or no white, as in deep or intense red. Varying saturation does not change the hue. Saturation in color television pictures varies with amplitude of chrominance signals.

Saturation.—Magnetic saturation is the degree of magnetization of an iron or steel core at which further increases of magnetizing force produce but small additional increases of flux in the core.

Saturation Factor.—The ratio of increase in field strength to the increase of voltage which results from it.

Sawtooth Wave.—Voltage or current changing rapidly between maximum positive and negative amplitudes at one end of each cycle and returning at a slower rate to maximum at the other end. The waveform has the shape of sawteeth. Employed in sweep and deflection systems for television picture and cathode-ray tubes.

S.C.E.—Single cotton covering over an enamel insulating layer on a wire.

Scale.—A series of marks printed on a flat surface over which the pointer of a meter moves. The value of the mark directly behind the pointer cor-

- responds to the meter reading.
- Scanning.**—In television, the process by which an image of a scene to be transmitted and reproduced has its lights and shades changed into corresponding changes of voltage and current for each small element or area of the scene, these electrical changes being transmitted and then reconverted into lights and shades at the receiver.
- Schematic Diagram.**—A diagram which shows electrical connections of a radio device by means of symbols which are used to represent the radio parts.
- Scratch Filter.**—A filter circuit used in connection with a phonograph pick-up to block those frequencies at the higher end of the audio range at which needle scratch is most prominent.
- Screen.**—In a television picture tube or cathode-ray tube, the surface on which are deposited phosphors that emit light when struck by the electron beam. The viewing screen.
- Screen Grid.**—An electrode mounted between the control grid and plate of a vacuum tube for the purpose of reducing the capacity between these two electrodes.
- Screen Grid Voltage.**—The d.c. voltage which is applied between the screen grid and the cathode of a vacuum tube to make the screen grid highly positive with respect to the cathode.
- S-curve.**—A voltage waveform in the audio output of a f.m. demodulator, representing deviations both ways from the center frequency. Has roughly the shape of a letter S lying on its side. Displayed by an oscilloscope for alignment of the f.m. demodulator transformer.
- Sealing Compound.**—An insulating compound which is poured around battery cell covers while hot and which makes a tight seal for the cells when it cools and hardens.
- Sealing In.**—Sealing the joint between the opening of an electric lamp bulb and the parts carrying the filament.
- Searchlighting.**—Projecting the radar beam continuously at any given object of target, instead of illuminating it once during each scan period.
- Sec.**—Secondary.
- Sechometer.**—An instrument for measuring inductance.
- Secohm.**—A henry.
- Secondary Battery.**—A storage battery. A d.c. voltage source which is capable of storing electrical energy. When exhausted, it can be recharged by sending direct current through it in the reverse direction. Each cell of an ordinary storage battery is a secondary cell.
- Secondary Coil.**—An induction coil producing high voltage current in its secondary winding.
- Secondary Current.**—The high voltage current produced by an induction coil or a transformer.
- Secondary Emission.**—Emission of electrons from a cold electrode when it is hit or bombarded by high-speed electrons.
- Secondary Winding.**—The coil or winding of a transformer which is connected to the load, the coil from which power leaves the transformer.
- Secondary Winding.**—Any of the output windings in a transformer.
- Secondary Wire.**—Wire having thick insulation and a comparatively small conductor, suitable for carrying high voltage current.
- Sediment.**—Material which sheds from the plates and collects in the bottom of a storage battery jar.
- Segment.**—One of several contact pieces over which a contact point or brush is moved. A commutator bar.
- Selective Signalling.**—Any method of calling one subscriber on a party telephone line without calling the others on that same line.
- Selectivity.**—The degree to which a radio receiver is capable of reproducing signals of one station while rejecting signals from all other stations.
- Selector Switch.**—A telephone exchange switch which connects automatically to a certain trunk.
- Selenium.**—A substance whose electrical resistance becomes less when it is exposed to light.
- Selenium Rectifier.**—A contact rectifier in which a thin layer of selenium is deposited on one side of an aluminum plate, with highly conductive metal coating over the selenium. Electrons flow more freely from the coating to the selenium than in the opposite direction.
- Self-Bias.**—Referring to a vacuum tube stage which produces its own grid bias voltage. Plate current flowing through a resistor in series with the cathode lead produces across this resistor the voltage drop used for grid bias purposes. Also called automatic C bias.
- Self Cleaning Contact.**—A contact which, in closing or opening, has a slight wiping motion which assists in keeping it free from dirt or roughness.
- Self-Excited.**—An electric machine in which the field current is secured from its own armature current.
- Self-focus.**—Automatic focusing in television picture tubes.
- Self Induced Current.**—The current produced in a conductor by self-induction.
- Self-Inductance.**—The property of a circuit whereby any change of current flowing in the circuit produces a counter emf that opposes the change that is taking place, an emf that tends to prevent an increasing current from increasing, and tends to prevent a decreasing current from decreasing. Measured in henrys. The

symbol is *L*.

Self-Induction.—The action by which any change of current, either an increase or a decrease, produces in the same circuit an electromotive force which is in such direction as to oppose the change of current. The action which occurs in a circuit possessing self-inductance.

Self-Synchronous Devices.—Two or more units, each containing a stator and rotor, so designed that when connected to the same alternating-current source the rotors of all the units assume the same relative positions, and any change of position of the rotor in one unit is accompanied by an exactly similar change in all the other connected units.

Selsyn Devices.—A type of self-synchronous device, which see.

Semi-Automatic Advance.—In an ignition system, both automatic and manual advance and retard of the ignition time.

Semi-Automatic Telephone System.—A system in which the operator completes the connection through automatic switches.

Semi-Indirect Lighting.—Lighting by reflection, as in indirect lighting, and at the same time by light coming through translucent covers under the lamps.

Semimagnetic Controller.—A controller in which part of the basic functions are performed by electromagnets and the remainder by hand or by mechanical means. Compare full-magnetic controller.

Sending Set.—The apparatus used for transmitting radio messages, the transmitting set.

Sensitivity.—In electrical measuring instruments, a measure of the current, voltage or power required to operate the meter itself and to cause its indicator to move. The less the required power the higher is the sensitivity.

Separable Spark Plug.—A spark plug from which the insulator and center electrode may be removed when a packing nut is removed. A two-piece spark plug.

Separately Excited.—Use of an exciter for sending current through the field windings of an electric machine in place of taking the field current from its own armature current.

Separator.—A sheet of wood, rubber or other insulating material placed between the plates of storage battery cells to prevent electrical contact between the plates. The separators are porous or are perforated to allow passage of electrolyte through them.

Sequential Color Television.—Any system with which phosphors for the three primary colors are excited one after another, not simultaneously, and in such rapid succession that the primaries blend together to produce the desired visual sensation.

Series Coil.—In a field winding, a relay winding, or similar electromagnetic part. The coil or winding through which all of the current in the main circuit flows.

Series Conductor.—A conductor connected in series with other parts of the circuit.

Series Connection.—A connection in which the same current must flow through all of the series-connected parts. When dry cells or batteries are connected in series so that their voltage add, the minus terminal of one cell must be connected to the plus terminal of the next cell.

Series Drum Winding.—A wave winding of an armature.

Series Field.—A field winding connected in series with the armature circuit.

Series Generator.—A generator whose field winding is connected in series with its armature circuit.

Series-Parallel.—Descriptive of a circuit or part of a circuit in which some parts or elements are connected together in series, with these series groups connected together in parallel; or parts connected in parallel and the groups in series.

Series-Parallel Dimming.—A connection of two or more lamps so that they may be connected in parallel with each other for full brightness and in series with each other for dimming.

Series Resonant Circuit.—A circuit in which a coil and condenser are connected in series, and have values such that the inductive reactance of the coil will be equal to the capacitive reactance of the condenser at the desired resonant frequency. At resonance, the current through a series resonant circuit is a maximum.

Series Transformer.—A transformer connected in series with a circuit for the purpose of taking off a secondary power circuit.

Series Turn.—The part of a field winding or an electromagnet winding that is connected in series with the armature or the main circuit.

Series Winding.—In a motor, generator or other electric machine, a winding in which flows all the current that enters or leaves the machine.

Series-Wound Motor.—A direct-current motor having its field windings connected in series with its armature, and with both the field and armature connected in series with the line, so that all armature current flows also through the field winding. Such a motor has relatively great starting torque per ampere, and its speed varies with the load.

Serrated Vertical Pulse.—In a composite television signal, six pulses closely spaced in time, each about five times as long as a horizontal sync pulse, and separated by brief drops to the black level which are called serrations. The six pulses act through an integrating filter to start each

- cycle in the vertical sweep oscillator.
- Service.**—The conductors and equipment which deliver electric energy and power from a transformer, feeder or main of a public service distribution system to the wiring system of a building or premises in which the power is utilized.
- Service Area.**—The region around a broadcast station in which its signal strength is strong enough to insure satisfactory reception at all times.
- Service Entrance.**—Descriptive of equipment and conductors used at the point where building wiring connects to the service.
- Service Wires.**—Wires connecting the interior circuits of a house or building with the outside supply circuit.
- Set Spark Ignition.**—An ignition system in which there is no provision for advancing and retarding the time of sparking in which the spark setting has a permanent advance.
- Setting.**—The current at which or in excess of which a circuit breaker or other adjustable protective device will operate to open its circuit.
- SG.**—Letters used to designate the screen grid electrode of a vacuum tube.
- Shaded Pole Motor.**—An alternating-current induction motor which is self-starting on single-phase current supply because of a partial displacement of magnetic lines or flux at the field poles through auxiliary currents and flux produced in closed conductive rings around parts of the pole tips.
- Shading Control.**—A hue control in a color television receiver.
- Shadow.**—In television pictures, a dark area at corners, sides, top, or bottom, resulting from the electron beam striking the picture tube neck and not reaching the phosphor screen. Also, a locality not reached by carrier waves because of objects intervening between transmitter and receiver.
- Shadow Mask.**—Immediately back of the phosphor dot screen in a three-gun color television picture tube, a thin sheet containing as many small openings as there are groups (trios or triads) of phosphor dots. Convergence occurs at these openings.
- Shadow Tuning Indicator.**—A tuning meter which has a small piece of cardboard attached to its pointer, with a pilot lamp mounted behind the pointer so that a shadow is thrown upon a glass screen. The meter is so constructed and connected into a radio receiver circuit that the shadow will be narrowest when the receiver is accurately tuned to a station.
- Sharp Tuning.**—The condition in which slight changes in the frequency of the received waves produces a considerable change in the induced current.
- Sheathing of Cable.**—The outside covering which protects a cable from mechanical injury or from the effects of water, oils, acids, etc.
- Shedding of Battery Plate.**—Dropping off of the active material from the plates in a storage battery.
- Shellac.**—An insulating liquid made of gums dissolved in alcohol.
- Shell Transformer.**—A transformer in which the core has a central portion or leg on which are the windings, and has extensions from the top and bottom of the central leg which pass around the outside of the windings and join the ends of the central leg. Magnetic flux in the central leg divides, part flowing through each of the outer legs to complete the magnetic circuit.
- Sheppard Tube.**—The Sheppard-Pierce tube, a trade name for all metal velocity modulation tube.
- Shield.**—A metal can or housing placed around a radio part to prevent its electric and magnetic fields from affecting nearby parts or to prevent other fields from affecting it.
- Shield Grid Thyatron.**—A thyatron with a control grid and an additional screen grid or shield grid.
- Shielded Wire.**—Insulated wire having around it a shield of tinned braided copper wire.
- Shoe.**—In an electric railway car or locomotive, the contact piece that slides along the third rail to collect current.
- Short Circuit.**—An accidental connection of low resistance between the two sides of a circuit so that little or no current flows through the current consuming device in the circuit.
- Short Shunt.**—In a compound wound machine, a connection of the shunt winding directly across the armature circuit so that the shunt field current does not flow through the series field.
- Short Time Rating.**—The rating at which an electric device can operate when making frequent stops of sufficient length to allow reasonable cooling.
- Short Waves.**—Wavelengths shorter than those included in the broadcast band, hence waves shorter than 200 meters. Short waves correspond to frequencies higher than the highest broadcast band frequency of 1600 kilocycles.
- Short-Wave Converter.**—A radio device which can be connected between a broadcast receiver and its antenna system to permit reception of higher-frequency stations which the receiver could not otherwise receive. It consists essentially of an oscillator-mixer-first detector arrangement like that used in a superheterodyne receiver, and serves to convert the high-frequency signals to a broadcast band frequency which can be handled by the regular receiver.
- Shorted Half-wave Line.**—A half-wave resonant line whose conductors are connected together at the far end. A series resonant element at the fre-

- quency of resonance.
- Shorted Quarter-wave Line.**—A quarter-wave resonant line whose conductors are connected together at the far end. A parallel resonant element at the frequency of resonance.
- Shunt.**—A resistor placed across the terminals of an ammeter to allow a definite part of the circuit current to go around the meter. Any parallel-connected part, or the act of placing one part in parallel with another.
- Shunt for Ammeter.**—See ammeter shunt.
- Shunt Coil.**—In an electromagnet or a field winding, the coil connected in parallel and through which only a part of the current flows.
- Shunt Field.**—A field winding connected in parallel with the armature circuit, connected across the brushes.
- Shunt Generator.**—A generator whose field winding is in parallel with the armature circuit, connected across the brushes so that only a part of the generated current flows through the winding.
- Shunt Ratio.**—The ratio of current through a shunt to the current through the whole circuit.
- Shunt Winding.**—In a motor, generator or other electric machine, a winding through which flows only a portion of the total current entering or leaving the machine; a winding which is in parallel with the armature windings.
- Shunt-Wound Motor.**—A direct-current motor with its field windings connected in parallel or in shunt with its armature, and with the paralleled armature and field connected across the line supply. Such motors tend to maintain fairly constant speed with moderate changes of load.
- Shunted.**—Connected in parallel, forming a shunt.
- Shuttle Armature.**—An H-armature.
- Side Circuit.**—The two-wire circuit that forms one side of a phantom circuit in telegraphy or telephony.
- Sign Flasher.**—See flasher.
- Signal.**—A radio wave or alternating current which carries intelligence of any form. More generally, any alternating current having other than an a.c. power line frequency.
- Signal Generator.**—A test instrument used by radio servicemen to produce a modulated or unmodulated r.f. carrier signal having a known radio frequency value, sometimes also at a known voltage. It is used as a signal source during alignment of a radio receiver and when hunting for the defective part in an improperly operating receiver. An all-wave signal generator has several ranges, and hence can be set to any carrier frequency which an all-wave receiver can receive.
- Signal-To-Noise-Ratio.**—The ratio of the intensity of a desired signal at any point to the intensity of noise there is to interfere with reception.
- Signal Tracing.**—A radio receiver servicing technique which involves tracing the progress of a radio signal through an entire receiver, stage by stage, while the receiver is in operation. Measurements which are made during this procedure by a special signal-tracing test instrument indicate when the defective part or stage has been reached.
- Silicon Bronze.**—Bronze containing silicon and sodium. It is used for wires and cables where mechanical strength and resistance to wear are needed.
- Silicon Crystal Diode.**—A crystal diode employing a piece of silicon. Used at ultra-high and super-high frequencies.
- Silicon Steel.**—Steel alloyed with silicon. It has a low hysteresis and eddy current loss.
- Silk Covered.**—Having an insulating covering of silk threads.
- Silver.**—A metal having a lower electrical resistance than copper. It is sometimes used for contact points.
- Simple Arc.**—An arc lamp having but two carbons.
- Simple Circuit.**—A circuit connecting one source with a current consuming device.
- Simple Magnet.**—A one-piece magnet, as distinguished from a compound magnet of two or more pieces.
- Simple Periodic Current.**—A current whose voltage and amperage go through a regular rise and fall in value.
- Simplex Circuit.**—A telegraph circuit operating in only one direction at a time.
- Simplex Winding.**—An armature winding having only two parallel paths from brush to brush.
- Simplex Circuit.**—In telephone work, the use of the two wires of a metallic circuit for one side of a signal circuit which is completed through ground.
- Simultaneous Color Television.**—Any system with which phosphors for the three primary colors may be excited at the same time, not one after another.
- Sine Wave.**—The rise, fall and reversal of an alternating current or voltage which would be induced in a conductor rotating at constant speed in a uniform magnetic field and moving around a circle in that field. The ideal form of an alternating wave.
- Single-Button Carbon Microphone.**—A microphone having a carbon-filled button on only one side of its diaphragm.
- Single Contact Lamp.**—A lamp whose base and socket are designed for use in a single-wire or grounded circuit. It has a single center contact point with the other side of the circuit completed through the side of the base.
- Single-gun Color Tube.**—A color television picture tube having only one

- electron gun and one electron beam, with the beam switched or deflected across phosphors for the three primary colors one after another or sequentially.
- Single Ignition.**—An ignition system using only a magneto as a source of current, without an auxiliary battery system.
- Single Loop Armature.**—An armature winding in which there is only one coil.
- Single-magnet Ion Trap.**—A television picture tube ion trap designed to operate with one magnetic field and a single external permanent magnet having suitable pole pieces.
- Single-Phase.**—Descriptive of an alternating-current circuit or apparatus in which there is but one alternating potential and the accompanying alternating current. Compare "poly-phase."
- Single Phase Circuit.**—A circuit carrying a single alternating current.
- Single Phase Generator.**—An alternating current generator producing a current with only one phase or wave.
- Single-Phase Motor.**—An alternating-current motor which operates from a single-phase current supply. Single-phase motors include the following types: Capacitor, repulsion, repulsion-induction, repulsion-start induction, shaded pole, and split-phase.
- Single Phase Transformer.**—A transformer operating with a single phase alternating current.
- Single-Pole.**—Connected with only one conductor in a circuit or with only one side of a circuit.
- Single-Pole Cutout.**—A single fuse in one side of a circuit.
- Single-Pole Switch.**—A toggle or knife switch having only one movable contact arm or blade.
- Single Reduction.**—Having but one pair of gears, pulleys, sprockets, etc., between which there is a reduction of speed.
- Single Stroke Bell.**—An electric bell which is struck only once for each time the bell circuit is closed.
- Single-Throw Switch.**—A toggle or knife switch in which each movable contact arm or blade always touches the same contact when closed.
- Single-Wire Circuit.**—A circuit in which one side is carried through ground, requiring but a single wire for the other side.
- Singly Re-Entrant Winding.**—An armature winding which includes all the conductors in a series circuit before closing on itself.
- Sinistorsal Helix or Solenoid.**—A coil wound left handed, in an anticlockwise direction, looking at the end.
- Sinusoidal.**—Having the form of a sine wave, which see.
- Sinusoidal Current.**—An alternating current whose wave form is represented by a sine curve.
- Six Phase Circuit.**—Alternating current circuits carrying currents whose phase difference is a sixth of a cycle, 60 degrees.
- Skew.**—Descriptive of television pictures having top, bottom, and sides not in line with top, bottom, and sides of the mask. Pictures are tilted. Due to incorrect rotation of the yoke with electromagnetic deflection, or of the entire tube with electrostatic deflection.
- Skin Effect.**—The effect of eddy currents and counter-emf's in the interior of a conductor that is carrying high-frequency currents. Current flow is largely restricted to the outer portion or skin of the conductor, thus decreasing the effective cross section and increasing the effective resistance.
- Skip Distance.**—The distance between the farthest point reached by the ground wave of a radio station and the nearest point at which the reflected skip wave comes back to earth. This skip effect usually occurs only during high-frequency transmissions (short-wave transmissions).
- Sky Waves.**—Radio waves which travel up into the sky from the transmitting antenna and are reflected back to earth by the Kennelly-Heaviside ionized layer.
- Slate.**—A clay-like stone readily cut into thin plates. It is used as an insulating mounting for switchboards, etc.
- Sleeve Joint.**—A joint made by slipping the ends of two conductors into a short length of tubing.
- Sleeving.**—A small tube of woven cotton which is slipped over wires to provide insulation.
- Slide Rule Dial.**—A type of tuning dial used on radio receivers, in which a vertical marker moves horizontally over long straight scales resembling the scales of a slide rule.
- Slide Wire Bridge.**—A form of Wheatstone bridge in which the known resistance is varied by moving a sliding contact.
- Sliding Contact.**—A contact piece which may be moved across a series of contacts or along the length of a conductor.
- Slip.**—The difference between the rotor speed of an induction motor and the speed of its rotating magnetic field.
- Slip Ring Motor.**—A wound rotor motor, which see.
- Slot.**—In an armature core, the space or groove in which a coil is carried.
- Slot Insulation.**—The insulation placed in an armature slot before the coils are put in.
- Slotted Armature.**—An armature having its coils placed in slots in the core.
- Slow Burning Conductor.**—A conductor whose insulation burns or chars slowly and without flame.
- Slag.**—The adjustable core of an inductor or coil used in a tuned circuit.

Smears.—Same as trailers in television pictures.

Smee Battery.—A primary electric cell using zinc and silver plates in sulphuric acid.

Smooth Core Armature.—An armature whose conductors are on the surface of the core in place of in slots.

Snap Switch.—A switch in which movement of the control member first places tension on a spring, after which the spring tension is released to suddenly open (and usually to suddenly close) the switch contacts.

Sneak Current.—A current too small to operate a protective circuit breaker or to blow a fuse, but which is still large enough to do harm in the circuit if allowed to continue.

Snow.— Numerous small flecks or streaks which shift continually on television pictures. Due to a combination of internally produced pulses of noise voltage in tubes and resistances, and a weak video signal at the picture tube input.

Soaking Charge.—In storage battery work, a long charge at a low rate which removes excess sulphate from the plates.

Socket.—A mounting device for tubes, **Soft Drawn Copper Wire.**—Copper wire that has been softened by annealing. plug-in coils, plug-in condensers, plug-in resistors and crystals, having holes with spring clips arranged to fit and grip the terminal prongs of the part being plugged in. Also, a bayonet or screw type socket for pilot lamps.

Soft Iron Vane Meter.— A meter in which a piece of soft iron is magnetized and is acted upon by a magnet.

Solder.— An alloy of lead and tin which melts at a fairly low temperature and is used in radio for making permanent electrical connections between parts and wires.

Soldering Iron.—A device used to apply heat to a joint which is to be made permanent by soldering.

Solenoid.—A tubular or cylindrical coil used for the production of a magnetic field. A solenoid in which current is flowing has the properties of a magnet. This name sometimes is applied to a plunger magnet.

Solenoid Ammeter.—An ammeter whose pointer is moved by drawing a plunger into a solenoid against the action of gravity or a spring.

Solenoid Core.—The soft iron around which a solenoid is wound and in which are concentrated the magnetic lines of force.

Solid Wire.—A conductor in one piece, as distinguished from stranded or braided conductors.

Solution for Battery.—The electrolyte or liquid used around the plates of a battery cell.

Soft Tube.—An electron tube having a low vacuum, usually with some gas

remaining. Soft tubes are generally used as detectors.

Sound.—A vibration of a body at a rate which can be heard by human ears. The extreme limits of human hearing are about 20 cycles and 20,000 cycles. Sound can travel through any medium which possesses the ability to vibrate; the resulting traveling vibrations are called sound waves.

Sound Bars.—Two or more alternate dark and bright horizontal areas or bars appearing on television pictures when audio-frequency voltage reaches the signal input circuit of the picture tube. Audio frequency is approximately equal to 60 times the number of pairs of bars.

Sound Carrier.—A television carrier whose frequency is modulated by sound or audio signals being transmitted. The unmodulated center frequency is 4.5 megacycles higher than the video carrier frequency in the same channel.

Sound Takeoff.—The coupling or connection at which television sound signals are taken to the sound amplifying and demodulating sections from the output of a mixer, r.f. amplifier, video detector, or sound detector.

Sounder.—In telegraphy, a relay whose operation produces a sound recognized by the receiving operator.

Sounder Resonator.— An open box placed around a telegraph sounder to increase and reflect the sound.

Source.—A term sometimes used to describe the part which is supplying electrical energy or radio signals to a circuit.

South Pole.—The pole of a magnet at which lines of force enter the magnet. The south seeking pole. The negative pole.

Space Charge.—A gathering of electrons near the cathode of a vacuum tube. Being negative, it tends to limit the number of electrons which can reach the plate, and hence limits the plate current.

Space Factor.— In a magnet winding, the ratio of the space filled by the active conductor to the total space occupied by the winding and its insulation.

Spaghetti.— Heavily varnished cloth tubing sometimes used to provide additional insulation for radio circuit wiring.

S.P.D.T. Switch.—Single pole, double throw switch.

Spark Advance and Retard.—A change of the instant at which an ignition spark takes place with reference to the position of the engine piston in its stroke.

Spark Coil.—An induction coil giving a high tension current from a secondary winding for a jump spark, or a self-induced current for a make-and-break spark.

Spark Condenser.— A condenser connected across two contacts to reduce

Spark Control

- sparkling as they open their circuit.
- Spark Control.**—In ignition work, the means provided for spark advance and retard.
- Spark Gap.**—Two points, rods or balls, between which a spark is caused to pass by a high voltage current.
- Spark-Gap Modulator.**—A modulator in which the high current switch takes the form of a spark gap. The spark gap may be either of the triggered or the rotary type.
- Spark Intensifier.**—In ignition work, a small additional gap placed in series with a secondary circuit to make it possible for a spark to pass between the points of a sooted spark plug.
- Spark Plug.**—In ignition work, a metal shell screwing into the cylinder wall and carrying an insulated center conductor from the end of which a high tension spark passes to the shell and to ground.
- Spark Sending.**—Transmitting radio telegraph messages with signals produced by the damped waves from sparks.
- Spark Timing.**—Connecting the ignition interrupter to its drive from the engine so that the spark takes place at the proper time during the engine's cycle.
- Spark Voltage.**—The lowest voltage at which a spark will pass between two conductors through air or other insulation.
- Sparkling of Brushes.**—Small flashes at the contact between a brush and its commutator due to a wrong brush position or to defects in the brush or commutator.
- Sparkless Commutation.**—Operation of a generator or motor such that there is no sparking at the brush contact on the commutator.
- Specific.**—Being measured with reference to certain exact conditions such as a certain size of conductor, etc.
- Specific Gravity.**—The ratio of the weight or mass of a substance to the weight or mass of an equal volume of pure water at the same temperature, or sometimes at a reference temperature of four degrees centigrade.
- Specific Inductive Capacity.**—The ratio of the change produced in a dielectric to the electromotive force that produces the change.
- Specific Magnetic Reluctance.**—The reluctance of a centimeter cube of the magnetic material being measured.
- Specific Resistance.**—The resistance through a centimeter cube of the substance measured.
- Spectrum Analyzer.**—A test instrument used to show the distribution of the energy contained in the frequencies emitted by pulsed magnetrons; to measure the Q of resonant cavities or lines; and to measure the cold impedance of a magnetron.
- Speed Controls.**—In a television receiver, the adjustable controls that

Sphere Gap

- set the operating frequencies of the vertical and horizontal oscillators at values which permit them to fall into step with or synchronize with the incoming signals.
- Sphere Gap.**—A spark gap formed between two balls or spheres on the ends of conductors.
- Spherical Candlepower.**—The light from a source measured in all directions from the source as a center.
- Spherical Face Plate.**—A television picture tube face plate curved on the outside in all directions, like part of the surface of a ball or sphere having large radius.
- Spider.**—A highly flexible fiber ring which serves to center the voice coil of a dynamic loudspeaker without appreciably hindering the in-and-out motion of the voice coil and its attached diaphragm.
- Spider Web Coil.**—A coil wound on a frame consisting of radiating arms like the spokes of a wheel, a basket coil.
- Spiral Scanning.**—A type of antenna rotation in which a point on the rf beam traces out a spiral. Only a small sector in the desired direction is illuminated.
- Splice.**—A joint between two wires which possesses mechanical strength as well as good electrical conductivity.
- Splice Box.**—A box in which cable joints and connections are made.
- Split Phase.**—The phase difference between alternating currents between which a single phase current is divided.
- Split Phase Motor.**—An alternating-current induction motor which is made self-starting on single-phase current by using two stator windings, in one of which the current is displaced in phase with reference to that in the other winding to produce a rotating field somewhat like the rotating field secured from two-phase current.
- Split Pole Converter.**—A converter using additional field poles or divided field poles for controlling the voltage.
- Split Sound.**—Same as dual channel sound.
- Sponge Lead.**—Pure metallic lead in a porous form. It forms the active material of the negative plate in a lead-acid storage battery.
- Spot Welding.**—Electric welding in which two parts are joined by welding small spots on their adjacent flat surfaces.
- S.P.S.T. Switch.**—Single pole, single throw switch.
- Spurious Resistance.**—The resistance to alternating current in excess of the ohmic resistance of the conductor.
- Square Mil.**—A measure or area equal to a square which is one thousandth of an inch on a side. The one millionth part of a square inch.
- Squealing.**—A condition in which a

high-pitched note is heard along with the desired radio program. It can be due to interference between stations or to a number of other causes.

Squirrel Cage Motor.—An alternating-current induction motor in which the conductors on the rotor consist of bars parallel to the rotor axis or shaft, joined together at the front and rear of the armature by conductive rings. The conductors, neglecting their supports, would have the general form of a squirrel cage.

Squirrel Cage Rotor.—In an induction motor, an auxiliary armature winding of copper rods arranged in cylindrical form with their ends joined.

Squirted Filament.—A lamp filament produced by forcing the soft material for the filament through small holes.

Stabilisation.—A system for maintaining a radar beam in a desired direction in space despite the roll and pitch of the ship or aircraft.

Stacked Antenna.—An antenna array consisting of two or more similar bays or groups of elements mounted one above another and so connected to a transmission line that signals from all bays are in phase to increase total signal strength or antenna gain.

Stagger Tuning.—In television intermediate-frequency amplifiers, resonating successive interstage couplings at different frequencies to provide overall response of required frequency width. The same resonant frequency may be used in alternate couplings, as in a first and third, or in a second and fourth.

Staggering of Brushes.—Placing two or more brushes so that they slightly overlap each other at their sides.

Stalling Torque.—The torque or twisting effort of a motor at the instant the load becomes so great that armature rotation is stopped.

Stand-Off Insulator.—An insulator used to support a wire at a desired distance away from the building or other support on which the insulator is mounted.

Standard Candle.—A candle that is used as a measure or a standard of lighting power.

Standard Cell.—The Weston primary cell, which is a legal standard of voltage. It gives practically one volt pressure.

Standard Ohm.—A wire having a resistance of exactly one ohm and used for comparing and calibrating.

Standard Resistance.—A carefully graduated resistance used for comparing with unknown resistances and for calibrating instruments.

Stand-by Battery.—A storage battery used in power stations to supply current in case it becomes necessary to stop the generators for a time.

Standing Waves.—Maximum and minimum values of voltage or current, and intervening values, which remain at fixed positions along a conductor in which electric charges or waves

are reflected from the far end back toward the source. Maximum standing amplitudes (antinodes) appear where outgoing and reflected charges add their strengths. Minimum amplitudes or zeros (nodes) stand where the outgoing and returning charges cancel because of opposite polarities.

Star Connection.—A three-phase connection in which the phases may be represented as connected together at a common point and extending outward from that point, with the line conductors connected to the outer ends of the phases.

Starter Coil.—A coil and vibrating interrupter used in connection with a magneto to give a stream or series of ignition sparks for starting an engine.

Starting Battery.—A storage battery capable of giving a high enough discharge of current to operate an automobile starting motor.

Starting Box.—A rheostat used for starting an electric motor.

Starting Motor.—A direct current series wound, electric motor suitable for cranking automobile engines.

Starting Rate.—In storage battery charging, the rate in amperes that is used from the beginning of a charge until the cells start to gas.

Starting Rheostat.—A rheostat used for starting an electric motor.

Starting Torque.—The maximum torque or turning effort an electric motor can exert in starting its load from a standstill, or the power required to start a load.

Starting Current.—The current in amperes required for cranking an automobile engine with an electric starting motor.

Static.—Interfering noises heard in a radio receiver due to radio waves created by atmospheric electrical disturbances such as discharges of lightning.

Static Breeze.—A movement of air produced by an electrostatic discharge.

Static Charge.—A quantity of electricity existing as a charge on conductors or on the plates of a condenser.

Static Convergence.—In a three-gun color television picture tube, convergence of the three electron beams in openings at and near the center of the shadow mask.

Static Electricity.—Electricity at rest, such as in the charge of a condenser, as distinguished from the electric current which is electricity in motion.

Static Generator.—A generator for the production of frictional electricity.

Static Transformer.—A transformer in which all the parts and windings are stationary.

Stator.—The stationary part of an electric machine. The moving part is called the rotor. The fixed set of plates in a variable condenser.

Stator.—The stationary winding in a

- variable inductance coil.
- Stray.**—Electrical disturbances which cause irregular noises in the telephone receivers.
- Steady Current.**—A direct current whose voltage does not rise or fall.
- Stearite.**—A kind of soapstone used for insulation that has to withstand high temperatures.
- Step-Down.**—Reducing the voltage from a higher to lower value.
- Step-Down Transformer.**—A transformer in which the secondary winding has fewer turns than the primary, so that the secondary delivers a lower voltage than is supplied to the primary.
- Step-Up Transformer.**—A transformer in which the secondary winding has more turns than the primary, so that the secondary delivers a higher voltage than is applied to the primary.
- Stop-Charge Regulation.**—Control of a battery charging generator by stopping the charge when the battery reaches maximum voltage.
- Storage Battery.**—A number of storage cells in a single case and connected with each other to give the desired voltage and current capacity.
- Storage Cell.**—A secondary cell. More specifically, one of the cells of the ordinary automotive storage battery, delivering a voltage slightly higher than two volts and capable of being recharged.
- Strain.**—The change of shape, size, or condition of a substance produced by a stress.
- Strain Insulator.**—An insulator placed between the parts of a guy wire to prevent the lower part of the wire from carrying current.
- Stranded Conductor.**—A conductor composed of a number of smaller conductors or wires.
- Stranded Wire.**—A wire which consists of a number of finer wires twisted together.
- Strap for Battery Plate.**—The flat piece of lead to which are attached the several plates forming the positive or the negative group in a storage cell.
- Stray Current.**—A current from the grounded side of light and power circuits. This current may enter other circuits and cause electrolysis of underground piping and metal parts.
- Stray Field.**—In the magnetic circuit of a field, the lines of force that do not pass through the armature conductors and therefore do no useful work.
- Stray Flux.**—Any magnetic lines of force that pass out of the part of the magnetic field circuit in which useful work is done.
- Strength of Current.**—The number of amperes of current.
- Strength of Magnetism.**—The magnetic flux.
- Stress.**—Any force or action that tends to make a change of size, of shape, or of condition in a substance.
- Strip Fuse.**—A fuse formed of a flat conductor.
- Stripping.**—In electroplating work, removing the old coating or plating from metal parts. Removing the insulation from wires.
- Stub.**—A matching stub.
- Stub's Wire Gauge.**—The Birmingham wire gauge, a gauge used for measurement of iron wire sizes.
- Subcarrier.**—In color television, a signal whose frequency is 3.579545 megacycles. Modulated by chrominance signals at the transmitter, but suppressed while only chrominance sidebands are transmitted. The subcarrier frequency is transmitted by burst signals, used at the receiver for synchronizing the color oscillator.
- Sub-Station.**—In electric railroad work, the electrical devices which transform the kind of current received from the power house into the kind of current used by the motors in the cars.
- Sulphate.**—Sulphate of lead. This compound is formed from both the positive and the negative plate material in lead-acid storage batteries on discharge.
- Sulphation.**—In a lead-acid storage battery, the conversion during discharge of an excessive amount of the active sponge lead and peroxide of lead into inactive sulphate of lead.
- Sulphuric Acid.**—The acid used, when diluted with water, as the electrolyte in the lead-acid storage battery and in other types of electric cells.
- Superheterodyne Receiver.**—A type of radio receiver in which the incoming modulated r.f. signals are amplified a small amount in the preselector, then fed into the frequency converter section (consisting of the oscillator, mixer or first detector) for conversion into a fixed, lower carrier frequency called the i.f. value of the receiver. The modulated i.f. signals are given very high amplification in the i.f. amplifier stages, then fed into the second detector for demodulation. The resulting audio signals are amplified in the conventional manner by the audio amplifier, then reproduced as sound waves by the loudspeaker.
- Super-high Frequencies.**—In radio and electronic applications, frequencies in excess of 3,000 megacycles per second.
- Superposed Circuit.**—A circuit completed through a part of another circuit used for a different purpose but allowing both functions to take place at the same time.
- Suppressed Subcarrier.**—The chrominance subcarrier in color television, so called because suppressed at the transmitter after helping produce chrominance sidebands.
- Suppressor.**—A resistor inserted in series with the spark plug lead or the distributor lead of an automobile engine to suppress spark interference

Suppressor Grid

which might otherwise interfere with reception of radio programs in the auto radio set.

Suppressor Grid.—An internal element of a pentode, located between screen and plate, to prevent secondary-emission electrons passing from plate to screen while the screen is momentarily more positive than the plate during strong signals.

Surface Leakage.—Leakage of current across the surface of an insulator.

Surface Metal Raceway.—A thin-walled flattened metallic covering and support for insulated wires, designed for mounting on the exposed surfaces of building members, and usually having a removable cover.

Surge Impedance.—Same as characteristic impedance.

Sweep.—Descriptive of horizontal or vertical deflection of the electron beam in a television picture tube or cathode-ray tube.

Surging Discharge.—An oscillating discharge.

Susceptance.—In an alternating current circuit, the wattless part of the admittance.

Susceptibility.—The relative ability of a material to allow magnetism to be induced in it by the induced magnetomotive force.

Suspension Cable.—An insulator through which a conductor is passed and which is hung from a supporting wire.

Suspension Insulator.—An insulator attached to a support above and carrying a conductor below.

Sweep Amplifier.—A television receiver amplifier to which is applied sawtooth voltage from a sweep oscillator, and in whose output is the same or a modified waveform as required for the following beam deflection circuits.

Sweep Generator.—An instrument containing oscillators and associated circuits which furnish voltage varying continually and repeatedly in frequency back and forth through a range called the sweep width. This voltage is used as input for any circuits or devices whose frequency response is to be observed on an oscilloscope.

Sweep Oscillator.—In a television receiver or oscilloscope, usually a relaxation oscillator but sometimes a sine wave type which controls charge and discharge of a capacitor for producing a sawtooth voltage which eventually causes deflection of the electron beam in the picture tube or cathode-ray tube.

Swinging Cross.—A short circuit between two conductors that are blown together by the wind.

Switch.—A mechanical device for opening and closing an electrical circuit, or for changing the connections between parts or circuits.

Switch Blade.—The movable part of a knife switch, the knife.

Switchboard.—A large exposed panel or panels carrying on the front, the

Switchboard Instrument

back, or both front and back, switches, buses, protective devices and instruments for measuring and indicating or recording values of current and voltage in parts of circuits controlled by equipment on the switchboard.

Switchboard Instrument.—A measuring instrument; voltmeter, ammeter, wattmeter, etc., designed for mounting on a switchboard.

Switch Plug.—A metal plug which, when pushed into a socket, completes or breaks an electric circuit.

Symbol.—A simple design used to represent a part on a schematic circuit diagram. A letter used in formulas to represent a particular quantity.

Symmetrical System.—Alternating currents having the same wave form and separated from each other by equal phase differences.

Sync.—Abbreviation for synchronizing.

Sync Limiter.—A tube circuit utilizing plate current cutoff, plate current saturation, or both, to prevent sync pulses from exceeding some predetermined maximum amplitude in the tube plate circuit.

Sync Pulse.—In a composite television signal, a voltage of approximately square waveform which extends from the black level oppositely from picture signals and is utilized for maintaining sweep oscillator frequency in correct time relation to picture fields and frames. There are horizontal, vertical, and equalizing sync pulses.

Sync Separator.—In a television receiver, a tube operated with such element voltages that, when a complete video or composite signal is applied to the grid, sync pulses accompanied by little or no picture signal variations appear in the plate circuit. Usually accomplished by biasing which allows picture signal voltages to make the grid negative beyond plate current cutoff.

Synchronized Sweep.—A sweep generator output voltage whose sweep rate, and time at which each sweep cycle begins and ends, is controlled by the same alternating voltage that causes the beginning and end, or the entire horizontal deflection, of the electron beam in the cathode-ray tube of a connected oscilloscope. Allows forward and return traces on the oscilloscope to superimpose and appear as a single trace or curve.

Synchronizer.—A device for indicating when alternating current machines are synchronous or in phase.

Synchronizing.—Timing of one varying voltage or current in such manner as to keep it exactly in step with some other varying voltage or current. The controlled and controlling voltages or currents need not be of the same kind or waveform, but the frequency and sometimes also the phase of the controlled quantity will be made equal to that of the controlling quantity.

Synchronizing Signal.—The portion of

Synchronizing Torque

a television signal that keeps the motions of the electron beam in the picture tube of the receiver in step with or synchronized with motions of the beam in the camera tube at the transmitter.

Synchronizing Torque. — A load which tends to bring two alternators into phase with each other.

Synchroscope.—An instrument which shows whether or not two machines are in synchronism and whether the one to be connected to a circuit lags or leads.

Synchronous.—Happening at the same time; having the same alternating phase relations and period; maintaining a frequency exactly proportional to operating speed, or a speed exactly proportional to supply frequency.

Synchronous Condenser. — An electric machine whose field strength may be changed in order to change the power factor in an alternating current system or to change the load voltage in such a system.

Synchronous Converter. — A rotating machine for changing alternating current to direct current, or direct current to alternating current. There is a single rotating armature carrying both alternating-current slip rings and a direct-current commutator.

Synchronous Generator. — An alternating current generator whose speed is in proportion to the frequency of its current.

Synchronous Machine.—An alternating current machine whose frequency is in proportion to the machine's speed.

Synchronous Motor. — An alternating-current motor in which the rotor turns at the same speed as the revolving magnetic field. There is no slip in a synchronous motor, as there is in an induction motor.

Synchronous Phase Advancer.—A synchronous condenser.

Synchronous Speed.—The synchronous speed of an alternating-current motor is the speed of its rotating magnetic field. The synchronous speed, in revolutions per minute, is equal to 120 times the frequency in cycles per second, divided by the total number of poles. If poles are counted as pairs, consisting of one north pole and one south pole, the synchronous speed is equal to 60 times the frequency, divided by the number of pairs of poles.

Synchronous Telegraphy. — A system operating with synchronous action of the parts at the two ends of the circuit.

Synchronous Vibrator. — A vibrator which serves the dual function of converting a low d.c. voltage to a low a.c. voltage and at the same time rectifying a high a.c. voltage. When used in an auto radio power pack, it eliminates the need for a rectifier tube.

Synchroscope. — An oscilloscope on

Syringe Hydrometer

which recurrent pulses or wave-forms may be observed, which incorporates a sweep-generator that produces one sweep for each pulse, regardless of frequency, thus allowing no more than one cycle to be viewed on the screen.

A radar term.

Syringe Hydrometer. — A hydrometer carried in a syringe so that the liquid to be tested may be drawn up into the barrel of the syringe.

T

t.—An abbreviation for "time," seconds.

Table Model Receiver.—A radio receiver having a cabinet of suitable shape and size to permit placing on a table.

Tachometer. — An instrument which measures and indicates the speed of a rotating part, a form of speed indicator.

Tandem Drive.—Two or more machines placed end to end with the shaft of one coupled directly to the shaft of another.

Tangent Galvanometer. — A galvanometer whose needle is deflected by the current being measured while the deflection is opposed by the earth's magnetism.

Tank.—A large electronic "tube" having a heavy metallic shell or envelope and a mercury pool cathode. Ignitrons, pool tubes, and grid-pool tubes often are of the tank type.

Tank Circuit.—The resonant plate circuit of an electron tube oscillator. The circuit from which oscillating voltage is delivered to other circuits.

Tantalum Filament Lamp.—An incandescent electric lamp having a filament of the metal tantalum.

Tap.—A connection made to a point intermediate between the ends of a coil, a resistor, or other element in a circuit or line.

Tap Circuit.—A circuit taking current directly from a branch circuit to a current consuming device without the use of switches or cutouts.

Tapering Charge.—In storage battery work, a charge at constant voltage so that the amperage grows less as the battery voltage rises toward full charge.

Target.—A visible part connected to some moving part, such as to the armature of a magnet, to indicate its movement.

Tear Out.—Sidewise displacement of part of a television picture due to interference, usually when there are faults in the horizontal sync system or when there is no automatic frequency control for the horizontal sweep oscillator.

Teaser. — A fine wire shunt winding placed on the poles of a series wound generator to keep a constant voltage.

Teeth of Armature. — The metal between the slots in an armature core.

Telegraph.—A system of sending messages by means of electromagnets

whose armatures make signalling sounds or movements when operated by current controlled by switches that are worked by the operator.

Telegraph Relay.—See relay magnet.

Telegraph Repeater.—See repeater.

Telegraph Sounder.—See sounder.

Telegraphic Alphabet or Code.—The signals used to represent letters, numbers, etc., in telegraphy.

Telegraphic Key.—The hand operated switch with which the operator sends telegraph signals.

Telegraphophone.—A device that carries and reproduces signals by magnetizing a moving steel wire or tape.

Telemetering.—Production of visible or audible indications of the operation of circuits and electrical devices which are located at a distance from the indicator.

Telephone.—A device which receives transmits, and reproduces sound by the action of electromagnets on diaphragms in the transmitter and receiver.

Telephone Cable.—Annealed copper wire which has been tinned before the insulation is applied.

Telephone Condenser.—Any condenser used in a telephone circuit. It is usually of the rolled paper and foil type with paraffin insulation.

Telephone Condenser.—The condenser connected in parallel with the receivers.

Telephone Conduit.—The underground passages of tile, concrete, etc., through which telephone wires are carried.

Telephone Cord.—A very flexible two-wire cable used for attaching a telephone receiver to the telephone instrument.

Telephone Exchange.—The central point at which connections are completed between various telephone lines.

Telephone Fuse.—A cartridge fuse, usually of 5 to 10 ampere capacity, used in telephone circuits.

Telephone Jack.—A form of switch which breaks one or more circuits while completing others through the insertion of a plug in a socket so that the various contacts are operated.

Telephone Receiver.—The electromagnetic device which changes the electric current in the telephone circuit into sound through a vibrating diaphragm.

Telephone Repeating Coil.—An electromagnetic coil which repeats the signals from one telephone circuit into another circuit.

Telephone Ringer.—An electromagnet with a vibrating armature which operates a clapper to ring a telephone bell.

Telephone Set.—The combination of transmitter, receiver, ringer, etc., which makes up the telephone installation in a subscriber's premises.

Television.—Reproduction of a scene, which may include moving objects and persons, at a distance from the point where the scene exists. Television requires the conversion of lights and shades of a scene into variations of voltage and current, transmission of these variations as radio waves, and reconversion at the receiver of the voltage variations into lights and shades, all at practically the same instants that changes are occurring in the distant scene.

Tell-tale.—A signal that indicates a fault or failure in some electrical apparatus.

Temperature Coefficient.—The rate of change in the resistance of a conductor with change in its temperature.

Temperature Correction.—The correction made in the apparent reading of any value, such as resistance or specific gravity, to make up for the change in that value caused by changes in temperature.

Temperature Limit.—The temperature at which there is some certain change, such as the greatest allowable resistance, in an electrical instrument.

Terminal.—A point to which electrical connections are made.

Terminal Voltage.—Voltage measured between the terminals of an electrical source or a current consuming device.

Tesla Coil.—A high ratio air-core transformer whose primary is excited by the discharge of a condenser across a spark gap, and in whose secondary is induced a high-frequency high-voltage current which forms a discharge in a spark gap which is part of the secondary circuit. It has no iron core.

Test Clip.—A spring clip attached to the end of a wire from which it is desired to make a temporary connection through the clip to a circuit or to a conductor.

Test Lamp.—An incandescent lamp bulb and base with two wires attached so that the lamp may be temporarily inserted in a circuit for testing purposes.

Test Lead.—A flexible insulated lead used chiefly for connecting meters and test instruments to a circuit under test.

Test Pattern.—A stationary design or pattern transmitted in the same manner as pictures from a television station, having lines, circles, and other designs which are helpful during adjustment of receiver controls.

Test Point.—A sharp metal prod attached to the end of a conductor so that it may temporarily be connected to a circuit for testing purposes.

Test Prod.—A sharp metal point provided with an insulated handle and means for connecting the point to a test lead. It is used for making a touch connection to a circuit terminal.

Test Set

Test Set.—Any set of electrical measuring instruments mounted for convenient use in making tests.

Testing Transformer.—A transformer inserted in a wiring system for the purpose of locating short circuits, grounds, etc.

Tetrapolar.—Having four poles.

Tetrode.—A four-electrode vacuum tube. Ordinarily, these electrodes will be the cathode, control grid, screen grid, and anode.

Thermal Devices.—Devices such as relays and cutouts that are operated usually by the expansion of parts which are heated by flow through them or through adjacent parts of an electric current. Excessive current causes excessive heating, and the expansion that operates the device. In other styles the overheating melts a fusible metal which releases the operating parts.

Thermionic Tube.—An electronic tube in which electron emission takes place from a heated cathode.

Thermocouple.—A device that converts heat directly into emf and electric current. The thermocouple consists of two metals, such as copper and constantan, directly in contact at a point which is heated and either directly in contact or connected through a meter or similar unit at a point kept relatively cool. The emf is proportional to the difference between temperatures at the hot and cold junctions.

Thermocouple Meter.—A moving coil meter equipped with a thermocouple heated by alternating current to be measured and producing a direct current that actuates the meter.

Thermo-Electricity.—Electricity produced by heat.

Thermo Galvanometer.—A galvanometer operating by the heating effect of electricity in conductors.

Thermostat.—A device made of two different metals fastened together so that their unequal expansion when heated bends the combination and opens or closes contacts in a circuit.

Thermostatic Regulation.—Regulation of a generator's output by means of a thermostat which acts to insert resistance or take it out of the field circuit with changes of the generator's temperature.

Thin-Plate Battery.—A lead-acid storage battery having very thin plates from which a high rate of discharge may be taken.

Third Brush Generator.—A direct current generator whose output is controlled by third brush regulation.

Third Brush Regulation.—Control of a direct current generator's output by the reduction in field current taken through an extra brush, as the effect of armature reaction at high speeds reduces the voltage at this extra brush.

Third Rail.—A rail placed a few inches

Thread Rubber Separator

above the track rails and through which current is taken into the motor circuits of an electric car or locomotive through contact shoes sliding along the third rail.

Thread Rubber Separator.—A storage battery plate separator made of hard rubber through which pass many thousands of fine cotton threads to allow circulation of the electrolyte.

Three-Band Receiver.—A radio receiver having three different tuning ranges. One range will always include the broadcast band, and may also include police stations operating on frequencies just above the broadcast band. The other two ranges will usually be from about 2.2 mc. to about 7.5 mc., and from about 7.25 mc. to about 24 mc.

Three-gun Picture Tube.—A color television picture tube in which three electron guns emit three electron beams, one for each primary color. Each beam is directed onto phosphor dots which emit only the corresponding primary color. Each gun is controlled by its appropriate primary color signal.

Three-Phase.—Descriptive of an alternating-current circuit or apparatus in which there are at the same time three separate alternating potentials and three accompanying alternating currents. The time difference between the three phases is 120 electrical degrees.

Three Phase Generator.—An alternating current generator furnishing current to a three phase circuit.

Three Phase Motor.—An alternating current motor operating on a three phase circuit.

Three-Pole.—A switch or other part controlling three conductors or three circuits at one time.

Three Unit Electrical System.—In automobile starting and lighting, a system using a separate generator, a separate starting motor, and a separate ignition system.

Three-Way Switch.—A switch that connects one of its terminals alternately to two other terminals, used in a circuit for controlling a single lamp from two different locations.

Three Wire Generator.—A direct current generator whose neutral wire is connected to the middle point of a balancer coil which is connected across the armature windings.

Three-Wire System.—A direct-current supply system in which the voltage from one wire, called the neutral, to either of the others is half that which exists between the other two wires. For example, the voltage from the neutral to either of the "outside wires" may be 110, and between the two outside wires may be 220.

Throw-Over Switch.—A double-pole switch that may be quickly thrown from one circuit connection to another.

Thyratron.—A gas-filled or a mercury-

- vapor type of hot-cathode electronic tube in which there is an electrostatic grid for control of the instant of starting of ionization and current flow. Some thyratrons have an additional shield grid or screen grid. Used as a controlled rectifier in such work as welding, motor control, voltage regulation, and similar fields.
- Tickler.** — A coil connected in series with the plate circuit for the purpose of feeding a portion of the amplified signal current back into the grid circuit by induction for repeated amplification. The tickler is used chiefly in regenerative detector circuits.
- Tilt Control.** — An adjustment for waveform of parabolic current or voltage in the convergence system of a three-gun color television picture tube. The peak of the waveform is shifted or tilted to occur earlier or later.
- Tilted Gun Ion Trap.** — A television picture tube ion trap design with which initial direction of both electrons and ions is at angle to the tube axis because of inclining the entire electron gun at an angle to the tube axis. Requires only a single external magnet to bring electrons onto the axis.
- Time Constant.** — A capacitive time constant or inductive time constant, which see.
- Time Delay Device.** — A device such as relay or circuit breaker that operates only after a period of time following some change of current or voltage, or some other action in an electrical system.
- Time Flutter.** — Variation in the synchronization of components of a radar system, leading to variations in the position of the observed pulse along the time base, and reducing the accuracy with which the time of arrival of a pulse may be determined.
- Time Signals.** — Naval Observatory time signals which are broadcast regularly each day by government radio station NAA in Arlington, Virginia on a number of different frequencies.
- Time Switch.** — A switch operated by clock work to open or close at a certain time.
- Timer.** — The device which closes and opens a primary ignition circuit through a rotating contact to determine the time at which the spark takes place, the commutator.
- Timer.** — That part of the radar set that initiates pulse transmission and synchronizes this with the beginning of indicator sweeps, timing of gates, range markers, etc.
- Timed Wire.** — Copper wire covered with a coating of tin to prevent the materials in the insulation from affecting the copper itself.
- Tip Side of Wire.** — In telephone work, the conductor connected to the tip side of the jack.
- Toggle Switch.** — A small switch operated by means of a lever.
- Toll Broadcasting.** — Broadcasting for the reception of which a charge is made.
- Tolerance.** — The permissible variation from a rated or assigned value.
- Tone.** — The general character of a reproduced radio program as it affects the human ear.
- Tone Control.** — A circuit control sometimes provided on a radio receiver to permit strengthening the response at either low or at high audio frequencies at will, so as to make the reproduced radio program more pleasing to a particular audience.
- Toothed Ring Armature.** — A ring armature having teeth on the core between which the windings are placed.
- Top Cap.** — A metal cap sometimes placed on the top of a vacuum tube and connected to one of the electrodes, usually the control grid.
- Torsion Balance.** — A device for measuring the repulsion between magnets or conductors carrying electric charges by their twisting effect on a wire.
- Torsion Dynamometer.** — A dynamometer which measures the torque of a machine by the effect produced in twisting a spring in the dynamometer.
- Torque.** — Turning effort. The effect of a force that tends to cause rotation of parts about a center. An electric motor exerts torque at its shaft when supplied with current, and if the torque is sufficiently great it will cause the shaft to rotate.
- Touring Switch.** — In an automobile starting and lighting system, a switch that may be opened to stop the generator from charging the battery.
- Trace.** — A visible luminous line produced on the phosphor or viewing screen of a television picture tube or cathode-ray tube by travel of the electron beam over the screen.
- Tracking.** — A term used to indicate that all of the tuned circuits in a receiver follow the frequency indicated by the tuning dial pointer as the receiver is tuned over its entire tuning range.
- Track Bond.** — See bond.
- Track Circuit.** — In electric railway work, the circuit through the rails and their bonds.
- Track Return.** — In electric railway work, a return circuit completed through the rails and bonds.
- Tractive Magnet.** — An electromagnet used to cause motion in a part attached by the magnet so that work is done.
- Trailers.** — In television pictures, bright streaks at the right of large dark areas or heavy dark lines of the pictures, or dark areas or streaks at the right of bright parts in pictures. Trailers may be so long as to extend through other objects in pictures. The usual cause is lack of gain at low video frequencies.

Train Lighting Battery.—A storage battery adapted for use in the electric lighting systems on railway trains.

Transconductance.—In an electronic tube containing a control grid, the ratio of a small change in plate current to the small change of control grid voltage that causes the current change when all other voltages in the tube remain unchanged. Equal to amplification factor divided by plate resistance. Plate current change in amperes divided by grid voltage change in volts gives transconductance in ohms. Multiplying by 1,000 gives transconductance in microohms, the usual unit. Transconductance is called also mutual conductance.

Transcription.—An electrical transcription in which a complete radio program is recorded for future use.

Transformer.—A device including two separate electric circuits and a common magnetic circuit. By induction, the transformer changes alternating current or pulsating direct current from one circuit to another with or without change in the voltage and amperage of the currents.

Transformer Coil.—An induction coil with two windings.

Transformer Coil Magneto.—An ignition magneto whose low tension current is used to produce high voltage in an outside transformer coil.

Transmission Line.—Any set of conductors used to carry r.f. or a.f. signals or energy from one location to another.

Transformer Coupling.—A connection made through transformers placed between the stages of amplification.

Transformer Efficiency.—The ratio of the electric power of the current going into a transformer to the power of the secondary circuit from the transformer.

Transformer Loss.—The difference between the power of the current used by a transformer and the power of the current produced by the transformer.

Transformer Oil.—Oil used to fill the space around transformer windings and cores. It provides insulation and also helps to carry away the heat.

Transformer Ratio.—The ratio of the voltage secured from a transformer to the voltage supplied to that transformer.

Transformer Substation.—A station in which are the transformers for reducing the high voltage current from the transmission lines to a voltage suitable for use in the light or power lines supplied from the station.

Transite.—A hard, tough insulating material used where there is little or no moisture.

Transmission Dynamometer.—A dynamometer which does not absorb nor dissipate the power or torque of the machine being tested.

Transmission Line.—Two conductors which connect the two sides of the gap in a dipole antenna to antenna input terminals of a tuner or receiver. The conductors may be supported only by spaced insulators, may be embedded in a ribbon of insulation, or may be in a coaxial cable.

Transmission Line.—The conductors through which high voltage current is carried for long distances between the power station and the sub-stations.

Transmission System.—A system of high voltage transmission lines.

Transmitter.—The part of a telephone set that receives the voice sounds and allows them to affect the circuit so that the message may be carried. A comprehensive term applying to all of the equipment used for generating and amplifying an r.f. carrier signal, modulating this carrier with intelligence, and radiating the modulated r.f. carrier into space after it is amplified additionally and fed to the transmitting antenna.

Transmitting Antenna.—An antenna especially designed and suited for sending out or transmitting radio waves.

Transmitting Set.—The apparatus used for sending radio messages.

Transponder.—The unit of the IFF system which receives the interrogator signal and automatically transmits the reply.

A radar term.
Transposition.—Changing the relative positions of wires with reference to each other at different points along a line to avoid induction and electrostatic effects between them.

Trap.—A wave trap.

Treble.—A word descriptive of the higher audible frequencies.

Tree.—A growth of conducting material that takes place between storage battery plates through any openings in their separators or around the edges of the separators.

T.R.F.—Tuned radio frequency.

Trembler.—The vibrating armature of an electromagnet, operated by its closing and opening the circuit around the magnet through contacts change in that value caused by attached to the armature.

Triad.—On the viewing screen of a three-gun color television picture tube, a triangular group of three small phosphor dots, each emitting one of the three primary colors.

Trickle Charge.—A long continued charge of a storage battery at a very low rate, usually at one-quarter to one-half ampere.

Tricolor Picture Tube.—One type of three-gun color television picture tube.

Trigger Control.—A form of control for thyratrons and ignitrons with which current flow may be started or stopped, but not regulated as to rate.

Triggered Spark Gap.—A fixed spark gap in which the discharge passes between two electrodes and is struck

Triggering

(started) by a subsidiary electrode, the trigger, to which low power pulses are applied at regular intervals from a pulse amplifier, thus closing the switch.

A radar term.

Triggering.—Causing a relaxation oscillator, such as a television sweep oscillator, to begin one of its operating cycles.

Trimming.—Fitting new carbons into arc lamps.

Trimmer Condenser.—A small semi-adjustable condenser, usually adjusted with a screwdriver, and used in the tuning circuits of radio receivers and other radio apparatus to permit accurate alignment of these circuits.

Trio.—Same as triad.

Triode.—A three-electrode vacuum tube, usually having a cathode, control grid and anode.

Triphase.—Three separate alternating currents generated by one machine and separated by one-third of a cycle. Three phase.

Triple Ignition.—An ignition system using a high tension magneto, also transformer coil ignition from the magneto, and also an auxiliary battery as the three sources of current.

Triple-Pole Switch.—A three-pole switch.

Trolley Cross-Over.—The device which allows two trolley lines to cross each other without electrical contact between them.

Trolley Frog.—The connection between two trolley wires where one line branches off from another.

Trolley Wire.—A wire carried above electric railroad tracks through which current is taken into the motor circuits of an electric car through a trolley wheel.

TR Switch.—Transmit-receive switch. A switch which prevents the transmitted energy from getting to the receiver, but allows the received energy, which is much weaker, to reach the receiver without appreciable loss. This is necessary when the same antenna is used for both transmission and reception.

A radar term.

True Power.—The power actually consumed in an alternating-current circuit or equipment, is distinguished from the apparent power which would be equal to the number of volts multiplied by the number of amperes input to the circuit. See Power Factor. Power factor is the ratio of true power to apparent power.

True Resistance.—Ohmic resistance.

Trunk.—The conductors between telephone exchanges or switchboards.

Tube.—A vacuum tube, gaseous tube or photoelectric cell mounted in a somewhat tube-shaped glass or metal envelope.

Tube Insulator.—A tubular insulator in which conductors are carried through

Tube Set

walls and partitions.

Tube Set.—A receiving set employing electron tubes as detectors and amplifiers.

Tube Tester.—A test instrument used to test the condition of radio tubes.

Tubular Condenser.—A paper or electrolytic condenser having as its plates long strips of foil which have been rolled into a compact tubular shape.

Tuned Circuit.—A resonant circuit, consisting of a coil and condenser which are preset or can be adjusted to give resonance at a desired frequency.

Tuned Transformer.—A transformer having a condenser in its circuit to allow adjustment of the circuit's natural frequency.

Tuned Radio Frequency Receiver.—A receiver in which r.f. amplification is provided by a number of vacuum tube amplifier stages, each of which has one or more circuits which are tuned to resonance at the incoming signal frequency by a section of the gang tuning condenser. The amplified r.f. signals are fed directly into the detector for demodulation.

Tuner.—The portion of a television or radio receiver located electrically between antenna or transmission line and the intermediate-frequency amplifier. Includes one or more r.f. amplifiers, an r.f. oscillator, a mixer, and their associated circuits.

Tungur Bulb.—A gaseous diode rectifier tube employed in battery chargers.

Tungsten.—A pure metal used in radio chiefly for the filaments and other elements of radio tubes.

Tungsten Filament.—An incandescent lamp bulb filament made of the metal tungsten, which may be safely heated to a higher degree than filaments of other materials and which consequently gives more light from the same current.

Tungsten Steel.—Steel alloyed with tungsten, the alloy being commonly used for making permanent magnets.

Tuning.—The process of varying the inductance of capacity in a coil-condenser circuit to provide resonance at a desired frequency. Also, the process of setting all of the tuning circuits in a radio receiver simultaneously to a desired frequency by rotating the tuning dial or pressing a button of a push-button tuner.

Tuning Coil.—A coil whose inductance is variable to allow adjustment to respond to a particular wave length.

Tuning Eye.—A cathode ray tuning indicator tube.

Tuning Indicator.—A device which indicates when a radio receiver is tuned accurately to a radio station.

Tuning Meter.—An ordinary meter connected into a radio receiver circuit for use as a tuning indicator.

Turn.—In a coil, one complete loop of wire around the coil form.

Turntable.—In a record player or electric phonograph, the motor-driven

- disc on which the phonograph record is placed. In a sound recorder, the motor-driven disc on which is placed the disc to be cut.
- Turret Tuner.**—A television tuner including a drum rotatable by the channel selector. Around the drum are strips of insulation that carry inductors, and sometimes capacitors and other elements, for tuning the antenna circuit, r.f. amplifier, and r.f. oscillator. There is one group of tuning elements and one strip or pair of strips for each channel. Rotating the drum or turret connects its elements through spring contacts to tube circuits.
- Twenty-four Hour Charge Rate.**—The rate in amperes at which a storage battery may be safely charged from the time it is placed in the charging circuit until the charge is complete.
- Twin Cable.**—A cable having two insulated conductors running parallel, without twisting.
- Two-Band Receiver.**—A radio receiver having two reception ranges. One will generally cover from 535 kc. to 1720 kc., which includes the broadcast band and some police calls, and the other will generally be between 5.65 mc. and 18.1 mc.
- Two-Phase.**—Descriptive of an alternating current circuit or equipment in which there are at the same time two voltages, and two currents differing in phase position by 90 electrical degrees.
- Two-Phase Generator.**—An alternating current generator furnishing current for a two-phase circuit.
- Two-Phase Motor.**—An alternating current motor operating on a two-phase circuit.
- Two-Pole.**—Connected to, or controlling the current in two conductors or two circuits at the same time.
- Two Spark Ignition.**—An ignition system which produces two sparks in the engine cylinder at exactly the same instant but at different points in the combustion space.
- Two Unit System.**—In automobile starting and lighting, a system which uses a separate starting motor with an ignition-generator, or one which uses a motor-generator with separate ignition.
- Two-Wire Circuit.**—A circuit in which both sides are carried through insulated conductors, with neither side grounded.
- U**
- U.H.F.**—Ultra-high frequency.
- Ultor.**—The television picture tube electrode or set of electrodes that operate at highest voltage, for electron beam acceleration. Called also the second anode.
- Ultra Audion.**—A tube capable of sustained oscillations in a local circuit, and thus adapted for beat reception.
- Ultra-high Frequencies.**—In radio and electronic applications, frequencies from 300 to 3,000 megacycles per second.
- Ultra-Violet.**—Radiation at wavelengths shorter than those of visible light, but longer than those of X-rays. Wavelengths between approximately 3,500 and 50 Angstrom units.
- Unbalanced Line.**—A transmission line of which one conductor is grounded and the other ungrounded, although both carry signal voltages from a dipole antenna to a receiver. A coaxial cable is the usual form.
- Unbalanced Load.**—In a light or power distributing system, a greater load on some branches than on others.
- Undamped Oscillation or Wave.**—Oscillations which maintain a constant amplitude, which do not rapidly die away.
- Undercharge of Battery.**—The condition of a storage battery brought about by insufficient charging current regardless of the amount of discharge.
- Undercompounded.**—In a compound wound generator, the proportion between the shunt, and the compound series windings that allows a drop of voltage as the load increases.
- Undercutting of Commutator.**—Removing the mica insulation between commutator segments to a little distance below the surface to clear the brush contact.
- Underfloor Raceway.**—A completely closed raceway of metal or fibre embedded in the fill, or in the fill and concrete, of floors. Also, open bottom raceway laid on a smooth pad of concrete within the floor or the floor fill.
- Underground Cable.**—A cable whose insulation is suited to withstand dampness and electrolysis when placed underground.
- Underload Circuit Breaker.**—A circuit breaker arranged to open when the current through its circuit drops below a certain value for which the breaker is set.
- Underplaster Extension.**—A flattened metal raceway, either rigid or in the form of flexible cable, designed to be placed in a groove cut into plaster or other wall finish and then covered with the finish.
- Undervoltage Protection.**—Means that, upon failure or reduction of voltage, the protective device interrupts power to the main circuit and maintains the interruption.
- Undervoltage Release.**—Means that, upon failure or reduction of voltage, the protective device interrupts power to the main circuit, but does not prevent again completing the main circuit upon return of voltage.
- Undulatory Current.**—A current whose polarity, or direction of flow, and whose amperage change slowly.
- Undulatory Discharge.**—A discharge whose amperage changes gradually.

Unidirectional

Unidirectional.—Maintaining the same polarity or the same direction of current flow at all times.

Uniphase.—A single alternating current.

Uniphase Alternator.—An alternating current generator producing a single-phase current.

Unipolar Armature.—The armature used with an acyclic machine.

Unipolar Machine.—An acyclic machine.

Unity Power Factor.—A power factor of 1.00, which exists in a circuit wherein the voltage and current are in phase.

Universal Motor.—A series-wound motor, with commutator and brushes, which is so designed and constructed as to run satisfactorily on either alternating or direct current.

Universal Output Transformer.—An iron-core a.f. output transformer having a number of taps on its windings to permit its use in practically any average radio receiver.

Universal Receiver.—A receiver capable of operating from either a.c. or d.c. power.

Unmodulated.—Without modulation. The r.f. carrier signal alone, as it exists during pauses between station programs.

V

V.—An abbreviation for "volts."

Vacuum.—A space from which practically all air has been removed.

Vacuum Cutout.—A reverse current cutout whose contacts are held closed by the vacuum in the intake of an internal combustion engine and which are allowed to open when the engine stops and the vacuum drops.

Vacuum Impregnating Process.—Filling the spaces in electrical parts with insulating compound which is allowed to flow around the parts while they are in a chamber from which the air is exhausted.

Vacuum Tube.—A device consisting of a number of electrodes mounted in an envelope or housing from which practically all air has been removed.

Vacuum Tube Detector.—A detector employing an electron tube.

Vacuum Tube Light.—Light produced by currents through vacuum tubes.

Vacuum Tube Voltmeter.—A measuring instrument usually containing a bridge circuit with triodes in two arms, so connected that a voltage applied to the grid of one triode unbalances the bridge. Resulting difference between plate or cathode currents goes through a d.c. current meter built into the instrument. Meter indications are proportional to, and read in, the voltage applied to the grid of one bridge tube. The chief characteristic is very great input resistance and proportionately light loading of measured circuits.

Valve.—The term used in Great Britain to designate radio tube.

Vapor Rectifier

Vapor Rectifier.—A mercury vapor rectifier.

Variable Condenser.—A condenser whose capacity may be changed either by varying the space between plates (as in a trimmer condenser) or by varying the amount of meshing between the two sets of plates (as in a tuning condenser).

Variable Inductance.—The inductance in circuits or coils having an iron core whose permeability changes with the change of magnetomotive force.

Variable Resistance.—A resistance so arranged that the amount of it in a circuit may be changed.

Variable Spark.—An ignition spark whose time of passing in the cylinder of an engine may be changed in relation to the position of the piston in its stroke.

Variable Speed Generator.—A generator having some system of control which prevents too high an output when the generator is operated at various speeds.

Variable Speed Motor.—A series wound motor whose speed changes according to the load it is driving. Also motors whose speed is varied by mechanical and electrical adjustments.

Variocoupler.—A coupler in which one winding may be rotated inside the other winding.

Variometer.—A pair of coil windings whose relative position may be adjusted to change the inductance in a circuit.

Varley Loop Test.—A method of testing telephone circuits for grounds, shorts, etc., by connecting the ends of the circuit to one side of a Wheatstone bridge.

Varnished Cloth or Cambric.—Cotton or linen cloth treated with linseed oil and resin. It has high electrical resistance. It is also called varnished cambric.

Velocity Constant or Factor.—Speed or velocity at which high-frequency waves or charges travel through a transmission line or a resonant line, expressed as a fraction of the wave velocity in space. Transmission line constants commonly are between 0.66 and 0.82, depending on structure and materials.

Velocity Modulation.—A type of modulation in which successive electrons in a stream of electrons are given different velocities at different instants by the action of varying electric fields. The faster electrons overtake the slower ones and form electron bunches at certain points in the stream, with intervening regions in which there are relatively few electrons. There are greater charges due to more electrons in the bunches, and weaker charges at the intervening regions.

Verdigris.—Copper sulphate, a greenish substance formed by the action of sulphuric acid on copper.

Vernier Condenser.—A small variable tuning condenser which is placed in parallel with a larger tuning condenser for the purpose of providing a finer adjustment after the large condenser has been set roughly to the desired position.

Vernier Coupling.—A driving coupling that allows very small relative changes to be made in the position of one shaft with reference to another shaft connected to it through the coupling.

Vernier Dial.—A type of tuning dial in which a complete rotation of the control knob makes the tuning condenser shaft rotate only a small fraction of a revolution, thereby permitting fine and accurate tuning.

Vertical Antenna.—A single vertical metal rod, suspended wire or metal tower used as an antenna.

Vertical Oscillator.—In a television receiver, the oscillator that utilizes the vertical synchronizing and blanking signals, also the equalizing signals, to produce voltages which, when amplified, operate the deflecting plates or coils in the picture tube.

Vertical Sync.—Correct timing or synchronization of vertical deflections of the electron beam in a television picture tube with respect to vertical sync pulses in the composite signal.

Very-high Frequencies.—In radio and electronic applications, frequencies from 30 to 300 megacycles per second.

Vestigial Sideband Transmission.—Descriptive of a television carrier whose sidebands extend to a frequency 4.0 megacycles higher than that of the video carrier, but to only 0.75 megacycle lower than that carrier, with cutoff of still lower sidebands. Allows video signals up to 4.0 megacycles, also a modulated sound carrier and necessary guard bands, within a standard 6.0-megacycle channel. The standard method of television transmission.

V.H.F.—Very-high frequency.

Vibrating Rectifier.—An alternating current rectifier in which current carrying contacts are made to operate in time with the alternating current cycle so that all impulses of one polarity are directed one way and all impulses of the other polarity in another way through a charging circuit.

Vibrating Relay Regulation.—Control of the output of a generator by a relay whose armature vibrates to open and close contacts which insert and withdraw a resistance in the field circuit of the generator.

Vibrator.—An electromagnetic device which converts a d.c. voltage to pulsating d.c. or a.c. It is used in the power packs of auto radios and some public address amplifiers to convert the 6-volt auto storage battery voltage to a low a.c. voltage. The a.c. voltage is then stepped up by a power transformer, and converted

into a high d.c. voltage either by a conventional rectifier tube circuit or by an extra set of contacts on the vibrator itself.

Vibrator Coil.—An ignition coil whose primary circuit is rapidly made and broken by the action of a vibrating armature and contacts operated by the magnetism in the core of the coil itself.

Video.—A latin word meaning "I see," applied to television parts and circuits which handle picture signals, and applied also to signals associated with the picture being transmitted.

Video Amplifier.—In a television receiver, the amplifier that strengthens video signals. Located electrically between output of the video detector and picture tube signal input elements. It is a broad band amplifier.

Video Carrier.—The television carrier wave whose amplitude is modulated by the video signal consisting of picture variations, blanking, and all sync pulses. The unmodulated frequency is 1.25 megacycles higher than the low limit of the channel, and 4.5 megacycles lower than the second sound carrier in the same channel.

Video Detector.—In a television receiver, the detector, usually a diode, that rectifies or demodulates video intermediate-frequency signals and thereby recovers amplitude modulation representing the composite television signal.

Video Frequency.—One of the frequencies present in the output of a television camera as a result of scanning the image being transmitted. It may be any value from almost zero to well over 4,000,000 cycles.

Video Signal.—The changing voltage which corresponds to the changing lights and shades in the image being scanned at the television receiver and reproduced at the receiver.

Viewing Screen.—In a television picture tube, the surface on which are phosphors made luminous by the electron beam during formation of picture lights and shadows. May be called the phosphor screen or simply the screen.

Viscous Hysteresis.—A gradual increase in magnetism caused by a long continued magnetizing force.

Voice Coil.—The moving coil which is attached to the diaphragm of a dynamic loudspeaker.

Volt.—The practical unit of electromotive force or pressure. One volt is the pressure required to send one ampere through a circuit whose resistance is one ohm.

Volt-Ohm-Milliammeter.—A test instrument having provisions for measuring voltage, resistance and current. It consists essentially of a single meter having the necessary number of scales, and a switch which places the meter in the correct circuit for a particular measurement.

Voltage Amplification.—Amplification which increases the voltage of a sig-

- nal rather than its power. Also a rating obtained by dividing the a.c. output voltage of an amplifier stage by the a.c. input voltage.
- Voltage Coil.**—A magnet or relay winding, the current and strength of which are changed by changes of voltage in a circuit to which the coil is connected in parallel.
- Voltage Divider.**—Two or more resistances or capacitances in series across a source of direct or alternating voltage. Taps, intermediate terminals, or sliding contacts on resistors, or adjustable sections of capacitors, allow taking a portion of total applied voltage to other circuits.
- Voltage Doubler.**—A voltage multiplier delivering d.c. voltage equal approximately to twice the applied a.c. r.m.s. line voltage.
- Voltage Drop.**—A difference in voltage due to flow of current between two points separated by resistance in conductors; equal to the current in amperes multiplied by the resistance in ohms through which the current flows.
- Voltage Gradient.**—The change of voltage or pressure along a circuit due to the resistance of the conductors.
- Voltage Loss.**—The voltage drop in a circuit.
- Voltage Multiplier.**—Rectifiers and capacitors connected to deliver d.c. output voltage equal to two, three, or more times the a.c. r.m.s. input voltage. The principle is that of charging capacitors in parallel from the rectified d.c. voltage and discharging them in series to add their voltage in the d.c. output.
- Voltage Ratio of Transformer.**—The ratio of the effective primary voltage to the effective secondary voltage of a transformer.
- Voltage Regulator.**—A transformer having windings in series with the circuit and other windings in shunt with the circuit, so that the voltage change is variable. A device used in a generator circuit or in connection with a generator to maintain a practically constant voltage as there are changes in speed or load.
- Voltage Regulation.**—See Regulation.
- Voltage Regulator Tube.**—A two-element gaseous tube used in a.c. radio receivers to keep the input a.c. voltage to the receiver power pack essentially constant despite wide variations in the line voltage. Also used to maintain a constant d.c. potential across a circuit.
- Voltage Rating of a Condenser.**—The maximum sustained voltage which can safely be applied across the terminals of a condenser without causing breakdown of the insulation between condenser plates.
- Voltage to Ground.**—In an ungrounded or two-wire circuit, the greatest voltage between the specified conductor and any other conductor. In a grounded circuit, the voltage between a specified conductor and the point in the circuit that is grounded.
- Voltaic Arc.**—An arc.
- Voltaic Battery.**—A number of voltaic cells connected together in series or parallel.
- Voltaic Cell.**—A combination of electrodes and electrolyte that acts as a source of electric voltage and current, as distinguished from an electrolytic cell which requires a current from an outside source.
- Voltaic Circuit.**—The circuit connected to a voltaic cell or battery.
- Voltaic Couple.**—The two electrodes which produce electricity when placed in an electrolyte to form a voltaic cell.
- Voltaic Electricity.**—Electricity produced by a voltaic cell.
- Voltammeter.**—A voltmeter and an ammeter in a single case, or sometimes an instrument for measuring watts (volts x amperes) in a direct-current circuit.
- Volt-Ampere.**—A unit of apparent power in an alternating-current circuit. Equal to the product of volts and amperes without reference to the phase difference, if any. Whenever there is any phase difference between voltage and current, the true power in watts is less than the apparent power in volt-amperes.
- Volt-Coulomb.**—The electrical energy which will increase the potential of a coulomb of electricity one volt. The joule.
- Voltmeter.**—An instrument which measures and indicates the pressure or potential of electricity directly in volts.
- Volume.**—The intensity of the sound produced by a radio loudspeaker.
- Volume Control.**—A device which varies the a.f. output of a receiver or p.a. amplifier, thereby changing the volume of the sound produced by the loudspeaker.
- Volume Expander.**—A special manually-adjusted audio circuit which can be set to increase the volume range of a radio program or phonograph record by making the weak passages weaker and the loud portions of the program louder. Volume expanders are also made as self-contained, self-powered units which can be inserted between a phono pick-up and the input terminals of an audio amplifier.
- Volume Unit.**—A recently developed method of expressing the power level in broadcast equipment with reference to a fixed power level of .001 watt.
- V.T.V.M.**—Vacuum tube voltmeter.
- VU.**—Volume unit.
- Vulcaneston.**—A moulded material made of asbestos and rubber.
- Vulcanite.**—Hard rubber.
- Vulcanized Fibre.**—An insulating material having fairly high electrical resistance, used where low first cost is important.

W

Wall Box.—A metal box set into a wall and carrying switches, fuses, etc.

Wall Insulator.—An insulator for carrying a conductor through a wall or partition.

Wall Socket.—A socket set into a wall so that conductors may be attached to the circuit through a plug inserted in the socket.

Watch Case Receiver.—A telephone receiver carried in a small case similar in shape to that for a watch.

Water Analogy.—The hydraulic analogy.

Water-Cooled Transformer.—A transformer, usually of large capacity, which is cooled by circulation water about its part.

Water-Proof Wire.—Wire having rubber insulation which resists the continued effect of water and dampness.

Wafer Socket.—A type of socket in which the clips for gripping the tube prongs are mounted between two wafers or sheets of insulating material.

Water Rheostat.—A resistance formed by inserting the ends of two conductors in a bath of water so that the resistance of the water between the conductors forms the rheostat.

Waterproof.—So protected or constructed that moisture will not interfere with satisfactory operation.

Watertight.—So protected or constructed that water will not enter the enclosure.

Watt.—The practical unit of electric power. In a direct-current circuit the expended power in watts is equal to the number of volts applied to the circuit multiplied by the number of amperes flowing in the circuit due to the applied voltage. In an alternating-current circuit the watts of power consumed are equal to the number of applied volts multiplied by the number of amperes of current, and multiplied by the power factor.

Wattage Rating.—A rating expressing the maximum power which a device can safely absorb or handle. To determine how high a wattage rating is required for a particular resistor, multiply the value in ohms of the resistor by the square of the current which is to flow through the resistor (resistance \times current \times current), and choose a resistor having a wattage rating approximately twice the computed value so as to give ample margin of safety in operation.

Watt-Hour.—A measure of electric power. The power of one watt used for one hour.

Watt-Hour Meter.—An electrical measuring instrument which indicates power in watt-hours.

Wattmeter.—An instrument for measuring the power of an electric current in watts.

Watt-Minute.—A power of one watt

used for one minute.

Watt-Second.—A power of one watt used for one second.

Wattless.—An alternating current which can not be used for useful work.

Wave.—Any continually varying quantity, such as an alternating current, sound wave, or radio wave.

Wave Bands.—The limits or range of wave lengths between which certain classes of broadcasting are allowed.

Wave Form.—The shape of a curve showing the rise and fall of alternating current through a cycle.

Wavelength.—The distance travelled in a time of one cycle by an alternating current, sound wave or radio wave. This is the same as the distance between successive peaks having the same polarity in the wave. For wave motion in ether the wavelength in meters is equal to the number 299,820,000 divided by the frequency in cycles per second.

Wave Meter.—An instrument for observing the form of an alternating current wave.

Wave Trap.—A circuit intended to attenuate or to bypass an undesired frequency. A parallel resonant trap circuit in series with a signal-carrying line attenuates the frequency at which the trap is resonant. A series resonant trap circuit from a line to ground or B-minus bypasses the trap resonant frequency to ground.

Wave Winding.—An armature winding in which each coil is connected at opposite or nearly opposite points on the commutator.

Weatherproof.—So protected or constructed that exposure to weather will not prevent or interfere with satisfactory operation.

Weatherproof.—Materials insulated with fabrics carrying compounds that resist the action of weather.

Weston Cell.—A primary electric cell used as a standard of voltage. It uses electrodes of mercury and cadmium.

Wet Storage.—Placing a storage battery out of service without removing the electrolyte or the plates from the cells.

Wheatstone Bridge.—An instrument that allows calculation of values of resistance, inductance or capacitance in parts or circuits connected into the bridge circuit; the calculation involving one ratio of resistances which are adjustable in the bridge circuit, and another ratio in which one value is known and the other is the value of the unknown resistance, inductance or capacitance. When adjustments make the two ratios equal the bridge is said to be balanced, and the condition of balance may be indicated by a galvanometer or other current-sensitive device.

White Level.—In a composite television signal, the potential or voltage that

Windage

causes brightest or whitest areas in pictures. In carrier signal modulation the white level is at approximately 15 per cent of the maximum or total amplitude from zero to peaks of sync pulses.

Windage.—The air's resistance or retarding effect against the rotation of an armature.

Wind Charger.—A generator driven by a propeller mounted on or geared to its shaft. The unit must be mounted in a location where wind velocity is sufficient to rotate the propeller; this means it should be on a mast or tower extending well above surrounding trees and buildings. The generator is usually of the d.c. type, and is used for charging a radio storage battery or the batteries of a 32-volt farm-lighting plant.

Winding.—One or more turns of wire which make up a continuous coil. Used chiefly in coils, transformers and electromagnetic devices.

Wipe Contact Distributor.—An ignition distributor whose rotor makes a wiping contact with segments through which the high tension current is carried to the spark plug wires.

Wipe Spark.—An electric spark produced by the separation of two conductors which have been wiped across one another.

Wiping Contact.—An electrical contact made between two parts which slide over one another.

Wire.—A metallic conductor having essentially uniform thickness, used in radio chiefly to provide a path for electric currents between two points. It may be bare or covered with an insulating material such as enamel, cotton, linen or silk.

Wire Finder.—A galvanometer used to locate the opposite ends of wires in a cable when one end is connected to a circuit.

Wire Gauge.—A measure of the diameter or size of a wire. The size is expressed in numbers.

Wired Radio.—Communication by means of radio waves or silk.

Wired Wireless.—Radio transmission through telephone, telegraph or other electric wires as a part of the circuit replacing the antenna and the air.

Wireless Record Player.—A motor-driven turntable and phono pick-up mounted in the same cabinet with an r.f. oscillator. The phono pick-up converts a recording into a.f. signals which modulate the r.f. carrier of the oscillator. The resulting signal is radiated through space, as a miniature broadcast signal, and can be picked up by any radio receiver in the same house merely by tuning that receiver to the broadcast band frequency on which the wireless record player is operating.

Wireway.—Sheet metal troughs which are installed as a complete raceway

Wire Wound

system to receive conductors.

Wire-Wound Resistor.—A resistor which is constructed by winding a high-resistance wire on an insulating form. The resulting element may or may not be covered with a ceramic insulating layer.

Wiring Cleat.—See cleat.

Wiring Connector.—See connector.

Wiring Symbols.—Small diagrams which indicate the different kinds of electrical devices and the different ways of making connections in a circuit.

Wobble Plate.—In a permanent-magnet centering device for a television picture tube, an iron plate or ring whose opening may be shifted in relation to the magnets for varying the direction of field lines and thereby shifting the entire picture on the viewing screen.

Wobbulator.—A sweep generator.

Wood Separator.—A storage battery plate separator made of wood that has been treated to remove the injurious organic acids.

Work.—A force multiplied by the distance through which it causes a mass or weight to move. If a force of one pound causes a movement of one foot, the work done is equal to one foot-pound, this being one of the units in which work may be measured. Work is the result of a force acting against some form of opposition to motion. It is measured as the product of the force and the distance through which it acts.

Wound Pole.—A field pole on which there is a winding, as distinguished from a consequent pole without a winding.

Wound Rotor Motor.—An alternating-current induction motor on whose rotor are wire windings connected to slip rings which rotate with the motor shaft and on which bear contact brushes. External adjustable resistors are connected into the rotor windings through the brushes and slip rings. The resistors permit adjustment of motor speed and torque.

Wrought Iron.—A kind of iron having great magnetic permeability, or ability to carry magnetism with ease.

X

Xc.—A symbol for capacitive reactance.
X-Cnt.—A piezo-electric crystal or quartz plate cut in such a manner that X-axis is perpendicular to its faces. Also sometimes called Currie cut and a zero-angle cut.

X-Rays.—A form of radiation which will penetrate opaque substances and affect photographic plates or films, or produce fluorescence, thus showing otherwise invisible differences in structure as lights and shadows. The rays are produced by the striking of an electron stream against a solid object called the target in an X-ray tube.

X's.—Disturbances caused by static.

Y.

Y

Y.—Symbol used for the admittance in ohms.

Yagi Antenna.—A half-wave dipole antenna with usually a single reflector but with two or more directors. Inherently a narrow band, high gain type with sharp directional properties.

Y-Axis.—In a quartz crystal, a line perpendicular to the two diametrically opposite parallel faces. It lies in a plane which is at right angles to the X-axis.

Y-Connection.—A connection between the inner ends of three alternating current circuits in the form of the letter Y, a star connection.

Y-Cut.—A piezo-electric crystal cut in such a manner that the y-axis is perpendicular to its faces. Also sometimes called a face-parallel cut or thirty-degree cut.

Yoke.—A structure mounted around the neck of a television picture tube, at or near the forward end of the neck, containing electromagnetic coils in

Z.

which sawtooth currents cause deflection of the electron beam. There is a pair of coils for vertical deflection, and another pair for horizontal deflection.

Yoke.—The frame to which the field magnet pole pieces are attached in an electric machine.

Y-signal.—The luminance signal in color television.

Z

Z.—A letter used in formulas to designate impedance.

Zero-Beat.—A condition where two frequencies are exactly the same.

Zero Bias.—Zero voltage between the control grid and cathode of a vacuum tube, so that these two electrodes are at the same potential.

Zero Potential.—Having neither positive nor negative voltage or pressure.

Zinc-Carbon Cell.—A primary electric cell using electrodes of zinc and carbon.

Zonal Flux.—The light from a source measured in certain places or zones

Data Section

The following section is the Data Section of this Dictionary & Data Book. It contains charts, formulas, wiring diagrams, symbols, rules and other quick reference material to aid you in your electrical or radio —Television Work.

All of this material has been especially selected to provide you with **IMPORTANT** material that electricians and radio-TV men have almost daily use for in their work.

SYMBOLS INTERIOR WIRING

Single Convenience Outlet		Ceiling Outlet	
Double Convenience Outlet		Ceiling Fan Outlet	
Watchman Station		Floor Outlet	
Special Purpose Outlet—Lighting, Heating and Power as Described in Specification		Drop Cord	
Special Purpose Outlet—Lighting, Heating and Power as Described in Specification		Wall Bracket	
Special Purpose Outlet—Lighting, Heating and Power as Described in Specification		Wall Fan Outlet	
Automatic Door Switch	S^D	Junction Box	
Key Push Button Switch	S^K	Exit Light	
Push Button Switch and Pilot	S^P	Pull Switch	
Remote Control Push Button	S^R	Electrolier Switch	S^E
Local Switch—Single Pole	S^1	Motor	
Local Switch—Double Pole	S^2	Motor Controller	
Local Switch—3 Way	S^{3^1}	Lighting Panel	
Local Switch—4 Way	S^4	Power Panel	
This Character Marked on Tap Circuits Indicates 2 No. 14 Conductors in 1/2-in. Conduit		Heating Panel	
3 No. 14 Conductors in 1/2 in. Conduit.		Pull Box	
4 No. 14 Conductors in 3/4 in. Conduit unless Marked 1/2 in.		Meter	
Cable Supporting Box		Transformer	

SYMBOLS INTERIOR WIRING

Feeder, Run Exposed	-----	Pole Line	
Feeder, Run concealed under Floor	--- --	Push Button	
Branch Circuit, Run concealed under Floor Above	_____	Annunciator	
Branch Circuit, Run Exposed	-----	Interior Telephone	
Branch Circuit, Run concealed under Floor	--- --	Public Telephone	
Feeder, Run concealed under Floor Above	_____	Clock (Secondary)	
Local Fire Alarm Gong		Speaking Tube	
Local Fire Alarm Station		Nurses Signal Plug	
Fire Alarm Central Station		Maid's Plug	
Electric Door Opener		Horn Outlet	

	STRAIGHT WIRES		BELL
	JOINED WIRES		BUZZER
	CROSSED WIRES		ELECTRO-MAGNET
	OPEN CIRCUIT PUSH BUTTON SWITCH		DROP RELAY
	CLOSED CIRCUIT PUSH BUTTON SWITCH		DOOR OPENER
	DOUBLE CIRCUIT PUSH BUTTON SWITCH		PONY RELAY
	SINGLE CELL		SOUNDER
	3 CELL BATTERY		KEY
			ANNUNCIATOR

SYMBOLS—INDUSTRIAL WIRING

CONTACTORS

MAIN CIRCUIT CONTACTS					
INSTANT CLOSING				DELAYED CLOSING (DASHPOT TYPE)	
WITH BLOWOUT		WITHOUT BLOWOUT		WITHOUT BLOWOUT	
N.O.	N.C.	N.O.	N.C.	WITH BLOWOUT	WITHOUT BLOWOUT

CONTACTOR - RELAY			AUXILIARY CIRCUIT CONTACTS		MECHANICAL INTER-LOCK
SHUNT	SERIES	THERMAL	N.O.	N.C.	

PUSH BUTTONS

SINGLE CIRCUIT		DOUBLE CIRCUIT		MAINTAINED CONTACT
N.O.	N.C.	N.O.	N.C.	

LIMIT SWITCHES

LUB ERD (EED) FITCH	N.O.		N.C.	
	INITIALLY - OPEN		INITIALLY - CLOSED	
	OPEN	CLOSED	OPEN	CLOSED

SOLENOID	REACTOR	TRANSFORMERS			FUSE
		AUTO.	POTENTIAL	CURRENT	

SYMBOLS—INDUSTRIAL WIRING

TIMING RELAY CONTACTS

DASHPOT OR PNEUMATIC ACTION RETARDED WHEN COIL IS -				
ENERGIZED			DE-ENERGIZED	
N.O.	N.C.	N.O.	N.O.	N.C.

KNIFE SWITCHES	
SINGLE POLE	
MULTI POLE	

MAINTAINED CONTACT SWITCHES		TERMINALS ON TERMINAL BLOCKS	PRESSURE OR VACUUM SWITCH		BATTERY (STORAGE OR PRIMARY)
SINGLE THROW	DOUBLE THROW		N.O.	N.C.	

RESISTORS			MEYER SHUNT	CONDENSER
FIXED	TAPPED	RHEOSTAT		

(DENOTE PURPOSE)

OVERLOAD RELAY CONTACTS

THERMAL	MAGNETIC			
	DASHPOT (DELAYED TRIP)		INSTANT. TRIP	
	N.C.	N.O.	N.C.	N.C.

AIR CIRCUIT BREAKERS	
SINGLE POLE	
MULTI POLE	

SEPARABLE CON-NECTOR	TEST JACK	METER	LIGHTS		FLOAT SWITCH	
			SIGNAL	DENOTE COLOR BY LETTER	N.O.	N.C.

CONDUCTORS AND INSULATION

Each type of conductor insulation affords a given maximum safe-operating temperature. Figure 15 shows various types of insulation, together with the "type letter"—which is the identification accepted by the trade in referring to the particular grade of insulation—and the maximum allowable operating temperature.

If a given type of conductor insulation is subjected for any considerable length of time to a temperature higher than its maximum operating temperature, the insulation will deteriorate rapidly.

Figure 15—Insulation Table

Insulation	Type Letter	Maximum Operating Temperature
Code Grade Rubber.....	R	50°C (122°F)
Performance Grade Rubber.....	RP	60°C (140°F)
Heat Resistant Rubber.....	RH	75°C (167°F)
Small Diameter Building Wire, Performance.....	RPT	60°C (140°F)
Small Diameter Building Wire, Heat Resistant.....	RHT	75°C (167°F)
Type RU Wire.....	RU	60°C (140°F)
Synthetic.....	SN	60°C (140°F)
Weatherproof.....	WP	80°C (176°F)

VOLTAGE DROP

The sizes of conductors given in the charts and figures in this handbook are based on the current-carrying capacity of the conductors only; no consideration has been given to voltage drop.

The conductors of an electrical system should be of sufficient size, not only so that the development of dangerous temperatures is prevented, but also wasted power in the form of voltage drop is restricted. It is impractical to avoid all "drop," but it must be held to nominal, practical proportions.

The recommended allowable maximum voltage drop on the various portions of an interior electrical system is illustrated in Figure 16. It is good

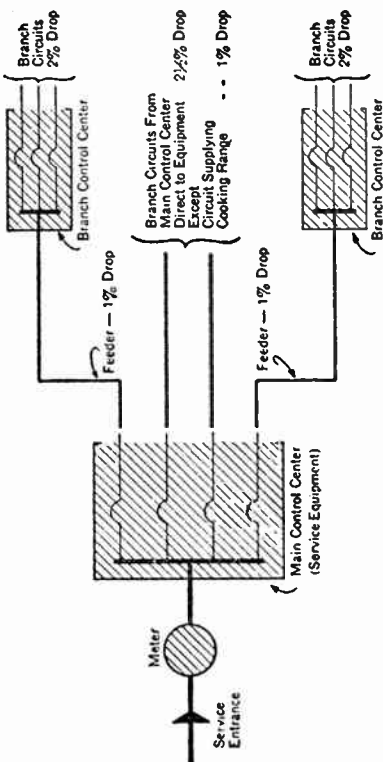

Fig. 16—Recommended Allowable Maximum Voltage Drops

practice to have the conductors on the system of such size as to keep the voltage drop within those shown on this figure. As a general rule, the voltage drop in a branch circuit supplying a cooking range should not exceed one per cent.

To determine if a conductor sized for "current-carrying capacity" will also keep the voltage within the allowable bounds shown in Figure 16, a check against Figures 17, 18, 19 or 20

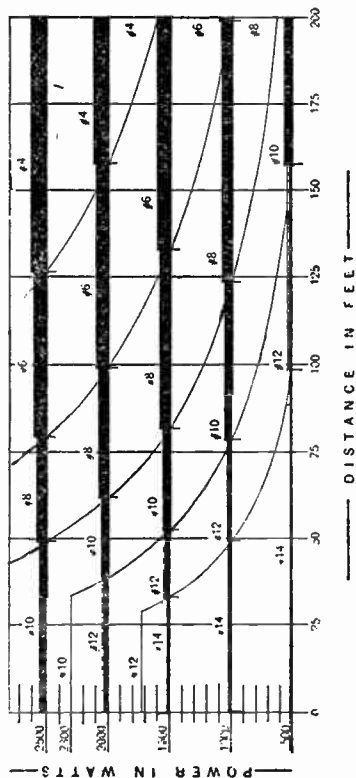

Fig. 17—Conductor Size Based on Voltage Drop. (115-Volt Branch Circuit—2% Drop)

will give the answer. Each of these figures covers a specific type of feeder or circuit, and — based on economical voltage drop, capacity of load in watts and the distance of the circuit in feet — the proper size of conductor can be readily selected. The wattages and the length of runs have been restricted to such as may be found in the average home

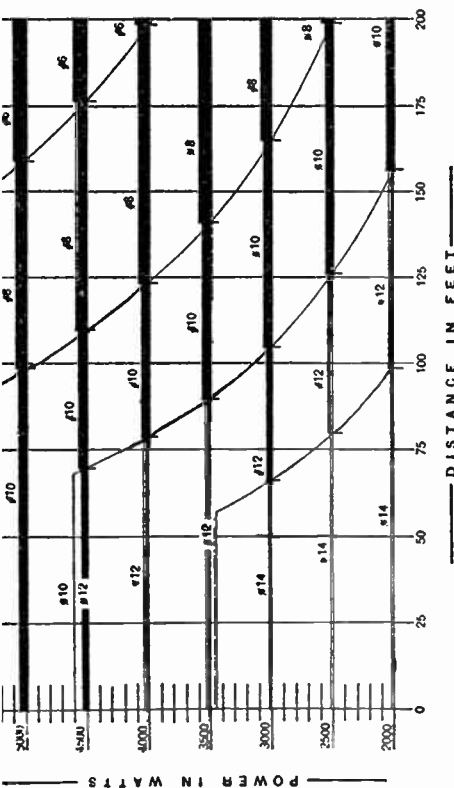

Fig. 18—Conductor Size Based on Voltage Drop. (230-Volt Branch Circuit—2% Drop)

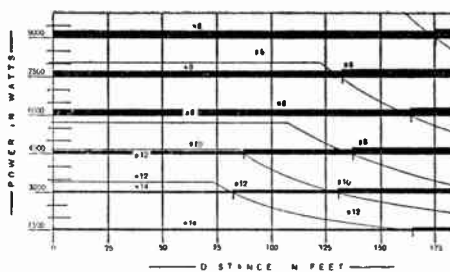

Fig. 19—Conductor Size Based on Voltage Drop (230-Volt Branch Circuit—2½ Drop)

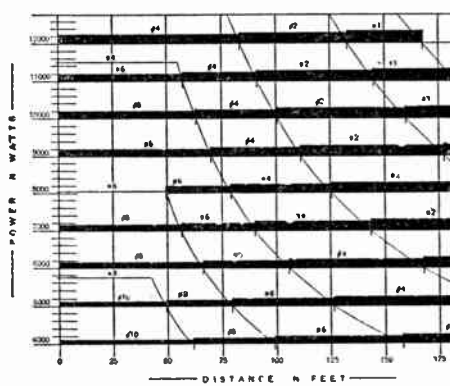

Fig. 20—Conductor Size Based on Voltage Drop. (230-Volt Branch Feeder—1% Drop)

The graphs in Figures 21 and 22 (see next page) indicate the relation of voltage to certain operating characteristics of the more common electric loads.

For example: In Figure 21 it will be noted that a 115-volt lamp, operated at 110 volts (95.7 per cent), gives light output less than 85 per cent—but the over-all cost of light increases by 5 per cent. In Figure 22, it is noted that a drop in voltage from 115 to 110 volts will decrease the temperature of a range surface unit to about 97 per cent of normal, and increase the time to about 107 per cent of normal.

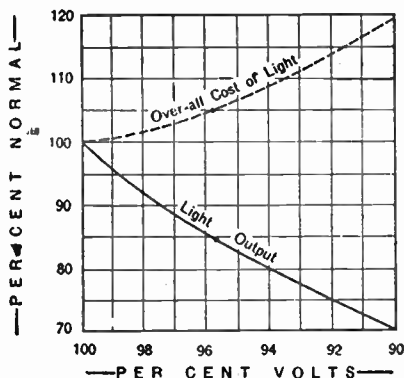

Fig. 21

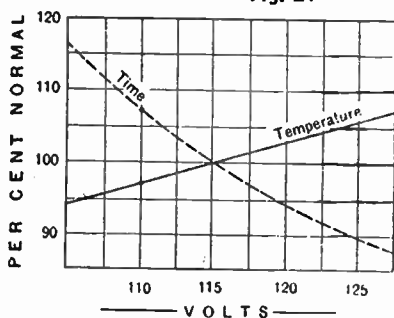

Fig. 22—

In order to show the application of the voltage drop figures, the following example is given:

Question:— A 115-volt branch circuit carries 1,500 watts (13 amp.) a distance of 75 feet. It is desired to keep within 2 per cent voltage drop (2.3 volts). Will a No. 12 conductor (carrying capacity, 20 amp.) satisfy?

Answer:— No. 12 conductor will not satisfy. Figure 17 shows that No. 12 conductor will carry 1,500 watts about 53 feet with a 2 per cent drop. No. 10 conductor is necessary to carry the given load 75 feet without uneconomical waste.

Some Basic Facts About Voltage Drop:

— When an electric current flows through a conductor, a part of the electrical energy is turned into heat, and the temperature of the conductor is raised. The amount of energy so changed into heat, measured in watts, is equal to the resistance of the conductor in ohms, multiplied by the square of the current or ($P=I^2R$).

For example: The resistance of 100 feet of No. 12 wire is approximately 0.16 ohm. (See table on "Properties of Copper Conductors" under Chapter X.) With a 10-ampere current flow in a No. 12 conductor, and a total length of wire of 100 feet, the energy lost in the form of heat will be $10 \times 10 \times 0.16$, or 16 watts. In doubling the current to 20 amperes, the loss in watts will be 64 ($20 \times 20 \times 0.16$).

Furthermore, voltage drop is equal to the resistance of the conductor in ohms, multiplied by the current in amperes ($E=IR$). In the case of the above example the voltage drop would be 10×0.16 , or 1.6 volts, and 20×0.16 , or 3.2 volts, respectively.

In other words, voltage drop is simply wasted electricity. A 5 per cent drop means a 5 per cent waste. The percentage decrease in heat produced by any electrically-heated device is approximately twice the percentage decrease in the voltage delivered.

For example: Assume the voltage (230 V) at the service equipment to be the same as the rated voltage (230 V) of the heating element of a cooking range. With a 5 per cent voltage drop (11.5 V) in the electric line to the range, the heat produced in the elements will be reduced 10 per cent—this can only mean unsatisfactory performance.

**DIAMETER, WEIGHT, AND RESISTANCE OF
STANDARD ANNEALED COPPER WIRE**
Round, Solid Conductor
(Based on National Bureau of Standards)

Awg Size	Diam, Mils	Area, Circular Mils	Weight, Bare Wire, Lb per 1000 Ft	Resistance at 25 C (77 F)	
				Ohms per 1000 Ft	Ft per Ohm
0000	460.0	211,600	640.5	0.04998	20,010
000	499.6	167,800	507.9	0.06302	15,870
00	361.8	133,100	402.8	0.07947	12,580
0	324.9	105,500	319.5	0.1002	9980
1	289.3	83,690	253.3	0.1264	7914
2	257.6	66,370	200.9	0.1593	6276
3	229.4	52,640	159.3	0.2009	4977
4	204.3	41,740	126.4	0.2533	3947
5	181.9	33,100	100.2	0.3195	3130
6	162.0	26,250	79.46	0.4028	2482
7	144.3	20,820	63.02	0.5080	1969
8	128.5	16,510	49.98	0.6405	1561
9	114.4	13,090	39.63	0.8077	1238
10	101.9	10,380	31.43	1.018	981.8
11	90.74	8234	24.92	1.284	778.7
12	80.81	6530	19.77	1.619	617.5
13	71.96	5178	15.68	2.042	489.7
14	64.08	4107	12.43	2.575	388.3
15	57.07	3257	9.858	3.247	308.0
16	50.82	2533	7.818	4.094	244.2
17	45.26	2048	6.200	5.163	193.7
18	40.30	1624	4.917	6.510	153.6
19	35.89	1288	3.899	8.210	121.8
20	31.96	1022	3.092	10.35	96.6
21	28.46	810.1	2.452	13.05	76.61
22	25.35	642.4	1.945	16.46	60.75
23	22.57	509.5	1.542	20.76	48.18
24	20.10	404.0	1.223	26.17	38.21
25	17.90	320.4	0.9699	33.00	30.30
26	15.94	254.1	0.7692	41.82	24.03
27	14.20	201.5	0.6100	52.48	19.06
28	12.64	159.8	0.4837	66.17	15.11
29	11.26	126.7	0.3836	83.44	11.98
30	10.03	100.5	0.3042	105.2	9.504
31	8.928	79.70	0.2413	132.7	7.537
32	7.950	63.21	0.1913	167.3	5.977
33	7.080	50.13	0.1517	211.0	4.740
34	6.305	39.75	0.1203	266.0	3.759
35	5.615	31.52	0.09542	335.5	2.981

**DIAMETER, WEIGHT, AND RESISTANCE OF
STANDARD ANNEALED COPPER WIRE (Co)**
Round, Solid Conductor
(Based on National Bureau of Standards)

Awg Size	Diam, Mils	Area, Circular Mils	Weight, Bare Wire, Lb per 1000 Ft	Resistance at 25 C (77 F)	
				Ohms per 1000 Ft	Ft per Ohm
36	5.000	25.00	0.07568	423.0	2.3
37	4.453	19.83	0.06001	533.4	1.8
38	3.965	15.72	0.04759	672.6	1.4
39	3.531	12.47	0.03774	848.1	1.1
40	3.145	9.89	0.02993	1069.	0.9
41	2.800	7.84	0.02374	1349.	0.7
42	2.494	6.22	0.01883	1701.	0.5
43	2.221	4.93	0.01493	2144.	0.4
44	1.978	3.91	0.01184	2704.	0.3

RECOMMENDED MAXIMUM CAPACITOR RATING WHEN CAPACITOR AND INDUCTION MOTOR ARE SWITCHED AS A UNIT*

Motor Hp Rating	Motor Speed, Rpm				
	3600	1800	1200	900	720
	Capacitor Rating, Kvar				
10	2.5	4	4	5	5
15	2.5	5	5	7.5	7.5
20	5	5	5	7.5	10
25	5	7.5	7.5	10	10
30	7.5	10	10	10	12.5
40	10	10	10	12.5	15
50	12.5	12.5	12.5	15	20
60	15	15	15	17.5	22.5
75	17.5	17.5	17.5	20	27.5
100	22.5	22.5	22.5	25	35
125	25	27.5	27.5	30	40
150	32.5	35	35	37.5	47.5
200	42.5	42.5	42.5	45	60

*Representative data for 3-phase, 60-cycle, general purpose, open-type induction motors. The motor full power factor with these capacitor ratings will range 95 to 98 per cent. The kvar values are selected to prevent overvoltage from motor self-excitation and to prevent excessive transient torque on the motor.

MOTOR WIRING

Approx Full-load Amp	Min. Size Wire, Awg or MCM, Type R	† Size Conduit, In.	† Rating of Branch-circuit Fuses, Amp	Approx Full-load Amp	Min. Size Wire, Awg or MCM, Type R	† Size Conduit, In.	† Rating of Branch-circuit Fuses, Amp
----------------------	------------------------------------	---------------------	---------------------------------------	----------------------	------------------------------------	---------------------	---------------------------------------

3-phase Squirrel-cage Induction Motors

220 VOLTS				440 VOLTS			
3.5	14	1 1/2	15	1.8	14	1 1/2	15
5	14	1 1/2	15	2.5	14	1 1/2	15
6.5	14	1 1/2	20	3.3	14	1 1/2	15
9	14	1 1/2	30	4.6	14	1 1/2	15
15	12	1 1/2	45	7.5	14	1 1/2	25
22	8	1	70	11	14	1 1/2	35
27	8	1	80	14	12	1 1/2	45
40	5	1 1/4	125	20	10	3/4	60
52	3	1 1/4	175	26	8	1	80
64	2	1 1/2	200	32	6	1 1/4	100
78	0	2	250	39	5	1 1/4	125
104	000	2	300	52	3	1 1/4	150
125	0000	2 1/2	350	63	2	1 1/2	175
150	300	3	400	75	0	2	200
185	400	3	500	93	00	2	250

Single-phase Induction Motors

115 VOLTS				230 VOLTS			
7.4	14	1 1/2	25	8.7	14	1 1/2	15
10.2	14	1 1/2	35	5.1	14	1 1/2	15
13	12	1 1/2	40	6.5	14	1 1/2	25
18.4	10	3/4	60	9.2	14	1 1/2	30
24	8	3/4	80	12	14	1 1/2	40
34	6	1	110	17	10	3/4	60
				28	8	3/4	70

The values given are for not more than three conductors raceway or cable, and having rubber insulation, other than the so-called performance and heat-resisting types. In general, larger current values are permitted for the latter types and for single conductors in free air. For which see National Electrical Code. In order to avoid excessive voltage drop where long runs are involved, it may be necessary to use conductors and conduit of sizes larger than the minimum sizes listed above. Conduit size for 3-phase squirrel-cage induction motors refers to three conductors in one conduit. Conduit size for single-phase and direct-current motors refers to two conductors in one conduit.

MOTOR WIRING (Cont.)

Hp	Approx Full-load Amp	Min. Size Wire, Awg or MCM, Type R	† Size Conduit, In.	† Rating of Branch-circuit Fuses, Amp	Approx Full-load Amp	Min. Size Wire, Awg or MCM, Type R	† Size Conduit, In.	† Rating of Branch-circuit Fuses, Amp
----	----------------------	------------------------------------	---------------------	---------------------------------------	----------------------	------------------------------------	---------------------	---------------------------------------

Direct-current Motors

	115 VOLTS			230 VOLTS				
	1	8.6	14	1 1/2	15	4.3	14	1 1/2
1 1/2	12.6	12	1 1/2	20	6.3	14	1 1/2	15
2	16.4	10	3/4	25	8.2	14	1 1/2	15
3	24	8	3/4	40	12	14	1 1/2	20
5	40	5	1 1/4	60	20	10	3/4	30
7 1/2	58	2	1 1/2	90	29	6	1	45
10	78	0	1 1/2	125	38	5	1 1/4	60
15	112	0000	2	175	56	2	1 1/4	90
20	148	300	2 1/2	225	74	0	1 1/2	125

† The fuse rating may be as much as 400% of motor rated current to permit motor to start, but should be kept as low as possible for best short-circuit protection. Additional protection of an approved type must be provided to protect each motor against overloads. Thermal air circuit breakers are also extensively used for branch-circuit protection. Ratings, in general, are somewhat lower than those listed for fuses.

MELTING POINTS OF ELEMENTS

(Based on National Bureau of Standards)

Element	Melting Point, C	Element	Melting Point, C
Aluminum.....	660.0±0.1	Molybdenum....	2625±50
Antimony.....	630.5±0.1	Nickel.....	1455±1
Beryllium.....	1280±40	Nitrogen.....	-210±0.3
Bismuth.....	271.3±0.1	Oxygen.....	-218.8±0.3
Cadmium.....	320.9±0.1	Palladium.....	1554±1
Carbon.....	3700±100	Platinum.....	1773.5±1
Chromium.....	1800±50	Potassium.....	63±1
Cobalt.....	1490±20	Silver.....	960.5±0.0
Copper.....	1083.0±0.1	Sodium.....	97.7±0.2
Gold.....	1063.0±0.0	Sulfur(Mono)...	119.2±0.2
Hydrogen.....	-259.2±0.1	Tantalum.....	3000±100
Iodine.....	114±1	Tin.....	231.9±0.1
Iridium.....	2454±3	Titanium.....	1820±100
Iron.....	1535±3	Tungsten.....	3410±20
Lead.....	327.4±0.1	Vanadium.....	1735±50
Magnesium.....	650±2	Zinc.....	419.5±0.1
Manganese.....	1260±20		
Mercury.....	-38.87±0.02		

Temperatures below -190 C are on the Centigrade Thermodynamic Scale

**FULL-LOAD AMPERES IN SINGLE-PHASE
CIRCUITS OF VARIOUS VOLTAGES**

Kva	120 V	240 V	480 V	2400 V	4160 V
1.5	12.5	6.3	3.1	0.63	0.36
2.5	20.8	10.4	5.2	1.04	0.60
3	25.0	12.5	6.3	1.25	0.72
5	41.7	20.8	10.4	2.08	1.20
7.5	62.5	31.3	15.6	3.13	1.80
10	83.3	41.7	20.8	4.17	2.40
15	125	62.5	31.3	6.25	3.61
25	208	104	52.1	10.4	6.01
37.5	313	156	78.1	15.6	9.01
50	417	208	104	20.8	12.0
75	625	313	156	31.3	18.0
100	833	417	208	41.7	24.0
150	1250	625	313	62.5	36.1
200	1667	833	417	83.3	48.1
250	2083	1042	521	104	60.1
333	2775	1388	694	139	80.0
500	4167	2083	1042	208	120

**FULL-LOAD AMPERES IN THREE-PHASE
CIRCUITS OF VARIOUS VOLTAGES**

Kva	208 V	240 V	480 V	2400 V	4160 V
4.5	12.5	10.8	5.41	1.08	1.08
7.5	20.8	18.0	9.02	1.80	1.80
9	25.0	21.7	10.8	2.17	1.80
10	27.8	24.1	12.0	2.41	1.80
15	41.6	36.1	18.0	3.61	2.41
22.5	62.5	54.1	27.1	5.41	3.61
25	69.4	60.1	30.1	6.01	3.61
30	83.3	72.2	36.1	7.22	4.81
37.5	104	90.2	45.1	9.02	6.01
45	125	108	54.1	10.8	6.01
50	139	120	60.1	12.0	6.01
75	208	180	90.2	18.0	10.8
100	278	241	120	24.1	13.8
112.5	312	271	135	27.1	15.6
150	416	361	180	36.1	20.8
200	555	481	241	48.1	27.1
225	625	541	271	54.1	31.3
300	833	722	361	72.2	41.7
450	1249	1083	541	108.3	62.5
500	1388	1203	601	120	69.4
600	1665	1443	722	144	83.3
750	2082	1804	902	180	104

Kva	4800 V	7200 V	7620 V	12,000 V	13,200 V
1.5	0.31	0.21	0.20	0.13	0.11
2.5	0.52	0.35	0.33	0.21	0.19
3	0.63	0.42	0.39	0.25	0.23
5	1.04	0.70	0.66	0.42	0.38
7.5	1.56	1.04	0.98	0.62	0.57
10	2.08	1.39	1.31	0.83	0.76
15	3.13	2.08	1.97	1.25	1.14
25	5.21	3.47	3.28	2.08	1.89
37.5	7.81	5.21	4.92	3.13	2.84
50	10.4	6.95	6.56	4.17	3.79
75	15.6	10.4	9.84	6.25	5.68
100	20.8	13.9	13.1	8.33	7.58
150	31.3	20.8	19.7	12.5	11.4
200	41.7	27.8	26.2	16.7	15.2
250	52.1	34.8	32.8	20.8	18.9
333	69.4	46.3	43.7	27.8	25.2
500	104.2	69.5	65.6	41.7	37.9

Kva	4800 V	7200 V	8320 V	11,500 V	12,000 V	13,200 V
4.5	0.54	0.36	0.31	0.23	0.22	0.2
7.5	0.90	0.60	0.52	0.38	0.36	0.3
9	1.08	0.72	0.62	0.45	0.43	0.3
10	1.20	0.80	0.69	0.50	0.48	0.4
15	1.80	1.2	1.04	0.75	0.72	0.6
22.5	2.71	1.8	1.56	1.13	1.08	0.9
25	3.01	2.0	1.73	1.26	1.20	1.0
30	3.61	2.4	2.08	1.51	1.44	1.3
37.5	4.51	3.0	2.60	1.88	1.80	1.6
45	5.41	3.6	3.12	2.26	2.17	1.9
50	6.01	4.0	3.47	2.51	2.41	2.1
75	9.02	6.0	6.21	3.77	3.61	3.2
100	12.0	8.0	6.94	5.02	4.81	4.3
112.5	13.5	9.0	7.81	5.65	5.41	4.8
150	18.0	12.0	10.4	7.53	7.22	6.2
200	24.1	16.0	13.9	10.0	9.62	8.7
225	27.1	18.0	15.6	11.3	10.8	9.6
300	36.1	24.1	20.8	15.1	14.4	13.1
450	54.1	36.1	31.2	22.6	21.7	19.7
500	60.1	40.1	34.7	25.1	24.1	21.6

**RESISTIVITY AND RELATIVE CONDUCTIVITY
[At 20 C (68 F)—Based on National Bureau of Standards]**

Material	Mi-crohms /Cm Cube	Per Cent of Annealed Copper	Material	Mi-crohms /Cm Cube	Per Cent of Annealed Copper
Aluminum†	2.780	62	Manganin	44	3.9
Aluminum‡	2.840	60.7	Mercury	95.78	1.8
Brass†	7	24.6	Molybdenum	5.7	30.2
Cobalt	9.7	17.8	Nickel	7.8	22.1
Constantan	49	3.5	Nichrome	100	1.7
Copper†	1.724	100.0	Platinum	10	17.2
Iron	10	17.2	Silver	1.641	108.1
Wrought Iron	13.9	12.4	Tungsten	5.51	31.3
Lead	22	7.8	Zinc	6.21	27.8

†Annealed—for annealed-copper standard, see page 47.
‡Hard-drawn.

GREEK ALPHABET

α	alpha	A	ν	nu
β	beta	B	ξ	xi
γ	gamma	Γ	ο	omicron
δ	delta	Δ	π	pi
ε	epsilon	E	ρ	rho
ζ	zeta	Z	σ	sigma
η	eta	H	τ	tau
θ	theta	Θ	υ	upsilon
ι	iota	I	φ	phi
κ	kappa	K	χ	chi
λ	lambda	Λ	ψ	psi
μ	mu	M	ω	omega

NUMBER OF CONDUCTORS IN CONDUIT OR TUBING

TABLE 4—One to Nine Conductors Rubber-Covered—Types R, RW, RP, RH, and RHT—600 V.

For more than nine conductors see Table 9.
(See sections 8032, 3466 and 3487, National Electrical Code.)

Size of Conductor	Number of Conductors in One Conduit or Tubing								
	1	2	3	4	5	6	7	8	9
No. 18	1/2	1/2	1/2	1/2	1/2	1/2	1/2	1/2	1/2
16	1/2	1/2	1/2	1/2	1/2	1/2	1/2	1/2	1/2
14	1/2	1/2	1/2	1/2	1/2	1/2	1/2	1/2	1/2
12	1/2	1/2	1/2	1/2	1/2	1	1	1	1 1/4
10	1/2	1/2	1/2	1/2	1	1	1 1/4	1 1/4	1 1/4
8	1/2	1/2	1/2	1	1 1/4	1 1/4	1 1/4	1 1/4	1 1/4
6	1/2	1	1 1/4	1 1/4	1 1/4	2	2	2	2
4	1/2	1 1/4	1 1/4	1 1/4	2	2	2	2	2 1/4
3	1/2	1 1/4	1 1/4	1 1/4	2	2	2	2 1/4	2 1/4
2	1/2	1 1/4	1 1/4	1 1/4	2	2	2 1/4	2 1/4	2 1/4
1	1/2	1 1/4	1 1/4	2	2	2 1/4	2 1/4	3	3
0	1	1 1/4	2	2	2 1/4	2 1/4	3	3	3
00	1	2	2	2 1/4	2 1/4	3	3	3 1/4	3 1/4
000	1	2	2	2 1/4	3	3	3	3 1/4	3 1/4
0000	1 1/4	2	2 1/4	2 1/4	3	3	3 1/4	3 1/4	4
250000	1 1/4	2 1/4	2 1/4	3	3	3 1/4	3 1/4	3 1/4	3 1/4
300000	1 1/4	2 1/4	3	3	3 1/4	3 1/4	3 1/4	3 1/4	3 1/4
350000	1 1/4	2 1/4	3	3 1/4	3 1/4	4	4	4	4
400000	1 1/4	3	3	3 1/4	4	4	4	4	4
450000	1 1/4	3	3	3 1/4	4	4 1/4	4 1/4	4 1/4	4 1/4
500000	1 1/4	3	3	3 1/4	4	4 1/4	4 1/4	4 1/4	4 1/4
550000	1 1/4	3	3 1/4	4	4 1/4	5	5	5	5
600000	2	3	3 1/4	4	4 1/4	5	5	5	5
650000	2	3 1/4	3 1/4	4	4 1/4	5	5	5	5
700000	2	3 1/4	3 1/4	4 1/4	5	5	5	5	5
750000	2	3 1/4	3 1/4	4 1/4	5	5	5	5	5
800000	2	3 1/4	4	4 1/4	5	5	5	5	5
850000	2	3 1/4	4	4 1/4	5	5	5	5	5
900000	2	3 1/4	4	4 1/4	5	5	5	5	5
950000	2	4	4	4 1/4	5	5	5	5	5
1000000	2	4	4	4 1/4	5	5	5	5	5
1250000	2 1/4	4 1/4	4 1/4	5	5	5	5	5	5
1500000	2 1/4	4 1/4	5	5	5	5	5	5	5
1750000	3	5	5	5	5	5	5	5	5
2000000	3	5	5	5	5	5	5	5	5

NUMBER OF CONDUCTORS IN CONDUIT OR TUBING

TABLE 5—Lead-Covered Types RL, RPL and RHL—600 V.

Size of Conductor	Number of Conductors in One Conduit or Tubing											
	Single Conductor Cable				2-Conductor Cable				3-Conductor Cable			
	1	2	3	4	1	2	3	4	1	2	3	4
14	1/2	1/2	1/2	1	1/2	1	1	1 1/4	1/2	1 1/4	1 1/4	1 1/4
12	1/2	1/2	1/2	1	1/2	1	1 1/4	1 1/4	1	1 1/4	1 1/4	1 1/4
10	1/2	1/2	1/2	1	1/2	1	1 1/4	1 1/4	1	1 1/4	1 1/4	1 1/4
8	1/2	1	1 1/4	1 1/4	1	1 1/4	1 1/4	2	1	2	2	2 1/4
6	1/2	1 1/4	1 1/4	1 1/4	1 1/4	1 1/4	2	2 1/4	1 1/4	2 1/4	3	3
4	1/2	1 1/4	1 1/4	1 1/4	1 1/4	2	2 1/4	2 1/4	1 1/4	3	3	3 1/4
3	1/2	1 1/4	1 1/4	2	1 1/4	2	2 1/4	3	1 1/4	3	3	3 1/4
2	1	1 1/4	1 1/4	2	1 1/4	2	2 1/4	3	1 1/4	3	3 1/4	4
1	1	1 1/4	2	2	1 1/4	2 1/4	3	3 1/4	2	3 1/4	4	4 1/4
0	1	2	2	2 1/4	2	2 1/4	3	3 1/4	2	4	4 1/4	5
00	1	2	2	2 1/4	2	2 1/4	3	3 1/4	2 1/4	4	4 1/4	5
000	1 1/4	2	2 1/4	2 1/4	2	3	3 1/4	4	2 1/4	4 1/4	4 1/4	5
0000	1 1/4	2 1/4	2 1/4	3	2 1/4	3	3 1/4	4 1/4	3	5	5	6
250,000	1 1/4	2 1/4	3	3	3	3	3	3	3	3	3	3
300,000	1 1/4	3	3	3 1/4	3	3	3	3	3	3	3	3
350,000	1 1/4	3	3	3 1/4	3	3	3	3	3	3	3	3
400,000	1 1/4	3	3	3 1/4	3	3	3	3	3	3	3	3
450,000	1 1/4	3	3	4	3	3	3	3	3	3	3	3
500,000	1 1/4	3	3 1/4	4	3	3	3	3	3	3	3	3
600,000	2	3 1/4	4	4 1/4	3	3	3	3	3	3	3	3
700,000	2	4	4	5	3	3	3	3	3	3	3	3
750,000	2	4	4	5	3	3	3	3	3	3	3	3
800,000	2	4	4 1/4	5	3	3	3	3	3	3	3	3
900,000	2 1/4	4	4 1/4	5	3	3	3	3	3	3	3	3
1,000,000	2 1/4	4 1/4	4 1/4	5	3	3	3	3	3	3	3	3
1,250,000	3	5	5	6	3	3	3	3	3	3	3	3
1,500,000	3	5	5	6	3	3	3	3	3	3	3	3
1,750,000	3	5	5	6	3	3	3	3	3	3	3	3
2,000,000	3 1/4	5	5	6	3	3	3	3	3	3	3	3

The above sizes apply to straight runs or with nominal offsets equivalent to not more than two quarter-bends.

TABLE 6—Small Diameter Building Wire, Types RHT and RPT, 600 Volts

One to Nine Conductors

Size of Conductor	Number of Conductors in One Conduit or Tubing								
	1	2	3	4	5	6	7	8	9
14	1/2	1/2	1/2	1/2	1/2	1/2	1/2	1/2	1/2
12	1/2	1/2	1/2	1/2	1/2	1/2	1/2	1/2	1/2
10	1/2	1/2	1/2	1/2	1/2	1/2	1/2	1/2	1/2
8	1/2	1/2	1/2	1/2	1/2	1/2	1/2	1/2	1 1/4

**Table 4 shall be used for the installation of Type RHT, small diameter building wire, except for rewiring in existing raceways as provided in sub-paragraph e of section 3065.

*Where a run of conduit or electrical metallic tubing does not exceed 50 feet in length and does not contain more than the equivalent of two quarter-bends from end to end; three No. 6 stranded conductors may be installed in a 1-inch conduit or tubing. For services only, three No. 3 insulated conductors may be installed in a 1/2-inch conduit or tubing; two No. 6 insulated and one No. 8, bare conductors or two No. 4 insulated and one No. 4 bare conductors may be installed in 1-inch conduit or tubing; and two No. 2, insulated and one No. 2, bare conductors in 1 1/2-inch conduit or tubing.

NUMBER OF CONDUCTORS IN CONDUIT OR TUBING

TABLE 7—One to Nine Conductors Synthetic, Type SN and Type RU, 600 Volts

Size of Conductor	Number of Conductors in One Conduit or Tubing								
	1	2	3	4	5	6	7	8	9
14	1 1/2	1 1/2	1 1/2	1 1/2	1 1/2	1 1/2	1 1/2	1 1/2	1 1/2
12	1 1/2	1 1/2	1 1/2	1 1/2	1 1/2	1 1/2	1 1/2	1 1/2	1 1/2
10	1 1/2	1 1/2	1 1/2	1 1/2	1 1/2	1 1/2	1 1/2	1 1/2	1 1/2
8	1 1/2	1 1/2	1 1/2	1 1/2	1 1/2	1 1/2	1 1/2	1 1/2	1 1/2
6	1 1/2	1 1/2	1 1/2	1 1/2	1 1/2	1 1/2	1 1/2	1 1/2	1 1/2
5	1 1/2	1 1/2	1 1/2	1 1/2	1 1/2	1 1/2	1 1/2	1 1/2	1 1/2
4	1 1/2	1 1/2	1 1/2	1 1/2	1 1/2	1 1/2	1 1/2	1 1/2	1 1/2
3	1 1/2	1 1/2	1 1/2	1 1/2	1 1/2	1 1/2	1 1/2	1 1/2	1 1/2
2	1 1/2	1 1/2	1 1/2	1 1/2	1 1/2	1 1/2	1 1/2	1 1/2	1 1/2
1	1 1/2	1 1/2	1 1/2	1 1/2	1 1/2	1 1/2	1 1/2	1 1/2	1 1/2
0	1 1/2	1 1/2	1 1/2	1 1/2	1 1/2	1 1/2	1 1/2	1 1/2	1 1/2
00	1 1/2	1 1/2	1 1/2	1 1/2	1 1/2	1 1/2	1 1/2	1 1/2	1 1/2
000	1 1/2	1 1/2	1 1/2	1 1/2	1 1/2	1 1/2	1 1/2	1 1/2	1 1/2
0000	1 1/2	1 1/2	1 1/2	1 1/2	1 1/2	1 1/2	1 1/2	1 1/2	1 1/2

TABLE 9—More Than Nine Conductors Rubber-Covered Types R, RW, RP, and RH—600 V.

Size of Conductor	Maximum Number of Conductors in Conduit or Tubing						
	Inch 1/4	Inch 1/2	Inch 3/4	Inch 1	Inch 1 1/2	Inch 2	Inch 3
18	13	22	38	53	87	124	191
16	11	19	33	45	74	106	163
14		11	19	26	43	61	95
12			15	21	34	50	77
10			12	16	27	38	60
8				13	22	31	49
6						14	22

*More than nine conductors are permitted in a single conduit for conductors between a motor and its controller; stage rocket and border circuits, section 5211; sign flashers, section 6021-d; elevator control conductors, section 5212; signal and control circuits, sections 5096-a-1 and 5012-b-2.

TABLE 10—Three-Conductor Convertible System Rubber-Covered Types R, RW, RP, and RH—600 V.

Size of Conductors	Size Conduit or Tubing	
	1 1/2 inch	2 inch
two	14 and one	10
"	12 "	8
"	10 "	6
"	8 "	4
"	6 "	2
"	5 "	1
"	4 "	0
"	3 "	00
"	2 "	000
"	1 "	0000
"	0 "	250000
"	00 "	350000
"	000 "	400000
"	0000 "	500000
"	250000 "	600000
"	300000 "	800000
"	400000 "	1000000
"	500000 "	1250000
"	600000 "	1500000
"	700000 "	1750000
"	800000 "	2000000

NUMBER OF CONDUCTORS IN CONDUIT OR TUBING

TABLE 11—Combination of Conductors Per Cent Area of Conduit or Tubing

Number of Conductors	Number of Conductors				
	1	2	3	4	Over 4
*Conductors (not lead covered) ..	53	31	43	40	40
Lead-covered conductors	65	30	40	38	35
For rewiring existing raceways with thinner insulated conductors as provided in 3005-d and e.	60	40	50	50	50

*For Type RHIT conductors used for other than rewiring in existing raceways, the areas shown in Table 13 shall be used in place of the areas shown in Table 14.

DIMENSIONS OF RUBBER-COVERED CONDUCTORS

TABLE 13—Types R, RW, RP, and RH

Size AWG-CM	Approx. Diam. Inches	Approx. Area Sq. Ins.	Size CM	Approx. Diam. Inches	Approx. Area Sq. Ins.
18	.14	.0154	450,000	1.08	.91
16	.15	.033	600,000	1.12	.99
14	.20	.031	650,000	1.17	1.08
12	.22	.038	600,000	1.22	1.16
10	.24	.045	650,000	1.25	1.23
8	.30	.071	700,000	1.29	1.30
6	.41	.13	750,000	1.33	1.38
4	.45	.16	800,000	1.36	1.43
2	.52	.21	850,000	1.39	1.52
1	.59	.27	900,000	1.43	1.60
0	.63	.31	950,000	1.46	1.68
00	.67	.35	1,000,000	1.49	1.75
000	.72	.41	1,250,000	1.68	2.22
0000	.78	.48	1,500,000	1.79	2.52
250,000	.86	.58	1,750,000	1.90	2.85
300,000	.92	.67	2,000,000	2.00	3.14
350,000	.98	.75			
400,000	1.03	.83			

No. 18 to No. 8, solid conductor, No. 6 and larger, stranded.

TABLE 14—Small Diameter Building Wires, Types RHIT and RPT

Size AWG	Approx. Diam. Inches	Approx. Area Sq. Ins.	Size AWG	Approx. Diam. Inches	Approx. Area Sq. Ins.
14	.162	.0206	10	.200	.0314
12	.179	.0252	8	.261	.0535

Note: Small diameter building wire, Type RPT, recognized in sizes Nos. 14, 12 and 10. No. 14 to No. 8, solid conductors.

TABLE 15—Synthetic Insulation, Type SN Type RU Insulation

Size AWG	Approx. Diam. Inches	Approx. Area Sq. Ins.	Size AWG	Approx. Diam. Inches	Approx. Area Sq. Ins.
14	.130	.0133	2	.423	.1405
12	.147	.0170	1	.496	.1935
10	.168	.0220	0	.637	.226
8	.227	.0405	00	.683	.267
6	.314	.0775	000	.634	.316
4	.363	.1035	0000	.692	.376

Note: Type SN conductors recognized in sizes Nos. 14 to No. 0000; Type RU conductors recognized in sizes No. 14 to No. 10.

No. 14 to No. 8, solid conductors, No. 6 and larger, stranded. Type N conductors without an outer covering and Type RU conductors with an outer covering have the same overall diameters.

**WIRING DIAGRAMS
(D. C. MOTORS)**

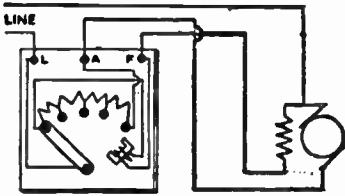

Three Wire Shunt or Compound Motor Starter

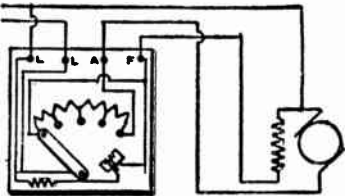

Four Wire Shunt or Compound Motor Starter

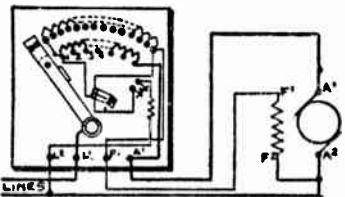

Shunt or Compound Motor Starter with Speed Control

**WIRING DIAGRAMS
(Transformers)**

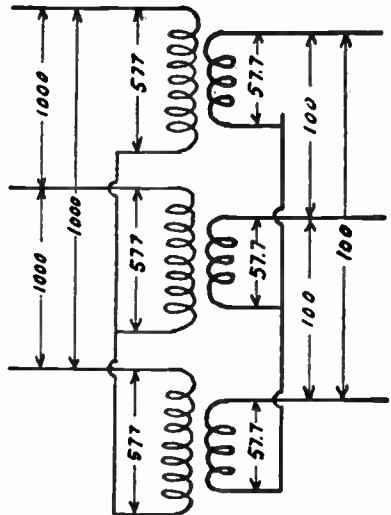
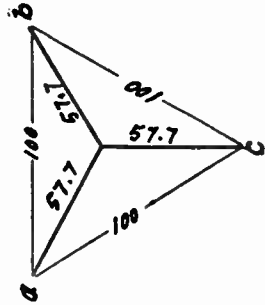

Star-Star Connection of Transformers

WIRING DIAGRAMS
(Ammeter Connections)

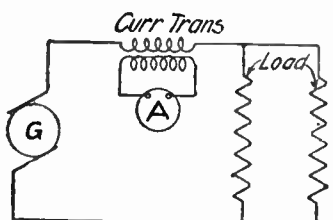
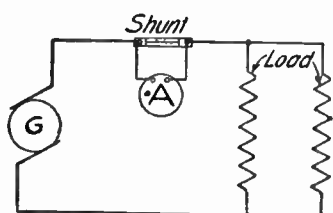
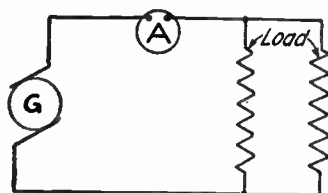

WIRING DIAGRAMS
(Voltmeter Connections)

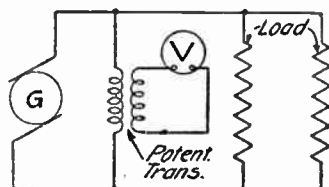
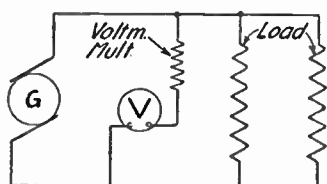
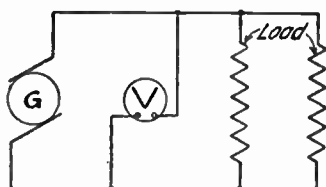

WIRING DIAGRAMS
(Transformers)

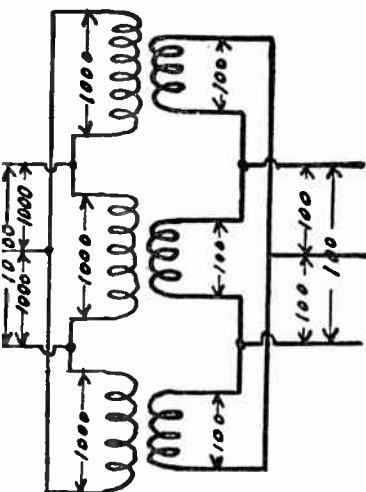

Delta-Delta Connection of Transformers

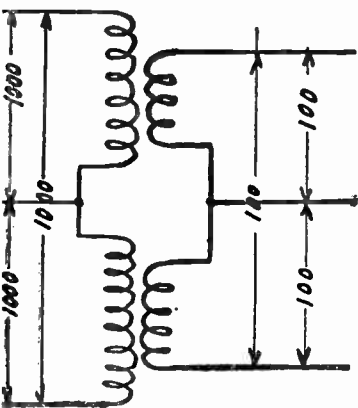

Open Delta or "V"

**DATA ON BARE, STRANDED, ANNEALED
COPPER CABLE—Concentric Lay**
(Based on National Bureau of Standards)

Size, Circular Mils	Diam, In.	No. of Wires	Diam of Wires, In.	Weight per 1000 Ft, Lb
2,000,000	1.631	127	0.1255	6180
1,750,000	1.526	127	0.1174	5400
1,500,000	1.412	91	0.1284	4630
1,250,000	1.289	91	0.1172	3860
1,000,000	1.152	61	0.1280	3090
750,000	0.998	61	0.1109	2320
500,000	0.814	37	0.1162	1540
400,000	0.728	37	0.1040	1240
300,000	0.630	37	0.0900	926
250,000	0.575	37	0.0822	772

Size, Circular Mils	Weight per Mile, Lb	D-c Resistance at 25 C (77 F)		Feet per Ohm at 25 C
		Ohms per 1000 Ft	Ohms per Mile	
2,000,000	32,630	0.00539	0.0285	185,500
1,750,000	28,512	0.00616	0.0325	162,300
1,500,000	24,446	0.00719	0.0380	139,100
1,250,000	20,381	0.00863	0.0456	115,900
1,000,000	16,315	0.0108	0.0570	92,590
750,000	12,250	0.0144	0.0760	69,440
500,000	8131	0.0216	0.1141	46,300
400,000	6547	0.0270	0.1426	37,040
300,000	4889	0.0360	0.1901	27,770
250,000	4076	0.0431	0.2281	23,200

HYDRAULIC FORMULAS

Lb per sq in = 0.434 × head of water in ft
 Head in ft = 2.3 × lb per sq in
 Weight per cu ft of fresh water at 32 F = 62.42 lb
 Weight per U. S. gallon of fresh water = 8.34 lb.

**Loss of Head (H) Due to Friction
In Clean Iron Pipes**

$$H = \frac{0.02 \times L \times V^2}{64.4 D}$$

L = length of pipe in ft; D = diameter in ft; and V = velocity of flow in fps. In calculating the total head to be pumped against, it is common to consider it equal to the sum of the friction head and the actual head.

*Average value for approximate calculations.

**FORMULÆ FOR DETERMINING AMPERES, HORSEPOWER,
KILOWATTS AND K. V. A.**

To Find	Direct Current	Alternating Current		
		Single-Phase	Two-Phase* Four-Wire	Three-Phase
Amperes when Horsepower is Known	$H.P. \times 746$ $E \times \% \text{Eff.}$	$H.P. \times 746$ $E \times \% \text{Eff.} \times P.F.$	$H.P. \times 746$ $2 \times E \times \% \text{Eff.} \times P.F.$	$H.P. \times 746$ $1.73 \times E \times \% \text{Eff.} \times P.F.$
Amperes when Kilowatts is Known	$K.W. \times 1000$ E	$K.W. \times 1000$ $E \times P.F.$	$K.W. \times 1000$ $2 \times E \times P.F.$	$K.W. \times 1000$ $1.73 \times E \times P.F.$
Amperes when K.V.A. is Known	$K.V.A. \times 1000$ E	$K.V.A. \times 1000$ E	$K.V.A. \times 1000$ $2 \times E$	$K.V.A. \times 1000$ $1.73 \times E$
Kilowatts	$\frac{I \times E}{1000}$	$\frac{I \times E \times P.F.}{1000}$	$\frac{I \times E \times 2 \times P.F.}{1000}$	$\frac{I \times E \times 1.73 \times P.F.}{1000}$
K.V.A.	$\frac{I \times E}{1000}$	$\frac{I \times E}{1000}$	$\frac{I \times E \times 2}{1000}$	$\frac{I \times E \times 1.73}{1000}$
Horse-power (Output)	$\frac{I \times E \times \% \text{Eff.}}{746}$	$\frac{I \times E \times \% \text{Eff.} \times P.F.}{746}$	$\frac{I \times E \times 2 \times \% \text{Eff.} \times P.F.}{746}$	$\frac{I \times E \times 1.73 \times \% \text{Eff.} \times P.F.}{746}$

I = Amperes; E = Volts; %Eff. = per cent Efficiency; P.F. = Power-Factor.
K.W. = Kilowatts; K.V.A. = Kilo Volt-Amperes; H.P. = Horsepower.

*For three-wire, two-phase circuits the current in the common conductor is 1.41 times that in either of the other two conductors.

POWER-FACTOR IMPROVEMENT
Figures below X kilowatt input = Kva of capacitance required to improve from one power factor to another.

Original Power-factor %	DESIRED POWER FACTOR			
	100%	95%	90%	85%
55	1.519	1.189	1.034	0.898
56	1.479	1.150	0.995	0.859
57	1.442	1.113	0.957	0.822
58	1.406	1.076	0.920	0.785
59	1.368	1.040	0.884	0.748
60	1.333	1.004	0.849	0.713
61	1.299	0.970	0.815	0.679
62	1.266	0.937	0.781	0.645
63	1.233	0.904	0.748	0.613
64	1.201	0.872	0.716	0.581
65	1.169	0.840	0.685	0.549
66	1.138	0.810	0.654	0.518
67	1.107	0.779	0.624	0.488
68	1.078	0.750	0.594	0.458
69	1.049	0.720	0.565	0.429
70	1.020	0.691	0.536	0.400
71	0.992	0.663	0.507	0.372
72	0.964	0.635	0.480	0.344
73	0.936	0.608	0.452	0.316
74	0.909	0.580	0.425	0.289
75	0.882	0.553	0.398	0.262
76	0.855	0.527	0.371	0.235
77	0.828	0.500	0.344	0.208
78	0.802	0.474	0.317	0.182
79	0.776	0.447	0.292	0.156
80	0.750	0.421	0.266	0.130
81	0.724	0.395	0.240	0.104
82	0.698	0.369	0.214	0.078
83	0.672	0.343	0.188	0.052
84	0.646	0.317	0.162	0.026
85	0.620	0.291	0.136	
86	0.593	0.265	0.109	
87	0.567	0.239	0.082	
88	0.541	0.213	0.055	
89	0.515	0.187	0.028	
90	0.489	0.161		
91	0.463	0.135		
92	0.437	0.109		
93	0.411	0.083		
94	0.385	0.056		
95	0.359	0.034		
96	0.333			
97	0.307			
98	0.281			
99	0.255			
100	0.229			

Example.—Total kw input of plant from watermeter reading 100 kw at 80 per cent. The kva of this plant is 125 kw. To raise the power factor to 90 per cent is found by multiplying the 100 kw by the factor found in the table which is 0.58. 100 kw X 0.58 = 58 kva in capacitor capacity. The nearest standard size, of course, is 60 kva. and this should be recommended.

VOLTAGE REGULATION—QUICK ESTIMATING DATA

KW x Distance is shown for 5% Regulation and 80% P.F.

Use correction factor for other power factors

Approximate Voltage Regulation Correction Factor 70 90 100 P.F. P.F.	Wire Size Copper Equivalent				KW x Hundreds of Feet				KW x Miles				% Loss for 5% Regulation and 80% P.F. Only 8" Sp 34" Sp				
	8	16	32	64	220v 10 30 60 120	440v 20 60 120 240	550v 30 90 180 360	2200v 120 360 720 1440	2200v 30 90 180 360	4000v 60 180 360 720	6600v 90 270 540 1080	13,200v 180 540 1080 2160					
0.85	1.04	1.14	1.25	1.38	8	16	32	64	220v 10 30 60 120	440v 20 60 120 240	550v 30 90 180 360	2200v 120 360 720 1440	2200v 30 90 180 360	4000v 60 180 360 720	6600v 90 270 540 1080	13,200v 180 540 1080 2160	6.9
0.84	1.08	1.25	1.38	1.55	6	21	42	84	220v 10 30 60 120	440v 20 60 120 240	550v 30 90 180 360	2200v 120 360 720 1440	2200v 30 90 180 360	4000v 60 180 360 720	6600v 90 270 540 1080	13,200v 180 540 1080 2160	6.6
0.83	1.10	1.38	1.55	1.75	4	33	66	132	220v 10 30 60 120	440v 20 60 120 240	550v 30 90 180 360	2200v 120 360 720 1440	2200v 30 90 180 360	4000v 60 180 360 720	6600v 90 270 540 1080	13,200v 180 540 1080 2160	6.3
0.80	1.15	1.55	2.00	2.50	2	48	96	192	220v 10 30 60 120	440v 20 60 120 240	550v 30 90 180 360	2200v 120 360 720 1440	2200v 30 90 180 360	4000v 60 180 360 720	6600v 90 270 540 1080	13,200v 180 540 1080 2160	6.1
0.87	1.19	1.80	2.40	3.15	0	65	130	260	220v 10 30 60 120	440v 20 60 120 240	550v 30 90 180 360	2200v 120 360 720 1440	2200v 30 90 180 360	4000v 60 180 360 720	6600v 90 270 540 1080	13,200v 180 540 1080 2160	5.8
0.87	1.21	2.00	2.70	3.60	0	75	150	300	220v 10 30 60 120	440v 20 60 120 240	550v 30 90 180 360	2200v 120 360 720 1440	2200v 30 90 180 360	4000v 60 180 360 720	6600v 90 270 540 1080	13,200v 180 540 1080 2160	5.5
0.85	1.25	2.33	3.15	4.20	0	100	200	400	220v 10 30 60 120	440v 20 60 120 240	550v 30 90 180 360	2200v 120 360 720 1440	2200v 30 90 180 360	4000v 60 180 360 720	6600v 90 270 540 1080	13,200v 180 540 1080 2160	5.3
0.82	1.29	2.70	3.60	4.80	0	120	240	480	220v 10 30 60 120	440v 20 60 120 240	550v 30 90 180 360	2200v 120 360 720 1440	2200v 30 90 180 360	4000v 60 180 360 720	6600v 90 270 540 1080	13,200v 180 540 1080 2160	5.0
0.81	1.32	3.05	4.00	5.25	0	135	270	540	220v 10 30 60 120	440v 20 60 120 240	550v 30 90 180 360	2200v 120 360 720 1440	2200v 30 90 180 360	4000v 60 180 360 720	6600v 90 270 540 1080	13,200v 180 540 1080 2160	4.8
0.80	1.34	3.28	4.30	5.60	0	150	300	600	220v 10 30 60 120	440v 20 60 120 240	550v 30 90 180 360	2200v 120 360 720 1440	2200v 30 90 180 360	4000v 60 180 360 720	6600v 90 270 540 1080	13,200v 180 540 1080 2160	4.6
0.80	1.35	3.45	4.50	5.85	0	157	315	630	220v 10 30 60 120	440v 20 60 120 240	550v 30 90 180 360	2200v 120 360 720 1440	2200v 30 90 180 360	4000v 60 180 360 720	6600v 90 270 540 1080	13,200v 180 540 1080 2160	4.5

Example: How much power can be transmitted 2.5 miles at 4,000 v., 36, over No. 2 wire at 90% P.F. and 7% regulation?
 * (1) From Table 550 + 2.5 = 220 KW for 5% Reg., 80% P.F.
 (2) 90% P.F. Correction Factor = 1.15; 1.15 x 220 = 253 KW at 90% P.F.
 (3) 253 x 7/5 = Approx. 350 KW at 7% Reg., 90% P.F.

DECIMAL AND METRIC EQUIVALENTS OF COMMON FRACTIONS

(Based on National Bureau of Standards)

Fractions of an Inch	Decimals of an Inch	Milli-meters	Fractions of an Inch	Decimals of an Inch	Milli-meters
1/16	0.01562	0.397	17/32	0.51562	13.097
1/8	0.03125	0.794	3/4	0.53125	13.494
3/16	0.04687	1.191	5/8	0.54687	13.891
1/4	0.0625	1.588	7/8	0.5625	14.288
5/16	0.07812	1.984	15/16	0.57812	14.684
3/8	0.09375	2.381	1	0.59375	15.081
7/16	0.10937	2.778			
1/2	0.1250	3.175			
9/16	0.14062	3.572			
5/8	0.15625	3.969			
11/16	0.17187	4.366			
3/4	0.1875	4.763			
13/16	0.20312	5.159			
7/8	0.21875	5.556			
15/16	0.23437	5.953			
1	0.2500	6.350			
1 1/16	0.26562	6.747			
1 1/8	0.28125	7.144			
1 1/4	0.29687	7.541			
1 1/2	0.3125	7.938			
1 3/4	0.32812	8.334			
2	0.34375	8.731			
2 1/16	0.35937	9.128			
2 1/8	0.37500	9.525			
2 1/4	0.39062	9.922			
2 1/2	0.40625	10.319			
2 3/4	0.42187	10.716			
3	0.4375	11.113			
3 1/8	0.45312	11.509			
3 1/4	0.46875	11.906			
3 1/2	0.48437	12.303			
4	0.5	12.700			

COPPER TEMPERATURE RESISTANCE COEFFICIENT

The temperature resistance coefficient at constant mass and free expansion of standard annealed copper of 100% conductivity is, per centigrade degree, 0.00393 at 20 C or 0.00385 at 25 C.

Resistance values of copper wire of 100% conductivity given in tables at 25 C may be corrected for any temperature by means of the following formula:

$$R_t = R_{25} (1 + 0.00385 (t - 25))$$

Where R_t = resistance in ohms at temperature t

R_{25} = resistance in ohms at 25 C

t = temperature of wire in degrees C

Conversion

Factors for Conversions—alphabetically arranged

Ampere	= 1,000,000,000,000 micromicro-amperes
Ampere	= 1,000,000 microamperes
Ampere	= 1,000 milliamperes
Cycle	= 0.000,001 megacycle
Cycle	= 0.001 kilocycle
Farad	= 1,000,000,000,000 micromicrofarads
Farad	= 1,000,000 microfarads
Farad	= 1,000 millifarads
Henry	= 1,000,000 microhenrys
Henry	= 1,000 millihenrys
Kilocycle	= 1,000 cycles
Kilovolt	= 1,000 volts
Kilowatt	= 1,000 watts
Megacycle	= 1,000,000 cycles
Mho	= 1,000,000 micromhos
Mho	= 1,000 millimhos
Microampere	= 0.000,001 ampere
Microfarad	= 0.000,001 farad
Microhenry	= 0.000,001 henry
Micromho	= 0.000,001 mho
Micro-ohm	= 0.000,001 ohm
Microvolt	= 0.000,001 volt
Microwatt	= 0.000,001 watt
Micromicrofarad	= 0.000,000,000,001 farad
Micromicro-ohm	= 0.000,000,000,001 ohm
Milliampere	= 0.001 ampere
Millihenry	= 0.001 henry
Millimho	= 0.001 mho
Milliohm	= 0.001 ohm
Millivolt	= 0.001 volt
Milliwatt	= 0.001 watt
Ohm	= 1,000,000,000,000 micromicro-ohms
Ohm	= 1,000,000 micro-ohms.
Ohm	= 1,000 milliohms
Volt	= 1,000,000 microvolts
Volt	= 1,000 millivolts
Watt	= 1,000,000 microwatts
Watt	= 1,000 milliwatts
Watt	= 0.001 kilowatt

CONVERSION TABLE

Diameter of a circle	$\times 3.1416 =$ Circumference.
Radius of a circle	$\times 6.283185 =$ Circumference.
Square of the radius of a circle	$\times 3.1416 =$ Area.
Square of the diameter of a circle	$\times 0.7854 =$ Area.
Square of the circumference of a circle	$\times 0.07958 =$ Area.
Half the circumference of a circle	\times half its diameter = Area.
Circumference of a circle	$\times 0.159155 =$ Radius.
Square root of the area of a circle	$\times 0.56419 =$ Radius.
Circumference of a circle	$\times 0.31831 =$ Diameter.
Square root of the area of a circle	$\times 1.12838 =$ Diameter.
Diameter of a circle	$\times 0.86 =$ Side of an inscribed equilateral triangle.
Diameter of a circle	$\times 0.7071 =$ Side of an inscribed square.
Circumference of a circle	$\times 0.225 =$ Side of an inscribed square.
Circumference of a circle	$\times 0.282 =$ Side of an equal square.
Diameter of a circle	$\times 0.8862 =$ Side of an equal square.
Base of a triangle	\times by one-half the altitude = Area.
Multiplying both diameter and	.7854 together = Area of an ellipse.
Surface of a sphere	\times by one-sixth of its diameter = Solidity.
Circumference of a sphere	\times by its diameter = Surface.
Square of the diameter of a sphere	$\times 3.1416 =$ Surface.
Square of the circumference of a sphere	$\times 0.3183 =$ Surface.
Cube of the diameter of a sphere	$\times 0.5236 =$ Solidity.
Cube of the circumference of a sphere	$\times 0.016887 =$ Solidity.
Radius of a sphere	$\times 1.1547 =$ Side of an inscribed cube.
Square root of (one-third of the square of) the diameter of a sphere	= Side of an inscribed cube.
Area of its base	\times one-third of its altitude = Solidity of a cone or pyramid, whether round, square or triangular.
Area of one of its side	$\times 6 =$ Surface of a cube.
Altitude of trapezoid	\times one-half the sum of its parallel sides = Area.

Grid Bias Resistor Calculations

The radio service man often finds it necessary to replace the grid bias resistor in receivers employing a self-biasing arrangement for obtaining the proper grid voltage. When the resistance value is not known, it may be calculated by dividing the grid voltage required at the plate voltage at which the tube is operating, by the plate current in amperes plus the screen current in amperes times the number of tubes passing current through the resistor.

Under the above rule, the grid bias resistor value is given by the following formula:

$$R = \frac{E_{c1} \times 1,000}{(I_B + I_{c2}) n}$$

where: R = Grid bias resistor value in ohms.

E_{c1} = The grid bias required in volts.

I_B = The plate current of a single tube in milliamperes.

I_{c2} = The screen-grid current of a single tube in milliamperes.

n = The number of tubes passing current through the resistor.

Example:

It is desired to determine the value of bias resistor used to obtain the proper value of grid bias on three type '35 tubes working in the radio frequency stages of a receiver. First determine the plate and screen voltages employed in this set. Suppose, in this case, it is found that the plate supply voltage is 250 and the screen voltage is 90. Looking in the characteristics chart, it is found that the proper grid bias for the '35 under these conditions is -3.0 volts. In addition, the plate current is 6.5 milliamperes and the screen current is 2.5 milliamperes. Substituting in the formula,

$$R = \frac{3.0 \times 1,000}{(6.5 + 2.5) 3} = 111 \text{ ohms.}$$

The value of grid bias resistors can be calculated in this manner for any type and any number of tubes. In the case of triodes, the screen current term drops out entirely.

Be sure to determine the plate voltage at which the tubes are working, the number of tubes being supplied from the bias resistor, the screen voltage, (if a tetrode or pentode), the correct value of grid bias voltage required, and the plate and screen current for the given plate voltage.

In the case of resistance-coupled amplifiers which employ high resistance in the plate circuit, it must be remembered that the plate voltage is equal to the plate supply voltage minus the voltage drop in the plate load resistance caused by the plate current. The net plate voltage alone determines the correct value of grid bias.

The foregoing methods of calculations cannot be used in connection with receivers employing a bleeder circuit to obtain grid bias.

IDENTIFYING CODE LETTERS ON ALTERNATING-CURRENT MOTORS

(Condensed from National Electrical Code, 1940)

Starting Kva* per Hp	NEC NEMA Code Letter*	BRANCH-CIRCUIT PROTECTION IN PER CENT OF MOTOR FULL-LOAD CURRENT†			
		Full-voltage Start		Autotransformer Start	
		Max. Fuse Rating	Max. Breaker Setting‡	Max. Fuse Rating	Max. Breaker Setting‡
0.00- 3.14	A	150	150	150	150
3.15- 3.54	B	250	200	200	200
3.55- 3.99	C	250	200	200	200
4.00- 4.49	D	250	200	200	200
4.50- 4.99	E	250	200	200	200
5.00- 5.59	F	300	250	250	200
5.60- 6.29	G	300	250	250	200
6.30- 7.09	H	300	250	250	200
7.10- 7.99	J	300	250	250	200
8.00- 8.99	K	300	250	250	200
9.00- 9.99	L	300	250	250	200
10.00-11.19	M	300	250	250	200
11.20-12.49	N	300	250	250	200
12.50-13.99	P	300	250	250	200
14.00-	R	300	250	250	200
Wound-rotor motor‡		150	150	150	150

*Sec. 94304, Chap. 9, NE Code. †Table 28, NE Code. ‡Time-limit type.

†Has no code letter.

Start. Kva = Volts x Locked-rotor Amp / 1000 x Horsepower × (1 for 1-phase / 2 for 2-phase / 1.732 for 3-phase)

Code Letters Usually Applied to Ratings of Motors Normally Started on Full Voltage

Code Letters	E	F	G	H	J	K	L	M	N
Horse- 3-phase	15 up	10-7 1/2	5	3	2	1 1/2	1	3/4	1/2
power 1-phase	5	3	1 1/2		1	3/4	1/2		

USEFUL CONVERSION RATIOS

Multiply	By	To Obtain
Diam. circle	3.1416	Circumference circle
Diam. circle	0.8862	Side of equal square
Diam. sphere cubed	0.5236	Volume of sphere
U. S. gallons	0.8327	Imperial gallons (British)
U. S. gallons	0.1337	Cubic feet
In. of mercury (0 C)	0.4912	Pounds per sq in
Feet of water (4 C)	0.4336	Pounds per sq in.
Cubic feet	62.427	Pounds of water (4 C)
U. S. gallons	8.330	Pounds of water (20 C)
U. S. gallons	3.7853	Liters
Knots	1.1516	Miles per hour
Inches	2.5400	Centimeters
Yards	0.9144	Meters
Miles	1.6093	Kilometers
Cubic inches	16.3872	Cubic centimeters
Ounces	28.3495	Grams
Pounds	0.4536	Kilograms

To obtain the above

Divide by

Starting with the above

COPPER RESISTIVITY AND DENSITY

(Based on International Electrotechnical Commission and National Bureau of Standards)

The internationally recognized standard for copper of 100% conductivity at 20 C (Circular No. 31, National Bureau of Standards) is as follows:

Resistance of a uniform copper wire one square millimeter in cross section and one meter long = 1/58 ohm = 0.017241 ohm. Density = 8.89 grams per cubic centimeter. Equivalents are:

- 0.017241 ohm (meter, mm²)
- 10.371 ohms per circular mil foot
- 1.7241 microhm per centimeter cube
- 0.67879 microhm per inch cube
- 0.15328 ohm (meter, gram)
- 875.20 pounds per mile—ohm

BREAKING LOADS OF COPPER WIRE

Awg Size	Breaking Load, Lb		Awg Size	Breaking Load, Lb	
	*Hard-drawn	†Annealed		*Hard-drawn	†Annealed
0000	8140	6980	8	825	480
0000	6720	4750	9	661	380
00	5520	3760	10	529	314
0	4620	2980	11	423	249
1	3590	2430	12	337	197
2	3000	1930	13	268	153
3	2440	1530	14	213	124
4	1970	1210	15	170	98
5	1590	962	16	135	78
6	1280	762	17	107	62
7	1030	605	18	85	49

*Based on ASTM B1-40

†Based on ASTM B3-41

EQUIVALENT VALUES

Electrical Units

- 1 kilowatt = 1000 watts
- 1 kilowatt = 1.3410 horsepower
- 1 kilowatt = 44,254 foot-pounds per minute
- 1 kilowatt = 56.883 British thermal units per minute
- 1 horsepower = 745.7 watts
- 1 horsepower = 33,000 foot-pounds per minute
- 1 horsepower = 42.418 British thermal units per minute
- 1 British thermal unit = 777.98 foot-pounds
- 1 British thermal unit = 0.2930 watt-hour
- 1 joule = 1 watt-second.

Miscellaneous

- Kilogram-meter = 7.2330 foot-pounds
- 1 foot-pound = 0.1383 kilogram-meter
- 1 metric horsepower = 0.9863 horsepower
- 1 horsepower = 1.0139 metric horsepower
- 1 liter per second = 2.119 cubic feet per minute
- 1 liter per second = 15.85 U. S. gallons per minute
- Absolute temperature (Kelvin scale) = Centigrade temperature + 273.17.
- Lumen = unit of luminous flux. One candle radiates 4 π lumens.

BASIC FORMULAS USEFUL IN ELECTRONICS

Wave Length and Frequency Relationship:

Speed = Frequency \times wave length
300,000,000 meters per second (approx.) = cycles per second \times meters

Electrical Resonance:

$f = \frac{1}{2\pi\sqrt{LC}}$ I = Inductance in henries

C = Capacitance in farads

Radiation and Temperature Relationship:

$E = K(T^4 - T_0^4)$ T = Absolute temperature of body
T₀ = Absolute temperature of surrounding walls
K = Constant depending upon nature of radiating surface
E = Total energy radiated by body

Wave Length of an Electron (Fundamental of the Electron Microscope):

$\lambda = \frac{12.2}{\sqrt{V}}$ λ = Wave length in angstrom units
V = Voltage accelerating the electron

Wien's Law (Wave Length — Temp. Relationship):

$\lambda mT = \text{a constant} = 2885$ λm = Wavelength in microns corresponding to the maximum of the energy curve of radiation
T = Absolute temperature

REFERENCE CONSTANTS USEFUL IN ELECTRONICS

Speed of Electromagnetic Radiations:
299,776 kilometers per second = approximately 186,000 miles per second

Velocity of Sound in Air at 32 F and 1 Atm.:

331.1 to 331.8 meters per second
1086.3 to 1088.4 feet per second
740.6 to 742.1 miles per hour

Charge of Electron:

4.8025×10^{-10} electrostatic units

Electronic Mass:

9.1066×10^{-31} g

Mass of Hydrogen Atom (¹H) (Light Hydrogen):

1.6734×10^{-27} g

Planck's Constant:

6.624×10^{-27} erg \times sec.

Wave Length of Red Line of Cadmium:

6438.4696 angstroms

Units of Length:

1 mm = 10^7 angstrom = 10^3 micron
1 cm = 10^8 angstrom
1 micron = 1/10,000 cm
1 angstrom = 1/100,000,000 cm

Units of Frequency:

1 kilocycle = 1000 cycles
1 megacycle = 1,000,000 cycles

SPECIFIC RESISTANCE OF METALS AND ALLOYS AT ORDINARY TEMPERATURES

(Based on National Bureau of Standards)

Substance	† Specific Resistance	Relative Conductance	Substance	Specific Resistance	Relative Conductance
Aluminum 99.996	2.6548	64.94	Lead	22	7.8
Brass	7	23.7-19.1	Mercury	95.783	1.8
Cobalt 99.8%	9.7	17.7	Molybdenum	5.14	34
Copper, annealed	1.7241	100%	Nickel	7.8	22.1
Copper, pure	1.692	102%	Platinum	9.83	17.24
Ger. Silver (18X)	30-40	5.7-4.3	Silver	1.629	106.4
Iron 98.98	10	17.24	Tungsten	5.51	31.9
Wrought Iron	13.9	12.4			

†In ohm-cm $\times 10^{-6}$

ALLOWABLE CURRENT-CARRYING CAPACITIES OF INSULATED CONDUCTORS IN AMPERES Not More Than Three Conductors in Raceway or Cable*

(From National Electrical Code, 1940. A revision of the N E Code, which should be referred to when available, was in progress at the time this diary went to press.)

Size, Awg or MCM	50 C	60 C	75 C	85 C
	Code Rubber, Type R, Moisture-resistant Rubber, Type RW	Synthetic Types SN, RU, Performance Rubber, Types RP, RPT	Heat-resistant Rubber, Types RH, RHT	Paper or Varnished-cambrio, Type V
14	15	18	22	23
12	20	23	27	29
10	25	31	37	38
8	35	41	49	50
6	45	54	65	68
5	52	63	75	78
4	60	72	86	89
3	69	83	99	104
2	80	96	115	118
1	91	110	131	138
0	105	127	151	157
00	120	145	173	184
000	138	166	199	209
0000	160	193	230	237
250	177	213	255	272
300	198	238	285	299
350	216	260	311	325
400	233	281	336	361
500	265	319	382	404
600	293	353	422	453
700	320	385	461	488
750	330	398	475	502
800	340	410	490	514
900	360	434	519	556
1,000	377	455	543	583

Correction Factors for Room Temperatures Over 30 C

C	F				
40	104	0.71	0.82	0.88	0.90
45	113	0.50	0.71	0.82	
50	122	0.00	0.58	0.75	0.80

*The above table is based on room temperature of 30 C or 86 F. For correction factors above 50 C, for single conductors in free air, for more than three conductors, and for other pertinent factors and data, see NE Code. For the duration of the war emergency, a number of Interim amendments to the 1940 NE Code have been approved but cannot be included here for lack of space. These interim amendments should be consulted.

Centigrade & Fahrenheit Temperature Scales

Centi-grade	Fahren-heit	Centi-grade	Fahren-heit	Centi-grade	Fahren-heit	Centi-grade	Fahren-heit
-15	5	15	59	45	113	75	167
-10	14	20	68	50	122	80	176
-5	23	25	77	55	131	85	185
0	32	30	86	60	140	90	194
5	41	35	95	65	149	95	203
10	50	40	104	70	158	100	212

Temp. F = 9/5 (Temp. C) + 32.

Temp. C = 5/9 (Temp. F - 32).

USEFUL INFORMATION Alternating Current Generators and Motors

Alternating Current Generators are built in two types, the revolving field and revolving armature types. The names of the two sets of windings are rotor and stator. The revolving field type machine is mostly used, because of the field current only having to pass through the brushes and collector rings, the high tension wires all being stationary.

Alternating Current Generators are separately excited. That is, the field current is supplied from an auxiliary Direct Current Generator, known as an exciter.

Current supplied from an Alternating Current Generator alternates in direction at regular intervals, and from this characteristic is derived the terms "frequency" or "cycles," which always has a numerical value which defines the period of the alternations. The most generally adopted systems operate at either 60 cycles, 720 alternations, or 25 cycles, 3000 alternations, while there are some Central Stations which supply either 40 cycle, 50 cycle, or 133 cycle current.

Alternating current is generated single, two or three phase, two and three phase systems being the most commonly used. They are better adapted for operating large motors. The three phase system has been universally adopted on account of economy in construction and operation. Single phase systems require two wires, two phase systems either three or four wires, and three phase systems three and four wires.

Alternating Current Motors are constructed single, two or three phase, and of many different types, and for all frequencies and synchronous speeds.

Single-Phase Motors: Single-phase motors are built in several different types, viz.: Repulsion, Repulsion Induction and Induction Types, being used for constant or variable speed service.

Repulsion Induction motors are the most generally used of all single-phase motors and furnished for constant and variable speed.

Polyphase Induction Motors: Polyphase Induction Motors are built in two types, viz.: Squirrel Cage and Slip Ring or Wire Wound Rotor Types.

Squirrel Cage Rotor Type motor has nearly a constant speed (starting torque high), and is the type most generally used for driving machinery.

Slip-ring motor is adapted for speed variation ranging from 50% to 100%, and also is used for constant speed service. It has a high starting torque with a low starting current demand, which particularly adapts it for any service where a heavy starting current is objectionable.

Both the Squirrel Cage and Slip-ring type motors can be supplied for any frequency, voltage or speed.

Starting Torque: The starting torque of a constant speed motor is twice full load torque on full voltage. In general the torque varies as the square of the applied voltage. The reason for using a reduced electromotive force at starting is to reduce the sudden shock which may throw off belts or cause mechanical injury, and to reduce the starting current. When 50% voltage is applied to the motor, half full load torque is given.

Synchronous Motors are principally used for power factor correction and are also sometimes called "Synchronous Condensers," because they can be operated at a leading current to raise the power factor of an alternating current system. Synchronous motors for driving power are equipped with an extra starting winding, which will give from 30% to 50% full load torque, and will operate at a constant or synchronous speed with no slip. It is advisable to have one or more synchronous motors on all alternating current systems. Each case requires a particular calculation to fit it with the proper sized motor for the conditions and should be referred to those familiar with synchronous motor installations.

Starting of Synchronous Motors: The starting of synchronous motors differs from the starting of induction motors, due to the fact that they have a field which is supplied from an auxiliary, known as an exciter.

Before starting the motor, first see that the field discharge switch is open from the field of the motor, but the motor field must be short circuited through the field discharge resistance. Otherwise, there will be a high voltage discharge between the field coils when the current is thrown on the motor, which is due to a transformer action

between the windings. After seeing that the field switch is in its proper position, set the field rheostat at a point to give zero power factor when the switch is thrown in. After these precautions have been taken, the motor is ready to start, and should come up to speed on throwing the compensator into the starting position. When the motor has attained full speed, throw the compensator into running position, and then close the field switch, when the motor will step into synchronism. After this the rheostat should be set for full field current, and the motor will then operate "leading."

To stop the motor, first turn the rheostat back to the zero power factor position, then open the field switch and throw off the compensator, the switches and rheostat being in position for next starting.

If a synchronous motor which has sufficient starting torque to meet the load conditions should fail to start when the current is thrown into the stator windings, it is probably due to the "standing" relation of the field to the stator windings, because of there being an equal number of stator to rotor coils, and should they both be in a central position to each other, the rotor will not have any starting torque. To remedy this move the rotor a slight distance in either direction, and the rotor will then start.

USEFUL INFORMATION

Alternating-Current Formulas

Power-factor of an alternating current is the number by which the apparent power in the circuit (volts times amperes) must be multiplied together in order to ascertain true power. When an alternating-current circuit contains inductance, the current lags behind the E. M. F., and when it contains capacity the current rises ahead of the E. M. F.; in each case the current and E. M. F. reach their maximum values at different instants, and the product of the E. M. F. and current at any instant is less than it would be if the two were in phase with each other. If the E. M. F. and current be measured separately the voltmeter and ammeter will give the individual mean effective values; if they are measured by a wattmeter, the instrument indicates their combined effect synchronously, not the product of their effec-

tive values which occur at different instants. Consequently, the wattmeter indication will be less than the product of the separate voltmeter and ammeter readings; the ratio of the power to this product is the power-factor of the circuit. Expressed as a formulae

$$\text{Power-Factor} = \frac{\text{Watts}}{\text{Amperes} \times \text{Volts}}$$

This gives rise to the two methods of rating electrical apparatus, one on the basis of watts or kilowatts, and the other on the basis of volt-amperes or kilowatt-amperes (K. V. A.).

The former represents actual power, usually in K. W., while the latter represents the apparent power, usually in K. V. A. (kilovolt ampere), generated, transmitted or used by the apparatus. The latter or K. V. A. rating is coming into more general use since it represents more adequately the voltage and current conditions to which the apparatus is subjected.

Current per Phase in Various Systems

$$I = \frac{W}{E \times P.F.} \text{ for Single-Phase Circuit.}$$

$$I = 0.50 \times \frac{W}{E \times P.F.} \text{ for Two-Phase Circuit.}$$

$$I = 0.58 \times \frac{W}{E \times P.F.} \text{ for Three-Phase Circ't.}$$

Temp. C. = $\frac{5}{9}$ (Temp. F. - 32)

Temp. F. = $\frac{9}{5}$ Temp. C. + 32

I = Current in line in amperes; W = Energy delivered in watts; E = Potential between mains in volts; P. F. = Power-Factor. When power-factor cannot be accurately determined it may be assumed as follows: Lighting load with no motors, 0.95; lighting and motors, 0.85; motors only, 0.80.

Alternating-Current Generator Data

Speeds—Speeds are standard to give the desired frequency. In order to obtain speed of a 60-cycle alternator, divide 7,200 by the number of poles. To obtain speed of a 25-cycle alternator, divide 3,000 by the number of poles, 1,200 R. P. M. and 100 R. P. M. are the maximum standard speeds.

Voltage—Standard voltages are 240, 480, 600, 1,200 and 2,400.

Cycles or Frequency—Standard frequencies most used are 60 cycles per second (7,200 alternations per min-

ute), and 25 cycles per second (3,000 alternations per minute). To obtain the frequency of an alternator in cycles per seconds, the formula is to multiply the speed by the number of poles and divide by 120.

60-cycle alternators are almost entirely used for central lighting and power stations.

25-cycle alternators are used for railway operation.

Phase—Standard alternators are built for three-phase or two-phase. (Any three-phase alternator will deliver continuously 70% to 75% of its three-phase capacity as single phase load connected to any two of its three terminals. The third terminal must be left disconnected. Two-phase machines should not be used to supply single-phase current. The usual plant conditions are best met by three-phase alternators.)

Amperes per Terminal—Amperes per terminal at 100% power-factor are determined in the various systems as follows:

$$\text{One-Phase Amperes per Terminal} = \frac{K.W. \times 1000}{\text{Volts}}$$

$$\text{Two-Phase Amperes per Terminal} = \frac{K.W. \times 500}{\text{Volts}}$$

$$\text{Three-Phase Amperes per Terminal} = \frac{K.W. \times 580}{\text{Volts}}$$

Regulation—Regulation is the percentage in voltage when load is thrown off, speed and excitation remaining constant. The smaller the rise, the better the regulation.

Wave Form—By accurate shaping of the pole-face and slots, alternators give a wave-form practically identical with the sine wave, which is the ideal.

Operation in Parallel—Alternators of different manufacturers will operate successfully in parallel with any other alternator, provided the angular velocity does not vary more than $2\frac{1}{2}$ electrical degrees (lagging or leading) from the normal. Thus a total variation not exceeding 5 electrical degrees is allowable. An electrical degree is the angle between adjacent poles divided by 180.

FACTORS CONCERNING INTERCHANGEABILITY

BULB DIMENSIONS

Tube types of identical bulb outline present no physical problems of interchangeability unless the variation in neck length is too great to be accommodated by the depth or arrangement of the chassis and cabinet. If changes in chassis and cabinet can be made to accommodate different bulb shapes and sizes, then the following factors enter the picture.

DEFLECTION ANGLE

In nearly all cases, it is not necessary to change the deflection yoke if the two tube types being interchanged are both listed as having a deflection angle in the range of 50 to 60 degrees. However, if a change is being made from a tube type having a deflection angle in the 50 to 60 degree range to one having a 66 to 70 degree angle it will be usually necessary to install a wide angle deflection yoke. The inductance of the new yoke should be approximately the same as the yoke being replaced if you are to avoid circuit changes to compensate for yokes of different inductances. In some cases it will also be necessary to increase the sweep power by means of a more efficient deflection transformer, or circuit modifications, to obtain full sweep.

HIGH VOLTAGE CONSIDERATIONS

In making a tube substitution it is important that the technician first determine the output voltage of the high voltage supply. If the available voltage is very much lower than that required for the replacement tube it will be necessary to increase the voltage supply to obtain satisfactory brightness. In general a variation of approximately 15% from the specified voltage may be tolerated.

There are many conversion kits, on the market, for increasing the high-voltage supply. In making circuit changes to increase the supply it is advisable to properly dress all leads and to make all soldered connections smooth and round to avoid corona and arcing.

ION-TRAP

Although it is not always necessary, it is advisable to use the specified type of ion-trap for a given tube type. Usually, because of space consideration on the tube neck, a double magnet ion-trap cannot be substituted for a single magnet type. However, a strong single magnet ion-trap can be used in place of a double magnet, or a weaker single magnet type. Using a

stronger than necessary ion-trap magnet will require placing the trap nearer the base than is considered normal. A good rule to follow is to use a trap which, when it is adjusted for optimum raster brightness lies slightly back over Grid No. 1. This insures being able to bracket the optimum ion-trap position, and reduces the danger of damage to the cathode-ray tube through improper ion-trap adjustment.

Improper adjustment of the ion-trap may result in permanent damage to the phosphor screen or the electron gun of the cathode-ray tube. No cathode-ray tube requiring an ion-trap should be operated more than a minute with the trap improperly adjusted. Very briefly, for adjustment the ion-trap is alternately or simultaneously rotated around the tube neck and moved back and forth along the tube neck to obtain the brightest raster. Small readjustment of the ion-trap position to improve centering or reduce corner shadow is permitted only if such readjustment does not reduce the brightness of the raster.

FOCUS FIELD STRENGTH

When tubes of different physical dimensions are interchanged, or when the applied anode voltage is changed, a change in the focus field will be necessary, and if a permanent magnet focalizer is used a magnet of different strength will be necessary. If an electro-magnetic type of focus coil is used it may be necessary to change the focus current range by making circuit changes in the focus coil voltage supply.

EXTERNAL CONDUCTIVE COATING

The external conductive coating, on tubes having the same, is used as part of the high voltage supply filter circuit. Therefore, if substituting a tube without an external coating, for one having a coating it will be necessary to install a filter condenser in the high-voltage circuit. If the anode voltage does not exceed 15,000 volts a 500 to 1500 uuf condenser connected between the tube anode terminal and ground will be satisfactory. For anode voltages in excess of 15,000 volts the condenser should not exceed 700 uuf.

TRIODE TO MULTIGRID

In most cases a tetrode type may be substituted, if necessary, for a type employing a triode gun structure by adding a G2 supply source and connecting to the proper terminal of the picture tube socket. If it is found that sufficient brightness is not obtained even with full adjustment of the brightness control the Grid 2 voltage supply should be increased in 10% steps. The voltage should not be increased above

500 volts. If the opposite is the case, that is the control cannot be adjusted to reduce the brightness to a desired level, the Grid 2 voltage should be reduced in 10% steps until the desired level is obtained within the range of the control.

MAGNETIZED METAL CONE CATHODE-RAY TUBES

In shipping, handling, servicing, etc. the cone of a metal cathode-ray tube may become magnetized sufficiently to cause noticeable distortion or kinks at an edge or corner of the raster. This effect may be distinguished from circuit defects by moving the raster, by means of the receiver centering adjustment. Distortion from a magnetized cone will not move when the raster is moved, but will remain in one position with respect to the face of the tube. Usually a pocket compass may be used to locate the magnetized area of the cone.

A magnetized cone may be demagnetized by an A.C. field of approximately 1200 ampere turns. Such a coil may be made by winding approximately 1500 turns of No. 24 insulated copper wire into a doughnut coil of six inches inside diameter. To use the coil hold it at least two feet away from the metal cone of the cathode-ray tube and connect the coil to a 110 VAC outlet. Move the coil up to within one inch of the tube, with the flat side of the coil held parallel to the area to be demagnetized, for at least ten seconds, or move the coil very slowly over the surface of the metal cone. Then slowly withdraw the coil from the tube until it is at least two feet away from the cone and disconnect the coil. Repeat procedure if necessary. Caution: The coil will overheat, if left on continuously.



TELEVISION PI

TYPE	BASING	ENVELOPE	FACE	RADIUS OF FACE CURVATURE Inches	TYPE OF FOCUS	TYPE OF DEFLECTION	DEFLECTION ANGLE Degrees	RULR DIMENSIONS		
								MAX. LENGTH Inches	MAX. DIAM. or WIDTH Inches	MIN. USEFUL SCREEN SIZE Inches
14DP4 ²	12D	Glass	Filter	27	Mag.	Mag.	70 Diag.	17 $\frac{1}{8}$	12 $\frac{1}{2}$	W=11 H=8 $\frac{1}{2}$
14EP4 ²	12N	Glass	Filter	27	Mag.	Mag.	70 Diag.	16 $\frac{1}{8}$	12 $\frac{3}{8}$	W=11 H=8 $\frac{1}{2}$
14GP4 ²⁻³	12L	Glass	Filter	27	Elec.	Mag.	70 Diag.	17 $\frac{3}{16}$	12 $\frac{3}{8}$	W=11 H=8 $\frac{3}{8}$
14KP4 ²	12N	Glass	Clear	27	Mag.	Mag.	70 Diag.	17 $\frac{3}{16}$	12 $\frac{5}{8}$	W=11 H=8 $\frac{1}{2}$
15AP4	12D	Glass	Clear	45	Mag.	Mag.	57	20 $\frac{7}{8}$	15 $\frac{3}{4}$	14
15CP4	12D	Glass	Clear	45	Mag.	Mag.	50	21 $\frac{1}{8}$	15 $\frac{3}{4}$	14
15DP4	12D	Glass	Clear	45	Mag.	Mag.	57	20 $\frac{7}{8}$	15 $\frac{3}{4}$	14
16AP4	12D	Metal	Clear	27	Mag.	Mag.	53	22 $\frac{3}{8}$		
16AP4A	12D	Metal	Filter	40	Mag.	Mag.	53	22 $\frac{3}{16}$	16	14 $\frac{5}{8}$
16AP4B ³	12D	Metal	Filter	27	Mag.	Mag.	53	22 $\frac{3}{8}$		
16ABP4 ²	12N	Glass	Filter	27	Elec.	Mag.	70 Diag.	19 $\frac{1}{8}$	14 $\frac{7}{8}$	W=13 H=10
16ACP4	12N	Glass	Clear	56 $\frac{5}{16}$	Elec.	Mag.	60	21 $\frac{1}{8}$	16	15 $\frac{1}{2}$
16AEP4 ²	12M	Glass	Filter	27	Elec.	Mag.	70 Diag.	19 $\frac{1}{8}$	14 $\frac{7}{8}$	W=13 H=10
16CP4	12D	Glass	Clear	56 $\frac{5}{16}$	Mag.	Mag.	52	21 $\frac{7}{8}$	15 $\frac{13}{16}$	15
16DP4	12D	Glass	Clear	60			60	21	15 $\frac{7}{8}$	15
16DP4A	12D	Glass	Filter	56 $\frac{5}{16}$	Mag.	Mag.	60	21	16	14 $\frac{1}{2}$
16EP4	12D	Metal	Clear							
16EP4A	12D	Metal	Filter	27	Mag.	Mag.	60	20	16	14 $\frac{3}{8}$
16EP4B ³	12D	Metal	Filter							
16FP4	12D	Glass	Clear	27	Mag.	Mag.	62	20 $\frac{5}{8}$	16 $\frac{3}{8}$	15
16GP4	12D	Metal	Filter							
16GP4A	12D	Metal	Clear	40	Mag.	Mag.	70	17 $\frac{11}{16}$	16	14 $\frac{3}{8}$
16GP4B ³	12D	Metal	Filter							
16GP4C ³	12D	Metal	Clear							
16HP4	12N	Glass	Clear	56 $\frac{5}{16}$	Mag.	Mag.	60	21 $\frac{5}{8}$	16	14 $\frac{1}{2}$
16HP4A	12N	Glass	Filter							
16JP4	12N	Glass	Clear	27	Mag.	Mag.	60	21 $\frac{1}{8}$	16 $\frac{3}{8}$	15
16JP4A	12N	Glass	Filter							
16KP4 ²	12N	Glass	Filter	27	Mag.	Mag.	70 Diag.	19 $\frac{1}{8}$	14 $\frac{7}{8}$	W=1 H=1
16KP4A ¹⁻²	12N	Glass	Filter	27	Mag.	Mag.	70 Diag.	19 $\frac{1}{8}$	14 $\frac{7}{8}$	W=1 H=1
16LP4	12N	Glass	Clear	56 $\frac{5}{16}$	Mag.	Mag.	52	22 $\frac{3}{8}$	16	14 $\frac{1}{2}$
16LP4A	12N	Glass	Filter							
16MP4	12N	Glass	Clear	27	Mag.	Mag.	60	22 $\frac{1}{8}$	16 $\frac{1}{4}$	14 $\frac{3}{8}$
16MP4A	12N	Glass	Filter							
16QP4 ²	12D	Glass	Filter	27	Mag.	Mag.	70 Diag.	19 $\frac{3}{4}$	14 $\frac{3}{4}$	W=1 H=1
16RP4 ²	12N	Glass	Filter	27	Mag.	Mag.	70 Diag.	19 $\frac{1}{8}$	15	W=1 H=1

¹ Metal backed screen. ² Rectangular face. ³ Etched face to reduce reflections. ⁴ Cyl.
THIS DATA IS COMPILED AS A SERVICE TO THE FIELD.

STRUCTURE TUBES



BULB CONTACT	HEATER		TYPICAL OPERATING CONDITIONS					EXTERNAL CONDUCTIVE COATING	ION TRAP
	VOLTS	AMPS.	FOCUS OR ANODE 1 VOLTS	ANODE 2 VOLTS	GRID 2 VOLTS	NEG. GRID 1 CUTOFF VOLTS	FOCUS CURRENT Ma.		
Cavity	6.3	0.6	—	11000	250	27-63	100	No	Double
Cavity	6.3	0.6	—	12000	300	33-77	110	Yes	Single
Cavity	6.3	0.6	2500	12000	300	33-77	—	Yes	Single
Cap	6.3	0.3	—	9000	250	20-60	—	Yes	Single
Ball	6.3	0.6	—	12000	250	27-63	159	No	None
Cavity	6.3	0.6	—	12000	250	27-63	115	No	Double
Ball	6.3	0.6	—	12000	250	27-63	140	No	Single
—	6.3	0.6	—	12000	300	33-77	89 80 89	—	Double
Cavity	6.3	0.6	Automatic Focus	14000	300	33-77	—	Yes	Single
Cavity	6.3	0.6	Automatic Focus	12000	250	33-68	—	Yes	Single
Cavity	6.3	0.6	-64 to 350	14000	300	33-77	—	Yes	Single
Cavity	6.3	0.6	—	12000	250	27-63	110	No	Double
Cavity	6.3	0.6	—	12000	250	27-63	115	No	Double
—	6.3	0.6	—	12000	300	33-77	105	—	Double Double Single
Ball	6.3	0.6	—	13000	250	27-63	146	No	Single
—	6.3	0.6	—	12000	300	33-77	100	—	Single
Cavity	6.3	0.6	—	12000	300	33-77	110	Yes	Double
Cavity	6.3	0.6	—	11000	250	27-63	115	Yes	Double
Cavity	6.3	0.6	—	12000	300	33-77	90	Yes	Single
Cavity	6.3	0.6	—	14000	250	27-63	108	Yes	Single
Cavity	6.3	0.6	—	12000	300	33-77	110	Yes	Double
Cavity	6.3	0.6	—	12000	300	33-77	110	Yes	Double
Cavity	6.3	0.6	—	12000	250	27-63	125	No	Double
Cavity	6.3	0.6	—	12000	300	33-77	100	Yes	Double

ical face to reduce reflections.

IS NOT INTENDED TO INDICATE TYPE AVAILABILITY.



TELEVISION PIC

TYPE	BASING	ENVELOPE	FACE	RADIUS OF FACE CURVATURE Inches	TYPE OF FOCUS	TYPE OF DEFLECTION	DEFLECTION ANGLE Degrees	BULB DIMENSIONS		
								MAX. LENGTH Inches	MAX. DIAM. or WIDTH Inches	MIN. USEFUL SCREEN SIZE Inches
16SP4	12N	Glass	Clear	56 $\frac{5}{16}$	Mag.	Mag.	70	17 $\frac{3}{8}$	16	14 $\frac{1}{2}$
16SP4A	12N	Glass	Filter							
16TP4 ²	12N	Glass	Filter	27	Mag.	Mag.	70 Diag.	18 $\frac{1}{2}$	16 $\frac{1}{2}$	W=13 $\frac{1}{2}$ H=10 $\frac{1}{8}$
16UP4 ²	12D	Glass	Filter	27	Mag.	Mag.	70 Diag.	18 $\frac{5}{8}$	14 $\frac{3}{4}$	W=13 $\frac{1}{2}$ H=10 $\frac{1}{8}$
16VP4	12D	Glass	Filter	56 $\frac{5}{16}$	Mag.	Mag.	70	17 $\frac{3}{8}$	16	14 $\frac{1}{2}$
16WP4	12D	Glass	Filter	56 $\frac{5}{16}$	Mag.	Mag.	70	18 $\frac{1}{8}$	16	14 $\frac{1}{2}$
16WP4A	12N	Glass	Filter							
16XP4 ²	12D	Glass	Filter	27	Mag.	Mag.	70 Diag.	19 $\frac{1}{8}$	14 $\frac{3}{4}$	W=13 $\frac{1}{2}$ H=10 $\frac{1}{8}$
16YP4	12N	Glass	Filter	56 $\frac{5}{16}$	Mag.	Mag.	70	17 $\frac{3}{8}$	16	14 $\frac{1}{2}$
16ZP4	12N	Glass	Filter	56 $\frac{5}{16}$	Mag.	Mag.	52	22 $\frac{3}{8}$	16	14 $\frac{1}{2}$
17AP4 ²	12N	Glass	Filter	27	Mag.	Mag.	70 Diag.	19	15 $\frac{3}{4}$	W=14 $\frac{1}{4}$ H=10 $\frac{3}{4}$
17BP4 ²	12D	Glass	Filter	27	Mag.	Mag.	70 Diag.	19 $\frac{5}{8}$	15 $\frac{1}{2}$	W=14 $\frac{1}{4}$ H=10 $\frac{3}{4}$
17BP4A ²	12N	Glass	Filter							
17BP4B ¹⁻²	12N	Glass	Filter							
17BP4C ²⁻³	12D	Glass	Filter							
17CP4 ²⁻³	12D	Metal	Filter	30	Mag.	Mag.	70 Diag.	19	16	W=14 $\frac{3}{8}$ H=10 $\frac{1}{16}$
17CP4A ²	12D	Metal	Filter							
17FP4 ²	12L	Glass	Filter	27	Elec.	Mag.	70 Diag.	19 $\frac{5}{8}$	15 $\frac{1}{2}$	W=14 $\frac{3}{8}$ H=10 $\frac{3}{4}$
17FP4A ²⁻³	12L	Glass	Filter							
17GP4 ²⁻³	12M	Metal	Filter	30	Elec.	Mag.	70 Diag.	19 $\frac{5}{16}$	16	W=14 $\frac{3}{8}$ H=10 $\frac{1}{16}$
17HP4 ²	12L	Glass	Filter	27	Elec.	Mag.	70 Diag.	19 $\frac{5}{16}$	15 $\frac{1}{2}$	W=14 $\frac{3}{8}$ H=10 $\frac{3}{4}$
17HP4A ²⁻³	12L	Glass	Filter							
17JP4 ²	12N	Glass	Filter	27	Mag.	Mag.	70 Diag.	19 $\frac{5}{8}$	15 $\frac{1}{2}$	W=14 $\frac{1}{4}$ H=10 $\frac{3}{4}$
17KP4 ²	12N	Glass	Filter	27	Elec.	Mag.	70 Diag.	19 $\frac{5}{8}$	15 $\frac{1}{2}$	W=14 $\frac{1}{4}$ H=10 $\frac{3}{4}$
17LP4 ²⁻³	12L	Glass	Filter	27	Elec.	Mag.	70 Diag.	19 $\frac{5}{8}$	15 $\frac{1}{2}$	W=14 $\frac{1}{4}$ H=10 $\frac{3}{4}$
17QP4 ²⁻³⁻⁴	12N	Glass	Filter	27	Mag.	Mag.	70 Diag.	19 $\frac{5}{8}$	15 $\frac{1}{2}$	W=14 $\frac{1}{4}$ H=10 $\frac{3}{4}$
17RP4 ²	12L	Glass	Filter	27	Elec.	Mag.	70 Diag.	19 $\frac{5}{8}$	15 $\frac{1}{2}$	W=14 $\frac{1}{4}$ H=10 $\frac{3}{4}$
17RP4A ²	12L	Glass	Filter							
17SP4 ²⁻⁴	12N	Glass	Filter	27	Elec.	Mag.	70 Diag.	19 $\frac{5}{16}$	15 $\frac{1}{2}$	W=14 $\frac{1}{2}$ H=10 $\frac{7}{8}$
17TP4 ²⁻³	12M	Metal	Filter	30	Elec.	Mag.	70 Diag.	19 $\frac{5}{16}$	16	W=14 $\frac{3}{8}$ H=10 $\frac{3}{8}$
17UP4 ²⁻⁴	12N	Glass	Filter	27	Mag.	Mag.	70 Diag.	19 $\frac{5}{16}$	15 $\frac{1}{2}$	W=14 $\frac{1}{2}$ H=10 $\frac{7}{8}$
17VP4 ²⁻⁴	12L	Glass	Filter	27	Elec.	Mag.	70 Diag.	19 $\frac{5}{16}$	15 $\frac{1}{2}$	W=14 $\frac{1}{2}$ H=10 $\frac{7}{8}$
17YP4 ²⁻⁴	12N	Glass	Filter	27	Mag.	Mag.	70 Diag.	19 $\frac{5}{16}$	15 $\frac{1}{2}$	W=14 $\frac{1}{4}$ H=10 $\frac{3}{4}$

¹ Metal backed screen. ² Rectangular face. ³ Etched face to reduce reflections. ⁴ Cylindrical
THIS DATA IS COMPILED AS A SERVICE TO THE FIELD.

VACUUM TUBES



	HEATER		TYPICAL OPERATING CONDITIONS					EXTERNAL CONDUCTIVE COATING	ION TRAP
	VOLTS	AMPS.	FOCUS OR ANODE 1 VOLTS	ANODE 2 VOLTS	GRID 2 VOLTS	NEG. GRID 1 CUTOFF VOLTS	FOCUS CURRENT Ma.		
6X4	6.3	0.6	—	12000	300	33-77	110	Yes	Double
6X4	6.3	0.6	—	12000	300	33-77	115	Yes	Single
6X4	6.3	0.6	—	12000	300	27-63	100	No	Single
6X4	6.3	0.6	—	12000	250	27-63	110	No	Single
6X4	6.3	0.6	—	12000	250	27-63	110	No Yes	Double Double
6X4	6.3	0.6	—	12000	250	27-63	100	No	Double
6X4	6.3	0.6	—	12000	300	33-77	100	Yes	Single
6X4	6.3	0.6	—	12000	300	33-77	110	Yes	Double
6X4	6.3	0.6	—	12000	300	33-77	100	Yes	Single
6X4	6.3	0.6	—	12000	300	33-77	100 92 92 100	No Yes Yes No	Single Single Single Single
6X4	6.3	0.6	—	12000	300	33-77	96	—	Single
6X4	6.3	0.6	2700	12000	300	33-77	—	Yes	Single
6X4	6.3	0.6	2400	12000	300	33-77	—	—	Single
6X4	6.3	0.6	—48 to 260	12000	300	33-77	—	Yes	Single
6X4	6.3	0.6	—	16000	300	33-77	100	Yes	Single
6X4	6.3	0.6	Selfocus	12000	300	33-77	—	Yes	Single
6X4	6.3	0.6	—48 to 260	12000	300	33-77	—	Yes	Single
6X4	6.3	0.6	—	12000	300	33-77	100	Yes	Single
6X4	6.3	0.6	—50 to 350	12000	300	33-77	—	Yes	Single
6X4	6.3	0.6	Automatic Focus	12000	250	33-66	—	Yes	Single
6X4	6.3	0.6	0-350	14000	300	33-77	—	—	Single
6X4	6.3	0.6	—	12000	250	33-66	110	Yes	Single
6X4	6.3	0.6	—48 to 260	12000	300	33-77	—	Yes	Single
6X4	6.3	0.6	—	12000	300	33-77	92	Yes	Single

1 face to reduce reflections.

NOT INTENDED TO INDICATE TYPE AVAILABILITY.



TELEVISION PI

TYPE	BASING	ENVELOPE	FACE	RADIUS OF FACE CURVATURE Inches	TYPE OF FOCUS	TYPE OF DEFLECTION	DEFLECTION ANGLE Degrees	BULB DIMENSIONS		
								MAX. LENGTH Inches	MAX. DIAM. or WIDTH Inches	MIN. USEFUL SCREEN SIZE Inches
19AP4	12D	Metal	Clear	28	Mag.	Mag.	66	22	18¾	17¾
19AP4A	12D	Metal	Filter							
19AP4B ³	12D	Metal	Filter							
19AP4C ¹	12D	Metal	Filter							
19AP4D ³	12D	Metal	Clear	60	Mag.	Mag.	66	21½	19	17¾
19DP4	12N	Glass	Clear							
19DP4A	12N	Glass	Filter	27	Mag.	Mag.	70 Diag.	21½	17½	W=16 H=12
19EP4 ²	12D	Glass	Filter							
19FP4	12D	Glass	Filter							
19GP4	12D	Glass	Filter							
19JP4 ²	12D	Glass	Filter	27	Mag.	Mag.	70 Diag.	21¾	18½	W=16 H=12
20AP4	12A	Glass	Clear	26	Elec.	Elec.	—	27¾	20	17
20BP4	12D	Glass	Clear	30	Mag.	Mag.	54	28¾	20¾	18¾
20CP4 ²	12D	Glass	Filter	40	Mag.	Mag.	70 Diag.	21¾	18¾	W=17 H=12½
20CP4A ²	12N	Glass	Filter							
20CP4C ²⁻³	12D	Glass	Filter							
20DP4 ²	12D	Glass	Filter	40	Mag.	Mag.	70 Diag.	22½	18¾	W=17 H=12½
20DP4A ²	12N	Glass	Filter							
20FP4 ²	12M	Glass	Filter	40	Elec.	Mag.	70 Diag.	22½	18¾	W=17½ H=13
20FP4A ²	12L	Glass	Filter							
20GP4 ²⁻³	12L	Glass	Filter	40	Elec.	Mag.	70 Diag.	22½	18½	W=17 H=12½
20HP4 ²	12M	Glass	Filter	40	Elec.	Mag.	70 Diag.	22½	18¾	W=17 H=12½
20HP4A ²	12L	Glass	Filter							
20HP4B ²⁻³	12M	Glass	Filter							
20JP4 ²	12N	Glass	Filter	40	Elec.	Mag.	70 Diag.	22½	18¾	W=17 H=12½
20LP4 ²	12L	Glass	Filter	40	Elec.	Mag.	70 Diag.	22½	18½	W=17 H=13
21AP4 ²⁻³	12D	Metal	Filter	33	Mag.	Mag.	70 Diag.	22¾	19¾	W=18½ H=13
21AFP4 ²	12M	Glass	Filter	40	Elec.	Mag.	70 Diag.	23¾	20¼	W=19 H=14
21DP4 ²⁻³	12M	Metal	Filter	33	Elec.	Mag.	70 Diag.	22¾	19¾	W=18 H=13
21EP4A ²⁻³⁻⁴	12N	Glass	Filter	35	Mag.	Mag.	70 Diag.	23¾	20¾	W=19 H=13
21EP4B ¹⁻²⁻⁴	12N	Glass	Filter							
21FP4 ²⁻³⁻⁴	12M	Glass	Filter	35	Elec.	Mag.	70 Diag.	23¾	20½	W=19 H=13
21FP4A ²⁻³⁻⁴	12L	Glass	Filter							

¹ Metal backed screen. ² Rectangular face. ³ Etched face to reduce reflections. ⁴ Cylindrical face.
THIS DATA IS COMPILED AS A SERVICE TO THE FIELD

TURE TUBES



BULB CONTACT	HEATER		TYPICAL OPERATING CONDITIONS					EXTERNAL CONDUCTIVE COATING	ION TRAP
	VOLTS	AMPS.	FOCUS OR ANODE 1 VOLTS	ANODE 2 VOLTS	GRID 2 VOLTS	NEG. GRID 1 CUTOFF VOLTS	FOCUS CURRENT Ma.		
—	6.3	0.6	—	12000	300	33-77	140	—	Single
Convity	6.3	0.6	—	13000	250	26-63	146	Yes	Single
Convity	6.3	0.6	—	13000	250	26-63	95	No	Single
Convity	6.3	0.6	—	13000	250	27-63	115	No	Double
Convity	6.3	0.6	—	13000	250	27-63	115	No	Single
Convity	6.3	0.6	—	12000	300	33-77	95	No	Single
Convity	6.3	0.6	-50 to 350	12000	300	33-77	—	Yes	Single
—	2.5	2.1	1000	4000	Anode 3 8000	40-120	—	No	None
Cap	6.3	0.6	—	15000	250	27-63	135	No	None
Convity	6.3	0.6	—	12000	300	33-77	95	No Yes No	Single Single Single
Convity	6.3	0.6	—	12000	300	33-77	95	No Yes	Single Single
Convity	6.3	0.6	2700	12000	300	33-77	—	No Yes	Single Single
Convity	6.3	0.6	3200	14000	300	33-77	—	Yes	Single
Convity	6.3	0.6	-48 to 260	12000	300	33-77	—	No Yes No	Single Single Single
Convity	6.3	0.6	Selfocus	12000	300	33-77	—	Yes	Single
Convity	6.3	0.6	0	14000	300	33-77	—	Yes	Single
Convity	6.3	0.6	-55 to 300	14000	300	33-77	—	Yes	Single
—	6.3	0.6	—	14000	300	33-77	104	—	Single
Convity	6.3	0.6	-500 to 1000	18000	500	125	—	No	Single
—	6.3	0.6	3200	14000	300	33-77	—	—	Single
Convity	6.3	0.6	—	12000	300	33-77	95	No Yes	Single Single
Convity	6.3	0.6	—	16000	300	33-77	116	Yes	Single
Convity	6.3	0.6	-56 to 308	14000	300	33-77	—	No Yes	Single Single

al face to reduce reflections.

IT IS NOT INTENDED TO INDICATE TYPE AVAILABILITY.



TELEVISION PIC

TYPE	BASING	ENVEL- OPE	FACE	RADIUS OF FACE CURVATURE Inches	TYPE OF FOCUS	TYPE OF DEFLEC- TION	DEFLEC- TION ANGLE Degrees	BULB DIMENSIONS		
								MAX. LENGTH Inches	MAX. DIAM. or WIDTH Inches	MIN. USEFUL SCREEN SIZE Inches
21FP4C ¹⁻²⁻¹	12L	Glass	Filter	35	Elec.	Mag.	70 Diag.	23 $\frac{3}{8}$	20 $\frac{1}{16}$	W = 19 $\frac{1}{8}$ H = 13 $\frac{3}{8}$
21GP4	12M	Metal	Filter	40	Elec.	Mag.	70 Diag.	22 $\frac{1}{8}$	19 $\frac{3}{8}$	W = 18 $\frac{1}{4}$ H = 13 $\frac{3}{8}$
21KP4 ²⁻¹	12D	Glass	Filter	35	Elec.	Mag.	70 Diag.	22 $\frac{1}{4}$	20 $\frac{3}{8}$	W = 19 $\frac{1}{8}$ H = 13 $\frac{3}{8}$
21KP4A ²⁻¹	12N	Glass	Filter	35	Elec.	Mag.	70 Diag.	22 $\frac{1}{4}$	20 $\frac{3}{8}$	W = 19 $\frac{1}{8}$ H = 13 $\frac{3}{8}$
21MP4 ²⁻³	12M	Metal	Filter	33	Elec.	Mag.	70 Diag.	22 $\frac{5}{8}$	19 $\frac{3}{8}$	W = 18 $\frac{1}{8}$ H = 13 $\frac{3}{4}$
21WP4 ²	12N	Glass	Filter	40	Mag.	Mag.	70 Diag.	22 $\frac{5}{8}$	18 $\frac{1}{16}$	W = 17 H = 12 $\frac{3}{4}$
21XP4 ²	12L	Glass	Filter	40	Elec.	Mag.	70 Diag.	22 $\frac{5}{8}$	18 $\frac{1}{16}$	W = 17 H = 12 $\frac{3}{4}$
21YP4 ²	12L	Glass	Filter	40	Elec.	Mag.	70 Diag.	23 $\frac{3}{8}$	20 $\frac{1}{16}$	W = 19 $\frac{1}{8}$ H = 14 $\frac{1}{16}$
21YP4A ¹⁻²	12L	Glass	Filter	40	Elec.	Mag.	70 Diag.	23 $\frac{3}{8}$	20 $\frac{1}{16}$	W = 19 $\frac{1}{8}$ H = 14 $\frac{1}{16}$
21ZP4 ²	12D	Glass	Filter	40	Mag.	Mag.	70 Diag.	23 $\frac{3}{8}$	20 $\frac{1}{16}$	W = 19 $\frac{1}{8}$ H = 13 $\frac{3}{8}$
21ZP4A ²	12N	Glass	Filter	40	Mag.	Mag.	70 Diag.	23 $\frac{3}{8}$	20 $\frac{1}{16}$	W = 19 $\frac{1}{8}$ H = 13 $\frac{3}{8}$
21ZP4B ¹⁻²	12N	Glass	Filter	40	Mag.	Mag.	70 Diag.	23 $\frac{3}{8}$	20 $\frac{1}{16}$	W = 19 $\frac{1}{8}$ H = 13 $\frac{3}{8}$
22AP4	12D	Metal	Clear	27	Mag.	Mag.	70	23 $\frac{3}{8}$	21 $\frac{1}{8}$	20 $\frac{1}{4}$
22AP4A	12D	Metal	Filter	27	Mag.	Mag.	70	23 $\frac{3}{8}$	21 $\frac{1}{8}$	20 $\frac{1}{4}$
24AP4	12D	Metal	Filter	40	Mag.	Mag.	70	24 $\frac{1}{2}$	24 $\frac{1}{4}$	22 $\frac{3}{8}$
24AP4A ¹	12D	Metal	Filter	40	Mag.	Mag.	70	24 $\frac{1}{2}$	24 $\frac{1}{4}$	22 $\frac{3}{8}$
24AP4B ³	12D	Metal	Filter	40	Mag.	Mag.	70	24 $\frac{1}{2}$	24 $\frac{1}{4}$	22 $\frac{3}{8}$
24BP4	12M	Metal	Filter	40	Elec.	Mag.	70	24 $\frac{3}{4}$	24 $\frac{1}{8}$	22 $\frac{1}{4}$
24CP4 ²	12N	Glass	Filter	40	Mag.	Mag.	90 Diag.	21 $\frac{1}{2}$	22 $\frac{1}{16}$	W = 21 $\frac{1}{4}$ H = 16 $\frac{3}{4}$
24CP4A ¹⁻²	12N	Glass	Filter	40	Mag.	Mag.	90 Diag.	21 $\frac{1}{2}$	22 $\frac{1}{16}$	W = 21 $\frac{1}{4}$ H = 16 $\frac{3}{4}$
24DP4 ²	12L	Glass	Filter	40	Elec.	Mag.	90 Diag.	21 $\frac{1}{2}$	22 $\frac{1}{16}$	W = 21 $\frac{1}{4}$ H = 16 $\frac{3}{4}$
24DP4A ¹⁻²	12L	Glass	Filter	40	Elec.	Mag.	90 Diag.	21 $\frac{1}{2}$	22 $\frac{1}{16}$	W = 21 $\frac{1}{4}$ H = 16 $\frac{3}{4}$
24QP4 ²	12N	Glass	Filter	40	Mag.	Mag.	90 Diag.	21 $\frac{1}{2}$	22 $\frac{1}{16}$	W = 21 $\frac{1}{8}$ H = 16 $\frac{3}{8}$
24TP4 ¹⁻²	12N	Glass	Filter	40	Mag.	Mag.	90 Diag.	21 $\frac{1}{2}$	22 $\frac{1}{16}$	W = 21 $\frac{1}{8}$ H = 17 $\frac{1}{8}$
24VP4 ²	12N	Glass	Filter	40	Mag.	Mag.	90 Diag.	21 $\frac{1}{2}$	22 $\frac{1}{16}$	W = 21 $\frac{3}{8}$ H = 16 $\frac{1}{16}$
24VP4A ¹⁻²	12N	Glass	Filter	40	Mag.	Mag.	90 Diag.	21 $\frac{1}{2}$	22 $\frac{1}{16}$	W = 21 $\frac{3}{8}$ H = 16 $\frac{1}{16}$
27AP4 ²⁻³	12M	Metal	Filter	40	Elec.	Mag.	90 Diag.	21 $\frac{7}{8}$	25 $\frac{3}{8}$	W = 23 $\frac{1}{8}$ H = 18 $\frac{1}{8}$
27EP4 ¹⁻²	12D	Glass	Filter	40	Mag.	Mag.	90 Diag.	23 $\frac{1}{16}$	25 $\frac{1}{16}$	W = 24 H = 18 $\frac{1}{2}$
27GP4 ²	12D	Glass	Filter	40	Mag.	Mag.	90 Diag.	23 $\frac{1}{16}$	25 $\frac{3}{16}$	W = 24 $\frac{1}{4}$ H = 18 $\frac{1}{4}$
27LP4 ¹⁻²	12N	Glass	Filter	40	Mag.	Mag.	90 Diag.	24 $\frac{3}{4}$	25 $\frac{3}{16}$	W = 23 $\frac{1}{2}$ H = 18 $\frac{1}{2}$
27MP4 ¹⁻²⁻³	12D	Metal	Filter	40	Mag.	Mag.	90 Diag.	22 $\frac{3}{16}$	25 $\frac{1}{16}$	W = 23 $\frac{1}{16}$ H = 18 $\frac{1}{16}$
27NP4 ²	12N	Glass	Filter	40	Mag.	Mag.	90 Diag.	23 $\frac{3}{8}$	25 $\frac{1}{16}$	W = 24 $\frac{1}{4}$ H = 18 $\frac{1}{4}$
27RP4 ¹⁻²	12N	Glass	Filter	40	Mag.	Mag.	90 Diag.	23 $\frac{1}{16}$	25 $\frac{1}{16}$	W = 24 H = 18 $\frac{1}{16}$
30BP4	12D	Metal	Filter	40	Mag.	Mag.	90	24 $\frac{1}{16}$	30 $\frac{3}{8}$	28 $\frac{1}{4}$

¹ Metal backed screen. ² Rectangular face. ³ Etched face to reduce reflectⁿ

TURE TUBES



BULB CONTACT	HEATER		TYPICAL OPERATING CONDITIONS				EXTERNAL CONDUCTIVE COATING	ION TRAP	
	VOLTS	AMPS.	FOCUS OR ANODE 1 VOLTS	ANODE 2 VOLTS	GRID 2 VOLTS	NEG. GRID 1 CUTOFF VOLTS			FOCUS CURRENT Ma.
Cavity	6.3	0.6	-56 to 310	14000	300	28-72	—	Yes	Single
—	6.3	0.6	Selfocus	17000	300	33-77	—	—	Single
Cavity	6.3	0.6	—	12000	300	33-77	—	No Yes	Single Single
—	6.3	0.6	-55 to 300	14000	300	33-77	—	—	Single
Cavity	6.3	0.6	—	16000	300	28-72	100	Yes	Single
Cavity	6.3	0.6	-64 to 352	16000	300	28-72	—	Yes	Single
Cavity	6.3	0.6	-64 to 352	16000	300	33-77	—	Yes	Single
Cavity	6.3	0.6	—	16000	300	33-77	95 100 118	No Yes Yes	Single Single Single
—	6.3	0.6	—	14000	300	33-77	117	—	Single
—	6.3	0.6	—	12000	300	33-77	91	—	Single
—	6.3	0.6	-48 to 260	12000	300	33-77	—	—	Single
Cavity	6.3	0.6	—	18000	300	33-77	115	Yes	Single
Cavity	6.3	0.6	-72 to 400	18000	300	33-77	—	Yes	Single
Cavity	6.3	0.6	—	16000	300	28-72	100	Yes	Single
Cavity	6.3	0.6	—	16000	300	33-77	110	Yes	Single
Cavity	6.3	0.6	—	20000	300	33-77	125	Yes	Single
—	6.3	0.6	-48 to 260	12000	300	33-77	—	—	Single
Cavity	6.3	0.6	—	16000	300	33-77	118	No	Single
Cavity	6.3	0.6	—	16000	300	33-77	95	No	Single
Cavity	6.3	0.6	—	20000	300	33-77	148	Yes	Single
—	6.3	0.6	—	17000	350	33-85	148	—	Single
Cavity	6.3	0.6	—	16000	300	28-72	95	Yes	Single
Cavity	6.3	0.6	—	16000	300	33-77	105	Yes	Single
—	6.3	0.6	—	12000	300	33-77	95	—	Single

s. † Cylindrical face to reduce reflections.

TEST TABLE I—ELECTROLYTICS

CHARGE TEST				DISCHARGE TEST	
D.C.W.V.	Sw Pos.	Meter Range ¹ (ma)	Allowable Leakage ² (for 20- μ f unit)	Meter Range	Allowable Indication (for 20- μ f unit)
450	5	Start at 120	4 ma (0.2 ma/ μ f)	12 ma	6 ma (past $\frac{1}{2}$ scale)
300	4	Start at 120	2 ma (0.1 ma/ μ f)	300 v.a.c.	200 v (past $\frac{3}{4}$ scale)
150	3	Start at 12	1 ma (0.05 ma/ μ f)	300 v.a.c.	150 v (past $\frac{1}{2}$ scale)
50	2	Start at 12	0.5 ma (.025 ma/ μ f)	60 v.a.c.	30 v (past $\frac{1}{2}$ scale)
25	1	Start at 12	0.5 ma (.025 ma/ μ f)	60 v.a.c.	15 v (past $\frac{1}{4}$ scale)

For meters with d.c. resistance of 20,000 and a.c. resistance of 1,000 ohms per volt

¹After charging (or forming) surge, reduce range to lowest safe scale for accurate stabilized reading.

²Allowable leakage for practical replacement purposes.

[These values are about twice the RETMA standard for new capacitors given by the formula: Leakage current = (factor \times μ f + 0.3) ma. Factor varies from .01 at 25 volts to .04 at 450 volts.]

TEST TABLE II—NONELECTROLYTICS

Sw Pos.	Capacitance (μ f)	Voltage	CHARGE TEST		DISCHARGE TEST	
			Meter Range (volts d.c.)	Allowable Leakage ² (meter divisions ¹)	Meter Range (volts d.c.)	Allowable Indication (approx. pointer swing ³)
5	1 or over	600 400	1,200	Below 6 " 10	1,200	$\frac{2}{3}$ scale
5	0.5-0.9	600 400	1,200	Below 4 " 7	1,200	$\frac{1}{2}$ scale
5	0.1-0.4	600 400	1,200	Below 2 " 4	1,200	$\frac{1}{3}$ scale
5	0.5-0.9	600 400	300	Below 2 " 4	300	$\frac{2}{3}$ scale
5	.01-.04	600 400	300	Below 2 " 4	300	$\frac{1}{3}$ scale
5	.001-.009	600 400	300	Below 1 " 2	300	1/12 scale
5	.005-.009	600 400	150 (v.t.v.m.)	Below 2 " 4	150 (v.t.v.m.)	$\frac{1}{3}$ scale
5	.001-.004	600 400	150 (v.t.v.m.)	Below 2 " 4	150 (v.t.v.m.)	$\frac{1}{4}$ scale

(Based on resistances of 20,000 ohms per volt d.c. and 1,000 ohms per volt a.c., except where v.t.v.m. is indicated)

¹Each division on 20,000-ohm voltmeter equals 50 μ a divided by number of divisions.

²For critical applications such as coupling capacitors, reading should be practically zero and definitely less than 1 μ a. All indications are for stabilized readings.

³Discharge swing should be approximately equal to charge swing. For comparing swings be sure to obtain full swing of each, using lever action, repeated if necessary. Exact readings are not necessary—appreciable difference will be noted with bad capacitor.

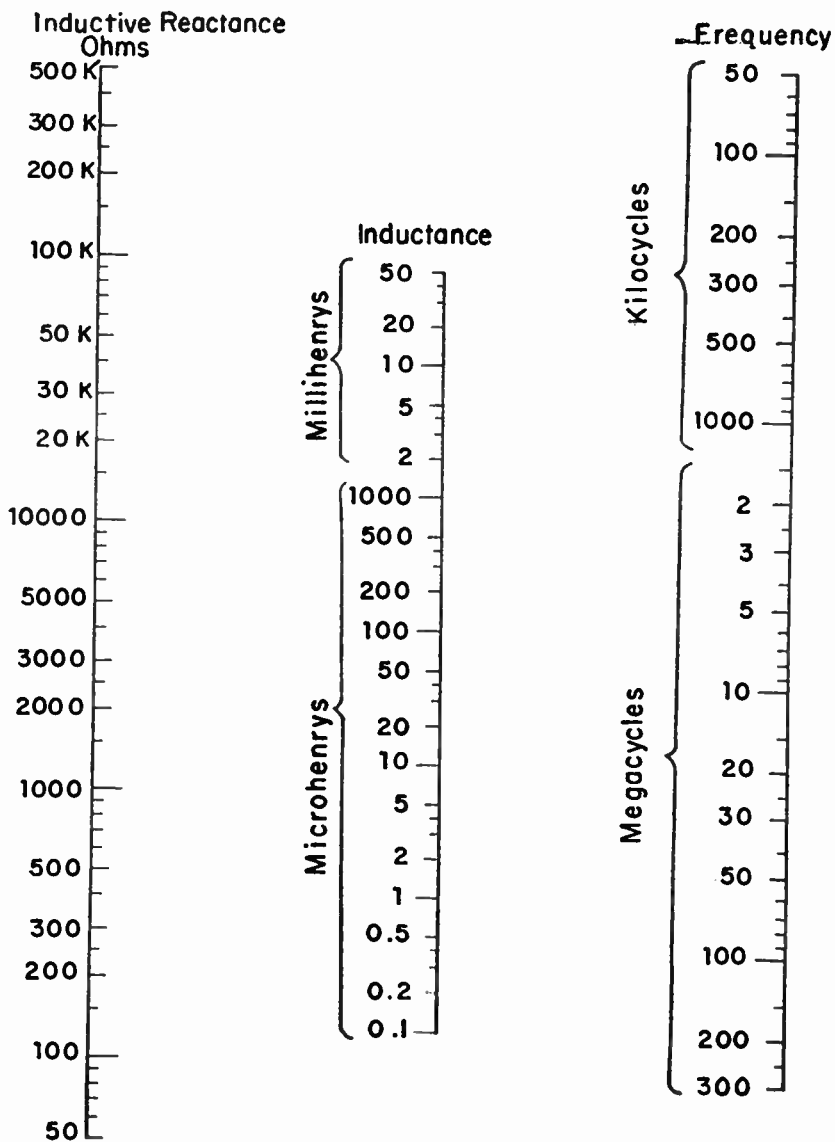
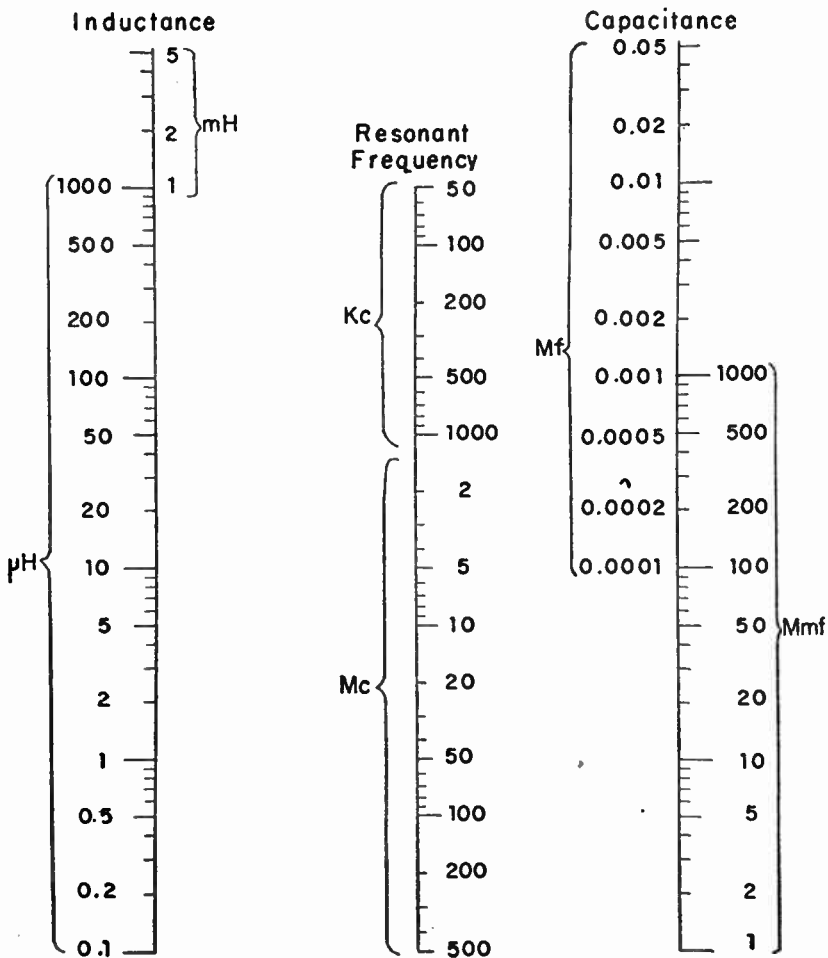

Chart for inductive reactances at high frequencies.



Alignment chart for inductance, capacitance and frequency of resonance. By laying the straightedge on known values of inductance and capacitance you can read the resonant frequency. With the straightedge on a known inductance and a desired resonant frequency it is possible to determine the capacitance required. When the straightedge is on a known capacitance and a desired frequency you can read the inductance required for the frequency of resonance.