

Father of Radio

*The
Autobiography
of*
LEE de FOREST

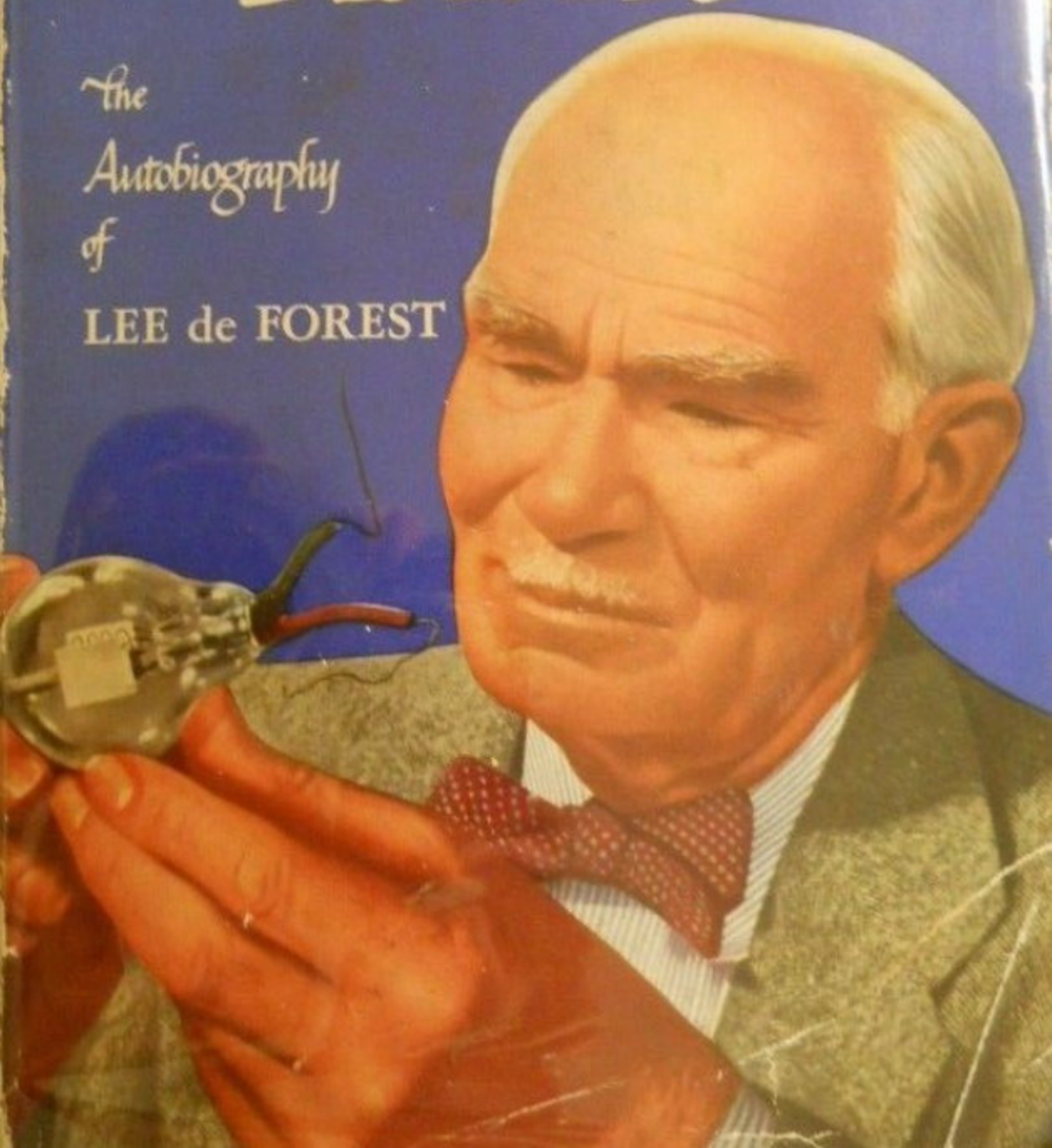



Father OF Radio

THE
autobiography
OF
Lee de Forest

1950

Wilcox & Follett Co. CHICAGO

EDITORS: *Linton J. Keith*
Arthur Brogue

DESIGNER: *Stanford W. Williamson*

COPYRIGHT, 1950, BY
Wilcox & Follett Co.
Chicago, Ill.

All rights in this book are reserved. No part of the text may be reproduced in any form without permission of the publisher, except brief quotations used in connection with reviews in magazines or newspapers.

PRINTED IN THE UNITED STATES OF AMERICA

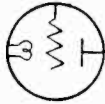

Dedication

To my old comrades and associates in the forgotten days of Wireless—to my eager assistants in the early years of the Audion and of Radiobroadcasting—to the multitudes of young men and women who loved, as I have loved, the long night hours of listening to distant signals and far-off voices—to the keen engineers who hastened to grasp the new electronic tools I laid before them, creating therewith a vast new universe—to the United States Navy, which was always prompt to use my new wireless and radio devices, whose operators heard my first radiobroadcast, and whose Admirals never failed to give me welcome encouragement when it was most sorely needed—to the United States Signal Corps, whose Chiefs and Officers have from the beginning continued to be friend and guide—to the Bell Laboratories engineers who first saw the worth of the Audion amplifier—to the radio announcers who must speak what is written though their hearts be not always therein—to the brilliant pioneers in our latest miracle of Television—to the partner of my earliest wireless experiments, E. W. Smythe, whose financial assistance, limited though it was, nevertheless made that beginning possible—to Max Stires, another friend in time of need—to all who have fought with or against me in the exciting battles of the patent field—and especially to the memory of those stalwart allies and firmest friends, grand old Captain Samuel E. Darby and his brilliant son, Samuel E. Darby, Jr. (both now departed)—TO ALL OF THESE this volume is devotedly dedicated.



Preface

Having spent the first fifty years of this century making, and helping to make, radio and television history, it seems fitting that I should now relax a little and take time off from my still-busy round to record a bit of that history, together with such details of my personal life as may be of interest to others.

I do this in the hope that a frank revelation of my own struggles, disappointments, and successes may encourage others to embark on a similar career of discovery and invention. The opportunities today are just as great as they were at the start of our century. Perhaps the pitfalls and obstacles are also as great, though I believe the reader who follows my story to its end will agree that I have encountered more than the usual share of difficulties.

Looking back, I realize that these difficulties are what made my life interesting—to me. I hope I have succeeded in making this account of it as interesting to my readers!

LEE DE FOREST

April, 1950

Acknowledgments

For their invaluable help during the years-long preparation of this volume I am deeply indebted to these three old friends: to George H. Clark, for much historical documentation for old photographs taken from his Radio Historical Library, and for his helpful suggestions and kind encouragement to proceed; to Hugo Gernsback, pioneer editor of Journals covering the experimental radio field, for additional material and help; and to my secretary, Alice Van Deusen Gazin, without whose untiring industry in typing and correlating the vast amount of material involved, the completion of this work would have been impossible.

LEE DE FOREST



Contents

CHAPTER	PAGE
<i>Introduction</i>	<i>I</i>
1 <i>Family Origins</i>	5
2 <i>Alabama Childhood</i>	15
3 <i>Southern Upbringing</i>	34
4 <i>Talladega Youth</i>	45
5 <i>Mt. Hermon Days</i>	55
6 <i>Yale Undergraduate Years</i>	64
7 <i>Graduate Years</i>	83
8 <i>First Love</i>	99
9 <i>Beginning Wireless</i>	110
10 <i>Ships Ahoy!</i>	123
11 <i>Early Wireless Operators</i>	136
12 <i>1903—Historic Firsts</i>	143
13 <i>Wireless Goes to War</i>	155
14 <i>Early Litigation</i>	159
15 <i>Overland Wireless</i>	163
16 <i>Big Navy Wireless</i>	173
17 <i>Little Old New York</i>	196
18 <i>Crossing the Atlantic</i>	201
19 <i>Conception of the Audion</i>	210
20 <i>Crash of First Fortune—Founding of Second</i>	216
21 <i>Radio and Romance</i>	222

CHAPTER	PAGE
22 <i>Radio Invades Europe</i>	236
23 <i>Radio Resurgent</i>	242
24 <i>Sadness and Joy</i>	251
25 <i>Opera by Radio</i>	267
26 <i>Radio Goes West</i>	272
27 <i>Collapse of Second Fortune</i>	281
28 <i>Palo Alto Again</i>	286
29 <i>A Lever to Move the World</i>	290
30 <i>Romance and Radio Resurgent</i>	300
31 <i>The Telephone Company Gets a Bargain</i>	304
32 <i>The Audion No Swindle!</i>	311
33 <i>Starting a Third Fortune</i>	316
34 <i>Transcontinental Telephony</i>	328
35 <i>Radio in New Roles</i>	331
36 <i>The Broadcasting Era Begins</i>	336
37 <i>A New Enchantment</i>	345
38 <i>Pioneering in Talking Pictures</i>	358
39 <i>Phonofilm Comes to Broadway</i>	367
40 <i>Historic Litigation</i>	375
41 <i>The Dam Goes Out—at Last</i>	387
42 <i>Phonofilm Fadeout</i>	398
43 <i>Marie Mosquini</i>	408
44 <i>Mountain Climbing</i>	412
45 <i>Early Television Work</i>	418
46 <i>Diathermy</i>	423
47 <i>For War and for Peace</i>	427
48 <i>Television</i>	433
49 <i>A Parent's Disappointment</i>	441
50 <i>A.R.R.L.—V.W.O.A.—I.R.E.</i>	452
51 <i>Finale</i>	458
APPENDIX	
<i>Poems</i>	469
<i>Evolution of the Audion</i>	477
<i>De Forest Patents—1902-1949</i>	485
<i>Index</i>	491



Introduction

I recall as though it happened but yesterday the thrill of significant achievement which possessed me on that sunny afternoon in early October, 1906, as I hurried to my laboratory carrying in my coat pocket the world's only supply of *three-electrode vacuum tubes*. They were just two in number, and I was eager to test them out to determine whether my latest invention—a tiny bent wire in the form of a grid inserted between the carbon filament and the platinum plate—was an improvement over my previous two-electrode detector; whether my new “grid Audion” could bring in wireless signals over substantially greater distances than other receiving devices then in use. My eagerness grew with every step.

To my excited delight I found that it did; the faint impulses which my short antenna brought to that new grid electrode sounded many times louder in the headphones than any wireless signal ever heard before. I was happy indeed. But I little realized that I held in my hand the long-sought Aladdin's lamp of our new world, “a lamp by which one might hear instead of read,” a lamp which when rubbed by the hands of gifted engineers would swiftly summon gigantic Genii to do our bidding, and all but remake our world.

Had I been gifted with clairvoyance, I could have seen in my little Audion a tiny acorn from which in time would grow a mighty oak with branches spreading to the farthest corners of the earth and even into the vastness of interstellar space. From

its trunk radiates worldwide communication by voice and code. Its leaves vibrate to the finest music that man has ever composed.

From its lofty foliage straight radials reach through the darkened skies to guide the aviator safely to his goal. Like homing pigeons to its boughs come back its radar and sonar echoes to tell him, and sailors far at sea, their sure direction and most safe distance from mountain, rock, or shoal. Man has even fashioned great boughs of this tree into strange shape of weapons, mighty cudgels with which to fight wars and direct rockets, robot planes, and other death-dealing missiles to their targets. In every hospital and doctor's office healing waves are radiated to the sick from its potent fruit.

The weaving branches of this tree make strange patterns to solve in seconds complicated equations else requiring weeks of labored calculation; from its finer branches have already fallen billions of little "acorns" (some of them so called), countless improved varieties of that primal one from which the great tree sprouted. With the magical electron tube, the engineer can now command electrons to do his bidding. For the first time he has ahold of electricity itself, not just its manifestations. The electron tube enables the scientist to split the atom and measure the heat from stars infinitely distant, extending boundlessly man's knowledge of his universe.

Already the thermionic tube is at work in a thousand industries. It will enter thousands more. Electronic devices control high-speed wrapping of packages, delicately fill bottles to the proper level, remove slate from coal at the mines, level elevators, open doors, detect smoke and fumes, measure vibrations and thickness. In uncounted factories electronic energy heats, welds, cements, selects, and counts, saving man from limitless hours of tedious toil. A hundred technical institutes devote their resources to research and study in electronics.

Many and emphatic are the authorities for these statements.

“When Dr. de Forest made the first electron tube he had in his hand the missing link in a great sequence of elemental revolutions in human history—something as wonderful as any of the great epochal discoveries in man’s development, such as the making of fire; of bronze; of iron; of the wheel; of sailing vessels; of the telescope and the microscope; of the application of steam, electric and automotive power! The visible evidence is a still-growing \$6,000,000,000 a year electronics industry!”

—From RCA booklet, *Electronics in Industry*, 1943

“Perhaps the most important event in the history of electronics [occurred] when a young experimenter named Lee de Forest inserted a third electrode in the form of a grid between the cathode and anode of a vacuum tube. The spectacular growth of electronics to an enormous industry employing over a million workers and benefiting untold millions of people in all parts of the world may be said to have begun with that event. Dr. de Forest’s invention of the triode tube not only solved certain problems of itself, it also acted as a stimulus to the efforts of hundreds of later inventors who devoted their lives to improving it and adapting it to an ever-increasing number of uses. Even today the full extent of its utility and value has only been scratched.”

—Charles F. Kettering, *Radio-Craft*, January, 1947

“Lee de Forest, in discovering that an electric current in a vacuum tube can be controlled by means of an interposed grid, laid the foundation for an extension of man’s senses—and an increase in speed and in sensitivity of many millionfold. The revolution has been as great in its way as that which may now be envisioned in other fields through our new control of nuclear power.”

—Dr. Irving Langmuir, *Radio-Craft*, January, 1947

“. . . so outstanding in its consequences that it almost ranks with the greatest inventions of all time.”

—Nobel prize winner, Dr. I. I. Rabi, quoted in *Invention and Innovation in the Radio Industry*, p. 70, W. Rupert MacLaurin, Macmillan Co., 1949

Unwittingly then had I discovered an Invisible Empire of the Air, intangible, yet solid as granite, whose structure shall persist while man inhabits the planet; a global organism, imponderable yet most substantial, both mundane and empyreal; fading not as the years, the centuries fade away—an electronic fabric influencing all our thinking, making our living more noble.

For this, my life has been rich indeed!

Within these pages are narrated the varied events of that life, a very human story, which already has encompassed well-nigh the Biblical fourscore years; most of them eventful years, filled with enticing tasks, much of romance, and a modicum of sorrow.

For many years now newspaper and radio journalists have been calling me “the father of radio.” Some of late have even taken to adding “and the grandfather of television.” That so great an honor is due me, I should be the last to assert. But I believe I may, without immodesty, claim to know better than any man living or dead the natal circumstances and early history of the things we call Radio and Television. It is therefore with a sense of obligation, as well as pride, that I endeavor in the pages of this book to share my great store of personal recollections with my readers. Here for the first time are revealed interesting chapters of history previously known only to myself and intimate acquaintances.

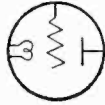

CHAPTER I

Family Origins

*F*ROM the little town of Waterloo, Iowa, come my earliest recollections. I recall as though they were of yesterday the simple surroundings in which my first years of childhood were lived.

Looking back after a lifetime devoted to the communication and reproduction of sound, it seems more than a coincidence that the early experience which made the most indelible impression on my memory was a visit during my fourth year to a local shop where I saw and heard an Edison tin-foil phonograph—the same early model which had been one of the chief attractions of the Centennial Exposition at Philadelphia the year before. That first demonstration of the wonder-working power of scientific invention struck a spark in my childish imagination which remained aglow throughout all my later years.

But my memories of Waterloo were not all of this prophetic sort. There was the usual run of experiences which make up the life of little boys everywhere.

I remember the awful spasms of fright when big bully Joe Leavitt chased me over his yard, waving a knife with which he threatened to amputate my very large ears. Of Waterloo also I have clear recollections of sneaking away from home—with “bad boys,” of course—to the depot, where the freight trains rolled along the tracks. There these reckless youngsters hooked onto the freight cars for stolen rides. I have no remembrance of ever hooking a ride myself, but it must have been only the shortness of my arms and legs that kept me from the attempt. Probably had I done so at the tender age of five years, I would not now be writing this account of my adventures.

Although my father was a Congregational minister, he and my mother were, nevertheless, sufficiently broad-minded to take Sister Mary and myself, on one wonderful occasion, to see the circus. The strange, monstrous animals, and the beautiful ladies in pink tights flitting from trapezes far aloft in the mighty top made further lasting impressions upon my memory. And I can remember how we two children later turned an upper bedroom into a circus, to the complete disarray of the furniture, where we insisted on turning somersaults and standing on our heads. I remember also my fine red toy balloon, nudging the ceiling when I fell asleep, but to my sad surprise under the bed next morning!

I believe my earliest chastisements, like Napoleon’s last one, occurred at Waterloo—Mama officiating, with back of hairbrush across open palm, tightly stretched. But that family tradition was carried on long after we left Iowa. Soon Papa had to take over.

Sister Mary was never, never bad, never had to suffer worse than five minutes of standing in the corner. At heart our parents were fond and loving, but seldom indulgent. Firm rules and strict discipline, accompanied before and after with prayer, contrived to rear us all in the paths of God’s children.

When I was five years old, the family moved to Muscatine. There for the next year we occupied a brick house directly across the street from my grandfather Robbins' home. Even at that early date, 1878, I remember the fine head of silky, silvery hair which adorned the brow and crowned the Grecian profile of my mother's father.

Alden Burrill Robbins was one of the members of the famous "Iowa Band," a heroic group of self-sacrificing pioneer home missionaries who had come from Massachusetts to Iowa in the early days of that territory to preach the Gospel. He was one of the founders of Muscatine, had established there the first Congregational Church in the territory, and built as a parsonage the fine old rambling frame structure which my childish years remember so well.

Grandfather Robbins had been born February 18, 1817, in Salem, Massachusetts. His father, David, born in 1783, was four generations descended from one Richard Robbins, whom chronology first records as living in Charlestown, Massachusetts, as early as 1639. This distant ancestor, born in England in 1610, presumably was among the passengers of the Mayflower. On his mother's side Grandfather Robbins was descended from John Alden.

After graduation from Amherst College and Andover Theological Seminary, he married and soon afterwards enlisted in the Iowa Band aforementioned. Until his death in 1896 he was to continue as the honored and beloved pastor of the Muscatine Congregational Church, of which he had been the founder.

My grandmother had died from cholera when my mother was only three years old. I well remember my mother's stern stepmother, whose sharp blue eyes, peering from behind steel-rimmed spectacles, were eternally on the alert whenever I entered the premises, and particularly when I thought to steal into the china closet where I knew lump sugar was concealed.

I could never bring myself to any state of warm affection for my step-grandma. But I was fond indeed of my grandfather and used to love to steal upstairs and around the long, darkened passageway which led to his book-lined study, there to scrutinize with wonder the intricate details of his student lamp and endeavor to understand how it was that the oil in the tank did not overflow while still able to supply the wick with oil.

Grandpa Robbins frequently had nuts and caramels to give us grandchildren, but Grandma fed us quassia root steeped in water, perhaps for the benefit of our bowels, but to the swift dissipation of our childish happiness.

I can well remember Christmas carols, my dear mother seated at the organ and all the grandchildren standing around singing the happy songs which we had learned at Sunday school. Of devotions, both at Grandpa's and at my father's home, there was indeed no lack or end, especially on Sundays.

Further recollections from Muscatine are of the silent-flowing Mississippi which we watched from the lofty banks; of the great rafts of logs that went slowly southward; of the annual Sunday-school excursion, when the small tug towed two large barges laden with exuberant scholars and worried teachers far down the river to some shady picnic bank; and in winter, of the steep mile-long road slide which started a short distance above my grandfather's home and stretched clear into town, down which on winter moonlight nights great bobsleds, each carrying perhaps twenty rollicking passengers, raced at dizzy pace, endangering the lives of all on board as well as any venturesome spirits who undertook to cross the road.

How cold those Iowa winters were! Hoarfrost coated the iron latches of the kitchen door. Once a villainous housemaid told us children that if we put our tongue on the latch we would hear the angels sing. We did!

Once during a visit some years later, a forbidden newspaper fell into my hands at Grandpapa's, giving a complete detailed description of one of John L. Sullivan's long bloody battles. At my first opportunity, I sneaked away to the privy behind the barn to read the grisly details without disturbance from my disapproving elders.

The great Hershey sawmill down by the riverside fascinated me as I used to stand near the great logs going through the bandsaws and being ripped into huge planks and twelve-foot beams. I remember little Gertie Musser who lived diagonally across the road in the great and awesome mansion of "the richest family in Muscatine"; the impressive stained-glass windows in the lordly brick mansion of Mr. Clark, a man who had suddenly attained wealth by some mysterious, devious method, but whose daughter, Katie, was nevertheless a mighty fine girl to play with; the cemetery two miles down the dusty road, where on Decoration Day the Muscatine Blues fired three frightening volleys over the graves of the Civil War dead; and the church way downtown, where my mother led the choir and my grandfather preached, while I struggled to keep awake by dwelling in anticipation upon the chicken dinner which would await us when we again climbed the long hill to the parsonage.

It was in Muscatine that school began for me. But not for long, because in 1879 my father accepted the presidency of Talladega College, established ten years previously for the general schooling and higher education of the "Freedmen," as the Negroes were then called so soon after slavery.

To move from Iowa to Alabama was just an adventure to us children, but a heroic sacrifice to our parents, particularly to my mother. Perhaps she then little realized what she was giving up, the delightful church and social life of a Northern town for the isolation and ostracism of a small Southern village.

Nevertheless Father regarded it a sacred duty as well as a wonderful opportunity to serve the cause of a neglected people who were then almost devoid of friends, and who stood in need of everything—mental, spiritual, and physical.

With infinite loyalty and heroic devotion to her husband and the good cause which he had espoused, my mother resolutely set her face to accompany him through all hardships, come what may. She and her three children then were to be sacrificed upon the altar of home missionary zeal; but we youngsters knew nothing of all this. Little did we realize how deeply the decision which our parents then made would influence all our later lives. We had then never heard the song, but our childish hearts were singing, nevertheless, "Look away, look away; away down south in Dixie." We were off for Alabama, with a banjo on our knee.

On my father's side I am descended from a family of French Huguenots. My father often told my brother and me that we were the eighth generation from France—by way of the Netherlands.

The pioneer émigré was Jesse who, through his descendants, founded the de Forest family in the New World. About 1612 Jesse de Forest moved from Avesnes, France, to Leyden, Holland. In 1623 he conducted an expedition in three vessels to the northern coast of South America. There, after several years of privation and suffering, he died. But in the latter half of 1636 his oldest son, Henry de Forest, then thirty years old, and his brother Isaac, twenty, decided to settle in New Amsterdam as tobacco planters. Both of the brothers seem to have been provided with sufficient means to make a propitious start. They sailed from Amsterdam on the first of October, 1636.

The upper portion of New York, or Manhattan Island, was then a mere wilderness of virgin forests and natural clearings.

To settle there was to risk life and fortune, as the events of the following decade proved. However, the de Forest brothers fixed upon a broad, fertile flat called Mascoutah and became the unprosperous founders of Harlem. Soon afterward Henry died.

For several years Isaac remained in Harlem, raising what tobacco he could from his hundred acres. In 1641 he married Sarah de Truit of New Amsterdam, spinster. From this union sprang the de Forest clan.

David, the youngest son, moved to Stratford, Connecticut, whence most of the de Forests of New England stem. His descendants remained farmers until the Revolution. Sixteen grandsons of David of Stratford served during the War of Independence. One of his great-grandsons was David Curtis de Forest, a roving seaman and privateer of checkered and adventurous career. By fortunate mercantile ventures at sea, he established in Montevideo and Buenos Aires a comparatively large fortune and eventually became the first United States Consul in Argentina. It was David Curtis de Forest's generous bequest to Yale College which later enabled my father, his two sons, and a grandson to enter and be graduated from Yale.

But to return to David de Forest of Stratford. Another of his great-grandsons was Gideon, born in 1765, who at a very early age enlisted in the cavalry troop of General Henry Lee, affectionately known as "Light Horse Harry." Following the Revolution Gideon married Hannah Birdsey and settled in 1795 in what was later Edmeston, in Otsego County, New York. There he built the fine old farmhouse which still stands and is known in the country thereabouts as the old de Forest homestead; and when the old gentleman died the property was inherited by my grandfather Lee, who had married Cynthia Stores Swift, of Mansfield, Connecticut. The fruit of this marriage was four sons and two daughters, all born in the old de Forest farmhouse.

Their third son, Henry Swift De* Forest, born March 17, 1833, was my honored father.

The family of Gideon de Forest is, I consider, typical of what was considered the best American citizenship during those early days. His children—Abel, Lee, Sally, Cyrus Hawley, Maria, Charles Augustus, Tracy Robinson, and Harriet—were born over a period extending from 1795 to 1813. My grandfather Lee was named in honor of his father's Revolutionary commander. My father was rightfully proud of the name which his father bore and its derivation, and I have always been grateful that he chose to name me—his first-born son—in honor of his father, Lee De Forest.

I can remember one summer, when I was still a very young boy, visiting with my father the old family homestead and the De Forest plot in the near-by graveyard, where he himself was destined to be buried (1896). My father took pride and delight in telling us of his father and ancestry. I remember once asking him if he cherished any recollections of his grandfather Gideon. He was a crusty old codger, as described by my father, a testy citizen who on one occasion, having stumbled and nearly fallen over a sled belonging to my father, threatened to burn the thing in a bonfire if Henry ever left it in his way again.

My father was the only one of the five sons who had any inclination towards a college education. His ambition to go to Yale College seemed strange to his associates.

There was an abundance of hard work on the farm for all the children of Lee, and it was by no means easy for Henry to study to prepare himself for entrance into college. By doing odd jobs and practicing most rigorous economy, a trait which distinguished him throughout his life, he was finally able to enter a preparatory school, from which he matriculated into the Fresh-

* My father and grandfather preferred to capitalize the *D*. While at Yale my brother and I resumed the style of earlier generations.

man class of '57 of Yale College. As might well be expected, he was a most diligent student and stood high in his classes. Before he was through college he determined to devote his life to the Christian ministry. In order to finance his study for the ministry after his graduation from Yale, he secured the position of tutor in mathematics at Beloit College, Wisconsin.

About 1860, shortly before the beginning of the Civil War, he returned from Beloit to New Haven to study in the Yale Divinity School. In the latter part of his studies there his name was selected by draft for the United States Federal troops; he joined the Eleventh Connecticut Volunteer Regiment as chaplain of that body. From that date until the end of the War his regiment was on active duty, notably in Grant's closing campaign in Virginia.

Father frequently recounted to his sons many details of his army life—telling them of the hardships, suffering, and privation of the Union troops during the terrific battles of the Wilderness; of how his regiment was decimated by the rebel fire; and of one torrid hot battlefield where he gathered up all the canteens he could find, filled them with water, and carried them across the field swept by rebel gunfire to his troops, as they cheered: "Bully for the chaplain!"

A favorite story concerned a fine old six-shooter Colt revolver, which was one of the prized possessions of the de Forest family. Father chanced to be in his captain's tent when a rebel captain was brought in prisoner with this revolver as a side arm. The Yankee captain told his orderly to disarm the rebel and, handing the gun to my father, said, "Here, Chaplain De Forest, you can have this." It was a muzzle-loader, for paper cartridges and percussion caps; and many a quiet afternoon in later years my father and his two sons stole out into a vacant lot, set up a target, and practiced shooting with this ancient Confederate firearm.

After the close of the War, Father traveled for some time in the interests of the Congregational churches of the North and West. In the course of these peregrinations he visited Grinnell, Iowa, where he first saw Anna Margaret Robbins, playing the college organ. Later, in Muscatine, he became acquainted with her father, the Reverend Alden B. Robbins, D.D. Anna Margaret was then a beautiful young lady of twenty years. My father fell deeply in love with her almost at first sight. But this affection was not returned by the young lady who, fourteen years his junior, frequently expressed herself as wishing that "Mr. De Forest would desist from his attentions." Undiscouraged, my father pursued his courtship, and so successfully that one year later, while he was filling his first pastorate at Des Moines, Iowa, he and his beloved were married in the Muscatine church, her father officiating. Two years later, at Andover Theological Seminary, the young husband obtained his degree of Doctor of Divinity.

Shortly after the birth of their first child, Mary Robbins, the father moved again to Iowa, to the pastorate of the First Congregational Church of Council Bluffs. There in the small parsonage on August 26, 1873, I first opened my eyes to that strange new world which some day I should have a hand in remaking. Three years later the family moved to Waterloo, where my story has already begun.



CHAPTER 2

Alabama Childhood

THUS it was that in the early fall of 1879 Henry Swift De Forest, D.D., his lovely young wife, and their three children alighted from a sooty day coach of the East Tennessee, Virginia, and Georgia Railroad on the dusty, hot platform of a dingy, rust-colored frame depot in Talladega, Alabama. Waiting for them was a two-seated buckboard buggy and a plank wagon for the baggage. Up unpaved, red, dusty streets from the village square to the hill on which stood the college, the forlorn little caravan wended its way.

At the time of our arrival at Talladega the college comprised two brick buildings. Swayne Hall, a fine cubical structure with portico and stately pillars of Athenian design, had been erected by slave laborers in 1850 as a white Baptist college. It stood in the center of a plot of some fifteen acres. Across the wide stretch of Battle Street was another plot of equal extent, in the corner of which stood Foster Hall, a long three-story brick dormitory for the girls of the institution. Near its southern end a small frame building housed the printing press of the

college. A fine large barn, sheltering a considerable herd of cattle and mules, stood near by.

In 1867 the American Missionary Association had chosen Talladega as a suitable site for a pioneer school and college "open to all of either sex, without regard to sect, race, or color." The original Baptist college building was bought with money donated by Civil War General Wager Swayne of the Freedmen's Bureau. In his honor this building was given the name, Swayne Hall, which it has borne ever since. Foster Hall was of later construction.

The early years of the institution were a period of constant struggle against local opposition, public indifference, and a never-ending shortage of funds with which to carry on. By 1879 the experiment had become securely enough established to require the services of a permanent administrator. After months of search for someone sufficiently consecrated to the farseeing purposes and high ideals of the institution, the American Missionary Association finally chose my father as the man best qualified. To him, as previously mentioned, the call came both as a duty and as a challenge, and he therefore lost no time in accepting it, though with much earnest concern over the consequences to his dearly loved family.

During the seventeen years until his death Talladega grew from a normal school, including primary and grammar divisions, into a full-fledged college. As fast as possible its curriculum was broadened to include theological and classical subjects as well as agriculture, industrial arts, domestic science, and nursing. And slowly but steadily the opposition of the community was changed to approval and co-operation as the purposes and results of the undertaking were made apparent.

But conditions in 1879 were bad enough to test the missionary zeal of even the most ardent friend of the downtrodden Negro. Broken windows in all the buildings, yards littered with debris,

skinny hogs and cattle with a free run of the "campus," primitive agriculture (sharpened sticks for plows), shiftlessness and slovenliness everywhere—these were only the most apparent of many causes for discouragement. More trying by far was the poor quality of teaching and the almost complete lack of adequate facilities.

At that time only a few schools open to Negroes existed below the Mason-Dixon line. For years the supply of teachers at Talladega was limited to men and women—white, of course—whose chief qualification was their missionary zeal for the elevation of the poor mistreated Negro. The beggarly salaries which the poverty-stricken institution could afford offered no inducement to qualified members of the teaching profession, and few indeed were the number willing to sacrifice the ample opportunities open to talent in the North for the sake of better education for the Southern Negro. In the face of such handicaps, the marvel is that the quality of instruction at Talladega was as good as the results later proved it to be. The fruits of Talladega education soon appeared in the higher quality of living of its graduates, many of whom quickly rose to positions of genuine worth and honor in their communities.

Those early years of toil for Father required long months away from home and family in search of money for the many needs of the poorly equipped school. A constitution originally strong but undermined by chaplain service in the Civil War made this effort of money-raising fatiguing and wearisome, but it was bravely and hopefully carried on. The missionary was cheered at times by large gifts for the college, such as the gift of \$5,000 which built Cassedy School for the lower grades. He was jubilant when a telegram came saying, "Mr. Erwin makes Talladega College a residuary legatee to the amount of about \$80,000." This was the largest gift received. Prayerful thanksgiving followed every gift, great or small.

During my father's administration the growth of Talladega College was continuous and rapid, the attendance nearly tripled, and the faculty doubled, with a corresponding increase in appliances and property, most of this made possible through his unceasing toil. That noble beginning has steadily progressed until today Talladega College stands high among the foremost Negro schools in the South. Its alumni include leaders in every American activity — preachers, educators, physicians, dentists, businessmen, and industrialists; each one a living tribute to those heroic pioneers whom Father led and inspired during his last seventeen years of noble life.

For two years our family lived crowded into two small rooms on the second floor of the girls' dormitory, eating our meals in the common dining room on the floor below. Many incidents of those early years are clear in memory. These college students were the first Negroes with whom I had ever come in contact, and I was, for a while, greatly puzzled over their dark skins. I remember examining with wonder the lighter colors of the palms of the hands of the girls and speculating, much to their amusement, as to the cause thereof, suggesting that it must be because they washed the palms of their hands much oftener than any other parts of their bodies.

Within two years after our arrival the college was enabled to build a large boys' dormitory, Stone Hall. To do so both cheaply and rapidly it was decided to make our own brick of the same fine clay of which those of Swayne Hall had been formed in slavery days. So brickmakers were hired, a simple horse-turned mixing machine was constructed on the premises, and then week after week an endless chain of Negro men and boys, some of them students, paddled back and forth from the press, laying out the freshly molded bricks in orderly rows on the ground to dry. When sufficiently hard, these were artfully piled up in pyramidal form over five long taper-shaped tunnels into which

the fuel was to be fed. At last there was a great mound containing bricks enough for the four tall walls of the new building.

Then for weeks huge pitch-pine logs blazed and burned. Strange and beautiful was the sight at night, the blazing flames lapping out from the tunnel mouths and licking up through all the crevices to the topmost tier, the lower bricks gleaming white-hot.

Hour after hour I stood there, fascinated, wondering at the mystery, at the alchemy of that fierce heat which was slowly transforming the soft clay I had formerly played upon into everlasting, rocklike bricks for the erection of a great building which would stand for eternity. This and the subsequent laying of the cornerstone impressed me profoundly.

I believe that in similar fashion the bricks for my father's home were made, as both structures went up within a year, when I was about the age of nine.

Each summer my father left the family in Talladega and went north to canvass zealously among his many friends from New England to Iowa, soliciting funds for the needy and growing institution to which he had determined to devote his life. Some of these good friends, realizing the sacrifice that Anna Robbins had made when she took her little flock to that far-distant black belt, were willing to contribute funds for the direct benefit of the De Forest family, rather than to the college itself. As a result of their sympathetic generosity it was possible to begin the erection of the aforementioned fine brick domicile. Our house was located in the center of a two-acre tract across the street from Foster Hall, and separated from it by a wide garden plot of turnips, which I ate raw by day, and of strawberries, which I purloined by night.

During the summer vacations many of the white teachers returned north. The dormitory then was nearly empty, and I can recall sleeping alone in a narrow room and relishing this inde-

pendent life. Then it was blissful to awake with the dawn and the singing birds, don in just one minute the cotton shirt, buttoned at the waist to my knickers, and sally forth barefoot over the dew-moistened grass. We children wore no shoes from the time school closed in mid-June until the opening of the new term in September. Stubbed toes, blistered soles, and swollen feet, were vacation memories.

One hot Alabama summer Papa took us two boys for a few weeks' respite up in the mountains of eastern Tennessee. There we ran wild, barefooted, hiking many miles to a wild logging stream and pond where we fished and enjoyed boundless sport, learning to ride and revolve the great rough-barked pine logs floating there—leaping from one to another and catapulting into the water when the spinning trunks suddenly reversed their motion—and at dark coming back with legs and bellies well smeared with pitch.

And how the "jiggers," microscopic red bugs which burrowed deep beneath the skin, raising welts which itched intolerably, made our scratching nights miserable, despite all the salt and bacon rind we could rub into our smarting hides!

Together with my sister Mary and two or three children of the faculty, I joined the grammar-school classes at Cassedy School, studying arithmetic, English grammar, penmanship, geography, and history. My teachers were all white, but I had no idea of the meaning of the "color line." (Only last year, at a meeting of the Chicago "Talladega Club" I met a fine-looking, buxom colored lady, apparently of some 70 years, who happily insisted: "I was your seat mate, Lee, in Cassedy School." Undoubtedly she was, for we were compelled to double up on seats. There was no thought there of segregation.) I enjoyed my studies and found little difficulty in keeping ahead of the majority of my classmates.

Before long a well-equipped carpentry shop was opened,

chiefly for the purpose of teaching carpentry. Eagerly did I seek this opportunity to learn; and dabbled for the first time in things mechanical.

I was nearly ten years old when we moved into our new home. The yard was surrounded on two sides with a picket fence, on the other two with barbed wire. In the rear of the house was a large cement-plastered cistern, which, together with a large iron tank in the attic, formed our sole reservoirs for water supply, limited wholly to what rain was caught on the roof. This was of the mansard type, with a flat, tin-covered, fenced-in deck over the center, and flat gutters about two feet wide running around the edge of the roof.

After a few weeks of drought the attic tank would be empty, and we then must depend on what remained in the deep capacious cistern. When this, too, ran dry, we depended for our water supply on large barrels brought to us by the college farmers with their mule teams.

Professor Andrews near by was more fortunate. He possessed a grand old well, and many a time I helped pull up the old oaken bucket, dripping with its heavy load of crystal coolness, into which I eagerly dipped the large tin dipper which always rested upon the stone coping of his well.

Throughout the South in those days of the early eighties—so soon after the regime of the detested carpetbaggers—bitter hate, angry prejudices, and sullen distrust were all too rampant. Particularly distasteful to the white gentry were the efforts of Northern missionaries to educate the Negroes. My parents, their children, and also those of all the faculty—educated, refined men and women from the best schools and influences of the North—were totally ostracized by the white citizens of Talladega. In later years this attitude softened.

My father was a great lover of the out-of-doors, and with his

family loved to take long walks of a Sunday afternoon. I remember one occasion when he, my sister Mary, and I were walking along a country road near our house and passed a typical Southern gentleman by the name of Colonel Hardy, to whom my father spoke a word of salutation. Thereupon the "genial" Southern gentleman moved hastily to the other side of the road and snarled, "I don't wish to be spoken to, suh, by a damned Yankee!"

Tales and legends of the night-riding Ku Klux Klan were often heard in those days from the lips of the Negroes, who remembered only too well their recent persecutions and terrorizing.

We were well frightened of the white boys of the town, knowing how they regarded us, and always felt safer in the company of two or three of the larger Negro boys of the school. On one occasion when we had been swimming, after Charles and I had dressed and were walking away from the swimming hole, we were overhauled by three full-grown white boys, who shouted, "Here's some of those damned blue-bellied Yankees! Hold on there, son, I want to see if your belly is blue!" And true to their word, they caught Charles and me and, pulling up our shirts, carefully and gleefully examined our abdomens. Apparently they were well satisfied with the degree of blueness there discovered, for with a snort and a rough laugh they released us—to our infinite relief. We were thoroughly frightened by this sally, and I doubt not my face turned as blue as my belly.

One of the richest men of the town was named Lewis. He lived on the other side of the village from the college but owned a large farm far beyond Talladega Creek. Quite frequently the three young Lewis boys would drive by our place in a small pony cart, on the bottom of which they had assembled a goodly collection of small stones and gravel, well prepared for a lively "rock battle with the Yankee boys and their nigger

Anna Margaret Robbins De Forest, mother of Lee, at forty-one. Her later years were brightened by the brilliant achievements of her first son.



Lee de Forest (1798–1888), grandfather, for whom the inventor was named (lower left). The de Forest family came to this country in 1636, settling in what is now New York City.

Henry Swift De Forest (1833–1896), Lee's father, at sixty-two (lower right). He did not live to share in the glory which his famous son brought to the De Forest name.



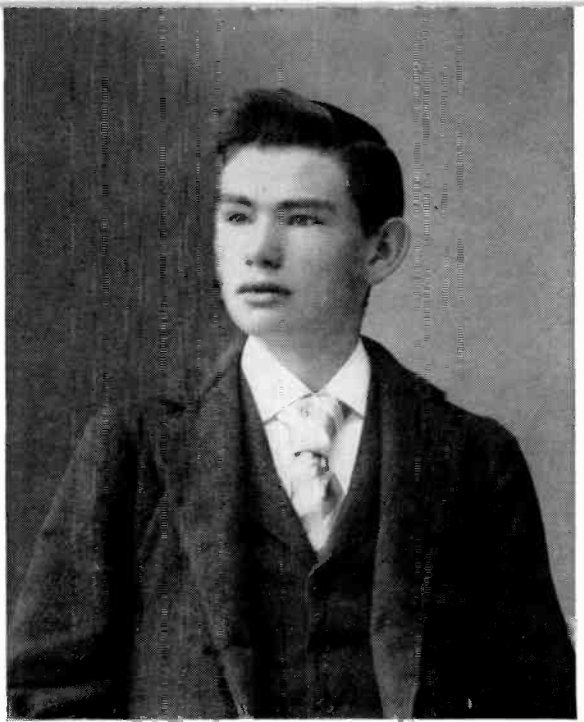

Lee at the age of six — about the time the family moved to Alabama

When he was eighteen, Lee spent a trying summer vacation working as a book agent in rural Vermont. By living frugally, he ended up forty dollars to the good.

Swayne Hall at Talladega College as it appeared in 1896. Here, under his father's excellent tutelage, Lee acquired the rudiments of a classical education.



friends up at the college." Knowing this, we did not hesitate to give them a rock battle, at least when we were safely fortified behind our paternal picket fence and with one or two good, straight-heaving Negro boys to help defend the De Forest domain.

About this time a company of Northern engineers, financed by British capital, undertook the erection of a large blast furnace for the smelting of iron ore about a mile east of our home. Ah, then indeed did life become interesting to me! Upon every possible occasion, and under every possible pretense, I would hurry to this weird spot to watch with envy the overalled mechanics riveting together the heavy steel plates for the tanks and assembling the gigantic air compressors. Above all was I fascinated by the little narrow-gauge railroad which these engineers built, running up hill and down dale to the low hills where iron ore was being excavated.

After the blast furnace finally went into operation, it was indeed an experience to go down to the plant near casting time, watch the sweating Negroes toil to pull the plug from the base of the huge furnace, and see the molten stream of yellow liquid fire come roaring out to run slowly down the main sluices into the hundreds of side molds, there to cool slowly into pig iron.

To see a blast furnace, a foundry, and a machine shop in operation was by far the most exciting thing that had ever happened to me. I learned all the details of how pig iron is made, the relative quantities of ore, limestone, and coke that are dumped into the furnaces, the operation of the gas ovens, air compressors, the length of time required for a cast, how the slag at the top of the molten iron is drawn off. In a word, every step of the process from the raw iron ore to the flatcars loaded with pig iron became known to me.

Soon I was seized with the determination to build and operate a blast furnace of my own! In an old ash can I punched two

holes near the base—one for the admission of the nozzle of the compressed-air supply, the other the taphole from which the charge of molten iron was to flow. A wooden elevator shaft was built beside the furnace walls for the purpose of hauling fuel to the top of the furnace; and a chimney, made of pine wood, completed the structure. For a compressed-air supply, I purloined from among the treasured family heirlooms a fine old-fashioned bellows.

Now the furnace was ready for operation. Red-hot it glowed from its charcoal fire, black smoke rolled from the top of its wooden stack—when that adjunct was not itself in flames—unknown quantities of limestone flux and priceless chunks of lead went in with the coal at the furnace top. The old ancestral bellows served excellently as a blowing engine until its nozzle was burned off! And many a mold was made with utmost skill and care in the sand bed awaiting the flow of pig. Thus after infinite patience and knocking out of fire-clay plugs, a minute globule of molten lead leaked out—in imagination a flow of iron which overran all our casting pit. And with blistered fingers and singed hair and brows, dividends were declared and the short-lived iron industry closed. That blast furnace, at least, although it cost the De Forest family a valued heirloom, was a practical success.

Within a year or two after its closing, the real blast furnace was also compelled to suspend its—unprofitable—operations. Then it was that the real value of this blast furnace and the work of the engineers who constructed it became apparent to us boys, for we fell heir to the long line of tiny, narrow-gauge track extending from the furnace far up into the hills where the iron ore had been mined. In the course of our explorations we discovered a train of twelve ore cars intact and ready for service. One after another these were uncoupled and with grunting efforts pushed to the top of the incline, to afford a wildly careen-

ing toboggan ride for us two frightened youngsters. Down the bumping slopes and around the tortuous curves we flew until a sufficiently level stretch was reached to slacken the speed of our vehicle enough for us to leap safely off into the sand, leaving the car to thunder on to an open switch or perhaps topple into a ditch. What did it matter to us if it was utterly impossible to push these heavy cars back up the incline? Other cars awaited at the top. And so one by one, day after day, this abandoned string of cars afforded us a succession of thrills such as few boys have ever been fortunate enough to experience.

Again and again fortune favored us, and we were never quite thrown off those careening gondolas to be lacerated or mangled upon the rough stones of the roadbed.

The road which passed our house led, at a distance of some three miles, to a beautiful ford across Talladega Creek. Not far above this ford was a genuine "ole swimmin' hole." From a tall rock along its side one could jump or dive into the clear water. Above this rock spread the branches of a fine old tree, from one of which—by rare good fortune—hung a grapevine strong enough to hold a boy. Pendulumlike, I would grab this vine, swing far over the water, and let go. No springboard over a swimming pool has ever afforded me half the pleasure I derived from swinging on that grapevine. Given such opportunities, it was not long before Charles and I learned to swim, and through many a hot sweltering afternoon we walked the railroad ties which led to the lofty trestle crossing Talladega Creek near our favorite "wash hole." We had picnics near its banks. We fished for suckers from its shores. I remember landing a huge one, and then slipping, clothes and all, off the bank, in my frantic efforts to prevent its slimy getaway.

I was ten or eleven years old when I first visited the Shelby Iron Works. I had always been intensely fascinated by steam

locomotives. From studying an article in the *Mechanical Encyclopedia* in the college library, I had acquired a fairly clear idea of the operation of the locomotive, but the reversing gear continued to baffle me. On my way home from the Iron Works one day I stopped off at the railroad yard. There on one of the sidetracks was a beautiful full-sized locomotive, deserted, a giant asleep. Here, at last, was my chance to find out just exactly how the engineer could reverse his locomotive.

Climbing up into the cab I even attempted to move the heavy reversing lever, knowing well that the engine would not start. Then I climbed down and crawled under the silent monster and lay on my back on the wooden ties peering up at the bottom of the boiler, observing the intricate scheme of the eccentric rods, pistons, and valve rods. I studied these closely for a long time, observing their connecting links and making my decisions as to what function each performed. In my mind I could see the locomotive in operation. The whole method of reversing the locomotive became clear at last to my mind. I can distinctly remember my joy as I skipped along my path toward home singing aloud to myself in glee, "Oh, I am happy; I am so happy."

Little wonder then that I could give myself no rest until I too had constructed a locomotive in our back yard.

Underneath our recently completed brick home extended a large cellar divided into three compartments by two brick walls. The central section was always black, no light being able to reach its inner recesses, for there were no openings in the side walls. We children named it "The Dark Place," and for a year or more it was filled with scrap lumber and timber, barrels, and what not, which the carpenters had thrown there. This, then, became an inexhaustible mine of carpenterial treasure for my youthful ambitions. From its dark depths I managed to

dig out and haul to our back yard an elaborate assortment of large, square packing cases, sugar barrels, paint kegs, barrel heads (for locomotive driver wheels), wooden strips (for driving rods), and a tin can (for whistle). Thus, with the exception of the bell, I was able to assemble about all the material and parts required by an ingenious and determined youngster for the construction of a locomotive—or at least something which might resemble a locomotive, even though I sadly realized that there could be no locomotion.

Nevertheless, when finished it was an impressive structure, with cowcatcher, connecting rods, smokestack, engineer's cabin into which I could crawl, and a sure-enough throttle. A heavy operative reversing lever actually served to move the links beneath the forward part of the boiler up and down and also functioned to slide the valve rods in and out of the steam chest above the cylinder. Downtown I found a large cracked dinner bell, a bargain at a quarter; this I mounted to ring with a short clothesline from the cab. Two or three additional packing cases constituted the tender. Part of this we filled with stovewood which Charlie, the fireman, was able to heave into the firebox piece by piece. To our boyish standards of comparison we had achieved a life-sized locomotive. Our playtime hours over a period of many weeks were devoted wholly to the completion of this masterpiece.

When done, it became the talk of the neighborhood. The children, white and black, all came to inspect this wonder. Even my father took parental pride in this creation of his son. The strange large toy in the yard behind the house attracted the attention of the white gentry of Talladega, who otherwise held the De Forest clan, and all our teachers' colony, in supreme contempt. Occasionally some of these would pull in their steeds before the front lawn of our house and ask permission to let

their little ones look at this new creation of the Yankee. Proudly I conducted the young visitors to my masterpiece and explained its construction and operation, part by part.

Directly back of the locomotive stood the family woodshed, and it was not strange that my father, trained as he was from boyhood to the benefits of chores and hard work about the homestead, instilled into his sons at a tender age the cardinal virtues of work, of daily duties to be performed within the house and around the yard. As soon as I was large enough to raise my foot to a log set upon the sawhorse, I was entrusted with the bucksaw, and many a tough log of oak or hickory did I cut into pieces of right length for splitting for the kitchen stove. My father taught me how to wield the ax, both for chopping down trees and for splitting firewood. And sometimes, far too frequently it seemed to me, my father led me into the woodshed for the traditional purpose for which fathers and sons sometimes enter the woodshed. He was a stern disciplinarian and would stand for no monkeyshines.

Being five years older than my brother I was naturally regarded as the instigator of most of our deviltry, however unjust such charges and suspicions might be at times. Moreover, I came to the licking age five years before my brother. My tutelage in the woodshed and in the cellar was severe and thoroughgoing, but I was a stubborn lad and could stand some terrific wallops before I would concede a yell. For this stubborn heroism I paid dearly. Charlie was more diplomatic, more obeisant. He yelled lustily even before provocation, and thus avoided much punishment which I considered would have been simple justice to apply.

So I was whaled into good behavior and to a wholesome reverence for law. If, by some magic, it were now possible for the grown-up boys of today to administer similar discipline to some of the present "flaming youths" and lawless young bandits

whom we see about, I am convinced that we would be living in more peaceful times, with less work for truant officers, more room in the reformatory, and fewer inmates of prisons.

There is no question in my mind that my father erred on the side of severity. I remember many a black hour of despair as I stole into "the dark place" with a gulping throat to sob away the ache resulting from the sense of injustice which tortured my boyish soul.

Quarrels and battles were frequent between my brother and myself. The difference in our ages was sufficient to cause differences in opinions and desires. It seemed to me in my childish pride that Charles lost no opportunity to taunt and tease me. If I met with any misfortune he was sure to laugh, usually waiting until he was at a safe distance. When I overtook him, I spared no slap or cuff to teach him proper manners and respect for his elders. I remember on one occasion when we were working together by the carpenter's bench in the cellar, I struck my thumb with a hammer. Charles slyly went into the distant exit from the cellar and burst into uproarious laughter. Maddened with pain and wrath, I hurled the hammer at him with all my force. Fortunately for both, my missile missed its mark, and when I emerged into the sunlight, Brother Charles's sturdy legs were seen disappearing around the corner of the barn.

My stern and upright father (he stood six feet two in his stocking feet) was generally admired and deeply loved by the elder students and deacons of the church, many regarding him with deepest awe. Not so however with some of the younger students, schoolmates with whom I associated, and whom I had occasionally overheard referring to the president of the college as "Old Man Dec." I may have resented, but I remembered well, this sobriquet. One hot day when I had labored long with pitchfork over the manure pile behind the barn, an opprobrious task to which my father had condemned me, I remarked to my

brother that this tough job had been forced upon me by "Old Man Dee," whereupon the little cuss promptly rushed outside of the barn and yelled, "Papa, Lee called you 'Old Man Dee.'" Without giving me any opportunity properly to chastise the impudent telltale brother for his treachery, my father, in stentorian tones, summoned me into the cellar, removed the stout leather belt from around his waist, and proceeded to give me a lesson in filial respect. Prudently, brother Charles kept out of my reach for some hours thereafter. But, if I recall correctly, he eventually received what was justly coming to him.

My father was an excellent horseman. Frequently he and my mother—who, of course, rode sidesaddle—took delightful horseback rides along the quiet country roads leading from the campus or beneath the great fragrant magnolia trees that beautified the little town of Talladega.

He was always anxious that I become a good horseman, an ambition and desire which I eagerly seconded. But it was no easy matter for him to arrange for the purchase of a suitable riding horse for his son. (Throughout his life in Talladega my father's services were rewarded by the princely salary of \$125 per month.) This horse, a small roan mare, became our family pride and joy. Jenny Lind was gentle, three-gaited, and could run very fast. My father gave me a small English saddle, but with leather-hooded stirrups. I soon learned to ride our mare with ease, usually at a mad gallop, and many a joyful journey we took together. Frequently during hot weather we took the long brown road to Talladega Creek. Usually on these occasions Charles rode behind me. One or two trusted Negro playmates walked along or met us at the swimming hole.

One summer while Father was north raising funds for Talladega College I was put to work on a New York farm with some family friends of most definite piety. There I learned with

tears what homesickness was. My chief solace was that I had abundant opportunity to study the mechanism of a mowing machine. I earned my board with farm chores, notably stowing away hay in the dusty barn loft through most of a long, hot August. One Sunday eve I was relating at the table a simple tale of the old lady whose young son had blown up and tied tight a paper bag before surreptitiously inserting that accouterment into Mama's bustle. "The pious old lady," I said, "went to church and sat down with a terrible bang, just when the choir was singing 'Sound the loud Jehovah.'" "Lee de Forest," snorted the good lady of the house, "be you careful, or you'll go straight to hell when you die, making fun of the Lord's name!" In my enthusiasm I had innocently confused the Hosanna of the sacred song with the Hebrew name for God—an almost unforgivable sin—and one I never repeated and never forgot.

The hot summer nights at Talladega were usually clear and brilliant with stars. How well do I remember the wonder and awe with which I watched from an upper window of Foster Hall, through many nights of 1880, the great glory of the brilliant comet of that year. I can remember with equal distinctness the historic transit of Venus across the blazing disk of the sun in 1882, an event long anticipated at the college and for which everyone had provided himself with smoked glass. I can recall the tearful wailing of one little Negro girl who found herself quite unable to distinguish the tiny black speck that traversed the sun, when she learned that it was her last chance for 122 years.

From his days at Yale, where he had studied astronomy under Professor Newcomb, my father was always an enthusiastic amateur astronomer. He knew by heart each constellation, and it was his delight during the long nights, when we children sat out with him to escape the unbearable heat within doors, to

point out for us, group by group, the heavenly bodies, giving us their names and something of the mythological history associated with them.

Upon one episode of those boyhood days my memory dwells with an unusual fondness. It was an episode bright with chivalry and all brave deeds. Taking ardent inspiration from some tale of medieval romance, we ransacked the cellar for material with which to build a castle. Beauteous of form, stately in outline, massive in dimension, rose then the plank walls of our proud "Castle de Luxembourg." Who shall tell the labor spent that its clapboard roof might not leak, or of the weight of cordwood stored in its barrel turret to prevent its collapsing before a storm?

Its impassable moat was dug to the full depth of one foot and thrice that width. By decree of the King himself, "all men must consider this moat impassable." When by means of its rattling cow-rope "chains" the drawbridge was raised and the massive "portcullis" shut on its hinges, our Castle was deemed proof against all onslaught from lances, battering-rams, or any half-hour's siege. Many indeed were the legions of French Cavaliers, of Saracens, and Infidels who invested this battle-scarred fortress in vain. Brickbatproof it was as well—in all save its frail window shutter—and was not that vulnerable opening amply protected by the King's decree: "Let no missiles more deadly than arrows be hurled against it?"

Numerous also were the costly tin swords and lance blades broken off in the chinks of its yawning walls. Many a yard of red-calico pennons flaunted defiance from its bristling staffs. There in the great hall rested the holy chest (to less romantic eyes resembling nothing so much as a cracker box) in which reposed the spotless tin armor of King Arthur—brought out on great occasions of state. With it "the sacred shield of Lancelot"—also of tin and artfully made of a boiler top. Many were the fabled

exploits of knights and nobles which were re-enacted with our "Castle" as their setting.

During those days I read every word in Cooper's *Leatherstocking Tales*. His hero, Natty Bumppo, became my hero. I imagined that I was the reincarnation of Natty and aspired to no sweeter and nobler life than, like him, to live in the woods and mingle with the Indians. From broomsticks I made two or three double-barreled wooden shotguns for myself and comrades.

Dearly I loved to stroll of a Saturday through the farm woodland and forest, in fancy ascribing that love to my inheritance from the old French ancestors, "*de la forêt.*" Always the forest fascinated me, beyond the power of field or river. Too well had I read my Cooper not to feel the freedom of the wood, nor know the massive trees as friends. Convenient to our home were the farm woods, and many were the treasured hours when I lay alone within their fastnesses of shade, a knowing eye turned to the great branches swinging far above, silhouetted in green against the blue vault,

And thus from home and the haunts of my boyhood I trace all sources of poetry, of sympathies with Nature, of love of the beautiful which have enriched my later life.

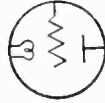

CHAPTER 3

Southern Upbringing

IN addition to my studies at school and at home, I delighted to climb up to the college library, there to spend many hours studying carefully the intricate drawings in the *Patent Office Gazette*. These sketches of complicated mechanical devices interested me unceasingly, developing juvenile ingenuity.

I seldom found my school studies uninteresting (with the exception of Latin, and yet more so of Greek—subjects which were not inflicted upon me until I was sixteen years of age), but in the early spring of each year came the rains which occasionally made it impossible for me to go to school. To work outside was also impractical; but such days at home, shut in, were seldom dreary. I knew what to do on rainy days. In a large, flat pasteboard box, which had originally contained dress patterns, were carefully stored treasured drawings of favorite inventions, especially of steam hammers and perpetual-motion machines. I knew nothing of steam hammers save what I could read in Father's encyclopedia, but that device fascinated me no

end. In my mind then the steam hammer had taken the place of the locomotive image of earlier years. I delighted to design various sizes and types of steam hammers, carefully working out on paper every detail of the pistons and steam valves for controlling the mechanism. Stretched prone on the sitting-room floor with this box and a large sheet of paper spread out before me, equipped with pencil, erasers, and ruler, I would work quietly, contentedly, for hours.

I remember with what deep inward pride I listened to my mother's answer to the question of a visiting neighbor who asked her, *sotto voce*, "Does Lee know what he is doing?" "Oh, yes," was the reply, "he must understand those subjects very thoroughly, for he is always inventing and drawing!"

But still nearer to my heart than lay the problem, age-old, of inventing an actual working perpetual-motion machine. In the encyclopedia I had read and reread every word on this classic subject, studied and resketched every mechanism there described, and brought myself to understand the fallacies which those ingenious designs embodied. This immemorial problem caught my fancy and challenged to the very depths of my brain all my inventiveness. My knowledge of the laws of physics, particularly of magnetism, was at that time too deficient for me to understand why a perpetual-motion machine was impossible. It *must* be possible! After long hours of concentration I mapped out sketches of a weird, complicated device involving permanent magnets, walking beams, and a magnetic shield. In truth, it was a marvelous machine, in which I took unlimited delight. The most careful analysis of its operation convinced me, beyond all doubt, that I had finally succeeded where all earlier inventors had failed.

When I had finished drawing the last detail, I was totally satisfied. I had solved the baffling mechanical problem of the ages. Great was my sense of triumph and innate satisfaction as I

printed at the bottom of the drawing this modest statement: "I am actually amazed that I, a mere youth of 13 years, by my inventive genius and concentrated thought and study, have succeeded where illustrious philosophers in times past have failed. I have at last furnished to humanity a machine which, without cost, can supply forever any and all demands of the human race for power." In my isolation there in the Talladega parlor I felt in my heart that I was, not that I was to be, an inventor!

I could always fix the age of thirteen as the year when I decided definitely that I was to be an inventor—determined to devote my life to that pursuit and all my future study to the concrete task of preparing myself for that profession. But I had yet to learn that invention is itself a process of constant disillusionment, of tearing down and building anew, and that many an invention has been destroyed in a single blast by the sudden emergence of new facts into the world laboratory of science.

At that time so little was known concerning electricity, especially in the backward jungles of civilization where we dwelt—in a small town which could not boast a lighting plant or even a single electrical machine—that mechanical subjects and problems rather than electrical dominated my awakening interests and my unquenchable curiosity. I have always regretted that in the '80's, and especially in a small Alabama village, so few mechanical and electrical toys or implements existed. My youthful progress along these lines was consequently much retarded. Any boy today, at the expense of a few dollars, can equip himself with a laboratory and workshop containing batteries, coils, motors, and tools which were entirely beyond the wildest dreams of my youth. Fired as I was by the vague insights into science which my early limited reading brought me, I can today only imagine what would have been my exaltation had there been at my disposal the relatively limitless opportuni-

ties for experimentation and invention which any young radio fan may have today.

And yet it was perhaps my very isolation and poverty of opportunity for scientific investigation or experiment in those early formative years which forced my mind to create its own resources of contemplation, imagination, and wonder; to find within myself a resourcefulness and ingenuity to make the utmost from next to nothing, and so enabled me later on to overcome great and genuine difficulties in the path to achievement.

Our mother was a skilled pianist, and possessed of a well-trained soprano voice. Father knew nothing of music but admired it in a general way. Mama cherished the admirable ambition that all her children should be musicians, or at least should be able to play the piano well. Sister Mary, naturally, was her prize pupil, and early during her life in Talladega took up the study of piano. This she pursued throughout her life, becoming a really skilled musician. I regarded the piano at that time as anything but a manly instrument and felt that a real boy should be ashamed to be found sitting at one. Little did I then realize how right my mother was, and of how much genuine joy and consolation my later years were to be deprived because of my boyish stubbornness and of my attitude toward the piano.

But of music I was even then very fond, so why not let me play a manly instrument? I knew of none which so well met this requirement as the cornet. "Mama," I said, "if I have simply got to be a musician, why don't you and Papa let me play the cornet? I hate the piano!" My parents finally decided that it was better to have a fairly good cornetist in the family than a third- or fourth-rate pianist. Whereupon a secondhand cornet was purchased downtown and arrangements made with Mr. Laverty, the town's blind piano tuner and himself a good cornetist, to give me semiweekly lessons. I became really deter-

mined to play the cornet well. My enthusiasm and love for this instrument, however, was in no whit shared by our neighbors. The lessons were given downtown in Mr. Laverly's home, to which, after Father had purchased Jenny Lind, I always went on horseback.

There was no dearth of music in our Talladega lives. There were always several of the faculty who possessed good voices, and Mother, together with the college music teacher and instructors, delighted to arrange recitals and community singing.

The Southern Negro is, of course, deeply musical by nature. There was at Talladega a college glee club and choir, and we all fervently loved the old Negro spirituals of slavery days. Well do I remember those lovely old melodies, simple, but of haunting quality. None could sing these like the older students, who had never developed the lack of reverence or the shallow disregard, even contempt, that many of the younger generation nowadays strangely exhibit for the rich, natural music of their race.

My father, although usually serious, had in addition to his appreciation of music, a keen sense of humor. He had a hearty, explosive, ringing laugh which was characteristic of his merry moments. These were sufficiently rare to make his gargantuan laughter noteworthy and infectious. I think I must owe my own keen sense of humor chiefly to inheritance from my father's side of the family, although my mother was invariably of a sunny, cheerful disposition.

After I learned to read well and understand its contents, my parents began to subscribe to the *Youth's Companion*, a thrice-welcome weekly, upon whose interesting pages I would concentrate for hours after each arrival, often to the detriment of my school homework. The *Youth's Companion's* interesting premium list offered me a luring invitation to acquire many coveted toys and implements which otherwise we could never have

aspired to possess. Chiefly desired among these proffered premiums was a small silver-plating outfit. Once possessed of that I foresaw opportunities for earning almost limitless sums of money by plating or replating the neighbors' silverware; and heaven knows I could afford to overlook no possible opportunity for earning money. My monthly allowance of ten cents I found totally inadequate to supply the needs of a growing young man, even in so isolated a community as was Talladega!

I earned perhaps five dollars by my electroplating operations, and I invested the profits promptly in tools and supplies for my fret-saw enterprise. Other meager means for raising money were the occasional sale of a chicken from our children's coop, or perhaps a half dozen of eggs, but such occasions were all too seldom found.

Naturally I was not always overly pleased, if never quite rebellious, by the superabundance of religious activity with which I was surrounded. I remember one notable occasion on which I expressed these sentiments rather unconsciously. It was during a summer vacation when all the family was visiting Grandpa's in Muscatine. One midsummer night Papa, Mama, Sister Mary, and I went to the fairgrounds to see a marvelous display of fireworks. After one particularly dazzling display, when the large assembly was hushed with awe, my childish treble cried out in tones that all could hear, "Oh, Papa, aren't you glad you're not at prayer meeting tonight?" The resounding laughter was probably what saved me from well-merited chastisement when we arrived home.

My years at home in the Southland, isolated though we were, were filled with many bright spots. My parents were always fond of and unceasingly considerate of each other. They loved their three children deeply, and sought continually, day and night, by prayer, precept, and example to inculcate in us fine character, a strict conscience, and a never-failing sense of duty

to our fellow men and to the God we worshiped. For many years after leaving the parental roof I looked back with fondest memories upon most of my life in the Talladega home. For example, there were the dear hours on cold Saturday nights when, after taking the weekly Saturday night bath in hot water in the family washtub beside the kitchen stove, I slipped into my cotton-flannel pajamas and ran softly into my father's study. There he would hold me fondly upon his paternal knee while I warmed my toes before his fire, speaking to me lovingly, almost caressingly, about the events of the week past, perhaps gently reproving me for some of my indiscretions, and giving me kindly advice which would make living during the ensuing week smoother and happier. Papa would then impress a tender kiss upon my lips, and I would pat his bearded cheek and run up the long front stairs and down the uncarpeted hall to the bedroom occupied by Charles and myself. Alas, too frequently I would find Charles in the middle of the bed and none too patiently push him over onto his side: whereat a loud outcry, a slap or two, more noise and disputing, and then I would hear the paternal footsteps coming upstairs, two or three at a time; whereupon both of us young devils would subside into sudden quietude and feigned slumber.

The frequent brotherly quarrels over our relative rights and positions in our common bed resulted in one of my earliest inventions, the "bedstick." This was a long, tapered piece of black walnut, thickly padded at either end to prevent scratching the bedstead or tearing a hole in the bottom of the sheet. The stick was located with mathematical exactitude, longitudinally midway in the bed. Or sometimes whoever went to bed first would seek surreptitiously to move the bedstick one or two inches into his brother's position. Then woe betide the finger or the knee or the toe that was caught transgressing this mutual barrier. *Wham!* And the battle was on, usually continuing

until parental voices from downstairs, sometimes urged by Sister Mary, who was attempting to sleep in her bedroom across the hall, caused us to cease and desist.

Our father was a tall man. He stood upright physically as well as morally, and continually adjured his sons to "walk straight, throw your shoulders back." In my mind's eye I can still see him striding across the diagonal path on the campus from Swayne Hall toward home, with that characteristic gait which I think both of his sons inherited from him, pausing now and then to pick up a stick or vagrant stone which was disfiguring the path. For he was a stickler for orderliness, always scrupulous in his neatness, in person and around his home. His books and papers were ever in perfect order, and his children were well taught the virtues of cleanliness and orderliness. It was my special duty to keep clean and in order all three sections of our large cellar. This possessed only an earth floor, of hard red dirt, and after years of industrious sweeping I came to realize that a dirt floor has no bottom.

My play and pastimes at Talladega were very much the same as those of any boy of that age. I loved to play "bunkum" marbles, to roll the coveted glass balls into small holes carved in the dirt, with the harsh knuckle-penalty for losing. I loved to play baseball with a tatterdemalion aggregation of Negro boys of all sizes and degrees of origin. We built a tennis court of sorts in our strawberry patch, which had ceased to bear. And with many a backache and blistered hands I hoed at the soil in desperate attempts to make the court partially level and smooth.

I was small and rather undersized in those early days. My father called me "puny" and was frequently worried about my condition, although I always had the best of food to eat and the best of milk to drink—and plenty of it. I remember the pardonable pride I felt when my parents decided that at last it was time for me to abandon knee pants and wear long

breeches. My schoolmates were amazed and gleeful. "Dey favors you, Lee, long pants sho' favors you, son," and I became thoroughly reconciled to the change—actually commemorated the event with an appropriate poem.

Little wonder was it that I acquired thoroughly, not only the Southern, but the Southern Negro's, methods of speech. Traces of that early dialect clung to me for many years thereafter, a thing of which I was well ashamed and strove valiantly to eradicate. Yet I fear that I never wholly and completely succeeded in this effort.

Perhaps the most prized of all the *Youth's Companion* premiums which I obtained either through subscription or by purchase was a little Weeden upright steam engine, with an alcohol burner under the boiler. Anxiously I had awaited its arrival, and in rubber boots and rubber coat waded through a terrific downpour all the way downtown to the express office and back. What inexpressible joy it was to see that little engine run, to open up the little whistle valve and listen to the *peewee* sound! It mattered little that when the whistle was open the engine quit running for lack of steam. But alcohol was very expensive in the South at that time. Pure ethyl was all we could buy; and after Father refused to purchase any more costly fuel for my upright engine, with a can opener I cut away the perforated skirt which held the boiler above the alcohol lamp, set the bottom of the boiler against the top of a kitchen stove lid, and thereafter proceeded to burn unlimited quantities of wood and coal whenever I felt the urge to become a stationary engineer. Our cook was certainly relieved when I tired of this method of firing my darling engine.

And as though such pastimes and my liberal education in household and farm chores afforded insufficient outlets for my physical energies, I must needs construct a gymnasium. The west cellar offered the only possible space, since the barn loft

was too frequently filled with hay. The cellar ceiling was scarcely seven feet high. But this did not deter me from hanging a trapeze therefrom, although when I hung from it by the knees my hands could propel my pendulations by pushing on the earth. And when hanging by my toes, as of course any gymnast must, my swinging skull just cleared the floor. In fact I had to dig a shallow trough therein with a shovel, to avoid doing so with my head. Parallel bars, of sharp one-inch strips heavily swathed in rags and burlap, were next in importance. Along these we boys spun dizzily. The college smithy welded for me two iron rings. These could be hung no higher than the trapeze, lest the whirling gymnast brain himself against the hard, slivery floor joists to which the sash-cord ring ropes were nailed. The low ceiling made practice on a "vaulting horse" perilously unsafe, so this idea was reluctantly abandoned. But that cellar gym afforded no end of fun and rainy-day exercise, until my growing height simply made this too painful to be fun, or funny.

When this or the other two cellars became mussed up, or the coalbin or woodpile in disarray, or the yard, garden, or barn littered up, I would go on an "order spree"—with broom and rake toiling savagely until dark, never resting or content until all was again "in apple-pie order," as Father expressed it. Such zeal was certainly inherited.

When the treasurer of the college, Mr. Silsby, built a nice new barn back of his house, some of the teachers who were dramatically inclined found in the upper loft opportunities for a small theater for the children. Some small pageants were staged there, in one of which I remember playing the part of a noble knight in homemade doublet and hose, with oversized slippers on my feet and an oversized beret cap with a long ostrich plume dangling therefrom, set jauntily on my head. This was a part which I relished, and I carried my spear with compelling bravado. But much less pleased was I when the play of "Little

Red Riding Hood" was rehearsed and I found myself cast in the role of the Big Bad Wolf, on all fours and completely covered with a big, woolly sheep(!) rug from the Silsby's parlor floor. I was coached to come in on all fours, emitting ferocious growls, and savagely to devour the poor grandma who, in boudoir cap and spectacles, proved to be my sister Mary. Little Hattie Silsby was Red Riding Hood.

The rehearsals were ended, the audience of some ten teachers and proud parents were assembled, the two flannel curtains strung on a wire were drawn back, and the tragic drama was on. Came the time for the bad wolf's appearance, and I went on strike, not from stage fright at all, but because I did not think the sheep rug was at all becoming to my assumed character and, furthermore, I very much disliked the idea of making my entrance on all fours. The cue of the prompter and the cajoling of the coach backstage were all unavailing. The wolf simply would not appear. Finally poor "Grandma" Mary called out for assistance across the footlights, "Mama, Lee won't come out; he's spoiling the play; you better come backstage and make him." This Mama did and, by tactfully appealing to my sense of the justice due the audience and the other players in the cast, finally induced the fierce bad wolf grudgingly to crawl out on the stage and, in a halfhearted manner, carry out his evil intentions. The play must go on—to the uproarious and hilarious laughter of the audience, who had never seen so gentle a wolf, even clad in sheep's clothing! I am sure that performance of Little Red Riding Hood proved to be far more successful than even its inexperienced impresario had intended. But it played no return engagement.



CHAPTER 4

Talladega Youth

AS a boy, lacking radio, motion pictures, and even pulp magazines, I had abundant opportunity and desire to read worth-while literature. Fortunately for me my father's library contained such works as the *Leatherstocking Tales* and *Sea Tales* of James Fenimore Cooper, the novels and poems of Sir Walter Scott, the poetry of Tennyson and Longfellow. Among my sister's prized possessions were *Tanglewood Tales* by Nathaniel Hawthorne, Lamb's *Tales from Shakespeare*, and *Children's Stories of the Grecian Myths*.

I read the Bible from cover to cover, even through the meaningless list of names in the Book of Numbers! This heroic task was then considered worthy of much praise, and beneficial to the soul of a young boy. Among ancient Talladega papers and memoranda I find this gem carefully penciled, at the presumed age of twelve:

The practical lesson I get from the last chapter of Genesis is that there is no merit without great labor and that diligence is always rewarded. By perseverance, merit, and application, one may rise to eminence and prosperity, as is so plainly shown in Joseph's life.

Upon finishing the Bible I read every word of Milton's *Paradise Lost*, and for full measure his *Paradise Regained*!

I remember once when I was ill and confined to the house, my mother read by the hour from *Ivanhoe* and *The Lady of the Lake*. I loved *Tales of a Wayside Inn* and was fascinated beyond expression with the melodious rhythms of *Hiawatha* and *Evangeline*. Eagerly I read tales of the Knights of the Round Table, of medieval castles and the mystic rites of knighthood that had originated in the sacred confines of some legendary domain.

I received at Talladega a very thorough high-school training in English and American literature, and learned to appreciate and love many of those fine writings which I was reading. Throughout my subsequent life I have deeply appreciated the early school training in, and familiarity with, fine literature, an appreciation which I owe to both my parents. I realized early that familiarity with and appreciation of the best in literature affords one of the deepest, most rewarding, and lasting pleasures of mind and soul which it is given human nature to acquire. Thus to read well, and write well, have been constant ambitions since boyhood days.

On one memorable summer, when I was fifteen, Father took me with him on his health-searching trip from Iowa through Nebraska to Colorado, where I spent several delightful weeks in a low-priced hotel in Manitou Springs, in the shadow of Pike's Peak. Despite his rugged constitution, my father's health had been sadly impaired by sleepless nights and the strain under which he usually labored in his devoted efforts to build up the college and expand the educational work for which he saw such crying need. He had developed a chronic bronchitis which at times became so harassing that he was compelled to leave Alabama and spend many lonely weeks in high, dry climates, such as that at Las Vegas, New Mexico. But during this summer of 1888 he took me with him for companionship.

It was in Manitou, at a concert in the Mansion Hotel, that I heard my first classical music by an orchestra. A letter to Mama details the deep pleasure I derived from this first revelation of the beauties of fine music.

On this trip to Colorado we had paused at Des Moines and Council Bluffs long enough for Father to renew many old and pleasant acquaintances. In recording this wonderful journey I had written to my mother: "I had a very nice time with Mr. Wallace's folks. (He had been a deacon in my father's church at Council Bluffs.) And I have got a girl here too. She is a *daisy!* Her name is Nettie Wallace. She gave me her photo also." (There will be more regarding the Wallace family later on in this history.)

Together Father and I toured the Garden of the Gods, went through the Royal Gorge on an open observation car, tarried at Ironton, and then walked the remaining eight miles over the thrilling mountain roads to Ouray. Throughout those memorable weeks in Colorado I fed my aspiring soul upon the grandeur of mighty mountains and towering crags, silhouetted against skies of such brilliant blueness as I had never known. There, under my father's fervent and nature-loving tutelage, I imbibed a love for the mountains and wild nature which has deepened and remained with me throughout my life.

I shall never forget our ascent of Pike's Peak, climbing up the trail from Manitou to the Halfway House, where we spent the night. Arising early the next morning we made the slow and cold ascent by horseback to the summit. Like thousands of others who have enjoyed this experience before and since, I was moved by the grandeur of the view to express myself in literary raptures, which I refrain from inflicting on my readers only with the greatest of restraint.

My debt to my father grew with the years. I can still see him now, over six feet tall, robust, walking in great strides down the

campus of Talladega College, coming from his classroom in old Swayne Hall, home to the family luncheon. In that college he taught his handful of advanced Negro students Moral Philosophy and Greek Testament. And when I after much effort had finished Caesar's *Commentaries*, he took delight in furthering my Latin learning, as we read together in Virgil's *Eclogues*, he pointing out in keen relish the beauty in the old poet's praise of Amaryllis and Daphne. Together we loved that afternoon hour, father and son seated on the lofty iron balcony under the massive portico of the slave-built Swayne Hall. A thorough Latin scholar, Father familiarized us children with Latin mottoes, urging each to choose, or frame, one for his life's guidance, as he himself long ago had done. After deep thought and study of our Latin lexicon I decided on *Esse Benedictus*, "To Be a Blessing." Then and there was formed a boy's resolve so to live and strive.

Among my earliest recollections were the rapt moments when he told us of his years at Yale. There, due to the De Forest Scholarship, the largess of his distant cousin David de Forest, first United States Consul in Argentina, he had been granted the intense desire of his youth, a college education. His sons were entitled to the same scholarship and must also go to Yale. From their beginning my studies were directed with that aim in view. I should take Latin, then Greek, for both were college requirements. But after I had read a catalogue of Yale's Sheffield Scientific School requirements, where furtively I had long determined to go rather than to Yale College, I foreswore Greek save for the alphabet, which symbols I learned were much used in higher mathematics—and dug with double diligence into Latin, then required by Sheffield.

Father and I had many earnest arguments on this subject so crucial to my coming career. Long and fervently had he prayed that both his sons should follow him into the ministry, or if not

that, then again like him, into teaching. Much as I loved my father I felt deep within my being that in honest fairness to myself I could never be a preacher, while the academic life of a professor, even of the sciences, could not possibly give proper vent to my inventive propensities. Papa sadly and wisely came finally to the bitter realization that his "boy's will was the wind's will, and the thoughts of youth are long, long thoughts," that in my case the wind blew strongly, and in one direction only—that of carving out a career of invention in mechanical engineering or in some pursuit of science. And so in the spring of 1889 I painfully typed on his old Fitch typewriter the following letter:

DEAR SIR: Will you favor me with your ears for a few moments? I wish to state my desires and purposes. I intend to be a machinist and inventor, because I have great talents in that direction. In this I think you will agree with me. If this be so, why not allow me to so study as to best prepare myself for that profession? In doing this it would be much better to prepare myself for and take the Sheffield Scientific course than the Yale University; besides I could prepare for it in one more year and the cost would be much less, which would be a great item with you, who have us all to educate. The time and money it would take to let me take both could not be spared, and a great deal of what I would learn in the University would be of no advantage to one of my profession. While what I would learn in the scientific course would be of greatest use. I think that you will agree with me about this on reflection, and earnestly hope you will act accordingly and educate me for my profession. I write this with no ill will in the least, but thinking that it is time to decide and choose my studies accordingly.

Your obedient son,
LEE DE FOREST

And then, as a sort of postscript:

This machine beats Mr. Silsby's all to flinders.

On the other side of this letter I had carefully typed a note for my mother. It began:

"Lives of great men all remind us
We can make our lives sublime,

And departing leave behind us
Footprints on the sands of time."

Dear Mama: The only footprints I will leave will be my inventions. I had better take the scientific course. Don't you think so?

After this earnest plea, Father reluctantly gave up the hopes he had cherished even from the birth of his first son, decided that even a Sheffield School education was preferable to no college training at all, and made me personally happy by saying: "Well, Lee, if you positively know you want that sort of half-baked education, you may have it. You will miss all the cultural refinements to which study of the classics brings one. When I think of what deep joy my Yale College training has meant to me all through my years, the helpful and inspiring acquaintances in my class, our choice companionships, days spent in study under the Old Elms, in my dormitory of Old South Middle, which Sheff men can never share, I can only say I hope you never regret the choice you are now making."

Never for one moment have I regretted my choice.

Often during those years at Talladega Papa at our eager request used to delight in recounting anecdotes of his youth, college, and army days. On fair Sunday afternoons, following the family service of prayer and song—Mama at the upright piano and our two colored servants joining in the family circle—Brother and I would trot along by his side while he told stories of his past: of early spring days in the New York sugar bush, where the snow sleds brought to the evaporation pan the tubs of sweet maple sap; of his grandfather, whose eldest son had one night left the wedges in a particularly tough log he was splitting for a rail fence. Old Gideon, discovering this heinous dereliction, had scolded the young man unmercifully: "Never quit a job unfinished, lad; never leave your wedges in a log." That heroic maxim thereafter became deeply implanted in my

father's mind and character; it was oft repeated when his sons would leave their chores unfinished to join a ball game, or on a hot day would steal off to the "wash hole" in Talladega Creek. And through my own life "never leave your wedges in the log" has been a corrective stimulus on many a tough job or occasion. It seemed to bring the heroic spirit of the Revolution directly into my modern life. Father was proud of that stoic heroism of his grandfather, and often urged each of his sons to "be a Gideon," like his grandfather and that Old Testament hero for whom he was named.

As my years at home drew towards a close, a better understanding between father and son gradually and happily developed. Papa began to realize the bent and inclination of this mind which apparently had been born in his elder son. Gradually he came to respect this will and to appreciate the wisdom of allowing me to follow my bent. On the other hand I began to appreciate the sterling Christian and mental qualities of my father's character. I began to realize with what travail of soul and stern, relentless physical effort he labored for the upbuilding of Talladega College, his life's dream; and for the regeneration, the economic, mental, and moral upbuilding of the Negro race which had so recently been freed from slavery. Their poverty was appalling; their ignorance of the fundamentals of living was unbelievable; their superstitions and vices were enough to discourage the most zealous missionary. Yet the evident ambition and consuming desire of most of those who had come to the college for aid in acquiring an education served as a reward, all too frequently the only reward, which my father and his brave band of devoted missionary teachers could hope to receive for their unceasing, unselfish labors.

First in my father's thoughts and prayers, foremost always in his program for work, was the need for bringing the Negroes into the Christian church. Secondly, there was the necessity

for giving them an education, both of mind and of hand. With all his intense nature he firmly believed that the Negroes should have equal opportunities with the white people. This he continually preached in the South as well as in the North during his frequent trips to raise funds for the college.

While of a tender age, during one of the frequent revival services, I had joined the Congregational Church of the college. But not even that could have made me a more regular, if none too devout, attendant at the supernumerous religious services. These were always held in the Swayne Hall Chapel, upon whose stiff benches of hardest pine, their only upholstering the gray paint they wore, I sat or squirmed through countless penitential hours.

In the latter half of my last school year at Talladega, when I was seventeen, I commenced to keep a diary. The first entry dated January 1, 1891, A.D., reads as follows:

Am resolved to write a Journal for this year and see whether it pays to continue it. I hope I will hold out for one year at least, and as it is my last year at home I hope it will be a pleasure at college and all my life to read it. It is said to be good discipline for the mind, so I want to try it and if I like it I will continue. I must write a little every night and try to have my writing improve every night.

Subsequent entries in this and many succeeding volumes of my diary show that I kept this vow throughout my years at prep school and my undergraduate years at Yale and with scarcely a single omission recorded briefly at night the doings of each day. The early entries are chiefly devoted to play, chores, and readings. Alas, they frequently reveal how woefully immature, lamentably childish for my years, I was then.

January 17th, Saturday: After dinner I read and then went to town by railroad and smoked a cubeb cigaret on the way, went to the bank and got a draft, and then went to express office after our rackets, etc.

January 25th: Be good, it will pay in this world and the next. I am resolved to do—not live and die and world be as bad as it was and not

know I ever lived. They shall know and be glad, and sorry when I die—so help me God. After meeting I sang and played cornet, can't sing very good tenor. After supper we all went to prayer meeting and Papa led, and Mr. Burnell spoke another good Bible talk.

January 29th: At 2 P.M. we had Prayer Meeting in our room until 2:45. Then I came home and practiced, and then we took a plank over to the shop and ripped it up in $\frac{1}{4}$ -inch strips. We worked till my muscle got like a rock and I raised a blood blister, till supper. On the last piece I had the luck to snag my thumb on the saw and ripped it up. It is bad off. After supper I composed my letter to Edison asking his advice about the kind of education needed to become an inventor. May it get a favorable answer. The strips are for our tennis court. Now read and bed.

May 2d: This A.M. I picked one quart strawberries, then read and plated my watch chain. It looks quite nice. After dinner went to Stone Hall and got two boys to go to the Creek for a swim. Came home, rested, and then irrigated strawberries with a funnel and hose from the barn pump. Slow work till supper. Then finished inventions and put up Jenny Lind. Read about how to get a bicycle free by selling 150 cans of baking powder. Don't think I can. Studied Virgil with Papa and read until bedtime.

Another entry from about this time expresses my hope of continuing my preparation for Yale in more favorable circumstances than Talladega could offer.

I want to go to Mount Hermon badly. The catalogue came today.

Monday, May 4th: We had our little family prayers before going to school, because Papa was going to New York at 11:00 A.M. [It was our invariable custom before parting for the little family group to stand close together with arms around each other while the tall father offered a fervent prayer to protect us all until the wanderer returned once more home.]

Saturday, May 23d: After work read *Tale of Two Cities* all the morning. Can understand it for having studied about French Revolution. Ought to read no such books before reading history about it first. [This was the only work of Dickens that ever interested me.]

Now reading *Tom Brown at Rugby*. Tonight sketched my airship invention and wound a magnet for my induction coil.

Read French Revolution. Never trashy literature. And played ball awhile. Saw a steam shovel at work. Very fine and interesting. [Picking strawberries and helping to make strawberry ice cream seems to have been an almost daily procedure.] This morning went down again to the tram

road and had some good rides. Every time we went over the break in the tram road Charles and I prayed to go safely over, went over, and thanked the Lord. Then I pushed three cars to the furnace and switched mine off and rode back. Strained myself very hard, but it makes muscle. I stick to a thing like a seed tick.

Wednesday, June 10th: Last day of school for me at dear old Talladega where I was educated. [!] After geometry examination came home and practiced "Swanee River" with Mama for the last time and read until dinner. After that got ready for the prize speaking [at which I had to play "Swanee River with Variations"]. I was scared and my mouth got so dry that I played poorly and threw off at the end. Dad-blame the luck. [That, I believe, was my last appearance as a public cornet soloist. Thereafter my musical ambitions sadly deteriorated.]

June 15th: Read all this A.M. as it rained all the time. Ditto P.M. Began to study Civil Government for Mount Hermon. Went to library and enjoyed the Patent Office reports and got the *History of the Conquest of Peru*. No novels.

June 27th: Finished the job of typewriting and wrote a letter to the Yost Typewriter Company for a place in their factory for the summer. Hope it will be more successful than Edison's. Went to town and bought a box of loaded shells, Papa's gift for Fourth of July. Read *Conquest of Peru*, very interesting, no dime novels for me. The Fourth of July number of *Youth's Companion* came and I read it most of the evening. I don't believe my offspring will have better reading matter than I have.

There were great preparations for our last Fourth of July at home. We had imported fireworks from the North, for nothing like that could be found in Talladega (except at Christmas time, which down South was then celebrated with fireworks and firewater, gunplay, and occasionally the Rebel Yell).

July 6th, 1891: Last day at my dear old home in Talladega, heading now for Lake Quinsigamond, which I think is the place for me. Bade good-by to all the neighbors, finished packing up. Dear old home, not very inviting to me now, but in later years, looking back through the misty vistas of the past, distance will lend enchantment to the view, concealing the harsh places, and clothing the happy hours spent here with a golden refulgence not its own. How often will I long to see these old rooms again! Dear home, farewell!

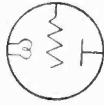

CHAPTER 5

Mt. Hermon Days

MY father's reluctance to send me north to prepare for college, or his economic inability to do so earlier, was responsible for the fact that I entered preparatory school when nineteen years of age, rather than at the usual age of seventeen or less.

After long discussion Mt. Hermon Boys' School at Mt. Hermon, Massachusetts, was finally decided upon. My sister Mary had left Talladega two years before to enter Northfield Seminary at East Northfield, Massachusetts, the original of the two schools founded by Dwight L. Moody and situated only three miles from Mt. Hermon, but across the Connecticut River. I was glad to know I would be so near my sister.

I was to spend the intervening summer of 1891 at "Natural History Camp," on a lake near Worcester. It was a camp characterized by plenty of drilling, swimming, camp inspections, discipline, and homesickness on rainy days. There I learned to row and swim well, to dive deep, and to run cross-country in "hare and hounds" chases. But most interesting to me were the

classes in electricity held at the camp. There in a small workshop I attempted to construct correctly certain electrical devices which I had failed to make operate at Talladega. My journal entries for that summer indicate that there was never an insurrection, rebellion, or wholesale infraction of camp rules without my being at least mixed up in it, if not one of the ringleaders. I was frequently put on guard duty, and suffered other disciplinary measures for my insubordination and disregard of rules. One diary entry reads:

Colonel told me to stay in my tent until relieved, which I did, and am now there, sewing my pants. This is as bad a summer as I have spent in my life.

On September 1 Father called for me and together we entrained for Mt. Hermon. The buildings impressed me as fine. Such a lot of men, mostly big and grown, I had never met before. Hesitant, half fearful, I thought I could never get acquainted. At the examination of new boys I made the Senior Middle and Latin classes, and found myself slated for farm work for two and one-half hours daily, with double that on Mondays, the school "holiday."

I was to "damn well learn" that Mt. Hermon was a school founded on basic, rock-ribbed Fundamentalism and rock-studded dirt farming. At Talladega I had had surfeit of one and plenty of the other. What I most needed I now learned was *not* what Mt. Hermon had most to offer. With a childhood environment such as I had been reared in, almost wholly isolated from white playmates of my own age, continually listening to Negro talk and imitating Negro manners (or lack of them), I stood badly in need of preparatory schooling where refinement and culture could gradually replace the boorishness and uncouthness of my earlier surroundings. This, I soon discovered, Mt. Hermon could not provide. I think my father little realized how his sons were handicapped by their years at Talladega. Yet, even if he

had, our financial situation was such that it was quite out of the question to enter me in one of the high-tuition schools of New England.

Nevertheless, despite its rigid Biblico-agricultural curriculum, Mt. Hermon prepared me to enter Yale "without condition," and I owed to its Professor Charles E. Dickerson an inspiration and incentive in science study which I especially needed at that formative stage of my life.

On the first Sunday began the customary four-mile walk to Northfield Church

to hear Dwight L. Moody preach on the five parts of repentance; conviction, confession, contrition, and—I can't remember the other two. Fine bean dinner at 2:30 and pie! pie!! Played my cornet and was invited to play as second cornet in the school orchestra. That'll be fine.

And on the first Monday "holiday" our gang dug 100 bushels of potatoes. "In the laundry I lost two towels and one sock. Hope they'll turn up." By working overtime, at 10¢ an hour, I began to lay up a little money, even at the cost of time which had been better bestowed upon my studies. Scholastic achievements in those days at Mt. Hermon were frequently rated as of less value than ability to milk cows and heave heavy rocks all day.

Upon learning that the boys who had sisters at the seminary were permitted to go beyond the Mt. Hermon boundaries, I often walked the four miles and back, saving bus fare—to visit with Mary and her girl friends, even as bashful as I was. Of one of these, Julia Winter, I soon became an ardent, but timid, admirer.

Occasionally Seniors from the seminary came over for an evening reception. Then indeed the question of bathing and dressing became important, for each student in Crosby Hall was assigned one quarter hour *per week* for use of the bathtub, and as my bath hour was on Wednesday night it was frequently

necessary to bathe myself in sections, for I found potato digging to be very dirty work.

I had to study hard on algebra, physics, and Virgil. Recitations were always in the forenoon, lest they interfere with the more important farm work. I loved the mathematics and science studies and found it not difficult to lead in those classes.

One very cold Sunday, I walked and ran over to Northfield Church with the champion mile walker of the preceding Field Day, and beat him. After this feat I determined to enter that contest. The many long, fast walks to Northfield and back afforded ample training opportunity. (Walking, or "hiking," has been my lifelong hobby ever since.) And over the first ice on the duckpond back of the school laundry, I took my first skating lesson, eagerly anticipated through all my Alabama winters.

During that first Christmas vacation at Mt. Hermon, I tried my first telephone conversation, from Professor Cutler's house to my sister at the "Sem." I heard little but a loud buzzing, and was ashamed to continue, not understanding her. "Drat old Edison," my diary peevied!

On January 1, 1892, I resolved to continue my diary for a second year. First entry:

I have no sentimental resolves or feelings to express, but keep right on trying with God's help to grow better. Celebrated the occasion by hearing the Boston Symphony Orchestra. It was grand. [This was my first introduction to great music.]

Now I soon began to train for the spring Field Day mile walk. Every day, and frequently after night study hour, I practiced grimly the heel-and-toe down the dirt road leading from the school. Field Day came. There were but three contestants. I was behind on the first round, passed the "champ" on the second, and gained until the finish, breaking the school's record

—in eight minutes, 26¼ seconds! How regretful I was that dear Julia Winter was not there to see me win!

During my years at Mt. Hermon, and also later, I never failed to write home each Sunday; and every week, either from my father or my mother, I received words of encouragement and admonition. In my diary I find pasted a few selected quotations from my father's letters of this period.

My early hard work has borne fruit all my life. It was good for me. The same heroic treatment might not be harmful to my children.

I hope that all your companions may be worthy fellows. An awkward boy who has character and worth in him may yet wear the laurel.

Self-reliance is developed in helping oneself. It is good to bear the yoke in your youth. A peck of barley a day and a race from Medina to Mecca, a distance of 70 miles, makes the Arabian steed.

May both my boys be stalwarts, regular Gideonites of the Tribe De Forest! No weak-kneed, fainthearted namby-pamby among my male successors; only two, but each a lion. Heroism at school augurs success in after years.

Summer vacation came, with no lucrative work in sight. So my roommate and I decided to become book agents, signed up to sell a hefty volume, *King's Handbook of the United States*. After ten days of high-pressure tutelage, we fared forth.

I approached the task with utmost reluctance, but my journal entries are not without humor:

Saw a lot of pretty girls and inquired the way to the Congregational minister. [!] His wife was kind, gave me lodging. The minister kindly took one, at a discount. Two seven-hour days of work resulted in two sales, both markdowns.

But I persevered and luck soon changed for the better. I ended up that trying summer forty dollars to the good.

After school reopened, our demigod founder of the school, Dwight L. Moody, sailed for Europe. His ship broke down in mid-ocean and nearly foundered in a heavy storm. Putting back

to port, he returned for a triumphal entry. All Mt. Hermon met his train with torches and brass bands, and trooped to church to hear him tell of his peril and how God had answered his prayers. I remember how we sang, "Safe home, safe home in port, torn sails, provisions short," and how even I, reverential as I then was, could scarcely suppress a smile to associate that last line with the huge, rotund belly of Mr. Moody reposing so peacefully above his knees as he sat on the chapel platform. "Provisions short?—my word!" But I harbored no shadow of doubt that his ship had been saved by an express act of the Divinity, and in answer to our fervent prayers.

Came Christmas vacation, and this time I was off with Peedee Hines to spend the week in Northampton in the home of his brother-in-law. There was ice on the Northampton Pond, and this time I really learned how to skate. The records would indicate that skating and night parties with the nurses at the hospital, where Peedee's sister Molly worked, were my chief interests during this brief vacation. Also I went to my first theater—down the wayward path!

During the autumn of my Senior year, Mt. Hermon's fine new Science Hall was erected. Through good luck, bluff, and cajoling of Mack, czar of all the jobs, I managed to land the fine job of cleaning up the new chemical laboratory where we Seniors studied qualitative chemistry. When the water supply was cut off, finding no more manual work there, I put in that time in hard study. The discovery of this insubordination maddened Mack, and he put me again on "work hour." Yet despite those long hours of farm work, with a curriculum overburdened with Bible study and Bible-training classes, interspersed with religious services no end, I was able to stand highest in all science classes, and adequately to prepare myself to enter Yale.

Also I toiled hard on my Bible Essay, resolved to get an "E" on it, and so earn a chance at the fifty-dollar prize. Preparations

for Commencement and Class Day programs busied us Seniors. I was elected to deliver the Scientific Oration. As the title I selected "Scientific Discovery," the subject dearest to my heart (next to Miss Winter).

At last came graduation day, with its solemnity and breath-taking suspense.

First the seemingly endless baccalaureate sermon. Then came the prizes. I felt sure I had that Bible Prize, not through any conceit or through comparing myself with the others, but I had prayed to God so much, and so earnestly, that I really had *Faith*. I knew I had the Prize, and trembled as though my name were printed on the program. I was on tiptoe ready to get up and walk up to the platform to receive it. Then "Prof" spoke the fateful words, "The Bible Prize in the sum of fifty dollars has this year been awarded to . . ." I absolutely *knew* that his next words would be my name. Alas, when he said, "Charles Snow," my youthful, trusting faith in God sustained a blow from which it never quite recovered. "Farewell to that bicycle," I gulped.

I received my diploma anyway, and took Julia to the collation. "She had a great appetite. I couldn't afford the 75¢ for the banquet. After she had departed I drank her health in two glasses of phospho water."(!)

My prep school days were finished. Mt. Hermon had given me all she could, had well prepared me to enter Yale. And from Professor Charles Dickerson, whom I now loved as an elder brother, I realized I had derived encouragement, inspiration, and enduring incentive in science study which I especially needed at that formative stage of my life.

I had determined to take, and pass, all the Yale Sheffield entrance exams that June; and so all through the following week, ten hours a day, I studied intensively my Virgil, geometry, and algebra, with never a rest save an evening swim in the Connecticut.

Then I took the train for New Haven, at last to be enrolled as a Freshman at Yale. I was tremblingly thrilled by the experience as 200 of us sub-Freshmen assembled in the upper corridors of Winchester Hall for the examinations, all wearing straw hats with brims so ridiculously wide that broad shoulders did not come in contact—the college fad that year.

I passed all the examinations; also I had the gratifying news that my tuition would be fully paid, thanks to that blessed De Forest scholarship.

But now also came sad news from Chicago. I had applied for a job as a guide at the World's Columbian Exposition, but there was no place for me. There remained nothing but to take up the hateful work of book canvassing again. This time the unwanted volume was "What Can A Woman Do?"—the place, Syracuse and environs. I was intent on earning sixty dollars so I could go to Chicago. Again day after day dragged by with one to three books sold. Finally I managed to collect the eighteen dollars for the round-trip ticket and was off on a long, crowded excursion train—sleeping upright—reaching the "Fair City" the next afternoon. I spent the first days in the Manufactures Building studying mechanical parts, typewriters especially.

The Fair, I wrote in my diary,

is immense and grand. I must stay as long as possible. Many chair-boys have struck and been discharged. I spent Friday in the United States Building studying models and gun manufacture, Saturday in the railroad department of the Transportation Building. I don't waste time or money in Woman's or State Buildings, or the Midway Plaisance, but study machines, engines, models almost entirely, and learn a great deal that will be of use to me. I want to stay longer and study all of this sort possible, as it is really money and a paying education for me, as well as the highest enjoyment.

At last I got a chair-pusher's job, paid eight dollars for a uniform, and went to work, rejoicing. I boarded at Aunt Hattie's

and slept at "Bingo Farm" for fifty cents a night. The night scenes seemed beautiful beyond compare and are indelibly fixed in memory. They repaid all the day's hard work.

When my patrons asked me what exhibits they should visit, invariably I would steer them into Machinery Hall. Of course if a fat butter-and-egger insisted on seeing the Streets of Cairo, even a son of Mt. Hermon could scarce refuse, but unblushingly watched the hootchy-kootchy dancer! I enjoyed it particularly when my customers desired to sit still on the lake front and watch the fireworks.

One night I laid off and hurried uptown to the Auditorium, where I bought standing room for the famed spectacle, "America." It was stupendous and grand. So much splendid ballet dancing and high kicking only made me restless to see more.

On September 16, 1893, I tied up my uniform and went in to the greatest of Fairs for the last time. How sad was it to leave, to take a last fond look at the Peristyle and other buildings! It was with regret that I heard the last dull click of the turnstile as it shut me out forever from that wonderful Exposition which had been my happy home for a month.

Little then did I imagine that eleven years later, at the next great World's Exposition, this chair-pusher's name in incandescence would emblazon the loftiest tower in that other city; that five separate exhibits would there display startling inventive achievement in an art, and a fast-expanding industry, which as yet had not been conceived.

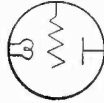

CHAPTER 6

Yale Undergraduate Years

*U*PON my return to New Haven in mid-September, I went first to 411 Temple Street on "Freshman Row," to Mrs. Goldsmith, my very pleasant old landlady. She showed me to a cozy, sunny back room with two south windows. Here, for the first time in my life, I could be alone and independent of others, could study alone, could write, think my own thoughts, all without interruption. Also my room was at the rear of the house; I knew that no bullying Juniors would yell up at my windows, "Fresh, put out that light." So I fixed up my room prettily, hung my Mt. Hermon curtains, stuck Julia's photograph in the mirror, bought a sturdy chair and a bookshelf, and began hard study. I realized from the beginning why I was at Yale and was resolved to make the very utmost of the opportunities I had so long and eagerly anticipated.

All my environment seemed strange and beautiful—the elm-lined avenues, the college streets, the walks and campus scenes made me love Yale right from the start. But the necessity for strict economy was not strange or new. I found me a "Five-Cent

Restaurant" within easy walking distance, where fifteen-cent meals were available, even cheaper with a three-dollar meal ticket for two dollars and seventy cents—good for one week's famishment.

German was my toughest assignment. Glad enough was I that all Latin now lay forever behind me.

On my first Saturday afternoon I hurried gaily from my study out to Yale Field to see the great varsity football team at practice and the fabulous Dutch Carter unlimber his pitching arm. Thus early did I thrill at Yale's prowess on the athletic field.

Each Sunday morning found me in Battell College Chapel, with the afternoon spent in long, meditative walks with some older Mt. Hermon men I found in the Old Brick Row, already so fondly described by my father. Thus I was never lonely, except that, as my diary indicates, I had become a lovelorn loon, longing for letters that never came or going up to Julia's home in Middletown to find out why. I wonder now that I was able to keep up in my classes as well as I did.

Now my inventions became another detriment to continuous study—an improved type-bar movement for my "typewriter"; an improved compass joint, which design I mailed to Keuffel & Esser; a puzzle game similar to the old "Pigs in Clover," which I called The Midway Plaisance; and sundry others, all designed with the profit motive in view to help me carry the financial burden of my schooling which I knew was a heavy drain on Father's resources. I wrote to Milton Bradley and the Ferris Wheel Puzzle Company regarding my puzzle invention, and on the strength of my expected royalties bought a large kerosene lamp to give off lots of heat and keep the room warm on cold nights!

At Mt. Hermon astronomy had been a favorite study. So upon reading in a newspaper an account of the position of Jupiter's fifth satellite, I excitedly made note in my diary:

It conforms very roughly with an estimate I made at Mt. Hermon, using Bode's Law.* Thus I consider the Law as proven to be more than a coincidence, as applying to the distances between Jupiter's satellites as well as those between the sun's planets, and very important. I hunted up the case of Uranus also, in Crittenden Library, and found that it likewise proved the Law. I felt highly elated and wrote to Professor Barnard, who had discovered the new moon. I believe that Jupiter has now a sixth and outer satellite yet undiscovered, for the fifth is exactly in place by Bode's Law and not too far in, as is the case with Neptune and of Uranus' last moon, showing that Jupiter has one beyond the fifth to pull it out where it should be! I stated the proportion between the discrepancies of Neptune and Uranus' fourth satellite as in the ratio of the gravitation of the sun and Neptune and of her moon and Uranus, taking into consideration centrifugal force, etc., and wrote him to work it out and see if it were true. If so, it's a strong proof of Bode's Law really being a law.

Intellectual modesty, evidently, was not among my cardinal virtues in my Freshman year!

That fall another dream of my young life was realized, to see the Yale-Harvard football game at Springfield, where those classics were then held. I was distressed to note that Harvard yelled a great deal more than Yale, and I had to do all the yelling in my section, as there were so many ladies and Harvard supporters about me! Yale won, 6-0. It was a glorious game. "I dreamt of nothing all last night but that game, and can think of little else today, but I don't buy Sunday papers"—good boy that I was!

One Sunday night at Dwight Hall a distinguished medical professor lectured on the human brain and its evolution. There was planted in my developing mind the first seed of agnosticism. Slowly thereafter many of the myths and beliefs which had been my spiritual pabulum through all my youth from infancy were broken asunder and discarded. One by one I began to test this and that belief and preachment with the corrosive acid of experience, scientific reasoning, and "the theory of probabilities."

* Bode's Law states an empirical rule regarding the relative distances of the planets from the sun.

That lecture was the entering edge of the knife which began there to open my hard clamshell of bigotry.

My first Christmas vacation in New Haven was lonely enough, for most of my classmates scattered to their homes, but not I. Despite all my Talladega and Mt. Hermon religious training, I found it difficult to concentrate on church sermons. During one service at this time,

I thought out the essentials for an underground trolley system, as I had just read in the *Scientific American* of a \$50,000 prize offered for the best design. I felt so supremely happy I could have shouted. I vowed to give \$5,000 to the Lord if I won the prize. I could think of nothing else all day. Drew out all the essential features successfully, as I think, before I could rest.

Though alone on Christmas Eve, I was not lonely, since I was drawing out details of my invention as they came to me.

Then in the public library I found the *Street Railway Review*, and read of a number of underground trolley systems. They all seemed to depend upon drainage to insure insulation. Mine could run under a foot of mud or water. I now began to realize the lamentable inadequacy of the Sheffield Scientific Library, being one of the very few members of the school who ever located and visited that institution.

On that meditative New Year's Eve I recalled with gratitude God's great mercy to me and all the family through the departing year. I had graduated from preparatory school, seen the great Fair, and entered Yale. I felt I had grown and developed in every way. But, I confessed to my diary, I yearned strongly for the company of girls and, for the lack of such companionship, was too prone to flirt. In further confession, I found I lacked strength, common sense, and manliness.

I don't improve all my opportunities, always resolving to do better, but too often repeating folly. I lack the individuality of character my life's work demands—am a fool!

This outburst of soul's remorse was doubtless due to my suddenly revealed lack of will power in not firmly resisting the wiles of Satan disguised in the form of petticoats; Chapel Street blind dates, a common Freshman fault, became my most besetting sin.

At class prayer meetings the cause of student volunteer missionaries was often strongly presented and we were zealously urged to devote our lives to that cause; but in the words of my diary, I already knew

what God had meant me for, by the only and plainest means He gives us—our undeniable talents, natural tastes, and endowments.

The news from Alabama was sad enough that spring, and depressing. Money was extremely scarce, and I was flat broke. I began working in spare hours for a graduate student in experimental psychology, earning ten cents an hour summing up his "reaction charts."

Now after Sunday chapel I delighted to read in the library the history of evolution. I aspired to learn much concerning Darwin and his theory,

to be able to have and defend sensible views on such subjects. Ah, to think, to have the power of keen, acute reasoning—that means all in this world, and distinguishes a true man from the animal, and his own shallow companions—to reach for and find truth, regardless of prejudice, training, or belief, with faith in the consciousness that the open, unbiased mind thus seeking cannot offend the Deity or harm the soul: for God is truth.

Through long passages I would now argue with myself on religio-philosophical topics, seeking determinedly to reconcile my newly found knowledge with my old, incompatible beliefs.

And thus was the amateur philosopher bit by bit shedding the outgrown husk which had confined and warped his mental growth through the adolescent years. My diary reveals how one after the other the cherished tenets of my faith, the religious doctrines which had been ingrained within me, were reluctantly

surrendered, challenged by my rapidly growing realization of the significance of the scientific approach.

One May night came the traditional Omega Lambda Chi celebration on the old campus. I hurled myself into the maelstrom of Freshmen as they jam-packed through the "Pass of Thermopylae" between the chapel and Durfee Hall, where we were kicked, pushed, and slugged by Sophs, waiting on both sides to receive us. Being in the front rank, a great honor, I got a smash in the mouth; and the Sophs kept the Fence!

At last my underground trolley system came back. The Metropolitan Railway Company had withdrawn its generous prize offer. That was too bad. I now had to look about for something else to invent. So I figured on the practicability of a steam-saver boiler invention, uncertain whether it would work out or not. "If I only had money to build a model!"

And now I began to study telegraphy in Crittenden Library, with an intuitive hunch that I might have something to do in that field some day.

Examinations over, I began waiting on tables at the restaurant where I had been a boarder, thus earning my board.

Saturday before Commencement, I was delightfully surprised by the arrival of my father. And now at last we walked together under the old Yale elms, soul-satisfying delight which we two had anticipated for years. How I reveled in the long-anticipated joys of a Yale Commencement, the Class Day exercises on the campus, the Planting of the Ivy, the announcement of prizes at Sheff! I received Honorable Mention in chemistry! Father was much pleased. And then came the alumni class reunions, and the colorful parade to the Yale Field, where I saw my first Yale-Harvard baseball game.

As usual in those days Yale won the boat race, and at night I celebrated madly, as a Yale Freshman had a right to do. I helped meet the victorious crew at the depot at midnight, joined

in the triumphal procession behind their tallyho to the old New Haven House, where the crew were then banqueted until morning. I waited around, watched alumni knock out the electric lights with candles. There was no bonfire, so I got to bed at two.

Next day I moved to the house of Yale's senior Greek professor, "Goat" Seymour, where I was to occupy a small upper room, in exchange for which I was to mow and water the professor's lawn. Also I began to work daily in the psychological laboratory, aiding two postgraduate students there.

That summer I spent many nights in my little hall bedroom reading deeply in great tomes such as the translation of Kundt's *Philosophy*. My diary entries are full of embryonic philosophical observations and attempts at reasoning—regarding self-consciousness, the ego, predetermination, and free will, the end of the world, and what not.

But of more practical interest is the following:

Mrs. Seymour wants me to do all sorts of odd jobs around the house to pay my room rent, and now she wants me to take Charles off for a day Tuesday to Glen Island! I guess it's my duty to go. . . . Tuesday, with Charles Seymour, I sailed to Glen Island. Saw the zoo there. The trip cost me only sixty cents, but Mrs. Seymour didn't put up an elaborate lunch or let us have any money for candy. I bought Charles some cracker-jack and popcorn.

That little boy Charles, then in knee pants, is now the honored ex-president of Yale University. I was indeed delighted, on meeting him recently at a Yale dinner, to learn that he still remembered that early excursion we made together.

I read deeply in metaphysics.

I don't like it very well, but it's good mental discipline. It's altogether too theoretical, yet without any tangible theory. Too much of the thingness of the wherefore. The truths with which it deals must be discovered through other channels than mere logic and reasoning. They must be got at by experiment and observed facts wherever such is possible. The ways leading to them are too obscure, the paths too long and devious to be followed by the mind guide alone.

Perhaps I should have devoted those study hours exclusively to engineering studies, as I did during later vacations. But I was determined to broaden my education so far as was possible, consistent with the one fixed purpose I had ever before me.

Prompted doubtless by reflections on many wasted hours already alluded to, I find in the diary this solemn little sermon on that vital theme:

Let each day teach a lesson for life, that of economy of time. If there is a task to be done, it must not be delayed until afternoon. The morning wasted, bitterly will its hours be craved, but no tears or remorse avail to bring back one golden moment. Another day we may have, but when life's sun is set, no morning dawn for desperate work will come, our task undone, our one chance a failure.

If there is a good book to read, a deep truth to learn, let me do it now. Let me not delay or ignore it, for such a chance may not come again. Life is too short, too short for novels (unless a few best for sake of style), too short to neglect a single opportunity for attaining all possible knowledge of my life's work or a chance to develop my brain to think. Too short for *my* work, anyway.

My independence of thought, custom, and action was rapidly developing at this early period. My soul awakened in revolt against the straitened limitations that had so long fretted it. That first Yale year had begun my realistic education.

Thus in deep reading and self-argumentation passed the summer nights away. Through that Freshman vacation at Yale I became more of a philosopher than I have ever been since. And thus, one by one, were my childhood's firm religious beliefs altered or reluctantly discarded.

Those summer weeks were hard. I often rose at four o'clock in the morning and cut weeds and grass and then put in eight hours a day in the psychological laboratory.

This is too little of a vacation, and I intend to knock off a week before term opens. I am too tired at nights to study or think. I have studied over my steam condenser to little purpose.

And yet page after page of my subsequent diary entries are filled with involved metaphysical discussions, mingled with sensory observations.

Now began my Junior year at Sheff.* I moved from Professor Seymour's back to Freshman Row. First I called on Professor Hastings to show him my boiler-condenser device, to which I had devoted so much inventive thought. My idea was that by introducing the condensed exhaust steam from an engine back into the boiler, instead of the usual cold water, a worth-while economy could be effected. The professor produced the old classic thermodynamic formula $\frac{W}{E} = \frac{(T' - T)}{T'}$ and clung determinedly to that stronghold, petulantly refusing to examine, in any degree or particular, the details of my scheme. I was quite unable to get him to admit that if one could put steam at 100° C. instead of cold water into the boiler this would save fuel. Rather he proceeded in his well-known sarcastic and cynical manner "to condense my exhaust steam with the ice water of his learned contempt." Dumfounded, baffled, and mad, but totally unconvinced, I withdrew. This was the first, but by no means the last, misunderstanding between Professor Charles Hastings and myself! I rose buoyantly to the surface with increased faith in my machine and magnified contempt for the entirely theoretical man. Today methods akin to my old idea have been customary steam-engine practice for decades, Hastings to the contrary notwithstanding.

I was now deeply enmeshed in Sheff's mechanical engineering course, enjoying intensely such subjects as solid analytics, mechanics, and drafting. I won First Division in French, German, and English. This was an honor which entailed much more work on those subjects than I wished to give. It is incomprehensible why I was not made to understand the value of a thorough work-

* Sheffield at that time operated on a three-year plan, omitting the Sophomore year.

ing knowledge of French and German in any engineering profession.

And now, since I had the right to smoke a pipe on the streets, I resolved to become a full-fledged Yale Junior. I spent a quarter for the pipe, not to impress others with my importance, but to keep me company and unembarrassed, something in my hand when happily I walked Chapel Street alone. Locked up deliberately in my room, with a package of "Hearts and Flowers," the mildest smoking tobacco I could buy, I smoked furiously one night.

Got sick, got over it, and then studied French. . . . We are grinding at infinitesimal calculus now.

The only respite from hard work I knew that fall was when classmate Chapman and I boarded the *Richard Peck* for New York, where in a driving rainstorm the Yale football team, —Frank Hinkey, captain—rolled the Princetons through the mud to the tune of 24-0. Due to our hilarious night's celebration we missed the midnight boat back to New Haven. Sadly forlorn we retraced our weary way to the Grand Union Hotel, where both of us slept in one narrow bed for one dollar. We found ourselves too poor for breakfast, lived on a bunch of figs until our twenty-five-cent dinner that night, and then attended services in the Baptist Church to witness an immersion.

Then we found that the New Haven boat did not sail on Sunday nights; so back once more to the same accommodations at the Grand Union! Monday morning two mud-bespattered, woe-begone students might be seen on 42nd Street with pants rolled up high and muddy, rusty shoes, sadly munching five cents' worth of fresh figs for breakfast and reading a four-cent guide-book of New York. We spent most of that day in the Central Park Zoo, conferring appropriately with Johannah, the missing link. Her human antics well repaid our visit. So at last on Tuesday, tired out, I stumbled into my New Haven room, hav-

ing spent eight dollars and twenty-five cents and taken four cuts, out of an estimated five dollars and one cut.

Looking back over the events of that fall, my undernourishment, my excessive work, my late hours, my exposure to cold and wet during my skating excursions on Lake Whitney, I don't wonder that I found myself one morning a very sick Junior. Goodhearted Mrs. Goldsmith fed me and gave me hot flatirons to keep me warm. Following an awful night alone with chills and fever, Dr. Foster, the good college Hippocrates, drove me to the Yale Infirmary. They had a splendid table, and I was ravenously hungry. How I did eat! And all was free for me, poor boy. Fortunately I lost but one week out of school, and was happy when Professor Brush, dean of Sheff, came up to see me. It made me homesick to leave the Yale Infirmary. It was then a splendid homelike spot, not a bit like a hospital, a god-send to sick students.

Then began again my long walks down to Jackson's Restaurant on Crown Street for my ten-cent breakfasts of milk toast. Now I bought warm underclothes and gym wear, for I resolved to "practice health" and keep strong, to lay up vigor for an arduous life. I realized that I must have vitality and muscle for my life's work. "I hope never to be sick again until my death, in the ninth decade."(!)

Now my Division began shop visiting. While intensely interesting, this so tired me that I could scarcely stand, or go to supper after the session. But I note that I was still able to stand in line at the theater box office for the Yale Glee Club Concert, where the Freshman class "was expected to raise fifteen different kinds of hell in the upper gallery of the Hyperion."

I had written home my aspirations of becoming an editor of the new *Sheff Magazine* and was much downhearted to have my mother write me discouraging advice, saying that she thought I had no particular gift in that direction and that I'd better not spend my time thus. Undeterred, I continued to write.

I remember how wonderful seemed to me now the manner in which the calculus I was studying could solve intricate problems in geometry and physics. I found the subject hard, yet fascinating, and determined to become proficient in it. I greatly enjoyed also the study of the mechanisms of the steam engine. With such studies and writing assiduously for the magazine, I was pushed every working minute. I confessed to being at last a "greasy grind," a creature held in general contempt by all normal Yale undergrads, myself among them.

Notwithstanding which, or as a remedy, I borrowed a book of Poe's prose works, and forthwith fell in love with the splendor of his poetical style of expression. "My will grows strong with following my plans for conducting my full work, and I shun the crowds in the streets"—a marked advance over my Freshman year!

Weakened as I then was through my illness and subsequent malnutrition, I now found it, recurrently and strangely, hard to study so continuously, and to work out numerous difficult problems in calculus. "I go to sleep over it and am so stupid. Where is my Mt. Hermon brilliancy? My drafting instructor called me lazy, and justifiedly." Small wonder, as I look back now and consider the emaciated, undernourished, overworked student that I was during those first two years at Yale.

'95S* has formed a chapter of Sigma Xi at Yale, a high stand society for "sharks" and future notables in the embryo—not merely an aggregation of grinds, like Phi Beta Kappa. I'll belong to it. [I did—in 1927!]

I was offered an invitation to join one secret society, but my poverty compelled me to decline.

I now began reading in the library magazines about Nikola Tesla, the outstandingly brilliant young electrical genius whose spectacular demonstrations of high-tension, high-frequency currents had aroused extreme and widespread interest. I admired Tesla sincerely.

* Sheffield graduating class of 1895.

His works are the greatest excitors to zealous work and study. How I pray that I may equal and excel him, that all this belief in my genius is not idle vision and conceit.

This diary excerpt is indeed revealing of my mental state during the latter part of my Junior year at Yale.

It is interesting to note how my mind was developing during the latter years at Yale, together with a firmness of will, an ever-clearer vision of what was to be the chief aim in my education and the ultimate goal in the life to follow. The random oscillations of my compass became progressively less noticeable as the pointer sought more and more undeviatingly the direction of my star.

My diary now records weeks of unrelenting work, continued hard study, preparations for examinations, mingled with writing, rewriting, and condensing to the specified 5,000 words my prize-seeking essay on "Aerial Navigation," struggling desperately against the deadline of May 1st.

The weather was getting too nice to work indoors those lovely moonlit evenings, when balmy air and freshening trees, tinkling hurdy-gurdies, good companionship, Yale Fence, music of man and nature (and the charming beauty of women) called one away. I was glad to get work done early of an evening and to mingle with my classmates.

After a long silence Julia Winter finally wrote me, enclosing a *tract!* Presumably, she felt that I had grown too ungodly for a prospective husband. She wrote she "can't write me again."

I am glad that the Balm of Time has so healed my heart that I now care not at all. Ah, that it ever could come to this—I, who was so fervid! Well, such is Life! So at last we are "quits"! Draw the curtain over this one-sided love scene; write *Finis* to this early romance, mostly a sad one for me. The sequel can afford little of interest, for *I* am satisfied; now I feel free to look about me!

So, as consolation, I went to Bible Class and then to see the Sophs ('97S) kick the Freshmen's tails as they came out of

Old Chapel after electing their Fence orator—great fun that was. Ah, those lovely moonlit evenings on the Fence! The fragrant pipes, the comrades—though few, alas, for a Sheff man—the songs, the fun! Those budding trees, and spring of year and life, made Yale to me that word so full of tender sentiments, associations, memories—too sweet a chapter in life's history to last for long. How swiftly sped the luscious days, the few short weeks of springtime there at Yale. Even then I realized that my college days were to be the happiest, most carefree of my life.

Such hours of college days spent on Lake Whitney in boat or canoe, or over its ice in winter, frame some of my choicest memories. Her classic waters have long since been fenced and barred away from rowing athletes and romantic lovers. But I have seen the yellow moon climb lazily up behind East Rock, frosting all the landscape and marking with a golden finger a rippling path across the mirrored lake, filling youthful hearts with joy and delight and love, a vague and nameless longing.

How wildly and arson-mindedly did I join in the building and maintaining, despite the campus cops, of the gigantic bonfire on Omega Lambda Chi night—and, again, fascinated, watched the calcium-light parades of the Junior secret societies! From my Temple Street attic I heard afar the mellow songs of the Alpha Delta Phi's, to which my father had belonged, chanting throughout the long spring night; and far off across the campus beneath the elms, the mellow, heart-gripping notes of "Amici"!

But amid all this idyllic ending of that second year I still persisted in inventing, as proven by this amazing entry:

Tried to invent a telephone relay. [Eleven years later I succeeded.]

But I did not get the Yale Scientific Monthly Prize after all. My prayers, perhaps less fervent than those of the Bible Prize at Mt. Hermon, went again unanswered. I never knew why, probably because my subject, "Aerial Navigation," seemed too

novel for "old foggy Professor Dubois," the umpire who had to pass on the Prize Essays. But forty years later the editors of the *Yale Scientific Magazine* esteemed it as good enough to republish in its entirety.

That memorable June I saw for the first time the Yale-Harvard boat race at New London—a splendid spectacle—the harbor, the Thames, the flag-bedecked yachts, and the "pretty girls." Yale won every championship that year.

A long, unpleasant summer as a waiter in a Block Island, Rhode Island, summer-resort hotel netted thirty dollars with which to start the Senior year. As recompense, however, there intervened a delightful visit with my parents and a needed rest in the quiet Hoosatic Valley of Connecticut. There Father and I got well acquainted, at last as two adults. We had a good visit, taking long strolls together. We reminisced of Talladega, and at last could discuss "our days at Yale." To actually have, at last, a Yale son gave him boundless pride. That visit proved to be the last time I was to see my father alive.

Senior year at Sheff began auspiciously except that the *Youth's Companion* returned my prize-story manuscript—my last and only attempt at story writing and the last of a long series of zealous tries for awards, all of which had failed.

Classmate Harry Foster invited me to go canoeing one autumn afternoon. So I cut military lecture. The day was a perfect one of Indian summer; the rains had swelled the river, making it ideal for canoeing. We went up Lake Whitney and the narrow, tortuous channel that feeds it, past milldams where we portaged the canoe, up through rapids and shallows, along quiet canals, over smooth lakes and millponds, through lovely woodlands, beautiful though seared and leafless, under country bridges, by brown meads and old New England farmhouses. Everywhere we beheld charming views of country fields and orchards,

and in the distance loomed old Mt. Carmel, purple with haze in the waning sunlight.

I know of nothing that could have furnished more ideal, more nearly perfect enjoyment, than that twilight hour when we were floating down in the valley through shaded woods and fields rusty with the glow of sunset. And to crown it all, the thinnest crescent of the new moon beamed upon us, a golden bow above a russet field. The addition of the loveliest of earth's gifts, a sweetheart, would have made the hour one of absolute happiness. Never was I more entranced.

On January 26, 1896, I was startled and greatly troubled by a telegram. Of course that meant bad news. In it my sister Mary said: "Father hurt by falling, medical attention secured, will keep you informed." What could be the injury, what the outcome? Suspense was agonizing. Were the long years of peace and home happiness, of unbroken love and good fortune, to end before I could have a home for my dear ones, before they could see me make Talladega College great? For ten years I had prayed earnestly to God for that opportunity.

The following day my father died. A sudden dizziness had resulted in a fall from which he never regained consciousness. He died in the home he had built and loved so well, died in the harness in the midst of his labors, full of fond plans for more efforts and further charities.

A Man of God has gone to God; a heroic task of sacrificing labor, of hard, unstinting, noble labor is done. A sweet rest is granted to the great soul who asked it not. The only recompense he wished—continued health for further, harder labor in that small-yielding field he loved so well.

The family was deeply impressed by the expressions of anxiety and sympathy that his passing caused. The white people of Talladega were amazingly expressive of solicitude. At the memorial services held in the plain old college chapel their minister spoke most appreciatively of the grand man the town had lost.

Charles, from Mt. Hermon, and I met Mother and Sister accompanying Father's body to South Edmeston, New York. There we buried him in the old De Forest family lot, where many years later Mother's ashes were to rest beside her loved one.

The return journey was made sweet by recalling all the happy memories of the goodness, the love, the quaint habits, and the remembered things with which Father had, throughout all his life, so blessed us.

Now I had to economize more than ever. I continued boarding at Yale Commons, but only until open weather, when I resumed the attack on Jackson's hash-house, so as to save one dollar a week. I had obtained an Honor Appointment at Sheff, for which I had to maintain my marks up to Three and write an acceptable thesis (on the "Laval Steam Turbine") for graduation. Also I had taken a hard mathematical subject for the military thesis—all of which kept me too busy for futile hours of sadness.

The best plan seemed to be for Mother to take a New Haven house that summer, thus making a home for the three children. I was to continue in postgraduate study. Charles was to change from Mt. Hermon to a local high school, preparatory to entering Yale the following year; and Mary was to give private piano lessons. She had become a fine pianist, having attended Oberlin Music Academy after leaving Northfield. So I searched for a large rooming house for student rentals, finding one quite suitable, right on Freshman Row. We found that our dear father despite his overwhelming generosity to missions and two failing investments, had saved from his meager salary about \$6,000 as our little inheritance—much more than we expected.

The scientific world now was agog over Professor Roentgen's recent discovery of "cathode-ray photography." Roentgen's "X rays" had not then come into vogue. With all Yale science students I listened excitedly to Professor Arthur (Buffalo)

Wright's first lecture on that new marvel, whose terrific possibilities no one then had begun to grasp. That lecture, if further incentive had been necessary, clinched the fixed purpose within me to pursue postgraduate studies at Yale, despite all hell and high water. More and more I knew now that the boyish resolve, when thirteen years old, made over my Talladega drawing board, was indeed my true and guiding star.

The year's Sigma Xi elections, the second ones at Yale ('95 Sheff had founded the chapter) were announced in May. To my chagrin I was passed over. My low marks last term in Professor Nichol's dull course in Strains and Structures had kept me out, I suppose. I had thought surely my magazine work, which I knew to be excellent and original, plus my promise of future original achievements, my keen interest in science, etc., would pull me in. But the powers ordered otherwise.

I felt soured, naturally, and think fairly that I ought to have had it. They say that a few may be taken in later if they show exceptional merit. [Evidently some of us did, for thirty-three years later Yale called me back to hand me the Sigma Xi—just thirty-three years late!] I have about learned, however, to take disappointment very philosophically and nonchalantly. At any rate I shall show them some day what a mistake they made. I will honor them then, and not they me!

Thus I kept my vision firmly fixed on a definite future. I wrote: "Now is a critical point in the curve of my life, for I am about to seek, by correspondence, work with Nikola Tesla." This effort continued, futilely, for the next three years. By correspondence also I was doing my utmost to keep Mama hopeful and happy. "She is gradually responding, but it is hard work I know; poor dear Mother, soon to leave 'Ivy Place,' so charming, so loved. It will be hard."

The class appointed me to write for our Class Book the history of our Senior year. As a summation of that last, beloved year as a Yale undergraduate, I quote here the final paragraphs:

The brightest time of the year is over, Yale, the brightest of life for us, oppressed only by the sense that these careless, halcyon days will all soon end forever. We while away the sunny afternoons upon the soft grass of the Field, watching the practice of the nine, or in pleasant sails down the harbor when the breeze is right.

And in the still moonlight of the evening we congregate about the walks or sit upon the old Fence on the campus, to listen to the Glee Club singing; for we are making firm those friendships which are to last while life may last. And then we sing ourselves, songs of friendship, songs to Yale; and from our pipes sweet incense rises on the soft air of the night. Or there is Lake Whitney for dreams and boating, where we may float through idle hours in chosen groups of two or three, and chat and smoke and drift along.

Such are the reveries that these last days at Yale recall. For they will soon be but a memory. Their end is near, in the gay whirl of Commencement Week. There will yet be the merry scenes of the Class Supper and Class Day, when we smoke the Class Pipe and listen to the merry jibes about each other. There will be the jolly dance upon those floors made sacred by many an ink blotch and many a memory of a desperate flunk or gallant "rush"; there will be the more pretentious elegance of the Senior Prom in old Alumni Hall—the closing exercises, and then the separation—ties sundered that have been three years in forming.

Our days of preparation are over. They may have been inadequate, but we have *lived* these days, and the way in which we meet the rubs and buffetings of life will show how well. Yet be fortune what it may, you'll ever find true hearts in '96 who hold—deep-graven—love and loyalty for SHEFF and YALE.

Came Commencement. Our Class Day exercises in cap and gown seemed very impressive. The "histories" were pretty good—mine brought lots of laughter. We smoked our class pipes, and *The Class Pipe*. Afterwards we marched and cheered the Yale buildings and Prexy Dwight's house. We did the "Yale Dance" together for the last time.

These last days as a Yale man—how much they mean and will mean in later years! How my father would have relished these days as I graduated. I found the Class Statistics interesting—I am voted the Nerviest in the class, also the Homeliest!



CHAPTER 7

Graduate Years

AFTER that last Commencement, Mother, Sister, and I (Charles being at summer work at Mt. Hermon) ate the first meal in our new home, 387 Temple Street. It was a sad one for Mother.

Now I knew the dread of a long vacation without work. I searched New Haven and environs in vain. Alas, there were then no large electric companies, as today, scouting for bright engineering students, even before they graduated.

I spent my days inventing a chainless bicycle and writing to interest the Victor and Columbia Bicycle companies in it. In spare time I read books on electricity, theory, and practice; for I realized how little on the subject I had derived last year from Professor Hastings' Senior class in electricity, which I had taken as extra, in addition to my mechanical engineering course. Also I continued to stock my memory with beautiful selections from Tennyson and the poems of Poe.

All hopes for summer work waned with the weeks. I studied the more assiduously. When the Pope Company of Hartford sent final rejection of the bicycle gear invention, my bitter motto became: "Hope all things, expect nothing."

This invention was a hydraulic gear designed to replace the bicycle chain. It involved a coiled collapsible rubber tube and a squeezing roller which would force a stream of fluid through a similar arrangement inside the rear-wheel hub. Speed multiplication was afforded. I did not then recognize that the device was obviously inoperative, using such tube material as then existed. But in 1909 I built a small water pump involving this principle for use with my water-jet arc generator of undamped high-frequency currents.

Now, in September, 1896, began my first postgraduate year. The big fact was that I was to attend two of Professor J. Willard Gibbs's classes in Sloane Physics Laboratory. Gradually I withdrew into my shell for my year's steady grind, to spur my ambition and self-confidence, to feel more poised in my studies, and therefore happy. I accepted an assignment to review the French scientific journals for the "Journal Club" and applied myself to doing a good job of it. Even Professor Hastings complimented me!

During these postgraduate years I began to appreciate highly the outside and civic lecture courses available to Yale men. I remember especially one devoted to Tennyson's "Maud" which opened my eyes to the wealth of beauty and deep sentiment in that noble poem. I was profoundly influenced by that lecture.

That year was not all grind. One afternoon my friend Max Stires and I walked to the lake to see the regatta.

We are always together on these occasions. How choice are such companionships, the long walks along these beautiful New Haven streets. How sweet will be the recollection in future years of such walks and confidences between ourselves as Yale men. The air was bracing, the skies sunny; the bright rays of the sinking sun lit with gorgeous hues the multi-colored autumn leaves. They formed a glorious setting for old East Rock.

Such occasions for renewing my nearly spent Yale camaraderie and associations are now few for me. Already a sadness appropriate to an old grad comes over me when I recall this light of other days. I have had so

pitifully little of it, a Sheff man with but three years in my class, out of a Society, rooming at a distance from my companions, and by poverty debarred from so many of their outings and gatherings, games, theaters. How often as I turned down Grove Street after recitation, or left the campus for my distant room, have I felt a vague, half-recognized regret, a bitterness that I was thus alone, that others were not more cordial, better acquainted.

And now began my first graduate laboratory work, to determine the "temperature coefficient" of a standard Clark battery cell. I nearly blinded myself trying to balance a D'Arsonval galvanometer and finally used a capillary electrometer, which prevented threatened insanity. Soon I felt inspired to write:

The certain knowledge of one's limitations and errors in the exact sciences teaches him as certainly to doubt the seeming truth of other branches, where the proof of error is not so clear, and to inquire as carefully and as humbly into all trains of reasoning elsewhere. . . .

Thus early had I learned, through my laboratory work, a basic truth, missed by so many who are book-trained only.

Soon I was promoted, down into the Winchester Hall basement, making electric generator current-voltage curves. I thought it great fun, really getting into electrical engineering, learning something of utmost practical value for the work I would later follow. But what a pathetic excuse for a course in electrical engineering was that at Sheff in those days! In hard fact the course in civil engineering was the only one there endowed with an adequate plant. I envied those classmates, Barbour, Collens, and Adams, who could study at Columbia or Cornell.

About this time I began, on my own, a bit of independent reading that was to make a lasting impression. Nikola Tesla, native of Serbia, was during that epoch a spectacular outstanding genius, the inventor of three-phase-current power transmission, and the darling of New York society, moving austerely in an upper intellectual, self-created, sphere. His New York lab-

oratory was a fabulous domain into which all ambitious young electrical students aspired to enter and there remain. So now I began reading his remarkable book containing his three famous lectures on high-voltage, high-frequency electric current phenomena. This reading was undertaken primarily in preparation for my proposed visit to him seeking future employment. I found it intensely interesting, inspiring in me—as nothing else in my life had done—a burning ardor to follow into the wonderful realms he had blazed open in science, so pregnant with possibilities for the benefit of the race. There lies a task, I thought, studying the almost unknown forces and phenomena of nature and training them to man's service.

To read those chapters on the higher vibratory forms, the intimate connection between light energy and electricity, the delicate experiments made and to be made, to read of these fires me with ambition to emulate, to myself enter into that tenuous realm that is the connecting link between God and mind and lower matter. It would make a genius of any man whose soul is not of clay. [Here appears the first clear intimation of that fascinating line of research which was later to frame my life.]

I did little now but grind, cared for little else. I begrudged every call from my books and electricity.

I have so much to do if I keep up in lectures and reading that the very thought can drive me wild, sighing for the thirty-hour day, or abolition of beds! Two courses in differential equations, a little vector analysis and much thermodynamics, and Tesla's book occupy my afternoons. Saturday I completed the invention of the "equationer" for fourth-power equations. . . . I explained my Wheatstone bridge arrangement for solving roots to Professor Pierpont, and he was greatly tickled. He ordered a paper read before the Math Club next week; but for all this I didn't make Sigma Xi this year either.

But I made my debut before the Mathematics Club, with considerable credit.

During Senior year Stires and I had got out a lovely little "Prom Souvenir," of miniature photographs of many Yale buildings, frat houses, etc. The edition had sold out during Junior

Promenade Week, netting us a neat sum of money. So now, we decided to do a "Regatta Souvenir" for the following summer's regatta at Poughkeepsie. Work on that ill-starred venture took many precious hours from intensive study. Many a day we spent in New York, pounding the streets seeking advertisements.

During spring vacation I was confined to the house by a crippled toe. I used my time reading Poincaré's *Mathematics*, learning a lot I might not have learned otherwise. How often, I thought, are we directed through such mathematics to solutions that experiments later prove true and which would never be reached otherwise. Yet will mathematics ever lead us to an explanation or a theory of the final, or semifinal, nature of matter and force? I can't believe that any system we have now will do so. Something radically different must be invented.

But alas, how little of real practical knowledge as to the application of mathematics to engineering problems did I acquire at Yale! A thoroughgoing training in manipulation of mathematical equations I obtained, but almost no knowledge, or instruction, as to how to apply these keen tools to actual problems in physics and in engineering. As a result very much of the time I spent in higher mathematics in my last years at Yale was totally wasted. I have small use for the pure mathematician who disdains the practical applications of his science in this very practical world.

The professor from whom I derived most—both of theoretical and practical mathematics—was J. Willard Gibbs. At the close of my second year under Gibbs I could write in my diary:

My mathematical training this year I find already of the greatest practical value. Without such, and every bit of it, I could not read these books leading up to Maxwell. I want another year, still higher. Then I can expect to deal intelligently with light and wave phenomena, *along which lines I see lies the great future of electronic advance.**

* Though the italics belong to 1950, the words themselves were first written in 1898.

My impressions of this great mathematical genius have already been recorded in a letter which I wrote several years ago to his biographer, Muriel Rukeyser.

Even as a Senior at Sheffield, I had begun to absorb from my professors and instructors something of the admiration which these former students of Professor Gibbs had themselves derived. To study under Gibbs I saw was a noble ambition; to be able to pursue his courses, the final test of a man's mathematical acumen. There developed, therefore, an intense desire to follow their example, a determination to sit at the feet of Yale's Great Man.

Gibbs's formulas and methods of analysis were extremely condensed, designed for abbreviated short cuts in procedure, deceptively simple in appearance, but in physical application demanding a very special ability. His interpretations were always those of pure intellect, clear, concise, non-physical. His mind seemed infinitely discerning, intimately dealing with imaginaries. Often he would remark in that quiet peculiar voice, almost lost in his beard of sandy gray, "We shall pretend we know nothing about this solution from Nature." And with most of us this was more than pretense! It was an event when my notebook recorded any reference to a physical example, a piece of laboratory apparatus.

With long acquaintance I found him a kindly, human soul. When I required an additional course for my Doctorate he volunteered to give me his special course in Orbits. There, very solemnly for one hour each week, we sat facing each other while he discoursed on the paths of comet and asteroid. In that course at least I proudly led the class—I was his only pupil!

Through Professor Wright, Gibbs followed, by remote control, the progress of my Thesis work on Hertzian waves along wires. I still recall the eager pride I felt when the great teacher finally entered my basement laboratory, where I outlined to him the work I was there conducting.

I can fervently say that it was Willard Gibbs's influence and inspiration which so firmly resolved me to continue my postgraduate studies for the second, and finally the third, year, to master as fully as I might the theory of electromagnetic waves, thus thoroughly to prepare myself for that project of research and invention which I had determined should be my life's work.*

J. Willard Gibbs was a colossal mind, now recognized as the greatest man of science which America has produced. Unfortu-

* Muriel Rukeyser, *Willard Gibbs* (New York: Doubleday, Doran & Company, 1942), pp. 307-10.

nately, he did not undertake to instruct his pupils in practical methods for applying his system to such problems as they would encounter in commercial research laboratories. We could follow his researches and understand his theories, but that was all.

Though mathematicians and chemists are no longer as indifferent to Gibbs as they were in his lifetime, even today's college graduates seldom realize that he is not only the most eminent figure in American science but a figure placed by Boltzmann, himself a colossus in the history of physics, beside none other than Newton. In fact, Yale University, to which he devoted his academic life, did not realize where Gibbs stood in the modern world until two years before his death in 1903, and then only because he had been awarded the Royal Society medal.

Dr. Pupin in his excellent autobiography *Immigrant to Inventor*, pays ardent tribute to the characters of great scientists—"Saints of Science," he well names them. If ever there was a Saint of Science in America, J. Willard Gibbs was that one. Thanks to the deep inspiration I was deriving from Gibbs, I well knew that the leaders in electrical development would be those who pursued the higher theory of waves and oscillations and the *transmission by these means of intelligence and power*; so in that training I was already cutting loose and relying on the correctness of my one aim. Should I prove wrong I would be away behind my classmates and it would go hard with me for not knowing my engineering better; but I risked all on the cast of that die.

When summer vacation arrived, I was still aiming at work with Tesla. If I reached that goal, I would be a long way ahead. "But I shall not fail. I shall go on, cutting orthodox lines, toward my unique aim. The years will prove the soundness of my judgment." So I applied for a graduate Fellowship, or a renewal of the De Forest Yale Scholarship.

That month in his Houston Street New York laboratory I met Nikola Tesla for the first time. He became quite cordial and communicative. At once I formed great hopes of getting in within a year as his mathematical assistant. But, he confided, "I must turn first to commercial lines and retrieve my fast-spending fortune—then enlarge and take in some assistants."

Twenty years later almost to the day, I was delighted to receive this letter from Nikola Tesla:

May 28, 1917

*Dr. Lee de Forest,
1391 Sedgwick Ave.
New York, N.Y.*

DEAR DR. DE FOREST:

I have just received your kind letter of the 26th inst. and wish to thank you for your courtesy and appreciation.

Our meeting in 1896 is still in my memory and I am glad that my judgment of your abilities at that time was better than your own. You have done excellent, practical work since, which I have commended whenever an occasion presented itself.

Hoping that you are achieving commensurate success in your inventive efforts and enterprises, I remain

Yours sincerely,
(signed) N. TESLA

I bicycled to Meriden, looked there, elsewhere, everywhere, for a job, and meanwhile read German and electricity. I celebrated the Fourth of July by reading Oliver Lodge's *Modern View of Electricity*. Later I read Maxwell and Hertz (the latter in German); also the German Bible for practice. It was a most unhappy, discontented summer. "I have to fight despondency these days."

Finally, the Yale Observatory could use several keen-eyed young observers during summer nights, to observe and take note of meteors. Many a lonely tryst I kept after observatory work in the predawn beside Lake Whitney or in East Rock Park, then to steal home to attempt a prose poem of description.

One incident occurred that dreary summer, significant as influencing all my subsequent study and career. Frederick Reed, my former Professor in Latin and Greek at Talladega, paid us a brief visit in New Haven. He showed keen interest in my past work and future outlook. He it was who strongly urged the importance of my staying on at Yale to secure the Doctor's degree. He essentially convinced Mother of the wisdom of this step.

Discussing the "expanding universe" of my mind and its growing agnosticism, he advocated liberalism. Quoting Emerson, he declaimed: "Anchor in port grandly, or sail the seas with God." I have never ceased to remember this ennobling injunction.

My diary shows I was not wholly unemployed during this long summer.

I worked four days this week for the Gas Company for eight dollars, getting enormously tired and learning more about the sickly sores of this world's denizens. In what filth and inexpediencies most people live. I wonder that they live. Oh, who shall teach this sick and stupid world that subtle art of living, the most abstract of sciences? Few have learned it in these days. Large spaces and the weeding out of slums are imperative.

How much unhappiness does error bring, in every way! Mother, who was trained in the old and narrow path of blind belief and fabled myths, would keep me in the same ancestral way, and when I instinctively and almost unconsciously turn independently to the light I see, and would do what I feel best behooves me, and satisfies my inner life and gives me greatest good and leads to nearest truth, Mother is pained and bears it silently in her closet, in sorrow and anguish, of which I think I realize but little. And yet the fault is not with me, nor with her. I cannot always be following idols and sham. I must begin to be true to myself. How it grieves her! A curse on the old puritans, and the old puritanical narrowness that cannot see when it has exhausted its usefulness and become a stumbling block to progress. Must all instruments of advance prove drags and anchors in the end? Finding error and narrowness in the old methods, may we not be mindful that our own beliefs and methods must also be outgrown? One of the hardest ironies of Truth is that those who claim closest relationship must suffer from her because they cannot grant that another may approach her more closely by a different path.

In October of that year, 1897, I moved into my new room in West Divinity Hall, "Home of the Great Unwashed," happy at last to room in a college dormitory. Classmate Brunell, Medical School Junior, was my studious roommate. At last I felt really collegiate. But I continued to board at Mother's appetizing table, as I had since she settled in New Haven. Jackson's hash was now only an unpleasant memory.

About this time I was deeply inspired by a thrilling lecture with demonstrations given by Professor Harry Bumstead in North Sheffield Hall. I began to repeat some of Hertz's experiments in the basement laboratory, watching eagerly for any opportunity to make original investigations of my own. It was at once fascinating and drudgery.

I began working nights now in the laboratory with the Lecher parallel-wire resonator, a simple device for measuring the wave lengths and frequencies of high-frequency waves, a subject with which I was to become thoroughly acquainted somewhat later.

I was getting right along in my work and talking about a Ph.D. with Professor Gibbs. But one night when I was working with a battery in Winchester Hall during a Sheff lecture, the lantern lamp blew a fuse, and of course I was to blame. After waiting for some time in Egyptian darkness, the audience was dismissed by candlelight—and I was dismissed by daylight next morning!

This accident was the final climax. The vials of Hastings' wrath were outpoured upon my devoted head. Now *he* blew a fuse! Months before he had found some nails driven into the oak laboratory table in the basement of Winchester Hall, around which I had twined certain recalcitrant, stiff wires. Hastings went almost apoplectic with wrath at that time. He told me in effect that "a man who hadn't any better sense than to drive nails into a table would never amount to anything." He was then disgusted no end, past almost *his* exquisite ability in sar-

casm and opprobrium. But now the affair of the storage-battery fuse was just one too many. Out from Sheff I must get instanter, or even more quickly.

But good, young, friendly Assistant Professor Bumstead, believing even yet that there was some merit in the lad, quickly persuaded Professor "Buffalo" Wright to take me in at Sloane Physics Laboratory; and there happily I resumed my Lecher wire experiments. Bumstead and Wright decided that I might still try for a Ph.D., Hastings dissenting.

My unpleasantries with Professor Hastings impelled me to write this passage:

The fear of men and the hustle and clash of purposes is more unpleasant and wears away the life and mental strength more fiercely than does any other conflict. I hate such, and would a thousand times prefer the most difficult problem and the fight with natural forces. After such experience it seems the sweetest joy of life to closet myself with hard work in Science. May this be my lot in life, to live in a little artificial world, away from the crowd and its friction, surrounded by companions and tasks of my own choosing, thus to gain insight into the great world and the universe of Science; to battle always, yes, but with inanimate forces. They are kinder than man's opposition, for they are the ways and the thoughts of God.

Today, after our two great World Wars, the wild, popular enthusiasm for a quick war to free Cuba is hard to appreciate; but it was intense and genuine in 1898. When it was announced that the Senate had finally recognized Cuba's independence, an impromptu parade started on the Yale campus and continued about town. It grew to a big array.

The war spirit soon got a strong hold on me. The project of a Yale Light Artillery Battery was very tempting. I became convinced that army experience would be valuable to me. Father had valued his Army years very highly. I had fallen into a slough of listlessness, a lack of interest in the realities of life. Physically I was badly off. This campaign of constant out-of-doors life

should build me up, make me very much more of a man! It should broaden my perceptions and modes of thought. It should quicken my sense of moral responsibility, my relation to my fellow man and the world.

I was confident that the war could not outlast six months, that the blockade must give us Cuba within six weeks. The Philippines were already being freed by Admiral Dewey. Six months seemed the greatest possible limit. "It is the chance of a lifetime, the last chance in our lifetime to enter in our country's warfare."(!)

As for fear that this break in my course might thwart my ambition, dull my interest in science, or kill my ability for study, that was out of the question. "Such desires are ingrained into my deepest soul and will be removed only with the loss of my sanity or by my death."

The Yale Artillery Company, it seemed, could be but a platoon in the Connecticut Volunteer Militia Battery. That was a curtailment and disappointment to us all, but forty or fifty Yale patriots departed for the Niantic Camp.

A little late, I rushed off to Niantic to enlist in the Yale Battery. I aspired to be a bugler, which would be a "fat cinch"—a horse, two red stripes on pant legs, and no guard duty. My old cornet practice should serve me well now, I thought. The weather was horrible—rain every night, cold as blue hell, grass wet, and food cold. Arriving too late to get into the Yale Platoon, I had to hang around camp for a week awaiting an opening. I was impatient to shed my old civilian togs and don the blue of Uncle Sam.

We poor tardy "substitutes" were booted around and finally out of the camp. We slept two nights in a hotel and one in the straw of the mess house, eating crackers, at pie wagons, etc., as cheaply as thirty cents per day. We slept once in a horse stall in the straw, but were still determined to enlist, despite

hell and high water. All were at a loss as to when the Battery would be mustered in and when we would go south, if ever.

No one knows anything. This is slow, even for New England; no guns, no sabers, no horses, not even new tactics. Our "Superior Officers" are a lot of stolid, bullet-headed "Yankees," of German and Irish origin.

Weary weeks of drill and guard duty passed before I got that job of bugler.

Sloth characterizes the management of this Battery especially. Sloth here and at Washington. I did my full stint on guard duty, through interminable hours standing in the drenching rain outside of the Captain's tent, armed with my saber. Had he but known it, I was the worst enemy he had this side of Cuba.

On July 3d, Cervera's fleet was destroyed. Two naval battles and one land battle made up the war. It was now over; we had been bitterly disappointed not to leave Niantic. We were ordered to Porto Rico, but peace came before we could go. Now I hoped only for discharge in September. The thought of garrison duty anywhere in time of peace was hateful, especially when I considered my fast-growing age and the last opportunity for getting into the electrical rut again, never to leave it. That army life made me prize the chance to work in science even more highly. We came home on the 15th of September, delighted, happy.

Lucky indeed were we to have stayed in Niantic, not in any of the southern pestholes which, thanks to War Secretary Alger and his crowd of incompetents and politicians, were invariably selected as camps in which to pen our soldiers—there to overwork and underfeed them, with the poorest of medical care, to exhaust their vitality and enervate them until, when hardship and disease came, they should fall by hundreds; the rest returning emaciated, weak, an army of wrecks, to carry in their bodies for years awful marks of the nation's shame, the heathen indifference and cruelty of our War Department. Many more

men died in the national camps than on foreign soil from both disease and bullets.

I returned to New Haven happy to resume my studies, stouter and stronger, healthy and hearty. Because of those four and a half months of constant out-of-doors life, eating, living, and sleeping in the open, I never felt better. I needed this renewed reservoir of health for the desperately hard work that lay before me.

When mustered out, I had earned sixty dollars, no small item at that time. Then, too, I felt that I had served my country, in spirit if not in actual deed.

After the kind of life I had been living, it was not easy to get back into the routine of hard confining study. For ten days before the start of classes I locked myself in my room and studied determinedly eight to ten hours a day in a desperate attempt to make up for the time lost after my enlistment the previous spring.

I soon felt myself equipped for Professor Gibbs's profound lectures on the Electromagnetic Theory of Light. And again I was to listen for two hours a week to his solemn discourses on the Orbits of Comets and Asteroids.

I finally induced Professor Wright to launch me on my thesis work, and that rejoiced me no end. The subject of the research I had chosen was "Reflection of Hertzian Waves from the Ends of Parallel Wires," a problem suggested to me by Dr. Bumstead and one intensely fascinating to me. I felt then that, at last, I was in my life's groove.

Throughout the winter and spring, six days a week—each morning for four long hours—were spent in the cold, dark basement of Sloane Laboratory, peering into the little box containing my glow tube (the best detector for that purpose then known)

while I carefully slid the little wire bridges back and forth along the tightly stretched parallel wires of my long Lecher system to determine the loci thereon of nodes and antinodes, to measure the wave lengths of the ultrahigh-frequency oscillations, self-excited by my little Blondlot spark generator immersed in a shallow glass can of kerosene. I was seeking to determine, by observation and theory, the divergence between the actual and calculated final quarter-wave lengths of the Lecher system. I know of no subject which could have better served to introduce me into the vast realm of Hertzian waves, where I felt, even then, I should devote my life's activities. An immense amount of dull drudgery was involved, but I toiled on, deeply fascinated.

As my journal records, my time was not all given to study and "lab" work. For relaxation I read Poe, Huxley, and Ruskin. From Huxley I acquired a profound respect for the laboratory worker patiently delving in the mines of truth buried from the outer world. I concluded that beyond the laboratory one cannot go far aright. Ruskin impressed me deeply by his marvelous descriptions of Nature's beauties—descriptions of thrilling eloquence and power.

At last, after seven long months in the cold, black cellar, my lab work was done. Part of this had dealt with the Branley coherer. I found it a most erratic, undependable device. (I was even then convinced that the coherer formed a very weak element in Marconi's wireless telegraph system.) Dame Nature had long coquetted with me in that laboratory and sorely tried my patience. "I have had to snatch the secrets of science by the mane, as it were. None came willingly."

After my thesis was completed, naught remained but hard, unremitting grind for my exams. This meant prodigious tasks of cramming, climaxed by ninety hours of dreary, determined review—and then three soul-trying days that brought my student

days to an end. A letter from Graduate Dean Phillips assured me that I had earned the Doctorate for which I had striven so long and hard.

For needed and deserved relaxation now I saw Maude Adams in *Romeo and Juliet*—and became sadly morose all next day from pity for all unhappy lovers—unknowingly preparing myself for what was soon to transpire.

That June, two hundred '96 Sheffield men came back for our Triennial Reunion. That banquet was a hilariously happy occasion: the old Yale songs so lustily sung; the dashing New York Cavalry Band; "Ph.D., Ph.D.," yelled in unison by a little group of three—Charley Warren (later dean of Sheff), Holmes Jackson (later a distinguished New York physician), and Lee de Forest—engaging in a mad triple dance around the reunion floor. Then came the fireworks parade—burned hats, shirts, eyes, hands—the bonfire, kegs on Dwight Hall porch and in the bronze lap of old President Woolsey, more reunion bands, my bugle calls again, raids on the Senior dances, or "Germans," stone jugs sent crashing down the tile floor of the corridor of West Divinity, and finally bed for me at 4:30. Then up at nine, for the last Commencement: cap and gown, a dripping rain, and my second Yale diploma!

Finis had come for my life at Yale.

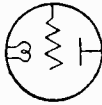

CHAPTER 8

First Love

*N*OW began a brief interval of emotional delirium such as I had never known before. I went west with Barbour on a "Christian Endeavor" excursion. After a day in Chicago with dear Cousin Nellie, I set off for Council Bluffs.

Here I am at last, back in my birthplace; and happy, oh, so happy! Jessie and Nettie Wallace are here, two of the dearest, choicest of God's girls. I think I am beginning to love again.

Old Deacon Wallace of the Council Bluffs Congregational Church, of which my father had been pastor twenty-three years before, had given me a cordial invitation to spend a few weeks with his family after leaving Yale and before I went out to win a job.

July 14th: And now there is no doubt about it. It grows day by day, and at night an overshadowing presence falls o'er my dreaming wanderings. One vague, omnipresent Jessie, the true, the gentle, the bewitching singer, Jessica. Words are powerless to attempt to describe the depth of the new-found joy that floods me when I look into those deep eloquent eyes and see there love that answers to my own. I cannot realize it yet,

it is so new, so strange, so unexpected; yet it is true. My fate is sealed, my love avowed, and sweet confession given in return.

At last the lonely heart had felt the beating of another in unison; at last there had entered into my life the sweet refining influence which it had so lacked and craved; now another ennobling stimulus was added to my ambition, "uplifting my ideals and leading me to truth." Low and clear and of indescribable sweetness was her voice as she stood and sang for me songs of trust and love—"Still as the Night" and "My Rosary." I knew she sang those songs for *me*, and the words were not only sweet and beautiful, but also full of deep and richest meaning. Together we took long walks and carriage rides. To Nettie and Jess I showed the riches of the sad melody of the prose and poetry of Poe. They too recognized the spell, vibrated to the music of his song. The wealth of maxim and ennobling breadth of Emerson found in their souls also answering chords as in my own. And many were the long and confidential talks we three had there together over a book, a memory, or some rich beauty of Nature.

One evening Jess and I took our lunch about five in the afternoon and went to the lake, took a little boat and rowed away and up a secluded creek or bayou, where we were all alone under the clear and rosy sky of the evening. There we moored our little craft, ate the lunch, and lay and watched the blush pale in the sky; the light blue deepened as the faint white stars dawned one by one. And then slowly a dim and misty glow spread like a vapor o'er the lake, the reeds, and all things. The full moon floated slowly above the eastern world, dimming again the pale stars and bathing the earth and the lake in an all unearthly glory. The faint notes of dance music far away stole over the waters and through the mists of light; and our hearts danced lightly in tune.

It was an hour never to be forgotten: for we were one and infinitely happy; the light of love in our eyes grew with the dawning light of the moon, as the orb of our love and our happiness ascended; and the light of other faces and of other eyes paled and grew dim at an infinite distance, as the light of the faraway stars. Heart to heart we lay, and marked not the lapse of time save by the beating of the pulse; in the music and the soft voices of the night we heard only the echoes of our own; in the light that wrapped us round and flooded us we saw only the love light of each other's eyes.

This then was IT! "Dear as love, *dear as first love* and wild with all regret!" Never again (such is the nature of man) was I to know, nor could I know, or feel so overwhelmingly, so completely, the intensity of love, its force and cruel joy, as was that of this first, supreme romance.

But now must I tear myself from Eden, and my loved one, and get to work.

Arrived in Chicago, I roomed in the home of my Aunt Hattie and Cousin Nellie, way out on the West Side of the city.

The day after my arrival I wrote a lilting poem, of which I quote only the last stanza:

*And through my heart without surcease
Shall ring forever and increase
Thy hymn of love's unmeasured peace,
My own Jessie!*

In Chicago the third place to which I applied, the Western Electric Company on Clinton Street, took me into their dynamo department. There I worked like a slave from seven in the morning to 5:15, with three quarters of an hour for lunch. I was learning a little, but not very much of use. There was too much chasing of parts and mopping of grease, and all for eight

dollars per week. I knew it was not all a Doctor of Philosophy might be worth in the proper place and was sometimes discouraged, always impatient. Were it not for the blessed strength and the joy and encouragement that came so often into my life from Jessie's letters and her love, it would have been unbearable. My room—with breakfast at 6:20—cost me only eight dollars a month, and so I hoped to save eight dollars a month at least. How long thus before I could buy my little girl the "ring"?

Fervent and frequent were now my letters to Council Bluffs, less ardent and sadly cooling became those to Chicago.

Sunday, September 3d: She wrote only once this week, and now I write her: "Steal away to me, my love, on two days of the week at least, steal away; and you shall steal away the cares and loneliness from a weary heart. Steal away, and you shall drive anxiety and misgiving from a brow grown dear to you; and you will add, yea manyfold, to another's life the hours, the pleasures, and the joy of life you steal thus from your own."

Such are passages from the first chapter of my first love romance.

Within one week what a change, complete, inscrutable, defying explanation, and torture to my heart. That last cruel letter came like a bolt from a clear sky; each cold and distant word stabbed me through and through, tore my heart in anguish. I borrowed ten dollars and immediately started for Council Bluffs. There was no other course for me. Inaction made my woe unbearable, and I struggled through long and bitter hours on the train, hurrying to a meeting that might have been so rich in joy.

It was a sad surprise, a sad, sad greeting. I had come five hundred miles to catch once more a glimpse of one dearer than all else, had come to tell her, as I could not write, the firm conviction that her true self slumbered; that her truest, deepest woman's nature was that which had loved me; that when again sight was clear and the visions of life's breadth and nobleness which she had seen with me had dawned she would turn again; that ideality and lofty ambition and pursuit of the beautiful in highest things would once again hold and frame her love. I had

Lee de Forest, Ph.D., Yale University, 1899, age 25. The subject of his doctoral thesis, "Reflection of Hertzian Waves from the Ends of Parallel Wires," pointed in the direction his later career was to follow.

The "Responder" (lower left). This is the instrument which de Forest took to New York in the summer of 1901 and used in his first attempt to report the International Yacht Races.

Another form of the "Responder" in use in 1902 (lower right)

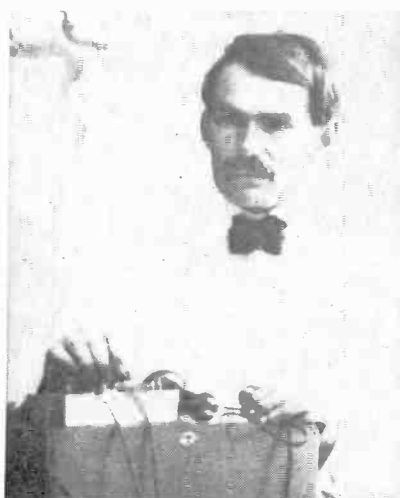
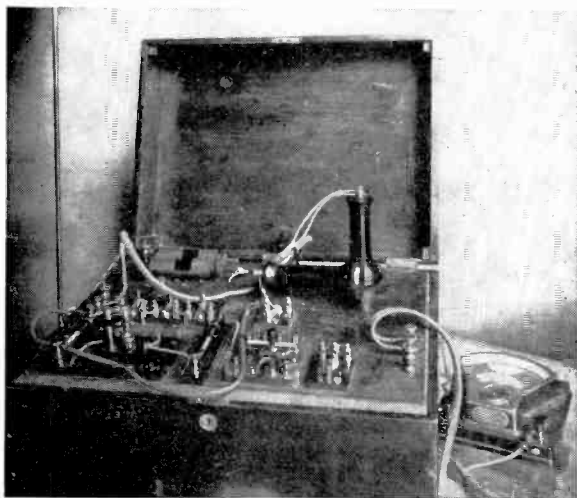
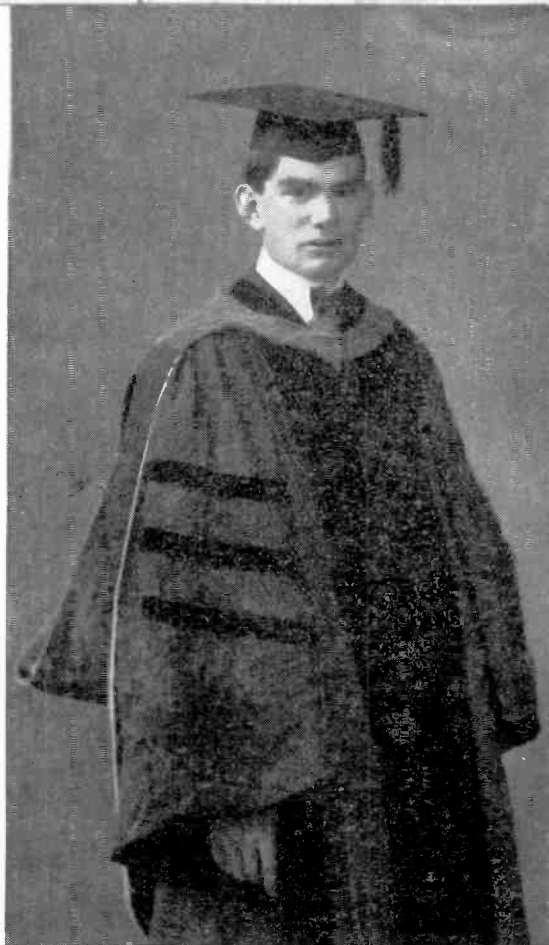

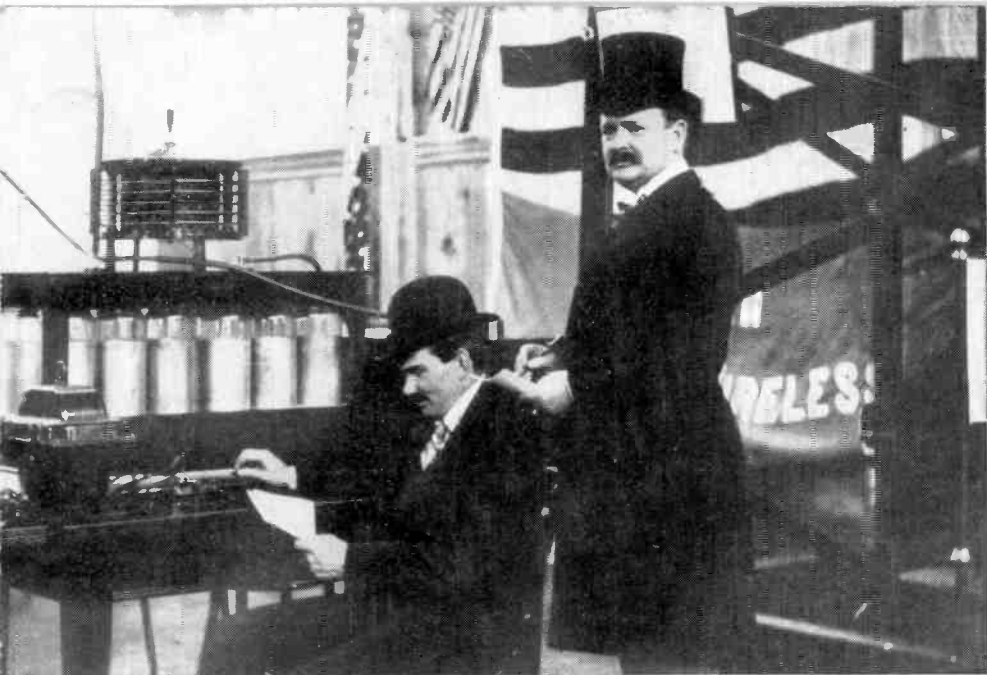

Lee de Forest and "Honest Abe" White at the transmitter in the De Forest Tower, St. Louis World's Exposition, 1904. Wireless communication between points as distant as St. Louis and Chicago was a novelty in those days.

The St. Louis World's Exposition was held in commemoration of the Louisiana Purchase. The De Forest wireless exhibit was one of the main attractions and received the Grand Prize and Gold Medal.

The first commercial wireless station on the Atlantic coast was erected near Cape Hatteras in 1902-3 by the American De Forest Wireless Telegraph Company.

Brown Brothers

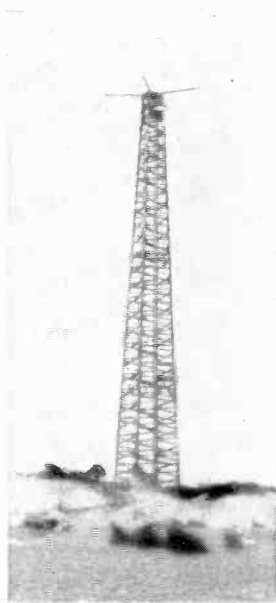

come to tell her that it was true love, the truest love we held together; that "we needs must love the highest when we see it!"

And so once more we stood upon the porch while the moon streamed softly through the sheltering leaves; stood again together by the railing where so short a time before I had given the first kiss, where her dear promise had been given. Now she said she knew not her heart, doubted if she had a heart. I told her the message I had brought so many miles, those cruel miles which alone had made unreal and meaningless the desires which had recently been her very life and happiness.

Next evening we drove together to the train, Jessie and I, as of old in the bright days of romance. And when we parted I kissed her once, as I had done at that happier parting one short month before.

Within my memory ever rests that last vision of my dear one, alone and in the twilight by the track, with my message in her hand—and was not indeed my vow and message in her heart?

In that hope I live and shall live only, till that hope be dead.

*There is a flower that blooms once only,
When faded dies forever;
A bird which startled ne'er returns to its nest;
A tide which ebbing never more flows;
A star, which, falling, gleams no more—
And my love.*

Upon my return to Chicago I applied to the head of the experimental laboratory at the Western Electric Company and was transferred to the seventh floor, to cleaner, lighter work in telephone cables, and given the hope of a speedy promotion to the telephone laboratory and to my cherished experimental work. This helped make life bearable. My heart was becoming hardened; and in study at night and plans for wireless telegraphy, etc., I found the time passing, though sadly, and at times despondently. The wait and the uncertainty were very hard to bear. The tender sympathy of Aunt Hattie and Nellie, and of Jessie's sister, was very dear to me.

I worked until nine o'clock some nights, and then took in the Castle Square Opera. It was well worth the cost, and I reveled in music as never before.

Music is opening to me a new world. All the high and the finer sentiments thrive with music, and one cannot go far wrong who lives in a bright and blithesome atmosphere of melody. Beauties that are unknown to thought, to words or eye, hover invisibly in the air and kindle soul through the avenue of sound. It is the dearest culture in all the world. There at least without a struggle we are carried upward and made nobler. Music is the thing on earth that's nearest Heaven.

October 15th: Again am I promoted—now to the Telephone Laboratory, goal of my hopes. Sargent is on a vacation, and I take his place, but hope to make it permanent. Here if ever can I invent and have the ideas count for something. I study blueprints and apparatus during spare moments, and at night read on telephony. And now at last can I be fascinated in my work and perhaps forget the recent pain of heart. Ah, the luxury of getting to work at 8:30! I can learn more here also, and am with refined and trained gentlemen.

Among my new associates were Ray Manson, now president of Stromberg-Carlson Radio Company, William Warren Dean, and Ed Smythe. Dean, handsome and light of heart, with heavy brown mustache and a sparkle in his eye, was a keen-minded, ingenious telephone expert and brilliant inventor, who soon became my ideal. A close friendship soon sprang up among us there, notably with Smythe, Dean, and myself. Many were the Rabelaisian stories Dean would recount to his assistants during lunch hour; and very much do I owe him for my familiarity with, and love of, grand opera, of which his knowledge seemed limitless.

I quickly became a fixture in the laboratory and enjoyed my work in telephone apparatus and circuits. Prophetically my diary records:

What finer task than to transfer the sound of a voice of song to one a thousand miles away. If I could do that tonight!

But this proved an ambition not to be easily realized. Fifteen years more of study and hard work had to elapse before the sound of voices could be transmitted a distance of two thousand miles. But in the telephone laboratory of Western Electric Company in 1899 I was making a first beginning.

Often I ate supper at the "ten cent," and went to the libraries and read until late. There was one free private library, the Crerar, cozy and with dark wood tables and shaded lamps, where the chairs just seemed to fit, and the atmosphere was a comforting one of quiet erudition and culture. And there I took great comfort in many books and periodicals, and in gazing at the old bookworms haunting the place. It was reviving to my ambition and desire for learning just to be there and to look through the shelves crowded with hosts of good and wise friends, all seeming to beg to be taken down in order to usher me into their delightful confidences.

And there now I began a serious systemized search through *Science Abstracts*, *Wiedemann's Annalen*, *Comptes Rendus*, and other physics journals, seeking to find some hint or suggestion that might possibly be a clue to the development of a new device which could be used as a detector for the receipt of wireless signals. Back in New Haven I had of course read of Oliver Lodge's work with Hertzian waves for signaling and of Marconi's early experiments, and I had actually built and experimented with the type of detector which Marconi had been using, a Branley coherer with tapping-back device and Morse inker. Marconi's method did not for a moment satisfy me. Obviously it was too slow and complicated. What wireless telegraphy required was a *self-restoring* detector which would permit the operator to hear in the headphones the sound, as it were, of the transmitter spark.

Finally, in the April, 1899, number of *Wiedemann's Annalen*, in an article by Aschkinass I found a brief description of a phe-

nomenon newly discovered which promised the solution I was after. Aschkinass there described his use of a thin piece of tin foil laid upon a plate of glass and cut in two with a razor. When a battery was connected across the terminals and a drop of water or alcohol placed over the gap he could hear in a telephone receiver in the circuit a weak ripping sound when a spark generator excited electric waves in the vicinity. The device was an anti- or de-cohering one, self-restoring. But the action observed was erratic and undependable.

My Chicago laboratory notebook contains many pages of descriptions of the experiments carried on by Aschkinass, and similar experiments by Neugschwender, conducted with characteristic German thoroughness. Here then was what I needed for a start, and I promptly began to duplicate Neugschwender's experiments in a small corner in the Western Electric laboratory, devoting much of my spare noon hour and a half hour or more at night before the doors were locked. Dean and Smythe began to take a casual interest in what I was doing, although neither knew anything about wireless telegraphy experimentation or Hertzian waves at that time. Nor did they share my enthusiastic belief as to the enormous developments in electrical science which awaited further perfection of the crude transmitting and receiving apparatus then in use in Europe.

Reluctantly and halfheartedly I continued to devote the working hours in the laboratory to my assigned tasks. But most of my leisure time was given to experimentation and study.

Not all, however. For Christmas I received from home a complete volume of Tennyson's *Poems*, a fine edition.

I shall enjoy to the utmost searching among that mine of jewels, renewing acquaintance with many precious thoughts, reawakening the echoes of many melodies heard before but forgotten. I need this inspiration now more than ever; for the engrossing work and the rush of the crowds dull the sentiments and the finer life, and muffle the notes of song—here far more than at college. And so, while the week nights must be diligently

given to science and my work, one evening I owe to music. The Sundays I must give to the poets and philosophers, to the deep and true thoughts. For I must cherish zealously the highest beauty, poetry, and romance. In my education itself there has been little of literature, art, essay—far too little. But at last by reading and natural sympathies some part of this soul has been awakened and stimulated to a great craving, and a little of inborn talent found. All the finest and the noblest of my character have grown from this, and the thoughts that science has bred of God and Nature have been deepened and made beautiful, clothed with finer forms by this other side of education—culture. I am pitifully in need of more. What paltry stock have most young men, and how cheaply rated! In this at least I can be above the average, and of finer strings. Emerson recognized the danger in a life of sheer fact, as now threatens me.

December 31, 1899: The new century is starting out well, for yesterday I was notified of my first raise, ten dollars a week, \$520 a year. Think of it! Ah, I shall begin to live indeed, buy a pair of new socks, a phonograph and an automobile at once, and move into a steam-heated flat before next winter. Never again shall I endure the discomfort of a stove, nor wear the same collar longer than three days. The prospect is wildly entrancing. I can have my shoes now shined twice a week, and take the streetcar oftener.

Through the dull unsuited drudgery of my work, fretted by the miserable commonplaces of these surroundings, I have endured many a bitter day and found my mind ruefully absent from study and work, when I should have done better and fought harder. I think the worst is over now, and I may begin to make myself forget. "Drink to forget," drink music and science and the deep ennobling thoughts of Emerson and great men, and realize the worth of the best, the real things that I should live for, realize the nobility of my calling and the grand field I am to work in.

That winter I wrote a reproachful farewell letter to Jessie, the one I had first called "my sweetheart." Therein was expressed with all the exuberance of my overwrought imagination a love that was compounded as much of poetry as of heartfelt passion.

I found and loved a heart of tenderest sympathies, a soul of finest strings, and destined for great and noble things. I loved a friend, a comrade true, above all else true and constant. Perhaps 'tis some fond illusion of the mind, the deep nature of the fine ideals that I saw in the

winsome songbird; perhaps, springing quickly because they had no depth, the higher aims have withered away. And this rare portrait—with the eyes of heavenly tenderness, fairly radiant with fine soul and the *spirituelle*—which hallows my wall is merely a mythical divinity that lived, alas, only in some artist's inspiration. Then I mourn the sweet creature that I knew—dead, and my heart her grave.

Was not that a companionship worth the keeping? Will you find offered many such? I think not, Jessie; and would you spurn it thus?

The nature I knew did live, no artist's dream, and it will triumph in the end. For above all the sound there is the music that can never die; and in the brightness of a new morning, when love may be a grown-up God, you will see again that land which is very far off.

You do not believe this now, but you shall. For "we needs must love the highest when we see it." That self *is* best and those ideals *are* true. It is but a poor voice speaking, and there be many nearer that are calling you away, and have called you away; and I cannot hope that you will hear my words—now. But the gleam is not false, nor the music out of tune, though lights still fail and chords cease throbbing.

Can you believe me writing this, not hastily, not unkindly, but for your own sake, Jessie, in the hope that some day it will help you hear the truth that calls you to a higher plane? Through life I will be always,

Your Truest Friend

Experiments on my new wireless "Responder," as I then called my first detector, began to occupy more and more of my time. My work on telephone tests and devices was never brilliant, for my thoughts were ever elsewhere. Dean became progressively more impatient with my work, yet was too considerate to fire me. He saw little of merit or promise in the experiments I was wrapped up in. Certainly he foresaw no possibility that the great Western Electric Company would *ever* become interested in wireless communication!

One day he exclaimed: "Look here, de Forest, you'll never make a telephone engineer. As far as I'm concerned you can go to hell in your own way. Do as you damn please!" With typical recklessness I took him at his word, turned to my little corner where I had my spark-gap and Responder parts, and thereafter spent eight hours a day at my own delectable task,

totally oblivious of the telephone work going on about me, and for which I was being paid.

Following the original German idea (which was obviously impractical as a wireless detector), I sought to overcome a pernicious tendency of my Responder to stop responding after a few seconds', or minutes', operation. This was due to the fact that the fluid across the gap soon became electrically decomposed by the passage of the tiny currents. I began the search for other electrodes and decohering fluids. I tried everything. The difficulty itself fascinated, tantalized me. Obviously wireless was still very much in a laboratory stage. The fact that as yet no one in particular, except Marconi and one Professor Slaby, wanted to communicate without wires made it all the more interesting and gave me courage to continue as an American pioneer.

Ed Smythe now proved himself to be a practical, modern, electrically minded engineer. He was swift to grasp the significance of my experiments, watched my work with interest, discussed the problems with me, and occasionally contributed helpful practical criticism and advice.



CHAPTER 9

Beginning Wireless

NOT satisfied with my situation at Western Electric, I began to look for a connection with more opportunities for recognition. A letter was written to Professor Johnson of Milwaukee, wealthy owner of the Johnson Pneumatic Heat-Control System and president of the newly organized American Wireless Telegraph Company. In this letter I outlined my preparation at Yale, my experience, and my ambitions. Soon afterwards, Professor Johnson came to Chicago and interviewed me in the upper offices of the Western Electric Company. After catechizing me closely, he finally asked if I would come with him, and at what wages. I gulped twice, screwed up my courage, and hesitatingly suggested fifteen dollars a week. My proposition was at once accepted, for unquestionably he came expecting to offer twice that sum if necessary.

So now in joyous excitement I chronicled:

Milwaukee, April 8, 1900: At last, at last, after long planning and plotting, years of study, and weeks of patient, weary waiting, I have the opportunity offered for the work that I have chosen, experimental work in wireless telegraphy. On the lake first, then with the navy, then navies, for-

eign travel, scientific investigations, success! Such are the prospects, and I think it rests largely with me how completely they are fulfilled. And I shall not be lethargic nor blind nor indifferent to the chances. I have worked hard toward this end and I shall not waste in time nor application. It will be my life's work if I can keep it so—wireless transmission!

It is the opportunity of a lifetime to enter first at the start in a scientific art all new, all to be developed, of a boundless, ever-widening, ever-enriching future.

I found Professor Johnson and his assistant, Fournier, working on a perfectly impractical system of wireless reception, employing a coherer which used iron filings (of all possible materials!) which were to be decohered by frequent little puffs of air blown up through the chamber from a pump driven by a clock mechanism or motor.

My diary says almost nothing of my experiments with this contraption, but details at great length the natural beauties which I witnessed from the lofty point beside Lake Michigan on which the wireless telegraph station was planted. My task there was to attempt to receive signals transmitted from the sending station (a large induction-coil, spark-gap transmitter) located at the Johnson factory in the heart of Milwaukee. Results were consistently discouraging, due to the fundamentally bad design of the Johnson coherer and the pneumatically operated relay. Throughout his so-called "system," the professor had attempted to utilize the pneumatic-control method which had proved so successful in his automatic heat-control thermostats, known the nation over. But here in wireless his consistency was his undoing.

After a few weeks of this waiting, none too patiently, hour by hour, for the signals to come through, I arrived at the conclusion that my poor estimate of Johnson's idea was scientifically sound, and that to continue to work with it would be for me a waste of time. Johnson had given me as assistant a little German, Lyman by name, who perhaps knew something about plumbing, but absolutely nothing about electricity. Becoming disgusted

finally with the Johnson-Fournier "non-receiving set," as I called it, I waited until such time as Lyman should be out of the way, then brought out my little Chicago "Responder" and a telephone receiver. Within an hour I was steadily receiving signals from Johnson's plop-plop transmitter. It was not long, however, before the returned Lyman, slyly watching over my shoulder, formed a fairly clear opinion as to what I was doing.

At the end of three months the professor had still made no progress with his work. I knew the experiments could not last indefinitely, that it was only a question of time before he tired of spending money. Lyman, sensing that his job too would shortly end, besought me to give my Responder to the professor, strictly "for the benefit of the company." He duly informed "Professor" of the Responder and of its comparative success in preliminary tests. Next day I was called on the carpet and ordered to divulge my invention. By this time, however, I had come to know the professor too well to consent under any circumstances to give him the benefits of my Chicago work and invention. He was frankly furious. "Are you going to be a fool and refuse to permit us the benefit of your knowledge?"

"It is not a matter of knowledge," I replied, "it is my invention. I do not yet know what practical possibilities it possesses. But I believe in it; I will not let it go into the hands of any company until that company is my own."

Professor Johnson's fury reminded me somewhat of that of Professor Hastings' three years previously. But on this occasion I was more defiant. Unabashed and little caring, I accepted my congé, visited the pay window, packed my few belongings, and took the night boat back to Chicago—but not without many happy memories of the days and evenings which I had spent by the lake, and with several prose poems which I had confided to the pages of my diary, such as the following fragment written with an uncanny prescience of what my future held. It

came to me one day when I sat in sadness by the lake and watched the flotsam being washed upon the shore:

WRECKAGE

The flotsam of our foundered happiness, the wreck of hopes—these do live for a surprising period; and it is a long, long calm in which they disappear. When we feel that they at last have sunk from life's horizon, and with our heart's load weighted, have been drowned for aye, how small the turmoil, how weak the adverse breeze, that stirs again those waters into turbidness and silt! And then our wreckage floats, and we see again the broken pattern of our poor hopes' hulk. Did we once dream to sail in that? Aha! It is a safer and a finer craft we pilot now; and in calm, or with a seaward breeze, we yet shall anchor in that other port, where wreckage is unknown.

Without much delay, after reaching Chicago, I secured a position as assistant editor on the staff of the *Western Electrician*, chiefly because of my ability to translate from many interesting electrical papers which had just been presented at the International Exposition in Paris. My salary again became ten dollars a week. I took a small bedroom on Washington Boulevard, not far from where Ed Smythe and his brother Will were rooming. And there every night that was not spent in the library was devoted to research and experiment on our wireless receiver. A small notebook describes minutely our various experiments and theoretical observations during that period.

Smythe was then a "comparatively rich" man, his salary being thirty dollars per week. Naturally our budget for experimental work was greatly limited, but a few simple little gadgets and contrivances were designed and rigged up for us by a complacent mechanic. It is remarkable how many experiments in the line along which we were engaged could be carried out at almost no cost for equipment. Some of the arrangements used to avoid the Responder's perverse inclination to clog show no little ingenuity.

Here is an entry in my notebook, in Smythe's handwriting, highly significant historically:

On the evening of September 19th, 1900, experiments were made to determine the manner in which the operation of the induction coil affects the light given off from a Welsbach burner, a phenomenon which had been first observed by de Forest on the evening of September 10th. By adjusting the flow of air and gas a condition was at last obtained where the light responded readily to the influence of the coil spark. This was when the flow was so adjusted that the mantle was slightly less than its maximum brilliancy and when portions of it were at what appeared to be red heat. When the coil was operated, such portions would immediately become heated to whiteness. The increase in the brilliancy of the light seemed to amount to several candle power. The light appeared to respond very quickly to making and breaking of the induction-coil circuit. If anything, the response to the making was a little quicker than to the breaking of the circuit.

The coil was some twelve to fifteen feet distant from the light. The spark gap was $\frac{1}{8}$ inch long. Current was supplied by two cells of storage battery, the interrupter of the hammer type. The Welsbach gas burner was about six feet from the floor. A gas pipe connecting to the burner probably ran down inside the wall. To eliminate any possible ultraviolet rays, a tin box was held between the burner and the spark gap, about one inch from the latter. No noticeable difference in the action on the matter was observed. [We thereby eliminated the effect of ultraviolet light but did not consider any possible effect that sound waves might have upon the flame—stupidly enough, but very fortunately.]

A possible explanation of this phenomenon seems to be the expansion of the cylindrical body of heated and highly sensitive gases within and about the mantle, this latter serving merely as a holder to keep the gases spread out in their most sensitive positions. The electrification of these gases by passage of a Hertzian wave may cause expansion and force the heated gases down upon the cooler and dark portions of the mantle, as we noticed to be the case.

Thus we theorized, and thus the startling idea became firmly fixed in my mind that I had here discovered a radically new and surprising influence of electromagnetic waves upon heated gases and/or incandescent particles. I was profoundly elated by this discovery and determined that as soon as opportunity offered I

would further investigate the phenomenon, and eventually apply it as a radically novel detector of Hertzian waves.

In the meantime I continued faithfully my experiments with the anti-coherer Responder, testing different materials and different sizes for our electrodes, as well as different solutions and various applied voltages. We tried inserting moistened silk and blotting paper wet with India ink, etc., in the narrow gap between the electrodes.

Soon I decided that I must give more time to my experimental work, and so arranged to divide my days between editing for the *Western Electrician* (at half pay) and experimenting in the laboratory of Armour Institute. Smythe agreed to contribute five dollars a week out of his own pay to enable me to carry on. Shortly thereafter he and his brother moved with me into two small rooms which we occupied together in "Armour Flats." A teaching job of two nights a week at Lewis Institute added something to my paltry income.

Ed Smythe loved music as much as I, and had greater familiarity with it; so we decided, come what may, to devote Saturday night each week to opera down at the Studebaker.

And what words may attempt the witness of the magic spell, most radiantly glowing, which stole possession of my spirit through that miracle of music, the Vorspiel of Wagner's *Lohengrin*. From the quiver of the first faint high-born notes of ecstasy, through growing fullness to the grandeur of the Grail's apotheosis, faint and dim, and dying far away, to the last glimpse of fading glory of the heavenly vision—one fine sweet strain of inexpressible beauty, a swaying river of mingled light and melody flowed serenely through an angel realm.

Never shall I forget the immeasurable debt, for deepest inspiration, for moments richest in spiritual ecstasy that I have ever known, which I owe to Wagner's music.

Professor Clarence Freeman at Armour Institute consented to allow me the run of the laboratory, in recompense for which I

agreed to take care of the apparatus therein and to assist—in a small way—the students in their laboratory work.

There in November Smythe and I again tried out the gas flame's response to the spark from the high-voltage coil. The expected effect was very marked. But, alas, when the coil was placed in another room and the intervening wooden door closed, the response of the gas burner ceased entirely, proving conclusively that *sound waves and not electromagnetic waves were the cause of the strange phenomenon*. I had discovered simply a novel form of "sensitive flame"!

But that exciting illusion had persisted in my mind so long and I had cogitated so intently in seeking some explanation for the supposed effect of Hertzian waves on incandescent gases that, notwithstanding this shocking disappointment, *I remained convinced that the supposed action and effect did nevertheless exist*. And, given opportunity, I was determined to prove it. I find this significant though illogical remark in my laboratory notebook of that time:

"Several have mentioned the weak acoustic action of a coherer; from analogy then might I not expect an electromagnetic action lurking somewhere in the sensitive flame, since that responds so to acoustic vibration?" *I was convinced that this action existed, and firmly resolved to find it when opportunity offered.*

Through the fall and winter months of that year my notebooks are crowded with details of an infinite number of experiments seeking to improve my electrolytic Responder, all carried on in the spacious laboratories of Armour Institute. As electrolyte I tried everything imaginable, from dilute ammonia to Woodbury's Facial Cream (!), singly and in combination, and with various fabric bodies. Tin electrodes I finally found the best, between which I inserted thin pastes compounded of lycodium powder or lead peroxide. Sometimes the Responder would re-

main sensitive for hours, even days at a time, before suddenly clogging. It was damnably tantalizing.

In August, 1900, Smythe and I applied for our *first patent*, directed to the various improvements we had then in mind, and aimed at distinguishing our invention from the Aschkinass disclosure. We made our claim as broad as possible within the limits of what we considered practical and patentable. Of necessity, Smythe became my financier.

It was not long after beginning my work at Armour Institute that I found my experiments so engrossing—and so confining—as to make it appear impractical for me to continue working even half time for the *Western Electrician*. So once more I “crossed the Rubicon,” burned my bridges, and with only the income of five dollars received from Lewis Institute for my night classes and an equal amount advanced by Smythe, I determined to continue my life as an inventor.

December 23, 1900: And now what of myself and my state; what do I accomplish through these days; my performance what? Twice have I renounced good and fairly promising positions for my faith in an idea and in myself. Risks have they been, and serious, for I am aging in years and will soon be twenty-eight. Money I have none, influence none, acquaintance none. In industry, diligence, I am not lacking, nor have lacked for many years. Of a capital of the surest and the type most inseparably my own, a fine, thorough, well-directed, carefully pursued education for the work, I am most certain. Courage I have, while optimism has ever been a cardinal characteristic of my youth. Why then should I not take the risk and boldly strike, though I start into a cold world without steed and small pence, for a lofty mark?

All is not as it could be desired, even now. I am often intruded upon. One whole day a week at least I must turn from my task to render pay for my tuition privileges. Never can experiment go in full swing forward as it should, for lack of instruments properly built, and when needed. I labor to make staunch a ship when by hard efforts I can gain a little on the leaks, which should be plugged firsthand. And time is short and Marconi sails fine and weatherworthy boats, and these boats are already

headed toward America. Yet I alone seem to realize that if our craft cannot meet him next spring, it might as well sink now. And if it sink, I sink deeply with it.

Every night during that long winter I studied until 11:30. This was the time of year when I always felt in a hard-working spirit, thoroughly attained in my years at Yale. And therein lay my deepest satisfaction with myself and my life, my lasting happiness built on something of worth, something I could really call my own. I saw more and more clearly the nobility of a life devoted to scientific achievement, to learning somewhat concerning this boundless miracle in which we live, and to extending a little the bounds of our knowledge; a life productive of something attained only by long and patient research, of something that would add to human welfare and progress. "The scientist," I wrote, "who can learn of Nature's secrets, and lessen the fierceness of human life, has the highest of callings. He is the pioneer, the most potent factor of civilization, and should therefore be, in the pursuit of his life's work, most truly happy. . . . My conscience is sore for time and opportunity lost, and my deepest pain is for my ill-preparedness and inefficiency. I am working hard to remedy these defects so far now as I may, and I shall always, if happy, lead a life of such hard study."

I was now building a reversing relay for the Responder, and not being an expert machinist I met delays and failures. Occasionally Allan Somner, expert mechanic for the Institute, would help me. I was very happy in this work despite impatience and fears, for it was all my own and for myself, and great hopes grew with each completed part. It would indeed have been hard for me to drop it and to go back to some task in a great shop or under any employer, where I might lack deep interest in the work. I had become spoiled!

What can life be without a keen and personal interest in the work of life? How fortunate the few whose work is their life, who come from the day's toil regretfully, to continue in other lines the same engaging study for the night, who can anticipate the morrow bravely, hopefully. Let that work be ennobling, that study broadening to the mind's horizon, *the hope and outcome utility to man*—and what of truer joy has life to offer?

I was becoming impatient to get my wheel into shape and speed away into the outskirts far from a noisy, dusty city, to get close to Nature's heart once more. But in the Armour laboratory I had a glimpse into the closer workings of some of her manifold wonders. Through the microscope I examined the action of our Responder, and a most fascinating insight it proved. Minutest particles, all but invisible, were seen torn off from the metal electrodes under the stress of that wondrous electric force and, floating in the fluid there, move across to the other electrode. Tiny ferryboats they were, each laden with its little electric charge, unloading their etheric cargo at the opposite electrode and retracing their journeyings or, caught by a cohesive force, building up little bridges, or trees with branches of quaint and beautiful patterns.

By pontoon bridges thus established, the current passed until the Hertzian waves arrived. Then all was commotion and change. Tiny bubbles of hydrogen appeared among the particles and, enlarging slowly or suddenly, broke or burst apart the bridges, while the click in the telephone told the ear that the eye beheld the rupture of the current's flow. But these little pontoon ferrymen instantly reformed to build new conducting paths. And so the process continued, the local currents re-establishing, the ether waves breaking up its highways of passage, with furious bubblings and agitations, a veritable tempest in a microscopic teapot. By such observations the actual explanation of my Responder's action became clear.

By May, experiments on the Responder became exceedingly encouraging, and I was happy. Very pleasant seemed the promised rewards of the unceasing toil, the unstinted self-denial, the forlorn hope, so patiently pursued. And it was nearly time; "the clothes are nearly tattered, the shoes run down, the meal ticket punched out. A few weeks more and the goal is mine—or lost. Let me not enthuse too early. Not yet have I laid my waking hands upon the castle of my dreams, not yet."

Until now my transmission tests had been confined to one room in the laboratory of the second floor of Armour Institute. But now I set my table out in the long hall and moved a large Ruhmkorff coil, battery, and string-manipulated key farther and farther down the hall, finally to its limit. As signals were still received at that "great distance," we decided on outdoor trials. My first transmitting antenna consisted of five wooden barrel hoops fifteen feet apart, with six strands of lamp cord stapled to the outside of the hoops, making a "bird-cage" antenna—perhaps the first one of this type ever constructed. This strange-appearing device Smythe and I hoisted to the top of the Armour Institute flagpole, and moved the transmitter up to the window in the upper floor. The spark-gap terminals were connected to the antenna lead, and to the steam pipes for ground. The Institute possessed a Wehnelt interrupter, and I chose to use that in place of the slow hammer interrupter, as affording an easily read signal in my telephone receiver. This latter was an ordinary hand telephone receiver, not of the headphone type.

It was not until July that we made our "long-range" tests. The first, though shortest, meant the most of all, for that decided whether our invention was good or whether the months of toil, of discouragement, of doubt, and anxious hope had been all in vain, other treasure sunk in the vast of Lost Endeavor. So as

I stood in the rain on the top of the Lakota Hotel, a scant half mile from the Institute, listening to the telephone receiver, my heart was pounding, madly awaiting the minute arranged when Smythe was to begin to send.

I have heard joyous symphonies of Beethoven and stirring measures of Wagner, in music ringing through the soul with all joy and inspiration; yet to my waiting ear the faint *whirr . . . whirr* spelling the H's of the agreed signal seemed the sweetest music ever heard by man! It sang of great success. In the mystery of its transmission through that dark void, silently, invisibly, timelessly, I felt for the first time the presence of another world than I had known, the ether realm, to thought boundless, to the soul inspiring, and to the life infinitude.

Thus did I sleep that night wearily but well, and in my dreams the castles, shadowy yet fair, seemed nearer to the morning hour.

It is impossible today to realize what that first wireless test meant to my young mind. *At last success had rewarded those long months of experiment and failure.*

In those days the name of Ferdinand W. Peck was a household word to Chicagoans. He had been largely responsible for the success of the Columbian World's Fair, and the building of the Auditorium, in whose lofty tower he then had his office.

So next day I went to the Auditorium to see Ferdinand Peck, told him what I was attempting to do, and besought his permission to string my antenna from the top of the Auditorium tower to a room at its base. Mr. Peck became greatly interested, granted me permission, and inquired as to my future plans.

The distance to be spanned here was some four miles, and once again, with Smythe at the key at Armour Institute, I was able to receive clearly and distinctly his signals. No attempt was made to transmit words by Morse, although by that time

through dint of study of the Morse code, into which I translated every advertising sign on the streetcar and elevated as I traveled, I was becoming a fair Morse operator.

Professor Freeman of Armour Institute's electrical faculty, who had been closely watching my work from the start, now began to get excited. He had a friend who owned a large yacht on the lake, and through his influence we were able to install our transmitter on board that vessel for some really worth-while tests. Then once more I realized the wonder of the world electric where I was at work as I stood on the four-mile crib, the faithful Responder (keen little listener to etheric melodies) by my side, and watched the yacht, bearing the spark coil and tall antenna, and some strange energy, become a speck upon the dim horizon, and then disappear. There was coal and fire on board, a whirling generator, a few wires—and the indestructibility of energy. I heard the voice of that inert carbon's chemical potential, translated through the heat into electric current, and carried by the wires to the spark coil, and through its spark again transformed to the silent and intangible waves from the antenna wires. And they rushed out to me, those etheric pulsations, infinitely rapid, and to all the wide horizon, the potential of the coal, bound there inert for centuries, now liberated and seeking another resting place. The Responder heard them in their journey, caught their silent vibrations, and translated them into sound. So I hearkened, and a great awe stole upon my heart, as I gazed across the silent waters toward that speck beyond their rim, and heard the message from the Deep.

The Chicago press had been tipped off concerning this *first attempt* on the Great Lakes, indeed in all America, to send dots and dashes by wireless. When the yacht had picked me up from the crib and had landed the party at Chicago, I was eagerly questioned by reporters. Next day several newspapers carried the front-page story. It was my first taste of publicity. I liked it!

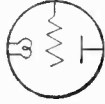

CHAPTER 10

Ships Ahoy!

EMBOLDENED by these successes in Chicago, I forced the hands of my confreres, Smythe and Professor Freeman, who after much argumentation, allowed me to transplant our activities to New York City late in August, 1901. I was convinced that my independence of management as well as my immediate future possibilities required that the start in commercial wireless should be made in the East. And in New York the start was made.

Long previously I had explained to Max Stires, Yale chum and Mt. Hermon classmate, who lived in Jersey City, that I would need his active aid in getting my soon-to-be-operating "wireless system" financed in New York. Also that I hoped to interest some New York paper to fit us out for reporting the forthcoming International Yacht Races, as had Marconi in 1899 for the Associated Press.

Stires now learned that the A.P. already had a contract with Marconi to do the same thing in 1901. Undiscouraged he finally succeeded in interesting the Publishers' Press Association in our

proposal, explaining the manifold advantages of the new American wireless system to that which the Associated Press was to employ. Now the problem was one of finances.

Those were days of doubt, hurry, rebuff, but not discouragement. Not a little of the delay and disgust was caused by the impossible attitude of Freeman in demanding too much from mere capital, and in postponing chances for the *ignis fatuus* of indefinite promises which came to nought.

At last perseverance and patience were rewarded. Stires, at whose good home I was staying, did yeoman service in persuasion, planning, and business negotiation. I wired for Somner, our good mainstay, to come east as mechanic in this work. Stires and I practically compelled my partners to accept the offered terms as good for themselves. I urged Henry Siedler, the wealthy man whom Stires had finally succeeded in mildly interesting, to order the transmitter generator made. This generator was Freeman's invention, consisting of a large number of mica condensers, with a complicated commutator, motor-driven; the idea being to charge the condensers in parallel from a 500-volt D.C. generator, and then to discharge them in series across a spark gap. His was the first device of this type ever constructed.

By dint of personal insistence, pleading, and urging, I forced an advance by all parties. Three weeks after I came east, and only a month before the International Yacht Races, the actual work of construction began.

So now we were working in Jersey City, feverishly, anxiously, the days few, the hours short, the nights filled with restlessness and unavailing cares. But the goal was gloriously attractive, the odds tremendously against us. For if we young men, with scarce a year's experience and only two months out of the Armour Institute laboratory, wanting in means and hampered in facilities, could now compete with Marconi's five years' development,

backed by unlimited capital, and could manage in one month's preparation to construct new machines, develop untried devices, complete a thousand details, and compete in reporting when the ether would be aquiver with the signals of the older system, then there should be credit for a really wonderful accomplishment. And if energy and industry, agony of effort, could bring success, I felt we would win.

Much against my better judgment we decided to construct and use the Freeman transmitter. Its principle was new and untried. There was in it absolutely no factor of safety, no adequate time available for its construction and correction. From the start I wished to use an alternator and transformer for supplying my spark-gap energy. But Freeman's financial assistance, small though it was, seemed just then absolutely essential; so Smythe and I had to agree to his demands.

Had the Regatta been held on time, we could never have been prepared, but the dastardly assassination of President McKinley caused the postponement of the International Races for five weeks. This added interval enabled us finally to complete the apparatus and install it—the day before the races—on a special tugboat hired for the purpose by the Publishers' Press Association.

As two years before, the Marconi apparatus—for the Associated Press and the *New York Herald*—was on board Commodore Gordon Bennett's palatial yacht. This time I had resolved to give him his first competition (competition that was to keep up aggressively for the next eleven years).

A week before the races I suffered a complete breakdown and was taken to a hospital. Despite doctor's explicit orders, after three days' internment and narrow escape from fever, I sneaked out. And each day I arose before dawn, tottered to the boat, and worked feverishly on the Freeman transmitter, trying to keep it from breakdown until we landed at Sandy Hook. After

the second race I threw the useless device overboard, and installed a large reliable spark coil with an interrupter. This stood up, but our Sandy Hook operator reported no signals from the tug.

Neither Marconi nor I had ever experienced wireless "jamming" before; neither boat got a signal message to shore. At that early date nothing was really known regarding practical tuning devices, designed to synchronize transmitter and receiver circuits so that a receiver would respond only to a certain transmitter. The antenna at each station was connected directly to one side of the spark gap or to the receiver. Those primitive transmitters radiated merely a powerful "blob" of energy, capable of exciting any and all untuned receivers. And yet the large newspaper headlines during those days, "Wireless Reports of the Yacht Races," were strictly true; but the type of wireless actually used was the good old-fashioned wigwag!

After it was all over and Lipton's *Shamrock* and we had lost, I went sick again. My friend George Barbour invited me down for a week at Rockaway Beach. That was a period of sweet rest and forgetfulness, a regaining of health and strength.

And there, if anywhere, one might get well, near a long line of white beach sand, and beyond, over limitless green waters, the line of the blue vault skirting the sea. There is at times a comfort and a sympathy in Old Ocean that I have vainly sought to find in man, teaching patience, and courage, and power.

I returned to New York to find that our financial affairs were in desperate straits—Siedler unwilling to do anything, "cold feet"—mutual and general disgust for Freeman—ineffectual attempts to get him to withdraw.

Never was one so handicapped, bound up, and tied down with such complication of "friends," partners, collaborators, patrons, sponsors, et al., as I was from the start in New York. "Poverty," said George, "is no disgrace, but it's damned inconvenient."

Certainly it had seemed long enough, those weeks since the Races, filled with rebuff, failure, successive turndowns, and hindrances from my associates. I had approached some twenty-five parties, to many of whom I hoped to point out some day the enormous folly of their timorous mistakes. This, however, was small enough comfort then, when I needed to pay a three-dollar board bill, buy whole-soled shoes, a lining in my overcoat, and a host of little luxuries which my life had been lacking (along with sympathy and an act or a word of encouragement) now for a full year and more.

I looked with eagerness to the mail for Smythe's \$5, and again with postponement and a self-loathing heart to Siedler for another—"as a personal loan"—never once offered without the request! To be sure, I was supposed to live on air, flavored with my youthful (though oft-blasted) hopes. Inventors generally do! Siedler was a rich man. I might die, go to work, or go to Guinea. Perhaps in six months, or six years, he would spend two hours to interest others to finance our little plan.

But I did meet some generous men, real friends in need, with sympathy, belief in me and the invention, willing to make an actual earnest move to help, and with a good word of encouragement thrown in. John Firth was one. He was having some work done in "our" machine shop at that time. God bless him! But for his persistent and well-directed effort in my behalf I should have been soon seeking the small cog in a big machine—or gone to Hades. E. R. Holden, Wall Street speculator, promised to be another. He believed in me, took an interest from the start. Notwithstanding the fact that our ungranted patents prevented a businesslike proposition, to help *me* get a footing and because of faith in my future and in my device, he seemed willing to take the system up, and on a big scale. He asked how I was living these weeks, and on learning said, "You call on me for another five dollars a week, de Forest, and come here whenever you are in need. I have a checkbook here which

is at your disposal any time." This was a new thing under the sun to me. This Holden was what I had read of, as in past years, or when the fairyfolk took interest in mortals, but I had long doubted its present existence. He was a new type to me. It was like food to a famished heart, a stimulant to courage.

But before Christmas Holden also was to be added to the twenty-five approached and interested, only to turn the proposition down at the last. And now Marconi was in Newfoundland, the papers were full of Marconi, the field was narrowing, and time was lapsing. I scarce dared, for my sanity, to look into a paper. We raised \$200 in a little pool, with \$200 more promised, and I went again to work at White's Machine Shop in Jersey City, building a new sender, now alternating current, to replace Freeman's broken-down and impossible contraption. But little enough time did I find to do my own work there. It was necessary to chase to New York each day—work for a clerk and not an inventor to do—seeking to get an agreement of all the factions, those of strength and weakness, of iron and clay, never to be reconciled.

I had to be everything—lawyer, diplomat, promoter, cash-raiser, manager, inventor. For two or three weeks now I was again getting \$15 a week, my high-water mark of income so far at the age of 28 years—a Doctor of Philosophy and five years a graduate! Meanwhile my faithful light overcoat had lost its sleeve linings and was now fringing at the cuffs. How long the coat would yet hold out I dared not calculate. But I found a desk at last and could study once more.

Those were the days when I needed every whit of my inherited fortitude to continue. I remembered then my rail-splitting ancestor Gideon and I would *not* give up.

Two or three months of hard hustling among capitalists had shown me a little of the disparity between the inventor's and the investor's points of view, something apparently entirely be-

yond the conception of the others, who had worked only in school and laboratory.

And now at last Siedler, he of the "fatherly interest" (at 1,500%) and the thousand dollars, refusing from the start to aid us, refused also to let others do so until he finally had sold 10% of his interest in our small holding company to Barbour for a thousand dollars; then he allowed the deal to go through, largely through my importuning. These things were highly trying, if instructive, and well calculated to sour any milk of human kindness, or disarrange any faith in the fairness, efficiency, or intelligence of human nature.

But a contract was at last signed. The new "capitalists" agreed to raise \$30,000 in sixteen months for the treasury of a one-million-dollar company! Siedler was to get 35% and we four (including Stires), 35% of the stock. And yet I was happy, and that Christmas was more merry than the two gone before.

All I ask is a chance to work out my salvation and future fortune; and I thank God tonight that the millstone seems removed at last from my neck, back at last at my work, no longer the promoter, or the driver of lukewarm friends. Debts are being paid off, like unpleasant memories to be forgotten. . . . Meanwhile (December, 1901) Signor Marconi has scored a shrewd coup. Whether or not the three dots he heard came from England or, like those Tesla heard, from Mars, if I am aught of a prophet we will hear of no more trans-Atlantic messages for some time.* In this art, as in all other inventions, advance will be by slow growth and evolution, not by magnificent bounds from 100 to 2,000 miles.

If only my Responder would not clog. That is still the great fear in my heart, the mote in my vision. The other problems seem easy. And, at all events, to solve natural problems is easy compared to those of human nature. Of the latter I have had my full share!

In January, 1902, a new figure crossed my horizon, one destined to play a vastly important part in my progress and that of American wireless for the ensuing six years—Abraham White, a very personable Wall Street character and extraordinarily lucky

* We did not—for seven years more!

stock gambler, who had risen to fame as the "postage-stamp" bidder for government bonds—financed by Russell Sage—and who had netted a neat fortune thereby. John Firth, a mutual friend, introduced me to "Abe" White, who had read newspaper accounts of my wireless inventions and the great future I had foretold for that newest marvel of science. White was gifted with the optimistic vision that J. Pierpont Morgan and other tycoons whom I had solicited, totally lacked. He readily saw now the possibilities, the unusual opportunity for wealth, for which he was seeking. He undertook to aid me, realizing at once that a new and larger corporation would be essential.

This step was quickly taken—the American De Forest Wireless Telegraph Company, a Maine corporation, with three million dollars of capital stock. He finally induced Smythe, Freeman, Barbour, and Stires to exchange their holdings in the smaller company for De Forest stock, or bought their interests outright. The ground and debris being thus cleared away, money began slowly to come into the new treasury; and happily I went back to my work in Jersey City.

Dating almost back to my latter Yale days, I had realized that the old European spark coil with hammer interrupter was badly adapted as a sending device for wireless signaling. Continual trouble from the interrupter points sticking, and the slow telegraph speed resulting from the sluggish interrupter, would always be a serious defect. The remedy would be an alternating-current generator with a step-up transformer, to supply a steady "high (acoustic) frequency" spark. So now, at last, I would prove that my idea was sound. Such a transmitter, together with a pair of headphones strapped together, worn over the operator's head and connected with the self-restoring detector, or Responder (instead of the slow Marconi coherer), would permit two good operators to wireless-telegraph almost as fast as over

a wire. That, then, was to be the new, the *American* system.

Early in 1902 the new alternating-current sender proved a grand success—a complete vindication of my faith therein and a sharp rebuke for the months and percentage lost with the ill-conceived Freeman invention.

Yet in my first tryout, with sender apparently working splendidly, I was able to get scarcely a signal across the river from Jersey City to the Bowling Green Building. Why, I was in despair to tell. It was such disappointments as these, with all the load of responsibility and doubt, with all the potential bearings on my very life which they involved, that were the real hardships to bear—not the mere poverty, the five dollars per week, endured even for a year.

From the start I had the one aim in view, to make my name at least rank with that of Marconi. Merit alone could win in this matter. "Efficiency," I wrote, "shall be the key to success and fame, and I shall neither ask nor borrow such from any other, nor allow such great injustice to be done myself." (I was to learn in later years how little I could do to prevent such thieving injustices.)

By now the American De Forest Wireless Telegraph Company was well launched; and under the magnetic enthusiasm and unceasing drive of Abraham White as president, sufficient funds through sales of stock were provided to enable the work to continue at the machine shop in Jersey City. A metal-framed, glass-walled, glass-roofed house was erected upon the roof of 17 State Street, overlooking Battery Park. A second station was installed at the Castleton Hotel, in Staten Island, with the idea of demonstrating the capabilities of the new American wireless telegraph system to transmit messages without wires across New York Bay.

A gratifying amount of public recognition resulted from this work. Newspapers sent reporters to each end of the "line," and

code messages were exchanged, to prove that this was no fake or flimflam. *It proved actually possible to telegraph over seven miles without wires or cable!*

For this ceaseless responsibility and thought, care, and unending labor, my services were valued at \$30 per week, and I was kept continually broke to keep the petty cash going. Worst of all seemed the reckless loss of time in filing patents. My "multiple syntony" patent application, delayed without excuse for six weeks, went in at last after another on the same lines had appeared.

February 10, 1902: I shall move all heaven and earth to put in at once a broad fundamental patent on *telephony* without wires by Hertzian waves.

My notebook discloses briefly my ideas how this could be accomplished, simply but crudely.

So far as I know no one at that time had ever proposed the possibility of transmitting the voice through etheric space. Few people, in fact, had then grasped the possibility of wireless telegraphy, as simple as that process then seemed to those of us who were creating that novelty of science.

My star was rising; I was very happy; but well did I know now that wireless work as it first fell to my lot beside Lake Michigan, while I was still careless and happy, would never be my chief interest again. Of that I was certain. And then, to make happiness and surprise complete, I received a letter from Jessie Wallace!

We now had two stations on New York Bay, others going up at Coney Island and at Rockaway; land bought for one at Montauk Point; soon two would go up at Key West and Havana—one at Atlantic City. Two steamboats were to be fitted out next month. We had two New York offices, a shop, thirteen patents pending, a payroll of \$200 a week (not much of it mine, however); competition with Marconi incessantly. There were para-

sites enough, God wot. Yet I thought that when the promoters and capitalists got through, my own share would be—perhaps not all I deserved, but still something!

Finances seemed to be brightening. Men were becoming interested, losing a little skepticism, beginning to see a possibility for a good investment. If we could keep afloat, I thought, until such time as some thousands of dollars could come to the relief of Mr. White, then the work would progress on a scale suitable to its needs and the dignity of the enterprise. We all realized that without abundance of money we could not hope to compete successfully with Marconi (who had spent half a million) no matter how meritorious our invention. So all my assistants, mechanics, laboratory men, and wireless operators, were making sacrifices in salary and expense, to tide ourselves over the dull depression of these summer months.

We have two “attachments” against us, creditors irate and galore; so much that I dread to go about Jersey City, and have seen my name, with that of the company I love almost as much, posted there on telegraph poles!

July 27, 1902: But that is past now; I think the lowest tide of depression has passed. Bills are being paid off, demonstrations are generally successful. Only the Responder will stop and balk and act irregularly at times. Mr. White has given me 600 additional shares of stock, \$6,000 if I can make their value par. Also I have had a second letter from Jessie! For a moment the old love came surging through my heart, to torment it again. I see many beautiful things, on the ocean, bay, and river—the distant blue horizon studded with sails of white, or the dim trails of steamers—the purple hills of Jersey in the west, perhaps garbed in sunset; or the fairy cluster of gray castles draped in mist and vapors, which is the great city; by morning clad in power, and at evening in a golden glory of great things accomplished. . . . Yet I see all this alone. No eye with mine beholds these beauties, and no voice yet tells me of another heart fired with the same inspirations. Perhaps it is better so, for this life is very short and there is much to be accomplished, more than one lifetime can admit.

Now I began to realize how immeasurably fortunate I had

been that my deep, consuming love had been unrequited. For without that pain and heartache—had all gone happily—I had never been willing, or able, to sacrifice my job, its chances for promotion, to take the risk and desperate gamble which alone had enabled me to carve out my destined career.

And now at last I was becoming inured to publicity. Perhaps the state of our affairs at this epoch could best be described by an article appearing in the *New York World* in April, 1902, which reads in part as follows:

A NEW YORK RIVAL OF MARCONI

Far up in the air, on the roof of the Chesebrough Building, at No. 17 State Street, is a wireless telegraph station, of the existence of which few persons have heard.

The system employed is the invention of an American, a Yale man not yet thirty years old, and is in no respect similar to that invented by Marconi.

The operator here has exchanged messages with the steamship *Deutschland* while that vessel was 100 miles at sea, and for simple demonstration, messages are constantly sent to another station located on the Hotel Castleton, on the heights at St. George, S.I., from which the replies made may be seen recorded as undeniable proof.

It is asserted that the newest system has many advantages, notably in speed and freedom from interruption, over that of Marconi; that it is no longer an experiment, but is so far advanced that when the next big Hamburg-American liner *Deutschland* crosses from the other side, commercial messages will be exchanged between it and the Manhattan station. Plans are under way for the erection of five new stations along the Atlantic Coast.

The speed of transmission by the Marconi system is at present limited, by mechanical barriers, to fewer than fifteen words a minute, less than one third the speed of the fastest work on land wires.

It is said that a speed of forty words a minute has been reached by the new wireless system, which is good work on a land wire and beyond the skill of an average Morse operator. . . .

I possess a small booklet dated in the fall of 1902 which reports the first interest in wireless telegraphy taken by the United States Army:

Whatever may be the ultimate outcome of the recent Army and Navy maneuvers conducted off the New England coast, so far as the relative efficiency of the two branches of the service are concerned, they have certainly demonstrated the great utility and, in fact, indispensability of wireless telegraphy in warfare.

Appreciating the important role that wireless telegraphy could be made to play, and to determine the actual merit and efficiency of each, General A. W. Greely, the Chief Signal Officer of the United States Army, made arrangements for the representation of three systems of wireless telegraphy, and to this end orders were placed some five weeks in advance with the de Forest, Marconi, and Fessenden systems, affording each company ample time to install and complete all details incidental to successful operation of apparatus. Each system was given fair field for operation and offered every facility conducive to results. The de Forest apparatus was installed at improvised stations at Fort Mansfield and on board the tug *Unique*, which acted as scout boat, the idea being to deceive the Navy and ferret out their plan of attack.

The stations of both the Marconi and Fessenden systems were practically inoperative from the start, and the entire burden of the three fell to the de Forest system, which system, though handicapped by insufficient equipment, as well as by the adverse conditions prevalent in warfare, performed its work in so eminently successful a manner that General Greely personally congratulated the inventor in complimentary terms, stating that "the *de Forest system* was the only one, of the three represented, fruitful of results, and therefore the only one of any benefit during the operations."

Wireless Telegraphy is now a *commercial factor*, not an experimental theory. The field for its application is as wide as the world; and that it will be speedily occupied is morally certain. Already many sea-going vessels have been equipped with wireless apparatus, and work on further installation is being vigorously prosecuted. In every instance the rates of marine insurance have been favorably affected. The vessels of the United States Navy are being fitted with masts to this end, and shore stations are being installed far and near. . . .

In almost every instance where coherer systems have been submitted to Government test in this country, they have been totally inoperative, completely collapsing under the strain of official investigations, as the recent tests conducted by the Navy Department between Annapolis Naval Academy and Washington Navy Yard prove.

Not bad for fourteen months out of Armour Institute laboratory!



CHAPTER II

*Early Wireless Operators**

SEVERAL months had followed the fiasco of the Yacht Races before I ventured to hire my next operator. While my State Street penthouse was nearing completion, a smooth-faced, sallow-complexioned young man insisted on visiting me on the roof, day after day, inquiring anxiously as to when the station would be ready for operation, and without hesitancy explaining that he, William Barnhardt, intended to be the first full-time American wireless telegraph operator. "Barney," as we soon came to call him, was a fast Western Union operator, employed in a downtown office. He spent his lunch hours in the penthouse station, watching the installation of the 100- to 5,000-volt transformer, the glass-plate tin-foil condenser, double spark gap, and other crude equipment, on an oak operating table.

The cumbersome key, with its half-inch copper contacts breaking under oil, interested "Barney" especially. He soon showed

* Much of the material given in this chapter was published in various issues of *CQ* magazine during the year 1931.

that he could pound out twenty-five words per minute with this curiosity. This, and his eager willingness to aid in installing the bird-cage antenna on the corner flagpole, soon convinced me that "Barney" was just the man for the job as "Chief Operator." Naturally, not much persuasion was needed to induce one so keenly interested in this brand-new wonder, "Wireless," to give up his well-paid job with Western Union for a most precarious salary of eighteen dollars per week (the "per" being an abbreviation for "perhaps").

Barnhardt's first duty was to lure a confederate away from Western Union or Postal. My Staten Island installation was already under way, and "big doings" were in the offing. There was grave doubt in the minds of nearly all interested as to what unknown difficulties must be first overcome before wireless could span this great gulf of ether. Up to that date, signaling across the Hudson River from Jersey City to the roof of Bowling Green Building, New York City, had been the limit of accomplishment. An operator was needed who could be relied upon to cope with the difficulties.

One day in the spring of 1902, Barney brought in a stocky young man, bespectacled and keen of mien, Harry Mac Horton by name, as one willing and eager to quit his lucrative press-wire job for the lure of wireless. To us Mac Horton soon dropped the Harry and became just good plain "Mac"; and for his fat salary of twenty dollars a week he gave an enthusiastic, whole-souled, unselfish devotion to his new mistress (and to "Doc") which I have never seen surpassed, if equaled, in all my subsequent experience with countless numbers of wireless, or radio, operators and engineers. Mac Horton was for De Forest Wireless "1,000 per cent," day and night.

And *how* he could send! No sooner had we finally established a two-way communication between Battery Park and Staten Island than Mac and Barney began to clip off that good old

American Morse and Phillips code at the rate of thirty to forty words per minute, with zest and enthusiasm unequaled since the early days of young Tom Edison. Nothing could stop them—not static or transformer breakdowns. I've actually seen Mac copying messages of greeting from some New York financier to his inquiring friend down at Staten Island for twenty minutes after the New York transmitter had blown up!

That was "wireless" indeed. "Never say die" and "You can't stop a Yank" were Horton's pet phrases, and he eternally embodied their spirit as long as he worked for me. That youthful spirit of enthusiastic devotion to duty and to his new profession possessed almost every operator who joined the slowly enlarging wireless circle.

Wages were no object to these eager-eyed pioneers. With sad frequency it befell them that the payroll was not forthcoming when Saturday noon came. Mac, or Barney, or "Pop" Athearn, or Hughes would match to see whose "biscuit" should go to the hock shop, so that the gang might eat over Sunday. They knew that wireless had a future which would some day handsomely reward them. They were pioneers all, completely imbued with that spirit of daring and risk which has typed the pioneer in exploration or in industry from the beginning of man.

It was the game, the fun, the unequaled satisfaction of traversing new lands, of overcoming strange new obstacles, of doing what no one else had done, that spurred them on. Wireless! Messages transmitted without wires, across cities, over waters wide and ever-widening! How their more cautious, less imaginative, less daring friends down on Broad Street envied them!

Those early operators didn't know much about wave lengths. A wavemeter did not exist in all America. The term *kilocycle* had not yet been coined. But they understood how to insulate a transmitting antenna, how properly to lead it in through the

roof of the shack, how to juggle the clip on the helix until maximum radiation was obtained.

Those were the days before the crystal detector or the rectifying electrolytic detector, when a "good" wireless operator was supposed to be able to rig up an anti-coherer with a needle and two pieces of aluminum wire or pencil graphite. Horton's boast was that a good resourceful wireless operator always finds somehow all the necessary ingredients for an operative detector in his pockets!

Of course we all used the double headphone receivers, Holtzer Cabots or Sullivans from England, long before the Baldwin ever existed. And what miracles of reception through static or jamming which would absolutely floor many skilled operators of today, did those early boys pull off! "Clamp the 'cans' on your ears, and damn well get under the table," was the precept for long distance through static. Hold your breath, remember the message, and then come up for air long enough to write it down—that was the procedure. Moreover, in those days there was no amplifier, and very little selectivity.

Key work was only a small part of the duties of the early wireless operators. They didn't know much of the theory, but they packed a lot of hard-won practical common sense regarding the simple circuits and how to rig an antenna, to patch up busted condensers, to dig into the black, stinking oil to find and repair a transformer burn-out. If ground plates had to be buried under frozen soil, or lowered under two-foot-thick ice, those operators never sat around waiting for some laborer to be brought upon the scene. They well knew that usually there was no more money than time for such idle luxury, and they "damn well" rolled up their sleeves, swung the pick or the ice ax, and hustled the job themselves.

And therein lies the secret of the swift progress of American

wireless in those early days—it was exactly the spirit of “do or die,” regardless of sacrifice or hardship, despite lack of help or material, often in lack of the remotest idea of what to do in some new emergency. Nevertheless, do it they did, with an intelligent determination which seemed to lead them instinctively to the right thing at the right time. Their loyalty to wireless and to “Doc” was at all times absolutely reliable, unswerving. No Communist-tainted A.C.A. (American Communications Association) for such men as those!

I think it was in the fall of 1902 that Harry Brown joined up, also “Sunny Jim” Easton (later to become U.S. Consul at Port Limón, after working there for years as the best wireless operator in Central America). The number of stations began to grow.

Vosburg was another tried and trusty veteran of the first “Old Guard,” one of the early few still in the game. He had gone down to the lone sandspit near Cape Hatteras with my Yale classmate Barbour, our construction engineer, a schooner load of lumber, an oil donkey engine, some glass plates, a transformer, antenna wire, and twenty-five square yards of copper plate for ground, to erect the first commercial station on the Atlantic Coast. They had lived like beachcombers, with such Carolina crackers as those desolate dunes afforded—lazy and shiftless, knowing nothing of wireless or electricity, and caring less. God only knows how Barbour and Vosburg ever erected, with such aid, that tall foursquare timber tower, which for many years thereafter was a seagoers’ landmark off Hatteras. “It’s dogged as does it,” said the old British skipper who captained their schooner south, and that motto inspired their discouraging labors, until at last Coney Island could exchange faint calls with that lonely Carolina outpost.

In the summer of 1902, we boldly bid for the job of reporting for the U.S. Signal Corps the war maneuvers at the eastern end of Long Island Sound. Old General Greely awarded

us the contract. Mac Horton and "Pop" Athearn built most of the apparatus, installing one set on the leased tugboat *Unique*, and the other at Fort Mansfield. An oil-engine, belt-driven, 60-cycle generator feeding into a one-kilowatt lighting transformer was bolted to the deck of the boat, and another was installed in a temporary shack about twenty yards behind the six-inch-gun battery at the fort. At the first salvo at the fort the entire receiving apparatus jumped two feet into the air and fell on the floor. But it was so simple—only a mercury-carbon anti-coherer, dry battery, tuning coil, and headphones—that it was undamaged. Thereafter it was suspended from the ceiling beams by strings and springs.

As usual, the simplicity of our apparatus, plus the absence of interference, plus the sleepless vigilance and tireless resourcefulness of my two operators, brought us complete success and a fat check from the Signal Corps Disbursement Office weeks later.

The maneuvers over, I boarded the tug at New London for the home voyage and told Mac I'd relieve him at the key while he caught up on some sleep. Before many moments the last, oft-repaired transformer began to emit those doleful squeaks and groans which we all knew so well, accompanied by little black spirals of vile-smelling smoke from under the cast-iron cover. I knew then our job was ended—but with victory already achieved. And so I reluctantly sank to sleep in the mate's bunk, to be quickly aroused by Mac's violent shaking, demanding in heartbroken tones: "Doc, what in hell did you do to the transformer; and for God's sake, where's the booze?"

As a result of our good work for the Signal Corps, the Navy now decided to try out the de Forest system in competition with German Slaby Arco apparatus, between Annapolis and the Washington Navy Yard. We had made some improvements in the meantime and with these, plus their now veteran experience in the new art of wireless, Mac, "Pop," and I spent a cold but

cheerful holiday season showing some future admirals how superior was the Yankee system—with its AC generator and transformer power supply, its simple electrolytic receiver and headphones—to the sputtering hammer interrupter, spark coil, and artistically lacquered brass gadgets of coherer, relay tapper, and Morse inker of the heretofore exclusively employed German equipment, purchased at a high cost from the Slaby-Arco Company.

My good friend Rear Admiral S. C. Hooper (now retired) was one of those midshipmen at Annapolis at that time. He well remembers the first wireless “news scoop” engineered there when Horton flashed to Athearn and me, at Washington, the first news of the accident at Annapolis to Secretary of the Navy Long, when the horses of his carriage ran away, severely injuring him. I telephoned the details to the Washington newspapers long before they got the news by the wire route.

We sold those sets to the Navy without specifications or bids, and began searching for new fields to conquer. It had been frightfully cold in Washington that holiday season, but now we must needs journey to still colder climes to demonstrate wireless to Canadians, between Toronto and Hamilton, over a three-foot layer of ice.



CHAPTER 12

1903 - Historic Firsts

THE following spring I visited our stations at Toronto and Hamilton in Canada; then I selected a station site on the lake near Cleveland and sites in Chicago, Kansas City, St. Louis, and Omaha.

At Hamilton I stopped over long enough to make an important experiment I had long had in mind—to prove that the mass of track-side telegraph wires acted as effective “wave chutes” to pick up all along their lengths relatively large amounts of “wireless” radiations, concentrate these into a relatively confined zone, or bundle, and then conduct this energy over long distances with small losses compared to those suffered by the unguided, cross-country, “grounded” waves.

Accordingly I now took my tiny portable detector box, telephone receiver, and 100 feet of antenna wire, walked down the tracks leading from Toronto for perhaps a mile from town, and strung my wire between two telegraph poles as high as I could reach. I skinned the bark off a small bush for my earth connection, sat down, and awaited the scheduled sending hour from distant Toronto.

The strength of the received signals, crude though my arrangements were, was positively amazing—demonstrating convincingly that my long-held theory as to the “guided wave” action of cross-country horizontal wires was correct. This same action was again demonstrated later that year at Block Island, and after my 1906 confirmations in New Haven, formed the basis of a broad patent issued to me several years thereafter.

True is it that such existing “accidental wave chutes” all over the country are today playing a profound, yet generally unrealized, part in long-distance radio communication, and have done so from the very beginning. I know of no quantitative investigation of this useful, almost self-evident phenomenon. The *Proceedings of the I.R.E.* have carried for years endlessly wearying observations and discussions of the effects on transmission of the Kennelly-Heaviside layer, the ionosphere, the Appleton layer, and all the way out to the moon. Away “up in the air” indeed, and no end!

But nothing so mundane as the functions played by lowly cross-country telegraph, telephone, and power lines as accidental, helpful carriers, has ever been to my knowledge carefully investigated. Of this fact today, however, every radio installation aboard a transcontinental club car or touring automobile is a convincing demonstration. And some day this as yet unrecognized principle may cheaply solve some television network problems. Who can tell?

In February, 1903, my good friend John Firth, confirmed and inveterate believer in the merits and the future of De Forest Wireless, had journeyed in our behalf to England. There he had interested Sir Thomas Lipton—preparing to make a third attempt to lift the America Cup—in the idea of equipping his private yacht, *Erin*, with wireless before her forthcoming voyage from Clyde Bank to New York as tender to his *Shamrock III*. Firth succeeded in showing Sir Thomas what it would mean to

get word of his flotilla's approach long before it was sighted from our shores, plus the great practical advantage of being in constant telegraphic touch with New York while aboard the *Erin* during its anchorage off Sandy Hook and throughout the course of the races. All of the De Forest Company, from president to office boy, was wildly jubilant over this good news.

Horton was selected to take across and install the equipment. He rebuilt it when he got to Glasgow. Within two days he had every mechanic and ship carpenter in the yard working for him.

They sailed from Scotland, and for three long weeks we waited in silent anxiety. The first wireless mast in New York had been erected at Steeple Chase Park in old Coney Island—a three-sticker 180 feet high, guyed with hemp. In the clapboard shack above the piles by the old boardwalk, three operators "spelled" each other every hour of the day and night when the *Erin* was 300 miles out, calling, then listening, raising blisters on their fingers from the slide tuners. I began to keep them company rather constantly as the calculated day of the *Shamrock's* arrival approached. At that time the old Cunarder *Lucania* was the only trans-Atlantic vessel equipped with wireless.

Great was the rivalry among the three operators—almost as intense as was their anxiety—to be the first to pick up *Erin's* call. We knew old Mac was somewhere out there alone at the key, day and night. The weather was rough and the yacht small. Horton was not a good sailor, just doggedly determined, no end, and with a keen ear.

No S O S was ever more intently hearkened for than that first audible call from the *Erin*. One bleak day, after hope had been nearly abandoned, the fear growing that the yacht might have foundered, or the wireless broken down—or Horton had died—Athearn and I returning from lunch saw one of the boys in the doorway wildly waving an Aerogram blank. "He's got

us. He's got us! Jim's copying Mac now!" There sat Easton, "can" on ears, pounding on his key, a happy grin on his face, and tears actually coursing down his cheeks, so happy was he to know that Mac Horton was O.K. and that our first foreign expedition was a success at last. Now, greetings over, he was clipping off a long cablegram to Tommy Lipton, giving him the long-awaited full report of the condition of his *Shamrock* and the crossing.

It was a full day after the first call before the little flotilla anchored inside Sandy Hook, and Mac landed, dog-tired from his ceaseless vigil—actually lashed in his chair to the desk, for the *Erin* had pitched continuously through sixty degrees—and violently seasick much of the trip. But the wireless had stood up through it all. Mac had started calling Coney Island when the *Erin* was one thousand miles out, such was his unbounded faith in De Forest Wireless and in our personnel. He had scarcely slept since that moment. Call, tune, and listen in vain, seasick and weary—for three days and nights before he picked us up, and then another day before he heard Easton's "OK 73 OM." He first picked up Coney Island seventy-five miles from Sandy Hook.

Sir Thomas Lipton had arranged with the Associated Press to route all his press news and business cables direct to Coney Island from the *Erin*, anchored or cruising in New York waters, throughout the entire period of preparation and the regattas. Operator Vosburg was sent to the *Erin* to relieve Horton, and he lived aboard that summer as one of the crew. Soon Vosburg and the boys at Steeplechase Park were handling Lipton's and the A.P. messages by Phillips code as if a cable connected them. Two of them knew Continental as well as American Morse, and they delighted to talk slowly to "Sparks," the Limey, on the Cunarder *Lucania* when she was in port, gradually increasing their speed until Sparks and his coherer-relay outfit were com-

pletely lost—above fifteen words a minute! Just a meaningless rattle of the relay above that speed for Sparks, while our Yankees copied merrily on! I believe Coney Island was the first station in the world to copy wireless on a “mill.”* That was “nuts” for Easton or Horton when Vosburg speeded up “on board S.Y. *Erin*.”

We had meanwhile loaded a huge tug with a cumbersome five-kilowatt, D.C.-motored, 60-cycle generator set, and enough storage batteries spread out over her afterdecks to well-nigh sink her. We were determined this year to have such an excess of power that the Marconi-equipped A.P. yacht couldn't successfully jam us as she had two years previously.

But the two squatty spars which our tug could carry supported an antenna all too small for that transmitter; and although our signals were plenty strong for the distances to Coney Island, they were of low spark frequency. Consequently, our tuning (and Marconi's too, for that matter) was still too broad to afford much protection against mutual jamming. In spite of our elaborate precautions, it looked then as though our yacht-race reporting, second episode, would read deplorably like the first.

Then, too, a new and entirely unexpected “sea serpent” appeared over the Sandy Hook horizon. A two-masted brick schooner, towed about aimlessly by a tug (for this pirate caravan was not permitted to follow the races), revealed on board a lively kerosene engine driving a two-kilowatt, 120-cycle generator, a well-designed spark transmitter, and a speedy operator who knew reams of ribald poetry and all the cuss words and obscenity in the English language. These he hurled over the ether in good Morse, from 10:00 A.M. until sunset; and neither the Marconi A.P. yacht nor De Forest Publishers' Press tug could get a word in spark-wise.

* Operator's typewriter.

To add to the confusion, a new installation had just opened up on Atlantic Highlands, chiefly for the purpose of showing the whole wireless world that the only real system of tuning was the Fessenden.

A complete log of the operators' pleasantries which were bandied back and forth through the Sandy Hook ether during those two weeks of September, 1903, would have made spicy reading for the Federal Communications Commission had there been such an institution in those good old free-for-all days.

After two days of long-wave wireless failure, and short-wave flag signaling, I realized that my floating Goliath was just a big radio bum, and that a high-finesse David could alone win the belated victory for Coney Island. Taking a leaf out of my early Armour Institute tests of two years previous, when a high-frequency spark had been generated from a Wehnelt interrupter and Ruhmkorff coil, Harry Brown, "Pop" Athearn, and I installed one overnight on our tug in place of the five-kilowatt, 60-cycle generator and transformer.

I couldn't find a ready-made electrolytic interrupter in all New York, but with a collection of long thin steel rods and a porcelain tube dipping down into an earthenware crock containing dilute sulphuric acid and a lead plate cathode, we managed fairly well. Its only drawback was that the end of the steel rod was consumed so rapidly by the submerged spark that it was necessary to push it down farther into the acid every minute or so. This process, while the high-tension spark coil was in operation at full speed, on deck of a tug tearing across the rough seas, with conducting salt spray flying over everything, the entire ensemble mounted on top of a hundred acid-leaking storage batteries (we had had no time to unload this heavy excess cargo), was a task calling at once for skill and dogged heroism, and a saving sense of humor.

I can still see Harry Brown perched up on a wooden stool,

for better insulation, with wry face and rich profanity reaching gingerly over at that jar of acid and gently tapping down the end of the steel rod with a small tack hammer whenever the sound of the spark became guttural and irregular! But this queer gear turned the trick. Our shrill, squealy signal, while not loud, nevertheless could be read by the keen ears at the Coney Island headphones through Marconi's hammerlike spark, through the more musical note from the 120-cycle of the pirate's brick schooner, and through the bursts of God's static which were frequently thrown in for good measure.

So the last of the yacht races of 1903 was finally reported to the quasi satisfaction of the Publishers Press Association. Another all-important fact was thereby demonstrated: *a high-frequency spark, though faint, could get through where low-frequency signals, though ten times more powerful, were useless.*

While *Shamrock III* and the *Defender* were tuning up for the America Cup Races, Barnhardt and I, having just completed installing at Point Judith, R.I., for the *Providence Journal*, the first press wireless station in the world, moved to Block Island to put in the other end of that first press route. Daily communication was speedily opened up, and for the first time in newspaper history daily news items, hot from the mainland, began to appear in an insular journal.

Shortly after this auspicious opening, a terrific storm leveled the Block Island mast. I had just returned to New York for the first race of the Regatta when the sad news arrived. At once I hurried to Block Island, in deep doubt as to what could be done in a hurry to restore the service on which the *Providence Journal* had built up such supreme hopes. On my arrival, Barnhardt met me with anything but gloom written on his sallow features. He pointed to the telephone line, supported on fifteen-foot poles, extending in a beeline across the Island towards

Point Judith. He had hooked tuner and detector to this line where it entered the shack. Rhode Island's signals were coming in over this directional, horizontal antenna—*the first such in wireless history*—with much greater intensity than ever before from the vertical aerial.

That was indeed a discovery, and a joyful one under the tempestuous circumstances. It was a welcome confirmation of what I had discovered the previous spring at Hamilton, Ontario. I warmly complimented Barney on his ingenious resourcefulness; and with renewed faith all hands went to work to speed the re-erection of another mast for the transmitter antenna. Thus with less than a week's interruption, the two-way service was restored.

In the summer of 1903, then, on little old Block Island, wireless history was made in a discovery which has proven of incalculable practical value ever since—the long, untuned, directive, horizontal receiving antenna. And one Barnhardt, the first American wireless telegraph operator, made the discovery.

That summer was indeed momentous in wireless history. Pity, indeed, is it that subsequent revolutionary improvements have ruthlessly blotted out a proper realization on the part of today's radio operators of such sterling pioneer achievements as I have here partially, and too briefly, recounted.

In 1903 experiments with de Forest radio were conducted by the Signal Corps between Fort Safety (near Nome, Alaska) and Fort St. Michael, 107 miles south across Norton Sound. At 9:00 A.M. on August 7, 1903, messages were exchanged satisfactorily between the two locations, and commercial service was immediately put into effect. It is believed that *this was the first wireless system in the world operated regularly as part of a telegraph system handling commercial traffic*. Certainly it was the first point-to-point wireless channel put into service on the American continent for commercial traffic.

U.S.N.
WIRELESS STATION
No. 1

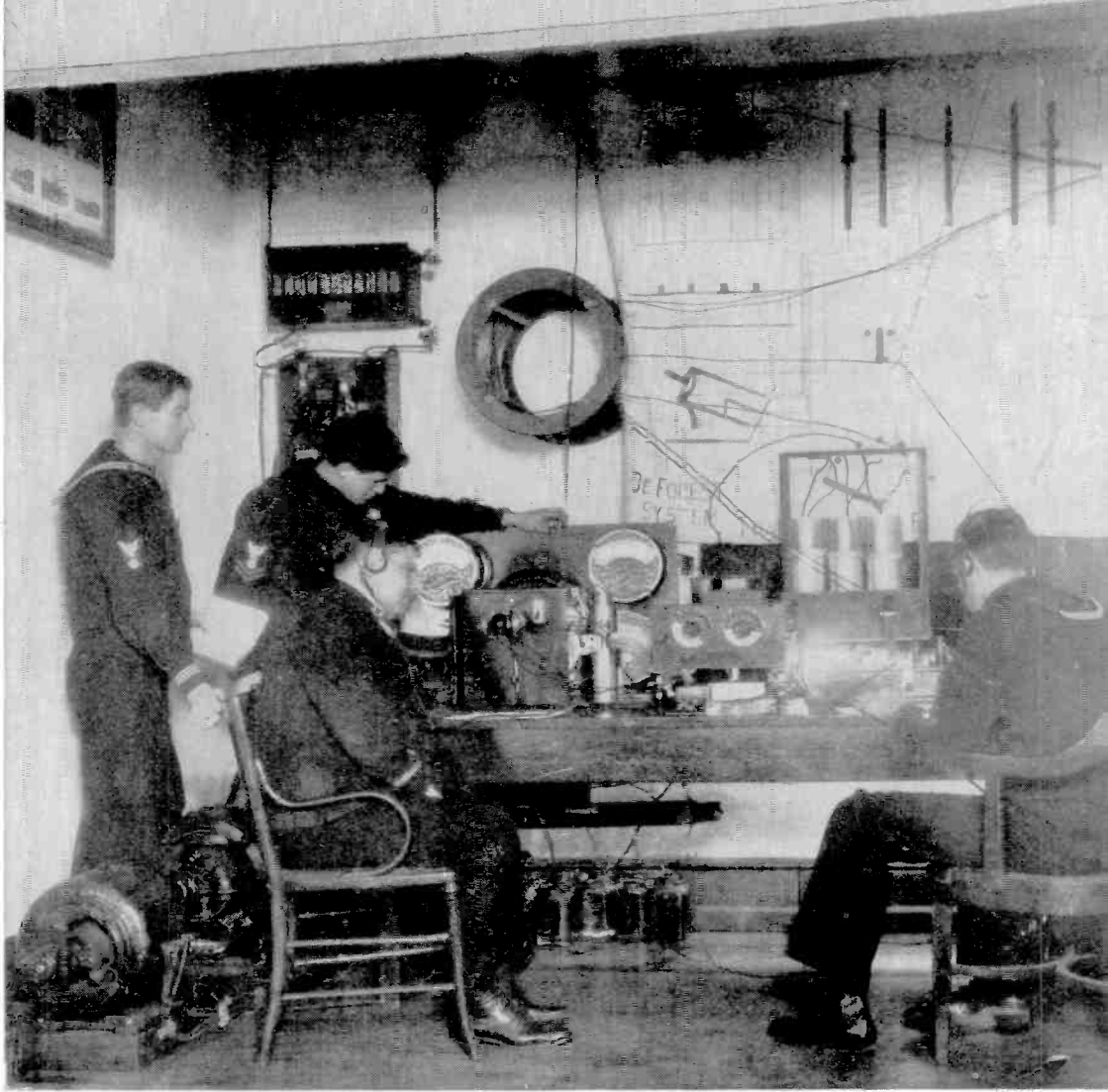

Almost from the beginning, the United States Navy was one of the biggest boosters for the De Forest system.

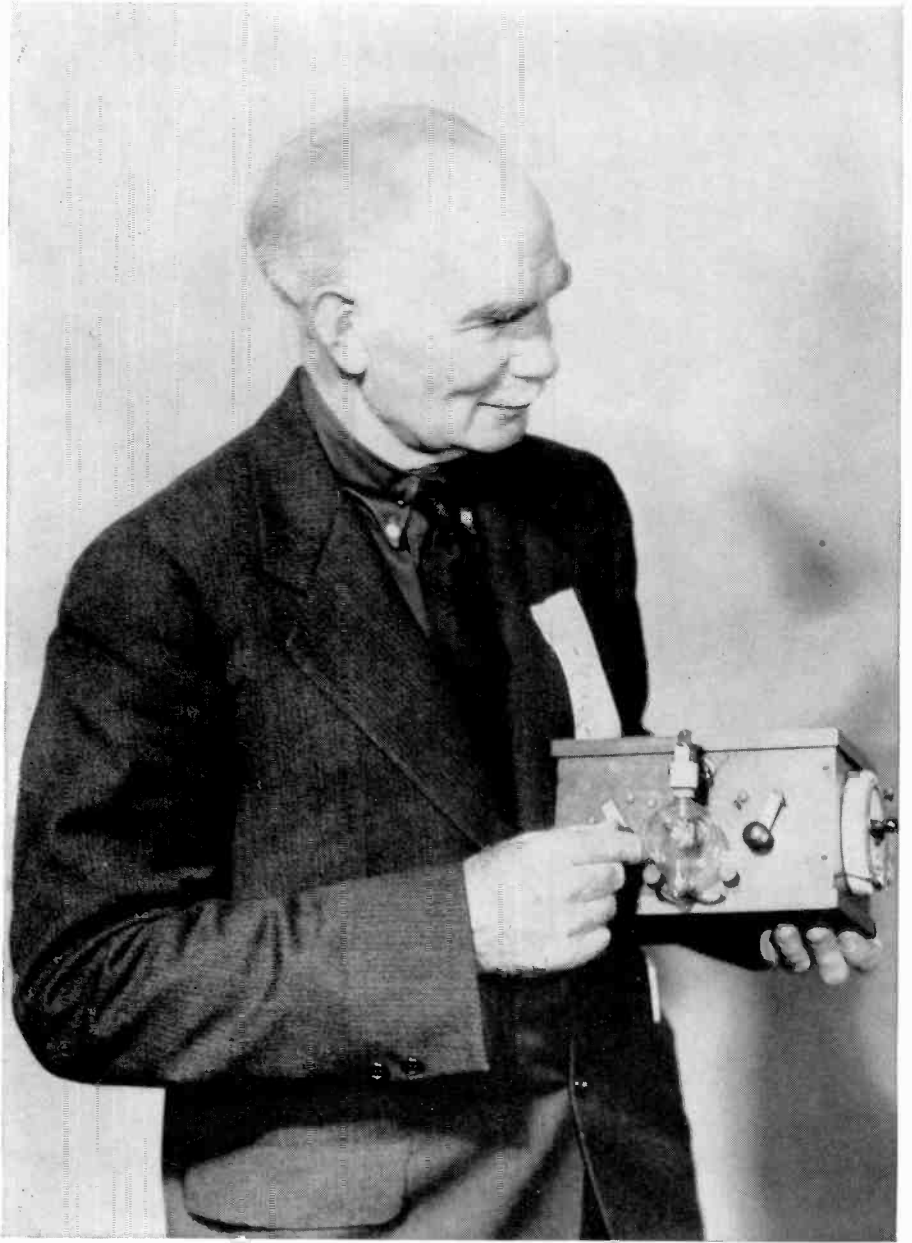

Replica of an early Audion

In summary, 1903 witnessed these important and significant "firsts" in wireless communication: the introduction to the U.S. Navy of the new American system, as contrasted with the Marconi and the German; the introduction of wireless to Canada, and the demonstration of the existence of "guided" wireless waves along overhead, long-distance wires, picked up from distant transmitters; proof that a long horizontal wire, extending in the direction of a far-distant transmitter, will pick up electromagnetic radiations therefrom and conduct these, in current form, to a detector connected with that wire; and that the simplified alternating-current-fed wireless transmitter, with self-restoring detector and headphone receiver, was incomparably superior, as to speed of signaling and reliability, to the then used European systems.

Finally, the U.S. Signal Corps established the first commercial, point-to-point wireless telegraph service in the world, and that over a distance exceeding 100 miles.

The year 1903 had already proven itself an outstanding milestone in the history of wireless, but another record achievement was yet in store.

During 1902-03 I had removed my laboratory from 24 Morris Street, Jersey City, where it had been since my New York arrival in 1901, to a small upper loft at 27 Thames Street, New York City. At this stage I hired a queer-looking, hawk-nosed, inventive individual endowed with an encyclopedic memory, by the name of Clifford D. Babcock. He had had wide experience with various inventors, Edison among others, and came to me fired with the determination to work with me in the further development of wireless. I was much in need at that time of just such an assistant; and inasmuch as he, like myself, was willing to work for practically nothing and promises, he was duly employed.

As a result of our fine work for Sir Thomas on the *Erin*, the British General Post Office that fall invited a demonstration of the "amazing" Yankee wireless system in competition with their own across the Irish Sea (where Sir Oliver Lodge had shortly before vainly made a trial of the Lodge-Muirhead system), from Holyhead, Wales, to Howth, near Dublin. Mac Horton and I therefore assembled two sets and, trusting to find necessary engine equipment and another good operator in London, sailed on the old S.S. *Majestic*, my first trip abroad.

With a single antenna wire, which Horton surreptitiously hung in the shrouds and brought in through our cabin's port-hole, we held New York until the ship was 140 miles out—and were well satisfied with the feat.

The small wireless station at Holyhead where we worked stood high on a rocky eminence overlooking South Stack Light. The scene was typical of the whole sullen coast of Wales. For grandeur of location, sternness of environment, and picturesqueness this spot was unique.

Close by the Coast Guard's shelter it stood, on the crest of a gigantic precipice of traprock and spar rising almost sheer 800 feet above the water. Never was a weirder setting. Directly at our feet, but so far below as to seem a mere modeling in clay, lay the great domelike rock crowned with the South Stack Light, dazzlingly white, and with the houses of the keepers and the retaining walls of their little eyrie sprawling over the dun stone.

I worked there as one entranced among unreal and fabulous surroundings, as in some weird cloud-world, far above the earth. At sunset a great pillar of flaming fire, huger and more gigantic than I had ever seen, stretched far across those Western waters, reaching from the red sun in its furnace of mist to my feet and setting the sea aflame. I knew then what was meant by the

“Spirit of God upon the face of the waters.” Well wrought the sages when they named this sea height “Holy Head.”

I'll never forget the cold bleak cliffs of Holyhead that wet November, 800 feet above the raging Channel of St. George; nor the nights with Horton and Cornish, our British operator, fighting off chilblains with the aid of 3-Star Hennessey before the roaring fire of the old Howth Bar.

It was no snap to get our English Fairbanks-Morse engine and the 120-cycle American generator up the rocky trail at Holyhead and installed in a portable clapboard shack, whose roof we had to anchor down with ropes and rock to keep the winds from rolling our outfit over the brink of the cliff.

Our Irish station was in the small hamlet of Howth, some 15 miles from Dublin on a level plateau overlooking the Irish Sea. It was necessary that I travel back and forth by the small night boat serving Holyhead, Dublin, and Howth.

At last the day of the test arrived, when the dignified silk-hatted official delegates from the General Post Office in London arrived at each station to watch us do our Yankee damnedest. They wrote out code messages which Horton and Cornish (who was exceptionally fast for an English-trained operator) ripped across “with looseness” at 35 words per minute in Continental Morse. The Lodge-Muirhead system had exhibited a maximum of 18 words per minute (when it functioned).

Then the officials themselves gingerly donned the “cans,” the first time they had ever received code through telephone receivers, and conversed slowly back and forth with no difficulty except that due to their inexperience in sound receiving by spark note. In sheer amazement they witnessed the ease and speed with which my two boys, eighty miles apart, slammed up and down the antenna transfer switch and got back their replies from their chattering American keys, far faster than the officials could write off their messages. It was, in short, *a day of complete*

triumph for American wireless, almost at the very birthplace of wireless telegraphy.

The tardy report of their tests and findings finally filtered through the cumbersome files of the British G.P.O.—and there the matter rested and died. For Great Britain decided that any wireless system as simple and rapid as ours could not possibly be safe and reliable; the more dignified European methods of Marconi, Lodge, and Slaby-Arco must be, by the very nature of their strictly scientific origins, “quite the best, don’t you know.”

However, it was not long before alternating-current generator transmitters, self-restoring detectors, and headphone receivers began to appear in certain British (and German) wireless stations! Our bleak November labors had at least driven a nail into the coherer’s coffin, and (unofficially) into official British concrete.

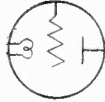

CHAPTER 13

Wireless Goes to War

*D*EFINITE good did come to us indirectly from that first American invasion of the European ether.

Horton and I returned on the same old ship, *Majestic*, with Captain Lionel James, famed war correspondent of the *London Times*, en route for the Orient via New York, where Russo-Japanese war clouds were then threatening. We learned of his presence as we sailed from Liverpool. We also learned that Prof. Fessenden, my keenest wireless rival, was likewise returning to America. Thereupon Horton and I promptly made James's acquaintance, and between us we never left him alone for one waking hour all the way across! By the time our ice-clad vessel sighted Sandy Hook, New Year's Day, 1904, we had thoroughly sold Captain James the idea that his way to be up to date and to scoop the entire press world was to take with him to Japan two complete de Forest wireless sets like those we had so satisfactorily demonstrated across the Irish Sea.

Lionel James tarried in New York just long enough to sell his idea to the *London Times* and the *New York Times*, and leaving strict orders that this equipment must be en route for Yokohama within two weeks, departed for Seattle.

Then was another wireless impossibility accomplished. There was no proper equipment available except those two sets in Holyhead and Howth. We cabled our British representative, fortunately very much of an American, to instantly locate Cornish, our "limey" operator, and get him to pack up and express to Liverpool both wireless sets, then rusting in their shacks on those far-separated bleak cliffs.

I believe no Englishman ever before hustled as Cornish hustled. He had thoroughly learned how from Horton, and a trip to America and Asia was to be his reward if he could catch that boat. He properly packed and brought two tons of machinery on board as personal luggage. That just saved the bacon for us. The entire equipment was unloaded, overhauled, repaired, repacked, and jammed into a chartered express car direct for Seattle within thirty-six hours after the ship docked at New York. But the excitement and triumph was too much for Cornish. Prohibition might have saved him for the Japanese expedition; but this was fifteen years before Volstead!

Hence a frantic call for volunteers. Athearn was already slated to go west with Cornish. Brown, of the recent yacht race episode, answered the call. So these two fine American wireless operators accompanied the express car to Seattle, caught the *Empress of China* by the skin of their teeth, and thus saved the day for ourselves and Lionel James. And again wireless history was made, thereby making the entire world wake up and recognize the utility of this startling new American enterprise.

Never before had wireless been used for press reporting. Here was an ideal opportunity—war maneuvers around the China Sea, where existed no means of communication whatsoever, save by boat and courier; James had chartered a swift tug for his press scout work, destined to make history in war news. He and his boat were ready when my two men arrived in Shanghai. The equipment was transferred to the *Haimun*, and she speeded off for Weihaiwei. Working like demons, Athearn and Brown in-

stalled our set indoors on the ship. The sturdy English Fairbanks-Morse engine from far-off Holyhead was ready for shore duty.

Then Lionel James promptly began to electrify the press of the world. His American wireless enabled the *London Times* and its New York and Philadelphia correspondent papers, to scoop the other newspapers—not merely by hours, but frequently by days.

His luck had him close by Admiral Togo's fleet when the Russian *Petropaulovsk* was sunk. After the Russian fleet had returned to Port Arthur, Togo steamed up, hoisted his battle flags, and gave his historic warning to the garrison there. When the *Korietz* opened fire, James handed to Athearn the famous message that the first shot had been fired. Brown, ever alert, waiting day and night alone, caught the word and shot it in to the *London Times* office hours before the shot was fired (by Greenwich time).

Not long before the Japanese bottled up Port Arthur's harbor, this little dispatch boat, *Haimun*, was overtaken by the Russian cruiser, *Bayan*, far out at sea. James, knowing the temper of the Russians toward the *London Times*, appreciated full well what might result to him and his party—but he had with him a weapon more powerful than guns or armament. Invisible, following wherever his boat sailed, was an etheric call, an intangible news channel, linking them with the very heart of London on the other side of the world, and keeping him in touch with the might of Great Britain's power—such was the wireless' power, now fully revealed to all the world.

So, as the *Bayan* drew nigh, he aërographed to Weihaiwei: "I am about to be boarded by the *Bayan*. If you don't hear from me within three hours, notify the *Times* and British Consul." It was a moment of dramatic interest and suspense. Would the world and England know his fate? Prompt and faithful, as on a wire, came back the reply from Brown at Weihaiwei, eighty-five miles across the sea: "O.K., will notify as requested."

The *Bayan's* officers approached and boarded the boat. They read the message and its reply. They knew they were at that instant being watched by the eye of London; and they promptly departed, leaving the plucky correspondent and his amazing wireless boat unharmed.

It is safe to say that never in the annals of telegraphy had any service performed a more faithful work at a critical time than did the de Forest system on board the *Times* boat *Haimun* on that morning far out in the Yellow Sea.

Cruising all over the Yellow Sea, from Chemulpo Harbor, 240 miles away, and even when at Nagasaki to coal, "Pop" kept always in touch with Brown at Weihaiwei. One notable war message of 800 words flashed over this distance at twenty-five words a minute without a single error. And that in early 1904, when wireless over such distances and for swift press purposes was an absolutely untried experiment! Nothing at all today—true. But those two lads made wireless history in 1904—such significant history that after the first six weeks of war, during which Lionel James and his wireless continued consistently to scoop the press of the world, the Japanese military authorities suddenly revoked her permit and summarily dismantled his tug, forcing James thereafter to resume the tedious, time-honored methods of his competitors.

"It ceased because the system proved to be of far greater excellence than was believed by the Japanese to be possible; far superior to their own military and naval wireless system of communication." These were the exact words of James at a banquet given in November, 1904, in London in honor of him and the Americans who had amazed the newspaper world by the astonishing efficiency of our wireless in war journalism.

It had proven indeed a lucky chance that Horton and I had caught the ship at Liverpool on which Lionel James started his epoch-making journey to the Orient.



CHAPTER 14

Early Litigation

THE success which the De Forest Wireless Telegraph system achieved even as early as 1902, had prompted efforts on the part of the American Marconi Company to stop us by means of patent litigation. A suit was brought in the Federal District Court, Judge Townsend presiding, under the original U.S. patent of Marconi, which claimed broadly the coherer in combination with the upright wire and earth connection. This was the first of an endless series of patent litigation waged against me and my company, and by us in turn against infringers of my patents, litigation which until recent years has harassed and held back development of the art throughout its long history, which resulted chiefly in the enrichment of a host of able patent attorneys, and which eventually might have ended in an absolute and unconscionable monopoly enjoyed—not by the original inventors and pioneers—but by those mercenary interests who had amassed and could command the most gigantic aggregations of capital.

Ultimately, it was the action of Congress in passing antitrust legislation and the subsequent investigation and prosecution carried on by the United States Attorney General under the Sherman and Clayton Anti-Trust acts, which accomplished a very necessary liberalization of this patent situation. Today, by virtue of this liberalization, individuals who are legitimately interested in carrying on a manufacturing business in the field of radio apparatus, are free to do so upon payment of not too exorbitant royalties. Meanwhile, many years of hairsplitting on the part of lawyers and judges, and brow furrowing on the part of inventors and investors, elapsed before the chaotic condition in American wireless and radio was eventually brought to some semblance of law and order.

That original litigation with the Marconi Company worried me not a little. The Marconi stock jobbers used the newspaper publicity to the utmost possible extent to discourage investors from continuing to finance the growing American De Forest Company. The newspapers in those years flamed with grandiloquent claims and counterclaims, flamboyant advertisements, notices of countersuits for patent infringement, libel, and slander. Those were merry days indeed down on Wall and Broad, where speculation in low-priced wireless stocks was rampant. In such battles Abraham White proved himself to be a man of mettle. He understood very thoroughly the arts and the wiles of stock manipulation. He equipped a small demonstration automobile with a tiny transmitter, stationed it on Broad Street, flashed De Forest stock quotations to near-by brokers' offices, and openly defied the "Italian camp"!

Meantime the patent fights went on, pro and con, to the enrichment of stock brokers and gamblers, but to the embarrassment and hamstringing of those who were sincerely striving to put the new art of wireless on a profitable commercial basis.

Eventually, to my infinite relief and satisfaction, Judge Townsend held the most threatening claims of the Marconi patent to be invalid, or un infringed by us. His invalidation was chiefly based on the earlier work and disclosures of Sir Oliver Lodge, of Popoff, the Russian, and of Branley, the French scientist who was unquestionably the originator of the coherer—a device, by the way, which was never used in American wireless.

Early in the spring of 1903 I had visited Prof. Reginald Fessenden at his home and laboratory at Fortress Monroe, Virginia. There I first met Dr. Frederick Vreeland, his assistant. They were using at that time a form of electrolytic detector for wireless signals, which, while resembling mine in the fact that both were anti-cohering devices, nevertheless differed in that it used a fine Wollaston wire (named after its inventor), dipping into a solution of dilute acid in which also was immersed a carbon or platinum cathode. One or two volts of potential were applied across these two electrodes, in series with a telephone receiver. During that visit Vreeland confidentially informed me that he, and not Professor Fessenden, was the inventor of this novel type of detector.

Thereupon we ourselves resolved to use a Wollaston-wire rectifier detector or its equivalent.

Upon my return to New York I began reading up on the history of the Wollaston wire and its various applications to the art. In the course of this research I came across an item in the *Electrical World* by Professor Pupin disclosing that he, long before Fessenden, had used a fine platinum wire, insulated except at its end and immersed in an acid electrolyte. This device of Pupin's acted as a very efficient rectifier of weak electric currents—that is, it would pass only one half of an alternating current, thereby turning it into a direct current. Thereupon I

set my able assistant, Babcock, upon the problem of designing a practical form of electrolytic rectifier using a minute insulated end, thus following the Pupin idea, which had not been patented.

In the meantime a patent infringement suit was brought by Professor Fessenden against our recent employment of the Wollaston-wire electrolytic detector, or rectifier.

After some weeks of busy experimentation, Babcock produced what we called the "spade" electrode, in which a thin piece of platinum leaf, almost completely insulated in a sealed-off glass tube so that only its extreme end surface was exposed, acted as a very efficient rectifier of minute high-frequency currents. This "spade" electrode device served as *a very efficient wireless detector* and was not apt to be burned off or destroyed by a severe shot of static, as was usually the case with the Vreeland-Fessenden electrode. To us and to our patent attorneys this device seemed, in view of the Pupin disclosure, to be entirely free from the Fessenden patent claims. Thereafter the "goo" type of anti-coherer Responder which we had been using up to that date was officially replaced by the "spade" electrolytic detector.

That Fessenden infringement suit dragged on for three years. A federal judge in Vermont could see no difference between the patented fine wire point dipping into an electrolyte and a fine end of one sealed into a glass insulator, *although the latter long preceded the Wollaston device, and was not patented*, but free to be used by all and sundry! Such are the quirks of an astute "legal mind." So we were held guilty of "infringement," and fined.

But by that time (1906), the De Forest Company had available both the carborundum detector and the Audion as substitutes for the debarred detector. Its operations were therefore not curtailed by the court's decision.



CHAPTER 15

Overland Wireless

MEANWHILE, starting in 1904, other tasks, more prosaic but more in the line of practical experimentation and perfection to commercial needs, had been under way. It had been decided, also for the first time in wireless history, to attempt commercial communication over 180 miles of frozen land and ice-jammed lake shore between Cleveland and Buffalo. Mac went to Nottingham, a few miles east of Cleveland, where Barbour, back from Hatteras, was erecting two 210-foot masts and a fan antenna.

Cornish and J. A. Wallace met me at Bay View, a frozen desolation near Buffalo. There contractors were erecting a station similar to that at Cleveland.

I shall never forget the icy dreariness of that lonely location, where we toiled through the bleak months of winter installing a huge recalcitrant oil engine, which Wallace called "The Cow," and which required all of us, and also any tramps in the neighborhood, to stand on its flywheel spokes to start it going. Nor

can I forget the agony of raising again and again that fan aerial after sleet had piled it and the stiffened hemp halyards an inch thick in ice; nor the multitudinous trenches radiating from and surrounding the shack, for the first ground system of its type—in ice-locked earth; nor the broken window panes in the road-house where we slept congealed beneath a foot thickness of blankets, the wash pitcher frozen solid each morning; nor the leathery flapjacks which Cornish used to fry for supper—so consistently tough that I pasted postage stamps on one and mailed it to New York!

And meantime, Horton and Elmer Bucher, a young cub operator (later a vice-president of R.C.A.), whom Horton had picked up at Cleveland, toiled and suffered similarly during the weeks we tested and tried, wire-telegraphed and tested, back and forth, tuning and retuning, puncturing glass-plate condensers in icy oil—wholly on our own resources, for New York sent us little of apparatus and less of money.

But at last, when it almost seemed that our wireless efforts must be abandoned before that long winter could draw to a close, we began to exchange messages occasionally, and then with gratifying regularity. *A new world's record for overland wireless!*

Then came the day of formal opening, with an exchange of greetings by the two mayors, and press representatives concocting all imaginable tests to determine whether or not this new thing, wireless, was genuine or a clever fake worked over a wire concealed under the Lake Erie ice. Countless were the difficulties and experiments before at last perfect communication was established between Cleveland and Buffalo, 180 miles, *the greatest distance yet covered over land and ice.*

That early Cleveland station stood for years in sight of the Lake Shore trains, and gave to countless big business men of New York and Chicago their first concrete idea that “wireless”

was an actuality which could some day play a vital part in their own business communications.

The American nation was now focusing its thought on the forthcoming World's Exposition, then in frantic preparation at St. Louis. My company was invited to make several wireless exhibits there, and I was summoned from the bleak isolation of Bay View to direct those diverse installations. Chief of these was that installed on the steel "De Forest Tower," by far the tallest structure at the Exposition. Mr. White had recently purchased this imposing structure, which had stood for many years at Niagara Falls, and had re-erected it at St. Louis.

That installation, in a glass house on the first platform one hundred feet above the ground, attracted unprecedented interest from the public. No one had ever seen a wireless station; few knew or would believe that wireless telegraphy was an accomplished fact. The staccato crackle of our spark, when purposely unmuffled, brought them swarming from all over that end of the Exposition grounds.

Before the Fair was a week old the *St. Louis Post-Dispatch* requested permission to install a receiver at their downtown station for a regular press news service from the Fair. When the first message was received at the *Post-Dispatch* office, from Governor Francis at the Exposition to the St. Louis mayor, flaring headlines heralded this "Triumph of Science"!

Soon our four operators were all swamped with work. Other recruits eagerly offered; the best only were chosen. Charley Cooper was moved to Springfield, Illinois, to put in the first of the two-link wireless chains already mapped out to give commercial telegraph service with Chicago.

Bright minds now began to concoct all imaginable kinds of stunts for this new, rapidly spreading wonder, American wireless. Roy Knabenshue, renowned balloonist, undertook some

flights from the Exposition grounds. "Could wireless reach far above the earth's surface?" Hertz's theory taught us that these new strange waves were "grounded" to the earth, their feet sliding over the conducting surface, their heads extending up some distance, none knew how high, above the earth. That was why we could telegraph over mountains and the earth's horizon. Wireless to a balloon had never in all the world been tried.

The *St. Louis Star* asked the question. Knabenshue offered the means for the experiment. I was in New York at the time. McQueen, our fearless Irishman, volunteered for the test. McQueen had been carefully taught that to send, or receive, messages by wireless an upright antenna *and an earth* connection were indispensable. So he threaded the aerial wire high up into the net of the balloon bag. The problem of an earth connection in a free balloon stumped him not at all. At the last moment before the take-off he appeared with a large tin pail filled with nice fresh earth, heaved it into the basket, and stuck the ground wire from his portable receiver deep into this "earth"; then the pair cut loose for a wireless flight for Science!

I doubt if a single one of the wondering throng standing about the basket thought for an instant of the absurdity of the thing—that that handful of dirt was the equivalent of a connection to the earth! Acker at the Tower key was blazing away and the balloon became a small bubble in the sky, then a speck on the horizon.

They descended in Illinois, and McQueen was soon telephoning triumphantly to the *Star* copies of the fragmentary messages he had received all the way up and down—proof positive that wireless waves traveled high, but nevertheless always sought the shortest path to "earth." This knowledge, so elementary today, was first demonstrated in that balloon. Wireless history again in the making—easily made in those primitive days of beginnings.

Charley Cooper began to "bring in" the station at Springfield, 110 miles north, as soon as he had his mast and aerial up. But the signal strength, especially during the severe static of that 1904 summer, convinced me that we could never raise Chicago with that 10-kilowatt transmitter, and with its antenna necessarily so close to the Tower's steel framework.

Immediately plans were outlined for a new giant station; the largest yet dreamed of in America. For not in all the world had anyone yet dared to attempt commercial wireless over 300 miles of dry country! Up on Art Hill, above the "Jerusalem" concession, a great gaunt wooden cross of latticed timber was erected 210 feet high. In the neat shack near its base a 20-kilowatt spark transmitter was assembled, with huge glass-plate condensers immersed in oil contained in four stout wooden "coffins," and connected in series-parallel circuit arrangement. But there I soon learned that if electrical energy increases as the square of the voltage, troubles and breakdowns increase as the cube power!

Shortly before the new Jerusalem "record breaker" was begun, an eager-eyed, curly-haired, gaunt-faced operator had introduced himself to me at the Tower as Frank E. Butler, a New York Central train dispatcher from Toledo, on a hurried sight-seeing visit to the Fair. He simply would not leave the wireless stations. At one or the other I invariably found Butler. When I told him I had no present vacancies, he told me, very simply, and with a snap of his firm jaw: "I'm going to be a wireless operator. Pay or no pay, I won't go home again." I smiled approvingly, understandingly, for I knew exactly how he felt. Wireless! Repeated refusals meant nothing to Frank. Up in the new shack he volunteered to help unpack the newly arrived equipment from the Jersey City factory. A huge pile of excelsior was left in a corner. "I'm nearly broke, Dr. de Forest. Can I sleep on that tonight? I'll watch this apparatus for you." I said

"Yes" to test his sincerity. When I arrived early next morning, he had cleaned up the place and most of the condenser plates were coated with tin foil and properly arranged in their tanks. That was enough for me.

"Butler, if you want to work for me here I'll try to get you on at half pay—the best we can do just now."

"Doctor, I'm going to be your assistant if you'll just tell me what to do. Damn the salary. Wireless is enough."

So Frank Butler of Toledo went wireless. Because of his intelligence, keen interest, demonstrated loyalty, and willingness to do anything and everything quickly, neatly, without question or complaint, day or night, I soon placed him in charge of that new big station at the Fair.

There we experimented for many weeks in privacy, free from the maddening crowds around our other wireless exhibits. It was soon found that many of the principles employed in the 10-kilowatt station at the De Forest Tower did not apply to the new station with its 60,000 volts of oscillating current. Heretofore we had been handling just a big lot of current, while now, comparatively, we were playing with miniature lightning. We did not know very well just how to handle it.

The spark-gap condensers, instead of being Leyden jars, were made in heavy two-inch plank boxes seven feet long, two and one-half feet high, and equally wide—and liquid-tight to hold kerosene. Immersed therein were two large sections of plate glass, with heavy sheets of tin foil pasted on both sides. Each complete tray weighed about a ton, and from four to six of these tanks were used. High transformers, six or seven feet high, "stepped up" the tremendous voltage. The spark gaps had terminals one and one-half inches in diameter, upon which a cold blast of air from an electric blower was constantly blown.

Our experiments continued to result in nothing but one failure after another. Sometimes, after hours of hard, painstaking work

building up the series of condensers, we would "blow up" the entire set in an instant, smashing the heavy glass plates to small pieces and spraying kerosene all over us and the premises. There was nothing to do but gather up the fragments, rebuild with new glass and tin foil, and try another hookup. Static electricity was so free and unharnessed in this station that it was not at all uncommon to get a "poke" in the head or elbow if one came within a foot of the apparatus while it was sending. The roar from the spark gap could be heard a block away, and it held its own in noise intensity with the ballyhoo bagpipes of the Jerusalem exhibit on the one side and the cannonading in the Boer War exhibit on the other. The odor of ozone mixed with kerosene, was always present, if not pleasant.

Thus blazing the radio trail, we encountered the immensity of space. Oftentimes we were awed at the thing we were trying to do. When we accomplished what we had aimed to do, the thrill was indescribable. We little thought then that we were piecing together some of the foundation stones of the huge radio structure which exists today. In my journal of those days, I wrote:

Night and day there is no respite from care, from toil, from interest. But it is a life well worth the living, the full accomplishment such, perchance, as is not given to many. Those who once enter this work, on whom the enticing spell of the wireless once falls, never quit it, no matter what the demands on patience or how great the sacrifices—always hopeful, always in effort, fascinated forever.

Control of the apparatus having been achieved, we immediately began to smash records for distance. The first event was on September 5, when firm communication was established between the new station and Springfield, Illinois, a distance of 105 miles. Shortly afterwards communication was established with the Railway Exchange Building in Chicago, a distance of 300 miles.

This was indeed a stride in progress, fulfilling careful promises, crowning long and discouraging efforts. Especially signifi-

cant was it that the formal opening of our St. Louis-Chicago service should occur on "Electricity Day" at the Fair, with the Jury of Awards and the delegates of the Electrical Congress present.

Among these at that time I met Elihu Thompson, whose handsome face and kindly personality captured my admiration, and John Stone Stone, who recognized me as a brother in wireless pioneering. (The friendship then established grew in affection until his death in 1943.) Professor Steinmetz, with panatella bristling, had come glowering into our shack, but tarried not, evidently thinking little enough of this upstart in electrical engineering.

It is amusing to recall the elaborate precautions this austere body of officials took to make certain that our news service was actually by wireless. Some of the party were stationed at Chicago and the remainder at St. Louis. Steinmetz was chairman of the Electrical Committee, but he was not present on this occasion. The actual conduct of the tests was under the direction of one William Hammer whom I knew well from my earliest days in New York. He had followed my work closely and had been an occasional visitor to my exhibit in St. Louis. But it was evident that he did not intend to be flimflammed or hoodwinked by any possible chicancery.

The attitude of the committee was that I was attempting to claim something which was obviously impossible of accomplishment. The St. Louis branch of the committee acted as if they were under sealed orders from Chicago. They had no idea as to just what tests they would be called upon to make until they opened the envelope. This was obviously to prevent any of my staff from becoming previously apprised and thus enabled to work some sort of legerdemain or skullduggery upon the astute committee.

Chicago would call up on the long-distance telephone and

ask for a certain code signal or cabalistic word. All these were duly transmitted and correctly received at Chicago. Then St. Louis would wireless Chicago to repeat certain words or messages over the long-distance phone. The wireless transmission met every requirement, one hundred per cent.

Complete communication was maintained all afternoon to their entire satisfaction, and as a result we were awarded the Grand Prize and Gold Medal, the highest honors bestowed upon any exhibitor at the Fair.

After that formal opening on "Electricity Day" at the Fair, our service was continuous, and many paid messages were daily received for transmission to Springfield and Chicago.

The day of revenue had at last arrived! Alas, how little I knew then of the malicious power of "static" to upset the most enthusiastic calculations.

Those months at St. Louis were among the most delightful and happiest of my life. Success followed success, triumph after triumph, and to live and work among the beauties of that Exposition filled my beauty-loving heart and romantic nature to their very depths.

The continued reports of the success of the *London Times*-Lionel James-de Forest demonstrations in the Far East were immeasurably gratifying. Wrote my brother: "They have placarded all the elevated stations in New York with the '*Times*-de Forest' posters and great is the wrath of our rivals, Marconi, Fessenden, Graf-Arco."

The aims of a year and a half of uninterrupted work had been accomplished—a great goal reached.

Not since that primitive night when I had stood in the rain on the roof of the Lakota Hotel only three years before and had heard for the first time the sound of wireless signals had such a joy seized me as, when again in Chicago, I heard the signals from St. Louis.

In October, 1904, I embarked on the S.S. *Baltic* for a brief one week's stay in London, chiefly to attend a dinner extended to me and Lionel James, then returned from his world-famous successes in reporting by wireless the naval war between Russia and Japan. Sir William Preece was in the chair. Present were some sixty men of science and "builders of the cable," who quite probably began then to wonder what havoc to their sacred networks Yankee wireless might work.

On that eastbound voyage I met many British delegates returning from the International Electrical Congress—among others, William Duddell and Sir William Thomson. And that voyage would have been yet more eventful had I but yielded to a violent impulse the night I left St. Louis, to elope to Europe with the lovely daughter of Louisiana's Senator McHenry as my bride. But for the wrong flip of a coin we would have sailed!



CHAPTER 16

Big Navy Wireless

AS a direct result of the record-breaking wireless work performed by the high-power apparatus and the loyal, enthusiastic operators in charge of it at the World's Fair in St. Louis, the United States Navy in 1904 awarded to the American De Forest Wireless Telegraph Company a contract for five of the most powerful stations which up to that date had ever been constructed anywhere on earth. San Juan, Porto Rico; Key West and Pensacola, Florida; Guantanamo, Cuba; and Colón, Isthmus of Panama, were the designated points. All transmitters were to be of 25-kilowatt input power except at Pensacola, where 10 kilowatts was deemed sufficient power for reaching its only regular corresponding station, Key West. At Pensacola, two ship-rigged masts supporting a double fan antenna were erected by Navy contractors, following plans drawn up by my company's engineers. At each of the four other stations triangularly spaced wooden towers of square-timber construction were raised to a height of 250 feet, to support an inverted pyramid of three fan antennas.

At Key West the motor-driven generator (gigantic in the eyes of all those old wireless experts!) was installed in the Navy powerhouse. Frank Butler was sent to Pensacola; Mac Horton had been sent there first and later to Key West. These were to be our first Navy stations. The more distant ones would be equipped later after we had learned from these relatively near stations how more surely to tackle the longer-range, more puzzling jobs.

But meantime inland and Atlantic Coast wireless matters of the American De Forest Company were by no means idle or neglected. At West Chicago a duplicate of the big St. Louis pioneer was nearing completion. Likewise a similar one at Kansas City. Fortunately (and also unfortunately, as it later proved) that summer of 1904 had produced comparatively little static. Our initial success between the World's Fair and Chicago was so gratifying that we saw immediate possibilities of successful overland competition with Western Union and Postal for commercial business traffic, at really "wireless rates"—not the almost identical tariffs with which present-day radio "competes" with wire and cable traffic. For a time we saw actually realized my early dreams of commercial wireless telegraphy overland; not restricted, as the European pioneers had been, to over-water communication.

Wireless telegraphy, like all other great inventions which have helped to annihilate time and space, had at its outset to pass through a period of public skepticism. But, as a matter of fact, the time required in putting it upon a commercial basis was amazingly short when compared to that required in bringing similar great inventions into general use. The first patent for a steamboat was issued in England in 1736, but it was not until 1807 that the steamboat passed from the "toy stage" in the voyage of the *Clermont* from New York to Albany. Stephenson constructed his first locomotive in 1814, but it was not until

1825 that the first English railroad which made use of locomotives was opened to travel; while on this side, Boston and New York were not connected by a continuous railroad until 1848. The first public appearance of the telephone was made at the Centennial Exhibition at Philadelphia. It was years before it became anything more than a toy. How slow was the process of its "commercialization" may be judged from the fact that the first building erected in New York for the purpose of a telephone exchange was less than twenty years old when I was equipping the first coast vessels with wireless!

WIRELESS MESSAGE SENT TO A MAN IN AUTOMOBILE.

De Forest Company's Experiment in Michigan Avenue Is Successful — Will Try Moving Machine Next.

An automobile equipped with a brass pole, from which dangled two wires, drew up in Michigan avenue yesterday afternoon, and at 4 o'clock received the following wireless telegraph message:

William H. Ocker, Automobile.—How do you like your first wireless ride? The fire department, steamships, and railways ought to adopt the same method of communication.

The message had been sent from the De Forest wireless telegraph office in the Railway Exchange building. Abraham White, president of the company, sent a message to THE TRIBUNE in care of the big touring car. It read: "Greetings to THE TRIBUNE from the De Forest Wireless."

Later in the week experiments will be tried in receiving from an automobile running at full speed "All that is necessary for the success of this experiment," said Mr. White, "is that a wire be trailed upon the ground. Hereafter, we hope it will be possible for business men, even while automobiling, to be kept in constant touch with La Salle street."

—From the *Chicago Tribune*, Jan. 8, 1905

On January 1, 1905, I began at Pensacola my first tour of inspection of our growing Navy stations. The station was nearly ready for test-out by the time I reached Key West. There ensued weeks of wireless work and experimenting, the most fascinating and delightful in all my experience—lost to the hectic existence of northern cities, in that indolent Island of Delight—a subtropic sanctuary from the wintry blasts I had left behind. With the willing aid of Horton and the Navy “ops”—ever eager to be of service and to learn the secrets of this new wonder—we established the first really high-power wireless station in America—in the world for that matter, if one overlooked the clumsy lumbering “limey” outfit at Poldu, whose cannonade of spark could be heard by ear almost as far as its wireless signal reached!

Two delightful weeks were spent in the little Navy shack in a grove of coconut palms which had been hewn partly away to clear space for our antenna wires. These were borne aloft by three slender white masts overlooking waters painted in such soft and vivid hues of green and violet as my eyes had never seen before. And then, having mapped out the work lying ahead for Horton and his Navy aids, Watts, Mineratti, and the others, I left that subtropic paradise for the chill North.

My travels took me through Washington, New York (where our new “42 Broadway” station was just being completed), Boston, Buffalo, Chicago, Kansas City, and St. Louis. At all these points I observed the work of installation and the new operators in training. Hard work, a multiplicity of tasks, voluminous correspondence accompanied me, followed me everywhere, night and day. Ah, but it was Wireless—it was life!

All through that winter, wireless traffic was brisk between Chicago, East St. Louis, and Kansas City. Every operator we had was keen to break a record, to receive a “wireless” farther than his rivals. And thus new records were an almost weekly occurrence.

Down at the little commercial station in Key West, where I went later that winter, I found Horton instructing our new civilian operator, Curtis—soon to be selected to superintend the fifth big Navy installation at Colón, Isthmus of Panama. Curtis learned his power stuff from the Navy station at Key West, and thus became amply qualified for that last big job, where Goethals and Gorgas, under T. R.'s stimulation, were already digging the big ditch and stamping out yellow jack.

But just now the little shack at Las Brisas near Key West was making wireless history. The Key West city current was of a bastard frequency of 133 cycles. Why, God only knew. But that little spark of Key West, Jr., had a sweet little singing note when Curtis set the spark balls close together, which, while apparently feeble, could be distinguished through static over distances up and down the coast quite unequaled by any big jammer then extant in the whole wireless world. It frequently happened that ships far at sea could read Las Brisas when the 60-cycle 25 kilowatts of the Key West Navy station was just a big noise lost in the louder roar of static.

We learned there and then, for the first time, the value of the high-frequency spark—one of approximately 400 per second; a discovery which years later in a famous patent suit brought in New York under the Fessenden "high-frequency signal" patent was held by the U.S. federal judge to invalidate a claim that would otherwise have dominated the entire wireless art for many years to come.

From Key West early in 1905, I pushed on farther south. Crossing with Horton to Havana we first supervised the installation of the commercial wireless station at Vedado, along the northern shore of Cuba.

Frank Butler had gone from Pensacola to Guantanamo, Cuba, where the U.S. Navy had recently acquired a naval base and coaling station. There a lonely, desolate, inaccessible promontory jutting out into the giant harbor of Guantanamo was cleared of

its tangled underbrush and mangrove; and there our second large wireless station was located. The site was five miles from the mouth of the bay, for the officials wished their source of communication to remain unharmed by bombardment as long as possible. Instead of first considering the location from the point of its adaptability for wireless work, the sapient Navy officials selected it because that particular place was down on the blueprint from Washington as *the* spot, just as was every other building planned for the reservation. A worse location could not have been chosen. The little peninsula upon which the station stood was wholly of coral formation, entirely dead as far as moisture or good ground facilities were concerned.

The weather, even at the commencement of the work, had been hot. Insects bothered the workmen to such a degree that work progressed slowly in the erection of the buildings and the installation of the apparatus. Frequently it was necessary to tie a towel around one's face, neck, and head, leaving only an opening for eyes and nose. Wearing overalls and shirts saturated in kerosene was another expedient used to ward off the pests.

The three 208-foot masts had been towed down from the States in sections. These masts were erected at each corner of a 300-foot equilateral triangle, with the station buildings in the center. Butler had directed that a stout cable be stretched between the tops of the three masts, and from each cable hung from individual insulators 45 stranded phosphor-bronze wires, tough and unruly as steel spring. The loose ends of these 135 wires were soldered together into a huge "rattail" at the center, anchored to a timber frame, and led into the condenser room through a great porcelain mushroom insulator. Altogether the three fans held 45,000 feet of wire!

Butler and his three good Navy assistants seemed overjoyed to see me: John Watts, chief electrician, from New York; Ford V. Greaves; Roscoe Kent. There was also a civilian elec-

trician, McLean, now with "Telefax" in New York. All five of these lads were slated for worth-while work in developing American wireless then and later on. One of them, Ford Greaves, was subsequently an assistant engineer for the Federal Telegraph Commission in Washington and is now the federal radio inspector at San Francisco.

I had no conception of the horrible conditions under which these enlisted and civilian operators were pioneering in wireless in southern Cuba. Here indeed was a paradise for mosquitoes, fleas, horned toads, snakes, scorpions, centipedes, tarantulas, wildcats, and all other kinds of tropical pests, flying and crawling. Testy Admiral Rogers, comfortable in white flannels aboard the old monitor *Amphritite* away out on Guantanamo Bay, was in command, and devil a lot did he or his aides care for the comfort of those poor devils over in the jungle.

Mosquito meshing had been requisitioned months before; and all in good time it would some day be received at the station. As there was no fresh-water supply on account of the dead ground formation, it was necessary to build a cement cistern to hold drinking water, supplied only too seldom by a Navy tug. When a wildcat fell into this cistern and drowned, it proved necessary for Butler to cable the Secretary of the Navy at Washington to secure belated action on the part of "Blinkey" Rogers' courteous and efficient staff to get the cistern pumped out, cleaned, and refilled with catless water.

A cursory examination through their volumes of Navy regulations, for peace or war, had disclosed no reference whatever to govern procedure in case a wildcat should drown in inland waters. Moreover the naval base possessed no feline Pulmotor. So, obviously nothing whatever could be done under such regrettable circumstances. Not until Secretary Taft, in Washington, instructed them.

A short time afterwards a case of yellow fever broke out in

the near-by laborers' camp, and Butler's three Navy companions were ordered to vacate the station and go aboard ship until the disease subsided. This inhuman action left Butler helpless and alone at the station with deadly danger imminent. Again he sought succor from the Navy Department, with instant and satisfactory results.

These latter episodes transpired after my visit to that hellhole of wireless in March, 1905, when the weather was fine and relatively cool. Even then static had been fierce, and scorpions more so. I had been mighty glad to sling my hammock from the engine-room rafters, using the twelve-inch belt as a step-up, where only mosquitoes, gnats, and bluebottle flies could reach me.

Occasionally, for good measure, lightning would strike, and burst an entire roomful of condensers—just finished after two weeks of hard work—throwing oil and plate glass all over the room and onto the walls. Then “a small cyclone—another entire span of 15,000 feet of antenna wire blew down.” . . . “Touched off station again and blower motor (for spark gap) blew up.” . . . “Herd of horses from workmen's camp broke corral at night and demolished the guy wires on the entire aerial spans, twisting wires badly.” . . . “Earthquake at 4:43 P.M.” . . . “Lightning again struck the station at 4:15 P.M., blowing up one set of condensers.” The Navy's lightning arresters proved inoperative.

And thus was waged the plucky battle in the face of endless delays, setbacks, discouragements. But never relenting, never quitting, Butler saw the job through to triumph and final Navy acceptance of the station in March, 1906.

Through such accidents as those here recounted we learned how to protect our apparatus from destructive high-frequency surges, how to design effective choke coils, sufficient condenser capacity and strength. And the makers of our transformers and generators learned how properly to insulate their windings to stand up under the terrific transient voltages to which our high-

power wireless transmitters subjected them. The radio engineer of today, installing from detailed blueprints, ready-made and science-perfected 100-kilowatt tubes, helices, and high-pressure condensers, has not the faintest conception of what griefs and heroic struggle his early predecessors had to endure.

Above the door of that Guantanamo shack was printed, even when I visited it, this legend:

Abandon hope, all ye who enter here, for verily this is Hell.

Back in New Orleans I found that my dear little Senator's daughter (with whom I had just escaped eloping when I left the World's Fair for London) had a pleasant surprise in store for me in the announcement of her coming marriage to a young Georgian. The engraved announcement now nestled lovingly near my heart—like a cold lump of lead. Thus do procrastination and jealous mothers rob us of our soul's happiness; and one after another do we again take up our paths along the lonely road of single selfishness. Once more I pleaded mightily for us to elope; but the invitations had gone forth, and no recourse was to be found.

However, I felt that I was becoming calcined, hopelessly selfish and unemotional, and altogether engrossed in my work—that romance and tender sentiment could never again take hold upon me as once they had; and that I could never love *anyone* with the ardent fervor and enthusiastic, whole-souled devotion which I had once felt.

And so I came away from New Orleans; and so ended another romance and another story—at least, so far as human pen will chronicle. And I, like the "Harvester," must take to the road once more—once more the long and patient search for happiness, the "Quest of the Golden Girl."

When I arrived back in St. Louis, I undertook one development which appeared to offer genuine commercial possibilities despite

static—namely, wireless communication to passenger trains. President S. M. Felton of the Chicago & Alton became intensely interested in my proposal and afforded me every facility to prove how far and how reliably messages could be received on board the daylight limited while traveling between St. Louis and Chicago.

I strung the receiving antenna through the train parallel to the bell cord. The receiving instrument was installed in a compartment of the last coach of the train, ground connection being made through a window to a truck below the car.

Not a peep was heard until the train got out of the city jam and along the clear tracks beside the river. Then the "D's" began to rip in, "like a ton of bricks off the roof," as Operator Ocker remarked. I wore a pair of phones and waited to see the effect of Merchants Bridge. Just as I had anticipated, as we watched the locomotive tender, baggage car, and first coaches slowly turn the curve and enter the long steel-box frame of the bridge, the signals began to grow weaker and finally faded to nothing. Then as the first coaches emerged on the Illinois side of the river the welcome signals again began, louder and louder, until our last car was again in the open—the first observation of this sort, so commonplace today.

As the flyer sped north, the strength of signals began slowly to fade. Suddenly, when some twenty miles north, they totally vanished. Keenly disappointed, I glanced out of the window—we were amid the low hills far from the river's side. Suddenly the low-pitched rattle of the call began again and grew loud. I looked out of the car window. There lay "Ole Man River" right alongside again. This astonishing phenomenon was repeated three times before the signals finally became too faint at a distance of fifty miles from St. Louis.

It was a beautiful demonstration of the theory, which wireless pioneers had already accepted, that these mysterious waves

follow water in preference to dry soil; that a relatively strong field of force follows the winding river and its moist conducting banks for much greater distances than along parallel wire lines over dry country. It also demonstrated that the mass of trackside wires played a most important part in this "wireless" transmission, and doubtless the rails also; which explained why our long, relatively low horizontal receiving antenna could pick up the signals from a vertical transmitter over such surprising distances, even with the train traveling in a direction at right angles to the radial lines of wave propagation from the transmitter.

The historic tests here described took place in June, 1905. They were carried on for some days. The Alton officials were thereby entirely convinced as to the practicability of wireless on fast-traveling trains. Plans were eagerly discussed by their telegraph officials and myself looking towards the permanent installation of a small transmitter, drawing its energy from a storage battery carried in the baggage car, and with properly insulated antenna mounted in links on top of the coaches. But when it came to the question of which company was to pay for the equipment and installation, the railroad economists decided that the proposed wireless service could hardly be self-supporting. As an advertisement the road had already received a vast amount of world-wide publicity, absolutely free of charge. So why run a chance of exchanging black for red? Once again young, enthusiastic, farsighted, pioneering wireless, with another significant history-making, startling success to its credit—was left holding the bag of empty promises.

That was forty-five years ago—and even today scarcely a railroad train throughout the entire world is equipped for the unquestionably useful, worth-while wireless communication service which we then, along the banks of the old Mississippi, proved to the world was a practicality. And even yet we occa-

sionally read of the "remarkable demonstration," the "amazing achievement," of transmitting radio signals to a fast train!

During that ensuing summer I learned to my dismay that Nature had been very kind to us as regards static during the World's Fair. For the summer of 1905 brought many days on end when, try as we might, it was found impossible to receive regular commercial messages between those widely separated stations of St. Louis and Chicago. Tentative contracts with brokers and meat-packing houses, who were eager to avail themselves of our cut-rate telegraph service, based on the remarkable success in transmitting their most complicated code messages during the preceding fall and winter from St. Louis and Kansas City, had now to be canceled. We learned then for the first time just how vicious and brain-defying God-made static interference could be. That fact was destined to have a profound and disastrous effect on carefully made plans for financing further developments of the American De Forest Wireless Telegraph Company.

Along with certain honest and sagacious directors of that company, Charles Galbraith in particular, I began now to argue against pushing further the ambitious plans of White, Wilson, and some of the stock salesmen, who advocated planting wireless stations all over the land as the promptest method of selling wireless "securities." Harry Shoemaker, whose old and moribund International Wireless Telegraph Company we had absorbed in the fall of 1903, and who was now in charge of our busy Jersey City factory, agreed with me that we should lay future emphasis on marine rather than overland wireless. Galbraith, in charge of our subsidiary Atlantic De Forest Wireless Telegraph Company, had battled valiantly with the White-Wilson group to induce them to spend all available funds upon the erection of more shore stations and the equipment of ships, coastal

and trans-Atlantic. But such counsels were outvoted. The stock-jobbing forces were too strong—their success too alluring. Ex-Confederate Army Colonel Christopher Columbus Wilson, stock promoter *par excellence*, “Colonel Sellers” incarnate, had his way to such an extent that wireless stations were now rushed up at Denver, Pueblo, Boulder, and Fort Collins, in Colorado. I visited these stations in July, but found scant encouragement there as to our ultimate ability to lick static in long-distance overland communication with any tools then known to wireless.

So I remained in the Midwest and battled with static throughout the summer, until Pensacola demanded my personal attention, as is outlined hereafter.

Our New York office was equally as active as our St. Louis headquarters—erecting Atlantic-shore stations, from Maine to Cuba, and driving hard after coast-vessel equipment. Able and genial vice-president Charley Galbraith had a winning way with skippers and fleet owners, most of whom in those days were skeptics regarding the possible need or utility of wireless. And the skippers, inured to gratifying isolation and independence of their New York office as soon as Sandy Hook was left astern, groused aplenty at the mention of wireless aboard. “The noise of that spark would disturb sleepy passengers—we don’t want it!” But, skippers notwithstanding, my best men frequently were rushed from the West temporarily to man a coaster, or help erect a stick on a strategic sand bar; to break in green men on how to insulate an antenna, or bring in a “rattail”; how to toughen rebellious ears to tight-clamped “cans” all day and all night; how to seesaw on the “slide tuner,” to read whispering Morse in “buzzer type” signals, to “get under the table” and read a “fist full” through “growling static,” to keep the skipper pacified and “sold” on the value of wireless, even though it made him “goddam” the New York office. American wireless grew apace on the Atlantic seaboard in 1904–05. And ere many

months every coast city—Coney Island, Atlantic Highlands, Galilee (near Long Branch, New Jersey), Atlantic City, Cape May, Norfolk, Charleston, Hatteras, Savannah, Jacksonville, Key West, and finally Havana—boasted of a single tall spar, pricking the barred clouds at sunset and pinning down to earth an invisible etheric mantle, of comfort and protection, spread over the mariner far out on the dark waters.

One of the surprising uses to which wireless could be put was amusingly demonstrated at Chicago during the summer of 1905. An old steamer, *City of Traverse*, had been covertly turned into a floating poolroom de luxe, with bar fixtures, bookie stalls, and all the paraphernalia dear to lovers of horseflesh—plus a few fishing poles for the sake of appearances. Up in the wheelhouse was a complete wireless station in charge of operators skilled in poolroom abbreviations. Thus equipped, the *City of Traverse* sailed boldly out to a watery spot where the three states of Illinois, Indiana, and Michigan merged into a theoretical no man's land beyond the jurisdiction of the local police.

For several days this strange "fishing" craft put out from Chicago, laden to the gunwales with bookies and racing touts. The sudden popularity of these brief "voyages to nowhere" and the dejected, wobbling swarms of "fishermen" who disembarked an hour or so after the distant racetracks had closed for the day, soon aroused the suspicions of Chicago's Assistant Chief of Police Schuettler. A day or two later our offices in the Railway Exchange were visited by keen-eyed detectives disguised as applicants for operators' jobs.

Next morning the headlines somewhat prematurely announced:

POLICE RAID WIRELESS OFFICE — CUT OFF FLOATING POOLROOM
RACE RESULTS

That afternoon it happened. The 3 P.M. flash from the De Forest Wireless offices to the good ship *City of Traverse* read: "It's all off. The coppers are here. No more results today." Our operators were arrested and our expensive instruments torn out and carried off to the Central Police Station.

But Chief Schuettler underestimated the resourcefulness of wireless men. Our managers, determined to stand their ground, retained the late Colonel J. Hamilton Lewis to make a test case in federal court of "the rights of the Wireless Company to transmit any news, not vulgar or obscene, to any place or person, leaving the punishment for the improper use of such information such as gambling, to those who actually gamble." "My clients," Colonel Lewis went on to argue, "are not responsible for what transpires at other places as a result of the news which they transmit."

In due time our position was sustained in federal court and an injunction was issued restraining the mayor, chief of police, *et al.* from interfering with our operations. Once more the doughty *City of Traverse* sailed the Lake, crowded with sports, bookmakers, and touts—this time with bands playing and crowds shouting in the ecstasy of victory.

Not to be outdone, the Chicago police set about erecting a wireless station of their own with which to jam our messages. Thereupon we transferred our transmitter to Michigan City to escape police interference. Their answering move was to erect secretly on a lonely sand dune at Buffington, Indiana, a second transmitter to jam our Michigan City station.

And now the row became interstate. An Indiana prosecuting attorney raided the wireless station which the Chicago authorities had unlawfully erected on the sovereign soil of Indiana. Two Chicago detectives were arrested for carrying concealed weapons and locked up overnight in the Buffington hoosegow, while their new wireless set totally disappeared.

Some interesting points of law—common carrier, common nuisance, municipal ordinance, and interstate commerce—were involved and thrashed out during that thrilling wireless summer on the shores of Lake Michigan. But at last the cold lake winds won the battle for the police. “Bet Boat’s Jig Is Up,” read the *Record Herald* of October 9. “After bouts with gamblers’ wiles Chief Collins’ face is wreathed in smiles. . . .”

Meanwhile, the plucky gangs of installers and operators down around the Gulf were struggling determinedly, resourcefully, against almost overwhelming odds. The big Key West transmitter which Horton and I had opened the preceding March was frequently heard by Iradell at the Pensacola Navy Yard. It was heard best during the few still static-less hours just at dawn. But try as he might Iradell could never get one signal dot-dash into Key West. There seemed to be a mysterious ethereal barrier stretched across the eastern Gulf through which the 10-kilowatt waves of “PN” simply could not penetrate. Horton had been up to Pensacola to investigate the trouble. He, quite naturally, looked first at the ground and installed an additional huge copper plate. The station was set amidst a desolate stretch of sand, dry as Sahara—even after torrential rains. Ten feet down, however, was salt water aplenty.

At the next schedule hour Hort and Iradell “called” Key West, confidently expecting a prompt O.K. It didn’t come.

Thereupon twelve forty-foot iron pipes were driven, or hosed, deep into the ground, arranged in a circle surrounding the station, their tops all bussed together and tied into the strip lead from the copper plate. But to Horton’s dismay, and contrary to all the laws of wireless and geology, “KW” was still deaf to “PN.” Discouraged and baffled, Horton wrote me all the details, and returned to Key West—just in time to escape being quarantined in Pensacola. For to make matters worse, yellow jack

broke out and Iradell thereafter was confined to the Navy Yard reservation.

Finally, it was decided that "the Doc" alone could correctly diagnose the strange ailment at the "PN." I must get under the stegomyia netting of the yellow-fever quarantine, where one hundred degrees was considered comfortably cool.

It was, I found, useless to attempt communication by daylight—static was absolutely continuous until late at night. I tried and retried every form of "static eliminator" circuit I had ever devised, but with indifferent results—so terrific was the disturbance around Pensacola; especially when all the cloud-framed horizon was pink and lurid from the continual glowing flashes of heat lightning, with never a growl of thunder. And when without antenna, earth, or tuner connection to the receiver I could still hear a constant grinding in the headphones I would resignedly lay down the "cans" and call upon the name of the Lord in prayer! That was *static*, as we knew it in the subtropics away back in 1905. That was thirty years before FM; but FM would have been useless for that 200-mile service—and *always* when signal-noise ratio is one to fifty thousand.

Remember that we had no aid of wavemeter, or even a good hot-wire meter in those crude days of "wireless in the raw." Consequently only by dint of "anchor spark-gap" readings, and groaning of the transformer, or length of blue-brush discharge, and by constant monitoring reports from Southwest Pass Station could we guess which was the best, or the most promising frequency, or the correct length of a spark gap. We easily calculated our wave lengths, but that solved no problems. We simply and doggedly tried every degree of coupling for each separate wave length, and varied the spark gap and transformer primary inductance for every individual setting of antenna inductance and capacity, keeping systematic records of each as we progressed. Not yet had the Audion Amplifier been conceived.

At last on Sept. 3, 1905, the triumph came: Key West, for the first time, had heard Pensacola. Another difficulty was overcome, one more problem solved. Happily I left that yellow-fever-infested spot.

The Navy Department at Washington was promptly notified, and shortly thereafter the Navy Department's first check for their first two high-power stations, Key West and Pensacola, was received in our St. Louis office. It was welcomed indeed—and photographed!

Just what it was we had done finally to drive that hole through the atmospheric wall to Key West we never exactly knew. All factors finally helped—the perfect ground, the improved antenna, the perfected attuning of the primary to the antenna circuit, the reduced losses in the circuits; but most important, doubtless, we finally found a wave length for which the sky wave (undreamed of at that period), or the shore-skirting wave, did *not* interfere with the ground wave, or direct-traveling wave. I could never convince myself that the peculiar geography of that West Florida coast line did not play some part in that strangely puzzling phenomenon. Suffice it that so long as “PN” stayed on that lucky wave length she never thereafter failed to raise “KW”—the gods of static permitting, always.

Nowadays, with undamped transmitters, with Audion Amplifiers and tuned radio frequency no end, such difficulties are swept aside too quickly even to be noted. But in 1905 they “sure were hell.” And I doubt not that today a careful radio survey between Pensacola and Key West might reveal some quite unusual and extremely interesting interference phenomena.

There was great excitement in American wireless circles during October, 1905, over the successful use of our service by President Theodore Roosevelt during his cruise from New Orleans

to Washington on the warship *West Virginia*, one of the first two warships equipped with American wireless. From our Cleveland station to the *West Virginia* off Hatteras, Governor Herrick of Ohio (later Ambassador to France) sent without benefit of relay a friendly message. And lucky Bucher at Nottingham again distinguished himself by pulling in the reply from "T. R."

Nothing in the early history of American wireless gave to that new development such an impetus as did the success of that first wireless installation on a U.S. cruiser. How proud our boys were that the Bureau of Equipment had selected our wireless instruments for that job! The President boarded the cruiser at New Orleans, and our far northern stations began almost immediately to copy her messages to the accompanying cruisers, the *Maryland*, the *Colorado*, and the *Pennsylvania*.

Today such matters are not news. But there is no doubt that the remarkable demonstrations of the efficiency and reliability of American wireless on this Rooseveltian cruise on the *West Virginia* definitely committed our Navy to a fixed program of development of the new art which has ever since kept her foremost in the field of sea communication.

By this time the fine work my boys had been accomplishing for the U.S. Navy, ashore and afloat, had brought about a complete reversal of the Navy's earlier avowed policy of requiring a tape-printer at each station for recording received messages. This absurd decision had compelled the purchase of a large number of German wireless sets, including coherers, during the preceding two years. But the simple electrolytic detector and head telephone receiver, coupled to the keen ears and clever wits of Yankee operators had, in 1905, put all this fine-looking, brass-plated Telefunken and Marconi apparatus on the museum shelves of our Navy Yards. Likewise, and for the same reasons,

the American De Forest System was now forging ahead of all of its rivals on this side of the Atlantic. Marconi and Telefunken sets were found only on European vessels.

Toward the close of 1905 our company had occupied brand-new offices at "42 Broadway," destined to be famous in the annals of wireless for years to come.

In the great penthouse of this downtown skyscraper I now began to repeat the history made three years previously in the little glass house on top of 27 Battery Place. Only with this great difference, significant of the rapid progress we had been making in wireless during those few work-packed years: here at 42 Broadway was a tall steel mast especially erected for the job (not a misused flagpole), a two-room operation station and, best of all, a large laboratory where my good old ever-reliable assistant, C. D. Babcock, presided.

And downstairs on the 16th floor, in the commodious offices of the company, clerks and secretaries under the direction of C. O. ("Charley") Galbraith were daily becoming more and more busy handling the rapidly growing ship-traffic and installation business of the company. For the wireless idea had now begun to catch on in American maritime circles. New vessels were being equipped every week. The Mallory, Clyde, Savannah, Red D, New York, and Puerto Rico steamship companies, Atlantic coasters, Standard Oil tankers, and numerous towing companies had now begun the race to equip their fleets. This demanded more shore stations: Bridgeport, New Haven, Boston, Portland, Montauk Point, Navesink Highlands, Atlantic City, Key West, Havana, Southwest Pass, Galveston—and the list kept growing.

And also on the Great Lakes, stations at Detroit, Port Huron, etc., were added to those already at Buffalo, Cleveland, Michigan City, and Chicago.

All of this meant, of course, ever-growing demands for new operators. A training school was now opened at 42 Broadway in charge of Henry Hughes, whose quiet demeanor, unruffled by anything human or electrical, imbued many a future wireless hero with the conviction that calm work with key, headphones, and pencil was, after all, more effective in time of crisis than consternation and cussing.

It had become increasingly difficult to get sufficient, suitable operators from Western Union, Postal, or brokers' wires. And thus commenced the era of the "ham." Young men, keen to learn about this new wonder, "wireless," began to master the code (it was still American Morse, not Continental, at the period of which I write), and to haunt the Hughes anteroom, the first authentic "static room" in the history of world wireless, and the first so named. This was the heyday of wireless around old New York, almost coincident with the opening of the subway. Thus "42 Broadway" began to make a name for herself all up and down the coast.

In addition to the fine new 2-kilowatt station atop 42 Broadway—my penthouse lab (birthplace of the first type of Audion)—and the rapidly growing installations aship and ashore, the autumn of 1905 was made memorable by the completion of America's first 50-kilowatt wireless station, "DF," at Manhattan Beach, Coney Island.

Back at the St. Louis World's Fair the preceding year, I had observed an electrician whose speed, strength of arm—and jaw—and neatness and dispatch of work had distinguished him among a host of hard workers. Harris was his name; "Driver" Harris, I nicknamed him. He soon quit Westinghouse Electric to rig antenna and power lines for us at the 25-kilowatt Jerusalem station up on Art Hill. Next came the East St. Louis station for Harris, and thence to Manhattan Beach, to the "daddy of

them all." I laid out that station shortly after our success at Key West, and I knew that Driver Harris, being as loyal to me as he was tough, hard-boiled, and profane, would follow my instructions to the letter, were I in Key West or England. And thus it proved. When I reached New York from Pensacola, Harris had "DF" nearly ready for the christening key; and had made every official and operator of the company his sworn enemy! He cussed them and defied them, and got whatever he wanted—"for Doc"—"them's Doc's orders!" And so we got along fine.

Thus it was that, ahead of schedule, "Old DF" began to burn up the ether all around New York and eastern waters. Its two wooden tower masts, 210 feet tall, 250 feet apart, and the large station house midway between, were located above a salt-water swamp—a perfect ground—a perfect location for overseas work.

First crack out of this big box, October 5, to Montreal, was received in Chicago. Elated, Harris worked harder than ever, as I drove him and "R. B.," our first operator there, to retune the station to longer wave lengths (up to 2,000 meters); to attempt to melt the ice off that immense fan antenna;* to replace it after the ice had brought it down. Thus on the night of December 19, A. C. Curtis, our operator at the new Navy station at Colón, overheard "DF" speaking to Pensacola. This latter feat so astounded the Navy cocked hats, dear old Admiral Manning presiding, that they gave out an official statement reading:

. . . The distance between Colón and Manhattan Beach, the extreme range of the message, is 2,150 miles. So extraordinary was this feat that the Bureau hesitated about making it public, and has only done so after receiving corroborative evidence from several points. This not only beats any previous record made by the Bureau but it beats the record of the first trans-Atlantic cable, which reached only 1,860 miles, from the west coast of Ireland to Newfoundland!

* First use in history of wireless. See De Forest-Clark patent, No. 802,151.

There was no Federal Radio Commission in those days; no regulation whatsoever save the unwritten code of courtesy among wireless operators (of the same system!). Our men considered the victories of Peace more worthy than those of War. In other words—"Never mind the Navy; get yours through first." And if a good old Yankee wireless jammed a Marconi lime-juicer—that was just too bad. Those were the days when it became conclusively proven that a coherer and tape recorder, or even a Marconi magnetic detector, were simply not in it when it came to reading through interference or static, compared to a carborundum detector, a pair of headphones, and a quick-witted Yankee "op." Against such a combination, "Sparks" was simply outclassed. Yet it required a long, long struggle before the Marconi Company learned its lesson and accepted the crystal and phone combination of their American rivals. But long before the bigwigs of London had capitulated, many a limey Sparks was concealing about his person a small chunk of "coal," as the Dunwoodie carborundum was later called.

Through these months the very air was electrically charged, literally and figuratively. The communications achieved with our equipment repeatedly thrilled the natives of far-distant cities and the Navy.

Those early Navy operators deserve utmost credit for the progress American wireless was now achieving. To mention just a few: George Scanlan, until his recent death with "Communications" at Washington; Watts and Sirbeck, of that record-breaking gang at Key West; Mineratti, Eaton, Geagan, Martin, and Cameron at the Washington Navy Yard; and pre-eminent at the Brooklyn Navy Yard was always good old George Davis, who stuck to his wireless work up through United Fruit and Tropical Wireless until he finally became a vice-president of R.C.A. Bless his memory!



CHAPTER 17

Little Old New York

*F*ROM my early Yale days New York City had been to my mind *the* spot for any man who aspired to work among the greatest, the most progressive characters in the electrical industry. Edison had there first introduced his incandescent lamp and built the first electric power plant. The Western Union and the Telephone Company's headquarters were there. The American Institute of Electrical Engineers was made up chiefly of New York men. The two leading electrical journals were published in New York. I had no doubt, therefore, that I must begin my real career work in New York, rather than in Chicago or elsewhere. And as my mind turned to wireless, the greatest shipping port in America seemed the only place for me to begin that activity.

The beauty of New York's skyline as I viewed it daily from the Jersey City ferryboat, or saw it across the bay from Staten Island, was deeply impressive. The feverish activity of downtown New York, where I had tramped searching a rich promoter, had fired me with burning zeal to work amid such scenes

and to conquer so mighty a realm. And when I began to live in that magical city, up on the heights of Morningside, my love for the great metropolis became almost fanatical. I was proud to claim it then as my home.

And those were the days, 1902 to 1906, the "late '90's," as they were later called, when "Little Old New York" meant something, when it still possessed an atmosphere of its own (before the new subway had become smelly from overcrowding); when the old Waldorf-Astoria was in flower, and the Hoffman House, Delmonico's, Rector's, Mouquin's, and Jack's gave service—not mere warmed-over relishes, relics of their ancient reputations; when a meal at Lüchow's* was a gastronomic epic, and the multi-wines of Little Hungary were warranted to put one in phase for poetry and starry-eyed eloquence.

There was more then to New York than "Broadway"—among other things, the old Astor House, famed for its cuisine, and the World's Dome, the loftiest tower in the city. Those were the times when Yale football fans debouched from Peck's Slip under the only Brooklyn Bridge; when John Drew and Maude Adams reigned at Charles Frohman's Empire, Ada Rehan and Modjeska at Daly's; when the exquisite lovelies Lillian Russell, Caroline Myskel Hoyt, and Maxine Elliot were the toast of the town; when Joseph Jefferson, Richard Mansfield, and Nat Goodwin were living billboard names, not memories of greatness long departed; when Fred Stone and David Montgomery in *Red Mill* and *Babes in Toyland* set the town to singing the music of Victor Herbert.

* A historic occasion here was the luncheon served in 1914 in honor of Professor Ferdinand Braun, inventor of the cathode-ray oscillograph tube, who was visiting New York, an important witness in the Fessenden *vs.* Marconi suit over the former's high-frequency-spark patent, subsequently held invalid. Presiding at this luncheon was Judge Julius Mayer who upheld the Marconi contention that the high-frequency spark long antedated Fessenden's work, a decision based largely on the use of such frequencies in my 1901 Armour Institute work, during the 1903 Yacht Races, and at our Key West commercial wireless station.

And away uptown stood Pabst Harlem, where poor Bohemians like me could come of a Sunday night to quaff deep steins of cold amber to the thrilling throbbing of a seventy-piece band playing the music that was music—of Weber and Offenbach, Liszt and Rossini—not, then, the emasculated emptiness of jazz and hysterical syncopation. Ah, those were indeed the days, gone now forever, when “Little Old New York” was one great family, with a name and a song and a family pride!

At this point in my history, when New York was so intimate a part of my life, I find it interesting to note the time curve of my poetic urge during the long years there since I, as a young romantic, left Yale.

During the years from 1902 to 1906 my diary reveals that I missed no opportunity to record the music to which my lonely heart was responding, or which was continually welling up within it. Fervent descriptions of Nature’s loveliness or glory, the River Hudson, the Potomac by moonlight, the ocean at Key West—frequent prose poems descriptive of my surroundings—and other poems, mostly melancholy in their tone.

Intently busy though I was through the fall days of 1902, yet inspired by the romantic setting in which I dwelt on Morningside Heights and by the deep love which I had by no means then forgotten, my poetic instincts were given full sway. One evening as I walked home from the elevated railway station, by which I came up from my little laboratory on Thames Street, or from our offices at 100 Broadway, climbing the steep, winding, stone stairs to Morningside Heights, I set aside all my day’s cares to compose this nocturne.

NOCTURNE

*O star above the western hill!
So soon in shadow hiding,
Whither vanishes thy radiance
So brief-abiding?*

*O gleam of silver in a mountain lake!
Thy moonbeam's silken tent
Holds me in rapt captivity
Of nightly covenant.*

*O fleece of fairy-floating clouds!
White flock o'er starry meadow,
Fain were I thy shepherd,
To fold thee safe in shadow!*

*There through all hours of summer night
The stars entranced creep;
By lake and moonlight peacefully the clouds
Lie down to sleep.*

From that lofty perch it was easy for me to reach Riverside Drive, there to take the long, peaceful, meditative walks which meant so much to me.

In unpacking a forgotten trunk in the new apartment, the old trunk in which I had brought my Responder from Chicago, I found a long-forgotten picture. There surged from the heart spontaneously, this poem:

LOST PORTRAIT

*Passed from my life! It is long years now
Since that day of tears and fond farewell,
Whereon I kissed her lips in pathos of adieu,
In agony no lips can tell.
Passed from my sight! For two years now
I had sealed away the portrait of lost Love,
And steeled my heart against the haunting view
Of eyes where Heaven seemed not fairer, nor above.*

*"Softer than roses' petals, and as sweet,"
The echoes of her voice were always ringing
Through Memory's desolated halls, and bringing
To my heart distress.
Sad with the sadness of celestial grace
Her glance seemed sadly conscious of my fate,
And knowing made more desolate
My utter loneliness.*

FATHER OF RADIO

*Today, as one who in some churchyard wandering,
Finds on a stone a name of long ago,
Thrilling with reverent joy and dread remembering;
Or as an exile on a lonely marge,
Finds driftwood wafted from his native shore—
I came upon her hidden portrait, with the glow
Of tenderness still beaming as of yore
In eyes—how fathomless, star-mirroring!*

*And now the call of woodland voices comes to me,
With perfume of her roses laden;
Half-hidden brooks, with lilting song
(Her voice, tho silenced now so long)
Sing to me all unbidden.
Out from the past a throng of faded memories start,
Memories of smiles and tears, with joy, and sad misgiving!*

*Ah, in this graveyard of my heart
Is that dead love still living?*



CHAPTER 18

Crossing the Atlantic

AT Christmas, 1905, dear old Admiral Manning who personally had taken an extraordinary interest in the early progress of wireless, had resolved on a grandiose experiment, and it was splendidly carried out. His idea was to get in touch with all stations south and north from Washington as the radiating point (Arlington was not yet built)—to broadcast Christmas greetings from the Navy and to receive responses from all stations possible, in the shortest possible time.

A reporting newspaper clipping finishes:

. . . Admiral Manning thinks getting messages across the Atlantic not impossible in the future.

And just to fortify him in his prophecy, on January 3, 1906, "DF" at Manhattan Beach sent the first 2,150-mile message to Curtis and Dorchester, our civilian operators at the newly completed Navy Station of Colón; almost the distance to the west coast of Ireland. This fixed my determination to cross the Atlantic.

During the year 1905 the phenomenal success of our American wireless had become so well authenticated abroad—what with the 1904 work in the China Sea for the *London Times*, the earlier demonstrations for the General Post Office across the Irish Channel, Holyhead to Howth, and now the increasing number of vessels reaching England equipped with the Yankee apparatus—that a group of London financiers headed by Lord Armstrong was persuaded to attempt to introduce the system directly into Great Britain.

Consequently a nightly transmitting schedule for “DF” covering some weeks in advance, was mapped out and entrusted for faithful fulfillment to the hands of “Driver” Harris. Then I set sail in February, 1906, on the old *Lucania* once more for London.

I arrived in London later in February. Horton was on hand to take me up to Oxford and Cambridge, not for another degree, but to inspect the first Yankee wireless telegraph stations on England’s soil. These new stations, already manned by his hand-picked and trained “limeys” exactly resembled those on our Atlantic seaboard, with alternating-current transformers, American Morse key in primary, and electrolytic detectors with head-phone connected to the three-coil slide tuners. All this differed radically from the British “gear.”

But now my thoughts were not on England but the southwest coast of Ireland, the land nearest America, and where it was reasonable to expect reliable kite winds through the spring season. For months prior to this trip I had been watching Professor Alexander Graham Bell’s interesting developments of his tetrahedral cell kite, near what is now Langley Field in Washington. Heavy kites they were, tailless, but possessing astonishing stability and great lifting power. It had then been suggested that using these Bell kites for holding aloft a long antenna wire might make possible the receipt of wireless signals over great distances through

reasonable periods of schedule. Using "Blue Hill" kites, Colonel Squier, at Ft. Leavenworth, Kansas, had been highly successful recently in pulling down our messages from the cruiser *West Virginia* during the aforementioned famous trip of President Roosevelt up the Atlantic Coast. And Professor Bell's kites should prove even better for this purpose.

I had therefore obtained from Colonel Squier, who was ever eager to aid in any new experiment in wireless, a quantity of strong, light, and flexible cable of fine tin-coated steel, stranded about a small hemp core. The Signal Corps had developed this cable particularly for the purpose of kite antennae.

I had also become well acquainted with Dr. Bell's kite expert, "Old Man McNeil," as we all called him. A fine rough specimen he was—a Cape Breton Scotchman with a clear and kindly eye and a tender heart, especially for those little spruce-lined silk-covered tetrahedral cells which only he knew how to construct, cover, and then tie together in light masses, and which could be built up as large as a house if one desired a man-lifter. Surely with such a combination—Squier's cable, Bell's tetrahedrals, and Old McNeil to construct and fly the kites—it should be possible now to go to the southwest tip of Ireland and pull down some interesting signals from 50-kilowatt "DF" at Manhattan Beach. Arrangements were soon completed to borrow from Professor Bell a crateful of cells and McNeil—for a two months' leave.

So now from London with complete receiver kit, McNeil, and his kites, the caravan started for Glengariff, beside the blue Bay of Bantry, Ireland. For a receiver shack we found a small stone dwelling, abandoned but snug, with smooth white walls within. Late each afternoon Horton and I would go out in an Irish jaunting car to our flying field and, if the rain had let up and the wind had begun to blow, we would—with McNeil's advice and help—struggle to get aloft the 5-foot-on-a-side tetrahedral kite, which usually had been assembled in the morn-

ing from the battered wreck of the night before. Too seldom, but occasionally, we would get the kite aloft near sundown, return to our hotel to spend the time until 1:00 A.M. reading in Hume's *History of England*, and then again, if it was not raining, we would climb into our chilly jaunting car and poke along to the schoolmaster's abandoned house on the hill.

And there, all too usually, an anxious pull on the kite string in the darkness would spell the disheartening news that the fickle wind had failed, that the wire lay along the clods, that McNeil's pride could be found next morning wrecked among the stone walls; and that faithful old Harris and his night "op" at "DF" might at that moment be frantically signaling to Mars, but not to us.

One night we came out with hopes high. The wind had kept a steady gale, the kite was tugging hard at its tether; we would certainly copy "DF" this night of our Lord! Mac Horton sharpened his pencils while I tuned for New York. Back and forth moved the three slide tuners, backward and forward, in every possible permutation of combinations. The night was still, and there was no static. I vowed to bring in New York or burst an eardrum. There was no interference, there was no static, there was—nothing. It was too goddam still! Finally I went outside and pulled on the kite wire. Then I came back, and with his newly sharpened pencil Mac engraved on the wall:

Four o'clock, April 1st, 1906. [Note that date!] At 2 A.M. the kite hit the grit; but the Doc was not wise, and tuned steadily for two hours.

And that final experience sufficed us for Glengariff. Horton had to return to his English work. We could no longer flirt with "th'inconstant" wind. Gathering together the remnants of our personal impediments, the four of us, including Mrs. Horton, loaded on a two-horse dray, set out over the highways to Cahermore, some thirty miles farther west from Bantry.

On the road we dusted past some thousands of British tars, reeling back from a pay-day debauch, all of them plastered, most of them drunk, many scarcely able to navigate. Jaunting cars designed for five held nine or ten stews, while other carts overflowed with jellied masses of doughty rum-soaked jackies.

Finally, on high cliffs overlooking the Atlantic, we reached a rambling string of stone houses constituting the domicile of "James O'Sullivan, Esq.," a typical Gaelic-sputtering Irishman. Hailing him, I asked first if the wind blew much in this region. "Wind is it?" he blurted. "Shure we niver have even so much as a whisper of wind all th' year round. Today be the windiest day we see in many a month."

Bitterly disappointed, we prepared to drive on. But when we explained to O'Sullivan that we were looking for a windy spot where we could fly our big kites all the time, day or night, he changed his tune. "Lord bliss ye! We have nothin' but wind hereabouts all the time. This day is the stillest day iver I've known hereabouts. Shure, an' it blows hard here, marnin', noon, an' night, begorra. Yez must stop over awhile, an' I'll prove it to yez. —Molly," calling out his buxom wife, "don't the wind blow hard here all th' time—and yez can depend on't?"

We liked Molly's clean appearance. We could understand her language, which was seldom the case with O'Sullivan. Furthermore, she had lived in Connecticut and could cook Yankee style. So we voted to accept O'Sullivan's latter version of existing meteorological conditions, and forthwith unlimbered our cramped limbs.

More bad luck ensued, until it began to look as though our efforts here would be no more successful than they had been at Glengarriff. Horton was summoned back to London, leaving McNeil and me alone to battle on.

Then one night, April 11, 1906, just about a week after Mac had departed, we got the winds we were waiting for—steady

and strong, from off the wide Atlantic. With blustering aid from the very windy O'Sullivan we got out our last remaining kite at 2 A.M. and sent her aloft without mishap. She went up 2,000 feet, and I tuned in while McNeil was slowly unreeling cable. Here is my last bulletin on that occasion:

Thursday, April 11th, '06. At 4 to 4:05 A.M. static quieted greatly. Heard N.Y. sending. Quite faint, but readable; stopped at 4:05. Tuning on C P.C. (pancake coil C) quite close at 2 div's; A P.C. (pancake coil A) at $5\frac{1}{2}$, 1 V.C. (variable condenser) in antenna—all in (180°). Did not hear N.Y. with this V.C. cut out.

L. DE F.

Had Horton been able to remain one week longer, he would undoubtedly have been able to copy that night the first wireless *messages* ever transmitted across the Atlantic; certainly the first from West to East. The speed of "DF's" sending was far too fast for my fist to follow. But his style of sending was strictly American, and his spark frequency was characteristically much higher than that of the British ships, to say nothing of the splashy "plop-plop" of Poldu. And I got his sign-off. The test therefore, while I cursed my luck that Mac could not have stayed just another week to copy the stuff, was equally as convincing as was the succession of triple dots which Marconi pulled in from a kite string four years before.

But I, not foreseeing the long wind delays and Horton's too early departure, erred in the other direction—messages and press only, and at 25 or 30 words per minute—with no simple succession of dots at all.

However all that water is long ago over the dam and washed out by ten thousand 20-watt oscillating-tube ham sets on both sides of the Atlantic—and the Pacific, and Antarctic oceans as well—with Audion detectors and amplifiers, the latter not even conceived until a half year later.

But strange to relate, although I had tried in every way to keep

quiet the news of my mission with kites to Ireland, I was greeted upon my return to Castletown two days later, en route to England, with a demand from His Majesty's G.P.O. officialdom for information as to whether I had been carrying on experiments for receiving telegraphic signals across "their" (!) Atlantic Ocean by kites or balloons; and if so, by what authority?

I could not suppress a chuckle to think how narrowly our little band had escaped Scotland Yard, as I penned my reply:

CASTLETOWN, IRE.

April 12, 1906

HONORABLE POST MASTER GENERAL

London

The object of my experiments with kites was twofold:

(1) To determine how far kites could be relied upon on these coasts to maintain an antenna.

(2) At what altitude a single wire must be placed to receive messages from a powerful station in New York.

The object of these experiments having been accomplished, they are now discontinued.

While I may be wrong in my ideas of equity and law, it strikes me as strange, to say the least, that objection could be urged to such experiments as I have carried out, with receiving apparatus alone.

I cannot understand why work of such harmless nature, and of such scientific interest and value, should not be encouraged, instead of frowned upon or prohibited, by the officials of England.

Very respectfully,

And so I hurried back to London feeling that I had at least done as much to demonstrate the feasibility of trans-Atlantic wireless telegraphy from West to East as had Marconi four years previously.

Before returning to America, I briefly visited Edinburgh and Liverpool. At Sterling Castle I had a delightful day with Alexander Graham Bell, strolling through the old ruins and meandering across the tourney fields at its base. I briefly outlined to Professor Bell what I had accomplished thus far in the field of wireless, and particularly what McNeil and I had experienced

with the Bell tetrahedral kites in Ireland. He gave me there a beautiful briar pipe engraved "Sterling," as a souvenir of the occasion and of our meeting, a trophy which I have cherished these many years.

An incident of that London sojourn I will not forget, my first and only free-balloon ascension. I was invited to join members of the London Aeronautical Society, under the direction of a Professor Huntington, then recognized as an authority on big wind-blown bubble aeronautics. The ascent was from the suburban field in a strong westerly wind. The giant bag was tugging wildly at its tethers, the tall basket well filled with passengers for—where? Sandbags were too slowly cast off. We arose deliberately, pendulating directly for a lofty church steeple which we missed by inches. Almost could I have grasped Gabriel's crown as we bobbed by.

After an hour's travel we could see the fast-approaching gray waters of the North Sea. The Professor reluctantly opened the gas valve. The sea continued to rush toward us. In desperation Huntington pulled the rip cord. We grounded, fortunately, in a plowed field, basket dragged sideways by the big bag, its halyard-grabbing occupants in a pile-up on the bottom side. Lowermost was the Professor. Someone's hand on the back of his head pushed it under the basket's plowing edge. To me it seemed impossible that a human neck could stretch so far without decapitation as that Professor's occiput plowed the humus. Scrambling farm hands finally stopped the plunging cage, and we birds escaped—the well-plucked eagle with his neck in splints. Literally the good Professor had "stuck his neck out."

Upon my return to New York from England in April, 1906, one of my first calls took me to our New Haven wireless station, where certain necessary repairs or alterations to the newly installed transmitter were being made. These finished, I seized the opportunity to carry out certain tests I had had in mind con-

cerning the directive effects which might be obtained by using a very low horizontal receiving antenna. Taking with me Frank Butler, recently emerged from the torments of Guantanamo, I tied one end of a 50-foot length of antenna wire to a six-foot pole set in the middle of a large vacant lot about five miles from the transmitter. I listened in the receiver headphones located at the pole while Butler, holding taut the other end of the wire, slowly described a circle. The results were astounding, but exactly what I had hoped to find. The direction in which the transmitter lay from the pole could be very closely determined. No signals were received with the wire lying at right angles thereto. The theory of "grounded waves" was beautifully substantiated, and the practical value of the low-lying horizontal wire as a direction finder here again convincingly demonstrated.

Following this work, on June 20, 1906, I filed an application covering broadly the horizontal antenna for sending and receiving—which issued later as Patent No. 1,101,533. A sample broad claim (in Patent Office language) reads:

In a system of wireless telegraphy a substantially horizontal receiving antenna and a transmitting antenna, said receiving antenna being substantially in the vertical plane passing through said transmitting antenna.

The patent also describes and claims the horizontal transmitting antenna in the same plane as the receiving, and having "its generator end nearer to the receiver than its tail end." The patent also clearly illustrates how to utilize the trackside telegraph wires as a wave chute between the transmitter and receiver, using the rails as earth connection. I consider this as having been a basic patent disclosing a method of utmost commercial practicability, one subsequently used by most of the transoceanic long-wave telegraph transmitters.



CHAPTER 19

Conception of the Audion

BUT gratifying as all this was to me at the time, I was far more interested in a little wooden box with which Babcock and I were experimenting in the penthouse lab at "42." Beneath its cover, to be dimly seen through a small glass window, was a tiny cylindrical-shaped lamp, having a carbon filament surrounded by a platinum plate. No one but Bab and I knew the inner contents of that box, or how to connect it to the receiving circuits and to the "A" (storage) battery and the 22-volt "B" dry battery, housed in a separate box. Surreptitiously one night we stole from the lab into the near-by operating room, hooked up the six brass binding posts, connected the headphones, and when Burchard had cleared a certain ship, we instructed him to have that ship "send 'D's' for ten minutes." Then the swift, nervous shift-over from the electrolytic detector to the mystery box.

I listened first, adjusting the rheostat knob on the cover. Then saying no word, I passed the phones over to Bab. A slow, sardonic grin crept over his grim visage. He nodded sagely.

Next we passed the "cans" over to the puzzled Burch. "My God, Doc, hear those signals! What you got in that box?" That I did not disclose; but a few days later the mystery box was a definite part of the receiving equipment at 42 Broadway. *The Audion had been born*—and "the child was doing fine."

Shortly thereafter duplicate, wax-sealed boxes were taken to the Navy Bureau of Equipment at Washington. The Navy would buy anything once in those days! And thus I soon had two Audion detectors in use in naval stations. But for a brief time only. The Navy "ops" would insist on cutting out more and more filament resistance to bring up those DX signals still louder, and out would go the little lamps. They demanded replacements faster than we could supply them. The Chief Clerk was adamant—and skeptical. "No more Audions; use your old detectors." So the Audion incubated for a year, so far as the Navy was concerned.

To understand clearly the sequence of the tube's development, let us retrace our steps a little. During the period 1901-1903 covered in preceding chapters, I was definitely determined to resume my investigations of the gas-flame detector of wireless signals, based upon my original observations in Chicago with the Welsbach gas-burner mantle, a subject which had ever since been in the back of my mind. Accordingly in 1903 I rigged up in the little Thames Street laboratory a Bunsen burner and inserted therein two platinum electrodes, to which were connected in series a telephone receiver and a dry battery. To one of these electrodes I connected an antenna wire running out the window and to the top of a flagpole on the roof. I connected the other electrode to a water pipe for a ground. Then I began to listen for wireless signals from one or two ships which were at that time equipped with wireless in New York Bay. It was not long before I succeeded in obtaining signals, genuine wireless signals, with this gas-flame detector.

This result abundantly justified the faith and confidence I had conceived back in the hall bedroom in Chicago, that a radically new type of sensitive wireless detector could be developed on the principle of using incandescent gases as the translating medium. Here there was no possibility that I was being misled or that the signals which I heard might be the result of any other action upon the gas flame than that of electromagnetic waves—high-frequency currents derived from a distant transmitter. Yet this Bunsen flame was a feeble light indeed for exploring a cavern filled with electronic jewels.

As usual I was so hampered for funds during this period that I could make but very slow progress with this new line of research, continually busied as I was with the absolute necessity of building up, and putting on a commercial basis, the De Forest Wireless Telegraph System.

It was perfectly obvious that the gas flame would be an impractical device on shipboard, so I next sought to heat incandescent gases directly by means of electric current. Babcock possessed a small carbon-arc lamp, and we carried out experiments using this strange device as a detector. It responded to my spark signals too, but was terrifically noisy. We wasted little time on that device.

Our next attempt—to heat the incandescent gases by means of a carbon-filament lamp connected to a storage battery—might be classed as pathetic. Babcock, who shared my eager zeal, also possessed an old Sprengle mercury air pump. We attempted to construct and exhaust our own incandescent lamps by this crude means. Babcock, I found, was only an indifferent glass blower. Our efforts here resulted only in continued failure and disappointment.

Ensued then the Yacht Races, my trips to the West, then England, back to Buffalo, then St. Louis. Not until 1904 could I resume, even sporadically, my pet experiments. Imperative

commercial demands exiled me from the Thames Street lab. But the seed had been sown, gestation started.

I was working in the greatest secrecy at this time because I believed that I had in my little poverty-stricken laboratory something destined to be of the utmost importance in the wireless art. But our repeated failures to accomplish what I was after with our own crude implements and skill finally induced me in 1905 to follow Bab's urgent advice to lay the problem of constructing an incandescent lamp containing a carbon filament and a small platinum plate, exhausted to contain the optimum amount of gas, in the lap of a manufacturer of miniature lamps, McCandless by name, whose shop was not far from mine. McCandless fortunately was an independent and took a sympathetic interest in what I was endeavoring to work out. In very short order he produced to my specifications *the first vacuum-tube detector to make use of two local sources of electric current.*

It was the use of a dry battery in the plate circuit that distinguished my new invention from earlier vacuum-tube detectors, such as the Fleming valve. As related above, the dry battery had been an essential element of all my experiments with incandescent gases. During the time I was developing the two-electrode detector I had never heard of the Fleming valve, and was therefore surprised when I later learned that my invention was being confused with it. The Fleming valve was only a device for rectifying the alternating current generated in a receiving antenna by incoming high-frequency waves. It did not—and could not—do anything to augment the energy of the wireless signals it received. It made therefore a very weak detector.

The Audion, even in its first crude form, was intrinsically very much more than a simple rectifier of high-frequency current. The addition of the plate battery made a great difference in the intensity of the signals received, for I was employing the

high-frequency energy, not to actuate a telephone diaphragm, as Fleming had done, but to control very much larger quantities of energy from the local battery.

Although I now had proof that I was on the right track, I was still not satisfied. My diode detector permitted part of the high-frequency energy to pass to earth through the telephone and battery circuit instead of concentrating it upon the ions between the plate and the filament. To overcome this imperfection and to improve still further the sensitivity of the detector, I wrapped a piece of tin foil around the outside of the cylindrical-shaped glass tube and connected this third electrode to the antenna or to one terminal of the high-frequency tuner. I then realized that the efficiency could be still further enhanced if this third electrode were introduced within the tube. I therefore had McCandless construct another "Audion"—as I now for the first time began to call it.* This new device contained two plates with a filament located midway between them. This detector showed distinct improvement over its predecessors.

It now occurred to me that the third, or control, electrode could be located more efficiently between the plate and the filament. Obviously, this third electrode so located should not be a solid plate. Consequently, I supplied McCandless with a small plate of platinum, perforated by a great number of small holes. This arrangement performed much better than anything preceding it, but in order to simplify and cheapen the construction I decided that the interposed third electrode would be better in the form of a grid, a simple piece of wire bent back and forth, located as close to the filament as possible.

I now possessed *the first three-electrode vacuum tube—the Audion*, granddaddy of all the vast progeny of electronic tubes that have come into existence since.

At this time I was using a 6-volt filament energized from a

* This name was Babcock's invention.

No. 841,387.

PATENTED JAN. 15, 1907.

L. DE FOREST.
DEVICE FOR AMPLIFYING FEEBLE ELECTRICAL CURRENTS.

APPLICATION FILED OCT. 25, 1906

2 SHEETS—SHEET 1.

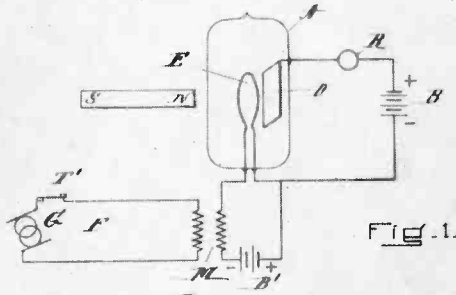

FIG. 1.

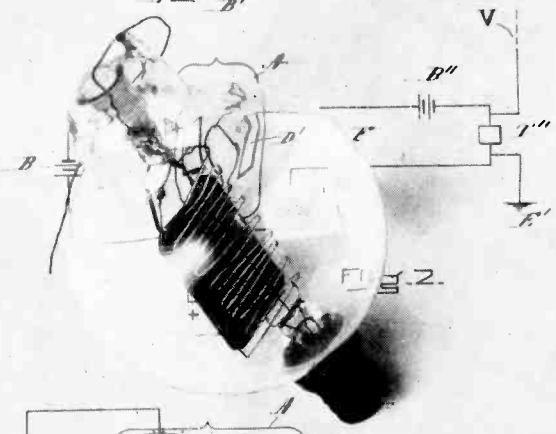

FIG. 2.

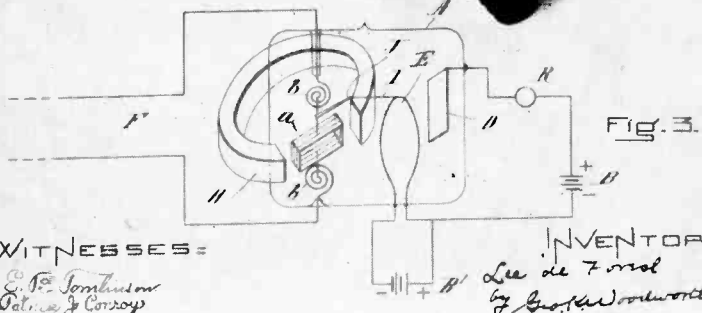
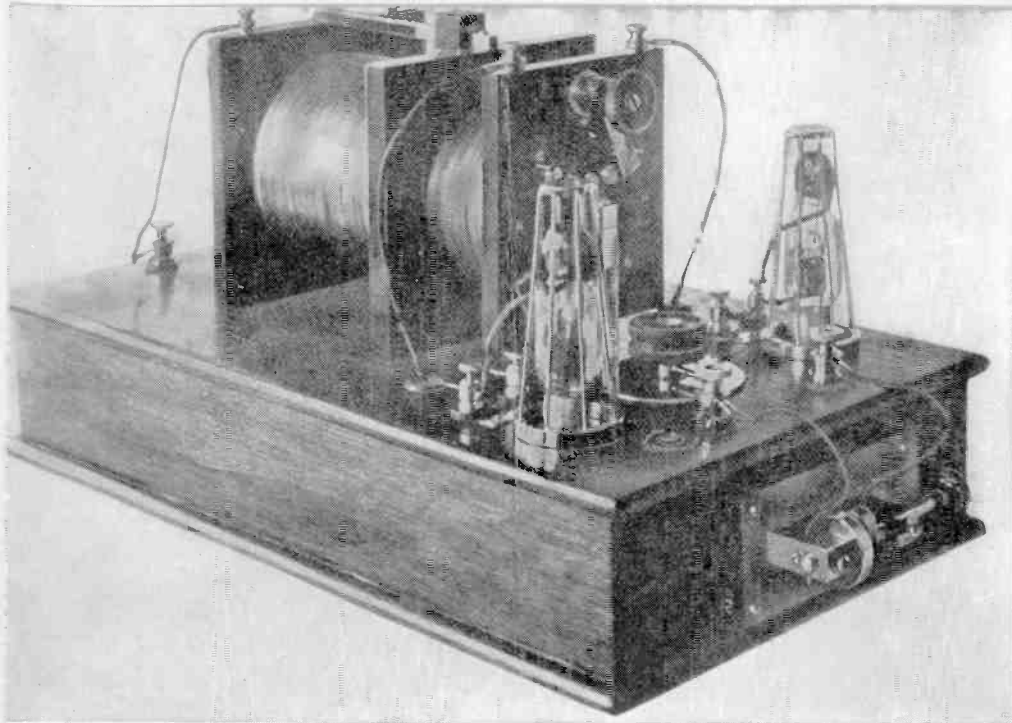

FIG. 3.

WITNESSES:
E. F. Tomlinson
Patrice J. Courroy

INVENTOR:
Lee de Forest
by Geo. W. Woodworth
attorney

Patent No. 841,387, of January 15, 1907, covering the invention of the three-electrode vacuum tube, is generally regarded as one of the most valuable patents ever issued by the United States Patent Office.



Early (1907) type of Audion and tuner

Two-electrode Audion receiver in use at the Key West naval station in late 1906

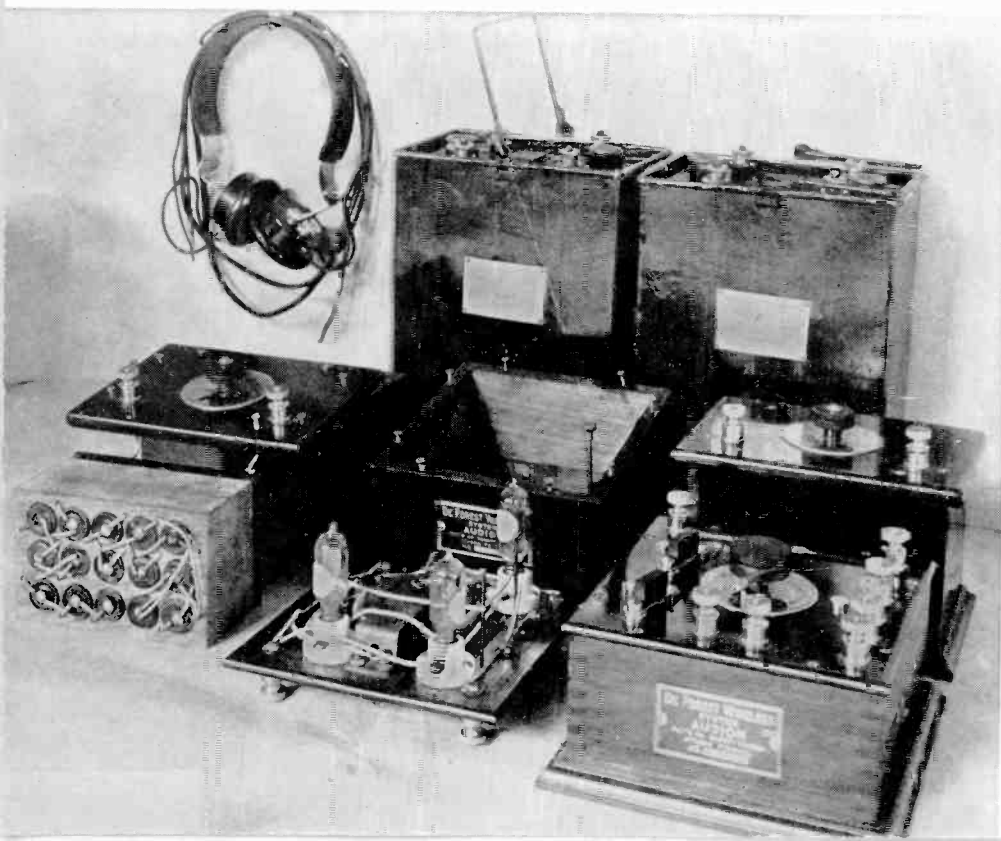

battery (dry or storage) which I called the A battery; the plate battery I called the B battery—terminology which has persisted to this day.

Early in 1907 I conceived the idea that this remarkable wireless telegraph detector—the three-element, or grid, Audion—which had already covered itself with glory in the minds of the hams and wireless telegraph operators—might also be useful as an amplifier of audio-frequency, or telephonic, currents. I had made some experiments in this direction, and took out a patent containing very broad claims on the device as an amplifier of currents without limitation of the frequency thereof. This patent, No. 841,387, granted January 15, 1907, has since been acclaimed as one of the most valuable patents ever issued by the United States Patent Office. The same, of course, can be truthfully said about the patent on the grid electrode, No. 879,532, filed January 29, 1907.

After Captain Darby became one of the directors of the Radio Telephone Company in the spring of 1907, I employed him exclusively as my patent attorney. It was clear to Captain Darby and the promoters that I was building up a really strong patent position, one well justifying their efforts to finance the Radio Telephone Company.

In the summer of 1906, I presented a paper before the American Institute of Electrical Engineers describing the Audion, but only as a diode *using the B battery*. I had not then applied for a patent on the grid, or control-electrode, type, and therefore I made only veiled reference in this paper to it.

In the discussion of that paper, Professor Pupin's only comment was to criticize the name "Audion." "It is," he peevish, "a *bastard* word, 'audio' being Latin and 'ion,' Greek." Yet he could suggest no better word; nor did he see anything of especial interest in the novel device of which I was so proud.



CHAPTER 20

Crash of First Fortune —Founding of Second

I HAD been home from England but a few months when an event occurred which I had been anticipating for years. It is thus described in my diary:

June 26, '06: My old Sheff class of '96 met again at Yale, this time for its Decennial. The reunion was all that could be desired. There was now after ten years far more of the real Yale spirit of fellowship and democracy among our boys than ever existed in college days, or at any previous reunion. President Hadley addressed us as the "Wireless Class," and I was "put up" amid yells! In these ten years since that sad, joyous commencement of mine I have done what I could, although not all I had planned or hoped. It was sweet to feel the hearty handshakes, the frank words of appreciation and pride from classmates willing to honor me for what success I have achieved.

But my joy was short-lived. Soon thereafter grim tragedy was to befall.

Before I had sailed for England I had left explicit instructions with Babcock and others that they were to have a quantity of

the new diode Audion detectors manufactured and to install them in all our receiving stations. This was to be done so that we would be prepared in case the Fessenden patent suit, then rapidly coming to a head, should result in an injunction which would embarrass our operations. Instead of doing this, however (happily for me, as it later proved), the company's directors decided to substitute the Dunwoody carborundum detector, a simple rectifier which had been discovered by General Dunwoody, former chief Signal Corps officer and now vice-president of the company. I had been assured by our patent attorneys, Philip Farnsworth and others, that I could make the proposed trip with perfect safety, that no injunction would be entered, and that if it were they could take care of the situation with my Audion detector.

To my astonishment I now learned that White and Wilson held me, as their chief engineer, personally responsible for the unpleasant situation brought about by the recently issued injunction against the use of the "spade" electrode detector with which all our stations were equipped. Moreover, during the summer of 1906, I found to my indignation and dismay a very definite change in attitude toward myself and my contributions to the company and the art of wireless on the part of White, Wilson, their stock-selling parasites, and Philip Farnsworth, the patent attorney for the company. It appeared that in their reckless sale of stock (their own as well as the company's) the scoundrelly promoters had actually oversold the stock remaining in the company's treasury. I learned now that for some time previously the treasury had been bankrupt. Following an old stock promoter's trick of that day, White and Wilson, it seemed, had connived to organize a new corporation called "United Wireless Telegraph Company," and had transferred to it the assets of the American De Forest Wireless Telegraph Company, leaving all its debts in the empty shell of the old company for the benefit of creditors!

It was flamboyantly announced in the press and in full-page advertisements that a consolidation had been, or was actually in process of being, effected with the American Marconi Company, a statement immediately branded by the latter's officials as one hundred per cent false.

When I learned of this situation, I indignantly resigned and offered to turn back into the stock-empty treasury of the American De Forest Company all of my stock, amounting to some 20 per cent of the entire capitalization. In exchange I demanded only the full rights to any pending Audion and Aerophone patents, \$1,000 in cash, and a general release and quitclaim. Saurian-eyed C. C. Wilson greedily grabbed at this quixotic offer on my outraged part, and Farnsworth (whom I had formerly regarded as one of my best friends) advised the company to accept my proposition, stating that the patent applications in question had *no value*, that my contributions had been negligible from the start of the enterprise!

"Honest Abe" White (who now had again changed his name* to "Abraham Lincoln White") had just pulled off a coup in Union Pacific stock and with his profits had made a fair-sized payment on McCall's huge mansion, "Shadow Lawn," at Long Branch, New Jersey. Thither he now retired with all the unction and high-hat of the *nouveau riche*, whose society he greedily courted. He had turned his back (and his name) on his Texas family the better to mingle with the Russell Sage and Morgan and Rockefeller tribes he so admired.

So while White reveled in gigantic sham at "Shadow Lawn" (where he ultimately cut out and hocked the McCall silver chandeliers and doorknobs during his subsequent submergence—before he for the first time landed in jail), I found myself once again walking the streets of New York, penniless, as I had been five years before. But this time with experience, confidence, an international reputation in wireless—and some certain pend-

* His name was originally *Schwartz*.

ing patent rights—which I had not had when first I came to the metropolis five years previously.

Even before being booted out of the company, I had begun to move my Audion equipment up to a little laboratory on the top floor of the Parker Building, 19th Street and Fourth Avenue. My former laboratory, in the attic of 42 Broadway, near the sending station, was too dark and crowded and too often visited by operators and those sent up from the office downstairs to interview me. In this little laboratory in the Parker Building momentous history was destined to be made, and in its confines I derived great comfort during the revelation of the various villainies which were under way down at 42 Broadway.

For the past two or three years, coincident with my development of the Audion from the Bunsen gas flame, I had been dominated more and more by the idea that the next big development in wireless communication would be the telephone; and I was increasingly resolved to turn my attention to that engaging problem. One motive for this course, as I had often remarked to my associates, was that it would be easier for me to develop a radiotelephone system than to continue my education as a speedy telegraph operator!

Some time previously I had ordered a 5,000-cycle generator, which I now purchased from the company for \$150. It had been my earlier idea to generate therewith a spark with a very high frequency, higher than the most essential frequencies in voice telephony, and to control or modulate the high-frequency energy from this generator, or from the spark gap energized thereby, by means of a microphone located either in the field of the generator, or directly in the ground connection of the radiating system.

I had never used this machine, as I had not then the means for purchasing a motor suitable for driving it; and also because about that time my friend, D. McFarlane Moore, on whom I

had called in his Jersey City laboratory, had informed me that it was not necessary to use the Poulsen arc-in-hydrogen (which was covered by a broad patent) in order to obtain undamped waves suitable for use in wireless telephony. Moore had pointed out that Nikola Tesla in his monumental early volume had, before Poulsen, clearly described the use of a direct-current arc burning in the flame of an alcohol-fed lamp. Moreover, about that same time I had read in some scientific journal in the library that an arc surrounded by an atmosphere of hydrogen had been used previous to Poulsen by P. M. Berthelot of France. It seemed quite clear, therefore, that I could expect to generate undamped waves from the electric arc without necessarily infringing any valid claims of Poulsen's patent.

The thousand dollars which Colonel Christopher Columbus Wilson had given me had been unceremoniously cut in half by the magnanimity (?) of the lawyer whom Babcock had recommended to finish the negotiations with Wilson and to draw up the necessary papers in correct legal form. C. C. Higgins was the immortal name of this outstanding gentleman. Upon receiving Wilson's check, he blandly asked me how much of this he should keep. Without giving me a chance to reply, he said, "I shall take half of it, and if you don't like that I shall take it all." So I decided to like it; and started on my wireless telephone work financed by the sum of \$500, out of which I owed the De Forest Company \$150 for that high-frequency generator!

But I had learned long ago not to let little things like this discourage me from great enterprise.

About this time I was approached by a Mrs. Hogan, who was very desirous that her son, John V. L., might be permitted to work in my little laboratory, as she intended later to send him to Sheffield Scientific School. She wished him to have some introduction to the mysteries of wireless before he matriculated. She showed the greatest interest in and sympathy with me in

the troubles I was then undergoing, and suggested that her husband might be instrumental in raising sufficient funds to finance the new "De Forest Radio Telephone Company" which I already contemplated organizing.

In due time, Mr. Hogan contributed a few hundred dollars to the empty treasury, and John Hogan started in as my first laboratory assistant. Although then in knee pants, he was already endowed with a rich bass voice suitable for broadcasting! Babcock was loyal, and frequently visited me at the Parker Building to give me the benefit of his suggestions and encouragement, as well as the low-down on what was going on at 42 Broadway—which was very "low down," indeed.

With such assistance I was enabled, late in 1906, to design and construct *my first crude carbon-arc transmitter*. I recall that it was on the last day of that year that Hogan picked up in the Audion and telephone receiver across the room the first words spoken into a microphone connected to my arc transmitter, then fed from a 220-volt direct-current source. All my radiotelephone work up to 1912 employed this transmitter.

Shortly thereafter the columns of the *London Electrician* ran a series of epistolary philippics between John Ambrose Fleming and myself. As the fame of the Audion detector's surpassing sensitivity spread in wireless circles, Professor Fleming accused me simply of imitating his valve, disguised under a novel name. To this I somewhat acidly replied, explaining the basic difference between a mere rectifier of received signal energy and a true "trigger" device whereby the incoming wireless signal served as a control over energy from a local battery source, thus producing an enormous increase in signal indication. The Fleming valve merely utilized the received wireless energy itself to produce the signal in the telephone receiver. Later, when he finally learned the function of the grid electrode, the good Professor bitterly strove to identify the valve with the Audion!



CHAPTER 21

Radio and Romance

JANUARY 1, 1907: Two hours of the New Year have already passed. The night without is still and calm, mild in the silver of the southern moon.

A New Year, a new Era, a new Hope has dawned upon my life. The world in the years past has dealt hardly with me, and I have seen hopes fail, friends betray. Courage only and faith in a final happiness have remained unchanged, the unaltered star toward which the world ever points its pole. It is a new thing for me, as new as this New Year (although like another year long gone), to feel the awakening of love. It is a sweet, a solemn thought to find that at last, at last, the long search is ended.

I sought through the world, seeking peace and found none—watching patiently, hoping, postponing—despairing at times of the quest's end. Now Fate, mocking at the wild plans of men, has brought *Her* to my door!

Let this quotation introduce to my life's history the second of my loves, Nora Stanton Blatch. With her mother, Harriet Stanton Blatch, she occupied the apartment directly adjoining mine. Propinquity had brought acquaintance. Through the thin separating wall I had often listened to her magnificent playing

of the piano in her mother's apartment. I found her to be a charming young lady and a recent graduate from Cornell University, their only alumna graduating as a civil engineer. Quite naturally, she became interested in my work. She and her mother expressed deep sympathy upon hearing the way I had been cast out of the company which I had founded.

They grew enthusiastic over my plans for the development of the wireless telephone, as it was then called, and particularly over my ideas of "broadcasting" from some central point in New York, music which could be heard by thousands of listeners all over the city.

The new year and my new work had not advanced far before Nora Blatch and I became tacitly engaged. But it was not until a year thereafter that we were married. My diary of that year is filled with excerpts copied from my love letters to her. There were nightly visits back and forth between the two apartments. During part of this period my mother came down from New Haven to spend a few weeks with me, and there was happy intercommunion among the four.

Nora became extremely interested in my studies. She was then working in the New York City Engineer's offices in connection with the city's new aqueduct project. At her own suggestion she elected to give up this work and take up a course of mathematics under Professor Pupin at Columbia University, the better to understand my work and to become a valuable assistant to me. (This proved to be the first grave mistake we made.)

January 16: You have played the Gladness of Spring into my heart tonight, and into its farthest recesses have crept the solemn, soothing notes of that Nocturne—your "Good Night Song." . . . What music shall we two not learn to hear through the years of the Song which must be Our Life!

You bring out, as my homage to you, all the poetry of my nature, and all that I have been storing away through the lonely years against the time when I could pour it out at your feet. . . . Think then of all the

joy and beauty which we can at random times scatter into the lives of each other, to keep fresh and fragrant our love forever!

Nora devoutly shared my love for poetry. Together we memorized favorite passages. Down the long narrow passageway of my apartment, as we walked to her door in parting, we voiced in unison, from "Ulalume":

"Here once, through an alley Titanic,
Of cypress, I roamed with my Soul—
Of cypress, with Psyche, my Soul . . ."

And surely never was a long narrow alley of a typical "gay nineties" New York apartment used in service more sweet than that!

January 30: And as I love Music more than all other expressions of Beauty so do I love your talent and ability to thus voice to me the passing beauty of your heart and your nature, thereby bringing such new beauty into my life, awakening from its ruins song. Your fingers are the rosy fingers of Aurora at whose touch my Memnon heart breathes music in this new dawn! . . . Now all is silent. You are again in your little room gazing out into the moonlit night. I can hear a stiller, finer music than ever fingers played. It is the love throbbing of your heart.

Dear Orpheane—Goddess where Orpheus was God! The harmonies from his lyre awakened songs from stone—and those from yours cause the stone of my heart to melt, and sing for joy at your music. I sit here amazed, thrilling at the beauty which your fingers summon so fluently to such rich and varied delight. A miracle again! What music do you not create out of insensate material things! Out of the dead unmusical chords of my heart, my whole life will be turned into harmony and joy by your touch. . . . Now the tender strains of your "*Gut' Nacht Lied*," each note a prayer breathing your care, each measure your good-night thought, each bar your kiss of farewell.

That was in a letter to her—and then I wrote in my diary, this:

Ah, you should hear her *play*. It is like the ripple of the brook or the rustle of the summer breeze through the corn, so tender and full of sweet soul. Or it is like the virtuoso's—strong, emphatic, technically excelling. . . . Musical, playing her piano with a skill and a heart which I have never known combined, ambitious, studious, energetic, hard-working,

broad-minded, free-thinking, liberal, yet most certain of herself and her principles—sweet and tender and womanly—such a paragon of all that is to be loved and admired.

Early in February, 1907, I had begun to use my new carbon-arc generator of undamped high-frequency “wireless waves” as a radiotelephone transmitter for the benefit of any wireless telegraph operators who might hear it, asking such listeners to telephone my laboratory in the Parker Building.

Also I had carried a little arc transmitter to the office of the Cahill Telharmonium Company, Broadway and 45th Street, and there energized it from the powerful music currents which they were generating for exhibition and distribution by wire to various halls and restaurants around the city. From my transmitter circuit in their offices a single antenna wire ran up to a flagpole on the roof. By these means I was hoping to show the Cahill brothers that their fine, synthetic, electric music could be widely distributed without wires.

So from both my own laboratory and the Telharmonium Building voice and music were being radiated at that early date. The reports I received from sundry wireless men scattered about the city or on the river, notably from Brooklyn Navy Yard (confirmed by newspaper reports cited hereafter), encouraged me immensely, as my diary here records:

February 28, 1907: Radio Telephony and Telharmony—new, epoch-marking, crowding one upon the other so rapidly, and with such bewildering complexity of possibilities that my mind cannot realize with what wonders I am toiling. There is Music, dearest of the soul's pleasures, created in largesse, broadcast like some merchandise, owned and distributed by a new art, unknown until yesterday. Leaving all its mysteries—physical, electrical, commercial—half realized, dimly comprehended, I rush forward still another bound into the radical future, and seek to transmit these glorious vibrations of sound made by the new electricity, without a medium save that intangible, viewless, bodiless mystery of mysteries—the ether.

March 5, 1907: My present task (happy one) is to distribute sweet melody broadcast over the city and sea, so that in time even the mariner

FATHER OF RADIO

far out across the silent waves may hear the music of his homeland, sung from unseen sources. But the sweetest music of all I hold for myself. That no wireless transmitter shall scatter from me; I have tuned my Audion to that song, and it alone; and it does ever echo to my listening heart a sweeter etheric melody than antenna wire e'er harped to.

These last two quotations, copied from my love letters, are a clear indication of what I was trying to accomplish with the new radiotelephone, to *broadcast* its message and its melody over wide areas, for unnumbered listeners. I cannot, of course, claim that I originated the term "broadcast," but I think that I was the first one to apply so descriptive a term to this new art which I was then beginning to create, and which was destined ultimately to spread over the civilized world.

In this respect I clearly saw the fundamental difference between *radio* and *wire* telephony. The inherent differences in their nature and application were to me so self-evident that the apparent misunderstanding of many of my classmates, to whom I went soliciting financial aid in my new enterprise, was absolutely incomprehensible. When to such I explained my patent situation,* and my ideas of building up a new enterprise differing wholly from the old wireless telegraph art and from the wire telephone, and yet possessing many unquestioned possibilities of great earning power, I was usually met with this question: "Lee, do you mean to say that if I had a radiotelephone in my office I could talk to my home, and that by tuning something I could talk to either Jack McCullough or Bill Pouch?" When I explained that at most only a score of messages could be carried on simultaneously over New York without interference, and that the communication would not be secret, a cynical or pitying smile would spread over the listener's fea-

* At this time I had, pending or issued, some twelve patents outlining and claiming each type of detector, from the open gas flame with two and three electrodes, the arc type, the two-electrode tube with a control electrode outside the envelope, the two-plate-filament type, the grid, and the amplifier for telephone currents. (It has been estimated that the last two have been worth some \$5 billion to licensees.)

tures. And he would say: "Well, then, of what possible use can your 'radiotelephone' be? It can't compete with the wire 'phone, you say, and it can't cover the distances that the wireless telegraph can cover. Then what the hell use is it anyway, Lee?" And so I would go on to my next prospect.

All in all I raised less than \$400 from members of my sapient Yale class—and this simply as loans, granted out of commiseration, and to be rid of my nonsense!

It was all depressingly discouraging, almost as discouraging as the reception I had received in 1901 when seeking to explain the possibilities of the wireless telegraph to the smart, brainy financiers downtown. Had a half dozen of those clever classmates pooled \$50,000 to finance my laboratory work, thereby assuring control of the Audion patents, they would have been worth today, at a conservative estimate, a hundred million dollars per man. But I searched in vain for my "Theodore Vail."

So again I was strapped, hampered, hog-tied, scarcely able to move forward in any direction. Again I was forced to create something from nothing—bricks without straw—lifting myself by my bootstraps, and again starting on a proverbial shoestring. The faith which Nora Blatch, her mother, and a few friends had in me—and above all the glowing love in my heart—were my sustaining comforts. These alone enabled me to plod ahead, to build up a second fortune, to create yet another New World.

March 7: Were it not for the bright light which this wondrous girl throws ever on my soul, I fear to think of my present condition—I might well be on the verge of madness these many months. Not since 1901 have I known such a winter as this, never ending, ever overclouded with storm and gloom. No sooner am I free of one dread, or rid of one enemy, or clear of the blight of one error and mistake, than another horrid shape usurps its place. White, then Wilson, then Higgins—ever-reappearing poverty, debt constantly upon me—the supreme difficulty to get started anew and aright—patent complications and constant drain and continual strain of expense—to create again something from nothing, or with nothing

—to organize a new company, to make a demonstration, meet rent, secure loans, file patents, emerge from one difficulty into another—one foot always sinking into the mire while I struggle to release the other! Oh, when will it all end? When can I be myself and work as I would, and can, and ought? When will this world allow me to earn my way in the fullness of my life, its possibilities, its deserts?

Through it all and over all is her love, and her mother's love, in confidence and aid. Ah, I am blessed indeed by Fortune that amid all this unusual load and battle, and hate of men, this most unusual propinquity and chance has given to me also this Harbor of Refuge.

Our broadcasts were by now attracting attention from the newspapers. The following appeared in the *New York Tribune* of May 15, 1907:

There is music in the air about the roof of the Hotel Normandy these days. A good deal of it is being collected by Lee de Forest's wireless telephone, ready for distribution to possible purchasers.

The power used to transmit the music from the sending apparatus on Telharmonic Hall to the Hotel Normandy was the same used to light an incandescent lamp. Dr. de Forest thought that this would not transmit the music more than a mile at most, but was astonished on Tuesday night when George Davis, chief of the United States Wireless Staff at the Navy Yard, telephoned Telharmonic Hall that the strains of "William Tell" were being mixed up with Naval orders at the Navy Yard five miles away. Yesterday when Dr. de Forest was demonstrating the telephone apparatus, messages from an incoming steamer were intercepted and heard distinctly.

But the above was not the first time the Brooklyn Navy Yard had heard my radiophone. To the best of my recollection that was during one of the earliest tests in February, when I was putting a part of an old speech and some phonograph music on the air. George Davis, chief electrician of the Brooklyn Navy Yard, was then called in by Wallace, one of his operators at the wireless station to listen to the speech and music coming in through the earphones. The operator was of the opinion that he had had a little too much beer at the corner, and wished to have himself reassured. Davis came in, donned a pair of phones,

and soon began to think that maybe he was reaching his dotage a little early. But the thing was a fact and four or five of the operators attested to it. His hearing could not be deceiving him. "De Forest," he thought, "is the only man in town who could be doing such an unheard-of thing." Going on this hunch, he went to the telephone and called my studio.

"Doc, am I drunk or crazy, or are you sending out some talk and music over that wireless of yours?" he asked me. I laughed, told him that I had a wireless telephone working, and asked him how he liked it.

The May, 1907, issue of the *Talking Machine World* quotes me as follows:

I consider wireless telephony more valuable as a commercial proposition than wireless telegraphy. Although the distance between the first stations on opposite sides of the Hudson is only two miles, I believe it would be possible even now to talk with Sandy Hook. Before the end of the year we will be able to talk fifty miles; in five years' time, 500 miles; and in ten or fifteen years, across the Atlantic. [As a matter of fact, this latter prediction was made good in less than nine years.]

The inventor has in mind one use for wireless telephony in New York that will appeal to music lovers. With the permission of the management of an opera house he could carry an opera performance up through the roof, he said, and send it hot off the griddle to people with wireless receivers in their homes.

As I have already related, the financing of my new departure in wireless signaling was beset with all the difficulties which might have been expected. The big guns down in Wall Street being as skeptical as they had been six years previously regarding wireless telegraphy, it proved necessary to look to the public for our financial support. The original De Forest Radio Telephone Company had been transformed into a larger organization, entitled the Radio Telephone Company. Two friends of mine, James Dunlap Smith and J. J. Thompkins, who had been

remarkably successful as stock salesmen for the American De Forest Wireless Telegraph Company had, simultaneously with myself, divorced themselves from the White-Wilson organization, with whose methods they also expressed extreme dissatisfaction and suspicion.

But these men found it desperately hard to raise capital during the early months of 1907, the days of the so-called "Roosevelt panic," when long queues of frightened depositors were lined up in front of some of the leading banks in New York City. Those were certainly anything but "boom" days, and the going was anything but easy for those who were trying to launch this new thing, the radiotelephone, on mundane shores and etheric oceans. However, sufficient funds were finally made available so that I could continue after a fashion my development work in the laboratory.

About this time my old World's Fair operator, Frank Butler, late of Guantanamo, came to New York bringing with him one Roscoe Kent, whose enlistment in the United States Navy had recently expired. These two boys, along with Jack Hogan, swelled my laboratory staff. Two of these are living witnesses of the rather rapid initial development of the three-electrode Audion detector in that tiny laboratory.

That spring I was visited by a magician, Carl Anderson by name, who was interested in staging a little mind-reading act wherein he could, while passing among the audience and asking questions or receiving answers, transmit what was said *sotto voce*—or whisper—by means of a small microphone concealed in his clothing, with wires extending down his trouser legs to spikes in the soles of his shoes. Beneath the aisle carpet were to be laid two sets of copper strips, the ends of which would be connected through a battery to a headphone concealed under the hair of his assistant, a lady standing or seated upon the stage. All his attempts to accomplish this so far had been futile, due to

the extremely weak signals received. He realized that a telephone amplifier would be necessary between the microphone and the receiver. He laid his problem before me.

I reasoned then that since the Audion was a very sensitive wireless telephone detector, it might also be adapted to serve as a wire-telephone amplifier, or repeater. I made some experiments at that time along these lines, and the results, although not very satisfactory to Professor Anderson, convinced me that the little Audion was actually a telephone repeater as well as a detector of radio signals.

In July of that year, Commodore W. R. Huntington of Elyria had become interested in the project of equipping his yacht *Thelma* with our radiotelephone for the purpose of reporting the regatta of the Interlakes Association during the week of July 15-20. Excepting ferry tests on the Lackawanna, the *Thelma* was the first craft in the world to be equipped with the radiotelephone. Butler and I went on to Put in Bay to install the equipment. During the races the *Thelma* followed the competing yachts around the course and graphic accounts were telephoned to the shore stations exactly as the event occurred.

"It was astonishing to note the clearness and fidelity of the reproduction," states the *London Electrician* of August 23, 1907, in reporting the event. The greatest distance at which the reports from the yacht were heard and recorded was four miles, which was considered remarkable in view of the low height of the *Thelma's* spars and the power of her transmitter.

So enthusiastic was I now over the possibilities of the radiotelephone, based chiefly upon the success which we had had in Lake Erie, that I stopped off at Elyria, Ohio, to call upon my old friend of the Western Electric days, W. W. Dean, then president of the Dean Telephone Company, manufacturing independent telephone equipment. It seemed probable that I might get his company interested in the manufacturing of radiotele-

phone equipment for us. I foresaw that the time was not far distant when there might be a great demand for such equipment, better made and in larger quantities than our own organization could expect to produce.

Dean was exceedingly interested in what I told him, and showed great pride in the fact that his young laboratory assistant of seven years ago had achieved so much in the development of the new art of wireless signaling. However he was very skeptical as to the future of the wireless telephone and of its acceptance by the public. He pointed to the not-too-large office in which we sat and said, "You could put in this room, de Forest, all the radiotelephone apparatus that the country will ever need!"

My letter of September 10th to Nora explains much, briefly:

Only a few months more and I will have my debts paid off. I will have this company in an assured position. I will have definite prospects which will warrant you in making me the happiest of all men—by fixing in January (possibly on that love-fraught anniversary of our hearts) the day for which I have so long been pleading, towards which I have been so long bending in my certain course. . . . I feel drowning beneath the great sea of sleep and weariness tonight. Good night, dear Wife-to-be.

The radiotelephone work which we had been doing during the spring and summer, and especially that at Put in Bay, had been closely watched by the U.S. Naval officers in Washington, notably Admiral Evans' staff. The following item appeared in the *New York Herald* of Saturday, September 8, 1907:

Wireless telephones are to be installed on the battleships *Connecticut* and *Virginia* of the North Atlantic Fleet, and before the warship armada sails for the Pacific the entire Fleet will be equipped.

This is attracting great attention, and is a departure almost as important as installation of wireless telegraphy on American ships. It is expected that the captains of the Fleet during their voyage will be able to converse with one another as readily at a distance of between five and ten miles as from one bureau of the Navy Department to another.

The equipment was put on board the battleships in the Brooklyn Navy Yard, and final tests were made on the eve of the ships' departure for New England waters. It was on that occasion that the first human voice actually sang into the radiotelephone transmitter. A handsome contralto singer by the name of Van Boos was invited to my laboratory to sing. The song she selected for this occasion was, "I Love You Truly." It was heard by operators Smith and Wallis in the Brooklyn Navy Yard.

During the test between the *Connecticut* and the *Virginia*, speech records of twenty-two miles were established. Admiral Evans came on board the *Connecticut* and showed a keen interest in the telephone installations. He was so impressed by the success of our tests that he issued peremptory orders that his sixteen battleships, six destroyers, and two auxiliary vessels should all be equipped with the radiotelephone before they left on the world-circling cruise.

The Navy gave us an almost impossibly short time in which to manufacture and install this apparatus. Never had my laboratory forces worked so feverishly, day and night, without respite, almost without sleep, to meet the tough requirements. When the last equipment was finally crated, several of the laboratory staff accompanied me to Hampton Roads to make the installation.

The six destroyers were to sail first, so all hands concentrated on that squadron, the *Whipple*, *Truxton*, *Lawrence*, *Hull*, *Hopkins*, and *Stuart*. There was no time whatever after the installations to instruct the operators in the proper handling of the apparatus. In fact, some of our men were carried down the Bay, put in the last licks en route, and were returned to headquarters by Navy tenders. Inevitably, the operation of these hurriedly installed radiophones by green and uninstructed men gave very poor results.

With the battleships we had a little more time. But here, for some strange reason (or unreason) the Navy authorities had decided to install this delicate apparatus out of doors on the bridge, where it would be exposed to the vagaries of the tempest and drenched with salt spray! This announcement was disheartening to me. I well realized what it meant; but there was no appeal. Carpenters were summoned to construct the necessary cabinets for housing the apparatus on each ship's bridge.

And here again little time was offered for instructing the operators in proper manipulation of the new apparatus. The results obtained therefore were what could have been foreseen. Those ships where the apparatus was in charge of well-trained and intelligent, co-operative operators gave a good account of themselves during the trip. On other ships the installations were practically useless.

From the *New York Globe*, December 3, 1907:

In the early days of wireless telegraphy Dr. de Forest was in the forefront, showing its practical use in the reporting of a contest for the American Cup between the *Shamrock* and the *Columbia*; and his enthusiasm of those days is fully matched, if not exceeded, by his enthusiasm of today, when he has accomplished something more marvelous, and most extraordinary in its simplicity. . . .

Rear Admiral Evans is a very busy man, but he found time to talk with enthusiasm of the innovation. Said he, "If there is one thing more than another in the Fleet of which I am proud it is the wireless telephone. There you have a triumph of the arts of peace playing a part with the instruments of war. One can hardly realize such a thing as a wireless telephone.

"The sailing of the Fleet and the flotilla of destroyers will mark a new era in maritime communications and is just ground for pride to every American that the United States Navy is the first to adopt and demonstrate this new method, and on such a comprehensive scale." [Would that good old Bob could have lived to see his Navy's radiotelephone service today!]

Immediately after the Fleet had passed out of sight from the Norfolk Cape, I turned my attention to the installation for the

U.S. Signal Corps of two radiotelephones, one at Fort Monroe and the other on the mine-planter tug *Ringgold*. The tug *Ringgold* towed the targets in practice, and it was the purpose of the Signal Corps to report immediately the results of the shots observed on the *Ringgold* during target practice. These installations, the first radiotelephones purchased by the United States Army, also met all test requirements.

Ah, those days and nights, week in and week out, while twenty-six sets were building and testing! Life was hard and relentless through those weeks. Love had little chance to thrive during the race with time to equip the Fleet at Hampton Roads. My impaired capital of strength and courage was drained to the last degree. Small wonder if the letters between my Love and me were not of the old type always. But love triumphed, and when at last on December 18 I almost staggered from the train at Jersey City, my dear one was there to greet me, while I was almost too weary to realize the good fortune I had won.

Then came a happy Christmas, Mother and Charles there with me, and the other family nearer than ever before. Then came tedious days of anxiety and waiting. During a fortnight spent in Chicago I received the stunning news that the Parker Building had been destroyed by fire, that the irreplaceable, invaluable samples of my early Audion tubes, outlining all its development since 1905, had been destroyed. I returned to New York to find that a temporary laboratory had been again set up in a loft on 14th Street, where my chief assistant, Leon Thomas, was doing his best to gather up a few remnants and organize the continuation of our work.



CHAPTER 22

Radio Invades Europe

THE Radio Telephone Company owned all of my U.S. patent rights. All the foreign rights belonged to Captain Darby and me. Before the Parker Building fire he and I had planned that I should travel early in 1908 to Europe to try to interest foreign capital or governments in the new radiotelephone system and in my recently filed foreign patents. Therefore, following the Fleet installations, as soon as I saw that the American company was prospering, under the capable management of Smith, Darby, and Thomas, I seized the opportunity to assemble two complete sets of radiotelephone instruments, transmitters, and receivers, and to make the trip a combination of business and honeymoon. My wife was to be my highly capable assistant.

On February 14, 1908, Nora and I were united in marriage by a justice of the peace at Greenwich, Connecticut. Following the wedding reception in my apartment, at which my wife (Ah, that word had meaning now!) was radiantly beautiful in a

gown of soft, pale blue, we ran away to a downtown hotel. Next morning in a cold, dreary rain we embarked upon the *Carmania* for Liverpool.

From Liverpool and London we went almost directly to Paris. The extraordinary amount of publicity which had appeared in the American newspapers concerning the equipment of Admiral Evans' around-the-world Fleet with the radiotelephone had aroused great interest in Europe. There had been some correspondence with the French military officials in Paris, and Nora's uncle, Theodore Stanton, who lived in Paris and was a close friend of the then French Minister of War, General Pi-quart, had obtained permission for us to make a demonstration of the new radiotelephone at the Eiffel Tower military station.

Considerable delay ensued before the apparatus passed through the French customs and was finally installed in a little wooden shack about two hundred feet from the southeast corner of the Eiffel Tower. There Colonel Ferrié, Chief of Radio for the French Government, an eminent scientist keenly interested in what I was attempting to accomplish, cordially extended to us every facility within his power.

At that time he was conducting most of his radio experiments and tests, using an antenna which ran up only to the first platform of the Tower, about a 125-foot elevation. The long main antenna from the top of the Tower was brought down to an entirely different station from the one where we installed our apparatus. Tests were to be carried on between the Eiffel Tower and Mont Valerien.

Satisfied with the results of our demonstration, Colonel Ferrié informed me that I would be allowed to use the main antenna, which ran almost to the top of the Tower, for the purpose of making long-distance radiotelephone tests. The night of the big test arrived; all that night Nora and I stayed at the transmitter, feeding records to the phonograph which was modulat-

ing the carrier current by means of a carbon microphone connected in the earth lead of the secondary circuit. Early in the morning, near dawn, we returned to our hotel to await results. Reports showed that we had been heard at many stations at distances up to 100 and 150 miles from Paris. Two days later, however, I was officially informed that my radio music had been heard on the Mediterranean Coast near Marseille, a distance of nearly 500 miles. This news was indeed cause of happiness and rejoicing.

And to cap the climax, I received the following cablegram from New York: ITALY ORDERS FOUR SETS SHIPMENT MARCH 25 REMAIN THERE TO INSTALL DARBY

As soon as the reports from the Eiffel Tower demonstration were received, we packed up the "cold cautery," or "radio knife"* apparatus which I had brought with me from New York, and traveled to Berlin—my first visit to Germany.

When we reached Berlin, Kaiser Wilhelm II was then at the apex of his power. Berlin was a magnificent and friendly city, and we found living in Germany at that time wholly delightful. I began active negotiations with the Lorentz Company for the sale to them of my German patent rights, and made a demonstration of my "radio knife" to a Berlin manufacturer of therapeutic apparatus.

Their engineers expressed great interest in this new applica-

* The "cold cautery," as I first styled it, had been discovered early in 1907 in the little Parker Building lab. During early experiments there with the carbon-arc generator of undamped oscillations, I had accidentally touched a finger to the end of a fine wire connected to the secondary coil of my radiotelephone transmitter. A deep cut by burning instantly resulted. But there was no blood from the cut. The sides of the gash were seared, cauterized, exactly as if made by a surgeon's white-hot cauterizing knife. Yet the wire itself remained cold. Realizing that this thing might be of interest to surgeons, who well knew that the sight of a white-hot cautery badly frightened the patient, I telephoned a classmate, Dr. Norman Ditman, skilled surgeon at St. Luke's Hospital. Dr. Ditman and two associates were so impressed by experiments they conducted on an anesthetized dog that they insisted I loan the generator to the hospital for actual use. There a number of typical operations were performed. The success of the "cold cautery" was immediate; a medical society paper on its promising characteristics appeared shortly thereafter. I applied for a patent which soon issued claiming very broadly the "cold cautery" principle.

tion of electrical currents in surgery, and inquired if I had ever applied the high-frequency undamped wave currents to electrotherapy purposes, such as diathermy. I confessed that I had never heard of diathermy at that time. Not until 27 years later did I actually engage in that pursuit, diathermy. The only source which was then known (in 1908) for producing undamped high-frequency electrical currents, the arc in hydrogen vapor, was very poorly adapted to be included in a physician's armentarium, either for surgery or diathermy.

During that visit to Berlin I had the opportunity of becoming acquainted with many eminent German scientists particularly interested in the wireless-telegraph field. Among these were Dr. Paul Zenneck (the well-known author in the field of "*Drahtlos*"), Dr. Heinemann, Dr. Ernst Ruhmer (who quite recently, by employing a Poulsen arc, had succeeded in telephoning some ten miles across the waters of the Wannsee near Berlin), Dr. Wolf of the Lorentz Company, Graf Arco of Telefunken, and most especially Dr. Georg Seibt, a brilliant, rising young German physicist, one possessing pronounced ingenuity, and who at that time was busily at work on the new system of "quenched-spark" radiotelegraphy, using the principle discovered by Dr. Max Wien of Vienna.

In his laboratory Dr. Seibt showed me some most interesting experiments, convincing proof as to the remarkable efficiency of the quenched spark combined with a high-frequency (500 cycles) alternating-current source. I at once realized that with the efficiency of this combination, and the comparatively high selectivity which the quenched-spark radiotelegraph offered, as compared with the other types of spark telegraph, it should not be difficult for my Radio Telephone Company in America to enter into the wireless-telegraph field, as well as that of the radiotelephone. I began, therefore, lively conversations with Dr. Seibt relative to his transplanting himself to my New York

laboratory. He became favorably impressed with the idea, and we left the matter open for further negotiations.

Shortly thereafter Nora and I journeyed to Milan and Spezia by way of the Saint Gotthard tunnel and the ragged, precipitous, be-tunneled littoral of the Italian Riviera. In Spezia we met difficulties galore. Neither Nora nor I spoke Italian, but with her command of French we managed to get along very well.

We remained in Spezia testing and demonstrating the radiotelephone under all sorts of conditions for nearly five weeks before turning over the equipment to the Italian officers. Then on to Rome, for well-merited relaxation and vacation. There again we were beset by reporters from the Rome newspapers, which notwithstanding their natural predilection for Marconi, printed long and enthusiastic reports of my work on Admiral Evans' battleship fleet, my work in Paris, and finally my work at Spezia.

We remained in Rome until we received the check from the Italian Government for the four installations at Spezia, paid to us despite frantic protests on the part of Marconi's representatives. His representative in Milan, Signor L. Solari, judging from a one-column outburst appearing in the *Tribunal* of June 9, 1908, evidently underwent a mental derangement over the stories appearing in the Rome papers regarding the recent success in Spezia. (This was long before the Fascist censor was on the job!)

For many past years I had passionately admired Poe's poem "The Coliseum." When I knew that I was actually to behold that magnificent ruin, I addressed myself to the benign task of thoroughly memorizing those stirring lines. So here in Rome, when I first entered the ancient amphitheater, I left Nora seated in the cab, clambered over wrecked tiers and broken buttresses up to the topmost ledge—where all its impressive vastness lay

outstretched below me—and there, aloud, declaimed slowly those perfectly befitting lines:

“Type of the antique Rome! Rich reliquary
Of lofty contemplation left to Time
By buried centuries of pomp and power!”

And on to the end of that inspiring poem.

Thus did I make of that lone moment of solitude one of deepest reverence, truly a worshiper at the most affecting ruin which man has ever created—and despoiled. It was an hour to which I had long looked forward—a profound realization which I have long remembered.

On my return to Paris I devoted my chief attention to demonstrating the radio knife, which I had then received from Berlin, before a number of interested French surgeons. It was finally decided that I should leave the apparatus at L’Hôpital St. Louis, where it was later used in a large number and variety of surgical operations—in use until one overenthusiastic young French surgeon, cutting too recklessly with this new electrical scalpel, severed a large artery of his patient, causing the poor creature nearly to bleed to death.

The difficulty at that time with the radio knife (or cold cautery, as I then called it) lay not with the implement itself, but with the crude form of undamped-wave generator then necessarily employed. It was not until years afterwards, when the oscillating three-electrode tube was in operation, that the radio knife for deep-cutting purposes was able to prove its immeasurable value to modern surgery. And by then my basic patent had nearly expired.

Early in June of 1908 I returned alone to New York, while Nora remained for a long visit with her English relatives at Basingstoke.



CHAPTER 23

Radio Resurgent

I WAS delighted to find that the Radio Telephone Company had made good progress during my absence. The treasury was well stocked. A fine new laboratory had been opened up on one of the upper floors of the new Terminal Building at 103 Park Avenue, on the roof of which was then being erected a fine steel tower with wooden mast atop, 125 feet above the roof. Under these conditions I resumed work with a vim, my first efforts being directed along the line of improving my arc transmitter to obtain more power—by immersing it in steam instead of an alcohol flame. I devised a very simple method for generating the steam atmosphere right at the arc itself, by making one of the electrodes in the form of a thin, rotating copper disk with its lower edge dipping into a pool of water. From this pool the edge of the disk picked up sufficient water to form a constant source of steam, through the heat of the arc, as the upper edge of the disk passed under the other electrode. When 500 volts of direct current was supplied across this steam arc, powerful, but not strictly undamped, oscillations were generated.

While this type of arc was noisier at the receiver station than was the carbon copper arc in alcohol flame, we found that the power radiated was much greater than we had ever obtained before. I began then to design and build larger and larger steam arcs of this type, totally unaware of the fact that in the little Audion tube, which I was then using only as a radio detector, lay dormant the principle of *oscillation* which, had I but realized it, would have caused me unceremoniously to dump into the ash can all the fine arc mechanisms which I had ever constructed, a procedure which a few years later actually took place all over the world!

In Berlin I had observed that Dr. Georg Seibt and others who were then working on the quenched-spark principle had completely abandoned the old-fashioned Leyden jars as condensers for their transmitters, and were chiefly using a new type of glass-jar condenser invented by Moskicki, a Polish savant. (He later became an honored President of Poland.) These condensers were then being manufactured in large quantities at Freiburg, Switzerland.

Arrived in New York, I promptly began negotiations with the Moskicki firm, and without much delay or difficulty was able to arrange a tentative contract permitting our manufacture of this new device in the United States and Canada. Inasmuch as the process of silvering the internal and external surfaces of the long Moskicki glass tubes was a delicate and involved one, requiring very careful manipulation and skilled understanding, it was at once evident that some engineer from our force must be sent to Freiburg, Switzerland, for an intensive course of study of this new process. Nora Blatch de Forest was the ideal person to send on this mission. The idea, as explained to her by our correspondence, appealed to Nora. Without delay she arranged to journey from England to Freiburg, where throughout the summer she made an intensive study of every detail of the opera-

tion of constructing, assembling, and testing the new Moskicki condensers.

How this letter rejoiced my lonely heart that summer:

FREIBURG, SWITZERLAND, August 12th, '08.

There should be a full moon in the sky tonight, but he has hidden his face. Perhaps he has lost a day in his life too, but a day does not mean much to the moon, for he lives almost forever. How I wish we did too. I know I'd never tire of living with you, nay, not for one thousand years.

As it happened, I had occasion to rejoin Nora sooner than we had expected. The success of the radiotelephone, first on Admiral Evans' ships, then from the Eiffel Tower, and later on the four Italian war vessels, had aroused great interest throughout Europe, so that now even the lethargic, unemotional, and slow-moving Lords of the British Admiralty reluctantly condescended to purchase for trial two of my radiotelephone outfits, conditioned upon satisfactory tests on board the old school ship *Vernon*, lying in Portsmouth Harbor, and on the cruiser *Furious*. This necessitated my return to England in September.

The success of our tests at Portsmouth was best described in the *New York Commercial* of October 2, 1908:

LONDON, October 1—Dr. Lee de Forest, working on instructions from the Admiralty, has just concluded very successful tests of wireless telephony between warships and Portsmouth Harbor. Dr. de Forest operated the transmitter on board the cruiser *Furious*, while Mrs. de Forest was at the receiver on the school ship *Vernon*. More than fifty miles separated the two ships. As a result of the tests, Admiral Gamble, who superintended the experiments, has recommended that the Admiralty install two complete sets of instruments.

The following translation of an article appearing about this time in an issue of the *Berliner Beobachter* is of especial interest, as indicative of how even then I missed no opportunity of spreading my conception of the future mission of the new radiotelephone—broadcasting:

THE WIRELESS OPERA

The newest development in the rapidly expanding field of wireless telephony is the "wireless opera." Lee de Forest, the English [sic] inventor of several systems of wireless telegraphy and telephony has now the intention to enthuse the utmost important personages in London with his plan to transmit an entire opera by the aid of wireless telephony to an unlimited number of listeners.

Every man who dwells within the radius of thirty English miles of Covent Garden Theatre will be able to hear the opera within his own home by wireless. The apparatus necessary therefore is so cheap that every person can purchase one. The cost of the transmission which will be imposed on him during the opera season will not exceed 4 marks monthly. [Here was outlined my idea of how radiobroadcasting would be financed; the British Government subsequently proceeded exactly along those lines.]

One of the greatest thrills I ever had was to read in the *Pottstown (Penn.) Ledger*, October 23, 1908, the following from an interview with Marconi:

Going back to my own hobby of wireless communication, I want to say that we shall not have long to wait for the wireless telephone. De Forest and his colleagues are doing great things in that direction.

Shades of Hertz and Maxwell! I had never expected a tribute like this coming from Marconi! Honored be his memory!

The remaining months of that year, following our return home, were exceedingly busy. The business of the company had outgrown the manufacturing facilities of my laboratory, so a Newark factory was rented, including a large annex for the manufacture of the Moskicki condensers. Pending the completion and equipment of that factory Mrs. de Forest went to work alongside of me in the laboratory on Park Avenue.

This continual propinquity, at home and in the office, where we were engaged in almost identical tasks, proved to be a grave mistake—the first flaw in the texture of our love, the first rift in the lute. There was music still, but played mostly on the black keys.

Naturally, I was working under great stress and drive on my various improvements in the radiotelephone transmitter and the Audion detector and amplifier, training my men and looking sharply after a thousand pressing details. The results of such tension were bound to react unfavorably on one of somewhat similar traits, and especially one filled with the instinct and yearning to work independently away from constant domination. To Nora I soon became her ball and chain.

The gratifying success of our long-distance tests from the lofty antenna on the Eiffel Tower in Paris had convinced me that it should soon be possible to telephone from Paris to New York without wires. Nearing completion at this time was the lofty tower of the Metropolitan Life Insurance Company, by far the highest structure in the city. I resolved that if I could capture that tower, thereby nearly duplicating the antenna height which I had enjoyed at the Eiffel Tower, it should be possible to span the Atlantic with the human voice. The transmitting station was installed in a penthouse on the roof of the old Metropolitan Life Building at the corner of Fourth Avenue and 23d Street. From that roof the antenna stretched up to the lantern balcony of the new tower, a distance of some 750 feet.

While I devoted most of my time to the growing problems of the Metropolitan Tower installation, the almost continual daily tests from the Park Avenue Terminal Building—including the transmission of voice and music to all who had receivers to hear—acted like sun and rain upon the growing crops in spring. Enthusiastic listening “hams” began springing up all over southern New York and eastern New Jersey.

About this time E. J. Simon, a young Columbia graduate, who was madly enthusiastic on the subject of radio—his sparkling black eyes radiating continuous and contagious enthusiasm whenever we discussed his favorite subject—became a fixture in my

Another early type of Audion tube. The doubled plates and grids are plainly visible.

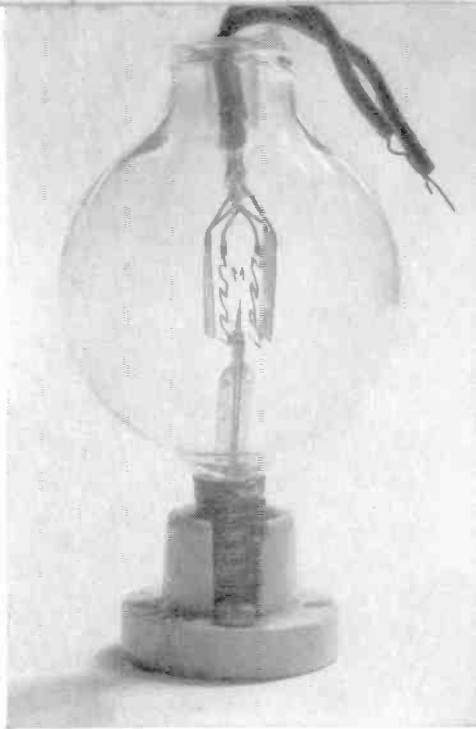

The first radiotelephone transmitter and receiver (1907), using Audions in the receiver and a carbon-arc generator in the transmitter. The use of the Audion tube as a generator of radio waves did not come until later.

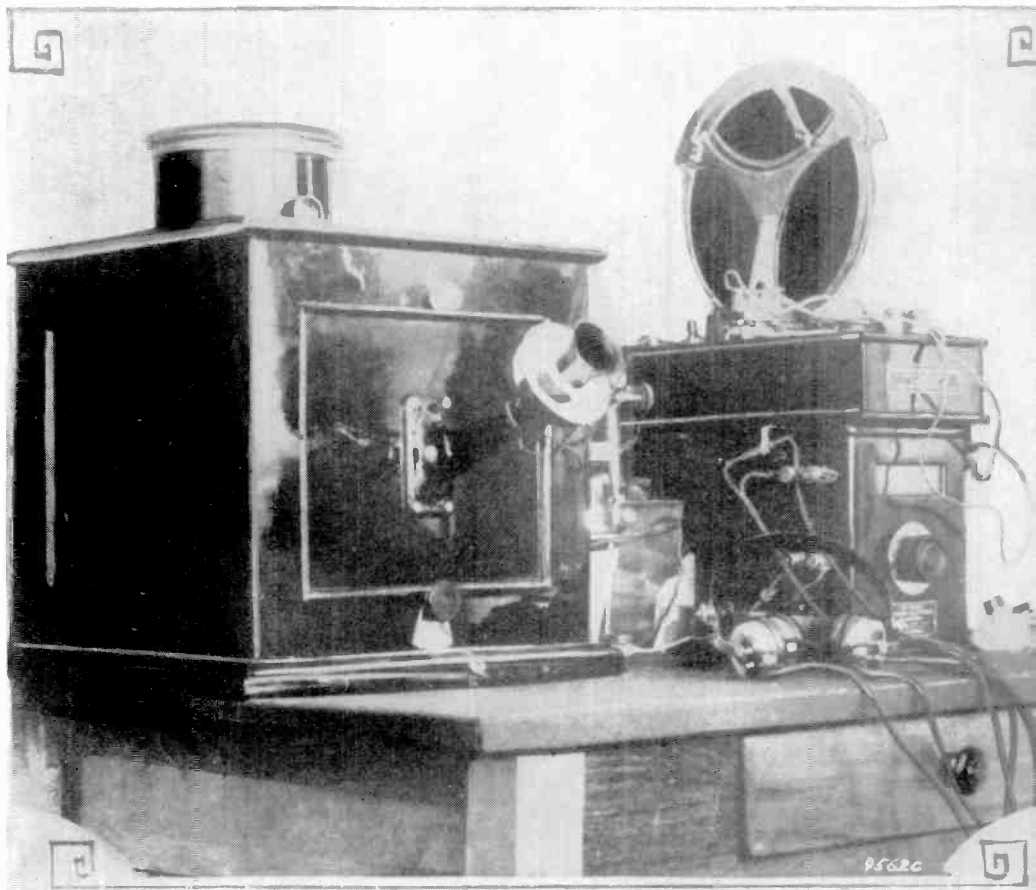



Radiobroadcasting began in 1907 with the voice-and-recorded-music programs which Lee de Forest put on the air from his Parker Building laboratory in New York City.

One big milestone in radio history was reached when the United States Navy installed de Forest radiotelephone equipment on the entire North Atlantic Fleet prior to its globe-circling cruise in 1908.

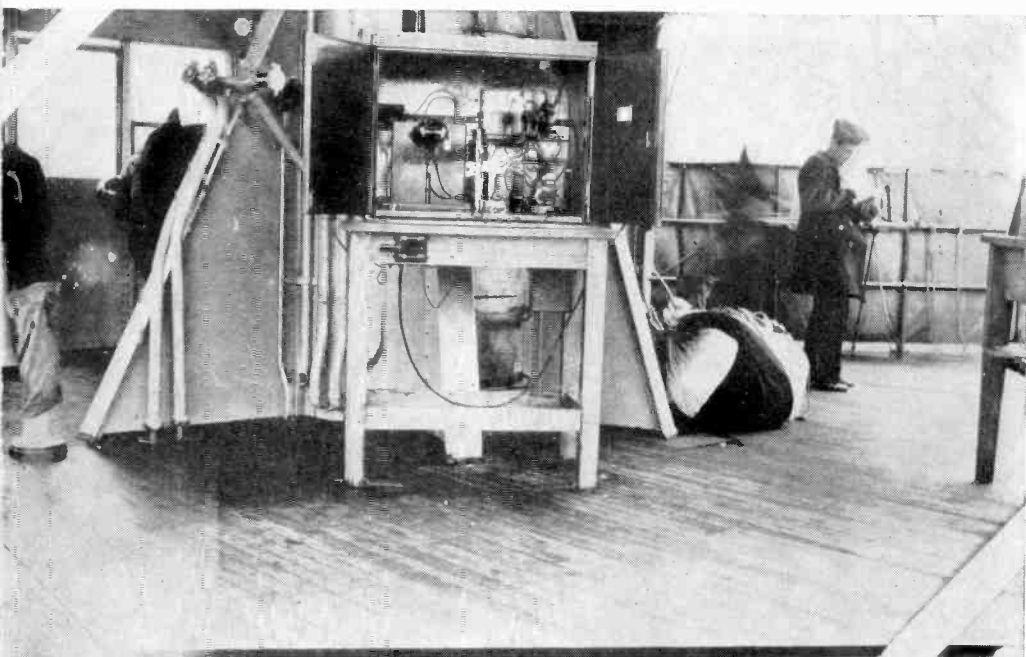

DE FOREST RADIO TELEPHONE INSTALLED ON UPPER BRIDGE, U. S. S. "RHODE ISLAND."

laboratory. Shortly before this the Stone Telegraph and Telephone Company of Boston had been compelled to terminate its activities, and some of Stone's best engineers now came with my company. Foremost of these were Frederick Kolster and Oscar Roos. So when Dr. Georg Seibt arrived from Germany about the first of January, 1909—at my urgent invitation—a highly skilled and competent organization had been built up. A little later we were joined by M. Giles, an engineer from the Moskicki factory at Freiburg, Switzerland.

We busied ourselves in the development of the quenched spark for wireless telegraph (on which Dr. Seibt and Emil Simon concentrated especially); the improvement of our "synchronizers," or tuning devices, to aid in elimination of interference; the manufacture of transmitting and receiving equipment at the Newark factory; the installation of new stations going up on the Lakes and elsewhere; and the training of competent operators to be put in charge of those stations.

In this Metropolitan Tower transmitter room I devised the first "grid leak," connected between the grid of the detector Audion and its filament—a graphite pencil mark on a strip of paper laid over a piece of hard rubber between two small binding posts.* We soon began to sell this simple device, the first of today's "painted circuit" components, to our "ham" customers. This proven early date of the grid leak enabled me later to invalidate the basic patent thereon of Richards of the American Telephone and Telegraph Company.

On the ninth floor of the Metropolitan Life Tower we now opened a suboffice devoted wholly to the display and sale of amateur radio-receiving apparatus and parts of our own manufacture. This was the first office or store in the world devoted

* The purpose of this device was to drain off the negative charge which tends to accumulate on the grid in a highly exhausted vacuum tube. If this charge were allowed to persist, the path of the electrons from the filament to the anode would eventually be blocked.

wholly to the sale of radio apparatus to the public. A recent Harvard graduate, Quincy R. Brackett, was placed in charge of this rapidly expanding end of our business. Brackett thus became the first radio salesman in the world. He has remained in radio ever since. Today he owns Station WSPR of Springfield, Massachusetts.

Dr. Seibt had brought with him from Germany many improved forms of radio-receiving apparatus, such as new inductive couplers, variable condensers, and the like. These we modified to meet American requirements, and began manufacturing them on an ever-increasing scale in our Newark factory. The business of our Company grew by leaps and bounds. The Moskicki condenser plant at the Newark factory, after overcoming a long series of difficulties (a triumph for Nora de Forest and M. Giles) was finally put into production. So in the spring of 1909 tall batteries of reliable Moskicki condensers were available for our new quenched-spark radio transmitters.

Ere long reports began to trickle in to New York from ships, and from United Wireless Telegraph stations along the Atlantic Coast, of astonishing distances over which that high-keyed (1,000 sparks per second) note was heard. Messages were read through static and interference which completely obliterated communication by the old low-frequency spark of the United Wireless. Attempts were immediately undertaken to interest United States Army and Navy officials in the advantages of the quenched-spark system. They soon began to follow the development of this new type of telegraph with the greatest interest, but it was not until the latter part of 1909 that we received our first contract. It came from the United States Army Signal Corps.

In the meantime my broadcasting efforts were by no means neglected. Nora's mother, Mrs. Harriet Stanton Blatch, thoroughly alive to the possibilities of the new medium for popular propaganda work, eagerly accepted my invitation to deliver a talk on woman suffrage from the newly opened radiotelephone

station in the Metropolitan Life Building. Her speech was unquestionably the first radiotelephone broadcast which might be classed as propaganda. The size and make-up of our audience at that time were not such as to justify any particular hope on her part of having accomplished very much for the "cause," but considerable newspaper publicity resulted from the effort. This broadcast can be set down as a landmark in the history of radio development.

About this time a Philadelphia station on the top of the Land-Title Building, equipped with both the quenched-spark transmitter and the steam-arc telephone, was opened up to operate with our new station in New York in the upper dome of the Manhattan Life Building at 52 Broadway. It was daring indeed to select this point, for there we could be sure of the most complete and hostile radio interference possible to imagine. Nevertheless, as the dome was copper-sheathed, I was willing to accept the challenge, anxious to test a great variety of anti-interfering circuits which I had in mind, following the teachings disclosed in the Stone patents, but using especially the three-coil pancake tuner, which I had found so effective in Havana and elsewhere. The old-fashioned spark gap and the carborundum detector which United was using at 42, and Pickerell up in the Marconi station on the Waldorf-Astoria with my old three-slide tuner, were simply put out of the running during the lively wars of interference in 1909 and 1910.

Inventors were few in those earliest years of the century. Invention was easy, the soil exceedingly fertile, and the Patent Office not yet clogged with thousands of pending applications on insignificant, or hardly distinguishable, details. Consequently the incentive to strike out and pioneer on paths radically new, and therefore wondrously attractive, was intense. In rapid succession followed the auto-detector (self-restoring, electrolytic, and crystal types), the telephone receiver, the alternating-current

transmitter, the two-tuned circuits at sender and receiver, the high-frequency spark, the quenched-spark gap, the Poulsen arc and tikker, the direction finder, the series-selective circuits of Stone, the heterodyne principle of Fessenden, the Audion as detector and as radio-frequency and telephone amplifier, the Alexanderson high-frequency generator, and the Audion oscillator (first as regenerator for heterodyne reception, then as transmitter for telegraph and telephone). All of these kaleidoscopic changes and epochal achievements were accomplished in less than eighteen years—from 1900 onward.

And, excepting the more recent return to the short-wave transmission of the very early days (such as the experiments of Hertz), transmitter arrays of antennae and crystal frequency control, the above list is, I believe, a truthful catalog of the really significant strides which made radio engineering what it was in 1940 (or until World War II ushered in the amazing miracles of radar and ultra-high frequencies, and the generators thereof—the magnetron and klystron). Everything else, though it may be important and the result of years of careful research and study, may be classified nevertheless as improvement in detail, electrical, mechanical, or chemical—as the case may be.

In truth this young giant Radio attained maturity with astonishing speed. We search in vain for a like development in all the history of man. Radio began to *run* in 1906, ever quickening its electronic stride. Thereafter it received a terrific impetus from the relentless demands of World War I, only to find directly following—instead of a breathing spell—a new incentive, alluringly financial and sometimes esthetic, *national radiobroadcasting*, truly the prelude to the Electronic Age.

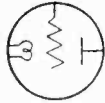

CHAPTER 24

Sadness and Joy

NORA'S work at the condenser factory in Newark was now absorbing so much of her time that she decided early in 1909 to take up residence in the little town of Milford, New Jersey. She was expecting a child in June and the long, tedious journeys to and from the factory by subway, ferry, and train were becoming too much of a strain both on her energy and her time. I pleaded with her to give up her work at the factory, for the next few months at least, but without avail. The old urge and zest for engineering employment and hard, concentrated, creative work, which she had put behind her during the months of our courtship, had now taken a renewed and redoubled hold upon her mind and heart. There appeared less and less room in her spirit for those emotions and devotions which had meant so very much to us both from the hours of our first acquaintance up to the time I made her a partner in my daily tasks in laboratory and office.

Subsequent observations have convinced me that such a form of close business co-operation between husband and wife very

seldom results in increased, or prolonged, happiness for either. So looking back upon the history of our romance and the later regrettable developments, I am not surprised by the unhappy outcome.

Up to the summer of 1908 I had never sold a share of my own stock, although under the terms of the original setup I had the privilege of disposing of a small percentage of my holdings. At that time I authorized Smith to sell a few hundred shares and with the proceeds I made an initial payment on what I considered a highly desirable site for my future home—at Spuyten Duyvil on the shores of the Hudson River, that noble stream which I had ever loved so intensely.

With much pride I had taken Mrs. Blatch out to the site, Nora being in Europe at the time, to show her this choice location; and pictured to her with utmost enthusiasm the details of the dream home which I there foresaw for her daughter and myself. Although she thought the location rather inaccessible, she agreed that Nora and I should be quite happy there; and when Nora returned in the fall, although not fully sharing my enthusiasm, she proceeded to draw up plans and outlines for the house which we expected shortly to start erecting there.

Contracts were let and the building actually started in the spring of 1909; and although I was soon unable to continue my payments, the contractor continued with his work and finished the house. It was destined to stand vacant and desolate until I should enter it years later to establish at last a home and name it "Riverlure—Where Dreams Come True."

Mrs. Blatch accompanied Nora to Milford to make a home for her and the expected child. I remained behind to live the life of a bachelor in our Riverside apartment, hoping that the unnatural situation would soon right itself.

But the total separation which ensued while we lived apart and I saw her only during my visits at the Newark factory, did

not prove conducive to a restoration of the old affection. The rift between us gradually widened. Not even the approaching birth of our child could heal it.

Another factor in the situation was the pronounced dislike which Mrs. de Forest developed toward the business managers of our company and toward their policies. Far better would it have been for me had I at that time shared her suspicions, or her womanly intuitions. But I was so wholly occupied with the technical and engineering aspects of the company's development, realizing that Smith and Thompkins had actually done a surprisingly fit job of financing the company under such difficult conditions, that neither Captain Darby nor I were disposed to interfere with the fiscal management of the organization.

In the spring of 1909 our books showed that the treasury had some \$125,000, with obligations and liabilities not exceeding one third of that amount. Our subsidiary, the Great Lakes Wireless Radio Telephone Company, with stations at Chicago, Toledo, Milwaukee, and Cleveland to its credit, and with a slowly growing number of lake ships equipped, also had some \$100,000 in its treasury. Everything looked well and prosperous for this, my second enterprise. With the exclusive ownership of the Audion, it seemed to be thoroughly on its way to making a permanent and ever-enlarging success.

At a directors' meeting in the late spring of that year, the president of the company, J. D. Smith, tendering his resignation as an officer and director, coolly informed us that the last block of 20,000 shares of stock which had been sold had been taken from his own, and not the treasury's, holdings. He then presented a balance sheet showing that the company was in debt some \$40,000, with practically no cash in its treasury. Wishing the remaining directors of the company every success and good fortune, he closed his desk and walked out of the door of the office.

In reaping the reward of my labors and my inventions, how shamefully short have I fallen—and chiefly because I failed to apply in my business, as well as in my inventive work, that Iron Song of Emerson: “Trust Thyself.” Too late did I realize that my associates were not as clear-sighted, as honest, or as self-sacrificing, as myself. Too long I believed the much-repeated heresy—“Stick to your laboratory. Inventors are not businessmen. Let others manage the finances for you.” Ill advice, unless one finds such associates as did Alexander Bell.

On January 24, 1909, the world was startled by widely published newspaper reports of distress signals received by wireless from the steamship *Republic*, which was then in a sinking condition. This was perhaps the most prominent and widespread recognition of the inestimable value of wireless on shipboard. But the story of the *Republic* recalled numerous other, earlier instances of aid rendered to ships in danger of wreck and to sea travelers in distress. The value of wireless in making known the situation to passing vessels and to persons on shore had been abundantly proven. In American waters the De Forest wireless system from the beginning had done its full share in this magnificent work of salvaging property and lives, even as early as 1904.

Prompted by the *Republic* disaster, a vital point was raised for the consideration of Congress, a committee of which was then deliberating over legislation for the compulsory establishment of wireless-telegraph apparatus on all ocean-going vessels carrying sixty or more passengers. Representative Cox of Indiana told the committee that he would carry the fight to the floor of the House if the bill was not made applicable to the Great Lakes also.

At this time four Great Lakes stations of my company were nearing completion. Out of consideration for the lake shippers

then seriously considering the equipment of their lake vessels with wireless telephone or telegraph, my company was naturally active in urging the passage of such eminently wise legislation by Congress. Representative Wilson of Illinois told the committee that "the 170,000 persons who travel annually on the Great Lakes ought to have as much protection as the few thousands that journey on the sea."

In view of today's universal acceptance of its value, and the practically unanimous willingness on the part of vessel owners to equip their ships with wireless, one can hardly believe that other members of the committee could argue that the extension of the bill to the Great Lakes would work a hardship to owners without a justifiable return to passengers, saying travel "is safe at present on the Lakes!" Representative Whaley of Maine advised the committee to go slowly when it was proposed to hold captains and officials criminally responsible for violation of the proposed law!

As usual, the committee debated this wireless legislation endlessly, and no definite steps were taken in Washington at that time.

In the *Jersey City Journal* of February 20, 1909, this interesting item appeared:

De Forest's predictions regarding the development of the wireless telephone are bolder than the dreams of fiction.

He foresees the time *when news and even advertising will be sent out to the public over wireless 'phones and when the opera will be brought into every home by the same means.**

The world today listens to de Forest and pioneers of his class with an almost boundless faith. From what has been done no man would venture to place a limit upon what may be done in the domain of applied science. The general feeling is that only the surface of the field has been scratched.

An extract from a full-page story on the wireless telephone in the *Chicago Inter-Ocean*, May 16, 1909, stated:

* Italics mine.

It is within the range of possibilities at an early date that the traveler by Great Lakes steamers may be able to spend his evenings listening to the voices of Caruso and Melba simultaneously with the audiences who see the singers in person at Covent Garden, London, or the Metropolitan on Manhattan Island in New York. . . .

Twenty-three years later David Sarnoff, president of RCA, with the eager co-operation of Edward Johnson, director of the Metropolitan Opera, turned this prophecy into actuality.

During all this period the Audion tubes which we had been using were manufactured exclusively by the McCandless Company in New York City. From the first tube up until 1909 the Audion tube envelope was cylindrical in shape, with candelabra base. The first filaments were of carbon; but it was not long before I substituted tantalum, and then, after a more ductile type of tungsten wire came on the market, I substituted this for tantalum. In the first Audions the grid and plate leads came out through the wall of the tube just above the candelabra base. The last sample of this earliest type was a small one which I gave in 1923 to my good friend General Ferrié of Paris, where it reposed in the Archives of the French National Radio Museum until Hitler's "*Kulturtruppen*" destroyed this rare relic along with most of the other French prewar radio instruments.

But before we had equipped the first ship in 1907, or even the yacht *Thelma*, I had modified the construction so that the plate and grid terminals came out from the upper end of the cylindrical tube in two flexible leads. The grid wire was invariably sleeved with a piece of green insulation, the plate lead with red. This was easy to remember, as the "G" stood for "grid." At first I called the plate electrode the "wing," as is indicated by some of the early patents, but later the anode was called the "plate," and is so called even unto this day.

About the summer of 1907 I had conceived the idea of having two filaments instead of one in the Audion, one as a spare;

McCandless accordingly brought out a small flexible wire from one end of this spare filament and recommended that we change the shape of our tube from the cylindrical to the spherical type, still retaining that feature of plate and grid emerging from the end of the bulb opposite the filament. He found the spherical type was much easier to manufacture.

In the early days the idea of putting the Audions inside a box, with a glass window through which they might be viewed, proved an excellent way to prevent the too-easy "losing" of the precious bulbs. There were but a few of these in existence, for they were not easy to manufacture; therefore we charged at that time a goodly retail price for these little "lamps," which were cherished like precious gems by the operators and those amateurs who were fortunate enough to own one. Six, and sometimes eight, dollars was the "popular" price at that time. Today, when manufacturers of radio tubes are compelled to sell a lot of six for less than two dollars, their mouths water as they look popeyed at the price lists of Audion tubes in those good old days.

At the time that I write this, 1950, it is conservatively estimated that radio tubes of every conceivable type and size are being manufactured in various centers scattered over the face of the globe at the rate of 2,000,000 per day.

The transmitter consisted of a handsome mahogany box containing two pancakes, primary and secondary, mounted so that the coupling between the two could be varied. The little carbon arc with the alcohol lamp was mounted on a bracket at the right-hand side of the cabinet. The microphones and mouthpiece were mounted on a standard telephone arm projecting from the front of the cabinet. Two special carbon microphones, one on either side of the tapered end of the mouthpiece, were mounted on this arm in such a manner that the voice waves acted on both diaphragms. The two carbon buttons were connected in series, in the earth connection between the transmitter secondary pan-

cake and the ground. The operator had always handy a pencil or screw driver with which he could tap (more or less gently) the microphone to restore articulation if "packing" resulted from overload. At other times the conversation could continue for long periods without interruption.

Meantime better and larger carbon microphones were obtained from Germany, and these in nests of from two to six in series-parallel (sometimes water-cooled) proved adequate for our requirements, up to the point where my radiotelephone development work was totally suspended by the dismal collapse of the company in 1910.

On top of the cabinet, or on the wall directly behind it, was mounted a rather large hot-wire ammeter, connected directly into the antenna lead in such a manner that the operator, while talking, could keep his eye on the needle of the ammeter (the world's first modulation meter) and thus determine by its fluctuation whether or not his voice was properly modulating the antenna-earth high-frequency current. A small carbon-filament bulb inductively energized from the oscillator current was also mounted on the front of the cabinet directly in view of the operator. By the glow of this lamp he could tell whether or not the oscillator was in operation. The carbon of the little arc light was operated by a solenoid in such manner that if the arc should suddenly be extinguished, the solenoid would act automatically to strike the arc again.

About this time I had the good fortune to make the acquaintance of Hugo Gernsback, who shortly before had established the first publication devoted chiefly to experimental work in wireless—*Modern Electrics*. Gernsback was then, and is today, a daring pioneer, endowed with enthusiasm and to an unusual degree the gift of prophecy in this new and rapidly expanding field, in the development of which his journals were to play an important part through the years to follow.

That at least as early as 1909 there were a sufficient number of radio "hams" with transmitters to cause very bothersome interference with wireless communication, is evidenced by a letter appearing in *Modern Electrics* addressed to the Wireless Association of America, to which organization I had recently been elected honorary president. In this letter I warned that

If the present promiscuous working of unlisted sending stations continues as it has, means effective and drastic will certainly be taken to remedy this evil.

Without question Congress will be asked to pass legislation requiring licenses for all transmitting stations, limiting their number in given districts, limiting their power, and prescribing the wave length that may be employed.

All stations not belonging to the Government or to legitimate commercial companies will doubtless be absolutely prohibited by law if the present inconsiderate interferences are continued.

Transmitting stations of more than one-quarter horsepower, except those with very carefully tuned radiating circuits using *very weakly damped oscillations*, should be at once discontinued if within fifty miles of Government stations.

Disregard of such warnings, whether or not you consider them right and just, will certainly result in drastic prohibitive legislation at a not far-distant date.

A scrapbook of mine covering the years 1907 to 1910 contains a brief prospectus of the Radio Telephone Company, printed in 1908. The prospectus contained this prophecy:

It will very soon be possible to distribute Grand Opera music from the transmitters placed on the stage of the Metropolitan Opera House by a radiotelephone station on its roof to almost any dwelling in greater New York. [Two years later exactly this was done.]

Interesting in view of today's ship-warning radio devices is this description of what I had patented and described in that booklet under the term

AEROPHORE AUTOMATIC SIGNALING

The Aerophore is an automatic signaling device which warns a mariner of near approach to a point of danger, giving him his direction therefrom,

FATHER OF RADIO

and that under all weather conditions when spark signals or lights are obstructed or uncertain. The Aerophore is inevitably to be installed at countless danger points all along the sea and lake coasts, lighthouses, at the mouths of rivers, harbors, etc.

The erection of Aerophore stations along the coast will compel owners to equip practically every vessel afloat with the simple receiving outfit required, thus greatly increasing the market for that sort of apparatus. The small Aerophore sets on shipboard will absolutely warn mariners of the approach of a vessel similarly equipped and its direction of approach.

Another prophecy in that prospectus:

The Aerophore principle adapted to locomotives furnishes an additional block-signal safety appliance of immense value. Engineers can be warned of the near approach of another locomotive one or two miles distant on the same track. This must inevitably be installed on the majority of locomotives, signal towers, and derailing switches of the existing railway systems in the country.

It is to me today a constant source of wonder and disappointment that such indisputably important applications of radio to the fields of safety signaling as were briefly outlined in this 1908 leaflet have not yet had widespread practical application. There was absolutely no question even then as to the operativeness and practicability of the aforementioned Aerophore warning and signaling devices, which I had outlined in great detail in two patents taken out in 1906, patents long ago expired.

Early in the morning on June 19, 1909, Mrs. Blatch telephoned me that I was the father of a little girl, born in the cottage at Milford. She was given the name Harriet.

That tiny baby—clutching infantile fingers around my own quickly entangled my lonely heart in tendrils which grew to tightly enfolding arms of steel. . . . But that summer was again a sad one of separation, with the gulf between my wife and me slowly, fatally widening. Strive as I might, plead as I could, I found it impossible to perceive again in Nora's heart the place I had once so fondly occupied.

Between August 20, 1908, and July 23, 1909, I find no entries in my diary, only blank pages, with this single exclamation: "What *might* have been here written!" And beneath this:

"Ah, Love! could you and I with Fate conspire
To grasp this sorry Scheme of Things entire,
Would not we shatter it to bits—and then
Re-mould it nearer to the Heart's Desire!"

July 23, 1909: Almost another year has passed since I wrote herein! And that silence can best express what this year has been to me—hopes gradually fading, rekindling, dying again and again, while a numbed heart felt the recurrent stab less and less, from long experience. God! What a world, and what hearts therein!

September 25, 1909, was my last day at "Yale Eyrie," our longitudinal 97th Street apartment overlooking Riverside Drive. At night we had a family gathering there, the last that would ever fill those rooms. It was the first time—and the only time—that my child slept beneath my roof. At last one dream of my years had come true. Dreams do come true!

It was the night of the Hudson-Fulton Centenary celebration. The scene from our windows on that night was fitting to this last occasion—the crowning beauty of all the glorious sights which I had beheld during the four long years I had dwelt by this lordly stream. It was a scene never to be forgotten, one worthy of the century-old anniversary which it honored.

Nora, nurse, and the sweet baby slept there, and next morning we took a ride up the Drive to see by daylight and individually the great warriors, somber and gray, which guard this memorial stream. In the afternoon I drove them down to the D., L. & W. ferry en route to Milford.

In view of the later Federal prosecution of myself and associates, it may be well at this point to go a little into detail as to the original organization and fundamental setup of the Radio

Telephone Company. These were honestly and simply stated in a bulletin dated May, 1907. Some of it reads:

. . . Out of the \$2,000,000 capitalization of the Radio Telephone Company, sufficient stock to insure control is given for patent rights, initial investment, and promotion.

The remaining stock, or allotments from it, will be sold, from time to time, for the benefit of the treasury, at such prices as the directors shall decide. The plan will be to obtain as great a net amount of cash for the treasury, out of the sale of this stock, as is possible, considering the expediency of providing quick funds for development purposes. It is expected that a sufficient amount will be realized from the first or "ground floor" offerings to secure ample working capital. . . .

The proven assets of the company, the Audion patents, have subsequently earned approximately a billion dollars for the companies licensed thereunder. Certainly the capitalization was not excessive!

With the efficient and apparently honest setup and financial management of the Radio Telephone Company, one was well justified in assuming that the new enterprise, possessing as it did patent rights of demonstrated value (although no one then could even conceive of the immensity of that value), would go steadily ahead to achieve an important and lasting, if not dominating, place in the radio industry.

And yet, notwithstanding Smith's previous good record, the shameful example of "Honest Abe" White and "Christopher Columbus" Wilson*—who then were soaring high in their stock-inflated balloons—was too great a temptation. Smith proved not sufficiently intelligent to recognize that he had here an opportunity that comes to only a few men in each generation—to build up a new national industry of inestimable value to mankind—to be to the pioneer inventor of radiotelephony what Theodore Vail had been to the pioneer inventor of the telephone, Alexander Graham Bell.

* Abraham Schwartz (alias White) was buried in a New York "Potter's Field" for paupers, in the early '40s. Christopher E. Wilson died in the Atlanta Federal Penitentiary.

It has ever been my lamentable bad fortune, never to have found my "Theodore Vail." Lacking such a friend and counselor, one capable of wide vision, energetic, ambitious, and absolutely honest, my lifework has never been crowned with the complete success, nor earned the monetary reward, to which inventive genius and unflagging energies are unquestionably entitled.

Following upon that tragic directors' meeting which earlier I have described and the unbelievably brazen announcement by Smith of his having coolly gutted the company's treasury, Captain Darby and I, together with E. E. Burlingame (who had been strikingly successful in raising the finances for the Great Lakes Radio Telephone Company), held several deliberative conferences as to the best course of procedure. Captain Darby and I were strongly of the opinion that the proper course would be to bring the entire matter immediately before the Federal District Attorney with a view to having Smith put behind prison bars.

After much deliberation Burlingame conceived what, he argued, was a better plan, the organization of a new and larger corporation, to be called the North American Wireless Corporation, which through exchange of stock could take over both the company and its affiliate, as well as the newly organized Atlantic Radio Telephone Company. Possessed of the assets of the three companies, he maintained that a bond issue could be floated which would be far more successful than the continued selling of stock; and that by this procedure the new company, owning as it did the quenched-spark telegraph system, would then be in a position to enter actively into competition with the United Wireless Telegraph Company and the American Marconi Wireless Telegraph Company, and soon be far stronger than the now-hamstrung Radio Telephone Company could ever expect to be.*

* This plan was materially altered in the working out. The North American Wireless Corporation, when organized, was a holding company with the Radio Telephone Company, the Great Lakes Wireless Radio Telephone Company, and the Atlantic Radio Telephone Company as its operating subsidiaries.

I was not satisfied that this was the best procedure, but Burlingame's eloquence convinced Captain Darby that he was right. Fully occupied as I then was with my laboratory and installation work, I was inclined to rely largely on the business judgment of Darby in such matters, and finally authorized him to draw up a contract with Burlingame covering the new amalgamation. By this arrangement my original proportion in the Radio Telephone Company would be maintained in stock ownership in the new corporation.

In that decision I made the second great mistake of my career—the first having been in 1906 when, instead of securing a capable, honest, fighting attorney to battle for my rights, expel the stock-jobbing bandits, and reorganize the American De Forest Wireless Telegraph Company, I turned back into that depleted treasury all my own stock, accepted a trifling sum and certain pending patent applications, and indignantly resigned.

It has been my conviction ever since that if Darby and I had firmly adopted in 1909 the course which we first considered, we could have saved the Radio Telephone Company in its original independent form and continued my experimental work in the laboratory until such time as I could prove to the Bell Telephone people that in the Audion amplifier lay their long-sought key to the telephone relay, or repeater, so urgently needed on their long-distance circuits. Had that course succeeded, the entire history of radio would have been written differently and the original stockholders of the Radio Telephone Company would doubtless have received hundreds of millions of dollars in royalties and earnings from those corporations which have made billions out of the basic inventions then owned by that small \$2,000,000 corporation.

The defalcation of Smith inevitably restricted very greatly the activities of the Radio Telephone Company, but the laboratory in the Terminal Building in New York, the Metropolitan Life

Tower station, and our sales office for radio products for amateurs continued in operation throughout the winter of 1909-10. The Newark factory continued to function, but with reduced payroll. The Philadelphia-New York radiotelegraph service was maintained for a time. The Great Lakes stations were kept in full activity, with the hope that ere long sufficient lake shippers could be interested in equipping with wireless telephone and telegraph to maintain those stations on a self-sustaining basis.

During this fall the rivalry between the Radio Telephone Company and United Wireless for telegraph business became most intense. At that time, before the federal law of 1912 regulating interference was enacted, it was too often the custom when another station was getting too much of the available business, for an operator to adopt the simple expedient of placing a dictionary, or some other large object, on his key, and then enjoy a quiet smoke. But my operators in the Manhattan Life Building and in Philadelphia were not to be so hindered. They proceeded to screen their operating rooms with chicken-wire netting, which was then grounded. Then a sectional screen was put over the receiving apparatus and grounded. A coating of tin foil was wrapped around the phone cord and grounded. With these extreme precautions and the sharp selectivity of the quenched-spark signals, telegraph traffic could be worked with ease in spite of interferences.

It seems almost unaccountable that the directors and engineers who were seeking to create a new method of communication should stoop to such petty business as deliberate interference for the sake of suppressing competition, when the utmost in cooperation was demanded for the sake of the art. Yet the opposition resorted rather to "cutting the other fellow's throat" than to the perfection of the apparatus and the establishment of the new science on a firm basis in the economic structure of the country.

Never did I stoop to these usual tactics, nor did I allow my operators to do it so far as it was practical to enforce such regulation. This was due more to my interest in the problems at hand and my idealism for the science, rather than to any high moral attitude. Being entirely human, there were times when I could have wrung the necks of various and sundry operators of the United and Marconi systems. But this type of interference resulted in high refinement in tuning devices and circuits and in more complete shielding of receiving apparatus than would perhaps have been achieved under less antagonistic, more co-operative tactics on the part of our competitors.*

* The FCC has happily removed all such source of rancor from today's radio "ops."



CHAPTER 25

Opera by Radio

AS was usual in my periods of deepest gloom or uncertainty, I again turned to music as my solace. Hence it was that during the winter of 1909-10 I realized my long-advocated ambition for the radiotelephone—the broadcasting of Grand Opera. Early in January I went to the Metropolitan Opera House and made the acquaintance of a kindly, bright-eyed, energetic young assistant director to Gatti-Casazza, Andreas Dippel, formerly a Wagnerian tenor in that organization. Dippel possessed the vision and enthusiasm which was exactly what I was looking for.

When I outlined what I had done in the past—in broadcasting the music of the Teleharmonium and the phonograph from my laboratory—and outlined what I foresaw as a prospective field for the new radiotelephone as a medium for bringing fine music to the masses, Dippel became intensely interested, and actively undertook to enable me to carry out my plans to make the necessary tests for broadcasting Grand Opera.

I was overjoyed. I harked back in memory to the old almost foodless days in Chicago when I spent nigh my last cent for a

seat up under the eaves of the Auditorium and the Studebaker Theater.

Since then I had seen a great many of my schemes come into actual being. And now I was going to the opera again, but was going as some part of it! I felt that I was doing something which might in time to come bring great music to many a young fellow in a position parallel to mine of the Chicago days.

By rare good fortune Kelly M. Turner, president of the National Dictograph Company, was at that very moment installing his Acousticon microphone on the Metropolitan stage, with receivers in the office of Gatti-Casazza so that the latter might hear what was going on on the stage over a telephone wire. At once I recognized that Turner's Acousticon microphone was exactly what I required to pick up the voice of the singer and the orchestra music at a distance, for in this respect the Acousticon was much superior to my own microphone.

The necessary permission having been given, Frank Butler and I proceeded to install one of my small carbon-arc transmitters in the attic of the Metropolitan. We rigged up a temporary bamboo mast on the roof, lashed it to one of the short flagpoles there, rigged up the largest antenna that was practical for such a situation, and ran the lead-in wire down through a ventilator to the transmitter. A "twisted pair" was run from the transmitter down through the flies backstage and connected with battery to the Turner microphone. An ordinary telephone receiver was then taped in front of my radiotelephone microphone, to serve as my telephone relay, or repeater. Preliminary tests in the Acousticon downstage showed that a very fair retransfer of energy was thus obtained.

For my debut in broadcasting of opera, Dippel suggested the double bill of *Cavalleria Rusticana* and *I Pagliacci*. The Acousticon microphone was located in the footlights, but for the opening aria, "La Siciliana," in *Cavalleria*, which was sung behind

the curtain, a duplicate microphone was located on a small table before which Ricardo Martin stood when he sang that aria. Then before the curtains were withdrawn for the opening scene, this microphone and the wires and table were swiftly removed from sight. For Caruso, as Canio in *Pagliacci*, the microphone was installed in the footlights. Kelly Turner superintended the arrangements down on the stage, and I was at the transmitter up in the attic of the Opera building.

This momentous event occurred on the night of January 13, 1910. The newspapers had been tipped off in advance and reporters were listening in at the Terminal Building, 103 Park Row, the Metropolitan Tower station, at the Hotel Breslin, on one of the ships downstream, and at our factory in Newark. Simultaneously, Turner was demonstrating in the *New York World* office his ability to transmit over telephone wires Grand Opera picked up from the stage with his Acousticon microphone.

Preliminary notices had appeared, as for example in the *New York World*, Sunday, January 9:

GRAND OPERA BY WIRELESS IS THE LATEST MODEL

By the simplest of inventions you may now listen to the Grand Opera's greatest singers in your distant home.

Messages picked out of the air without towers.

Two new wireless marvels were tested by the *World* yesterday. One brings a performance of grand opera to the home of anyone having a telephone; the other picks wireless messages out of the air without the aid of the tower that has hitherto been considered necessary for the receiving of wireless telegrams. . . . Grand opera by means of the ordinary telephone or by connection with a wireless telephone is shown to be no longer a dream.

The technical journal, *Telephony*, carried an interesting account of the performance:

GRAND OPERA BY WIRELESS

Interesting experiments with the De Forest system of wireless telephony have been carried on in New York City with a view to determining

whether it is practical to transmit music by this method. The experiments were carried out from a transmitting station on the stage of the Metropolitan Opera House. Efforts were made to transmit music as far as Boston (!), and receiving sets were set up in several places in New York City. On the Royal Mail steamer *Avon*, 260 guests were assembled and listened to Caruso's voice produced by wireless telephony. The transmitter employed was the loud-speaking instrument used in the Dictograph.

Satisfactory results were obtained at the stations where the Marconi magnetic detector was used, but not a failure to get a greater portion of the music took place where the receiver was equipped with the Audion, Dr. de Forest's well-known invention. This sensitive device was included in the apparatus in the inventor's laboratory at the Terminal Building, 103 Park Row, the Metropolitan Tower Station, and the Radio Telephone Company's factory over in Newark, the greatest range reported. All these stations got encouraging results although there was some interruption owing to deliberate and studied interference from the operator of the Manhattan Beach station of the United Wireless Company. All other stations courteously refrained from unnecessary demonstrations of their power, and the Marconi Company was especially courteous in placing special equipment on board the *Avon*, anchored off 13th Street in North River.

During my work at the Metropolitan Opera House I became well acquainted with its chief electrician, Harry Williams, who naturally took great interest in my idea of broadcasting the opera music by radiotelephone. He asked me to return for any performance I should like to hear, offering to share with me the electrician's box, which was beneath the stage and equipped with a small hood alongside of the prompter's box in the center of the stage. There at floor level one's head was only a few feet from the very center of the opera stage. Was that invitation a delight to me! Time and again I accepted Williams' kind offer, and there intimately renewed my familiarity with the opera favorites I loved so well.

Caruso was then in the fullest splendor of his voice, at the zenith of his career. I well remember how as Rodolfo in the last act of *La Boheme* he battled boisterously with Marcel and Collin with long loaves of French bread—and boylike as usual, he tried his best to kick some of the husky crusts into my face as I grinned up at him from my box! And during the tragic

last scene of *Madame Butterfly*, how lovely Geraldine Farrar appeared as she sat upon the stage not five feet from me, speaking softly to the little son as she blindfolded him and put into his hands the two small American flags. I could hear her distinctly whisper instructions to the little fellow. I am sure that no one was ever so close to Farrar as she sang those affecting lines!

You may be sure I made the greatest possible use of my "free pass" to the very heart of the Metropolitan Opera House throughout the rest of that season.

But by no means satisfied with my broadcasting of the voices of Signori Caruso and Martin, I wrote to the Metropolitan's great rival during those years, Oscar Hammerstein, impresario of the Manhattan Opera Company, asking permission for his famous prima donna, Mme. Mazarin (recently imported for the opera *Elektra*) to sing into my microphone at the Terminal Building laboratory.

Hammerstein promptly complied, and I had again the unusual delight of meeting so great a star, and of personally instructing her in the technique of the microphone. Mazarin's voice was of such tremendous power that at first she actually blasted the microphone, causing it to cut off completely. The radiation ammeter needle swung down to zero—indicating much more than a hundred per cent modulation(!), so that I was compelled to have her sit back at a considerable distance, and then to sway forward somewhat for the softer passages.

The aria chosen was "La Habanera" from *Carmen*; and magnificently was that rich contralto reproduced in the listening headphones. The newspaper representatives were again on hand, some to photograph the artist at the radio microphone, others at the Metropolitan Tower receiving station, and elsewhere.



CHAPTER 26

Radio Goes West

*E*ARLY in the spring of 1910 the United States Army Signal Corps, which had been carefully watching our developments of the quenched-spark wireless telegraph, became convinced of its superiority and awarded our company a greatly appreciated contract for the equipment on the Pacific Coast of two Army transports, the *Dix* at Seattle and the *Buford* at San Francisco. While this new equipment was under construction, I was compelled to make an extensive trip to the Pacific Coast, stopping in Chicago only long enough to open up the newly completed radio station (XMJ) on the Majestic Theater Building, and then on through Canada to Vancouver and Seattle. I carried with me one of the newest type of radiotelephone transmitters. That journey through the Canadian Rockies was one prolonged inspiration to me, so many years separated from the mighty mountains I had so loved—and worshiped.

I was greatly pleased with the *Dix* installation and the fine work which it immediately achieved. Messages from the *Dix* in Honolulu were received on the West Coast; and later, when

the *Buford* was equipped in San Francisco, the two transports were enabled to work regularly from port to port, something which had been absolutely unheard of up to that day.

All during the time that these ship sets were being installed, Frank Merriam—the very capable and hard-working young installation engineer who accompanied me—and I were employing our spare moments with further tests. I was struck with the idea of employing the quenched spark for the generation of slightly damped waves to be used as a carrier for voice modulation, not merely for telegraph signals. And as usual, as soon as I had the idea I set about perfecting the necessary apparatus to give it a trial. Ordinarily in telegraphing if one used a 500-cycle generator, the sound frequency was simply a pure high-pitched note of 1,000 frequency, with one discharge across the gap for every half cycle of the generator. However, when only a few of the tiny spark gaps were in series in the circuit, it was possible to obtain a number of separate discharges for each half cycle of the generator. By this method I obtained an irregular frequency of about 15,000 cycles at the antenna input. This served very well as a carrier for speech modulation. Of course, there was always the hiss of the carrier in the background, but the resultant telephonic message picked up was perfectly clear and distinguishable. Very little harmonic “mush” was created with the telephone in spite of the fact that the microphone was put directly in the ground circuit of the antenna, just as when using the carbon-arc transmitter.

San Francisco—my first view of that fascinating town, renowned of song and story, and the Golden Gate! Daydreams of a lifetime of anticipation seemed realized at last. Although the Phoenix City was then but four years arisen from her tragic ashes, although her shore streets still revealed the crest and node of the earthquake’s trail, although shattered walls of tumbled

palaces still crowned Nob Hill, I could yet be transported to her fabled Golden Age and to the Roaring Forties. The spell of Bret Harte and Robert Louis Stevenson fell upon me. At last to tread the streets they had described, the haunts they had made notable!

I borrowed a fine edition of the *Works of Stevenson*, and in these, for the first time, I browsed with indolent delight whenever a rare hour for idleness was granted me. Seated at twilight before his bronze galleon in Portsmouth Square, I imagined that I too, like him, was a lonely wanderer, a thousand leagues from all my old friends, thrilling with the same romantic thoughts of Pacific adventure which had inspired his graphic pen.

As soon as the installation on the transport *Buford* was completed and our long-distance tests made to the complete satisfaction of the Signal Corps officers, I journeyed southward to Los Angeles, my first glimpse of southern California.

Here, breathing in the fresh ozone of the marvelous Pacific, I am at work all day, day after day. Indeed I am fortunate to be able to work in such a place, amid such uniquely delightful surroundings, during these anxious days. It helps me to forget what I cannot help, and impels me to best effort, encourages my spirit, and keeps me in superb health. So I cannot but be optimistic—as I was during “the beginning” in 1901, and again during the second struggle to the top in 1907.

How iron Fate and History repeat—repeat!

When first I saw Los Angeles the town was small, uncrowded; the Iowan Invasion had scarce begun. The gentle flavor of early California, the influence of Colonial Spain, of the Padres of *El Camino Real* were yet in its sunny atmosphere. How unlike the big, sprawling, teeming city of today!

I journeyed back to San Francisco on board the steamship *Yale*, my first voyage on the vast Pacific Ocean.

It is the hour of midafternoon. The Pacific is as calm as its name, as its vastness. There are no horizons in the west, but mist and blue heavens,

and dazzling islands of floating suns. The hours are golden; all voyagers are dreamers, eaters of the "lotus of the sea"; and Care is a great way off.

After many delays and a long series of testing, satisfactory radiotelegraph communication was established between Los Angeles and our San Francisco station in the Phelan Building. Some traffic was handled, but at a loss.

Now I recommenced the experiments which I had begun in Seattle, to adapt the quenched-spark telegraph transmitter for telephonic communication, believing that thereby I might achieve considerably greater distances than I had been able to do with the arc in steam. Not yet did I know that in the little Audion tube lay the magic which would solve this and a hundred other difficult problems. But the time was waxing nigh.

Reports of the financial condition of the company back in New York were now anything but reassuring, and I made one or two hurried trips there to look over the ground and see what could be done to keep the magnificent plant and plan which I had been building up since 1907 from folding up in total collapse. Work in the factory and laboratory had so nearly ceased that early in 1911 I was forced to the conclusion that it would be only a matter of months—unless some new blood was transfused into the rapidly failing body—until a complete and lasting coma could be expected. The condition of my marital affairs also was no more reassuring than I found the business situation to be. With heavy heart I returned to my work on the Pacific Coast.

Now days of poverty were known once more—both for me and for my loyal assistants—to remind me sadly of early Chicago and Jersey City days. Frix, my San Francisco operator, and I found rooms in a little dump of a cheap hotel above "Coffee Dan's" basement eat-shop. That institution was indeed a valued asset—a great good bun and a large cup of steaming coffee for a dime!

Yet we were jolly, worrying little if at all—such was the atmosphere, physical and psychical, of old San Francisco in those preprohibition days. And then there were the Barbary Coast and Chinatown for surcease from sorrow. More than ever now did I feel kinship with Robert Louis Stevenson. And when there was no work to do I loved to withdraw to my little room, there to spend busy hours in writing, attempts at prose and poetry—among these “Lost River,” a sad allegory, relating to the love which had welled so romantically, then had sunk so sadly into life’s barren sands.

And one poem, inspired in Golden Gate Park by the twilight vision I had obtained of those sad pillars standing pale beside the little tarn, was named after them the “Portals of the Past.”

My last trip to New York had convinced me that I could no longer look forward to redemption of the sad wreck which had been my second foundation of fortune and lasting success. I accepted the doom and reconciled myself to the fact that I must at once seek employment. For some time past I had cultivated the friendship of Cyril F. Elwell of Palo Alto, one of the most brilliant graduates from Stanford University, who two years previously had brought from Denmark the American patent rights and specifications of the Poulsen-arc generator and “tikker” receiver. With these as assets, Elwell had succeeded in organizing the Poulsen Telegraph and Telephone Company, which had at first been inadequately financed by sale of stock to the public. Operating on a small scale at Palo Alto with the encouragement and moral backing of some Stanford professors, he had finally succeeded in interesting several San Francisco capitalists, largely through the promotional efforts of one Beach Thompson.

At the time I met Elwell, Thompson had reorganized the concern into the Federal Telegraph Company, with Elwell as the chief engineer and a large stockholder. Elwell had, of course,

read of the work I had been doing in radiotelephony in the East, and was particularly interested in my Audion detector.

Therefore when I made the suggestion that it might soon be advisable, or necessary, for me to seek radio employment on the Pacific Coast, the idea immediately appealed to Elwell, and without difficulty he obtained authorization from Beach Thompson, president of the Federal Telegraph Company, to offer me employment at a fairly lucrative salary in the Palo Alto laboratory of the new company.

So now I was again at work, in another little laboratory, at the kind of work I loved so dearly. First there was an abundance of tasks for me in reporting to Elwell and his engineers many of the facts and lessons which I had amassed during my past years in developing the wireless telegraph, the "loop antenna," the novel loose-coupling devices, improved double-fan antenna for transmitting, etc.* I was soon dispatched to the Beach Station of the company a few miles south of Golden Gate Park, where operators A. Y. Tuel and McNeal were exceedingly busy handling telegraph traffic with the Los Angeles station of the company on West Adams Street. The Federal Telegraph Company was the first in the world to maintain *profitable* wireless telegraph traffic between two distant cities.

Those two stations were already heavily crowded with traffic, so I promptly devised a "diplex" system of telegraphing, using a high-speed "chopper," which automatically changed the wave length of the transmitter from "A" to "B" a great number of times per second, so that both the A and B operators could dispatch their messages as fast as they pleased, each man quite independent of the other. In the receiving station in Los Angeles, two independent receivers connected to the same receiving antenna were tuned—one to the A wave and the other to the B—

* All of the many patents on those inventions belonged now to the United Wireless Telegraph Company. Only the Audion patents and a considerable number more recently filed were the property of the Radio Telephone Company.

so that two operators there could receive their respective messages independently of each other. Poulsen's undamped-wave system permitted of such innovations, impossible with spark telegraphy.

A great deal of research and experimentation, however, was necessary before the actual chopper mechanism was finally built to stand up under the extremely tough conditions obtaining when this relatively large amount of undamped-wave energy was rapidly shifted from one wave length to the other, each circuit being alternately supplied from the same Poulsen-arc source. Yet all these difficulties were finally overcome. The diplex system was pronounced a success and put into daily operation during the rush traffic hours at San Francisco. But before duplicate equipment could be built for the Los Angeles end, it was decided to erect a second and much larger transmitting station on the bay promontory at South City so that the company would have two independent stations at San Francisco.

The method of keying employed by the Federal Telegraph Company was very unlike that used in spark telegraphy. The arc generator was in operation continuously, without interruption or cessation, so long as the operator was transmitting. His key merely operated to alter the number of turns in the antenna helix, in other words the amount of inductance, and therefore the wave length of the transmitted wave. In their parlance, when the key was closed the "sending wave" was radiated; when the key was up the "compensation wave" was being sent out from the antenna.

I noted that at certain times almost daily through most of the year, and under certain meteorological conditions, surprising changes in the intensity of the received signals occurred when using certain wave lengths. For example, the Los Angeles station might be using a 3,260-meter wave for sending, and a 3,100-meter "compensation" wave. Within a few moments the "send-

ing" wave would grow faint or completely die out at the San Francisco receiving station (350 miles north), while remaining at normal strength at their new station at Phoenix, Arizona (300 miles east). Yet at the same time the "compensation" wave, which was less than five per cent shorter, continued to come in at San Francisco with full, even *at times increased*, intensity.

During such periods of fading it was necessary for the operator to reverse his transmitting key, so as to employ what was previously his "compensation" wave for signaling purposes. Then when this "compensation" wave in its turn began to fade, the operator would once more reverse his key. Otherwise, if both of these waves were reported as faint, the sending operator must find a wave length which did not fade at that time, between those two stations. (What nightmares would our FCC engineers have then suffered—had there been any such!)

This phenomenon of fading, then defined as "selective absorption," was particularly marked along the Pacific Coast. It occurred most frequently near sunset and extended late into the night, but was seldom observed at midday.

My observations demonstrated the existence of this fading as due to atmospheric causes. I made many careful observations of this novel effect, heretofore unrecorded. It was evidently a property peculiar to undamped-wave transmission. It had never been observed in all my wide experience with damped-wave transmission from spark transmitters, quenched or open gap.

While in New York a year later, in the fall of 1912, I had the honor of collaborating with a few other radio pioneers, including Robert Marriott, E. J. Simon, Fred Kolster, J. K. Thompson, and Dr. Alfred Goldsmith, in founding the Institute of Radio Engineers. At one of the first meetings of that body (destined later to exert such profound influence upon the gigantic developments of the then infant science and industry of radio) I presented a paper describing these newly observed and wholly

surprising phenomena of selective fading.* In that paper I stated:

It is possible that under certain atmospheric conditions, such as the presence of low-lying clouds or fog masses (a condition which occurs along the Pacific coast with great regularity throughout certain seasons of the year) the energy of the higher portions of the wave is deflected or bent downward. The receiving antenna is then acted upon by two wave trains following paths of unequal lengths, or even of unlike velocities. Thereby a phase displacement and resultant interference occur at certain localities, which become nodal points, where total or partial annulment occurs.

The reflections with which we were here concerned were very plausibly the result of layers of the atmosphere, or strata thereof, possessing marked gradients, such as of moisture content, temperature, barometric pressure, today known as tropospheric variants. The lofty Heaviside layers, the "ionosphere," are by no means the only ones which may be responsible for the annoyances experienced today from fading. Others, far lower, play a part.

At all events [my paper continued], this selective atmospheric interference affords one more evidence as to the utter futility of scientific attempts to predict by general calculations the quantitative laws of radiation and energy transmission in actual wireless telegraphy.

As a practical proposition such mathematical analysis is worse than useless, however exalting from the standpoint of academic theory. Too many factors of the equation must necessarily remain unknown. The alleged mathematical laws of radiation and absorption are completely misleading, and to that extent harmful. It is equally unprofitable to attempt to postulate from the general laws of thermodynamics and mechanics the exact force, direction, and pulse of the winds about a mountain, or over the waves of the sea!

Thus was published the first knowledge that there was such a thing as selective fading, and the word definitely put in the dictionary of the radio engineer.

* At this early I.R.E. meeting in Fayerweather Hall I caused considerable merriment by classifying the then new General Electric aliases of the Audion—"pliotron," "thyatron," "dynatron," et al.—as being merely "Greco-Schenectady" soubriquets of the three-electrode tube. That descriptive adjective is in humorous use even until this day.



CHAPTER 27

Collapse of Second Fortune

DURING the hectic year between my first journey to the Pacific Coast and my joining the Federal Telegraph Company, my time had been mostly lost, my energies dissipated, my talents wasting, while the doomed structure which the stock castle-builders had built upon my foundations was falling dismally around my head—and their heels.

But now it seemed that, as a last hope, the New York office had wrought a complete reorganization of the North American Wireless Corporation. A capable business executive was made president, and a German-American electrical engineer in whom he had utmost confidence, Fritz Lowenstein, had been placed in full charge of the engineering and manufacturing activities of the company. Some attractive United States Government contracts had again been secured, and to effect necessary economies the Newark factory had been completely closed and our governmental contracts had been turned over to the C & C Company on the outskirts of Newark. So it seemed wise to have one more conference there before finally signing up with Federal. My presence in New York was once more requested.

I remained in the East for six weeks, but in my diary I can find nothing but descriptions of my daily visits with little Harriet.

I went down yesterday for my last visit—for how long who knows—with my little girl, one day before her second birthday—two years old tomorrow. The joy of being with her was not completely spoiled by the “separation papers” with which her mother there presented me.

*Her glance, her smile, her promise spoken,
Must out from my memory pass—
As dew o' the night o'er the summer grass,
As the sound of a harp string broken,
As the pang of a heartstring broken.*

While I was living in New York, each morning at eight o'clock found me promptly at the apartment of Nora Stanton Blatch de Forest, who was usually by that time off to her engineering work downtown, and where I spent a joyful hour watching little Harriet have her breakfast and bath. My diary during those weeks contains little but detailed description of those delightful hours with my baby daughter, who brought so much joy to my heart.

In this year, 1950, I am a proud grandparent of wee Harriet's children, Catherine de Forest Allaben, her twin brothers, Lee and Stanton Allaben, and John Wagner. So I cannot refrain from quoting the following paragraph from that first “Diary of a Baby,” written in 1911:

Perhaps in a score or so of years this same scene will be repeated, and married Harriet (husband-loving, let us hope!) shall be herself immortalized in my grandchild! I try to recall the summer less than two bitter years ago when she was a little red wonder, all creases and meaningless cries—seemingly so far from a human being; yet the soft kernel from which this adorable flower of sunlight and intelligence and love has grown! Oh, life, life—your mystery is beyond wonder, above our awe!

So, resignedly, and yet gladly, I returned to my new tasks in Palo Alto. There, one afternoon late in March, while Elwell

was in Honolulu supervising the expected opening of wireless telegraphic service with the new South City station, I was visited by two men who quietly informed me that as United States marshals they had an order from the Federal Judge in San Francisco for my arrest.

Stunned, I inquired the cause. ". . . use of the mails to defraud" read their papers. They were kindly disposed, and gave me until midnight to arrange for bail. I at once telephoned Beach Thompson at the company's San Francisco office and, fortunately finding him in, hurriedly explained my perilous predicament. He went to bat with vim in my behalf, and by ten o'clock that night had arranged with two wealthy members of the board of directors, men whom I had never even met, to post the \$10,000 cash demanded by the court. Thus had I a shudderingly close escape that day from prison doors that seemed suddenly yawning before me, victim of those unprincipled promoters who had so villainously wrecked my radiotelephone enterprise and stolen the savings of the multitudes who had with their earnings backed my efforts to create a new art and industry.

I find this entry in my diary:

Palo Alto, March 29, '12: Since Wednesday I have worried more over what my arrest will cost my dear ones than about its outcome to me. Being guiltless, I fear not the outcome—only this heavy and renewed expense and the sense of the rank injustice of it all. I will probably fight it out here and not go east for a long time, as here is my work and my income, especially during the coming summer when "static" problems must be solved.

One thing was quickly sure, that I had made some mighty staunch and true friends indeed in the great West. When two directors of the company employing you, one of whom you have never seen, hustle out between 4:00 and 6:00 of an afternoon, when banks and commissioners' offices are closed, and put up a \$10,000 bond to keep you one night out of jail—it spells FRIENDS with big letters.

I have wired and written mother and relatives not to be alarmed, and I want none of my dear ones to worry over this. It will all come out right and be forgotten along with some other lesser, but more solemn, troubles

of bygone days! Meantime the hillsides about Palo Alto are at their greenest and a myriad poppies are pouring Springtime from all their cups of gold—so I'll continue smiling!

Nay, though in my youth I led in arithmetic, knew algebra to permutations, followed Euclid even across the *Pons Asinorum*, and in calculus could integrate the simultaneous covariants of transcendental functions—yet have I studied in vain. No theory of harmonics have I learned. Giant discords, minors and majors in elemental warfare, inconsistencies, injustices, violation of inviolate laws, refutation of facts and theories, jumbles and puzzles—frayed threads of what promised a massive tapestry—all of these have I encountered or created.

The shame and harmful publicity attendant upon the arrest of the directors put the final quietus upon the yet bleeding corpse of the Radio Telephone Company and its ill-conceived successor, Burlingame's North American Wireless Corporation.

Long before this, unsurprised and approvingly, I had read of the arrest, trial, and prison sentences imposed upon Colonel Christopher Columbus Wilson and certain members of his choice gang of wireless wreckers of my first enterprise, and at that time directors of the United Wireless Telegraph Company.* Yet notwithstanding that, Charles Galbraith and his corps of honest, capable, hard-working men, engineers, and operators who had been instrumental in building up the American De Forest Wireless Telegraph Company, had gone determinedly ahead developing "United" along sane and businesslike lines until, at the time of its forced and wholly unjustifiable bankruptcy, this successor to the company I had founded had far more wireless telegraph installations, on ship and ashore, than all the other wireless companies in the world combined!

Only by this forced receivership and sale was the American Marconi Company enabled to survive commercially. But by this strategic move and dominating stratagem the latter company acquired overnight almost a total monopoly of wireless telegra-

* For some reason best known to the U.S. Prosecuting Attorney, "Honest Abe" White was not indicted.

phy in the United States, a thing which they never could have accomplished by dint of their incomplete and sadly shattered patent position, or by virtue of any superiority of their system or methods. Until after World War I and the subsequent gradual substitution of the three-electrode tube transmitter and Audion (as detector, oscillator, and amplifier), the bulk of the ship-to-shore equipment in America was still the remains of United Wireless built upon American De Forest Wireless Company's designs and manufacture. At the time of the receiver's sale, United owned over 600 ship-to-shore installations, six times those of the Marconi Company.

It was thus and only thus that the American Marconi Company (British-dominated) managed finally to become the nucleus which after the first World War made possible the Radio Corporation of America. As I have shown, it all stemmed from the original American De Forest Wireless Telegraph Company. The chief reasons for the relatively inferior status of the Marconi Company were: the slow speed of transmission due to the antiquated British apparatus used; the natural American prejudice against use of a British device if an equally good or better American one were available; and the enterprising spirit of salesmanship which so characterized the officials of the American De Forest Company.

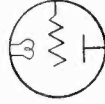

CHAPTER 28

Palo Alto Again

HERE in Palo Alto is one of the finest specimens of live oak in all the world. Last night I watched the full moon weaving through its witchery of leaves and gnarled boughs a Silver Legend. Here it is so still I scarce can sleep for silence.

The new job called for frequent trips between San Francisco and Los Angeles. When time permitted I journeyed by boat.

The sail, San Francisco bound, from the harbor of San Pedro was a refreshing change from the drowsy parching heat of the Los Angeles noon. I sat near the starboard rail and watched the great panorama of this southern California coast, rugged and alluring, unroll slowly across the vision. Hazy memories of the vague white cliffs of Dover on the English coast flitted across the mind's horizon, as unlike this picture as is old England unlike the land Cabrillo found. Perhaps the old Spanish padres brought to this land the strange warm beauty, the soul-soothing atmosphere of *dolce far niente* which has slumbered through these centuries of afternoon. I only know that its charm is irresistible, its poetic spell all compelling.

It was at the old Beach Station of the Federal Company that I first met Charles V. Logwood. Logwood was totally unlearned in engineering, innocent of higher mathematics, and yet possessed of an inborn instinct, a boundless amount of ingenuity, resourcefulness, and the quality of determined stick-to-it-iveness

which peculiarly endowed him for work in radio invention and design—and to a unique and most remarkable degree. In all my wide experience I have never met anyone possessing to such an unusual degree all those invaluable characteristics. He had a veritable genius for the solving of wireless telegraph and telephone problems. His mind seemed naturally to run in those channels. He was forever scheming and drawing circuits, and he seemed to possess an intuition which led him by direct short-cut routes to the end he was after. Or, if not to the exact end which he had in mind, his powers of observation were so keen that nothing which occurred in the course of his experiments passed by unnoticed, these frequently leading him to inventions of considerable importance.

“Charlie” Logwood at first was a little jealous of me, rather resentful that I should have come into the organization, probably to intrude in a field which he, quite justifiably, had mapped out for himself. But after we had “jointly and co-operatively” settled determinedly upon the tough problem given us by the directors (to make the newly opened Poulsen station at Medford, Oregon, into a reliable commercial correspondent with San Francisco and Seattle), Logwood began to realize that I could be of some real help to him, began to respect my superior training and knowledge, my many long years of hard-bought experience in radio, and the practical wireless education which I had acquired.

Charlie had never seen an Audion until I showed him one, but he immediately fell in love with the little device and became imbued with respect and admiration for the one who had produced such a wonder. Thereafter he devoted himself wholeheartedly, and with the utmost loyalty, to co-operating with me in whatever task I should undertake.

Close and intimate was the friendship developed between Charles Logwood and myself, one which lasted throughout my stay with the Federal Telegraph Company in Palo Alto and for many years afterward in New York, through the brave days and

the long battles which marked the founding of my third fortune, and the gradual upbuilding of the deserved success in which we could both take such a profound and well-justified satisfaction.

While I was developing the diplex transmitting system for the Beach station, Logwood was of great assistance to me. Frequently we worked there all night because we could not begin our experiments or alterations until traffic was shut down in the late evening. Then, after the operator had gone home, we would dismantle the standard equipment and go to work in secret. By early sunrise we would rearrange the circuits and put them in order for the day's traffic.

Meanwhile in the little laboratory house I kept hard and happily at work, nights and days. A host of new problems faced me, many fascinating ones to which the spark telegraphy (at least under the incompetent or criminal management by which it had always been cursed) had never attained.

For example, diplex telegraphy to enable two north and two south transmissions simultaneously, both sending and receiving; attempts to amplify the received signals, using the new "compound tikker" of Logwood, by means of two mechanical relays, or "repeaters"; improving the efficiency of the Poulsen arc, silent or when generating an audio note which could give a better received signal than did the tikker.

Then there was my old enemy, the twelve-year-old *bête noire* of all wireless investigators, as yet baffling us all when vicious—"growling" static.

I made frequent trips into the city to the big station with this or that instrument for trial; but the quiet of that small village, its dreamy dawns, its warm noons, its silent nights, its welcome atmosphere of quiet erudition and genuine, unpraised effort, seemed to be working upon my mind and body a wholesome peace and contentment, which was good though sometimes almost alarming.

My Sundays during the earlier San Francisco period were frequently spent in exciting and health-giving hikes and climbs around the Sausalito Hills, a Sabbath habit which I began to develop shortly after my first arrival in San Francisco. How fascinated I became with old Mount Tamalpais and that country of Marin County! Even when I moved to Palo Alto I would come up by train, take the ferry for Sausalito, and either alone or, preferably, with Logwood, spend the entire day in vigorous climbing, sometimes going over the ridge as far as Rodeo, where a little runnel empties into the thirsty sands by the plunging sea.

On the steep western slope of the mountain has stood alone for centuries a gigantic redwood, beside what is known as the "Lone Tree Trail." Its loneliness, its rugged strength, its ageless endurance deeply impressed me, teaching a lesson then earnestly needed—inspired my courage—and I wrote:

THE LONE TREE OF TAMALPAIS*

*Hail, stalwart Guardian of the barren slope!
Tall sentry of the Lone Tree Trail,
Hale and green thy form as living Hope,
Far from thy clustered brethren of the redwood vale.*

*Through centuries of storm, through summers numberless
Thy arrow shaft, thy vernal feathered blade
Has shot aloft, nor dared the gale the less
Because thy kinsmen in the valleys grouped their shade.*

*Here once a seedling, foundling of the winds,
Fed from this oozing spring of tempests' tears
High on the hillside, now thy rough bark binds
The storm-bred courage of a thousand years!*

*Athwart the sunset stretch thy vernal bars!
Teach thou my soul a strength which shall not fail,
Through night and mist still reaching toward the stars,
O straight and staunch Defender of the Lone Tree Trail!*

* Published in *American Forests*, March, 1939, p. 114.



CHAPTER 29

A Lever to Move the World

AND now my Palo Alto work went on apace. Since the first of 1912 I had had as my assistant, in addition to Logwood, one Herbert Van Etten, graduate of Stevens Institute and an engineer for the Pacific Telephone and Telegraph Company in San Francisco, who desired to change to the new work in which we were here so eagerly engaged.

Soon we three became co-ordinated in the task of signal amplification. Elwell had placed the Palo Alto engineering, the design and construction of ever-larger transmitter arcs, in the charge of Leonard Fuller, under whom worked Ralph Beal and Archie Stevens—men who have since carved their names high in the annals of radio.

Late that spring I felt financially justified in seeking again to establish a home. I contracted, therefore, to purchase on installments a neat and cozy little cottage on Bryant Street and invited my dear mother to make it her home. By this time I had happily reconciled myself to the thought of being a Californian permanently associated with the Federal Telegraph Company, to which I was already assigning certain patent applications.

My mother accordingly came to Palo Alto and lived with me there in quiet peace and contentment, continuing to dwell in Palo Alto almost until the time of her death in 1927 at the age of 79.

Now the Federal Telegraph Company demanded more in telegraphic speed for their rapidly growing trans-Pacific and coast-wise traffic. The Danish-designed photographic telegraph signal printer on which I had toiled assiduously in the little hotbox of a station at Los Angeles proved too elaborate and unreliable. I suggested that we cut the Gordian knot with a simple fine steel wire. The San Francisco agent for the American Telegraphone Company was keen to comply with my request and to loan me two of their telegraphone machines. I ran these at high speed while recording magnetically upon the fine steel wire of the telegraphone, high-speed telegraph signals transmitted from a previously punched tape, the same tape as had long been used in high-speed telegraph for cable transmission. I then reran the steel wire at a rate slow enough to permit the operator listening in the telegraphone headphone to transcribe the recorded messages on his typewriter.

This was all very well, but the long-distance telegraph signals impressed thereon from Logwood's simplified—but highly ingenious—"tikker" were too weak for satisfactory recording. Thereupon Logwood and I, using the Audion tubes and batteries which I had brought down with me from the deserted Phelan Building station, set about constructing therewith an *amplifier* for telephone signals. Van Etten, telephone engineer, watched with keenest interest, but with conservative and constructive skepticism. He well knew how the telephone profession had vainly toiled for many years to accomplish exactly what we raw wireless inventors, unlearned in the telephone art, were so innocently, sanguinely, attempting.

So I made Van Etten be my umpire. Whenever I had a new circuit arrangement or a new induction-coil setup, with his

watch tick at the transmitter (a telephone receiver, *not* a microphone) and with a headphone set for listening, I would ask "Van's" opinion as to whether or not I had here attained any amplification. For with the Audion bulbs we were then using, more or less gassy, designed entirely as radio detectors, and with coarse grid structure, it was by no means a simple thing to obtain any observable degree of amplification of telephone signals. For three tedious weeks Van would merely shake his head. Finally, Charlie and I secured a degree of amplification which could not be questioned or denied.

"Waal," finally drawled Van Etten, "the thing *do* boost!"

At last we had triumphed. Thereupon I set about cascading two Audion tubes, the "wing," or plate, circuit of the first Audion feeding the grid circuit of the other Audion by induction through a properly designed telephone repeater coil, or transformer (I had the shop wind dozens of these during the experiments).

We now found that we were stopped from obtaining greater amplitude by the fact that when the B battery potentials were raised to secure greater power output the tubes invariably "blue-hazed" on account of the gas therein. I had recently obtained a dozen tubes from McCandless, re-exhausted to the very limits of his lamp pumps. These were still too soft however, so I finally found a maker of X-ray tubes in San Francisco (Lamont, I believe was his name) who re-tubulated and re-exhausted the McCandless bulbs, giving them the identical treatment he had been giving his X-ray tubes. With these re-exhausted tubes we could safely apply as much as 120 volts or more to the anodes.

Now with these Audions, in double and triple cascade, I really began to get astonishingly fine amplification. We tested this amplifier always by reproducing magnetic records from the Poulsen telegraphone. I had obtained a small loud-speaker, which was nothing more than a large telephone receiver with a short elbow-shaped, double-mouthed horn attached thereto. My

method of measuring the relative amplitude levels obtained under varying conditions was truly simple, ready-made, but effective. Instead of the "transmission units" of the telephone engineer, I measured my gains in "blocks" and "half blocks!" I placed the loud-speaker in the laboratory window and walked down the street until the threshold of clear audibility was reached. After I had obtained a "two-block" gain, I felt reasonably satisfied with *the Audion amplifier*.

Thereupon I sat me down and wrote a long detailed description of what I was doing with the Audion as a telephone amplifier to my good friend John Stone Stone in New York. By return mail he expressed the utmost interest in the information I had conveyed to him, and volunteered his willingness to lay the matter of this telephone repeater, or amplifier, before his friend, J. J. Carty, vice-president of the American Telephone and Telegraph Company in New York City. Further correspondence followed. Soon Stone informed me that he had made arrangements for me to demonstrate the Audion amplifier before engineers of the Western Electric Company in the Bell Telephone Laboratory in New York.

But meanwhile, during the early stages of my Palo Alto development of the cascade amplifier, I had accidentally made another discovery—a discovery which was destined a few years later to completely revolutionize the entire art of radio transmission.

This was the "feed-back" principle.

Van Etten's notebook (which has now become classic by having been introduced as evidence in one of the most long-drawn-out, bitterly contested, and historic interference procedures in the history of the United States Patent Office) states that on August 16, 1912, I had so arranged the inductance coils connecting the first and second Audions of the cascade amplifier in reflex manner that low or high musical tones could be heard in the tele-

phone receiver connected to the output circuit of the second amplifier. The record goes on to show how we investigated this

*Exchanged Coils #1 & #2 so that each
 in turn had a large & a small coil attached & were the
 response for generating up & down jing. in each case.
 Found the following circuit would repeat
 and work each way*

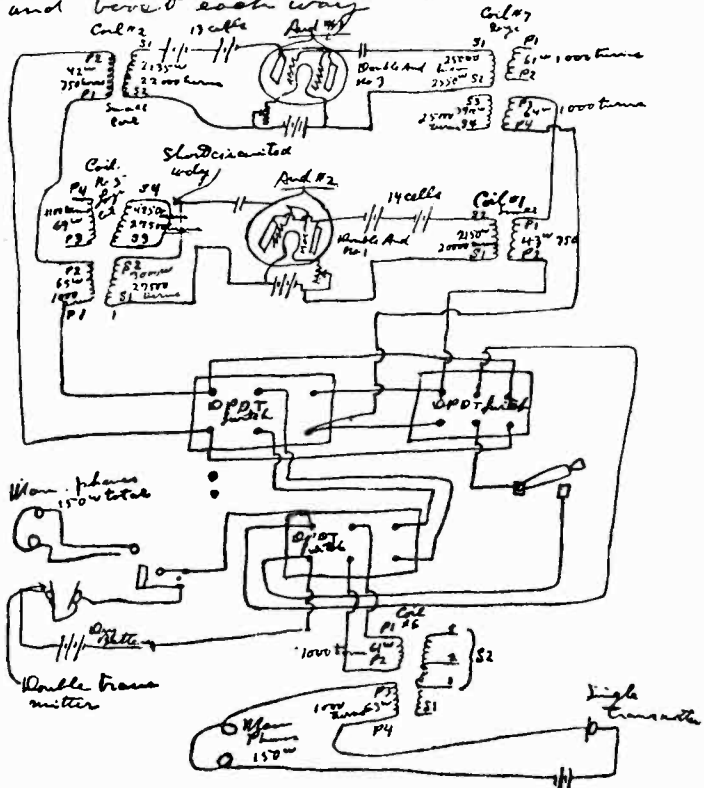

One of the pages from Van Etten's notebook which helped establish my prior discovery of the feed-back effect. In one of the most famous interference cases in U.S. history, the Supreme Court recognized this document as proof of my claim to priority. (See p. 382.)

phenomenon and found that we were able to change the pitch of the reproduced note through a wide range of frequencies, de-

pending upon the amount of inductance in the circuit and capacity in shunt thereto. By reversing the connections (either to the input of the second Audion, or the output of the first) the feedback, or *regenerative*, effect could be annulled; and then, by renewed reversal, again reproduced.

One of Van Etten's notes (he was the recording secretary in these experiments, Logwood and I being too busy and excited in preparing the circuits and calling the turns on the experiments to pay much attention to the actual recording of the results obtained) shows that on one occasion, having available at the time only one satisfactory Audion, we had undertaken to make that bulb do the work of two by deliberately connecting, or associating, the output circuit with the input—a clear indication of the fact that we then understood thoroughly the phenomenon with which we were dealing, the feed-back principle, and even at that early date were seeking to obtain self-amplification. But in so doing we obtained instead self-regeneration—in other words we put the Audion into a *self-oscillating condition*.

My own notebooks confirmed these operations. But the entry, which in the later opinion of the Supreme Court definitely determined the earliest date which I could claim for my discovery, the feed-back circuit, was an entry in Van Etten's notebook.

In the latter part of September, Beach Thompson was making a business trip to New York and very kindly offered to take me along with him, for I had frankly explained to him the entire situation—that John Stone Stone had made definite arrangements with the Telephone Company for me to give a demonstration before their engineers in New York. I showed Thompson my earlier patents, assigned to the Radio Telephone Company, covering both the grid Audion and the three-electrode-tube amplifier. So he clearly realized that ownership of my invention could not be claimed by the Federal Telegraph Company. Yet he was

generous and bighearted enough to do what he could to facilitate my plan to interest the Telephone Company in a device which, while it might be interesting and useful to the Federal Telegraph Company in amplifying their signals, should prove of inestimable value—in fact, indispensable—to the Telephone Company on their long-distance lines.

Arrived in New York, I made the Engineering Society's Library my headquarters and there spent most of my spare time in studying—delving through engineering journals to which I had been denied access while in Palo Alto. But first I set up my cascade Audion amplifier in an upper room of the Fine Arts Club on Gramercy Square, where John Stone Stone was then living. Stone, of course, expressed the very keenest interest in what I had to show, and listened intently to my account of all I had to relate regarding the experiments I had made in Palo Alto leading up to the construction of the finished amplifier.

Among other things I informed him in detail of my discovery of the feed-back phenomenon and of the way I had applied this, even using in addition to the telephone induction coils my pancake tuner coils wherein frequency oscillations that were inaudibly high must have been generated. Stone's testimony to this effect in the subsequent interference proceedings and Supreme Court hearings proved of great importance.

Now without delay Stone arranged through John J. Carty for me to take the apparatus down to the Western Electric-Bell Laboratories on West Street, where a small room was set aside for this purpose. By early afternoon of the first day I had the apparatus set up and in operation and then notified Carty. The Western Electric and Bell Laboratory engineers filed in to see what de Forest, the wireless telegraph man who had rather recently been filling the ether with voice and music instead of dots and dashes, might possibly have to offer which could be of interest to the telephone engineers!

This corps of telephone engineers was headed by Dr. J. De Forest Arnold. Under him were Richards, Dr. Colpitts, and several others whose names have since escaped me. The men were mildly interested in what I had to show them, asked me a few questions, and finally suggested that I might leave the apparatus there overnight and perhaps come in the following day, at which time they might desire to ask further questions. J. J. Carty was conspicuous by his absence.

On the following day the attitude of these previously indifferent and rather aloof telephone engineers towards myself and my apparatus had undergone a very marked and encouraging alteration. Where before was indifference and an attitude of boredom, now an atmosphere of keenest interest pervaded the room. As one after another donned my awkward headphones and listened to the resounding thud in their ears when I dropped a handkerchief a few inches away from the telephone receiver (which was acting as my input transmitter), expressions of incredulity and surprise spread over their faces. At the close of the séance it was very evident that all present were keenly interested in the Audion amplifier as a telephone repeater or relay.

Dr. Arnold asked me if I would be willing to leave the apparatus with them for a short time, and inasmuch as the circuits which I had shown them were in the main covered in my earlier patents, Mr. Stone and I accepted his assurance that my rights in the invention would be most scrupulously guarded.

And so the matter rested (so far as I was able to find out!) for nearly one year. I was perfectly willing to leave the apparatus with the Western Electric engineers to make any further tests or experiments which they might see fit, believing that in this manner their interest in it would be most rapidly and intensely focused and that before many weeks they would be in a position to inform me whether or not the Telephone Company was interested in the possibility of acquiring rights under my patents for

use of the devices and circuits on their long-distance telephone lines.

And thus, rudimentary though it was in 1912, there was introduced to an impatiently waiting world—nay, many worlds, of Science, Industry, Medicine, Universal Communications, and Music—that magical Genie, *the Amplifier*, which was to open boundless vistas for the swift advancement of mankind; the electronic lever wherewith man should pry open the age-old clam-shell within which, otherwise, he must stay forever confined.

I lingered on in New York week after week, expecting some report from West Street, or 195 Broadway. Meantime, inasmuch as I had been wise enough to bring with me two sets of Audion amplifiers, I began to demonstrate to other parties with my duplicate set. O'Reilly of San Francisco had insisted that I go to the Springfield, Massachusetts, headquarters of the American Telegraphone Company, and demonstrate there the Audion amplifier as applied to the telegraphone. This I did. The Telegraphone directors there, and their New York representative and attorney, "Honest John" Lindley, showed considerable interest in the possibilities of using this amplifier in connection with the telegraphone.

During those tedious weeks in New York awaiting word from the Telephone Company, I went over to Orange, New Jersey, to the Edison laboratories and factories. Miller Reese Hutchison, Edison's personal representative, whom I had known earlier during my first broadcasts in New York, piloted me around. The ingenious and highly efficient methods of manufacturing the various parts for the Edison storage battery were exceedingly interesting to watch. I was profoundly impressed by the evidences of indefatigable labor, of painstaking care in an infinity of details, and of unlimited expense, which were first necessary to produce the product.

The "Old Man" was now hard in the midst of one of his "campaigns," putting the finishing touches on the disk, and preparing machinery for manufacturing the phonograph instruments in large quantities. Hence he was sleeping less than usual, and all of his helpers, mechanics, and immediate workmen belonged to the "insomnia club!" The day we were there he had had his first sleep in a bed and first wash in three days—but there he was again at 10 P.M., coatless, beltless, white boiled shirt already grimy, "white" bow tie off under his left ear, pants almost open—an inspiring, almost pathetic sight. He was 65 years old then and looked much more—with straggly white locks scattered over his big bald pate and shaggy eyebrows over his gold-rimmed spectacles.

Hutchison found him away up in the top loft of one of the numerous factories and arranged for me to meet him for a few moments. At a time like that, when he was "campaigning" and self-isolated from the world, this was a very unusual thing to achieve.

When introduced, he said in a soft, weak voice, full of kindly interest, "Oh, de Forest? Yes, yes. Well, what's the latest in wireless?" I yelled into his ear a brief account of our work on the Coast and of the Audion amplifier. He was much interested, and recalled many early experiments of various sorts of his own, making crude sketches on my note paper, using (and *keeping*) my lead pencil. His great deafness made it difficult to talk to him. We chatted (one in a soft grandfatherly voice—the other in ear-splitting tones) for perhaps ten minutes, and then the greatest inventor in history returned to his relentless grind, more fascinating doubtless to him than any sport or game could be to any youth—and I to the city, proud of my interview and filled with a new admiration.



CHAPTER 30

Romance and Radio *Resurgent*

“You know, my Friends, how long since in my House
For a new Marriage I did make Carouse;
Divorced old barren Reason from my Bed,
And took the Daughter of the Vine to Spouse!”

DURING the early part of my stay in New York I had renewed with great delight my old acquaintanceship with Emil J. Simon, who was then employed by old Colonel John Firth, the man who first took me under his wing and showed the first interest in my wireless telegraph apparatus and plans when I came to New Jersey in 1901. One night in October, “E. J.” and I went to the Grand Opera House to a performance of the *Quaker Girl*, a tuneful musical comedy then enjoying considerable popularity in New York. He was acquainted with some of that company and after the performance introduced me to a charming member of the chorus, Miss Mary Mayo, possessor

of a dramatic soprano voice of very unusual quality, absolutely true to pitch and of a natural, birdlike purity.

This chance acquaintanceship rapidly deepened into a sincere mutual interest, and by the end of that momentous year of 1912 ripened into deep affection and love between the beautiful Mary Mayo and myself. So that when the San Francisco office finally wrote me that if I wished to continue in their employ it would be imperative for me to return to my Palo Alto work, we promptly decided upon marriage and a western honeymoon.

By this time, since John Stone Stone had received no information whatever from the Telephone Company as to what progress they were making with the Audion amplifier, and inasmuch as "Honest John" Lindley and the Telegraph Company's directors were equally undecided, or disposed to indefinite postponement—to continue with the Federal Telegraph Company was my only alternative.

By January 30, 1913, I was back again in Palo Alto after four months in New York—momentous months—back again, yet so differently.

So often already, even as now, have the liquid notes of her voice, the mellow tones played by her fingers, tender and talented, called me from my little den to the living room where the fire logs crackle, embers glow red, and lamplight floats upon the dark night of her hair!

Hours glorious, golden, of morning and midday, when even a California springtime hastens its primrose footsteps down the hillside of the opening year; when ruddier beams than usual, even for this Paradise, gladden the sunset skies.

Mother continued to live with us there, all in happy contentment. But I, although happy and wholly occupied with my laboratory tasks, lived ever in the hope that the Audion seed which I had sowed the past autumn back in New York would soon spring up into a new harvest, calling for my return, to reap at last the reward for which I had battled since my first conception of the three-electrode tube.

In March of that year John Stone Stone came to San Francisco to see me. He had had intimations from his old friend, J. J. Carty, that the Telephone Company would definitely be interested in acquiring rights under my Audion patents if the tests still under way in New York continued to give promise of commercial applicability to their lines, and that he desired in such event to deal with Stone as my representative.

Thereupon Stone and I drew up a gentlemen's agreement empowering him to negotiate with the Telephone Company for the sale of these rights, and to receive a commission if such sale was effected. The sale price for the wire rights to the patents was not then fixed, but the sum of \$500,000 was mentioned as a fair price.

My engineering efforts during that spring were divided between improving the transmission of the new high-power station at South City and work in the laboratory, the latter chiefly directed to further efforts to eliminate, or at least to reduce greatly, interference with wireless communication from static disturbances.

The South City station originally had one large fan antenna supported between two 300-foot wooden masts, but the energy radiated was far from satisfactory. I had the contractors double this span, stretching the mid-sections of the two halves away from each other as far as feasible, in a diamond-shaped formation. This was an improvement, but not sufficient. I then rigged a wide horizontal flat-top antenna stretched between the two towers and—halfway up—extended between the two fans. From both ends of this flat top, cables were brought down and connected to the earth plates. These latter I had designed of a multitude of long spokes of copper strips and copper wires, extending radially from the station in every direction, because the high plateau on which the station was erected was altogether too dry to afford a satisfactory ground connection. This pro-

cedure was based on my wide experience with high-power wireless telegraph stations in the East.

This novel arrangement of a compound antenna increased by 25 per cent the best previous radiation, and Honolulu immediately reported a marked increase in the strength of our signals.

During the preceding spring in Palo Alto I had striven by various ingenious methods to develop a *heterodyne detector*—in other words an oscillating detector which would heterodyne with the received undamped-wave signals from the distant transmitter, to give us, instead of the rough musical note of the improved Poulsen-Logwood tikker, a clear, high-pitched musical sound similar to that which I had long ago found so effective in my spark-telegraph days. So now, in the spring of 1913, profiting from what I had learned the preceding August relative to the feed-back principle, I hooked up the Audion detector with a small pancake coil in its "plate" circuit, or telephone. I then loose-coupled this coil to a similar pancake coil inserted in the secondary, or grid, circuit of my receiving transformer, that is in the grid-filament circuit of the Audion.

And now for the first time, listening to the undamped-wave signals coming in from South City, I was able to record in my laboratory notebook this phrase, destined later to become historical in the annals of that famous patent-interference suit with Armstrong: "This day I obtained the long-sought-for *beat-note* phenomenon."

In high glee I called Fuller, Beal, Stevens, and Logwood into the receiving laboratory room where I was then at work. They all heard the Poulsen signals as they had never heard them before, in the form of a high squealing note, *the pitch of which could be altered at will by simply changing slightly the tuning condenser in the grid circuit*. No one but Logwood, however, understood the circuit whereby I was able to obtain this highly desired effect.



CHAPTER 31

The Telephone Company Gets a Bargain

ABOUT this time I began to receive encouraging letters from "Honest John" Lindley and his associates in New York, Dr. Louis Duncan and Sam Young. These letters indicated that this group had become very much interested in the Audion amplifier and that funds shortly would be provided to bring me again to New York to carry on certain laboratory experiments which I had outlined to him on my previous visit. This referred to a combination of the Audion amplifier with a specially designed type of telegraphone recorder and reproducer, one which could be synchronized with a motion-picture film for the purpose of achieving talking motion pictures.

Toward the end of April, 1913, funds were actually in hand for this eastern trip, together with assurances of definite employment again in New York. So I resolved once more to cross my Rubicon, burn my bridges behind me, leave our little Palo Alto

home, which had been my shelter for less than a year, and take my bride back to the Eastern metropolis.

Again I packed up my Audion amplifiers and personal belongings, and bade a long farewell to Palo Alto and to the California which I had learned to love so dearly. I turned the home back to the original owner and established my mother in a very pleasant little apartment. There she seemed quite contented, because she had already during her one year's stay in Palo Alto formed many pleasant acquaintances with our distant relatives (by marriage), Mrs. Albert De Forest and Mrs. Tracy De Forest—wife and mother respectively of my father's cousin.

Arriving in New York early in May, I learned that the house at Spuyten Duyvil had long ago been completed but never occupied, and that we could move in and occupy the premises until such time as we could find a way to pay for it, or until some other purchaser of the property could be found. Thereupon, Mary Mayo and I moved into the new home, which I forthwith named "Riverlure—Where Dreams Come True." We lived there through that summer, content with such scant furnishings as I could obtain on very long-term installment payments from "Bloomingdale's in the Bronx." Mary Mayo became a good cook, and we managed to get along quite comfortably—at least so long as I received the small salary that Duncan and Young were to pay.

The old 14th Street studio of the Biograph Company, William Hammer, manager, whose main studios were then in the Bronx, afforded ample room for my work. Hammer was very much interested in the plans, as I outlined them to him, for creating the talking picture. The American Telegraphone Company at Springfield was also interested in the possibilities of using the telegraphone for this work, and furnished me with their newest model. There was an old projection machine available on the premises, and I began to design and to have built mech-

anisms whereby the telegraphone wire could run over a large pulley attached to the socket spindle of the projector in such a manner that the steel wire, as it traveled from one telegraphone reel to the other, would exactly synchronize with the travel of the picture film. This was, I believe, *the first idea of a talking picture with sound recorded on a steel medium*. The date was 1913.

Experiments were encouraging, so much so that it soon became evident that I should have a piano for recording purposes. About this time the meager finances which had been supplied by Messrs. Duncan and Young became more and more irregularly forthcoming, more meager, and finally dried up altogether. So here again I found myself high and dry, without money, but with plenty of courage and determination—for I was working along a line which could bring a fortune.

When in my desperation I went to "Honest John" Lindley and almost begged him for a brief continuation of my meager salary, or even a personal loan, I received only this comforting word: "The curse of the poor is their poverty." Had that stingy old fool but known who was, even then, ready to bid for limited rights under those Audion amplifier patents!

Mary Mayo hocked her ring and I my watch so that I could rent a piano, because I was convinced that if I could make a few satisfactory demonstrations with my talking-picture apparatus, it should not be difficult to interest the Biograph Company in financing my further work.

Still no word, either to Stone or myself, from the Telephone Company. I went to see my old friend and helper, McCandless. He informed me that for some months after my demonstrations their engineers, Arnold and Richards, had caused him to build a great number of Audion tubes of various types and designs; but for a long time subsequently he had neither seen nor heard anything from that quarter.

My condition became desperate indeed. Just how we managed

to exist through the balance of that summer I cannot now say, but the fact remains we did, and furthermore we entertained company at Riverlure. John Stone Stone came to call upon us, and dear old Mac Horton to renew in happy reminiscence the lively battles we had waged way back on the coasts of Holyhead and down along the Caribbean waters, and later on the southwest coast of Ireland, where the rains fell, and the winds were fickle, and the Bell tetrahedral kites cracked up!

In my diary under date of July 17, 1913, I find the following:

Two or three weeks yet of waiting and hoping, and it is a jolly(?) struggle to keep alive and cheerful in the meantime (and then that awful dread the while).

To dine of an evening on our riverward veranda, to watch the great steamers plow majestically past, or perchance see the black shadow of a schooner's sails glooming against the darker Palisades! Then, when all is night, and only twinkling lights out on the river wink and nod to the cooling breeze, Mary will open her piano and the night becomes all melody, and the starlights twinkle in her song!

She is at it now, as I write—the "Rondo Capricioso," and she as beautiful as the notes she plays, and as full of graces! Yes, it is worth all it costs.

During this summer I was occasionally in contact with Burlingame and some of his henchmen, dummies whom he had placed in particular charge of the moribund Radio Telephone Company. One day late in August these informed me that they had been approached by a dapper young attorney by the name of Sidney Meyers, who represented clients interested in making an offer for certain patent rights of the company.

Shortly thereafter this same Mr. Meyers called upon me at my 14th Street studio. He was pleasant and suave as he explained his errand. I informed him that ten months previously I had demonstrated my Audion amplifier to the engineers of the Western Electric Company, that they had seemed well pleased with its possibilities for application to long-distance telephone lines, but that ever since then I had been waiting to hear from

the Telephone Company regarding the purchase of the patent rights. I told him the wire rights in which he said his clients were interested could be of value only to the American Telephone and Telegraph Company, and I could not understand why any other party could be interested in acquiring the wire rights under those patents.

Meyers assured me, "on his word of honor as a gentleman," that he did not represent the Telephone Company. He was very secretive as to who his real clients were, but when I pressed him for further details he admitted that it was possible they might have some idea of developing the invention further and then interesting the Telephone Company therein. He stated that his clients had authorized him to offer \$50,000 for the wire rights under a group of seven Audion patents. This was their price and there was no need in our attempting to raise their offer. In other words, he very politely told us that we could "take it or leave it." And he went on to say that before any money could be paid over, contracts would have to be drawn up, stockholders' meetings of the Radio Telephone Company and the North American Wireless Company would have to be held authorizing the officials of those companies to sign, and that I myself would have to sign the contract personally.

I was, of course, disturbed and greatly disappointed not to have had any word from the Telephone Company, but realizing the desperate condition of the Radio Telephone Company and the North American Wireless, and of my own situation, and well realizing (then almost literally) that a crust of bread is better than no bread at all, I advised the company's officers that we had best accept this proposition of Meyers. His offer, had we then realized from whence it came, could well have been characterized as a piece of "crust." At a subsequent meeting Sidney Meyers informed us that he had looked thoroughly into the condition of the companies and found out that the Radio

Telephone Company was badly in arrears with its New Jersey state taxes, and that it might even be necessary to go through the formality of an auction sale of the assets of that company at the courthouse in Trenton. This suggestion fairly frightened us because we well realized that under those conditions his clients could probably angle to obtain not only the wire rights, but all of my patents *in toto*, for a few thousand dollars, of which we would receive not one cent.

Accordingly, Sidney Meyers was authorized by us to proceed immediately to draw up the necessary papers. The North American Wireless Telegraph Company was a Maine corporation, so it was necessary for us to go through the formality of holding a stockholders' meeting at Portland. Meyers' clients obligingly advanced a few hundred dollars to pay the expenses of holding this meeting, and a group of some six or eight journeyed to Portland, Maine, for this purpose. During the trip I became well acquainted with Frederick Williamson, one of the directors, the only one of the lot who seemed to understand me and my previous services, and to sympathize with my predicament.

Shortly afterward we held a stockholders' meeting of the Radio Telephone Company in Jersey City, at which, very much to the surprise of Burlingame's dummy president, I, as majority stockholder, proceeded to elect new directors, who in turn elected Frederick Williamson as president and myself as vice-president of the company.

And so at last the papers were all signed, sealed, and delivered to Mr. Sidney Meyers. Captain Darby approved the assignment papers, giving to Meyers "and his assignees" exclusive wire rights to the group of seven Audion patents. His check for \$50,000 was duly turned over.

Thereupon the truth leaked out. Meyers' clients turned out to be none other than the American Telephone and Telegraph Company! I later learned, on reliable but unofficial authority,

that the directors of A.T. & T. had voted to pay as high as \$500,000 for the wire rights under the Audion patents. If so, the "forced-sale" tactics employed by their go-between, Meyers, saved them \$450,000—at the expense of the stockholders to whom the patent rights belonged.

To me at that time the check, however small, was as a breath of air to one smothering—as a morsel of food to a starving man. I had already found a new empty building on Sedgewick Avenue, the Bronx, at High Bridge, within ready access from my Spuyten Duyvil home by New York Central train. I finally persuaded Williamson that this was the ideal spot for my laboratory. An office was to be opened downtown for more conveniently reaching vessel owners and the growing number of amateur wireless fans.

I was determined to lose no time in getting under way again. The prospects looked bright for my experimental laboratory and the manufacture of radio receivers, amplifiers, and set parts, for the new markets which I was confident could be rapidly built up.

No sooner was Meyers' check in the bank than I wrote to Charlie Logwood to pack up and come east. Nothing loath to leave California, where *his* marital affairs had recently met tragic shipwreck, he came on, but by way of Washington with C. F. Elwell, where the two demonstrated at the big new Arlington Naval wireless station a large Poulsen arc, Logwood's tikker detector, and a cascade Audion amplifier which they had constructed, breadboard form, in Palo Alto after my departure.

So there in the large empty two-story loft of the High Bridge plant, Logwood and I immediately began our experimentation with Audion amplifiers and oscillators, starting again where we had discontinued that fascinating work more than a year previously in Palo Alto.

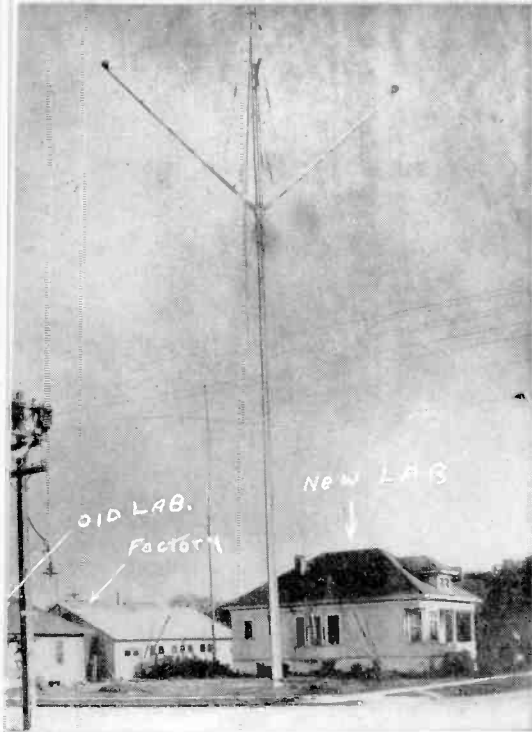

In the Palo Alto laboratory of the Federal Telegraph Company, Lee de Forest made two of the most important inventions of his career: the Audion amplifier and the feed-back circuit.

*A four-stage Audion amplifier as developed by Lee de Forest in 1913
(upper right)*

The Audion grows up and becomes an Ultra-Audion, or oscillion, used in broadcasting stations as a generator of radio waves. These tubes belong to the years 1916-1917.

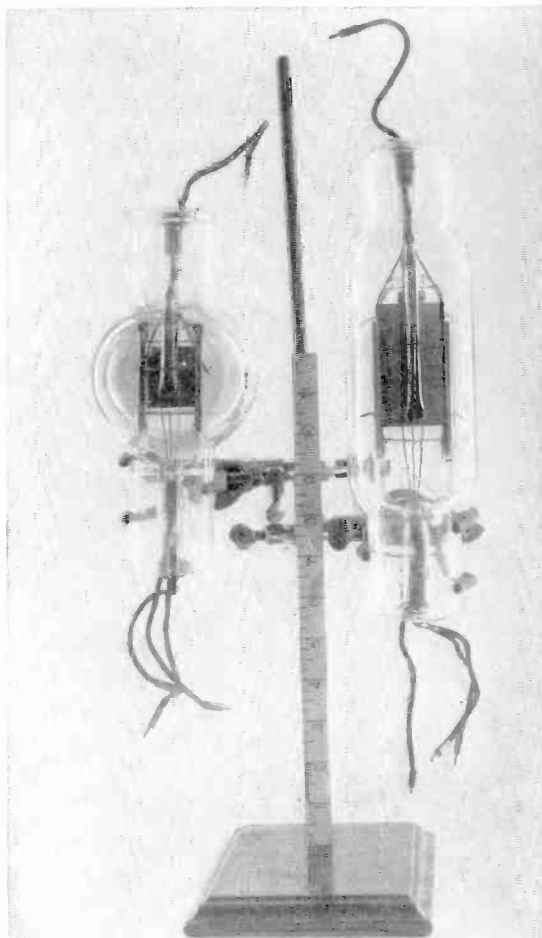

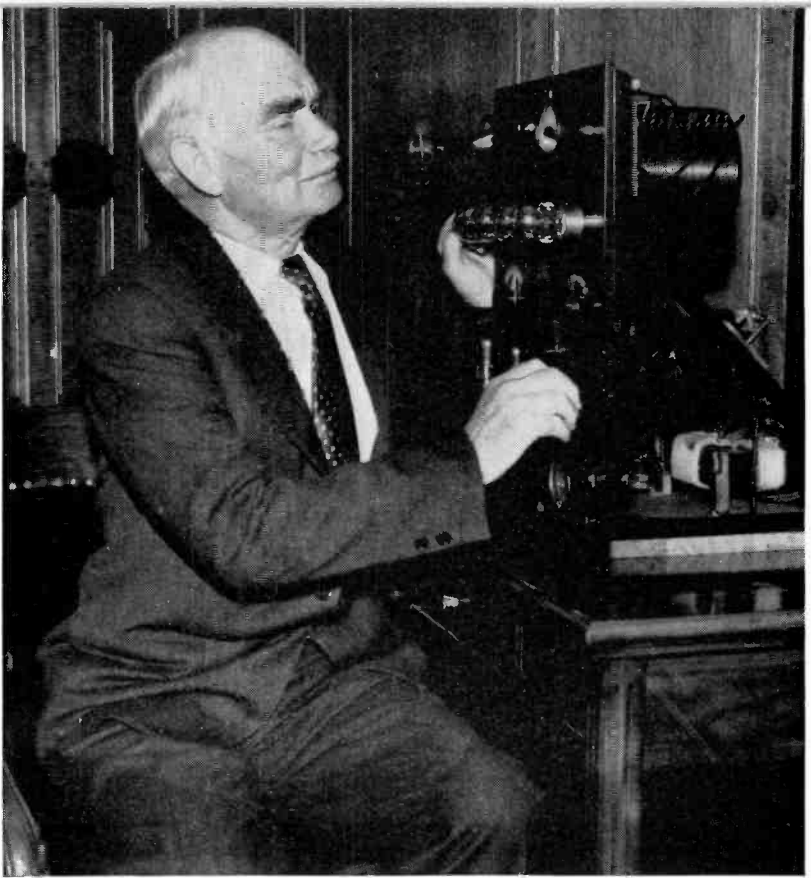

Lee de Forest at one of the first radiobroadcasting transmitters



In 1916 de Forest made the first demonstration of radio transmission from airplanes.



CHAPTER 32

The Audion No Swindle!

AND now, shortly prior to my first Thanksgiving Day in the new home, the black lowering cloud of that dread Federal prosecution mantled my soul with sodden gloom. Throughout the preceding summer I had done nothing to prepare my defense. I had been quite without funds all those months, while Captain Darby had employed Martin J. Littleton to defend himself, and the others had hired expensive counsel. Knowing that I was not dishonest, had robbed no one, I felt perforce compelled to rely on my blind faith that Justice would triumph, that no judge or jury could find me guilty.

Yet my perilous predicament had been noised around. Certain of my Yale friends, notably Lloyd Smith, '95S, chairman of the *Yale Scientific Monthly* at the time I was elected to the new Board, with George Parmly Day and George McLanahan, '96, of Washington, realizing my peril far more than I, had circularized (entirely unknown to me) certain of my classmates, and had underwritten a "de Forest Defense Fund" amounting to perhaps \$2,500. An active, crusading young attorney, Howard

Deming, then arose to defend the maligned inventor, who, lacking such aid, would have been able to put up no defense whatever.

And so I began to prepare. My nights were spent in the laboratory with Logwood, but my days were spent at Deming's office, where John Stone Stone was usually found aiding in every way to defend the intrinsic value of my inventions and of the patents I had assigned to my company. Frank Butler came on, under subpoena, from his Toledo home. Leon Thomas and others of my old boys were glad to testify to the practical value of the Audion and to the honesty of the inventor. Mr. Edwin W. Hammer, an eminent electrical engineer and patent expert, testified as to my excellent reputation among electrical and wireless authorities. The American Marconi Company, apparently unsolicited, transported an employee from the Gulf of Mexico to New York to testify as to the good work performed by the Audion on Admiral Evans' fleet in 1908 when he was a Navy operator.

But neither the American Telephone and Telegraph Company, its Western Electric affiliate, nor J. J. Carty, who alone at that time could have testified as to the high value which the Telephone Company had already set upon the wire rights under the Audion patents, volunteered any helpful testimony, nor (so far as I ever heard) advised the Judge as "Friend of the Court" on our behalf.

All of the defendants were charged with "use of the mails to defraud, by selling stock to the public, in a company incorporated for \$2,000,000(!) whose only assets were de Forest patents directed chiefly to a queer little bulb like an incandescent lamp which he called an 'audion,' and which device had proven to be worthless—was not even a good lamp." And contemptuously the learned prosecuting federal district attorney held up for the jury's gaze one of the little bulbs.

Furthermore, the federal district attorney informed the judge during the course of his attacks on me (against whom he showed an especial animus), "De Forest has said in many newspapers, and over his signature, that it would be possible to transmit the human voice across the Atlantic before many years!" (Within a scant two years Western Electric radio engineers were telephoning from Washington to Paris.)

"Based on these absurd and deliberately misleading statements of de Forest, the misguided public, Your Honor, has been persuaded to purchase stock in this company, paying as high as ten and twenty dollars a share for the stock!"

This learned district attorney, Robert Stephenson by name—a man who, if still alive, must be highly proud of the statements he made during that trial—ended his impassioned plea by urging in the name of the People of the United States, that de Forest, Darby, and their associates be given the limit of the law and be sent to Atlanta Penitentiary.

The long dreary weeks of that trial dragged on, six of them, finally terminating on the last day of that Hoodoo Year, 1913.

The judge's charge was given to the jury at noon. The jury stayed out for thirteen hours. From the streets below that upper courtroom in the old Federal Building we could hear the mounting din and clamor as the milling throngs celebrated New Year's Eve. Mad joy and reckless gaiety below, awful dread and horrifying suspense in the hearts of those above who nervously awaited the exit from the jury room of twelve "good men and true."

Could it be, I reasoned, could it be, in reality, possible that *this* should now be my actual predicament, my reward for all the years I had toiled and economized, building on foundations so carefully planned, firm foundations of character and hard scientific study, of endless experiments; always rebuffed but never baffled, discomfited but never discouraged? Oh, it could not be!

They could not find me—or good old honest, trusting Captain Darby—actually guilty of fraud. That was impossible!

And yet as the jury filed in and took their seats, my heart beat with triphammer blows. My breath came and went uncontrollably—loud and rasping—so that Deming by my side, muttered, “What is the matter with you, de Forest?”

One kindly face in the jury covertly smiled at me, I thought. I braced myself for the verdict.

“Smith, Thompkins, Burlingame—guilty on all counts.

“De Forest, Darby—*not guilty!*”

Then the jury filed out, extending cordial hands to the Captain and myself.

So *that* was our Happy New Year!

I think that neither the judge nor the jury had been much impressed by any evidence as to the intrinsic value of the Audion patents. The Audion was to them at best only a wireless detector somewhat superior to other types; our radiotelephone accomplishments seemed to have come to nought. Sales of stock to the public appeared to them unjustified—and criminal where Smith and Thompkins pocketed the proceeds. Captain Darby and I were cleared then on grounds of our complete honesty and unflinching faith in the worth of my inventions and the future earnings of the company which owned my patents.

As to the other defendants: Smith and Thompkins were sentenced to ten years in Atlanta Penitentiary. They did not appeal. Burlingame appealed his lighter—five-year—sentence, and lost.

Had the judge and jury been apprised of the actual value then placed upon the Audion patent rights by the Telephone Company, none of the defendants probably would have been found guilty under the fraud charge. Smith and Thompkins would have been jailed then by a New York court for fraudulently selling their own stock and thereby wrecking the company.

After the verdict on that dramatic night, I first telephoned to relieve my wife's anxiety, and then Darby and I took several mem-

bers of that jury down across the Avenue to a crowded pub, where we all drank each other's health and prosperity. And then I took the Broadway subway for the long walk from the 231st Street station over the black hills of Spuyten Duyvil—to "Riverlure, where dreams come true"—in a New Year.

Thus have I escaped, cursed with the strain of that trial, and with a debt that sickens me and frets, alas, too wearily long, the soul of my beloved wife. . . . Yet we live in Riverlure, where dreams come true, some glad, future day.

One thing I had accomplished while the trial dragged on to its fateful close ("even while the jury was out," as Deming upbraidingly remarked when I told him of my plans). Together with Williamson and the aid of a keen and resourceful attorney, Banzaff by name, I had reorganized the Radio Telephone Company, forming a new corporation to be called The Radio Telephone and Telegraph Company, the stock of which should be offered in exchange on a fair basis to the old stockholders of the Radio Telephone Company and to the bondholders of the North American Wireless Telegraph Company.

It had required all the courage and swift adroitness of Banzaff to proceed so effectually as to checkmate Burlingame's dummy president, Walters, who was still taking orders from his Atlanta-bound chief and striving his yellow damnedest to put the old corporations into bankruptcy so that he could, perhaps as receiver, batten on the wreck (and its fifty thousand dollars). But this choice son of Belial was finally ousted, and our plans carried through to my satisfaction and the potential salvation of those stockholders who, during the succeeding two years, elected to make the proffered exchange of their stock. But it was a "narrow squeak!"



CHAPTER 33

Starting a Third Fortune

*T*HROUGHOUT most of the weeks of the trial Logwood and I had lost no opportunity to experiment and design. I knew the United States Navy was much interested in the Audion amplifier to be used in connection with their wireless telegraph receivers. So I designed and built sample one-, two-, and three-stage amplifiers, housed in tall, narrow mahogany cabinets, with 60 volts of dry cells for each stage, with hard rubber or Bakelite panels, carrying filament rheostats and B battery switches. The Audion bulbs hung pendent one above the other from sockets attached to the front of the panel. Usually the uppermost bulb was the detector, with grid condenser and high-resistance leak attached to the inside of the panel. These grid leaks at that time consisted of graphite pencil marks on white paper, cemented to small Bakelite slabs.

The Navy was not long in ordering such samples; and soon repeat orders began coming in, in encouragingly increasing quantities.

We had equipped the shop downstairs with lathes and drill

presses, and these soon began to hum with new industry, gladdening my long-battered heart. The downtown office now hired A. B. Cole, the first radio-parts salesman since the early regime of Q. H. Brackett in the Metropolitan Tower. Bulletins and circulars were published, and the hams began to "beat a new pathway to" the corridors of 101 Park Avenue, next door to the old Terminal Building, where still stood the steel tower of my 1908 laboratory. This was repurchased and installed atop the High Bridge factory.

One of the first tasks to which I assigned Logwood after the new laboratory was "organized," with a pathetically small quantity of equipment and instruments, was that of setting up the oscillating Audion feed-back circuits of the preceding year at Palo Alto. I was eagerly impatient now to create a new radio-telephone transmitter far better than the carbon arc. I recognized that at first it could be of only a few watts power, but I aimed to increase this power as fast as our ingenuity and McCandless' improved pumps would permit.

In the course of these experiments—I think it was in late November or December, 1913—while Logwood and I were hooking up such a circuit, by mistake we connected the lower end of the high-frequency coil in the plate circuit directly to the stopping condenser of the grid, instead of to the terminal of the B battery. In other words, the B battery then led directly to the plate, with the radio-frequency inductance and variable condenser in shunt thereto, connected across the grid and plate electrodes of the tube. We did not at once discover the mistake, because the Audion began to oscillate as we had expected. At this time our simple test for determining whether or not a tube was oscillating was to listen in the telephone receiver—in the plate circuit—and then to touch with the finger one of the terminals of the filament or grid. A characteristic clucking sound indicated that the tube was in oscillation.

But now when we analyzed this circuit we found that we had made a new invention, or discovery. We called this the *Ultra-Audion* because when it was used as a detector of undamped waves it was far more sensitive than anything we had hitherto used, and was moreover decidedly simpler, calling for less equipment than did the Audion with two inductances, one in the plate and the other in the grid circuit—the more conventional feed-back circuit. For some time thereafter we preferred this Ultra-Audion circuit for our transmitters. Inspection of my patents will show that most of our power transmission and circuits during the next year or two embodied this so-called Ultra-Audion circuit. Subsequently, however, we went back to the straight feed-back circuits as better suited for large power transmitters. But the Ultra-Audion receiver circuits are in use in many cases even today.

Now with this little Ultra-Audion transmitter, or oscillator, comprising one of our standard high-vacuum amplifier tubes (which were still two inches in diameter), with the secondary of a telephone repeating coil connected in the grid circuit and a microphone and battery in the primary circuit, we were able to transmit beautifully clear, though faint, telephonic messages across the laboratory. The receiver detector was an identical bulb, a simple Audion detector, or combination of detector and amplifier tube. The perfection of operation and flawless clarity of this transmission, although from a mere toy, delighted me no end and unquestionably aided me to bear up under the crucifixion which I was then undergoing downtown.

Also during that fall of 1913 I presented a paper on "The Audion Amplifier" before a meeting of the Institute of Radio Engineers at Columbia University—the best attended meeting yet held by that burgeoning organization. My demonstration of the crashing sounds emitted from my loud-speaker when I

dropped a handkerchief on the table before the telephone receiver serving as my "pickup," or microphone, aroused great astonishment and applause.

On that occasion young Edwin H. Armstrong, wrapped in deepest mystery, had a small, carefully concealed box in an adjoining room into which neither I nor my assistant Logwood was permitted to peek. But when he, Armstrong, led two wires to my amplifier input to demonstrate the squeals and whistles and signals he was receiving from some radiotelegraph transmitter down the Bay, "C. V." and I thought we had a pretty fair idea of what the young inventor had concealed in his box of mystery. So we proceeded, meekly and obediently, to amplify whatever signals came over the wires from that room.

Early in 1914 the National Academy of Science held a convention and exhibit at the Bureau of Standards in Washington. There Dr. Frederick Vreeland was demonstrating his mercury-vapor audio-frequency oscillator, or pure sine-wave generator. Dr. Irving Langmuir was in charge of the highly interesting exhibit of the General Electric Company. I demonstrated my Ultra-Audion oscillator, its output amplified by three Audions in cascade, and fed into a loud-speaker with metal horn. Its piercing note I could run over the entire audible gamut by simply twisting the condenser knob. This phenomenon was then wholly novel, and brought many interested savants to our booth.

Among these strode hurriedly, in great excitement and high cludgeon, Professor Michael Pupin, whom I had long known as a kindly friend. "What right have you," he loudly demanded, "to have that here? That thing is not yours. That belongs to Armstrong!" I was nonplused, too flabbergasted to reply. Open-eyed, but close-mouthed, I gazed upon his surprising wrath, and continued the siren sounds.

Then I knew for a certainty what it was that Armstrong had had in his little magic box at Columbia. And that outburst by

Professor Pupin was the opening gun of the bitterly contested patent battle to be waged for years in the Patent Office interference proceedings; and thereafter for years more until at long last the United States Supreme Court should finally decide the historic contest. At that same meeting in Washington, Dr. Langmuir, fingering in a friendly manner one of my Audion tubes, remarked: "When you put that little grid in this tube you really did something." This, coming from an expert authority like Langmuir, I considered as praise indeed.

Thus at last, in 1914, clear sailing again loomed ahead. And once more—for the third time—was I enabled to lay a foundation for my life's success—this time determined that no sinister, false friends boring from within should destroy the fine thing which I was building.

I was now to receive a modest salary—assured at least until that \$50,000 had been all expended in rents and materials, pay rolls and advertising, and patent expenses! And determinedly now did all hands plan and toil that the remnants of that sum should not be paid away before the income of the company began to exceed the outgo.

I could begin now to pay off that large indebtedness. I pared personal expenses to the very bone until that duty had been performed in full. This job lasted until the first anniversary of my trial, as shown by the following letter from George Parmly Day of Yale University:

*Guy E. Beardsley, Esq.,
Secretary, Class of 1896S,
153 Oxford St.,
Hartford, Conn.*

40 Wall Street
New Haven, Conn.
Nov. 18, 1914

DEAR MR. BEARDSLEY:

You will no doubt recall my letter of November 15, 1913, in regard to the indictment of Lee de Forest, '96S, for fraudulent use of the mails, etc., and setting forth the necessity of prompt action to avert the probability of

his being "railroaded to jail" even though he might be innocent. Because of the urgency of the situation I had agreed with George McLanahan to underwrite the expense of having the case properly prepared and de Forest defended, confident that when matters were explained to his class, the members of '96S would raise the \$2,500 necessary for these purposes.

As a result of your efforts in the matter, twenty-nine members of the class of '96S contributed a total of \$803 to the "De Forest Defense Fund."

The result of the trial justified the efforts made in behalf of de Forest, as the Government failed to prove its case against him. Upon the conclusion of the legal proceedings Lee de Forest announced his intention of repaying at the earliest possible date the sums subscribed to aid him, and has now repaid such subscriptions in full. He has furthermore, by adding interest on the sums advanced, made possible the repayment of such subscriptions without deduction for expenses incurred in soliciting funds in his behalf.

Because of the publicity given by you originally to the appeal for contributions to the "De Forest Defense Fund" I feel that like publicity should be given to his action in so promptly repaying the subscriptions. In spite of the fact then that but a comparatively small number of '96S contributed to the fund, I shall hope that you will inform every member of the class of the manner in which Lee de Forest has discharged his obligations.

Faithfully yours,

(signed)

GEORGE PARMLY DAY

In January, 1914, on a visit to Washington soliciting orders from the Navy and Army, I had called on McLanahan to express my gratitude. He listened to the account of my trial, and in departing said, "Now, de Forest, that you are out of that mess, the best thing for you is to forget you are an inventor, forget radio, and find a 'garden variety' of job for yourself. Good luck and good-by."

I forebore to express aloud what his blind, unthinking advice had made to surge through my brain. "Sez you!!" would have briefly phrased it had that bit of slang then been current.

His parting words made more obdurate my firm determination to complete this adventurous comeback on which I had now happily engaged, to carry through—despite hell and high water—to a grand success, which should be a final vindication of my judgment, my plan of living, and my fealty to my ideal.

And through my memory flashed, again and again, those stanch words of Emerson: "Trust thyself. Each heart vibrates to that iron string," and "God will not have His work made manifest by cowards."

Toward the close of the summer of 1914 the Allied armies, being already deep in the horrors of war, began to order from us large quantities of tubes and amplifying apparatus. Our facilities for supply became altogether inadequate to the demand, and soon all those nations were forced to begin manufacturing to supply their own requirements. As lack of funds had prevented me from keeping up the annual taxes on my Audion patents in these countries, I obtained no royalties on any of this production abroad.

Even before the beginning of the great World War in August of that year, the military attachés of Great Britain, France, and Japan had visited our High Bridge factory for demonstrations of the Audion, by then useful as oscillator as well as an ultra-sensitive detector and amplifier—in a field where it stood alone!

McCandless' factory was swamped with orders for tubes. I suspect that he "bootlegged" quite a little, for the news soon spread among Fandom as to where these coveted tubes were manufactured.

Reports now came to my ears that the American Marconi Company had found (despite repeated assertions of Professor Fleming in columns of the *London Electrician* that the de Forest Audion was nothing but a new American name for the Fleming valve) that their operators were putting the "bloody valves" into their table drawers and were demanding and secretly using the de Forest Audions in their place.

And now L. F. H. Betts, of the firm of patent attorneys who had from the beginning represented the American Marconi Company, the same firm whom I had good reason to know and respect for the long, tough battles they had given me twelve years

before on the vertical antenna patent of Marconi, notified us that their clients regarded the Audion as an infringement of the Fleming valve patent. Betts requested a conference with Captain Darby as our attorney before filing suit.

At this conference Darby informed them that our information was to the effect that the Marconi Company was even then infringing the three-electrode Audion tube patent. The De Forest Company would be compelled to file countersuit under our own patent claims. Betts suggested the wisdom of interchange of licenses on the patents in dispute. I was agreeable to accepting such a proposition until Betts stated that such an agreement must stipulate that the De Forest Company would not enter the marine wireless telegraph field—in short, must confine itself to the radiotelephone.

This limitation we could not accept. We were already building some direct-current radiotelegraph transmitters designed for marine telegraph, and installing them under contract aboard two coastwise vessels. It was in fact this very activity in the marine field, now to be their own exclusive bailiwick, which had determined the Marconi Company to bring new patent suits, if necessary, to stop our competition.

It might have been the part of wisdom to have accepted Betts's proposal and ended then and forever the subsequent litigation. Such an arrangement would have rendered unnecessary, perhaps impossible, the subsequent contract in October of that year with the Western Electric Company and their representative, Sidney Meyers. Had I then known Judge Julius Mayer, as I later came to know him, I would not long have hesitated in accepting that offer!

Darby and I finally decided not to compromise but to fight. One weighty factor in this decision was the fact that the Fleming valve patent contained several obviously invalid claims, claims broad enough actually to cover the ancient "Edison effect." Farnsworth, who was now called in to lead our attack, as having

had valuable early experience in battling with Betts and Marconi, argued that the Marconi Company, now admittedly using the grid Audion, had absolutely no defense. We could at once obtain an injunction against their continued use of the Audion, which they now found so essential in the conduct of their long-distance transmissions. Meanwhile their suit must fail from patent invalidity, and we could then enter into the more equitable type of contract to which we felt we were eminently entitled.

And so we joined battle. Farnsworth asked that Judge Mayer hear the case because during the earlier months of that year, when Fessenden was suing the American Marconi Company under his high-frequency spark patents, I had been a fact witness for the defendant, and my testimony regarding my very early use of that type of spark, first at Armour Institute, then during the 1903 yacht races, and later at Las Brisas, Key West, had been a strong factor in causing the Court to find the Fessenden patent invalid. After that trial the Judge had expressed the friendliest and most cordial attitude toward me, as did the Marconi Company representatives as well. I was then very much "persona grata."

We reasoned that Judge Mayer would be eminently fair, and give us "all the breaks." But we overlooked the parallel fact that he had also "smiled" broadly upon the Marconi Company during that previous case.

At the trial's opening Betts did two amazing things: he filed a disclaimer of the broad invalid Fleming claims and admitted the validity of my grid Audion patents and the infringement thereof.

Farnsworth at once moved for a permanent injunction against the Marconi Company, this procedure now seeming to us uncontested. But we had "reasoned without our host."

"Oh no," quoth the Honorable Judge Julius Mayer, "these parties came into court and in forthright and manly fashion

admitted their sins. They should not therefore be punished for so doing. Injunction is denied!"

From then on we knew we were licked. Roy Weagant, chief engineer of the Marconi Company, easily persuaded the Judge that the Fleming valve was an amplifier. (Every radio engineer knew that it was not.) Then he argued that the valve was also an oscillator. (Every radio student knew this was untrue, except that when gassy and in series with a high resistance, the "RC" effect could make of it a controllable high-frequency interrupter.) The Judge agreed with him, holding that the Audion was an infringement upon the Fleming valve both as amplifier and as oscillator. Had Betts realized in time how thorough a job Mayer was predisposed to render, he need not have admitted validity or infringement of the basic Audion claims!

As a result of this decision, we were now enjoined from making, using, or selling Audions, while the Marconi Company was left free to infringe upon our admittedly valid Audion patents. This they proceeded to do.

Outraged by this gross miscarriage of justice, we immediately appealed the decision to a higher court. Nearly two years elapsed, however, before our appeal came to a hearing. During this time both we and the Marconi Company continued manufacturing Audions pending final decision.

When the case finally came to court in September, 1916, Philip Farnsworth, now delectable in morning frock coat, striped pants, and white spats, must have had the same irritating effect on grouchy old Judge Charlie Hough that he had had on Mayer when less sartorially gotten up. Anyway, that lordly "Duke of Ulcer" soured on him, thoroughly and throughout—and also exhibited an inexorable animosity against me.

So again we got what was coming our way. The lower court's injunction against us was sustained and we were ordered to render an accounting to the Marconi Company for all the Audi-

ons which we had manufactured and sold from the beginning. But to add to the general confusion, Judge Hough held that the Marconi Company, having admitted infringement of our patents, were likewise accountable to us for the Audions they had manufactured. A Master was appointed to supervise the mutual accounting thus required. Henceforth, both companies were enjoined from making and selling tubes without the other's consent.

As a result of this decision, the radio-tube industry remained a hopelessly tangled mess until the Fleming valve patent expired in 1922. During the war, our firm was granted immunity from the injunction to enable it to fulfill government contracts. Efforts to reach a mutual understanding between the two companies failed. The situation was eased somewhat after 1919 when the Marconi Company licensed a San Francisco lamp manufacturer named Moorehead to make Fleming valves after we had enjoined him from making Audions. We thereupon began buying Audions from Moorehead. Marconi in turn bought from us. In this roundabout way, the Audion finally reached the market—but with results satisfactory to no one except the attorneys who thrived upon the long-drawn-out legal controversy. The climax came many years later (1943) when the U.S. Supreme Court found the Fleming valve patent to have been invalid all the time.*

Before then my own patents had long expired and the opportunity of profiting from my invention was lost forever.

In October, 1914, Sidney Meyers paid us another visit. Williamson and I twitted him and his "word of honor as a gentleman" unmercifully. So now he frankly said he came representing the Telephone Company and that they now wanted to acquire additional license rights under those patents for the fields of radio signaling. They already possessed the wire rights. Meyers began with a generous offer—\$10,000. I demanded

* See page 457.

\$100,000, "take it or leave it." This time he did not know how near to the bottom of the barrel our treasury was. We finally compromised on \$90,000. Assignment papers were drawn up between the Western Electric Company and ourselves and duly signed. We retained only the right of manufacturing Audions for "amateur and experimental use."

This additional sum seemed a godsend to us at the time, harassed as we were by that Marconi suit. However, looking backward, we should rather have put the company and its patents on ice, closed shop, and lived again on cheese and crackers for a year, rather than to have given that company *assignable* rights to the patents, which later proved so indispensable for radio signaling.

But the yearning to manufacture, to construct, to keep forever active in a well-equipped laboratory was constantly upon me. I could not endure the thought of again watching the world whirl on while I remained inactive, assailed by doubts and lingering misgivings—supinely awaiting another, richer ship to arrive.

So this second deal was consummated. And again the factory hummed. The laboratory was busy night and day: new inventions, additional patents; mainly directed to improvements in vacuum tubes and their circuits—ever seeking to increase the power I could get from larger and better-evacuated "oscillion" tubes. We now began to install our own tube factory and pumps, to compress our own liquid air for the high-vacuum pumps, and to prepare our own oxide-coated filament material.

In those years of 1913 and 1914 the knowledge of electronics made giant forward strides, notably in the Telephone Company and De Forest laboratories. After thirteen strangely eventful years apart, the Western Electric Company and I were working together again.



CHAPTER 34

Transcontinental Telephony

NINETEEN FIFTEEN was to be a World's Fair year. Enormous sums of money had been spent in preparation of the beautiful Panama-Pacific International Exposition at San Francisco to commemorate the opening of the Panama Canal. The Radio Telephone and Telegraph Company was then in a sufficiently prosperous condition to justify us in installing a large exhibit, for we well knew the interest which proper display of the Audion detector and amplifier and our various types of amateur apparatus would there arouse among the visitors generally, and among the attachés of foreign governments especially.

The exhibit of the American Telephone and Telegraph Company, also in the Palace of Electricity, was situated not far from our own exhibit. Several times every day a popular lecture was delivered in their small amphitheater, in which the speaker outlined in popular language the history of the transcontinental telephone line which had just been opened between New York

City and the Exposition in San Francisco. At the close of each lecture, opportunity was given to those interested to listen to the sound of some man speaking in New York City, after which the New York receiver was switched to Coney Island so that those on the Pacific Coast might hear the swish and roar of the breakers on the Atlantic.

The speaker described the line of the Telephone Company in great detail and placed due emphasis upon the use therein of the Pupin loading coils, which equalized or balanced the line for all the frequencies involved in human speech. But not one word did he say about any telephone amplifiers or repeaters along that 3,000-mile stretch of wire, the device which more than all else made possible that amazing feat of voice transmission. So far as his public was led to understand, the voice of the distant speaker was heard thus clearly and distinctly without the aid of any booster or amplifier.

At the close of these lectures the Telephone Company handed out to all who would read them neat little booklets, the title of which read:

THE STORY OF A GREAT ACHIEVEMENT

Telephone Communication from Coast to Coast

I studied this booklet carefully and spent the entire night drawing up a booklet which should be outwardly a facsimile in size, color, and format of that "historical" document put out by the Telephone Company, but whose title should read:

THE STORY OF A GREAT ACHIEVEMENT

Which Made Telephone Communication from Coast to Coast Possible

The next morning I found a firm of printers, and by the following day the attendants at the De Forest booth were handing out this second edition of THE STORY OF A GREAT ACHIEVEMENT in large quantities to thousands of sight-seers just come from the Bell Telephone booth, marveling at what they had

heard, and mystified as to how it had suddenly been made possible. That second edition amplified their understanding!

The pages of that booklet spread before the public a few terse statements which chanced to be wholly omitted from the corresponding booklet put out by the Telephone Company. Therein was outlined very briefly a neglected chapter of telephone history—the 20-year futile search of the telephone engineers for a repeater or amplifying relay which should be at once extremely sensitive, free from delicate and frequent adjustment, yet which would amplify every modulation or variation of the human voice without distortion, and which would make possible the transmission of the voice across the breadth of North America.

That amplifier was at last discovered—not by telephone engineers, whose minds had for years spun in the old rut of receiver-microphone “Siamesed” together.

In 1912 Lee de Forest found that when a strange device called the Audion was properly connected in the line between a transmitter and a receiver, it actually *amplified* the voice currents, giving a reproduction of perfect fidelity without a trace of lag or distortion, yet with a great increase in volume, or intensity.

It is this device—patented by de Forest in 1907 and licensed by him to the Telephone Company in 1913—which at last and alone enables you today to talk from the Panama-Pacific Exposition to New York or Maine.

Not satisfied, I erected a long, handsome sign at the back of our booth reading, “The De Forest Audion Made Possible Telephone Communication from Coast to Coast.” My assistant, “Chief” Myers, and I chuckled to watch the Bell engineers, one after another, walk nonchalantly down the aisle to read slantwise that informing message, the truth of which they too well understood to attempt to deny.

Before the close of the Exposition, my company was awarded a Grand Prize and Gold Medal for its exhibit, as had been the case at the World’s Fair at St. Louis in 1904.



CHAPTER 35

Radio in New Roles

*T*HE year of 1915 saw several significant beginnings, embryonic at the time perhaps, but destined in later years to grow into mighty developments in radio signaling of every type and in industrial applications as well. Early in that year I began work on the first musical instrument utilizing the oscillating Audion, one with the audible “beat-note” effect, produced by two radio-frequency oscillating circuits, one of which was adjustably varied, so that notes of any desired pitch could be produced. This was the original precursor of the Theremin.

Another method of obtaining musical effects was by direct feed-back in circuits of audio frequencies where the tones were varied by altering either the capacity across the inductance or by varying the high resistance in the grid or the plate circuit. By the latter means it was easy to obtain a great variety of tone qualities, or timbres. Simply by closing certain switches the loud-speaker would give forth sounds resembling violin, cello, wood winds, muted brasses—and other sounds resembling nothing ever heard from an orchestra or by the human ear up to that time—of the sort now so often heard in the nerve-racking, maniacal ca-

cophonies of a lunatic swing band. Such tones led me to dub my new musical instrument the "squawk-a-phone," as I jokingly exhibited it at our Class Dinner that winter at the Yale Club.

In 1929, this ancient idea, on which I had filed patent in April, 1915 (No. 1,543,990), was licensed to the Wurlitzer Company. The idea then demonstrated was the basic principle on which the marvelous panorchestral instrument, the Hammond "Novachord," was subsequently developed. The Novachord embodies 163 tubes as tone generators and amplifiers, of which 158 are descended from the Audion.

By 1915 the cult of radio "hams" was growing rapidly, and the manufacture of Audion tubes became a substantial portion of McCandless' lamp business—a thing which he did not particularly relish, for he had a great deal of trouble with the little devils, regarded the business largely as a nuisance, and never went after the problem of Audion manufacture on an engineering production basis. Ere long his company was taken over by the Westinghouse Electric, and thereafter he was not permitted to manufacture Audion tubes. As a result several bootleggers sprang up over the country, chief and most mischievous of whom was Moorehead of San Francisco, aided and abetted by my Fair assistant, E. B. Myers.

During the spring of 1915 I had been actively at work in developing the "Oscillion" (as I then styled the oscillating power tube), to carry larger and larger amounts of power. By that time Henry Coyer, my loyal and indefatigable superintendent of the newly installed exhaust-pumping plant, had acquired great skill along those lines. Two, and later three, skilled glass blowers were kept hard at work day and night assembling oscillions and repairing the pumps and glass manifolds. I previously had no conception of the endless list of troubles and disasters with which such a vacuum-tube plant could be endowed. One fault or failure corrected, some other immediately appeared.

My first oscillions were of spherical shape, three inches in diameter, constructed by McCandless and exhausted in our own plant. Then we obtained four-inch and five-inch globes direct from Corning and made our own tubes completely. At first, due to slight traces of gas which we were then unable to eliminate completely, our transmitter tubes became very hot. A small fan blast proved inadequate when I stepped up the power, so I immersed the oscillion bulbs in a canister of water, and contrived to master the insulation difficulties thereby encountered—the first water-cooled tubes in the art.

By the summer of 1915 I had abandoned the spherical type of transmitter tube, and we began the manufacture of the cylindrical form, using glass blanks $2\frac{1}{2}$ inches in diameter and 10 inches in over-all length. The plate and grid leads continued to be brought out through the upper end of the tube, the filament leads from the lower, as was first done in the 1907 detectors.

About this time we began to receive orders from the United States Navy, which had been very carefully watching the development of the oscillating tube. The Navy specifications called for small transmitter tubes about $1\frac{1}{4}$ inches in diameter and 5 inches in over-all height, with all four terminals coming out at a common base. I think these were the first power tubes ever made having the four terminals brought out at the lower end. The Navy engineers had designed their own small transmitter sets in which these new power tubes were to be used. Lieutenant Commander (now Rear Admiral) Stanford C. Hooper specified this development, in which he became keenly interested.

Also about this time exceedingly interesting rumors reached me from Washington to the effect that Western Electric engineers were tremendously busy assembling numerous tall racks filled with oscillator transmitter tubes similar to those which I had just shown to the Naval officials. Press dispatches from Washington soon announced that radiotelephone voice tests

were shortly to begin from Arlington to the Paris Eiffel Tower; and also to the Pearl Harbor station at Honolulu.

Thereupon I resolved to be in Paris upon the occasion of the formal demonstration of that magnificent accomplishment, the true grandeur and social significance of which I felt no man was in better position to appreciate than myself, since I had been the first to foresee its coming. Consequently, my wife and I embarked for England. That was indeed a perilous voyage through submarine-infested waters. But we escaped the torpedoes and arrived in blacked-out London two days after Zeppelin bombs had destroyed a nest of buildings near the Hotel Astor, where we stopped. Those ruins were ghastly reminders of the dangers we had courted.

London newspaper reporters inquired what useful invention I was bringing with me to aid the British War Office in warding off the deadly Zeps. I had entertained no such thought, but realizing what was evidently expected of me, I conceived then and there, and invented as I talked, a combination of two or more large megaphones, mounted in gimbals, each equipped with a microphone leading through Audion amplifiers to a headphone to be worn by the soldiers on watch. I explained how with two such gigantic "ears," each feeding a separate amplifier and ear-phone, the observer could detect at a great distance, and accurately locate, the sound of the Zeppelin's propellers.

Details of this spontaneous American invention appeared in that afternoon's papers, and I promptly received an invitation to visit the British National Defense Council, old Hiram Maxim in charge, to explain my ideas to that Board.

Upon arriving in Paris, I found it impossible to obtain permission to visit the Eiffel Tower, where the first wireless telephone conversations with Washington were already going on. But the Paris newspapermen were all greatly interested in the information I gave them regarding the transatlantic telephone transmission and what part therein was being played by the

three-electrode tube, then in use as oscillator at the Arlington transmitter, and here in Paris as detector and amplifier.

Upon my return to the New York offices, I was greeted by Charles Gilbert, the young treasurer who had been chosen shortly before my departure for Europe to aid Williamson in managing the fiscal affairs of the company, with the cheerful information that Williamson had been conspiring, ever since I had gone aboard ship, to oust me from the company's management.

Shortly after the formation of the Radio Telephone and Telegraph Company, I had negotiated with John Stone Stone and his board of directors and had purchased all the Stone patents, some sixty in number, giving in exchange a large block of our stock. I considered these Stone patents exceedingly valuable, covering as they did broadly all systems of loose-coupling primary, secondary, and intermediate circuits. Among them was the Stone-Cabot patent covering the application of a positive potential to the grid electrode of the Audion.

The Stone Company, having thus become substantial stockholders in my company, was in a position to aid Williamson in his attempt to call a stockholders' meeting and possibly oust me from my control. Messrs. Johnson and Brown, to whom Stone had largely delegated the business matters of his defunct corporation, came down to New York for this meeting. I had returned in the nick of time.

I had no great difficulty in persuading them of the rank injustice and irrationality of Williamson's proposal. It was defeated. Williamson thereupon offered his resignation, which was promptly accepted. I was elected president of the company and Charles Gilbert, treasurer. Shortly thereafter, in a stockholders' meeting, the name of the company was changed to read "De Forest Radio Telephone and Telegraph Company."



CHAPTER 36

The Broadcasting Era Begins

THE year of 1916 is memorable in my life. It marked very definitely the actual beginning of planned and systematic radiobroadcasting and of the use of the three-electrode tube as *transmitter*.

Referring to that era, in *A Brief Sketch of the Development of Radio Telephony*, one of Western Electric's most brilliant engineers, Dr. Van der Bij'l, stated:

"The three-electrode tube became the greatest and most powerful device in the whole realm of radio."

Early in the summer Henry Coyer, in charge of our glass blowing and high-vacuum exhaust pumps, had so mastered his technique that we were turning out with fair regularity serviceable, reasonably long-lived, oscillion tubes of 50 to 125 watts power. These were just what I had been awaiting. I could now begin again my old broadcasting hobby—with a range and clarity of speech never before approached.

The top of our High Bridge tower, 125 feet above the factory roof, was yet far below the level of the High Bridge and Washington Bridge, and of the stone cliff on the west side of the Harlem River opposite us. A less desirable site for a transmitting station could scarcely be imagined. However an antenna was now rigged and systematic tests of our transmitter panels and oscillator tubes were undertaken.

Logwood and I had a number of skilled radio-fan friends in Manhattan and the Bronx, and soon our phone was kept busy with reports from these listeners and others as far afield as Bridgeport, Connecticut, and down New Jersey way.

One hundred and twenty-five watts output from one tube was our limit as yet. I was after ten times that amount. We now began installing the first "Radio Concert" transmitter at the Columbia Gramophone Building on 38th Street as probably giving us greater ranges than from High Bridge; and with a very sound business idea, thereby to greatly increase our sale of Audions and listening equipment. And Columbia was interested, as a very cheap sponsor, because I was to play each day a goodly number of their new records, announcing the title and "Columbia Gramophone Company" with each playing. Thus I became the world's first "disk jockey." That was then the limit of my radio advertising for this early sire of "CBS."

This was unquestionably the first "sponsored" radio program service. It aroused a deal of interest on the part of radio fans, not merely telegraph-code hams, and our sales of radio receivers, Audions, and crystal sets, began to pick up most gratifyingly.

Broadcasting coverage from the 38th Street Columbia Building proving no greater, I moved the transmitter back to the High Bridge tower and resumed our testing, taking with me the Columbia phonograph and a goodly supply of records, with which I continued generously to regale all radio listeners. I distinctly remember how I then began to extol through the microphone the merits of our various radio wares; rather shamefacedly

it is true, because I still cherished the earlier, quixotic idea that nought but good music and good entertainment or educational matter should go out over the radio. And when shortly thereafter the Western Electric Company opened up a radiotelephone transmitter for testing purposes on their West Street building, we heard them announce that "*they* had no superior quality variable condensers for sale." I felt the implied rebuke so keenly that thereafter all advertising matter was taboo from any radio station which I controlled.

On election night we sent out bulletins from the *New York American* for six hours, and on that historic occasion I, as the chief announcer, proclaimed at 11 o'clock, just before I closed down the station, the election of Charles Evans Hughes!

The *New York Times* of Wednesday, November 8, 1916, contained the following news item:

RETURNS BY WIRELESS

De Forest Radio Laboratories
Flashed Bulletins at Highbridge

The Bronx produced an election-night innovation when, shortly after dark last evening, the De Forest radio laboratories in Highbridge began flashing returns by wireless. Amateur operators within a radius of 200 miles had been forewarned of the new information service, and it was estimated that several thousand of them received the news, many through using the newly manufactured wireless telephones.

Some 200,000 persons, many of them minors, heard the returns in the main thoroughfares of Bronx County. For the most part they were orderly, particularly after the police, who were on duty in force, had divested the more frolicsome of their talcum powder and ticklers. The temper of the majority seemed to be on the Wilson side early in the evening, but, after the manner of election crowds, the spirit changed as soon as news that Mr. Hughes was elected was generally accepted.

This was the first use of radiotelephone for broadcasting news of general interest—and it took place four years before the much publicized broadcast of the Harding-Cox election returns by Westinghouse Station KDKA.

In the summer of 1916 I took my first airplane flight. At Mitchell Field, Long Island, I took to the air to test out a small radiotelephone transmitter with trailing antenna. The result was sufficiently interesting to persuade the Army aviation service to order one or two such sets. So far as I know, these were the first radiotelephone sets ever installed in an airplane.

December 12, 1916: For the past three years I have noted a strange, sad change coming over me. I am more or less a dead man alive—my former eager and youthful spirit has slowly died, due to the struggle for success against great odds; due more than all else to the recurrent sadness and despair of soul which the lapses into drunken stupor, ever recurrent, of my wife have caused me. So far from her being a mental companion to me, I have lived practically a hermit's life with her here in this home which I built as the little Temple of all my early ideals. I named it "Riverlure—where dreams come true"; and here, month after month, year after year, one dream after another has atrophied and died, with my heart its tomb. Shriveled and withered is my heart, with all its roseate dreams. . . .

Shortly after the 1914 sale of radio patent rights to the Western Electric Company, a flock of patents began to be issued to their engineers disclosing circuit arrangements so similar to some I had been using that I began to file applications of my own deliberately making identical claims. This I did for the purpose of interference.

As these interference proceedings progressed, it became more and more evident to the Western Electric patent attorneys that the 1914 deal had not been sufficiently comprehensive, that "that pestiferous de Forest might still have something we will need." So a new, third deal was contemplated. This was exactly what I had in mind in filing my new applications.

Rumors that a sale of the De Forest Company to the Atlantic Communication Company (the American branch of the German Telefunken Company) was shortly to be consummated, brought a telephone call for a conference from my now good friend, George Folk, chief patent attorney for the Telephone Company. Folk had shown himself to be very fair, and even sympathetic, to me since the 1914 negotiations. I told him frankly that the Atlantic Communication negotiations would not be called off unless the Western Electric Company was willing to meet our price for the rights under all pending patent applications, and those to be filed during the ensuing seven years (as they had proposed).

After some bickering, the price to be paid was fixed at a quarter of a million dollars. It was stipulated that my company should retain rights in the commercial, foreign, and governmental fields. I was not too happy about the deal, but I feared the possibilities of the Cooper Hewitt or the Fessenden undamped-wave patents being held valid.* In such event it would be impossible for my company to progress.

April 8, 1917, marked final completion of my deal with the Western Electric Company, which had been brewing for a year and on which I had spent much patient planning and waiting. But the surrender in that contract of any radio-for-public-pay service brought to an end the ambitions of my struggling years to achieve transatlantic radiotelephony.

Nevertheless, mine was the satisfaction of knowing that this would be done through my invention—that little Audion and its gigantic development.

Looking back today after the demonstrated fact that many hundred million dollars have been earned for the Telephone Company as sub-licensees by the inventions covered in the patent

* Both of these men were suing Western Electric Company for infringement of their respective patents. Western Electric defeated both plaintiffs when the suits came to trial.

rights conveyed by that contract, the price paid might seem today almost infinitesimal. However at that time, with the war on, with all commercial markets cut off, threatened as we were by patent litigation which might well have proven ruinous, my patent attorneys, Farnsworth and Scull, strongly urged me to grasp that opportunity while it was yet open.

In fact, to them the deal seemed quite too good to be true! The one feature which I lamented then, and have ever since increasingly regretted, is that my attorney, Henry Quinby, did not definitely hold out for the exclusive rights to license others than the Telephone Company and its dependent organizations. I feel confident that by longer, more determined insistence, we could have retained those rights. Had we done this, the royalties earned by those two oscillating feed-back circuit patents, later twice sustained by the Supreme Court, should alone have earned the De Forest Company many millions of dollars.

Now the gathering war clouds caused the United States Government to shut down all amateur and most commercial radio activities. The lead to the High Bridge antenna was cut and officially sealed, and thereby was terminated my radio concert broadcasting activities for a period, as it later proved, of nearly two years' duration.

But the treasury of my company, now well stocked, could afford to declare generous dividends. And as I held some 120,000 shares of the company's stock, I felt, for the first time in my struggling life—almost "rich"!

The war abroad had created a great demand for Audion products. We began rushing thirty combination Audion-Ultra-Audion amplifier sets for Australia, other lots for New Zealand and Russia, two transmitter field sets for Japan, and 185 Audion amplifiers for the United States Navy.

The Illinois Drainage Canal Commission now gave us our first opportunity to install the new oscillion telephone. Mean-

time the company continued to thrive, chiefly on "war orders" from the United States Navy. We were crowded with work and must immediately enlarge the factory. I had labor troubles, swift strikes, and back-to-work again; and I summarily fired the superintendent we had so carefully picked to ease my burden—before he quite ruined the business I had patiently built up.

And so the first year of our war dragged on. The United States Signal Corps required radio receiving tubes in great numbers—far greater than my company, McCandless, and my old assistant, Babcock (who was now in that manufacturing game), could begin to supply. Moreover, they demanded four-prong-base tubes. We reconstructed and greatly enlarged our tube department, and devised production lines for forming and welding the grid structures, installed automatic stem-making machinery, etc.

General Electric and Westinghouse were soon called upon to supply these ever-increasing requirements of Army and Navy. Then it was that the first VT type of Audion tubes were manufactured, destined to be famously efficient for amplifiers and small transmitter purposes for years thereafter.

In January of 1918, the coldest in recent history, after ten successive days of subzero weather I walked across the icebound Hudson from my Spuyten Duyvil home to climb the opposite Palisade, "for a neighborly call"! The *New York Sun*, commenting on this rash excursion, said: "Until this winter no one had ever crossed within the limits of New York City." But that was a reckless "fool stunt," worthy only of my Yale years!

To Newport News I then took my latest ultra-compact oscillion telephone transmitter for range tests on Navy seaplanes. Installed in the forward seat, with barely sufficient room for breathing between me and the screen shielding the two large transmitter tubes with 1,500 volts on their plate terminals, I

carried on conversations with the Navy base while we flew west until almost in sight of Washington. Returning, my pilot obligingly flew upside down—my first sight of huge battleships floating in the sky directly above me—but with the high-voltage switch open!

Later that winter I took Mother for a week's visit to my boyhood home in Talladega—my first visit to the old town in twenty-seven years. How changed it all seemed—greatly improved, enlarged, but less impressive than to boyhood's eyes. The college looked much the same, but now a fine brick De Forest Memorial Chapel stood where I had once gathered and eaten turnips. And the president's house, where once more I slept in my old bedroom (*sans* bedstick!), was so covered with ivy, devotedly planted by my father, as to be scarcely recognizable.

Many of the good old Negroes were still alive. Pleasant indeed were their sincere, white-toothed smiles of greeting. More of the older generation had gone to join my father. But the spirit of the place was as sincere and honest as he had endowed and left it. His spirit still was present there. With strangely mingled emotions I stood upon that chapel platform and recalled to the large audience the primitive days when my dear mother and I had lived, taught, and studied among those well-loved surroundings.

Strange and welcome change had come over the attitude of the native whites to the Negro college and its heroic faculty members. These latter were no longer pariahs. Leading citizens of the community were now among the trustees; and I was actually hailed as a great credit to the city and state, and was invited to lecture downtown on this strange novelty of "Wireless Telephony, which Talladega's distinguished former citizen has invented or created"!

A recent handsome road map of Alabama reads:

An Alabama hillbilly boy strode from the mountain sides in Talladega County and gave to the world the vacuum tube, to which the radio, talking pictures, and television owe their existence. A star fell on the little mountainous city of Talladega and Dr. Lee de Forest emerged from its brilliance with a little tube to set the world to music and pictures. . . .

Would that my father had lived to read *that!*

In the spring of 1918 the U. S. Signal Corps' need for Audions—or radio tubes as they now began to be called—became insatiable. Our enlarged forces worked overtime. Government inspectors, notably Miss Alice Davison, daughter of Henry P. Davison, and Lieutenant Frank Eldridge, now executive engineer for Westinghouse Lamp Works Radio Tube Division, were installed at High Bridge for perpetual inspection of our product.

In the fall of 1918, I journeyed to Europe with my patent attorney to assist the British government in a legal contest over the validity of the Fleming valve patent. While there I sought to interest British and French army officials in a small, battery-driven radiotelephone transmitter which I had designed for use in the trenches. But I had barely arrived on French soil when the war ended, and I joined with boyish alacrity in the wild joy of Armistice Day in Paris. A leisurely return trip brought me home at the dawn of the New Year, 1919.



CHAPTER 37

A New Enchantment

THANKS largely to the skillful financial guidance of Gilbert and the efficiency of Superintendent Curtis, my company had done surprisingly and gratifyingly well during the year just ended. At the January, 1919, meeting of stockholders a return of capital assets was voted which netted me a little over \$100,000.

Now if we can carry through our plan of licensing the Government under all our patents, there will be another big dividend; and then I can feel justified in spending a generous sum in experimental development of some of my "darling ideas," notably a new phonograph invention [sound photographed on film]. For never do I listen in vital joy to the music of opera or orchestra without feeling a keen ambition to record and reproduce it in all its manifold beauties and volume (for my own thirsty ear, if for no other). For the best of our phonographs today give merely crude, barbaric suggestions of the music they attempt to record.

The second goal of my life's ambition calls me now, to reproduce real music, free of scratch and falseness, and to be heard in ecstasy and comfort, not by the few brief minutes but by the half hour or hour, entire acts of opera, long musical compositions, replayed as originals, not brief make-believes of "reproduction." If I can succeed in this, the sheer joy of listening to such echoëd music will be full reward for all my efforts. I want to hear this play before I die.

In explanation, I had already built an experimental model of an endless-film machine for recording and reproducing a spiraled sound track of several hours' duration. With such a machine I hoped to realize that high ideal. Long before I could complete the invention the more insistent commercial demands upon my time for realizing the talking film for the cinema intervened. Yet the need for it, by lovers of fine music, musicians, and composers, is more insistent than it ever was. The magnetic wire or tape is today's closest approach to that 1919 dream.

In February, 1919, we two journeyed once more, after six years, on a new honeymoon to our well-loved California, this time to Sierra Madre.

Now already the fine air of California, plus the joy of life here among the flowers and birds' songs have restored her voice, so that at last she begins to thrill me by her glorious notes. We have taken for three months a beautiful villa, "Italia Mia," overlooking a pretty garden of California trees and flowers and a Japanese garden of exotic charm. From our bedroom windows or upper deck, we look across the wide vale to the sunrise, with soft blue hills far to the east. Far behind us tower the rugged green peaks, trail-scarred and hike-inviting, which lead up to Mt. Wilson.

Ah, these are at last the days of which I dreamed so fondly long ago, "When love, red love with tears and joy, shall lend new life unto my dreaming." All these and health and strength renewed has "my California" again given unto me. Again the yellow and gold of poppy petals gladden the table, and again after six years has my Mary come to lift from their opening buds their little caps of green. My old stamina of Tamalpais and the 'Frisco hikes is fast returning to my lazy limbs, and I am glad. My next attempt should win Mt. Wilson. Mother is here now from Palo Alto, and it is a joy to us three to be together once more as in those brave, poor days of 1913, but with so many joys of intervening victories which then were only hopes and plans!

All I lacked to be happy there was work, my own work, then so far away. My soul was uneasy; for always I felt the time was flying and I was letting others do my work; or worse, that no one was doing it. The oscillion and the film phonograph called me always.

I invent a little, sketch circuits and frame patents, but that is all, and all so easy that I am not quite content. If I could build a home here, one on a hillside by the sea, and at the foot of these mountains, with a laboratory near by, then my dream of Riverlure would soon vanish away.

And now after a glorious trip rich in romance among old Spanish missions and to La Jolla by the dark blue sea, and following a pilgrimage to Riverside and the spell of Roubidoux at Easter dawn, we set faces homeward to what would *at last* become indeed our home—"where dreams come true." "For at last, after lonely years, barring mishap, a little life comes to gladden ours."

I think no man has desired children more devoutly than myself. The birth in 1909 of my first child, Harriet Blatch de Forest, had brought me a great joy, but a sadly fleeting one. I was denied companionship with the baby except on those few brief occasions when I could visit her on trips from Palo Alto to New York. While living in Riverlure, I had been granted only one opportunity to watch that blossoming flower.

Like myself Mary Mayo had ever ardently wished for a child, but such happiness had long been denied us. But the early months of 1919 brought us renewed hope. Our joy knew no bounds when at last a daughter, Eleanor, was born to us on September 30.

Oh, may this strange good thing which has so tardily come into my life have, even yet, the potent spell to re-awaken my soul. For care and toil and disappointment for years endured have shriveled my heart. The arteries of my finer being have hardened long ago—the sinews of my soul have atrophied from long disuse. I have too completely buried my being in the dry debris of work and care to easily respond to the olden joys. Too long, alas, too long, has my finer self hibernated through winters of unceasing work to sense the spring.

Already I begin to realize what "happiness" must mean. So long have the echoes that I had hoped to hear within these walls been silent. Little girl, awaken them! So long has "Riverlure, where dreams come true" been but an abiding place. Make it now my *Home!*

During my absence from the laboratory I had sought by mail to direct Coyer to build and Logwood to test various types of glow lamps for sound-recording purposes. I was now determined to devote much of my attention to that problem. More and more, as I pondered the problem, I had become convinced that the talking motion picture was a practical idea, technically and economically. I had now pioneered in wireless and radio for nineteen years. The field was becoming somewhat crowded. The war had aroused lively interest in the new art on the part of such large concerns as the Telephone Company, General Electric, and Westinghouse. The Radio Corporation of America had been formed; and soon a hundred engineers would be making a smooth and beaten road out of what had been a wild and fascinating trail. The Spirit of the Pioneer beckoned me again.

If I was to work along new paths I must seek a new frontier. I decided on the "talking motion picture"—not as Edison and Webb had attempted to solve it (by synchronized phonograph), nor with the steel telegraph wire as I had attempted to do it in 1913, but as I had first envisioned it in 1900 and again during the past five years: *by light recording of sound directly upon the photographic motion-picture film*. So through that hot summer I toiled to record sound, first upon large circular disks cut from glass negative plates, mounted on a metamorphosed Edison disk phonograph machine and recorded in a darkroom. Next I purchased a German motion-picture camera in a wooden case, cut a hole in the rear for insertion there of my tubular "glow light" at a point where the film would be moving continuously, instead of in step-by-step motion, and added an extra sprocket properly to propel the film past the aperture. The light from the glow lamp reached the sensitive negative film through a mechanical slit of adjustable fineness.

Looking back today when this type of photographic voice recording is so simple and sure, the long and patient experiments

through which I toiled before I succeeded in recording and reproducing even the first few intelligible words seem incredibly difficult to understand. But the fact remains that I tried every variety of film then obtainable and every possible type of developer. My notebooks, which were scrupulously and painstakingly kept, record literally hundreds of experiments and tests.

Early in 1919 a Canadian, A. C. Wissner, contracted with the Ontario Power Commission to demonstrate (*for the first time in radio history*) the ability of long, high-voltage power wires to transmit clear intelligible speech by means of high-frequency "carrier" waves, voice-modulated. At Wissner's urgent invitation, Charles Logwood and I went to Toronto in May with Captain Charles Culver, former Signal Corps radio expert, a man of sterling intelligence, a wizard in radio communications problems.

Upon my arrival I found that Culver and Logwood already had a good, practical setup, and there was little I could do but serve as adviser and observer. The demonstrations were successful; the Commission's experts seemed convinced; and this novel, historically important equipment was put into permanent form and left for them to operate.

Yet it was not all work that summer long. In June I was delighted to take time off to go with Ed Darby back to his alma mater, Syracuse University, where good old Chancellor Day, and Dean Graham of the Engineering Faculty, presented me in 1919 with my first honorary degree, Doctor of Science.

In the fall of 1919, the war ban on noncommercial radio transmission was at last lifted in Washington. The war had resulted in the training of many thousands of young radiotelegraph operators and the awakening in the minds of all their acquaintances an interest in the marvels of radio never before experienced.

Therefore I lost no time in again opening up my High Bridge broadcasting station. Bob Gowen's enthusiasm exceeded even my own. He and Bill Garity took turns at the microphone as announcer. The "radio concerts" once more became a five-night-a-week affair.

Phonograph records were, of course, our main stand-by, with an occasional radio talk and once or twice an alleged humorist. In 1916 we had staged the first "radio dance" for a friend's house party down near Elizabeth, New Jersey, which had been so novel and complete a success that upon request we occasionally repeated such performances; and dance music was henceforth frequently heard on the air.

Gowen, living way up in Ossining, and tiring of the late, long night trips home, began construction of a little radiophone transmitter for installation at his house. And soon there were two programs on the air. Coverage of that Ossining station, mounted high above the Hudson, was soon surpassing that of High Bridge; and just then, as a friend in need, E. J. Simon, whose powerful commercial radiotelegraph station atop the World's Tower Building, 46th Street and Broadway, was in wireless communication by day with Cleveland and Chicago, kindly offered the night facilities of his antenna for my broadcasting station. I lost no time in accepting his offer. Without realizing that a new permit should first be obtained from the New York federal radio inspector, we transferred our transmitter to that more favorable downtown location. The station's call letters were 2XG.

Richard Klein, our sales manager, who possessed a fairly wide acquaintance among Broadway show people and scores of artists, became the first radio impresario, or program director. Under his enthusiastic control our broadcasting programs rapidly assumed a lively interest, impossible before. Listeners by the hundreds now began to take notice of Station 2XG. The bulk of our entertainment consisted of playing new records supplied this

time by the Brunswick-Balke-Collender Company, in return for which gratuity we made the brief announcement that the records were furnished by this company.

In December, Klein introduced to the radio audience an artist who could justly claim to be the "First Lady of Radio," Miss Vaughn de Leath. She was an instant success. Her voice and her cordial, unassuming microphone presence were ideally suited to the novel task. Without instruction she seemed to sense exactly what was necessary in song and patter to successfully put herself across. A flood of fan mail (first of all the billions of radio fan letters since received the world over) testified as to the important broadcasting success which she had here suddenly achieved. Thereafter she appeared frequently before that early microphone.

But alas, our popular success, our new high-volume level and its wide coverage, were to be our undoing. The New York federal radio inspector, Arthur Bachelor, doubtless urged on by incensed Navy and commercial telegraph operators (and perhaps by other more jealous interests), suddenly clamped the lid down upon that first Manhattan broadcasting station. I was officially notified that, having illegally transplanted my transmitter from its duly licensed bailiwick in the Bronx, I should at once and forthwith cease, desist, and terminate my radio-telephone activities.

Pressed for an explanation, Mr. Inspector informed me that, among other things, interference with commercial communications by the radiotelephone could no longer be tolerated; that "*there is no room in the ether for entertainment*"(!)

A sorry world indeed would ours be today had that ruling stuck.

Had I been permitted to continue that world's first pioneer broadcasting station, or had my Bronx station license been reinstated, that franchise and the fame which would ever after

have attached thereto would unquestionably be worth today many millions of dollars.

On January 15, 1920, I read my paper on the Audion and its evolution before the Franklin Institute at Philadelphia. (See page 479.) It was well received, except by one E. H. Armstrong who sought to show that it was he who had invented the feedback circuit. "All de Forest invented was the Audion! We'll concede that," he growled. Whereupon the chairman ordered him to "sit down." The Institute honored me by the award of the Elliot Cresson Medal.

In February all the New York City papers gave some fine publicity to Gowen's work in broadcasting from Ossining to Chicago. Despite Mr. Bachelor, this broadcasting station, a bud from the parent stem at High Bridge, was still functioning and establishing enviable records. The World's Tower station had reached as far west as Buffalo, but when Gowen's phonograph and vaudeville programs featuring the famed Duncan Sisters were heard in Chicago—that was a record, deserving public comment indeed. And this was in February, 1920, not in November (when KDKA took to the air).

The year 1920 takes one back to the age when the man in the block who owned a wireless set that actually worked was looked upon as a wizard second only to Edison and Steinmetz. Friends gathered in his front room and waited in rapt attention while a noisy signal was tuned in and earphones were passed around from one pair of ears to another for all to hear and wonder at.

Those were the happy days when a good pair of earphones cost twelve dollars and were hard to get at that price. Individual earphones were carefully matched in order that the signal might be equal in each ear. Little wonder crystal sets "complete with

tested crystal and a single earphone" were offered for fifteen dollars. After each evening's operation the crystal was removed with care, tenderly washed in alcohol, and put to bed swathed in fine cotton in its own little container. Who will ever forget the sight of four to eight ranged around a table with long black cords extending in graceful loops from a "multi-connector" to each pair of earphones?

Hardly had the public mastered the crystal sets when "bulbs" became the talk of the town. The rush for these advanced necessities created the first tube scarcity and made possible a fine profit-plus-bonus for the dealers. Many a man reading these lines still retains a grudge against the mushroom radio store that demanded eight dollars for a six-dollar tube.

Bob Gowen thought up the installment method of assembling a complete set by individual units. One bought a detector unit this week; on next payday he added one stage of audio, and a little later a second. If one were wealthy, he could begin on the other side of the detector and add radio-frequency stages until the table was covered. Radio publications carried pictures of the man who had so many of these units that they formed a semi-circle around the room. A little matter of thirty years ago spots the period when stores didn't need to reduce prices to draw crowds. A simple statement that "there is no shortage of parts here" sufficed to form lines into the place of business.

Experts advised ambitious experimenters to choose between adding a stage of A. F. (audio frequency) or R. F. (radio frequency), it being supposed that he couldn't possibly need both.

In recalling those pioneer days, the programs themselves can scarcely be ignored. Of special features there were few. When Ed Wynn took his troupe across the river to Newark and played part of his show for the microphone, Broadway shook its head. No good could come to the profession from such exhibitions. It was a lowering of dignity for actors to recognize a child's toy.

Broadcasting was a fad and would soon die out. Besides, there was no money in it for the artists, and why should they act for publicity alone!*

In March of 1920 I left New York for a brief stay in San Francisco. I was determined to escape from two burs beneath my saddle—that New York federal district injunction, and that New York federal radio inspector's authority. I was also determined to get back as quickly as possible to my pet project, radiobroadcasting.

But first I set about opening a tube factory for the manufacture of oscillion, or transmitter power, tubes. New vacuum pumps were shipped from the East, and Coyer's most skilled tube man was rehired to take charge. I began collaborating with Henry Shaw of the Atlantic and Pacific Company, which company for years past had manufactured Bakelite bases for our VT tubes. Shaw was now opening a similar plant in San Francisco. An alliance was made with Elmer P. Cunningham and his struggling Remler Company to take over the control of the Moorehead Company. The Moorehead Company had been licensed under the Fleming valve patents long before by the American Marconi Company but was stopped by injunction from manufacturing Audions for the general market. Thus was untied a very knotty patent situation. Under our control the Moorehead Laboratories were soon producing Audions again.

Former Naval Lieutenant Ellery Stone, today the president of the Federal Radio and Telephone Company, joined our forces about this time and San Francisco soon began to rival New York in radio-manufacturing activities.

Early in April, intent on renewing my broadcasting, I completed arrangements with the California Theater and the Humboldt Bank Building for the installation of a radio transmitter

* Walter Pitt, *New York Sun*, August 24, 1929.

to send out broadcasts of the excellent music played by the California Theater's orchestra. Herman Heller, the energetic leader of that fine orchestra, was all enthusiasm when the project was outlined. The pickup microphones were suspended in the orchestra pit. The original High Bridge radio transmitter was installed in the flies of the theater, and a long antenna was strung to the lofty top of the Humboldt Bank tower adjoining.

As soon as possible we began broadcasting the week-day matinee performances of that notable organization. Each Sunday morning Heller's orchestra played an hour's special program of fine music. This became a real event among coast radio listeners. In one isolated community far back in the Coast Range, an opulent rancher installed a receiver and loud-speaker, and for miles around, his neighbors would journey each Sunday to hear that marvel coming out of the air from 'Frisco.

Later that spring, Charles Logwood, who was again with me in California as assistant, arranged for the personal appearance of pretty little Mary White (now—1950—the charming Mrs. Henry Wallace, one of my neighbors in Hollywood) occasionally to sing and patter over our microphone backstage. All this was seven months before KDKA took to the air.

Thus this California offshoot of my pioneer New York broadcasting kept alive the fine tradition. Even after my return to New York, the station continued for nearly a year under Shaw's management, broadcasting its history-making programs throughout the Bay district.

My stay in San Francisco afforded me prized opportunities for again visiting my mother in Palo Alto—and also for renewing my delight in California. It was with growing reluctance that I again pulled myself away and returned to New York. More and more I felt the contrast between the bleak canyonlike streets of the city and the seemingly limitless expanses of the West.

During that trip east I invented a substitute for the heterodyne detector, a novel circuit to generate a musical note at the receiver for continuous-wave reception. Later a patent was issued on this invention, No. 1,478,029.

In the spring of 1920, my old Army buddy and stanch friend, C. S. Thompson, together with John F. Hubbard, organized the Radio News and Music Company and began making systematic efforts to sell our radiotelephone transmitters to various newspaper owners. The panels of the transmitters mounted four, or eight, VT-type hard tubes in parallel, or push-pull circuit, as oscillators, with two rectifier tubes in the plate-supply circuit when AC supply was available. For DC supply a small motor generator was used.

Thompson finally succeeded in interesting William E. Scripps, owner of the *Detroit Daily News*. He quickly became convinced that the *Detroit News* must be the first newspaper in the country to have a radiobroadcasting transmitter, a De Forest Type OT-10. That transmitter could be heard about a hundred miles when WWJ began broadcasting on August 20, 1920—the first commercial radio station in America to broadcast regular daily programs.

Since that pioneer founding (months ahead of Station KDKA), twenty-nine years of uninterrupted broadcasting have brought America's oldest radiobroadcasting station, WWJ, a rich background of memories and accomplishments.

And now another busy year rolled by.

August 26, 1920: Not since August 26, 1873, have I been idle! I have worked on this, my 47th birthday.

And that night, a perfect one of midsummer, a full moon beamed down through the trees of Columbia's campus where sat an audience of over 10,000. To the accompaniment of Dr. Franco Goldman's Band, Mary, my sweet-voiced wife, made her

first debut with an orchestra. She was radiantly beautiful. I debated whether she was more lovely or her voice more entrancing. It rang out clear and true, with that rare natural sweetness which I have never heard save in one or two other (professional) singers. Which did she delight the more, the eye or the ear? She was an instant success, and violently applauded. I was justly proud.

On September 2, Mary Mayo again sang with Goldman's Band, in Central Park Mall, the same two songs as before. Clear, sweet, rich and powerful, wondrous quality in open air.

Again I am proud of her and happy at her success. Where can one hear elsewhere a voice so near perfection?

September 4: My latest film, made Wednesday, talks better than all preceding. I feel much encouraged—the deepest mental happiness of which I am nowadays capable. *But, oh, could I really again sense happiness!*

Many and harsh have been the discouragements or difficulties. Yet in the long run—given health, sufficient funds to continue this fight, and courage enough—providing all these little details are in the picture—it may eventually become a *moving* picture; nay, a *talking* picture—and net handsome returns on the investment.

That September Mother arrived at Riverlure after a visit in Wisconsin. It was indeed sweet to see mother, wife, and daughter—three dear ones—together.

Another “dream come true” in Riverlure! Mary is working hard on *Tosca*.

I know, I love, three wondrous womankind. One in the evening of life, white-haired and saintly sweet—my mother; one in the full bloom of lovely womanhood—my wife, Mary; and one with gentle baby feet standing at the threshold of life's morning—my daughter, Eleanor. These three I love, and cherish—and I am very rich!



CHAPTER 38

Pioneering in Talking Pictures

*T*O pioneer had always been with me an obsession. Perhaps the yearning to explore new fields was an inheritance from colonial ancestors. Vanished geographical frontiers still left far vaster regions in science and technology to explore. When early wireless had begun to be a bit crowded, the radiotelephone field, then scarcely a dream even among communication engineers, beckoned me irresistibly. The primitive beginning of the radiobroadcast in 1907 logically necessitated the development of the electronic amplifier from the Audion detector tube; and thus again I managed to escape the crowd. And when in 1912 this new amplifier proved to be also an oscillator, a boundless ocean disclosing alluring archipelagoes of practical application was opened to scientific research.

It then had become apparent that many a forgotten dream of other early inventors might finally be brought to realization. Among such in the sea of television were the scanning disk of Nipkow; the cathode-beam picture of Rossing; Campbell-Swin-

ton's invention of the cathode-scanning beam (later perfected in Zworykin's "iconoscope")—all brilliant conceptions which remained only blueprints and letters patent for the simple lack of an inertia-less amplifier of a billion magnifying power.

The field of the talking motion picture, the *Phonofilm*, therefore irresistibly beckoned me, as one which I might enter almost unaided. Perhaps the one consideration which prompted me more than any other was a desire personally to develop a new and useful application of my Audion amplifier, one which I could expect to develop largely through my own efforts as distinguished from its application to long-distance telephony, where obviously the intensive efforts of a large corps of engineers backed by a gigantic business organization were indispensable. Another motive was my desire to possess a phonographic device which would be free of many of the inherent shortcomings of the disk machine, notably the short length of record and the necessity for the frequent change of needles. I had the belief that by means of a pencil of light it might be possible to escape from the needle scratch which had always been inseparable from the existing types of phonographs.

The excitement of entering a new, highly practical field of invention, so radically different from radio, caused a marked resurgence in my inventiveness. This had somewhat staled since the old radio field had become crowded with eager engineers from the great old corporations, Western Electric, General Electric, and Westinghouse Electric, institutions which had watched with amazing indifference from 1907 and 1913 and 1917 the progress being achieved in the fields of radio communication. Time had come for the pioneer to search for new frontiers, and this pioneer chose to put voice and music on the too-long silent film, to take the noise from the studio and put it into the theater!

So it was a source of deep satisfaction to note how in this new field my inventiveness flared anew. There was much to be done, and I gloried in the new tasks presented.

There is a craving in most hearts to achieve, or create, or to strive after the Beautiful. This chiefly accounts for the lifelong struggles of poets and artists, poor and unappreciated. Intensely have I loved the Beautiful, in art and life, and nature. Hence this new art of the Phonofilm which I am creating, of registering, perpetuating, and reproducing new and beautiful effects in the combination of pictured and aural loveliness, appeals to me as no mere scientific or technical problem could. Now at last I have attained that stage so patiently sought and so frequently postponed, of daily contact with this beauty, of knowing that my work will bring artistic pleasure and happiness to myself and others.

As early as November, 1920, with a long look ahead, I had framed these as possible names for the talking motion picture: Vitaphone, Biophone, Cinephone, Kinephone, Phonofilm—each with “ph” or “f” spelling. The last three I had copyrighted at that time, strangely neglecting the first! So I named them all—before them all.

During the night of November 19 my factory was destroyed by fire. This misfortune was reminiscent of the Parker Building fire of 1908. “What of myself had been burned up between those two conflagrations?” I found the tower standing, and the walls. Only the glass department was completely destroyed. The total loss exceeded \$35,000. The delay in again starting the oscillation manufacture was a big blow.

But work on the talking film progressed through all these troubles and distractions. I toiled incessantly days, nights, and holidays; so much so that on the holiday occasions Mary Mayo literally “raised hell” with me—as when she had to drive down to the Sedgwick Avenue lab on a Thanksgiving Day morning to drag me, reluctant and expostulating, back to the elaborate turkey, cranberry sauce, and fixin’s she had bountifully prepared.

The consistently encouraging Phonofilm experiments served then as my balm of Gilead. I actually began to combine voice and picture on the same film; and what was more significant of an early appreciation of the future value of the today uni-

versal "dubbing process," I described a method for recording sound on one film synchronized with a separate picture film.

The Phonofilm continued to occupy me throughout the early months of 1921. In June I attended the reunion of the Yale class of '96, where the twenty-five intervening years were forgotten in the joy of renewing happy college ties.

About this time the Consul General of France decorated me with the award of the Cross of the Legion of Honor in recognition of what the Audion, as detector and amplifier, had accomplished during the World War for the Military and Naval Services of the République.

July 9: Today I made my first "talking movie" picture—of myself, very hot and somewhat flurried; talked too loud, and the photography was poor, due to white "back drop" and bad placing of the light. But it was *at last made*, despite all jinxes and hoodoos—two months behind schedule, and after two years of hard work in preparation—a definite promise of great things to come.

In June, 1921, we were visited by two engineers from the firm of Eric Huth G.M.B.H. of Berlin, an active and growing rival in central Europe of the Telefunken and Lorentz Companies. These stolid *Herren* desired to acquire all of our patents and rights to file in Germany, Austria, and Czechoslovakia. For these they offered a small sum in American money and a bale of German paper marks.

The contract was finally drawn up, and after we had generously regaled these gentry on prohibition near-beer (spiked until large beads of perspiration mantled their wide, pale foreheads), the involved document was duly signed. Thereupon I suddenly decided to accept their invitation to visit their Berlin plant.

While there the observations I made of Berlin's conditions, living and monetary, made a deep and significant impression upon me. Here, I thought, both Mary and I could be busy and

happy—she with her music, I with Phonofilm, free from the ever-harrowing specter of debt, of large income spent faster than received with scarce anything but the bare necessities of home life in return.

Given an American income and a German outgo, with prices ridiculously low, with the falling mark already at 100 to a dollar, people with our taste for music, art, and comfort could surely live happily in Berlin for a long time, busily engaged and deriving far more than would in any way be possible in New York City for any expenditure of money.

Most impelling of all was the idea that away in distant Berlin I could be completely free from all business distractions, all radio problems, experimental and manufacturing—free to direct my every thought and energy to the ever-pressing problem of perfecting the Phonofilm to the stage where I could make public demonstrations and seek financial backing, and so work a needed revolution in the motion-picture industry. Moreover, on account of the greatly reduced costs of material and skilled labor, I could expect to make faster progress on my necessarily limited budget than would be possible in New York.

To free myself for concentrated effort on the talking-picture problem and to insure efficient operation of the De Forest Radio Company during my European sojourn, I made a generous contract with Charles Gilbert and Randall Keator whereby these two were to have full and undisputed control of the concern and receive one-half of any dividends earned by my stock. The single restriction was that they could not dispose of my stock or the treasury's stock without my explicit consent. My salary in reduced amount was to be sent me in Berlin.

October 2, 1921: My last Sunday in Riverlure. No more shall I see you dim white sail slowly vanishing into the darkness of the Palisades or the campfires blinking a friendly farewell by the purple margin. My tall trees, their leaves still thick against the blue, mount their last guard around

him who has cherished them so fondly through past years. The twilight breeze sings through their branches long sighs of regretful farewell. After the second dawn this rippled river will bear my ship out to the awaiting sea, carrying me and all I love to a remote land where new tasks await, new hopes, new life.

I am not sad as these years at Riverlure should make me in this leaving. This life of concentration, of rush and responsibility, has dulled so far the finer sensibilities, has crushed so completely the fine petals of my flower of poetry, that now I cannot feel, nor speak, nor write as befits one who leaves (perhaps forever) this lovely home he has for eight years cherished to his heart.

October 30: Hotel Adlon—my German disillusionment has already begun. Fretting about getting a permit to dwell in an apartment. Eleanor is already learning German words.

After five weeks it became certain that we were one American family who would not have a Thanksgiving dinner in a home of our own, much as we had counted on it. But my fifteen *Kisten* (chests) were at last at my lab and I was ready to begin real work on the film. The lab walls were heavily hung with *Stoffen*, and in this echoless room I believed I could make real voice pictures.

We were finally settled in time to celebrate our first German *Weihnacht* none too festively in a sumptuous, too huge, apartment, on Kurfürstendamm. The loneliness and the strangeness of it all, despite the few American or English friends we could find in Berlin, were already proving too harsh an experience for Mary Mayo.

Too late I began to realize the gravity of the mistake we had made in this transplantation to Germany. But now I felt we should fight it through, at least until I had achieved sufficient progress on my problem to justify the effort involved. And thus dawned, in bitterest cold and many privations, the year of 1922.

The supposed availability of all needed equipment proved a delusion. Wages were low and the reichsmark-dollar ratio was ever increasing, but even skilled glass blowers were hard to find

and maddeningly slow. Dr. Seibt gave me some help in his large factory. Dr. Siegmund Loewe, ever co-operative, was to me a fortifying friend in an alien land. A German camera was found, better suited than the old New York wooden one, and in that was embodied my small dumbbell-shaped glow tube, energized from a small radio-frequency transmitter. Berlin motion-picture laboratories did none too well in developing my sound film records. And so my work limpingly progressed.

As a brief respite from the woes of Berlin, made unbearable by Mary's failure to follow Herr Doktor's repeated injunction, "Kein Alkohol," we sojourned for ten days in the snowy fastnesses of the Hartz Mountains, there to try my first skis. Then back to Bedlam with its dark and narrow lodgments. Among other icy annoyances came the electric power and water strike, when long queues stood shivering before the neighborhood pump for two buckets of water per household, with extra water for bathing once a week. Brussels sprouts and cauliflower were our unending fare. Candles and cold rooms took us back forcibly to the barbarities of a century ago and made me wonder at the cheerful fortitude which, through all the dark ages preceding the Electric Age, enabled mankind to accomplish his civilization and learning. Little do we realize—pampered weaklings of modern luxury—our blessings, our comforts, our unknown opportunities for efficiency—until such a misfortune as this brings to modern city dwellers a forceful taste of what our fathers and their sires endured.

But wee Eleanor thrived, fostered by her German nurse, sang German songs cutely, and became my only joy during the endless weeks.

When April continued the drear winter's tale, we fled Berlin again. In our Benz we drove to Coblenz and down the storied Rhine. In a small boat we ferried our car across the river at Drachenfels, where, still on a night bewitched, the Lorelei sing

their Rhine daughter's song. Then up the noble stream we drove past Ehrenbreitstein and "Alt" Heidelberg, beneath ancient castles from whose beetling pinnacles fluttered to my mind's eye the banners of the medieval robber barons and the pomp of Charlemagne. On through the lovely land of ancient fable we drove to a night in the storied Cloister of Constance beside the Bodensee, whence flows the Rhine. On to Friedrichshafen and homeward through the Bavarian Alps, to pause at Munich for her art galleries and her famed Bierstuben; to the Nuremberg of Hans Sachs and Albrecht Dürer, the chambers of medieval torture, and the entrancing Glockenspiel in the old market place. Then on to Rothenburg, where six centuries still lay asleep, to spend our night within its fourteenth-century walls.

Yet that Berlin winter was not without its compensation. At the *Staats Opern* we enjoyed more good opera, most of it Wagner's, than ever in our lives before, and at prices ridiculously low. We sat in the Kaiser's Box or mingled with the between-acts, sandwich-eating *Herren* and calico-frocked *Frauen* in the pit.

By April I was ready for the clumsy German theater projector on which to install my sound reproducer, exciter lamp, and the Kuntz photoelectric cells brought from the distant High Bridge laboratory. Then began endless and tedious testing. My none-too-brilliant assistant, Dr. Fritz Holborn, was a violinist of sorts, and stood for many an hour sawing his *Geige*, and speaking slow German into our microphone.

By September we were ready for demonstration. There proved to be plenty of "wows" in the reproductions from the Pathé cone loud-speaker, driven by four Baldwin telephone receivers gang-connected to a common shaft. A large flywheel on the sound sprocket partially corrected that trouble. The audio output of this United States-German aggregation was disappointing but adequate for the immediate purpose.

Finally, the Berlin Press was invited. Their comments were

polite, if not enthusiastically laudatory. I had progressed now as far as I could expect under the handicapping circumstances, and decided to pack up the whole "ball of wax," transmitter, camera, printer,* amplifier, theater projector, and my last photo-electric cell, and ship them all to New York.

The harsh and somber winter had left its mark of deep depression on my wife, so much so that I sent her now to the Riviera to seek a dwelling place on the song-awakening summer shores of the Mediterranean. She returned restored in spirit, with glowing tales of a large estate, owned by an impoverished Russian general, which could be leased for a song—or at least for a Grand Opera. So just before I was due to return to my New York laboratories with Phonofilm, the little family, with our four faithful German servants, entrained for Menton. I found "Chateau Diadato" all that Mary had described. Its grounds were capacious. Delightfully embowered in flowers reared the large old chateau, its marble-columned music room richly adorned with paintings and rugs of fabulous worth. Well-kept paths wandered on walled terraces, with stairways of stone leading down to a silvery graveled private beach, with spacious boat cavern opening to the warm blue sea. Here indeed could a man live, his soul expand; here if anywhere could a budding opera singer sing from her heart of happiness. So a contract with the old general was signed; the entire family, with four Germans and chauffeur Dawson, who had driven the big Pierce limousine down from Paris, were safely ensconced; and I returned alone to Berlin. Within a week all my precious apparatus was encased and aboard my ship for New York.

* This was an historically interesting piece of apparatus. A German film printer was so remodeled that the two films, positive and negative, went through simultaneously, but the separate sound-printing lamp was so displaced along the film that the sound record lay some 24 frames behind the corresponding picture frame. Thereby proper synchronism between picture and its sound when projected and reproduced was always maintained. This first sound printer, rebuilt and improved in the De Forest Radio Company's Jersey City factory, was used for two years, being then replaced by a fine, remade, Bell and Howell film printer.



CHAPTER 39

Phonofilm Comes to Broadway

ARRIVING at the Yale Club, I was besought by the press for my story. I had returned from a year's experimental work in Berlin on the problem of sound-on-film talking pictures. "When would this be ready for demonstration?"

"Possibly within a year, perhaps less."

"Would this revolutionize our present silent pictures?"

"In time, yes."

No rush of picture producers or theater owners to my door resulted. I had expected none. Only one man in New York—indeed, in America—was sufficiently interested to inquire—Dr. Hugo Riesenfeld, musical director of the Paramount theaters, Rivoli and Rialto. To him I owe more than I can express. Without his keen vision, his belief, unique among his entire profession, that the talking picture had a very great future, my progress along that path of endeavor would have been devious and slow indeed. He volunteered to find for me a suitable studio, even a cameraman; when I was ready he would supply musicians

for recording; when my Phonofilm was ready for public presentation, the Rivoli Theater would be at my disposal! It all sounded too unbelievably good to be true.

Eagerly then did I get to my work. I found I could lease suitable space in the old Talmadge Studio on East 48th Street. There was available all I should need, ample space, large array of picture sets, lighting equipment of every type, and skilled help. There came from Dr. Riesenfeld one Harry Owens, a pert, diminutive cameraman, eager to help me, eager to help himself—as later proven. Together we unpacked and set up all my Berlin equipment. Owens' knowledge of cameras, printers, and New York film laboratories was of real value. Soon he learned the intricacies of my circuits. Good mechanics of the De Forest Radio Jersey City machine shop were set to work to improve my camera and to remake the printer. The camera was so noisy it had to be enclosed in a telephone booth, double-walled—the first “blimp.” Earnestly urged though he was, Dr. Kuntz, of the University of Illinois, could not find time to make the sensitive photoelectric cells I required. I was forced therefore to use the Case sensitive thalafide cell, though this proved definitely deaf to any frequency above 3,500!

By November, 1922, I began to Phonofilm orchestras and pretty musical acts sent over by Dr. Riesenfeld. Theodore Case came to see what I was doing, and became greatly interested. He learned quickly, and was soon a faithful imitator. He began to experiment at his Auburn home, following my lines and advice. One week end he invited me up to observe a gassy Western Electric amplifier tube wherein the blue glow fluttered in response to low-voltage plate modulation. At once I told his clever assistant, E. I. Sponable (the real brains of the pair, to whom was due ninety per cent of all that Case later “achieved”), how to design a test-tube-shaped partially exhausted envelope having an oxide-coated filament located close to one end with

an anode sealed in thereby. The tube contained a small amount of argon and helium, sometimes in addition a minute droplet of mercury. This tube I inserted in my camera and discarded the high-frequency, high-voltage "photion" I had been employing. It worked on low voltages and was therefore decidedly more convenient. Its activity equaled, even surpassed, that of the radio-frequency photions used up to that time.

Again at my request Sponable modified a Bell-Howell camera to locate therein the "Aeo* light," as he called the new photion, in such a way that its sound-modulated light was projected, exactly as in my earlier camera, through a fine slit upon the margin of the negative film next to the picture record, making a photographic sound track approximately $\frac{1}{8}$ inch wide. Case and Sponable now began to haunt the 48th Street studio, wasting a lot of its valuable time experimenting with an impractical thermophone microphone and studying minutely our new printer.

During this period E. B. Craft, president of the Western Electric Laboratory, became very co-operative. He loaned me a panel amplifier and several electrostatic "mikes." Later he sent Engineer Hitchcock to watch minutely our sound-on-film recording processes and our laboratory procedure.

In November of that year I organized the De Forest Phonofilm Corporation and the De Forest Patent Holding Company. To the latter I assigned all my sound-recording and reproducing patents and numerous patent applications. Until 1925 I alone financed all the development work, an ever-increasing burden as our work rapidly developed.

By April, 1923, the new facility had sufficiently progressed to justify Dr. Riesenfeld in presenting Phonofilm to his Rivoli Theater audience. As a preview the sound films were first exhibited before the New York Electrical Society in the Auditorium of the Engineering Societies Building. The hall was jammed. I

* Actinic earth oxide.

had prepared a layman's outline of the methods used in recording and reproducing sound and pictures on the same film. Reversing the usual procedure of lecture and demonstration, the audience being seated, the lights of the hall suddenly went out. A picture of Henry Cass appeared, speaking in loud clear tones, giving a brief description of Phonofilm. Then came Eddie Cantor in monologue and song and Lillian Powell in her graceful bubble dance to lovely music by Brahms. Other numbers, exquisitely beautiful or of rollicking comedy, followed in unbroken succession.

As the lights came on, the rapt pleasure and wonderment of the applauding audience resoundingly confirmed the judgment of Dr. Riesenfeld that the public would eagerly accept the talking motion picture. Two weeks later Phonofilm opened at the Rivoli on Broadway.

This date—April 12, 1923—is truly historic; for it, and not the sound-on-disk Vitaphone opening in August, 1926, marked the genuine beginning of commercial sound-on-film and the talking picture—an innovation destined in seven years to wipe from all the theater screens the “time-honored, sacrosanct, never-to-be-improved-on” silent motion picture. All that was lacking in 1923 was a daring motion-picture producer willing to risk a million dollars to prove what any open-minded observer could then have seen—that sound-on-film had arrived, was practical in studio and theater, and that the public would “eat it up” if only given artistically acted, sumptuously staged, cleverly directed pictures.

To find such a motion-picture director now became the task of Dr. Riesenfeld and myself. It should not have been difficult; but what stone walls of indifference, stupidity, and stolid negativity did we unearth among the dead bones and concrete skulls of motion-picture “magnates”! To me it was the same old story of the wireless telegraph in 1902, the radiotelephone and broad-

casting in 1909—the common lot of daring inventors everywhere, every time: Robert Fulton and his steamboat, Westinghouse and his air brake, Morse and his telegraph, Bell and his telephone.

Riesensfeld called in Adolph Zukor. Carl Laemmle was vainly importuned. His man Cochrane saw the light and heard the prophetic voice, but his superiors outvoted him. Balaban and Katz, Sydney Kent, all evinced the same reaction—No, Never, *Nein und Nimmer!* “The Publics dunot vant talking pictures.” “Edison had tried it and failed.”

So Phonofilm had to struggle on unaided.

Directly after the triumph at the Rivoli, and leaving further studio production in William Waddell's competent hands, I took a five weeks' holiday, my first real vacation since Yale days, and visited my little family at the fabulous Chateau Diadato by the blue Mediterranean.

This is indeed a paradise on earth for me—until I think of the great, onward-rushing world of the West, and of *my work*. And then I become unhappy, and feel that all this seductive loveliness is a glorious Delilah, robbing me of my strength to deliver me over to the Philistines, a slave to beauty, but alas, an idle, *workless* slave!

That Mediterranean trip was briefly repeated in September when I brought back from her Monte Carlo Opera my sweet singer, Mary, with Eleanor and our faithful troupe of German house help, home to the greatly enlarged and beautified Riverlure. For with the sudden increase in my fortune, resulting from sale of my De Forest Radio stock, I had resolved to realize in large measure all the long-cherished dreams for my acres overlooking the noble Hudson. There I should enlarge the house to a modest mansion of comfortable elegance, set amid curving lawns where Japanese rock gardens, lily pools, and a waterfall made a graceful setting for the giant tulip trees and weeping willows. Graceful stone seats and bird fountains added to the

natural charm. There should my lovely wife reign through her exquisite voice, and my children happily play, and in that cultured atmosphere attain becoming beauty. And there too should I find delicious moments, nay hours, of relaxation, as from my western balcony I watched the play of color and shadow on the River's surface, through a "drowsy afternoon, and evening steeped in honeyed indolence."

You can readily discern in its planning and beautification how fondly its owner had put therein all the love of beauty, all the romantic idealism, all the appreciation of grandeur of scenery, and the inarticulate yearning for security and seclusion of which his heart and soul were capable. If ever land and a home, landscape and a garden, interpreted and expressed a human personality—Riverlure was the visual expression of my soul.*

Having, for reasons already mentioned, decided to devote my energies wholly to the perfecting of talking pictures, I entered into negotiation with Theodore Luce, Ned Jewett, and other Detroit capitalists to sell my control of De Forest Telephone and Telegraph Company. I saw that "Radio" had at last taken hold. My primitive audiences of eager hams had suddenly swelled to large and swiftly increasing thousands. The Telephone Company had begun to link up various broadcasting stations (and also had shown them how to sell time to sponsors). No longer were the profits to be limited to manufacturers and distributors of radio receivers. The novel ideals which David Sarnoff and I had been preaching, profits from sales of "music boxes," as in 1916 he had styled broadcasting receivers, paled quickly before the dazzling glare of sponsor's gold.

The flagrant evils of recent years were by no means evident in 1922 when WEAJ instituted the "commercial broadcast." But highly moral as it then may have been by today's degraded standards, I lost no opportunity in season and out to protest against broadcasting sponsorship. "A voice crying in the wilder-

*From my diary written years later, after I had left Riverlure for the last time.

ness"—nothing more. Radio was already aboard a raft, "sold down the river" and traveling fast. Had I then foreseen to what degradation she was ultimately headed I might never have made the *greatest mistake of my career* in selling control of the company I had struggled so desperately to found in 1907 and to redeem and retrieve in 1913. I should have kept the original banner nailed high to the masthead, my radio tower, and maintained the world's pioneer broadcasting station as a model of high ideals, dispenser of fine music, of cultural topics, for the elevation of America's mass intelligence.

But not endowed with insight so prophetic, I thought I saw radio at last in safe hands. I required a large sum of money for my Phonofilm adventure, and so I sold my birthright. It was a very large sum the Detroiters paid me. I turned over my control and buried myself in the East 48th Street studio.

Five times have I gambled with my life. In 1897, when I decided to struggle on at Yale rather than to seek a job as my classmates were doing; in 1900, when again I left a position of sure, slow progress, in the Western Electric Company, to carve success out of nothing and Wireless; in 1906, when I abandoned my first Company and Wireless to create a Radio Telephone system; in 1913, when I threw away my \$300 per month with the Federal Telegraph Company to come East and build up a third enterprise based on the Audion; in 1921, when I forsook Radio to work out a new success in Phonofilm.

The triumphs now being won in the patent courts seemed symbolic of the corresponding success of De Forest Radio in manufacturing and merchandising radio receivers and tubes. When I sold my control to the Detroit tycoons, it was with the idea that "an inventor is seldom a good business director." I should therefore put my company, born with what labor pains in 1907, and rescued from famishment in 1913, into competent hands who, first giving it ample funds, would rapidly build it into a large and potent factor in the now awakened world of radio.

Luce turned over to Jesse Livermore the job of marketing the treasury stock. So fine a job did Jesse do that inside of six months the corporation had a million and a half dollars in its coffers. And within eighteen months thereafter the company was in receivership! Utterly shiftless absentee management on the part of Jewett and Luce, coupled with an asinine contract with their chief engineer, William Priess, wrecked their Company in record time. Priess designed a so-called "reflex circuit," a receiver he called the Priess "straight eight," under a contract giving him a fat royalty for every unit of his design sold. Naturally, all other types of receivers, which had previously proven highly acceptable, were put in the discard. National distributors and dealers, thoroughly sold on the merits of prior De Forest products, loaded to their top shelves. The public quickly began to complain, the dealers returned hundreds of thousands of dollars worth of merchandise. The fold-up was inevitable and swift.

But although from 1923 on, radio progress was to be none of my concern, I was to be involved for many years more in an aftermath of patent litigation.



CHAPTER 40

Historic Litigation

ON January 3, 1921, a suit destined to become famous in patent annals came to trial in Judge Mayer's court. The Westinghouse Company as licensee under the Armstrong regenerative circuit patent* had sued the Radio Telephone and Telegraph Company for infringement.

I was first on the stand, followed by Ralph Beal of the Federal Telegraph Company. He made an excellent witness relative to the demonstration of the "true beat note" which I had obtained with the Audion in the Palo Alto laboratory in April, 1913.

Judge Julius soon showed himself to be as keen a friend to Armstrong as he had been to Marconi five years before. His bias was strangely evidenced when at the Columbia University tests of the Armstrong circuit and at my High Bridge laboratory

* With another, broader patent application of his, my own two patent applications on the feed-back circuit, together with those of Irving Langmuir and the German, Meissner, had been involved in bitterly contested interference proceedings since 1915. As these four applications had proceeded upward through the process of successive appeals, the Examiner of Interferences and the lower Patent Office up to the Commissioner himself had in turn held Armstrong, then Langmuir, and again Armstrong, to be entitled to priority claims. My application had been consistently defeated.

demonstration of the Ultra-Audion circuit, he and Professor Pupin, Armstrong's mentor, walked off arm and arm together.

As this unjudicial conduct prepared us to expect, the Judge found for the plaintiff. We appealed and of course lost again—the appellate judge being none other than Charlie Hough.

Thus handicapped with another of Judge Mayer's typical anti-De Forest decisions, and another typical affirmation by our Judge Hough, it became clear that to continue to manufacture and sell Ultra-Audion and feed-back circuit devices we must become an Armstrong licensee. But the Westinghouse Company, which now controlled this patent of Armstrong, refused to license my company. Thereupon we bought up a small corporation owning such license, and proceeded thus to make our regenerative receivers. The earned royalties we proffered to the Westinghouse Company.

To our amazement, that large corporation took legal steps to declare that particular license nontransferable by corporation purchase, to have it in effect declared null and void. More wearying months of legal fencing, mounting legal expenses, and loss of revenue ensued. This time, however, we arranged to get the suit tried before a New Jersey chancellor, and there for the first time we began to get "some of the breaks" at court.

For it had by now become evident that the De Forest Company simply could not obtain any shadow of justice from the Federal Court in the Southern District of New York. So in 1922, while I was absent in Berlin, the acting president, Charles Gilbert, had wisely removed factory and office to Jersey City. Immediately, the gloom of our patent atmosphere began to lighten. No longer did the outrageous injustices of the past nine years obtain. The oppressive injunctions secured by RCA (inherited from American Marconi) and Westinghouse were lifted. Then finally the Court of Appeals of the District of Columbia decided that my two feed-back patent applications were valid.

Thus there were ultimately issued to me on September 2, 1924, patents No. 1,507,016 and No. 1,507,017 (*on applications filed March, 1914, and September, 1915, respectively*) covering broadly the oscillating Audion, or feed-back, circuits—circuits which made possible a revolution in radio transmitters which had already begun to junk every spark and arc and high-frequency generator in the world. These two patents—equal in importance and value to my grid and amplifier patents—dominated the radio transmission art until they expired on September 2, 1941.

My compelling proofs of priority in this long interference proceeding were the notebooks from the little old Federal Laboratory of 1912, located at 913 Emerson Street, Palo Alto.

The issuance of my feed-back patent promptly renewed the now historic battle with Armstrong which had been waged in the Patent Office since 1915. Backed by Westinghouse, whom he had licensed, he now sought in the Wilmington Federal Court an order cancelling the newly issued patents. Simultaneously we brought action in the Federal Court of Philadelphia* to declare his 1914 patent on the Regenerative Audion invalid in view of the District of Columbia Court's award of priority. We won our action. Armstrong-Westinghouse lost theirs. They appealed both decisions, lost both. The victory was all ours, but it did not mean the end of the war.

As a result of these decisions the Armstrong regenerative circuit became in infringing use (under the De Forest feed-back patents) in over one half of the radio sets manufactured in the United States by licensees of Major Armstrong and the Westinghouse Electric and Manufacturing Company.

In this battle I received unexpected help. Back in the days when Armstrong had succeeded in hamstringing the De Forest Company in Julius Mayer's New York Federal Court, George

* De Forest Radio Telephone and Telegraph Company, Plaintiff, *v.* Westinghouse Electric and Manufacturing Company, Defendant. In equity No. 3,125, under Section 4,918 R.S.

Folk, chief patent counsel of Western Electric Company, had studied minutely into our priority claims, had cross-examined Herbert Van Etten, Ralph Beal, Dr. Leonard Fuller, and other Federal Telegraph engineers, and had finally decided that my dates of conception could be legally established against Armstrong. My 1917 Western Electric contract gave them license rights under all my issued patents and pending patent applications. The Western Electric Company could have had like rights through Westinghouse should Armstrong's patent stand. But Folk decided to back my battle. This he did magnificently.

Armstrong, his "regenerative" patent having been previously sustained by Judge Hough of the New York Court of Appeals, appealed now to the Supreme Court.

Sam E. Darby, the brilliant son of old Captain Darby, had been ably fighting all of my patent cases since the miserable flop of Philip Farnsworth before Judge Hough in the Marconi-Fleming valve suit. Having won against Armstrong's brilliant array of legal lights at Philadelphia and Wilmington, Darby rejoiced at the opportunity to carry the battle again to Washington.

In 1928 the United States Supreme Court decided that I was the originator of the feed-back circuit, that the Palo Alto evidence was good and valid, the conception date August 12, 1912.

But did this decision end the fourteen-year-old controversy? It did not. Armstrong, having recently lost, by Patent Office interference proceedings, his superheterodyne patent to his predecessor and tutor, Lieutenant Lucien Levy of France, and his super-regenerative receiver patent application to Turner and Logwood, now elected to defend Radio Electric Laboratory, whom RCA had recently sued for infringement of my feed-back patent. Judge Thomas of the Federal District of Eastern New York, relying on the recent Supreme Court decision, found for the plaintiff. This, it seemed, was just what Armstrong wanted.

Radio Electric Laboratory appealed Thomas' decision up to the Federal Court of Appeals in New York, up to Judge Manton (who later went to the penitentiary). This doughty judge dared reverse the Supreme Court in a decision unprecedented in Patent Court annals. In effect he ruled (in agreement with Professor Pupin in a violent *New York Times* protest) that "the Supreme Court did not understand the true merits of the controversy." Accordingly, he reversed Judge Thomas.

This reversal by a Circuit Court judge of the findings of the Supreme Court of the United States made it indeed a *cause célèbre* among all the annals of patent jurisprudence. In fact, so original was this situation I am almost tempted to style it "patented" jurisprudence.

Here then was a situation which our highest tribunal could not overlook or condone. Darby and Armstrong's attorneys again faced the court. For the first time in its long history the same patent issue had come twice before our Supreme Court—and not for a mere rehearing. This time the Court, in sustaining itself and reversing Manton, handed down a masterly worded decision, the work of Mr. Justice Cardozo, admittedly one of the most brilliant and competent justices who ever sat on that high bench.

RADIO CORPORATION OF AMERICA, American Telephone & Telegraph Company, and De Forest Radio Company, Petitioners,

vs.

RADIO ENGINEERING LABORATORIES, INC., Respondent.
(293 U.S. 1-14, 79 L. Ed. 164)

On writ of Certiorari to the United States Circuit Court of Appeals for the Second Circuit to review a decree reversing a decree in favor of infringement of a patent. Reversed.

.
The previous decision of this court is controlling in this case on the question of priority.

On the undisputed facts De Forest is the prior inventor under the law.
.....

Respondent has the right to an untrammelled judicial determination of the question whether Armstrong made the invention before De Forest did, independently of the interference proceedings which culminated in the *per curiam* opinion of this Court in the Westinghouse Cases.
.....

The petitioners, assignees of two patents, numbers 1,507,016 and 1,507,017, granted to Lee De Forest on September 2, 1924, have sued to restrain an infringement and for other relief.

The respondent, defendant in the trial court, admits the infringement if the patents are valid, but maintains that they are void in that they were issued to a patentee who was not the first inventor.

Long before this suit the rival claimants to the invention, Armstrong and De Forest, had fought out between themselves the legal battle now renewed. The outcome of their contest was a decree whereby priority of invention was found in accordance with the patents now assailed by several assignees. For the purpose of any controversy between Armstrong and De Forest the validity of the patents must be accepted as a datum. Even for the purpose of a controversy with strangers there is a presumption of validity, a presumption not to be overthrown except by clear and cogent evidence. The question is whether the respondent has sustained that heavy burden.

At the outset there were four claimants to priority of title. All four, acting independently, had made the same or nearly the same discovery at times not widely separate. The prize of an exclusive patent falls to the one who had the fortune to be first. . . . The others gain nothing for all their toil and talents. Of the four claimants Langmuir filed an application for a patent on October 29, 1913, claiming August 1, 1913, as the date of his invention. Armstrong filed an application on October 29, 1913, and the second one on December 18, 1913, fixing the date of his invention as the fall of 1912 or the beginning of 1913. As early as October 6, 1914, he received a patent covering the subject matter of his first application (patent No. 1,113,149), but not the subject matter of his second. Meissner filed an application on March 16, 1914, fixing the date of his invention as April 9, 1913. De Forest filed an application on March 20, 1914, and another on September 23, 1915, fixing as the date of his invention, August 6, 1912, the earliest date of all, which would make him the first inventor if the claim could be made good.

Interferences were declared by the Patent Office as the result of these conflicting applications.
.....

The Court of Appeals of the District of Columbia decreed priority of invention in favor of De Forest. On September 2, 1924, pursuant to the mandate of that court, patents numbers 1,507,016 and 1,507,017 were issued by the Patent Office.

At this point in the decision, there follows a detailed version of the history already told on pages 377-379.

. . . This court held the view when these patents were last before it that the evidence was insufficient to overcome the presumption of their validity in any clear or certain way. If our estimate of probative values had been different, the invention must have gone to Armstrong, no matter though other courts or administrative officers had been persuaded to the contrary. The evidence that was insufficient at that time to evoke a clear conviction that the patents were invalid is the same in all essentials as the evidence before us now. We must pronounce a like decree unless we are prepared to say in the light of fuller argument that the first decree was wrong.

The record has been re-examined patiently without inducing that persuasion. After all that has been written about the De Forest patents in these many years of litigation, there is no need to fill the pages of our reports with an analysis of the opposing arguments as if we were a court of first instance trying the controversy anew. For present purposes, it is enough to bring out into sharp relief a few considerations of dominating significance. Patent No. 1,507,017 is for an invention known as a "feed-back circuit" and patent No. 1,507,016 for an invention known as the audion "oscillator." The two, however, are closely associated, for the oscillator can be produced only by use of the feed-back circuit, though the feed-back circuit can be used without producing an oscillator. As far back as 1908, De Forest had received a patent for a form of vacuum tube to which he gave the name of "audion." . . .

The device established itself almost at once as a revolutionary improvement in the art of transmitting sounds at great distances by wire and through the air. At the beginning, however, its potencies were not fully appreciated by electrical experts, not even by its inventor. Many experiments were made with a view to exploring its capacities and developing them. Among those interested and curious was Armstrong, then a very young man, a student at the school of electrical engineering at Columbia University. He conceived the idea about January, 1913, that through a hookup or coupling of the output and the input circuit, there would be a feed-back or regeneration of energy whereby the plate in the audion would become an independent generator of continuous oscillations. Tun-

ing the circuit to the appropriate frequency, he found that the messages communicated through the antenna of a radio station were heard with a new clearness. Signals from distant lands were borne to him across the seas.

It was a brilliant conception, but another creative mind, working independently, had developed it before in designs and apparatus till then unknown to the art. De Forest with his assistant Van Etten had been working during the summer of 1912 along two lines of thought. One was the use of the audion as a telephone repeater to amplify weak telephone currents and thus facilitate the transmission of long-distance messages. The other was its development as a generator of alternating currents for any and all uses, some perhaps indefinite, that were capable of being served by oscillations thus produced. On August 6, 1912, a diagram showing a feed-back hookup of the input and output circuits is recorded in Van Etten's notebook with a note that by the use of the coupling "a beautiful clear tone" had been developed, which means that oscillations had been produced and that the oscillations were sustained. There is also a note that the pitch, i.e., the frequency, was varied by altering the plate voltage, which means that the frequency could be varied at will. Armstrong does not deny that all this was done just as stated by De Forest. Indeed, the authenticity of the notebook entries has never been disputed through the many phases of the controversy. What Armstrong does deny is that anything done or recorded in August, 1912, is an anticipation of his own invention. He says that the sustained oscillations generated at that time were of audio and not of radio frequency, and this, it seems, is admitted. He says there was then no perception of thought that the audion plate could be made to oscillate at radio as well as audible frequencies through a coupling of the circuits. This De Forest denies. He maintains, with the backing of other witnesses, that upon discovering the effect of the feed-back in generating sustained oscillations of the plate, he understood at once that by controlling the inductance or capacity in the oscillating circuit he could also control the frequency. This, he says in substance, must have been obvious upon reflection to any competent electrician, though there would be need of a certain amount of adjustment and experiment in substituting the correct inductance or capacity, a process, it is argued, that would be well within the ability of anyone skillful in the art. Beyond this he insists that having discovered the generative virtue of the feed-back, he was not confined in his invention to the uses then developed, but if his patent claims were broad enough was entitled to the benefit of other and related uses made manifest thereafter.

We think that for all these contentions of De Forest adequate support exists in the record and the law. There is evidence that in August, 1912,

he discussed with his assistants the possibility of using sustained oscillations of the audion in generating and transmitting radio waves as well as those of audio frequency. There is evidence that intermittently in 1913 he worked upon that theory, and particularly that on April 17 of that year at Palo Alto, California, he received a clear note, the true heterodyne beat note, from the radio signal station at San Francisco Beach with the aid of the coupled circuits. The entry in his notebook made the same day tells us, "This day I got the long looked for beat note." This was long before he had heard of Armstrong or of like experiments by anyone. There is evidence that in the early part of 1914, he renewed his investigations in that field of research, after being temporarily diverted, and finally on February 27, 1914, recorded in his notebook, as the outcome of a number of experiments, that he had "full proof that the audion acts as a generator of high-frequency currents."

The decree of the Circuit Court of Appeals should be reversed and that of the District Court affirmed.

It is so ordered.

(Argued May 2 and 3, 1934.

Decided May 21, 1934.)

This second verdict by the Supreme Court in 1934 finally terminated the nineteen-year-old battle over the feed-back patent. Thereafter no court hesitated in deciding the question of its infringement. Numerous were the defendants found guilty. This last of my really basic patents expired in 1941, to the vast relief of sundry manufacturers of radio transmitters and diathermy generators. All but the De Forest and Federal companies (the latter enjoyed "shop rights" under the patents) had paid abundant tribute, ample to defray the huge expenses of that record-breaking legal battle.

Of almost equal importance, in the development of the three-electrode vacuum tube for signaling purposes and for use in industry, was the long-drawn-out patent interference between Irving Langmuir of the General Electric Company and De Forest Arnold of the Western Electric Company, each claiming the initial discovery of the advantages of a very high vacuum in such tubes and employment thereof. This interference finally resulted

in a patent to Langmuir which covered broadly the use of high vacua in amplifier and oscillator tubes.

With this comprehensive weapon, General Electric sought to clean up and dominate the entire signaling art and industry. When they attacked the De Forest Radio Company, that company brought suit to declare invalid the Langmuir claims. The Court's decision in this suit stated:

That the production of the high-vacuum tube was no more than the application of the skill of the art to the problem in hand is apparent when it is realized that the invention involved only the application of this knowledge to the common forms of low-vacuum discharge devices such as the Fleming and De Forest tubes.

Once known that gas ionization in the tube caused an irregularity of current which did not occur in a high vacuum, it did not need the genius of the inventor to recognize and act upon the truth that a better tube for amplifying could be made by taking out the gas.

Arnold, who was skilled in the art and who had made studies of electrical discharges in high vacua, when shown a De Forest audion for the first time on November 14, 1912, immediately recognized and said that by increasing the vacuum the discharge would be sufficiently stable and have adequate power levels to enable the tube to be employed as a relay device in transcontinental telephony.

The very fact that all of significance in the Langmuir improvement was obvious to one skilled in the art as soon as he saw the unimproved tube, lies athwart a finding of invention.

This decision, of great importance to the radio world, was announced in May, 1931. Thereby the Supreme Court of the United States reversed a decision of the Third Circuit Court of Appeals, and held the Langmuir high-vacuum tube patent to be invalid as being not an invention.

The effect of this decision was that the patent was not infringed by the De Forest Company. The De Forest suit had contended that unless the patent was set aside, General Electric would have a virtual monopoly of all radio tubes in common use. The decision was heralded by the press as "another smashing victory over the radio trust."

The Langmuir high-vacuum patent had been considered one of the most important items in the patent pool of Radio Corporation of America, General Electric Company, Westinghouse Electric and Manufacturing Company, American Telephone and Telegraph Company, and General Motors Corporation, which pool the United States Government had sued to dissolve as a violation of the Sherman Law.

Also in that hectic year of patent-law decisions (1931) the Supreme Court refused to grant the petition of the Radio Corporation of America for a writ of certiorari to the Circuit Court of Appeals for the Third Circuit, to review the judgment of that court in another radio tube case of major interest to the entire radio-manufacturing industry.

The suit was originally instituted by the De Forest Company against the Radio Corporation in the Federal District Court at Wilmington, seeking an injunction under Section 16 of the Clayton Act, to enjoin that corporation from enforcing provisions of patent-license contracts made with some twenty-five manufacturers of radio receiving sets.

The District Court issued a permanent injunction against the Radio Corporation, and the Circuit Court of Appeals sustained the decision. The Radio Corporation then petitioned the Supreme Court to review the case, but the petition was denied.

In March, 1931, the scene of the far-reaching patent battle between the De Forest Radio Company and the Radio Corporation of America, one which involved millions of dollars and the basic patents of the radio industry, shifted to Baltimore.

Charging infringement of thirteen patents, the De Forest Company filed suit in United States District Court, seeking a restraining injunction, an accounting, payment of profits earned by use of the patents, and triple damages.

While the suit was directed primarily at the "Theremin," it

involved all instruments employing vacuum tubes in the synthetic reproduction of music. Talking motion pictures, electrical phonographs, electric chimes, and the new electric organs were involved. Without these patents, it was contended, broadcasting and reception of that day would be impossible.

The De Forest Radio Company won and was awarded heavy damages.

The suit was but one blow in a fight which had been progressing in the courts since 1914, although it was said to be the first time the thirteen patents listed in the bill of complaint had been drawn into the battle.

As I look back today over the long years of radio's growth I am deeply pleased to note that the old rancor and bitterness of competition, the long patent struggles between its originators and their exploiters have subsided. The pooling of radio's tens of thousands of patents and the policy of easy licensing and freed competition, auger powerfully for more rapid growth and wider dispersal of the great human benefits which radio's industry increasingly confers.

Leader in this new era of peaceful development today is the Radio Corporation of America under the equitable and far-sighted direction of its able president, General David Sarnoff.* And the long-standing change of attitude on the part of the Telephone Company has been most gratifyingly exemplified by the assistance in late years extended to me and my inventive efforts by its magnificent research arm, the Bell Telephone Laboratories, with Dr. Oliver E. Buckley at its helm. That the activities of the world's foremost communication-research organization is so largely devoted to the refinement and application of the amplifier which I brought to them so long ago, is a source of boundless satisfaction to me.

* Now chairman of the Board.



CHAPTER 41

The Dam Goes Out—at Last

BUT to return to Phonofilm!

In the three-sided presidential campaign of 1924 we equipped a pickup truck with battery-operated sound camera and amplifier (loaned by Case), went to Washington, and induced President Coolidge to unbend sufficiently for a brief speech on "National Economy." That same afternoon old Senator Bob La Follette came out on the Senate sidewalk while we recorded a rousing Progressive appeal. Later we drove out to the Long Island home of Democratic candidate, John W. Davis, to record his voice while he fumbled his notes in answer to his own question: "What is honesty in government?" He appeared none too sure.

These three political addresses were reproduced in more than thirty Phonofilm-equipped theaters during that political campaign, arousing great public attention. Unquestionably those historic events began to undermine the rock-ribbed fossils found in the concrete existing between movie producers' ears—the con-

viction that "the public did not want talking pictures." But two more years of widespread public demonstration were necessary before the dam of indifference and opposition went out.

Late in 1924 actor Arthur Donaldson produced in Phonofilm the world's first talking-picture play, "Domen," first in Swedish, then the English version, "Retribution." This was two years before Al Jolson's much-exploited "Jazz Singer."

There were thirteen characters in the play and its duration or time-on-screen was approximately forty minutes. This was in truth *the first genuine talking motion picture*, the first of countless thousands which following years have produced—a genuine monument in the history of the cinema.

By 1925 we had thirty-four theaters "wired for sound," from Cleveland east and south to Florida. The 48th Street studio was producing several "shorts" per week: orchestra numbers, vaudeville acts, and monologues. Notable among the latter was old Chauncey Depew's "Recollections of Abraham Lincoln." Such orchestras as Ben Bernie's, George Olson's, and Paul Specht's supplied music. Outstandingly lovely was Madame Pavlova dancing to Saint-Saëns' "Swan." A series of dances by Doris Niles proved popular. De Wolfe Hopper in his immortal "Casey at the Bat," Raymond Hitchcock, Weber and Fields, George Jessel, Phil Baker with his accordion, talking back from the screen to his actual stooge in a stage box—all these were Phonofilm "hits."

No lovelier idyll can be imagined than the troupe of Sarova's young dancers swaying in attitudes of exquisite grace—to the music of Grieg's "Song to Spring"—over the sloping lawns and among the shrubberies and the Japanese bridges of Riverlure. They danced to the music of a single violin and cello, but the developed film was then projected on the studio screen while the full Rivoli orchestra replayed the music in perfect synchronization with the dancers. This pioneer "dubbed" picture (made

in June, 1924) was sold to all our theaters and was received with delighted approval.*

I felt immeasurably pleased and encouraged by such results. These were unquestionably the finest recordings we had ever made. I had already proven that we could record, well-nigh perfectly, fine orchestral numbers, far better than any phonograph of that day after all the years and all the millions spent on its development. Truly, my life's works had brought me into contact with great things and wonderful!

An enormous amount of publicity, most of it highly laudatory, now began to appear in newspapers all over the country, especially in cities where theaters were Phonofilm-equipped. It seems incredible that the stupid skepticism or marked hostility of film producers and theater magnates should not have softened forthwith. But so acid-proof was the enamel lining of their crania that nothing of the sort transpired until 1926. Yet there is no question that those three pioneering years of Phonofilm were the softening agent which induced the 1926 rash of imitation and emulation.

The outstandingly beautiful and descriptive musical score of the "Covered Wagon" by Dr. Riesefeld was largely responsible for the record-breaking Broadway success of that silent classic. I persuaded him to project this film on our studio screen while his Rivoli Theater orchestra played the score. This was recorded on the first sound-only camera and mechanically coupled to the projector so that the recorded sound film synchronized perfectly with the picture themes. We then borrowed a duped picture negative and printed the music and picture together. Thereafter

* Patent No. 1,716,033, of May, 1924, covers broadly this now universal process of dubbing of separately recorded picture and sound negatives, later printed on the same positive film.

It was in the spring of 1921, that my difficulties in properly developing a sadly underexposed sound record and overexposed picture on the same film suggested the use of two separate, synchronized negatives, one for the picture, one for the sound, each given its proper development, and each printed successively on a common positive.

for several months the "Supper Show," which until then had been silent, played the Riesenfeld score in perfect synchronism with the picture. This then marked another historically important "World's First"—in 1924.

This was indeed an epoch-marking achievement in the field of motion-picture entertainment, one undoubtedly destined to have a profound influence upon the popularity of the cinema.

The following year when the German film "Siegfried" showed in the Century Theater, Riesenfeld adapted Wagner's immortal "Ring" music to that version. On that occasion we had synchronized our new sound camera, located backstage, to the theater projector and were recording the orchestra beautifully when the Maestro, sensing the microphone in the footlights, called the first musicians' antirecording strike in history. And this without benefit of J. Caesar Petrillo! Their holdup was brief. We agreed to pay tribute, and registered as lovely a recording of the "Rhine Journey" and companion pieces as I have ever heard, one which was demonstrated to all lovers of good music who came to view the "Siegfried" film in our studio.

In the spring of 1925 I determined to film sound on Technicolor, this notwithstanding Dr. Kalmus' typically tough bargaining. The entire show of Baliëff's "Chauve Souris" was chosen for this daring novelty. At the close of their New York run the entire cast and props moved to the studio for a two weeks' siege. Technicolor's camera was outrageously noisy. We built a gigantic airtight "icebox" for its housing, in which their cameraman nigh perished rapidly. This camera was driven by a selsyn motor synchronized to that of our remote, sound-recording camera. The reproduction of Baliëff's music as played from our sound negative was superb, but Technicolor's printing and dyeing processes in 1925 were too faulty to give acceptable sound on either the red or green margin, to enable theater showing, save for a silent view of those pretty acts.



The recording of sound-on-film became a reality when de Forest developed the Audion amplifier into the "glow tube" (1920-21). The use of the amplifier tube remains an indispensable part of talking pictures to this day.

The filming of important news happenings was still a sensational novelty when the De Forest Phonofilm of Lindbergh showed at the Capitol Theater (1927).





Riverlure — the de Forest estate overlooking the Hudson. Into its creation the owner put "all the love of beauty, all the romantic idealism, all the appreciation of grandeur of scenery, and the inarticulate yearning for security of which his heart and soul were capable."

One of the inventor's dreams which came true at Riverlure was the filming of a ballet troupe dancing on the lawn to the strains of Grieg's "Song to Spring." The showing of this sound picture proved popular with Phonofilm audiences.



However, at the last moment of Technicolor's stay, a lovely California dancer was secured and by strange good fortune the printed sound of the orchestra was as beautiful to hear as the dance was entrancing to see. Thus another "World's First"—a *Technicolor sound film* was distributed. That summer this film produced a sensation in the London Tivoli, which my old friend of Palo Alto days, C. F. Elwell, had equipped for Phonofilm.

By this time our patent situation appeared rather comprehensive. We had purchased for stock the two basic Elias Ries patents covering the use of a very narrow slit, both for recording and reproducing photographic sound-on-film. My Patent No. 1,446,247, filed in March, 1921, covered broadly the glow tube as a recording light source. In July, 1925, while in Switzerland, I was offered the U.S. rights to the Tri Ergon patents for fifteen per cent of the Phonofilm's stock. Subsequent developments showed that in rejecting this offer I made a great mistake. William Fox later purchased those rights for a very large sum, covering among other things the "free flywheel" wow-eliminator; and would thereby have put all sound-on-film in this country into his pocket had not his extortionate demands on the entire film industry induced the Supreme Court to declare that essential device nonpatentable.

Another patent issued during this Phonofilm epoch, No. 1,554,561 (filed in 1919), described a phonograph pickup employing either diode or triode, the elements of which were impelled directly by the reproducing stylus, a forgotten device which only recently has been put to use for the above purpose by a certain large manufacturer with rather inappropriate publicity.

My sound-film-printing patent, arbitrarily arranging the sound track with reference to its corresponding picture frame, was No. 1,695,415, filed May 17, 1924; that covering the process of dubbing sound to fit a previously made projected picture was No.

1,716,033, filed June 7, 1924. Basic in sound-on-film history, was my Re-issue Patent No. 18,108, originally filed in 1924. Therein is disclosed the pioneer "noiseless recording" invention, effected by automatically blackening in the printer the positive sound record during the intervals of no sound recording. Another pioneering patent, No. 1,843,972, covers multiple sound tracks on the same film. No. 1,769,907, of 1926, discloses binaural recording and reproducing, using two spatially separated microphones and loud-speakers, a method only now being advocated for greatly improved realism in the cinema.

A highly original invention of this epoch was the diffractive microphone, without any moving parts whatever. Today's microphone experts, unaware of the principle involved, should find Patent No. 1,726,289 interesting. Also interesting in these days of frequency modulation is Patent No. 1,466,701, filed in 1919. This discloses a condenser of instantaneously variable capacity having an ionizable gas dielectric, the condenser's capacity being altered by a beam of ultraviolet light controlled by audio signals, a beautiful method of directly modulating—by frequency shift—high-frequency currents, without complicated frequency-multiplication methods.

During the "Phonofilm Era," from 1920 to 1930, were filed and issued 79 patents, all dealing with sound-on-film or associated topics, such as microphones, loud-speakers, sound-recording cameras, and the like.

By 1925 my investment in talking pictures had totaled over \$200,000. Outside financing was becoming essential. Again Wall Street was combed, with the usual negative results where an epoch-making invention was involved. The firm of Hayden Stone alone seemed interested. Negotiations proceeded favorably until they informed me that upon obtaining stock control they intended summary dismissal of my entire staff. I could

see no sense in this, only gravest injustice to all the men who had taken a long chance with me and had served loyally for three years. Among these was such an outstanding, long-experienced motion-picture engineer as William Waddell, who had been with Edison's "Kinetoscope," was skilled in every phase of the business, and was favorably known everywhere in the profession. Also involved were Lou Reynolds and Louis Hoffman, trained and clever sound engineers. Stone's offer appeared merely a sellout, for a later coup. I wanted most of all to continue the fascinating development, now that Phonofilm had turned the corner and was at last a going concern.

So it was again to the public I had to turn for financing. Phonofilm stock met eager acceptance. Through a sales organization the treasury became rapidly replenished. Suddenly something happened.

Who can say what gigantic future competition instigated again the "Majesty of the Law"? This time the sovereign State of New York decided that "the public did not want talking pictures," neither should it invest money therein. As a "savior of the populace from fraud," one Keyes Winter, Deputy Attorney General, seized our books, decreed that all sale of stock should cease, questioned the validity of our fifty patents, and sought (unsuccessfully) to force the company into receivership. At his tyrannical insistence a total ignoramus was installed to manage our production.

This was a troublous period in my family affairs as well. Through boyhood and youth I had ever hoped to be some day blessed with a son, to perpetuate the family name, haply to carry on my work. After years of repeated disappointment, in May, 1926, that dream was realized. But for a brief moment only! "Little Brother," as his mother called Lee, Jr., lived but two days. Like a tiny meteor this baby flashed across our heaven—

then vanished, leaving only a fleeting memory, trailed with grief. The sky was blacker for the brightness gone.

Proudly I had planned to enter him in the Yale Class of '48 when I went back that June, to my Thirtieth Reunion, to receive the coveted D.Sc. from my Alma Mater. Grief-stricken amid the business reversals of that trying period, that spring brought profound spiritual depression, not lightened when my wife, to escape her grief, sailed with our two daughters* for Switzerland.

This tragedy, clearly ascribable to the recurrent curse which had dismayed and distraught me through all the past years, caused the final, sad separation. "Broken was the golden bowl," past all remedy or repair.

An ultimate divorce resulted. "Riverlure—where dreams come true," lost its sweet enchantment. No more over the lordly Hudson the bewitching spell of its azure afternoons. Too lonely, I fled from the haunting echoes of the childish voices through my cherished home. Housed downtown in the Hotel Shelton I joined the coterie of wit and charm of Arthur Garfield Hayes's "Friday Nights," became in spirit one of Greenwich Village, met minds like philosophers Max Eastman, Durant, and Channing Pollock, poetess Kathleen Millay, sister of Edna St. Vincent, gifted writer Eloise Popini, Miriam Wolf, Georgette Carneal, my later biographer, and many another light from whom the isolation of life at Riverlure had kept me separated during all my latter New York years.

After 1925 I quit using the costly Case thalafide light cells, which had proved unsatisfactory, being virtually deaf to high frequencies. From another source I was able now to procure fairly reliable potassium hydride photoelectric cells of practical shape and dimensions. About the same time De Forest Radio Com-

* Marilyn, our second daughter (my third), had been born December 1, 1924.

pany began to manufacture low-voltage photion glow tubes, and so I also quit using the Sponable-Case Aeo light.

But just when things began picking up again for Phonofilm, I met with another rebuff. For the past two years, I had been using amplifiers and microphones loaned to me by E. B. Craft, president of Western Electric Company. But the time had come when Western Electric, too, saw the possibility of profit in sound motion pictures and put its newly formed subsidiary, Electric Radio Products, Inc. (ERPI), to work. John Otterson, the new ERPI president, abruptly changed his formerly neighborly attitude and refused the longer loan of Western Electric amplifiers and microphones. "What's the low-down on this holdup?" I asked Otterson. His reply was a hearty, rather cynical laugh.

When Sam Warner was introduced in 1926 to Western Electric's sound-on-disk synchronized to a motion-picture projector, his enthusiasm infected brother Harry. Warner Brothers' tottering Vitagraph Company put up a last (borrowed) million to produce Barrymore's "Don Juan" with music and elaborate olio.

The success of "Don Juan" at the Warner Theatre on Broadway was spectacular. Block-long queues lined up at 11 A.M. for the matinee performances. The recorded musical accompaniment to that silent picture, and especially the vaudeville acts of pictured voice and music following the picture, plus their flamboyant advertising, rapidly convinced the reluctant theater owners that what I had been demonstrating, and preaching, for the past three years was their destiny. They must rush for the band wagon or their houses would soon be dark, their box offices deserted.

And so Western Electric, with synchronized disk, and RKO-RCA-General Electric with sound-on-film were swamped with orders for sound equipment, at \$25,000 per theater. The stupid

scepticism of the past suddenly vanished. The dam of opposition went out before the overwhelming surge of public approval.

Phonofilm's success from 1923 to 1926 had determined Western Electric and General Electric that the time was at hand to go into talking pictures. Unprovable, but beyond question that brave pioneering had produced unheralded activity within sealed laboratories. Yet even then ERPI had no easy task. Despite vigorous efforts by Agent Walter Rich no producer could be interested until "Don Juan" broke the ice.

William Fox had been aboard the *Leviathan* when I returned with my equipment from Berlin in 1922. I sent him my card, but it went unnoticed. In 1925 Phonofilm was installed in many of the Fox southern theaters. When he, returning from another European trip, heard of it, he peremptorily ordered the equipment thrown out. He "would have no talking pictures in *his* theaters." Just after Vitaphone staggered Broadway and blasted out some producers' bridgework, Fox's business agent, Cortland Smith, approached by a Case salesman, ordered a Case sound projector and Western Electric amplifier installed surreptitiously in the Tenth Street Fox Studio while Bill was out of town. Fox returned, saw, listened, demanded: "What is that? Buy it!" Smith knew nothing of the true origin of what Case had sold him. Certain it is that neither Case nor Sponable enlightened Fox as to the origin of the "Case System," so-called. A patent suit filed by Sam Darby promptly enlightened him. Suddenly agitated, Smith rushed to my studio, offered and paid \$100,000 for a 90-day option to buy my control of Phonofilm for something over \$2,000,000.

Fox became suddenly and sheepishly friendly. He said that he immediately intended equipping all Fox theaters with what he and Case had already dubbed "Movietone." But General Electric, to whom they had gone for equipment, had their own theater plans and so desired no Fox competition. Where then

could he get his equipment? he asked me. At that time ERPI agent Walter Rich and I were very friendly. He had sought to interest Harry Warner also in sound-on-film. "Oh, no," quoth Harry, "the synchronized disk is the only solution." (He required six years and three huge warehouses filled with phonoplayers to realize how wrong he was.)

I told Rich of the Fox option and his desire to tie up with a competent manufacturer licensed under the amplifier patents. I introduced Smith to Rich. It was decided that Rich should then introduce Smith to John Otterson who, notwithstanding a prior contract with Warner, might be induced to manufacture for the Fox theaters. Fox was not to be present, as his personality might very readily spoil the deal. Confident that, on account of the patent suit, Fox would take up his option, I felt that I had brought to ERPI a multimillion-dollar contract.

Fox did attend that conference. And he was told (by Otterson) that on account of the 1917 Western Electric-De Forest contract, Western was licensed under all my talking-picture patents; Fox thereupon concluded that he need not take up his option, quite overlooking the fact that we had also sued him under the Ries patents, which covered the fine slit for recording and reproducing sound photographically on cine film. The 90 days expired; the option was not exercised. Fox sued me for obtaining \$100,000 under false representation. ERPI soon began manufacturing sound-on-film for Fox. That was my reward for bringing to John Otterson a customer anxious to pay him many millions in cash!



CHAPTER 42

Phonofilm Fadeout

*E*ARLY in 1927 I learned that for a monetary consideration paid to certain deserving Fascists, Benito Mussolini could be Phonofilmed. So taking my camera and faithful assistant, Gene Moehring, I hurried off to Rome.

The occasion was to be a Black Shirt review in a public square. At the prearranged spot, we set up the camera and amplifier, and awaited Il Duce's arrival. The troops marched in and assumed their places. Then with a great fanfare of trumpets, the All High himself swaggered in, his uniform impressively bedecked in gold lace. He stalked once around the square and departed without pausing even an instant before our camera.

We could only conclude that said monetary consideration had not been divided with the proper higher-ups (including perhaps the All High himself) to earn us the opportunity for which we had traveled so far. Our laughter deserved instant arrest, but we were allowed to nurse our chagrin in peace.

But my days in Rome were not all wasted. I spent many entranced hours in the old churches and in the galleries of the Vatican, or beside the singing waters of the Villa d'Este, feeding my soul with the pabulum of "buried centuries of pomp and power."

In the Borghese Gardens: "For hours I wandered happy, though alone, through groves where fountains spray their melodies for the songs of poets. On some gray seat of ancient stone, beneath titanic sycamores, I loved to bask through sunlit hours of a Roman afternoon, and glimpse the 'Golden Age' of which Virgil sang; with *dolce far niente* in my veins, and languor in my heart, and dusk of dreams."

Upon returning to Manhattan I found Phonofilm affairs so miserably messed up that radical reorganization and financing were imperative. President Lowell Brown's efforts to raise finances proved abortive.

Amid all this bedevilment and confusion, production went steadily ahead—at my expense. Lindbergh had flown the Atlantic in May, 1927. A huge national welcome to Washington, D.C., was planned. Our sound truck was on hand near the grandstand where Coolidge was officially to welcome the intrepid flyer. Our microphone was alongside those of three broadcast chains and also "Movietone's." This was Fox's first news pickup (three years after Phonofilm's first).

Our Lindbergh film was perfect. Rushed to New York that afternoon the print was shown at Colonel Bowes's Capitol Theater in competition with the Sponable-Fox version at Roxy's near by. There was little to choose from, as both had been made with identical apparatus and methods. Names only differed. Despite "winter and high water," competition and imitation, I saw to it that the "show must go on," and it scored a complete triumph. One New York newspaper had the following comment to make:

The enthusiastic applause and the unprecedented sensation caused by the combination of picture and the clear enunciation of President Coolidge, the applause which greeted the intrepid aviator's first appearance, the tumultuous approval of Mrs. Lindbergh, the stirring strains of the "Star-Spangled Banner," which instantly brings the huge audiences of the Capitol to their feet at every performance, amply attest that this first Phonofilm of a big public event was a complete success and marks a new era in motion-picture entertainment.

It is impossible for one who has not seen and heard the Phonofilm at the Capitol to realize just how vital a medium this new invention is for putting before the public the actual, almost living, personality of our great figures.

I had journeyed to Palo Alto for what proved to be a farewell visit with my mother, whose health was slowly failing as she neared the mark of fourscore years. "What comfort then was the thought that each week for 36 years since I left the Southern home I had written to my mother. For my letters, and those of Charles and Mary, coming so regularly into her life had brought dependable sunshine and a serene joy which none but a mother so filially remembered can know." She passed away a few months later, her three children by her side.

The sweetness of her character, the devotional peace which crowned her later years, is to me perfectly typified by the "Largo" of Dvorak's *Symphony from the New World*. I never hear the softly harmonious loveliness of that sublime music without picturing in memory the sainted presence of my mother, her loving tenderness. Never was a character so exquisitely portrayed as here. The brush of the artist falls in futility before the spell of such perfection of sound portraiture. When comes the hour of my funeral I ask only that over the wide expanses of the ether may be broadcast, as Radio's service of farewell, the wild grandeurs and the soothing solace of that, my best-loved, symphony.

About this time I enjoyed my last visit with Edison. It took place at the Atlantic City Convention of the National Electric

Light Association. The first Phonofilm "industrial" was there exhibited for the Serval Refrigerator and it quickly became the sensation of the exposition. I went down to be present when Edison came by and was photographed with him and Mrs. Edison. Then I showed him the Phonofilm equipment, reminding him of his seventeen-year-old verdict that "the public did not want talking pictures." More deaf than ever, the Phonofilm was only a silent motion picture to him!

That night at the Convention, after a glowing introduction by Sam Insull and a rousing ovation, the Old Man stood up and delivered the shortest speech on record—"Good Night!"

In the summer of 1927 M. A. Schlesinger and his millionaire brother "I.W." offered to reorganize the moribund enterprise and put unlimited capital into it. I had recently poured most of the Fox option money into the treasury, but it had been like water poured into a rathole. Phonofilm required at least a million to carry on against Warner, Fox, and RKO competition. "I. W."—who owned a large chain of theaters in South Africa—had the millions and was ready to go. "The sky's the limit," he remarked enthusiastically as he sailed for London, leaving Max to carry out his plans. But Maximilian proved a timid soul, except when driving an avaricious bargain. Then he was arrogance personified. "I. W." bought my British and South African patents, and while erecting forthwith a Phonofilm sound studio in London, began equipping his South African theaters, as well as certain theaters in England.

But conservative brother Max, once left alone, decided to wait a year to be very sure that "the public wanted talking pictures." From 1927 to 1928 he watchfully waited while his three competitors were signing up all the large houses at \$15,000 to \$25,000 each. Finally, only the third-rate \$1,500 installations remained for General Talking Pictures, Phonofilm's unhappy successor. Some six hundred of these small fry were finally

equipped when the big depression of the 1930's blew most of their paper into Schlesinger's face.

Max was no more sagacious, nor fortunate, in his Hollywood plans. He allowed the patent suit I had filed against Fox in 1926 to fizzle, unwilling to pay attorney's fees. But he did file suit under the same Ries patents against Warner-owned Stanley Company's New Jersey theaters. The trial in Judge Morris' Federal District Court at Wilmington resulted in a decree sustaining the validity of the Ries fine-slit patents both for recording and reproducing photographic sound. Western Electric, defending Stanley, appealed. The Federal Court of Appeals in Philadelphia sustained the lower Court, holding the recording patent valid but not infringed by Stanley theaters. Western had urged as one defense that my 1917 contract gave them license even under my not yet conceived inventions in the unthought-of field of talking pictures. Judge Morris held that the contract did not so intend, thereby fully upholding my claims as involved in the Fox option. Immediately Fox dropped his suit to recover his \$100,000. But this did not terminate the legalities of that situation, as will appear later.

The Philadelphia decision was potentially worth a few millions to General Talking Pictures. Until 1932, Fox Movietone was infringing the Ries fine-slit patent on every frame of sound film recorded. It was a cinch that the California Federal Court would follow the eastern higher Court. But did M. A. Schlesinger proceed to fight for and collect damages? Valiantly he proceeded to Hollywood, rented the Joe Schenk penthouse on the Roosevelt Hotel, had Walt Disney and all the small-fry producers lined up hat in hand, and called in the Los Angeles Press. Breathing fire and brimstone he served notice that he and none other was going to control sound-on-film productions in Hollywood, or nearly so. But over a hot Labor Day, Joe Schenk and Louis B. Mayer took Max out for a yacht cruise. It was a "one-

way ride" so far as the "Schlesinger Productions" were concerned. Joe and L. B., so I was told, proceeded to show M. A. that if he started his patent suits in California, I. W. would get no more Hollywood films for his South African theater chain! So Maximilian faded out in the reddest-faced sunburn I had ever seen and took the first Super Chief for New York.

In 1929 the Federal District Court of Delaware upheld the contention of the Tri-Ergon Corporation that the De Forest patent, owned by General Talking Pictures Corporation and De Forest Phonofilms, was invalid. The Circuit Court of Appeals in Philadelphia reversed the Delaware Court.

The Court declared that "although de Forest did not file his patent application until September, 1919, three months after the Germans filed theirs in Germany, the evidence in the case showed that the American inventor had his idea well under way in October, 1918." The evidence leading to this verdict was a long-forgotten sketch made on the transport *Carmania* and preserved in a copy of Alan Seeger's *Poems* with which I had entertained myself during my voyage to England. This sketch illustrated several circuits and descriptions of proposed methods for photographically recording sound on film. Darby had witnessed and dated these sketches. That paper, thrust into the book of Seeger's poems, lay completely forgotten for years. Its existence proved decisive evidence in establishing a decisive priority date of conception of my invention for recording sound by means of the glow-light tube.

In 1933 after Judge Morris had held that the 1917 Western Electric contract did not contemplate licensing that organization under inventions later to be conceived in the talking-picture field, I approached my former Phonofilm attorney, Arthur Garfield Hays. "Why didn't I now have valid claim for heavy damages against ERPI and John Otterson, its president, for having per-

sueded Fox to forfeit his hundred-thousand-dollar option rather than buy my Phonofilm stock for better than \$2,000,000?" Hays thought I had. Also, Sam Untermyer. They agreed to prosecute for me on a 50-50 contingency basis. Untermyer, if anybody, knew Bill Fox like a book. For shortly before, when the over-inflated balloon of the Fox Empire had blown up, he had saved Bill a "few lousy millions."

Untermyer knew that if Fox would testify in court that he had been disposed to take up my option until Otterson persuaded him to renig, our case would be in the bag. If he would not so testify or if he should suffer a sudden stroke of aphasia, our case had not a Chinaman's chance. Everyone knew William Fox to be 100 per cent unpredictable, undependable. The night before the trial he might solemnly promise Untermyer to so testify, while next morning on the stand he might say he never discussed the option with Otterson. Obviously a settlement out of court was indicated. ERPI's attorneys were faced with a suit for \$2,000,000 plus. They offered the traditional \$10,000. After many conferences with them and Fox, Untermyer persuaded them to raise their ante to \$60,000; and the last and final litigation involving the vanished Phonofilm Empire was written off the calendar. William Waddell had a contractual interest in any Fox settlement, and he was paid off. Thus ended the adventure in talking pictures—and ten years of a man's life.

Had Fox taken up his option, I intended with my proceeds to take De Forest Radio out of receivership in 1926 and regain control, being well convinced by comparing its history under my management with that under the Detroiters, that an inventor's business judgment wasn't necessarily too bad after all. That company under the wise management of Receiver Arthur Lord had at last won all its patent suits and had a well-equipped factory and tube plant in Jersey City all ready to go. But fate (alias Fox) decreed differently.

In the spring of 1928 Wylie Reynolds, of Jackson, Michigan, and W. R. Hearst became convinced of the future of De Forest Radio and asked the Jersey Court for permission to buy it from receivership. Reynolds acquired the prize, buying the treasury stock and control at fifty cents per share. Immediately history repeated itself. In the runaway stock market of that year, Reynolds' brokers required only a few months to put the De Forest stock up to \$8.00, to \$15.00, and finally to \$34.00 per share.

With De Forest Radio thus refinanced, Reynolds put in charge as president, a James W. Garside, of Kalamazoo, a man who had already distinguished himself in several reorganizations of ill-managed concerns by bringing them from near bankruptcy to going and growing successes. Garside lost no time in doing this for De Forest Radio. Within a year three types of Audion tubes, on which production he specialized, were in nationwide demand at prices well above those asked by RCA and others for similar types. Atwater Kent, then at the crest of his radio wave, purchased those high-priced tubes in prodigious quantities.

Garside induced the young engineer, Allen B. Du Mont, to forsake Westinghouse Electric and become the company's chief engineer. Allen won his spurs in short order, designing new automatic tube machinery, and equipping the fine large Passaic plant which Garside and Reynolds then leased. Nationwide billboard advertising and the highest class of radio talent—Mary Garden, Anna Case, Richard Bonelli, Rudolf Ganz, Charles Hackett, the Russian Symphonic Choir (with a minimum of commercial program content)—built up sales to more than \$8,000,000 in 1929. Garside's ideals for highest-class cultural radio programs coincided perfectly with those I had so long cherished. Yet, costly as these were, he found them lucrative. (Would to God more such radio impresarios existed today!) Soon the Navy signed a million-dollar contract for tube transmitters. De Forest Radio had finally entered into its own.

To add to the endless vicissitudes of patent litigation and wolfish competition, the company found its plant infested with spies engaged in suborning its best employees and stealing the secrets which made De Forest's tubes the best in the market. These loathsome practices stopped when the company won its suit against RCA for violation of the Clayton Act. That corporation, in enforcing its receiving-circuit license agreements with a large number of radio manufacturers, compelled these and their distributors to use only RCA tubes in their radio sets. This restraint of trade resulted in serious losses to other vacuum-tube manufacturers. After long litigation De Forest Company in 1929 sued RCA at Wilmington for triple damages and collected some \$3,000,000 from the now chastened defendant.

This, plus the Navy contract for a million dollars and a contract to manufacture the tubes for all Atwater Kent radios, should have brought the De Forest Company through the depression in excellent shape. But when Garside resigned because Reynolds blue-penciled his advertising budget, sales fell off disastrously, and the subsequent management, plus Reynolds' insistence on an immediate payment of his notes, brought the now historic company into its final receivership, ending in sale to RCA in 1933. During the stock boom of 1928-29, including a wicked, utterly indefensible, purchase by De Forest Company of "Jenkins Television," Reynolds had cleaned up (if one may use that fine word for such foul business) some eight million dollars. And the stockholders, of course, were cleaned out. (Subsequent blue-sky laws have made like skullduggeries less easy.)

Thus RCA finally acquired the patents and all the assets, except the personal name, "Lee de Forest." Du Mont retired to his Montclair cellar, shortly to emerge master of the oscilloscope, and later to become America's foremost maker of Television—verily a genius in the field he carved for himself.

So at last the long circuit was closed and completed—American De Forest Wireless into United Wireless, which eventually

formed five-sixths of the tangible assets of RCA (American Marconi, one-sixth); De Forest Radio Telephone & Telegraph into De Forest Radio and finally into RCA. From the 1907 issuance of the Audion amplifier patent to 1941, when my feed-back oscillator patents expired, the entire radio art and all related electronic appurtenances thereto had been dominated by those basic patents. These had earned nearly a billion dollars for their licensees. I could rest satisfied before that headstone, even though I personally had received less than one-tenth of one per cent of those earnings. There were other forms of remuneration: profound mental satisfaction was among them.

With the termination of my decade lost in launching talking pictures came also the wreckage of a short-lived romance which had flashed from New York to the Gothic cathedrals of the storied Loire, only to expire gaspingly, tragically, as such ill-starred affairs usually terminate. *Hélas pour Henriette!*

EPHEMERIS

*Into my life you came so suddenly,
A breeze of morning to a desert land,
A flower falling from a barren tree
A wild bird quickly nestling in my hand—
So came you unto me!*

*A burst of music on the silent night,
A rift of sunlight through a somber cloud,
The glad cry of a swallow's flight,
A smile of welcome in a city's crowd—
So shone your smile to me!*

Sadly now I realized that New York was no more my ambition, my love, my home. Again, as in 1910, California called me. In Los Angeles I should again find sanctuary.

For even Riverlure, with its wraith of shattered dreams, became a plague spot to flee. And in California I met the realest, truest, most genuine joy of my storm-tossed life. Peaceful harbor at last!



CHAPTER 43

Marie Mosquini

I must forget—have steadfastly forgotten—the old joys and sorrows—so that I may still enjoy the hours of Today and Tomorrow.

ALMOST upon my arrival from Toronto, where as 1930 president of the Institute of Radio Engineers I had addressed the Canadian Convention, lovely Bebe Daniels invited me to her home. Through her mother Bebe was descended from David Curtis de Forest, and so was a distant cousin. The occasion was a swim party at her Santa Monica beach house. Her Uncle Jack and I went surf swimming. There were other guests in the waves. I spoke to one, a charming girl far out from shore. Later at the house I recognized her, one of Bebe's guests. A brief acquaintance ripened swiftly into love. Within six weeks Marie Mosquini and I were married in Lower California. My dear friend, John Stone Stone, was best man, by proxy. He remained in San Diego the while but gave me his warmest blessing.

That marriage was blessed. For since that October day in 1930 Marie and I have proved to all acquaintances and to the world that a sudden marriage *can* last for life—and lifelong happiness. Hence I earnestly urge the motto, hackneyed but proven good: "If at first, etc. . . . try, try again!"

Starting at an early age in Hal Roach's Culver City studio, Marie Mosquini had been a most vivacious actress of the silent pictures, playing along with Harold Lloyd and Bebe Daniels in those rollicking Roach comedies—in days when outdoor sunshine was the main illuminant, when pantomime and quickee cleverness were all essential, when one week was the allotted time per production (sometimes two), when plots were developed before the cranking camera. They were the good old days when cues were shouted and actors talked *ad lib*—before all the joy and the spontaneity had been stripped and terrorized from the motion-picture lot.

Then Will Rogers took a fancy to Marie. She became his leading lady in parodies on the "Covered Wagon," "Blood and Sand," and twenty-six other comedies. Little did I think, when riding out to the 1929 Edison Celebration at Dearborn in the same car with Will Rogers, that within a year I should be married to his former leading lady. How roll the dice from the Cup of Fate!

The last and best screen appearances of Marie Mosquini were as co-star with Janet Gaynor in "Two Girls Wanted" and as Madame Gobin in "Seventh Heaven." In later voice tryouts at Warners' she qualified completely, but before another five-year contract could be signed for talking pictures she signed for life with the creator of talking pictures, and has talked sweetly and pertly ever since.

Many and long have been the auto outings made together through western wonderlands—Yosemite, Death Valley, Redwood Empire, and to Crater Lake and Shasta. Together in such

wanderings, car piled high with camping paraphernalia, we have opened bales of richest happiness, in blest oases where our caravan has rested. Among other talents Mi Mijita, as I lovingly named her, proved a wonderful camp cook, already well trained by like jaunts with her devoted mother. Marie's sunny nature, usually brimming over with jollity, has been a perpetual source of happiness to us both. So that, despite some seasons of grievous tribulation and darkened fortune, our life together has been one of ever-recurrent honeymoon. For four seasons we occupied Ted Cook's tiny cabin in the chasm of Whitney Portal where after set of sun a small red flame momentarily rests on the crag of Candlelight Mountain, 4,000 feet above. We nested close under the great gray cliff which towers a sheer 2,000 feet into the air, a Titan's wall which the full moon emblazons with such dazzling white that one may read by it at midnight. And on each such holiday the pink of dawn translated into heavenly vision the giant fang of Mount Whitney's peak, soaring 6,000 feet above our green-boughed nest, an irresistible challenge to one more ascent.

In Borrego Valley we dug our oven in the earth. By streams like Devil's Canyon I learned to build camp stoves out of hikers' tins, smashed flat with rocks, self-supported as oven top for skillet and coffeepot. In Death Valley the night gale once buried us smothering in the wreck of our tent and scattered our outfit over twenty acres of hot sand. Near Idyllwild we drove our car into forbidden forest and kept silent all night by a rushing stream lest the Ranger find our illicit camp. At Summit Lake near Mount Lassen we tented in the rain under a leaky canvas whose trickle persistently found the neck of Marie's sleeping bag. In attempting to correct this condition at midnight, I dumped a tubful upon her head.

Our midwinter treks were ever as thrilling as those of summer. Once in February, quite breathless, we reached Shangri-Putnam

at 9,000 feet elevation, far above Whitney Portal, having made the arduous ascent on snowshoes. Then on we went to Happy Jack's, near McGee Creek, to enjoy the skiing on the deep slope. There my poor wife lay for hours like a wounded bird on the snow with a twice-broken leg, awaiting the agonizing twenty-eight-mile truck ride to Bishop Hospital. An earlier winter at Crestview—where ours were the first skis the natives ever saw—was followed there by later ones when an up-ski was buzzing seven hours a day; where I climbed Glass Mountain on “webs,” routing near the summit my first Siberian hare. One winter I broke my foot, the next a rib. But still we yearned for the lure of the snow-clad mountains, calling us each winter to toboggan pack, snowshoes, and skis: to “lift up mine eyes unto the hills, from whence cometh my”—health.

Always together, inseparable companions, our married life has left nothing to be desired—save only that no child has blessed our union. Fortunate beyond Fortune is the husband who has so rare a wife, so lovingly solicitous and so lovely, as I have found in my Marie Mosquini. In this regard again am I rich indeed.

TO MI MIJITA

*You ask of me a poem,
Of me who now no poet am;
Strive as I may no phrases come
Suited to spell the peace and calm
Which your dear Vision brings to mine;
Its loveliness defies my pen,
Your face so fair, your voice so sweet,
Your eyes as full of love as when
At first you kissed me on a street
In happy sun-kissed Avalon.
'Tis poem enough to know that now, as then,
You are my poem, and my song.*



CHAPTER 44

Mountain Climbing

*But breathe the air of mountains
And their unapproachable summits
Will lift thee to the level of themselves.*

—LONGFELLOW,
“Masque of Pandora”

TO realize the beauty and the inspiration of my California surroundings, let me quote this excerpt from my diary:

To thrill at the view of these mist-veiled mountains, range beyond range, reaching to the uttermost horizon, deep green-clad and road-slashed canyons at our feet, colossal billows of terrestrial ocean, to read from above a thrilling chapter of old Earth's autobiography, written in titanic symbols, and illumined in millenia!

Each Sunday morning to hike the hill trails of Hollywood, or drive alone up Angeles Crest Highway where, stripped of shirt, I would explore unknown trails, or scorning such, scale a mile-long, thirty-degree “firebreak,” or coveting some alluring summit undergo on knees and belly a painful “manzanita mas-

sage," emerging well-tattooed, sans even an undershirt. A long stocking filled with small oranges and tied about my belt served both as knapsack and canteen. I loved long and trying hikes in all the surrounding canyons and cliffsides, hardening muscles and sweating off surplus flesh. I aspired to scale Mount Wilson from Arroyo Seco by firebreaks, no trail, arriving at the end ten-thirty at night more dead than alive, to quiet my devoted wife who, long waiting, had routed out the forest rangers to find her lost, probably dead, husband.

Soon I thought nothing of stiff hikes ten, twenty, even twenty-four miles long, all-day efforts over mountain roads and precipitous trails. Invariably a long stout hiking stick of lightest yucca was my constant companion, invaluable for the steep slopes up and down, and in vaulting from rock to boulder. I tackled Mount Baldy from Currie's Camp via Telegraph Mountain, and often later, from Saddle Road; Mount Islip from Silver Lake; Mount Santiago, or Saddle Mountain; Strawberry Peak, Mount Josephine, via cliff and manzanita jungle, scorning the trail; down Big Tujunga Canyon where I slid nude over a twelve-foot waterfall rather than retrace my steps seven miles to my car. Invariably alone, for I knew no one who could or would follow such trails, it's a hundred wonders that I broke never a bone nor sprained an ankle.

With a group starting from Pasadena at 3:00 A.M. for Forest Home and San Gorgonio's 11,485-foot summit, I was second man up. Half of the troop never arrived. The next week I topped San Jacinto across the Gorgonio Pass, later to repeat this again and again. Having done Mammoth Mountain, Mount Dunderberg, San Joaquin Peak, Black Mountain, Glass Mountain near Crestview (on snowshoes of a February), and almost every peak of the Sierra Madres, I felt fit for Mount Whitney's 14,501 feet, highest in the United States. Marie and I made a camping trip of it as we had every summer, for she also loves that life. Start-

ing belatedly at 8:00 A.M. from our 8,000-foot camp, with no pause at 10,000-foot Outpost, save to greet there the mountain wonder-woman, Margaret Cook, I reached the summit in six hours, back to Outpost in two more, where Marie met me and we tented the night. From Whitney's summit the clear sky revealed a soul-thrilling scan of 60,000 square miles!

The next year, and again the following, starting from Outpost, I scaled the long, tedious, breath-taking trail to Whitney's top. Nothing at all to Alpiners, but it was surprising to see how many who attempted the Whitney trail turned back. When I first ascended, in 1937, I proposed to repeat the stunt each birthday for ten years, but after my third ascent I yearned for new conquests. We camped in 1939 at Panther Meadows, some 6,000 feet up toward Mount Shasta's 14,161-foot glacial summit. Knowing naught of any trail, I started out across country direct for what seemed the easiest slope. After reaching what I later learned was the back, or eastern face, of Thumb Rock, I found myself on a glacier's crest with bottomless crevasses uncomfortably near. Rounding that pinnacle with great care I saw the path forward leading across an icy slope steep and slippery in the sunlight. One step convinced me that the next would send me scooting down a 1,000-foot chute at express speed without local stops. I refrained from that next stride. Crestfallen, I was able to reach camp before darkness engulfed the mountain.

The following year I induced my old Palo Alto chum, Van Etten, San Francisco Engineer for Pacific Telephone and Telegraph, who also loved mountaineering, to join my second attempt on Shasta. At 10,000 feet fiercely sudden snow flurries made the going tough. I escaped the worst by crouching in slight caverns in the rock side of the great flue up which we had struggled. Finally, I reached the foot of the plateau over which, I knew, an easy trail led three miles to the summit. The storm became too fierce for three younger companions who, after

warning me, started back. I continued alone, seeking a way to scale that plateau's edge. Just as I discerned the route over a glacier's upper edge the blizzard broke. Visibility was less than fifteen feet. Reluctantly I realized that I would probably become confused, lost, perish; for my altimeter had frozen stiff at 11,000 feet. Once again I had to swallow defeat. Once again old Shasta had licked me.

On the way back I met Van Etten, who had not kept up with us, but who was still doggedly fighting upward. Van and I vowed we'd be back next year to conquer Shasta, but as yet we never have.

Next summer Marie and I packed up to Cottonwood Lakes, home of our friends, the Towers, again in our High Sierras. I then induced Margaret Cook to accompany me up Mount Langley, another 14,000-foot giant.

A week later, again starting early from Outpost where I had spent the night in a sleeping bag, I hiked over the now badly broken remnants of the Whitney Trail once more to the summit. I reached it less wearied than ever before; but the descent, after clearing Whitney Pass, of the quarter-mile steep slope, post-holed every three feet with deep snow craters, seemed endlessly tiring. By contrast, the two miles of climbing up, over, and down tanton granite blocks seemed repast and refreshment. Night was already falling when I reached Whitney Portal, the welcoming arms of my devoted wife, and the grand dinner which she had prepared for me.

On my seventieth birthday—August 26, 1943—I climbed old Mount Whitney for my fifth—and last—time. Again we spent three happy weeks in the little house at the Portal. After spending a night at Outpost under such blazing stars as were never seen elsewhere, and enjoying my predawn campfire breakfast, I set out. By error I took a false trail which led me to the crest of a 3,000-foot precipice. This resulted in my having to climb

the mountain almost twice. By the time I reached the top, I could rest but ten minutes, for the sun was already too low for lingering. Two thousand feet below I could see Margaret (Cook) and Iceberg Lakes. I vowed to visit them the following days. Then I made my way "home" over a blacked-out trail, too weary to eat of the birthday cake Marie had so lovingly baked in the old wood stove. During the next days the two terrific hikes required to reach Margaret and Iceberg Lakes proved even more strenuous than scaling the mountain itself. Yet on Labor Day I must needs clamber 1,100 feet up a rock crevasse to hang the nation's flag to the lowest bough of an unbelievably huge lodgepole pine growing in a granite cirque, which to the eye seemed utterly inaccessible save by helicopter or by a 2,000-foot rope from the overhanging precipice above. Remnants of that flag may still be there, too small to be visible from the Portal. Let him redeem them who can find my secret trail!

Those over-strenuous climbs ended my high mountain work. Undoubtedly I had thereby strained an oversized heart. Next summer Outpost's 10,000 feet satisfied me, and soon I shall be content with leisurely hikes at half that altitude. Perhaps it is fortunate that I did not remove to California at a much younger age, for as a youth I should most assuredly have attempted rock climbing. Those ascents by the Sierra Club up the east face of Whitney always fascinated me, terribly; and, reckless always, I might very likely not now be writing of the saner climbs which I have so greatly enjoyed.

Still I long to stride out at fast pace over and up those steep slopes; but wise old men and doctors—and now my own heart—warn me to go slow in climbing. Much as I love it, I love life more and longer; and so I must rein in my old-time desire to hike and climb every slope I see. It is really a cross to bear, for I yearn to ascend. My solace is that I have conquered many a noble peak; my regret, that I did not settle earlier in California,

so that I could have climbed them all while I still had my youthful heart.

I can never forget my first of countless later climbs of Mount Waterman before the Angeles Crest Highway was cut through. Reaching its summit easily, I plunged down into Devils Canyon, and had scaled both of the Twin Peaks by three o'clock. But the remainder of the afternoon and most of the ensuing night I spent following the canyon and scaling three trackless ridges, mostly on my stomach under densest chaparral, in drinkless struggle to reach the highway at Chaleo which at times I could dimly glimpse beneath the blazing moon.

Shortly before dawn I found Marie, nearly hysterical, in the Ranger's cabin. Next day I learned that one hundred yards beyond where I left the stream to go up the bank the Devils Canyon trail debouched. Ignorance is always costly, sometimes fatal. A thousand wonders I had not wriggled upon a rattlesnake on those wild slopes!

When I first began to hike the Hollywood Hills, clear trails crowned every ridge and slope. Of late years these are mostly invisible, weed-grown, completely neglected. Sadly enough the old hiking spirit has waned, save with the Boy Scouts, future saviors of America. The lazy automobile has done away with the manly hike and the legs of iron. Thus has tomorrow's youth lost his finest exhilaration—the upbuilding of body, the uplifting of spirit. Lost today, to far too many, are those inspiring days spent in mountain fastness or in some noble forest, where “one reads this sign on every tree: tread these wood-trails reverently.” I can never adequately thank my father for my inborn love for the great highways of the hills. Many a deep thought, many an inventive idea, many a remembered poem have come to me through such lonely wanderings.

I have kept young by association with the oldest things on earth.

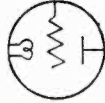

CHAPTER 45

Early Television Work

LOS ANGELES has been my home since 1930. To a comfortably large and lovely house on Hollywood Boulevard I removed many of the former adornments from Riverlure, and there resumed my studies and inventing. Inasmuch as the Schlesinger Hollywood fiasco had ended my plans for further work on studio sound, I turned now (1931) to problems of television for theater projection.

This was when television was still mechanical, employing scanning disks at both transmitter and receiver, and carrier frequencies were chosen *ad lib* so long as they were outside of the radiobroadcasting range. I had witnessed in Jersey City pathetic attempts by Replogle and Huffman to develop the Jenkins system (then owned by De Forest Radio) into something merchantable. In 1929 Allen Du Mont and I had journeyed to Schenectady to see Dr. Alexanderson's giant lens-studded scanning disk throw on a 6' by 8' screen in an absolutely dark theater a much too faint picture from a great water-cooled glow lamp, amplifier-modulated by a television signal from a small scanning-

disk "pickup" a quarter of a mile distant. I realized then the utter futility of theater television by any such methods. Obviously, adequate screen illumination would require a theater projector arc lamp or its equivalent.

I began with a blank 35-mm. film stock coated on one side with a thin layer of pure metallic silver, not photosensitive. This film was run at 24-frame speed over a curved brass "anvil" block located directly on the theater projector only three inches in front of the lens. Rotating at high speed above the anvil was a drum carrying on its periphery a series of fine needles spaced 27 mm. apart, of such length that their points passed 0.001 inch above the silvered film surface, transversely to the film. The drum diameter and speed (3,600 r.p.m.) were such that 90 needle traverses occurred per picture frame, thus giving a 90-line picture instead of the coarse standard 48-line television picture of that day. The needle drum carried a commutator whereby each needle, as it swept across the film, was brush-connected singly to the output of a small high-frequency generator. A television amplifier modulated this generator at video frequencies. Thereby a very fine modulated spark train traversed the film and etched away the silver in proportion to the strength of the television impulse as received from the distant television transmitter. The film, now bearing the etched picture, then passed in intermittent motion behind the projector lens. Thus was thrown upon the theater screen, under the full brilliancy of the arc projector, the picture televised and etched just two and one-half seconds before.

Patents were filed. James Garside resigned from De Forest Radio and came on from Kalamazoo to organize the American Television Laboratories, a Delaware corporation. And while my work was progressing, he proceeded to raise capital, chiefly from his Kalamazoo friends. He induced Charles Huffman to leave his eastern employment. His assistance, experienced as he was with the Jenkins development, proved invaluable in designing

the scanning disk pickup camera and its electronic appurtenances.

A chemist from California Institute of Technology, Professor Arnold Beckman, later of "pH-meter" fame, designed the chemical process for depositing the minutely thin silver coating over the film stock. This proved to be an unexpectedly difficult problem, or succession of tough problems—in fact, the bottleneck of the entire invention. The coatings were too light, too heavy, or not of uniform density from foot to foot, as the scrupulously clean film passed through the ester and silver nitrate troughs to the distilled water "laundry," the dryer, and to the windup reel. Dr. Beckman toiled skillfully, ingeniously, and zealously.

At times our results were amazingly good. Bright, life-size pictures of almost photographic quality were projected on the large screen. The heavy camera on its rubber-tired "dolly" was at times out in the adjoining lot shooting passing traffic. At other times it was in our studio for artist pickup.

We took our etched "tele-film" to theaters for full screen projection and once to M-G-M's studio theater for demonstration. I am sure that Mr. Louis B. Mayer thought he was viewing a new type of motion picture intended to replace studio camera methods! He hadn't the faintest idea of the meaning of the word "television." No wonder that his reaction there was: "So what?"

Tirelessly then did we toil on—Huffman, myself, and our highly skilled mechanics, Dr. Beckman and his clever apprentice, Charles Scheid (now a leading sound engineer with M-G-M). One bug after another was located and eliminated. We expected the sparking would wear away and shorten the etching needles. They grew longer instead and scratched the film. This was due to deposition thereon of vaporized silver! So an emery stone with microscopic adjustment was located to grind off the growing needles to registered lengths.

On a theater screen the 90-line picture, while amply bright, presented too much a Venetian-blind effect to observers down front. Designs were therefore drafted for a 150-line picture. Dr. Beckman finally decided that the wet film coating process could not be made sufficiently dependable, so he turned to the vacuum "sputter process." I designed a pilot plant for that process, but the machine was never quite completed.

We all felt that, given six months more and another \$100,000, we would be ready for actual theater television demonstrations, at which time the system could begin to earn its way. This was late in 1932. Then the Kalamazoo, and a thousand other, banks closed; no more money for the experiment was in sight. "Tony" Biddle, Garside's close friend, and a former director of De Forest Radio, was on the point of investing \$75,000 when the Sonora collapse, plus certain domestic difficulties, suddenly tied his purse strings.

So in 1933 the most promising of all mechanical television systems for large-screen projection folded completely. The equipment so carefully engineered and nicely built went on the auction block. Television, for large or diminutive pictures, needs must await the coming of the perfected cathode-beam tube. This pending development had already doomed to quick obsolescence all mechanical scanning systems, "needle-point" among them. But it was grand fun, those two years, solving an involved problem by methods so utterly unique.

During this 1932 work, to show the possibilities of the new system for high-speed telegraphy, I lettered a large sign, dimensions 3' by 4' which read: "This was sent at the rate of 12,000 words per minute," and recorded it on a hundred feet of film 24 times per second—actually 17,280 words per minute. Western Union engineers came from San Francisco to observe the operation; they expressed keen interest in its possibilities over long lines designed for the necessary carrier frequencies involved.

In 1936 I built new apparatus designed wholly for high-speed telegraphic use, but here again was I stymied by the problem of properly metallized paper, film being far too costly. Western Union had not then developed their facsimile copy paper. The idea, I believe, still possesses interesting commercial possibilities, even though television is now able to trans-receive 500 words per frame thirty times a second—nearly a million words per minute! This I believe is a somewhat greater rate than that now maintained by all the commercial radio announcers of the world speaking in harmonious unison!

On July 19, 1937, Marconi died in Rome, of a heart attack. For the *New York Times* two days later I wrote:

To Guglielmo Marconi unquestionably belongs the credit of first transmitting telegraphic signals through space without wires. His first and chief contribution to our generation was this demonstration that by means of the upright wire and earth connection the electric waves, discovered originally by Hertz, could be transmitted over long distances. Marconi convinced a skeptical world that the Hertzian waves could bend around the curvature of the earth, and therefore make possible transoceanic wireless telegraph.

His labors, therefore, in the early stages of wireless telegraphy laid the foundation for that art. It is true that he employed, both at transmitter and receiver, devices well known to science at that time, devices which were very soon supplanted by improvements for which American inventors were chiefly responsible. But Marconi's pioneer work and daring vision well entitles him to be called "the father of the wireless telegraph."

To the radiotelephone, radiobroadcasting, radiotherapy and all the host of modern inventions on which our present radio and long-distance telephone systems are built up, Marconi modestly made no claims. But the thousands of elevated antennas on ship and ashore stand as tall monuments to his daring genius.

Throughout the early years of wireless, Marconi and I enjoyed many a keen competitive battle in and out of the patent courts, and it seems strange that in all our years of work along kindred lines, our paths never crossed. I never had the pleasure of personally meeting this fine and gifted gentleman, now departed; and I deeply deplore that his life should have been cut off at so untimely an age.



CHAPTER 46

Diathermy

*I*N 1934 I found myself with nothing to do but study. Had I returned East a dozen attractive openings awaited; but I was then wedded to California. I chose rather to learn what my German confreres, some of whom doubtless remembered my 1908 visit with the first "radio knife," had since achieved in the field of diathermy. In the library I found a mass of highly significant material by Schliepacke, Debys, and others. But I learned of no high-frequency diathermy work in America. Here then was another field for the pioneer, highly interesting, humanitarian, presumably profitable.

With two Los Angeles friends a partnership was formed and the first portable diathermy instrument was constructed. My dear friend, then Captain, now retired Rear Admiral, Stanford Hooper, who had been so helpful to me in interesting the Navy in my early radiophone and power tubes in 1917, urged that I approach his Annapolis classmate, Captain Webb, chief of the San Diego Naval Hospital. Webb allowed us to demonstrate

before his Dr. Spalding, physiotherapist at the hospital. Immediately he became interested. We left the unit. In a few weeks Dr. Spalding could give us highly significant case reports of the new modality. But strangely again we encountered great indifference, nay skepticism, among most physicians. Why was "short wave" superior to the classical spark-gap diathermy of d'Arsonval and Tesla—or a good hot-water bottle?

The American Medical Association held very far aloof. The secretary of their Physiotherapy Section, one Howard Carter (not the famous pill man), was frigid toward the new-fangled heat exciter, remaining congealed unto this day. Demonstrations before medical conferences were made. Gradually one doctor after another became sold. The business, starting from a shoestring, began to grow. Competition "reared its ugly head," sure indication that I was on the right track again. I made a quick trip to London and Berlin to learn what Europe had in the new diathermy. England, as expected, had nothing; the Germans were far advanced. I was happy again to meet my good friend, Dr. Siegmund Loewe, who was then busy putting two and three triodes, r.c.—(resistance-capacity) coupled, into a common large glass envelope. Therewith he was licking all Telefunken competition, to such an extent that Hitler shortly afterwards expelled him to England.

I returned to my Hollywood laboratory to embody in our diathermy equipment the practical improvements I had seen in Berlin, such as bi-wave and pan-wave generators. So set against the German teachings of specificity in diathermy treatments was the A.M.A., no persuasive evidence of such being forthcoming, that we soon confined our product to the 6- and 18-meter emitters, the former for deep penetration using applicator pads, the latter better suited for induction-cable work.

The business of diathermy manufacture now grew apace. Before long we had equipped every Navy Hospital afloat and

ashore and an imposing list of major hospitals in the United States and Canada.

The radiotherapy emitter is basically akin to a short-wave radio transmitter. The output (applicator) circuit is the equivalent of the antenna radiating circuit of a radio station, but with radiation suppressed. In its simplest form we bring the "antenna" (represented by one applicator pad and its cable) over into close proximity with the "earth" (here represented by the other applicator pad).

Then one lies down upon the "earth" with the "antenna" pad resting above the body; and the identical lines of electric force which constitute the "Hertzian waves" in radiotelegraphy instead of flying out through space, are concentrated into a bundle of lines which thread back and forth through the body many million times per second and, by setting up both resistance currents, and especially the so-called displacement currents, within the tissues of the body produce instantaneous heating and other physiologically important effects throughout the parts of the body thus irradiated.

This was common—and common-sense—practice with physicians in the late '30's. But spurred on by the powerful communication interests, the Federal Communications Commission later imposed such narrow and rigid requirements, as regards basic frequencies and band widths under which radiotherapy is permitted to operate, that a large and growing young industry, of immense proven value to the public, has been materially limited.

To me the situation is reminiscent of the New York radio inspector's famous dictum of 1920: "There is no room in the ether for entertainment." Today's equally unreasonable rule is: There is scant room in the ether for healing the sick.

I am, of course, well aware that expensive, impractical crystal-controlled diathermy instruments exist which do meet the rigid

requirements of the Commission's engineers. But every physician who has operated such an instrument (27.325 megacycles) knows too well the difficulties of continuously delivering the desired wattage to a mobile, restless patient. The overwhelming evidence is that crystal-controlled sets are *not* practical from a diathermy standpoint. A few non-crystal units have also qualified. But the Commission's engineers incline to regard the problem chiefly from the communication angle. So here, in strange contrast to their lamentable failure to take any effective steps to relieve the radio public from the evils of broadcasting's excessive commercialism, the Federal Communications Commission has imposed on the medical fraternity and their millions of patients, prohibitions or hardships which are wholly unnecessary, and most emphatically not "in the public interest, necessity, and convenience." The Commission's repeated refusal to give to therapeutic diathermy as generous treatment as a purely entertainment or commercial facility receives—not even a single half-megacycle waveband—is, in my opinion, quite unjustifiable.

I doubt if any man has taken more diathermy treatments than myself. A small portable set on my study desk at home has been in use for hours on many a night, as I wrote or studied. For throat and chest colds treatments were applied for hours, often all night while I slept. I can truthfully ascribe much of my present outstandingly fine health to the enhanced blood and lymph circulation and the stimulated metabolism produced by the prolonged mild diathermy treatments to which I have subjected myself.



CHAPTER 47

For War and for Peace

IN 1936 while playing with Priess's ingenious vibrating-mirror television scanner, I had chanced to rotate it about the mirror's center. At once the novel effect of a radial, or diametric, scanning suggested itself. Several patents were shortly issued to me showing various methods of obtaining this radial scanning by *mechanical* means. I next reasoned out a method of obtaining this new scanning effect *electronically*, in the cathode-beam tube. Broad claims covering basically the entire radial-scanning principle issued to me in May, 1941, Patent No. 2,241,809.

I promptly sold the rights under this patent to Radio Corporation of America. At the time, very few had heard of radar, or of the idea of indicating received etheric echoes on the face of a cathode-ray tube. I realized that the radial scan would find small employment in television, save for special purposes like scanning the sun's corona during total eclipse—a use which I brought to the notice of Dr. Skellett of Bell Laboratories. Had

I then foreseen the rotating antenna of radar or the recorded pips of the cathode-tube "class A" scan, I would not have been so quick to sell my rights under the radial-scanning patent.

When, a year later, the news of radar "broke" in the United States, the immeasurably important PPI* system of target location was not long in realization. My invention was promptly put to work. Whenever today I see a reproduction of a PPI fluorescent map, I experience a profound satisfaction that through a comparatively recent invention, I was able to contribute something to winning the war; and, more worthily, to the science of modern navigation by air and sea.

How completely have those three basic electronic inventions dovetailed together: amplifier, oscillator, and the cathode-beam tube!

However, not all of my efforts to help the war effort met with similar success.

When the clouds of World War II first lowered in Europe, I began to study night bombing. Quickly I conceived, and sought to patent, a self-directing night bomb, carrying in its nose two pairs of photoelectric cells each shielded in its own quadrant. Behind these were to be located two pairs of identical small amplifiers, the output of which governed differentially two small battery-operated motors. When equal light fell on all photoelectric cells, their balanced amplifiers delivered no current to either motor. If one cell was more brightly illuminated than its companion, its amplifier would cause one of the motors to turn clockwise. If the companion cell received the greater amount of light, the motor, differentially wound, would rotate counterclockwise. This motor actuated two guiding fins located on opposite sides of the bomb's tail, and the other motor operated another pair of rudder vanes, located in a common plane at right angles to that of the first pair of vanes. That pair of rudders moved right or

* Plan Position Indicator.

left in response to the cell of that pair which was receiving the more light. The bomb (properly styled "moth" because it would seek to move towards a light from the target below) was to be released from a height too great for accurate bombing by means of the usual bombsight, well above all anti-aircraft fire range, and over the general area of a target already *spotted by flares or in conflagration*.

My friend, John Corbett, old friend of Charles Edison, then Secretary of the Navy, took the blueprints to Washington on my behalf. Edison at once grasped the idea and sent it on its way down the red-tape chute. Corbett outlined its operation also to certain Bell Laboratories engineers in New York. They fully confirmed our opinion that the idea was completely sound and practical from a physical standpoint.

Months passed; the war flamed fiercely. Britain was night-bombing Germany, and doing a distressingly poor job of it. The need for a self-directing bomb seemed thoroughly demonstrated. Finally came a letter from the Navy Department. It cited ten specific reasons why such a bomb was impractical. Gems from this intellectual masterpiece were the following:

. . . (e) Under the best conceivable conditions (large, motionless, light-colored ship, bright sun,* calm water, location such as to catch maximum reflected light from the target) the "electric eye" could not function at 18,000 feet and that under such conditions a maximum range of only 6,000 feet would be more probable.

(f) It would be badly disturbed by direct rays from the sun,* or reflections from the sun path on the water or from intervening light clouds.

(g) The device would be badly disturbed by the presence of whitecaps.

(h) With a darkly painted ship or in overcast weather, it would not function except possibly to head for the white wake of the ship.

(i) Upkeep and adjustment would probably present serious difficulties and complications, in wartime.

(j) Any practice exercises with the bomb would probably result in its loss.

* The bomb had not been designed for daytime use or marine targets.

To such objections I asked in my reply: "Is this a sample of the 'intelligence' which today dictates the policy of the United States Navy? Do you actually believe that the Navy now recovers intact the powder and shell used in target practice, or if not, that target practice should be deemed inadvisable? Lacking such information I am compelled to question the accuracy of your conclusions."

Still unconvinced that our services could not use a self-directing missile, I next approached a recently found friend, Major General Henry Wilson. He was interested and soon arranged that a test of my dummy bomb be made at Muroc Dry Lake Flying Field. I had been told by an extraordinarily wise expert, one of Lockheed's consultants, that to be effective in deflecting such a falling missile, rudder surfaces as large as a small plane's elevators would be needed! I knew he was wrong, but to make deflection certain I located a pair of small fins near the *nose* of my iron dummy, rather than at its tail. These fins were clamped at a small angle (5 degrees) from the bomb's axis. It was equipped with the standard Air Force bomb-clutch and release hooks; then it was carted to Muroc Field and taken aloft in a two-engine bomber.

The bombardier assured me that those fins would prove useless at that small angle and should be mounted at the tail. A second bomber with motion-picture camera was to fly parallel to and a little below the bomb carrier. We observers were stationed in a steel tower located a quarter of a mile from the target. At 5,000 feet and almost directly above our station the bomb was released. Instead of following the expected parabola, the bomb started tumbling and fell almost directly downward, landing about 150 feet from the observation tower! I had reasoned that the 5-degree offset of the nose fins could cause the horizontally pointed cylinder to begin its downward deflection when launched and that, lacking any corrective action (there were, of

course, no photocells, amplifiers, or motors in that dummy), the turning action would continue, resulting in a whirling tumble. Exactly this happened, thus amply proving that even a 5-degree fin deflection was far too much for the bomb's directing. I did not, however, foresee that this tumbling would cause the bomb to fall almost vertically, instead of in the usual parabolic path.

Months after the test the Army condescended to send me the 16-mm. film taken as the bomb fell. This film showed that the yellow missile dropped almost instantly out of sight of the lens, as the observer plane continued to parallel the bomber plane—instead of remaining in view while the camera lens was gradually directed lower as the two planes traveled forward towards the target.

This perfunctory test terminated all interest on the part of the Army in a bomb which could be made to fall vertically from its point of release* and could therefore be far more accurately placed than bombs aimed at targets lying several miles in advance of the bomber. It also terminated the Army's consideration of a self-directing night bomb capable of finding its way to an illuminated target.

The success of the light-controlled "proximity fuse" later developed by Bell Laboratories demonstrated beyond question the feasibility of my idea so far as a mechanism's response to differential light sources was concerned. And subsequent developments in guided missiles have abundantly proven how basically sound was that ridiculed idea of 1940.

In my opinion both branches of our Armed Forces overlooked

*It now appears that the Army did learn something after all from that tumbling bomb. The discovery made at Muroc Dry Lake has subsequently been put to practical use in the design of the Aerobee rocket. When the rocket starts descending, a small controlled explosion knocks off its tail fins. The rocket is thus rendered unstable and tumbles to the ground, thereby taking maximum advantage of air resistance. Falling at a speed of some 150 feet per second, it lands with an impact not great enough to destroy the instruments it carried aloft, especially on desert sand or soft soil. The first full-dress demonstration of an Aerobee was in November, 1947, five years after my demonstration.

what could have been developed into a very useful weapon. But I then learned that unless one belongs to the sacrosanct National Research Board or to the Big Brass, he usually wastes his time trying to aid in our war effort. During World War I, Thomas Edison complained of similar treatment. Beyond question the war could be won without my help, too!

Nevertheless, the exciting developments in technology, notably electronics, during World War II awakened in me new enthusiasm and desire to contribute further, if possible, to our aviation progress. I was enabled to open and equip a laboratory in Los Angeles when the Bell Telephone Laboratories, a subsidiary of the American Telephone and Telegraph Company, entered into a contract with me under the terms of which I have received during the past six years ample funds for the development of new inventions and for filing and prosecuting patent applications thereon.

Nothing in recent years has afforded me more gratification than that action on the part of the Telephone Company. For my part I was to grant the Bell Laboratories options for non-exclusive license under all applications and patents resulting from this mutual arrangement.

Among my postwar patents are three of special interest to aviation: No. 2,391,554, December 25, 1945, Aircraft Speed and Course Indicator; No. 2,410,868, November 12, 1946, Means and Method for Altitude Determination; and No. 2,421,248, May 27, 1947, Method for Determining Absolute Altitude.

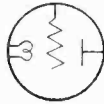

CHAPTER 48

Television

AMID my experimental activities in the early 1940's I wrote the book *Television Today and Tomorrow*.^{*} Its Foreword briefly sums up, as I see it, the scope of that electronic miracle.

TELEVISION!

Euphonious word embodying within its syllables all, and exactly, the meaning of the ancient words from which it derived.

To see from a distance details that defy telescopic vision; to have sight through barriers; to re-create in the home—in a million homes—not merely messages and music for the ear, but actual scenes as they transpire miles beyond the horizon, across continents.

To bring into one's room an athletic field, a race track, a ship sailing a far sea; in fireside comfort to meet and hear the nation's leaders as they counsel, instruct, and inspire; to annihilate space and separation, to enrich the home lives of modern millions through the medium of the mightiest miracle which science has ever yet conceived. . . .

This is Television!

^{*} Dial Press, 1943.

As we recognize it today, whether for telegraph, telephone, or other forms of audio signaling, radio is the direct outgrowth and offspring of the older wireless. Television in turn is the direct offshoot of radio, magically engineered for the eye instead of the ear of man. And as both of these modern wonders were made possible by the thermionic tube it is perhaps fitting that I have been called "Grandfather of Television"! If so, then proudly—yet with all humility—do I acknowledge such indirect parent-hood.

Already broken out in a healthy rash of gleaming tubes, large and small, this new infant, the television receiver, even as I write today, has entered nearly three million American homes, in an exciting upsurge limited only by the inability of manufacturers to meet the insistent crescendo of popular demand.

Thus have I lived to see the sudden, strange popularity of radio in the early 1920's repeated within another quarter of a century. This renewed magical spell over the national imagination has already proven truly terrific. For television possesses a new, and more potent, power to vitalize our democracy. In every phase of social and cultural life its influence will be even more significant, far more profound, than has been that of the radio-broadcast.

Already what were considered two years ago as wild dreams are today proven ultraconservative. Television's growth has confounded the visionaries. The ardent support now accorded this surging tide by the FCC is most heartening.

Dr. Walter R. Baker, vice-president of General Electric Company and former chairman of the Radio Technical Planning Board, predicted in 1944 that five years after the war there would be at least 100 master television stations in operation throughout the country, serving areas with combined populations of 67,000,000. The year 1950 proves how strangely right he was.

Having had an active hand in large, bright-screen, mechanical television, and been a close student of its cathode-ray development since my 1933 observation of Dr. Kurt Schlesinger's then amazing demonstrations in Berlin, and throughout the 1930's those of America's outstanding pioneer, Allen B. Du Mont, I find myself a confirmed enthusiast as to the unlimited future of this new art and industry.

Today the question of color television is on every tongue; how soon will we have color, and should one postpone buying a receiver awaiting color? I have followed the experimental development of color television with intense interest: first, that by Columbia Broadcasting System, the mechanical, color-subtractive method; and more recently RCA's all-electronic system.

Even with their present refinements, reducing their frequency channels from the 16-, to the 12-, and down to the 6-megacycle band, sanctioned now by the FCC, both systems possess inherent objections which seem definitely to indicate that several years of further development lie ahead before a solution is found for the commercial problem of how to adapt existing television sets to receive pictures in natural colors, as well as in black-and-white.

The FCC has indicated as their determined requirement that a color TV system before official acceptance must demonstrate its ready adaptation to existing monochrome receivers, and at a reasonable cost to the set owner. Also that the receiver shall be capable of delivering either black-and-white or color pictures, interchangeably. Those stated requirements seemed so tough, so difficult to meet by any known color-television system or method, that I set out several years ago to solve the problem myself.

With the swift resurgence of television activity following the close of World War II, I became dissatisfied with the meager opportunities then existing in California for research and experi-

mentation in that exciting new field. Enlarged opportunity offered in Chicago with the American Television Laboratories, directed by my long-time friend, U. A. Sanabria, leading television pioneer who, as far back as 1928, had conceived and patented the brilliant basic idea of interlinear scanning, now universally used in every television picture to prevent optical flicker.

I consider his brother, Colonel John Sanabria, to stand among the topmost of today's television engineers and inventors. His latest invention, ghost erasure by means of delay circuits and phase reversal, should prove of incalculable worth as the number of television transmitters and receivers in urban centers rapidly multiplies.

Today, although the transmitting and receiving equipment which I have constructed is yet far from perfected, it is in its main features very simple, and is not costly at the receiver station; and it has abundantly demonstrated that it can transmit the three primary colors, using only the accepted R.M.A. (Radio Manufacturers Association) FCC-sponsored TV black-white signal standards, all within the allotted 6-megacycle television bands.

Like that of CBS, mine is a mechanical system, but entirely avoids the serious drawback of requiring a whirling color disk more than twice the diameter of that of the kinescope tube at the receiver. It seemed quite unnecessary that all of the picture be viewed at any one time through a single color-filter sector or strip, the strips to sweep down over the face of the kinescope in rapid red, green, and blue sequence. Unlike that of CBS, my system is *compatible*. That means the transmitted color picture can be viewed in black-and-white on any ordinary kinescope set.

My color filters at transmitter and receiver are made up of a large number of hexagonal or rectangular segments arranged symmetrically in tri-color order. The entire filter frame, three by four in aspect ratio, is of only slightly greater area than that of the picture raster on the face of the tube. A simple motor-

actuated mechanism causes the filter frame to follow a circular, orbital movement over the face of the kinescope. A similar color filter and mechanism for driving it in synchronism with that at the receiver is located before the pickup camera at the transmitter. By this simple means all portions of the color image at the camera are being scanned 30 times per second with one or another of the three colors, and so rapidly that each picture element is scanned by each color 20 times per second simultaneously all over the picture image.

The television transmitter broadcasts only "black-white" impulses, the same as from monochrome picture images, but the individual impulses are modified by the absence of certain impulses subtracted from various portions of the scene by the color segments of the filter. A similar color subtraction at the receiver allows only certain light elements to pass through the color segments of the filter as these shift in synchronism with similar segments at the pickup camera. In other words, a pure-green element of the original picture can penetrate to the camera only when a green filter segment lies between it and the camera. That "green" signal (as a modified black-white impulse) then is radiated and picked up at the receiver. But at that instant a green filter lies before the black-white picture element on the kinescope face. The observer therefore sees that picture element only as green. Similarly for all the pure-red and all the pure-blue elements of the original image.

The three pure, or primary, color picture elements at the transmitter are made to appear in their natural colors at the receiver, and since all colors are made up of certain combinations of those three primaries, and since the images pass so swiftly before camera and kinescope alike, we obtain the desired mixture of the three color elements and the eye is deceived into seeing all the natural colors properly reproduced on the kinescope's face. If the small filter and frame are removed from before the cam-

era and the kinescope, ordinary black-and-white pictures will appear.

The color system here described, although remarkably simple and inexpensive, still requires many months of development and refinement. There appears no question, however, that it can be so developed as to solve the problem of a color television that will meet the present requirements of the Federal Communication Commission. But that will take months—perhaps years.

With such an intensely interesting and absorbing problem as I have above outlined, I have been kept busily engaged in the American Television Laboratories in Chicago, finding therein that eager zest in life which has kept me happily at work from the time, 50 years ago, also in Chicago, when I began my primitive experiments in wireless telegraphy.

Of one thing we may be positively certain. Television will eventually be enriched by natural color—not in every low-priced receiver, and perhaps only when direct line-of-sight transmission on ultrahigh frequencies is available. But in five years, probably fewer, television will dress herself in the enchantment of natural colors.

The television engineer has done a magnificent job to date. He has completed a nicely performing, consistently good electronic system, at transmitter and receiver. So we are justified in expecting that, from the standpoint of electrical mechanics, our television machine performs to almost everyone's satisfaction. But however perfect the machine for conveying the programs to our screens, if the entertainment of the programs presented is not continuously and consistently good—as reliable as is the operation of the transmitter and receiver involved—then will television miss its fullest mission. The program director and his exponents should be as skilled in their work as the engineer and service organization.

At an age when most men are forced by declining strength to forego strenuous exercise, Lee de Forest turned to mountain climbing as an outlet for his inexhaustible energy. From San Geronio he went on to scale Mount Whitney, the tallest mountain in the United States.



Diathermy occupied the inventor's attention during the middle thirties. In his Los Angeles laboratory he designed, among other things, an instrument to induce artificial fever.

Acme

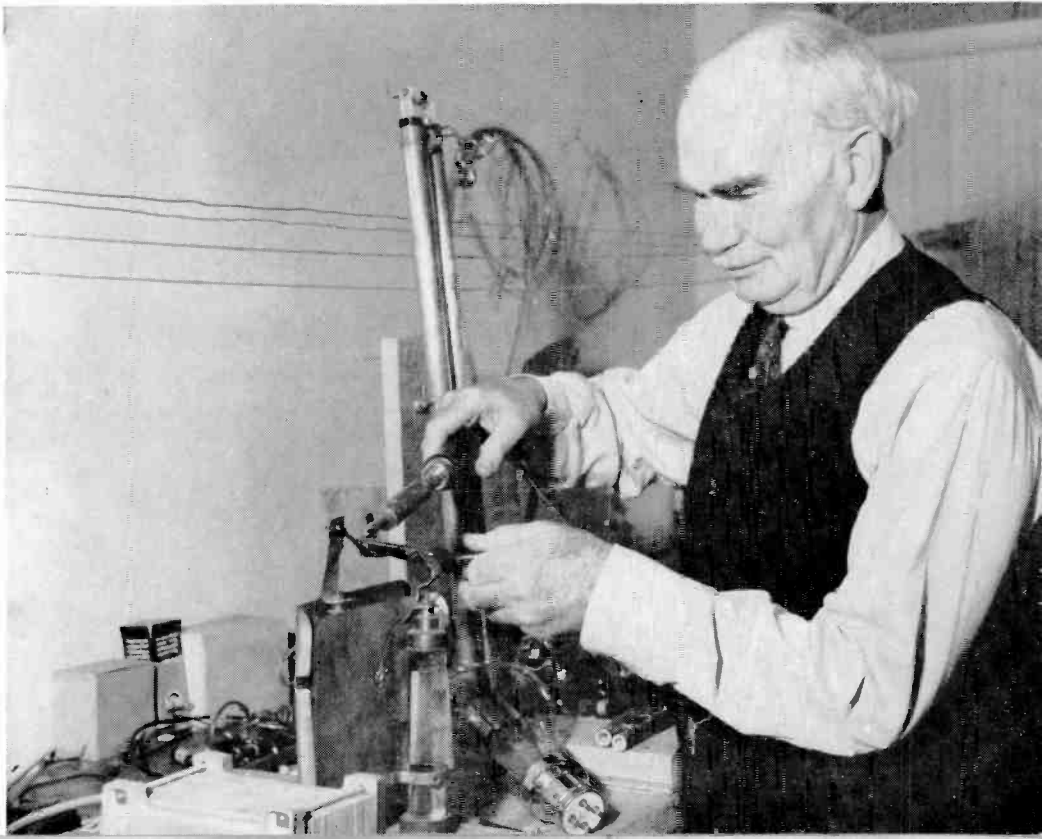



In their Hollywood home, Lee and Marie de Forest indulge in one of their favorite pastimes — the enjoyment of recorded music on "the world's finest phonograph."

What has thus far appeared on television screens is clear evidence that to date the program planners and directors have a very great deal to learn. There have been a few brilliant exceptions, of course, and we all recognize that these pioneers have been groping their way around. Even as good an authority as the daytime television director of WOR admits that "ninety per cent of television programing to date has been unspeakably bad."

Intimate experience with, and long observation of, the talking motion picture have allowed me perhaps a clearer perspective of the economics of lucrative television than has been given to some of those engineers too engrossed with television's trees to see the great forest. Telecasters have operated almost wholly on the theory that live acts only will be acceptable, that general use of film is to be taboo in television, and that television has one special mission to perform: the creation of a radically new type of entertainment, comparatively unknown to mortal heretofore—neither stage nor screen nor radio.

Therein they consistently overlooked the indisputable fact that, while science can and does work revolutions "overnight," yet the same old human instincts, likes and dislikes, desires and appetites remain, ageless, unchanged. After their all is said and done, television program directors will find that a screen show is a screen show, in theater or home, some large, others small, but both nonetheless a presentation of shadows. The actual living human presence—seen, heard, and felt only on the stage—is perforce absent from both mediums.

It is, of course, granted that a host of television acts are far better done without film, where immediacy is vital, like athletic contests, window displays, model revues—a host of others—chiefly of local and ephemeral interest. I am not speaking of educational lectures, as for schools, nor for the far from "educational" bedtime frivolities for the kiddies. Nevertheless, as long ago learned by the exhibitor, and recently by the television program-

mer, "the play's the thing." And where so much of expensive and painstaking effort have been expended in the staging of a worth-while drama or comedy, I claim it is mere economic sinfulness to waste its sweetness only once upon the empty air. For some years, until we have properly operating nation-wide television chains, etheric or coaxial, such worth-repeating spectacles cannot be merely flashed and then forgotten—a lovely tapestry, artfully woven, to be burned to ashes.

Once our leading film producers realize the inevitability of nation-wide television—tens of millions of viewers in the home—they will be quick to grasp the fact that this new form of mass entertainment lies exactly up their alley—or, at least, an almost identical street.

Given an intelligent understanding of the basic differences inherent in the theater screen and theater audiences and in the home screen and home audiences, the present directors of cinematic entertainment should be the best qualified to formulate and direct the coming television programs. They enjoy at present highly valuable advantages over any televisor, who is faced with the gigantic tasks of building from the ground his studio and its stages, assembling his hosts of writers, actors, and scene designers, and painfully acquiring his "know how." They are best equipped by previous experience to produce satisfactory television drama, being trained in skillful variation of medium and close-up shots and how to blend these and varied backgrounds into a smoothly running continuity.



CHAPTER 49

A Parent's Disappointment

*A*S the so-called "Father of Radio," I have naturally been much concerned over the kind of adult my child has grown to be. Like any proud father, I started with the expectation that radio would become a great and powerful influence for good—a communications medium which would make education and culture freely available to all. As late as 1922, I continued to cherish this hope. On the occasion of WOR's first anniversary in July of that year, I voiced my high expectation in these words:

In 1907, when the idea of radiobroadcasting first occurred to me, and three years later when the music of the Metropolitan Opera was launched upon the ether, and again in 1916 when for the first time regular radio concerts were broadcast nightly, there dawned before me a vision of the astonishing potentialities of radio. But I confess that in those early pioneer days my eager imagination fell far short of picturing the astonishing hold with which during the last eighteen months this idea has so suddenly gripped our entire nation.

I predict that as an educational medium the radiotelephone broadcast will in time prove second in importance only to the public school.

When one seriously considers the human side of this broadcasting idea and its possibilities, one must admit that it possesses potentialities for uni-

versal education—and for all the train of good which results from universal education—which can be compared only to that brought about during the past five centuries by the art of printing. Only this new revolution will grow to maturity in a decade, instead of 500 years—a graphic commentary on the acceleration of man's present progress.

I have for a long time maintained that this educational value of radio-broadcasting will prove by far its greatest worth—to the people of our country—and later of all nations. No doubt just now the entertainment feature is the most striking, the phase most appealing to the popular desire, naturally enough. Unquestionably, the fine programs which are now being given by the large broadcasting stations are accountable for the astonishing growth of radio listening during the past eighteen months.

But as the years passed, my early expectations gradually turned into bitter disappointment.

In 1922 the Western Electric station WEAJ began regular operation and appropriated to itself the dubious honor of being the first to broadcast a commercial message, its sponsor a Long Island realtor. This example was rapidly followed by WOR and other leading stations.

In newspaper interviews that year I strongly protested against such use of the new wonder; for it was my thought that radio programs should be sponsored and maintained by those who would benefit from the sale of radio receivers and accessories, sales ever profitably increasing with the size of the audiences, attracted to buy by the ever-improving quality and appeal of the sustaining programs. How simple such naiveté—to suppose that once this growing octopus had tasted blood it would not demand continually more and more, as it spread its network tentacles over the entire nation!

As I look back today over the entire history of radiobroadcasting since my 1907 hand-cranked phonograph spread abroad (to the Navy Yard boys!) that "William Tell Overture," I contrast the high ideals which I then cherished for its cultural usefulness to America with 90 per cent of what radio listeners have to endure today and am filled with a heartsickness. Throughout my long career I have lost no opportunity to cry out in

earnest protest against the crass commercialism, the etheric vandalism of the vulgar hucksters, agencies, advertisers, station owners—all who, lacking awareness of their grand opportunities and moral responsibilities to make of radio an uplifting influence, continue to enslave and sell for quick cash the grandest medium which has yet been given to man to help upward his struggling spirit.

I find I cannot frame a better introduction to a discussion of the qualities and trends of today's average radio program than to quote from my letter which appeared in the *Chicago Tribune* of October 28, 1946:

A FATHER MOURNS HIS CHILD*

In the Palmer House is assembled the Convention of the National Association of Broadcasters. There many words are being spoken on behalf of a great industry which thrives chiefly on spoken words.

One wonders if our simian ancestors had any conception that in ages to come such monkey chatter as they originated would be transformed into the essentials of livelihood. Of such are the mysteries of evolution. Today fabulous sums are paid for talk. Speech, not silence, has proved golden; and the dispensers of such merchandise to the millions are here foregathered to plan for more speech, for more money.

Had I, who originated the idea and the means for broadcasting, been invited to their council, I should say to them: "What have you gentlemen done with my child? He was conceived as a potent instrumentality for culture, fine music, the uplifting of America's mass intelligence. You have debased this child, you have sent him out in the streets in rags of rag-time, tatters of jive and boogie woogie, to collect money from all and sundry, for hubba hubba and audio jitterbug. You have made of him a laughing stock to the intelligence, surely a stench in the nostrils of the gods of the ionosphere; you have cut time into tiny parcels called spots (more rightly 'stains'), wherewith the occasional fine program is periodically smeared with impudent insistence to buy or try.

"Murder mysteries rule the waves by night and children are rendered psychopathic by your bedtime stories. This child of mine, now thirty years in age, has been resolutely kept to the average intelligence of thirteen years, as though you and your sponsors believe the majority of listeners

* This *Tribune* letter was quoted and discussed by columnists all over the land, by *Time*, *Fortune*, *Readers Digest*, *Public Opinion*—even in Germany, where I was designated as "Papa Drahtlos."(!)

have only moron minds. Nay, the curse of your commercials has grown consistently more cursed, year by year.

"But his British brother has had a different upbringing. Under government sponsorship, radio appeals there to the higher intelligence, realizing its fine mission to elevate, and not degrade. This is anathema to America's broadcasters—vastly enriched by their freedom from all restraint. We prefer to pay the colossal bill in gold, and in the debased coinage of the anesthetized intellect. We might learn much from England.

"Yet, withal, I am still proud of my child. Here and there from every station come each day some brief flashes worth the hearing, some symphony, some intelligent debate, some playlet worth the wattage. The average mind is slowly broadening, and despite all the debasement of most of radio's offerings, our music tastes are slowly advancing.

"Some day the program director will attain the intelligent skill of the engineers who erected his towers and built the marvel which he now so ineptly uses."

LEE DE FOREST

From the beginning it was recognized that radiobroadcasting should serve the public interest. Herbert Hoover, while Secretary of Commerce, repeatedly insisted that "radio communication is not to be considered as merely a business carried on for private gain, for public advertisement, or for the entertainment of the curious. It is a public concern impressed with the public trust." As he put it, the radio industry did not create, and does not own, the channels over which it operates. It is merely licensed by Government to use them. The Federal Communications Commission therefore unquestionably had the authority, and indisputably also the moral obligation, to direct that licensed broadcasters have a very solemn and compelling obligation to the public whose free air they continue to use. But until recently the Commission has stubbornly refrained from any interference with our stations' program policies, limiting itself merely to policing the radio frequencies employed.

The inevitable followed. With ever-enlarging radio audiences, larger and larger sums were obtained from the sponsors, more and more money was poured into more costly programs, ever-

higher salaries were paid to radio performers, until no name on stage or picture studio was too sacrosanct or costly to succumb to the lure of the mighty microphone.

And as the sponsor was forced by the networks to ever-higher advertising budgets, the greedier he became for more time on the air for his "sales message." Louder and more strident became the shrieks of his zealous announcers, more insistent, impudent, and repetitious his demands that listeners rush out forthwith to buy his merchandise, his nostrum, his laxative.

And then the advertising agency stepped into our picture, more skilled in salesmanship, congenitally more rapacious than the station owner or his sponsor, and too often totally lacking in all conception of courtesy, consideration for his public, or his professional dignity. As the effectiveness of one type of commercial diminishes, he invents new devices, increasingly offensive, to compel attention, such as the caterwaul of the "singing commercial," the strident whistle and senseless cries, all doubtless designed to convulse the adult and deeply impress the infantile mind. And then there is the hysterical "mike" addict who works himself into apoplectic frenzy each fifteen minutes lest some careless listener should perchance forget the address or the telephone number, endlessly repeated, of his momentary sponsor. And finally the "give away" programs, as an all-time lower than low!

Such radio salesmen are the uncouth tramps, interlopers, who intrude their obnoxious presence into every home, until the tormented listener, awaiting a newscast, or the resumption of a musical number so viciously interrupted, snaps the cutoff switch, and is done with radio for the evening.

But the consistently worsening quality of our *average* American radio programs, even without their crass and blatant commercialism, is a saddening symbol, a symptom which should be evident to every thinking mind.

To me the quality of radiobroadcasting is an index of the mental or moral qualities of the people who formulate its policies, or who continue faithfully to listen to its output. If the reiterated reply to their critics is a correct one, that the radio stations give to their public only what they desire, and what their fan mail calls for—then indeed may the thinking man despair of the present state of our national intelligence.

And thus does today's American radio stand condemned of deplorable lack of any adequate sense of its public responsibility, shamefully and fatefully indifferent to its magnificent potentialities for uplift—to guide our citizenry to higher levels of citizenship, to educate the mass mind, to instill therein a familiarity with, and therefore a love for, better music, and to enlarge our mental horizons, our level of national culture.

Alas, that so few of our night hours of radio are now devoted to such fine programs as are granted to us only on a Saturday or Sunday afternoon; that the tycoons of radio are content to sell our listening birthright for such a stinking mess of pottage!

The radiobroadcast is a glaring example of how far man's engineering achievements are ahead of his moral capacity rightly to utilize his best creations. The radio engineer has worked miracles in research, invention, and clever engineering. But a comparable knowledge of the basic factors of the social equations to be solved seldom is found in the executive offices of his employers.

There are, of course, some outstanding exceptions both among programs and among stations. The Standard School Broadcast and the Standard Symphony Hour on NBC's Pacific Coast network are excellent examples of the kind of program radio sponsors and broadcasters should promote. Distributed to all schools are interestingly written leaflets, explaining briefly the varied

programs, the meaning of the day's music, notes regarding the composers, and the characteristic instruments which will be heard. Twenty minutes of elementary lesson are followed by an advanced lesson, all in preparation for the Symphony Hour to be heard the next Sunday evening at home. Notes for collateral study are included in the leaflets, and if these delightful courses are carefully studied and earnestly followed, a widespread interest in, and understanding of, noble music will result which could not possibly be obtained by other means than the radio.

Would that more great corporations throughout this land of liberty and ballyhoo might follow the fine precedent of enlightened commercialism set by the Standard Oil Company.

A few stations in cities made fortunate by their presence afford even better examples of what the cultural value of radio can be. Foremost of these are stations KFAC, "The Music Station" of Los Angeles, and WQXR, directed by John V. L. Hogan, my assistant at the first 1907 broadcast. Ever since the station's inception, Hogan has consistently maintained the highest quality of music programs. He is a staunch exponent of the ideals I have stood for from the beginning. M. Lincoln Schuster characterizes WQXR as "radio with a soul." Here is an FM station which has thrived for fifteen years by giving to its listeners the maximum of cultural entertainment with a minimum of commercial advertising, yet I dare say that no single station in the world can claim so many enthusiastic admirers. A recent survey conducted by the station shows that its programs go into homes of every description and every degree of wealth or poverty.

Similar "good music stations," usually of FM transmission, are found in other cities. Outstanding in this class are stations WEFM and WXRT, Chicago, which devote all their available time exclusively to music transcriptions. When worth-while compositions, not necessarily classical, are accompanied by brief

statements regarding their composers and the interpreting orchestras, they become invaluable music teachers to America's masses.

Such stations should be subsidized by state legislatures, as are public schools, in order that their number may be multiplied throughout the land and our musical culture and appreciation be richly enhanced. To this extent I am a socialist, knowing how anathemic is that suggestion to the radio hucksters of America.

In addition to its marked ability to reduce static and numerous other interferences to which AM is prone, the advocates of frequency modulation have emphasized constantly its adaptability to high-fidelity transmission and reproduction. Coupled with these qualities, the educators and apostles of cultural uplift by radio have earnestly hoped that by its means far superior standards of programs will be forthcoming.

Major E. H. Armstrong deserves the greatest credit for the development of his system of frequency modulation—brought out in spite of the skepticism of the profession, and a reluctant FCC. He has given to radiobroadcasting a new arm; for this I salute him.

Let us fervently hope that FM will prove to be also a new tongue, to give to the world programs of the highest quality, where its older sister has often so lamentably failed. And if not FM, then television will soon free millions of listeners from the blighting curse which has so long debased AM broadcasting.

In spite of its manifold sins and shortcomings I am deeply gratified to think of radio as a comfort to those unfortunates who are more or less shut in. Radio has proven one of the greatest comforts and blessings which mankind has ever found. I yet have faith that it will in time grow greater and better, achieving more and more its predestined mission to bring beauty and culture and truth into the human heart, to dispel loneliness and

despair, and ultimately to unite in a sense of neighborliness and understanding—first through music, then through a universal language—all the peoples of this earth. Therefore I am proud to have had a prominent part in this new evangel.

Nothing has given me more profound joy than such letters as the following, similar to countless numbers received in the years since broadcasting became popular:

DEAR SIR:

If by any chance this humble little card should be passed on to you by your secretary, may one, who can no longer see, venture to convey to the Father of Radio, a greeting—simple, plain, undecorated—and a very humble word of appreciation for the greatest benefits which I, and legions of other listeners, have received in the year now closing?

Merry Christmas and a Happy New Year, and thank you for Radio, which brings to us who cannot go to it, the wide world and its music, entertainment and people.

Very respectfully,
(Mrs.) ANNA BRENNAN

MY RADIO RECEIVER

Years ago I deemed it appropriate that the "Father of Radio" should possess the world's finest radio receiver. And this I have—so pronounced by every musician or connoisseur of good music who has ever visited our Hollywood home. Its chassis was designed by my good friend, Engineer Louis Pacent—a straight radio-frequency double detector, linear audio amplifier, having separate low- and high-frequency controls, with a common volume control. This chassis is mounted in a dwarf console cabinet with record changer. In this cabinet I installed a tone filter having one outlet for the higher—and another for the lower—frequencies with a broad region of overlap. A volume control is found in each output from this amplifier.

Unseen from each outlet runs a twin conductor, one to the base of a large grandfather's clock cabinet in the southwest cor-

ner of the room, the other to a similar "columnaire" cabinet in the northwest corner. Twenty-eight feet separate the two cabinets; each is some twenty feet from the console beside the preferred audience seat, our couch. In the top of one cabinet is mounted a ten-inch speaker pointing upward. The other cabinet carries a smaller speaker similarly pointing. The lofty ceiling of the room is domed so that the sounds from the two speakers gorgeously intermingle as they are reflected downward to the ears of the listener. I have in this instrument an approximated binaural effect from a single origin of signal.

It is not generally realized that tone distortion, or change in tone balance, occurs when reproduction is not at the original volume. Where this is under concert-hall level, tone compensation becomes essential if the reproduced sound is to have the same tonal balance as the original in the concert hall. This was one reason for the arrangement adopted. My music room permits almost concert-hall volume.

The instrument (for truly it deserves such appellation) is not designed for distance reception, but to give the maximum possible of perfect, realistic reproduction from phonograph or local radio station, with complete yet simple modulation facility. The discriminating listener may control in relative volumes of upper and lower register the aural loveliness he so much desires, but which, alas, is woefully denied him in a commercial instrument, however high-priced the cabinet or chrome-plated the chassis, with its booming loud-speaker and twittering tweeter nested close together near the carpeted floor.

As a result of the arrangement described, I can sit by the hour enjoying the rendition of a noble symphony or a grand opera in complete realism of all the instruments of a great orchestra, the rich full voices of artists, the thrilling volume of a chorus of voices, filling all the large room with soul-stirring sound. I have heard nothing to compare with this instrument, in any home or

demonstration studio. Many musicians have confirmed my own high estimate of it.

It has always puzzled me why designers of high-priced radio-phonograph assemblies remain blind to the obvious fact, that even approximate realism of orchestral reproduction requires double—or multiple—outlet *separation*, combined with tone filters and elevated speakers. These designers seem enslaved to the doghouse-next-to-the-carpet dogma, that a radio must be confined in a single varnished piece, Adam or Sheraton as preferred. They seemingly fail to realize that the room itself is a vital part of the loud-speaker system. The highest-quality, highest-priced units obviously should be acoustically designed to match the architectural characteristics of the room, and the three, or more, cabinet units designed to harmonize with the furnishings and appointments of a home auditorium, worthy of the richness of reproduction which would then result. But radio receivers today, so far as sound reproduction is concerned, retain the crudities of the late 1930's.

As previously told, the radio is responsible for widespread and encouraging appreciation of fine music throughout our land. Equally certain is it that once a music lover is newly converted, the paucity of worth-while programs, unsmearred by "spots" and ads, compels him to acquire a record changer and begin investing increasingly in phonograph music. This accounts for the prosperity of multitudes of record shops in every city and village in the land. Thanks to radio and its deplorable shortcomings, the American appetite for classical music is growing today.



CHAPTER 50

A.R.R.L.—V.W.O.A.— I.R.E.

*T*o most radio listeners, the initials in the title of this chapter mean nothing. And yet we all owe a debt of thanks to the three organizations for which they stand. They have contributed to radio progress in ways which have never received the public recognition to which they are entitled. I owe them especial gratitude, for without their frequent help and constant encouragement, I should have found my own labors both more difficult and less rewarding.

THE AMERICAN RADIO RELAY LEAGUE

No institution or organization has had so widespread an influence in popularizing the art of radio throughout the world as the A.R.R.L.—to call it by its popular designation. Founded in 1912 by an enthusiastic handful of early radio fans, it has had nearly forty years of continuous, useful existence. Its prime movers were Kenneth Warner and the late Hiram Percy Maxim—until his death in 1936, the League's president. With the help

of its official magazine *Q.S.T.*, the League and its foreign affiliates rapidly linked radio amateurs the world over into an international web of communication and camaraderie altogether unique in history.

Its founding was most opportune. For two years later—in 1914—the first oscillating three-electrode tube was presented to the world. The first heterodyne and autodyne detectors were then initially demonstrated to our Navy and put into actual military and commercial service. And it was in no small measure the loyal and eager patronage, the hard-found dollars from the ever-spreading hordes of hams during those struggling pre-war and patent-litigation days, which enabled my early development of the Audion, Ultra-Audion and oscillion to continue.

And what this nation (and all nations) owe to the Radio Amateur for his eager enlistment during the war, for his sleepless vigilance in times of storm or disaster, his ever-ready aid to explorers—the MacMillans, the Byrds, the McDonalds—for his clever ingenuity in developing new hookups, his willingness, when forced into the “useless” short-wave bands, to carry on and thereby demonstrate new possibilities to older engineers in an art already become conservative and skeptical—until today the entire world spins enmeshed in a friendly web of antipodal C.Q. megacycles—these not all the volumes of a thousand *Q.S.T.’s* can ever adequately record!

Foremost in the world awakening to the marvels and the friendliness of short-wave wireless will always stand the American Radio Relay League. Its growth year by year has never languished, rather increased. The 5,000 ham stations of 1934 have already increased to more than 80,000.

When addressing gatherings of members of the American Radio Relay League, or any similar assemblage, I like to dwell on the prospects and problems now facing television, and on the importance of study, notably in the fields closely allied to radio.

I urge upon those who are experimentally inclined to haunt the libraries, to get out of the usual radio ruts, the mere rehashing over the air of their present "rigs"—to look ahead and afield—to see if they cannot contrive some radically new improvements, discover some new principle or a novel application to radio of a principle already known in some other branch of science.

Thus I point out that the frontiers of radio and electronics lie still beyond, are ever widening as we advance, presenting fascinating vistas, as alluring and unlimited as those which beckoned me fifty years ago when I began my earliest experiments in wireless. My message to all radio-minded youths: study, think, prepare for research and invention, keep out of the usual rut, explore, pioneer, and eagerly push forward. The rewards—uplifting, self-gratifying, if not often financial—will be well worth all the effort expended.

THE VETERAN WIRELESS OPERATORS ASSOCIATION, INC.

This group is made up of professional wireless operators having ten years or more of practical experience in civilian or governmental service. Honorary membership is conferred upon individuals other than veteran operators who have "contributed signally to the art of wireless telegraphy." I have been Honorary President of the association since 1939—an honor which I deeply cherish. Each February I send a message to be read at their "Annual Cruise."

V.W.O.A. keeps constant watch over the saving of life through the medium of radio communication, and the heroic actions of radio operators are memorialized by presentation of its Scroll of Honor in recognition of distinguished service in the line of duty. Few professions can boast of more glorious traditions than wireless communications, and the V.W.O.A. is ever alert to recognize and encourage meritorious service on the part of members and nonmembers alike.

THE INSTITUTE OF RADIO ENGINEERS

As its name implies, this organization draws its members from the profession most actively engaged in the advancement of radio science. Founded in 1912 as a successor to the Society of Wireless Telegraph Engineers, it has ever since been closely identified with the major developments of the electronics industry, and remains today one of the most enterprising and highly respected of all the many technical societies. I am proud to have been one of the original members of this splendid organization.

Cofounder and one-time president of the I.R.E. was my very dear friend, John Stone Stone. This friendship began at the St. Louis World's Fair in 1904 and lasted without interruption right up to the time of his death on May 20, 1943. Often he aided me in the involved mathematics of some radio problem on which I was working.

My parting tribute to this great man was published in the September, 1943, issue of *Proceedings of the I.R.E.*

In the lamentable death today of John Stone Stone, the radio engineering profession has lost one of the few who remained of the original pioneers of wireless. And none of those early researchers into the great new realm revealed by the immortal experiments of Hertz can begin to compare with Stone in clear-sighted mathematical analyses of the basic principles on which the science of radio is founded. He was the first of us all to reduce to concise analytical terms the fundamentals of synchronism, mapping precisely the laws of resonant, tuned circuits, then but dimly understood. Even today no exposition of these laws of circuit resonance has been so clearly set forth as in the early patents of John Stone Stone. His theoretical analyses are classics for their insight and clarity of exposition. John Stone invariably prepared his own patent papers and I know of none in any art whose language is so precise, yet so elegant in expression. To read them is a delight, for they may well be classed as literature, difficult to the layman, but of the highest order.

When Marconi's early experiments were first heralded, Stone turned his keen and highly ingenious mind to the fascinating problems of wireless communication, embarking upon a career of theoretical yet practical research, marked by no less than 100 patents in the new art.

One of Stone's earliest patents covers broadly the basic principles of direction finding and wave projection. In this special field his brain was transcendently brilliant. In later years, following the advent of short-wave transmission, the new science and technique of directive antenna arrays owes its origin and completeness largely to the genius of John Stone Stone. His many patents in this branch are truly basic and show amazing ingenuity and widest knowledge.

I shall never forget that Stone was the first radio engineer to recognize the epochal qualities of the grid Audion tube. As early as 1907 he was extending to me needed encouragement in its development, at a time when few indeed foresaw the possibilities lying latent in that Promethean device.

As he grew older, his ingenuity never wearied, never grew stale. Whenever I visited him in San Diego, where his ailing heart had forced him to live quietly, almost as a recluse, for the last twenty years of his life, he would eagerly describe novel ideas and new inventions, on which he was then preparing patent papers.

His mind was ever sparkling and effervescent, a quiet humor ever pervading; ready and keen for a joke, he laughed easily and loved a good story; a somewhat Rabelaisian spirit—a friend of rarest worth, such as are too seldom known on earth, such as I shall never find again.

By the irony of fate Stone's death occurred less than one month before the Supreme Court of the United States, in a historic decision handed down June 21, 1943, announced the invalidity of the once famed "four-tuned circuits" patent of Marconi. This was the Marconi patent that almost stopped the American De Forest Wireless Telegraph Co. in 1905. The belated decision was therefore especially interesting and gratifying to me.

In coming to its decision, the Court laid especial emphasis on the early work of Stone and Tesla, particularly the Stone patent No. 714,756, applied for nine months prior to Marconi's and allowed February 2, 1902, a year and a half before the grant of Marconi's patent. This, the Court said, "showed a four-circuit wireless telegraph apparatus substantially like that later specified and patented by Marconi. It described adjustable tuning . . . of the closed circuits of both transmitter and receiver, with antenna circuits so constructed as to be resonant to the same frequencies as the closed circuits."

The Court points out Stone's emphasis on "loose coupling," the first in the art so to do. Quoting freely from the Stone patent, the Court adds: "These statements sufficiently indicate Stone's broad purpose of providing a high degree of tuning at sending and receiving stations," and "Stone's full appreciation of the value of making all of his circuits resonant to the same frequency. . . . Stone showed tuning of the antenna circuits before Marconi, and if this involved invention, Stone was the first inventor."

Incidentally, in the same opinion, but in connection with another suit, the Supreme Court found the Fleming valve patent to have been invalid long before the first infringement suit was filed under it, in 1915. The disclaimer of obviously too broad claims then filed did not in any wise restore that patent's validity.

About this time Sir John Fleming, still unregenerate at ninety-two, published an amazing article in which he ignored all the earlier work done with the rectifier valve by Preece and Howell, claiming even the discovery of the so-called "Edison effect," but never mentioning Edison's name! For this omission I wrote him in righteous reproach, incidentally calling to his attention the recent Supreme Court decision. Fleming's reply evinced profound disdain for what a mere Yankee court might think of his best-loved child. Having married a young opera singer at 84, he lived to the ripe old age of 95, dying in 1945. He never yielded in his firm conviction that he was radio's true inventor!



CHAPTER *SI*

Finale

FINDING that I can no longer endure Chicago's winters as I did fifty years ago, I now divide my time between my Los Angeles home and the inspiring big windy city beside the lake I learned to love when Wireless and I were both very young. And here I am actively engaged in my experiments on color television and other projects.

My present extremely fascinating television work is carried on in the Chicago American Television Laboratories, as Director of Research in collaboration with U. A. and John Sanabria. My winters are serenely spent in our Hollywood home, in electronic study, reading, and reveling in the world's best music from the world's finest phonograph instrument; these lavishly interspersed with inspiring trips to Nature's varied wonderlands throughout our great West.

And thus I propose to keep happily at my work until the End of the Chapter!

I am still inventing and experimenting. Five patent applications are now pending—relative mostly to color television systems.

Still others are in gestation. Today's technological and scientific progress is so amazing, so continuously, increasingly fascinating that my interest therein remains yet keen. While my inventive faculties are yet active, some of the old eager enthusiasm for inventive research has, quite naturally, diminished.

My 1947 winter in Chicago, the first since 1901, brought me the satisfaction of the Fortieth Anniversary of my Amplifier Patent, celebrated in a noteworthy issue of *Radio-Craft* in which my good friend from earliest radio days, Editor Hugo Gernsback, impressively summarized the early invention of the Audion and its subsequent development.

Coincidentally, the American Institute of Electrical Engineers bestowed upon me my most cherished honor, the Edison Medal for 1946—a laurel better late than posthumous! The medal was awarded “for pioneering achievements in Radio and for the invention of the grid-controlled vacuum tube with its profound technical and social consequences.”

I have lived long enough to see new inventions come into existence which are bound, in part at least, to supersede inventions of my own. That is, of course, the inevitable result of progress.

Chiefly as a result of Bell Laboratory research, science has discovered at least three non-grid amplifiers! Most useful is the “transistor,” utilizing a form of the old crystal detector, but with two “cat’s whiskers” exceedingly close together upon a germanium alloy surface with two biasing batteries. Now made rugged and dependable, the tiny transistor amplifier promises great utility where space, low cost, and permanence are important factors. It is especially useful in midget sets, such as hearing aids, and long-line amplifiers, where its inherent noise is not serious.

Another type is the “traveling wave” amplifier, possessing valuable properties for microwave work where very wide bands

of frequencies are involved. Here the energy of a microwave train is greatly enhanced by an accompanying beam of electrons from a conventional cathode and gun.

The latest addition to Bell Laboratory amplifiers is the "co-axial, twin, tubular electron streams" device. This also is chiefly valuable in microwave work.

Doubtless other special types of amplifiers will be discovered, in barrier layers, semiconductors, and matter under stress. But, by and large, the electron *in vacuo* will continue to rule the amplifier roost, and we may rest assured that generally that roost will be in the form of a grid!

My travels about the country in recent years have afforded frequent opportunities for seeing my daughters and grandchildren. The coming of this new generation has strengthened family bonds and brought new joys to my passing years.

Harriet, my eldest daughter, has had a varied career. She studied at the University of Wisconsin, then in Paris, evincing unusual talent as an artist, especially in portraiture. For a time she lived with her mother, Nora de Forest Barney, in Greenwich, Connecticut, until she married Marshall Allaben, Yale '29. Soon after the birth, in 1935, of their first child, Catherine, Harriet learned to fly. She rapidly acquired such skill as an aviatrix that the Navy employed her during the early war years to instruct cadet and officer flyers at a Pennsylvania training camp. Only the approach of childbirth caused her to stop. In August, 1943, identical twins were born to the Allaben family—Lee de Forest and Stanton de Forest—the latter named for Harriet's maternal great-grandmother, Elizabeth Cady Stanton, America's first suffragette.

So fascinated with aviation was Harriet that following the war she and Marshall operated a flying school for two years at Plymouth, Connecticut. After several planes were cracked up by

green students, she abandoned professional flying and again took up her brushes for a livelihood.

I regret to record that divorce has subsequently split the Allabens—the twins remaining with their father and Catherine living with her mother. In 1948, as Mrs. John Wagner, Harriet added a fourth grandson, John, to my family tree.

I am very proud of a most lifelike portrait which Harriet recently painted of me. It now hangs in my music room in Hollywood.

After our separation, Mary Mayo lived for two years with our two little daughters in Montreux, Switzerland, and in Paris. I visited them there in 1927 and 1928. Later they returned to a New York apartment. I found that Eleanor had acquired a fluent command of French in the *écoles* of Paris and Montreux. Back in America she was placed in a private school near Ossining, New York, and later attended Briar Cliff High School, where she remained deeply immersed in her literary studies until her graduation in 1936.

I then induced her to accompany me to our Hollywood home. Mary Mayo soon followed her favorite daughter, and the two dwelt together in Los Angeles until Eleanor married Hugh Bream, an upright, 6-foot-3 citizen of Azusa, California. Shortly thereafter Hugh was inducted into war service, became a radar expert, and saw fierce fighting at Okinawa. Again I have to record that, following the paternal tradition, Eleanor and Hugh were eventually divorced.

In June, 1949, she married again—this time a bright, hard-working University of California "G.I." student in electrical engineering, Fred Peck by name. I predict lasting happiness, for they are very much in love. They now reside in West Los Angeles.

Marilyn continued to dwell with her mother until old enough to enter Mary Immaculate Convent in Ossining. There she won the love of all the sisters and obtained a fine grammar- and high-

school education. On my every trip east from California I would go up to the convent to spend happy hours with that lovely budding flower. She graduated in 1941, and sought to train as a nurse in Westchester Hospital, but her health began to break under the heavy strain of her duties. During the war she worked in a large eastern manufacturing plant until I brought her to Hollywood to live with Marie and me. While serving as nurse in a near-by doctor's office, she met and fell deeply in love with Major Edwin Swanke, graduate of Iowa State College, then recently returned from three harsh years of military duty in Burma. The two were married in Spokane, Washington, where he was then stationed. Shortly afterwards they moved to Fort Francis Warren at Cheyenne, Wyoming. There Edwin Lee was born, July 26, 1947. So fine was Major Swanke's postwar service record that, after careful screening by Army Headquarters, he was recently promoted to highly confidential work in the Atomic Energy Corps and is now living with his small family at Albuquerque, New Mexico.

My sister, Mary, was married in New Haven in 1901 to Rev. Philip Ralph, then recently graduated from Yale Divinity School. That union was blessed with three stalwart sons, Henry, Philip Lee, and Robbins. The elder Ralphs now reside in St. Petersburg, Florida.

In April, 1947, following two years of a distressing nervous illness, my only brother, Charles, succumbed at the age of 69. In tribute to a life chiefly devoted to the cause of Youth, his close friend and classmate, Robert V. Spencer, has published this estimate of his work with the National Tuberculosis Association:

As most of the world's millions of radio listeners are ignorant of the inventions of Dr. Lee de Forest which made national and international broadcasting possible, so the tens of thousands who are alive and well to-

day because of his brother Charles's work as field secretary of the National Tuberculosis Association have forgotten or never knew the name of their benefactor.

During the two years that Charles served as national seal sales secretary, he helped to set up the ground structure which for years has made tuberculosis work the best financed of any of the national voluntary health agencies.

His fund-raising work was dwarfed in importance by his Children's Modern Health Crusade. Starting at a time when child-health work in the public schools of the country was still in a very crude stage, he organized upward of four million schoolchildren in his brigades for health-habit formation by doing. The Crusade became so strong that many school systems which would not co-operate with any outside movement were obliged to improve their health-education curricula. The writer, without fear of challenge, asserts that no other man or woman, living or dead, ever gave child-health education such a forward impetus.

Charles left a son, Dr. Walter de Forest. His son, my grand-nephew, born in December, 1949, bears the name Robert Lee de Forest. I am most happy to see my name thus perpetuated. Doubtless the young man will sign his name, "R. Lee de Forest."

These later years are often saddened by the black-rimmed post cards from my Class Secretary, telling with increasing frequency of the passing, one by one, of the men I knew and loved as lads at Yale. Many also of the old pioneers in Wireless have gone, stanch and loyal associates, employees, or collaborators in days when the strange new science and industry of Radio Communication were in the making—Babcock, Shoemaker, Mac Horton, Logwood, Butler, and Galbraith.

Late in 1947 the sudden and unexpected death of my best-loved friend—and valiant champion in all my patent litigation since 1915—came as a grievous blow. In all his work and his play Samuel Edgar Darby, Jr., was ever as he was on that first Armistice Day in Paris—full of youthful energy, enthusiasm, and the joy of living. Few men ever got so much out of a moment of time as did Sam Darby. Few ever worked so hard,

or to such amazing advantage, as he. It was his exhaustless energy and verve, his ceaseless determination to do the job himself, quickly, efficiently, and successfully, that kept in him the fires of effort which must necessarily consume him in the end.

No patent attorney has appeared so often before the United States Supreme Court as he. During the last ten years of his work he won all but three of the cases tried before that august tribunal. The legal profession has lost an outstanding figure—a veritable giant, a true genius. We shall not see his like again. His loss to his family, associates, clients, friends—and even his opponents at law—is an irreparable tragedy.

“Lo! some we loved, the loveliest and best
That Time and Fate of all their vintage prest,
Have drunk their cup a round or two before
And one by one crept silently to rest.”

A few stanch hearts still beat (my own among them), but the lengthening shadow on the dial relentlessly seems to read: “It is later than you think.”

Throughout my life I have sought to keep my feet on the ground of actuality and realism. I have never heard “wireless signals from Mars”; nor shared in the vaporings of those who foresee mankind’s interplanetary navigation. And although my spirit can soar beyond the star-spattered walls of our universe, I refrain from any unbased belief that each individual on earth may some day “wireless” to any other. I recognize the electromagnetic laws—and the FCC!

Always of a studious nature, I have learned many lessons from life. A most fascinating teacher I have found her—severe, insistent, reiterant, unyielding. Perhaps her lesson of the greatest import, the most widely applicable, is that truth is absolutely independent of advantage or desire.

Fact is fact, nor can it be altered by opinion or belief. Tradition, early teaching, the “point of view”—may all be wrong—

were usually proven so to be. Faith in supernatural power, in any aid from "Divine Providence," proved to be snare and delusion. We are what we make ourselves. We can be and can accomplish only what our strength of character, of will, plus our mental and physical equipment can, under the laws of psychology and physiology, achieve: these, aided by good fortune or "luck." If good fortune is not with one, if one has no "luck"—one must but battle the harder to overcome the handicap.

Perhaps a little more of good nature, of early affability, of social friendliness, generosity of spirit, or broader point of view, would have found more friends worth while and able or willing to aid over life's roughest obstacles.

But—with or without "luck"—courage, persistence, pluck, energy, awakeness to opportunity, foresighted vision, can win—given only health.

So much for the standpoint of achievement—life's success, as the world visions it. But life has taught me another lesson, from a subjective standpoint even more valuable. That is the genuine worth of appreciation of the Beautiful, a vital love for all that the world of Nature and Art offers of the magnificent, the inspiring, the glorious of form, the harmonious of color, the harmony of sound. Regardless of what wealth and fame life may have won—the spirit which is blind to Beauty, or deaf to the exquisite joy of Music, will go through life forever and hopelessly a pauper.

Life has taught me the need to create, the joy of creation—the richness of Life's Beauty.

Health, and the joy of living, the bliss of requited love, ecstatic moments, gladness of the spring and sunshine, a child's guileless affection, moments of great music—these and their glad memories—the intense satisfaction of creative accomplishment, of ameliorating in some degree the lot of our fellow man; that rare ability to realize present happiness, unalloyed by anticipation or

postponement; joy in nature's communion; contemplation of the infinite universe from whose atoms we have evolved and into whose star-shadows we shall everyone eventually merge—these alone are our golden sands, pitiably few, fragmentary, ephemeral, upon the shores of our earthly "Paradise."

Towards the close of a long life the composer Haydn wrote to a group who had expressed pleasure in his oratorio, *Creation*:

You gave me the welcome assurance—and this is the greatest comfort of my declining years—that I am often the source from which you and many other families receptive to heart-felt emotion, derive pleasure and satisfaction in the quiet of your homes. How soothing this reflection is to me!

It has been my great good fortune deeply to realize a pleasure and satisfaction like to those which Haydn thus so feelingly expressed.

Alexander Graham Bell once said to Helen Keller: "It is not you but circumstances that will determine your work." Save in the one chance instance of the flickering Welsbach burner in Chicago, I cannot say that in my case his statement was true. In spite of circumstances, always most unfavorable, I hewed out the way I had mapped for myself—against poverty, despite adversity, cynical skepticism, and endless discouragement, and without adequate tools, financial or other.

Looking back today the course I have followed, spite of fate and love and hate, seems incredible. But I had the vision, inner faith in myself, the inflexible resolve, the all-so-necessary courage.

Appendix

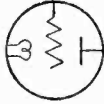

Poems

Regret

If I could loiter in green fields where birds are singing,
If I could lie beneath some green-thatched tree,
If deep long breaths into my heart were bringing
Again the Spring and Springtime's harmony;

If from the eager battlegrounds where wealth is won
The visions of a boyhood dream could veil my life's success,
And to ambition's striving for a moment bring oblivion—
Methinks I might, perchance, again taste happiness.

But yesterday there lived—Ah saddest of all sorrow—
Realities which now mere mocking fantasies appear;
Alas those sunlit songs, forever and tomorrow,
Have grown too faint, too tremulous to hear!

May, 1905

Autumn Evening in Garfield Park

(after Walt Whitman)

As I rode through the park at evening,
As I rode through the park toward the descending sun,
I breathed deep the fragrance of the Fall—
The breath of grass, new mown and dying in the autumn air;
The perfume of dead leaves dropping from the branches—
The dead leaves which rustled, ghostlike, as I rode over them—
The odor that rises with Autumn, from the decaying year.
I saw the soft light looming up from the golden lake,
And sifting through the drooping harp strings of the willows, bowed
 above the lake.
I saw the feathery clouds, white in the sapphire sky,
And the white flotilla of swans, ebbing over the azure water.
From the rosy light into the dark shadows they glided,
Save where golden lances from the low-set sun flashed through the
 aisles of trees upon them.
All was beauty beyond man's expression,
Beauty that I cannot describe, nor that any poet can describe.
Such beauty can be told of only by music,
Music such as the sun's fingers play on the strings of the willows,
As the wind breathes at evening and whispers to the branches;
Or as the twilight murmurs as it steals softly from the east;
Or as the songs of birds at morning or evening, in exquisite tone tints,
Plaintive calls, delicate twittering, an endless flow of lawless melody,
Rising in one voluptuous flood of mellow song.
Yet have I heard such descriptions in music which man has written—
Beethoven at times, and Wagner, and especially Mascagni, the Italian.
In the city and opera, and far from the beauty of the fields and sky
I have heard the tonal counterpart of all the glories of sight;
And I have blessed *Music*, because she alone could so describe my
 Paradise.

October, 1900

Dream Rose

What were the dreams of the Rose
Ere the dawn stole over the eastern height
Rifting with gold the curtains of night,
All purple the valleys flushing?
Soft as the sun-kissed petals uncloze,
Vanished the dews with the secret heard
To inspire the passionate song of each bird,
And left the red rose blushing.

I saw my Love asleep
In her chamber with the deep
Cool shadows of the morning and night's angels guarding there,
Her face in sweet repose,
Fairer than Aiden's rose—
Deep harbored in the wavy ripples of her hair.

I dared to claim as mine
This rose so all divine,
And kneeling touched so sacredly the lips of her.
Softly unclosed her eyes,
Twin gates of Paradise,
Wreathing a smile more sweet than Paradise itself can e'er confer.

Of me were the dreams of the Rose,
While the poppy's breath was wafted down
To the vale where she dwelt, while the lotus crown
On her Fancy's world lay gleaming.
Ah Fate! That my kiss should a thorn disclose,
To stab through my heart through the years while I wait!
Would God, by the port of the Ivory Gate
I had left her to her dreaming!

February, 1902

Los Angeles

Well named the Padres in the olden time
This Eden near the westward seas,
Where fadeless flowers, and spirit airs combine
To spell the words—*Los Angeles!*

Dawn, from her amber chalice spills the fading stars;
Dew-pearls with rubies cluster in the pepper trees
Where wakening birds, the morning's vibrant messengers,
Spread their glad wing—*Los Angeles.*

Empyrean noon a golden mist distills
On golden apples of a new Hesperides,
Gleaming in shades of cool green groves, and fills
Ambrosian cups for gods—*Los Angeles.*

Descending suns from vineyard clouds have pressed
The red of priceless vintages,
And, drunk with wine of Empires of the West,
Sink in the purple sea—*Los Angeles.*

Above the nodding palm plumes of the plain
Swings the full moon. In ghostly mists she sees
The phantomed shapes of sunlit years again
Lavished in glorious dreams—*Los Angeles.*

1912

California Twilight

I love a pine tree outlined on the night,
Behind it spread a drapery of light—
The moonbeams weaving witchery's delight,
Mysterious, mysterious.

I love the glimmer of a mountain stream
When twilight's glow has faded to a dream,
In pools where mirrored stars descending seem
Pendulous, pendulous.

I love the spectral shadows of the hill
Across the canyon, when the night is chill,
And silence seals the river, singing deep and still
Melodious, melodious.

September 2, 1911

To Mary

The beauty of her arm entrances me
As I behold it limned against a veil
Of purple, as by twilight on the sea
The purple mists in parting might reveal
A slender rift of glory lingeringly.

The beauty of her upturned face!
I saw it limned against the mist
Of gossamer her fingers' grace
Held gently as a wafted kiss
That hovers birdlike o'er its nesting place.

1913

September

In the cool September morning
When the diamonds dew the lawn,
And the eastern skies are forming
Mist-framed memories of dawn,
Southward flows the sapphire river,
Heartward flows my blood, aquiver
With the gladness that I thrilled to when a boy.
Cares seem then a desecration,
Every breath exhilaration,
Every glance brings inspiration
And a boundless joy.

In the rich September evenings
When the river, silver-clear,
Loiters where the misty weavings
Of the Palisades appear.
Northward float the star-lit steamers
To a shadowland of dreamers,
Lotus-eaters, in a land beyond our view.
O'er the waters moonbeams falling
Pave a path for fairies, calling
To my heart, my Love, enthralling
Heart o' mine and you.

Circa 1916

Riverlure

By Riverlure the tall trees stand
Erect and slender as a wand,
Straight sentinels on every hand
To guard my loved one's slumbers.

O'er Riverlure the still trees dream
Above the wavering, wind-soothed stream
When silver weaves with golden gleam
A carpet of Hesperides.

A magic carpet year by year
Night and the stream have woven here,
Ever receding, and yet more near,
For my fancy's travels.

When sinks the moon on the Palisades
And the golden carpet mystically fades,
Upon it I join in the stars' parades
Over far fields of shadow.

Far and away to the sunset lands
Where the garnered stars form an ocean's sands,
Past cities and temples not made by hands
And castles builded in dreams.

Opiate vapors and opaline hues,
Dews of the fountain and night-distilled dews,
Moon paving peace o'er the star avenues,
And a path through the trees to the river.

1916

Roses of Riverlure

"Let's dream us back in Arcady!"

Here high above the river's brink
Is the same green hedge, and by its side,
Blooming in lonely loveliness,
Roses of Riverlure abide.
Red for your lips; for your cheeks the pink;
Some white as the flesh of your bosom's snow.
Their petals still nod to the wind's caress.
My lonely heart is a wilderness,
Its dim horizon one night and one day
When we plucked the roses of Arcady.

"Let's dream us back in Arcady!"

And traveling swiftly through the night
To an Inn beside the tranquil lake;
How gladly gay your laughter light
By the fount of the foaming wine!
Apples of Eden you bade me take,
Eve's fairest child; each sinuous line
Ensnared me, 'til the break of day
New roses brought to Arcady.

"Let's dream us back in Arcady!"

Far down the stream of the winding Loire
Fabled with tales of the Kings of France,
Of War, and the Maid, and the Renaissance,
We found the Roses of Riverlure.
They brought us the moon and the nightingale,
Maintenon's ruins and Chaumont's queen,
(A flash of red in deep aisles of green)
We followed a never-forgotten trail.
'Twould lead you *here*, if you only knew
How sweet are the Roses I'd pluck for you!

Riverlure, July 8, 1928



Evolution of the Audion

Extracts from a paper — "The Audion, Its Action and Some Recent Applications" — which I read before the Franklin Institute at Philadelphia, January 15, 1920.

Analogies are apt to be interesting, and in scientific matters frequently instructive and clarifying. The title of tonight's paper, "The Audion," suggestive of *sound*, prompts the consideration of an analogy in the realm of *sight*—the microscope. The Audion, in a measure, is to the sense of sound what the microscope is to that of sight. As the microscope has opened to man new worlds of revelation, studies of structure and life, and manifestations of natural processes and chemical reactions whose knowledge has proven of inestimable value through the past three generations, so the Audion has, during the scant thirteen years of its history, opened fields of research and wrought lines of useful achievement which may not unfairly be compared with the benefits from that older prototype and magnifier of light waves. But when the first steps were taken in the work which eventually resulted in the Audion of today, I no more foresaw the future possibilities than did the ancient who first observed magnification through a drop of water.

In 1900, while experimenting with an electrolytic detector for wireless signals, it was my luck to be working by the light of a Welsbach burner. That light dimmed and brightened again as my little spark transmitter was operated. The elation over this startling discovery outlasted my disappointment when I proved that the unusual effect observed was merely acoustic and not electromagnetic. The illusion had served its purpose. I had become convinced that in gases enveloping an incandescent electrode resided latent forces which could be utilized in a detector of Hertzian oscillations far more delicate and sensitive than any known form of detecting device.

The first "commercial" Audion, as it originally appeared in 1906, was therefore no accident or sudden inspiration. Failing to find in an incandescent mantle the genuine effect of response to electrical vibrations, I next explored the Bunsen burner flame, using two platinum electrodes held

FATHER OF RADIO

close together in the flame, with an outside circuit containing a battery of some 18 volts and a telephone receiver. See Figure 1—the form used in 1903. Now when one electrode was connected to the upright antenna and the other to the earth, I clearly heard in the telephone receiver the signals from a distant wireless telegraph transmitter. The resistance of this new “flame detector” was decreased when the flame was enriched by a salt. Next the incandescent gases of an electric arc were considered; and likewise the action in the more attenuated gases of an ordinary lamp bulb, surrounding an incandescent filament or filaments.

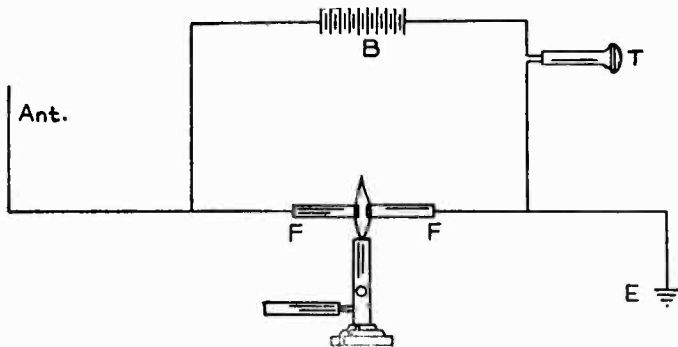

FIG. 1. Gas-flame detector (1903). Ant. = antenna. B = battery. E = earth. F = platinum electrodes. T = telephone receiver.

At the period under consideration, 1903-5, I was familiar with the Edison effect and with many of the investigations thereof carried on by scientists, Professor Fleming among others. In 1904, I had outlined a plan of using a gas heated by an incandescent carbon filament in a partially exhausted gas vessel as a wireless detector, in place of the open flame. But here the rectification effect between hot filament and a cold electrode was not considered. Two filaments heated from separate batteries would give the desired detector effect equally well. What I had already found in the flame detector, and now sought in a more stable and practical form, was a constant passage of electric carriers in a medium of extraordinary sensitiveness, or tenuity, which carriers could be in any conceivable manner affected to a marked degree by exceedingly weak electrical impulses, delivered to the medium indirectly or through the hot electrodes (Fig. 2).

But during these early years I was afforded little time to concentrate on this laboratory problem, and it was not until 1905 that I had opportunity and facilities for putting to actual proof my conviction that the same detector action which had been found in the neighborhood of an incandescent platinum wire in a gas flame existed also in the more attenuated gas surround-

EVOLUTION OF THE AUDION

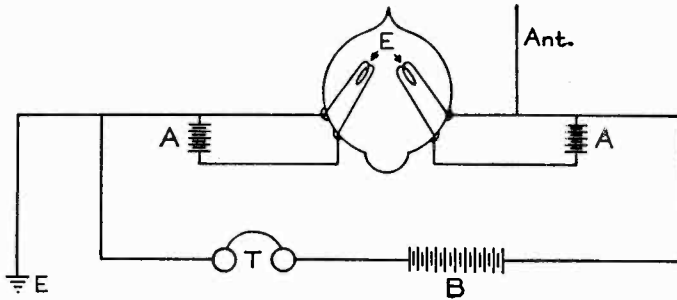

FIG. 2. Plan for an early carbon filament detector (1904). A = "A" batteries. B = "B" battery. E = earth. T = headphone.

ing the filament of an incandescent lamp. In one case the burning gases heated the electrodes; in the other the electrodes heated the gases. But in both it was, *first*, the electrons from the hot electrodes, and, *second*, ionization of the gases which these electrons produced, that established an electrically conducting state which was extraordinarily sensitive to any sudden change in electrical potential produced on the electrodes from an outside source.

The ordinary small incandescent lamp of that epoch supplied admirably the conditions I required, merely by the introduction of a second electrode. That added electrode could be either hot or cold. Obviously, therefore, use it cold, avoiding thus the unnecessary battery. Then obviously, too, I must so connect my telephone battery as to make this cold electrode positive, for otherwise no local current could flow through the gaseous space in the lamp between the unlike electrodes (Fig. 3).

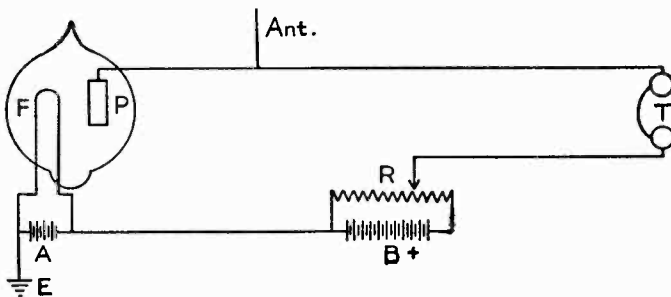

FIG. 3. First two-electrode Audion (1905). A = "A" battery. B = "B" battery. E = earth. F = filament (hot electrode). P = plate (cold electrode). R = condenser. T = headphone.

FATHER OF RADIO

Considering this actual genesis of the Audion it will be seen that it was never, strictly speaking, a *rectifying* device. True, both electrodes were seldom alike and a "polarization" was always had from the outside battery, but any rectification of the alternating currents impressed on the detector was merely incidental and played no vital part in the action of the Audion. From the beginning I was obsessed with the idea of finding a *relay* detector, in which local electric energy should be controlled by the incoming waves—and not a mere manifestation of the electrical energy of the waves itself. Hence it was that the external battery as a source of local energy was always employed. The incandescent filament was utilized as the source of electric carriers through the gas. The battery for lighting the filament F was styled the "A" battery and, as distinguished from this, the other battery was named the "B" battery. This nomenclature has been retained, and is today commonly accepted, even by the many who for various reasons refuse to recognize the name "Audion."

The two-electrode Audion, with A and B batteries, was not primarily a "valve." And I have always objected to this misapplication of the name *valve* to the Audion; a name which our British friends have from the first persisted, with a stubbornness worthy of a better cause, in misapplying. The responsive action of this two-electrode Audion was due to the asymmetry of its characteristic curve, rather than to its rectifying property. This latter property could be made to aid, to increase the intensity of the signal produced originally and mainly by the so-called "trigger," or genuine *relay* action of the device, which was always *controlling* the local energy by means of a much smaller income energy. But aside from this effect, the rectifying property of the tube had no importance.

Long before the two-electrode relay Audion of 1905 had a chance to prove its worth in commercial wireless service, I had found that the in-

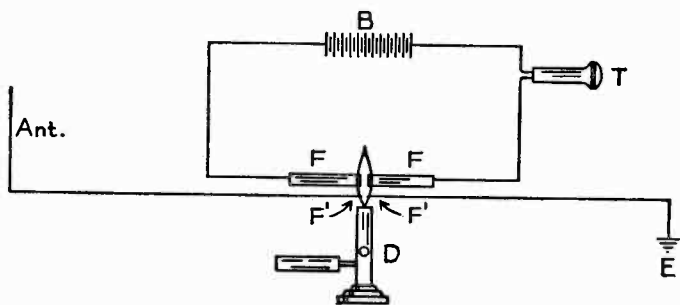

FIG. 4. Three-electrode gas-flame detector (1903). B = battery. D = gas burner. F = platinum electrodes. F' = third electrode. T = telephone receiver.

fluence of the high-frequency impulses could be impressed to better advantage on the conducting medium from a *third* electrode. In its first inception the third electrode also dates back to the flame detector of 1903. Figure 4, taken from the earliest patent of the Audion group, shows the original idea of keeping the high-frequency current path distinct from that of the local telephone current. Consequently, after I had secured the maximum efficiency from the two-electrode vacuum type, it was but natural to revert to this earlier plan of separating the two circuits. The new electrode connected to the high-frequency secondary circuit was at first applied to the outside of the cylindrical lamp vessel; the other terminal of the secondary circuit was led to one terminal of the lamp filament. Figure 5, of a 1906 patent, shows this progenitor of the third electrode. This simple arrangement proving to be a step in advance, I concluded that if

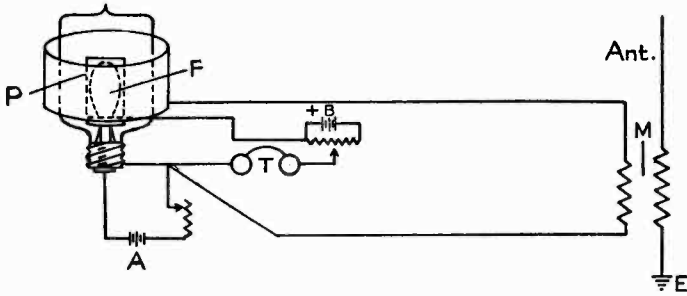

Fig. 5. Early Audion with third electrode outside the lamp (1906). A = "A" battery. B = "B" battery. F = filament. M = high-frequency transformer.

this auxiliary electrode were placed within the lamp, the weak charges thereto applied would be still more effective in controlling the electronic current passing between the filament and plate.

Figure 6, taken from a patent filed two months after the preceding one, illustrates the next arrangement tried. Here I used two plates, one on either side of the filament—one in the telephone circuit, the other in the high-frequency circuit associated with the antenna. It will be noted also that here for the first time was shown the third, or "C" battery, in the input circuit, so much employed of late, notably when the Audion is used as amplifier of telephonic currents. This two-plate device proved to be another decided step forward, and I realized then that if this third electrode were placed directly in the path of the carriers between the filament and plate anode, I would obtain the maximum effect of the incoming

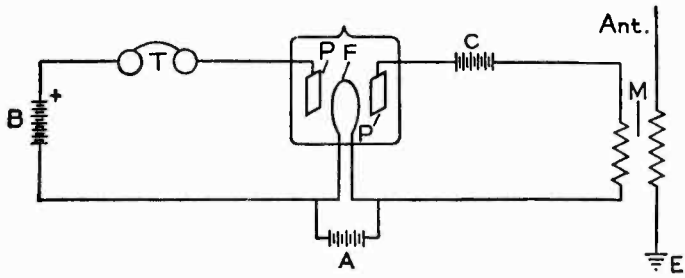

FIG. 6. Two-plate Audion (1906). A = "A" battery. B = "B" battery. C = "C" battery. F = filament. P = plates. M = transformer.

impulses upon the local current flow. But obviously another electrode thus placed directly in the stream must not be a plate—it must be perforated to permit the carriers to reach the anode. A wire bent back and forth in the form of a grid should answer admirably. Figure 7, taken from the patent filed in January, 1907, the so-called "Grid Audion" patent, illustrates the preferred form which the idea promptly assumed.

It was in the summer of 1912, when at work on the problem of Audion amplifiers in cascade arrangements for telephone repeaters, that I first discovered that if the input, or grid, circuit was inductively coupled with the output, or plate, inductance, the Audion became a *generator* of continuous alternating currents, originally made evident by a shrill tone in the telephone receiver. The explanation of the operation is simple. An initial impulse in the plate circuit, however produced, induces a similar one in the grid circuit, which, if of proper polarity, will impress on the grid a

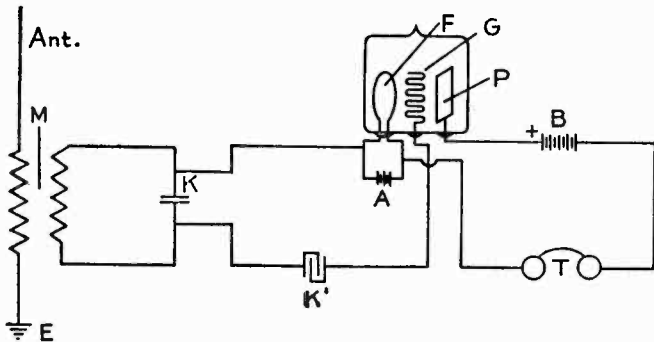

FIG. 7. Grid Audion (1906). F = filament. G = grid. K = condenser. M = transformer. P = plate.

sudden change in potential which may in its turn produce an impulse in the plate current in the opposite direction to the original disturbance. This reaction then becomes self-sustaining, provided the resistance and hysteresis losses in the two circuits are not too great. The amplitude of the oscillating current thus set up goes on increasing, taking energy supply from the B battery, until the losses in the circuits equal the increment of energy drawn from the battery. Thereafter an alternating current of perfectly constant amplitude and wave form is maintained.

A few months after this type of circuit was first used for the production of alternating currents of audible frequency, I demonstrated the fact that weak *high-frequency* currents could equally well be generated, simply by substituting radio-frequency coils for the original iron-cored coils, and small variable air condensers for the large telephone condensers of the

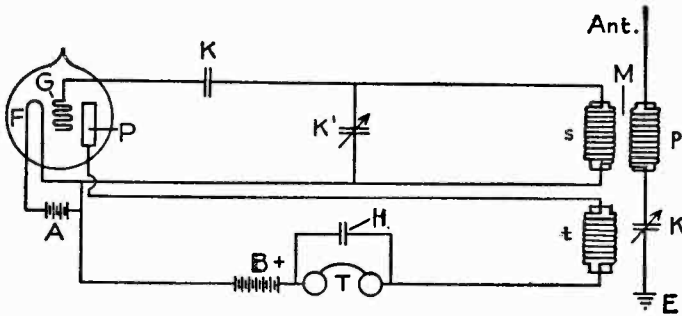

FIG. 8. Ultra-Audion oscillator (1913). F = filament. G = grid. H = high-frequency condenser. K = variable condenser. M = transformer: p = primary coil, s = secondary coil, t = tertiary coil. P = plate.

original experiment. And quite naturally, also, since I was at the time engaged chiefly in work on undamped-wave radio transmission, this generation of radio-frequency waves was first demonstrated in receiving heterodyne—or, more exactly, autodyne—signals. The circuit used at this early date, April, 1913, which was almost identical with that in Figure 8, shows the usual antenna receiving circuit, the usual secondary circuit connected across the grid and filament of the Audion, but with another coil similar to the secondary in series with the telephone receiver, which in this case was bridged by a small condenser.

In the fall of that year my assistant, Charles Logwood, and I discovered, largely by accident, that if the secondary receiving circuit be connected across the grid and plate, instead of between the grid and filament of an Audion, the circuit became a persistent *oscillator*, very simple and effective

as a receiver of undamped-wave signals. On account of the great sensitiveness of this combination the name "Ultra-Audion" was applied to it. Countless modifications and adaptations of these two general types of oscillating Audion circuits have been developed by radiomen here and abroad.

For their simplicity, the ease with which all the advantages of the beautiful heterodyne principle of Vreeland and Professor Fessenden can be realized, the clarity of note and range of pitch which the receiving operator can instantly command—coupled with a degree of sensitiveness of a different order from that of any other type of detector—these advantages very quickly relegated to the scrap heap the ticker and tone wheel; and at once placed the transmission by undamped waves upon an altogether different level from that of the older spark methods.

There seems to be in fact no limit to the number of applications to which this three-electrode vacuum tube can be applied as a tool in the hands of the experimental physicist. For one fundamental property of the Audion is that an electrical influence in one circuit may, through the grid, be made to produce effects in another circuit without appreciable reaction. For the energy absorbed by the control electrode may be considered negligible—frequently far less than that required in moving a galvanometer needle.

Probably the most promising field of all, the arrangement of Audions in cascade as amplifiers, of pulsating currents of any form or frequency, opens to the ear what the microscope has given to the eye—new regions of research in numerous and diversified fields. With such a series it is possible to detect with certainty alternating currents of one ten-thousand-millionth of a volt on the input grid—involving magnifications of the order of twenty billion times.

Little imagination is required to depict new developments in radio telephone communication, all of which have lain fallow heretofore awaiting a simple lamp by which one can speak instead of read.



De Forest Patents 1902 - 1949

716,000, Dec. 16, 1902,	Apparatus for Space Communications
716,203, Dec. 16, 1902,	Wireless Telegraphy
716,334, Dec. 16, 1902,	Method of Communicating Through Space
720,568, Feb. 17, 1903,	Space Telegraphy
730,246, June 9, 1903,	Space Telegraphy
730,247, June 9, 1903,	Wireless Telegraphy
730,819, June 9, 1903,	Wireless Signaling
748,597, Jan. 5, 1904,	Wireless Signaling Device
749,131, Jan. 5, 1904,	Wireless Signaling Apparatus
749,178, Jan. 12, 1904,	Wireless Signaling Apparatus
749,371, Jan. 12, 1904,	Wireless-Telegraph Receiver
749,732, Jan. 12, 1904,	Art of Wireless Telegraphy
749,434, Jan. 12, 1904,	Wireless Signaling Apparatus
749,435, Jan. 12, 1904,	Wireless-Telegraphy Generating Set
749,436, Jan. 12, 1904,	Wireless-Telegraph Range Finder
750,180, Jan. 19, 1904,	Spark-Production Control Method
750,181, Jan. 19, 1904,	Device for Cleaning Ice from Antenna
758,517, Apr. 26, 1904,	Art of Wireless Telegraphy
759,216, May 3, 1904,	Wireless Signaling Apparatus
770,228, Sept. 13, 1904,	Receiver for Space Signaling
770,229, Sept. 13, 1904,	Wireless Signaling Apparatus
771,818, Oct. 11, 1904,	Wireless Signaling Apparatus
771,819, Oct. 11, 1904,	Wireless Signaling Apparatus
771,820, Oct. 11, 1904,	Protecting High-Frequency Apparatus
772,878, Oct. 18, 1904,	Magnetic Detector
772,879, Oct. 18, 1904,	Art of Duplex Wireless Telegraphy
806,966, Dec. 12, 1905,	Wireless Telegraph System
822,936, June 12, 1906,	Wireless Telegraph System
823,902, June 12, 1906,	Static Valve for Wireless Systems
824,003, June 19, 1906,	Wireless Telegraph System

FATHER OF RADIO

- *824,637, June 26, 1906, Early Gas Type of Audion
 *824,638, June 26, 1906, Gas-Flame Detector
 827,523, July 31, 1906, Wireless Telegraph System
 827,524, July 31, 1906, Wireless Telegraph System
 833,034, Oct. 9, 1906, Aerophone
 836,015, Nov. 13, 1906, Aerophone
 *836,070, Nov. 13, 1906, Diode Audion with B Battery
 *836,071, Nov. 13, 1906, Gaseous Detector
 836,072, Nov. 13, 1906, Aerophone
 *837,901, Dec. 4, 1906, Diode with Mercury Anode
 *841,386, Jan. 15, 1907, Audion with External Control Electrode
 *841,387, Jan. 15, 1907, First Audion Amplifier
 850,917, Apr. 23, 1907, Space Telegraphy
 852,381, Apr. 30, 1907, Wireless-Telegraph Receiving System
 *867,876, Oct. 8, 1907, Arc-Type Audion
 *867,877, Oct. 8, 1907, Gas-Flame Detector
 *867,878, Oct. 8, 1907, Oscillation Detector, Gas-Flame Type
 874,178, Dec. 17, 1907, Cold Cautery, Radio Knife
 876,165, Jan. 7, 1908, Wireless-Telegraph Sending System
 877,069, Jan. 21, 1908, Magnetic Detector
 *879,532, Feb. 18, 1908, The Grid Audion
 894,317, July 28, 1908, Electrolytic Detector Electrode
 894,318, July 28, 1908, Aerophone
 894,378, July 28, 1908, Wireless Signaling Apparatus
 913,718, Mar. 2, 1909, Space Telegraphy
 926,933, July 6, 1909, Wireless Telegraphy
 926,934, July 6, 1909, Wireless-Telegraph Tuning Device
 926,935, July 6, 1909, Wireless-Telegraph Transmitter
 926,936, July 6, 1909, Space Telegraphy
 926,937, July 6, 1909, Space Telephony
 *943,969, Dec. 21, 1909, Gaseous Discharge Tube
 966,539, Aug. 9, 1910, Transmitting Apparatus
 973,644, Oct. 25, 1910, Aerophone
 *979,275, Dec. 20, 1910, Gas-Flame Detector
 979,276, Dec. 20, 1910, Space Telegraphy
 979,277, Dec. 20, 1910, High-Frequency Oscillator
 *995,126, June 13, 1911, Amplifier for Radio-Frequency Currents
 995,339, June 13, 1911, Space Telegraphy
 1,006,635, Oct. 24, 1911, Space Telephony

* Patents marked (*) outline, in the order of their filing, the evolution of the Audion from the flame detector to the grid type. The original flame detector patent was filed in 1902 but abandoned for lack of prosecution.

DE FOREST PATENTS

1,006,636,	Oct. 24, 1911,	Space Telephony
1,025,908,	May 7, 1912,	Wireless Music Transmitter
1,042,205,	Oct. 22, 1912,	Duplex Wireless Transmission System
1,101,533,	June 30, 1914,	Wireless Telegraphy
1,123,118,	Dec. 29, 1914,	Signaling System
1,123,119,	Dec. 29, 1914,	Wireless Communication Secrecy System
1,123,120,	Dec. 29, 1914,	Space-Communications Arc Mechanism
1,125,496,	Jan. 19, 1915,	Wireless-Telephone Transmitter
1,134,593,	Apr. 6, 1915,	Electromagnetic-Radiation Receiver
1,134,594,	Apr. 6, 1915,	Increasing Strength of Electric Currents
1,170,881,	Feb. 8, 1916,	Wireless Receiving System
1,170,882,	Feb. 8, 1916,	Telephone-System Automatic Switch
1,171,598,	Feb. 15, 1916,	Radiotone Wireless-Telegraph Spark Gap
1,177,848,	Apr. 4, 1916,	Method of Recording Fluctuating Currents
1,183,802,	May 16, 1916,	Range Teller
1,183,803,	May 16, 1916,	Wireless Telephone System
1,190,869,	July 11, 1916,	Quenched-Spark Discharger
1,201,270,	Oct. 17, 1916,	Oscillating-Current Generator
1,201,271,	Oct. 17, 1916,	Oscillating Audion
1,201,272,	Oct. 17, 1916,	Telegraph and Telephone Receiving System
1,201,273,	Oct. 17, 1916,	Oscillation Generator
1,214,283,	Jan. 30, 1917,	Wireless Telegraphy
1,221,033,	Apr. 3, 1917,	Wireless-Telegraph Signaling System
1,221,034,	Apr. 3, 1917,	Oscillating-Current Generator
1,221,035,	Apr. 3, 1917,	Wire or Radio Communications Apparatus
1,230,874,	June 26, 1917,	Metallic Audion
1,299,356,	Apr. 1, 1919,	Radio Communication Apparatus
1,309,753,	July 15, 1919,	Vibrations Transducer
1,311,264,	July 29, 1919,	Oscillation Generator
1,314,250,	Aug. 26, 1919,	Current-Pulse Reproducer and Amplifier
1,314,251,	Aug. 26, 1919,	Radiotelephony
1,314,252,	Aug. 26, 1919,	Oscillation Generator
1,314,253,	Aug. 26, 1919,	Wire or Radio Communication Apparatus
1,329,758,	Feb. 3, 1920,	Oscillating-Current Generator
1,348,157,	Aug. 3, 1920,	Amplifier for Pulsating Electric Currents
1,348,213,	Aug. 3, 1920,	Radiotelephone System
14,959,	Reissued Oct. 19, 1920,	Wireless Telephone System
1,365,157,	Jan. 11, 1921,	Apparatus for Telegraphy or Telephony
1,365,237,	Jan. 11, 1921,	Endless-Film Arrangement
1,375,447,	Apr. 19, 1921,	Means for Amplifying Currents
1,377,405,	May 10, 1921,	Audion Circuit
1,395,575,	Nov. 22, 1921,	Selective Audion Amplifier

FATHER OF RADIO

1,417,662, May 30, 1922,	Radio Signaling System
1,424,805, Aug. 8, 1922,	Subterranean Signaling System
1,437,498, Dec. 5, 1922,	Oscillation
1,442,426, Jan. 16, 1923,	Sound-Controlled Light Variations
1,442,682, Jan. 16, 1923,	Endless Sound-Record and Mechanism
15,540, Reissued Feb. 13, 1923,	Changing Motion to Electricity
1,446,246, Feb. 20, 1923,	Recording and Reproducing Sound
1,446,247, Feb. 20, 1923,	Light-Controlling Means
1,452,827, Apr. 24, 1923,	Telephone Device
1,466,701, Sept. 4, 1923,	Light-Variation Current Control
1,478,029, Dec. 18, 1923,	Radio Receiving System
1,482,119, Jan. 29, 1924,	Recording and Reproducing Sound
1,486,866, Mar. 18, 1924,	Sound Producer
1,489,314, Apr. 8, 1924,	Recording Sound
*1,507,016, Sept. 2, 1924,	Radio Signaling System
*1,507,017, Sept. 2, 1924,	Wireless Telegraph and Telephone
1,515,152, Nov. 11, 1924,	Communication System for Trains
1,526,778, Feb. 17, 1925,	Thermophone
1,543,990, June 30, 1925,	Producing Musical Notes Electrically
1,552,914, Sept. 8, 1925,	Telephone Device
1,554,561, Sept. 22, 1925,	Sound-Reproducing Mechanism
1,554,794, Sept. 22, 1925,	Loud-Speaking Device
1,554,795, Sept. 22, 1925,	Radio Signaling System
1,560,502, Nov. 3, 1925,	Sound-Reproducing Device
1,561,596, Nov. 17, 1925,	Indicating Device for Fluid Tanks
69,443, Reissued Feb. 16, 1926,	Loud-Speaker
1,629,152, May 17, 1927,	Slot Cleaner for Motion-Picture Machines
1,641,664, Sept. 6, 1927,	Electrical Sound-Reproducing Apparatus
1,642,363, Sept. 13, 1927,	Telephone Device
1,653,155, Dec. 20, 1927,	Talking Moving-Picture Equipment
1,659,909, Feb. 21, 1928,	Film-Protecting Arrangement
1,659,910, Feb. 21, 1928,	Slot Cleaner for Phonofilm Attachments
1,680,207, Aug. 7, 1928,	Radio Signaling System

* In the entire communication art the most important and commercially valuable patents since my grid Audion and amplifier patents. To these two patents was accorded the unique honor of having been *twice sustained by the United States Supreme Court*, after fourteen years of patent-office interference proceedings and subsequent litigation in various Federal District and Appellate courts. These two patents now stand as the complete and final vindication of my contention that I was the original inventor of the all-important feed-back or regenerative principle. Had they not been immolated for so long a period in the Patent Office, they would have long ago expired. They expired in September, 1941. By them the RCA and the Telephone Company were enabled quickly to suppress infringers of these highly valuable rights. As for myself—the pioneer inventor—I enjoyed the credit of being one of many licensed under these (my own) patents!

DE FOREST PATENTS

1,683,451,	Sept. 4,	1928,	Recording and Reproducing Sound
1,687,364,	Oct. 9,	1928,	Radio Transmitting System
1,693,071,	Nov. 27,	1928,	Sound-Recording Device for Movie Cameras
1,693,072,	Nov. 27,	1928,	Shielding for Detector and Amplifier
1,695,414,	Dec. 18,	1928,	Talking Moving-Picture Machine
1,695,415,	Dec. 18,	1928,	Talking Motion-Picture Record
1,701,911,	Feb. 12,	1929,	Acoustic Apparatus
1,710,922,	Apr. 30,	1929,	Motion-Picture Screen
1,716,033,	June 4,	1929,	Producing Talking Motion-Picture Films
1,718,337,	June 25,	1929,	Loud-Speaker Motor
1,720,544,	July 9,	1929,	Radio Receiving Apparatus
1,722,280,	July 30,	1929,	Photo-Electric Cell
1,726,289,	Aug. 27,	1929,	Diffraction Microphone
1,736,035,	Nov. 19,	1929,	Sound-Reproducing Device
1,738,988,	Dec. 10,	1929,	Sound-Actuated and -Producing Device
1,740,577,	Dec. 24,	1929,	Wireless Telegraph and Telephone System
1,761,619,	June 3,	1930,	Sound- and Picture-Recording Camera
1,764,938,	June 17,	1930,	Producing Talking Motion-Picture Films
1,766,612,	June 24,	1930,	Sound-Reproducing Device
1,769,907,	July 1,	1930,	Binaural Recording and Reproducing Sound
1,769,908,	July 1,	1930,	Recording and Reproducing Sound
1,769,909,	July 1,	1930,	Talking Picture Exciting Lamp Switch
1,777,037,	Sept. 30,	1930,	Binaural Recording Sound
1,777,828,	Oct. 7,	1930,	Sound-Picture Photography
1,785,377,	Dec. 16,	1930,	Loud-Speaker
1,795,936,	Mar. 10,	1931,	Sound Reproducer
1,802,595,	Apr. 28,	1931,	Automatic Photographic Sound Reproducer
1,806,744,	May 26,	1931,	Talking-Picture-Machine Drive Mechanism
1,806,745,	May 26,	1931,	Sound-Producing Device
1,806,746,	May 26,	1931,	Luminous Discharge Device
1,810,8	Reissued June 23,	1931,	Obliterating Parts of Talking Film
1,812,687,	June 30,	1931,	Sound Chamber and Set Frame
1,827,283,	Oct. 13,	1931,	Sound Reproducer
1,834,051,	Dec. 1,	1931,	Microphone
1,843,972,	Feb. 9,	1932,	Talking Motion-Picture Apparatus
1,853,850,	Apr. 12,	1932,	Sound-Reproducing Device
1,859,435,	May 24,	1932,	Sound-on-Film Phonograph
1,866,090,	July 5,	1932,	Sound-Reproducing Device
1,873,558,	Aug. 23,	1932,	Gaseous Discharge Device
1,885,900,	Nov. 1,	1932,	Talking Motion-Picture Attachment
1,888,910,	Nov. 22,	1932,	Synchronization in Talkie Photography
1,894,024,	Jan. 10,	1933,	Photographic Sound Reproduction

FATHER OF RADIO

1,897,363, Feb. 14, 1933,	Luminous Discharge Device
1,929,626, Oct. 10, 1933,	Soundproofing Picture Camera
1,944,929, Jan. 30, 1934,	Gaseous Discharge Device
1,992,201, Feb. 26, 1935,	Apparatus for Reproducing Sound-on-Film
2,003,680, June 4, 1935,	Television Reception and Projection
2,026,872, Jan. 7, 1936,	Television-Receiving Method and Apparatus
2,045,570, June 30, 1936,	Synchronizing Televised Images
2,049,763, Aug. 4, 1936,	Television Sign
2,052,133, Aug. 25, 1936,	Television Apparatus
2,064,593, Dec. 15, 1936,	Apparatus for Reproducing Sound-on-Film
2,122,456, July 5, 1938,	Television System and Method
2,126,541, Aug. 9, 1938,	High-Frequency Oscillating System
2,163,749, June 27, 1939,	Radial-Scanning Television System
2,241,809, May 13, 1941,	Radial Scanning with Cathode Beam
2,391,554, Dec. 25, 1945,	Aircraft Speed and Course Indicator
2,410,868, Nov. 12, 1946,	Means and Method for Altitude Determination
2,421,248, May 27, 1947,	Method for Determining Absolute Altitude
2,452,293, Oct. 26, 1948,	Color Television
2,457,980, Jan. 4, 1949,	Apparatus for Bunching Electrons
2,457,989, Jan. 4, 1949,	Cathode-Beam Tube
2,462,367, Feb. 22, 1949,	Variable Capacity
2,489,082, Nov. 22, 1949,	High-Voltage Generator

Pat. 1,201,271 discloses a metallic triode tube many years before General Electric brought out their first metal tube. Pat. 1,230,874 discloses the welding between glass and thin steel in the construction of a large power electron tube. This method is currently employed for cathode-beam tubes—kinescopes. Pat. 1,437,498 is the first disclosure of a “tetrode,” having two grids—ten years ahead of the tube art. These patents are all subsequent to the three basic patents—the grid tube, the amplifier tube, and the two feed-back circuit patents, of 1907 and 1915.



Index

- A battery, 210, 215, 480
Acousticon microphone, 268, 269
Aeo light, 369, 395
Aerophone, 218
Aerophore, 259-60
Allaben, Catherine de Forest,
 (granddaughter), 282, 460, 461
Allaben, Lee de Forest (grandson),
 282, 460, 461
Allaben, Marshall, 460
Allaben, Stanton de Forest (grand-
 son), 282, 460, 461
American De Forest Wireless Tele-
 graph Company, 130, 131, 134,
 160, 162, 173, 174, 184, 217,
 218, 264, 284, 285, 406
American Institute of Electrical En-
 gineers, 196, 215, 459
American Marconi Wireless Tele-
 graph Company, 159, 195, 218,
 263, 284, 285, 312, 322-26,
 354, 407
American Missionary Association, 16
American Radio Relay League, 451-
 53
American Telegraphone Company,
 291, 298, 305
American Telephone and Telegraph
 Company, 293, 296, 298, 301,
 302, 306, 308, 309-10, 312,
 326, 328, 330, 340, 372, 432
American Television Laboratories,
 419, 436, 438, 458
American wireless system, 124, 131,
 135, 142, 151, 152, 192, 195
Amplifiers, 215, 231, 246, 291-93,
 297, 298, 310, 316, 330, 342,
 419, 459-60, 481, 484
Antennae, 120, 121, 122, 126, 183,
 189, 194, 209, 237, 250, 268,
 273, 277, 278, 302, 422
Armour Institute, 115, 116, 120,
 121
Armstrong, Edwin H., 319, 352,
 375, 377-83, 448
Arnold, Dr. J. De Forest, 297, 306,
 383, 384
A.R.R.L., 452
Aschkinass, 105-6, 117
Athearn, "Pop," 138, 141, 148, 156,
 157, 158
Atlantic Communication Co., 340
Atlantic De Forest Wireless Tele-
 graph Company, 184
Atlantic Radio Telephone Co., 263
Audion, 215, 217, 221, 235, 243,
 250, 256-57, 270, 312, 318,
 324, 381, 477-84
 as amplifier, 231, 291-93, 297,
 304, 330, 342, 484
 as transmitter, 317-18, 322, 332-
 33, 335, 336, 342
 development of, 256-57, 291-97,
 482-84
 invention of, 1, 210-15, 477-81
 significance of, 1-4, 320, 336, 361,
 484
 uses of, 2, 215, 231, 304, 322,
 330, 331-32, 484
Audion-Ultra-Audion, 341

- "Autumn Evening in Garfield Park," 470
- Babcock, Clifford D., 151, 162, 192, 210, 212, 214, 220, 221, 342, 463
- Baker, Dr. Walter R., 434
- Barbour, George, 126, 130, 140, 163
- Barnhardt, William, 136-37, 149-50
- B battery, 210, 215, 292, 317, 482
- Beal, Ralph, 375, 378
- Beat-note, 303, 331, 375, 383
- Beckman, Prof. Arnold, 420, 421
- Bell, Alexander Graham, 202, 207, 466
- Bell Telephone Laboratories, 296, 386, 432, 459, 460
- Berlin, (Germany), 238, 361, 363, 365, 366
- Betts, L. F. H., 322, 324
- Blatch, Harriet Stanton, 222, 248, 252
- Blatch, Nora Stanton (wife), 222-25, 232, 236, 237, 240, 241, 243, 245, 246, 248, 251, 252, 253, 261, 282, 460
- Borghese Gardens, 399
- Brackett, Quincy R., 248
- Branley coherer, 97, 105, 161
- Bream, Hugh, 461
- British General Post Office, 152, 153-54, 207
- Broadcasting, 223, 224-25, 228, 233, 237-38, 244, 248, 249, 267-71, 336-39, 350, 354, 441
- Brown, Harry, 140, 148, 156, 157, 158
- Brunswick-Balke-Collender Co., 351
- Bucher, Elmer, 164, 191
- Buckley, Dr. Oliver E., 386
- Buford*, 272, 273, 274
- Bumstead, Prof. Harry, 92, 93
- Bunsen-burner experiment, 211-12, 479
- Burchard, "Old Burch," 210-11
- Burlingame, E. E., 263, 264, 307, 309, 314
- Butler, Frank E., 167-68, 174, 177, 179, 180, 209, 230, 268, 312, 463
- "California Twilight," 473
- Carbon-arc transmitter, 221, 225, 242, 257-58
- Carborundum detector, 162, 195, 217, 249
- Cardozo, Justice Benjamin, 379
- Carmania*, 403
- Carty, John J., 293, 296, 297, 302, 312
- Caruso, Enrico, 269, 270
- Cascading, 292-93, 319, 482, 484
- Case, Theodore, 368, 396
- Cassedy School, 17, 20
- Cathode-beam tube, 421, 427
- C battery, 483
- Chateau Diadato, 366, 371
- Chicago, Ill., 101, 103, 113, 121, 122, 169, 170, 171, 186-88, 436, 458, 459
- Chicago & Alton Railroad, 182-83
- Chicago Inter-Ocean*, 255
- Chicago Record Herald*, 188
- Chicago Tribune*, 175, 443
- Chicago World's Columbian Exposition, 62-63
- City of Traverse*, 186-87
- Coherers, 135, 161, 195
- Branley, 97, 105
- Johnson, 111
- Marconi, 130
- "Cold cautery," 238, 241
- "Coliseum, The," 240
- Colón (Isthmus of Panama), 177, 194, 201
- Color television, 435
- Columbia Broadcasting System, 435, 436
- Columbia Gramophone Co., 337
- "Compensation" wave, 278-79
- Cook, Margaret, 414, 415
- Coolidge, Pres. Calvin, 387
- Cooper, Charles, 165, 167
- Corbett, John, 429

- Cornish (British wireless operator),
153, 156, 163, 164
- Council Bluffs, Iowa, 14, 47, 99
- Coyer, Henry, 332, 336, 348, 354
- Craft, E. B., 369, 395
- Cross of the Legion of Honor, 361
- Crystal detector, 195, 217, 250, 352-53
- Cunningham, Elmer P., 354
- Curtis, A. C., 177, 194, 345
- Daniels, Bebe, 408
- Darby, Capt. Samuel E., 215, 236, 253, 263, 264, 309, 311, 314, 323, 378
- Darby, Samuel E., Jr., 349, 378, 379, 403, 462-63
- Davis, George, 195, 228
- Davis, John W., 387
- Day, George Parmly, 311, 320-21
- Dean, William Warren, 104, 106, 108, 231
- De Forest, Charles (brother), 28-30, 40, 80, 85, 235, 400, 461-62
- De Forest, David Curtis, 11, 48
- De Forest, Eleanor (daughter), 347, 357, 364, 371, 461
- De Forest, Gideon (great-grandfather), 11, 12, 50
- De Forest, Harriet Blatch (daughter), 260, 282, 347, 460-61
- De Forest, Henry Swift (father), 6, 12-14, 15, 16, 17, 19, 21-22, 28-29, 30, 31, 38, 40-41, 46-48, 49-52, 69, 78, 79
- De Forest, Jesse, 10
- De Forest, Lee:
birth, 14
early childhood, 5-10
moves to Alabama, 9-10, 15
life at Talladega, 18-54
associations with Negroes, 18, 22-23, 30, 38, 41
play and pastimes, 19, 20, 22-23, 25, 26-28, 30-33, 34, 37, 41, 42-44
goes to grammar school, 20-21
ostracized by white citizens, 21-23, 27-28
fascinated by locomotives, 25-28
becomes interested in invention, 34-37, 49
becomes interested in literature, 33, 45-46, 53, 54
decides to be an inventor, 36
early inventions, 35-36, 40, 65, 67, 69, 72, 77, 83-84, 86
becomes interested in music, 37-38, 47
high-school training, 46, 48, 54
decides upon a scientific education, 48-50
joins Congregational Church, 52
starts a diary, 52
life at Mt. Hermon, 55-61
works as book agent, 59
enters Yale, 62
works as chair-pusher, 62-63
life at Yale, 64-98
questions religious beliefs, 66-67, 68-69, 91
studies telegraphy, 69
growing independence of thought, 71, 76
enjoys mechanical engineering, 72
graduates from Yale, 82
postgraduate work, 84-92, 96-98
studies electrical engineering, 85-86
works on doctor's thesis, 92, 96-97
goes to war, 93-96
becomes a Ph.D., 98
first love, 99-101, 102-3, 107-8
life in Chicago, 101-9, 113-22
starts work for Western Electric Company, 101
early experiments in wireless telegraphy, 103, 105-6, 108-9, 113-15, 116, 118-20
works briefly in Milwaukee, 110-112
returns to Chicago, 113
Welsbach-burner experiment, 114, 116

FATHER OF RADIO

- applies for first patent, 117
- first wireless tests, 120-22
- moves to New York City, 123
- competes with Marconi, 124-26
- struggles for financial backing, 127-30
- forms first company, 130, 131
- conceives wireless telephone, 132
- introduces wireless system to U.S. Navy, 135, 141-42
- proves superiority of de Forest wireless system, 135, 142, 149, 151, 154
- reports International Yacht Races, 149
- introduces wireless to Canada, 142-43
- demonstrates existence of "guided waves," 143-44
- introduces wireless system to Britain, 152-54
- equipment used to report Russo-Japanese War, 155-58
- patent litigation begins, 159-61, 162
- demonstrates at St. Louis World's Exposition, 165
- awarded Grand Prize and Gold Medal, 171
- nearly elopes, 172
- visits London, 172
- lands first large contract, 173
- inspects new Navy stations, 176-78
- communicates with moving train, 182-83
- wireless finally catches on, 192
- starts training school, 193
- sets new long-distance record, 194
- goes to Ireland, 202-7
- hears first transoceanic message, 206
- makes balloon ascension, 208
- invents the Audion, 210-215
- patents the Audion, 215
- loses first fortune, 217-18
- resigns from company, 218
- turns attention to wireless telephone, 219
- organizes new company, 221, 229
- becomes engaged, 222-23
- begins radiobroadcasting, 225, 228
- marries Nora Blatch, 236
- takes radio to Europe, 236-41
- visits Rome, 240
- begins manufacture of radio equipment, 245, 247-48
- Nora moves out, 251-52
- business prospers, 253
- birth of first daughter, 260
- business reorganization, 263-65
- first opera broadcast, 267-71
- goes to California, 272-75
- business goes bad, 275, 276
- goes to work for Federal Telegraph Company, 277
- discovers "selective fading," 278-79, 280
- divorced by Nora, 282
- "arrested" for "fraud," 283
- discovers Audion is an amplifier, 292-93
- discovers feed-back principle, 293-95
- discovers Audion is an oscillator, 295
- demonstrates Audion to Telephone Company, 296-97
- marries Mary Mayo, 300-301
- obtains "beat-note," 303
- returns East, 305-6
- settles at Riverlure, 305
- sells wire rights to Telephone Company, 308-10
- stands trial for "fraud," 311-15
- acquitted, 314
- reorganizes company, 315
- starts building third fortune, 320
- repays defense loan, 320-21
- enjoyed from making and selling Audions, 325
- sells radio license rights, 326-27

- exhibits at Panama-Pacific Ex-
 position, 328-30
 wins Grand Prize and Gold Med-
 al, 330
 goes to Paris, 334
 elected president of company, 335
 begins sponsored broadcasting,
 337
 broadcasts election (1916), 338-
 39
 takes first airplane flight, 339
 sells exclusive patent rights to
 Telephone Company, 339-41
 World War boosts business, 341-
 43
 revisits Talladega, 343
 becomes interested in sound-on-
 film, 345-46
 revisits California, 346
 daughter Eleanor is born, 347
 first honorary degree, 349
 station closed down, 351
 reads Franklin Institute paper,
 352
 goes to San Francisco, 354
 begins broadcasting again, 355
 back in New York, 356
 resumes work on talking film,
 359-60
 awarded Cross of the Legion of
 Honor, 361
 goes to Berlin, 361-62
 returns to New York, 366
 organizes Phonofilm Company,
 369
 Phonofilm comes to Broadway,
 370
 quits radio, 372-73
 engages in patent litigation, 375-
 86
 awarded feed-back patents, 377
 wins important Supreme Court
 decisions, 378-84
 goes ahead with Phonofilm, 387-
 92
 daughter Marilyn is born, 394
 divorces Mary Mayo, 394
 revisits Rome, 398-99
 Phonofilm fades out, 401-3
 De Forest Radio sold to RCA, 406
 returns to California, 407
 marries Marie Mosquini, 408
 takes up mountain climbing, 412-
 17
 goes into television, 418-21
 develops diathermy, 423-26
 invents a night bomb, 428-31
 television again, 433-40
 deplors radio commercialism,
 441-47
 divides time between Los Angeles
 and Chicago, 458
 mourns death of friends, 455-56,
 463-64
 awarded Edison Medal, 459
 De Forest, Lee (grandfather), 11, 12
 De Forest, Lee, Jr. (son), 393-94
 De Forest, Marilyn (daughter), 394,
 461-62
 De Forest, Mary Robbins (sister),
 6, 14, 20, 37, 55, 57, 80, 83,
 400, 461
 De Forest, Robert Lee (grand-
 nephew), 463
 De Forest, Dr. Walter (nephew),
 463
 De Forest Defense Fund, 311, 320-
 21
 De Forest Phonofilm Corporation,
 369, 403
 De Forest Radio Company, 407
 De Forest Radio Telephone and
 Telegraph Company, 335, 362,
 372, 373, 375, 376, 384, 385,
 394, 404, 405-7
 De Forest Radio Telephone Com-
 pany, 221, 229
 De Forest Scholarship, 11, 48, 89
 De Forest Tower (St. Louis), 165,
 168
 De Leath, Vaughn, 351
 Deming, Howard, 311-12, 314

- Detectors, 105, 226, 246, 250
 Audion, 162, 210-15, 246, 303, 477-84
 Branley-coherer, 97, 105, 161
 carbon-arc lamp, 212
 carborundum (crystal), 162, 195, 217, 249
 electrolytic, 106, 116, 119, 161-62
 Fessenden, 161
 Fleming-valve, 213, 482
 gas-flame, 211-12, 477-78
 glow-tube, 96
 heterodyne, 303, 483, 484
 Johnson-coherer, 111
 Marconi-magnetic, 270
 Responder, 108, 112, 118
 "spade"-electrode, 162, 217
 Ultra-Audion, 318, 484
 vacuum-tube, 213-15, 479-80
 Wollaston-wire, 161-62
Detroit Daily News, 356
 DF (wireless station), 193-94, 201, 202, 203, 204
 Diary, 52-54, 58, 198, 224, 225, 261, 282, 283, 412
 Diathermy, 239, 423-26
 Dickerson, Prof. Charles E., 57, 61
 Diffractive microphone, 392
 Diode tube; *see* Vacuum tube, two-electrode
 Duplex system, 277, 278, 288
 Dippel, Andreas, 267
Dix, 272
 "Dream Rose," 471
 Dubbing, 389, 391
 Du Mont, Allen B., 405, 406, 418, 435
 Duncan, Dr. Louis, 304, 306
 Dunwoody carborundum detector, 195, 217
 Easton, "Sunny Jim," 140, 146
 Edison, Thomas Alva, 298-99, 400-401, 429
 Edison effect, 323, 480
 Edmeston, N.Y., 11, 80
 Eiffel Tower, 237, 244, 246, 334
 Electric Radio Products, Inc., 395, 396, 397, 403, 404
 Electrolytic detector, 106, 116, 119, 161-62, 210; *see* Responder
 "Electron streams" amplifier, 460
 Elliot Cresson Medal, 352
 Elwell, Cyril F., 276, 277, 282, 310, 391
 "Ephemeris," 407
 Eric Huth G.M.B.H., 361
Erin, 144-45, 146, 147
 ERPI, 395, 396, 397, 403, 404
 Evans, Adm., 232, 233, 234
 Fading, 279, 280
 Farnsworth, Philip, 217, 218, 323-24, 341, 378
 Farrar, Geraldine, 271
 Federal Communications Commission, 425, 426, 435, 438, 444
 Federal Telegraph Company, 276, 277, 278, 287, 290, 291, 301
 Feed-back, 293-95, 296, 303, 317, 318, 331, 341, 352, 377, 381, 382, 383, 407
 Fessenden, Prof. Reginald, 155, 161, 162, 177, 197, 217, 324, 340
 Fessenden system, 135, 148
 Film phonograph, 345, 346
 Firth, John, 127, 130, 144, 300
 Fleming, Sir John Ambrose, 221, 322, 457, 478
 Fleming valve, 213-14, 221, 322-26, 344, 354, 457
 Folk, George, 340, 377-78
 Fox, William, 391, 396, 397, 402, 404
 Fox Movietone, 399, 402
 Franklin Institute, 352, 477
 Franklin papers, 477-84
 Freeman, Prof. Clarence, 115, 122, 124, 125, 126, 130
 Galbraith, Charles, 184, 185, 192, 284, 463

- Garside, James W., 405, 406, 419
 Gatti-Casazza, 267, 268
 General Electric Company, 342, 383, 384, 385, 396
 General Motors Corporation, 385
 General Post Office, 152, 153-54, 207
 General Talking Pictures, 401, 402, 403
 Generators, 122, 141, 219, 377, 381-83, 482
 AC, 142
 Alexanderson, 250
 Blondlot, 97
 oscillation, 327, 332-33, 336
 Poulsen-arc, 220, 239, 276, 278
 Ultra-Audion, 318
 Vreeland, 319
 Gernsback, Hugo, 258, 459
 Gibbs, J. Willard, 84, 87-88, 89
 Gilbert, Charles, 335, 345, 362, 376
 Glengariff (Ireland), 203, 204
 Glow-tube, 348, 391
 Gowen, Robert, 350, 352, 353
 Grand Opera, 245, 267-71
 Great Lakes Wireless Radio Telephone Company, 253, 263
 Grid, 1, 3, 214, 247, 256, 317, 320, 482, 484
 Grid leak, 247, 316
 Guantanamo, Cuba, 177-78
 Guided-wave action of horizontal wires, 143-44, 183, 209

 Hadley, Arthur Twining, 216
 Hammer, William, 170, 305
 Hammerstein, Oscar, 271
 Hammond "Novachord," 332
 "Hams," 193, 246, 259, 317, 332, 451-53
 Harris, "Driver," 193-94, 202, 204
 Hastings, Prof. Charles, 72, 83, 84, 92, 93
 Hays, Arthur Garfield, 403, 404
 Henriette, 407
 Hertzian waves, 88, 96-97, 105-6, 114-15, 116, 119, 132, 422, 425, 477
 Heterodyne, 250, 303, 383
 High Bridge, 310, 317, 322, 337, 341, 350, 352
 Hogan, John V. L., 220-21, 230, 447
 Holden, E. R., 127, 128
 Holyhead (Wales), 152
 Hooper, Adm. Stanford C., 142, 333, 423
 Horizontal antenna, 150, 209
 Horton, Harry Mac, 137, 141, 145-46, 152, 155, 163, 164, 174, 176, 177, 188, 202, 203, 204, 205, 307, 463
 Hough, Judge Charles, 325-26, 376, 378
 Howth (Ireland), 152
 Huffman, Charles, 418, 419, 420
 Hughes, Henry, 193
 Huntington, Com. W. R., 231
 Huntington, Prof., 208
 Hutchison, Miller Reese, 298, 299

 Institute of Radio Engineers, 279-80, 318, 408, 455
 International Yacht Races, 123-26, 147-49
 "Iowa Band," 7
 Iradell, G. S., 188
 I.R.E., 455-57

 James, Capt. Lionel, 155, 156-58, 171, 172
Jersey City Journal, 255
 Jewett, Ned, 372, 374
 Johnson, Prof., 110-12

 Kennelly-Heaviside layer, 144, 280
 Kent, Atwater, 405, 406
 Kent, Roscoe, 230
 Key West, Fla., 173, 174, 176, 188, 190
 KFAC (radio station), 447
 Kinescope, 436, 437, 438

FATHER OF RADIO

- Kite, tetrahedral cell, 202-7, 208
 Klein, Richard, 350, 351
 Klystron, 250
 Knabenshue, Roy, 165-66
- La Follette, Sen. Bob, 387
 Lake Whitney, 74, 77, 78, 82
 Langmuir, Dr. Irving, 3, 319, 320, 380, 383, 384, 385
Leatherstocking Tales, 33, 45
 Lecher parallel-wire resonator, 92, 93
 Lewis, Col. J. Hamilton, 187
 Lewis Institute, 115
 Lindbergh, Charles A., 399
 Lindley, "Honest John," 298, 301, 304, 306
 Lipton, Sir Thomas, 126, 144, 146
 Literature, de Forest's interest in, 33, 45-46, 53, 71, 100, 106-7
 Lodge, Oliver, 90, 105, 152, 154
 Loewe, Dr. Siegmund, 364, 424
 Logwood, Charles V., 286-88, 289, 290, 292, 303, 310, 312, 316, 317, 319, 337, 348, 349, 355, 378, 463, 483
 London Aeronautical Society, 208
London Electrician, 231
London Times, 155, 157, 171, 202
 "Lone Tree of Tamalpais," 289
 Loose coupling, 456
 "Los Angeles," 472
 Los Angeles, Calif., 274, 278, 407, 418, 458
 "Lost Portrait," 199-200
 Luce, Theodore, 372, 374
- McCandless, H. W., 213, 214, 256, 257, 292, 306, 332, 333, 342
 Mac Horton, Harry; *see* Horton, Harry Mac
 McLanahan, George, 311, 321
 McNeil, "Old Man," 203-4
 Magnetron, 250
 Manning, Adm., 194, 201
 Manton, Judge, 379
- Marconi, 97, 105, 109, 123, 125, 126, 128, 129, 133, 134, 135, 147, 149, 159, 191, 192, 240, 245, 422, 456, 457
 Marriott, Robert, 279
 Maxim, Hiram Percy, 452
 Mayer, Judge Julius, 197, 323-25, 375
 Mayer, Louis B., 402, 420
 Mayo, Mary (wife), 300-301, 305, 306, 307, 347, 356, 360, 361, 363, 364, 366, 371, 394, 461
 Mazarin, Mme., 271
 Merriam, Frank, 273
 Metropolitan Life Tower, 246, 247, 264-65, 271
 Metropolitan Opera, 256, 267-71
 Meyers, Sidney, 307-10, 326
 Microphone, 257, 258, 268, 269, 271, 273, 319, 392
 Mineratti, H. J., 176, 195
Modern Electrics, 258, 259
 Moody, Dwight, L., 55, 57, 59-60
 Moorehead Company, 326, 332, 354
 Morris, Judge, 402, 403
 Moskicki condenser, 242-43, 245, 248
 Mosquini, Marie (wife), 408-11
 Mountains, de Forest's interest in, 47, 410, 412-17
 Mt. Hermon Boys' School, 53, 55-63
 Mount Langley, 415
 Mount Shasta, 414-15
 Mount Tamalpais, 289
 Mount Whitney, 410, 413-14, 415
 Mt. Wilson, 346, 413
 Muscatine, Iowa, 7-9
 Music, de Forest's interest in, 37-38, 47, 58, 104, 107, 115, 224, 225-26, 267-68, 270-71, 345, 450
 Mussolini, Benito, 398
- National Ass'n of Broadcasters, 443
 National Electric Light Ass'n., 400-401

- Neugschwender, 106
 New Orleans, La., 181
 New York, N.Y., 196-99
New York American, 338
New York Commercial, 244
New York Globe, 234
New York Herald, 125, 232
New York Times, 338, 422
New York Tribune, 228
New York World, 134, 269
 Niantic, Conn., 94, 95
 "Nocturne," 198-99
 Non-grid amplifiers, 459-60
 North American Wireless Corp.,
 263, 281, 284, 308, 309, 315
 Oscillation, 243
 Oscillator, 250, 258, 295, 310, 317-
 18, 319, 322, 335, 356, 381,
 382, 485
 Oscillion tube, 327, 332, 333, 336,
 341, 342, 354, 360
 Ossining, N.Y., 350, 461
 O'Sullivan, James, 205, 206
 Otterson, John, 395, 397, 403, 404
 Overland wireless, 164, 169
 Owens, Harry, 368
 Pacent, Louis, 449
 Pacific Telephone and Telegraph
 Company, 290
 Palo Alto, Calif., 276, 277, 282,
 286, 287, 289, 290, 291, 301
 Panama-Pacific International Ex-
 position, San Francisco, 328
 Parker Building, 219, 225, 235
 Patent litigation, 159, 162, 177,
 323-26, 339, 341, 375-86, 402,
 403, 456-57
Patent Office Gazette, 34
 Patents, de Forest, 485-90
 Peck, Ferdinand W., 121
 Peck, Fred, 461-62
 Pensacola, Fla., 173, 174, 176, 185,
 188, 189-90, 194
 Phonofilm, 359, 360, 361, 362, 365-
 66, 368, 370, 371, 373, 383,
 387, 388, 389, 393, 395, 396,
 399, 401
 Photion, 369, 395
 Pike's Peak, Colo., 47
 Plan Position Indicator, 428
 Poems, de Forest, 101, 103, 198-
 200, 282, 289, 407, 411, 469-
 76
Pottstown Ledger, 245
 Poulsen arc, 220, 239, 276, 278,
 288
 Poulsen Telegraph and Telephone
 Company, 276
Proceedings of the I.R.E., 144, 455
Providence Journal, 149
Publishers' Press Association, 123,
 125, 147, 149
 Pupin, Dr. Michael, 89, 161, 329,
 379
 "Quenched-spark," 239, 243, 247,
 249, 250, 265, 272, 273, 275
Q.S.T., 453
 Radar, 250, 427, 428
 Radial scanning, 427
 Radio, 224-26, 231, 237, 250, 260,
 349, 372, 373, 441-49, 451;
see also Telephony, wireless;
 Radiotelephone
 Radiobroadcasting, 250, 336-39
 Radio Corporation of America, 285,
 348, 376, 385, 386, 406, 407
Radio-Craft, 459
 Radio knife, 241
 Radio News and Music Co., 356
 Radiotelephone, 219, 225, 226, 230,
 231, 233, 235, 237, 244
 Radio Telephone and Telegraph
 Company, 315, 328, 335
 Radio Telephone Company, 215,
 229, 236, 239, 242, 259, 261-
 62, 263, 264, 265, 277, 284,
 308, 309, 315
 Radio tubes, 344

- Rectifiers
 electrolytic, 162
 thermionic, 213, 217, 221
 Reed, Frederick, 91
 "Reflection of Hertzian Waves from
 the Ends of Parallel Wires," 88,
 96-97
 Regenerative effect, 295
 "Regret," 469
Republic, 254
 "Responder," 108-9, 112, 113, 115,
 116, 118-22, 130, 133, 162
 Reynolds, Lou, 393
 Reynolds, Wylie, 405, 406
 Rich, Walter, 396, 397
 Riesenfeld, Dr. Hugo, 367, 368,
 369, 370, 389, 390
 Riverlure, 252, 305, 307, 315, 339,
 347, 357, 362, 363, 371-72,
 388, 394, 407, 418
 "Riverlure," 475
 Rivoli Theater, 368, 369, 389
 Robbins, Alden Burrill, 7, 14
 Robbins, Anna Margaret (mother),
 14, 19, 37, 80, 81, 83, 91,
 235, 291, 301, 305, 343, 346,
 355, 357, 400
 Rogers, Will, 409
 Rome (Italy), 240, 398-99
 Roosevelt, Pres. Theodore, 190-91
 "Roses of Riverlure," 476
 Ruhmkorff spark coil, 120, 148
 Rukeyser, Muriel, 88
 Russo-Japanese War, 155-58

 St. Louis, Mo., 165, 170, 171, 181,
 185
St. Louis Post-Dispatch, 165
St. Louis Star, 166
 St. Louis World's Exposition, 63,
 165-71
 Sanabria, Col. John, 436, 458
 Sanabria, U. A., 436, 458
 San Francisco, Calif., 273-74, 278,
 289, 290, 354, 355
 Sarnoff, David, 386
 Scanlon, J. W., 195
 Schlesinger, I. W., 401
 Schlesinger, M. A., 401, 402, 403
 Seibt, Dr. Georg, 239, 243, 247,
 248, 364
 Self-directing night bomb, 428
 Self-regeneration, 295
 "Sending wave," 278-79
 "September," 474
 Seymour, Charles, 70
Shamrock, 126, 144, 145, 147
 Shaw, Henry, 354, 355
Sheff Magazine, 74
 Sheffield Scientific School, 48, 85
 Shoemaker, Harry, 184, 463
 Siedler, Henry, 124, 126, 127, 129
 Simon Emil J., 246, 300, 350
 Slaby-Arco, 141, 142, 154
 Smith, Cortland, 396, 397
 Smith, James Dunlap, 229, 253, 262,
 263, 314
 Smythe, Ed, 104, 106, 109, 113,
 115, 116, 117, 120-21, 125,
 127, 130
 Society of Wireless Telegraph En-
 gineers, 455
 Somner, Allan, 118, 124
 Sound-on-film, 345-46, 348, 370,
 391, 397; *see also* Phonofilm
 Spanish-American War, 93-96
 Sponable, E. I., 368, 369, 396
 Springfield, Ill., 165, 167, 169, 171
 "Squawk-a-phone," 331-32
 Static, 189, 288, 302
 Steinmetz, Prof. Charles P., 170
 Stires, Max, 84, 86, 123-24, 130
 Stone, Lt. Ellery, 354
 Stone, John Stone, 170, 293, 295,
 296, 301, 302, 307, 312, 335,
 408, 455, 456
 "Story of a Great Achievement,
 The," 329-30
 Swanke, Maj. Edwin (son-in-law),
 462
 Swanke, Edwin Lee (grandson),
 462

- Swayne, Gen. Wager, 16
Symphony from the New World, 400
 Syracuse University, 349
- Talking Machine World*, 229
 Talking pictures, 304, 305-6, 348, 357, 358-66, 370, 388, 392
 Talladega, Ala., 15, 16, 30, 79, 343
 Talladega College, 9, 15-18, 38, 51, 343
 Technicolor, 390, 391
 Telefunken, 191, 192, 239, 340
 Telegraphone, 291, 292, 298, 301, 304, 305
 Telegraphy, wireless, 105, 110, 132, 135, 164, 166, 174, 209, 239, 272, 280, 284-85
 Marconi's system, 97, 105, 107, 134, 135
 de Forest's system, 130-31, 134-35, 142, 151, 152, 154, 192, 195
 Fessenden system, 135, 148
 quenched-spark, 239, 248, 272, 273
 Telephone amplifier, 231, 296-98, 329-30
Telephony, 269
 Telephony, wireless, 132, 227, 228, 229, 232, 234, 244, 245, 255, 269-70
 Television, 418, 433-40
Television Today and Tomorrow, 433
 Tesla, Nikola, 75, 85-86, 90, 220, 456
 Thalafide cells, 368, 394
Thelma, 231
 Theremin, 331, 385
 Thermionic tube, 2, 213-15, 434;
 see also Audion
 Thomas, Leon, 235, 312
 Thompkins, J. J., 229, 253, 314
 Thompson, Beach, 276, 277, 283, 295
 Thompson, C. S., 356
 Tikker, 250, 276, 288, 291, 303, 310
 Togo, Adm. Heihaichiro, 157
 "To Mary," 473
 "To Mi Mijita," 411
 Townsend, Judge, 159, 161
 Transatlantic telephony, 334, 340
 Transcontinental telegraphy, 328-30
 Transistor, 459
 Transmitters, 120, 122, 126, 130, 146, 167, 168, 169, 190, 246, 250, 257, 277, 323
 alternating-current sender, 128, 130-31, 151, 250
 Blondlot spark-generator, 97
 carbon-arc, 221, 225, 242, 257-58
 Freeman, 124, 125-27
 oscillator, 317-18, 332-33, 336, 354, 483-84
 quenched-spark, 239, 248, 249, 273, 275
 television, 418-19, 436, 437
 Wehnelt-interrupter, 120, 148
 "Traveling-wave" amplifier, 459
 Triode tube; *see* Audion; Vacuum tube, three-electrode
 Turner, Kelly M., 268, 269
- Ultra-Audion, 318, 319, 376, 486
 Undamped waves, 220, 239, 242, 278-79, 303, 318, 483, 484
 U.S. Army, 134-35, 430-31
 U.S. Army Signal Corps, 140, 141, 150, 151, 235, 248, 272, 342, 344
 U.S. Navy, 135, 141, 151, 173, 177-80, 190-91, 201, 211, 232-34, 316, 333, 341, 342, 405, 429, 430
 U.S. Supreme Court, 326, 341, 378-85, 456, 457
 United Wireless Telegraph Company, 217, 248, 263, 265, 277, 284, 285, 406
 Untermyer, Sam, 404

FATHER OF RADIO

- Vacuum tubes
 two-electrode, 213, 215, 482-83
 three-electrode, 1, 3, 214, 481-82,
 484; *see also* Audion
- Van Etten, Herbert, 290, 291, 292,
 293, 378, 382, 414, 415
- Veteran Wireless Operators Asso-
 ciation, Inc., 454
- Vitagraph Company, 395
- Vitaphone, 370
- Vosburg (wireless operator), 140,
 146
- Vreeland, Dr. Frederick, 161, 319
- V.W.O.A., 454
- Waddell, William, 371, 393, 404
- Wagner, John (grandson), 282, 461
- Wallace, Deacon, 47, 99
- Wallace, Mrs. Henry (neighbor),
 355
- Wallace, Jessie, 99-101, 102, 103,
 107-8, 132, 133
- Wallace, Nettie, 47, 99, 100
- Warner, Harry, 395, 397
- Warner, Kenneth, 452
- Warner, Sam, 395
- Waterloo, Iowa, 5, 6
- Watts, John, 176, 178, 195
- WEAF (radio station), 442
- Weagant, Roy, 325
- WEFM (radio station), 447
- Wehnelt interrupter, 120, 144
- Welsbach burner, 114, 211, 466,
 477
- Western Electric Company, 101,
 103, 105, 108, 293, 296, 307-
 10, 312, 327, 333, 338, 339,
 340, 383, 395, 396, 402
Western Electrician, 113, 115, 117
 Westinghouse Electric Company,
 332, 342, 375, 376, 377, 385
West Virginia, 191, 203
 White, Abraham, 129, 131, 160,
 184, 217, 218, 262, 284
 White, Mary, 355
 Whitney Portal, 410, 415
Wiedemann's Annalen, 105
 Williams, Harry, 270, 335
 Williamson, Frederick, 309, 310,
 315
 Wilson, "Christopher Columbus,"
 184, 185, 217, 218, 220, 262,
 284
 Wilson, Maj. Gen. Henry, 430
 Winter, Julia, 57, 59, 61, 64, 65, 76
 Wireless; *see* Telegraphy, wireless
 Wireless Association of America, 259
Works of Stevenson, 274
 World's Columbian Exposition,
 Chicago, 62-63
 World's Exposition, St. Louis, 63,
 165-71
 WQXR (radio station), 447
 Wright, Prof. Arthur, 80-81, 88, 93
 Wurlitzer Company, 332
 WXRT (radio station), 447
 Yale Light Artillery Battery, 93-94
Yale Scientific Magazine, 78
 Yale University, 48, 64-81, 216
 Young, Sam, 304, 306
Youth's Companion, 38, 42, 78