

The RADIO DEALER

Vol. 2 No. 1

OCTOBER, 1922

One Dollar The Year

Entered as Second Class Matter, at the Post Office at New York, N. Y., under the Act of March 3, 1879

Make the Most
of the
Holiday Trade!

ORDER NOW A Full Line
of Nationally Advertised Products

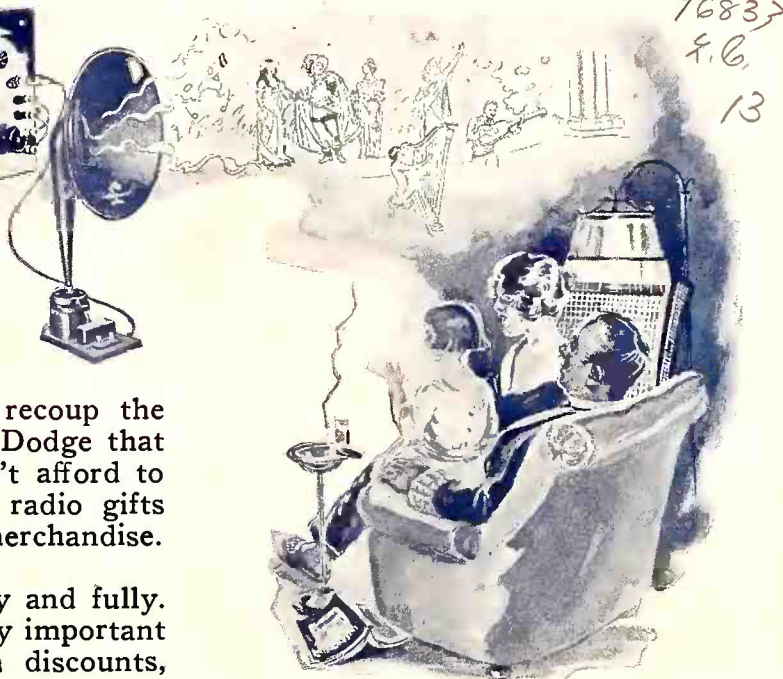
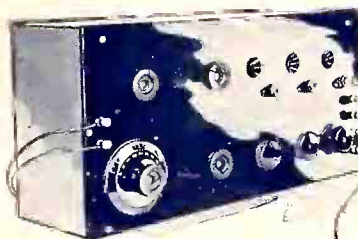

96837
f.6.
13

THE HOLIDAYS are your big opportunity to recoup the losses of a dull summer and get a fresh start. Dodge that costly last minute rush to get stock. You can't afford to wait too long. Everybody will want to select their radio gifts from a wide assortment of well known, standard merchandise. Order early and completely.

We can handle your order now, promptly, carefully and fully. Anything in any quantity from the lines of 16 nationally important manufacturers. Every possible advantage to you in discounts, shipments and accommodating methods.

**THERE IS NO PROFIT IN WAITING
PREPARE NOW FOR A SURE THING!**

*Try an Order of
These Staples*

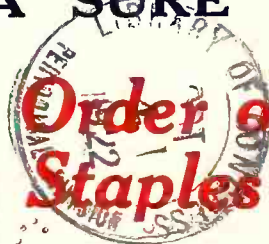

Koehler 3-Plate Vernier Variable Condensers

Heavy aluminum plates, thick Bakelite ends, other parts of brass, nickel-plated. .000075 Mfd. capacity. Accurately manufactured and carefully tested. Koehler Condensers have made good. Also made in other sizes.

LIST
\$1.50

GREWOL Crystal Detectors

No trouble selling this fixed detector. Stays adjusted. Guaranteed tested crystal and dust-proof glass cup.

LIST
\$2.00

Test our service with a trial order of these two standard sellers

**DISTRIBUTORS
FOR**

- Acme
- Baldwin
- Bradleystat
- Chelsea
- De Forest
- Eveready
- Federal
- Homcharger
- Jefferson
- Klosner
- Magnavox
- Murdock
- Paragon
- Thordarson
- Tuska
- Western Electric

**WHOLESALE
ONLY**

Write for Attractive Discounts on Our Complete Line

Wholesale Radio Equipment Co.

24 WILLIAM STREET, NEWARK, N. J.

T116540
R35



PHONES

Made to Serve—Not to Sell

Built by a German manufacturer for government wireless use, cost did not enter into the construction of "N & K" phones. They were built to serve, not to sell. It was a matter of making the most scientifically perfect head set possible and the "N & K" phone is the result.

Only Phones with Oversize Ear Cups

The ear cups on "N & K" phones are 2 3/4 inches in diameter, nearly a third larger than any other phone made. This permits their being used for hours without the least fatigue, eliminates all outside noises and increases the clarity of reception. Highly supersensitive, the tone quality of "N & K" phones is marvelous. Comparison is all that is needed to prove superiority. Note the features below.

Attractive Proposition to the Trade

We are the sole U. S. distributors for "N & K" phones. Their advent in the American market offers the trade an opportunity to meet the ever increasing demand of the radio public for quality instead of cheapness. Just a demonstration of "N & K" phones sells them. Our advertising creates the demand. Be ready to supply it. Have "N & K" phones in stock and display them. Order from your jobber. If he cannot supply you, write or wire us direct. The turnover is fast. The profits are sweet. To handle "N & K" phones is to build for permanent business and satisfied radio patrons.

N. & K. Telephone Receivers
Of German manufacture, this headset was found to have a resistance of 6100 ohms. In crystal and tube receiving circuits, the sensitivity was unusually good. The construction is very neat and rugged. Cases are turned from brass, nickel plated inside and out, 2 1/4 inches in diameter at the diaphragm and 5/8 inch in thickness. Two-piece magnets are used, in two semicircular sections, with very neat small bobbins, rectangular in shape and cloth covered. Soldering and connections are well done. Internal metal parts are nicked, and a thin metal washer is employed as a spacer between the case rim and the tinned diaphragm. Caps are of polished hard rubber, fitting comfortably. A 6-foot cord is connected to the cases outside. Two spring bands are used in the headband assembly, black leather covered, fastened by two knurled adjustment nuts through the center of which the supporting rods pass.
Awarded The Evening Mail Certificate of Excellence.

Illustrations are Actual Size



Note these Features

- 6,000 ohms resistance.
- Each magnet has 3,800 turns of wire.
- Each magnet has 1,500 ohms D. C. resistance.
- Magnets made of laminated magnet steel, the best steel made in Germany.
- Coil winding protected by triple covering of insulating material.

Be the First in Your Territory to Show A Real Head Set

6000 OHMS

LIST PRICE

\$14.50

HERBERT & HUESGEN CO.,
18 EAST 42nd ST.,
NEW YORK CITY

Between Fifth Ave. and Grand Central



Note these Features

- The thin steel diaphragms are only 0.2 MM. in thickness.
- The impedance is 20,000 ohms at 800 cycles
- All leather head bands, no webbing used.
- Cases turned from brass, nickel plated inside and out, 2 1/4 inches in diameter at the diaphragm and 5/8 inch in thickness.
- Caps of polished hard rubber.



Scene from the Opera "Faust"

MOMENTOUS events in the arts and sciences are the result of rising above out-worn principles, independent of the tools of mediocrity. Beginning where others have been content to finish, a forward-looking group of radio engineers, comprising the Mu-Rad Laboratories, have designed and successfully constructed radio apparatus which is as advanced as the twenty-one-jewel watch is over the key-winder. Prices of this apparatus insure that great numbers will benefit from their achievements. Descriptive literature upon request.

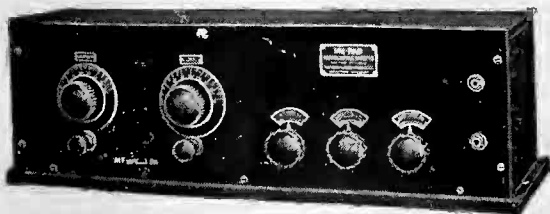

MU-RAD
LABORATORIES
 INCORPORATED
 ASBURY PARK
 NEW JERSEY

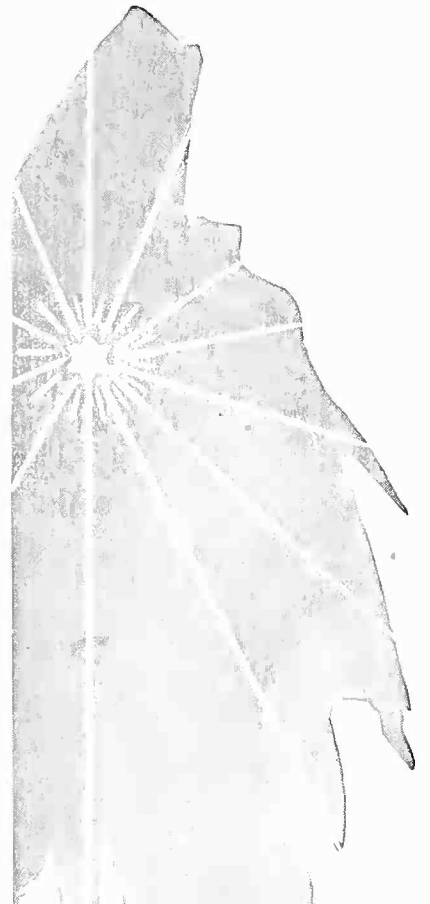

The New
 Star in
 the Radio
 World

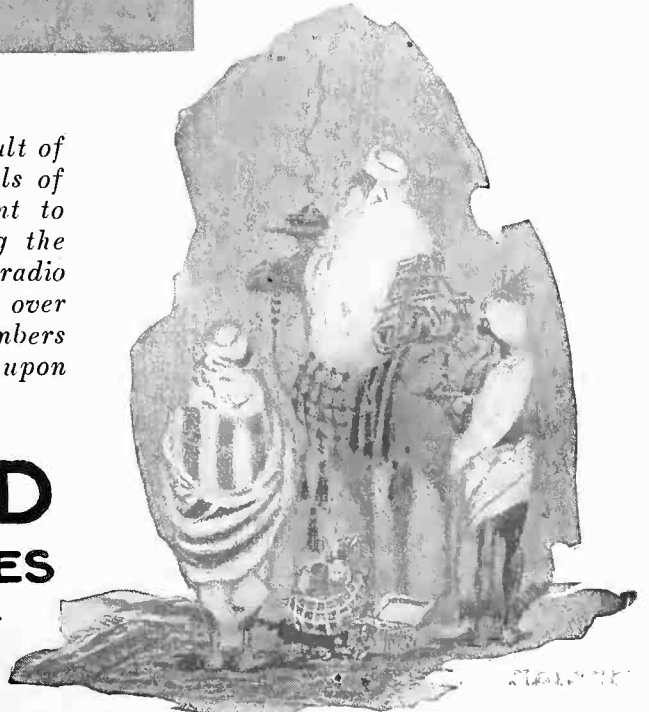

Electric Service Engineering Co.

105 West 47th Street

New York City

Bryant 2743-2744-2080

Amrad

Fada

Chelsea

Federal

Dubilier

General Apparatus

Make *ESECO* Your
HEADQUARTERS
"It Will Pay You!"

The advice of the Electric Service Engineering Co. to its dealers is equally as valuable as the promptness of deliveries and the reliability of its supplies. Esecos experience antedates the existence of the majority of its competitors.

"We don't guess—we know."

A Complete Stock of HARD-TO-GET Accessories

Retailers and Jobbers Take Notice!

NOTE: The coupon at the left will appear in our advertisement in November Radio News.

This advertisement will be read by over quarter of a million Radio enthusiasts. We are spending thousands of dollars in this way to make your sales easier.

NEW HAVEN RADIO COMPANY, Chapel and Hamilton Streets, NEW HAVEN, CONN.

Coupon good until November 10, anywhere in the world. Order today as many condensers as you need as we will not make this offer again.

Messrs..... (Date).....
(Dealer's name and address)

Please deliver to me the Marshall Variable Air Condensers I have checked, (Write in squares number of each desired)

3 Plate	5 Plate	9 Plate	17 Plate	23 Plate	35 Plate	43 Plate	67 Plate	5-23 Plate Outfit Radio Expert Size
---------	---------	---------	----------	----------	----------	----------	----------	---

and accept this coupon in payment of.....dollars and.....cents of the cost of same, (10% of the retail price) the balance to be paid for in cash.

Name..... Address.....

RETAILERS AND JOBBERS:—We, the New Haven Radio Company, authorize you to accept this coupon. We will accept it from you at its face value when properly filled out and signed, in partial payment on any order for assembled Marshall Variable Air Condensers, placed with us either by the retail dealer direct or through his jobber, until December 1, 1922. Our references: Dun or Bradstreet, or any bank in New Haven. NEW HAVEN RADIO CO., NEW HAVEN, CONN.

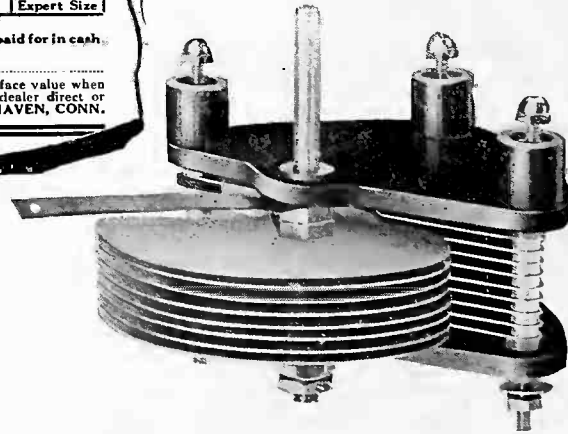

Prepare to Meet the Demand for MARSHALL CONDENSERS Created by This Unique, Sensational Offer

READ the above special coupon offer on Marshall Condensers which will appear in Radio News for November. The coupon is worth a full 10% reduction off the retail price. It does not matter whether you order one or one thousand Marshall Condensers, there is 10% off just the same.

JOBBERS: Put this information IMMEDIATELY in the hands of road men, and order samples for them.
DEALERS: Run this coupon in your advertising and announce that you will accept all Marshall Condenser coupons on above terms.
Marshall Condensers have passed every test and are proved the highest grade condensers on the American market. It pays to sell the best.

Read, think, and act before the "other fellow" does.

NEW HAVEN RADIO COMPANY, New Haven, Connecticut, U. S. A.
Canadian Factory: 20 Hayter Street, Toronto, Canada

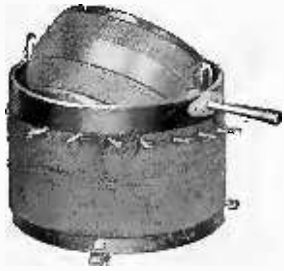

VARIOCOUPLER — Acknowledged standard in design and material. Exceptionally finished throughout. Contains seven unit taps and seven taps of seven turns each. Price \$4.00.

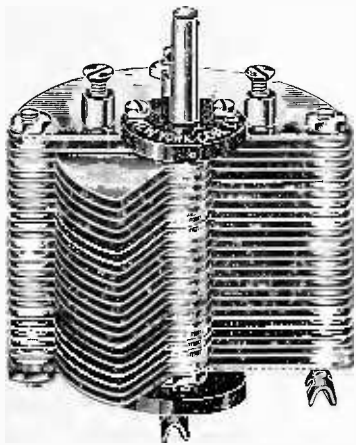

VARIABLE CONDENSERS — Design originated by us. Has proven its value under all conditions and must not be compared with many flimsy, poorly made and assembled imitations. Template for attaching accompanies each instrument. Made in three sizes:

- 11 Plate..... \$1.50
- 23 Plate 2.00
- 43 Plate..... 3.00
- Three Plate Veneer..... 1.25

COMBINED VARIOMETER & TUNING INDUCTANCE—Wave length 150 to 600 meters. Very popular with the more advanced wireless constructor. Contains primary and secondary windings, properly attached to New York standard Variometer. Allows large variety of hook-ups. Price \$6.00.



NEW YORK ENTERTAIN-A-PHONE RECEIVING SET No. 2—Complete with detector and two stages of amplification, all in one cabinet. Contains a non-regenerative two circuit hook-up with two stages audio amplification. Results are simply a revelation. It must be operated and heard to be appreciated. Workmanship and design and material of exceptional character throughout. Of unusual interest to the jobber. Price \$50.00, fully guaranteed.

**New York Coil Company Radio Products
Are Built to Work—Not Just to
Sell**

NOTE REDUCED PRICES

The leadership they enjoy is due to correct design, exceptional workmanship and eighteen years' experience in the manufacture of wireless and precision electrical devices. Two especially equipped factories and quantity production is responsible for our low prices and *popularity with the dealer and jobber*. A set constructed of New York products is certain to give satisfaction and highest possible efficiency. Why experiment with untried devices?

Jobbers and Dealers—Satisfactory discounts and a line that will increase your business.

NEW YORK COIL COMPANY
338 Pearl St., New York City, N. Y.



VARIOMETER — Widely copied, yet unequalled. This is an extremely large instrument containing proper number of turns and exact proportions throughout. Maximum results are assured by its using, as proven by thousands of satisfied customers. Must be seen to be fully appreciated. Price \$4.00.



AUDIO FREQUENCY TRANSFORMERS—Choice of leading manufacturers and radio engineers. Guaranteed to give high magnification, less distortion and better all round efficiency. No howling. Price \$4.00.

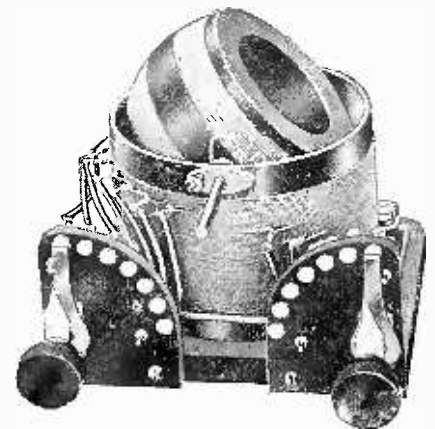

COMBINED MOUNTED VARIOCOUPLER—The only Variocoupler on the market that allows panel or table connection and eliminates the connecting of taps, soldering, drilling, etc. A great advantage in Radio. Nothing like it on the market. Handsomely finished. Price \$8.00.

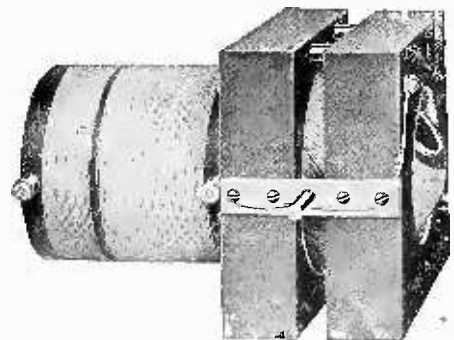



Type B, Keystone Radio Arrester. Retail Price, \$2.00

KEYSTONE

LIGHTNING ARRESTERS

Listed as Standard by Underwriters' Laboratories (No. 362 A-4)

You can sell hundreds of Keystone Arresters for these reasons—Small in size; weatherproof; entirely enclosed and sealed; foolproof; constructed by a Company having 30 years' experience in lightning arrester design; low capacity and high resistance; no vacuum to lose and so reduce the efficiency of the arrester to a point where it is practically valueless.

Get your order in before there is a possible scarcity. Liberal Dealer discounts. Write for complete information.

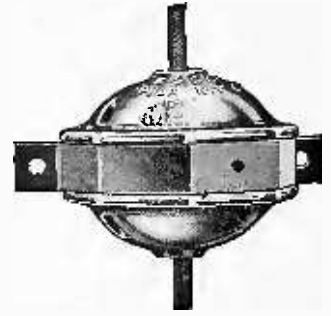

Type A, Keystone Radio Arrester. Retail Price, \$2.00

Simplex Panel Units

and
Unmounted
Variometers
and
Vario-Couplers



No. 47488
Simplex Variometer,
Showing Side View of
Panel Mounted Type

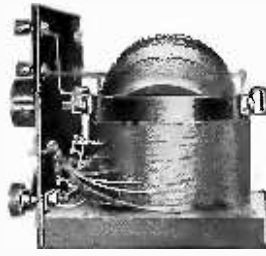

No. 47489
Simplex Vario-Coupler,
Showing Side View of
Panel Mounted Type



No. 47541
Simplex Condenser
Panel—Side View



No. 47490
Simplex Detector Panel
Side View



No. 47491
Simplex Amplifier Panel
Side View



No. 47483
Simplex Vario-Coupler,
Unmounted



No. 47482
Simplex Variometer,
Unmounted



Manufacturer of
Lightning Arresters for 30 years
Distributors for
SIMPLEX RADIO CO.

There is a big demand for Simplex Panel Units among your customers because they permit trying-out many different hook-ups and thus determining the best for their certain locality without having to disassemble a complete outfit. This is a decided advantage, but of no less interest is the fact that the beginner can first purchase one Vario-Coupler Panel and one Detector Panel and have a fairly good receiving set at minimum cost with the advantage of later adding additional units to obtain greater sensitivity and selectivity. Thus the user can add to his Simplex outfit and when he has purchased it complete it is unquestionably one of the most attractive and efficient receiving sets now offered to the public. This is a very attractive line for Jobbers and Dealers. Write for new descriptive circular and discounts on Panel Units and Unmounted Variometers and Vario-Couplers. Simplex Material is high grade in every respect.

ELECTRIC SERVICE SUPPLIES Co.

PHILADELPHIA
17th and Cambria Streets

NEW YORK
50 Church Street

CHICAGO
Monadnock Bldg.

Branch Offices: Boston, Scranton, Pittsburgh
Canadian Distributors: Lyman Tube & Supply Co., Ltd., Montreal, Toronto, Winnipeg, Vancouver

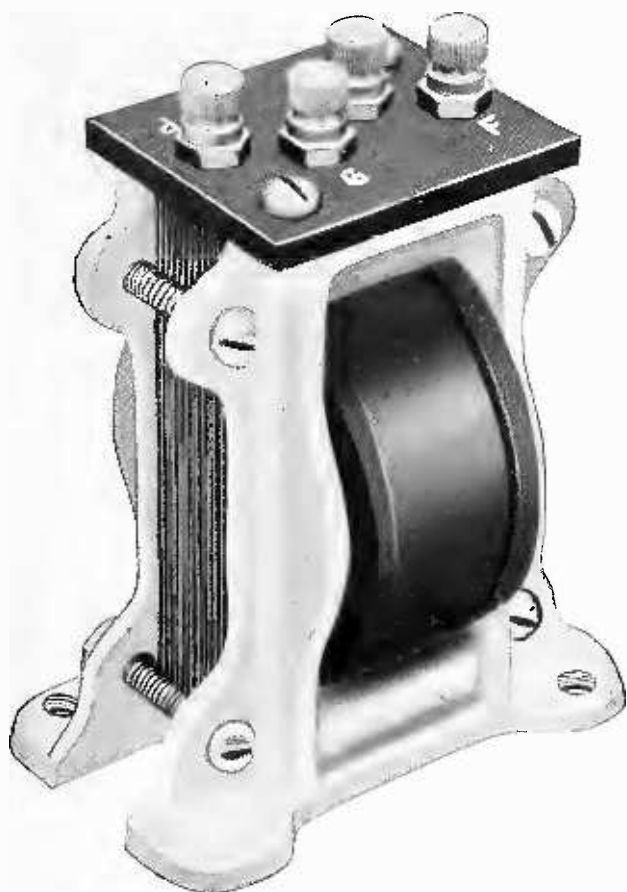

RETAIL PRICE, \$6.00
ORDER FROM YOUR
JOBBER

What Jobbers Say About 3 Y Q

“We find that they are all that you claim.”

Pittsburgh, Pa. Jobber & Mfgr.

* * *

“The transformers certainly have quality. Please ship the order at once.”

Mfgr. & Jobber, Newark, N. J.

* * *

“Have tried these transformers out and find them perfectly satisfactory. Please send at once fifty transformers.”

Mfgr. & Jobber, Baltimore, Md.

* * *

Names and addresses of above furnished on request.

3 Y Q Transformer Sales Prove That Radio Fans Appreciate Quality and Scientific Efficiency

More and more Radio Fans decide that the 3 Y Q Audio Frequency Transformer is the only transformer they care to use. Our sales sheet shows that dealers are moving 3 Y Q Transformers.

And that shows that the Fans appreciate *Amplification without distortion* and that they have accepted the 3 Y Q Transformer as the most efficient of all amplifying devices, young as it is.

Dealers who intend to help make Radio a permanent and growing business cannot afford to overlook the 3 Y Q Transformer—it builds good will, repeat orders and sends new customers into the store.

Order from your jobber. We are taking space in consumer magazines to tell the fans to buy from the dealer.

Descriptive literature for free counter distribution sent free upon request.

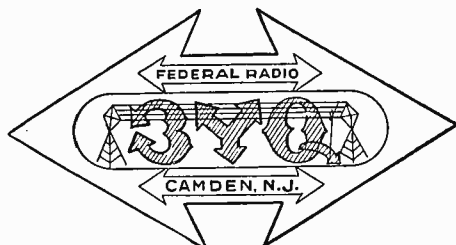

Federal Institute of Radio Telegraphy
 Second and Federal Streets
CAMDEN, N. J.

Your Trade Wants This Set

THE
Simple-X
Crystal Radio Receiver

*Superior to Sets Costing Five Times the
Price of This Wonderful Set*

PRICE **\$4.75**

READ THE FACTS:—

1. Will receive Broadcast Concerts within a radius of 25 miles.
2. The only set equipped with the Simple-x (fool-proof) Detector.
3. The only set with the Mul-Ti-Tec Crystal—a thousand crystals in one. No fussing to find a sensitive spot. No loss of time or interruption of the programme.
4. Built with Roller Sliders to give a smooth, constant contact.
5. No wearing or short-circuiting of coil wires due to frictional scraping.
6. The only set having a flat Coil and indicating sliders.

Awarded Certificate of Excellence by N. Y. Evening Mail, and approved by Tribune Institute.

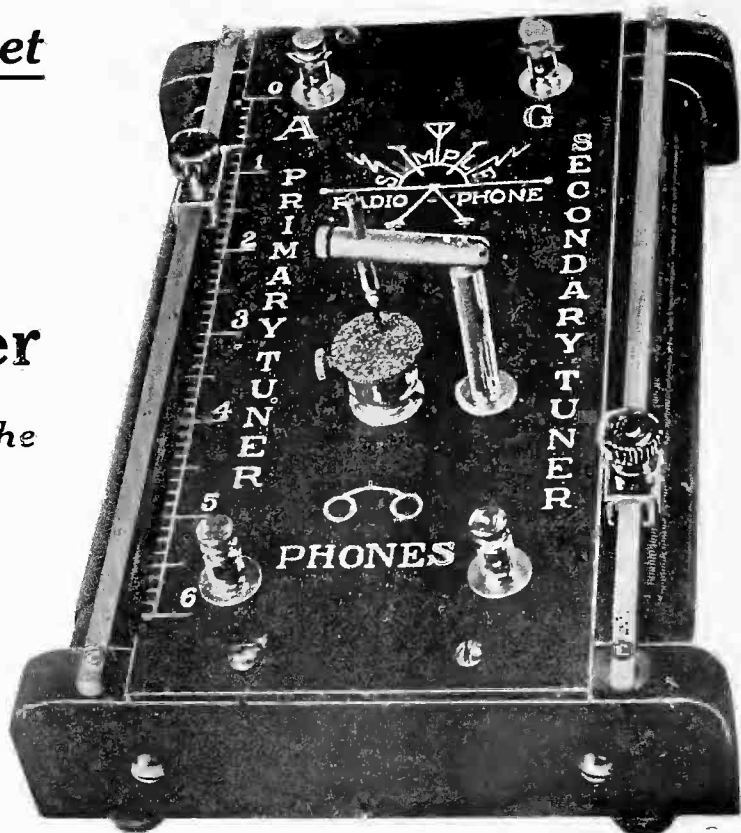

(Patent Applied For)

For Discount Schedule, wire, write, or call

CARAGOL-CLARKE CO., Inc.

82 Beaver St. (Tel. Bowling Green 1990-1-2) New York City

The DeLuxe U. S. Navy Type Radio Receiver

List \$595.00

FOR IMMEDIATE DELIVERY



CHARLES R. ABLETT CO.

199 Fulton St., NEW YORK CITY

Best of its type—must not be confused with instruments selling for from \$200 to \$300. Highly selective. Will pick up messages, music, lectures, etc., that lower priced instruments will not hear. This receiver is equipped with binding posts which are normally short circuited for 300 to 6800 meters by which wave lengths up to 23,000 meters may be received by the attachment of loading coils. Capacities of proper loading coils for above are: Primary 50; Secondary 50; Tickler 30 millihenries. While the receiver is provided with a "standby" or untuned circuit, it also has an unusual degree of selectivity. Although primarily designed for the more advanced fields of radio work, or the laboratory, the simplicity of arrangement and beauty of finish make it unusually desirable for the radio club or for the individual who desires the finest equipment obtainable for his home or office. In the receiver, Bakelite tubes, threaded, provide the forms on which inductance coils of high frequency cable are bank-wound. After assembling, the coils are impregnated with an insulating compound, in vacuum, and thoroughly baked. The inductance switch controls a mechanism whereby the different sections may be connected, completely disconnected and opened, or completely disconnected and individually short circuited. This arrangement is important for, by it, each coil has a natural period when connected which is less than the shortest wave length in the receiver's range. The reception of parasitic signals is overcome, the absorption of desired signals by the coils is minimized, more energy is forced to the detector and on all wave lengths the interference is reduced.

Dictograph *Radio* Loud Speaker Proves Sensational Success!

A NOTHER success for Dictograph! Here at last is the Loud Speaker the radio public has been waiting for—the Loud Speaker *for the home*—backed by a name known the world over—and sold at a low price within the reach of all!

From the very first announcement, the success of the Dictograph Radio Loud Speaker was assured. Orders poured in—in advance of production—and in such volume that original production plans were increased and the price reduced! Instead of \$25 as first announced, the LIST PRICE IS NOW ONLY \$20—complete with 5 ft. flexible cord.

The Public has been waiting for this perfect Loud Speaker for the home

Everyone knew that a Radio Loud Speaker made by the Dictograph Products Corporation would be the BEST LOUD SPEAKER THAT COULD BE MADE at the price. Its superiority was GUARANTEED by Dictograph resources, Dictograph experience, and by the world-wide reputation of all Dictograph products—the “Acousticon” for the deaf, the Detective Dictograph, the Dictograph System of Loud-Speaking Telephones.

At the list price of ONLY \$20, the Dictograph Radio Loud Speaker is a real opportunity for dealers. Here is the most perfect reproduction of sound known to radio engineering—clear, natural tones, in full volume, and absolutely FREE FROM DISTORTION OR

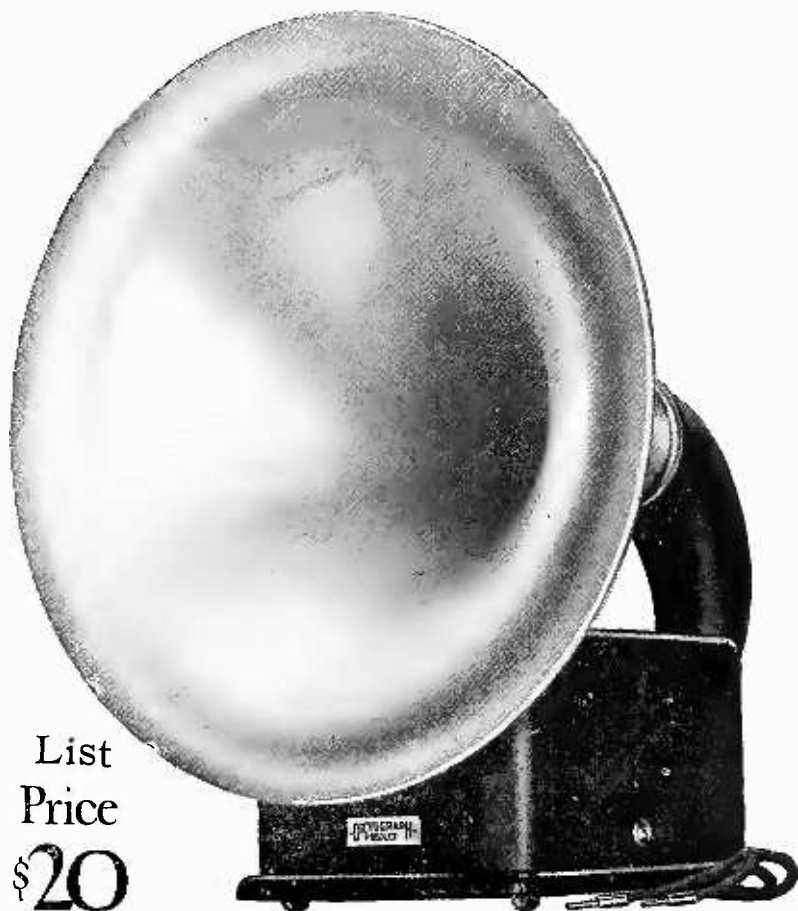

List Price
\$20

NOISE. Perfect results with any vacuum tube receiving unit. No extra batteries required.

Another strong selling feature—the handsome appearance of the Dictograph Radio Loud Speaker: highly burnished French lacquered spun copper bell horn 11 inches in diameter attached to die cast black enamel tone arm, finished with nickel trimmings. Cabinet of solid ebony-finished hardwood, size 6 x 5 inches base, 4 inches high, mounted on rubber knobs to avoid marring of polished tables. List price \$20 complete with 5 ft. flexible silk cord and standard terminals.

PROTECT YOUR PROFITS on the Dictograph Radio Loud Speaker. Wire your jobber or communicate direct for names of authorized distributors.



3000 ohms

List Price
\$12

THE STANDARD OF THE WORLD

Electrotypes for catalogs, advertising, etc., are available and will be furnished on request

DICTOGRAPH *Radio* HEAD SET

Bigger and bigger sales every month are the best proof in the world of the established demand for the Dictograph Radio Head Set. A product of unmatched quality. 3,000 ohms. For any receiving set, crystal detector or vacuum tube. No radio dealer can afford NOT to carry the Dictograph Head Set—it means quick turnover and SURE PROFITS. If you have not already stocked, get your order in NOW to your jobber or communicate direct for names of authorized distributors. *The best Head Set in the world regardless of price!* Regularly furnished as Standard Equipment with the Leading Receiving Sets made.

DICTOGRAPH PRODUCTS CORPORATION

220 WEST 42nd STREET

BRANCHES IN ALL PRINCIPAL CITIES

NEW YORK CITY

VARIO COUPLER

VARIOMETER

SHORT WAVE UNIT

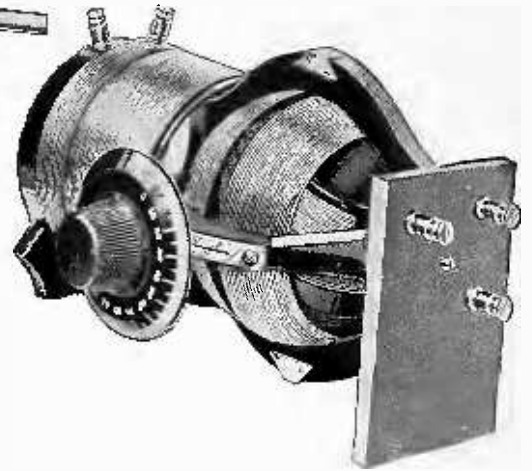
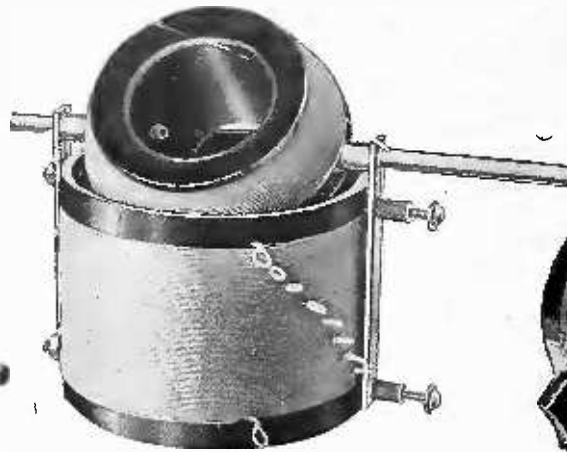
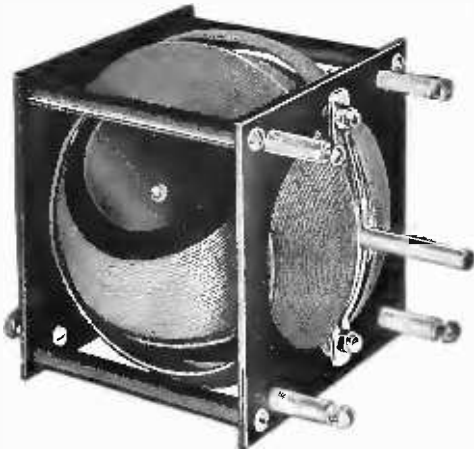

List Price - - - \$3.50

Unique in Design—Efficient in Operation

Dealers and Jobbers Write for Particulars

An Exclusive Utility Combination

List Price - - - \$4.50

List Price - - - \$10.00

NELSON RADIO PARTS CO.

89 ACADEMY STREET,

NEWARK, N. J.

*Dependable Equipment Must Answer
FALL DEMAND*

WE DISTRIBUTE FOR

RADIO CORPORATION OF AMERICA,
MURDOCK, RHAMSTINE, FADA,
BRANDES, DE FOREST, SIGNAL,
CLAPP-EASTHAM, CUTLER-HAMMER

AND OTHERS

THE RADIO ELECTRIC CO.
Manufacturers and Jobbers in



RADIO EQUIPMENT

1427-29 LIBERTY AVENUE
PITTSBURGH, PA.



"VICTOR PRODUCTS"



TUNER, DETECTOR AND TWO-STAGE AMPLIFIER
—Type 115—

WE manufacture a complete line of Radio Sets and Parts, consisting of:
 Receiving Sets,
 Tuners,
 Tuners and Detectors,
 Tuner, Detector and Two Stage Amplifiers,
 Tuner, Detector and Three Stage Amplifiers,
 Two Stage Amplifiers,
 Variometers,
 Variocouplers,
 V. T. Sockets,
 Rheostats,
 Grid Condensers,
 Variable Condensers,
 Knobs,
 Dials,
 Binding Post,
 Etc.



SOCKET
Type 109

EVERYTHING —IN RADIO—

MR. JOBBER AND DEALER: Does years of experience in manufacturing Radio Transmitting and Receiving Apparatus for the **UNITED STATES GOVERNMENT** mean anything to you?

VICTOR engineers and workmen have had this experience and are capable of producing highly satisfactory apparatus.

JOBBERS AND DEALERS are invited to write us for complete information regarding our attractive proposition.

CATALOGUE SENT ON REQUEST.



VICT-RA-PHONE CONSOLE TABLE

VICTOR RADIO CORPORATION

799 East 135th Street, New York City

Manufacturers of Complete Radio Sets and Parts



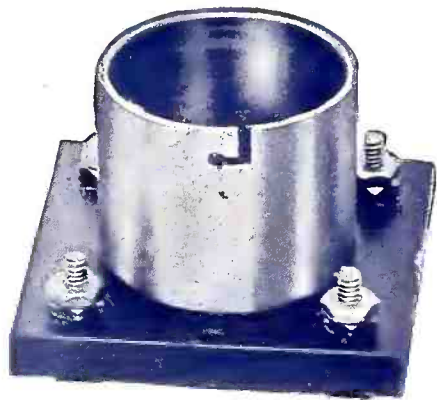

V. T. SOCKET
Type R104
Price, 85 cents

"RECO PRODUCTS"

**PUT 'EM IN STOCK
AND WATCH 'EM MOVE**

"Reco Products" Are Constructed of the Best Materials Obtainable.

We Guarantee These Products and Will Gladly Replace any Goods Which Are Not to Your Satisfaction.

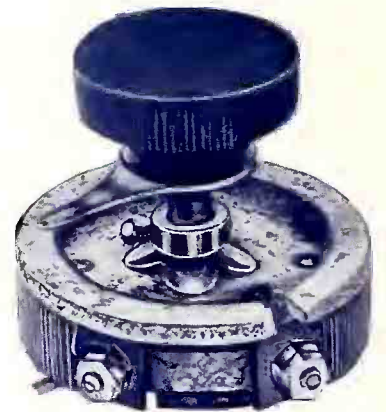

RHEOSTAT
Type R101
Price, \$1.00

**We Can Make
Prompt Deliveries**

JOBBERS AND DEALERS

Are Invited to Wire or Write Us for *Attractive Proposition and Liberal Discounts*. We Will Gladly Submit Samples for Your Inspection.

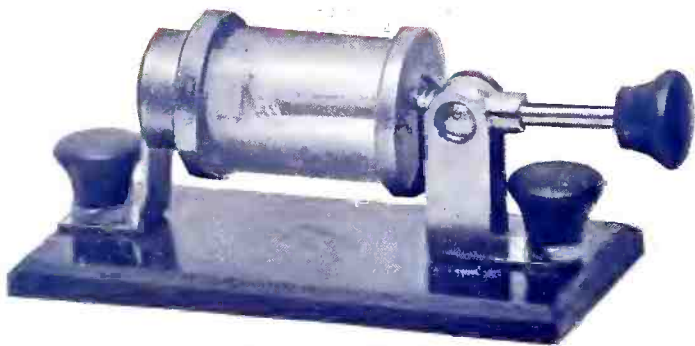

CRYSTAL DETECTOR
Type R102. Price, \$1.30

RECO RADIO ENGINEERING CO.

16 UNION AVE.

NEW ROCHELLE, N. Y.

The Better Kind of Radio Sets That Everybody Is Clamoring For



A WIDELY different radio public, educated and alive to the essentials of value, is demanding better made, more easily operated, medium priced sets. Dealers, of their own accord, have written us that *Erasing* Sets meet this demand to a "T." The best evidence of this quality is our unconditional money-back guarantee on every set. Every dealer who is earnestly interested in lining up with the general demand for better apparatus should get our proposition on *Erasing* Sets.

CONSIDER THESE SELLING POINTS

Simple, non-regenerative sets. Such devices as efficient condensers and vari-couplers of manufacturers own design; with separate jacks and rheostats for independent use of steps, make a strong appeal. The wide wave length range of *Erasing* Sets, from 150 to 2,500 meters, allows for any changes in wave length and increases the number of stations which can be heard.

- Type X3, single circuit, as illustrated, list.....\$100
- The R-3 "standard" Tuner, Detector and 2 Stage Amplifier, sells for only, list..... 75
- Type L-2, list..... 30

Write for Very Interesting Proposition and Literature



ESSEX RADIO SERVICE, Inc.

Main Office and Factory: 56 SUMMER AVENUE, NEWARK, N. J.

DOES YOUR RADIO DEPARTMENT PAY?

LET "FRANCO" SHOW THE WAY

"FRANCO" Is The BRAND To Know—It Means THE BEST IN RADIO

"FRANCO" SELLS BECAUSE IT EXCELS

FRANCO SHORT WAVE RECEIVER

"The customer's choice—for Music and Voice"



"UNSURPASSED TO RECEIVE BROADCAST"

This receiver is the result of careful and thorough research work.

No. RT 132.....List \$35.00

FRANCO RADIO FREQUENCY TRANSFORMER

"RENOUNDED FOR SOUND"

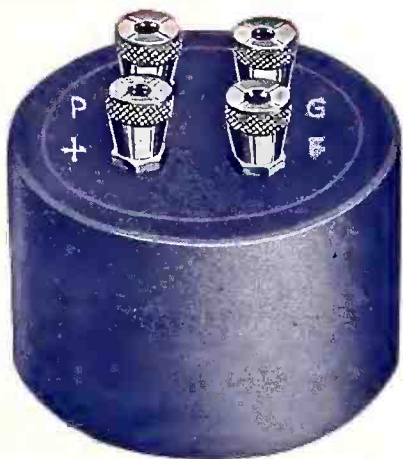

HAS NO PEER FOR RECEIVING CLEAR

Scientifically tested—150 to 500 meters. Guaranteed to give service—or your money back.

No. R 200.....List \$3.00

FRANCO POTENTIOMETER

Electrically and mechanically perfect. Your set deserves a Franco. Bakelite base—phosphor bronze contact lever. 250 Ohms resistance.

No. P 205.....List \$1.65

FRANCO TRIPLE COIL MOUNTING

"A FRANCO MOUNTING WILL BEHAVES—REGARDLESS OF THE LENGTH OF WAVES"

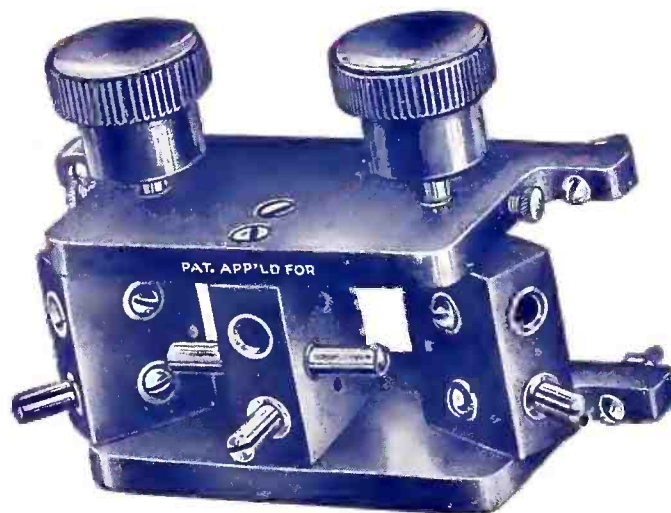

Made of polished Bakelite, with patented screw adjustment.

No. 303—Triple.....List \$5.00
No. 302—Double.....List 3.50
No. 301—Single.....List .55

FRANCO QUALITY PRODUCTS

- Porcelain Rheostats
- Composition Rheostats
- Composition Dials
- Unbreakable Dials
- Crystal Detectors
- Moulded Sockets
- V. T. Sockets
- Crystal Receiving Sets
- Federal Phones
- Federal Apparatus
- Turney Phones
- Dictograph Phones
- Thordason Transformers
- Klosner Vernier Rheostats
- Variable Condensers
- Phone Condensers

FRANCO SELLS BECAUSE IT EXCELS

FRANK RADIO CO.

Manufacturers

Distributors

122 Fifth Avenue

Dealers and Jobbers write for catalogues and attractive discounts. . . .

Samples gladly sent on request—without obligation. . . .

**Tone
Tells
Sound
Sells**



MODEL XL

PATENTS PENDING

Reg. U. S. Pat. Office

THE Oranola

PATENTS - PENDING

NO AERIAL USED

LOOP ANTENNA self-contained in artistic piano-finished cabinet eliminates any wiring by purchaser.

COMBINATION RADIO and PHONOGRAPH

RADIO ENGINEERS universally agree that radio and audio frequency transformation of energy received is best for receiving broadcasting.

That is why we use the radio and audio frequency amplification.

NO EXPENSE has been spared to make our product the best in every detail. Having passed through the experimental stage, we are prepared to stand behind each instrument with our unqualified guarantee.

OUR TALKING MACHINE (well known as THE PERFECT TALKING MACHINE), combined with our radio instrument, provides a universal means of sound reproduction without equal. Purity of tone in ample volume without distortion makes the ORANOLA almost human.

OUR KEYNOTE is simplicity of operation. No knowledge of electricity or wireless is required.

SEVERAL MODELS with or without talking machine combination, listing from \$150 to \$450. Descriptive circulars and discounts on application. WIRE OR WRITE for exclusive territory proposition. DEMONSTRATIONS at our office during broadcasting periods.

ORANOLA RADIO CORPORATION
228 SEVENTH AVENUE
NEW YORK CITY



NO. 57.—RECEIVER

Which will undoubtedly prove to be the best seller of the season

Including

- NO. 57.—RADIO RECEIVER.
- NO. 58.—D. X. RADIO RECEIVER
- NO. 55.—TWO-STAGE RADIO FREQUENCY AMPLIFIER
- NO. 56.—ONE-STAGE RADIO FREQUENCY AMPLIFIER AND DETECTOR

For Further Information

WRITE FOR

BULLETIN NO. 119-W

IT IS A TEXT BOOK ON RADIO FREQUENCY AMPLIFICATION

Federal Telephone and Telegraph Company
BUFFALO, N. Y.

The Radio Fan
Has Been Waiting For This

RADIO FREQUENCY RECEIVING APPARATUS

THE MOST SENSITIVE INSTRUMENTS YET DEVISED

We are now ready to place on the market
Our Latest Product

RADIO FREQUENCY AMPLIFYING EQUIPMENT

**GET IN
ON THIS**



"Comin' In Great!"

At Last! — High Efficiency Receivers at a Down-to-Earth Quick-Sale Price

ELEVEN years in the manufacture of delicate electrical units and apparatus—eleven years concentrated in the production of one line of equipment—all electrical, means something in accumulated experience and facilities.

That's the answer to how we have been able to place on the market this super-sensitive radio head set for \$6.00.



"Hear" More and Cost Less

All the high-priced qualities—extreme sensitiveness, perfect balance, natural voice pitch, no scratching—are all Basco Receiver refinements. Light weight, aluminum case—solid horse shoe type magnet, no laminations—bus-bar connections, no loose, hairlike wires.

Light, extra sensitive diaphragm, set to thousandths-of-an-inch accuracy from magnet poles. Clean cut, rugged design throughout—easy on the head—comfortable on the ears and good to look at. Compare them with any other head set, irrespective of price—then you'll be convinced they're what you want, for quick turnover.

*Write for exceptional dealer proposition and list of Basco Radio Equipment
Ask for name of our nearest local factory representative.*

Briggs & Stratton Co.
Milwaukee  PRODUCT  Wisconsin



\$6.00

Put up in attractive orange-colored cartons

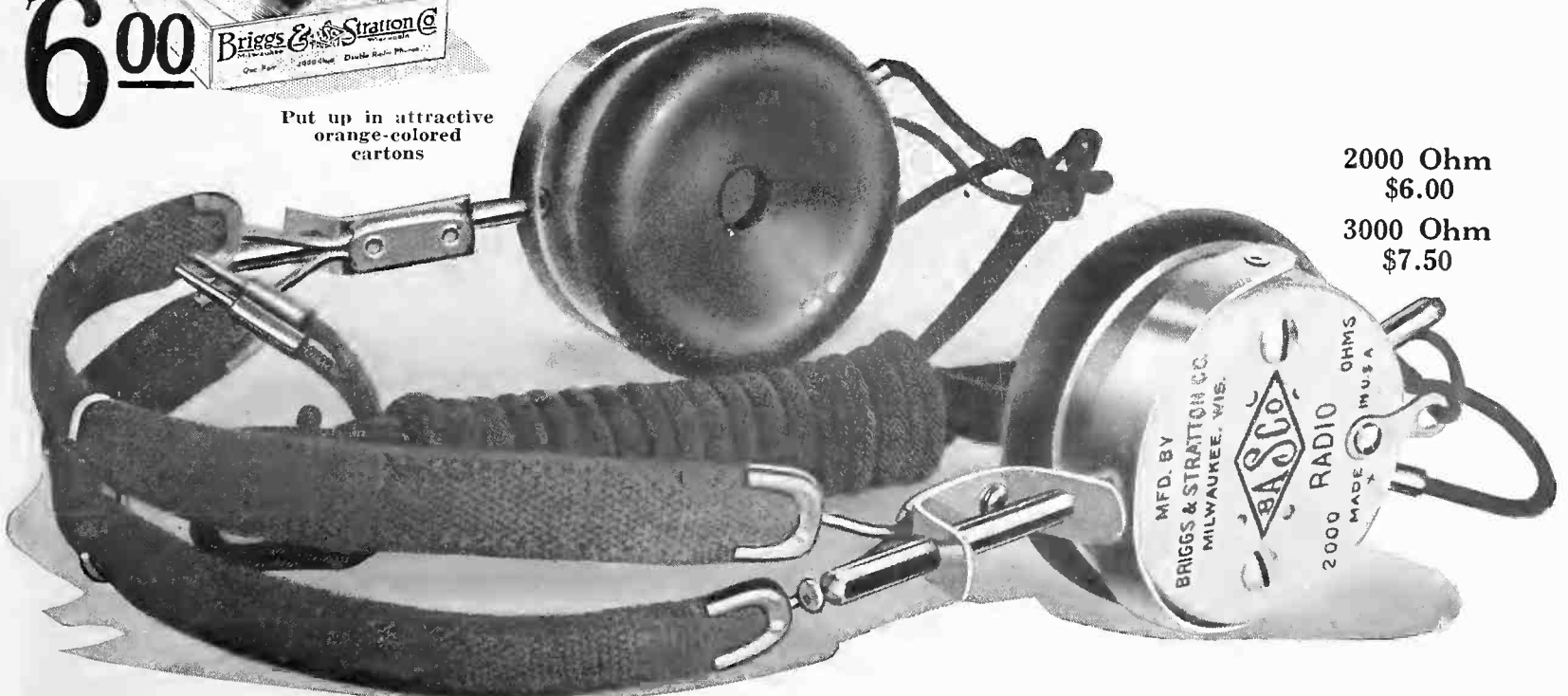

2000 Ohm
\$6.00

3000 Ohm
\$7.50



Paul F. Godley, designer of Paragon Radio Products, listening in

Godley Warns Radio Operators of Trouble This Winter

Paul F. Godley expects a chaotic situation in radio receiving this winter. Due to the delay in governmental regulation of broadcasting, operators of single circuit receivers are bound to have serious trouble. Mr. Godley says:—

“The coming season will see from ten to twenty times as many broadcasting stations as there were last year, all concentrating on one narrow band of wavelength. With a single circuit receiver, jamming and mixed messages are bound to result. Market reports, election returns, time signals, musical selections—all will be jumbled together in hopeless discord.

“The only way to cope with a situation like this is to use a three circuit regenerative receiver.

“For example, the Paragon three circuit receiver can select between broadcasting stations of about the same signal strength with less than one per cent differential.”

It is scarcely necessary to point out the remarkable opportunity this situation offers Paragon dealers. It would be difficult to imagine a more convincing selling argument for Paragon receivers in particular and Paragon Radio Products in general.

We shall appreciate it if you will let us know your requirements as early as you can to prevent possible disappointment later in the season.

ADAMS-MORGAN CO., 12 Alvin Ave., Upper Montclair, N. J.

Also Manufacturers of PARAGON

Radio Telephone
Transmitters
V. T. Control Units
Rheostats
Potentiometers
V. T. Sockets
Amplifier Transformers
Detectors
Control Dials
Amplifiers
Receivers
Switches
Variometers

PARAGON

Reg. U. S. Pat. Off.

RADIO PRODUCTS

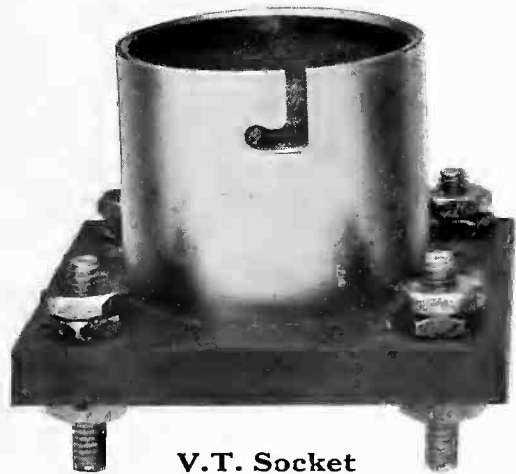

V.T. Socket

Single	\$1.00
Double	1.90
Triple	2.80
Quadruple	3.70

**THRADIO
CONDENSERS
HEAD SETS
SOCKETS
RHEOSTATS
TRANSFORMERS**



Manufactured by
THRESHER RADIO CORP.

476-484 Eighteenth Ave.
Newark, N. J.

The discriminating buyer is insisting upon Apparatus of the HIGHEST MERIT in Electrical and Mechanical Design and Workmanship.

*Attractive Discounts to
Distributors and Jobbers*

"AEREX" Long Range Radio Receiver Model RA-4

2 Stages Radio Frequency Amplification

2 Stages Audio Frequency Amplification

Using Only Two Amplifier Tubes

Features

1. Longer mile range
2. Supersensitive
3. Quality workmanship
4. Quality material
5. Saving of batteries
6. Saving of vacuum tubes, only three required to perform the work of five

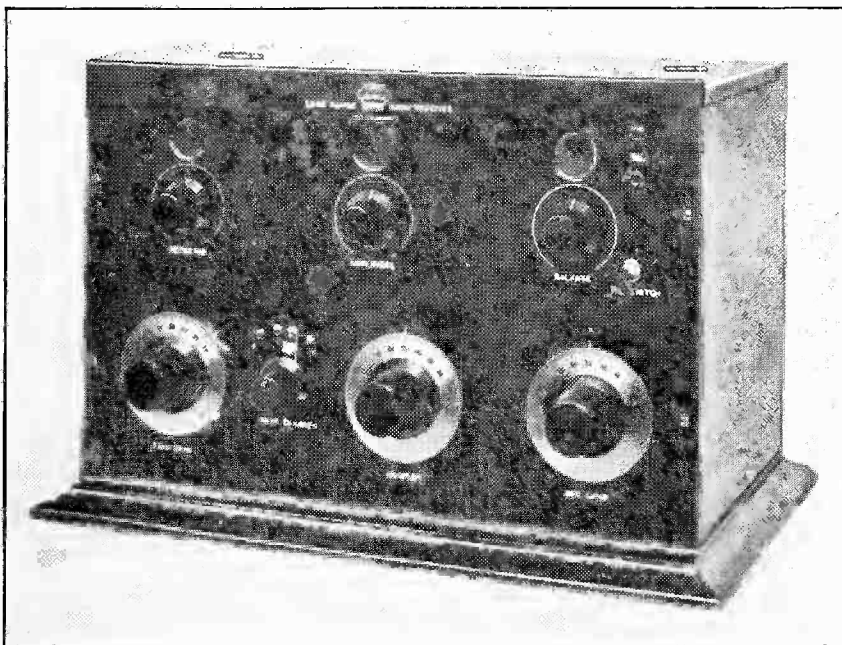

Features

7. Adapted for use of loop or outside aerials
8. All binding posts on back, no messy wiring
9. Four stages of amplification.
10. Attractive appearance

SPECIFICATIONS

Cabinet—Solid Mahogany. Rubbed piano finish. 16x11x7.
Panel—Genuine Bakelite beautifully engraved.
Dials—Three-inch metal engraved.
Knobs—Tapered Bakelite Knobs.

Condensers—Permanent capacity.
Rheostats—Specially designed, positive contact, smooth action.
Transformers—2 Radio Frequency and 2 Audio Frequency.
Sockets—Standard moulded Bakelite.

Binding Posts—Hard rubber composition. All mounted on back panel, plainly marked.
Circuit—Patents pending. 2 stage radio frequency amplifications, 2 stage audio frequency amplifications, one detector using only three vacuum tubes to perform the work of five.

This set is guaranteed to receive broadcasting within a radius of 400 miles. Provision is made for using a loop aerial.
The marvel set. Equal to super-regeneration.
A long range radio receiving set which is also adapted for use with a loop antenna for local broadcasting.

Long Range sets will be in demand this year. Will you be able to supply such a set in a THREE TUBE UNIT.
Some territories still open for live dealers.

LIST PRICE, \$125.00 *Discounts Upon Request*

AEREX RADIOPHONE CORP., 342 Madison Avenue, NEW YORK CITY

Let Our Free Service Bureau Help You Supply Your Needs

Tell us your needs and we'll put you in touch with reputable firms to the end that you will receive information on the latest and best equipment. A post card will do or use the coupon below.

- | | | | | |
|---|---|---|---|---|
| <p>A</p> <p>1 "A" Batteries
2 Aerials
3 Aerial wire
4 Aerial protectors
5 Aerial switches
6 Aerial insulators
7 Aerials, loop
8 Air condensers
9 Adapters
10 Amplifiers
11 Amplifying units
12 Aluminum wire
13 Ammeters
14 Amplifying tubes
15 Amplifying horns
16 Amplifying transformers
17 Antennae, cage
20 Antenna light wire plugs
18 Audio frequency transformers
19 Automatic transmitters</p> <p>B</p> <p>21 "B" Batteries
22 Batteries, "A"
23 Batteries, dry
24 Batteries, storage
25 Battery chemicals
26 Battery chargers
27 Battery testing instruments
28 Battery switches
29 Battery rheostats
30 Battery clips
31 Battery handles
32 Battery potentiometers
33 Binding posts
34 Books
39 Boxes
35 Brass parts
36 Bushings
37 Bulbs
38 Buzzers</p> <p>C</p> <p>41 Cabinets
42 Cam switches
43 Carbon potentiometers
44 Change-over switches
45 Charging rectifiers
46 Choke coils
47 Cat whiskers
48 Cap nuts
49 Carbon walls
50 Cardboard tubes
78 Charts
51 Chopper, rotary
52 Clamps
53 Clips
54 Coils
55 Coil mountings
56 Coil plugs
57 Coils, spark
58 Condensers
59 Condensers, fixed
60 Condensers, variable
61 Condensers, air</p> | <p>62 Condensers, mica
63 Condensers, loading
64 Connection blocks
77 Contract work
65 Control panels
66 Condenser parts
67 Copper wire
68 Cords
69 Cord tips
70 Crystals
71 Crystal detector units
72 Crystal receiving sets
73 C. W. Transmitter sets
74 C. W. Filament heated transformers
75 C. W. Inductances
76 C. W. Power transformers</p> <p>D</p> <p>81 Detectors
82 Detector panels
83 Detector tubes
84 Detector minerals
85 Detector units
86 Dictionary, Radio
87 Dials
80 Dial switches
88 Dry batteries
89 Drawings
90 Diagrams</p> <p>E</p> <p>91 End mountings (tubes)
92 Engraving
93 Electrotypes</p> <p>F</p> <p>95 Fibre spools
96 Fan switches
97 Filter reactors
98 Fixed condensers
99 Fire extinguishers
100 Filament rheostat
101 Filter coils
102 Flashlights
103 Fuse terminals</p> <p>G</p> <p>106 Gaps, Spark
107 Generators
105 Glass
108 Grid condensers
109 Grid leaks
110 Grid leaks, variable
111 Grid coils
112 Ground clamps
113 Ground wires
114 Ground switches</p> <p>H</p> <p>116 Headsets and bands
117 Honeycomb coils
118 Honeycomb mountings
119 Honeycomb plugs
120 Hook switches
121 Horns
122 Hydrometers</p> | <p>I</p> <p>126 Indicators
127 Inductances, C. W. Transmitting
128 Insulators
129 Insulation
130 Invention developments</p> <p>J</p> <p>131 Jacks</p> <p>K</p> <p>132 Knock down units</p> <p>L</p> <p>136 Lead-in wire
137 Lead-in switches
138 Lead-in bushings
139 Lead-in insulators
140 Levers, Switch
141 Lightning arrestors
142 Lightning switches
143 Loading coils
144 Loading inductance
145 Loose couplers
146 Loud speakers
147 Locked lever switches
148 Lock nuts
149 Loop aerials
150 Lugs</p> <p>M</p> <p>313 Mailing lists
314 Metals
151 Magnetic modulator
152 Modulation transformers
153 Machine screws
154 Magnet wire
155 Magazines, Radio
156 Mica
157 Mica diaphragms
158 Mica condensers
159 Mica diaphragm transformers
160 Microphone transformers
161 Milliammeters
162 Milli-voltmeters
163 Motors
164 Motor generators
165 Mounting coils
166 Minerals
167 Mountings</p> <p>N</p> <p>171 Name plates
172 Nickel parts
173 Nuts</p> <p>O</p> <p>176 One stage amplifier units
177 Oscillation transformers</p> <p>P</p> <p>178 Panels
179 Panel plugs
180 Panel controls
181 Paper tubes
311 Patent registration</p> | <p>182 Patent wire
183 Patent wire terminals
184 Plans
185 Phonograph attachments
186 Plate condensers
187 Porcelain
188 Porcelain cleats
189 Porcelain insulators
190 Porcelain mountings
191 Porcelain tubes
192 Porcelain V. T. receptacles
193 Porcelain V. T. sockets
194 Precision instruments
195 Polarity indicators
196 Plate connectors
197 Paste solder
198 Phosphor-bronze wire sheets</p> <p>Q</p> <p>307 Quenching spark gaps</p> <p>R</p> <p>308 Radio books
309 Radio schools
310 Radio publications
199 Radio frequency transformers
200 Reactor, plate circuit
201 Reactor, filter
202 Receiving sets
203 Receiving head sets
204 Receiving transformers
205 Receptors
206 Receiver magnets
207 Rectifiers
208 Rectifying tubes
209 Regenerative sets
210 Rheostats
211 Rheostat wire
212 Rods
213 Rotary lever switches
214 Rotary spark gaps
215 Rotary variable condensers
216 Rubber parts
217 Rotors</p> <p>S</p> <p>221 Safety switches
222 Safety fuses
223 Sliders and rods
224 Sockets
225 Soft metal
226 Shielded dials
227 Short wave sets
228 Solder
229 Solder, bar
312 Soldering irons (electric)</p> <p>230 Spark transformers
231 Spark coil selectors
232 Spaghetti tubing
233 Special apparatus
234 Spark gaps
235 Spring clips
236 Storage batteries
237 Sectional receiving sets</p> | <p>238 Switches
239 Switch levers
240 Switch points
241 Symbols</p> <p>T</p> <p>246 Tapes
247 Telephone cord
248 Telephone plugs
249 Telephone receivers
250 Telegraph keys
251 Telegraph teachers
252 Testing instruments
253 Testing clips
254 Terminals
255 Thermometers
256 Tools
257 Trade marks
258 Transformers
259 Transmitters
260 Transmitting sets
261 Towers
262 Three coil mounting
263 Tin foil
264 Tvaing coils
265 Tubes, amplifier
266 Tubes, detector
267 Tubing, flexible
268 Tube sockets
269 Tubes
270 Tuner and detector cabinets
271 Two stage cabinets
272 Two stage amplifier unit</p> <p>U</p> <p>276 Unit type receiving sets
277 Unassembled sets</p> <p>V</p> <p>281 Vacuum tubes
282 Vacuum tube sockets
283 Variable condensers
284 Variometers
285 Vario couplers
286 Variable grid leak
287 Vernier adjusters
288 Vibrators
289 Vocalouds
290 Voltmeters
291 Vulcanized fibre sheets
292 V. T. receiving sets
293 Variogrid leak
294 V. T. detector units
295 V. T. control units
296 V. T. receptacle</p> <p>W</p> <p>297 Washers
298 Watch case receivers
299 Wattmeters
300 Wavemeters
301 Wave tuner
302 Wire
303 Wire, aerial
304 Wire phosphor bronze
305 Wire, copper clad
306 Wire, magnet</p> |
|---|---|---|---|---|

Note the number of the item you want to buy—then check the corresponding number in the coupon below and mail to us.

TEAR OFF HERE

1	2	3	4	5	6	7	8	9	10	11	12	13	14	15	16	17	18	19	20	21
22	23	24	25	26	27	28	29	30	31	32	33	34	35	36	37	38	39	40	41	42
43	44	45	46	47	48	49	50	51	52	53	54	55	56	57	58	59	60	61	62	63
64	65	66	67	68	69	70	71	72	73	74	75	76	77	78	79	80	81	82	83	84
85	86	87	88	89	90	91	92	93	94	95	96	97	98	99	100	101	102	103	104	105
106	107	108	109	110	111	112	113	114	115	116	117	118	119	120	121	122	123	124	125	126
127	128	129	130	131	132	133	134	135	136	137	138	139	140	141	142	143	144	145	146	147
148	149	150	151	152	153	154	155	156	157	158	159	160	161	162	163	164	165	166	167	168
169	170	171	172	173	174	175	176	177	178	179	180	181	182	183	184	185	186	187	188	189
190	191	192	193	194	195	196	197	198	199	200	201	202	203	204	205	206	207	208	209	210
211	212	213	214	215	216	217	218	219	220	221	222	223	224	225	226	227	228	229	230	231
232	233	234	235	236	237	238	239	240	241	242	243	244	245	246	247	248	249	250	251	252
253	254	255	256	257	258	259	260	261	262	263	264	265	266	267	268	269	270	271	272	273
274	275	276	277	278	279	280	281	282	283	284	285	286	287	288	289	290	291	292	293	294
295	296	297	298	299	300	301	302	303	304	305	306	307	308	309	310	311	312	313	314	315

Service Bureau The Radio Dealer,
1133 Broadway, New York City.

We are interested in buying radio equipment and have circled the numbers on this coupon of the items we are ready to buy now. Please have manufacturers of these lines quote us dealers' prices.

Name.....

Address.....

..... 1922.
We are
—Retailers
—Jobbers
—Manufacturers

MORE SENSITIVE

THAN THE

ARMSTRONG SUPER REGENERATIVE

REPORTS a reliable manufacturer who has built a number of the new Armstrong Sets and made comparative tests.



EXTERIOR VIEW

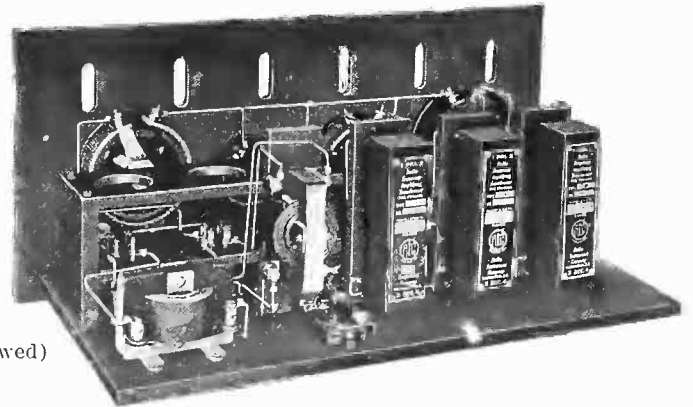

INTERIOR VIEW

(Patent Allowed)

The JM-6

Price \$130.00

RADIO-AUDIO DETECTOR AMPLIFIER

FOR THE PAST TEN MONTHS HAS MAINTAINED ITS REPUTATION OF BEING THE MOST SENSITIVE AND DEPENDABLE RECEIVING INSTRUMENT ON THE MARKET

This Instrument Is Ideal For Indoor Coil Aerial Reception

The **DX** Radio Frequency Transformer is the "heart" of the JM-6. The remarkable results obtained with the DX RF Transformer throughout the country, as evidenced by the hearty response from amateurs, dealers, jobbers and manufacturers.



(Patents Pending)

Gives absolute assurance of its superior quality and dependability. One amateur station is hearing broadcasting stations in *SIXTEEN STATES* and *HAWAII* by using three stages of DX RF TRANSFORMERS.

WAVELENGTH RANGE

DX-1	170- 450	\$8.00
DX-S	400-1200	8.00
DX-2	900-3000	8.00

WRITE FOR BULLETIN No. 12
Curves and Data on Coil Aerials. .50c
All Prices F.O.B. Factory

"IT PAYS TO HAVE THE BEST"

**RADIO
INSTRUMENT COMPANY, INC.
WASHINGTON, D. C.**



NATIONAL SEAMLESS TUBING

In Large Diameters

For Vario-couplers, Vario-meters, Tuning Coils and wherever you use large diameter fibre tubing, National Seamless Tubing is less expensive and infinitely superior.

National Seamless Tubing is a specially developed, laminated tubing that retains its form and will not warp, swell or shrink. Exact in both diameters and easily worked.

Can be furnished in dark gray fibre or black fibre. Any quantities, diameters from 3" to 4½" I. D. Any wall from 3/32 up.

Give us your specifications. We'll send samples and prices.

National Fibre for Panels

Hard Black Panel Stock of good dielectric strength. Gives satisfaction for condenser tops and bottoms, rheostat bases, washers bushings, etc. Let us quote on the stock itself, or on completed parts machined to order.

Peerless Insulation

The standard thin weight fibre insulation or "fish paper."

National Fibre & Insulation Co.

Box 453 Yorklyn, Delaware

New York, Chicago, Philadelphia, Detroit, San Francisco, Cleveland, Omaha, Pittsburgh, Boston, Rochester, Birmingham, St. Louis, Baltimore, London, England
In Canada, National Fibre Co. of Canada, Ltd., Toronto

\$10

A TUBE SET

—*that really performs*

- ☞ THE HAWK JR. *receives as efficiently as the highest priced set.*
- ☞ THE HAWK JR. *is mechanically perfect.*
- ☞ THE HAWK JR. *is well and substantially made.*
- ☞ THE HAWK JR. *is built of the very best of materials.*
- ☞ THE HAWK JR. *is the simplest set on the market to operate.*

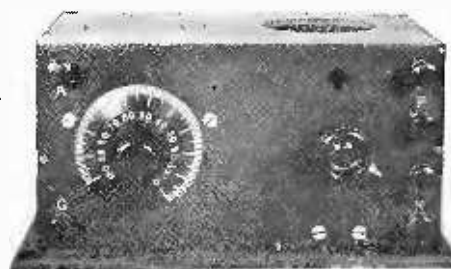

HAWK JUNIOR
DETECTOR TUBE SET

A LIBERAL PROFIT FOR DEALERS

Dealers, jobbers and distributors wanted to tie up with our national advertising campaign.

Hawk Radio Manufacturing Co.

150th St. and Melrose Ave.

New York City

!!!THE PREMIER RADIOVOICE!!!

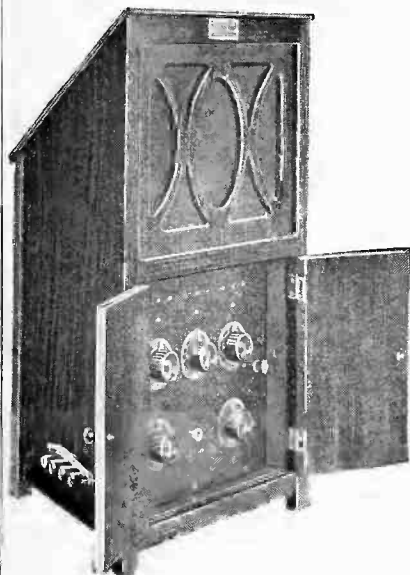

Is the first practical and commercial accomplishment of meeting the public's requirements and demand for a *Complete, Simple, Compact, Attractive and Efficient Loud Talking-Detector and 2-Stage Radio Receiver* at a Popular Price, Simple in Control—Wide in Range.

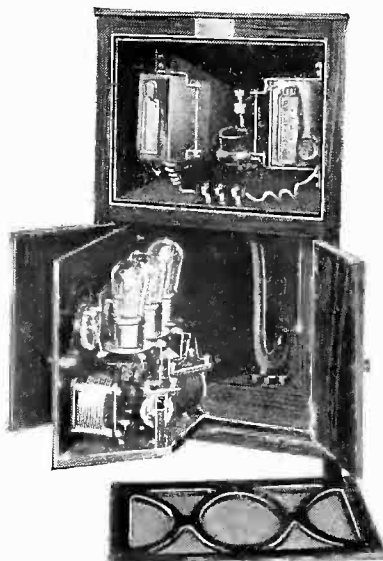

Mounted on a Bakelite Panel are

Premier Built and Tested Radio Condensers, Rheostats, V. T. Sockets, Transformers, Tuning Coils, Jacks, etc.; the panel being hinged within the beautiful 5 ply Mahogany Veneer Loud Talker Cabinet, measuring 21" in height by 12" in width, weighing, completely equipped with "B" Batteries and Loud Talking Phone as shown, only 17 lbs. Can be set in a corner of the living room, on library or end table, or on a piano, blending into the richest of furnishings with equal attractiveness. Price complete, excluding only bulbs and "A" battery—\$95.00.

Where an even lower priced equipment is desired, eliminating the phone and loud talker cabinet, our Type P equipment, including "B" batteries, mounted in cabinet as shown, parts, hookup and panel being identical to that used in the Premier Radiovoice, is priced at \$55.00.

The Premier Radio Corporation is an old electrical manufacturing concern, which has turned its entire resources and equipment to production of high class radio parts and receiving sets. The Premier line is handled and is available to only the highest class of dealer, jobber or distributor, and to such is offered discounts to permit profitable merchandising. Descriptive bulletins sent on request.

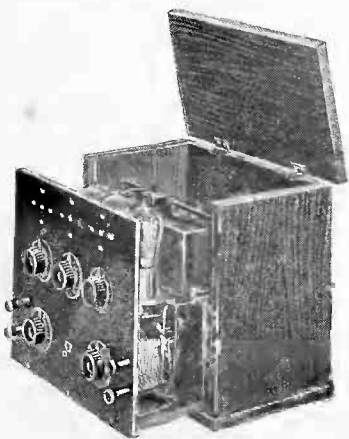

**Premier
Radio
Corporation**

6800 Bostwick Ave.
Detroit, Mich.

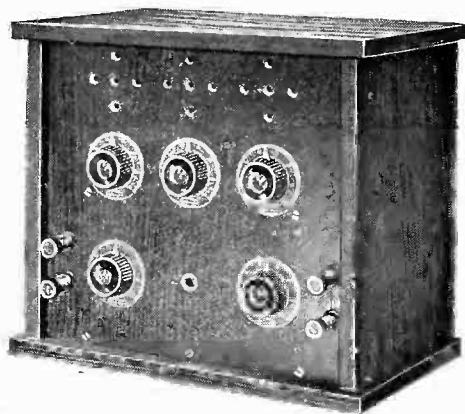

SPECIAL AUGUST PRICES



Hard Vulcanized Rubber Polished Knob

Hand Buffed—Nickel Parts
Non-Binding Bearing
500 Lots, 16c Each



Composition Knob

Tapered and Highly Polished
500 Lots, 14c Each



Composition Knob

Hand Polished and Buffed
500 Lots, 12c Each

Further Reductions on Larger Quantities
Pink-a-tone Receiving Set Complete
\$12.50

Special Prices on Filament
Rheostats

CHAMPLIN MFG. CO.

90 WEST BROADWAY
NEW YORK

Tel. Barclay 8676

Established 1860

The National Trade Survey Now Being Published in

The Radio Dealer Weekly

Should be of interest to

EVERY MANUFACTURER

Subscription to the WEEKLY

One Dollar the Year, payable in advance

Sample free on request

THE RADIO DEALER WEEKLY

1133 Broadway

New York, N. Y.

INSURE YOURSELF AGAINST TUBE "COME BACKS"

AND WIN SATISFIED CUSTOMERS BY INSTALLING A W-B-L VACUUM TUBE TESTER



Type 1001
Showing a Tube Mounted for Test.

The only instrument made which will tell you in a simple, direct, and not-to-be-disputed manner the true characteristics of the tubes you are buying and selling—whether they oscillate; how well they detect; how well they amplify; the best operating plate voltage and filament current—and many other things you have wanted to know about your tubes.

Complete in itself, not dependent on broadcasting, it eliminates all guess work. Simple to operate.

The cost?—A negligible sum considering the money it will save you and the satisfied customers it will win. The salvage of a few supposedly-defective tubes will alone pay for it.

Manufactured by W-B-L Radio Co., exclusively for

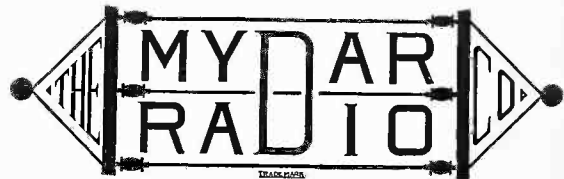

845 BROAD STREET, NEWARK, N. J.

WESTERN SALES DEPT.: 8405 DETROIT AVE., CLEVELAND, O.

WHY "PRAMCO"?

Made to a Standard



Largest Variety

GUARANTEED BY TRADE MARK ON EACH ITEM.

STANDARD PRICES THAT LEAVE YOU A GOOD MARGIN OF PROFIT.

NATIONAL ADVERTISING AND CIRCULAR MATTER THAT WILL HELP YOUR SALES.

A LINE FOR RELIABLE JOBBERS AND DEALERS WITH A REPUTATION TO MAINTAIN.

PREMIER RADIO MFG. CO.

1900 No. 6th Street

Philadelphia, Pa.

Are You Making Money Out of Radio ?

THE RADIO TELEPHONE HANDBOOK

By H. G. Cisin, M.E.

TELLS YOU HOW

It Contains the Following Facts About Radio You Want To Know

- What Radio Apparatus to Stock
- What Class of Radio Sets to Handle
- The Operating Principles of Radio
- The Various Types of Radiophone Receivers—the Best Methods of Adjusting Them
- How Crystal Detectors Work
- What Crystals Work Best
- How the Vacuum Tube Works
- What Is Meant by Cascade Amplification

- The Principles of Regeneration
- How to Select Telephone Head Sets
- Types and Uses of Tuning Devices
- The Meanings of Everyday Radiophone Terms
- How to Select and Install the Demonstration Set
- What Service to Give in Connection with the Sale of Radiophones
- How to Utilize Newspaper and Other Publicity

With This Book You Can Tell Your Customer

- The Best Way to Erect His Aerial Which Is Preferable, a One or a Four-Wire Aerial
- What Determines the Length of the Aerial
- Underwriters Requirements
- License Requirements
- How Best to Protect Against Lightning
- Why Some Radio Sets Are Simple and Others Are Complicated
- Which Sets to Recommend
- What Batteries, if Any, Are Necessary
- How High to Put the Aerial
- When an Indoor Aerial Can Be Used
- Under What Circumstances Ground Connection May Be Dispensed With
- When a Loud Speaker May Be Used
- What the Loop Aerial Is

How Amplification May Be Obtained

- Whether a Vacuum Tube May Be Used in Conjunction With a Crystal Detector
- Whether More Than One Radio Receiving Set May Be Connected to the Same Aerial
- The Correct Way to Measure Aerial Length
- When Shielding Is Necessary
- How to Check Up the Condition of the Storage Battery
- How to Eliminate Howling
- Causes and Remedies for Weak Signals and Local Noises in Connection with Vacuum Tube Sets
- How to Locate Faults in Vacuum Tube Radiophone Receiving Sets

Why the Radio Telephone Handbook is Authentic
Facts about its Author
 GRADUATE OF CORNELL UNIVERSITY, ELECTRICAL AND MECHANICAL ENGINEER.
 GRADUATE OF MARCONI RADIO INSTITUTE.
 FORMERLY INSTRUCTOR OF ELECTRICAL ENGINEERING AT:
 CORNELL UNIVERSITY,
 JOHNS HOPKINS UNIVERSITY,
 U. S. NAVY ELECTRICAL SCHOOL.
 STEVENS INSTITUTE OF TECHNOLOGY.
 LICENSED RADIO OPERATOR.
 RADIO OPERATING EXPERIENCE AT SEA DURING WAR.
 ENSIGN, U. S. NAVY DURING WAR.
 AUTHOR OF PRACTICAL ELECTRICAL ENGINEERING.

Single Copies.....	Price \$1.00
One Dozen Lots.....	33% discount
Four Dozen Lots.....	40% discount

Special Discounts on Quantity Orders

Attractive Exclusive Proposition for Distributors

Published By

THE ALLIED ENGINEERING INSTITUTE
1400 Broadway, NEW YORK CITY

FILL THIS OUT, TEAR OFF AND MAIL

THE ALLIED ENGINEERING INSTITUTE
NEW YORK, N. Y.

GENTLEMEN:

SEND..... COPIES OF THE RADIO TELEPHONE HANDBOOK FOR WHICH FIND ENCLOSED \$.....
 We will pay postman \$.....

NAME.....
 ADDRESS.....
 CITY.....
 STATE.....

U. S. GOVERNMENT RECEIVING SETS

Special Proposition on
Limited Quantities

Write for Particulars

Also: 500 Pairs CONNECTICUT
U. S. Government 'Phones. **\$3.45**
CAN BE RETAILED AT



MORSCAN RADIO CO.

196 Market Street, NEWARK, N. J.

TRIPLE TEST TRANSFORMERS

THE TRIPLE TEST

What do they mean to you?

In a market glutted with new radio products, some well made, some poorly and cheaply constructed, a few articles stand out prominently from the rest because the manufacturer employs highly competent engineers, the best of material and skilled workmanship. The Radio Service Laboratories goes a step further and submits each individual transformer to its famous triple test before shipping same to the jobber, dealer and ultimate user.

THE TRIPLE TEST

First—Test of Windings.

The bobbins when wound and sealed are tested for continuity of winding and for shorts and leaks.

Second—Test for Inductance of Windings.

After assembly of the bobbin within the container a careful test is made of the inductance of the primary and secondary windings to insure the consumer against any wrong connections or hasty careless construction.

Third—Test for Amplification.

After the iron core is assembled and the transformer sealed, each transformer is given an actual circuit test in a radio amplifier; the gain in signal strength being noted over that of the detector tube alone and required to meet the gain of our standard laboratory model.

THE RESULT

is a Radio Frequency Transformer that increases the strength of Radio Signals or waves before they are applied to the detector tube where they are made audible—

“Louder Signals with less noise
Greater Range with same equipment”

Radio Service Laboratories Transformers by actual test are superior to any domestic or foreign make in the market. For sale at any electrical shop or store where Radio supplies are sold.

ATTENTION OF DEALERS

TRIPLE TEST TRANSFORMERS are steadily advertised in the leading radio magazines and readers are urged to purchase from their local dealer. The Rasla Sales Corporation will gladly supply counter, window or wall display cards to dealers on request and urges them to obtain a supply of their transformers from their jobbers. In order to facilitate such orders, we append a list of jobbers handling this product.



The only completely shielded iron core.

- BALTIMORE, MD.
Chesapeake Electric Co.
Ship Owners Radio Service, Inc.
- BOSTON, MASS.
A. P. Merchant & Co.
Ship Owners Radio Service, Inc.
- CEDAR RAPIDS, IA.
Western Auto Specialty Co.
- CHICAGO, ILL.
Ship Owners Radio Service, Inc.
- CLEVELAND, OHIO
Elliott Electric Company
Erner Electric Company
- DALLAS, TEXAS
C. C. White Electric Co.
- FORT DODGE, IA.
Standard Radio Equipment Co.
- FORT WAYNE, IND.
Luxam Electrical Supply Co.
- INDEPENDENCE, KANSAS
Daniels Radio Supply Co.
- KANSAS CITY, MO.
American Radio Mfg. Company
- NEWARK, N. J.
Wholesale Radio Equipment Co.
- NEW YORK CITY
J. H. Bunnell & Company
Royal-Eastern Electrical Co.
Ship Owners Radio Service, Inc.
Stanley & Patterson
- NEW ORLEANS, LA.
Electron Engineering Co.
Ship Owners Radio Service, Inc.
- NORFOLK, VA.
Ship Owners Radio Service, Inc.
- PHILADELPHIA, PA.
Quaker Light & Supply Company
Schimmel Electric Supply Company
Frank H. Stewart Electric Company
- PITTSBURGH, PA.
Ludwig Hommel & Company
Robbins Electric Company
Union Electric Company
- ROCHESTER, N. Y.
Wheeler-Green Electric Co.
- SAN ANTONIO, TEXAS
Alamo Radio Electric Company
- SAN FRANCISCO, CAL.
Ship Owners Radio Service, Inc.
- SAVANNAH, GA.
Ship Owners Radio Service, Inc.
- SCRANTON, PA.
Scranton Electrical Construction Co.
- SEATTLE, WASHINGTON
Ship Owners Radio Service, Inc.
- ST. LOUIS, MO.
McGraw Company
- TROY, N. Y.
Hinsdill Electric Co.

*Western Jobbers desiring distributing proposition
Communicate with our Western Sales Agents*

DETSCH & COMPANY

555 Turk Street, San Francisco, Calif.

WESTERN RADIO DISTRIBUTING CO.

1114 L. C. Smith Bldg. Seattle, Washington

Special circular sent on request by the

Rasla Sales Corporation

National Distributors

10 East 43d Street

New York City

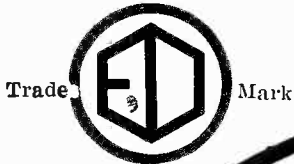

The Set that Grows



Front View
Panel No. 2

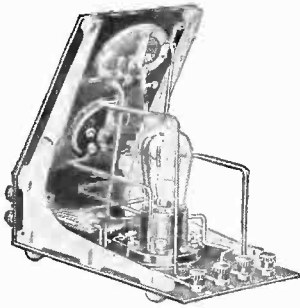

Rear View, with Cover
Removed, Panel No. 9

The two panels shown are only the beginning of a most elaborate receiving set. While they form a complete set with a wave length range of from 150 to 3000 meters, embodying bank wound inductance, potentiometer, interchangeable grid leak, etc., your customer will want to match his original purchase from time to time with radio frequency, audio frequency, loop or honeycomb mounting panels and so on, and he will ask you to supply him with them.

Why not find out more about this novel set—developed by engineers that know how and built completely in a plant with thirty years of manufacturing experience in this line of highest grade electrical instruments?

Our Bulletin No. 302 describes these panels

Write for a copy!

THE E-D-MANUFACTURING CO.
PHILADELPHIA, PA.

"LISTEN IN WITH ED."

NULOID

Scientific Chemical Compound Especially
Adaptable For Radio Parts and Panels

For panel work and other radio parts Nuloid is fast taking the place of hard rubber and other materials.

Its light weight and smooth polished surface combined with its high resistance powers make it particularly adaptable for radio requirements.

Approved and Tested

Tested by leading radio and electrical engineers and by the Columbia University laboratory, Nuloid was found to resist warping, water, oil, heat and cold, and to resist a 23,300 high frequency voltage on a 3/16th inch thickness.

All Colors

Nuloid is manufactured in mahogany, and all colors, plain

and mottled, and its attractiveness adds materially to the appearance of receiving sets and all exposed parts.

Retains High Polish

Regardless of climatic conditions, Nuloid retains its high polish, and under all conditions it can be easily worked, as it does not chip, crack or break, and can be engraved, cut, drilled, threaded and polished.

Nuloid prices are no higher than hard rubber and substitutes, but being lighter in weight Nuloid costs less in the final analysis.

Let us estimate on your specifications
and send you some samples of Nuloid.

NULOID CORPORATION

119 Chambers Street

Phone: Worth 0156

New York, N. Y.

LABORATORIES AND FACTORY, KENILWORTH, N. J.

HOMCHARGE



Your
**RADIO
 BATTERY**
for
A NICKEL

THIS slogan, Mr. Dealer, has made the HOMCHARGER the most popular rectifier in the entire radio and automobile field.

Its popularity is being further increased thru dominating HOMCHARGER advertisements appearing regularly in thirty-one of the leading radio, automobile and national publications.

In addition, an entirely new and greatly augmented series of attractive sales helps are now available for your use. The

RADIO HOMCHARGER DE LUXE

is the simplest, the most efficient and most reliable battery charger on the market, and the only rectifier combining the following essential HOMCHARGER features:

- 1—Simplicity itself. Attach to any lamp socket and connect to battery.
- 2—SELF-POLARIZING. Battery may be connected either way and it will always charge.
- 3—Fully automatic in operation—gives taper charge—cannot overcharge or injure your battery.
- 4—Safe, all parts entirely enclosed, no danger from fire. APPROVED BY UNDERWRITERS EVERYWHERE.
- 5—Silent in operation. May be used in the home.
- 6—Constructed of the best material—genuine Bakelite Panel, Jewell Ammeter, Closed Core Silicon Steel Transformer. No castings used, only the finest stampings throughout.
- 7—Only one moving and two wearing parts. Replaceable as a unit at small cost.
- 8—Uses standard 15-ampere plug fuse obtainable at any electrical store.
- 9—CHARGES ANY "A" OR "B" BATTERY OVER NIGHT. UNQUALIFIEDLY GUARANTEED.

AN ORNAMENT FOR THE LIVING ROOM

Beauty has been combined with utility in the new RADIO HOMCHARGER DE LUXE. The body is beautifully finished in rich Antique Mahogany, the base and fittings in handsome Dull Gold. Equipped with rubber feet, it cannot mar polished surfaces. It harmonizes with the finest living room.

OVER 50,000 HOMCHARGERS

were sold by live dealers and jobbers last spring. Over 150,000 will be sold this fall and winter. Our special dealer booklet, "Homcharger Business Builders", shows how you can obtain your share of this business, and illustrates the many and various sales helps and other co-operation given HOMCHARGER dealers. Send for your copy today, or, better yet, order a case of one-half dozen or so from your jobber, and cash in on this fast-selling and profitable radio and automobile accessory. Furnished complete with attachment cord and plug, charging cable and battery clips. No extras to buy. \$18.50 U. S. A., \$25.00 in Canada.

RADIO FANS, AUTO OWNERS, ETC.

See the new RADIO HOMCHARGER DE LUXE at your nearest dealer. If he does not carry it, send for our free Bulletin 637 illustrating the new RADIO HOMCHARGER DE LUXE in actual colors, or your order will receive prompt attention if sent direct to the factory.

The Automatic Electrical Devices Co.

West Third Street

Cincinnati, Ohio

Largest Manufacturers

of

Vibrating Rectifiers in the World

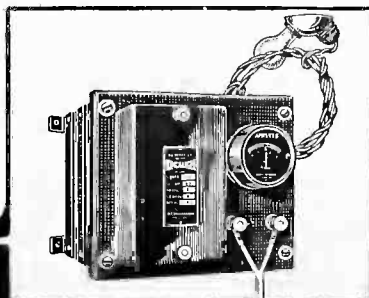

BRANCH OFFICES

New York Chicago Pittsburgh
 Detroit Dallas
 Philadelphia Los Angeles
 Baltimore Minneapolis Kansas City
 St. Louis Atlanta

TYPE "A" FOR WALL MOUNTING

~ OVER 50,000 IN USE ~

Adjustable Coil Mountings for Armstrong's Super-Regenerative Circuit

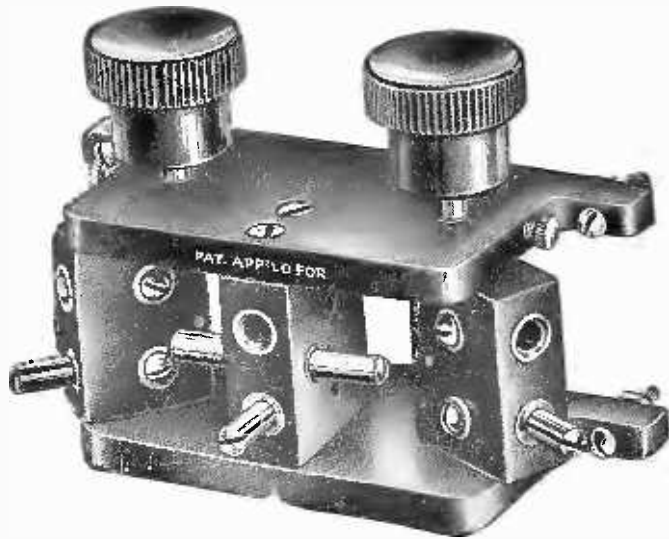

Single and Double Coil mountings adapted for use with the new Armstrong super-regenerative circuits. These mountings are adjustable. Made of genuine Formica, with high polish and fine finish. All metal parts heavily nickel plated. Not a moulded affair.

The Unbreakable Dial



The New Triple Coil Mounting with the following features:

- 1—A patented feature; *locks* the coil in place. This prevents the coil from being thrown out of adjustment once the station is tuned in.
- 2—The *simplest* mounting to install on your set. No rear mounting. Mounts on front of panel.
- 3—The tension on specially constructed bearings is adjustable.
- 4—Constructed of the highest *grade* of insulation material. Its high polish and fine finish give it a very attractive appearance. All metal parts heavily nickel plated. Not a moulded affair.

- Triple Coil Mounting, List Price.....\$5.00
- Two Coil Mounting, List Price..... 3.50
- Single Coil Mounting, List Price..... .55
- 3" UNBREAKABLE Dial, List Price..... .70
- 3 1/2" UNBREAKABLE Dial, List Price.... .90
- Amco Radio Plug, List Price..... 1.00

Our production is large and your orders will receive immediate attention.

Jobbers write for special discount

ASTORLOID MFG. CO., INC.

416 Marcy Ave., Brooklyn

Price
\$2.00
Post Paid

Triphone Plug

The most convenient and practical accessory since the advent of Broadcasting

Triphone is an accommodation plug that enables you to plug in one or two headsets besides the one headset or loudspeaker that is permanently connected to it. In appearance the TRIPHONE is an addition to any set.

The body is a highly polished moulded material.

Internal jacks are constructed with nickel silver springs and the short circuiting contacts are of solid silver. It is perfectly insulated throughout.

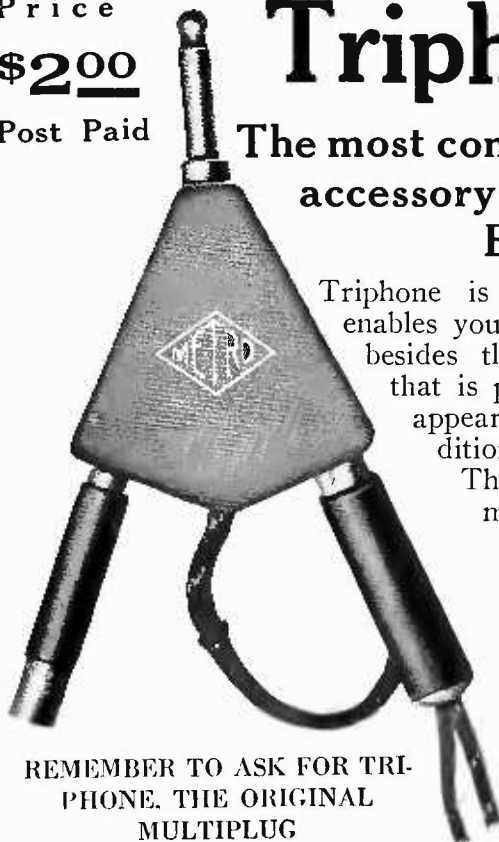

REMEMBER TO ASK FOR TRIPHONE. THE ORIGINAL MULTIPLUG

Send for Descriptive Circular

Attractive Propositions to Jobbers and Dealers

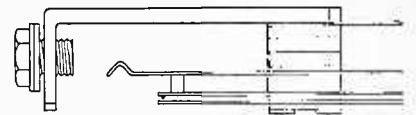

METRO JACKS

"Metro Jacks" Nickel Silver Springs, Coin Silver Contact points. Screws insulated. High Class finish made in 5 types;

- No. 1 Single Open\$0.55
- No. 2 Single Circuit65
- No. 3 Double85
- No. 4 3 Spring Filament Control... .95
- No. 5 5 Spring Filament Control... 1.15



Moulded Base



Fibre Base

No. 24 Single V. T. Socket Moulded Base—Brass tube heavy-nickel plated counter sunk contacts\$1.00

V. T. Sockets Made in Three Styles Fibre Base
No. 32 Single V. T. Socket. .75
No. 33 Double V. T. " 1.50
No. 34 Triple V. T. " 2.25
These Sockets have heavily nickel-plated brass tubes.



ELECTRIC MFG. CO. INC.

121 PRINCE ST.
NEW YORK

U S C
TRADE MARK

RADIO SPECIALTIES



The Little Gem
(cut half size)

The dealer will at once appreciate the potential sales possibilities of this wonderfully efficient and beautiful little crystal receiving set. Has a large receiving radius. Test it yourself. You can then recommend it with the same confidence that we do. Stand and all other metal parts of solid brass and nickel plated.

The Multilistener

The Multilistener is furnished either with rubber ear tips as shown, or with ear plates. With one set of double Head Phones this outfit provides listening facilities for eight persons. When used with Vacuum Tube Sets, the Multilistener permits that degree of adjustment for perfection in natural and musical tone effects, as is unsurpassed by any other means.

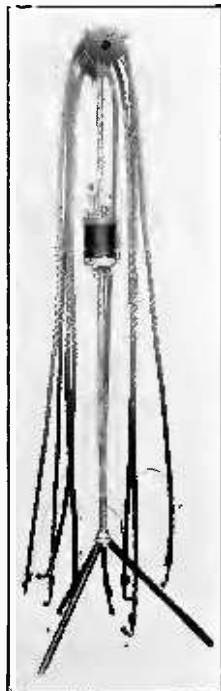

Model 8-T Multilistener with Little Gem

List Prices

- Little Gem Receiving Set\$6.50
- Little Gem with Multilistener15.00
- Multilistener only, Model 8-T with 8 tubes and 46" adj. stand10.00
- Model 4-T, with 4 tubes, short stand, using one receiver only 5.00

Order through your jobber or communicate direct with us.

United Specialties Co., Inc.

Manufacturers & Distributors

57 Spring St.,

Newark, N. J.

A Wonderful Seller
Because it is
Such a Wonderful Buy

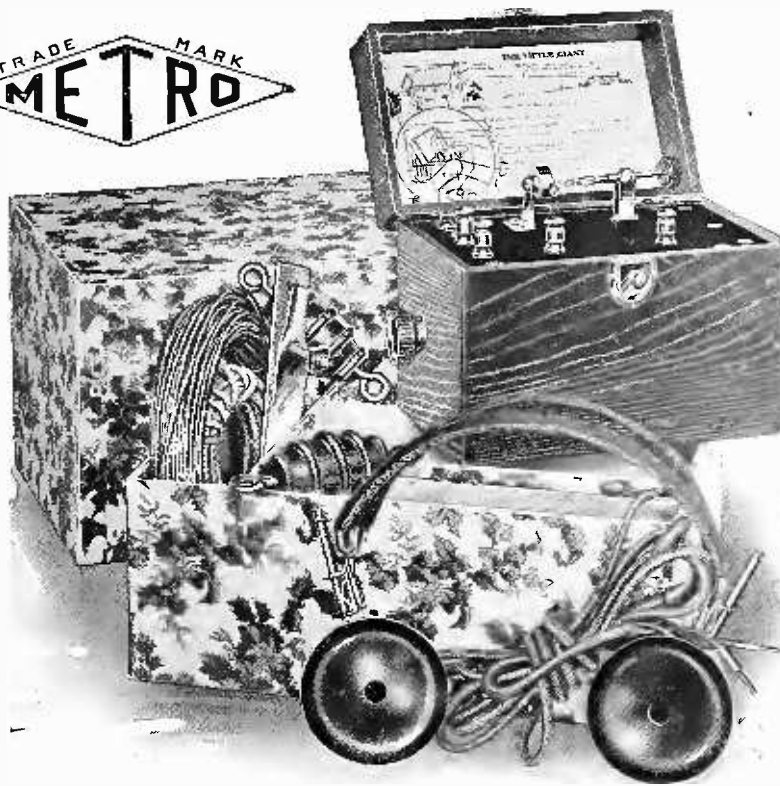

The LITTLE GIANT

Trade Mark

Radio Receiving Outfit

The Ideal Gift!

SELLS AT A POPULAR PRICE, attractively put up in holiday box. A gift for anyone because there isn't a person who can't use the *Little Giant*, it's so simple. It's complete ready to put together and use. Nothing extra needed to enjoy the program. Easily demonstrated and fool-proof. Its beautiful cabinet, neat workmanship and compactness help its sale immensely. Make the *Little Giant* your leader for holiday trade.

Write Today for Propostioon

Complete

With Metro Head-phones, Aerial, Insulators, Ground Wire, Ground Clamp and all Accessories.

In Holiday Box \$15 Net

METROPOLITAN RADIO CORPORATION

70-74 Goble St., -:- Newark, N. J.

THE PATHÉ LOUD SPEAKER

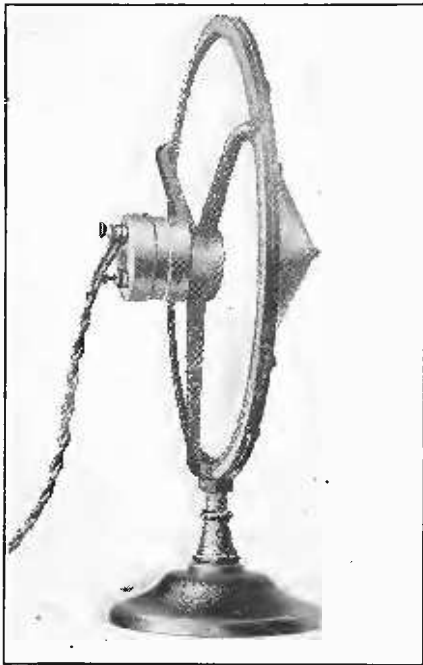

IS NOW READY FOR DELIVERY. SEND ORDERS AT ONCE FOR STOCK FOR THE SEASON'S BUSINESS.

List Price

\$24.00 Nickel Finish

\$22.00 Japan Finish

THE SOUND WAVE CORPORATION
30 GRAND AVENUE, BROOKLYN, N. Y.

MICA RADIO INSULATION BUSINESS BUILDING PRODUCTS



EMPIRE OILED TUBING (CALLED SPAGHETTI)

Empire (Spaghetti) Tubing is a Business Building Product because amateurs who buy it come back for more. Empire Tubing provides perfect insulation for all wiring connections. Very flexible, durable, smooth, and of great dielectric strength. All colors, all sizes, 36 inch lengths.

EMPIRE OILED CLOTH AND TAPE

Remarkable for its insulating properties electric and mechanical strength. Its resistance to heat and moisture makes it of great value in mounting tube sockets, rheostats, transformers, couplers, and in high powered transmitting stations where the voltage is very high. Empire Oiled Cloth practically sells itself to amateurs, experimenters, and experts. Supplied in a variety of thicknesses in sheets 36 inches square, in tape widths from $\frac{3}{8}$ ".

Call and talk it over or send today for samples and quotations

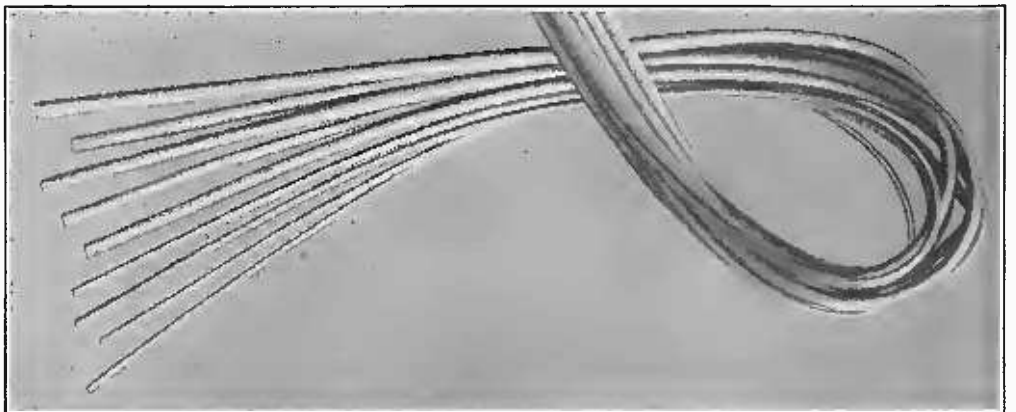

2020-F

MICA INSULATOR COMPANY

68 Church Street, New York.

542 So. Dearborn Street, Chicago.

Works: Schenectady, N. Y.

Agencies—Monroe Brass & Wire Co., Cincinnati; G. Arthur Morrell, Cleveland; Electrical Specialty Co., San Francisco and Los Angeles

Dealers!

Every person interested in wireless will hail this marvelous Receiver as the missing factor in the complete realization of radio's possibilities.

It will stand the most rigid tests.

It is being nationally advertised.

Discounts afford excellent profits.

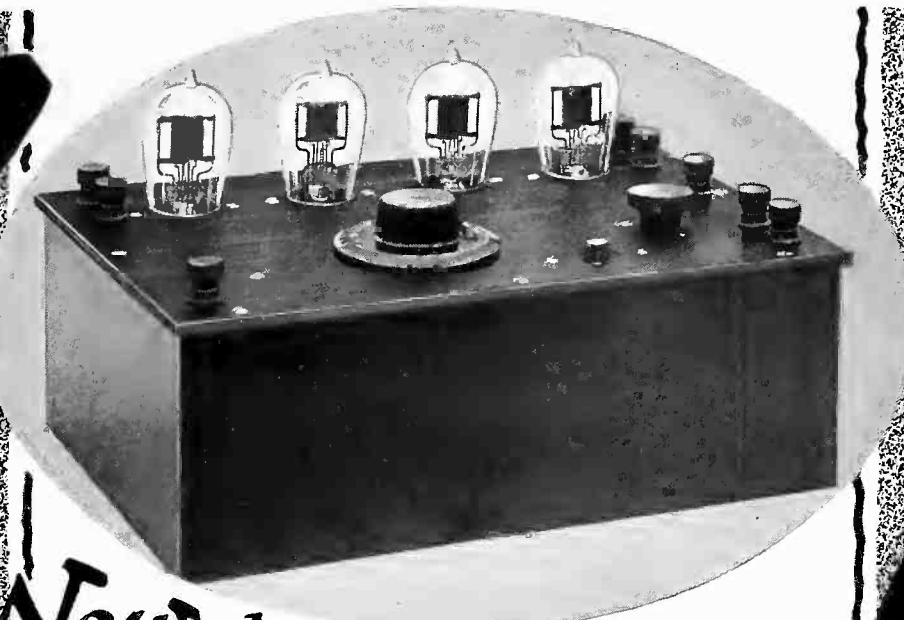

Now the 100% Receiving Set!

Destined to be the Greatest Seller on the Market

Five years of untiring effort—engineering, NEW inventions, experiments—then this 100% instrument, head and shoulders above any other receiving set on the market. This is the story of the splendid achievement found in the WARE 3-step RADIO FREQUENCY Amplifier-Detector-Set.

It affords a higher degree of amplification and wider tuning range than ever before obtainable. With clear, crisp and perfect tone reproduction the Ware Type AD2 Receiver readily brings in broadcasted programs hundreds of miles on 1-foot indoor coil aerial.

Ware

TYPE AD2

R-F AMPLIFIER-DETECTOR

RECEIVER

Price \$110—(without tubes)

Unquestionably the MOST SENSITIVE RECEIVING SET on the market. *Makes genuine loose-coupling practicable.* For absolutely faithful long or short distance reception—free from distortion, static, induction and interfering transmitters—it has never been equaled.

Simple to operate—beautiful—compact—guaranteed. One demonstration is all that is necessary to convince the amateur as well as the most expert radio enthusiast.

WARE RADIO CORP'N
 160-162 Duane Street New York City

Get this Business

Our national advertising, liberal discounts and cooperation—plus the genuine merit of this great set, make it the best dealer proposition of the year.

Write now for descriptive folder and full particulars.

RADIO EQUIPMENT SERVICE

Announces

A Sure Sales Builder,

RADIOLITE

Registered U. S. Patent Office

A Sensation in the World of Advertising

Receives Market Reports, Current Events, News Items,
Lectures and Entertainment from Famous Broadcasting Stations

COAST TO COAST

And Flashes Your ADVERTISING

“BROADCAST”

With Force and Dignity

**ESPECIALLY ADAPTED TO INDOOR OR OUTDOOR
ADVERTISING OR THE HOME BEAUTIFUL**

Name, Construction and Design
Protected by Patents Pending

For Proposition to The Trade, Write or Wire at Once

RADIO EQUIPMENT SERVICE

National Distributors

500 Fifth Avenue, New York City

For the Liveliest Business Man in Your Town

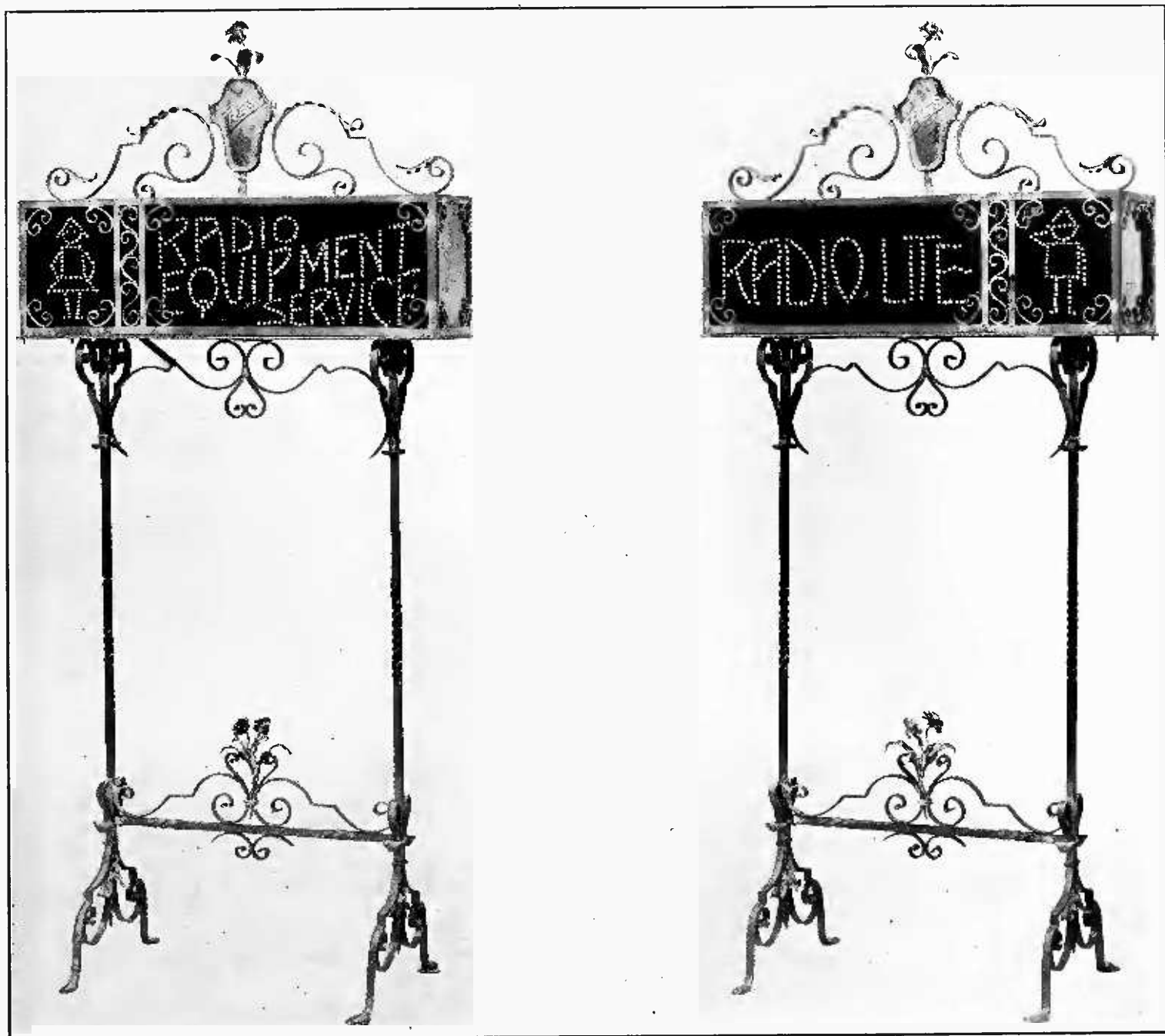

The RADIOLITE sign and talker pictured here will sell quickly to the liveliest business man in every town. He will buy on sight. Take this advertisement out of the paper and show the design to the owner of your best hotel, to the president of the new bank, to the publisher of the daily newspaper. Show it to a real live-wire and you will begin to find out just how easy it will be to sell this latest novelty in the radio business.

Here's some of the selling points that will make this a winner for you--

A flashing electric sign.—A different design on either side, a flashing figure on the side of the sign that assumes half a dozen different positions—every sign made to special order according to the wishes of the buyer—a wrought iron model that is indeed a thing of beauty.

Special designs for indoors with seven-foot stand as pictured, or outdoor types that can be hung just like any other electric sign.

Equipped with a high grade radio set that will bring in broadcasting perfectly. The set sold complete with all batteries, and plug for wiring in the sign. Screw in the socket and hook up the aerial.

Watch the crowd hunt for the loud speaker—it's in "the sign that talks."

Regular Discounts for live wires,—and NOT high-priced. Trade name registered U. S. Patent Office.

RADIO EQUIPMENT SERVICE

Manufacturers

500 Fifth Ave.

New York, N. Y.



The Gould Radio "B" Battery is uniquely designed, compact and attractive. Provides 24 volts variable in 2-volt steps. Non-slopping hard rubber case. A battery that does not detract from the appearance of the finest set and assures a steady, continuous, noiseless service. Retail price, \$8.50.

Patents Applied For

A Radio "B" Battery You Can Back to the Limit

MANY receiving troubles variously attributed to "static," weak broadcasting, etc., disappear when a Gould Radio "B" Battery is placed in the circuit.

When once the proper voltage for tubes is ascertained there is no change required in the adjustment. Gould Radio "B" Batteries maintain a constant voltage while in operation, and give a steady, continuous, noiseless service.

Compact, non-fragile, free from danger of buckling or short circuiting of plates or from acid creepage, Gould Radio "B" Batteries represent the highest attainment in storage "B" battery design and construction.

Gould Radio Batteries are distributed through leading electrical jobbers. You are probably doing business with the Gould jobber for your territory. If you want a reliable source of supply for Radio Batteries bearing a nationally-advertised name, write us for name of nearest Gould jobber and attractive dealer proposition.

*On Sale by Radio Dealers and
over 3000 Gould Service Stations*

GOULD STORAGE BATTERY COMPANY
30 East 42nd St., New York Works: Depew, N.Y.

Gould

Gould Radio "A" Batteries are used by the various Radio Branches of the U. S. Government. Built for dependable continuous service. Made in sizes from 60 A.H. to 160 A.H.

Retail Prices
\$17.00 to \$29.00
(f.o.b. factory)

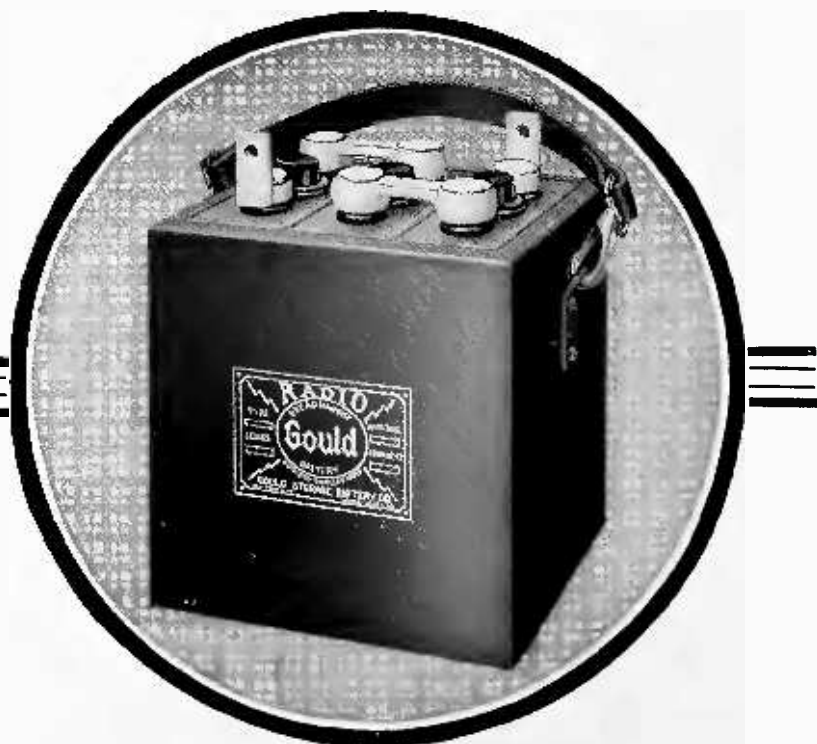

NO STORAGE BATTERY REQUIRED

OPERATES ON ONE DRY CELL FOR AT LEAST 80 HOURS



A HARD PROBLEM —
THE SIMPLE SOLUTION — →

THE BRU No. 3

Vacuum Receiving Set
Sold under our unconditional guarantee

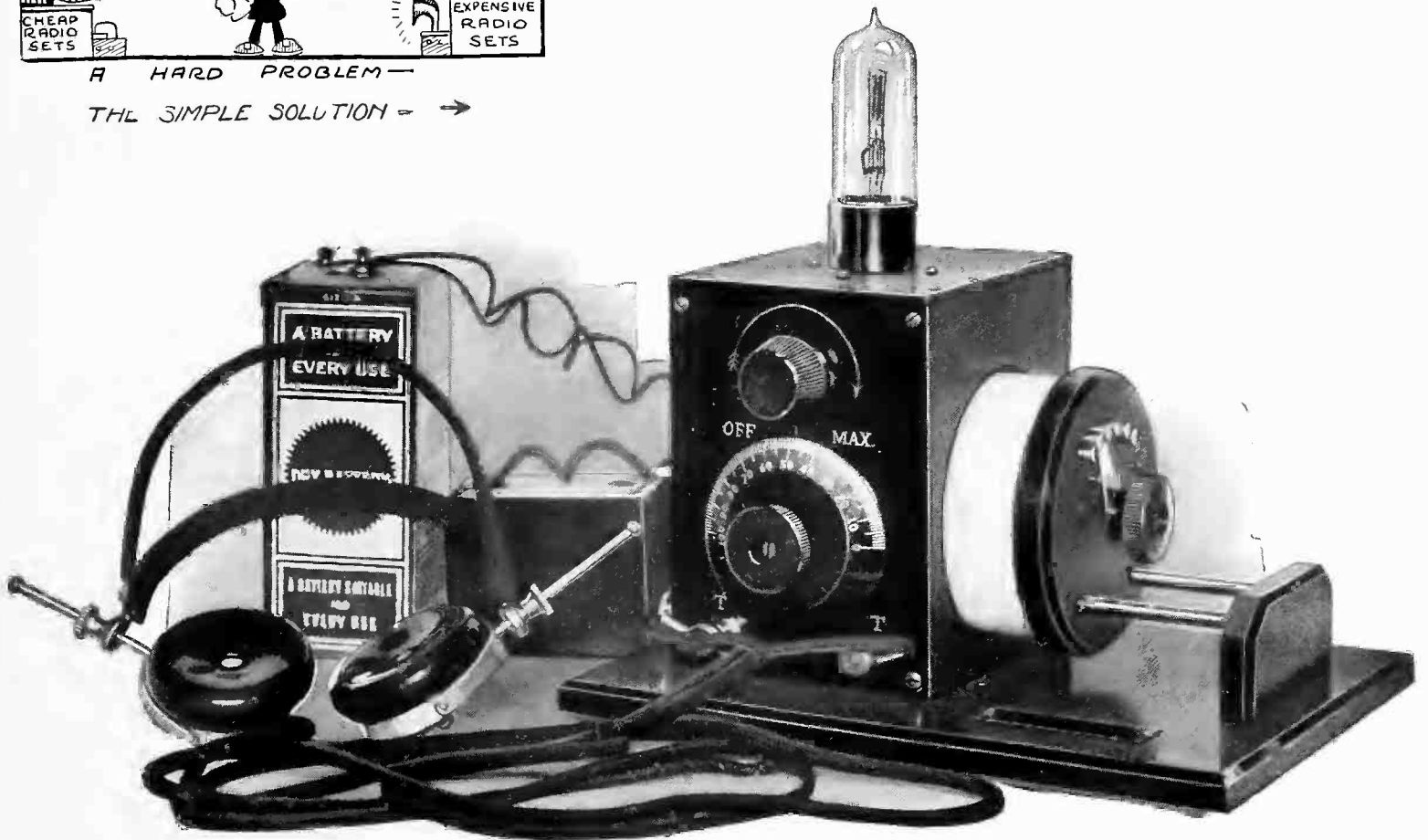

Designed to meet the demand for a "tube set," that is a combination of EFFICIENCY, SIMPLICITY, NEATNESS and ECONOMY OF OPERATION.

BRU No. 3 Specifications. Cabinet is of piano finish mahogany, with bakelite panels. Trim-mings are of highly polished, nickel plated brass. Normal wave length of 150 to 600 meters. Binding posts are provided to "load" the primary and secondary inductances, so that the reception of almost all wave lengths is possible.

BRU No. 3 Receiving Unit, List Price..\$30

BRU No. 3C Receiving Unit.....\$49
Complete including WD 11 Detector Bulb, phones, "A" and "B" batteries, aerial, lead in, ground wires, ground clamp, insulators, nails, screws, etc. Absolutely nothing else required.

A GOOD MARGIN OF PROFIT FOR THE DEALER

Complete instructions with each set

TRADE MARK
BRUNO RADIO CORPORATION
152 West NEW YORK 14th Street YORK

JOBBERs, DEALERS and DISTRIBUTORS wanted to tie up with our national advertising campaign.

In Response to Demand

THE RADIO DEALER WEEKLY

Published by The Service Bureau

of THE RADIO DEALER

announces:

A SPECIAL OFFER

Effective September 1st,—

listings in the WHERE TO BUY RADIO EQUIPMENT guide appearing in THE RADIO DEALER WEEKLY each week, will be sold at the very low rate of .

TEN DOLLARS PER TWO LINE LISTING

from Now until October 1, 1923. Less than THREE CENTS A DAY. To include a free subscription to the WEEKLY.

The Radio Dealer Weekly Where to Buy Guide reaches the widest range of any similar list on the market today.

Where a number of these listings can be handled at one time the cost of changes, etc., will be materially reduced, and it is only thru the savings thus effected that this special offer can be made.

THIS OFFER IS FOR A LIMITED TIME ONLY AND WILL BE WITHDRAWN AT AN EARLY DATE. After which the regular charge will be twenty-five dollars per year.

USE THIS COUPON

THE RADIO DEALER WEEKLY,
1133 Broadway, New York, N. Y.

Please list us as manufacturers of in THE RADIO DEALER WEEKLY until October 1, 1923, beginning with the next issue, for which we agree to pay *ten* dollars for each two line listing. It is understood we are to receive the WEEKLY free as long as this listing appears.

Signed (Pres., etc.)

Firm name and address.....

.....
Please typewrite or print exactly as it should appear in the WEEKLY

\$5.00**\$5.00**

A Wonderful Phone at a Wonderful Price



NOTE OUR NEW
AND
ATTRACTIVE BOX

We maintain that the public will demand a phone that is capable of giving good results on crystal detector sets; and that will not cost more than \$5.00.

We recommend our "ROYALFONE" King of All," \$5.00 List. It is of exceptional quality in material and workmanship. It is the only phone that will give best results on crystal and bulb detector sets.

Let us send you a sample for trial and advise you of our attractive jobber discounts.

Be prepared to meet the demand for a crystal phone for a crystal set.

ROYAL ELECTRICAL LABORATORIES
MANUFACTURERS OF
Electrical and Radio Equipment

207 MARKET STREET, NEWARK, N. J.

Royalfone

Gilbert Radio Apparatus

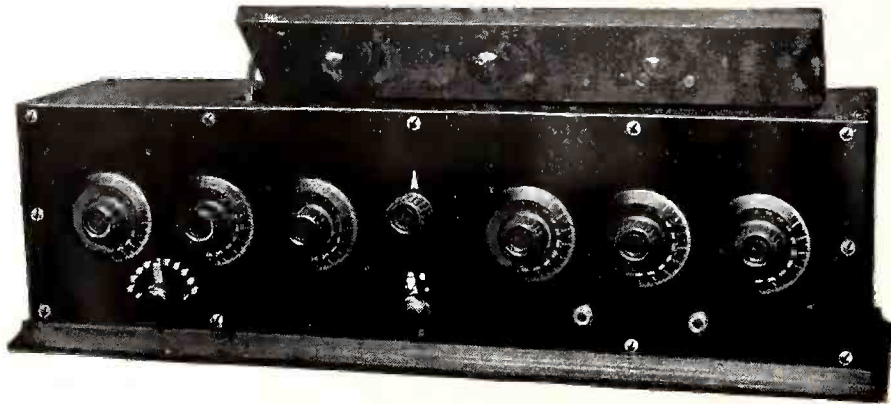

No. 4023

RADIO FREQUENCY

Long Distance Receiving—Splendid Tone Quality

For long distance receiving and splendid tone quality this new Radio Frequency Set is unrivalled at anywhere near the price. It is based on the wonderful principle of Radio Frequency Amplification, the highest type of receiving set yet produced.

This and other outfits together with a number of the most advanced radio parts go to make up the Gilbert Line—a line of good, serviceable radio apparatus, efficient and at the same time priced to meet the popular demand—with good profit to yourself.

Send for catalog No. 54 illustrating and describing this new Radio Frequency Set with all other Gilbert Radio Apparatus.

THE A. C. GILBERT COMPANY

DEPT. C

NEW HAVEN, CONN.

In Canada: The A. C. Gilbert Menzies Co., Ltd., Toronto

THE RADIO DEALER

The Radio Trade Journal
For The Radio Retailer

CONTENTS OCTOBER, 1922

SPECIAL ARTICLES

Display Hangers.....	By Karl M. Jones	53
Dealers Err in Rating Receiver.....	By Frederick Dietrich	103
Development of Radio Frequency Amplification.....	By R. J. Whitaw	46
Etherola Aerial Equalizer.....	By Bernard Freedman	53
Explains Proper Hook Up for Loop Aerial.....	By Thomas S. Loeser	54
International Trade-Mark Registration.....	By Chauncey P. Carter	48
Merchandising in the Radio Business.....	By John L. Simmons	55
Moffat Radio Lock Protects Receiving Sets.....	By W. L. Moffat, Jr.	59
New Tester Characterizes Tubes.....	By William B. Brough	64
Optimistic Outlook Shown by Radio Research.....	By John R. Hall	41
Origin and Growth of Cambrie Tubing.....	By A. W. Stringham	49
Oranola Talking Machine De Luxe.....	By R. C. Hull	94
Passing of the Unfit Tradesman.....	By Henry L. Seidman	47
Public Demands Guaranteed Products.....	By W. S. Lemmon	56
Rely on Quality—Not Price.....	By A. L. Strassburger	45
Radio Interference Obviated by Towers.....	By S. W. Hull	68
Radio Securities of Value.....	By Frank T. Stanton	54
Small Space Socket Slotless.....	By Milton Alden	99
The Development of the Loud Speaker.....	By Herbert E. Metcalf	44
Vulcanized Fibre in Radio Manufacture.....	By A. P. Southworth	45
Wooton Headsets Tested Before Shipped.....	By S. J. Williams	100

DEPARTMENTS

Baltimore	117
Book Review.....	87
Editorial	50
Pittsburgh Paragraphs.....	72
Philadelphia	73
Trade-Mark Department.....	114
Washington Waves.....	97
What the Manufacturers Are Doing.....	62

THE RADIO DEALER, THE RADIO TRADE JOURNAL, published monthly on the first, at 1133 Broadway, New York, N. Y., by THE RADIO DEALER COMPANY, in the interest of dealers in Radio Supplies. HARRY M. KONWISER, Publisher; LAURENCE A. NIXON, Managing Editor; JOHN L. SIMMONS and BERNARD J. FARRELL, Editors; A. L. KONWISER, B.S., Technical Editor; N. B. ZIMMERMAN, BERNARD FREEDMAN and EUGENE J. SCANLON, Associates; R. DESREAU, Circulation Manager; M. JAY KLEIN, Research Manager; E. B. STERN, Manager Service Bureau.

REPRESENTATIVES IN THE TRADE: ELMER W. MOORE, JOHN R. HALL, H. E. BENNETT, WM. B. WILKINSON, JR., J. MAURICE CASPER, J. A. DOUCET, H. L. KRENZ, M. A. CLARK, C. L. GEESEY, S. A. FRANK, C. M. MINIER, M. P. MCNEELEY, W. H. OKE, C. B. CABANISS, R. C. HULL.

PUBLICATION OFFICE
1133 Broadway, New York, N. Y.
Telephone Watkins 8926-8927

PITTSBURGH
Suite 570, Union Arcade, Pittsburgh, Penna.
PACIFIC COAST
Suite 510, 456 S. Spring St., Los Angeles, Calif.
Telephone Los Angeles 12052

CENTRAL STATES
35 South Dearborn Street, Chicago, Ill.
Telephone Dearborn 4053

SOUTHERN STATES
730 Gravier Street, New Orleans, La.

CANADIAN OFFICE
23 Lily Street, Winnipeg, Manitoba

NEW JERSEY
845 Broad Street, Newark, N. J.
Telephone Market 4659

Advertising Rates and detailed statement of circulation and other information for advertisers furnished on application.

Advertising forms close the 15th of the month prior to date of issue.

Circulation restricted to manufacturers, jobbers and retailers in wireless equipment. Subscription in the United States, one dollar the year, payable invariably in advance. Subscription in foreign countries, two dollars the year, payable invariably in advance.



Not like the rest

They are the best

—the very best

The Finch Automatic Code Recorder Brings a New Pleasure to the Radio Fan

Live dealers are now extending sales by stocking this wonderful new device which may be used in connection with any vacuum tube receiver.

Fastest Code Messages Recorded with Ease and Read
at Leisure

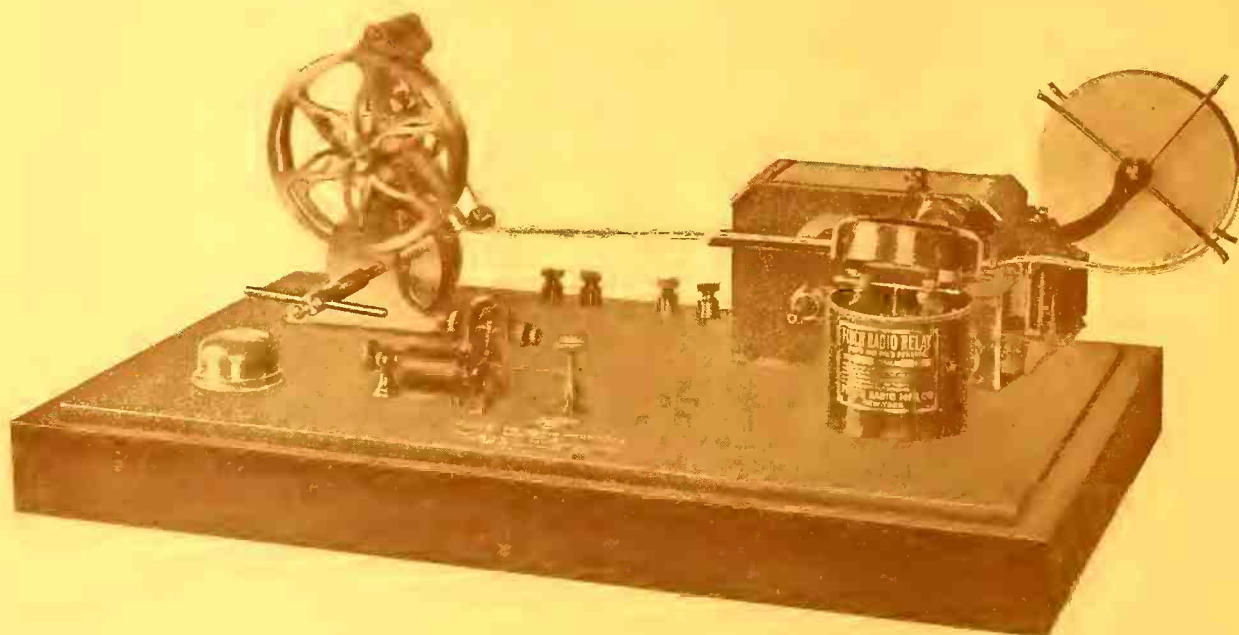

FINCH AUTOMATIC RADIO RECORDER AND RELAY MOUNTED AND WIRED
READY FOR IMMEDIATE USE—LIST \$200 COMPLETE

INSTRUMENTS SEPARATE

Finch Radio Relay.....	\$75.00
Std. Tape Register.....	60.00
Telegraph Relay.....	7.00
Tape Winder.....	10.00
Paper Tape, per roll.....	.10
Register Ink, 2 oz. bot.....	.50
Register Ink, pt. bot.....	2.00

Prices of other auxiliaries on
request

FASTEST CODE MESSAGES RECORDED WITH EASE AND READ AT LEISURE

Every radio fan would like to be able to read the code messages that his instrument picks up, but this would require a great deal of time and study. How nice it would be if he could hook some kind of a device up to his receiver that would copy the code signals on a tape. Then it would be possible to "listen in" on the big commercial and trans-Atlantic stations. The Finch Automatic Code Recorder does exactly this; it makes a visible and lasting record of code signals no matter how fast they are sent. It is reliable and positive in its operation and although highly sensitive it is at the same time rugged and foolproof. No special knowledge is required to operate it and any radio fan can connect it to his receiver and have it in operation in five minutes. Costs nothing to run and will last a lifetime.

This marvelous device is one of the outstanding developments of the year. When set up and in operation, it will bring a crowd to any store and many amateurs will buy it on sight.

Wire or write for literature, prices, and proposition

Other Things You Can Do by Radio with the Finch Relay

- 1.—Automatically Receive and Record.
- 2.—Operate a Telegraph Sounder.
- 3.—Ring a Bell.
- 4.—Ignite Explosives by Radio.
- 5.—Control a Moving Vehicle.
- 6.—Visible Indication.
- 7.—Radio Burglar Alarm.
- 8.—Simultaneously Record and Transmit Messages.

Tested by the New York "Evening Mail" Radio Institute, approved and awarded Certificate of Excellence.

GREATEST TUBE EVENT IN RADIO

We have secured a quantity of genuine Western Electric V.T. 1 and V.T. 2 Vacuum Tubes. They are not rejects, but are Signal Corps surplus stock. These tubes are superior in every way to other tubes on the market, and heretofore were impossible to obtain at any price.

These tubes were tested by the New York "EVENING MAIL" RADIO INSTITUTE, APPROVED AND AWARDED THEIR CERTIFICATE OF EXCELLENCE.

WESTERN ELECTRIC V.T. 1 (J) TUBE, made for the U. S. Signal Corps; excellent detector and amplifier. Regular price \$10.00; List, \$7.50.

WESTERN ELECTRIC V.T. 2 TUBE, made for the U. S. Signal Corps; excellent amplifier and power tube. Regular price, \$12.00; List, \$8.50.

Representatives

DOMESTIC

Automotive Electric Co., Dallas, Texas
Baldwin-Stewart Electric Co., Hartford, Conn.
Hallock & Watson, 192 Park St., Portland, Ore.
John J. Reiger, 15 Fairview Place, Buffalo, N. Y.
J. A. Comer, 1035 Merchants National Bank Bldg., Los Angeles, Cal.
Electrical Supply Co., 324 Camp St., New Orleans, La.
Radio Manufacturing Co., 416 Pecore Ave., Houston, Texas
Schmelzer Company, Kansas City, Mo.
Engineering Sales Co., 220 North State St., Chicago, Ill.

FOREIGN

S. SARASOLA, Colegio de San Bartolome, Bogota, Colombia, South America
CHARLES W. KERWOOD, c/o Equitable Trust Co., 23, rue de la Paix, 23, Paris, France
ORIENTAL RADIO COMPANY, No. 16 Bluff, Yokohama, Tokyo, Kobe, Osaka, Japan; Shanghai, China
NEUSTADT COMPANY, 24 California St., San Francisco, Cal. (Representative for Honolulu)

When you VISIT NEW YORK, call and see our EXHIBIT at the PERMANENT RADIO FAIR—RED ROOM, HOTEL IMPERIAL, Broadway and 32nd Street

"Madame Radora," the Feature Attraction at the RADIO FAIR,
is operated through the instrumentality of the Finch Radio Relay

Fully protected by our Patents and Manufactured only by

FINCH RADIO MFG. CO.,

303 Fifth Avenue, New York, N. Y.

The Radio Dealer

THE RADIO TRADE JOURNAL

Edited and Published at

1133 Broadway, New York, N. Y.

FOR THE RADIO RETAILER

VOL. 2. NO. 1

OCTOBER, 1922

ONE DOLLAR THE YEAR

Optimistic Outlook Shown By Radio Research

Analysis of Reports Show That The Industry Has Prepared
For Increased Business

By JOHN R. HALL
Research Editor, The Radio Dealer

The result of the very recent research completed by the Research Department of THE RADIO DEALER should prove a boon to many manufacturers, jobbers and dealers who have been ailing from a chronic attack of pessimism nourished by the recent slump in the radio business. The keynote of optimism rings through the hundreds of reports that go to show business conditions improving rapidly.

The main facts brought out by this research were several. The exit from the field of a number of get-rich-quick members was evident from the first returns. Those that have remained are particularly the old concerns who have either been in the radio field for several years or those who have been long established in some line for which a field has been found in the Radio industry; there are those also, who are new to the industry both as to name and product but who have proven themselves of business acumen that warrants their staying in the field. These remaining are out to boost radio as their business and to turn out products that will stand up under normal use. In so far as manufacturers, jobbers, and dealers are concerned the field has been fairly well cleared up and the fittest have survived.

The products themselves have seen the same sweeping out. Those of poor quality are disappearing rapidly. True there were

a number of reliable firms that manufactured what now would be considered a low grade product but nearly all have seen fit to improve their products as fast as possible, until at present the market is well stocked with equipment that is of high calibre. Several radical changes have been brought about by new inventions and a better knowledge of radio itself. This improvement of equipment is continuing rapidly and it bids fair to soon place radio in a lime light that will be the envy of many long established industries.

The lower cost of equipment has been brought about by systematic quantity production on the part of large manufacturers together with increased competition and the falling off of the abnormal demand of last spring. This drop in price has helped along the increased demand that is now being experienced.

Of course, the main cause of the craze that came last spring has also aided greatly in reviving the interest of the public, that is the broadcasting stations. The improvement in programs, the increased number of stations and the recent announcement of having a few special stations in each district has given radio the needed impetus to bring back the demand that was partly destroyed by poor equipment and service that was handed out to the public some months back.

(Continued on page 123)

***T H R E E T H O U S A N D
manufacturers in the radio
field employ over SIXTY-
FIVE THOUSAND people
in their factories, thus sup-
porting over S I X T Y
THOUSAND FAMILIES.
RADIO IS A REAL IN-
D U S T R Y, o n e o f t h e
largest in the country to-
day.***

***R A D I O I S H E R E T O
S T A Y.***

Radio Station KSD of Good Public Service

St. Louis Post-Dispatch Is First Station to Be Licensed to Broadcast on 400 Meters—The New Class B

By N. B. ZIMMERMAN

"This is the radio broadcasting station KSD, the St. Louis Post-Dispatch."

This phrase has a real meaning to the radio enthusiasts of the St. Louis section, because the St. Louis Post-Dispatch has gone to great expense to establish a proper broadcasting station.

A brick structure on the roof of the Post-Dispatch building houses this transmitting station and the radio waves depart and travel to the enjoyment of thousands.

The full beauty and perfection of modern radio is demonstrated by Station KSD.

Broadcasting was begun by this St. Louis paper in the middle of last winter and the results were so pleasing that the present elaborate installation was made.

A radio plant, for powerful broadcasting, is only built to order for the reason that geographical location and service requirements modify certain details of construction. And then, after being built, there are many tests to be made before the station can be installed. An engineer surveyed the Post-Dispatch location, specifications were drawn up, and then began a three months' manufacturing, testing and installation job.

And this new station—what is it? Compared with the station KSD had been using, the new apparatus is like the latest battleship alongside a tug-boat. It can be stated in another way: On the set just abandoned, the power tubes used as oscillators had an output of 15 watts; the tubes in the new transmitter have an output of 500 watts. The same figures are true of the tubes used as modulators. In other words, while the old transmitter has a total output of 30 watts the new one has an output of 1,000 watts. That, however, is one detail of the new station which indicates size merely; there are others, showing far greater points of superiority, which will be explained later.

Let us first, however, visit the radio studio on the second floor of the Post-Dispatch building while a test is being made. One leaves the elevator and steps into the office directly fronting the visitor. This is a reception room only, where those who are to take part

in the evening's program can await the call to the studio.

A door between the reception room and the studio shortly opens and an attendant gives the signal to a singer and an accompanist that the time for their number has arrived. They walk into a room the like of which cannot be found in St. Louis.

First of all, it will be noticed that the voice has a most strange quality, so unusual, in fact, as to be uncanny. This is due to the fact that every inch of hard surface in the studio has been treated so as to prevent any reflection of sound waves. Strike one note on a piano in your home and you hear the true sound wave followed by countless reflections—reverberations—from walls, floors, ceilings, windows, doors. Strike a note on the piano, in the studio, and you hear just the tune sound wave—that is all.

Everything in the studio has been made reverberation proof.

The next thing that attracts attention are the four red lights—one in each wall. Under each red light is a neatly framed warning which reads:

When the light is burning any sound of any kind in this studio goes out broadcast by radio.

The program director—the red lights are turned off—gives a few suggestions to the vocalist, places a microphone on a little stand and touches a button.

This gives a code signal to the radio operator in the building on the roof, the red lights are turned on, the program director makes his announcement and the entertainment begins.

Concluding, another button is pressed, the red lights are turned off, conversation is permitted—and the same procedure is followed for the next "act."

It is interesting to note just how the entertainer's voice gets to the roof and then out by wireless. The little microphone provides the first stage of travel. It is a small affair, about the size of a round mantel clock and perfectly helpless in appearance. It is delicate, unbelievably so, and picks up sound waves.

These sound waves, no matter how feeble, are translated, so to speak, into electric waves of absolutely identical character and these travel an electric circuit to the roof.

These waves are carefully guarded—they must be—by having the wires encased in a conduit all the way to the top of the building, and this conduit is grounded every 20 feet.

It is not necessary to go to the top
(Continued on page 107)

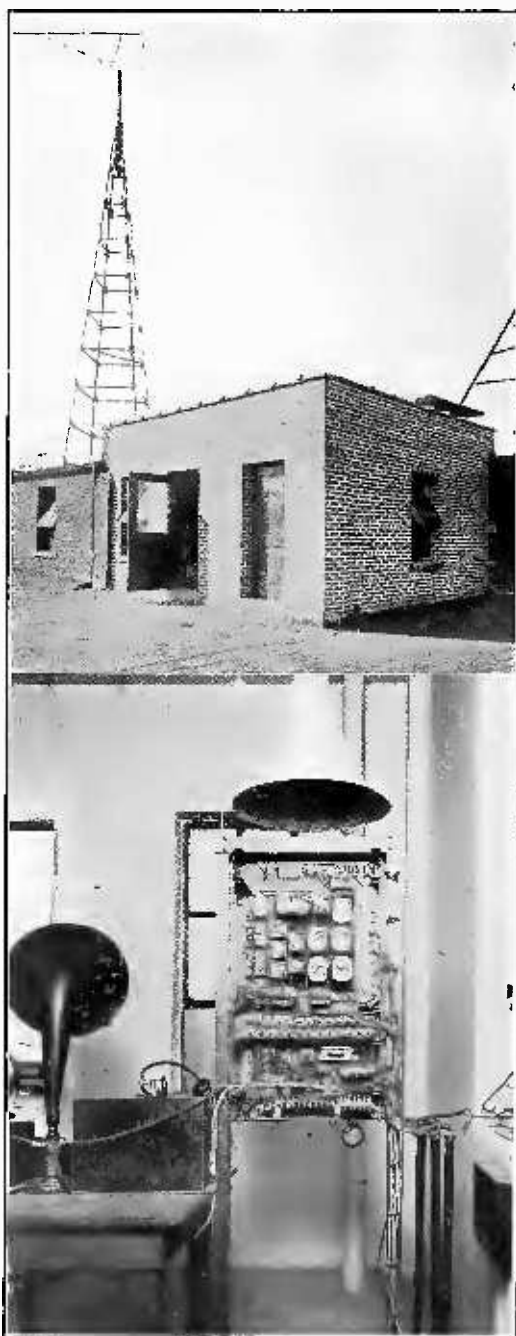

STATION KSD

Top—Brick Structure on the Roof of the Post-Dispatch Building Which Encloses the Transmission Apparatus

Bottom—Rear View of Speech Input Panel with Protecting Guards Removed

The Milliken Radio Tower

Radio Towers Can Be Sold by Dealers Without Carrying a Stock —That's the Milliken Way

By J. E. JENNINGS, M. Am. Soc. C. E.

Vice-President, Milliken Brothers Mfg. Co., Inc.

In the September issue of THE RADIO DEALER, mention was made of a new and attractive catalog recently issued by the Milliken Brothers Mfg. Co., Inc. This book contains a large amount of useful data pertaining to the antenna and its supporting tower and it is believed to be the first publication of its kind in the radio field.

In addition to this data, the catalog illustrates many of the large eastern broadcasting stations that are equipped with Milliken Radio Towers. For want of space, other large stations similarly equipped have not been shown.

These large installations show that the design and construction of the Milliken Radio Tower meet the approval of engineers to the exclusion of any other construction.

This article is written, however, for the smaller operator and to show him that his antenna requirements are bet-

ter served by the use of a properly constructed steel radio tower than with a wood construction on the one hand or by an improvised steel tower of the "windmill" or "transmission" type on the other.

The special requirements of a radio tower are, fundamentally, good design with properly proportioned steel members of high elastic strength, security of connections and provision for simple erection.

Because structural steel is usually associated with construction of magnitude, radio dealers and operators look upon steel towers as a subject requiring special skill in the installation and erection. The fact is that the Milliken Tower is an assembly of light steel angles of high elastic strength, each one of which can be easily handled by one or two men.

For an antenna, say, fifty or sixty feet from the ground, the support may be a tree, the corner or ridge of a house or a wood pole or steel pipe properly guyed to the ground. When you extend beyond this height, available supports are difficult to find, and

if a pole is used, the multiplicity of necessary stays and guys is not only unsightly and expensive, but in most cases is really unsafe.

One can visualize what may be called the curve of mental or actual hazard in terms of height of supports. At the low end, the family clothes post; at the other end the 900 ft. towers at Bordeaux, France; the Eiffel Tower in Paris, etc. Between these extremes, there are well defined divisions of height which variously affect the mind. We step from the clothes post to the flag pole and without difficulty carry this to a height of, say, 30 ft.; then with the aid of top guys we can go to, say, 60 or 70 feet. With additional intermediate guys and stayed splices, we may extend this to one hundred feet, but beyond that height we resort to steel.

But with the use of steel, one type of construction may be used up to, say, 200 ft. in height. Another type extends to 300 ft. and still others are higher, until we reach the maximum

One may answer that the mechanics
(Continued on page 118)

John E. Jennings Expert on Transmission Structures

When steel structures first came into prominence for high tension transmission to the present day experiment and development have been important factors.

Specialists have come forward, men who not only were engineers but who had a proper appreciation of the necessity for continuity of electric service. Prominent among those who have contributed to the development of the industry in the economical adaptation of structural steel to high-tension systems is J. E. Jennings, vice-president and chief engineer of the Milliken Brothers Manufacturing Company of New York. In 1907 the Great Western Power Company adopted his design for a double-circuit steel tower for a portion of its system. This marked the entrance of Mr. Jennings and his company into the electric power transmission field.

(Continued on page 102)



J. E. JENNINGS

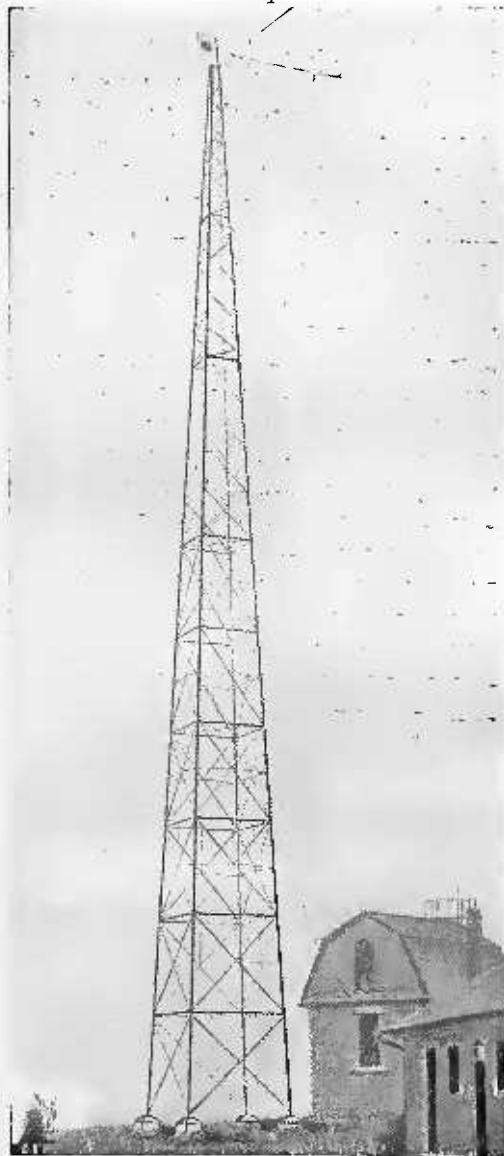

Development of Loud Speaker Idea for Radio

Years of Experimental Work Gave Radio Its Present Efficient Instrument for Amplifying Reception

By **HERBERT E. METCALF**
Radio Engineer, Magnavox Company

The story of the development of the electro-dynamic, loud-speaking reproducer, so popular now for the reception of broadcasted speech and music, gives an example of the struggles of a new art to make itself known and successful.

In 1909 Edwin S. Pridham, at that time a graduate student of electrical engineering at Stanford University, became associated as engineer with a group of other engineers and capitalists who purchased for their company the United States rights in the Poulsen Arc Patents. As would naturally be supposed, Dr. Poulsen sent over to the United States the initial instruments with which to erect several pioneer stations, and also sent along with them a young Danish engineer by the name of Peter L. Jensen. Thus started the beginning of a friendship and co-partnership between Edwin S. Pridham and Peter L. Jensen which has become permanent. These two men supplemented each other and invariably they worked together.

After a short stay with the Poulsen interests, in the course of which a large amount of experimental work was done on the arc and its receiving apparatus, Jensen and Pridham left the Poulsen people and became the chief engineers of a new company known as the Commercial Wireless & Development Company. A site was chosen for a laboratory in Napa, California, and a wireless station erected and an experimental shop opened. As one of the many problems which had been interesting them during their stay with the Poulsen interests had been the recording of radio signals, they had made a very exhaustive study of all existing forms of telephone receivers. They became fully aware of the inherent defects in all existing types, which were then the magnetic attractive, or what is properly known as the electro magnetic receiver.

As is commonly known, inventors often work for years and years to perfect an existing type of apparatus with but little success, because certain types of apparatus can be refined only, any great radical change being

impossible. Jensen and Pridham, however, were determined to make a telephone receiver which would be not only better than the ones in use but which would operate along absolutely different lines and on a different principle. They started out by making experiments with an Einthoven String Galvanometer. The Einthoven String Galvanometer, as most of us know, is composed of a very fine quartz fibre, silver plated, which is placed in the field of a very powerful electro-magnet. If a current is passed along this quartz string conducted by the silver, the string will have a tendency to be

attracted into or repelled from this magnetic field. By making the field very strong and the quartz fibre very thin, great sensitiveness can be obtained from this instrument, the finest of which are used for recording the actual currents of electricity generated by the heart muscle during its beating. The co-inventors substituted a heavier wire for the quartz string and then attached the middle of this wire to a telephone diaphragm. Then by using a transmitter and battery in series with the string the voice was reproduced,—very, very weak, it was true, but after careful experimentation, it was found that the reproductions, particularly those of the consonants "T," "P," and "S," were far better than the ordinary type receiver. Upon working out the formula of this type of instrument it was found that the force acting on the diaphragm was proportional not only to the strength of the field and the amount of current flowing in the wire, but was also proportional to the length of the wire in the magnetic field. The next step was, therefore, to lengthen the amount of wire by winding a many-layered annular coil and then placing this annular coil in a strong magnetic field. So this was done, and the first true electro-dynamic receiver had been created. This instrument consisted of two very heavy electric magnets and a circular coil wound to an impedance of 70 ohms, rigidly attached to a diaphragm. The floating coil was about three inches long by one and one-half inches wide, and the complete instrument weighed in the neighborhood of sixty pounds. The sound box was so designed that a listening tube could be brought out from each side of the diaphragm and the tube was then led to each ear so that one ear listened on one side of the diaphragm and the other ear listened on the opposite side. In this way the air vibrations on each side of the diaphragm would be utilized. As the floating coil was then wound so that the instrument could be used on telephone lines, many trials were conducted in which

(Continued on page 74)



HERBERT E. METCALF

Radio engineer of the Magnavox Company, who has written this interesting story of the loud speaker especially for the Radio Dealer. This photo was taken while Mr. Metcalf was in the Service as an officer of the Radio Corps. Mr. Metcalf is acknowledged to be an authority on the subject he writes about.

Vulcanized Fibre in Radio Manufacture

Importance of This Material is More Apparent to Those Who Are Well Informed About Vulcanized Fibre Uses

By A. P. SOUTHWORTH

New England Representative National Fibre and Insulation Co.

The most of us are fairly well informed regarding materials most commonly used in the manufacture of radio equipment, but there are few who know and appreciate the many varied uses of materials that have recently been approved for more efficient use. The lack of knowledge concerning the use of vulcanized fibre is apparent. Like a great many things about which there is little known, the use of vulcanized fibre is looked upon with scorn by many. Some dealers and jobbers have refused to purchase fibre material, preferring to stock the more expensive material though this has proven to be no more efficient. With this thought in mind a few enlightening remarks about this much abused material would not be amiss.

Vulcanized fibre is a material which is made from a cotton paper base. Layer upon layer of paper is used until the fibre is built up to the proper thickness, whereupon the material is reduced to a cellulose and becomes one homogeneous mass. Upon drying, this material is pressed in huge steam-heated presses and becomes a very hard, tough sheet.

Fibre can be furnished in a number of colors, the most common of which are red, black and gray. Thicknesses can be obtained running from .005 in. to about 2 in. Vulcanized fibre can also be obtained in tubes and rods of a great many characteristics which make it especially desirable for radio work. Its shearing strength of 13,000 lbs. per square inch, together with its crushing strength of 43,000 lbs. per square inch and tensile strength of 13,000 lbs. per square inch, make this material strong enough for almost any use to which it might be put. Fibre is an excellent insulator and stands a breakdown voltage of approximately 25,000 volts per $\frac{1}{8}$ in. in thickness.

It is interesting to note the number of ways vulcanized fibre is used in the manufacture of radio apparatus. Invariably, rheostats of the wire-wound type use a fibre strip to support their winding. The flexibility of the fibre enables the winding to be bent to a sufficiently small diameter to make a compact rheostat. The combustion point of fibre of 650 degrees Fahrenheit is more than sufficient to withstand the heat. Inductances of many

different types use fibre tubing to support the windings. One fibre manufacturer has succeeded in perfecting a tube which is excellent for this purpose. This tube is made by wrapping thin-weight fibre around a mandrel and securing the layers in place by an adhesive. This process of manufacturing tubing prevents the finished tube from shrinking or warping, thus causing the wire to loosen. Vari-

couplers, tuning coils, and loose couplers come in this class. Honeycomb coils are usually secured to their mounting with a perforated fibre strip. It might be well to mention here that fibre used on honeycomb coils has been severely criticized in the past, due to the fact that an improper grade of fibre was used. Fibre which had been made flexible by impregnating it

(Continued on page 82)

Rely On Quality, Not Price, to Sell Your Goods

By A. L. STRASSBURGER

Tri-State Products Co. of Philadelphia

The radio dealer who desires to make a success and build up a business for the future must bear in mind that the public, while having a general knowledge of the various parts necessary to make up a receiving set, knows very little about quality and it is up to the dealer to instruct his trade.

There was a time when a customer coming into a store selling radio supplies had no idea as to just what he wanted. He knew he needed this and that to make up his set but had to take the advice of the dealer as to what make of article to choose. In many cases the dealer was ignorant of the right make of article to sell him. This brought about a peculiar situation, the customer could not get his

set to work properly and in some cases he lost heart and cast it aside, always feeling that he had been stung; this was true to a more or less extent, but the dealer had no intention of giving him anything but what was right. Not having the proper knowledge parts were sold, made by irresponsible concerns who sold parts not properly constructed and therefore gave poor results, if any.

It is therefore necessary for the manufacturer of radio parts of quality to impress the dealer with the standing of his company. In this way the dealer will get to recognize those companies making only quality products which he can guarantee to his customers.

Where a dealer is selling a complete receiving set it is a simple matter to demonstrate how it works and have the customer listen in; but where the customer wants to make the set himself, it is then that the dealer should instruct and impress upon the customer the importance of buying well known parts which are backed up by the manufacturer. It is only the financially responsible makers who will stand back of their products.

It is the duty of the manufacturer to instill in the mind of the dealer that he must not buy price but quality. In turn the dealer must instruct the customer that the best results can only be had by the use of well constructed

(Continued on page 93)



A. L. STRASSBURGER
Prominent Philadelphia Radio Man who
urges quality above all

Development of Radio Frequency Amplification

Detailed Information on Neat Radio Frequency Amplifying Unit Made by Nationally Famous Radio Pioneers

By R. J. WHITAWA

The application of radio frequency amplification for the reception of broadcasting for the amateur work has been greatly developed by Amrad.

Before making a practical explanation of amplification, it is proper to generalize. There are two kinds of amplification—audio frequency and radio frequency.

The ordinary kind of amplification is audio frequency amplification. This increases the audibility of the music or speech that is barely heard with a V.T. Detector.

Audio frequency amplification is very useful. For a while it was the only kind available. It is still useful, but its usefulness has been increased by the development of radio frequency amplification which increases the radio impulses picked up by the receiving set before they pass through the V.T. Detector.

Under ordinary circumstances two stages of A.F. amplification represent the greatest increase that can be satisfactorily added to the V.T. Detector.

Where an extremely sensitive receiving outfit is desired, the only

alternative is the use of radio frequency amplification. A radio frequency amplifier, as stated above, amplifies the radio frequency caught by the antenna and tuner before it is applied to the detector tube. It amplifies the radio frequency only; hence it does not increase the intensity of audio frequency noises impressed on the antenna, such as some forms of static, nor does it increase the hissing or sizzling of the detector tube. It simply increases the strength of the incoming impulses before they reach your detector.

The Amrad R. F. Amplifiers are available in two types—No. 3071, particularly for use with Amrad Short Wave Tuner No. 2596 and Amrad Detector 2-Stage Amplifier No. 2634; and No. 3045 for use with any of the Amrad Units comprising the well-known Amrad unit system.

It is the established Amrad policy never to bring out new and improved equipment that would render obsolete previous Amrad products. Accordingly, the new Amrad R. F. Amplifiers are especially designed to work with the Amrad equipment noted above.

The trade may safely purchase Amrad Radio with the assurance that their equipment will not become inferior due to progress in the art.

Amrad R. F. Amplifier No. 3045 may also be employed with any tuner or detector units now available according to a recent bulletin.

Both types are identical, except that No. 3071 is encased in a cabinet with rounded corners while No. 3045 is provided with square corners.

R. F. Amplifiers should be so designed as to permit use of radio frequency amplifying transformers suitable for various wave length bands. Both Amrad R. F. Amplifiers No. 3071 and No. 3045 permit use of different wave length range radio frequency amplifying transformers, or Radiformers—the Amrad designation.

The unique design of Amrad Radiformers, a product of Amrad research, has been carefully tested, assuring highest possible efficiency in the operation of either Amrad R. F. Amplifier.

The two Radiformers, shown herewith, are inserted in specially molded

(Continued on page 65)



Three Views of the Amrad New Radio Frequency Amplifying Unit

The Passing of the Unfit Tradesman

Accounting Methods of Many Radio Firms Very Lax, Inviting Almost Certain Failure.

By HENRY L. SEIDMAN
Certified Public Accountant

An examination of the recent bankruptcies which occurred among the manufacturers and dealers of radio apparatus, brings to light one of the most chaotic and appalling conditions that ever existed in any industry. Because of these conditions there is being waged among a certain class of dealers, one of the most serious cut-throat wars that ever took place; and these "warriors" are enabled to sell their merchandise at prices considerably below cost because the manufacturers who made them did not know what they cost to manufacture. It is obvious that there is only one end for such men—the bankruptcy courts.

The industry seems to have attracted men who are woefully unfit to be in it; whose experience, or rather, lack of it, in wireless work is pitifully inadequate. One case I know of is a typical example. A man who had been an electrician once upon a time, working for electrical contractors,

quit such work and went to work for a metal stamping concern where his job was to operate certain machines

Cisin Added to Staff of Dictograph Products

Expert Is Placed in Charge of Radio Department

The Dictograph Products Corporation recently secured the services of H. G. Cisin, author of "The Radio Telephone Handbook." Mr. Cisin has been placed in charge of Dictograph radio sales promotion, advertising and publicity. He was formerly engineering editor of *Electrical Record*.

Mr. Cisin is a Cornell graduate, holding the degree of mechanical engineer and certificate of electrical engineer. In addition to being the author of "The Radio Telephone Handbook," he has written a number of other books, including "Radio Phone Terms Simply Explained" and "Practical Electrical Engineering." He has taught electrical engineering at Cornell University, Johns Hopkins University, U. S. Navy Electrical School and Stevens Institute of Technology. During the war he served in the U. S. Navy as ensign, and his radio knowledge was gained through practice as well as theory.

Since Mr. Cisin has joined the Dictograph Products Corporation, there has been great expansion in its radio department. The Dictograph Company has been manufacturing sound transmission and reception apparatus for many years, being makers of the world famous "Acousticon" for the deaf, the Dictograph office intercommunicating system and the well-known Detective Dictograph. However, the reputations achieved by the Dictograph Radio Head-Set and the Dictograph Radio Loud Speaker have served to place these in a class by themselves and have resulted in making the radio branch of the Dictograph Corporation one of its most important departments.

which stamped out tin discs which were used as covers for small tin cans.

He had been away from the electrical line for five years when the radio boom came along last fall. This man, because he saw some plate condensers and some sockets, became convinced that manufacturing radio apparatus was just the thing for him to engage in. Did he not know the electrical business? Had he not followed wiring diagrams for years? And what else was a 43-plate condenser but a series of stamped metal plates fitted together, about one-quarter of an inch apart?

He set up in business for himself. He lasted three months—and was one of the bankrupts mentioned above.

What were his troubles? A great many. First, was his absolute ignorance of the technical theory of radio; second, his inability to figure the cost of his article; he was wrong on the quantities of material, wrong on labor, and he never heard of such a thing as manufacturing and general overhead expenses. If his material cost him 50 cents and his labor another 50 cents, he could make a pile

(Continued on page 80)

Henry L. Seidman, whose article appears on this page, desires to call attention to the value of proper bookkeeping. Mr. Seidman is an expert public accountant and auditor of Bettman & Seidman, 276 Fifth avenue, New York, and will answer questions put to him regarding bookkeeping and accounting problems, as well as income tax matters.

In future articles Mr. Seidman will deal specifically with the following subjects:

- Costs of manufacturing.
- Overhead.
- Inventories.
- Selling costs.
- Administrative costs.

Through the medium of these articles the readers of THE RADIO DEALER will acquire a clearer understanding of the principles underlying their business as seen through the eyes of an accountant who is familiar with the radio industry.



H. G. CISIN

International Trade-Mark Registration

Advisability of Securing Early Protection in Foreign Countries for Trade Marks for Salable Apparatus

By CHAUNCEY P. CARTER
Trade-mark Specialist

It is believed that the slump in exports from the United States has passed the low mark and that from now on gradual but sure recovery may be expected. Owing to the publicity talents born in the average American, practically every well-known trade-marked article on the market here sooner or later finds its way into foreign markets to some extent. Consequently, the owner of every trade-marked product that is enjoying or may enjoy any popularity in this country should early turn his thoughts to the possibilities of foreign markets.

While it is often said that the same qualities of salesmanship that act to "put across" a product in this country will do the same in any foreign country and that in the last analysis buyers of all nationalities are alike in fundamental psychological reactions, it must be admitted that the idiosyncracies of every buyer influences his action and should therefore be taken into consideration in trying to "sell" him, and that there are idiosyncracies common to all buyers in certain localities even in the United States.

Examples are legion of the failure of advertising copy and campaigns directed to the American public to influence the English or Australian buyer and it is, of course, unnecessary to even refer to the folly of sending to a list of South American prospects literature not translated into the native language of the country to which it is directed.

Thus, in the matter of trade-mark protection, we find that each country has sufficient ideas concerning this, and whereas in the United States the condition of our common and statute law is such as to protect even the most lazy and short-sighted trade-mark owner from aggression, the laws of foreign countries, particularly those wherein the English language and customs do not prevail, are not so kind.

In the United States, a man may use a trade-mark for years without complying with any formalities for registration, etc., and still be entitled

to the full protection of the courts when infringement arises. In Cuba, however, the registration of a trade-mark is obligatory prior to use, and the use of the trade-mark in any form but that in which it was registered affords sufficient grounds for cancellation of the trade-mark right as evidenced by registration.

In Argentina and most Latin countries, anyone may acquire the right to the exclusive use of another man's trade-mark by simply registering the same and being the first to do so. It is not at all uncommon in such countries for a local merchant to register in his own name well-known American trade-marks advertised in our leading magazines and trade papers, and then demand the local exclusive agency for such products.

From this it will be seen that the foresighted trade-mark owner will not even be content with applying for registration of his trade-mark in for-

ign countries as soon as shipments are made but will make his application in those countries where the law permits piracy of foreign marks as soon as he has any reason to believe that his goods will eventually be shipped to such countries.

It is, of course, expensive from the standpoint of initial outlay to register a trade-mark throughout the world, but the expense of such registration has in recent years been considerably lowered by the coming into operation of the Buenos Aires Trade-mark Convention of 1910. Under this convention there has been established in Havana, Cuba, an international bureau where any trade-mark registered in the United States Patent Office may be deposited and thereafter enjoy the benefits of registration in some fourteen Latin-American countries that have ratified this convention. This protection may be had at an average cost of 35 cents per annum per country, and no trade-mark owner should be without it.

Amendment Creates New Class of Broadcasting Station

The Department of Commerce recently authorized an amendment to the regulations governing radio broadcasting that introduces a new class of broadcasting station to be known as Class B stations. The Class B stations are designated by certain fixed rules that, of the 500 broadcasting stations located throughout the country, about 15 are equipped to fulfill. Not only does the amendment specify the general equipment of the station to be allowed in this class but it also permits supervision of the broadcasting program. One of the rules specifies that no "canned music" will be allowed except in an emergency.

The Amendment reads as follows: To radio inspectors and others concerned: Regulation 57, page 55, amended August 8, 1922, to read: Class 2—Limited commercial stations are not open to public service and are licensed for a specific commercial service defined in the license. Stations of this class must not transmit to or accept public messages from other stations. No rates are authorized. Licenses of this class are required for all transmitting radio stations used for broadcasting news, concerts, lectures and such matters. A wave length of 360 meters is authorized for such service, and a wave

(Continued on page 78)

Origin and Growth of Cambric Tubing

"Spaghetti" and "Macaroni" for General and Varied Purposes Has a Sound Foothold in the Radio Field

By A. W. STRINGHAM

Mail Sales Department, Mitchell Rand Mfg. Co.

It is only of comparatively recent date that the present form of insulating tubing has been used in the electrical field. Until about ten years ago the standard method of covering short terminal and connecting wires was by the use of a cotton sleeving or braided tubing then known as stockinet; after having been put in place this sleeving was given a coating of varnish to produce a smooth surface. However, the material was not satisfactory, as it was readily effected by moisture or oil, as in motors, dynamos, transformers, etc., and the dielectric strength of the varnish gradually weakened and finally broke down. Where high temperatures also prevail the disintegration process was so rapid that the insulation afforded only temporary protection. In other instances the sleeving was used more as a finish than an insulation, (such as inside of meters and similar instruments,) and with quite satisfactory results, although the varnishing process was time-consuming, inasmuch as it had to be done after the instrument was assembled and care had to be exercised to keep it off adjacent parts.

Then a new style of tubular insulation was introduced to the trade by the name of impregnated varnished tubing, in the form of sleeving properly treated and ready for use. Different colors aided in marking polarity, etc., and, because of its flexibility, its oilproof, waterproof, acid, alkali and heat resisting properties, many uses were at once found for it in electrical construction (particularly in instances where a dependably flexible insulation had been sought to confine high potentials,) and an assortment of various sizes ultimately became "stock" in every shop where highest standards prevailed in both new construction and general repair work. Someone, possibly preferring a shorter name to impregnated varnished tubing, and aided by the resemblance of the material itself, dubbed it "Macaroni," and the name stuck. Since the smaller sizes became popular, "Spaghetti" has been the designating shop term.

During the war the U. S. Government tested several makes of "spaghetti." The "impregnated" style stood highest in every test and many thousands of feet were used in

radio and other work by the various bureaus of our own government as well as those of foreign countries.

When manufacturers of electrical apparatus took up the production of radio sets they naturally used spaghetti on leads of exposed wiring, primarily as a protection against "shorts," although the "dressed up" appearance thus attained was at once recognized as an aid to selling; and notwithstanding the fact that cheaper substitutes are available, the manufacturers of practically all of the highest grade sets continue to use the "impregnated" style.

However, from makers of the lower priced sets, and from amateurs, came a growing demand for something less expensive, something that would serve mostly as a mechanical protection, yet have sufficient finish to impart the desired appearance. This call was immediately met by a "dipped" tubing and, quite recently, by "radio" tubing. The three styles of spaghetti now on the market may be briefly described as follows:

The style has a base of cotton sleeving impregnated through and through with varnish and baked, then given from eight to ten additional coats, each coat being baked and rubbed down. This is known as macaroni in the larger diameters and spaghetti in the smaller sizes. The wall around the sleeving is thus built up of nearly a dozen layers of varnish, is homogeneous and of tremendously high insulating value. As the final coat is also rubbed down the finish is smooth but not brilliant. The dielectric value is approximately 7,000 volts.

In the "dipped" tubing the cotton tubing is treated with a dressing, or filler, instead of varnish, dried and dipped five or six times in varnish, each coat being baked dry before the succeeding one is applied. This method produces a tube with a high gloss that is moisture proof, oil resisting and, when properly made, will withstand breakdown tests up to an average of 5,000 volts. There are several makes of dipped style and while some are quite suitable for radio and similar work, there are others that quickly bleach and dry out, crack, powder and sooner or later become utterly worthless as an insulator. And it is difficult to determine quality

by either price or appearance, as some of the most highly polished are built up entirely of collodion, cellulose, or other gun cotton compound, to which castor oil is added to retard hardening, and as they contain absolutely no varnish whatever they soon become hard, brittle and crack; then, too, some are highly inflammable, burn with an intense heat and, when carried in stock, introduce a fire hazard that warrants most serious thought.

The "radio" tubing is white or colored cambric cloth cut in narrow bias strips, rolled lengthwise to form a tube 36" long, and covered with an insulating compound resembling (but not containing) rubber. To produce yellow tubing amber colored compound is used over white cloth, whereas both cloth and compound are of the same color when other shades are made. In every case the coating is transparent, permanently flexible and will give excellent electrical protection up to about 1,000 volts in ordinary apparatus where it does not come in contact with water or oils. This form of "spaghetti" is ideal for radio instruments, inasmuch as it offers insulating protection with a factor of safety many times in excess of that required; its low cost permits of its liberal use and where more than one color is employed to trace out different circuits the result is an improvement in appearance that has repeatedly proven to be of no small assistance in selling.

As "radio" tube is somewhat softer than the other types, care should be taken to prevent its being cut by sharp pliers when the covered wires are bent at the turns.

Space does not permit going into a description of the many and varied uses of "spaghetti." Suffice it to say that, though the manufacturers have seen fit to use it extensively, yet there is the large and ever increasing so-called class of amateurs that has not as yet been thoroughly educated to the use of this material in the construction of their sets. What is needed in this line, as in many others that have a field in radio that is not fully realized, is an extensive education of the public regarding the facts by manufacturer, jobber and dealer.

With The Editor

Service to Trade Has Made This Paper Trade's Leading Periodical

Many people in the radio and electrical field have marvelled at the growth of this paper. They have seen trade papers come and go but ne'er have they witnessed so astonishing a success as THE RADIO DEALER appears to be.

THE RADIO DEALER is a success and has achieved the top spot in the radio trade, following the fact that it was first in the field, because we have employed one especial policy—service to advertisers and readers generally.

Every effort has been made to serve the trade.

This pleasant programme has developed a large part—for subscription. No trade paper in recent years—we believe—can point to a bigger paid-for list in the seven months that have ensued since THE RADIO DEALER was first launched.

THE RADIO DEALER has succeeded where others have failed, because this paper has day by day gone about its own business—to serve the radio trade.

In our first issue we plainly stated THE RADIO DEALER would have but one master—the radio trade—and we have hewed to that mark very, very carefully.

THE RADIO DEALER represents no faction; has no promotions to put over; has no axes to grind of any kind, but is merely a response to a demand.

Why are we telling this? Merely to put ourselves on record as believing, not in Santa Claus, but in the patent fact that THE RADIO DEALER achieved its rank as the trade's leading paper, as well as the trade's first paper, because THE RADIO DEALER extended real service in months passed when so many of our tradesmen were groping in the dark.

In those days many newspapers, featuring (?) radio departments excited the minds of many business men, pointing out the great business in sight—all to be gobbled up by the first comers.

THE RADIO DEALER advised caution. THE RADIO DEALER convinced many business men. THE RADIO DEALER adduced facts to seekers.

THE RADIO DEALER paid-for circulation has been achieved because of the dollar subscription price. That price has been the real bait that has acquired for this paper what amounts to almost the entire field.

THE RADIO DEALER covers the retail and jobbing field, being

read by radio dealers, electrical dealers, phonograph dealers, department store radio managers, hardware dealers and drug chain system heads.

THE RADIO DEALER circulation will increase as new dealers in radio equipment develop—no faster. This paper has no newsstand circulation, every copy being mailed out to retailers, jobbers and manufacturers.

Pardon this talking about ourselves, but we do want you to know that our success is built upon the solid rock of service and that word Service is to remain our one special creed for ever and the next day.

What can we do for you?

Sure-thing Stock Sellers Have Been Unsuccessful

A great deal has been written about the sure-thing promoters who have stopped selling oil stocks in order to acquire easy money via radio stock-selling.

It is doubtful whether the radio stock selling lads have acquired great quantities of wealth, because the newspapers—which helped materially in developing radio usage—were alert and pounded away at promoters.

Some of our newspapers even refused to print the advertising offered them by radio concerns obviously created for the purpose of stock-selling. (*The Radio Dealer* has declined advertising from such concerns.)

One of the reasons for the apparent indifference on the part of the easily-beguiled public lies in the fact that there are but a few radio concerns listed in Wall Street.

The daily newspapers report transactions on the New York Stock Exchange, as well as on the Curb Market—but these exchanges have become critical in recent years, due to public outcry, and they are not wont to hastily permit trading in stock issued by new and untried organizations.

Cheap or Reasonable Prices

The difference between cheap goods and reasonably priced goods is so slight for the manufacturer that it is hard to understand some of the apparatus on the market today.

To do a good job of wiring on a set costs very little more than a poor set of connections, while a cent a pound more of certain kind of materials will often mean fifty per cent better operation for the part.

Retailers throughout the country are finding that the best goods that give the best service are often but a little higher than shoddy goods made by irresponsible firms. A retailer has to stay in business to make any money and more and more they are refusing to buy anything but the best. Quality brings repeat orders while poor material often loses a radio fan for the game.

Dealers are becoming educated to recognize quality, and the wise makers are quick to read the handwriting on the wall that warns them that "quality tells."

There is no room in the radio industry today for manufacturers that do not produce goods of high quality, and the trade is rapidly convincing the last of the fly-by-nights that the time has come for them to turn to some other field of endeavor.

The Coming Business And One Price to All

Business is on the upward trend in radio circles, judging from reports being received from many centres of broadcasting activities.

It is likely that last year's rush will be duplicated this fall, but the bulk of the business will go to those concerns who have established some sort of a "Rep" for their wares or their firm names.

The unknown — the get-it-quick manufacturers of last year—might as well close up shop. They haven't much of an opportunity to put over hastily-made wares.

Retailers and jobbers have learned their lessons. They will not buy without guarantees. There are to-day thousands of dollars' worth of poorly-made radio apparatus on the shelves of some retailers who are also wholesalers.

Some of last year's new folks in the radio business knew very little about electrical equipment. They imagined, for instance, that a 'phone head set if it looked the part served its purpose. Some head set "manufacturers" have achieved financial headaches rather than real business.

There have been failures, financial and otherwise, in abundance and some of the larger radio concerns have been hard-pressed to control their jobbers and retailers who became scared at the very recent summer slump.

Cool heads have won out, thanks to the larger concerns who have not oversold the market and the fall and winter business season will open up very soon with a genuine demand on the part of retailers and jobbers for practical radio apparatus that can be sold on a guaranteed basis, at a living wage profit.

The manufacturers and jobbers who are legitimately engaged in the sale of radio apparatus are extending proper terms to their customers. These manufacturers must succeed.

There is one rule that insures success to every business house and that is to treat every customer the same. Extending special prices to certain dealers is not good business; it does not make for trade stability.

The best concerns in the radio trade are treating their customers alike. No other rule will satisfy the present retailers and jobbers in the radio field.

Test May Eliminate Radio Interference

Judging from the new schedule in effect for the radio broadcasting stations in the Metropolitan area, announced to go into effect today (October 1st), Arthur Batcheller, Radio Inspector for the Second New York District, is to make a test that may eliminate radio interference.

It is planned to send out programs simultaneously on 400 and 360 meter wave-bands.

The General Electric Company, in Schenectady, broadcasting station is to operate on a 400-meter wave length on the first, while the Rensselaer Polytechnic Institute, at Troy, will operate on the customary 360-meter wave length.

This is an interesting experiment and it will be watched very closely by every one of the five hundred broadcasting stations, as it is sure to have an important bearing on all future broadcasting. (For reports see **Radio Dealer Weekly**.)

Persons in the capital district of New York will listen and determine if they can satisfactorily separate the programs so there will be no interference with either.

WGY—the Schenectady station—will operate under the experimental license granted to the General Electric Company, starting at 8:45 o'clock, daylight saving time.

WHAZ—the Troy station—will start its program at 8:15 o'clock, daylight saving.

This will give persons one-half hour to listen to Troy before Schenectady starts.

Listeners are invited to render reports to Inspector Batcheller.

Representatives of the General Electric Company, in a statement rendered to newspapers, say that the outcome of this test will have an important bearing in solving one of the greatest problems that has arisen since broadcasting started. There are about twenty broadcasting stations in the second district, all operating on a 360-meter wave length. Inspector Batcheller arranged with the Department of Commerce for an additional wave length of 400 meters to be assigned the larger and more powerful stations equipped to maintain a high standard of programs and prepared to maintain a regular program throughout the year.

The question arose whether persons with receiving sets could satisfactorily tune out a station on a wave length of forty meters difference, and to settle the question the test between the Troy and Schenectady stations for Monday night was decided upon.

Radio and Radio Failures

The race is for the strong, and the old law of the survival of the fittest is purging the radio industry as other lines were cleared during the general depression after the war. The increased number of failures among radio firms during the past summer, while hard on some of us, will work for the general good.

Makers of inefficient equipment, firms with poor merchandising policies and with profit ideas out of proportion with justice, under-capitalized concerns, and those with inefficient management, wild stock selling companies, all these are falling by the wayside, working for the general betterment of the industry for those remaining.

The march of radio should be speeded—among the trade—by this weeding out of inefficient.

The Fly-by-Night Radio Retailer

When the boom came on last spring every corner store put in a radio stock, charged high prices and sold the public what they asked for—as long as it could be found in a jumbled stock.

The summer slump gave these would-be dealers a chance to discover that radio supplies, like everything else in the world, required a little bit more knowledge about their selling than the vending of newspapers on the street corner.

The radio retailer must carry sufficient stock to supply demand, and he must be able to give a certain amount of service to his customers. The live dealer reads up on his business and is prepared to tell customers what to buy—and why.

The cigar store radio dealer, the drug store counter, the hardware man, the electrical man, in fact every dealer in radio equipment has found that radio retailing requires thought and study, and the weaker dealers are slowly fading away.

Air Programs Meet Today's Public Requirements

Criticism, in goodly quantities, has been directed at the many prevailing radio programs, and a great deal of this caviling is of the capricious type.

The present type of radio programs are serving their clientele, and it is safe to record that when the great American public demands programs of another type the broadcasting folks will make proper changes—in accordance with public demand.

It has been declared that the current styles of programs are not of the uplift sort; that they pander to the simpler tastes; that like the movies they are "undermining America" because of their featureless arrangements.

Environment, it is agreed, makes us. So it is with the radio broadcasting folks. Just as long as their clientele is pleased with concerts, with Wall Street prices, with baseball scores and the other features daily served, just so long will they be broadcasted.

When the public begins to cry for Ibsen and Shaw or mayhap editorials from the New Republic, then will another era of air service become the vogue.

It may even develop that the radio enthusiasts will ask for original fiction stories, supplemented by

readings from the classics. Why not?

Radio broadcasting managers can take heed from the activities of the movie folks. These mercenary entertainers give the public what they think the public will want—at box office prices.

Movie magnates do not, as a rule, force high-brow entertainment down into the public's sight, because the major part of our people really seem to enjoy custard-throwing comedy—viewed from the box office results. And the spoken drama is not much different. Even the famed Guild of New York can attest to the fact that high-brow plays do not land the food coupled with eggs.

It is barely possible that too many radio broadcasters have taken the complaints of the comparatively few too seriously.

There is an art to radio broadcasting, but it's in an indefinite shape, but it needs no apologists as yet.

In the play houses the public demand the custard-pie and the sob stuff—the things generally favored by the mentality of the average person—and it is tendered them.

So it is with the radio programs. When the demand, from the big public, arises the broadcasters will heed that demand. The present programs are ample for the day.

On one New York street of less than six blocks at one time there flourished over a dozen radio stores, all flourishing on the face of things. Today, with a public educated to better things only three stores are to be seen in this section. They are not as busy as before, but the dealers say gross sales are higher.

Just as the fly-by-night makers have folded their tents and silently fled, the fly-by-night retailer has sold his stock of junk to a cut rate dealer and put back the cigars and

light bulbs that occupied the radio-section this time last year.

Less junk dealers and more radio dealers bring better business for better manufacturers, to say nothing of advancing the use of radio sets among the general public.

Radio retailing is a business, today, and business men are in the large majority among those remaining in the trade.

After all, sometimes, slumps help!

The New Etherola Aerial Equalizer

By **BERNARD FREEDMAN**

The writer has been watching the development and tests of the Etherola aerial equalizer and the Etherola ground separator tubes, for replacing the usual high long aerial and water pipe and other ground connections, so commonly used and which pick up and convey to the amplifier so much interference.

Many radio men have been developing "equalizers" and "separator tubes" for replacing the usual high, long aerial and water pipe ground connections.

The Etherola aerial equalizer and the Etherola ground separator tubes are the results of tests, properly made for connections so commonly used and which pick up and convey to the amplifier so much interference.

These equalizers and separator tubes seem to solve the many aerial problems as well as doing away with the necessity of a ground connection, which, of course, eliminates the so-called danger from lightning.

The tubes are made of sheet aluminum, in tubular form, from $4\frac{3}{4}$ inches to $9\frac{1}{4}$ inches in diameter and 20, 24 and $38\frac{1}{2}$ inches long and are suspended by insulators either in or out doors as desired by their purchasers.

They are effective on almost any make of receiving sets of one stage of amplification and over on head phones and on four stages of amplification on loud speakers; can be suspended in almost any convenient spot at any height, and seem to be free from the usual directional quality, with which all loop aerials have to contend.

The contents of the tubes and their arrangement and capacity has not been made public as yet and will not be until the pending patents as to basis, operation and design are granted, but it is understood that they contain a large number of different metallic discs, so made and connected that they pick up the carrier wave in its greatest strength, clarify and equalize it and separate it from most of its bad parts, and pass it to the receiver in nearly perfect form for detection and amplification. And it would seem that whatever the tubes do to the wave (judging from the clear tones produced), that a point has been covered by "doing it in the

aerial" which others have been doing or attempting to do after the wave enters the receiving apparatus.

It looks as though the system used is the correct one, and the Etherola Corporation, 6216 Broad Street, Pittsburgh, Penna., who are manufacturing the tubes, under license of patentee, apparently have a device which radio fans have been looking for, as it requires no change in one's receiving set to use them.

Jobbers and dealers would do well to look carefully into these devices, as they look like real "best bets" in aerials and grounds. The company is reliable, well financed and ready to "deliver the goods" and guarantee results.

The Etherola Corporation also manufactures a self-contained cabinet of unique design to contain these tubes. This cabinet is called the "Etherola" and the tone results are said to be amazing.

Chicago Show for October

National Show Plans on Having Manufacturers' Exhibits Only

The Chicago Radio Show to open October 14 is planned to be exclusively a manufacturers' radio show. According to recent reports the majority of large manufacturers had arranged for representation and it is expected that there will be a high class showing of radio apparatus that will bid fair to eclipse that of any show held thus far. Big interest in the show has been expressed by numerous dealers throughout the Middle West, who are anxiously inquiring as to the accommodations to be had at the city hotels.

Most of the space has already been reserved and reports have it that several foreign countries will have representative exhibits. The directors are seeing to it that no undesirable exhibits gain admission, by carefully scrutinizing the status of all applicants for space.

The plans call for a big attendance like all shows, but the difference between this show and many of those of the past is that all indications point to a successful carrying out of the plan. As one writer puts it and as it is hoped, "the Chicago Radio Show will be the largest and finest radio exposition ever held anywhere."

Display Hangers

A Valuable Form of Advertising That Costs Very Little

By **KARL M. JONES**
Vice-President of Mercury Radio Products
Co., Little Falls, New Jersey

The importance of an attractive display hanger shown on the dealer's counter, or in the window cannot be spoken of too highly. A good display hanger with the right selling message in a few words and the proper illustration, will bring immeasurable returns in dollars and cents. This has proven to be an inexpensive form of publicity, besides, it adds to the attractive appearance of the store.

It would, perhaps, do to use a standard size hanger, 10 x 14 inches, preferably made of four-ply cardboard, and provided with two eyelets at the top for the purpose of putting a piece of cord through. It costs far less to use cord at the top than an easel back for displaying the card. If a cardboard easel is used in the back for standing the card in an upright position, so much the better, but this will add approximately a half cent to each display. The majority of easels in use, however, have proved practical with the string attached.

The most practical colors to use for such an easel are black as a basis, and orange or red for certain parts to be emphasized. The suggestion is to use plenty of black, and not too much red for emphasis, and for getting a strong contrast. Plenty of white should be used around the border, as a black, white and orange combination is very harmonious to the eye. For example, a clever selling slogan should be emphasized in orange; the name of a product should also be so emphasized. An illustration and the brief descriptive or specification matter should be in black.

To sum up, a few thousand display hangers judiciously distributed among dealers will do far more good to back up the consumer demand than any amount of salesmanship or circularizing could do—besides a display hanger is a silent salesman that works continuously twenty-four hours a day, and costs negligibly little, as compared with selling to the consumer by word of mouth.

GLOBE ELECTRIC SET

The Globe Electric Company of Milwaukee, Wis., manufacturers of a two-unit set consisting of a regenerative Detector and Tuner Unit No. 610, and a Two-Stage Amplifier Unit, No. 615. The Detector Unit consists of a vario-coupler, variable condenser, detector tube, rheostat, grid condenser and leak.

Explains Proper Hook Up for Loop Aerial

Expert Gives Sound Advice to Dealers and Jobbers in Connection with Loop Aerial Sales

By THOMAS S. LOESER

Radio Research Department, Eagle Radio Company

It has been continually said of loop aerials that they were not quite as efficient as outdoor aerials under conditions permitting the use of both kinds. The loop aerial has ever been considered in disfavor by the radio public because those whose duty it was to inform them accurately have themselves been misinformed. There is no good and sufficient reason why loop aerials should not come into their own with a little educational propaganda spread by the dealers and jobbers who handle this product.

A loop aerial accomplishes the same effect as a suspended aerial but they should not be connected in the same manner, when used with the ordinary type of receiver and audio frequency amplifier now on the market, except in a few cases. It is because of this difference that there are continual complaints that loop aerials are not what is claimed for them. In many cases the interested party cannot erect an outdoor aerial, with the result that they suspend their efforts to operate a set until such time as they can erect an outdoor aerial or until they obtain a set that can be operated on a loop. The result is that there are many purchasers of radio sets lost to the market because of the lack of knowledge of proper connection for the loop aerials.

The following suggestions are given to dealers and jobbers that they may in turn pass them on to the public and thereby make a greater market for their products among those who are in such a position that does not permit their erecting an outdoor aerial.

In so far as the connection of a loop aerial to a radio frequency set is concerned there is little need for explanation, so that no consideration need be given it here. With those sets using merely an audio frequency amplifier, detector and any type of tuner, regenerative or not, loop aerials should always be connected in the secondary circuit of the tuner; not to the "aerial" and "ground" posts, or in the primary circuit as so many people believe. Once the aerial is so placed, about ninety-five per cent. of loop aerial "trouble" will be eliminated, the other five per cent. will disappear when the aerial is connected efficiently and the operator has learned

the proper method of tuning. The only occasion when the loop aerial may be connected to the aerial and ground posts is when the set in use is near the transmitting station and even then some trouble will be experienced. Even many of those who have been in the radio field for several years and who have a fair knowledge of radio technique commit this error, and when the set refuses to receive broadcasted news or music they decide that the use of a radio frequency amplifier is necessary to permit reception with a loop aerial. Tell them that they are wrong and you are labelled as a novice or just crazy, haven't they tried it? The story changes when they are shown how easy it is done; then they recall that they had seen it explained some-time ago in a back issue of some radio magazine.

One more point to remember in connection with the proper installation of a loop aerial is that if it should be necessary to place it in series with the secondary of the variocoupler fewer turns of wire should be used

than if the variocoupler secondary were removed and the aerial put in its place. The reason for this is that the variocoupler secondary, if placed in series with the loop will raise the wave length of the circuit to such an extent that it will be practically impossible to tune in a low wave length station efficiently, if at all. The lowest wave length of the loop together with its leads, tuning condenser or variometer and the wire used in connecting it to the detector tube should be approximately one-half to one-third the wave length to which the set is to be operated. If this conditions does not exist the set will work, but not with a satisfactory degree of efficiency.

In some cases it will be found advantageous to connect a wire from the negative terminal to the "A" battery to a good ground.

Let the public be informed of these facts and a noticeable increase in the sale of loop aerials and receiving sets will result. Let the cry against loop aerials be stilled.

Some Radio Securities that Are of Value

By FRANK T. STANTON

During the past few weeks, the radio industry has passed a crisis. Many concerns which were brought out on the crest of the broadcasting wave, some with inferior equipment and others with the sole purpose of selling stock, are being relegated to the scrap heap. The sound organizations were never in a better position, both from a property and stock market standpoint.

During the summer months, co-ordinated efforts on the part of the manufacturers, developed radio from a craze to an enthusiastic industry. They improved designs, wisely planned constructive advertising campaigns, in short laid a sound foundation for the coming radio boom, which seems so clearly defined. The stock market, functioning as a barometer, is beginning to discount by advancing

quotations, the indicated boom, which in my judgment should materialize this winter. In substantiation of this possibility I might mention that extensive radio expositions are planned this fall, in all important cities of the country, varied broadcasting programs arranged, etc., further assuring the utility and popularity of radio and creating an enormous demand for representative equipment. Securities of reliable companies should be purchased now in order to benefit by the large earnings which will be reported early in 1923.

For the information and guidance of prospective investors in radio securities, I am outlining below interesting data on several leading concerns.

RADIO CORPORATION: Under an agreement announced recently, all the land lines and several thousand

(Continued on page 119)

Merchandising in the Radio Business

The Successful Jobber and Retailer Will Study His Turnover and Watch His Step

By JOHN L. SIMMONS

Any commercial activity which has distribution for its principal object, has as its fundamental factor the matter of merchandising. While merchandising may not be the most important phase in commerce, it is a very necessary and vital business link and upon its understanding and proper conception the individual in the jobbing and retail trade must rise or fall. It is a subject often too little thought of and the sooner the radio trade pays it the attention it deserves, the better for that trade.

Merchandising, briefly stated, is the providing of merchandise or "goods" in certain quantities, qualities and assortments as to supply the tastes, desires and wants of the consuming or buying public. Thus, the function of merchandising includes the many varied operations of business which results in the journey of the goods from the manufacturer to the consumer. We are concerned primarily with an inner trip of this journey and we shall try to consider those general factors most useful from the standpoint of the jobber or wholesale distributor. And we shall confine ourselves mainly to one important part of merchandising—the turnover of stock.

Of course, the beginning of a jobbing business is the purchase of stock at the lowest price consistent with good judgment. Once the initial stock is in, there comes merchandising's most vital and fundamental factor, the "turnover." Turnover, of course, has financial profit for its direct object, so its importance may be easily realized. Its purpose is the use of the least possible amount of business capital as investment in stocks on hand, consistent with always having enough to fill orders promptly. Its value is best judged if we take the element of speculation out of consideration and assume that goods are plentiful and may be readily obtained.

In the radio business at the present time we find most severe competition and an almost total absence of the speculative element. Due to this keen competition, the margin of gross profit is not large and therefore dealers and jobbers must find their salvation in solving the prob-

lem of how to obtain sufficient net returns on their volume of business—or, in other words, on their stock turnover.

Let us judge this importance of turnover from a typical case. Mr. "A." buys radio equipment valued at \$10,000 and does a business of \$30,000 annually at cost figures. He therefore turns over his stock three times. Meantime, Jobber "B.," handling a similar line of radio goods, has on hand a stock valued at only \$7,500, but does the same volume of business as Mr. "A.," namely, \$30,000 a year. His turnover is therefore four times a year, and thus, other things being equal, Jobber "B." saves a carrying charge on \$2,500 a year (the difference in the stocks on hand), or about \$300 a year because of a greater turnover. There is also another factor of importance, namely, that the \$2,500 saved because of more rapid turnover, may be invested, if desired, in stock on hand to increase the stock

to that extent and thus earn an average rate of profit. The more rapid the turnover the greater the profits and the less the losses on investments.

Some jobbers, figuring that prices are low, stock up for a long period on what they term a "rising" market, believing that they are doing a smart piece of work. They put all their capital out and get goods in return, without figuring turnover, carrying charges and the loss of interest on their money. Other jobbers, paying no heed to the probabilities of a "rising" market, buy sufficient goods for immediate needs, sell these promptly, turn over the money for new stock and so keep an original small investment constantly working and turning over. It is this class of jobbers who in the end will be successful, for they know the value of the rapid turnover.

The radio trade, being in its in-

(Continued on Page 122)

Newark Radio Show to Have Dealers' Night, Oct. 6

Newark's second radio show is to be held at the Robert Treat Hotel, October 4 to 7, inclusive, and it is predicted that this exhibition will show some startling displays.

Each booth will be decorated in gold and blue, so as to be strictly in the color scheme and in keeping with the magnificence of the ballroom. The Japanese and Chippendale rooms, adjoining the main ballroom, will be devoted entirely to the demonstration of loud-speaking apparatus, where their qualities can be gone over by the prospective dealer without interference from the activities in the main ballroom. Loud speakers will not be allowed to operate in the main exhibition room.

The McCarter Gallery will be devoted exclusively to the exhibition of the sets submitted by amateurs for the amateur prize-winning contest. Young and old radio fans have been signing up rapidly for the exhibition of their sets. From

all indications this will be a great feature of the show. All types of sets have already been qualified to enter the contests, from the simple "oatmeal box tuner" to the "Armstrong Super-Regenerative Set." The usual prizes in the form of loving cups will be awarded to the winners.

The judges for the amateur radio contest are: H. T. Hunt of the Dreyfuss-Sales Corporation; Bernays Johnson, Westinghouse Lamp Company; H. Thompson, De Forest Radio Telephone and Telegraph Company; E. M. James of the De Forest Radio Telephone and Telegraph Company, M. B. Sleeper of the Sleeper Radio Corporation, Robert Hand of the "Star-Eagle" and Albert E. Sonn of the "Newark Sunday Call."

A dealers' night has been set aside for Friday, October 6, at which time all of the dealers of Newark and vicinity, will come to-

(Continued on page 60)

Public Demands Guaranteed Products

Production of Inferior Products Has Brought About a Demand For Approved Apparatus

By W. S. LEMMON
Radio Engineer, Malone-Lemmon Laboratories

The manufacture of radio apparatus in the days preceding the craze brought about by general broadcasting of news and music was synonymous with good engineering practice. The sudden boom in the sale of radio parts and sets brought about a change that wrought considerable harm to the industry; a harm that lost many customers to the trade; a harm that will be paid for in the many dollars of advertising necessary to regain the goodwill of these same customers. What was this change that proved so harmful to the industry? It was not the summer slump, that is already overloaded with blame for many things, nor was it the migration of the public to the country and seashore; the fault lay with the industry itself. The cause can be laid directly to those manufacturers who produced equipment that was not of a standard that good design would approve. Anything that would sell to a public that was greedy for anything that sold under the name "radio" was shoved on the market. Once again the gullible public was imposed upon, and now the same public demands restitution in cold cash. Restitution has already started. Many concerns that were doing a thriving business last spring have already been forced out of business. Much money has already been spent for propaganda to regain the favor of valued customers.

Finally, the public is going to take no more chances with "radio" and the immediate future will doubtless find our "dear" public asking for guarantees, certificates of merit and many other requisites that would not have been necessary had the manufacturers started out on the right foot. Nor were manufacturers the only ones guilty of this grave offense to economy and good business. Let us consider the case of jobbers and dealers.

Jobbers and dealers in a measure were not entirely responsible for their part in this offense. A plea for leniency could well be entered in their case. Some, however, urged many manufacturers into the radio field; manufacturers of responsibility in their own fields but who knew little or



WALTER S. LEMMON, E.E.

Began experimenting with Radio in 1908.

Became a member of the Radio Club of America in 1909 and the Institute of Radio Engineers in 1913. Engaged in shipboard Radio work during 1914 and 1915. Graduated from Columbia University as Electrical Engineer in 1917 and was awarded Trowbridge Research Fellowship in the same year. Left Columbia to join the Naval Reserve and was commissioned Lieutenant. Placed in charge of Radio and Signal Instruction at Pelham Bay Naval Station. Later placed in charge of administration and development of Radio Telephones at the Navy Bureau of Engineering. Organized long range radio telephone tests aboard the U.S.S. "George Washington" during Presidential trips. Resigned from Navy Department in 1919 to join the Sales Engineering Staff of the S K F Industries, Inc., New York. Appointed Division Sales Manager in 1920 and resigned in the Spring of this year to return to Radio and assist in the organization of the Malone-Lemmon Laboratories.

nothing of radio and therefore took the dealer's or jobber's word for the design and use of material of the parts manufactured. Dealers and jobbers found much dead stock on their shelves upon the advent of the summer season and many started to unload on the public at reduced prices; they, too, will pay for that, and in fact already are paying for it.

To sum up, the radio industry is accused of having tricked the public, and the public has pronounced sentence in the form of certain require-

ments. These requirements are several, the more important being a guarantee of some sort, a certificate of merit from some recognized source or convincing proof that the manufacturer has made every effort possible to design and produce an efficient article.

Realizing that a number of manufacturers have entered the radio field and wish to remain in it and live up to requirements testing laboratories are becoming more and more important. They are functioning to assist the manufacturer of radio apparatus.

These organizations, thoroughly capable of designing, testing and merchandising radio apparatus, can greatly aid the manufacturer and the dealer. Through laboratory co-operation manufacturers can be assured of development in their plans of apparatus of the highest quality workmanship and electrical efficiency. The trade more and more demands tested apparatus and soon the user will look for the official stamp of approval before buying.

CHARGING "B" BATTERIES

The Mueller Electric Company of Cleveland has placed on the market a rectifier for use in charging "B" storage batteries. It requires from 15 to 20 hours to charge the battery and the set needs little attention during the charging period. The Mueller Rectifier Set is intended primarily for use with a source of 100 volts to 115 volts alternating current such as is quite generally afforded by the lamp socket in the home. It may, however, be used for charging from direct current. The set consists of the necessary lamp cord, an attachment plug, two clips, a wooden mounting block, a lamp socket, a charge of borax, an aluminum and a lead rod and wooden supporting cleat for the two rods. It is necessary for the user to furnish a common drinking glass and an incandescent lamp.

The lamp, the rectifier and the battery to be charged are connected in a simple electrical series circuit across a 110 volt a. c. line.

THE-ONLY-KNOB-AND-DIAL-WITHOUT-A-SET-SCREW

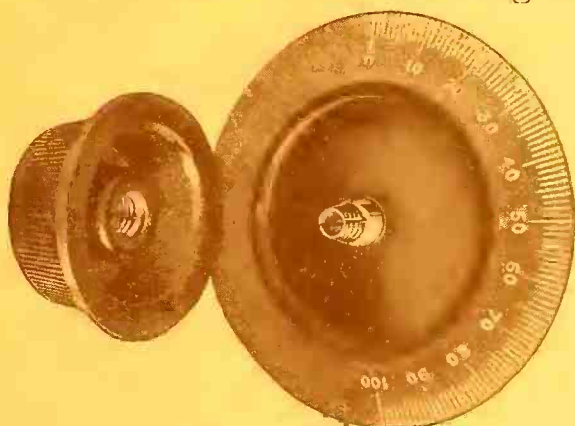

Patented June 20, 1922

The unsightly and troublesome SET-SCREW is at last eliminated. No more loosening of dials, splitting the head of the set-screw, or stripping of threads, perhaps ruining the dials.

To mount the TAIT KNOB AND DIAL simply hold the dial with one hand and screw on the knob with the other; a few seconds does it. No tools are necessary; when fastened it is self centering and self aligning. Numerals at correct angle for the best visibility.

This beautifully patterned KNOB AND DIAL is made of the best grade of BAKELITE.

MANUFACTURERS—It will greatly beautify your receiving sets, also reduce your labor costs in assembly.

JOBBERs—This product is merchandized to the trade strictly through you. It sells on sight and is revolutionary in its field.

Dealers—write us and we will notify you of nearest jobber

List Price
4 in.—\$1.50
3 in.—\$1.00

TAIT-KNOB-AND-DIAL-CO., Inc.

MANUFACTURERS

11 EAST 42nd STREET

NEW YORK

NOW READY!

ACE WIRELESS BATTERIES



No. 115

They sell on prestige.
They mean more profit.
They are bigger sellers now!

THE CARBON PRODUCTS CO.
LANCASTER, OHIO

The greatest sales stimulator for wireless business. Not only sells more ACE Wireless Batteries but sells your other radio supplies as well.

THE ACE RADIO BOOK

Get Your Supply — Costs you nothing

ACE RADIO BOOK	ACE RADIO BOOK
A BOOK ON RADIO RECEIVING	ONE FREE TO EACH CUSTOMER

Give One Away With Every ACE Wireless Battery

Have YOU

Done this Yet

?

READ

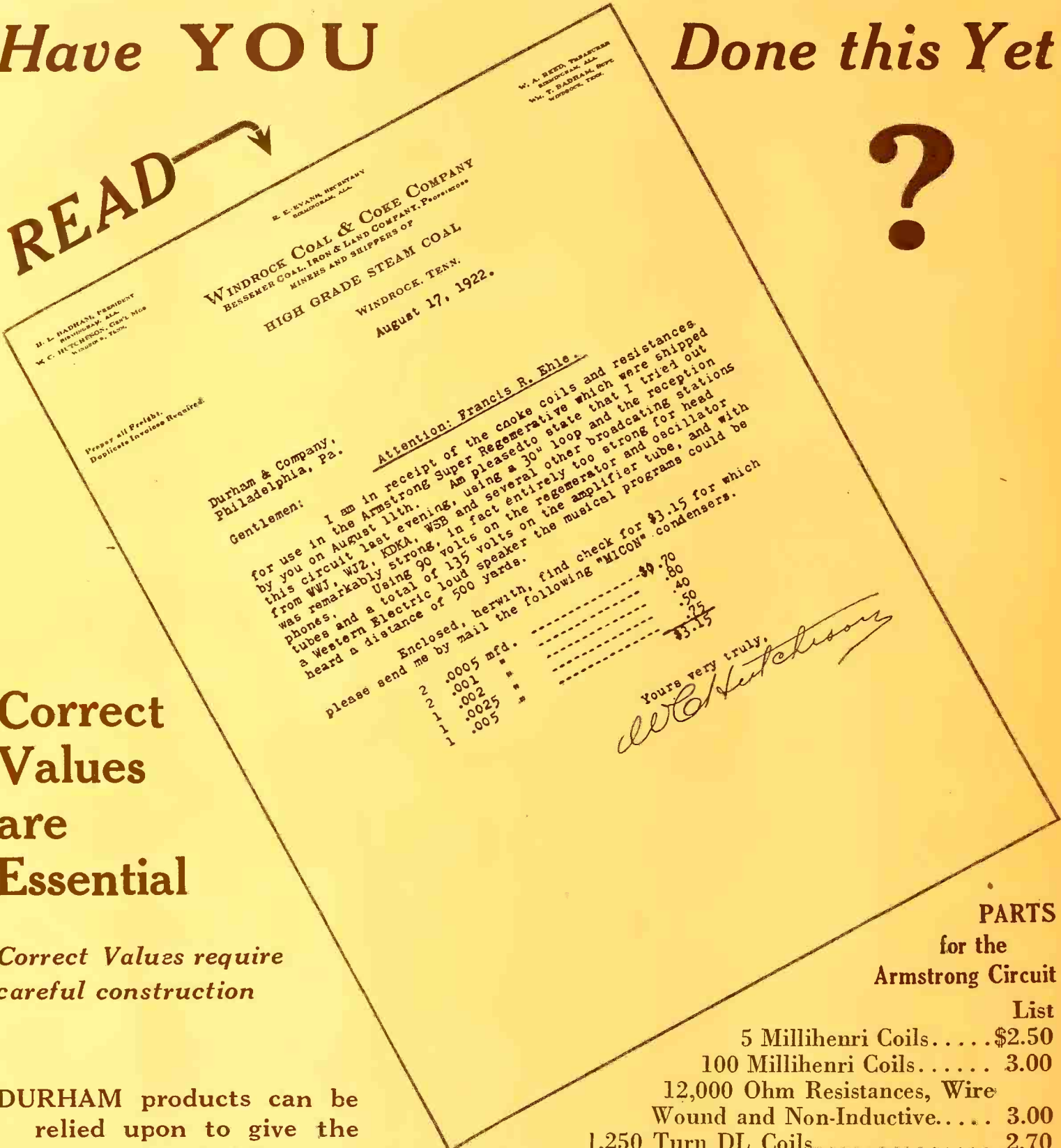

Correct Values are Essential

Correct Values require careful construction

DURHAM products can be relied upon to give the utmost in service in all respects.

PARTS

for the Armstrong Circuit

	List
5 Millihenri Coils.....	\$2.50
100 Millihenri Coils.....	3.00
12,000 Ohm Resistances, Wire Wound and Non-Inductive.....	3.00
1,250 Turn DL Coils.....	2.70
1,500 Turn DL Coils.....	3.30
.0025 Micon Condensers.....	.50
.005 Micon Condensers.....	.75
Variocouplers—Especially Wound.....	7.00

Diagram of Our Own Demonstrating Set Furnished WITH ALL ORDERS

DURHAM & COMPANY

Radio Engineers

1936 Market Street

Philadelphia, Pa.

Moffat Radio Lock Protects Receiving Sets

Owner of Valuable Receiving Set Now Enjoys Practical Insurance Against Damage to His Set

By W. L. MOFFAT, Jr.
Vice-President, Joseph Ross & Co.

Radio has opened an entirely new field of work for persons of an inventive mind.

It is as true in radio as in all other sciences that a very large number of articles which have and will be offered to radio users will be found to be of no practical value.

Protection of the valuable instruments composing a radio set has long been desired, but other than placing them in a locked wooden cabinet, no method had been devised.

The Moffat Radio Lock completely solves this important problem and has at once become a necessity for the radio user. It is being manufactured by Joseph Ross & Co., of Irvington, N. J.

The owner of a radio set, having invested in costly and delicate instruments, has never had insurance against the use of his property by curious or meddling people who, without knowledge of radio, nevertheless will attempt to adjust the set so they may listen in, if the opportunity offers. The result of this ignorant use is always injurious and often very costly.

It was to give the owner absolute protection against the unauthorized use of his instruments that the Moffat Radio Lock was produced after many months of experimental work. The lock is positive in its action, of simple design and strongly constructed. It is adapted for use in all radio parts operated by a shaft. It is made as a lock only; as a complete lock and rheostat and as a lock circuit switch. The lock rheostat and circuit switch are complete in themselves and ready to install on a set.

To attach the lock only, to a rheostat already mounted, is but a few moments' work, the knob and shaft of the original rheostat being removed, and the knob and shaft containing the Moffat Radio Lock inserted in its place.

To operate, the key is inserted and the knob turned until the key engages. The position of the pointer on the panel will then correspond to the position of the contact blade on the rheostat or circuit switch. When



W. L. MOFFAT, JR.

the designer of the Moffat Radio Lock, served as 1st Lieutenant in the Signal Corps and later was transferred to the General Staff as Captain. At present he is working on an automatic wire winding machine which, when perfected, will be suitable for winding transformers.

the key is withdrawn, the contact blade remains in its final adjustment. The knob will now rotate on the shaft without turning it.

Just imagine the safety this provides for the tubes, the most expensive and easily damaged part of a set! An owner may now turn off his set in one of two ways and be certain no one will use it. Either all the rheostats are turned off and the keys withdrawn, or the adjustments are locked by withdrawing the keys and the whole circuit locked off by means of the circuit switch. By this latter method, when the circuit switch is again turned on, the rheostats are properly adjusted for the stations broadcasting when the set was turned off.

Here are only three of the savings that the Moffat Radio Lock accom-

plishes: First, it protects the tubes from damage by being operated by meddling or unskilled persons; second, it saves time in readjusting the tuning of a set, and third, it saves the A Battery from being run down because someone has forgotten to turn the rheostat completely off.

All of these are real savings besides the added security afforded.

The Moffat Radio Lock will also be added to dials for vario-couplers, variometers, variable condensers. This means that the set may be tuned in all its parts, and that no part of set can be disturbed. All that is necessary to obtain instant response to broadcasting is to unlock the circuit switch. This method permits of a set being tuned and left for any length of time although ready on the instant to give service. The owner simply unlocks the switch, adjusts the head set or the loud speaker and the set is in action.

How many owners have put on their head set wishing to hear the baseball scores or the closing prices of stocks, only to find that the set was out of adjustment and by the time they had tuned it, the news they desired to obtain had been finished by the broadcasting station? Information which might mean a large financial gain or loss had escaped him through someone having used his set and left it out of adjustment. The Moffat Radio Lock insures against any such occurrence and against many others of similar nature.

Besides appealing to the average radio novice, this lock is certain to be most popular with the amateur of twelve to fifteen years of age. We all know that he will go to any extreme to make certain that no one will use anything of which he is particularly fond during his absence, and now he can go away and know that none of his brothers, sisters or friends will be able to operate his set. The older person may also go to business and know that his set is secure. The radio dealer may have his sets for demonstrating purposes on the counter, and be sure that the adjustments he has made will not be changed, or the set damaged.

Mortimer J. Salzman Urges Association

Head of Wholesale Radio Equipment Company Dines Radio Business Men and Starts Jersey Dealers' Association

Radio dealers all over the land recognize that one of the crying needs of the century's newest mercantile industry is proper organization among the tradesmen in the radio field.

There isn't a man more sold on this proposition than is Mortimer J. Salzman, head of the Wholesale Radio Equipment Company of Newark, N. J.

To prove it—to promote his keen appreciation for an organization of the tradesmen in and about New Jersey's biggest city, Mr. Salzman asked some of his business friends to meet him, at a dinner at Achtelstetters Restaurant, one night last week, and it was decided to meet again next week to properly organize the New Jersey Radio Dealers' Association.

"The foundation for a real organization of radio tradesmen has been laid," said Mr. Salzman after the meeting, "and we do expect to accomplish the difficult proposition of acquiring the membership of every bona fide radio wholesaler in our state."

Speaking to a representative of the RADIO DEALER, Mr. Salzman said:

"Every business man in the radio industry in New Jersey is invited to tender his application for membership.

"Just what the association will do or can do is not the point—now. The main thing is to organize for the betterment of the trade.

"An association of business men can surely be of service.

"An association of this character can establish standards for the manufacturer and for themselves.

"The legitimate manufacturer can save himself a lot of money if the selling trade is a recognized factor—for if it's that they will know what they ought to sell. They will not care to sell inferior wares, not if they're properly organized.

"Referring to regulation, of course an association of business men in our industry, will supervise shows, co-operate with amateur bodies in movements for the betterment of the science of radio.

"An association of our kind, properly working, will have a laboratory affiliation. This technical service should prove of good to everyone—except the fakers, who must be put out of the radio industry.

"An association of the best radio people will co-operate to acquire and maintain proper publicity.

"An association of this sort will help us in neutralizing the present

trouble-making tendencies of patent holders and patent infringers. We dealers are the innocent victims of patent litigants.

"Naturally, an association of business men cannot benefit itself or its membership without doing something real for each member and it hardly is necessary to point out that this proposed body of New Jersey's foremost radio wholesalers will benefit each member."

"But," added Mr. Salzman, "that does not mean that this association of ours is to serve only its members—for if we cannot benefit the entire industry our object for organization is not achieved."

Any business in which an exchange of ideas and co-operation in meeting merchandising problems, is better for such mutual action.

An association is the one logical means for developing such a condition.

There's a lot of meat in the statement above printed. And Mr. Salzman and some of his business friends have an all-abiding belief in the statement.

At the dinner meeting Mr. Salzman spoke upon the present conditions in the radio industry, showing that the activities, at this time, can properly remain in the hands of *the business men* in the radio industry.

Mr. Salzman pointed to the fact that some retailers and jobbers, in and about Newark and New York City, as well, were running sales, but losing money; that these same dealers were losers in business in the end because they could not afford to give real service.

"And no business," says Mortimer J. Salzman, "which does not give real service can get far ahead."

When the Jersey trade body is properly organized it will probably meet at least once each week, around a meal—a good idea—to talk over trade matters in an informal way.

Mr. Salzman's ideas about an effective organization for the radio industry are ideal and worthy of every radio man's attention. He says that he'd enjoy explaining the idea to each and every radio business man in New Jersey.

BAYLEY CONDENSER

The salient feature of the Bayley Condenser, manufactured by the Bayley Condenser Co., of Brooklyn N. Y., a die-cast product, is the permanent spacing of the plates. Movable plates are cast solid on a centre spindle, and stationary plates are cast as in one piece on three upright supports. The spacing, due to its rigidity, is very close, which, it is claimed, allows sharp tuning.

Radio Regulations Based on Rules of Fire Underwriters

Newark, N. J., has issued specifications for radio receiving, as follows:

ANTENNA.—No antenna shall be erected over or under any wire of more than 600 volts, or fastened to any pole supporting light or power wires. If erected over an electric light or power wire of 600 volts or less the separation distance between the antenna and the wires shall exceed the distance spanned by the antenna.

If erected under an electric light or power wire of 600 volts or less the separation distance shall exceed the distance between the supports of the electric light or power wire.

All splices and joints should be soldered. All wires used to support the antenna should be galvanized or of copper to prevent rusting.

LEAD IN WIRES.—Lead in wires shall be not less than No. 14 B & S gauge copper or No. 17 B & S gauge copper clad steel.

The distance between electric light or power wires and the lead in wire on the building shall be not less than four inches and the lead in wire shall have enough supports spaced close enough to prevent the lead in wire from coming in contact with the electric light or power wire.

A porcelain, fiber or composition tube shall be provided for the lead in wire where it enters the building.

No special distance is required for spacing the lead in wire from the building. It should, however, be

(Continued on page 98)

PANDORA CRYSTAL SET

The Brooklyn Metal Stamping Company of Brooklyn, N. Y., have placed on the market a novel, compact and readily portable crystal set called the Pandora. The set as shown by the accompanying photograph is enclosed in a metal case on which are placed aerial, ground and



phone connections. The operation of a single dial is the only effort necessary to tune in the nearby broadcasting station once the crystal has been adjusted. The set covers a wave length of from 300 to 600 meters which are brought in by merely turning the knob. The set has brought in broadcasted music at a distance of 25 miles from the transmitting station. The company claims that the set has been well received by the trade.

C. & W. RECEIVER TYPE 14

The Pioneer Radio Corporation of New York City are distributors for the Cutting and Washington receiving-set Type 14 and special indoor coil aerial. Though designed primarily for persons who, because of restrictions or location cannot use a conventional outdoor aerial, this receiving system possesses certain advantages which appeal even to those who may not be so restricted.

Easy to install and readily portable; a large reduction in "static" annoyance.

The company claims that with the larger of the two coils supplied, the receiving range is comparable to that of a conventional regenerative detector and two step amplifier connected to an outdoor aerial, coupled with which is an elegance of control, quietness and lack of interference which to those unaccustomed to coil aerial reception is truly desirable.

This apparatus is the result of much experimentation and research and marks a distinct advance in the design of super-sensitive receiving apparatus for popular use. The addition of a loud speaker completes the equipment.

How Science has bridged with wireless the miles between city and country

THOUSANDS of families have only "gone in for wireless" after hearing demonstrations of Magnavox Radio—the *Reproducer Supreme*. Magnavox Radio offers the dealer an ample profit margin and a quality product essential to complete radio supply service. In perfection of mechanism, quality of manufacture and satisfaction in actual service, Magnavox Radio has absolutely no competition.

Write for prices and information regarding Magnavox advertising and sales helps.

THE MAGNAVOX COMPANY
 Home Office and Factory: Oakland, California
 New York Office: 370 Seventh Avenue

MAGNAVOX
Radio
The Reproducer Supreme

R-3 Magnavox Radio with 14-inch horn (here illustrated), is ideal for use in homes, offices, etc.
 R-2 Magnavox Radio with 18-inch horn for those who wish the utmost in amplifying power; for large audiences, dance halls, etc.
 Model "C" Magnavox Power Amplifier insures getting the largest possible power input for your Magnavox Radio.

What the Manufacturers Are Doing

New Vernier Potentiometer Made By Mid-West Firm

VERNIER POTENTIOMETER

The vernier potentiometer, recently placed on the market by the Central Radio Laboratories of Milwaukee, represents a new development in the radio field and is meeting the demand of those who have been looking for



Potentiometer Made by Central Radio Laboratory

a very fine control for vacuum tubes used for experimental work and for sets on which extreme sensitiveness is desired according to its makers.

The resistor consists of a machine winding, the turns of which are anchored firmly on a substantial insulated core. This wound core is retained in a groove between insulating discs. The use of enameled wire makes short-circuiting of the ad-

jacent turns impossible. This design insures smooth, noiseless action and a uniform change of circuit resistance.

The vernier wire for the fine adjustment is six inches long and is carried



View of Vernier Potentiometer

on the outer edge of a separate disc on which two contact shoes, which ride on the main winding, are mounted. This vernier wire shunts those turns of the main potentiometer winding which lie between the two contact shoes and thus provided for very accurate adjustment of the potential.

A small thermoplex knob, located in front of the main knob, operates the vernier shoe. The relative sizes and shapes of the two operating knobs are such that they are easily manipulated.

A potentiometer of the plain type, manufactured by the same company, is of the same general design and construction as the vernier potentiometer already described, minus the vernier attachment. Both potentiometers have an advertised resistance of 250 ohms.

PACENT DETECTOR STAND

The Pacent Electric Company, of New York City, have recently placed on the market a new detector stand known as the Pacent Universal Detec-



tor Stand. The construction insures against dust and rust. The top and base are moulded and a substantial glass covering protects the crystal. The binding posts and all metal parts are machined. The accompanying photograph attests to the fine appearance of this product.

LOUD-SPEAKER SETS FLUSH ON PANEL

Double Radio Co., 57 Dey street, New York City, are manufacturing a compact Amplifying set. It is made in two types, one with a loud-speaker which sets flush on the panel.

DAVISTONE DISTRIBUTER

Henry Paulson & Company of Chicago are distributing the Davistone loud-speaker that attracted considerable attention at the recent National Radio Show in Chicago.

COMBINATION VARIO-COUPLER

The New York Coil Company of New York City in their recent circular claims that they have the only variocoupler on the market that allows panel mounting or table connection, which eliminates one of the most difficult and tedious operations in building a set, namely, taking off of taps and mounting switches and switch buttons. The instrument consists of a high-grade insulating tube $4\frac{1}{8}$ inches in diameter and $3\frac{1}{3}$ inch rotor. Seven single turn taps are brought out on one side and seven taps on opposite side, each tap containing seven turns. Two switch levers make contact with these taps. By an ingenious arrangement the simple loosening of a setscrew allows the shaft of each switch to be pulled out bodily without disturbing the switch lever.

A template accompanies each instrument to enable the constructor to get the correct position of the three holes through the panel—one for rotating secondary and one hole for each of the switch shafts.

It is therefore necessary in panel mounting to drill but three holes through the panel—eliminating all soldering, all laying out of switch buttons and drilling for same.

This instrument has a particular appeal to those who desire to try out various circuits before their set is built in cabinet form, as when coupler



is purchased, same may be used instantly by simply making connections to two binding posts provided.

The variocoupler is mounted on $\frac{1}{2}$ inch hard wood black finished base. Switch buttons are mounted on strong insulating material. Handsome knobs are equipped with nicked pointers included. The workmanship and finish is extra fine.

Freshman Products

Antenella Plug and Micon Condensers

Antenella manufactured by Charles Freshman Company, Inc., of 290 Hudson Street, New York, N. Y., is a high grade product designed for attachment to the ordinary light socket. The strength of signals received through this device is as great as with an ordinary outside antenna, according to the manufacturers.

Antenella is licensed under the Jones patents applied for. The con-



densers used are of the proper capacity to replace the ordinary antenna and the timing elements of an ordinary receiver give all adjustments necessary.

The condensers are constructed of ruby India mica, incased in the seamless brass tubing licensed under the Micon patents applied for of Charles E. Vawter of the Thompson Levering Co., Philadelphia. The design of the condensers insures constant capacity and practically no noises at all. No current is consumed as a result of the attachment to the lighting wires and the results obtained justify the statements that not only are the antenellas very convenient, but due



to extreme selectivity of wave lengths, static is almost entirely eliminated.

Reports from Seattle, Washington, made public by the manufacturers recently, state that Antenella successfully received signals from Catalina Island fifteen hundred miles distant.

The plug is very pleasing in appearance and careful workmanship is displayed. The interior is exceptionally neat and it is altogether a high grade article.

The officers of the Freshman corporation are Charles Freshman, president; Myron Goldsoll, vice-president and sales manager; Ernest Walker Sawyer, secretary and chief engineer.



New ABC Tuner No. 5750—a dependable apparatus that meets the big demand for a quality tuner at a very low price.

The Ideal Tuner for Popular Broadcast Reception

AFTER intensive study of the needs of radio users Professor Morecroft of Columbia University has designed the ABC Radio Tuner No. 5750 to fit into the ABC Standardized Radio Units System.

The tuning in is done by means of two 2I-plate ABC variable condensers and a vario-coupler of compact and radically new design.

This vario-coupler has a lower distributed capacity, by actual test, than any other on the market. ABC Tuner No. 5750 is ideal for receiving the programs sent out by the broadcasting stations. It is made for the quick, profitable market.

The perfect hookup of ABC Units is illustrated below. Send today for full information about ABC Units and Parts, and how we help you sell them.

Jewett Manufacturing Corp.

342 Madison Ave., (Dept. F. 10) New York City

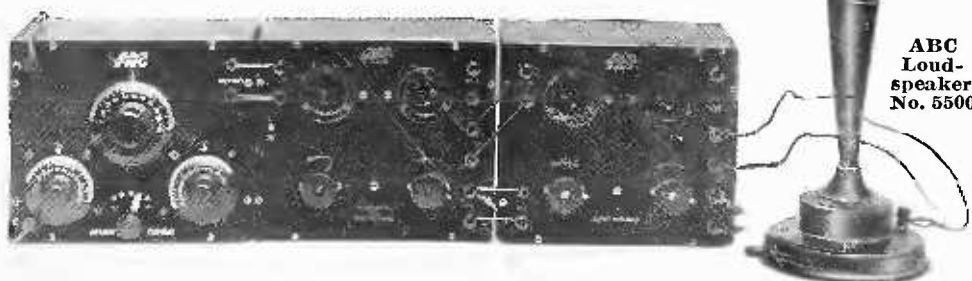

ABC Radio Tuner No. 5750

ABC Detector and One Step Amplifier No. 5013

ABC Two Step Amplifier No. 5014

ABC Loud-speaker No. 5500

\$4.75 CONDENSERS \$1.25

Finest 43 Plate. .001 M. F. Perfect insulation. Amply separated and accurately spaced hard aluminum plates.

\$4.00	23 plate same as above	\$1.10
5.00	Variometers, A-1 sellers	1.75
1.00	Phone cords, double	.35
7.00	Switch points, N. P. with nuts, thousand	4.00
.75	Finest million point mounted crystals	.10
.10	Square tinned copper bus wire, foot	.02
1.00	Double covered head bands	.35
.75	Crystal detectors	.20
2.50	Lightning arresters	1.00
1.25	Phone slugs, good seller	.45
.15	Copper ground clamps, complete	.05
.15	Special antenna insulators	.06

All strictly fresh "B" batteries, discount, 50%

\$6.50 TURNEY PHONES \$3.25

Highly sensitive. Matched tone receivers. Awarded N. Y. Mail Certificate of Merit.

\$0.35	Condensers, asstd. capacities, all types	\$0.06
.25	Crystal cups with set screw	.08
1.00	Asstd. screws, washers and nuts, hundred	.50
5.00	Transformers, radio frequency	2.00
5.00	Transformers, audio frequency	2.75
18.50	"Homechargers" for "A" or "B" batteries	12.50
.25	Spaghetti, extra tough, foot	.03
.50	Sockets for base or panel mounting	.20
3.00	Phonograph attachments	1.50
.75	Honeycomb coil mountings	.30
10.00	Loud speaker horns, very good	4.00
	Binding posts, N. P., complete, hundred	2.00
10.00	Name plates, asstd., very neat, hundred	3.00

\$4.50 VARIO COUPLERS \$1.25

Baldwin Type. 14 Taps. Green wire.

\$1.75	Potenteometers, bakelite	\$0.75
4.00	8" Tuning coils, 2 slides	1.75
1.50	Unmounted tuning coils, 8"	.50
.40	Tubing, asstd. sizes, A-1	.12
10.00	Switch stops, with nut, thous.	5.00
	All Radio Corporation mdse. less	30%
.75	Dials, beautiful tapered knob	.15
.75	Switch levers, tapered knob, A-1	.17
1.25	Phone plugs, good quality	.45
1.00	Jacks, open 25c, closed 30c, double	.40
.30	Slider rods, 3/16x12, drilled	.07
.30	Sliders, brass and rubber, for above	.10
	Experimenter's Manual, very good	.10

IMMEDIATE DELIVERY

Good Honest Merchandise. Everything Guaranteed.

TERMS:

10% with order. Balance C. O. D.

RADIO ENGINEERING CO.

Fifth Ave. at 28th St.

New York City

Standardized Radio Supplies

New Tester Determines Characteristics of Tubes

By WILLIAM B. BROUGH
Consulting Radio Engineer, W-B-L Radio Co.

"Does this tube oscillate?" "Is it a good detector?" "What is the best plate voltage at which to operate it?" "Is it 'hard' or 'soft'?" "Does it amplify as it should?"—These and many other similar questions arise sooner or later in the mind of the jobber or dealer handling vacuum tubes; questions that are prompted often by the more or less frequent return of customers with tubes which they claim do not perform and upon which they demand replacement.

True, it is to be assumed that reputable makes of vacuum tubes are properly tested by their makers and are not allowed to leave the factories until it has been definitely determined that they conform with an established standard, but at their best vacuum tubes lack a uniformity in characteristics which gives rise at times to decided differences of opinion as to the true worth of some individual tube. I dare say there is hardly a dealer in existence who has not at some time or another had to handle a delicate situation arising from the complaint of some customer whose tube has failed to function properly. To replace the tube without question is costly to the dealer, yet with no definite means at his command to convince the customer that the fault lies, not with the tube in question but with some other factor, is not always an easy task for the dealer, and rather than embark on thin ice with the possibility of losing a valued customer, more than one dealer has chosen the easiest way out by giving the customer a new tube and pocketing the loss.

In the W-B-L Vacuum Tube Tester we believe that we have just the instrument needed. To all intents and purposes this instrument, which was developed by the writer and is now being manufactured by our company exclusively for the Mydar Radio Company, of 843 Broad Street, Newark, N. J., general distributors, may be described as a transmitter, detector and amplifier in one. By placing a tube in the standard socket and connecting it up with the necessary "A" and "B" batteries it is possible in less than two minutes time to determine in a non-disputable manner every essential and important characteristic the tube may



WILLIAM B. BROUGH
Consulting Engineer, W-B-L Radio Co.,
Newark, N. J.

possess: whether it detects and how well; the best operating filament current, a factor which varies with every tube; the best operating plate voltage, another variable factor of extreme importance, as a variation of as little as 5 volts in the plate current has been known to seriously affect the operation of a tube; whether or not the tube oscillates, a matter of increasing importance with the increased use of regenerative, super-regenerative and super-hetrodyne circuits, a tube which does not oscillate being of no value in these hook-ups.

In amplifying tubes the "amplifying constant" or what is known technically as the Mu of the tube is of interest and importance. The Mu is the ratio of the plate to grid voltage and is a factor which determines to some degree the amplifying qualities of the tube. The average tube now being sold for amateur use has an amplifying constant of between 6 and 7. A tube which falls short of this figure may be designated as a poor amplifier. Where the W-B-L tester is used this characteristic is determined by a direct dial reading and leaves nothing to the imagination.

RADIO FREQUENCY

(Continued from page 46)

sockets at the rear of the Amplifier. They are as readily removable as a V. T. Tube. As no R. F. amplifier is better than its transformer, great care should be exercised in the selection of this device. The Amrad R. F. amplifiers employ only radiformers and have been designed for use with U.V. 201 Radiotron amplifying tubes.

Both Amrad R. F. amplifiers are encased in polished solid mahogany cabinets and mounted on standard engraved formica panels 10"x5" in size. Two dial adjustments only are necessary. Complete operating instructions accompany each instrument.

Each Amrad R. F. amplifier is provided with an insulated switch for cutting out the radio frequency amplification, thus permitting use of the detector together with any audio frequency amplification with which the receiving set may be equipped.

Both radio frequency amplifiers are intended for use on non-regenerative receivers.

The Amrad 2-stage R. F. amplifier when added to a non-regenerative receiver, will give results considerably in excess of these obtainable by the use of regeneration.

Where several stages of radio frequency amplification are desired, the Radiformer in the first stage should differ from those in subsequent stages. At present there are two Radiformers available, No. 3057-1 and No. 3120. Both are intended for 360 meters reception, although amplification is obtained over a wavelength range from 300 to 600 meters. Peak intensity is secured at 360 meters, which is the broadcasting wave band.

In receiving 360 meter broadcasting, Radiformer No. 3057-1 is used in the first stage of amplification, and Radiformer No. 3120 in all subsequent stages. Other types will be available later for higher and lower wavelength bands.

Wiring diagrams and instructions are supplied with each Radiformer.

FILAMENT CONTROL

The Radiall Company of New York City recently issued a five-page folder that explains carefully and clearly the structure and action of the vacuum tube filament. This information should prove enlightening to any owner of a tube set. The folder deals with the advantages of the use of a filament control which heats the filament to its best working temperature at the moment the current is turned on, in much the same manner that the ordinary house electric lamp is operated.



Send For
The Bestone Radio Catalog

THE Bestone catalog illustrates and describes a complete line of the latest and most scientifically-designed radio apparatus, produced by a leading manufacturer.



BESTONE 3000 OHM HEAD SET
(Navy Type)

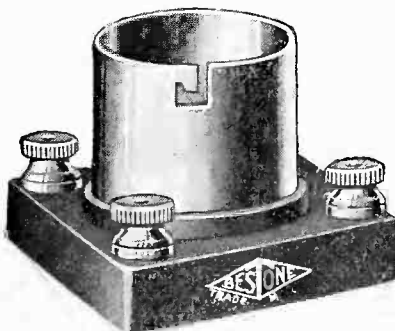

BESTONE V. T. SOCKET



BESTONE PHONE CONDENSER

We offer you an exceptionally high-grade Radio line at popular list prices, and a plan of sales co-operation that will mean attractive profits for you.

Write for Catalog "R"

HENRY HYMAN & CO., Inc.

Manufacturers

EXECUTIVE OFFICES
476 Broadway, New York

BRANCH OFFICE
212 W. Austin Ave., Chicago, Ill.

SHELTONE LOUD SPEAKER



Patent Applied For

Dealers, here is the profitable and quick selling Loud Speaker.

SHELTONE

Equipped with one
Baldwin Receiver

TYPE C

Most satisfactory of all Loud Speakers for home use
Low in price

The Sheltone is shaped like a shell. At its base is an open tone chamber over which any two standard receivers fit. This chamber carries the sound to the curved surface of the Sheltone, causing each note to marvelously swell in volume.

No tubing to rob the sound of its fullness; no horn, as on ordinary loud speakers, to destroy or distort the most delicate notes. Every sound is true, sweet, mellow and distinct to everyone in the room.

RETAIL PRICES

Sheltone, with Baldwin Receiver...\$12.50
Sheltone, without Receiver..... 5.00

Big Discounts Allowed.

Made of special light non-metallic sound-ing metal. Beautiful colors.

THE SHELTONE COMPANY
20 CLINTON ST., NEWARK, N. J.

SPECIALISTS ENTER RADIO FIELD WITH POLICY

The Connecticut Instrument Company of Stamford, Connecticut, have entered the radio field as specialists in acoustic development and manufacture. The first product the company is to place on the market is a head-set with a non-metallic diaphragm designed to produce correct reproduction of music and an adjustment claimed to insure the utmost in sensitivity.

The company is well known and long established. The personnel is as follows: R. E. Gillmor, president (formerly vice-president of the Sperry Gyroscope Co.); G. B. Crouse, chief engineer (formerly chief engineer of the Ford Instrument Co.); J. B. Allen, factory superintendent (formerly plant superintendent of the Sperry Co.); and G. M. Fischer, sales manager, who has had many years' experience in manufacturing, jobbing and retailing.

The policy of the company has been reported to be: (1) specialization in one thing at a time, with a view to qualitative rather than quantitative production results; (2) representation and distribution solely through exclusive jobbers for each territory; (3) liberal jobbers' discount with no variation for quantity.

AMES RADIO PRODUCTS

The Picard Radio Corporation of New York are exclusive national distributors of the Ames Radio Products manufactured by the Heinze Electric Company.

REGAL DISTRIBUTERS

The Radio and Mechanical Trading Company of New York City are distributors of the "Regal" products, manufactured by the American Specialty Company of Bridgeport, Con-

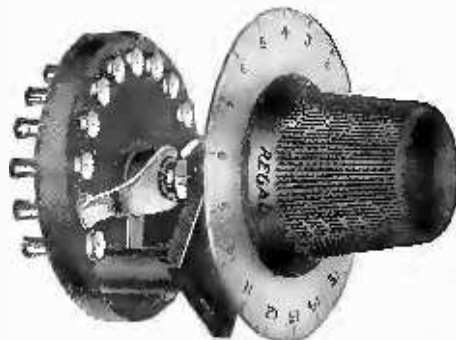

necticut. An idea of the high-class products sold under the name "Regal" may be had from the photograph shown herewith of the Regal Inductance Switch.

The features of the switch are that it has 15 points in one unit, only one hole is needed in the panel for mounting and its construction does away with all switch points.

ZELLAC

Economical Equipment Finishes

Zeller Lacquers constitute the most economical finishes on the market today for radio equipment of all kinds. They are easily applied either by dipping, brushing or spraying and completely dry in normal room temperatures within 15 minutes.

Zellac is made in all colors and can be applied to all materials. Beside the standard natural wood finishes, our Hard Rubber Black has become popular among manufacturers for finishing instrument bases as well as cabinets while our White is used exclusively by many organizations for the graduations on dials and knobs, as well as for panel work. Our bronzing solutions and enamels assist materially in reducing distortion and vibration in loud speakers. A thin coat of our material, which has a high dielectric strength, applied to coil windings, holds them permanently in place without causing the usual undesirable effects.

We welcome the opportunity to discuss finishing problems with radio equipment manufacturers. May we be of assistance to you? In any event, write today for a copy of our free booklet, "250 Lacquer Questions Answered," using your business stationery.

ZELLER LACQUER MFG. CO., Inc.

342 Madison Ave., New York

"IDEAL" SWITCH LEVERS

The Newark Radio Supply Company, Newark, N. J., is manufacturing very neat and attractive looking switch levers, known as the "Ideal" switch levers with the mirror-like knobs.

The knobs are made of genuine Thermoplax, a cold molded heat-resisting composition, strong and tough. They are hand-buffed and have a very high polish, that maintains its brilliancy no matter how much handling the knob gets.

The levers are blue nickled and unusually highly polished. All parts are made of brass and nickled. All parts are made so as to insure good contact on all points, and easy working leverage.

The switches are made in two sizes Senior and Junior. The Senior is made with a lever of a radius of $1\frac{3}{8}$ inches or $1\frac{1}{2}$ inches while the Junior has a radius of 1 inch.

The company also manufactures "Ideal" Tuning Coils, made in two sizes, 6 and 8 inches, each 3 inches in diameter. These coils are made solid and very attractive in appearance. They are baked and treated with bakelite varnish, and are wound with No.

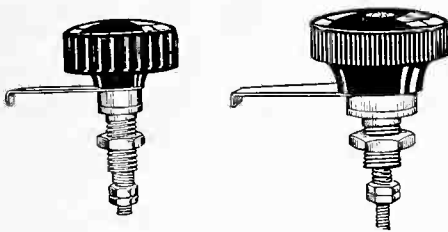

20 enamel wire. The ends are finished off with varnished tape, thus giving them a glossy finish.

In addition to these products the company handles a complete line of variable condensers, rheostats, sockets, plugs, jacks, variocouplers, variometers, transformers, etc.

MANUFACTURES PHONE CORDS

The Runzel-Lenz Manufacturing Company, of Chicago, are manufacturers of cords used for many standard types of head phones and loud speakers. The specifications of Style Y state that conductors are of multiples of stranded quality electric thread; each conductor has double insulation consisting of braids of quality cotton thread; respective conductors are marked for polarity and the finish braid is of first quality mercerized black thread. A special feature is found in the reinforcement applied where branches for the head phones leave the main body of the cord.

ATWATER KENT

2-STAGE AMPLIFIER



Price \$16⁰⁰

THE OUTSTANDING *Advantages* OF THIS INSTRUMENT are

- § Excellence of reproduction.
- § Amplification regulation by small steps.
- § A complete instrument in itself.
- § Compactness.
- § Regulation entirely by knob, no jacks to equip.
- § Transformers protected by steel housing.
- § Short wiring connections eliminate capacity effect.
- § Hermetically sealed, absolutely no moisture troubles.

THE LOW PRICE IS MADE POSSIBLE AS A RESULT OF 20 YEARS' EXPERIENCE IN QUANTITY MANUFACTURE OF SCIENTIFIC ELECTRICAL INSTRUMENTS

An Excellent Merchandising Proposition

ATWATER KENT MANUFACTURING COMPANY
4941 STENTON AVE. Radio Department PHILADELPHIA, PA.

Wotton

Radio Headsets

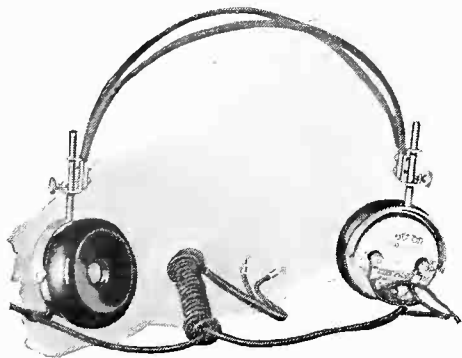

Retail Price

\$6.50

3000 Ohms

All Wotton headsets are sold on an absolute "satisfaction or money back" guarantee.

This is not a new product—thousands have been placed in the hands of users in the past year and with an unbroken record of perfect satisfaction.

The phones are high grade, highly sensitive, with a light aluminum shell, and at a record low price for a head set of this kind.

Every phone is tested on a receiving set—and all sets are perfectly matched and packed in attractive corrugated boxes.

Note the unusual permanent adjustment of the phones in the military head band, all parts of which are absolutely rustproof.

Write for our proposition and a sample set for inspection and test.

This Company established in 1908.

The Electric Products Company

1715 Clarkstone Road

Cleveland, Ohio

New York Office—30 Church Street

Radio Interference Obviated by Properly Erected Towers

By S. W. HULL

The radio tower, with its antenna seventy-five to one hundred feet above the ground, might be compared with small indoor loop antenna much as our modern six-cylinder automobiles compare with the small one-cylinder vehicles of twenty years ago.

Those little vehicles were always out of order and not running for one reason or another. At that time we all had our own idea of what the reason was, but as long as the principle of design was incorrect the effort to get results was useless.

So it is with the radio tower at this time. We know that to receive clearly or send efficiently we cannot get results as long as there is serious interference such as buildings.

It is important to get above this interference, and this can only be done by means of a steel pole or tower. It has been found that to raise a steel pole one hundred feet high from the ground to a perpendicular position is impossible without heavy tackle and a lot of help. Whereas, to build a light weight, wide base tower up, piece by piece, is a simple matter. This had to be learned from experience.

For years S. W. Hull & Company have been building transmission towers for power companies in all parts of the country. With the coming of radio development they were among the first to realize the importance of building an inexpensive tower to meet the popular demand. At great expense a series of tests were conducted to test the tower against high winds and ice loads.

The result of these tests formed the keystone for the design of the standard Hull Radio Towers.

When the first Hull towers were erected for the Shaw Technical High School of Cleveland, many radio enthusiasts would bring their sets and hook them on the high antenna. The results were very satisfactory, and in many cases where no results were being obtained at all at home, the owner would be made happy by hearing clearly.

Many of these young men could not afford to buy a tower, but were handy with tools and with the right kind of blueprints could make one in a short



S. W. Hull, engineer and manufacturer executive, a pioneer and specialist on steel radio towers. He is the president of S. W. Hull & Company, steel tower specialists, Cleveland, O. The strictly technical phases of Mr. Hull's activities have brought about many economics and practical advances in radio tower design. He has designed towers for all climates and wind conditions, at the same time keeping in mind that many of these towers were to be erected without skilled labor. This study and practical experience has developed into the design of the standard Hull Radio Tower now in use in all parts of the country.

time at a nominal cost. With a set of radio tower plans that are drawn in perspective, many have built their own tower, each piece being detailed by itself and marked to tally with an erection diagram. These Hull radio tower blueprint plans are now obtainable at most any radio dealers' establishment.

NEWARK RADIO SHOW

(Continued from page 55)

gether under one roof to listen to speeches, policies and general discussions regarding the future of radio. Here they will view the new sets under ideal conditions. The subject of "How to Merchandise Radio" will be a subject of interest to all dealers.

The speakers of the evening will be William Davis of the Magnavox Company; H. C. Gawler, Radio Corporation of America; M. B. Sleeper of the Sleeper Radio Corporation and H. Thompson of the De Forest Radio Telephone and Telegraph Company.

Members of the committee are as follows: M. Salzman, Wholesale Radio and Equipment Company, chairman; M. Krich, Krich Light and Electric Company; George Ollendorf, National Light and Electric Company; William Nevins, Radio Distributing Company; T. Ryan, American Radio and Equipment Company; M. Rost, Newark Electrical Supply Company; Mr. Viall, Premier Accessory and Specialty Company; P. M. Dreyfuss, Dreyfuss Sales Corporation; H. Denburg, Royal Electric Laboratories; Mr. Anderson, Irvington Varnish and Insulator Company, and M. Shields of the Mercury Radio Products Company.

YALE STORAGE BATTERY

The Yale Storage Battery, the product of the Yale Storage Battery Company of Indianapolis, Ind., is compact and enclosed in a mahogany finished case that is specially treated to resist acid.

The battery proper is provided with excess gassing chamber beneath the cover, and with vent caps of suitable design to prevent leakage of acid. The plates are thick, strong and durable, and are produced under strict laboratory control, and under supervision of experts who have had vast experience in producing batteries of this and similar types. The terminals are efficient and conveniently arranged and a suitable handle is provided so that battery can be carried in one hand. The batteries are provided in a sufficient range of sizes to suit the individual requirements of any radio equipment.

ECHO-TONE IS DIFFERENT

A novel radio horn manufactured by the Ampli-Radio Company of Toledo, Ohio, employs a construction different from other horns on the market. It consists primarily of a resonance chamber at the neck of the horn.

PARADEX UNITS

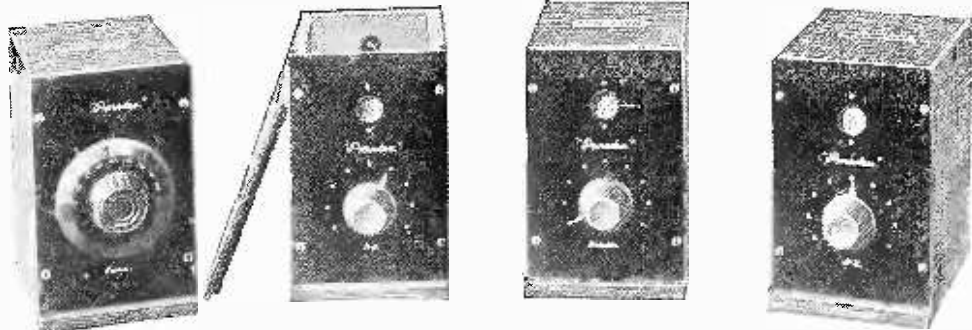

Write for Dealers' and Jobbers' Proposition
TUNER (Pat. Applied for).....\$20.00 **AUDIO FREQ. AMP.**.....\$18.00
DETECTOR 10.00 **RADIO FREQ. AMP.**..... 20.00

Manufactured by

PACIFIC RADIO EXCHANGE

439 CALL BUILDING

SAN FRANCISCO, CAL.

All American Audio and Radio Frequency Transformers Now—Completely Shielded



Radio Frequency Transformers
R-10—\$4.50

When you hear the man who knows talk about Radio and Audio Frequency Transformers he will be pretty sure to say "That looks good, but how does it compare with the "All-American?"—More and more manufacturers are adopting these transformers as standard equipment—Radio fans all over the country prefer them for their home made sets.

All of this has been brought about by the unusual results in competitive tests that these transformers have given.

Both transformers are enclosed in highly polished nickel plated shields. They are attractive-looking as well as mechanically perfect, and the best sellers on the market.

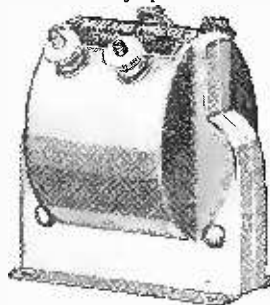

Audio Frequency Transformers
R-12 Ratio 3 to 1—\$4.50
R-13 Ratio 10 to 1—\$4.75

SEND FOR ILLUSTRATED PULLETIN NO. 22 AND DISCOUNTS.

RAULAND MFG. CO.
35 So. Dearborn St., Chicago, Ill.

DEALERS AND JOBBERS

Our new Fall Catalogue No. 25 is ready, consisting of new featured Sets and Accessories. Our prices are right. Send for catalogue.

Manufacturers and Distributors of

- | | | |
|-------------|-----------------|-----------------|
| Condensers | Potentiometers | Radio Frequency |
| Vacuum Tube | Plugs | Transformers |
| Sockets | Jacks | Audio Frequency |
| Honeycomb | Tube Sets | Transformers |
| Mountings | Crystal Sets | Switch Levers |
| Dials | Knock-Down Sets | Binding Posts |
| Rheostats | Headphones | |

DISTRIBUTORS WANTED



78 Fifth Avenue

New York

ELECTRIC TESTING

Of all materials entering into Radio Construction. Meters repaired or calibrated

**CHEMICAL ANALYSES
STRENGTH TESTS**

Investigation or Development of New Materials. Routine Tests at Special Rates

**NEW YORK TESTING
LABORATORIES**

80 Washington Street

Bowling Green 7016

DOUBLELL ETHERTROLA

The Ethertrola, a receiving set manufactured by the Doublell Radio Company, New York City, is built compactly in a 10 x 15 inch highly polished mahogany-finished cabinet. The panel is of grade XX Bakelite and is hand-engraved. It is built on the two-story plan, transformers, tubes and tube controls are in the upper section, and the tuning units in the lower section. All parts are moulded. Everything in the set is mounted on the front panel and an inside bakelite shelf, permitting the removal of the entire set from the cabinet for inspection.

The Ethertrola is wired throughout by the Telfunken Bus Bar method. All battery connections are made from the rear of the set so that no unsightly, straggly wires mar its appearance.

An added feature is the push-and-pull switch on the front of the panel that controls both A and B batteries, so that when the set is not in use neither of the batteries is being discharged.

For long distance reception the Doublell Company recommends the outdoor aerial, but for nearby stations and where an outdoor aerial can not be erected, a loop aerial is suitable. No change is necessary in the construction of the set for use of either type of aerial.

**Na-ald
De Luxe
V.T. Socket**

Contact strips of laminated Phosphor bronze press firmly against contact pins, regardless of variation in length. No open current trouble possible. Socket moulded from genuine Condensite. Practically unbreakable. Special protected slot, with exterior reinforcement. Unaffected by heat of bulbs or soldering iron. All excess metal eliminated, aiding reception. May be used for 5 Watt power tube. Highest quality throughout. Price 75c.

Special proposition to dealers and jobbers

ALDEN-NAPIER CO.

52 Willow St. Dept. H Springfield, Mass.

**The RADIO
BOOK of
BOOKS****Contents:**

1. Detector Hookup.
2. Two-stage Amplifier Hookup.
3. Radio Amplifier Hookup.
4. Radio Audio Amplifier Hookup.

5. Armstrong Regenerative Detector Hookup.
6. Same with Amplifiers.
7. Armstrong's New Super-Regenerative Hookup.

Dealers! YOU make 66 $\frac{2}{3}$ %
on every dollar you invest.

ARCHWAY BOOKSTORE

224 Pike St.

Seattle, Wash.

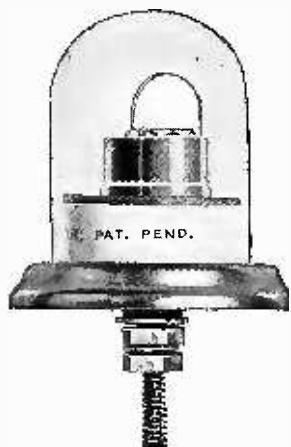
**THE FAMOUS GREWOL
FIXED DETECTOR****PRICE \$2.00**

In using the

GREWOL

you don't have to find the spot.

**THIS DETECTOR IS
ALWAYS SET AND READY**

completely protected from dust.

Gives the best results

If your dealer does not handle the Grewol send us \$2.00 and we will mail one to you.

A Good Proposition
For Every Radio Dealer

RANDEL WIRELESS CO.

9 Central Ave.

Newark, N. J.

C & W SET GOES ABROAD

Rodman Wanamaker took with him on his recent trip abroad, an American-made receiving set for the purpose of showing it in Paris and London as representative of America's progress in the manufacture of radio apparatus. Much interest has been shown abroad in America's rapid development of efficient radio apparatus.

Mr. Wanamaker, who was accompanied abroad by Commissioner Enright and Doctor Harris, used the set aboard the Olympic to receive entertainment from stations on both sides of the Atlantic as they left the American shore and approached Europe.

The set taken by Mr. Wanamaker was a Cutting & Washington Type 11 Regenerative Receiver and Amplifier. It was especially procured and rushed through for Mr. Wanamaker by the Pioneer Radio Corporation, who are distributors for C. & W.

INCORPORATIONS

The "list of new radio companies" has had but few additions this past month—in comparison to other months. Can it be that the ex-cil stock promoters are out of numbers? Or are their sucker lists bringing poor results? The RADIO DEALER believes the public isn't buying much of the new radio stock offered. The honest-to-goodness Wall Street records prove it.

DEALERS

Have you tried "PRACO"
Service?

We are distributors to the trade for all representative manufacturers, and specialize in the cutting of panels and tubing to your order.

Have you our latest price list and discount sheet?

**PITTSBURGH RADIO AND
APPLIANCE CO., Inc.**

Desk D

112 Diamond St., Pittsburgh, Pa.

**DEALER
SECURITY**

When the dealer buys, he must know he is getting goods which will give his customers complete satisfaction.

Write for details on the Aerovox line—radio equipment that satisfies. We are supplying our dealers with complete Armstrong Super Regenerative Booklets for distribution.

The new circuit will increase the sale of Duo-Lateral Honeycomb and Remler Coils, 12,000 ohms resistance and 100 mil-henry iron core choke coils.

We have this material ready for immediate shipment. Write for prices and Armstrong Regenerative wiring diagrams.

BRADY
ELECTRIC MFG. CO.
PITTSBURGH, PENNA. U.S.A.
415 S. Highland Ave.

ROYAL ELECTRIC PHONES

The Royal Electric Laboratories of 207 Market St., Newark, N. J., are manufacturers of a radio headset known as the Royalfone. The phone is the result of two years of effort. It is well constructed and the best of materials are used in producing this high grade and sensitive phone. Charles Lehrfeld, the designer, who is well known to the trade, having been in radio for a number of years, first became interested in radio when he was about 10 years old and followed radio as an amateur until he enlisted in the navy. He was then stationed at the Newport Radio School as an instructor and also fulfilled the duty there as an operator. After serving in this capacity for a time he was transferred to special light ship duty as an aid to sub-chasers in the Atlantic. C. Lehrfeld is in charge of activities at the laboratories and reports a national advertising campaign soon under way to place the Royalfone in its well deserved place among the leading headsets on the market.

WESTPHAL ADAPTER

The Westphal Adapter, an instrument for using the phonograph as a loud speaker, is the product of the Westphal Manufacturing Company, of Chicago, Ill. The company claims that the adapter may be attached to 95 per cent. of the phonographs on the market without harming the instrument in any way and may be connected or removed in a moment. Only one of the phones is used in connection with the adapter, the other being shorted with a piece of solder or wire, the contention being that in the use of two phones there is conflict of sound. The Westphal Company claims an increase of 50 per cent. in volume of sound with the use of the adapter. It is constructed of a non-magnetic alloy which takes a very high polish and adds to the general appearance of the phonograph.

LORNETTE PHONE HANDLE

The Globe Lorgnette Handle, a device for holding a receiver to the ear, is the product of the Globe Phone Manufacturing Company of Reading, Mass. The handle is properly insulated, having a hard rubber grip, is light in weight and of convenient length to hold in absolute comfort. The purpose of this instrument is to permit a convenient method of holding one receiver when the head bands are not used. The company claims a big demand for the single handle having a telescopic or extension handle. The Globe Lorgnette Handle may be attached to any standard phones.

THE MARK  OF QUALITY

"REGAL" No. 80 Variable CONDENSER
Precision Built



- 43 Plate, .001-MF.....\$4.50
- 23 " .0005-MF..... 3.50
- 11 " .00025-MF..... 3.00
- 3 " Vernier..... 2.50
- Knob and Dial..... \$1.00 extra

"REGAL" MOULDED TUBE SOCKET—No. 205



A fine moulded Socket—different from others. Popular with all radio operators.
Price\$0.75

"REGAL" TELEPHONE CONNECTOR—No. 162

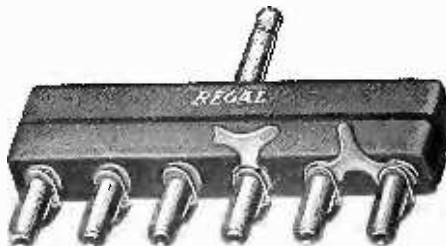

Does away with all Binding Posts. Permits use of three sets of phones. Only two connections to be wired.
For Panel Mounting.....\$1.50
With Plug as shown..... 2.50

Jobbers and Dealers are making real money selling "REGAL" Quality Radio Products. The reason—Precision Made Instruments Honestly Priced and Guaranteed. Send for our handsome new Catalog No. 10 showing our full line.

"REGAL" INDUCTANCE SWITCH—No. 164

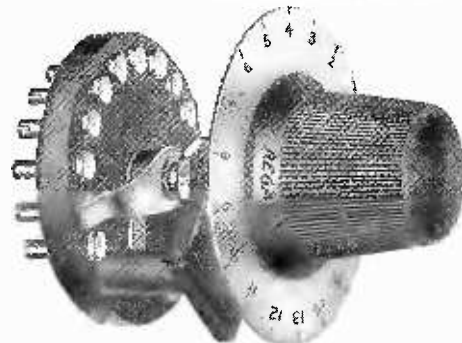

15 point switch complete in one unit. Does away with all switch points. Requires but one hole to mount on panel. BIGGEST HIT IN RADIO.

Price (complete with Knob and Dial)....\$2.00

"REGAL" FILAMENT RHEOSTAT—No. 140

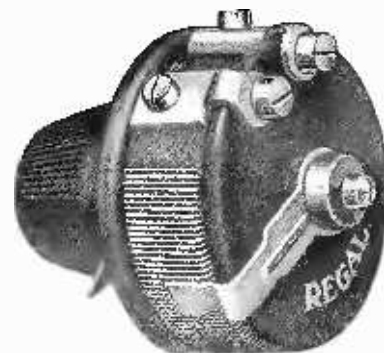

HANDSOME—EFFICIENT—SCIENTIFIC
Exposed resistance wire, giving smooth working, even tension control at all times. 6 Ohms—2-2 Amperes. Ask any radio engineer.

Price (complete with Knob).....\$1.25

"REGAL" VARIO COUPLER—No. 165

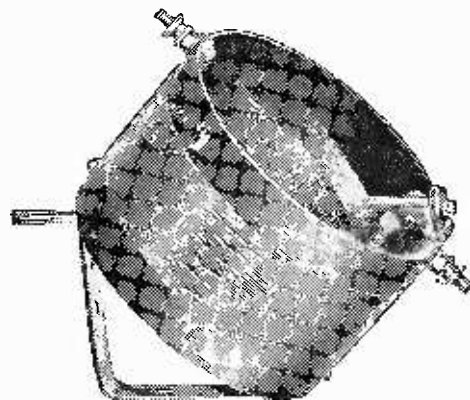

Precision wound—perfect alignment and positive contact. A wonderfully efficient instrument.
Price\$5.00

[Home of "REGAL" Radio Products

We still have some territory open for distributors.



Our co-operation with our jobbers, dealers and distributors is the talk of the trade.

THE AMERICAN SPECIALTY MFG. COMPANY—BRIDGEPORT, CONN.



Mercury Radio Sets

A PROFITABLE line to handle, from the dealers' standpoint. A reasonably priced line to buy from the consumers' standpoint.

The low price is made possible by quantity manufacture in our large factory where every part is made, not merely assembled.

*Write for details
and trade prices.*

**MERCURY RADIO
PRODUCTS CO.**

LITTLE FALLS NEW JERSEY

"ETHEROLA"

**AERIAL
EQUALIZER TUBES
AND
GROUND
SEPARATOR TUBES**

Replaces Long Wire Aerials and Water Pipe or Other Grounds.

USED INDOOR OR OUTDOOR

**TO DEALERS
JOBBERs**

Demonstrate a Set and Get the Biz. Selling Rapidly Wherever Shown.

Assist you greatly in sale of high grade Receiving Sets

GET YOUR TERRITORY O.K.

Write us now. Results guaranteed

**THE ETHEROLA
CORPORATION**

6216 Broad Street
PITTSBURGH, PENNA.

PITTSBURGH PARAGRAPHS

Etherola Corp. are putting out an antenna that is new in principle and cylindrical in shape. For tube sets only, it has given remarkable results, eliminating the many and varied noises that interfere with clear and uninterrupted reception. It also has the advantage of not being directional. The Etherola Corp. has recently taken up new quarters at 6216 Broad St., Pittsburgh, Pa., where they have excellent facilities for demonstration.

Pittsburgh Radio and Appliance Co. are among the largest manufacturers of panels in the industry. They are preparing for a volume business in the panel business. They have also a large business built up on their Vernier Condenser, which is somewhat of a departure from the general assembly of plate condensers.

A very attractive crystal detector set enclosed in an attractive wood case, and retailing for \$9.00, without phones, was recently put on the market by the Radio Apparatus Co., located at 6600 Hamilton Ave.

TRIANGLE LOUD SPEAKER

The Triangle Phono-Parts Company of New York City have perfected and will soon market a new loud speaker of the hornless type. The instrument consists primarily of an amplifying chamber. It is very compact, being only seven inches high and about six inches wide. It can be hooked up to any tube set and will give sufficient volume to be clearly heard in the average home. The sound is adjustable without impairing the quality of the tone.

CLARIPHONE ATTACHMENT

The Colytt Laboratories of Chicago is producing an attachment for headsets for which they claim amplification without static or distorting noises. The attachment consists of a light screen or auxiliary diaphragm made to screw adjacent to the diaphragm on the telephone receiver. This auxiliary diaphragm has a trap arranged so that any confusing sounds or vibrations of the receiver diaphragm are cut out or trapped in the Clariphone. This device is made of aluminum, is exceedingly simple and is sold under guarantee to give satisfaction.

Recommended for Reliability

RADIO STORES CORP.
VARIABLE CONDENSERS—
PLUGS—RESISTANCE UNITS, ETC.
222 West 34th Street, New York

The Sign of **QUALITY-PLUS** Instruments
ARROW RADIO CO.
Mfrs. of Quality-Plus Instruments
Hackensack New Jersey



DEALERS ATTENTION!!

Most complete licensed crystal set in market—RADIOPHONA No. 1—equipped with 23-plate condenser and loose coupler. Includes Mesco double headset and aerial equipment. Buy direct from manufacturer, save money and make big profits. Write for prices and discounts.

M. P. RADIO CO.
453 W. 53rd St. New York City

Maclite Vario-Coupler

Price \$5.00

Is, in the opinion of experts, the most efficient on the market.

All Other Maclite Parts are equally efficient, including the Maclite Variometer, Double Slide Tuner, Variable Condensers and Crystal Detectors. The Maclite Single Tube set at \$25.00 is the best buy we have ever seen. Let us tell you more about this set, also all other Maclite parts.

Dealers and Jobbers Write for Discounts

MACLITE RADIO CO.
701 Maclite Bldg., Claredon St.
Boston, Mass.



Radio
Supplies
of
Exceptional
Character
at
Correct Price
and
Liberal Discount

*Write for Descriptive
Catalogue*

Harold M. Schwab, Inc.
419 West 42nd Street
New York City

Philadelphia

DIAMOND GRID BATTERY

The Philadelphia Storage Battery Company has placed on the market a new radio "B" battery, which has unusual features. The battery is of a shape that is easy to handle and use, and is neatly and compactly sealed in a one-piece hard rubber case. Several units can be grouped on a shelf or table, occupying a very small space, and the projecting lugs provide for convenient and unlimited voltage taps.

A new feature about the battery is that the battery is fully charged, and shipped to the dealer absolutely dry.

It requires no initial charge and is ready for use upon adding the necessary electrolyte solution. This does away with loss of charge or wasting on the dealer's shelf. The dealer may remove the battery from its original carton and add the electrolyte solution in the presence of the customer at the time of the sale. This means that storage "B" batteries, fresh and fully charged, can be sold without waiting for the initial charge to be given.

MUSIC MASTER SPEAKER

The Music Master loud speaker, manufactured and distributed by the General Radio Corporation, is a new product in this field for which its makers claim wonderful possibilities. It is designed and built on principles which have been used in highly priced phonographs, and is proudly designated by its makers as the "Stradivarius of radio amplifiers." The tone is enriched and mellowed through the resonance of sonorous wood, increasing the volume of sound while refining and clarifying every vibration. It requires no additional batteries or current, and will fit any tube set.

The Music Master is fully covered by patents held by the General Radio Corporation. The material used in its construction is the finest quality mahogany.

The Beaumont Radiophone Company, of 1326 Arch Street, has recently changed hands, and is now being operated as the Noble, Wacker and De Arellano Radiophone Company. The new proprietors are doing volume business in wholesale and retail channels.

The Rubicon Company have decided to market their new micrometer control rheostat under the trademark, "Micontrol Rheostat."

Killing the Goose—

that laid golden eggs, and selling cheaply made, disappointing Radio sets amount to one and the same thing.

And if you, Mr. Dealer, would make your business what you want it to be—permanently profitable—then shun "claptrap" instruments as you would the plague.

ONE-KNOB CONTROL CUSTOM BUILT CONQUEROR RECEIVING SETS

are sets that are built like Packard "Twin-Sixes," mechanically perfect in every detail, simple to operate and capable of super-sharp tuning.

—Unconditionally guaranteed as to quality, materials and workmanship—and to give as good or better results than any instrument at any price. And that holds good for any tuner, detector and two-stage amplifier made—bar none.

THIS IS HOW A CONQUEROR IS BUILT

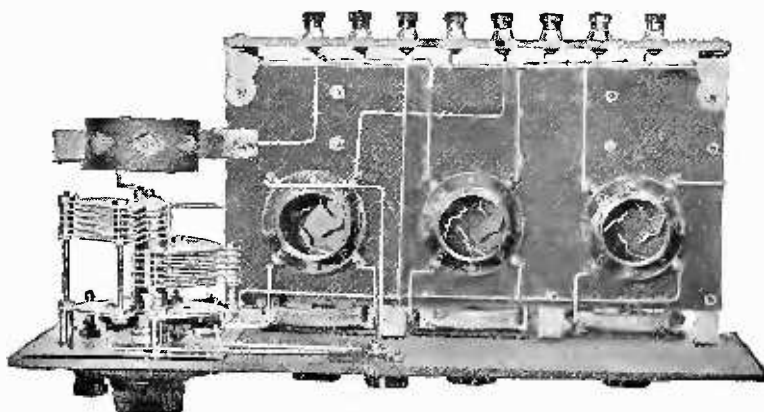

—**BUT** you have to see, operate and listen in on a *Conqueror* to truly appreciate what perfection in receiving sets means.

TWO MINUTES TAKEN TO WRITE US
WOULD BE TIME PROFITABLY SPENT

LEWIS & DERROY RADIO CORP.

MAKERS OF
CONQUEROR
PRODUCTS



560 Seventh Avenue
NEW YORK CITY

Phone BRYANT 7759

"UNITED" Radio Products



Two Finishes—Black Enamel or Buffed Nickel Plated \$4.50

"UNITED" Audio Frequency Transformers

Radio dealers will find in the "United" Transformer the same high grade workmanship and engineering skill which have made the "United" Condensers the standard in the variable condenser field.

"UNITED" Variable Condensers

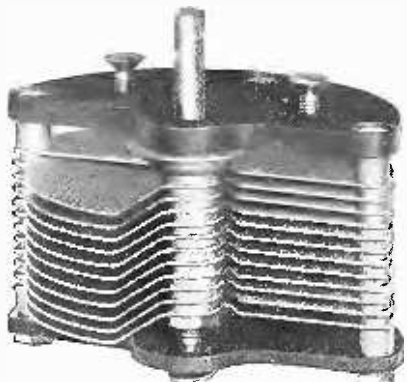

In every field there is a standard by which everything else is compared. The fact that "United" Variable Condensers have been accepted as the standard is sufficient in itself to warrant your not buying any other until you have made a comparison.

Prices	
43 plate	\$4.50
23 "	4.00
11 "	3.50
5 "	2.75
3 "	2.25

Without dial or knob.
Write for Discounts

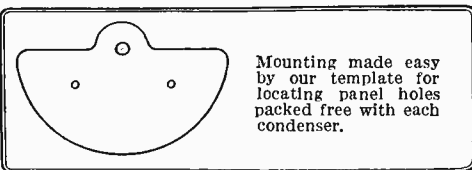

Mounting made easy by our template for locating panel holes packed free with each condenser.

NOTE

Any advertised claim of having an arrangement with us to sell our product at special prices, is fraudulent.

United Mfg. & Distributing Co.
536 Lake Shore Drive Chicago, Ill.

Development of The Loud Speaker

(Continued from page 44)

this pioneer instrument competed directly with the ordinary telephone instrument, and in all cases it was found that the reproduction was far better. When they came to use this instrument on phone lines, however, they found that, due to the fact that the little coil was almost entirely surrounded by iron, the impedance of the coil was very small. This gave the instrument an excellent degree of efficiency and sensitiveness. In fact, conversation was held over a direct copper line between Denver and New York City, using this instrument when the ordinary phone was unintelligible.

Patents having been taken out on this instrument, experiment was then carried further in order to refine the mechanical details, and it was during these further experiments that it was found that if the floating coil was wound to a low value and a large amount of current passed through it, this instrument would act as a true loud-speaking reproducer. Consequently, the design of the coil was changed, and at present the floating coil has a direct current resistance of 8 ohms and an impedance at 800 cycles of only 20 ohms. During the experimentation a loud-speaking transmitter or really heavy current transmitter was developed, and the transmitter was then placed so that a phonograph could play directly into it. Modulation of the current was sufficient when passed through the floating coil to give such a volume of sound that early in 1915, music was heard in the Napa Valley over nine miles away from the reproducer, which had been placed on top of the laboratory chimney. It was then that the two inventors had a new inspiration. They called the instrument "Magna Vox," meaning "great voice," because it had the inherent quality of being able to reproduce the voice or any other sound with volume limited only by the means to supply the necessary energy.

For a while most of the inventors' energy was turned to the use of this instrument for the amplification of public speeches or the amplification of phonograph music, and on Christmas Eve, 1915, the first public demonstration of the Magnavox took place in San Francisco, where the community speakers spoke to 50,000 people with perfect ease, this being the largest crowd that had ever satisfactorily

"RADIO" VARIABLE CONDENSERS

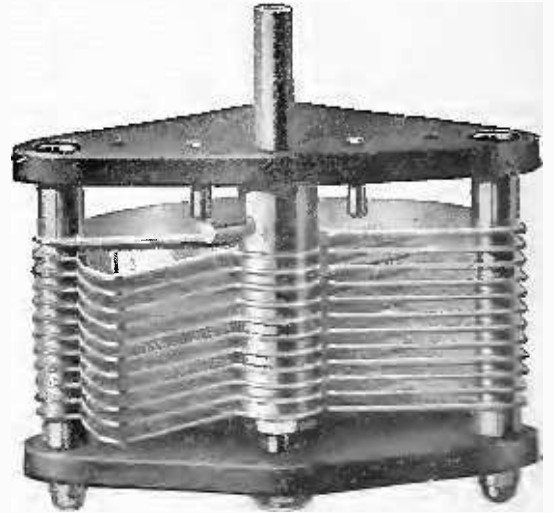

These condensers are the Standard of Quality. Carefully tested, inspected, balanced and adjusted to give maximum satisfaction.

3 plate Vernier.....	\$1.50
23 plate.....	4.00
43 plate.....	5.00

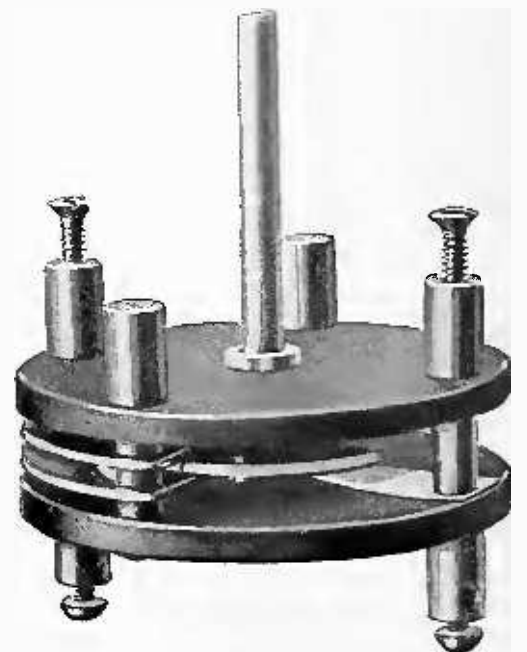

Jobbers and Dealers write or wire for the biggest proposition in Radio—TODAY!

FREDERICK H. PRUDEN
INCORPORATED
LERNER BUILDING
991 Bergen Ave.
JERSEY CITY, N. J.

heard a public speaker at the same time. Since that time, as everyone knows, the Magnavox has been used by practically every prominent public speaker in the United States when addressing large audiences.

Here, then, was an instrument altogether different in principle from the magnetic attractive receiver. Here was an instrument which not only was sensitive but which would reproduce sound in any volume. There were no pole pieces to interfere with diaphragm motion. The diaphragm could be made of soft material and could vibrate freely and with great latitude.

The inventors then associated themselves with a new company which was formed to take over the interests of the Commercial Wireless and Development Company, the new company being known as The Magnavox Company. Almost immediately the Magnavox, in addition to its phonograph application, was developed to be used as a receiver for wireless signals. This was easily done by using a step-down coil which would adapt the impedance of the Magnavox to the output impedance of the receiving set.

However, the war stopped most of this work, as the Magnavox Company became very busy making anti-noise transmitters—also a product of Pridham's and Jensen's inventive genius—and almost nothing was done with the loud-speaker until the close of the war. The radio loud-speaker, then known as the radio telemegafone, was put on the market with a horn for loud signals and ear pieces for weaker signals. Various mechanical refinements were worked out and incorporated in this instrument, but even then the instrument was high in price and not within the reach of the average radio amateur. In early 1921 there were approximately only 10,000 receiving sets in the United States, and most of these stations were operated by amateurs, the great majority of whom were young and who had no great amount of money to spend.

The Magnavox Company then decided to redesign its radio telemegafone so that it might be put into quantity production and the price placed at a figure which would allow the owners of these 10,000 stations to own a real loud-speaking reproducer, and in March, 1921, the new product, known as Magnavox Radio Type R-3, was placed on the market, selling for \$45. There was an instant response, although broadcasting, of course, had not yet taken its present hold upon the public. Throughout 1921, a large

ESTABLISHED 1888

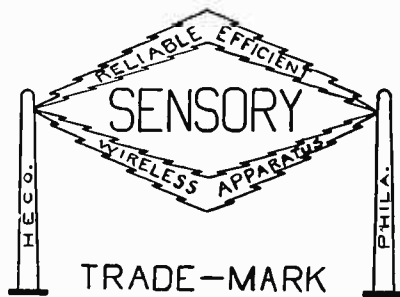

SENSORY CABINET UNITS

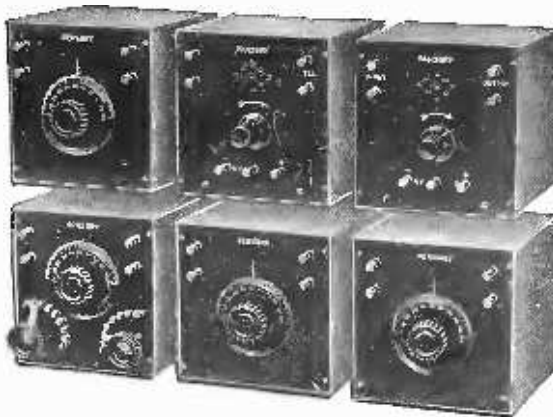

The most flexible method of adding to, or obtaining a variety of hook-ups, and giving an appearance equal to any single cabinet set. Each cabinet contains a "Sensory" element.

THE FULL LINE OF "SENSORY" ACCESSORIES IS SHOWN IN OUR NEW BULLETIN NO. 12
WRITE FOR IT TODAY



HEINEMANN ELECTRIC COMPANY
Manufacturers

Radio Division

Philadelphia, Pa.

KING QUALITY

ALL THE NAME IMPLIES

RADIO APPARATUS

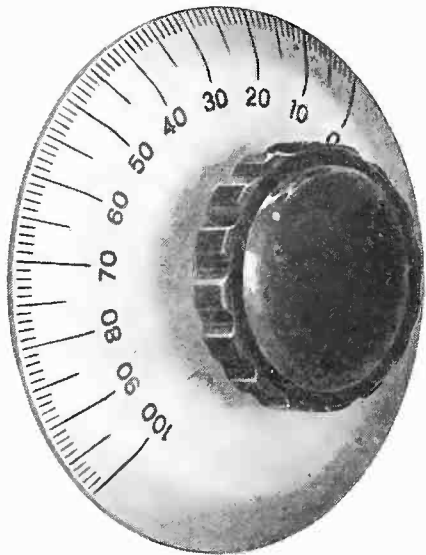
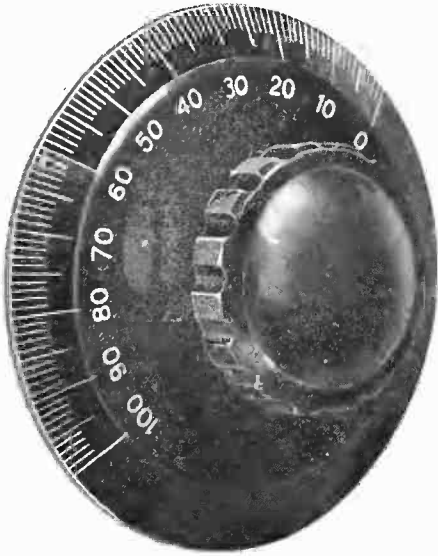

KNOBS AND DIALS

THE development of these dials has brought another mark of perfection to KING QUALITY Radio Apparatus. These dials are the neatest, most durable and most practical dials being made today.

KING QUALITY dials are finished with a high permanent polish which improves the appearance of every outfit. They are unbreakable, will not warp, being accurate in design with high dielectric properties.

The knob is moulded Bakelite and is fastened to the dial by a special brass bushing. The bushing is drilled for $\frac{1}{4}$ " or $\frac{3}{16}$ " shaft and the set screw passes through both knob and dial.

Sold only to recognized distributors, Jobbers and Manufacturers.

Manufactured by Radio Apparatus Division
**KING SEWING MACHINE
 COMPANY**
 BUFFALO :: :: :: N. Y.

number of instruments were sold and when it was decided to broadcast the returns of the Carpentier-Dempsey fight from the ringside at Jersey City, there was an unprecedented demand for Magnavox Radio. It is interesting to note that at the same time the "big brother" to the Magnavox Radio, the Magnavox public speaking and announcing equipment, was used at the ringside to announce introductions, etc., to the 93,000 fight fans present. At that time Magnavox Radio was a comparatively unimportant part of the Magnavox Company's activities, but just before the Carpentier-Dempsey fight great activity was seen and approximately 600 instruments were turned out quickly with overtime work for this occasion alone. From that time on, as we all know, the growth of broadcasting was rapid, and in exact proportion the Magnavox Radio production was increased. Dealers all over the country used Magnavox Radio to demonstrate the radio concerts for their customers, but even then the deliveries of the Magnavox Radio equipment could not keep up with the orders which poured in. Raw materials of certain kinds in the spring of 1922 became almost unobtainable and the ingenuity of the two inventors was kept continually exerted to keep up the standard of quality necessary.

At the same time development was started on power amplifiers to give to the Magnavox as much volume as could be wished for by any one. Today the activities of Magnavox Radio and its allied amplifiers has grown into a business of most impressive importance until it is now of international scope.

Great credit must be given to the two chief engineers of the Magnavox Company, Messrs. Pridham and Jensen, for their efforts. They have appreciated and solved the many problems of a radio loud-speaker because they are essentially radio men, as well as being pioneers, and are said by many to be the best-posted and well-informed scientists on problems of sound engineering in the world today.

As an interesting story to conclude, we might say that Peter L. Jensen was the first man in the world to hear voice modulated arc continuous waves used for wireless telephone transmission, this occurring in the fall of 1906 when he was working for Dr. Poulsen. How little did Jensen realize at that time, as he excitedly told Dr. Poulsen of what he had heard, that he would be one of the inventors of a new principle which helped to establish the popular use of wireless telephone in the home so many years later!



The Portabloop Tuner and Portabloop Receiver are Now Ready

Write Us For Prices
 and Details

Radio Frequency Here at Last



212 Central Avenue

DUKANE VARIABLE CONDENSER THOROUGHLY TESTED

The Duquesne Radio & Mfg. Co., 6426 Hamilton Avenue, Pittsburgh, are concentrating their efforts towards the manufacture of a good substantial and compact variable condenser.

This condenser—the DuKane—is built for durability. It features die-cast aluminum end plates, non-warping screws and is of high capacity.

The DuKane has been tested thoroughly, it is stated by the makers, by competent engineers and also at the Carnegie Institute of Technology.

DETECTOR AND TWO STAGE

The States Radio Corporation of Chicago are producing a detector and two stage amplifier set that is neat and attractive in appearance and embodies the latest designs of efficient receivers. The feature of the set is parts that are easily detached in much the same manner that the ordinary bulb is removed from its socket. There are no binding posts to come loose, no loose wires, everything being compactly and firmly placed. The panel is of metal, an innovation that minimizes disturbance caused by the manipulation of dials. The transformers are incased in the tube sockets to reduce wiring, and are easily replaceable in case of a change in broadcasting wave length. All parts are easily accessible from the rear of the panel.

CLUB RESUMES ACTIVITY

The Hudson City Radio Club, Inc., of 37 Sherman avenue, Jersey City, N. J., announces that the club will reopen for the "big fall rush." Harry A. Bremer, Chairman of the Publicity Committee, reports that the regular wireless course, held four nights a week, will "push the code very strongly." "Harry A." requests that radio manufacturers send their catalogs to the club. He would also appreciate having their radio engineers make arrangements with the club to address the members on practical radio topics.

The club is out to push radio and should receive the earnest co-operation of the trade.

DETROIT ELECTRIC CATALOG

Catalog No. 10 issued by the Detroit Electric Company of Detroit, is attractively and concisely arranged between two covers that please the eye. The photographs are neatly arranged and prices tabulated for easy reference. The back cover shows the symbols of the International Morse Code.



ESTABLISHED 1911

The Original and Genuine Mica Diaphragm Amplifying Loud Speaker

NEW LIST PRICE \$25.00

CHEAPER THAN THE WORTHLESS IMITATIONS

SPECIFICATIONS

HORN: Seamless brass, triple lacquer, scientifically correct. Gives a rich, clear tone, not a metallic rasp.

AMPLIFYING CHAMBER: Exclusive "Modern" amplifying chamber of machined aluminum, polished and lacquered.

RECEIVER: Highest grade mica diaphragm amplifying receiver, built like a phonograph reproducer.

BASE: Oak wood base finished in early English, green felt bottom.

POST: Eby patented binding post.

NO BATTERIES ARE NEEDED TO OPERATE THIS LOUD SPEAKER—JUST CONNECT IT TO YOUR SET—PRESTO—HEAR 'EM ALL OVER THE HOUSE.

This is the original and genuine loud speaker—designed to do the work of a loud speaker—and is not an empty horn or shell that "any" receiver fits.

The Makers of the "FIRST" are Makers of the "BEST"

HORNING EXPERIMENTAL LABORATORIES

Sole Distributors of "Modern Apparatus"

Elizabeth Trust Company Bldg.

ELIZABETH, N. J.

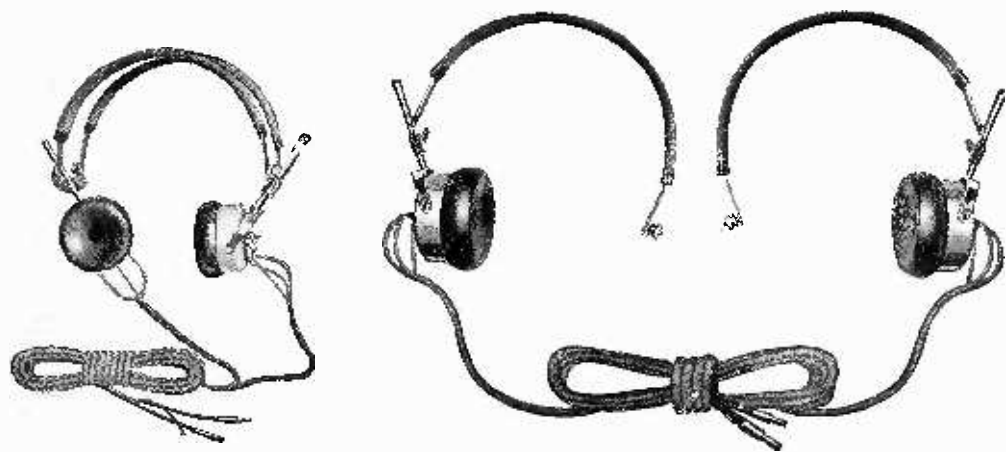
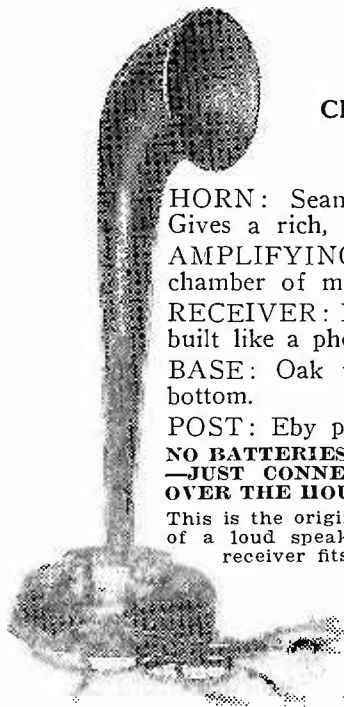

The Band Splits Into Two Parts. Each Having an Overhead Strip, Is Very Convenient for Two Persons

Premier Duplex

PATENTS APPLIED FOR

Phones

2000 Ohms \$6.50

3000 Ohms \$8.00

Discount to Dealers

PREMIER ACCESSORY & SPECIALTY CORP.

27 CONGRESS STREET

NEWARK, N. J.



The B & P INSULATOR Should Be Included In Your Line of Staple Sellers

SUCCESSFUL radio dealers follow the wise practise of stocking small staple sellers to produce a steady, dependable profit rather than tying up all this capital in higher priced, more expensive merchandise. They find it worth their while to carefully consider the quality of these staples.

The B & P Insulator, in every store, where it's handled, has gone plugging ahead turning over a very satisfactory profit on a small investment.

They look GOOD. That starts the buying! They stand the tests and actual use by amateurs. That spreads the advice that the best insulators are for sale at your store.

Our prices give you plenty of room for your idea of a fair profit. May we quote you on the quantities you could use?

Wholesale Only

BANISTER & POLLARD CO.
204 Market St. Newark, N. J.

New Broadcasting Station Wave Length

(Continued from page 48)

length of 485 meters is authorized for broadcasting crop reports and weather forecasts, provided the use of such wave lengths does not interfere with ship to shore or ship to ship service.

A new class of radiotelephone broadcasting station license is hereby established, to be known as Class "B." A license will not be issued for a station in this class which does not comply in every respect with the specifications hereunder. Specifications covering the requirements governing the construction, licensing, operating and service of Class "B" radiotelephone broadcasting stations:

Wave Length—The wave length of 400 meters only will be assigned for the use of stations of this class, which must be reasonably free from harmonies.

Power—The power supply must be dependable and non-fluctuating. The minimum required will be 500 watts in the antenna and the maximum shall not exceed 1,000 watts in the antenna.

Modulation—The system must be so arranged as to cause the generated radio frequency current to vary accurately, according to the sound impressed upon the microphone system.

Spare Parts—Sufficient tubes and other material must be readily available to insure continuity and reliability of the announced schedule of service.

Antenna—The antenna must be so constructed as to prevent swinging.

Signaling System—Some dependable system must be provided for communication between the operating room and the studio.

Studio—The radio equipment in the studio must be limited to that essential for use in the room. The room shall be so arranged as to avoid sound reverberation and to exclude external and unnecessary noises.

Programs—The programs must be carefully supervised and maintained to insure satisfactory service to the public.

Music — Mechanically operated musical instruments may be used only in an emergency and during intermission periods in regular program.

Division of Time—Where two or more stations of Class B are licensed in the same city or locality a division of time will be required if necessary.

Licenses issued for the use of the

Scott Detector

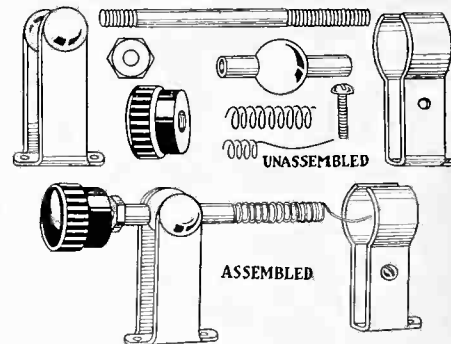

Complete parts as illustrated. Brass. Nickel Plated. Ready for mounting. **List 40c**

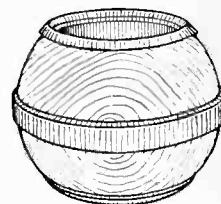

Manufacturers, Jobbers and Dealers

Write

SCOTT NOVELTY CO.
33 Springfield Ave. Newark, N. J.

It pays to advertise—ask our advertisers.

If you have something to sell the Radio Trade, fill in the blank below—an ad this size would only cost \$18.60 per issue on contract

ADVERTISING ORDER

THE RADIO DEALER,
1133 Broadway, New York City.

You may insert our advertisement, copy attached, in the next 12 issues of the RADIO DEALER, to occupy space of six inches, for which we agree to pay you at the rate of \$18.60 per issue.

(Signed)

(Address)

(City and State)

Minimum order, four inches

400-meters wave length shall specifically provide that any failure to maintain the standards prescribed for such stations may result in the cancellation of the license and requiring the station to use the 360-meters wave length.

The advantages of this ruling are obvious. It eliminates a great deal of the interference heretofore experienced in broadcasting and will allow at least one good program in every district.

“USL” APPOINTS VICE-PRESIDENT

John A. White, who is well known as one of the pioneers in the battery industry in the United States, has been appointed a vice-president of the U. S. Light & Heat Corporation, manufacturers of “USL” storage batteries. Mr. White has been continuously engaged in storage battery sales work for more than twenty-three years. After graduating at Harvard with the degree of A. M., he entered the employ of the Electric Storage Battery Company in 1898 and was successively connected with the Boston, Chicago and St. Louis offices, and later became manager of the Pittsburgh office of the Electric Storage Battery Company. In December, 1908, he went with the National Battery Company as manager of its Boston office, continuing as manager of this office when the National Battery Company was absorbed by the United States Light & Heating Company. He remained at Boston until 1916 and was then made manager of the Chicago office of the U. S. Light & Heat Corporation. On January 1, 1917, he was appointed sales-manager of the battery department, with headquarters at the USL factory in Niagara Falls, where he will continue to be located as vice-president, in charge of sales to manufacturers.

MUSIO’S CIRCULARS

Two circulars recently distributed by the Musio Radio Company, Inc., of Pittsburgh, Pa., can scarcely be described in words that will do them justice. Printed in folder form with an open spread of about 14 by 21 inches, in three colors, the story of the Musio crystal detector and crystal set is told completely and convincingly. The set itself is shown in actual size and color, while the features of the set and the opportunity for dealers is clearly told. A more attractive “business-getter” display has yet to come to the attention of the RADIO DEALER office. If in doubt, see it for yourself.

Marconi says:

THIS country is far in advance of any other in the radio development—so does NYCO; we ought to know, because we are supplying dealers and amateurs throughout the country with the best standard equipment.

*A complete set—or any part of it!
“Write for our latest price booklet”*

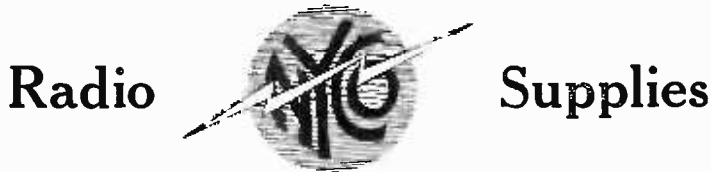

507 PENWOOD AVENUE

WILKINSBURG, PA.

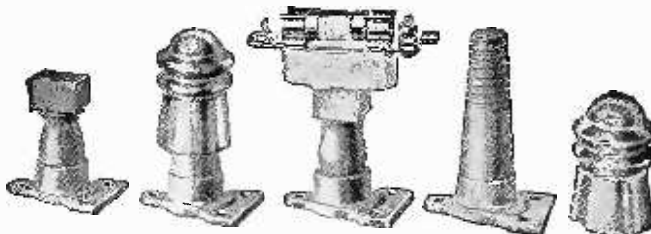

X-RAY INSULATOR ADAPTER

fills a long felt want for a lead in insulator—approved, up-to-date, complies with every regulation, both national and local, made in two styles—one for lead in, one for lightning arrester.

Aeroplane Wire

19 Strand Silicon Bronze Aerial Wire. Each strand (tinned.)
Guaranteed to give 100 per cent satisfaction.
This wire was used during the war by the U. S. Government for aeroplane and trench work and was the only wire to stand up under these conditions.
We have the entire supply and are prepared to make immediate shipments.

Cory Phones 2000 Ohms Connecticut Phones 3000 Ohms Turney Phones 3000 Ohms

Liberal Dealers' Proposition

HINTZE BROS., Inc., 459 Central Ave., Newark, N. J.



Junior List \$0.35

“IDEAL” SWITCH LEVERS

Look “IDEAL” on any panel
The switch levers with the
“Mirror-Like Knob”



Senior List \$0.50

What looks more ideal than “Ideal” Switch Levers on a panel? The knobs are made of genuine THERMOPLAX, a cold molded composition. Each and every knob is hand buffed, thus giving it a very high polish. AND THE POLISH LASTS. The levers are blue-nickled, and all the parts are highly polished. They are really perfect products that will improve the appearance of any set.

Made in two sizes, both with plain, highly polished surface knobs.

JUNIOR—Radius of lever 1”.

SENIOR—Radius of lever, 1 3/8” and 1 1/2”.

Write for Attractive Discounts and Circulars.

“IDEAL” Variable Condensers

Bakelite tops and bottoms. ALL parts nickel-plated brass. Can be used for either table or panel mounting. Highly efficient and all capacities are strictly guaranteed.

43 plate Cap.....	.001	\$3.50	5 plate Cap.....	.000095	\$1.75
21 plate Cap.....	.0005	2.75	8 plate Cap.....	.000075	1.25
11 plate Cap.....	.000025	2.25			

We carry a complete line of radio supplies in stock. Transformers, rheostats, potentiometers, sockets, variometers, variocouplers, coil mountings, dials, spaghetti, etc.

Write for Price Lists and Discounts.

NEWARK RADIO SUPPLY CO.

Manufacturers and Distributors Radio Supplies and Equipment

284 Market Street

Newark, N. J.

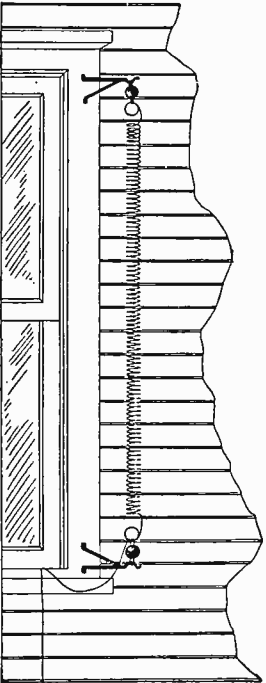

**“K-N”
HELIX ANTENNA**

Only 6 feet of space required to install
100 feet of wire

The “K-N” is adjustable to any space

The ideal aerial, made from ideal Antenna Wire

The “K-N” is a spirally wound aerial and is therefore adjustable to the available space, either on the roof, outside the window or within the home.

Jobbers and Dealers write for special discounts

Receptive area in all directions.
Remains taut—no swaying.
Installed with greater ease.

RETAIL PRICE, \$1.60

Manufactured by
WALTER S. KRENZ

339 So. Central Park Blvd. CHICAGO, ILL.

Forms for the
NOVEMBER ISSUE OF THE RADIO DEALER
Close at New York, October 15th. Advertisers desiring proofs
should have copy in considerably earlier
ADVERTISING DEPT., THE RADIO DEALER
1133 Broadway, New York, N. Y.

QUALITY-PLUS INSTRUMENTS



Type 711

HOME Radiophone Receiver

A vacuum tube set with wave length range of 150 to 2600 meters. Wonderful reception; simplicity of operation and extremely attractive appearance.

List Price, \$35

ADD-A-STEP DETECTORS AND AMPLIFIERS

Handiest instrument for station or laboratory ADD-A-STEP at any time. Extremely efficient, neat and compact.

PRICE: Detector, 704, \$5.75; Amplifier, 705, \$10.50. These instruments awarded the Mail Radio Institute Certificates of Excellence, May 20, 1922.

DEALERS, JOBBERS, DISTRIBUTERS

Liberal discounts, quick turnover and hearty co-operation
Does this interest you? Wire or write immediately

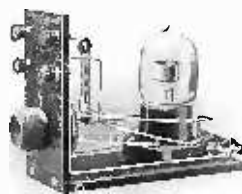

Type 704

ARROW RADIO CO.

Manufacturers of QUALITY-PLUS Instruments

HACKENSACK

NEW JERSEY

Passing of Unfit

(Continued from page 47)

of money by selling the article for \$1.10, so he reasoned. He knew nothing of the executive end of a business; scientific production, cutting waste, salesmanship, financing, all these were foreign to him. Yet he went into the radio business! And out again, as a matter of course.

This type of man is being weeded out by the law of the survival of the fittest. The men who are remaining are those who have all the requirements he lacked.

Years ago the pioneer in a new industry could get no help from other sources than his immediate associates. He was compelled, by the force of his own brain-power to solve his own problems and overcome the obstacles he continually met.

The pioneer in the radio business to-day has better chances for success. He can call to his aid more men trained in the principles of the business world, trained in that bugaboo of manufacturing—costs, and trained in finance.

These men are the Certified Public Accountants of each state, whose profession is one of great assistance to the business man.

One of the things most astonishing to me was that none of the bankrupts employed an accountant, or even had a competent system of accounts.

It is a deplorable fact, and one well known, that few concerns in the radio field, be they manufacturers or dealers, made any real money within the past year; this in spite of the fact that for a period of six months or so merchandise was hard to get, and brought a large sum when sales were made. Why?

In my opinion it was simply a case of men working blindly, with nothing to guide them or to throw some light on where they were and where they were going.

Take the question of purchasing alone. A simple system of inventory-keeping can keep a man from either filling up his shelves with unsalable merchandise or from being caught without any merchandise when he most needs it.

Mr. Manufacturer and Mr. Dealer, your books are a veritable “gold mine” of information if you will but use them. An analysis of them will prevent you from doing things that will hurt your chances of making money, and will aid you to realize the direction in which you are headed.

The profits of a business can be substantially increased, its operations greatly simplified, and the "inevitable" uncertainties eliminated by the installation of a simple system of accounts.

Do you know just what your overhead expenses are for manufacturing, for selling, for administering the business? Are you figuring the proper rate of depreciation on your machinery or the cost of financing the business?

The radio business is fast getting to a point where its stability will be the same as in other businesses, where growing efficiency makes for keener, more legitimate competition, and when "feeling your way" will be eliminated.

FOLDER CATALOG

The McConnell Cable and Specialty Company of Chicago have distributed a compact circular-catalog that opens in a manner that invites perusal. Printed on firm stock, the circular lies flat when opened and remains in sight thus, defying the inattention of the more ordinarily disinterested customer.

NEW MOUNTING FOR CRYSTALS

The Radial Electric Company of Passaic, N. J., reports that it has a method of mounting crystals that does away with the use of the heat necessary for mounting with woods metal. The company uses a special conducting compound that has all the appearance of a metal. This process covers the general objection often raised that the use of heat is injurious to the crystal.

LINGA VARIABLE CONDENSERS

The Linga Variable Air Condensers, the product of the General Radio Laboratories of Chicago, are made of high-grade materials and are high-class in value, appearance and efficiency. The panel mounting type is furnished complete with large composition dial and knob. The scale reading in hundredths aids in making fine adjustments.

The peculiar construction of the Linga condensers adds greatly to their efficiency and appearance. The stationary plates, machine spaced, are riveted into the tubular posts and the movable plates are cast into the center posts, making perfect electrical contacts throughout the various units of the condenser thereby eliminating current leaks due to inefficient or faulty spacing between plates.



A Sales Room in New York for a Dollar a Day

at the

Permanent Radio Fair

(Located in the "Buying Hub" of the United States)

Under the personal direction of

Raymond Francis Yates

Radio Editor, New York Evening Mail

GEORGE T. KEEN,
Business Manager

MORTON STERNS, I.R.E.,
Technical Director

At the present time the radio industry is badly in need of a centralized exhibition of reliable merchandise, where buyers may come and make their purchases with a feeling of security. The Permanent Radio Fair is such a place; it is the official radio buying center of the United States. Buyers from every part of the country are visiting the Fair, because it saves them time and worry in selecting their merchandise. Only apparatus of recognized standing is being displayed and nothing will be accepted that does not meet with the approval of Mr. Yates, Director of the Fair. The Fair is open only to buyers during the morning. General public admitted during afternoon and evening.

The Permanent Radio Fair is being held in the famous Red Room of the Hotel Imperial, where 165 glass-covered compartments ranging in size from 24 x 24 x 36 inches to 36 x 36 x 36 inches have been provided. These spaces rent at a charge of from \$1 to \$3 a day.

Send for Literature

A partial list of the exhibitors follows:

DeForest Telephone & Telegraph Co.	W. E. Supply & Service Corp.
A. H. Grebe & Co.	Norman W. Henley Pub. Co.
C. Brandes, Inc.	Finch Radio Co.
Multiple Storage Battery Co.	Radio Winding Co.
Pacent Electric Co.	Victor Radio Co.
Signal Electric Co.	Mercury Radio Co.
Federal Telephone & Telegraph Co.	Post Electric Co.
Dubilier Condenser & Radio Corp.	Metropolitan Radio Corp.
Cutting & Washington	Wireless Press.
Horne Manufacturing Co.	Electrad Corp.
Radio Corporation of America.	Globe Radio Co.
Hopewell Insulation & Mfg. Co.	Bruno Radio Corp.
Jewett Manufacturing Co.	Radio Laboratories of New Jersey.
Man-Day Radio Corp.	National Airphone Co.
Acme Apparatus Co.	Cairns Radio Corp.
Arrow Radio Co.	And many others.

Fair Opened Sept. 30th—Closes May 30th

PERMANENT RADIO FAIR, Inc.

Hotel Imperial

32nd Street and Broadway

New York City

COMPOSITION

LIST PRICE

DIALS **50^c** DIALSAdjustable Switchlevers
Knobs

NEW YORK-RADIO-DIAL CO.

316 Holden Bldg.,

Detroit, Mich.

Ask Our Service Bureau

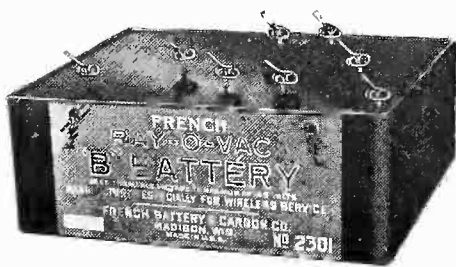
Sell Ray-O-Vac
"B" Batteries*Because they Reduce
Receiving Noises*

Your customers will notice the difference as soon as they start using Ray-O-Vacs. Ray-O-Vacs are unusually quiet because of their special construction—the thorough cell insulation, hand-soldered connections, perfect binding compound which holds cells absolutely rigid, the patent wire-spring clip that holds the smallest wire tight without cutting it.

Ray-O-Vacs are made by the same battery experts that have made French Ray-O-Lites famous for their quality and long life. You can build up a big circle of satisfied customers with Ray-O-Vacs. 22½, 45 and 100-volt sizes. Send for Bulletin 225 and prices.

French Battery & Carbon Co.

Madison, Wisconsin

Chicago Dallas Atlanta New York
Denver Minneapolis Kansas CityFrench FAY-O-VAC
"B"
Batteries

Vulcanized Fibre

(Continued from page 45)

with glycerine was originally used on honeycomb coils. In hot weather the glycerine was drawn out of the fibre in a manner that the radio amateur called "sweating." This caused a loss of energy in the honeycomb coils and since has been done away with by the use of a proper grade of fibre. Black fibre sheet can be polished to present a good appearance and is oftentimes used for panels on the cheaper sets. After being secured in place by screwing the panel to the cabinet, it shows no tendency whatsoever to warp. Fixed condensers made of tinfoil and paraffin paper are often wound around a fibre strip, which in this case acts as a support and also allows the use of a terminal at either end. Fibre sheet can be readily machined to the proper shapes for use as variable condenser tops and bottoms. Thin weight fibre, commonly known to the trade as "fish paper," is frequently used in transformers. Radio manufacturers making transmitting transformers oftentimes use this fish paper to insulate their windings from the core and also from each other. Amplifying transformers of the radio frequency type sometimes are enclosed in a fibre tube and the audio frequency type often uses fish paper for its insulation. Telephone receivers use fibre for their magnet heads. Plugs and jacks use vulcanized fibre for their insulation. Polished fibre tubing can be used to form the handle of a plug and small fibre punchings are used to insulate the contact springs of the jacks. The sparking points of lightning arresters are oftentimes enclosed in a fibre tube. Fibre sheet, when cut to size, makes a nice base for crystal detectors and other instruments. At least one manufacturer in this country makes a horn for his loud speaker out of thin-weight fibre. Sliders used on tuning coils are sometimes made from fibre. In this case, a square fibre rod is milled out to the proper size so it will fit over the brass rod. The contact of the operator's hand in adjusting a slider of this type causes no loss in the signal strength.

In attempting to show the use of vulcanized fibre in radio construction, it has been quite impossible to more than roughly cover the field and a great many small fibre parts are used which it would be impossible to enumerate.

States Radio Corporation

Manufactures

RADIO EQUIPMENT

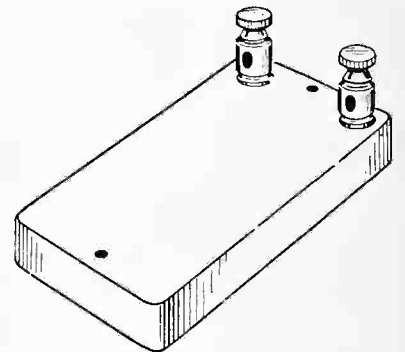

501 S. Jefferson St., Chicago, Ill.

Attention
Radio Dealers
and Jobbers
Sercos Radio
ProductsSercos Fixed Condensers,
moulded, 70 centsSercos Fixed Condensers,
moulded, 90 cents

Sercos Crystal Detector, \$1.25

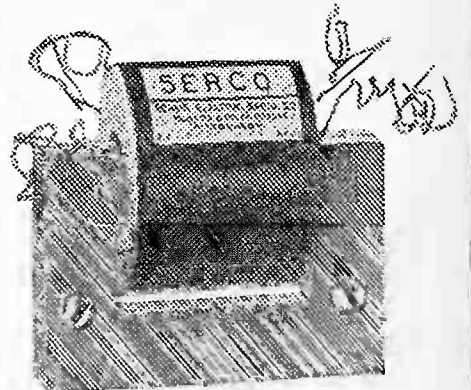
Sercos Amplifying Trans-
former, 10 to 1 ratio, \$3.25We are Manufacturers
of
Sercos Radio Products

Write for Trade Discounts

Scheib Elec. Radio Co.
6243 Station Street
Pittsburgh, Pa.

"N & K" NAVAL PHONES

The Herbert and Huesgen Company of New York City have obtained the sole distributing rights in the United States for the "N & K" phones, which were originally designed and constructed by a German manufacturer for naval use. Not being made for commercial use, but as the best possible product for the German naval service, the phones embody the latest items of scientific phone construction.

A detailed description of the phones gives definite proof of the superior workmanship embodied in their manufacture. They are of 6,000 ohms, two-and-three-quarter inches in diameter, with over-sized ear-cups for ease and comfort to the wearer; brass turned cases, nickel-plated inside and out; two-piece magnets in two semi-circular sections; small neat bobbins, rectangular in shape and cloth covered. The soldering and connections are neatly made. The internal metal parts are nickel-plated. A thin metal washer is used as a spacer between the case rim and the diaphragm. Leather head bands are carefully stitched and a six-foot cord is connected to the outside of the cases.

This company has announced its intention of conducting an extensive advertising and selling campaign to inform the public of the many features and quality of the "N & K" phones.

NEW VACUUM TUBE

A vacuum tube capable of supplying 100,000 watts, or 200 times the power required for the ordinary radio broadcasting station of 100 mile range, has been developed in the Bell Telephone system laboratories of the Western Electric Company, it was recently announced.

"The significance of these big tubes," says the company, "is that only a very few of them would be necessary to operate the largest radio stations now in service. The combination of vacuum tube and its current supply, it is expected, will be less costly, more rugged and more easily adapted to various wave lengths than any other source of radio power now in use."

The biggest problem was making the tube airtight. W. G. Houskeeper, a Western Electric engineer, solved it by discovering a way to seal copper to glass which would make an airtight joint that would not crack at any ordinary working temperature.

AMES

RADIO PRODUCTS

Manufactured by Heinze Electric Company, one of New England's foremost and oldest electrical organizations. Noted for its skill, quality of workmanship and efficiency for nearly one quarter of a century.

All radio products bearing the Ames trade mark are manufactured complete by the Heinze Electric Company and distributed nationally exclusively by Picard Radio Corporation.

Each product is uniformly guaranteed and due to large production prices are generally lower than competing articles of similar quality.

Distributors, jobbers and manufacturers write Picard Radio Corporation, 16 West 46th Street, New York City, at once for special discounts.

AMES Audio Frequency Transformer



Completely encased in non-magnetic metal, it is perfectly shielded.

Appearance and performance of the Ames Audio

Transformer are second to none. The round casing enables placing of the cores at right angles without detracting from the appearance of the set.

List price, \$5.00
Write for discounts

AMES Vario-Coupler

The appearance of this coupler alone is a guarantee of its salability.



Dealers everywhere pronounce it not only the best in appearance, but in performance.

All connections may be made without soldering if so desired. This is practically an exclusive feature.

Effective range 150-600 meters.
List price, \$6.00
Write for discounts

AMES Variable Condenser



In this condenser special attention has been paid to accurate spacing of the plates and to rigidity of construction, which is achieved by our own pat-

ented brass enameled end mountings.

Thus the annoyance of "shorts" between plates has been practically eliminated as well as unequalled variations in capacity.

All insulation is genuine Micarta.
11 plate, list price.....\$2.00
23 plate, list price..... 2.50
43 plate, list price..... 3.00

Write for discounts

Genuine Picardite Dials

"Fit any shaft"

A real man's size clean-cut dial with our exclusive interchangeable center bushing of brass, made



to fit either 3/16" or 1/4" shaft, thereby reducing the stock necessary to be carried by radio dealers.

Write for sample dial sent post-paid, 25c

List prices 2 1/2" size, \$0.60
3" size, .75
4" size, 1.00

Maximum discounts on minimum quantities

Sold only to recognized distributors, jobbers and manufacturers

Distributed nationally only by

PICARD RADIO CORPORATION
16 West 46th St. New York

These four cards, each 10 x 15 inches, sell the idea of radio to the people who pass your store.

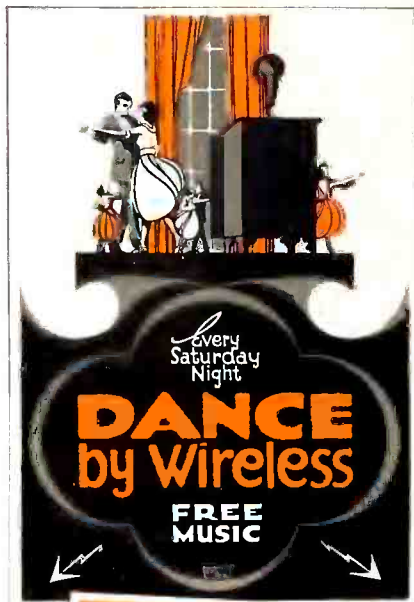

This map, size 19x28 inches, on heavy board, with easel.

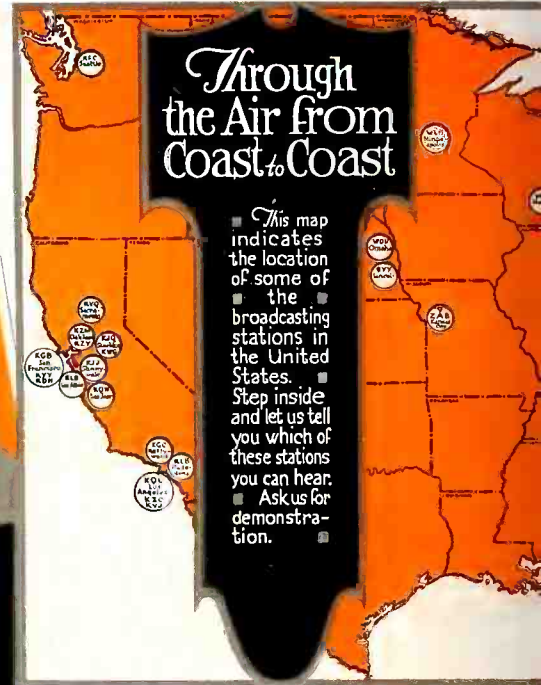

DEALERS! DEALERS! DEALERS!

This Complete

10-Piece Window Display

is YOURS—if you mail the Coupon—NOW!

A COMPLETE display—a real knock-out! Eye catching map, cards and streamers, in bright colors. Hand lettered by Millard, famous New York Artist. Originals worth nearly \$1,000. (See detailed description at right.)

The quantity is limited. Case of "first come, first served." If you want this big, classy, colorful material for your windows you must

act quickly. This announcement may not appear again.

Every dealer who has seen or used this display outfit says, "It pulls 'em to the window quicker than my loud-speaker. Gets 'em interested. 'Nough stuff in this one outfit for two big windows or for two showings in small window."

CLARK & TILSON, - - - 51 E. 42nd Street, New York

RADIO

This big strip, size 9 x 45 inches, to paste on the glass of your show window.



These four cards, each 10 x 15 inches sell merchandise for you—of any make.

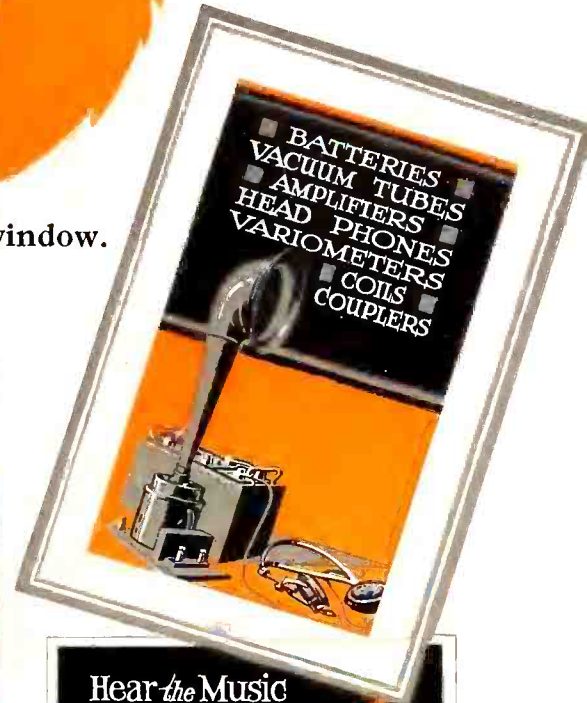

Detailed Description

This outfit consists of ten pieces as follows:

- 4 Cards, each 10 x 15 inches. Subjects, Dancing Concerts, Bed Time Stories, Time Signals, etc.
- 4 Cards, each 10 x 15 inches. Subjects, Make Your Own Receiving Sets, Complete Radio Outfits, Books and Magazines, and Miscellaneous Parts.
- 1 Large Map, size 19 x 28 inches, showing all of the Broadcasting Stations.
- 1 Large Streamer for Plate Glass, size 9 x 45 inches, (over yard long). Word "RADIO" in lightning effect letters.

Original paintings by Millard, New York Artist, who makes displays for famous Rivoli and Rialto Theatres and many well-known stores.

Lithographed in three bright colors on heavy cardboard. Each piece has heavy easel mounted in back to make piece stand upright in show-window.

All ten pieces, neatly finished and completely packed in single shipping container, ready for mailing to you.

SEND NO MONEY!

To get this beautiful set of window display material you must mail your order in to us. No salesman will call on you. This is a mail-order proposition. The supply is limited. If you want to be sure of a set,

TEAR OFF AND MAIL THIS COUPON—NOW!

CLARK & TILSON

51 East 42nd Street, New York City

We want one of the 10-piece Window Display Outfits described in the October RADIO DEALER. We believe it will help us get more people interested in Radio, and will greatly stimulate our sales.

Enter our order for shipment as soon as possible; we are sending no money—just this coupon. When the mail man brings our outfit we will pay him \$6, which is to cover the complete cost. It is understood that the outfit is to be sent us prepaid.

Name

Address

Town

State

A BEAUTIFUL RECEIVING SET—SIZE 8 x 2¾ x 4 INCHES
SPECIAL COMPOSITION METAL, CABINET FINISHED IN HIGH GLOSS, BLACK JAPAN, WITH POLISHED NICKEL TRIMMINGS

LIST PRICE
\$5.00

“PANDORA”

A GREAT HOLIDAY LEADER WITH A LARGE PROFIT

WRITE FOR ATTRACTIVE DISCOUNTS

SELECTIVE TUNING AND EXCELLENT REPRODUCTION, COMPACT AND DURABLE, WORKING PARTS PROTECTED FROM MOISTURE AND DUST

LIST PRICE
\$5.00

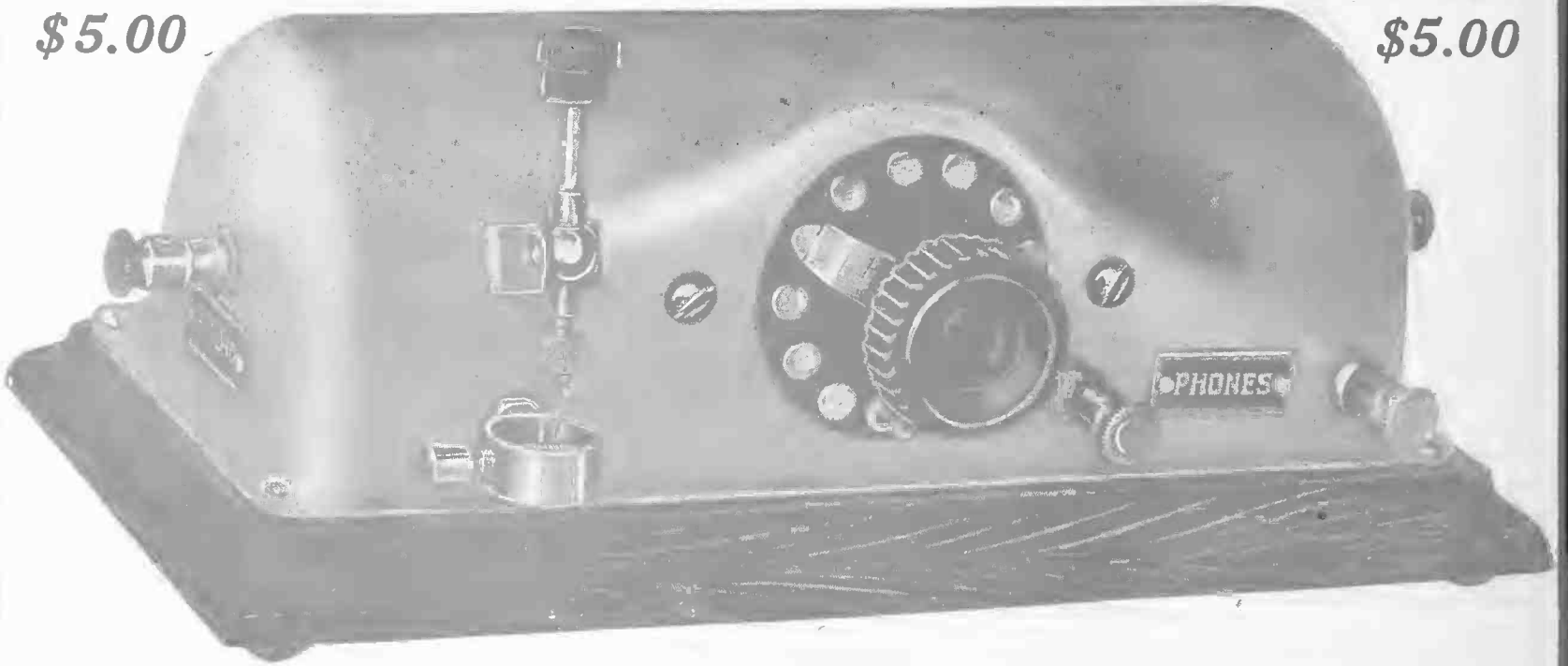

BROOKLYN METAL STAMPING CO., 718-728 ATLANTIC AVE., BROOKLYN, N. Y.



THE RIGHT SET IN A “SELLING MARKET”

Vacations are over! The public is again taking up Radio—greatest of indoor sports.

They are now radio-wise—they know what they want and at what price. They will buy only machines of highest quality—and STANDARD MERIT.

Be sure the sets you sell will stand the acid test of a “selling market”!

Our unique sales policy will make biggest profits for you. Write for it—Now!

Aerial-A surpasses in selectiveness and strength of tone machines of twice its price. Neat, compact, light in weight and

beautifully finished, Aerial-A sells at sight! A demonstration is a clincher!

Simple and easy to operate. Dealers have no difficulty in selling “Aerial-A.”

Manufactured by

W.E. Supply & Service Corp.

18 Murray Street, New York

Fisk Building, Broadway at 57th St., New York

Book Review

By **BERNARD JEROME FARRELL**

The Editors of the *RADIO DEALER* will be glad to review new publications in this field as they may be issued. Address them attention **BOOK REVIEW EDITOR**, the *RADIO DEALER*, 1133 Broadway, New York City.

THE A B C OF VACUUM TUBES USED IN RADIO TRANSMISSION. By E. H. Lewis. Published by Norman Henley Publishing Co., New York City.

The book explains thoroughly and clearly the use of the vacuum tube. It is extremely suitable for the beginner who knows little or nothing about radio and electricity. Starting with an explanation of elementary electrical terms and a list of symbols, the functioning of various vacuum tubes as detector and amplifier is explained completely and in an easily understandable manner. Speech distortion is thoroughly covered and a clear explanation of its elimination is discussed. Many practical circuits are shown and explained. The use of technical terms has been used only after their explanation has been given. The last chapter is devoted to the answering of a number of practical questions.

THE RADIO EXPERIMENTERS' HANDBOOK. By M. B. Sleeper. Published by Norman Henley Publishing Co., New York City.

For the amateur who is experimentally inclined this book should prove a valuable text book. It covers in a clear and concise manner the "Why" of radio, what makes it work, how to build simple transmitting and receiving sets. In the chapters on radio receivers the simple crystal, the simple tube and the regenerative types of receivers are explained in some detail. The questions of antenna is covered thoroughly and numerous suggestions are offered for experimentation. For those who desire to construct transmitters there is sufficient information given for the complete construction of a spark set, a C W set and a small radio telephone set.

RADIO, HOW AND WHY. E. G. Macay. 25 cents. 47 pages. The Radio Handbook Publishing Co., Philadelphia.

"This book is dedicated to the juvenile 'fan' and his Dad, who want to know how and why their receiving set works." This dedication explains the *raison d'etre* of this interesting little handbook.

MANUFACTURERS — JOBBERS — DEALERS



PLACE YOUR ORDERS FOR

EBY BINDING POSTS

NOW

Commander "H" Ensign "H"

Sergeant "SS" Buddy

To satisfy the tremendous demands for EBY posts, we have arranged with responsible jobbers everywhere to carry a complete stock.

Write for Bulletin 11 and latest discounts

THE H. H. EBY MANUFACTURING COMPANY, PHILADELPHIA, PENNA.

WALD ELECTRIC COMPANY

Manufacturers

"MICROSTAT"

A VERNIER THROUGHOUT ITS RANGE

INDISPENSABLE FOR NEW ARMSTRONG-SUPER-REGENERATIVE CIRCUIT, WILL ELIMINATE NOISES USUALLY MISTAKEN FOR STATIC

7 OHMS

2 AMPERES

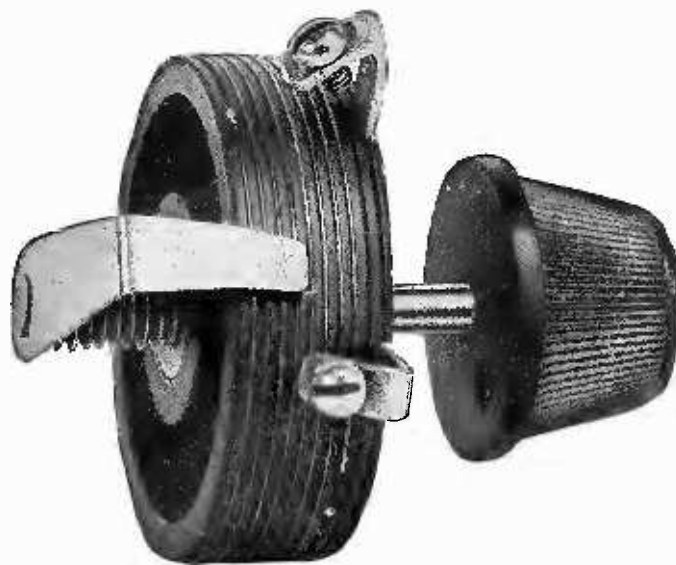

STEPLESS FILAMENT CONTROL

List Price

\$1.50

An Instrument of Merit

(PATENT PENDING)

HIGH HEAT RESISTING MOULDED V.T. SOCKET PHOSPHOR BRONZE CONTACT SPRINGS, 60c LIST.

DEALERS AND JOBBERS—WRITE FOR DISCOUNTS AND LIST OF RADIO PARTS WE MANUFACTURE

Sales Department

LOUIS A. STAFF CO.

1755 Broadway

NEW YORK



"True-Tone"
SUPERSENSITIVE
3000 Ohms

Worth More, Yet
Costs Less

"TRUE-TONE" Phones Perform Perfectly with all types of apparatus. Every factor of Scientific Design is coupled with 3000 Ohms Resistance.

Backed by a Guarantee—

JOBBERS—DEALERS

"True-Tone" Phones assure Quick, Profitable Turn-Over Our Advertising Backs You Up

Write or Wire— NOW **\$5.00** List 3000 Ohms

TRUE-TONE RADIO MFG. CO.
186 No. La Salle Ave., Chicago, Ill.

The Essentials of a Successful Radio Business Are Complete Sets and Phones

We are now making deliveries of

- Clapp-Eastham H-R—H-Z. \$80.00
- Grebe CR-9..... 130.00
- Grebe CR5-RORK..... 135.00
- Westinghouse RC..... 132.50
- Westinghouse RA-DA.... 138.00
- Frost Fones No. 162..... 5.00
- Murdock, No. 56, 2000 ohms 5.00

Send for our complete catalog of standard makes of Radio Sets, Parts and Supplies, and Dealers' Discounts. We have a big stock for you to draw from.

Julius Andrae & Sons Co.
In Business Since 1860
114 Michigan St., Milwaukee, Wis.

Mr. Macay starts with the history of Radio from the Electromagnetic theory of light to the present time, and unfolds the steps by which Radio attained its present growth. The fundamentals of Radio are then taken up, and by the aid of diagrams the various kinds of currents, resistance, capacity, and inductance are studied.

Mr. Macay's book leads the fan gradually into the study of circuits, which are fully explained by the use of a multitude of circuit drawings and cuts of various parts. The Radio Laws and Regulations of the United States, and the regulations of the fire underwriters, are included in the volume.

WIRELESS TELEGRAPHY AND TELEPHONY SIMPLY EXPLAINED. By Alfred P. Morgan. Published by the Norman Henley Publishing Co., New York City.

This is a most comprehensive treatise on the subject, and a close study of its pages will enable one to master all the details of the wireless transmission of messages. The author has filled a long-felt want and has succeeded in furnishing a lucid, comprehensive explanation in simple language of the theory and practice of wireless telegraphy and telephony.

This book treats the subject from an entirely new standpoint. It is well illustrated by over one hundred and fifty interesting photographs and drawings. All diagrams have been made in perspective, showing the instruments as they actually appear in practice. The drawings are carefully keyed and labelled. Many of the photographs are accompanied by phantom drawings which reveal the name and purpose of each part.

WHITALL CATALOG

The Whitall Radio Company, of Springfield, Mass., have issued a catalog that is both interesting and complete. The first few pages are devoted to an explanation of the principles of radio and a short history of the progress of the company, together with a list of the popular broadcasting stations, a key to symbols used in drawings and the international code and conventional signs. The catalog shows hook-ups of various sets from a two-slide crystal set to a detector and two-stage amplifying set, giving with each hook-up a list of the equipment necessary for assembling and the price of the respective parts. The reader can readily determine which set is best suited to his taste and pocketbook

100% Radio

Altadena Radio Laboratory

560 E. Colorado Street
Pasadena, Calif.

Jobbers of All Standard Radio Apparatus, including

- A-C Electrical Mfg. Company
- Acme Apparatus Company
- Adams-Morgan Company
- American Hard Rubber Company
- Automatic Electrical Devices Company
- Nathaniel Baldwin, Inc.
- L. S. Brach Supply Company
- Burgess Battery Company
- Blank Radio Call Book
- Central Radio Laboratories
- Edison Storage Battery Company
- Everett Electric Corporation
- Federal Telephone & Telegraph Company
- General Apparatus Company
- General Radio Company
- Jewell Electrical Instrument Company
- Colin B. Kennedy Company
- Magnavox Company
- Karlowa Radio Company
- Parkin Mfg. Company
- Radio Corporation of America
- John A. Roebings Sons Company
- Splittorf Electrical Company
- Thordarson Electric Mfg. Company
- C. D. Tuska Company
- Western Electric Company
- Westinghouse Electric & Mfg. Company
- Weston Electrical Instrument Company
- The Wireless Shop

PAUL FRANKLIN JOHNSON

THE KENTONE RADIO AMPLIFYING HORN



Made of brass, highly polished and nickel plated. Fifteen inches high, six inch bell

RETAILS FOR \$6.00

Write for particulars

F. C. KENT CO.

IRVINGTON NEW JERSEY

without spending much time shopping for this information. The latter half of the catalog is devoted to parts of various makes in detail. It permits the reader to decide just what set is best suited to his needs and all that remains for him to do is to place his order. It is seldom that a more complete, yet compact, catalog finds its way to the dealer's store.

CONSTRUCTION OF RADIOPHONE AND TELEGRAPH RECEIVERS FOR BEGINNERS. By M. B. Sleeper. Published by the Norman Henley Publishing Co., New York City.

The man who wants to feel the real thrill of accomplishment, and who is not satisfied in the merely making use of what others have done for him, builds his own radio apparatus. Experimenters and novices must take their instructions from reliable sources, however, to assure the success of their work. Radio men can follow the data in "Radiophone and Telegraph Receivers" in full confidence because each piece of apparatus described was first made, tested, and found efficient before the final design was accepted, according to the publishers. Special receivers, both crystal and audion, are shown in detail. Regenerative circuits as well as audio and radio frequency amplifiers are described and illustrated by clear photos, diagrams, and working drawings prepared especially for the novice and the man who wants to receive what is being broadcasted daily by the broadcasting station. A special feature is the phonograph type radio set and the loud speaker which is suitable for installation in the parlor or living room of the home.

EXPERIMENTAL WIRELESS STATIONS. By P. E. Edelman. Published by Norman Henley Publishing Co., New York City.

The theory, design, construction and operation is fully treated, including Wireless Telephony, Vacuum Tube, and quenched spark systems. The new and enlarged edition is just issued and is up to date, correct and complete. This book tells how to make apparatus to hear not only all telephoned and telegraphed radio messages, but also how to make simple equipment that works for transmission over reasonably long distances. There is a host of new information included. This volume anticipates every need of the reader who wants the gist of the art, its principles, simplified calculations, apparatus dimensions, the understandable directions for efficient operation. Vacuum tube circuits; amplifiers; long-distance sets; loop,



No. 410. Cut 3/4 Size.
Pat. Applied For

"THE BEST  IN RADIO"

This new panel mounting Rotary Dial SWITCH is absolutely the BEST. Just what you're looking for. Fully Guaranteed. Money back if you are not satisfied.

LIST PRICE \$1.00

Very Attractive Proposition to Dealers and Jobbers

VIRGINIA RADIO CORPORATION

Manufacturers—Jobbers

Charlottesville, - Virginia

MANUFACTURERS!

If you have not seen a copy of

The Radio Dealer Weekly

write for one today

Address: **The Service Bureau
The Radio Dealer**

1133 Broadway

New York City



2200 Ohms

List Price

Only

\$9.00

"East and West, the Globe is Best"

GLOBE RADIO HEAD PHONES

Highly sensitive Matched receivers Natural in tone. Each receiver tested by radio. Light weight (11 oz.). Comfortable to wear. Specially designed adjustable headband. Will not distort signals when amplified. Articulation is perfect.

There are many types of head sets on the market but not too many good ones. The GLOBE RADIO HEAD SET incorporates a knowledge of acoustics not possessed by other companies. It embodies correct design with the best of materials.

THE GLOBE PHONES ARE FOR THOSE WHO DISCRIMINATE.

Ask about the Globe Antenna Attachment Plug for using electric light wire

GLOBE PHONE MFG. CO.

EARL C. HANSON, Technical Radio Expert

Reading, Mass., U. S. A.

ANTENELLA



Forms perfect receiving aerial.

No outside wires necessary.

Plugs into any light socket.

Uses no current.

Eliminates most static.

Saves cost of lightning arrester.

Receives in any room of the house.

Gives sharper tuning than an outside antenna.

The New York Mail says: "An exceptionally neat plug, well designed and well constructed. Awarded the Evening Mail Certificate of Excellence."

Price \$2.00

Jobbers: Wire or write for Proposition

Manufactured only by

Chas. Freshman Company, Inc.

Dept. RD

290 Hudson St. New York City

coil, and underground receivers; tables of wave-lengths, capacity, inductance; such are a few of the subjects presented in detail that satisfies. It is independent and one of the few that describe all modern systems.

CONSTRUCTION OF NEW TYPE TRANS-ATLANTIC RECEIVING SETS. By M. B. Sleeper. Published by the Norman Henley Publishing Co., New York City.

In addition to the listening to ships and broadcasting stations on short wave-lengths there is a peculiar fascination about listening to the high-power telegraph stations of England, France, Germany, Russia and Italy as well as those located in the Pacific Ocean and the Oriental Countries. The sending is very slow, a feature of assistance to the beginner in telegraphy. Several types of receiving sets for this task are described. Detectors, amplifiers, oscillators, etc., for long-distance reception are also described. Suggestions for the operation of relays by the signals and the reproduction of them on a phonograph are given. In addition there is some valuable data on home made wave-meters for testing and experimenting.

LEFAX HANDBOOK

Lefax, Incorporated, of Philadelphia, report the sale of ten thousand copies of their loose-leaf Radio Handbook, and are following up this useful handbook with a file of neat "Apparatus Sheets" that should prove very useful to the trade. This apparatus file is made up of separate sheets that tell in a clear and concise manner the equipment manufactured by various radio concerns. It is the intention of the company to list only those firms whose apparatus meet a definite standard. The file is continually added to so that the buyer is well informed as to what new and worth-while equipment is on the market.

HOW TO MAKE COMMERCIAL TYPE RADIO APPARATUS. By M. B. Sleeper. Published by the Norman Henley Publishing Co., New York City.

For the man who builds and designs his own equipment there is a lot of satisfaction in knowing that his apparatus is comparable to that of commercial design. The book describes in detail many commercial types of transmitting spark and vacuum tube sets, both telephone and telegraph and receiving equipment of all kinds. The experimenter will be able to get a world of ideas for the design and construction of his next piece of radio equipment from the very clear descriptions and the many clearly illustrated figures.

TRADE **HPMCO** MARK

Reg. U. S. Patent Office

Molded fixed Condensers are best by test. The newcomers to radio invariably want this type. Experienced amateurs demand them as the molding process.

No. 20 Fixed Condenser 70c.

insures permanent capacity.

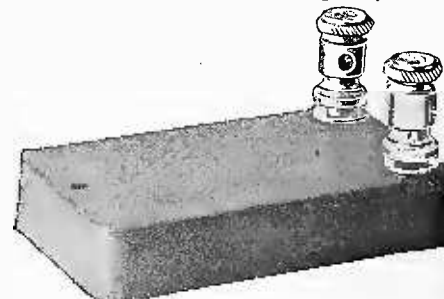

Duplex Binding Post Clips are just what your customers demand when using two pairs of headsets. 5c each. Each Clip adds two extra connections.

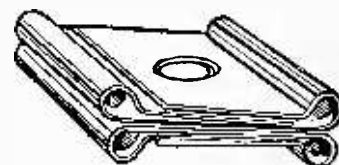

Write for Our Liberal Discounts.

HEDDEN PLACE MACHINE CO.
44 HEDDEN PLACE
EAST ORANGE, N. J.



Dealers All Over the Country Handle Our

STANDARD RADIO GOODS

OUR TRADE PRICES
AFFORD GOOD MARGIN

*Write for catalogue
and price list*

**WIENER WIRELESS
SPECIALTY COMPANY**

21 ACADEMY ST.

NEWARK NEW JERSEY

"BECO"

RADIO FREQUENCY
SETS

145 TO 600 METERS
\$160.00

"BROADCASTER"
MODEL VARIO METER

Lightest and Most
Compact on the Market

"RIEHL"
AUDIO FREQUENCY
TRANSFORMERS

\$4.50

HIGH GRADE CONDENSER
PLATES

DUO-LATERAL COILS

**BISSELL
ENGINEERING CO.**

161-67 WEST 64th ST.
NEW YORK

DESIGN DATA. By M. B. Sleeper. Published by the Norman Henley Publishing Co., New York City. There are few books on the market that deal with the designing of radio transmitting and receiving sets without the use of advanced mathematics. The system used is that which permits an intelligent effort in the construction. Many experiment aimlessly until they strike upon something. With the use of this book the experimenter and designer are taken step by step through the elementary stages of approved design. When they have finished only the first twenty pages they are in a position to work with a more intelligent and directive effort. There is not a single freak diagram in the book.

KING RADIO CATALOG

Among the many catalogs which have come to the office of THE RADIO DEALER, one that stands out as distinctive and efficient is that of the King Sewing Machine Company of Buffalo, N. Y. The catalog has a sturdy and attractive cover and is of loose leaf type. Sheets are issued at various periods that are to be included in the catalog in the form of bulletins dated and numbered for the convenience of the reader.

ADD-A-UNIT RECEIVER

The Sieffert Radio Laboratories of Evansville, Indiana, are manufacturing a receiving set that is of the progressive unit type which has been appropriately named Add-A-Unit. The units consist of Variometer, Variocoupler, Detector, Single and Two Stage Amplifiers. Separate variometers and variocouplers are produced under the Sieffert name together with a special six volt "A" battery.

A. R. R. L. AMATEUR TESTS

Announcement has been made by F. H. Schnell, traffic manager of the American Radio Relay League with executive headquarters at Hartford, Conn., that the Third Series of Trans-Atlantic Tests will be conducted by that organization in conjunction with the Wireless Society of London. The tests are to be conducted from December 12th to 31st, inclusive.

There is to be an elimination contest held from October 25th to November 3rd inclusive to determine which stations will be permitted to transmit to the foreign amateurs, one requisite for qualification being that the transmitter must have been heard over an air line distance of 1,200 miles.

JOBBERS and DEALERS

Our Motto: Service and Quality

25 years in the Electrical field. We are in full production on 50 Standard Radio parts. Engineered and designed right, and manufactured under minimum overhead.

Our prices will interest you

Write for Catalog No. 50

ALDINE RADIO & MFG. COMPANY
 Dept. B10 Aldine Square Chicago, Ill.

**WHAT HAPPENS
 When You Get *Our* Franchise!**

WE have built our business on the sound belief that it is better to supply a few good dealers with all they need than it is to take orders from Tom, Dick and Harry and fill as many of these as high speed production and not too careful methods will permit.

Instead—we make our retail organization fit our actual production. We work ceaselessly to increase production; yet we work just as ceaselessly to see that every product of this increased production will mean a satisfied user and an enthusiastic and permanent dealer.

In the face of the terrific demand for Radio Sets, ours in particular, it is no easy matter to turn down orders. But we find that it pays us extremely well. Every one of our retailers knows that all of his orders will be filled on time. And he knows that every piece of Radio apparatus will be of highest quality, fully inspected, rigidly guaranteed by us and worthy of his own personal endorsement.

Each week sees an increase in our production of the right kind of Essential Radio parts and Complete Sets. Each week we have a real connection to offer a few good dealers. It will pay you to learn all details of our remarkable proposition. Write us NOW. Be in line to get our service when our production warrants this step.

We are one of America's soundest financed manufacturing concerns. To our dealers this means responsibility, permanence and a continually more valuable and profitable connection.

The Public Knows
 The Value of This
TRADE MARK
 This distinguished mark on any Radio Apparatus means "A Quality Product Worth More Than Its Price." It makes steady customers for the retailer and for us.



Makers of Radio Quality Products
GRAND RAPIDS - - MICH., U. S. A.

ZETA RADIO FREQUENCY TRANSFORMER

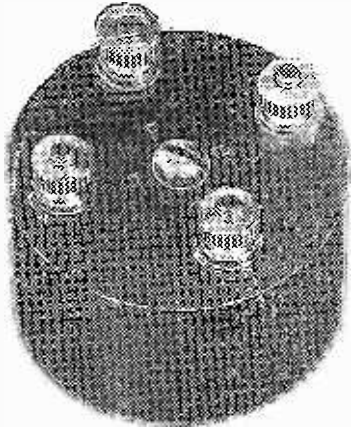

SCIENTIFICALLY TESTED
FOR ALL CHARACTERISTICS

LIST PRICE, \$3.50

Satisfaction Guaranteed

JOBBERs and DEALERS
WRITE FOR DISCOUNTS

CLARK & TILSON

51 East 42nd St. New York

Conquerer Radio Set Built by Lewis DeRoy

The Lewis-DeRoy Radio Corporation of New York City have presented to the market a receiving set that is the product of their knowledge gleaned

set are the shielded bakelite panels solid mahogany piano finish cabinet, balanced type single bearing variable condensers, special designed air-

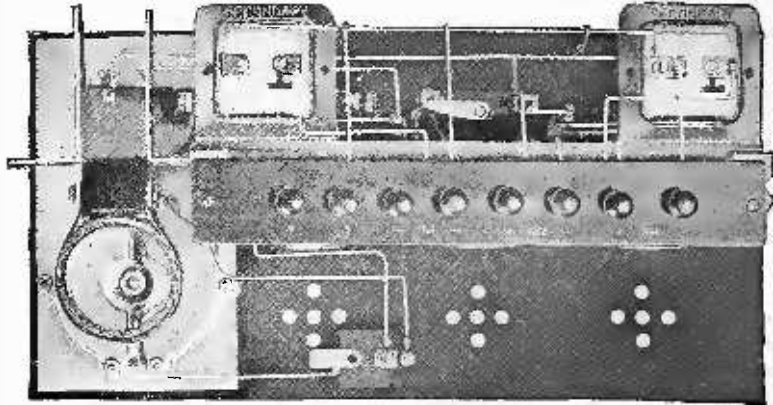

The Conqueror

from 17 years' experience in radio, under the appropriate name of Conquerer. The set is attractively and efficiently constructed and simple to operate. Among the features of the

cooled rheostats, sockets with positive locked contacts, transformers that give volume without distortion. A wave length range of from 150 to 15,000 is claimed for the set.

Stories in the Air

W O R Has a Short Story Contest as Feature

Short story writers, past and present, professional and amateur, have been submitting short stories for the past two weeks in a contest arranged by WOR, the radio broadcasting station of L. Bamberger & Co., of Newark, N. J.

There were no restrictions as to the subject matter of the short stories eligible for this contest, except that the stories should be short enough to be read in twenty minutes.

The winning story will be broadcasted just as soon as the judges have made their selections.

Score another for radio.

VERNIER RHEOSTAT

The Cutler-Hammer Manufacturing Company of Milwaukee, Wisconsin, are manufacturers of the Vernier rheostat now on the market. The instruments comprise the result of the long experience of Cutler-Hammer in the manufacture of electric controlling devices. The material used in the rheostats is the best that good usage ordains and the workmanship is of the best.

The Gelman Plug



The GELMAN UNIVERSAL RADIO PLUG fills a long felt want for a simple substantial plug which can be used with telephone cords having pin tips, spade tips or plain wire ends. All METAL PARTS heavily nickel plated. NO SOLDERING NECESSARY. List price, \$1.00.

AGENTS WANTED THRUOUT THE U. S.

Sample Sent C.O.D. Upon Request

Jobbers and Distributors

Write for Our Proposition

S. S. NOVELTY CO.

255 Bowery

New York, N. Y.



24 Hour Service!

A reality — your order shipped within one day after we receive it. No needless delay—no broken delivery promises to your customers. Our stock is large and complete — standard, well known apparatus only being carried. Each article accurately tested in our own laboratory by expert radio engineers.

We are distributors for the Radio Corporation of America and also handle everything necessary for the construction and operation of the Armstrong Super-Regenerative Receiver.

Write for our booklet!

**Radio & Mechanical
Trading Corporation**

23 Warren Street, New York City
Phone Barclay 0926

RELY ON QUALITY

(Continued from page 45)

parts made by manufacturers of recognized merit.

The writer has noted in getting around to the stores of radio dealers that dealers were willing to sell an inferior article when they knew it would not give proper satisfaction and where, with good salesmanship and right instruction the buyer would get better results and lasting satisfaction by making his set with quality products, and a better sale would result and a satisfied customer assured the dealer.

Therefore, it is necessary for all manufacturers of radio parts and sets of quality to have their salesman start a "campaign" of instruction for the dealer. They should be taught to recognize the importance of handling only well known makes of standard quality and pass this on to the consumer who will profit thereby in the satisfaction derived from their sets.

LEE PRODUCTS COMPLETE

The Lee Radio Corporation of Haddonfield, N. J., are producing several combinations of sets that include everything from a simple crystal detector set to a two stage audio-frequency amplifier. The sets are attractively built and enclosed in solid mahogany cases and some are also of the panel type.

The single circuit non-regenerative receiver and bulb detector is mounted on a formica panel and enclosed in a solid mahogany case. Two aerial binding posts are provided, one for long and the other for short wave lengths. By connecting the grid condenser binding posts and hooking in a radio frequency transformer, the detector bulb may be used as a radio frequency amplifier.

The company claims that this instrument has received 'phone messages over a distance of more than 500 miles.

THE ACMESTAT

The Acme Electric Company, of Milwaukee, manufacture a vacuum tube filament control rheostat known as the Acme-stat which is a radical change from the popular wire resistance rheostat that is found on the market today. The principle of operation is a resistance material in which is placed a crumbling spring operated by a screwed knob. A feature of the Acme-stat is the addition of a switch which permits the resistance setting to remain in position when the current is turned off and the set not in use.

ESTABLISHED 1909

DEPENDABLE  LINE



NO. 41 VARIOMETER



NO. 42 VARICOUPLER

INSTRUMENTS
WITH
100% RADIO
EFFICIENCY

THE EASTERN SPECIALTY CO.

3551 N. FIFTH STREET

PHILADELPHIA

Correspondence Solicited

STOP-LOOK-WRITE

DEALERS, JOBBERS AND MANUFACTURERS

Before placing orders, write us first and get samples and our big discount sheet.

Condensers 43-Plate.....	List \$3.50	Turney Head Sets.....	List \$6.50
" 23- "	2.75	Dials 3"75
" 11- "	2.25	Variometers	3.50
" 7- "	2.00	Variocouplers	3.50
" 3- "	1.50		

SPIRO BROTHERS, Manufacturers and Distributors

519 Real Estate Trust Building

Philadelphia, Pa.

LATEST and MOST POPULAR

Radio Books

- Radio Hook-Ups**,* by M. B. Sleeper \$.75
An indispensable book to the radio amateur who designs or builds his own receiving apparatus.
- Radio Design Data**, by M. B. Sleeper75
A book giving tables and data for designing receiving and transmitting apparatus.
- Construction of New Type Trans-Atlantic Receiving Set**, by M. B. Sleeper .75
Tells how to listen to the high-power telegraph stations of foreign countries.
- Construction of Radiophone and Telegraph Receivers for Beginners**, by M. B. Sleeper75
Tells in detail the building of radio apparatus.
- How to Make Commercial Type Radio Apparatus**, by M. B. Sleeper.. .75
Describes in detail many commercial types of transmitting spark and vacuum tube sets, both telephone and telegraph and receiving equipment of all kinds.
- Wireless Telegraphy and Telephony Simply Explained**, by A. P. Morgan. 1.50
A book the Radio experimenter cannot afford to be without.
- Experimental Wireless Stations**, by P. E. Edelman 3.00
A book describing all modern improvements.
- A B C of Vacuum Tubes Used in Radio Reception**, by E. H. Lewis. . . 1.00
A book explaining in detail all about vacuum tubes.

FREE! Catalogue of Wireless, Automobile and Other Books Sent Free on Request

The Norman W. Henley Publishing Co.

2 West 45th Street, New York

Liberal Discount to Supply Houses. Write for full particulars and dealer's proposition.

Oranola Perfection Talking Machine De Luxe

Properly Perfected Combination Radio and Talking Machine Produced
by Talking Machine Makers of Genuine Repute

By R. C. HULL

Music is both a comfort and solace, aye, it is a universal language which reveals inspiring thoughts to an inner human consciousness, and when music can be brought to our homes from hundreds of miles distant, without wires—the wonder is supreme.

That's the thought that comes to mind as one views the Oranola.

It is not necessary to make many complimentary statements about the Oranola, regarded by many as "the perfect talking machine" because "seeing is believing" and I have seen and heard the Oranola.

These perfect receiving sets, carrying the title, Oranola, are of three different designs, ranging in retail price from \$150 to \$450.

The model known as "De Luxe" is hailed as the utmost in present day radio receiving sets, inasmuch as it is a combination radio and talking machine. Each is complete in itself. Coupled it is a masterpiece production. And so the "De Luxe" title is no misnomer.

The Oranola De Luxe is of the Console type, Cabinet, mahogany, piano finish and as a piece of furniture would be considered an ornament in any drawing room.

So wonderful are the sounds that are emitted from this radio talking machine that listeners are not certain they're not hearing the real concert—rather than a reproduction.

The Oranola, it is apparent, makes for another era in radio for it couples the phonograph with radio definitely and indicates the path of success to many phonograph manufacturers. The Oranola is a pioneer in this and congratulations should be extended to the makers for their activities.

A brief description of the Oranola, illustrated herewith, will not be amiss.

The Oranola includes radio and audio frequency transformation of the energy received from the transmitting stations, so proportioned that the volume of sound is obtained without distortion. The current supplied to the vacuum tubes is controlled by a single push button switch.

Tuning is accomplished by a single adjustment. Signal strength is regulated by a potentiometer gradually to

a maximum with a detector and filament current controlled by rheostats.

Wave length adjustment is 200 to 500 meters.

Binding posts and connections are provided for outdoor aerial. Connections are provided for battery charge, so that batteries may be recharged without removal from the cabinet.

The Oranola was first displayed to the public at the recent National Merchandise Fair, at New York. The models were properly admired and the host of visitors were treated to real entertainment—for the Oranola does produce perfect music.

One reason for the successful Oranola is due to the knowledge had by the makers, the Perfection Talking Machine Company, of 228 Seventh Avenue, New York City. This organization has been identified with the talking machine industry since its inception and have had large experience in sound reproducing machines.

The Oranola is built by these men—these proven experts in the talking machine field and is not the result of any haphazard experimentation.

The president of the company making the Oranola is Edward B. Jordan, Jr., and Edward B. Jordan is its treasurer. The latter gentleman is well known in fraternal circles, being the founder of the famous Lu Lu Temple of Philadelphia and of which body he was its first Potentate.

CROSLY STATION OPEN

The new broadcasting station of the Crosley Manufacturing Company, of Cincinnati, Ohio, was officially opened on September 22nd, with an elaborate program. Powel Crosley, Jr., president of the company, and Mayor G. P. Carrel were among those who addressed the listeners of WLW's powerful station.



The Oranola Combined Set

New Distributor

Central States Engineering Company to Operate on Large Scale

J. Donald Vandercook who has been identified with radio since 1907, in the commercial end as manufacturer and retailer since 1914, has organized the Central States Engineering Company, 184 West Washington Street, Chicago.

This organization is to represent manufacturers of non-conflicting lines and will act as a distributor throughout the Middle West territory.

Speaking to a RADIO DEALER representative, Mr. Vandercook said:

"Briefly, my plan is to secure the representation of your products and a few other non-conflicting lines, and actively promote their wholesale distribution to my present clientele and to all other prospects in this territory. This I propose to do through several methods.

"First, by personal contact with my present clientele.

"Second, by circularizing a list of over 2600 potential purchasers in a manner that will 'tie-up' with the national advertising of the products, and as this list is one which I personally compiled during my recent trip, it contains the very minimum of 'dead timber' and the returns from it will assuredly be greater than usual.

"Third, I have associated with me several young men of real sales ability, who are also radio technicians.

"This organization will personally follow up all leads secured from the circularizing, not only to take orders but to assist these new clients in a semi-technical way. This sort of service has proved its worth many times and will hold the client as a regular purchaser.

"Fourth, within a short time I will have a centrally located Sales Office in Chicago, and in addition to the above I will exhibit all products I handle at every important radio show or exhibition in this territory."

Mr. Vandercook, it might be stated, also is an officer in the Technical Development Section of the Signal Reserve Corps, U. S. A., and is also an Associate of the Institute of Radio Engineers.

A GOOD THING

Mitchell-Rand Manufacturing Co., of New York City, employ the slogan "Everything In Insulation" and prove this slogan to their customers and to those who receive the circulars and bulletins. The best thought for today: Ask to be placed on the Mitchell-Rand mailing list.

"TUNING IN"

To the right tune is very simple when your connections are soldered with the
NEW "POST SOLDERING IRON"
(The iron with the platinum heating unit)
Removable Soldering Tip

Designed especially to cover every requirement for delicate work.

The smallest practical-efficient instrument on the market.

Attaches to any socket, Universal Current. Fully Guaranteed.

From your jobber or write

POST ELECTRIC COMPANY

30 EAST 42nd STREET

Office 509

NEW YORK

(1/2 actual size)
List \$6.00

SPECIALTY SERVICE COMPANY

Manufacturers of

RITE RADIO PRODUCTS

Distributors for

LAWSAM LINE

OF QUALITY RADIO PRODUCTS

and Other Standard Equipment

Write for Prices and Discounts

Cor. 4th Ave. and Pacific St.

Brooklyn, N. Y.

Want to Buy Radio Equipment?

Ask Our Service Bureau

See Page Eighteen

KEYSTONE

FILAMENT RHEOSTAT

V. T. SOCKET

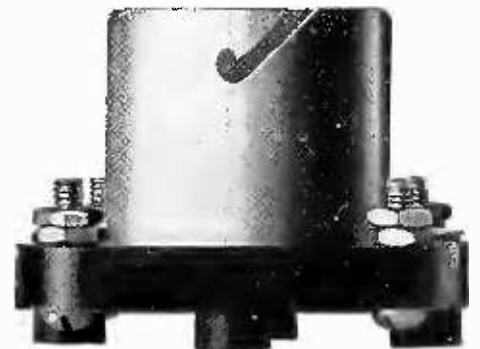

Resistance, 6 Ohms.
Carrying Capacity, 1 1/2 Amps.
Base, made of black moulded Bakelite.
All parts made of brass and nickel plated.
Large Knob, and polished pointer.
List Price, \$1.00

BASE and feet of moulded natural color Bakelite.

Contact Springs, Heavy Phosphor Bronze.
Heavy binding post.

Tube of heavy, polished Aluminum.

All brass parts nickel plated.

List Price, 90 Cents

Dealers and Jobbers, wire or write for discounts—Immediate Delivery

MANUFACTURED BY

KEYSTONE RADIO COMPANY

Dept. D.

GREENVILLE, PENN.



CRYSTALS **GAENA SILICON**

CRYSTAL DETECTORS List \$2.00

CRYSTAL RECEIVERS List \$9.00

RADIO APPARATUS CO.

6600 Hamilton Ave. Pittsburgh, Pa.

Prompt Deliveries

Jet black high finish panels, .01 per inch, 3" nonbreakable, flexible dial with knob \$.70

3½" Vario-Coupler.. 2.00

Complete Receiving Set, \$25.00

Beau Ivorie Novelty Co., Inc.

127-129 Van Buren Street
Newark, N. J.



THE BEST HEAD SET AS YET LIST \$5.75

Distributors—Jobbers
Dealers—Write

STANDARD ELECTRIC MFG. CO.

843 Broad Street
NEWARK, N. J.

SPRAGUE RADIO MODELS

The Sprague Radio Corporation of New York City, is manufacturing several models of radio receiving sets that bring to the radio field a pronounced touch of the artistic in so far as cabinet design is concerned. The sets themselves are the result of the experience the company has enjoyed in designing and building many successful transmitting stations for marine and land service, and as one of the principal suppliers of the Government and commercial companies. Sprague home sets are manufactured with all the care and precision used in the construction of their fine professional equipment.

Besides the set enclosed in a Queen Anne Period Console, the company markets a sectional receiving set consisting of a detector battery case, three stage amplifier and a Spragaphone loud speaker. The assembled units occupy comparatively little room and are mounted two units long and two high.

The officers of the company are C. W. Sprague, president; A. W. Duckett, secretary and treasurer. W. H. Knowles, well known in radio circles is in charge of the factory at Portchester, N. Y. Other men in charge of radio at the company's factory are H. Shoemaker and George Farrand, who were for many years connected with Marconi in the capacity of consulting engineers.

SALES TIPS BY RADIO

The latest trade promoting stunt devised by the Commerce Department to get the jump on America's competitors for the world's market is the broadcasting by radio of the inquiries for American goods coming into the Bureau of Foreign and Domestic Commerce from consuls, commercial attaches and other government representatives in foreign countries.

Selling American goods in foreign markets through the help of ether waves can be readily extended to other parts of the United States, in the opinion of Dr. Julius Klein, Director of the Bureau of Foreign and Domestic Commerce. Director Klein pointed out that his Bureau maintains 34 district and cooperative offices in this country, in addition to the Boston branch. The sending out of the information in each case is a problem for the local manager to arrange with some nearby broadcasting station, as all of them have been authorized to undertake the work.

RADION HARD RUBBER PANELS

Cut to Any Size
DISCS, WASHERS, BUSHINGS, ETC.
Made to Order

New York Hard Rubber Turning Co.
212 Centre Street, N. Y. C.

WOOD PARTS

Variometers, Cabinets, Rotors, Coil Ends, Etc.
Mill Established 1849
Lowest Prices

THE R. C. MILLS

Executive Offices 30 E. 23d St., N. Y. C.

RACONY PLUG

Genuine Mica Dielectric \$3.00 Made to Stand 2500 Volts

4 Outlet Plug with 14 Combinations

THE RACONY CORP.
799 Broadway New York City

MANUFACTURERS—DISTRIBUTORS

You Haven't Seen Our Line of
VERNIER and VARIABLE CONDENSERS

Tell us who and where you are and we will show the best line on the market.

ELECTRIC PRODUCTS CO.
11 Pemberton Sq. Boston, Mass.

American Radio & Electric Co.

1133 Broadway New York City

WRITE FOR OUR CATALOG
JUST OFF THE PRESS

GANAERITE

Detector Crystals

Twenty years of practical mineralogy gave us the material to produce the highest quality crystal.

We are now undertaking the largest single order for mounted crystals in the market.

We individually test and guarantee to replace or refund on any unsatisfactory Ganaerite crystal.

The Harris Laboratory
26 Cortlandt St., New York City

Washington Waves

By 3BSB
DX Transformer

The Radio Instrument Company, of this city, have had wonderful success with the DX radio frequency transformer, which differs widely in design from other transformers now on the market. A great aid in selling this article has been the diagram of a set built with the aid of these transformers, which is furnished free with each purchase.

The primary and secondary coils are so wound on a special iron core that the capacity effect between coils is reduced to a minimum. The coupling takes place through the core and is of the electro-magnetic type giving the greatest voltage transformation. The iron core is made up of thin tissue iron laminations, each insulated from the other so that losses from eddy currents and hysteresis are practically eliminated. The great advantage of the iron core coupling is to be found in the wide range of wave lengths over which the transformer will function efficiently. The use of an iron core makes possible small primary and secondary coils, thus preventing feed-back effects between transformers. Below 600 meters air core transformers are efficient only over a very limited range of wave lengths. Another feature of this transformer is the distance between the primary and secondary terminals, eliminating the loss due to capacity effects between these two sets of terminals.

There are three types of DX transformers, the DX-I, with a range of 170-450 meters; the DX-S, 400-1200 meters, and the DX-2, 900-3000 meters.

The Central Armature Works have placed on the market an unique, neat, and highly efficient crystal set on which they hold several patents. This concern was among the pioneers in radio in the Capitol City, and have profited by their experience with crystal sets, as is shown by the efficiency of their new set.

White and Boyer are doing an extensive wholesale and distributing business in Washington as well as throughout the south and southwest. Their broadcasting station is among the most powerful in Washington.

Thomas J. Williams is another experienced retailer and wholesaler who is doing a volume business in standard apparatus.



The Ideal Insulation

Every RADION part moulded by us has been designed only after a survey of the needs of the radio industry with a view to our future position in this field, and due regard to the protection of our reputation as oldest and largest specialists in Hard Rubber.

RADION Standard Parts include Panels, Dials, Sockets, Knobs, Insulators, Tubes, Rods, Discs, Bases, etc.

RADION PANELS in black, brown and mahogany are admittedly superior in finish, resistance to warping, and easy working qualities. In insulation value RADION is supreme. Competitive tests by the highest electrical authorities have established this fact.

Dealers will want our RADION illustrated circular, just issued. Write today.

Manufacturers—We are prepared to mould hard rubber pieces in quantity to exact specifications, such as Ear Caps, Condenser Bases, Knobs, etc.





VERNIER VARIABLE CONDENSER

With a capacity of .00001 to .003 MED. and the finest adjustment on the market today.

If you want to hear the far off concerts use this condenser.

Retail Price \$3.50

BUNTING STAMP CO.

713 Liberty Ave. Pittsburgh, Pa.

Manufacturers of Bakelite Dials
Fixed—Phone and Grid Condensers

RADIO REGULATIONS

(Continued from page 60)

spaced 5 inches if possible from grounded metal gutters, leaders, etc.

PROTECTIVE DEVICE.—Each lead in wire shall be provided with a protection device. This device shall be a lightning arrester of a type approved by this bureau.

It shall be located at the point the wire enters the building and properly connected. It may be inside or outside the building and mounted directly on the building, no separation distance being required.

It shall not be placed near inflammable gases or vapors or flyings of combustible materials such as gasoline, lace curtains, etc.

Antenna grounding switches are not approved unless a lightning arrester is also used, in which case the switch when closed shall form a shunt around the arrester.

PROTECTIVE GROUND WIRE—This ground wire may be bare or insulated and shall be not less than No. 14 B & S gauge copper or No. 17 B & S gauge copper clad. This wire should not have any sharp turns or kinks and should be run as direct as possible to the ground.

This ground should be a cold water pipe whenever possible. Gas piping should not be used under any circumstances.

If a driven pipe ground is used the pipe must be galvanized, 1 in. inside diameter and driven down at least 6 feet (the deeper the better).

When a ground wire is run outside, care should be taken to protect it from injury. This can be done by the use of wooden moulding or flexible non-metallic tubing fastened directly to the building. (Never use iron pipe to protect ground wire.)

When a cold water pipe or a driven ground is not possible this Bureau should be consulted as to method of grounding. An approved ground clamp shall be used to connect the wire to the pipe.

WIRES INSIDE BUILDING.—Wires inside building shall run in a workmanlike manner and spaced no nearer than two inches to any electric light or power wire unless encased in porcelain or flexible tubing.

APPARATUS GROUND WIRE.—This wire may be bare or insulated not less than No. 14 B & S gauge or No. 17 B & S copper clad. It may be run inside or outside. If run in full compliance with rules for protective ground wire it may be used as the ground conductor for the protective device.

**CLEARER
BETTER
PURER TONE**

NOISES ELIMINATED

Send for
Circular No. 26

Liberal Discounts



Adjustable

**THE FASTEST
SELLING PRODUCT
IN RADIO**

**EVERY FAN
WILL BUY THEM**

Made for all phones

Immediate Shipments

RADIO MICA PRODUCTS CO., Sole Mfrs., 156 E. 43rd St., New York City

Ask Our Service Bureau



Standard
2500 Ohm
Headset

Retails at \$5.75

Guaranteed to be equal to any phone on the market retailing at \$8.00

Polished aluminum shell—excellent appearance.
Duranoid cap—strong and durable.
Laminated magnets—maximum flux density.
Enameled diaphragm—prevents corrosion.
Adjustable pole pieces—no rattling as loud speaker.
Perfect workmanship—backed by 15 years electrical instrument manufacturing experience.

JUDGE FOR YOURSELF
Dealers and Jobbers Write

THE MILLS RADIO & ELECTRIC CO.
Distributors for:
STANDARD headset
Irvington SPA-
GHETTI
KENTONE Amplifying Horn
U. S. Variable Condensers

Manufacturer of AER-WIN Products:
Vernier Adjuster
Variometer and Variocoupler
Model "A" Receiving Unit
Special Detector Crystal

1010 Springfield Ave. Irvington, N. J.

SUNRAID

Rheostats

List

PRODUCTS

\$1.25



Radio men who want a Rheostat of high class workmanship that gives a maximum amount of service will find it worth their while to buy the **SUNRAID RHEOSTAT**. It gives perfect contact against winding at all times. (See spring attachment in above photograph.)

Windings guaranteed not to jump out.

SUNRAID PRODUCTS are guaranteed. Distributors wanted for all parts of the country.

DISTRIBUTORS — Samples will be sent to you C.O.D. upon request.

Also Manufacturers of 3" and 4" All-Condensite Dials.

SUNRAID

534 EIGHTH AVENUE



PRODUCTS

Trade Mark

RADIO CO.

NEW YORK CITY, U.S.A.

The **SUNRAID RHEOSTAT** has been tested in all the best Radio Testing Laboratories, and has been awarded the Stamp of Excellence.

Small Space Socket Slotless

By MILTON ALDEN

Alden-Napier Co., Springfield, Mass.

To the user, we think that the newsy part of the DeLux Socket story lies in the patent clip. This clip makes a positive connection to the prongs of the vacuum tube under any and all conditions, as when the tube slips into place there is a wiping action across the bottom, and wiping contact is also made at the side. The operator using these sockets in his set can be sure that he is free from open circuit troubles in this part of his apparatus. As this socket is slotless and made of genuine condensite, it is practically unbreakable. It serves equally well for 5-watt power tubes, as there is ample spacing between the contact strip and the bottom of the base.

The interesting part of the small space socket is that we have produced a quality article, due to quantity production, at a very low price. It also takes up very little room, making it particularly valuable where two and three tubes are to be used. This is also moulded of genuine condensite and is unaffected by the heat of the bulbs or the heat of the soldering iron in soldering connections.

The dial has quite a number of outstanding qualities besides its low price. As it is made of genuine condensite, it cannot warp and runs true. It is also one of the few 3" dials on which the fingers can be placed on the knob without covering the numerals. The shape of the knob and the numerals on the bevel has accomplished this result. We have also been advised by some radio engineers, but we do not know how true it is, that our dial is unique, in that we have eliminated excess material, which reduces the absorption losses to a minimum.

The "newsy" part of our proposition to the dealer and jobber, besides the fact that we are producing extra quality articles at a low price, is that we are supplying dealer helps. With each 100 dials the dealer is supplied, without charge, with a hand-painted display card on which is mounted a dial. These are proving very effective in producing sales and can be used for both counter and window display. The small space socket is packed 20 in a lithographed Brooks display container, which acts as a silent salesman. The DeLux Socket is packed in a quality lithographed box.

"Red Star" Head Phones are Quick and Easy Sellers — and They STAY Sold

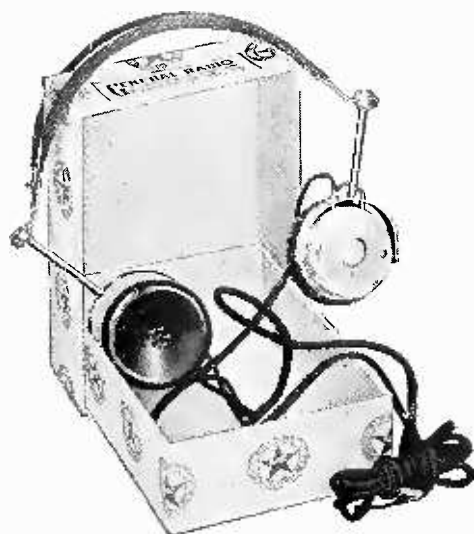

Each set is packed in an attractive box that makes a fine showing on shelf or counter.

The set itself is so light in weight and so handsomely finished that buyers quickly give it the preference.

Then, when they USE it, they find it so comfortable to wear, and its messages so clear, that every customer becomes a booster.

Monocoil - - - (2000 ohms) - \$5.00

Long Distance - (3200 ohms) - \$8.00

including a head band and 6 ft. of cord.

Liberal discounts to recognized jobbers and their dealers.

Order ONE for inspection and comparison.

GENERAL RADIO EQUIPMENT MFG. CO.

1131½ Diversey Parkway

Chicago, Ill.

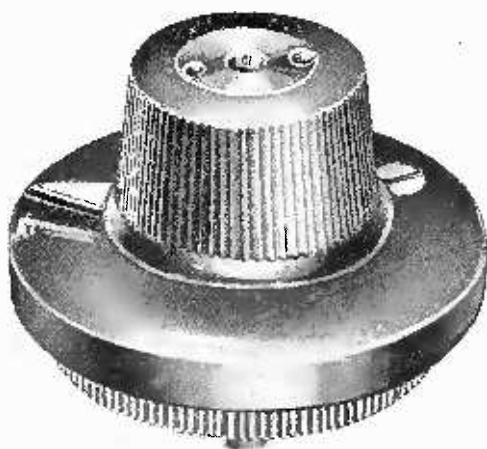

ACTUAL SIZE

MOFFAT RADIO LOCK RHEOSTAT

LOCKS OFF CURRENT
LOCKS ADJUSTMENT



LOCK

PATENT PENDING

MOFFAT RADIO LOCK CIRCUIT SWITCH

LOCKS ALL
TUBES

LOCKS ANY SET

NO MORE TUBES DAMAGED BY MEDDLESOME PERSONS
NO MORE TIME LOST IN READJUSTING TUNING
NO MORE LOSS OF BATTERY CURRENT

FITS ANY STANDARD INSTRUMENT OPERATED BY A SHAFT

JOBBERS WRITE

JOSEPH ROSS & CO., IRVINGTON, N. J.

ESTABLISHED 1875

DEALERS:—

WE are Jobbers for
Grebe Receiving Sets
Murdock Products
Baldwin Phones
Federal, Fada and
Radio Shop Products

Write for Our Special Proposition A

The Radio Shop
OF NEWARK
41 South Orange Ave., Newark, N. J.

**Whirco Square
Tinned Bus Wire**

In 2 Feet Lengths or in Hun-
dred to Thousand Pound Lots
Quoted.

Shipments *F. O. B. Mill*

WHITE RADIO CO.
123 East 23rd Street
New York City

**Quick Sales and
Lots of Them**

Every owner of a tube
set needs a **CHASLYN**
Ball Battery Tester.

And the moment you show
it and explain how this set
enables him to test his acid
at a glance for both condition
and depth, *out comes his dollar!*
Sinking of white, green or red
ball shows whether battery is
right, lean or dead.

Special Introductory Offer
Send one dollar for **TWO** sets.
That's below our wholesale
price.

THE CHASLYN CO.
4323 Kenmore Ave. Chicago

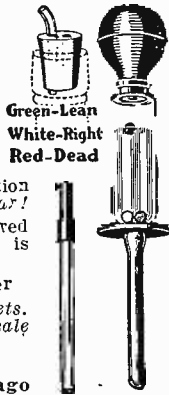

Immediate delivery on anything in
the Radio line. Our U. S. Eagle
crystals mounted and unmounted are
positively guaranteed to be sensitive.

Write for prices

U. S. Radio Co. of Penna., Inc.
Pittsburgh, Pa.

THORNTON

**AUDIO FREQUENCY
AMPLIFYING TRANSFORMERS**

Supreme Test Transformer

These transformers are supplied in
either mounted or unmounted types.
*Special attention paid to the manu-
facturer of receiving sets.*

THORNTON
TRANSFORMER CO., Inc.
30 Church Street, New York City

Wooton Headsets
Tested Before Shipped

Does Not Depend Solely on
Laboratory Equipment

By S. J. WILLIAMS

Secretary, The Electric Products Company
Cleveland, O.

The Wooton headset is of the 3,000
ohm type, the coils being wound on
soft iron cores, very specially insu-
lated, each coil wound to 750 ohms,
1,500 ohms per receiver, or 3,000
ohms for the headset.

The shell is of drawn aluminum,
highly polished, machine finished, in-
destructible, and light in weight. The
magnets are made from the very best
grade of magnet steel.

We claim for our phones maximum
sensitivity and we are always glad to
submit sample sets to jobbers and
dealers for their inspection and any
tests they may wish to make.

We test every phone on a receiving
set, not depending upon laboratory
equipment in the approval of our
phones for the user. We prefer to
test every phone under the actual con-
ditions under which it will be used,
and every set is perfectly matched.
The phones are packed in very attrac-
tively labeled corrugated cartons,
these cartons being of the very sub-
stantial type approved for mailing.
This makes it possible for the dealer
to simply remove a set from his
shelves and attach his shipping tag
and mail, without any cost of packing.

The headband is of the military
type, but is so designed that it will
not drop off the head of the wearer,
even though one bends to the floor.
All exposed metal parts are made of
brass, nickel-plated, while the wire is
of phosphor bronze. This means that
all parts of the headband are abso-
lutely rust-proof. The webbing is of
the tubular type, and the highest grade
that can be obtained.

The cord is of the standard five-
foot type, arranged so that either
phone may be removed from the head-
band to enable two persons to listen
in simultaneously. And in addition to
all of this our phones are beautiful
in appearance, a factor which no one
can lose sight of.

The Wooton is made and sold by
the Electric Products Company, of
Cleveland, Ohio, who also market
other electrical lines which they manu-
facture. They are a fourteen-year
"young" concern.

Ask Our
Service Bureau

We Specialize in

Brass Rod and Tubing
Sheet Copper, Aerial Wire
and Binding Posts

McKenna Brass and Mfg. Co.

First Ave. and Ross St., Pittsburgh, Pa.

'Phone, Court 637



Glass
Tubes
for
Crystal
Detector
Sets

Special Prices in Quantity

Vineland Scientific Glass Co.
New York Office 1133 Broadway
Factory Vineland, N. J.

ROCKY MOUNTAIN CRYSTALS

Better Than Galena

The most sensitive mineral rectifier known.
Can also be used with one or more stages of
amplification.

Mounted 35c. Unmounted 20c. Postpaid

Manufacturers, Jobbers, Dealers, Clubs.
Apply for Special Prices.

Rocky Mountain Radio Products, Inc.
9 Church Street, New York, N. Y.

Variable Condensers

SEMI-CIRCULAR TYPE

	List
43 Plate.....	\$3.75
23 Plate.....	3.00
11 Plate.....	2.75
3 Plate.....	1.50

BALANCE TYPE

.001 Mfd.....	\$5.50
.0005 Mfd.....	4.75
.0025 Mfd.....	4.00

SQUARE LAW TYPE

.0015 Mfd.....	\$6.50
.001 Mfd.....	5.50
.00075 Mfd.....	4.50
.0005 Mfd.....	3.50

Montrose Mfg. Co.

1200 Bedford Ave. Brookl'n. N. Y.

Vermica Condenser

Valuable for Sharp Tuning and Gives Perfect Control

A particularly good and inexpensive variable condenser is now being put on the market by C. S. Cherpeck, of 3125 Davlin Court, Chicago, Illinois.

By means of a special screw adjustment, fine, accurate tuning, is made possible. In fact, with only a single knob or dial, what is essentially vernier control is obtained.

Another big feature of this condenser, is that it can be knocked around considerably without being put out of order or having its efficiency impaired. This makes it a handy and ideal piece of equipment for experimental, amateur, and general all-around radio work.

Its convenient size makes it readily adaptable for either table or panel mounting. It can be mounted on any size panel up to 1/2".

The Vermica variable condenser is neat and attractive. Its appearance is sure to draw the attention of the purchaser, and its high efficiency, reliability, and low price, will make it a highly desirable addition to any radio set.

It is sold under the slogan "a better condenser for less money." The capacity is .0005 MFD.

BREMER-TULLY CONDENSER

A micrometer adjusting condenser is the product recently placed on the market by the Bremer-Tully Company of Chicago, Ill. The condenser is attractive in design and among many features of the instrument is the novel way in which the micrometer is operated and attached. The micrometer plate is at the far end of the shaft away from the dial and is operated by a special small knob that protrudes slightly beyond the main knob. This smaller knob moves independent of the larger and has a small arrow engraved on it which shows the position of the micrometer plate. Among other features that the company claims is the intermediate insulating plate that makes the short circuiting of the vernier plate impossible, vernier plate has but one active face which makes for greater sensitivity, compensating double spring which gives perfect action of main rotor, complete independence of vernier and positive electrical contacts, and shafts adjustable to different panel thicknesses.

A SUPERIOR AUDIO FREQUENCY TRANSFORMER

USED AND RECOMMENDED by LEADING REPUTABLE MANUFACTURERS of RADIO APPARATUS

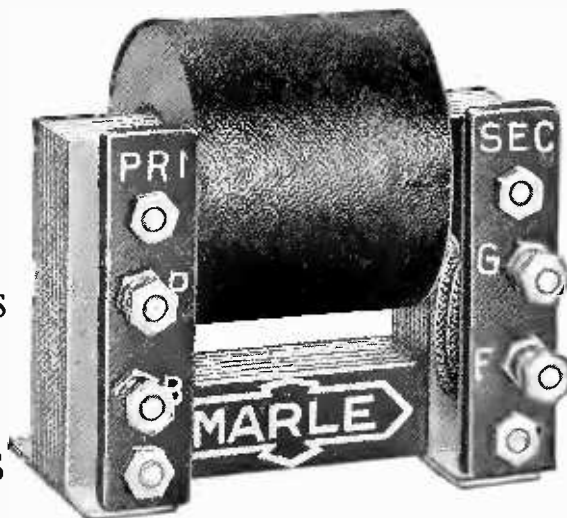

LIST 3.75 MOUNTED

Write for Information and Discounts

Jobbing Concessions Restricted

Manufactured by

MARLE ENGINEERING CO., ORANGE, N. J.

Special Prices Quoted On Unmounted Type To Manufacturers

Milliken Radio Towers

Are the choice of important wireless stations in different parts of the country. Made of galvanized steel, self-supporting, standard types and heights. Dealers can broaden their markets by selling these towers. Let us explain our proposition.

AGENTS WANTED

Send for Catalog No. 16

MILLIKEN BROTHERS

MFG. CO., INC.

Woolworth Building
New York, N. Y.

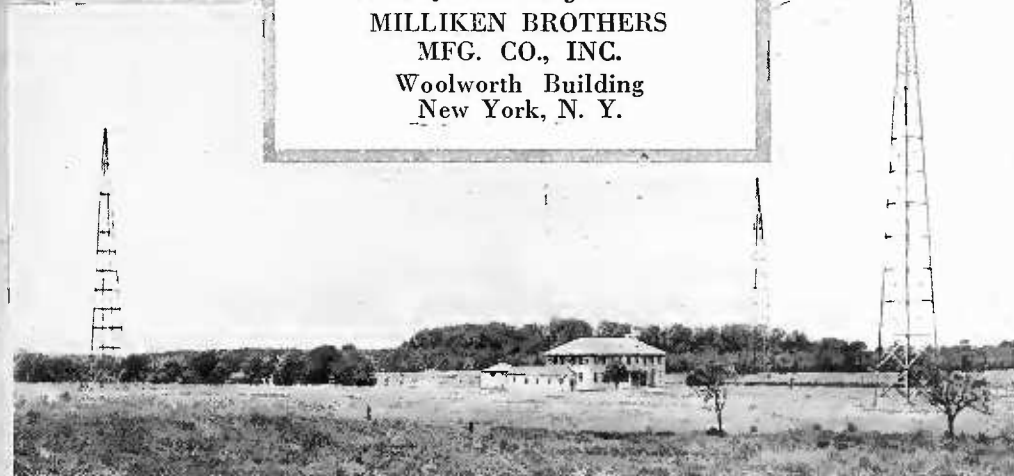
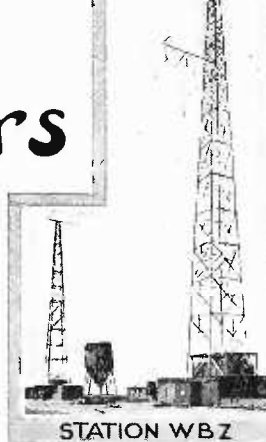
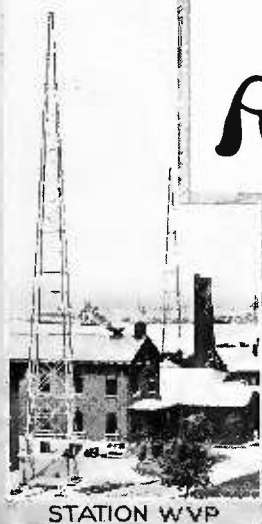

EVEREADY
RADIO "A" BATTERY
Immediate Delivery from Stock
 Manhattan
 Storage Battery Co., Inc.
 204 West 76th Street
 New York City

ELCO RADIO SUPPLY CO.
Manufacturers' Distributors
 2728 Broadway, New York City



More Warren Radio Loops Being Sold Than Ever.
For Use With—
 Armstrong Receiver Portable Sets—Sets on Moving Vehicles—Powerful Tube Sets—Displace Outside Aerials.

The Warren Radio Loop
 That Made Famous the Radio Rolling Chair at Asbury Park as featured on front cover of Radio News and Wireless Age.

A very superior instrument. Wound on new principle. Entirely enclosed. Directional. With honeycomb coil, tunes to high power long wave length stations.

With the growing use of more powerful sets, the demand for the Warren Radio Loop is increasing rapidly. Get your share of this business. Write for Bulletin P-102, price lists and discounts.

V-DE-CO RADIO MFG. CO.
 Dept. D. Asbury Park, N. J.

JOHN E. JENNINGS
(Continued from page 43)

Mr. Jennings was born in Brooklyn in 1875 and attended public school until fifteen years of age, when he started work in the construction department of a large Eastern railroad. At the same time he continued his studies at Cooper Union, from which he was graduated in 1896. With his railroad structural experience for a background, he then began a career of more than twenty-five years devoted to technical structural steel work, during the last fifteen of which he has specialized in transmission-tower development. In this time he has personally supervised the design and manufacture of steel towers for use on thousands of miles of high-tension transmission systems operating now in almost every quarter of the globe.

Mr. Jennings' activities have brought about many economies and practical advances in tower design. His original method of arriving at a safety factor by increasing by a suitable percentage the calculated actual field forces arising from climatic and mechanical conditions of service has become the general practice of many large power companies for obtaining the test loads to which a full-size tower must be subjected. His design work has embodied many original features concerning the economic relation of sag, wire stress and span.

Mr. Jennings has been employed in a consulting capacity by a number of large power companies and syndicates as well as by the government of Norway. His work in connection with tower design for the Norwegian authorities called him from the United States in 1920 and resulted in a trip around the world for transmission-line study, inspection and business in an engineering and contracting capacity for his company. His travels led him as far as Australia, where his skill as a designer will soon be evident in a 100-mile line extending from Melbourne to the Morwell brown-coal fields, which are to play a large part in electrical development.

As an expert in transmission structures Mr. Jennings has designed the radio towers in use at important wireless stations in many parts of the world. Here as in his transmission-tower work he has striven to reduce his designs to a general standard permitting recognition of the peculiarities of each system.

MANUFACTURERS OF
 Receiving Sets Complete
 Unites Mounted and Unmounted
Send for Description and Prices
RADIO OUTFITTING CORP.
Mfg. High Grade Radio Apparatus
 410-412 East 34th St. New York, N. Y.

To Manufacturers and Distributors
A SPECIFIC GUARANTEE
 Backs **CONTAINA CRYSTAL** Setting
 (Patent Pending)
MAXIMUM SENSITIVE AREA AVAILABLE
 Awarded Evening Mail Certificate of Excellence
CURTIS G. CULIN
 366 Broadway New York City

GROWING AND GROWING GREATER

You are a member of a great industry and here is an opportunity to advertise in the only publication of its kind in the RADIO Field.

A Trade Directory and Buyers' Guide

Purely a business proposition—Referred to at all times by buyers.

Reaches every dealer, manufacturer and jobber including hardware, phonograph, department store and electrical dealers.

A Wealth of interest for the buyer
 National in scope
 Circulation 10,000
 WRITE FOR RATES

Mailing list service to our advertisers

The Radio Red Book Pub. Co.
 406 West 31st Street, New York, N. Y.
 "The Radio Trade Directory"
 Watkins 5987-88

Dealers Err in Rating Receiver

Resistance Not Indicative of Sensitivity of Phones

By FREDERICK DIETRICH

President, C. Brandes, Inc.

(Statement made to the RADIO DEALER by Mr. Dietrich)

"Yes, this is a very good receiver. It has a resistance of four thousand ohms." This is a sales talk that many clerks in the radio shops give to unwary purchasers of headsets. In doing so, they not only show their ignorance concerning 'phone construction and design, but they help to create an impression that is entirely wrong. They are responsible for the notion that the sensitivity of a headset is indicated by the resistance of the receivers.

In commenting upon this, Frederick Dietrich, president of C. Brandes, Inc., recently said: "This policy of selling headsets on the strength of their resistance is wrong and should be discouraged by dealers. It not only hoodwinks a badly mis-informed public but it is a gross injustice to manufacturers who, for sound technical reasons, do not wish to carry the d.c. resistance of their headsets to such a high value. One might just as well measure the horsepower of an automobile by the size of its carburetor. The average two-thousand ohm headset is as sensitive and in many cases more so than the receiver with a resistance of four thousand ohms. Radio receivers should be rated by their impedance. The Brandes headset is designed to have the same impedance as the average circuit in which they are used, since it has been found that this gives maximum efficiency. This impedance varies, of course, with the frequency of the current. The Brandes Company have taken as a standard one thousand cycles and at this frequency their headsets have an impedance of 22,000 ohms. It has been found that this is the resistance of the average crystal or tube circuit. This in itself, however, does not guarantee the efficiency of a headset, since there are many other requirements and features that determine the operating efficiency and sensitivity of a radio headset."

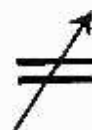
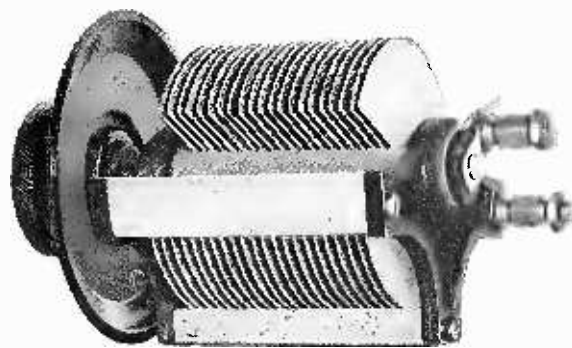

Radio Finds a Better Condenser

Bayley's 23-0005 and 43 Plate 0011 Variable Condenser is what Radio has found.

Its plates spaced close give it the finest tuning qualities.

The plates are assembled as a solid integral part of the whole by the die cast process. It is impossible for any plates to loosen in service.

Solid rubber end pieces finished like black morocco leather, make it beauti-

ful. It is of good design and high grade workmanship. In an official test measures up to 0011 M.F.D. capacity and is uniform, it does not vary.

Each condenser has our guarantee, backed with a manufacturing record of more than forty years.

A sample order will convince you of its value.

And Make You, Certainly, A BAYLEY CONDENSER BOOSTER

We want business from houses that appreciate real value. It will give satisfaction and stay sold

Price, 23 Plates \$3.25 each. 43 Plates \$3.75 each. Dials 75c. each, extra TO JOBBERS AND DEALERS A SPLENDID PROPOSITION

BAYLEY CONDENSER CO.

105-109 Vanderveer Street

Brooklyn, New York

Mt. Tamalpais, California, in the shadow of whose lofty peak PARKIN Parts are made.

"The Peak of Perfection"

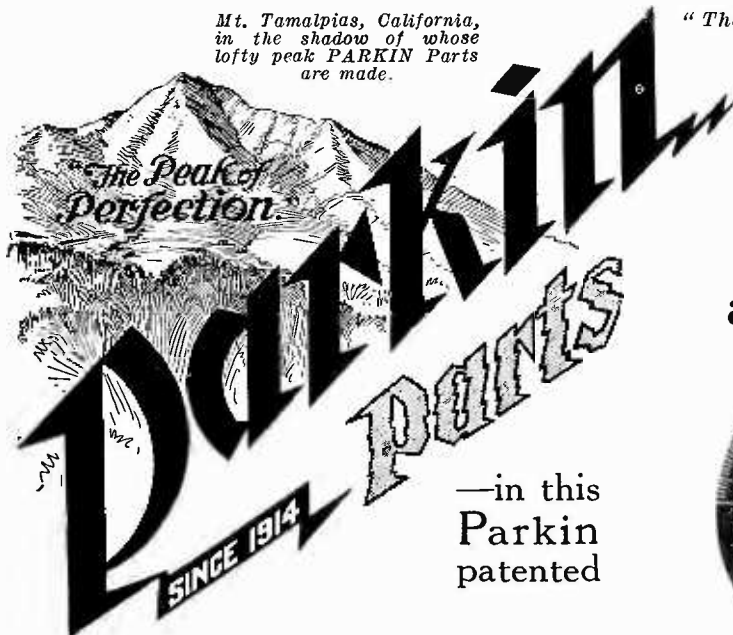

3
big
advantages

—in this
Parkin
patented

DIAL-TYPE RHEOSTAT

(Patented August 1, 1922)

In the Parkin Dial-Type Rheostat the resistance element is placed outside the cabinet in a recessed groove in the back of a three-inch moulded Bakelite dial. This patented construction gives the Parkin Dial-Type Rheostat three big exclusive advantages found in absolutely no other rheostat.

1. It saves the cost of an extra part.
2. It gives far more cabinet space.
3. It eliminates resistance heating from inside the cabinet.

An off position is provided, and a stop on the dial engages stationary contacts at the extreme positions. Polished Bakelite dial and knob, 0° to 180° graduation from right to left for clockwise rotation. Resistance, 5 ohms; carrying capacity, 1½ amperes. Retail price, complete with screw for mounting, \$1.50.

Quality Jobbers and Dealers write for complete catalog (No. 10) of Parkin Peak of Perfection Parts, and Proposition.

PARKIN MFG. CO., SAN RAFAEL, CALIF.



Price, \$1.50
Complete

Best by Test!



Hundreds of manufacturers, dealers and owners of receiving sets everywhere have tested and found our crystals the most sensitive and efficient obtainable.

Double your pleasure and increase the efficiency of your set by using our

ALL-SENSITIVE GALENA CRYSTALS

Galena Crystal, Mounted - - 35c
Galena Crystal, Unmounted - 25c

IMMEDIATE DELIVERY

Every Crystal

GUARANTEED PERFECT

Manufacturers, Jobbers, Dealers, write for quantity prices

GALENA CRYSTAL MFG. CO.

463 Bushwick Ave. Brooklyn, N. Y.

CRYSTAL SET

"The Little Wonder" \$4
To Retail at

UNMOUNTED AT \$2.50

Thousands of them in use in all parts of the United States and giving perfect satisfaction.

Good Profit for Dealers

Write for interesting proposition. "Little Wonders" sell fast and are good profit makers for live dealers.

SEND FOR FREE CATALOG

It lists our high grade line of radio parts and supplies at prices allowing you a juicy profit.

Holloway Elec. Supply Co., Inc.
238 Third Ave. New York City

DEPEND ON CRAMER RADIO



SPECIAL FOR LIMITED TIME

This \$80 Receiver at 50% Discount

The CH5 receiver needs no introduction. Judged by any standard it is without equal anywhere. Simple in control; handsome in appearance; super-efficient in operation. Includes in its 150 to 3000 meter range, amateur, commercial and Navy waves, special land stations, ship stations and Arlington "time." Employees latest inventions. Especially efficient for radiophone concert reception. Guaranteed in writing for one year. Regular price \$80 with 25% discount—and worth it. **SPECIAL DISCOUNT—50%.**

EVERY DEALER SHOULD HAVE AT LEAST ONE! Send cash only—no CODs or charges. Not more than 6 sold to one dealer.

W. R. CRAMER, DEPT. 3, OMAHA, NEB. "Pioneer Radio Manufacturers"

Boston Exposition

New England Folks to Boom Radio in Big Way

The Boston Radio Exposition and New England Amateur Convention will be held in Mechanics' Building, Boston, from October 30 to November 4.

At a recent luncheon at the Boston City Club, attended by S. H. Fairbanks, general manager of the Exposition, and members of the advisory committees, composed of leading manufacturers, dealers, distributors and radio editors, important matters of policy were decided upon.

An absolute rule that no more than one demonstration of broadcast reception be permitted at one time, was adopted and a sub-committee appointed to pass on the qualifications of exhibitors to protect the public from fakers and manufacturers of inferior apparatus.

At a subsequent meeting of the New England Executive Radio Council, formerly the Boston Executive Radio Council, Phillip F. Robinson, division manager of the American Radio Relay League, was appointed chairman of the banquet committee, and E. B. Dallin was made chairman of the publicity committee.

The First District Amateur banquet will be held on Saturday, November 4, the closing day of the Exposition.

O. C. Roos, Fellow of the Institute of Radio Engineers, is again technical director of the Exposition, and Chester I. Campbell, nationally known through his direction of war exhibits and the national auto show held in Boston, is advisory director.

Manufacturers represented on the advisory committee are: Acme Apparatus Co., American Radio & Research Corporation, Clapp-Eastham Company, General Radio Company, Wm. J. Murdock Co., Radio Corporation of America, Sleeper Radio Corporation, Stern & Co. and Wireless Specialty Apparatus Co.

An even more extensive educational and entertainment program than that which was a feature of the first Boston Exposition held last May has been planned and the leading radio amateurs and engineers of New England are co-operating with Mr. Roos to this end.

At the first exposition more than 100 manufacturers, dealers and distributors were represented by exhibits.

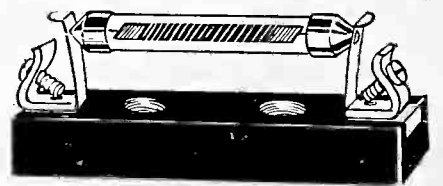

PRECISION

GRID LEAKS AND MOUNTINGS

Resistance ranges from .05 megohms to 5. megohms. Accuracy guaranteed.

Grid Leaks75c
Mountings50c

Radiophone Equipment Co.

45 New Street Newark, N. J.



Echophone Loud Speaker Sets

IMMEDIATE DELIVERY

Discounts to jobbers and dealers **AERIAL WIRE.**

19 strand tinned silicon bronze **VARIABLE CONDENSERS**

11-21-23-43 Plate

EISEMANN HEAD PHONES

Super-sensitive

Variometers Variocouplers
Binding Posts Contact Points

General Auto Electric Co.

231 Halsey St.

Newark New Jersey

BRACH

VACUUM LIGHTNING ARRESTER

Sells On Its Merits

The Brach Arrester protects radio and home—frees the radio fan from concern over static interference—commends itself by its 16 years performance in railroad, telegraph and U. S. Army service.

Dealers never need force the sale of the Brach Arrester—it sells itself.



Listed by the Underwriters' Laboratories

L. S. BRACH MFG. CO.
Newark, N. J.

Makers of Solderall—Mends Metals.
Connects Wires.

Coast Representatives—Pacific States Elec. Co., San Francisco, Los Angeles, Oakland, Seattle, Portland, Spokane.

Aerex Receiver

Greater Sensitivity Achieved in New Instrument

The Aerex Radiophone Corporation of New York City, are now marketing what they claim to be an achievement in the radio field in their Model RA-4 Long Range Radio Receiver.

It has been produced after months of constant research in their laboratory with the idea of providing the maximum in radio telephony. Greater sensitivity than has ever been obtained before in any radiophone receiving instrument has been developed.

The set has been constructed of standard quality materials, beautifully and scientifically designed to conform to the highest engineering standards.

It has been designed for use of both the loop antenna in local broadcasting and the outside aerial for long range reception.

Separate binding posts are provided on the back of the instrument when an outside aerial is used and when it is desired to use a loop. When a loop is used the wiring is so arranged that most of the tuning inductance is cut out with only a variable condenser across the loop.

The circuit is unusual, inasmuch as it consists of two stages of radio frequency amplification and two stages of audio frequency amplification and one detector and it has been so designed for use of only three tubes, one detector and two amplification tubes instead of the five tubes.

"A REAL HOME"

Walter C. Jacobs, President of the Central Electrotype Foundry Company, is proudly proclaiming the fact that when they are installed in their new home at 69-71 Warren Street, Newark, they will be operating from a factory that is really "most modern" in every respect for the proper production of electrotypes, amalgatypes and stereotypes.

MUELLER'S NEW FACTORY

The Mueller Electric Company have announced to the trade the opening of their new office building and factory at 1583 East Thirty-first Street, Cleveland, Ohio. The new brick factory and office building was a necessity which grew out of increased business that the favor of their high class products warranted.

CONDENSITE CELORON

Sets a New Standard in Radio Panels and Parts

Cut your panels from Condensite Celoron. This strong, handsome, jet-black, insulating material will give your customers a surface and volume resistivity greater than they will ever need. It is the ideal panel material because it machines readily, engraves with clean, cut characters and takes a high, natural polish or a rich, dull mat finish.

**Give your customers Quality
and they will give you orders**

Condensite Celoron—approved by the Navy Department, Bureau of Engineering—offers a sales opportunity unequalled to the live wire dealer who is keen on building his business on a quality basis. Write us today for our Special Dealer's Proposition and let us give you all the facts.

Diamond State Fibre Company

Bridgeport (near Philadelphia), Pa.

Branch Factory and Warehouse, Chicago

Offices in Principal Cities

In Canada: Diamond State Fibre Co., of Canada, Ltd., Toronto

Ask Our Service Bureau



\$3.75

MADE
IN
NEWARK
N.J.

**Rad'O Crystal
Attachment**

**For Your Crystal Set Use One Ear Phone, a
RAD'O and the Whole Family Can Listen In**

Made of Aluminum—and designed according to the laws of acoustics, and guaranteed to give satisfaction. Tubes of best quality rubber, with heavy walls; the ear tubes made of hard rubber and easily kept in sanitary condition. By the use of the Rad'O all distortion is eliminated.

Jobbers
Communicate

RAD'O, P. O. BOX 418, NEWARK, N. J.

Dealers Ask
Your Jobber

Variable Condenser—Tested and Guaranteed. Immediate Deliveries.

43 plate001	\$3.50
25 "0005	2.75
13 "0003	2.50
11 "00025	2.25
3 "	Vernier	1.25

Liberal Discounts to Dealers

DETROIT RADIO SUPPLY CO., MFRS.
228 East Baltimore Detroit, Michigan

RECEIVERS REWOUND AND REPAIRED

Any make, copper wire, any resistance
Work guaranteed
Commissions to Dealers

MONTCLAIR RADIO CO.
272 Bloomfield Avenue Montclair, N. J.

M-R FLEXIBLE VARNISHED TUBING THE GENUINE**"SPAGHETTI"**

TWO STYLES—BEST GRADES MADE—ALL SIZES—ALL COLORS

Varnishes, Waxes, Compounds, Papers, etc.

MITCHELL-RAND MFG. CO.
14 VESEY STREET NEW YORK, N. Y.

KRAMER RADIO COMPANY

4713 Sheridan Road, CHICAGO, ILL.
MIDWEST DISTRIBUTORS

Of Quality Radio Products

Write Us for Catalog and Discounts

BEFORE you adopt a trade-mark

Have the Radio Dealer Trade-mark Bureau give you a report on its novelty based on registrations in the Patent Office AND IN THE RADIO DEALER TRADE-MARK BUREAU.

AFTER you have adopted a novel trade-mark Register it at once in the

RADIO DEALER TRADE-MARK BUREAU

4907 Potomac Ave., N. W.
Washington, D. C.

GOOD WIRELESS BATTERIES**Air Pockets Provide for Escaping Gases**

The Ace Wireless Batteries are especially constructed with air pockets which provide space for escaping gases and eliminate the common defect with many batteries, namely blown seals.

The Ace factory have made thousands of these batteries and have never experienced difficulty of this sort.

Another feature in the Ace Wireless Battery is that the batteries are constructed from individual cells made from seamless drawn zinc cans of extra thickness so that the chemicals of the cell will not eat through to waste and corrode the battery. Also, especially selected materials are used which give unusually high voltage, which is one of the most important things in making wireless batteries.

These batteries are made by The Carbon Products Company of Lancaster, Ohio, and the retailer and jobber who "ties up" with the Ace makers makes no mistake.

VERNIER CONDENSER

The Electric Products Company of Boston, Mass., are manufacturing variable condensers that are suitable for panel or table mounting. They are of four classes, 5, 9, 15 and 29 plates. The company is also manufacturing a vernier variable condenser which has a maximum capacity of .001 mfd. The condensers have two patent adjustments which enable them to be of efficient service for considerable time. To quote the company's representative, "although they are not gotten up at all fancy, or not in any way meant to attract the eye, they are extremely efficient, and when installed do the work they are built for."

Ask Our

Service Bureau

See Page 18

"COPPERWELD"

TRADE MARK REG. U.S. PAT. OFF.

ANTENNA WIRE

50% stronger than either solid or stranded copper

ELIMINATES SAGGING

Adopted by Largest Radio Corporations
100, 150, 200 ft. per Carton

LEAD-IN and GROUND WIRE

has the Underwriters' O. K.
Rubber Insulated—Brown Braid

25, 50, 100 ft. per Carton

BUY IT IN CARTONS

with construction directions

COPPER CLAD STEEL COMPANY

New York Chicago
Braddock P. O., Rankin, Pa.

NOTE TO THE TRADE:

Quote us prices, terms, discounts and deliveries

WE ARE
NATIONAL
DISTRIBUTORS

Complete sets
Radio Equipment
SPECIALTIES

Manufacturers

Desirous of New York Representation communicate at once

RADIO EQUIPMENT SERVICE

500 FIFTH AVENUE
NEW YORK CITY

STATION K-S-D

(Continued from page 42)

of the building on the roof to see what happens to these electric waves.

The path takes them directly to a "speech input" panel where they are amplified several hundred thousand times passing through various devices which preserve the original purity of tone and perfect modulation. This assures true transmission of whatever goes into the microphone in the studio.

That was not a typographical error, by the way, in the last paragraph. "Amplified several hundred thousand times" is correct. Listen to a few notes played on a violin by Kreisler and then let the same notes be repeated by an amateur. So far as the string vibrations are concerned both may have been the same and yet the trained ear would discern a difference—not measurable, but a real difference nevertheless. Now translate that difference into tiny electric waves; amplify those electric waves several hundred thousand times; send them out through the air, through rain and snow and sleet, through clouds, stone walls, windows, brick, and steel; through trees, our bodies, and everything else; then hundreds, perhaps a thousand miles or more away pick up those wireless waves on your receiving set and turn them back into sound waves, and you could tell which was Kreisler and which one the amateur, just as if you had been in the room where they were playing—that, indeed, is the marvel of wireless.

From the speech input panel, just described, the electric current, now much amplified goes to the transmitter set. It first enters a 50-watt tube for further amplification, then into the circuit which leads finally to the antennae and out into the air—to be picked up in Texas, Florida, Minnesota, Pennsylvania—wherever within range an adequate receiving set is properly tuned into pick up the KSD program.

When you first arrived on the roof, your attention is surely attracted to the two steel towers. These are 14 feet square at the base and rise to a height of 70 feet. From the top extends a wooden mast 10 feet long. The legs of the towers go down through the roof to rest on the steel framework of the building itself.

The antennae consist of phosphor bronze wires—four of them—spaced six feet apart. The length from mast to mast is 131 feet. The lead in comes from the center, giving a "T" aerial.

A look around the transmission room in the building on the roof is worth while. In a sound-proof com-

It Will Be a Radio Christmas

BOSTON RADIO EXPOSITION and N. E. AMATEUR CONVENTION

Mechanics Building

Entire Week October 30—November 4

*Covers New England with
One Exposition*

SPACE AVAILABLE NOW

Executive Offices: 5 Park Square, Boston, Mass.

LET OUR FREE SERVICE BUREAU

Help You Buy Your Supplies
SEE PAGE EIGHTEEN

NATIONAL DIRECTORY OF RADIO
DEALERS, MANUFACTURERS, ETC.

SUPPLEMENTARY SERVICE OF
ADDITIONS, REVISIONS, ETC.

Sydell's Radio Directory and Service

557 SCHENCK AVENUE

BROOKLYN, NEW YORK

Card Catalog Directory of Radio Dealers

Sent upon APPROVAL

(Also available on SHEETS)

No comparison between this directory and similar commercial
"mailing lists"

No mailing list companies offer to send theirs upon approval

WHY?

Names in our directory are annotated to indicate wherever possible the distinction between exclusive dealers in RADIO equipment; those who handle RADIO only as a side line, as dealers in electrical supplies, hardware stores, jobbers, manufacturers' distributors, etc.

This list has been compiled from information secured from State Chambers of Commerce, current RADIO periodicals and newspapers having RADIO departments, and contributions from Manufacturers, Dealers, Jobbers, etc.

Dealers desiring inclusion please send particulars without obligation.

In Preparation

A similar directory of RADIO MANUFACTURERS

Please send descriptive literature

RADIO DEALERS

We Are Manufacturers of

**AUDIO AMPLIFYING
TRANSFORMERS,
SENSITIVE CRYSTALS,
EYELET TYPE MICA
CONDENSERS,
LOOSE COUPLERS,
DOUBLE SLIDE
TUNING COILS**



*Dealers and Jobbers
Write Us for Proposition*

IMMEDIATE DELIVERY

FORD MICA CO., Inc.

14 CHRISTOPHER ST.

NEW YORK CITY

USE THIS COUPON TO JOIN

THE RADIO TRADE ASSOCIATION

THE RADIO DEALER,

1133 Broadway,
New York City.

Please count us in as charter members of

THE RADIO TRADE ASSOCIATION

and send us all bulletins regarding same as they are issued.

We are jobbers . . . , retailers . . . , manufacturers . . . of radio equipment.

Name

Town

State

Date.....

generator set, a three unit design. This, weighing more than a ton, rests upon heavy felt so as to keep the vibration of the motor from affecting the amplifiers and transmission. The motor is of five horsepower. One generator develops 1,600 volts for what is known as the plate circuit in the 250-watt power tubes—of which there are four. The other generator develops 16 volts for the filament circuit in the tubes.

In the operator's room you hear the program. Connected with the circuit from the studio is a monitor system, the principal parts of which are an amplifier and loud speaker. This gives the operator proper knowledge of tone qualities and imperfections can quickly be corrected.

The transmitter proper is a cabinet about six and one-half feet tall.

The various pieces of apparatus that make up each unit are mounted on a black finished angle iron framework, rectangle in shape, in order to provide a rigid and compact structure. The vacuum tubes, coils, filters, relays, resistances and other auxiliary apparatus which ordinarily do not require observation are mounted inside the frame. The antenna relay is on top of the framework.

The four ammeters which serve to indicate respectively the antenna current, the oscillator plate current, the oscillator grid current, and the modulator plate current, are mounted on the insulating panel, at the top front of the radio transmitter.

The cases of the oscillator slate current milliammeter and the modulator plate current milliammeter are covered with a grounded guard, in view of the fact that these instruments are subjected to the full voltage of the plate circuit generator, whose voltage may be either 1,600 or 800.

The radio transmitter is essentially a generator of radio frequency energy (an oscillation generator), which means for modulating this energy in accordance with current variations produced by the microphone operating in conjunction with the amplifier and certain other auxiliary equipment. The oscillator comprises vacuum tubes, previously described, and a tuned circuit which includes the antennae system. This tuned circuit determines the frequency or wave length of the radiated energy.

The modulating system provides means whereby the alternating currents corresponding to speech or music are supplied in amplified form direct to the oscillator circuit. The operation of this system may be understood by considering that the plate circuit of the oscillator is supplied with speech currents directly from the modulator.

currents directly from the modulator. The combined circuits provide a sort of mixing chamber in which the speech currents are combined with the steady carrier wave supplied by the oscillator to produce the modulated wave required.

The frequency of the transmitted energy (wave length) is controlled by the value of the inductance in the oscillatory circuit which includes the antennae. The inductance is adjusted by means of a variometer. To provide this feature a portion of the oscillator coil included in the antennae circuit is arranged to turn on an axis at right angles to its normal axis, so that the inductance of the movable coil either aids or opposes the inductance of the remainder of the coil.

The movable coil also serves to vary the coupling between the antennae circuit and that portion of the coil system which is connected to the plates and grids of the oscillator tubes in a manner to insure satisfactory operating conditions throughout the frequency range for which the transmitter is designed.

A variable condenser connected across the plate coil controls the plate current through the oscillator tubes, and to a large extent the output of these tubes. This condenser consists of a variable unit in parallel with two fixed units which may be switched in or out of the circuit as required. The variable unit is controlled by a knob on the front of the set and is designated "Oscillator Adjustment."

Both the adjustable inductance and the adjustable condenser are provided with graduated dials so that after the transmitting set has once been calibrated in connection with its associated antennae, wave length adjustments can be made without a wave meter.

The antennae relay is operated by means of push buttons and is used while the equipment is in operation to change connections from "send" to "receive" and vice versa. When the relay is in "receive" position an auxiliary contact is opened which renders the transmitter inactive and prevents it from interfering with local reception.

In order that the vacuum tubes used for modulating and speech amplifying purposes may operate under the most favorable conditions to prevent distortion, the grid circuits of these tubes are given a negative bias by means of a resistance connected between the negative terminal of the high potential generator and the filaments of the tubes.

The plate circuits of the vacuum tubes are supplied with direct current from a high potential generator. A

For CORRECT RADIO MAILING LISTS Use THE POCKET LIST

Of Radio Manufacturers, Jobbers and Dealers in the United States and Canada. Issued quarterly—January, April, July and October. October, 1922, issue corrected to September 15th, 1922. Classified under three different headings—Manufacturers, Jobbers and Dealers—and alphabetically arranged by states, cities, towns and names of firms. Containing over 15,000 names and addresses.

We have been exceptionally careful to see to it that every manufacturer, jobber and dealer is listed and, under the PROPER CLASSIFICATION. Most mailing list concerns charge more than \$100 for a list of this kind, and, as a rule, those supplied are far from being correct. Compare this list with any other and you will find it to be the very best obtainable anywhere at any price.

October number ready for distribution September 25th. Price \$5.00 per copy or \$10.00 per year (four issues, including monthly supplements which keep the list absolutely correct and up to date at all times). October edition limited, send in your order with remittance today.

1021 Carrington Street F. D. PICKENS JANESVILLE, WISCONSIN

"EURACO" MICA GRID CONDENSERS AND LEAKS

Price 60 cents
(Designed to fit Standard Grid Leak Base)

GRID LEAK
VALUES:

.5—1.0—1.5
2.0—2.5—3.0
Megohms

Price, 60 Cents



COMPACT,
INTER-
CHANGEABLE,
HANDY,
MOST
EFFICIENT

"Euraco" Condensers are composed of Copper Sheet and Best Grade India Ruby Mica, and are entirely Hand Made.

Manufactured in following capacities:

- .000025 Mfd—Correct for Myers Radio-Audion RAC-3
- .0001 " —For Special or Experimental Circuits
- .00025 " —Correct for Super-Hetrodyne & UV 201
- .0005 " —Correct for Radiotron UV 200

Condenser—Leak Mountings

Bakelite Base with Single Mounting	\$.40
Bakelite Base with Double Mounting60
Bakelite Base with Triple Mounting80

SHIP OWNERS RADIO SERVICE, Inc., DISTRIBUTORS

80 Washington St., New York

Interesting Proposition to Dealers

(Mfd. By EUROPEAN RADIO CO., 1342 East 22d St., Brooklyn, N. Y.)

NOVO "B" Batteries



for Radio Outfits

NOISELESS—DEPENDABLE—GUARANTEED

All Sizes—Plain and Variable

22½, 45 and 105 Volts

Send for Catalogue and Discounts

NOVO MANUFACTURING CO.

424 W. 33rd St.
NEW YORK

531 So. Dearborn St.
CHICAGO

DIAMANT
VARIABLE CONDENSERS
AND CRYSTAL DETECTORS
 Electrically and Mechanically Guaranteed
 Diamant Tool & Mfg. Co., Inc.
 93 Runyon Street Newark, N. J.

BUY DIRECT
for greater profits
ROGERS RADIO RECEIVER

Type B, complete short wave tuner detector and two stage amplifier in mahogany cabinet, no jacks, rear connections, list \$60.00. Liberal discounts.

Rogers Radio Co.
 5133 Woodworth St. Pittsburg, Pa.

LOOK WHAT WE HAVE TO OFFER
 Variable air condensers, no junk, 43 plate, list at..... \$4.00
 Variable air condensers, no junk, 23 plate, list at..... 3.00
 Discount, 50% of the list price.
 Rheostats and Bulldog Plugs for immediate delivery.
 Ducon aerial plugs and Novo Batteries, always on hand.
TUBES
 UV 200 and UV 201, U. S. Signal Corps Tubes, VT 1 and VT 2 also in stock.
 Western Electric Loud Speakers and Magnavoxs.
Liberal Discounts to Dealers
 Small orders receive the same attention as large orders.
 Write—Wire
WHITE RADIO CO.
 141 West 33d Street New York City

\$1.25 List Price
One of the Best

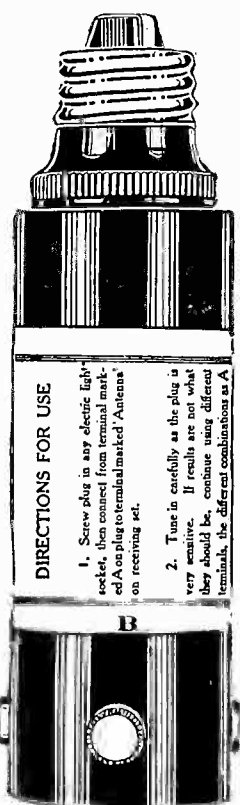

DIRECTIONS FOR USE
 1. Screw plug in any electric light socket, then connect from terminal marked A to plug terminal marked Antenna on receiving set.
 2. Tune in carefully as the plug is very sensitive. If results are not what they should be, combine using different terminals, the different combinations as A

GUARANTEED TO WORK ANYWHERE

JOBBER AND DISTRIBUTORS WANTED

MALTZ ELECTRIC CO.
 158 Belmont Avenue
 Newark, N. J.

noise filter is used to eliminate commutator noises and is mounted on the framework of the radio transmitter.

Under certain conditions, if the plate circuit is closed before the filament circuit, a destructive rush of current through the tubes may occur. To prevent damage due to this cause, a delayed action relay is provided. This relay which is operated by the filament current requires approximately 20 seconds to operate and its contacts are so arranged that the full plate potential is not applied to the tubes until the filaments have been lighted for this period of time.

The motor of the motor generator set is started or stopped by means of momentary contact push buttons. The main push buttons are located on the power switchboard, but similar push buttons connected in parallel are located at the operator's desk.

Two voltmeters are provided on the power switchboard. One of these is used to indicate the potential delivered to the filament circuit of the vacuum tubes; the other the potential of the high voltage generator.

The case of the high potential voltmeter is connected to ground, and it is not necessary, therefore, to use an insulated guard to protect the operator. The low potential voltmeter mounted on the power switchboard is not connected direct to the terminals of the low voltage machine, but is wired to the filament circuit on the radio transmitter. Under these conditions, the reading of the voltmeter indicates the actual voltage across the terminals of the tubes, and it is not necessary to make allowance for voltage drop in the wiring, etc.

A circuit breaker mounted on the power switchboard is provided for the plate current supply circuit. It is usually adjusted to open under an overload of about 25 per cent.

Field rheostats are included in the field circuits of both generators, but only the low voltage generator rheostat may be adjusted from the front of the panel. The rheostat of the high voltage generator is adjusted from the rear. This rheostat requires infrequent settings since when properly set and the potential of the low voltage machine is correctly adjusted, the potential of high voltage machine is established at the correct operating value.

Current to operate the microphone is supplied by an 18-volt storage battery, and is regulated by a rheostat on the input amplifier by a rheostat on input amplifier panel. Filament current for the input amplifier is obtained from the same 18-volt storage battery that supplies the current to the mi-



HALL-MARK OF QUALITY

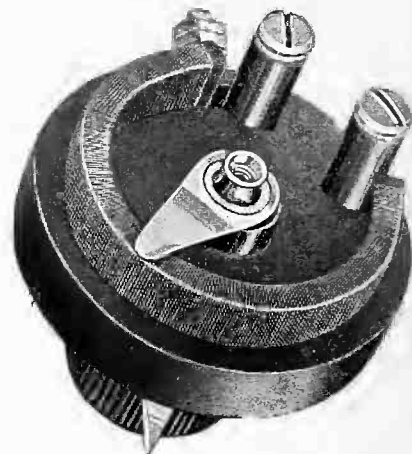

MODEL—A205

POTENTIOMETER
 230 OHMS 0-2 AMPS

SPECIFICATIONS

Condensite Base
Ideal Resistance Unit
Phosphor Bronze Contact
Brass Posts
Highly Nickered

SEND FOR OUR BOOKLET
"WHY WE USE CONDENSITE"

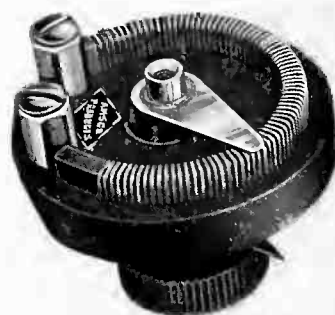

MODEL—A101

RHEOSTAT

ADVANCE METAL STAMPING CO.

MANUFACTURERS

Department RE
 19 THOMPSON ST., NEW YORK

Buy Apparatus
From a Reliable Manufacturer

FREED-EISEMANN RADIO CORP.
255 Fourth Ave., New York City

Radak
Reg. U. S. Pat. Off.

RELIABLE RADIO EQUIPMENT
made by America's oldest and largest manufacturers of radio equipment exclusively. Sold by the best electrical and radio dealers.

CLAPP - EASTHAM CO.
133 Main Street Cambridge, Mass.

RADIO MAILING LISTS

9270 Radio dealers by states.....	per M.	\$7.50
1164 Radio mfrs.	per list	10.00
1330 Radio supply jobbers.....	per list	12.50
260 Radio stations.....	per list	4.00
267 Mfrs. appliances, who make and assemble complete sets.....	per list	4.00
14000 Radio amateurs and managers of Radio stations.....	per M.	7.50

All Typewritten and Ready To Send on Receipt of Remittance

TRADE CIRCULAR ADDRESSING CO.
166 W. Adams Street Chicago, Ill.

Solder Your Connections

for best results. Get the "Wonder" a Self Heating Iron. Use it anywhere without stove. No workshop complete without it. Cheap to operate. Generates own vapor in two minutes. Absolutely safe—a child can operate. Nothing to get out of order. Use it as a blow torch also. Boxed complete with solder, salamoniac and full soldering directions. **Send No Money**—just your name and address on a post card. When the postman delivers, pay him \$2.50.

Dealers—a big seller, write for proposition.

North Shore Radio Works, Dept. 6017
810 Davis Street, Evanston, Ill.

PATENTS

PROTECT YOUR INVENTION TODAY

Write for 1922 illustrated book free. Radio-Electrical, chemical and mechanical experts; over 20 years' experience.

A. M. WILSON, INC., (Radio 3 ARH)
309-20 Victor Building, Washington, D. C.
(Successors to business established 1891 by A. M. Wilson)

JOY-KELSEY CORPORATION
Manufacturers
RADIO EQUIPMENT
4021 West Kinzie St. Chicago Ill.

ESSEX BUS WIRE NO. 14
Square Tinned—Specially Prepared and Will Give Entire Satisfaction.
\$1.00 Per Hundred Feet.

ESSEX LIGHTNING ARRESTERS
\$1.00 Each. List Price, \$1.50.
Send for Dealers' Quantity Prices

ESSEX MANUFACTURING CO.
117 Mulberry Street, Newark, N. J.



DEALERS: Get our Price List before placing your orders

We are distributors of Federal, Patent, National, Miraco, Uradiola, etc., lines of Quality Radio Apparatus.

THE EDW. J. GOETZ CO.
604 Race Street Cincinnati, Ohio

CAP SCREW AND NUT CO.
OF AMERICA

318 West 47th Street New York
Manufacturers of Screws, Bolts, and Nuts of Every Description

In Stock for Immediate Delivery
Switch Stops, Binding Posts, Contact Points

Cutler-Hammer Make Good Radio Parts

Pioneer Rheostat Builders Enter Radio Field

The Cutler-Hammer Mfg. Company of Milwaukee, one of the pioneer rheostat builders, are soon to place on the market their latest development, the C-H Vacuum-Tube Rheostat. It will be furnished in two styles, with vernier adjustment for control of detector tubes, or without vernier for control of tubes. They are designed to carry one ampere and have an operating range of from zero to four ohms. Two amperes may, however, be carried in an emergency.

These new rheostats are built along entirely new lines and incorporate many novel features. A "full off" position is provided, eliminating the necessity of additional switches in the "A" battery circuit. A "full on" position is also provided which makes total battery potential available, rendering charging unnecessary until its full voltage has dropped below tube requirements. A nicked pointer indicates at all times the amount of resistance in the circuit.

The spring contact fingers are adjustable, and are so mounted as to lie in the direction of travel of the resistor, insuring smooth, quiet, positive regulation. The number of turns of low resistance each cut out or in, one at a time, provides fine graduation of control, minimizing clicking in the receivers during filament adjustment.

The rheostats are designed for panel mounting and are readily adjustable for panels ranging from one-eighth to one-half inch in thickness. Cone-shaped knobs of genuine Thermoplas are provided which are of excellent appearance and do not cramp or tire the fingers. All metal parts throughout are finished in highly polished nickel.

L'ART IN CATALOGS

A catalog that encourages one to look through it from cover to cover—and then to read it through again—is one issued by the Widdicomb Furniture Company of Chicago. It is not a catalog that deals with radio, yet it is one deserving of mention. However, it is appropriate in that its contents could readily be used in the radio field and its photographs give range to the imagination of things that remain undone in the radio industry insofar as artistic catalogs are concerned. Each picture is a "home setting" accompanied by a short, appropriate word sketch.

Condensers—Guaranteed—Tested—Perfect
Order now for immediate or fall delivery

43 plate001	\$2.00
21 "0005	1.35
11 "00025	1.10
3 "	Vernier	.80
.005 variable for Armstrong circuits.....		6.00
Fixed Phone Grid—Grid Leak.....		.07

Special Offer to Jobbers
DUKE RADIO CO.
1758 Bergen Street Brooklyn, N. Y.

PATENTS

on radio inventions apply to
OTTO K. ZWINGENBERGER
38 Park Row, New York
Cortlandt 3207

PATENTS
ELECTRICAL MECHANICAL
RADIO

SEND SKETCH AND DESCRIPTION FOR OPINION

EMIL ALEXANDER KERN
328 SOUTH SEVENTH STREET
NEWARK, N. J.

PATENT

your Ideas. Protect your rights by U. S. and Foreign Patents and Trade-Marks. Moderate rates. CALL, WRITE or send us your invention.

May one of our representatives call on you?

FREE CONSULTATION

Phone: Vanderbilt 7212.

ASK MANUFACTURERS PATENT CO.
FOR 520 FIFTH AVE. NEW YORK

AEREX King of the Air

COMBINATION RECEIVING SET
CRYSTAL—DETECTOR—TWO STEP

Aerex Radiophone Corporation
342 MADISON AVENUE, New York City

SCREW MACHINES IDLE

Battery of Seven Automatic Screw Machines for Making Parts for Radio Equipment.

SEND BLUE PRINTS AND SPECIFY QUANTITY

The Carlyle Johnson Machine Co.
MANCHESTER, CONN.

Fine Cuts for Illustrating
CENTRAL ELECTROTYPE
FOUNDRY COMPANY

Electrotyping and Engravings
9 Campbell Street Newark, N. J.
Telephone: Mulberry 1698

Moss Radio Company

Jobbers in
Radio Sets and Equipments

202 West 23rd Street
New York City
Phone Watkins 5078

BOUDOIR SET ATTRACTIVE

Novelties in the radio business seem to be coming thick and fast. The smallest set has made its debut, the largest set is also with us, and a hundred-and-one other novelties are to be seen everywhere. The W. E. Supply Co., of New York City, are bringing out a set specially designed to interest the lady of the house, called a "Boudoir" set.

It is claimed that the Aerial A, as this set is called, is one of the simplest of vacuum tube sets to operate, and is specially designed to harmonize with the surroundings of boudoir or home, and besides being a thing of beauty, it is an efficient set.

One of the features of this set is the fact that there are only two dials-to operate, and one rheostat for filament control. All wiring is concealed and is connected from the back of the machine. The set is durably and attractively built.

The simplicity of the design, together with the fact that the best of standard parts are used throughout, assures the radio buyer that he is getting a set that is as efficient as good practice warrants.

The Aerial A was found to have a wave length of from 150 to 750 meters when tested by a well-known New York laboratory.

COLUMBIA VARIOMETER

The Columbia Moulded Variometer, the product of the Columbia Radio Corporation of Chicago, Ill., is the result of labor spent to perfect a mechanically and electrically efficient instrument. The specifications cover stators moulded in two halves with maximum diameter of 5 1/4 inches. The rotor is also moulded and highly polished, the maximum diameter being 4 inches. Large dimensions permit the use of low resistance wire. The rotor fits into the stator with minimum clearance. There is no possibility of shrinkage or warping in these moulded parts. No shellac or paraffine is used in the wiring. Perfect contact is assured by a spring tension on the bearing. Width across stator 3 inches. Shaft 3/16 inch diameter. Polished nicked hardware and terminal binding posts. Base and panel mounting is provided for. Wave length is 175-650 meters.

The complete instrument is a thing of beauty and symmetry.



IMMEDIATE SHIPMENT
Also
All Other Radio Needs
 WRITE FOR PRICE LIST

RADIO ACCESSORIES CO.
 220 West 42nd Street
 New York



EMELOID DIALS—2"—3"—4"
 2" 35c—3" 50c—4" 60c
 MANUFACTURERS—JOBBER—DEALERS
 WRITE FOR DISCOUNTS
 EMELOID CO., INC., 536 JUNIUS ST., BROOKLYN, N. Y.

MR. RADIO RETAILER!

You **NEED** This Paper. Do you think it will be worth a dollar to get **THE RADIO DEALER** every month for the next year? Use the blank below, rubber stamp or print your name and address, then mail to us. Do it today.

HARRY M. KONWISER, *Publisher,*
The Radio Dealer,
 1133 Broadway,
 New York City.

Please send **THE RADIO DEALER** to the following address for one year
 for which { we enclose one dollar
 { we will send one dollar on receipt of bill.

(Name)

(Address)

(City and State).....

Make remittance by check, money order or registered mail

STRAHS ALUMINUM CO.
 announce their removal from 53
 Grand Street to much larger premises.
 New Address
 48 FRANKLIN STREET
 NEW YORK CITY

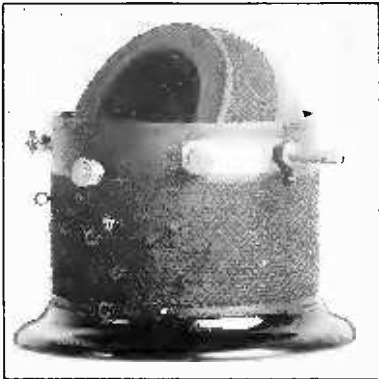

The EMBE Variocoupler
 List Price \$4.50
 Attractive Trade Proposition
 Manufactured by
Marvin B. Fallgatter
 Waupaca, Wisconsin

Stanton's WIRELESS Bulletin



The Authority on Wireless Stocks

Reynolds Spring Co.
 Radio Corp. of America Spanish Marconi
 American Marconi Canadian Marconi
 English Marconi Federal Tel. & Tel.
 De Forest Radio Tel. & Tel.

FRANK T. STANTON & CO.
 Broad 5819 35 Broad St., N. Y. C.

Free Will help **YOU** increase sales

This catalog will show you how to secure the names of your best prospective customers, those you want to reach most. Counts and prices are given on thousands of different Lists, covering business concerns, professions and individuals, such as Noodle Manufacturers, Druggists, Coal Mines, Farmers, etc. Personalized sales letters and descriptive literature mailed to live prospects will increase your sales by creating direct orders or inquiries.

99% Guaranteed Mailing Lists backed by our 5¢ refund

Insure your getting up-to-date information, for our Lists must be compiled from latest sources to avoid heavy losses through the guarantee.

Send for FREE Reference Book today
 A postcard will bring this valuable sales help,
 ROSS-GOULD CO., N. 10th, St. Louis.

Ross-Gould Mailing Lists St. Louis

Trade - Mark Department
 Conducted by **Chauncey P. Carter, Trade-mark Specialist**
 of Washington, D. C.

Radio Trade-Marks Recently Accepted by the Patent Office
 ACCEPTED AUGUST 15

BKUMA YRLSBUG — Code-memorizing charts for radio beginners and pamphlets and books relating to radio-telegraphy published from time to time.—Cheever K. Dodge, Mamaroneck, N. Y.

DREADNAUGHT — Attachment plugs—Cutler-Hammer Mfg. Co., Milwaukee. Oct. 28, 1921.

MICADONS — Electrical condensers—Dubilier Condenser Co., New York, N. Y. March 28, 1922.

DURASNAP—Electrical box connectors—Tubular Woven Fabric Co., Pawtucket, R. I. March 25, 1922.

ETHEROLA — Cabinet receiving outfits.—Ralph A. McKinney, Pittsburgh. February 1, 1922.

LISSENIN—Receiving sets.—Lissenin Radio Parts Co., Ridgefield Park, N. J. January 20, 1922.

SOCOSTAT—Tube mountings.—J. Roy Hunt, Inc., Long Island City. April 15, 1922.

SUPERADIO — Receiving and sending sets and parts.—DeWitt LaFrance Co., Cambridge, Mass. May 10, 1922.

CHAMPION—Jacks and plugs and bulb sockets.—Champion Radio Co., Detroit. April 6, 1922.

MINATRON—Vacuum tubes and valves.—Radio Corp. of America, New York. May 27, 1922.

RADIOLETTE—Vacuum tubes and valves.—Radio Corp. of America, New York. May 27, 1922.

KAPACITON—Condensers. Meirrowsky Bros., Jersey City, N. J. May 1, 1922.

PROTEX—Antenna plugs.—Genl. Radio Mfg. Co., Pittsburgh. Sept. 30, 1921.

VOCAROLA—Loud speakers and amplifiers.—Westinghouse E. & M. Co., East Pittsburgh. December 1, 1921.

DUCON—Condensers. — Dubilier Condenser & Radio Corp., New York. May 20, 1922.

RADIOSTAT — Controlling devices.—Allen Bradley Co., Milwaukee. April 1, 1922.

UNIVERSAL—Connector plugs.

KNOCKDOWN APPARATUS
 Variometer with brass fittings, boxed.
 Variocoupler with brass fittings, boxed.
 Crystal set with complete instructions for hook up and assembly.
 Rotors, stators, and coil ends always on hand.
Write for circular and discounts
RITTER WOOD WORK CO.
 118 Walker St., New York City

The Comet Battery Co.
Manufacturers
Radio "B" Batteries
 Cleveland, Ohio

RADIO BOXES AND CABINETS
 Send us your specification and let us figure on your requirements.
 PROMPT DELIVERIES.
THE WEIS MFG. CO.
 Monroe, Mich.

SHIPPED FROM STOCK

Prices Net to Dealers Only

Variometer, complete\$2.00
 Variometer Parts, all necessary parts except wire..... 1.00
 Variocoupler, complete 1.50
 Variocoupler Parts, complete set of parts, except wire.... .85
 Thordarson Amplifying Transformer 2.75

Scientific Dealers Supply Co.
 2727 Fullerton Ave., Chicago, Ill.

—Pacent Electric Co., New York, N. Y. May 18, 1921.

ACCEPTED AUGUST 29

HIGH-10-SHUN — Resistors, lightning arrestors and fuses.—High Tension Supplies Co., Wilmington, Del. Oct. 18, 1920.

TELERADIO—Wireless and electrical equipment. — Teleradio Engineering Corporation, New York. March 11, 1922.

AMPERITE—Automatic filament control adjuster.—Radiall Co., New York. March 15, 1922.

AUDIOLA—Receiving and transmitting sets and parts.—Audiola Radio Co., Chicago. March 31, 1922.

RADION—Battery jars, receiver cases, horns, etc.—American Hard Rubber Co., Hempstead, L. I. April 14, 1922.

RA-FONE—Receiving sets and other radio parts.—Ra-Tone Electric Co., Detroit. March, 1922.

Recent Registrations in Radio Dealer Trade-Mark Bureau

ALL SENSITIVE—Galena Crystal Mfg. Co., 464 Bushwick Avenue, Brooklyn, N. Y.—for Galena. Adopted June 15, 1922. First used June 22, 1922.

SERCO — Condensers, detectors and transformers.—Scheib Electric Radio Co., 6243 Station Street, East Liberty, Pittsburgh, Pa. Adopted and first used April 1, 1920.

SIMPLE-X NOVEL SET

Among the new and novel crystal receiving sets that are being brought out by manufacturers, because of the increase in broadcasting, is one known as the Simple-X, the construction of which is out of the ordinary. This set is the invention of Charles Hanington and Joseph Gallow.

The Simple-X consists of a flat coil, which is a feature that is patented, and not to be found in any other set, regardless of price, according to the makers. A standard two-slide tuner circuit is employed. The coil of the set is mounted on a well insulated wooden panel, with neat white lettering. Highly polished nickel-plated trimmings are used, and both sliders have rolling contacts, thus assuring good spring action.

The detecting unit of this set is very novel and unique, because the ordinary "catwhisker" is replaced by a wire brush of many strands, and acts on the "multitek" flat crystal, which is a flat area of galena granules bound together with a conducting material.

Clarke-Caragol & Co., of 82 Beaver street, New York City, are distributors of this set.

WHY EXPERIMENT—MR. MANUFACTURER?

For years we have been cutting, drilling, machining, grain-ing and polishing Bakelite Dilecto.

Put this experience to work on your panels. Write us for proposition and sample.

STANDARD WIRELESS PANEL COMPANY

49 MECHANIC STREET

NEWARK, N. J.

Binding Posts—Contact Points

Knock-down Detector Sets

VARIABLE CONDENSERS

with patented adjustable tension

JOHN A. COZZONE & CO.

61 Arlington Street

Newark, N. J.

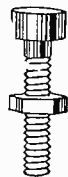

INTERESTED IN RADIO PATENTS?

Radio Business men and Manufacturers who are interested in the patents issued by the U. S. Patent office may find this information each week in

THE RADIO DEALER WEEKLY

One dollar the year. Sample free on request

Address

THE RADIO DEALER WEEKLY, 1133 Broadway, New York, N. Y.

Trade-Marks Secure Trade Registrations Secure Trade-Marks

I Secure Registrations

CHAUNCEY P. CARTER

Radio Trade-Mark Specialist

4907 Potomac Avenue, N. W. Washington, D. C.

Correspondents in all countries

P. D. JACKSON

Direct Factory Representative
Radio Equipment Manufacturers
HEAD SETS A SPECIALTY
1441 So. State Street Chicago, Ill.

VACUUM TUBE DETECTOR \$5.50

Including complete cabinet with all instruments wired ready for use.

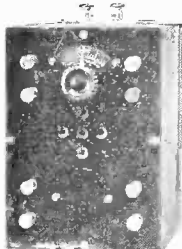

DETECTOR A N D
TWO STAGE AM-
PLIFIER \$22.50

With transformers and all other instruments in cabinet, ready for operation. This equipment is of high quality, and distances of as high as 3000 miles have been obtained with ease.

BATTERIES AND
TUBES EXTRA

2000 Ohm receivers \$5.00

SUPERIOR CRYSTAL RECEIVING SET \$4.75

Attractive dealers proposition

STEINMETZ WIRELESS MFG. CO.

5706 Penn Ave., Pittsburgh, Pa.

Mr. Dealer: Tie up to High-Grade

FROST RADIO Merchandise

A well-known National Reputation for Satisfactory Service guarantees you a Quick Turnover.

FROST-RADIO LEADERS

Frost-Fones
A Quality Achievement. Ideal Receivers for use with Home Radio Sets. Combine maximum efficiency with permanent sensitiveness.

Frost-Radio Extension Cord and Plug
Comes in lengths from 10 to 100 ft. Loud speaker can be placed anywhere and connected with Radio set with Frost-Radio Extension Cord.

Frost-Radio Receiving Transformers
Will tune in all stations up to 3,500 meters. Hand rubbed mahogany finish. Wound with green silk covered wire. Immediate deliveries.

Frost-Radio Protector
Listed by Underwriters' Laboratories under April, 1922, regulations. No interference with clear Radio receiving. Never Grounds. Mounts indoors. Price \$1.50. Good deliveries on this approved device. The best Jobbers in your locality can supply you. See them now

Improved Plugs and Jacks
Specially designed for Radio Panel Work. Plugs are interchangeable with other standard makes.

Cunningham Vacuum Tubes
Nationally recognized as the Ideal Detector or Amplifier Tubes for use with Radio Receiving Sets.

Remler Radio Apparatus
Radiates Quality. Every Remler item is first studied and tested for its practical Radio utility before being marketed.



HERBERT H. FROST
NATIONAL FACTORY DISTRIBUTORS
TO THE ELECTRICAL RADIO JOBBERS
154 W. LAKE ST. CHICAGO, ILL.

Crosley Publicity

Cincinnati Folks Furnish Live
Wire Radio News

R. F. Stayman, publicity manager for the Crosley Manufacturing Company, is to be commended for his practical efforts to boost radio.

The Crosley folks are doing things and the publicity matter sent out by this progressive house is adaptable for use by daily newspapers and must be appreciated by the radio editors who are on the Crosley mailing list.

A regular weekly sheet of short items just suitable for the daily press is a feature of their service.

"QUALITONE" RADIO HORN

The Dual Tool Company of Cleveland are producing a new radio horn known as the "Qualitone." W. E. Disbrow, president of the company, in writing of the horn says, "The secret of the success of the 'Qualitone' is due to the built-in double tone chambers more than anything else. Without the rings which form the tone chambers this horn would be like a megaphone. Many months of experimenting were required for determining the right number of rings, their size and the spacing, in order to produce the quality of tone for which this horn is named."

The company has recently started production on another horn of the same type which can be used with a single head piece, believing that there is an increasing demand for this style of horn.

MAIN RADIOPHONE SET

The Main Radiophone Receiving Set, the product of the Main Radio Company of Cleveland, consists of three separate units, in genuine solid mahogany cabinets, finished in natural color, and hand rubbed finish. Panels polished black formica, with high grade dials 3 inches in diameter.

The tuning unit contains a 23 plate variable condenser, with 3 in. dial, a separate vernier condenser with knob, 180° type variocoupler. Wave length switch and contact points with stops, for up to over 600 meters.

The detector unit consists of high grade rheostat of 200 steps of 6 ohms, good sized knob and indicator hand. Socket, using little metal and a jack.

The units permit the use of a loud speaker and for sharp tuning, the jacks provide a means of quick attachment of the head set.

CABINETS

Write for quotations

MARVIN B. FALLGATTER

Waupaca, Wisconsin

Ask Our Service Bureau



Radio Reception Explained

HOW TO BUILD

- Double Slider Type Crystal Receiving Set
- Loose Coupler Type Crystal Receiving Set
- Single Circuit Vacuum Tube Receiving Set
- Vacuum Tube Receiver and Two Step Amplifier
- Loose Coupler Tuner and Vacuum Tube Detector
- Short Wave Long Distance Variometer Regenerative Tuner
- Radio Frequency Amplifier and Variometer Regenerative Tuner
- Combined Radio-Audio Frequency Amplifier Circuit

Great Lakes Publishing Company
Detroit, Michigan

BUILD BUSINESS

Sell more parts by creating interest in radio matters. Distribute an inexpensive book which not only explains radio reception but also tells how to build eight separate types of receiving outfits out of parts you are selling. Complete bills of material given for each type listed and described. This will be of great help to your customers and profitable also.

List, 50c Sample, 20c Very liberal discounts
Desk 4—Great Lakes Publishing Co., Park Place, Detroit, Mich.

VOLTA

PRODUCTS

VARIOMO-COUPLER.....\$3.85 List
No taps, the only coupler with sharp primary tuning.

VARIOMETER.....\$3.25 List
Low distributed capacity, high range.

CRYSTAL SET.....\$8.50 List
Sharp tuning, triple range.

VACUUM TUBE SETS

Write for Trade Discounts

VOLTA ENGINEERING CO.
172-4 Lorimer St. Brooklyn, N. Y.

FRANKLIN VARIOMETER

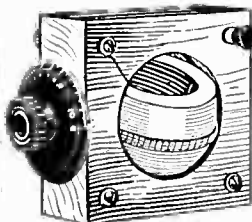

Made of selected hardwood. Permanent contacts assure smoothness of operation, unsurpassed by any other make.

Price \$4.50

Sample sent prepaid \$3.50

Dealers Write for Discounts

FRANKLIN RADIO MFG. CO.

711 Penn Ave. Wilkensburg, Pa.

GUARANTEED
QUALITY radio supplies at LOW PRICES and PROFIT allowing discounts.

Variometers\$3.75 up
Vario Couplers.... 2.50 "
Vario Condensers... 2.00 "
B Batteries..... 1.75 "

Wire, Parts and Supplies
Special Purchasing Service

McConnell Cable & Specialty Co.

426 1/2 S. Clinton St., Chicago, Ill.

Baltimore

The Autovoix Company, of Lexington Street, are completing plans for extensively marketing a new loud speaker which has been shown by tests to be 100% efficient. The new speaker combines the best acoustic and electrical properties and is distinctive in design. The price is one to fit everyone's pocket.

The Jones Radio Manufacturing Company, constructing all small parts as well as complete sets, and having their hands full making the output of their large plant meet even local design. Among other products, this company has devised and is producing a tube socket built especially for the "peanut" tube, which is being used so widely.

Reuben S. Baldwin, of the Fidelity Trust Building, is distributing nationally, a complete set which is made by a firm of repute in the electrical instrument field. Plans for national advertising and merchandising of this set are now under way, and it will soon be on the market.

NEW GROUNDING DEVICE

The Fargo Manufacturing Company, Poughkeepsie, N. Y., are producing a new grounding device that bids fair to find a ready market. The device secures a perfect connection of a grounding wire with seven full turns around a grounding pipe or rod, and is fastened by hexagonal semi-finished clamping bolts through a clearance hole in one clamp and threaded hole in the other clamp, and locked with a hexagonal jam nut.

The clamps are made of malleable iron well reinforced with bosses hot galvanized.

This device can be applied easily and quickly.

BOOK REVIEW

The Radio Pathfinder, by R. H. Ranger. Published by Double-day-Page and Co., Garden City, N. Y.

R. H. Ranger, who is an engineer on the staff of the Radio Corporation of America, has covered the path of the broadcasted wave from the moment it strikes the aerial until it is intercepted in the receiver and horn. The book contains more than fifty line drawings, aiding greatly in making the written description clearly and easily understood.

A Vernier Condenser That Has No Equal

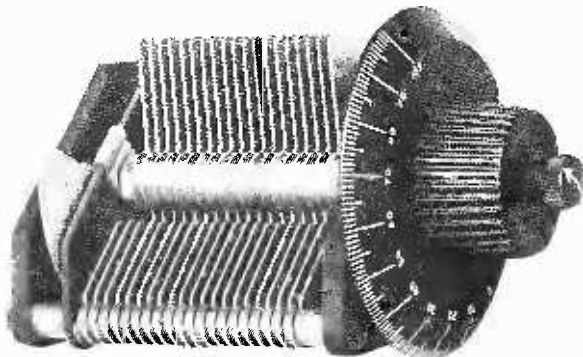

.0005 - \$5.00 .001 - \$6.00

WITH 3-INCH DIAL

Special Sizes Made to Order

ALSO PLAIN CONDENSERS,
SPAGHETTI, RUBBER TUB-
ING, KNOBS, DIALS, GRID
LEAKS, GRID CONDENSERS

BREMER-TULLY RADIO CO., Manufacturers

532-536 S. CANAL ST.

CHICAGO, ILL.

MANUFACTURERS!

DEALERS!

RADIO PANELS

of Genuine XX Grade Black

BAKELITE—DILECTO

Cut to Any Size

STANDARD RADIO PARTS CO.

30 Church Street, Room 2013 (Phone Cortlandt 2515) New York

"ASK OUR SERVICE BUREAU"

Dealers, Jobbers and Manufacturers who are not heeding this advice are missing a service that works with speed and efficiency, and in addition costs nothing.

If you want to buy anything in Radio

"Ask Our Service Bureau"

(Advertisement on Page EIGHTEEN, this issue)



VERNIER DIAL
ATTACHMENT

"BROUN"



DOUBLE CIRCUIT JACK
Made in Single Open, Single Closed
and Double Circuit Jacks



BATTERY
SWITCH

The above Jacks and Battery Switch manufactured by the Radio Improvement Co. and the Vernier Dial Attachment manufactured by us are essential parts for the perfect operation of a Radio Receiving Set.

As manufacturers and manufacturers' representatives we have a complete line of Radio Apparatus, each part of which is backed up by our guarantee.

Many advancements in design and sales features will be found in all of our apparatus.

Write for new catalogue.

BROUN RADIO COMPANY

Sales Office, 552 Seventh Avenue, New York City

RADIO CONCERTS CORACO

America's Greatest Radio Receiver
No Inside or Outside Connections
GOTHAM THEATRE BUILDING
Broadway at 138th Street

T-B-H PHONES

Speak for Themselves
Pure Natural Tones, Light Weight
Ornamental Appearance

A Sturdy Reliable Head Set That Will
Sell and Stay Sold

Let us send a sample set for your
inspection

List \$7.00

Substantial Discounts to Jobbers and Dealers

T. B. H. CORPORATION
Dansville, N. Y., U. S. A.



HONEYCOMB COILS

Size	Price	
	Mounted	Unmounted
DL-25	\$1.54	\$0.50
DL-35	1.54	.50
DL-50	1.65	.60
DL-75	1.65	.60
DL-100	1.71	.65
DL-150	1.76	.70
DL-200	1.82	.75
DL-250	1.87	.80
DL-300	1.93	.85
DL-400	1.98	.90
DL-500	2.20	1.00
DL-600	2.37	1.15
DL-750	2.59	1.35
DL-1000	2.86	1.60
DL-1250	3.30	2.00
DL-1500	3.85	2.50

Both the mounted and unmounted coils are perfectly wound and have the proper inductances, capacities, etc.

Mountings

This is an article which we have originated to meet the demand for a device suitable for mounting unmounted honeycomb coils. It consists of a plug, which has been drilled and tapped and prepared for soldering, and which is equipped with two plates and two screws and a perforated fiber band, long enough to encircle the largest size honeycomb coil. It sells at 80c.

Special Discounts to Dealers and
Jobbers

VIKING RADIO CO.
26-D Cortlandt Street
New York City

MILLIKEN TOWERS

(Continued from page 43)

of construction involved will in itself safely accommodate these various conditions. This is partially true when we come to the higher towers, but not entirely, because, unfortunately, the forces of nature, in the form of wind, sleet and ice, and the fallibility of man, make it impossible to limit the corresponding effects. The qualified designing engineer will provide a factor of safety against these elements, but the degree of this will be influenced by the height of the tower.

In the earliest days of bridge building, the first was probably a tree thrown across a stream or gully; then it was found, quite obviously, that two trees side by side would carry twice the load, and that two trees, one on top of the other and fastened together, would carry more than twice the load. From this the development extended to wood trusses, until some very massive wood bridges were finally constructed, some of which still exist.

This development, however, was by a method of extending the service of wood from step to step by more or less empirical formula. Sometimes the extension was carried too far and the bridge collapsed.

Likewise, in wood pole construction, up to certain heights, experience has shown that it is quite satisfactory, but beyond these limits there is always danger of an extension too great.

In the previously mentioned height curve, the Milliken Brothers Mfg. Co., Inc., supply galvanized steel towers for two of the divisions—namely, that extending from 66 ft. to 165 ft. in one and from 200 ft. to 300 ft. in the other. For the division below 66 ft., it is suitable and perhaps more economical to use a wood construction. Above 300 ft., the construction requires a type of riveted steel tower that is beyond the practicable possibilities of galvanizing and consequently outside of the class of the company's products.

Both types of the Milliken Radio Tower are standardized, made to fixed designs fully illustrated by the catalog. The material is shipped knocked down, in pieces easily handled and erected. All connections are made with bolts and lock nuts. The problem of foundations is very simple and these can always be made with local labor. The catalog shows the details of the foundations as well as the details of the tower, but in addition, with each tower order is mailed a complete erection diagram that shows the mark and location of every member in the tower.

Telephones: 5454 Beekman 2787

NAME PLATE COMPANY
ETCHED OR LITHOGRAPHED METAL
NAME PLATES, SIGNS, DIALS
125 FULTON ST., NEW YORK

MELCHIOR RADIO EQUIPMENT CO.



MANUFACTURERS OF
THE SMALLEST TUBE
SET ON THE MARKET

A well made set using a reliable condenser, rheostat, vario-coupler and a variometer.

MELCHIOR EQUIPMENT CO.
306-308 E. 34th Street New York City
Dealers—Write for our Proposition.

Ask Our Service Bureau

See page 18



35c. each.

3 for \$1.00

Na-ald

GENUINE
CONDENSITE DIAL

The Dial that Runs True

Numerals engraved on bevel and knob so shaped that fingers do not hide them. Thin edge with clear graduation to make accurate reading easy. Concealed set screw in metal insert. Will not warp or chip. Finish and enamel permanent. Low price with this quality possible only through quantity production.

Special dealer and jobber
proposition. An opportunity.

ALDEN-NAPIER CO.

52 Willow St. Dept. J Springfield, Mass.

Do You Know

We are the recognized authorities on wireless securities. Our Information and Analytical Departments are unexcelled. Let us know what company you are interested in and we will furnish without obligation, detailed information and opinion respecting its merits

FRANK T. STANTON & CO.

Specialists in Wireless Securities
Since 1915

35 Broad St. New York

Phone: Broad 1670-3641-5819

RADIO STOCKS

(Continued from page 54)

stations of the Postal Telegraph-Cable Company in this country are to be placed at the disposal of the Radio Corporation of America, for the delivery and collection of radio messages between America and all parts of the world where radio service is possible. This agreement places speedy and cheap radio service in virtually every town and hamlet in the United States and direct competition with the cable service to foreign countries. The importance of this agreement cannot be overestimated. It places the final stamp of approval on radio as a means of better communication. Additional announcements of a constructive character are expected, which should further stimulate increased buying of Radio Corporation shares.

ENGLISH MARCONI: The broadcasting craze is now sweeping England. As the pioneer radio concern and having a practical monopoly of the business in England, English Marconi should come in for a large share of equipment buying. This is a dividend paying stock with good possibilities for capital appreciation. A Lisbon message says that the Portuguese Parliament has approved a contract with the Marconi Company for the erection of wireless stations in Lisbon, Madeira, the Cape Verde Islands, Angola and Mozambique, to be ready in four years.

CANADIAN MARCONI: As in the case of England, Canada is beginning to appreciate broadcasting possibilities. Heavy demand is reported for radio licenses. Theatres, hotels, etc., are installing radio equipment for the entertainment of the fans.

DE FOREST RADIO: This company recently announced that Dr. Lee De Forest, who has been in Germany for the past year, is returning to America to demonstrate his perfected talking movies. This invention is bound to revolutionize the motion picture industry which has through lack of novelty, declined considerably in entertainment value. This billion dollar industry opens up a vast profitable field for the De Forest development, since practically every producer is a potential buyer of this equipment. Aside from the profits to be derived by this new invention, the company is showing satisfactory earnings from its radio business.

WESTERN ELECTRIC: The directors of the Western Electric Company at a recent meeting

ELECTRICAL TESTING

Of all materials entering into Radio Construction. Meters and apparatus calibrated and repaired.

**CHEMICAL ANALYSES
STRENGTH TESTS**

Investigation or Development of New Apparatus and Materials. Routine Tests at Special Rates.

NEW YORK TESTING LABORATORIES
80 Washington Street

Bowling Green 7016

SEABOARD

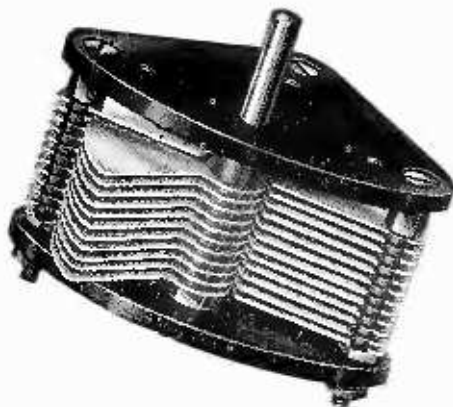

No. 1 Variable Condenser for Panel Mounting. IMMEDIATE DELIVERY. Jobbers and retailers—write for discounts. 23 plate—list price, \$3.00.

CAREFUL construction in all SEABOARD products, courteous attention to all SEABOARD clients, and full-of-value prices for all SEABOARD parts have combined to make an organization efficient and dependable. Send us your radio-needs and let us "talk turkey" on some of the lowest prices on the radio market.

Every part tested and inspected before shipment. Our guaranty stands behind all SEABOARD products.

SEABOARD RADIO CORPORATION - 266 GRAND STREET NEW YORK CITY

SERVICE TO THE RADIO TRADE PROMPTS THE PUBLICATION OF

The Radio Dealer Weekly

1133 BROADWAY

NEW YORK, N. Y.

RADIO CABINETS

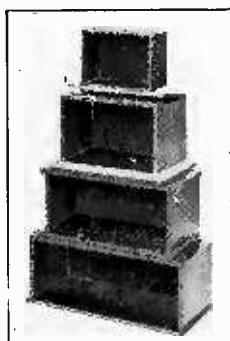

We manufacture a complete line of radio cabinets, of mahogany, walnut, oak, and white wood, in all sizes, and in any finish. Best of construction. Dirt, dust and moisture proof. Quick deliveries—quantity production prices. Send us your specifications, or a sample of your cabinets, and get our prices. We also make indoor loop aerials.

CABINET WORK SINCE 1900

E. ESHOO CABINET WORKS

635 HERKIMER ST. BROOKLYN, N. Y.

::

TELEPHONE LAFAYETTE 2324

declared the regular quarterly dividend of $1\frac{3}{4}$ per cent. on the preferred stock of the company, payable Sept. 30th to stock of record Sept. 16th. A dividend of \$2.50 per share was also declared on the common stock, similarly payable.

AMERICAN TEL. & TEL.: This company opened America's first Radio news service on September 1st. A digest of the day's important news will be supplied to the owners of radio sets within short distance of New York. In addition to general news, the digest will feature information pertaining to new inventions in radio and will conduct a department of questions and answers for the benefit of its "listeners in." Company recently issued \$115,000,000 of 9% stock.

WESTINGHOUSE ELECTRIC: There is no let-up in the demand for the Company's products. Earnings show a healthy increase. Company is extensively experimenting for the further advancement of radio. The stock looks materially higher.

GENERAL ELECTRIC: General Electric's July bookings were at annual rate of \$270,000,000 against \$260,000,000 for the first half of this year and \$208,000,000 for the first quarter. Increase since first of the year has been about \$10,000,000 a month. Strong financial position is indicated by investments in securities not classed as cash approximating \$75,000,000. Cash at end of first quarter exceeded \$63,500,000. By 1923, despite carrying charges of heavy goods, cash will probably be above \$80,000,000.

The stock recently made a new high selling at \$188. This represents an advance of more than fifty points above its low last year.

REYNOLDS SPRING: Reports from the company's plant at Jackson, Michigan, show a great increase in the volume of business handled for the month of August, particularly in the spring department. Production was increased 50% above that of July. In the Radio department the new installed bakelite plant which is the largest plant of its kind in the state of Michigan has proven a valuable accessory to the spring business, and have already received a large order from the Dodge Brothers Co. for automobile caps. They are figuring on other orders for material that their bakelite plant can produce. They also have started work on new models for the De Forest Radio Tel. & Tel., who are looking forward for large volume of business this fall. The stock on the New York Stock Exchange for the past month has ranged between 26

ANNOUNCING

The Latest and Most Efficient Non-Regenerative Receiving Circuit

The GRIMES combination of RADIO and AUDIO frequency insures both DISTANCE and VOLUME.

3 Models for October Delivery

- | | |
|------------|--|
| TYPE G-A-2 | Consists of Tuner, Detector, 1 Stage Radio, 1 Stage Audio Frequency Amplification. |
| TYPE G-A-3 | Consists of Tuner, Detector, 2 Stages Radio and 2 Stages Audio Frequency Amplification. |
| TYPE G-D-4 | Consists of Tuner, Detector, 3 Stages of Radio and 3 Stages Audio Frequency Clear Speaker, A and B Batteries, Charger, etc. Complete in mahogany cabinet (illustrated on page 100 of September issue). |

Types G-A-2 and G-A-3 are designed to operate either on aerial or indoor loop. Type G-D-4 requires no aerial-ground or loop, the receiving element being enclosed in the cabinet.

GRIMES RADIO ENGINEERING CO., INC.
Grasmere, Borough Richmond NEW YORK CITY

Revised Radio Dealer List

Do not attempt to do without the best radio dealer list—you cannot save your money that way.

Buy our list, recently revised from local sources. It will make money for you and get you there first. Write for prices and details.

Revised Radio Jobber List

This is a fully inclusive one, with many recent names. You cannot fail to find it valuable. Write for prices and details.

Unique New Mounted Broadcasting Map

Ready to hang on wall, large size, colored pins marking government, newspaper and private stations; circles, marking crystal and tube set range, \$37.50. Also special large sizes.

Radio Merchandising Research

This is 100 typewritten page analysis of situation; illustrated with charts; up-to-date, expert sales and distribution analysis. Price \$150.00. New or old radio firms should not fail to buy it.

The Business Bourse

International, Inc.

For 14 Years the National Clearing House of Business Data

15 W. 37th St., New York City

Telephone, Fitzroy 6720

and 32 and has reached the level where it can be bought for higher prices.

MANHATTAN ELECTRICAL SUPPLY: The annual report for the year ended December 31, 1921, shows total assets of \$6,173,126.53 of which current items amounted to \$2,662,268.83 against current liabilities of \$435,869.43 (ratio of 6 to 1), leaving a substantial working capital. Surplus amounted to \$737,257.10; cash on hand at \$409,255.55 and inventories \$1,519,054.72. Altogether, the report is considered a favorable one. The company's business consists of electrical and radio equipment, for which there is reported, a heavy demand. Dividends of \$4 per share annually are being paid on the 70,000 shares of no par outstanding. Stock sold for \$30 this time last year and on the radio boom subsequent reached \$60. Present quotations, \$53.

	Bid	Asked
All Amer. Cables	116	118
Amer. Tel. & Cable	62¼	63
Amer. Marconi Stamped	5c.	25c.
Amer. Marconi Unstamped ..	7	9
Amer. Tel. & Tel.	123¾	123½
Canadian Marconi	2¼	3¼
De Forest Radio Tel. & Tel..	7	10
English Marconi Common ...	10	14
English Marconi Preferred ..	10	14
Federal Tel. & Tel. Calif. ...	7	7½
Federal Tel. Co. New York ..	8	12
General Electric	180	183
International Tel. & Tel.	55	65
Mackay Co. Common	101½	103
Manhattan Electric Supply ..	52	55
Marconi Int. Marine	6	8
New York Tel. 6½% Pfd.	109½	110
Pacific Tel. and Tel.	56	62
Radio Common	4¾	5
Radio Preferred	3¾	3¾
Reynolds Spring Common ...	26	29
Spanish Marconi	1	3
United Fruit	152	153
Western Union	64	65
Westinghouse E. & M.	63	64
Westinghouse E. & M. 1st Pfd.	75	77

I will be pleased to answer any inquiries concerning radio securities.

MYDAR NOVEL CATALOG

The Mydar Radio Company of Newark, N. J., have recently compiled a catalog of radio devices, which is a good example of what radio manufacturers can do in the way of supplying their trade with a really useful catalog.

It is called a perpetual, ready reference catalog. Bound in a good quality cover, and pages "loose-leafed," all items are carefully thumb-indexed on the lower right hand corner. Complete and detailed information is found on each page regarding the article described, and nothing is left to imagination.

Additional pages for the catalog are sent to all dealers who are on the company's mailing list, each time a new item is produced.



R-D-5 Tuner \$75 PARAGON A-2 Two-step Amplifier \$50
 Wave length 510 meters. Same circuit as in R-A-10-1000 meters with the same finish and workmanship. Very selective.
 Get your order in now. Best service and discounts.
E. M. WILSON & CO., 11 Lafayette St., NEWARK, N. J.

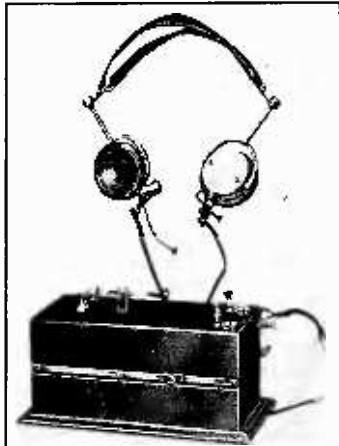

In lots of 100, \$3.50 each. In smaller lots, \$4.00 each.

Retail prices optional, so that special sales may be held.

A superior receiving set with a vocal and musical range of from 38 to 45 miles—code range, 150 to 200 miles
 MAHOGANY CASE, BAKELITE PANELS, NICKEL FIXTURES
 8½" COIL AND TWO-SLIDE TUNER

STANDARD PRODUCTS CO.
 93 WILSEY STREET NEWARK, N. J.

Ask Our Service Bureau

Positive Contact **COMPRESSED, BAKED, SEALED** **Permanent Capacity**

KAPACITON
 INDIVIDUALLY TESTED
KONDENSERS

ARE BETTER CONDENSERS!

'Phone * Grid * Grid with built-in leak * Grid with detachable and variable leak * (Pat. pend.) All capacities.

Aleironsky
 Established 1910 Jersey City, N. J.

"Aerovox Products"



No. 1011 V. T. Socket

The "AEROVOX" Vacuum Tube Socket adds to the quality of any vacuum tube set. It is well designed and attractive in appearance.

A FEW INTERESTING FACTS:

1. Highly polished moulded tube socket, with 3/16" wall which eliminates the danger of cracking.
2. Contact springs are of heavy phosphor bronze, nickel plated, set in grooves moulded in the base. This prevents slipping.
3. Connection symbols moulded into the base.

Awarded Certificate of Merit, N. Y. Evening Mail Laboratory.

SPECIALISTS IN PARTS FOR VACUUM AND CRYSTAL SETS

JOBBER! ATTENTION!

Wire or write for open territory

Radiola Wireless Corp.

208 West 17th St., New York City

MERCHANDISING RADIO

(Continued from page 55)

fancy, has to contend with the constant improvements in equipment that are being made right along. The man who stocks up for a long time ahead may find himself facing a big loss due to newly discovered improvements being sold. Jobbers and dealers would do well to take heed of this factor.

Buy what you need, don't be niggardly in your purchases, but don't overstock. In the radio business we may expect "something new under the sun" every little while. In the early stages of America's business, success came to those who not only had the vision to see the future, but to those gifted with that rare quality of seizing opportunities and of making a fortune at the flood. Soon the pioneer days passed and opportunity had to be created. Today we are faced with the alternative of using scientific methods to create opportunities or of going to the wall. Yet in this particular business, just developing and slowly getting to a standardized and staple basis, there are opportunities galore for the man who combines the art of seizing opportunities and of creating them.

The successful radio merchant will first of all take heed of how he stocks his place and then he will watch closely his turnover and its relation to his investment. He will not be led into the error of oversupply by the plea of "low prices now but higher next month"; he will keep his finger on the market pulse, buy steadily what he needs and follow certain sound business principles.

SUCCESSORS TO F. C. MANNING CO.

Announcement has been made by F. C. Manning, of the F. C. Manning Company, Newark, N. J., that the United Specialties Company, Inc., are successors to the Manning Company. The new firm is marketing a novel crystal set called the Little Gem Receiving Set, which has been developed by the company's radio engineer, Edward Moore. This set consists of a vertical tuning coil, on the upper end of which is placed the detector and aerial binding post. The binding posts for ground and phones are on the opposite end. The set is supported by a small tripod in much the same manner that a camera is mounted on its tripod. This concern also manufactures and distributes the Multilistener, a device permitting two or more people to listen in with a single pair of phones.

ADBRI LABORATORIES

Manufacturing all kinds of Crystals in Wood's Metal. Guaranteed Tested.

469 Broad St., Newark, N. J.

We manufacture 7 different styles of **VARIO COUPLERS**

To Sell from \$1.25 up

All Guaranteed Perfect (JEWELL'S)

JOBBER—DEALER—AGENT

Write for Discounts

JEWELL RADIO SALE CO.

90 West St., New York City

Phone Rector 1035

TUNING COILS

Double Ply—Dull and Bright Finish—9x3 1/2, End Pieces Made of Composition Fibre.

REGULAR \$3.50 - NOW \$1.30

BERSHAW RADIO & MFG. CO.
82 Barclay St. Newark, N. J.

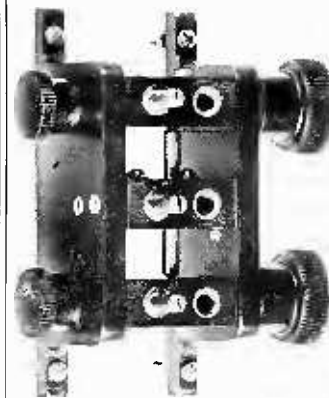

TRIPLE DOUBLE and SINGLE COIL MOUNTS

not moulded, fully dielectric, special lock knob, preventing any moving of

coils after being set, assures closest tuning.

	List Price
TRIPLE COIL MOUNTS.....	\$5.50
DOUBLE COIL MOUNTS.....	3.75
SINGLE COIL MOUNTS.....	.50

Trade Discounts Allowed

OSLAND, INC.

122 Fifth Ave. New York City



Our Radio Department is conducted by electrical engineers which assures you with dependable and highly efficient Radio equipment, either in complete sets or separate units, such as Head Receivers, Varicouplers, Variometer, Cabinets, Detectors, Antennas, Rotary Spark Gaps, Sliders, Panels, Dials, Knobs, Condensers, Grid Leaks, Contacts, Galena Crystals, etc.

For a popular home receiving set we recommend the **RESODON**. This set comes in a beautiful mahogany finished cabinet. Write for literature.

PAUL G. NIEHOFF & CO., Inc.
Electrical Laboratories and Manufacturers
238 E. Ohio Street Chicago

OPTIMISTIC OUTLOOK

(Continued from page 41)

Of course, some credence must be given the fact that the public is returning from its out-of-door life, and radio will prove a source of entertainment during the cold months; this is helping to increase the logical demand. Static, continual reference to radio and lighting in many news articles, circulars, etc., and continual mention of a "slump" helped bring on a real slump, but these things have all proven mythical, and it is doubtful if the radio industry will ever know another sudden drop as has been recently experienced. Now that this sort of myth has been dispelled and only facts remain, the campaign for continued good business will be more energetic. Manufacturers, jobbers and dealers throughout the country are of the opinion that the industry has been tested and found to be a necessity, not a toy or a passing fancy.

Radio has shaken off the parasites; has forced out poor equipment; has entered into a real competition; has learned to discern fact from fancy all on a rising market that bids well to bring radio into its proper and deserving place among the industries of the world.

PRACO CONDENSER

The Pittsburgh Radio & Appliance Company of Pittsburgh have placed a new and novel variable condenser on the market. The condenser is said to be the best to be obtained, insofar as material and high-grade construction is concerned.

The "Praco Service," for those who are acquainted with the distributors, is fast becoming a trade by-word. The company is specializing in panels and tubing.

"SPECIAL TYPE" COUPLER

After careful research and experimentation Theo. Marine, of the Marine Radio Co., of New York City, has finally completed a special type coupler which he claims will work superior to the old type variocoupler and variometer combination. When put in circuit with a .0014 condenser it gives very selective tuning and volume.

The company is marketing these coils separately as well as in complete tuning units.

DEALERS—This ad in consumer papers will bring you orders. Write us today. Get your's now. Packed 24 in an attractive display carton

One turn of the nut gives a death-like grip—Each PLUG-A-POST is a miniature chuck—made on precision machines - a beautiful piece of Workmanship--
made with Watchmaker's accuracy

THE PLUG-A-POST BINDING POST TAKES PHONE PIN TIPS, SPADE TIPS, OR PLAIN WIRE

Dealers - Send for name of nearest Jobber

RADIO TECHNICAL LABORATORIES INC.
9-15 CLINTON ST. NEWARK, N. J.

Every QUEENS instrument inspected before it leaves our factory

QUEENS Vario Coupler

The BEST THERE IS!

Not because we say so, but facts prove that Queens Variocouplers are the best to be had regardless of price. They are designed and manufactured by men who have made radio their life, work—beginning long before the days of broadcasting. This priceless experience, coupled with huge production have made such a low price possible. The real proof of the efficiency of Queens Variocouplers is comparison. Compare them with any other variocoupler on the market. Examine the fine workmanship and be convinced that what we say of the Queens' is so. None are so good at anywhere near the price of the Queens.

IT'S COLLEAGUE, the variometer, matches the coupler in quality as well as appearance and is an equally efficient instrument. When used together with the coupler, the utmost in clear and distinct reception of speech and code is obtained. Queens Variocouplers and Variometers are perfectly adapted for use in the Armstrong regenerative and super-regenerative circuits.

If you sell Queens instruments, you will retain pleased customers and enjoy good profits. Attractive discounts to dealers and jobbers. Backed by national advertising, these instruments will be big sellers. Write today and let us tell you more about ourselves and our instruments. Cash in on big profits with real efficient apparatus. Order your stock of Queens Variocouplers and Variometers today.

QUEENS RADIO COMPANY, Inc.
12A Forest St. Winfield, L. I.

Look for our Inspection Tag on every QUEENS instrument

QUEENS Vario Meter

IMMEDIATE DELIVERY



Pointer Radius 1", 1 1/4", 1 1/2" 

500 Lots, 14c each 

Parallel Series
500 Lots, 18c

A Detector that STAYS PUT



Beauty of line, smoothness of operation and velvet strength in every part 

100 Lots, 50c



Delivery Two Weeks 

Quantity Price 32c

2" Dials, 18c
C. C. Binding Posts
\$22.50 per M

HAYDON  FENTON

Manufacturers

167 Chambers Street - New York

Agents Write. Some territory still open

The Dubilier Variadon

Compact, Variable Mica Condenser Having a Movable Plate

By P. W. SMITH

Dubilier Condenser & Radio Corporation

Because a very sharp tuning is necessary for continuous wave reception with vacuum tubes, variable condensers are generally used. The dielectric of a variable condenser is air. A set of semi-circular plates is rotated between a corresponding set of fixed plates forming alternate layers of air dielectric with adjacent conductors of opposite polarity. A variable air condenser is bulky; it consists of many fixed and rotatable plates which must be fastened with small, light screws, difficult to handle.

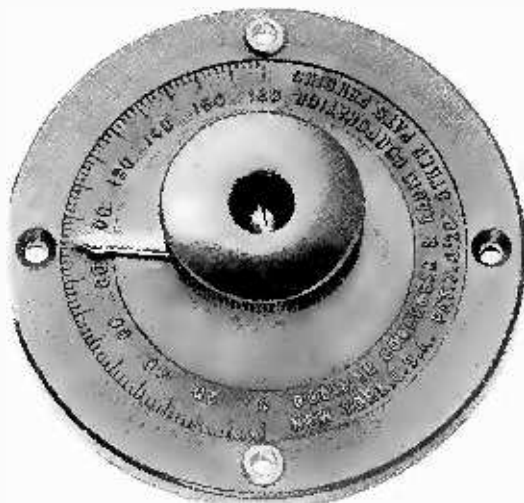

Despite the care taken in mounting, the plates of the ordinary air condenser sag in time. Vibrations and shocks destroy the adjustment, so that short circuits may occur.

With the introduction of the Dubilier Variadon these objections and difficulties disappear.

In the first place, the Variadon is a variable mica condenser. It contains but one moving element. Hence it is not only light, but compact as well—so compact, in fact, that it is no thicker than the mere three-inch dial of the ordinary variable air condenser.

There is nothing to sag or warp in the Variadon. It is always in perfect balance. The adjustment cannot be destroyed by either the shock of a fall or by vibration. Hence short circuits are practically impossible. The Variadon actually improves with use; its life is indefinite.

In the Variadon, mica and not air is the dielectric, and mica is generally conceded to be the best dielectric for condensers of any type. Because mica is relied upon instead of air, the



DUCON

\$1.50 Retail

No outside antenna; simply place plug in any electric socket.

The original (patented) DUCON plug, variable condensers, crystals, Dubilier Micadons, etc.

KING QUALITY RADIO EQUIPMENT

Dials, switch levers, knobs, contact points, sockets. There is no other equipment of such quality at such a price.

Invincible crystal sets that are a thing of beauty and a joy forever. Super-radio vacuum tube sets.

Wire, phone or write for prices and discounts

THE INVINCIBLE PRODUCTS CO., INC.

159 N. State St. Chicago, Ill.

"The clouds roll by, but the blue sky remains."

THE TITAN-O-TONE \$10

WITH HEADSET and AERIAL

Same with Double Titan-O-Tone Headset - - \$12



A well made and very efficient outfit mounted in genuine mahogany cabinet. Discounts 40 and 10.

For Jobbers and Manufacturers!

- Per 100 net
- 3" Aluminum Dial with Knob \$8.00
- Large Contact switch 8.00
- Large Knob with set screw . . . 2.50
- Crystal Detector, Knocked Down . . . 13.00
- Mounted Galena Crystal, Tested 4.50
- Crystal Wash. 1 oz. Bottle. 8.00



T-F RADIOPHONE CO., Inc.

Manufacturers "Titan-O-Tone" Products

667 Coney Island Ave., Brooklyn, N. Y.

plates of the Variadon can be very close together, with the result that an extremely compact variable condenser is produced.

Multiple plate air condensers are generally used in the primary circuit and a small variable condenser or "vernier" is connected in parallel with it. The vernier aids in tuning sharply. The Variadon, however, requires no vernier. It is so made that it permits fine tuning in itself.

The Variadon enables amateurs and manufacturers to make small, compact, inexpensive sets which can be tuned as sharply as the larger and more cumbersome receivers equipped with variable condensers and verniers.

Existing sets can be equipped with it and the reception greatly improved.

The terminals are so insulated that it can be mounted on either metal or insulated cases. The terminal screws can be used for mounting if necessary.

The maximum capacity of the Variadon is .0006 mfd. This means that the capacity is equivalent to that of a twenty-three plate air condenser of wheel design.

"DE LUXE" RADIO RECEIVER

Sold by Ablett

The Charles R. Ablett Co. announce that they are now ready to distribute their De Luxe Navy Type Receiver. This receiver combines in a compact case the latest developments in radio and, Mr. Ablett claims, will pick up music, voice, etc., on any wave length. The normal wave length is from 300 to 6,800 meters, but a loading coil attachment permits reception on wave lengths up to 23,000 meters. Capacities of proper loading coils are: primary, 50; secondary, 50; tickler, 30 millihenries. It is claimed that this receiver has an unusual degree of selectivity.

It is pointed out that, although this receiver was primarily designed for laboratory and experimental work, where the greatest efficiency is required, its simple arrangements and unusually beautiful finish make it highly desirable for clubs, hotels and homes where the last word in radio equipment is demanded.

The operation of a switching mechanism permits the use of either two tuned circuits or an untuned secondary.

The handsome containing case is of heavy mahogany, in which the receiver is mounted on bakelite-dilecto panel. A switch is provided for protection of detector during transmission and also reception.



Patents Pending

PRESTO AERIAL SUPERSEDER ADJUSTABLE

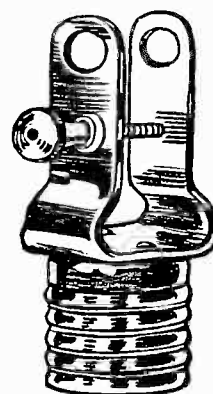

Patents Pending
Phone Attacher

Eliminates need of inside or outside antennas or aerials for radio receiving sets.

Lessens static, improves and amplifies tone. Equally efficient with A. C. or D. C.

Makes the receiving set really portable. It can be instantly moved from room to room.

Just attach to any electric socket or to telephone by means of special "phone attacher" included, and connect to the set—simplicity itself, and superior results.

Guaranteed not to short circuit, blow fuses or shock. No electric current passes through the Presto Aerial Superseder—it is a conductor of radio waves only.

For use with electric socket (as illustrated below).

Seven methods (or adjustments) of connecting are provided: to binding post, A or B or C—to A & B—to B & C—to A & C; or to A, B & C.

Very good results are frequently obtained without a ground connection. The aerial terminal of set can also be connected to binding post A or B and the ground terminal of set to C.

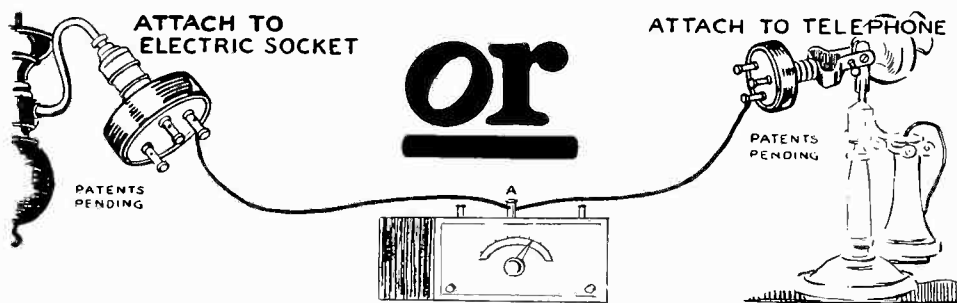

For use with telephone (as illustrated above).

Radio reception can be enjoyed and the telephone used at the same time without interference to either.

Be safe and be satisfied. The Presto Aerial Superseder—adjustable—retails for only \$2.75.

Jobbers and Dealers Inquiries Welcomed

PRODUCTS DISTRIBUTING CORPORATION

360 Madison Avenue

New York

Phone Murray Hill 2048



Presto Aerial Superseders—Presto Super Head-Phones—Presto Bull-Dog Detectors

BALDWIN HEADSETS

NEW MASTER BALDWIN DOUBLE HEADSET

LIST PRICE \$16.00

(The Master Baldwin is 40% better than Type C)

NEW MASTER BALDWIN SINGLE HEADSET

LIST PRICE \$9.00

The Master Baldwin is 40% better than Type C)

MASTER BALDWIN CLAROPHONE

LIST PRICE \$22.50

DEALERS—Write, Wire or Phone Your Order Today

CLARK & TILSON

51 East 42nd Street, New York

Bru No. 3

New, Novel Set Placed on the Market

A recent addition to the many novel receiving sets on the market is that of the "Bru No. 3" which is manufactured by the Bruno Radio Corporation of New York City.

The "Bru No. 3" is a vacuum tube set that uses a W D II bulb, thereby eliminating the expensive storage battery, which has always been the bugaboo of the radio fan. In the place of the storage battery, an ordinary dry cell is used which the manufacturers claim will supply enough current to light up the filament for eighty hours.

A few of the features that the manufacturers claim are that the tube is mounted on top of the cabinet, and that a loose coupler is employed, enabling much finer tuning. The flexibility of the circuit, which enables loading on both the primary and secondary circuit, makes this set ideal for long wave reception. The wave length of the "Bru No. 3" is from 150 to 600 meters, and is specially adaptable for radio phone broadcasting reception.

The Bruno Radio Corporation is headed by William A. Bruno, a member of the Society of Electrical Engineers; and Nathan Litwin, who is in charge of the selling end of the corporation. This company is about to launch many new things in radio, and the fact that "Bill" Bruno is quite fussy about things that will bear his name, the name Bruno will stand for the best in radio.

CORACO RECEIVER

The Coraco Super-Radiophone, the invention of Arthur C. Olsen of New York City, has just been added to the many wonderful developments in the radio field.

The idea of the Coraco Super-Radiophone was first conceived and designed in 1919 but only recently was it brought out in its present form.

It is claimed that the instrument requires no aerial or ground, and as demonstrated before an audience of technical experts, can be moved from one room to another with very satisfactory results. It is reported to have worked satisfactorily in a moving steel passenger elevator, much to the surprise of some radio authorities.

Demonstrations have proven that while the instrument is in a receptive state, and no concerts are being received, absolutely no static, howling or whistling noises can be heard, the instrument remaining perfectly quiet.

SOCKET-RHEOSTAT

Registered U. S. Patent Office

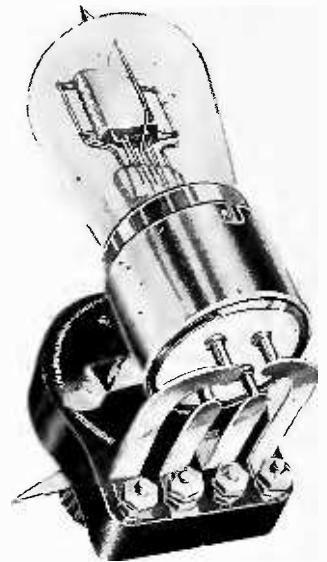

Type A-5 ohms, suitable for detector bulb
Type B-2 ohms, suitable for power bulb
\$2.00
TWO IN ONE. A socket and rheostat so combined as to form a single unit.
No more unnecessary leads between socket and rheostat. Just connect your leads to the four posts marked P F F G and you are hooked up as far as the SOCKET-RHEOSTAT is concerned.

MANUFACTURED BY

Ajax Radio Corporation

Telephone, Bigelow 4097
538 SOUTH 10th STREET
NEWARK, N. J.

Meet us at

Booth 68

Week of October 7th
to 14th

New York Electrical and
Industrial Exposition

Grand Central Palace
New York City

American Radio
and Electric Co.

1133 Broadway
New York City

S & S

VARIOMETERS VARIO-COUPPLERS

\$3 each

Unsurpassed for Efficiency
Workmanship and Design

Liberal Discounts to
Dealers and Jobbers

Write for Descriptive Folder

Sunday & Scholtz Co.

2638 West Cabot Street
Philadelphia, Pa.

\$10 Tube Set

Hawk Mfg. Co. Offers Low Priced Tube Set That "Works"

Up in the Bronx, New York City, where the subway becomes elevated, and where the elevated becomes a nuisance, and every car line passes one spot, is located the factory and laboratory of the Hawk Radio Manufacturing Co. The reader can just imagine the "fun" that can be had at this spot when trying to get music from the air, but Olan Hawk, the genial head of this concern, overcomes all obstacles and tests all of his sets in this place. (The only howl he hears is that of young Olan, Jr., who is now getting his teeth, and who is a daily visitor at the shop.)

Mr. Hawk in his experiments has recently brought out a tube set that will sell for ten dollars which he claims will get just as good results as many of the higher-priced ones. This set is called the "Hawk, Jr.," and is a well-made set that compares favorably with other sets now on the market, in so far as reception is concerned.

Though young in years, Mr. Hawk has a radio experience that is vast and is the inventor of many new things used in radio. He was formerly connected with the United States Navy and had charge of one of the radio stations during the war.

List
AIR-MUSE, COMPLETE, \$20.00
WITH 3,000 OHM DOUBLE PHONES

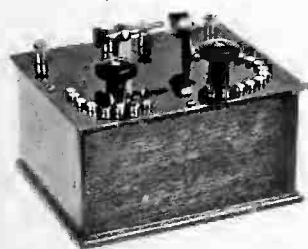

Lightning
Arrester
Approved By
National Board
of Fire
Underwriters.
And All
Accessories

Air-Muse will receive thirty-five miles or more. It is perfectly balanced, there being eight course leads off and ten selective. All joints are soldered. The detector has a backward and forward spring movement. The case is polished oak—all metal parts are nicked. Only Insulite and Bakelite used. Packed complete in box. Write, wire or phone.

MANUFACTURED BY
DETROIT RADIO COMPANY
One West 34th Street,
NEW YORK CITY
Fitzroy 2114

"SUPERIOR PRODUCTS"

The ROLLS-ROYCE of RADIO

Our ideal is to establish a permanent clientele by selling products which reflect credit to the industry and to the dealers who handle them, and by this policy, to establish ourselves as permanent factors in the industry.

GUARANTEE

To every purchaser of Superior Products we guarantee that our radio instruments are of the highest electrical efficiency and that they will give absolute satisfaction—or money back.
SUPERIOR PRODUCTS MFG. CORP.

To enable us to extend our guarantee, we have selected for our line the finest articles of their kind. Each is tested for superiority in workmanship, material, appearance and electrical efficiency.

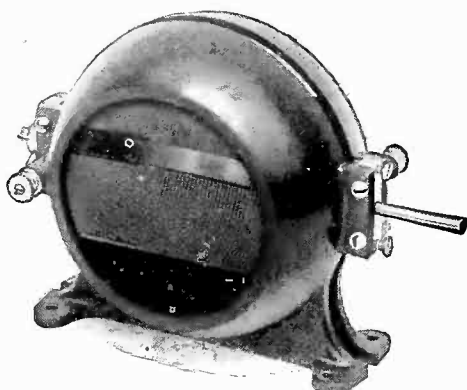

VARIOMETER

The inherent beauty of our moulded variometer, the smooth rotation of its perfectly balanced rotor, the close limits of accuracy in construction, the maintenance of minimum clearance between stator and rotor, the wide range of inductance with minimum resistance, make this a "Superior Product." Price, \$7.50.

The Superior variocoupler has the same general appearance as the variometer. The rotor is slightly smaller and employs spaced winding. Designed for 150 to 500 meters. Price \$8.00.

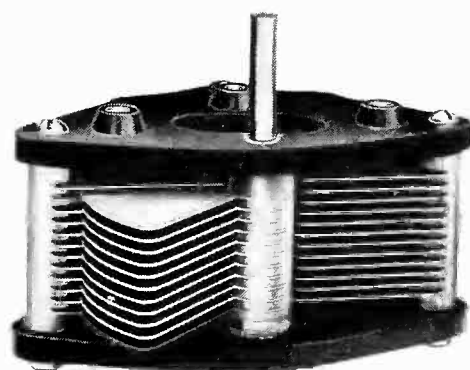

VARIABLE CONDENSER

A Superior Variable Condenser selling at but little above average price. Machine assembly permits of accuracy in spacing to a degree impossible with hand assembled washer types. Positive rigid three point suspension by three heavy posts accurately slotted. Very low capacity at zero point. Moulded bakelite top and base with ample insulating space between fixed and moveable plates.

13 plate	.00083 MF	\$3.75
23 "	.0006 MF	4.00
43 "	.001 MF	4.50

HEADPHONES

Superior Headphones automatically adjust themselves to fit comfortably any shaped head. No protruding horn-like bars. One-piece headband of heavily plated nickel. Nothing to catch the hair. No cloth or fabric used and hence no accumulation of germs, dandruff or grease. Weight, twelve ounces. Accurately matched for tone quality. Comparison tests with other headsets for sensitiveness and tone quality prove ours a "Superior Product." Price, \$8.00.

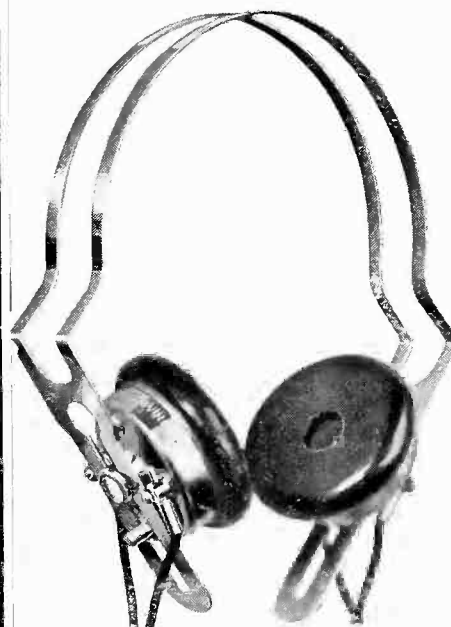

Superior Dials are manufactured under Tait Patents, for which we are exclusive distributors in eight states. The Tait dial has no set screw; no capacity effect; no trouble; absolute bull dog grip. Three inch, \$1.00; Four inch, \$1.50.

Dealers! Write for Proposition

SUPERIOR PRODUCTS MFG. CORPORATION
1080 Springfield Avenue
Irvington, N. J.

MORADIO Every Wire Contact COUPLER

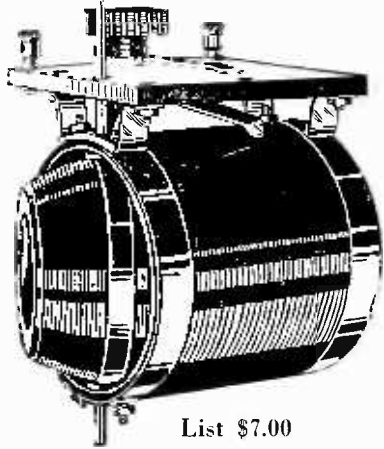

List \$7.00

Its adaptability to any panel set or hookup makes it popular.

Write for descriptive circular and dealers prices.

MORELAND SALES CORP.
30 Ogden St., Newark, N. J.

Got a good idea on selling radio equipment? Send it along, help the other fellow and he'll help you.



100% PROFIT Mr. Dealer

Radio Research Buttons for your trade will bring customers back to your store.

As a premium for your set buyers or as a sales proposition this can't be beat.

100% PROFIT

Mounted on a neat three color display card

Write for full particulars as to exclusive proposition.

Radio Research Guild
11 Clinton St., Newark, N. J.



Radiphono Adapter - \$3.00

Add quality of tone and volume to your radio concerts

Designed for Edison, Victrola, Brunswick and other makes of phonographs. With this adapter you can eliminate distorted and metallic sounds and improve your receiving. This is a real adapter built along proper lines of a reproducing musical instrument. It gives better results than self-contained, expensive amplifying loud speakers.

Jobbers Communicate Dealers Ask Your Jobber

Manufactured by
Industrial Sales Engineering Co.
671 BROAD ST., NEWARK, N. J.

TUNING COILS

Cross Weave Tuning Coils the heart of a receiving set just the coils for bringing in the Radiophone Broadcasting stations 180-500 Meters. Price \$1.25 each, or set of three coils Primary, Secondary and Ticker Coils, \$3.50 per set with circuit diagram.

CONDENSERS

Phone and Grid built of the best material obtainable. Price \$1.00 each.

MOTOR-GENERATOR SET

250 Volt DC 175 Watt Generator and 110 Volt AC 60 Cycle (Any Cycle) Motor. The best there is. Price \$78.00 complete.

AERIPHONE

The wireless telephones. Price \$35.00 to \$300.00.

PANELS

Treated with a special process made by us. Will not Warp or Shrink and is not affected by Temperature changes. Waterproof and possesses High Dielectric properties. Easily machined and will not Crack or BREAK. Looks as good as Bakelite. We are prepared to ship promptly the following sizes:

6" x 6"	x 1/4" thick	\$.60
6" x 7"	x 1/4" thick	.75
6" x 10 1/2"	x 1/4" thick	1.00
6" x 12"	x 1/4" thick	1.25
9" x 12"	x 1/4" thick	1.50
9" x 14"	x 1/4" thick	1.75
12" x 14"	x 1/4" thick	2.20
12" x 21"	x 1/4" thick	3.00

Strips 3 1/2 x 6; 3 1/2 x 8, \$.40 each; 3 1/2 x 10, 3 1/2 x 12, \$.60 each; 3 1/2 x 18, \$.75 each. Add postage for 1 lb. for Panels up to 6 x 12 x 1/4; and 2 lbs. for larger sizes.

We will be pleased to quote prices on these panels cut to a different size on receipt of your specifications. NO FREE SAMPLES.

NATIONAL RADIO CO.
MARSHALL, MINN.

RT-4 Radio FREQUENCY Transformer



Wave length range 250-450 meters with full amplification at both extremes

Air core, untuned type, giving highest possible amplification for this type of transformer.

Adapted for both regenerative and non-regenerative circuits.

Can be used with one, two or three stages of radio frequency amplification.

Can be used with any vacuum tubes.

LIST \$2.00

Also ADAPTERS for the NEW W-B-11 tubes, helps you move your old V. T. Sockets, Variable Antenna Plugs, Coils, Sockets, Rheostats, Jacks, Couplers, etc.

We are the exclusive distributors of the Planet Loud Speaker—no batteries and as good as a Magnavox.

See the new Plan-a-Phone, \$3.50 list

Dealers write for Discounts

National Distributors

GENERAL MERCHANDISE CO.

142 Market Street, Newark, N. J.

The New Thumtune Radio Receiver

One of the outstanding features of the many new designs of radio equipment on display this fall is the "Thumtune," a new and compact radio receiving outfit manufactured by The Radiaud Corporation of New York City. This instrument is a radical departure from the "hackneyed" type of construction now prevalent.

According to its designer, the "Thumtune" is the result of much experimental work and was tested under actual operating conditions for over a year before it was finally placed in quantity production. While entirely different from the commonly accepted idea of radio receiving apparatus, this newcomer in the radio market avoids any freakishness of de-



sign. On the contrary, it makes use of standard parts wherever possible.

It is the belief of the Radiaud Corporation officials that a great many of the radio outfits now offered for sale to the general public are far too complicated to meet with popular favor, therefore the design of the "Thumtune" was simplified to the utmost detail. The object kept in view was to produce an instrument which even a child could operate, intelligently, and in the "Thumtune" this object seems to have been achieved.

Instead of tuning with dials or switches, the "Thumtune" tunes with a touch of the thumb—that is, tuning is accomplished by merely running the thumb over the two knurled knobs which protrude from the lower corner of the case. This case is of molded construction and is made in the shape of a sector of a circle, of a size to fit easily into the palm of the hand.

The detector, which is always a vital part of any set, is of accepted standard design in the "Thumtune." The method of mounting this detector, however, is decidedly novel. The detector crystal-holder and the detector post are mounted upon a molded base hinged to the side of the case,

so that the entire detector swings into the case when not in use. Not only does this novel and original procedure permit of great reduction in size of the entire set, but it also keeps dust from the detector crystal.

Binding posts are entirely done away with in the construction of the "Thumtune." Four holes are provided in the side of the case, two on each side, for making antenna, ground and head-set connections. The wires and phone tips are pushed through these holes and connection is thus automatically established on the inside.

From all reports, the "Thumtune" aroused considerable interest since the first moment it was introduced to the radio market.

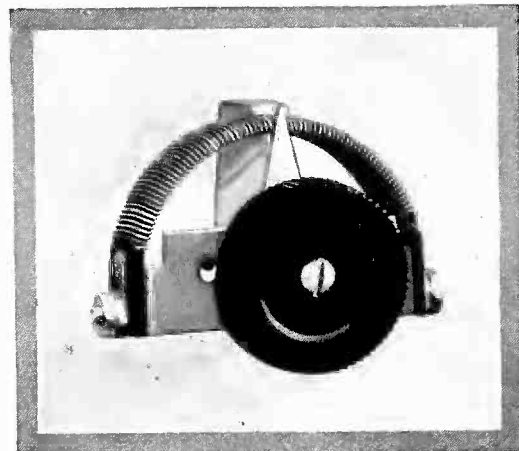

A BETTER RHEOSTAT

A nicer looking, smoother working and better made rheostat than you have ever seen before.

Furnished with or without vernier this instrument will improve the operation of any radio equipment.

The many valuable features coupled with national advertising make this an instrument every dealer and jobber should stock—liberal discounts give ample margin of profit and low list means quick turnover. Order now.

List Prices
123A Plain..... 80c
Type 123B Vernier..... \$1.40

THE WILCOX LABORATORIES
LANSING MICHIGAN

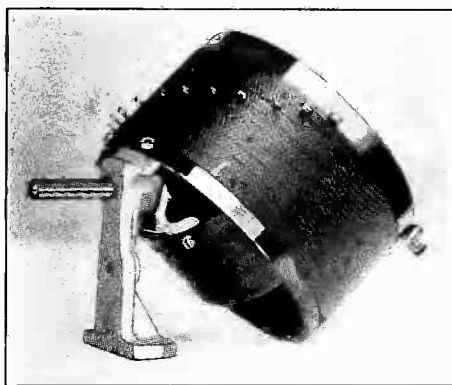

Shamrock Vario-Coupler

LIST \$4.50

Both
Primary and Secondary Tubes
Are Made of

BAKELITE

Also Manufacture a Complete Line of
RADIO JACKS

and
VARIABLE CONDENSERS

Dealers and Jobbers Write for
ATTRACTIVE DISCOUNTS

SHAMROCK RADIO CO.
GENERAL OFFICE AND FACTORY

152 Sussex Avenue Newark, N. J.

TRESKO RADIO

Licensed under Armstrong U. S. Patent 1,113,149

The simplicity of the Tresco Receiving Set means everything to the dealer.

Few parts, practically indestructible, easy to learn to operate.

Once sold it stays sold and requires no service by the dealer.



Orders are now being placed for fall delivery—are you ready? Better write us for our discounts.

Remember the "Tresco" is a regenerative set, manufactured under the Armstrong License.



TRESKO RADIO
J. Matheson Bell Sales Mgr.
Davenport, Iowa, U. S. A.

Metro Multi-plug

Permits Several People to Listen In at the Same Time

The Metro Electric Manufacturing Company of New York City are producing a plug which does away with headsets can be used at the same time the necessity of "shorting" when using two or more phones. The plug is known as the Triphone. Three from the single jack of any receiving set. The Triphone is an accommodation plug which fits any standard jack. One headset or loud-speaker is permanently connected to the Triphone as connected to any phone plug. On either side of the cord is a separate jack built in the body of the Triphone, each of which accommodates a standard plug or, if desired, another Triphone, making it possible to use a half dozen or more headsets. When the extra headsets are removed the internal jacks of the Triphone automatically "short" and enable the operator to use single headset or loud-speaker as in the case of the single phone plug.

In appearance the Triphone is an addition to any set. The body is of highly polished moulded material. Perfectly finished and not much larger than the average plug. The contact stem is perfectly insulated, making short circuits impossible. The internal jacks are constructed with nickel silver springs and the short-circuiting contacts are of solid silver. In addition each plug is tested before leaving the factory.

WINTNER RECEIVING SET

The Wintner Radio Corporation of New York City has begun an extensive campaign on its Wintner Type DA-2 receiving set. This set received the certificate of excellence from the *New York Evening Mail* Radio Institute Laboratories.

The outfit utilities audio frequency principles, being a detector and two stage amplifier unit, assembled from high grade, standard radio parts, completely wired, and including three 22½ volt cyclone B batteries, placed within the cabinet so that connections on face panel are unnecessary. In addition, included in the equipment are Turney 3,000 ohm double head phones,—so that all that has to be done in order to listen in, is to hook up antenna and ground and make connections to the storage battery. There is no complex system of controls or wiring and the Wintner Radio Corporation expects to do a very large volume of business on this set alone.

GUARANTEED



WINTNER RADIO CORP.
115 W. 30th ST., N.Y.C.
Manufacturers and Distributors

PRODUCTS

a standard radio set

We'll back it against the "other" kind any time—
and when you consider the following facts concerning

WINTNER



TYPE DA-2

- ¶ High grade standard parts throughout, completely wired and enclosed in a beautiful cabinet made in tinted walnut and mahogany.
- ¶ Assembled in our laboratories by real radio men.
- ¶ WDA-2 has a wave length range of from 175 to 2,000 meters, and will tune sharply throughout this scale.
- ¶ Three 22½ volt "Cyclone" B Batteries built into the set.
- ¶ A set of Turney 3,000 ohm double headphones included with the outfit.
- ¶ And, most important of all, our best guarantee of proper construction and efficiency of operation is that this is the set which was certified for its excellence by the Mail Radio Institute Laboratories of the "New York Evening Mail."

we have no doubt that you will then agree with us that it would be an attractive buy, at a price a good deal higher than our advertised retail price.—

\$90.00

NOTE—Of course, we have so scaled our discounts to the jobbing and retail trade that a fine margin of profit can be realized. We will be very pleased to quote our discounts, upon application, and mail you our illustrated folder describing the set.

WE ARE NATIONAL DISTRIBUTORS
OF STANDARD RADIO PRODUCTS

WINTNER RADIO CORPORATION

117 West 30th Street

New York, N. Y.

Where to Buy

A Handy Guide for the Convenience of Our Readers

AERIALS		CABINET SETS		Electric Service Supplies Co..... 6	
Walter S. Krenz..... 80		Heinemann Electric Co..... 75		Frank Radio Co..... 13	
"A" BATTERIES		Oranola Radio Corporation..... 14		The Edw. J. Goetz Co..... 112	
Manhattan Storage Battery Co., Inc. 102		Premier Radio Corp..... 21		Herbert H. Frost..... 116	
AERIAL EQUALIZER TUBES		COIL MOUNTINGS		Julius Andrae & Sons Co..... 88	
The Etherola Corp..... 72		Osland, Inc. 122		Kramer Radio Co..... 106	
ARMSTRONG CIRCUIT PARTS		Astorloid Mfg. Co..... 28		Moss Radio Co..... 112	
Durham & Co..... 58		COMPLETE LINE		New York Coil Co..... 5	
ARMSTRONG HOOK-UP		American Radio & Electric Co..... 96		Nyco 79	
Brady Electric Mfg. Co..... 70		The American Specialty Mfg. Co.... 71		P. D. Jackson..... 116	
AMPLIFIERS		Adams Morgan Co..... 16		Pittsburgh Radio & Appliance Co.... 70	
F. C. Kent Co..... 88		Clapp Eastham Co..... 112		Premier Radio Corp. of Amer..... 69	
Magnavox Co. 61		Curtis, C. Culin..... 102		Radio Electric Co..... 10	
Sheltone Radio Sales Co..... 66		Freed-Eisemann Radio Corp..... 112		Radio Engineering Co..... 64	
AMPLIFIER UNITS		Frank Radio Co..... 13		Radio Equipment Service..... 106	
Atwater Kent Mfg. Co..... 67		A. C. Gilbert Co..... 38		Ship Owners' Radio Service, Inc..... 109	
ANTENNA WIRE		Maclite Radio Co..... 72		Specialty Service Co..... 95	
Hintze Bros. 79		New Haven Radio Co..... 4		Schwab, Harold M..... 72	
Copper Clad Steel Co..... 106		Reco Radio Engineering Co..... 12		The Radio Shop of Newark..... 100	
ANTENNA LIGHT WIRE PLUGS		Superior Products Mfg. Co..... 127		United Mfg. & Distributing Co..... 74	
Maltz Electric Co..... 110		Picard Radio Corporation..... 83		Weiner Wireless Specialty Co..... 90	
Products Distributing Corp..... 125		Victor Radio Corp..... 11		Wholesale Radio Equipment Co.....	Front Cover
Chas. Freshman Co., Inc..... 90		Union Radio Corp..... 128		ELECTRIC TESTING	
BAKELITE PANELS		COMPOSITION		New York Testing Laboratories..79-119	
Standard Wireless Panel Co..... 115		Diamond State Fibre Co..... 105		ELECTROTYPERS	
BATTERY CHARGERS		Nuloid Corp. 26		Central Electrotyping Co..... 112	
The Automatic Elec. Devices Co.... 27		CONDENSERS		EXPOSITIONS	
"B" BATTERIES		Duke Radio Co..... 112		Boston Radio Exposition..... 107	
Gould Storage Battery Co..... 34		European Radio Co..... 109		Permanent Radio Fair..... 81	
BATTERIES		Hedden Place Machine Co..... 90		FINISH	
Carbon Products Co..... 57		Meirowsky Bros. 121		Zeller Laquer Mfg. Co., Inc..... 66	
Comet Battery Co..... 114		Radio Laboratories of New Jersey... 114		GLASS	
French Battery & Carbon Co..... 82		Scheib Elec. Radio Co..... 82		Vineland Scientific Glass Co..... 100	
Manhattan Storage Battery Co..... 116		CONDENSER PARTS		GRID LEAKS	
Multiple Storage Battery Corp.....		New Haven Radio Co..... 4		Radiophone Equipment Co..... 104	
.....Back Cover		CONTRACT WORK		Radio Mechanical Trading Corp..... 92	
Novo Manufacturing Co..... 109		Carlyle Johnson Machine Co..... 112		HEAD SETS	
BATTERY TESTERS		CRYSTALS		Briggs & Stratton Co..... 15	
The Chaslyn Co..... 100		Adbrin Laboratories 122		Dictograph Products Corp..... 9	
BESTONE PRODUCTS		Galena Crystal Mfg. Co..... 104		The Electric Products Co..... 68	
Henry Hyman & Co., Inc..... 65		Harris Laboratory 96		General Radio Equipment Mfg. Co.. 99	
BINDING POSTS		Rocky Mountain Radio Products, Inc. 100		Globe Phone Mfg. Co..... 89	
The H. H. Eby Mfg. Co..... 87		U. S. Radic Co. of Penna., Inc..... 100		Herbert & Huesgen Co. Inside Front Cover	
McKenna Brass & Mfg. Co..... 100		CRYSTAL DETECTORS		Royal Electrical Laboratories..... 37	
Premier Radio Mfg. Co..... 22		Brooklyn Metal Stamping Co..... 86		Standard Electric Co..... 96	
Radio Accessories Co..... 113		Diamant Tool & Mfg. Co., Inc..... 110		Mills Radio & Electric Co..... 104	
Radio Technical Laboratories, Inc... 123		Randel Wireless Co..... 70		HONEYCOMB COILS	
BOOKS		Scott Novelty Co..... 79		Viking Radio Co..... 118	
Allied Engineering Institute..... 23		CRYSTAL SETS		INFORMATION	
Archway Bookstore 116		Aerex Radiophone Corp.....17-112		Service Bureau 18	
Great Lakes Publishing Co..... 116		Caragol-Clarke Co., Inc..... 8		INSULATORS	
Norman W. Henley Pub. Co..... 93		T. F. Radiophone Co..... 124		Bannister & Pollard..... 79	
Radio Red Book Publishing Co..... 102		Holloway Elec. Supply Co., Inc..... 104		KNOBS & DIALS	
BOXES		M. P. Radio Co..... 72		King Sewing Machine Co..... 76	
Wels Mfg. Co..... 114		W. E. Supply & Service Co..... 86		Tait Knob & Dial Co..... 57	
CABINETS		DIALS		LIGHTNING ARRESTERS	
E. Eshoo Cabinet Works..... 119		Alden-Napier Co. 118		L. S. Brach Mfg. Co..... 104	
Marvin B. Fallgatter..... 116		New York Radio Dial Co..... 82		Essex Mfg. Co..... 112	
		The Emeloid Co., Inc..... 113		Electric Service Supplies Co..... 6	
		DISTRIBUTORS		LOCKS	
		Altadena Radio Laboratories..... 88		Joseph Ross & Co..... 99	
		Arrow Radio Co. 80			
		Broun Radio Co. 117			
		Elco Radio Supply Co..... 102			
		Electric Service Engineering Co..... 4			

SEE ALPHABETICAL INDEX OF ADVERTISERS ON PAGE 130

Where to Buy

A Handy Guide For the Convenience of Our Readers

LOOP AERIALS		RADIO TOWERS		SWITCH STOPS	
Eagle Radio Co.....	76	Milliken Bros. Mfg. Co., Inc.....	101	Newark Radio Supply Co.....	79
V-De-Co.	102	RECEIVING SETS		Virginia Radio Corporation.....	89
LOUD SPEAKERS		Atlantic-Pacific Radio Supplies Co. Inside Back Cover		TESTING LABORATORIES	
Dictograph Products Corp.....	9	Arex Radiophone Co.....	17	N. Y. Testing Laboratories.....	70
Horning Experimental Laboratories.	77	Beau Ivorie Novelty Co., Inc.....	96	TOWERS	
The Magnavox Co.....	61	Bruno Radio Corp.....	35	Milliken Bros. Mfg. Co., Inc.....	101
The Sound Wave Corp.....	30	Bissell Engineering Co.....	90	TRADE MARKS	
LOUD SPEAKER SETS		Brooklyn Metal Stamping Co.....	83	Chauncey P. Carter.....	115
General Auto Electric Co.....	104	Caragol-Clarke	8	Radio Dealer Trade Mark Bureau...	106
Radio Equipment Service.....	32, 33	Charles R. Ablett Co.....	8	TRANSFORMERS	
MAILING LISTS		Coraco Corp.	118	Clark and Tilson.....	92
Business Bourse Int., Inc., The....	120	Doublell Radio Co.....	113	Federal Institute of Radio Telegraphy	7
Trade Circular Addressing Co.....	112	Essex Radio Service, Inc.....	12	Ford Mica Co.....	108
F. D. Pickens.....	109	Federal Tel & Teleg. Co.....	14	Marle Engineering Co.....	101
Ross-Gould Co.	114	Grimes Radio Engineering Co., Inc..	120	Rauland Mfg. Co.....	69
Sydell's Radio Directory & Service..	107	The E. D. Mfg. Co.....	26	Rasla Sales Corporation.....	25
MANUFACTURERS' REPRESENTA- TIVES		Lewis & DeRoy Co.....	73	Thornton Transformer Co.....	100
Radio Equipment Service.....	106	Melchior Equipment Co.....	118	UNIT TYPE SETS	
METALS		Mercury Radio Products Co.....	72	Jewett Mfg. Co.....	63
Strahs Aluminum Co.....	114	Metropolitan Radio Corp.....	29	Pacific Radio Exchange.....	69
MICA		Michigan Radio Corp.....	91	VACUUM TUBE SOCKETS	
Mica Insulator Co.....	30	Mu-Rad Laboratories, Inc.....	3	Radiola Wireless Corp.....	122
MICA DIAPHRAGMS		Neihoff Co., Paul G.....	122	VACUUM TUBE TESTER	
Radio Mica Products Co.....	98	Radio Outfitting Corp.....	102	The Mydar Radio Co., Inc.....	22
MULTILISTENER		Radio Instrument Co.....	19	VARIABLE CONDENSERS	
United Specialties Co., The.....	29	Joy Kelsey Corp.....	112	Bayley Condenser Co.....	103
PANELS		Rogers Radio Co.....	110	Bunting Stamp Co.....	97
American Hard Rubber Co.....	97	States Radio Corp.....	82	John Cozzzone Co.....	115
New York Hard Rubber Turning Co.	96	Steinmetz Wireless Mfg. Co.....	116	Duquesne Radio & Mfg. Co.....	115
Poster & Co.....	111	W. R. Cramcr Co.....	104	Detroit Radio Supply Co.....	106
Standard Radio Parts Co.....	117	United Radio & Electric Co.....	89	Electric Products Co.....	96
Standard Wireless Panel Co.....	115	Wintner Radio Corporation.....	131	Electric Service Engineering Co.....	4
The Continental Fibre Co.....	111	W. E. Supply & Service Corp.....	86	Montrose Mfg. Co.....	100
PART MAKERS		Ware Radio Corp.....	31	Radio Stores Corporation.....	72
Aldine Radio Mfg. Co.....	91	E. M. Wilson & Co.....	121	Frederick H. Pruden.....	74
Premier Accessory & Specialty Corp.	77	RHEOSTATS		Seaboard Radio Corporation.....	119
Radio Apparatus Co.....	96	Acorn Radio Supply Co.....	111	Spiro Bros.	93
PATENTS		Parkin Mfg. Co.....	103	VARIO-COUPLERS	
A. M. Wilson, Inc.....	112	Reco Radio Engineering Co.....	12	Marvin B. Fallgatter.....	114
Emil Alexander Kern.....	112	Louis A. Staff Co.....	87	Queens Radio Co., Inc.....	123
Manufacturers Patent Co.....	112	Keystone Radio Co.....	95	VARIOMETERS	
Otto K. Zwingenberger.....	112	Sunraid Radio Co.....	98	Eastern Specialty Co.....	93
PHONES		SCREW MACHINE PRODUCTS		Franklin Radio Mfg. Co.....	116
Clark and Tilson.....	126	Cap Screw & Nut Co. of America...	112	McConnell Cable and Specialty Co...	116
The Mills Radio & Elec. Co.....	98	SIGNS		Nelson Radio Parts Co.....	10
T-B-H Corporation	118	Clark & Tilson.....	84, 85	Ritter Wood Work Co.....	114
True-Tone Radio Mfg. Co.....	88	SOCKET RHEOSTAT		Sunday and Scholtz.....	126
PLUGS		Ajax Radio Corp.....	126	Volta Engineering Co.....	116
Invincible Products Co., Inc., The...	124	SOCKETS		VARIOMETERS AND PARTS	
Metro Electric Mfg. Co., Inc.....	28	Alden-Napier Co.	70	Scientific Dealers' Supply Co.....	114
Racony Corp., The.....	96	Thresher Radio Corp.....	17	VERNIER CONDENSERS	
S. S. Novelty Co.....	92	SOLDERING IRONS		Bremer-Tully Radio Co.....	117
POTENTIOMETERS		North Shore Radio Works.....	112	WINDING	
Advance Metal Stamping Co.....	110	Post Electric Co.....	95	Montclair Radio Co.....	106
PUBLICATIONS		SPAGHETTI TUBING		WIRE	
Radio Dealer Weekly.....	36	Mitchell Rand Mfg. Co.....	106	White Radio Co.....	100
RADIO CRYSTAL ATTACHMENT		STOCK BROKERS		WOOD PARTS	
Rad'O	105	Frank T. Stanton & Co.....	114	R. C. Mills.....	96
		SWITCH LEVERS			
		Haydon & Fenton.....	124		

SEE ALPHABETICAL INDEX OF ADVERTISERS ON PAGE 130

Association of Radio Dealers Formed

Metropolitan Radio Dealers Organized for Betterment and Protection of Radio Business Men

By WILLIAM J. MOSES

Secretary of the Metropolitan Radio Dealers' Association

Business economics recognize that in the development of an industry real efficiency requires some basis of organization, by which united effort can be made supplement to individual effort. The solution of the problem that faces the radio industry to-day is co-operation and competition each in its proper place, guided by recognized leaders.

On September 20th a meeting of men prominent in the radio retail trade of New York City was held at the Hotel McAlpin for the purpose of discussing the formation of an organization composed of radio dealers in the metropolitan area. The purpose of the association is to promote, by means of co-operation among retail dealers, a more stable condition in the radio trade.

The need for such an organization has been severely felt during the past several months not only in New York City but throughout the entire country. After the meeting was called John W. Griffin, of the Griffin Radio Service, Inc., was unanimously elected president of the new organization and William J. Moses of the Manhattan Hardware Company was elected secretary.

Mr. Griffin gave a short talk on the need for such an organization and the benefits derived both for the dealer and the public. Following Mr. Griffin's interesting talk Mr. Moses laid stress on the need of all members entering into the building up of the organization with earnestness of purpose and assured all present that he would fill the office conferred on him with the utmost of his ability and effort.

After a brief and lively discussion regarding the more important questions needing immediate consideration, the chairman appointed several committees to submit reports at the next meeting to be held at an early date.

The committee on price cutting was advised that they report, after careful consideration, the policy of the organization with regard to the unfair marketing of goods at cut rates. The general opinion of the members assembled was that each dealer be allowed to advertise a sale on but one article, and only one at any time, all other sets or parts to be sold at regular list price.

The second committee was advised to report on what was to be constituted as fair advertising. This question was brought out as a result of unfair methods that have been used by some dealers in making misleading statements through error or direct intent in their respective advertisements.

The committee on public information was appointed to determine ways and means of best instructing the public on the subject of radio and to co-operate with the broadcasting stations to promote such education and to aid in the bettering of broadcasting programs will also be a duty of this committee.

Committee number four has for its duties the standardization of radio parts in so far as is possible. The belief of the meeting was that there are too many small and needless dif-

ferences in similar parts. Standardization makes for efficiency.

Committee number five is to consider what shall be recognized as a fair margin of profit on all radio goods.

The last committee was appointed to report on the establishment of co-operation among the members and mutual aid in various matters pertaining to the trade.

The association also determined that for the present the dues shall be ten dollars for the year. All members present at the recent meeting were made charter members. The temporary headquarters will be at 497 Third Avenue, New York City.

If the interest and activity shown at the recent meeting is any criterion of the future of the association we may rest assured that the Metropolitan Radio Dealers' Association is heading for big things.

New Tube Socket

A vacuum tube socket built upon entirely new lines, and being adopted by many manufacturers of high grade receiving sets is manufactured by the Thresher Radio Corporation of Newark, N. J., as part of its line of Thradio Products, and has many features of design that entirely eliminate the difficulties from structural weakness and loose and faulty connections, which are the source of so much noise, causing poor reception and amplification.

The body of the socket is of seamless brass tubing, drawn to exact internal diameter to give proper clearance for the tube base, and is heavily nickel-plated and polished.

The base is of bakelite dilecto sheet $\frac{1}{4}$ " thick, grain finish. It is bored to a less diameter than the outer diameter of the brass tube, which is turned down, leaving a shoulder that rests upon the base. The lower edge of the tubing is spun over a shoulder counterbored in the under side of the base and firmly riveted in place, so that it can neither turn nor pull out of the base but is held rigidly in position.

This construction brings the bottom of the tubing well up into the base and leaves a space of $\frac{1}{8}$ " between its lower edge and the contact strips, giving a very high resistance and proportionately reducing the leakage at this point.

The contacts are punched from Tobin spring bronze and have ample contact surface, so that when in position the contact points rest in the center of the contact surface and have a true bearing. They are held securely in place by the terminal stud and in addition are keyed to the base, making it impossible for them to become loose or get out of position.

The contact studs are of ample length for securing the wiring connection, which can be made either above or below the base.

The bayonet lock is so designed that the tube, when once in position, will not jar loose. The form of construction employed makes it possible to mount these sockets in any multiple. The design is neat, well finished and adds greatly to the appearance of the receiving set in which they are installed.

The A-P Special

A marvelous new A-P

Receiver

which
requires

no ground

no aerial

The set thousands have been waiting for, made possible by a recent scientific development—"The Oard Phantom No-ground Circuit." The set whose wonderful achievements are astounding the radio world. The set that operates at full efficiency over short or long distances without aerial or ground connection—



"It's all inside"

It sells both as a home set and as a portable. Ideal for automobile use, because it is so compact, easily transported, and quickly placed in operation.

The Oard Phantom Receptor

"Marvelous" is really the word that best describes this A-P Special—*The Oard Phantom Receptor*. For general receiving it requires only a single short antenna wire which may be concealed in the picture moulding, suspended at some convenient point, laid on the floor or ground, fastened to the bows of your automobile top, or wound around the cabinet of the instrument. It does not require either ground or aerial, *it operates best without them*. It enables the operator to eliminate static and other interference almost entirely. It has all the apparent advantages of radio frequency amplification without its delicate or complicated adjustments. With equal ease and efficiency it receives either broadcasted programs or spark signals over short or long distances. And it works just as effectively in a speeding automobile as on the table at home. Wave length range 300 to 1,000 meters.

The tremendous selling possibilities of such a set should be obvious to every alert and aggressive dealer. In addition to these inherent advantages it is being nationally advertised. Write us for Bulletin D-2 and our special co-operative merchandising plan.

Atlantic-Pacific Radio Supplies Co.

Radio
Supplies

646-50 MISSION ST.,
SAN FRANCISCO, CAL.

Receiving
Sets

Hook Your Radio Sales to this Revolutionary Battery Principle!

You can give permanent satisfaction to your customers and build up enduring good will for yourself by equipping all the radio sets you sell with Radiobats.

RADIOBATS are not merely batteries with improvements. They are built on radically new and different principles that put the old automobile type "A" battery and dry cell "B" battery *out of date*.

Radiobats, both "A" and "B," have nothing to leak. They contain the first successful and semi-solid electrolyte. This revolutionary principle plus the rugged strength of the exclusive Radiobat reinforced grid has made the use of any kind of separators unnecessary.

Radiobat "B" is a genuine 22 volt storage battery which is rechargeable at

home from either A.C. or D.C. It is compact and rugged. Most important of all—it is utterly noiseless in operation.

Radiobat "A" is smaller, lighter in weight and easier to handle than any other "A" battery of equal rating. It maintains a steady discharge rate throughout its entire life.

"A" and "B" Radiobats used together form "The Permanent Radio Power Unit." Any standard radio set equipped with Radiobats will give a new experience of dependability and complete satisfaction with radio.

The Radiobat policy is to distribute through radio stores and not through service stations. You should have the radio battery business service stations are now getting. You can get it with Radiobats — designed exclusively for radio use.

Radiobats have the backing of a tremendous national advertising campaign—the most powerful in radio. Prices are fair—discounts liberal. Write or wire for complete description and outline of sales plan.

Multiple Storage Battery Corp.
352 Madison Avenue, N. Y. C.



"A"
and
"B"

RADIOBATS

The Permanent Radio Power-UNIT