

TELEVISION ENGINEERING

JUNE, 1951

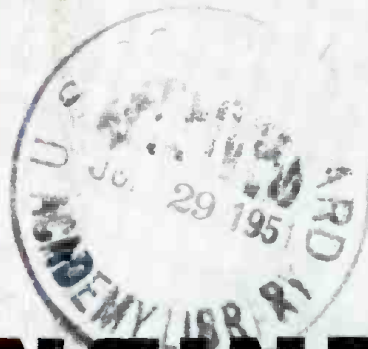

The News-Engineering Journal of The TV Industry



Test setup for a miniaturized variable resistor.



ACE HIGH • • for miniaturization, mounting, and temperature problems

Here they come, right off the top of the deck, to fill in what's been needed—new ways of mounting subminiature capacitors in military electronic equipment!

You'll find side stud, end stud, threaded neck, and two types of side bracket capacitors in Sprague's new 16 page Engineering Bulletin 213-B

These new Sprague-pioneered designs make even broader the world's most complete line of solder-seal terminal metal-

encased subminiature paper capacitors.

And they're now available as standard in a 125°C. temperature rating Vitamin Q® capacitor series. Voltage ratings range from 100 to 1000 volts in both inserted tab and extended foil constructions.

And remember, Sprague Capacitors are the standard of dependability for critical electronic circuits. Write for your copy of Bulletin 213-B which gives the complete Sprague Subminiature Story.

SPRAGUE

PIONEERS IN / \ ELECTRIC AND ELECTRONIC DEVELOPMENT

SPRAGUE ELECTRIC COMPANY
NORTH ADAMS, MASSACHUSETTS

TELEVISION ENGINEERING

Including Radio Engineering, Communications and Broadcast Engineering. Registered U. S. Patent Office.
Research . . . Design . . . Production . . . Instrumentation . . . Operation

VOLUME 2

JUNE, 1951

NUMBER 6

TVE-grams	3
<i>Military and Civilian Production Blueprint . . . The Controlled Materials Plan . . . Highlights of the NTSC Report . . . TV Recording Techniques . . . RF Dielectric Standards . . . New Materials.</i>	
The Cosine Deflection Yoke	<i>John Pell</i> 10
<i>Design and Application Features of Yoke Designed to Prevent Electron-Beam Distortion.</i>	
Component Miniaturization Techniques	<i>Ralph G. Peters</i> 12
<i>Report on Methods and Materials Which Have Been Found Adaptable to Production of Smaller Parts Featuring Stable Performance at High Temperatures.</i>	
Application of Polarity Diplexing to Microwave Relay Systems	<i>C. A. Rosencrans</i> 14
<i>System Permits Transmission of Two Signals Along Same Path to Two Receivers, With One Antenna Arranged to Radiate Vertically-Polarized Wave and Other a Horizontally-Polarized Wave.</i>	
TV Maintenance and Safety Measures	<i>John B. Ledbetter</i> 15
<i>Rules Which Should Be Followed in Plant and at Stations to Prevent Accidents.</i>	
Super-Gain TV Antenna Engineering	<i>M. E. Hiehle</i> 18
<i>Generalized Design Factors Which Must Be Met in Choice of Final Electrical and Mechanical Specs.</i>	
Cathode-Coupled Clipper Response Speed	<i>Philip F. Ordnung and Herbert L. Krauss</i> 21
<i>Concluding Installation, With Details on Circuitry of Dynamic Test Systems Used in Probe.</i>	

MONTHLY FEATURES

Viewpoints	<i>Lewis Winner</i> 3
TVE-grams	4
Personals	9
Production Aids	22
TV Parts and Accessory Review	22
Industry Literature	25
Instrument News	26
TV Broadcast Equipment	26
Veteran Wireless Operators' Association News	28
Advertising Index	31
Briefly Speaking	31

Cover Illustration

Checking recently-developed miniaturized variable resistor in the test laboratory of Chicago Telephone Supply Corp. Left to right: B. S. Turner, CTS executive vice president, and W. A. Nicely, vice president and sales manager.

Editor: LEWIS WINNER



Published monthly by Bryan Davis Publishing Co., Inc., 52 Vanderbilt Avenue, New York 17, N. Y. Telephone: MURRAY Hill 4-0170.



Bryan S. Davis, President. Paul S. Weil, Vice-Pres.-Gen. Mgr. Lewis Winner, Editorial Director. F. Walen, Secretary. A. Goebel, Circulation Manager.

Mid-West Representative: Stuart I. Osten, 333 N. Michigan Ave., Chicago 1, Illinois. Telephone: Dearborn 2-3507
 East-Central Representative: James C. Munn, 2253 Delaware Drive, Cleveland 6, Ohio. Telephone: ERIEview 1-1726.
 Pacific Coast Representative: Brand & Brand, 1052 West 6th Street, Los Angeles 14, Cal. Telephone: Michigan 1732.
 Suite 1204, Russ Building, San Francisco 4, Cal. Telephone: SUTter 1-2251.

Reentered as second-class matter February 7, 1950 at the Post Office at New York, N. Y., under the act of March 3, 1879. Subscription Price: \$3.00 per year in the United States of America and Canada; 50c per copy. \$4.00 per year in foreign countries; 60c per copy.

To Aro Book Depot: Wellington, New Zealand. McGill's Agency: Melbourne, Australia.

TELEVISION ENGINEERING is indexed in the Engineering Index.
 Entire Contents Copyright 1951, Bryan Davis Publishing Co., Inc.

...*“It was easy to conduct a person-to-person canvass at all company plants and offices”*

ROY A. HUNT
President, Aluminum Company
of America

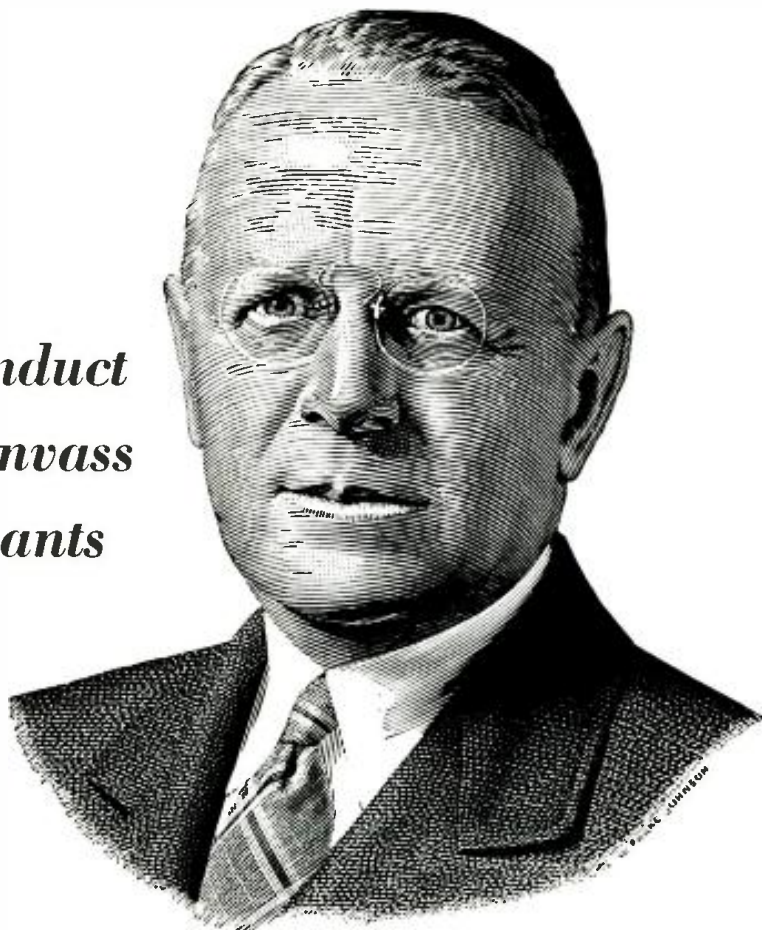

“Our employees like the Payroll Savings Plan for U. S. Savings Bonds. It was easy, therefore, to conduct a person-to-person canvass at all company plants and offices.

“I believe every company which promotes the systematic investment in U. S. Savings Bonds in this way provides a highly desirable service for its employees and at the same time gives practical support to an important national effort.”

Yes, it is easy to conduct a person-to-person canvass of your offices and plants to ascertain who wants to help America and build for his or her security by the systematic purchase of U. S. Defense Bonds through the Payroll Savings Plan. Have you conducted a person-to-person canvass in your plant?

If you haven't, here are the three easy steps:

- Phone, wire or write to Savings Bond Division, U. S. Treasury Department, Suite 700, Washington Building, Washington, D. C.
- Your State Director, U.S. Treasury Department, will contact you or the executive you designate to conduct the canvass and tell you exactly how to proceed. He will furnish posters, pay envelope stuffers, application blanks and other aids.
- All you have to do is to see that every employee in

your company is handed a Payroll Savings Application and given an opportunity to make his or her own decision. No pressure is needed.

Simple as the plan is, it works — to the benefit of employees, the company and America. In the last six months approximately 4,000 more companies have installed the Payroll Savings Plan for their employees. Approximately 600,000 working men and women have joined the millions of smart savers already on the Payroll Savings Plan. In plant after plant, employee participation has jumped to 70%, 80% — even 90% because, as Mr. Hunt so aptly puts it, “employees like the Payroll Savings Plan.”

Make it easy for *your* employees to help themselves, their Country and their company by the systematic purchase of U. S. Savings Bonds — Defense Bonds now, because they are an important factor in combating inflation and building a stronger America.

The U. S. Government does not pay for this advertising. The Treasury Department thanks, for their patriotic donation, the Advertising Council and

TELEVISION ENGINEERING



TELEVISION ENGINEERING

LEWIS WINNER, Editor

June, 1951

Delayed Film Telecasting for Sports—With the threat raised by motion-picture owners that they might band together and secure exclusive common-carrier rights for showing on theatre television only, such program material as championship prize fights, big-time tennis and golf, and football games of national interest, telecasters appear to be faced with quite an awkward problem. The medium which they have been so careful to nurse along and build into a powerful agent of entertainment, has become attractive to others who feel that now they'd like to take care of this healthy youngster. Of course, there are a limited number of theaters currently available for projection, and the immediate effect cannot be too severe. But, as equipment does become available and tie-ins expand, the problem can become acute.

The scrambled picture services, available at a fee, have received serious consideration as one solution. However, there has also appeared another approach which many have declared to be very practical and very attractive, there being no consumer charges involved in the scheme. The plan proposes the filming of events, and through the use of rapid development systems, immediate telecasting after the game or bout. Through the application of one system and others under development, films could be made available in a matter of minutes, if such speeds were desirable. Such a plan would permit the sale of programs to sponsors, minimize the fear of reduced audiences, since there would be no immediate telecast, and still provide those at home with pictorial coverage of an important event of the day or night.

Even theaters could arrange for an immediate pickup to cater to those who want to see the event as it happens, and thus additional revenue would be available from the telecast. One net is applying the idea, in a modified form, by transmitting motion pictures of fights taken a week earlier. The time element could be improved for the benefit of viewers and to the satisfaction of potential sponsors.

The delayed-film idea has significant possibilities, according to many of the boys in the field, providing a practical and profitable link for the theater, sponsor, viewer and telecaster.

More Ice for the Freezer—Just as it appeared as if the iceblock on the air channels would finally receive a gentle heave-ho, there appeared the views of the Federal Communications Bar Association, as well as the concurring comments of Senator Edwin Johnson, implying that the recent proposal of block allocations on a geographical

basis was not legal. Noting his opinions, as chairman of the powerful Senate Interstate and Foreign Commerce Committee, the Senator declared that he did not think that the Commission could . . . "prejudge and restrict" . . . the number of channels available to each geographical area." He felt that the proposal bluntly was arbitrary and could not be . . . "justified by the public interest, the basic law, or the engineering facts."

To further confuse the issue, Senator William Benton has decided to introduce a resolution calling for an amendment of the Communications Act which would require the FCC to grant TV station licenses on a yearly basis, instead of the three to five-year arrangement now holding, and in addition hold in abeyance the freeze for another six months or possibly a year, until all the issues in the latter problem were ironed out to his satisfaction.

Undoubtedly, hearings scheduled before the allocations session and during the frequency debate, soon to begin, will see vigorous action on these provoking hurdles, action which it is hoped will result in a concrete acceptable plan, which will definitely end the three-year long freeze.

Color Experimentation Welcomed, Says FCC—In an interesting statement on color TV, the Commission has declared that . . . "genuine programs of experimentation in the color field" . . . certainly may be carried on.

Continuing their explanation of the experimental provision, the air patrolmen added that should the proponents of any system feel that they'd like an investigation of their method, demonstrations of the system could be conducted in Washington, receiving equipment could be brought to the Commission's laboratories at Laurel, Maryland, for study and evaluation, and of course, an appropriate petition would have to be presented for rule-making proceedings. Seven criteria have been posted by the Commission as the goal which must be met by a color system. Briefly these criteria declare that the picture must be sufficiently bright to permit an adequate contrast range and be capable of being viewed under normal home conditions without objectionable flicker; the picture also must have good texture and not be marred by misregistration, line crawl, jitter, etc.; the equipment must be capable of operating through receivers that are simple to control in the home and have no critical registration and color controls, and particularly, is *cheap enough in price to be available to the great mass of the American purchasing public.*

Perhaps the reds, greens and blues will soon be dancing around again in the halls of Washington.—L. W.

Civilian and Military Production Blueprints

As Washington Sees It: Industry faces a towering production job during the next eighteen months, in the opinion of DPA acting administrator Edwin T. Gibson, who during the recent RTMA annual meeting in Chicago declared that several billions will be spent for military gear alone during that period.

So far as defense production is concerned, he pointed out, industry is just about now being called upon to supply ever-increasing quantities of equipment and components to the military program. Of the total money available during fiscal '51 for this gear, he said, 2-billion 482-million dollars had been obligated as of May 1, and the backlog of orders as of that date, including some long lead time material going back to fiscal '50, amounted to 2-billion 784-million dollars. The end-product delivery lag, due chiefly because of shortages of critical components is disappearing, it was disclosed, and deliveries are beginning to speed up. The expected rate of deliveries will be 881-million dollars worth during the fourth quarter of this year, with much, much more to come in '52, said Gibson.

Reviewing the striking growth of the industry and its potential usefulness to the nation, the defense program aide said that a recent look at the record has shown that in '39 industry was producing at the rate of some 230-million dollars. Of this sum, the greater part of 160-million dollars, represented home radio receiving sets. But by late '43, the production rate had jumped to a rate of 2-billion 252-million dollars, he said, the peak coming in '44, when goods valued at 2-billion 834-million dollars were turned out, essentially all of them military. That, he declared, was a record for everyone to be proud of, an almost twelve-fold increase in five years.

Analyzing the labor and engineering aspects of the military job, Gibson noted that the radars needed today are numerically only a small fraction of the TV sets which can be built, but it takes several hundred times as long to build a modern radar. Price-wise, he said, this complex electronic equipment requires a vastly greater investment of labor and engineering by the end-product manufacturer than a comparable home television combination. For example, it was shown that about 86 per cent of the price of a typical 17-inch set is represented by purchased materials and components, labor and engineering representing the balance. For a modern airborne radar setup, only 49 per cent represents materials, while the balance represents the value of the labor and engineering.

Describing the problems of the future, Gibson declared that it is possible to balance the bright against the dim views. At present, in general, the consumer durable goods industries are permitted to use 70 per cent of the steel, 60 per cent of the copper and 50 of the aluminum used in the base period. But going further than that, he noted, the full impact of material shortages will be felt next year, and it is difficult at this time to tell exactly how severe they will be.

Conservation of all metals, particularly the strategic elements like tungsten and cobalt, it was noted, will continue to be required. In addition, he said, shortages of technically trained manpower may in time become as difficult a problem as shortages of materials.

On the bright side, Gibson offered four facts:

(1) Industry has not been asked to discontinue civilian production entirely, since the program is geared for defense mobilization, or preparation for readiness and not for all-out war.

(2) Under the *controlled materials plan*, which will be

NPA's basic system for distribution, industry will be certain of getting a required supply of critical materials for defense and defense-supporting programs.

(3) All procurement agencies are being guided by the policy to spread both prime and sub-contracts among the largest possible number of companies, both large and small, to build our current effort on the broadest possible base.

(4) As industry is forced to cut back civilian production, at least a good part of the productive capacity can be taken care of with defense orders, and there is every reason to believe that active markets and high product demand will continue.

Industry's Views: According to RTMA board chairman, Bob Sprague, the continuing requirements of the military for electronic equipment and parts, and the shortages of critical materials brought on by the national defense program will certainly curtail production of civilian equipment. But he felt that the military program will take up much of the slack, and the future prospects of the industry are bright indeed.

By the end of '52, Sprague disclosed the combined civilian and military production of electronic equipment by industry will be at the rate of about \$4.5 billion a year. From the standpoint of facilities and manpower, it was pointed out, this will be equivalent to an industry production record of about \$3.25 billion of civilian electronic equipment, certainly a very substantial gain over recent production records.

The problem of saturation, raised during the past few months, was discounted by Sprague, who said that we are far from a point of saturation in television receivers. He recalled that the same defeatist opinions were expressed about radio, long before World War II.

In '30, he said, there were about 13,000,000 radio sets in the hands of the public, and only about 29,000,000 American homes: a 40% saturation at the time. The present saturation of TV sets in that portion of the market, which is served by the 107 broadcasting stations now on the air, is also, on the average, about 40%, he said.

In '50, he noted, 20 years after we reached a 40% saturation in radio sets, the industry manufactured and sold 14½ million radios, and this despite the fact that about 95% of American homes have at least one radio!

In his opinion, with a normal replacement market for TV sets, the establishment of a million and a half new families a year, the desire for larger screen sets on the part of those who originally bought small screen sets, and the purchase of the second and even third television set for the home, the future looks bright indeed with only 12½ million television sets in the hands of the public, as compared to about 95,000,000 radio sets!

Picture-tube 200-gram tube support brackets, molded of Plaskon alkyd, which serve to hold the front end of metal-enclosed tube in place in Emerson 17-inch chassis. Brackets were molded by Plastimold, Inc. (Attleboro, Mass.), using fast curing alkyd materials on self-contained automatic presses.



The Controlled Materials Plan

Highlights of the Control: On and after July 1, there'll be three characters which will probably be referred to as often as the time of the day: *CMP*. For, effective on that date, government will set the wheels of this all-important procedure or method in official operation, which will provide a record of what is being done and afford a back check, not only on industry operations, but on the operations of the claimant agencies who are responsible to those in NPA and to industry for the job they are doing.

Specifically, *CMP* will enable Washington to determine how much is left for civilian operations. For the first time, there'll be on record figures on the tonnage and poundage of steel, copper and aluminum available for consumer durable goods items.

The general consensus is that the first quarter of operation under *CMP* will be very much in the nature of a dry run. Material will probably be allotted to everybody who has been asked to file. The first quarter is actually being called a training period, with Washington validating orders placed on the mills with a *CMP* allotment.

During the period of change from *DO* orders to *CMP*, *DO* ratings and directives will be honored at the mill level right along with allotment numbers. Mills holding orders will have to be notified promptly as soon as an allotment number is received, so that they can write the number alongside the present *DO*. Mills will honor *DO*'s and allotments during this transition period.

Incidentally, *DO*'s are not out entirely under *CMP*. Whenever an authorized program is received with a *CMP* allotment for steel, copper and aluminum, a *DO* order is supplied right along with it. That *DO* rating permits purchasing of the things needed in production other than steel, copper and aluminum. A *DO* rating is necessary to get many critical items, besides steel, copper and aluminum.

Many have been wondering if there'll be a scramble for free materials, after government determines how much material is required for defense and civilian production. This situation might occur and thus Washington plans to control such a scramble to a certain extent by issuing the old *L* type of order, now called *M* orders. By issuing that kind of order, which would cut production down to the proper level, it is believed that the scramble will be kept within reasonable bounds. In the event of a scramble small business will have a problem because small business usually has a much more difficult time in a scramble. To minimize this problem, there is now being prepared a small order exemption regulation which will state that those who use less than a certain quan-

tity of steel, copper or aluminum in a quarter can self-assign an allotment number which is used for small business. It will, of course, be necessary to keep the tonnage quantity pretty small, although that information doesn't always indicate the size of the business. For instance, ten tons of steel may keep a large watch company going, because they use so little steel.

Under the *CMP* plan each government agency will work out its own program. The Defense Department will plan a program for the production of so many tanks for example, during a given quarter.

Orders to carry out these programs will be presented to the prime contractors who, together with their subcontractors, will work out production schedules and determine the amounts of steel, copper and aluminum needed for manufacturing these products.

This information will be returned to the government agency initiating the program. This agency, along with the other agencies, will present its program, now converted from so many end-items into specific amounts of steel, copper and aluminum, to the Program Bureau of the Defense Production Administration.

The Program Bureau will thus be able to weigh each of these programs against the other and against the total available supply of steel, copper and aluminum. If necessary, the Program Bureau will revise the size of the program downward. Once the size of the program has been established, the prime contractor will be given allotments of controlled materials and an authorized production schedule to carry out his part in it.

The prime contractor and his subcontractors will thus have a check to draw upon the fund of *CMP* materials which has been set aside for the program.

Following World War II's *CMP* pattern, component parts will be classified into *A* and *B* products. *A* products will be those of specialized design, usually manufactured specifically for a certain end product.

A wheel for a freight car is an example. But many of the nuts, bolts and bearings going into that freight car, however, can be used interchangeably in automobiles, tractors and other end items. Such general use products will be classified as *B* products.

The special *B* products list will allow the continuous manufacture of certain components which are used throughout the industry generally, and will eliminate much of the paper work involved in working out schedules and materials requirements for these products.



Complete details appear in *CMP* regulation 3.

(Right)
Tube-ruggedness quality-control test, involving plunging of cold tubes in boiling water, employed at Tung-Sol Lamp Works.

(Left)
Capacitor winding machines recently installed in the Planet plant.



On the Color Front

The NTSC Report: Several months ago, upon the publication of the final report of the FCC approving the disc color system, several members of government intimated that industry should continue its interest in color and attempt to evolve an acceptable compatible method. Particularly emphatic in this view was Senator Edwin C. Johnson, chairman of the Senate Committee on Interstate Foreign Commerce. These suggestions prompted the National Television System Committee to set up an Ad Hoc committee, with instructions to conduct a comprehensive appraisal of the state of the art in color. The results of the committee's work have appeared in a report offering proposed system standards for a compatible system and the program which industry will follow to determine the merits of the system, a program which it is hoped will be completed in January, '52, and subsequently be described, with demonstrations, before the Commission.

The proposed standards cited that chromatic information shall be transmitted by means of a color subcarrier modulated in amplitude and phase with respect to a reference subcarrier of the same frequency. The color subcarrier shall be transmitted simultaneously with the video signal and during only the video portion of the composite signal. Synchronizing signals to transmit information concerning the reference subcarrier shall be transmitted only during the synchronizing and blanking intervals of the composite video signal. . . . To ensure practical invisibility of the color subcarrier its normal frequency, but not phase, shall be related to the horizontal scanning frequency in the following manner: The color subcarrier frequency shall be an odd multiple of half the horizontal scanning frequency. . . . For standard operating conditions, the amplitude of the primary video signal and the amplitude and phase of the color subcarrier shall be specified in terms of a *proper* set of taking characteristics. (A *proper* set of taking characteristics was defined as a set, each one of which is a linear combination of ICI distribution characteristics.) . . . The color sync signal shall be transmitted by means of a burst of the reference carrier superimposed on the back porch following each horizontal sync pulse.

The committee believed that the foregoing standards were entirely practical and that they provide a sound framework within which the whole television industry can conduct further testing of high-quality compatible color television.

As a result of such tests, involving the operation of the standards and of specific equipment (receivers, transmitters and studio equipment), it is expected that numerical values for the standards can shortly be defined by the industry.

It is anticipated that many, desiring to participate in the design and manufacture of color receivers, studio and transmitter equipment, will conduct their own product testing.

According to G.E., experimental color television broadcasting will begin *as soon as possible* with the recommended NTSC color system, from Electronics Park in Syracuse, N. Y. The initial color telecasts will consist of still pictures. Others are planning similar experimental tests.

The report revealed that intensive studies and tests had been made by the committee's members and their respective companies. In one commentary on color techniques, Sylvania engineers disclosed that they found that only three time variant signals are required to describe completely a color picture, provided the camera transducers have spectral responses related to the ICI spectral tristimulus responses (\bar{x} , \bar{y} , \bar{z}) by a linear transformation. Deviation from such camera transducer responses represents infidelity, some of which may prove tolerable and even expedient. It was also discovered that the eye's acuity for color detail is very much poorer than for intensity detail, such that excellent rendition can be had by adding two degrees of low definition color information to a monochrome picture by way of a *subcarrier* which is an odd multiple of half the line frequency. The two degrees of color information can be double-sideband modulated onto orthogonal subcarriers at the same frequency, and separated by synchronous demodulation with separate but orthogonal sinusoidal signals at subcarrier frequency. The color signals, according to Sylvania, should be in terms of a set of real primaries to be specified for the system. These primaries should represent good engineering choices for practical color television. Preferably each of the two signals sent by *subcarrier* should be the difference between the instruction to one primary. Describing gamma correction, the boys said that, to compensate for non-linearity of the picture tube transfer characteristic, it should be at the transmitter, if possible. For least distortion due to crosstalk between colors, the correction must be applied to signals which are as nearly as possible of the same form as the voltage to be applied between grid and cathode of each picture tube. Even then some distortion will arise from cross-modulation between the mixed highs and color frequencies because of the non-linearity of the *crt* transfer characteristic. This should be evaluated. Placing of this correction at the transmitter, they felt, will simplify the receiver and enhance compatibility.

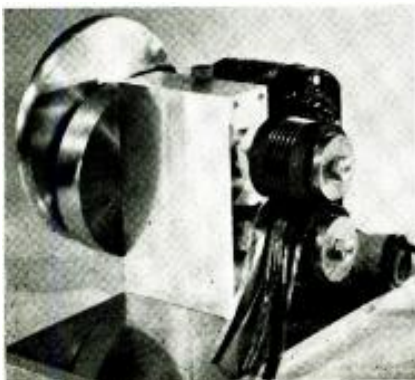

Left: Electrically driven tape slitter which cuts recently-developed Bureau of Standards high-temperature adhesive-tape resistor into strips of desired width. Twelve disk knives, mounted in pairs and spaced by accurately-ground spacers, overlap slightly to give a scissors action. Right: Family curve for adhesive tape resistor, showing formulation used to obtain resistor values. Resistor values shown are based on standard dimensions of 0.13" width and 0.5" length (0.3" interelectrode distance). Various commercial graphites and carbon blacks have been used in the tape-coating formulations, mixed in various proportions with DC 996 silicone resin. Mixture is diluted with solvent before being sprayed on a belt of asbestos paper tape. Developed under the sponsorship of the Navy Bureau of Aeronautics the new resistor system, it is said, will yield individual values ranging from about 100 ohms to 10 megohms. Curve represents results obtained with a Continental AA type (Witco Chemical Co., New York) with a range of about 60,000 ohms to 4 megohms.

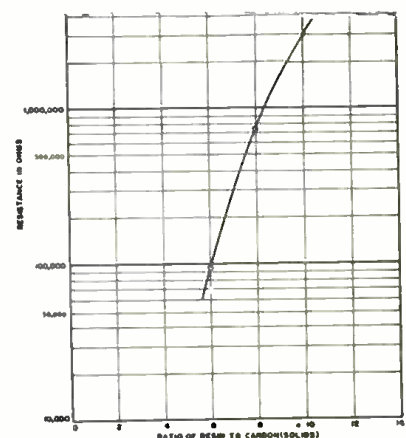

New Test Procedures

R-F Dielectric Standards: To aid in determining the properties of dielectrics and their dependence on frequency, temperature, and humidity, there have been available at the Bureau of Standards *rf* standards for dielectric measurements. Recently, these facilities were expanded to include calibration services for solid dielectric specimens, dielectric constant and power factor in the 10 kc to approximately 600 mc frequency range.

The NBS technique for evaluating dielectric properties employs a disk-shaped capacitor made from the material to be investigated. The complex dielectric constant of this capacitor is measured by bridge or resonance methods. Special micrometer electrode systems are used consisting essentially of two plates which form a variable capacitor. They are precision instruments constructed so that the circular electrodes are plane parallel and near optical flatness. One electrode is insulated by a quartz disk, while the movable or grounded electrode is attached to a holder by metal bellows arranged so that there are no sliding contacts. The position of the movable electrode is accurately controlled by a micrometer, and the capacitance of the entire system is calibrated against an incremental precision capacitor. The structure supporting the movable electrode forms an effective shield for the electrode system.

The NBS micrometer electrode system is used in conjunction with conventional bridges or resonance indicating devices. The dielectric specimen is inserted between the electrodes, and the bridge is balanced or the circuit resonated. The specimen is then removed and the spacing between the electrodes is reduced until the bridge rebalances or the circuit re-resonates. The dielectric constant is determined from the capacitance corresponding to this reading on the micrometer dial and the capacitance corresponding to the micrometer dial when set to the known thickness of the specimen. This technique for determining the dielectric constant circumvents fringing errors and is known as the susceptance variation method. It is valid with commercially available bridges for frequencies up to approximately 300 mc. It has been found that errors due to series inductance can be reduced, becoming a function only of the change in length of the movable electrode, which is negligible for most values of capacitance.

At frequencies above 500 kc, the power factor and dielectric constant are usually determined most accurately by a resonance method. In this technique, the circuit including the electrode system and the specimen is resonated, and the volt-

age across the unknown is recorded. The specimen is then removed, the circuit re-resonated, and the voltage across the air capacitor is recorded. From these voltages and the known *Q* of the electrode system, the loss properties of the specimen are evaluated. Again, the dielectric constant is simply determined from the dial reading of the micrometer at the resonant point and the corresponding calibrated capacitance.

This resonance technique is used over a wide frequency range and is particularly applicable at frequencies above 100 mc. At these frequencies the inductor becomes a single turn; therefore a doubly reentrant resonant cavity (essentially a coax structure shorted at both ends with a variable gap in the center conductor) of either fixed or variable length is utilized. The test specimen occupies the gap between the reentrant posts. The frequency of operation of the fixed-length cavity is governed by the constants of the specimen inserted between the reentrant posts as well as by the geometry of the cavity. Consequently, the operating frequency cannot be specified in advance. The variable electrode, similar in structure to the movable electrode of the micrometer electrode system, is also micrometer-controlled and is calibrated at the lower frequency in terms of the capacitance between the reentrant posts. This again permits measurements without appreciable corrections for lead inductance. The techniques used in the resonance method are equally applicable to reentrant-cavity measurements. Resonant cavities have been found to be advantageous because *Q*'s of the order of 1000 to 3000 are readily obtainable, thus providing convenient voltage ratios even in the case of very low-loss specimen such as polystyrene or quartz.

New Materials

Silver-Clad Steel Strip: A laminated strip product, consisting of a solid sheet of silver, clad on either one or both sides of a core of mild steel, has been developed.‡

Strip, available in widths up to 4", in thicknesses down to .005", and in any required temper, is being manufactured in various silver-to-steel thickness ratios and rolled and slit to commercial or precision tolerances.

The silver-clad steel, it is said, can be used as a substitute for brass, nickel-silver, nickel, and other restricted metals. It can be shaped by stamping, bending, drawing, spinning, and other conventional metal-working processes, and component parts can be assembled by means of silver brazing or soft soldering.

‡Rolled Plate Division, American Silver Co., Inc., Flushing, New York.



(Left)
Sealing picture-tube face plate to metal shell at DuMont.

(Right)
Semi-automatic equipment, designed to produce miniaturized apparatus recently developed at Sylvania under sponsorship of Air Material Command, and described by W. H. Hannahs and Walter Serniuk of Sylvania physics labs at IRE Dayton airborne-electronics meeting. Unit employs a flexible sheet or *blanket* of a rubber-type plastic in which wiring is imbedded. The sheet is wrapped around an indexed assembly of the components. Minimum amount of necessary soldering is accomplished by an automatically indexed machine. Complete assembly has a circular cross section with terminals distributed radially along the circumference. The terminals may be soldered or welded.



TV Recording

35-MM Recording Camera: Photographing the television picture tube has been found to involve many problems, one of which is the frame rate. It is, of course, possible to record satisfactorily television images at the rates of 30, 15, 10 or multiple of 30 frames per second. Since, however, the motion picture and television industries are firmly standardized at their present frame rates, it is essential for television recording equipment to convert 30-frame, 60-field per second television images to 24-frame per second picture records. This variation of frame frequencies gives rise to the phenomenon termed *shutter-bar*, or more accurately defined as a *picture-splice*.

Surveying this situation at the N. Y. City SMPTE conclave, John Kiehl of Producers Service Company in Burbank, Calif., said that a virtual multitude of optical, mechanical, electrical, and film factors affect the perfection of the splice. Angular shutter size was cited as the greatest individual factor regulating the perfection of the splice. If the shutter opening (or exposure time) is too small it will omit proportionately fewer scanning lines of the third lace field, resulting in an unexposed area of the film—hence, an imperfect line structure or a white shutter bar on the negative picture. This is inversely true if the shutter opening is too large and scanning lines of the third lace field excessively double-expose those of the second lace field. When either of these types of shutter-bar exists in a recording, Kiehl stated, a regional 12-cycle density variation or *flicker* is very evident and extremely annoying when viewed.

Since the frame rate of the television system is precisely 1/30th second, it was shown that theoretically it would seem a perfect splice would be attained with angular shutter opening of 288° or exactly 1/30th second exposure time. This would, during the opening cycle or gradual fade-in and corresponding fade-out as the shutter closes, allow the same total photographic energy to reach the film in the double exposed splice area as the rest of the picture area would receive in one complete exposure, recorded without shutter interference.

Unfortunately, noted Kiehl, the mechanical theoretical consideration is insufficient since certain film phenomena are directly related to the shutter angular size. The singular behavior of these phenomena can not be practically isolated, and thus one must theorize on the extent of their individual effects. One of these, it was pointed out, is the *intermittency* effect, by which the effect of two successive exposures on film will not produce the same negative density as a single exposure containing the same total photographic energy as the com-

bined two. Under certain conditions the density produced by the intermittent exposures will be of greater density than that of a single exposure. When a low intensity light is used, comparable to amount emitted by the monitor tube, the intermittent exposure invariably produces less density than the single exposure. This indicates, it was noted, that the shutter opening should be greater than 288° to increase the exposure beyond 1/30th second. In practice, however, it is always necessary for the exposure time to be slightly less than 1/30th second. An explanation for this is found, said Kiehl, when the Clayden effect is considered in combination with phosphor persistence.

This effect consists in the reduction of effectiveness of a low intensity exposure when preceded by a high intensity one. Incidentally, it was said, the effectiveness of the initial high intensity exposure may or may not be reduced, although a distinct reduction, or reversal effect, usually occurs. This, however, is relatively unimportant, when considering the effect on the splice. Of most significance, declared Kiehl, is the fact that the order of exposures, to produce a reduction in their combined effectiveness, must be short and intense followed by long and dim, and not the reverse.

The normal brightness and brightness decay of P11 phosphor radiates in a manner ideal for producing this phenomenon. When the phosphor is excited by the scanning beam, it instantaneously fluoresces to a certain intensity, rapidly decreases in intensity as great as 100 to 1 in .1 millisecond, and then continues to fluoresce at a low intensity for several milliseconds. Hence, the sequence of emission is short and intense—long and dim.

The electrical possibilities of an imperfect splice also are directly related to the shutter. Briefly, said Kiehl, a fluctuation of input frequency affects the television camera's power supply, which in turn varies the vertical deflection time constant of the monitoring tube. It is, therefore, essential that the shutter fluctuate in angular rotation to the same extent as the input frequency irregularities and with the identical *a/c* time constant sync generator. This was described as having been accomplished in a new camera*** by driving the shutter with a separate synchronous motor and low inertia gearing mechanism. This motor and the main camera drive motor are kept in phase during starting and stopping by a floating coupling device which physically disconnects during the recording operation.

***Acme.



Recording room in new thirteen-floor Radio Canada building in Montreal, where any of 50 programs passing through master control can be chosen automatically for recording. Each of fourteen recorders (disc or tape) which has its own control panel, clock, light and overhead speaker, can record simultaneously or separately. The building, with 26 studios, will soon feature three special studios for TV. From these studios in a five-story television wing, CBC will produce TV programs for broadcast from a transmitter atop Mount Royal. The entire TV wing has been so constructed that two more floors can be added if necessary. All the television equipment for the three studios has been ordered. Standard video equipment has been ordered while the accompanying sound equipment is being manufactured in Canada to CBC design and specifications. CBC television in Montreal will also operate a mobile van for outside events (sports, etc.). The van will have its own transmitter and portable equipment.

New Posts: *Ray Simon*, formerly chief engineer of Eicor, Inc., is now chief engineer of Carter Motor Co., Chicago, Ill. . . . *Dr. Harry F. Olson*, director of the acoustical laboratory of RCA laboratories in Princeton, has been elected president of the Acoustical Society of America for '52. . . . *Dr. Harry N. Walker* has been named vice president, in charge of sales, of Richardson-Allen Corp., selenium-rectifier manufacturers. . . . *Preston M. Covington* has become director of property maintenance for WBT, WBT-FM and WBTW, Charlotte, N. C. . . . *George O. Smith*, author of *Venus Equilateral, Pattern for Conquest*, etc., has been appointed manager of components engineering at Emerson. . . . *A. H. Schenkel* has been elected president of the recently reorganized Utah Radio Products Co., Inc., Huntington, Indiana, a wholly owned subsidiary of Newport Steel Corp. Others elected were *E. V. Norfleet*, secretary and treasurer; *F. W. Tower*, general sales manager; and *M. G. Wike*, sales manager of the jobber and industrial division. . . . *Dr. Saul Rosen*, formerly assistant professor of mathematics at Drexel Institute of Technology, has joined the research division of the Burroughs Adding Machine Co., Philadelphia, Pa. . . . *J. H. Chrysler* and *Charles B. Nairn* have been appointed district reps for the G.E. tube divisions, with headquarters in Chicago. Chrysler will be responsible for sale of tubes, component parts and test equipment in the Chicago and Indiana areas, while Nairn will cover Minnesota, Wisconsin and North and South Dakota in the same capacity. . . . *George F. Sandore*, formerly district manager for the RCA Atlanta area, has become manager of the sales and merchandising section of the technical products division of the RCA Service Co. *Carl E. Johnson*, formerly manager of the theatre service section, has been named manager of district operations, and *Adolph Goodman*, formerly manager of the district sales section, has become manager of commercial operations, in charge of the Camden repair shop, the communications service groups, and the public demonstration group. *C. L. Swinney*, formerly supervisor of the Atlanta district, has been appointed manager of the district. . . . *S. K. Burnell*, formerly with Westinghouse International, has been appointed advertising director of Burlingame Associates, New York City. . . . *Carl Wasmansdorff* has been appointed director of engineering for the Hoffman Radio Corp., Los Angeles. He was formerly director of development engineering. . . . *Raymond W. Andrews*, formerly merchandising manager of the radio tube and television picture tube divisions

of Sylvania Electric, has been promoted to manager of factory sales, and *William T. Buschmann* has been appointed merchandising coordinator. *William G. Blowers*, formerly associated with the Franklin Life Insurance Co. as an agency manager, has been appointed merchandising supervisor of Sylvania's television picture tube division. . . . *Dr. Arthur W. Wishart*, vice president of the McKee Glass Co., Jeannette, Pa., has joined the Westinghouse Electric Corp. as manager of the glass manufacturing division. He will headquarter temporarily in Fairmount, W. Va. . . . *Dr. George J. Goepfert* is now director of research for the Speer Carbon Co. and its subsidiary the International Graphite and Electrode Corp. . . . *Dr. Louis T. Rader* has been appointed assistant manager of engineering of the G.E. control divisions at Schenectady, N. Y. . . . *Edwin A. Freed*, formerly with the tube department of RCA, is now sales manager of products manufactured at the Elizabeth plant of General Instrument Corp. (variable condensers, TV and auto radio tuners, automatic record changers, and other electro-mechanical products). *Lee Balmengee* has been named manager of the G. I. Chicago sales office. . . . *Jay E. Browder* has been named chief of the radio communications engineering section of Kollsman Instrument Corp., a subsidiary of Standard Coil Products Co., Inc. Formerly Browder was with the Sperry Gyroscope, where he was engineering section head for aeronautical radio equipment. . . . *Joseph M. Kittner* is now assistant chief of the FCC broadcast bureau which is headed by *Curtis B. Plummer*. *James E. Barr* has become chief of the aural facilities division; *Cyril M. Braum*, chief of the television facilities division; *Dwight D. Doty*, chief of the renewal and transfer division; *Frederick W. Ford*, chief of the hearing division; and *Paul Dobin*, chief of the rules and standards division. . . . *Albert J. Rosebraugh* has been named to a new Philco post, manager of distribution. *John J. Moran* succeeds him as sales manager of radio, and *John L. Utz* has been appointed special television representative. . . . *A. M. Katz* has been elected chairman of the board of directors of Ideal Plastics Corporation, Hollis, L. I. . . . Vice president *A. B. Clark* of Bell Telephone Labs has been assigned to a new post in which he will coordinate all Bell System programs at the labs. He will be responsible for the labs' relations with A. T. & T. and W. E. *Dr. James W. McRae*, who has been appointed vice president, succeeds Clark in charge of the system's development organization.

Magnavox vice prexy Edwin S. Pridham (left), with a testimonial portfolio presented to him by R. A. O'Connor, chairman of the board of Magnavox, during a dinner at Fort Wayne, Ind., honoring Pridham on his 40th year with the company. Pridham, one of the founders of Magnavox, in '15 produced the first loud-speaker.

W. M. Kohring, founder and owner of Wilkor Products, which was recently merged with Aerovox, and W. Myron Owen, president of Aerovox. Kohring will be in direct charge of the Wilkor subsidiary.

Col. E. E. Kimble, right, founder of Kimble Glass (now a division of Owens-Illinois Glass Co.), listening to H. B. Richmond, chairman of the awards committee of the Scientific Apparatus Makers Association and board chairman of General Radio, read a citation naming him recipient of the SAMA Award for Outstanding Service.



The Cosine Deflection Yoke

by JOHN PELL,

Manager of TV Service, Philco Corp.

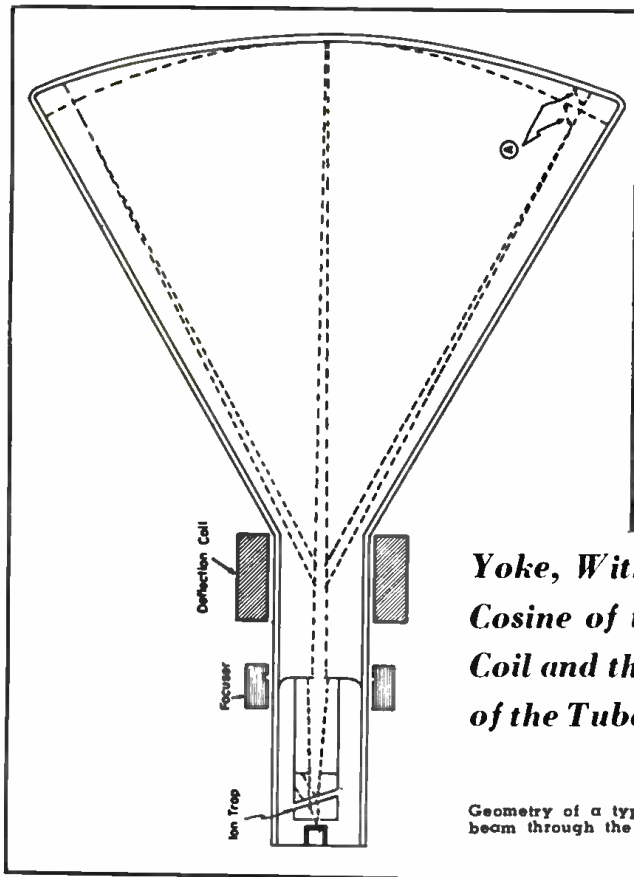

Yoke, With Windings Distributed in Proportion to the Cosine of the Angle Between the Deflection Axis of the Coil and the Radial Position of the Winding on the Neck of the Tube, Found to Prevent Electron Beam Distortion.

Figure 1

Geometry of a typical 16-inch 55° deflection system, showing the relative size of the electron beam through the deflection coil and the change in the angle of incidence (a) of the beam to the screen at large deflection angles.

WITH THE ADVENT of the wider-angle picture tubes and the corresponding trend to more compact chassis, designers have been confronted by several problems, one of which has been electron beam distortion.

In one effort to solve the difficulty, there has been developed a deflection yoke which prevents electron beam distortion by distribution of the deflection windings, providing a uniform magnetic field. The yoke has been named a *cosine yoke*, because the windings are

distributed in proportion to the cosine of the angle between the deflection axis of the coil and the radial position of the winding on the neck of the tube.

Uniformity of focus, assuming proper construction of the picture tube and focuser system, has been found to be hindered by two principal factors. In one instance, there appears the elliptical distortion of the spot due to geo-

metric relations of the picture tube screen, position of the deflection coils and the deflection angle.

A second and more important cause of electron-beam distortion has been found to be the action of a non-uniform deflection field on the electron beam. This type of distortion is not directly affected by the deflection angle. The distortion caused by a non-uniform deflection field can be just as damaging in a 55° deflection system as in a 70° system. Figure 1 illustrates the conditions in a 16" 55° tube, with respect to the location and action of the focuser, location of the deflection coil and the size of the electron beam passing through the deflection coil; the same general

Figure 2

Cross-sectional view of ordinary deflection coil, showing non-uniform magnetic field, and the relative size of beam (d) and elliptical distortion produced. At (a) is a cross section of one-half of a horizontal deflection coil. (The coil turns run parallel to the tube neck, cross tube and return on other side.) Beam, distorted by action of a non-uniform field, appears at (b). The curved lines of force (c) illustrate the non-uniform magnetic field. The second half of the horizontal deflection coil appears at (e).

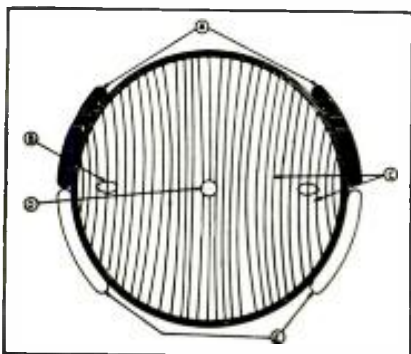

Figure 3

Enlarged view of electron beam striking screen, showing small amount of elliptical distortion caused by a change in the angle of incidence of the beam to the screen. At (a) the beam is at zero deflection angle; (b) beam has moved through large deflection angle; (c) is the picture tube screen; (d) distortion, 1/2 actual size; (e) normal scanning spot; (f) elliptical distortion of spot at large deflection angle.

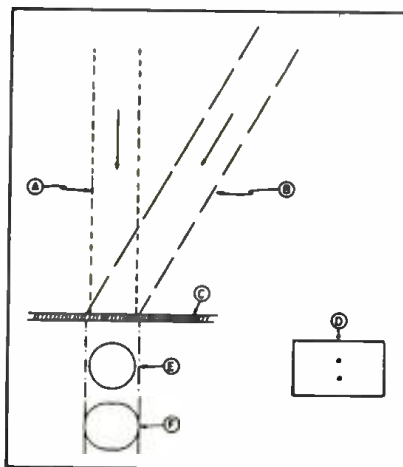
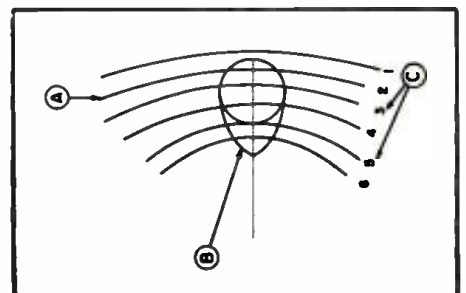

Figure 4

Enlarged view illustrating action of beam in a non-uniform field. At (a) are the lines of force, showing points of equal field strength. The beam distorted by the field increasing in strength, from right to left, is shown at (b), while at (c) is illustrated the field strength increasing from right to left.



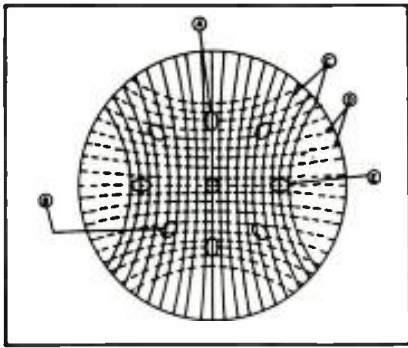

Figure 5 (left)
Effect of non-uniform deflection fields on electron beam shape. Vertical distortion appears at (a), and combined horizontal and vertical distortion appears at (b). The solid lines at (c) represent the horizontal field, while the broken lines at (d) show the vertical field. Horizontal distortion appears at (e).

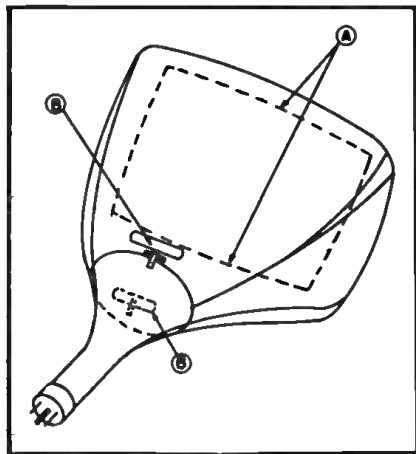

Figure 6 (left)
A three-quarter view of a 20-inch picture tube, showing placement and effect of pin-cushioning correction magnets (b). The top and bottom of the picture is illustrated at (a).

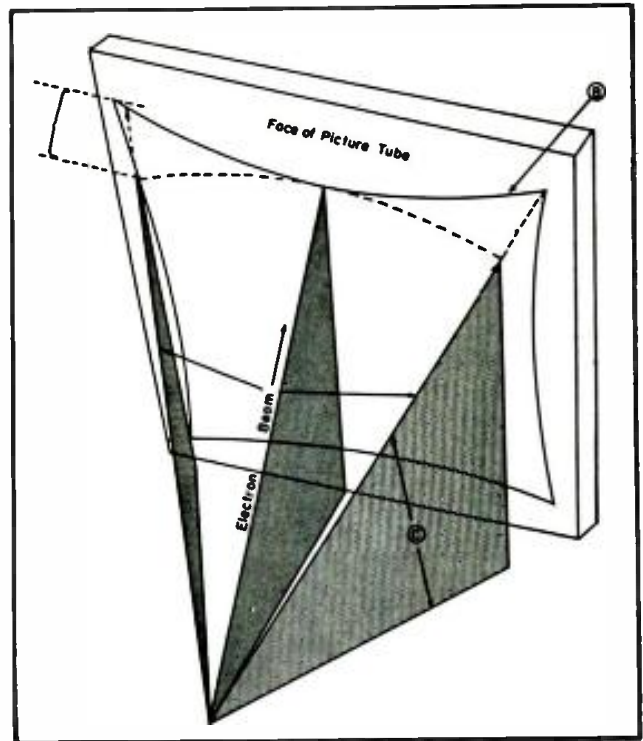

Figure 7
Pin-cushioning caused by beam traveling greater distance at larger deflection angle to strike the face of the tube, having a face-plate curvature on the radius larger than the radius of the beam from the deflection coil. The path of beam on the face of the picture tube (shown flat to simplify illustration) appears at (b). Constant angle maintained in all three positions of the beam is illustrated at (c).

conditions would hold for a 16" 70° deflection system.

In Figure 2 appears the cross-section of an ordinary deflection yoke showing the distribution of the deflection windings, and the shape of the horizontal deflection field produced by this winding distribution. Illustrated also is a cross-section of the electron beam passing through the deflection field. It will be noted that this type usually produces a non-uniform field which is undesirable, principally because the electron beam has a relatively large cross-section at this point.

Oddly enough, some of the effects of a non-uniform deflection field have been found desirable, at least on the surface. For several years the criteria of good deflection coil design was the accuracy with which it reproduced the physical placement of picture elements, without regard to how well the picture elements were reproduced.

In the ordinary deflection system the outward bowing of the raster is compensated by an opposing distortion of the raster only (the distortion of the spot is not corrected) due to the dif-

ference in radius of the picture tube screen as compared with the radius of the deflected electron beam. If it were not for the distortion of the ordinary yoke the sides of the raster would be bowed inward or *pin-cushioned*, as show in Figure 7.

The use of the cosine distribution of the deflection winding has the undesired effect of allowing the geometric distortion of the raster, illustrated in Figure 7, to become apparent, resulting in a *pin-cushioned* picture. However,
(Continued on page 27)

¹Philco 2100.

Figure 8
Barrel distortion of raster produced by non-uniform fields.

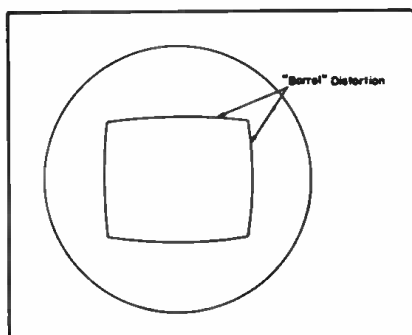
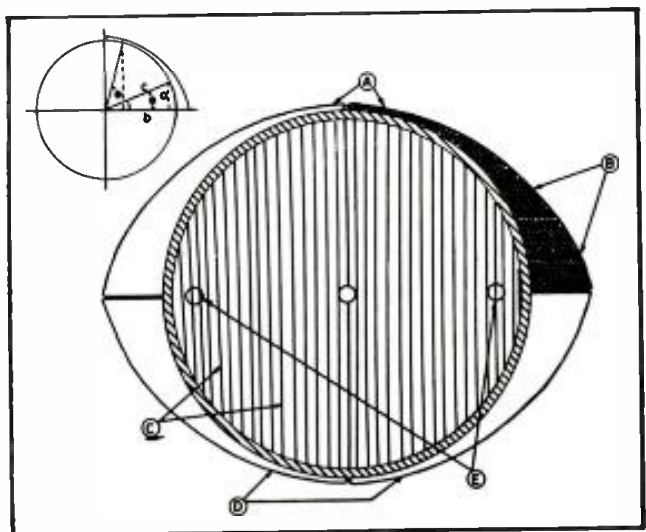

Figure 9
Cross section view of cosine yoke and picture-tube neck showing uniform field and freedom from distortion as a result of cosine distribution. One-half of the horizontal deflection coil is shown at (a). At (b) is illustrated the cosine distribution of the horizontal-deflection coil winding. Lines of force, nearly straight, indicating uniform magnetic field are represented at (c). The other half of the horizontal deflection coil is shown at (d) and at (e) is illustrated the undistorted beam at the extremes of deflection. Turns (N) are distributed as the cosine of the angle
$$\theta; N = \frac{b}{c}$$



Component



Miniaturized variable resistor.
(Courtesy Chicago Telephone Supply)

MINIATURIZATION TECHNIQUES

by RALPH G. PETERS

IN THE DESIGN of components and equipment, the size aspect has always been a basic factor, serving in many instances as the nucleus of planning. Many plants have instituted extensive programs revolving about size, or specifically the miniaturization of salient components of comparatively large size.

Miniaturization requirements have been found to affect not only component sizes, but physical shapes as well. To illustrate, an *if* strip under development required *if* coils which were not available commercially. A unit was developed using flat toroids of magnetic material so arranged as to nest within a compact assembly under the tube. Efficient utilization of available space was obtained, as well as minimization of stray magnetic fields, by means of the toroid design.

The current trends toward miniaturization and high-temperature operation of electronics equipment have greatly accelerated the design of new capacitor and resistor types.¹ Ceramic dielectrics have been introduced in many of the new units, and both industry and the services are supporting research and development programs for further improvements of their characteristics.

As the result of one development* there has been produced low-dielectric constant (approximately ten) ceramic (lead-boron) capacitors which can be

operated at temperatures as high as 250° C. Although these capacitors are generally used in high-Q circuits at temperatures below 100° C, both their capacity deviation and dielectric losses are relatively small for general purpose applications at temperatures as great as 250° C. The leads are attached with hard cadmium-tin solders which melt at 300° C. The dielectric constant of the ceramic has been reported to be essentially invariant at all frequencies as high as 100 mc. At that frequency the manufacturer's measurements are masked by the resonant effect of the connecting leads of the capacitor.

Titanium dioxide and its combinations with alkaline earths such as barium and strontium oxides are very widely used in the production of ceramic capacitors. Certain mixes of these materials have dielectric constants ranging from ten to one hundred, and corresponding temperature coefficients of capacitance from +100 through 0 to minus several thousand parts per million per degree C.

These temperature-coefficient characteristics can be utilized to good advantage in many types of quality equipment. The zero-coefficient type can be used where the characteristics, such as

those of a resonant-circuit capacitor, must be invariant over a wide temperature range. The positive or negative-temperature coefficient types are utilized where the undesirable temperature characteristics of other circuit elements must be compensated by those of the capacitor. It should be noted, however, that the compensation can be exact at only one temperature. The temperature coefficients of capacitance of all compensating capacitors have been found to vary slightly with temperature changes.

Generally, the temperature range of ceramic capacitors now commercially available is specified at from -60° C to +85° C. However, one lab** specifies that their ceramic films, with a dielectric constant of approximately ninety, exhibit low-loss characteristics to temperatures as high as 250° C. At this temperature the power factor is approximately .0009 and the temperature coefficient is approximately 500 parts/10⁶/° C.

Some of the titanate materials have been found to have dielectric constants as high as 18,000, and capacitors incorporating these materials can therefore be made very small. Commercial units are commonly fabricated in the form of wafers with two metal-film electrodes bonded to the opposite surfaces of the wafers. This design permits efficient

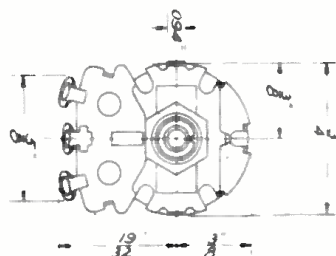
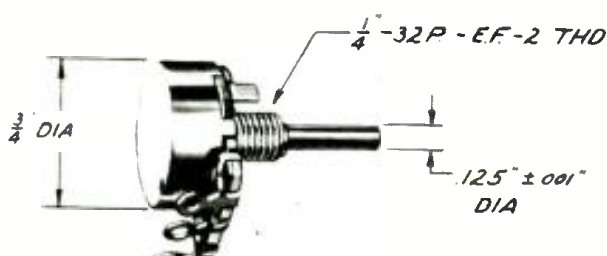

(Left)
Actual-size illustrations of miniaturized variable resistor, using silicone Fiberglass insulation.

(Courtesy Chicago Telephone Supply Corp.)

*Based on Stanford Research Institute data appearing in report on Electronic Equipment Construction.

Report* on Methods and Materials Which Have Been Found Adaptable to the Production of Miniaturized Parts Featuring Stable Performance at High Temperatures.

utilization of the entire capacitor volume and also minimizes lead length, so that the self-resonant frequency of the capacitor may be made as high as possible. One 1000-mmfd unit ** is a good example, a 400-volt unit measuring only 1/8" by 1/8" by 1/32", either radial or axial leads being provided. Other manufacturers have produced a number of 500-volt, 0.001-01 mfd units of disc shape with diameters and thicknesses of approximately 3/4" and 5/32", respectively. They are available as unmounted discs for printed circuit use, or as fabricated, insulated units.

The temperature characteristics of high-dielectric-constant titanate materials are of primary importance. They are analogous to the impedance-versus-

(Continued on page 29)

**Raleo Research Labs.

Cross-sectional view of larger counterpart of miniature variable, shown at left.
(Courtesy Chicago Telephone Supply)

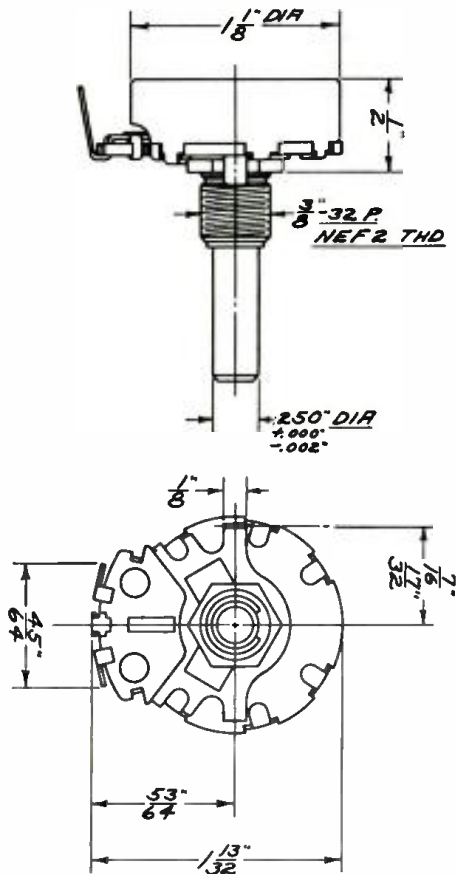

Chart of broad quantitative comparisons of characteristics of general classes of resistors, many of which are of miniaturized construction.
(From Stanford Research Institute report)

RESISTOR TYPE	GENERAL FEATURES	RESISTANCE RANGE (OHMS)		TOLERANCES (PER CENT)		TEMP COEFF (PER CENT/°C)		VOLT COEFF (PER CENT/VOLT)		DERATING TEMPERATURES (CENTIGRADE)			HUMIDITY TEST (%AR)			
		MIN.	MAX.	MIN.	MAX.	MIN.	MAX.	100% RATED POWER	50% RATED POWER	10% RATED POWER	1000-HR. STAB. (%AR)	SHELF: RATED	MIN.	MAX.		
COMPOSITION	GENERAL USE	10	2 x 10 ⁷	5.0	20	0.07	0.15	-0.005	-0.03	50	75	100	1.0	5.0	1.0	5.0
CRACKED CARBON FILM	PRECISION	1.0	2 x 10 ⁸	1.0	5.0	0.025	0.06	-0.0005	-0.001	90	115	140	0.03	1.2	0.0	2.0
CARBON FILM (WITH BINDER)	STANDARD AND PRINTED CIRCUITS	30	10 ¹²	5.0	20	0.03	0.1	-0.004	-0.04	50	75	100	1.0	5.0	2.0	10
TAPE	PRINTED CIRCUITS (STABLE TO 200°C)	50	5 x 10 ⁵	10	20	--	--	--	--	--	--	--	--	--	--	--
CERAMIC	MINIATURE HIGH-TEMPERATURE	10	4.7 x 10 ⁶	5.0	20	0.04	0.12	-0.03	-0.12	250	300	350	--	5.0	--	--
METAL FILM (NOBLELOY)	PRECISION	1.0	3 x 10 ⁷	0.5	5.0	0.001	0.06	-0.0002	-0.001	100	125	150	0.002	1.0	0.0	1.0
WIRE WOUND	POWER AND PRECISION	0.05	5 x 10 ⁶	0.01	10	0.0002	0.02	0.0	0.0	50	90	130	0.0	--	0.0	0.0

Application of Polarity Diplexing to Microwave Relay Systems

by C. A. ROSECRANS

TV Terminal Equipment Group, RCA Engineering Products Department



Figure 1
Feed line for normal (horizontal) polarization.

System Permits Transmission of Two Signals Along Same Path to Two Receivers, With One Antenna Arranged to Radiate a Vertically Polarized Wave and Other a Horizontally Polarized Wave.

THERE ARE TIMES when station operators employing several microwave circuits would find it to their advantage if their microwave equipments were all operated in the same channel. Some rather special setups can be operated in this manner with no change in the existing equipment. For example, a station operating both an *stl* and a remote pickup circuit may find it possible to operate them both on the same frequency by observing that the remote receiver is located near the studio (the *stl* transmitter), and that the remote receiver is located at least 100' to the rear of the *stl* transmitter. Remote pickups requiring multiple hops may also be operated in the same manner if the repeater is more or less in line

with the terminal transmitter and receiver and there is roughly a 100' separation between the repeater receiver and repeater transmitter. However, other system arrangements usually have required the use of more than one channel for successful operation.

The propagation characteristics and antenna patterns associated with microwave transmission systems lend themselves to the applications of a system of diplexing, which has been described as *polarity diplexing*. This offers an effective solution to some system problems. In its simplest form, two signals having the same frequency are transmitted along the same path to two receivers. One antenna is arranged to radiate a vertically polarized wave and

the other a horizontally polarized wave. Matching antennas are employed at the receivers. Under ideal conditions, the cross-talk between the two systems, even though they are operating at the same frequency, may have an extremely small value.

Practically, however, cross-talk levels lower than -20 db may be difficult to obtain, although in a carefully arranged setup, a -30 db level might be expected. Several factors enter the problem and may greatly influence the results obtained. First, the radiation from an antenna system employing a parabolic reflector (Figure 1) will not be entirely of one polarity. There will be found a small component polarized at 90° to the main field. Second, in the case of a portable setup, it will be found rather difficult to orient the two transmitting antennas so that the fields are exactly 90° to each other, as well as make the normal elevation and azimuth adjustments.

The results obtained will also be modified by the presence of any reflecting system in the transmission path. A plane reflector may generate a cross-polarized signal unless its horizontal

(Continued on page 27)

Figure 2
Twisted feed line to provide vertical polarization. This is interchangeable with the standard feed shown in Figure 1.

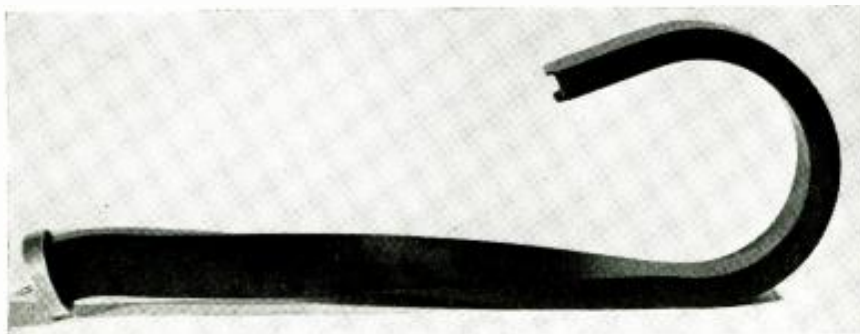

¹RCA TTR and TRR units have been used with system.

TV Maintenance Safety

Measures

by JOHN B. LEDBETTER

Engineer, WKRC-TV

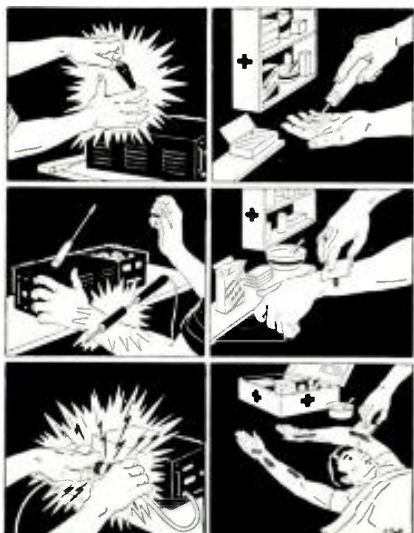

Vital Rules Which All Involved in TV Receiver and Transmitter Operation Should Follow.

IT IS A HUMAN TENDENCY to become lax or a bit careless when dealing with familiar objects. Expert hunters have become involved in tragic accidents because *they didn't think the gun was loaded*; good drivers have become agents of destruction because *they were going faster than they thought, or too fast to stop.*

These people could not afford to be careless . . . *neither can you!* The hunter may have handled guns all his life, and probably observed all safety regulations in handling and discharging them. *But the one time* he became careless, someone suffered.

The Importance of First Aid

All TV equipment involves the use of high voltages and highly evacuated picture tubes. This means danger from three distinct sources: *electric shock, burns, and cuts.* If you have no idea of how first aid should be applied, you are urged to learn *now*, not just the theory, but the actual step by step application. Every radio man should be prepared to give first aid. There is no way of telling when or where you may be required to use it. You may be the sole means of saving the life of a fellow worker or one of the members of your own family. Or, as in a number of such cases, *the life you save may be your own!*

Electric Shock

Safety Precautions: It has been proved that only a few milliamperes of electric current are sufficient to cause death if body conditions, resistance, etc., are just right. Although shock

from the high-voltage supply of a TV monitor or receiver is not usually fatal unless your physical condition is low or unless you are subjected to a continuous closed circuit, it is extremely unpleasant and may cause further personal injury through body recoil.

There are eight simple precautions which should be taken in every case:

(1) You should be sure that the floor or surface in front of your service bench or test position is of dry wood. If not, a rubber runner mat should be used. TV equipment should not be serviced while standing on a damp cement floor.

(2) Adjustments to hot equipment should be made with one hand. The other hand should be kept behind or in the pocket to eliminate the possibility of short-circuiting *hv* through the body.

(3) Before changing tubes or making adjustments inside the equipment, you should be sure that the power is *off* and all capacitors completely discharged. To avoid casualties or serious injury, *hv* capacitors should be discharged with a copper or brass grounding stick. (It is good practice to ground the *hv* circuit with a piece of braid and an alligator clip as protection

against accidental operation or short-circuiting of the power switch).

(4) Safety interlocks should be bypassed or short-circuited only when absolutely necessary. Bypasses should be labelled or tagged with a large red card. It is important to be extremely careful when using and *not to forget* that the circuit is *on*.

(5) The high-voltage circuit, component or lead should not be touched without first being *absolutely sure* that the power *is* off. The power switch may be defective or welded in the *on* position.

(6) Instruments should be checked on a metal-top *grounded* bench.

(7) The negative lead or ground terminal of all voltmeters or test equipment should be grounded so that their cases will not be above ground potential. It is important to be sure that the high-voltage test leads have adequate insulation.

(8) One should be extremely careful when servicing TV equipment in the presence of visitors. Inexperienced persons should *not* be asked to help. They stand the possibility of personal injury, while your company stands the chance of a lawsuit.

Burns

Safety Precautions: First or second-degree burns can result when overheated tubes, transformers, resistors, etc., are touched or handled. Small receiving-type tubes should be removed with an approved-type tube puller. Attempting to remove with the fingers may not only result in painful burns,

(Continued on page 30)

(Above, left)

Burns and first-aid suggestions. First degree burn (top view) in which skin is reddened, requires first-aid use of baking soda or Unguentine. Second degree burn (center) in which skin is blistered, can be treated with baking soda, or a wet compress using tannic acid jelly or foille jelly. Third degree burn, in which flesh is charred (bottom illustration) requires use of baking soda or a wet compress using tannic acid jelly or foille spray. Patient must also be treated for shock.

(Courtesy RCA)

Unique!

MINIATURIZED

VARIABLE RESISTOR for MILITARY USE

Manufactured from specially developed materials, Type 65 variable composition resistor is a unique, successful combination of miniature size and unprecedented high temperature and humidity stability. For example, Type 65 delivers top performance in fast military airplanes flying in tropical areas where both temperature and humidity vary tremendously from ground level to extreme altitudes.

Exceptionally good delivery cycle due to tremendous precision mass production facilities.

Please give complete details on your requirements when writing or phoning for further information.

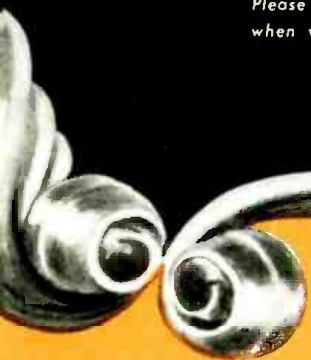

VARIABLE RESISTORS (COMPOSITION and WIRE WOUND)
WITH or WITHOUT ASSOCIATED SWITCH COMBINATIONS

Specialists in Precision Mass Production
of Variable Resistors

FOUNDED 1896

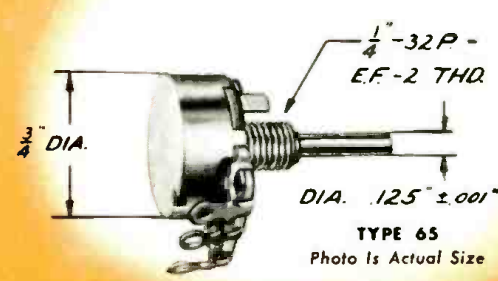
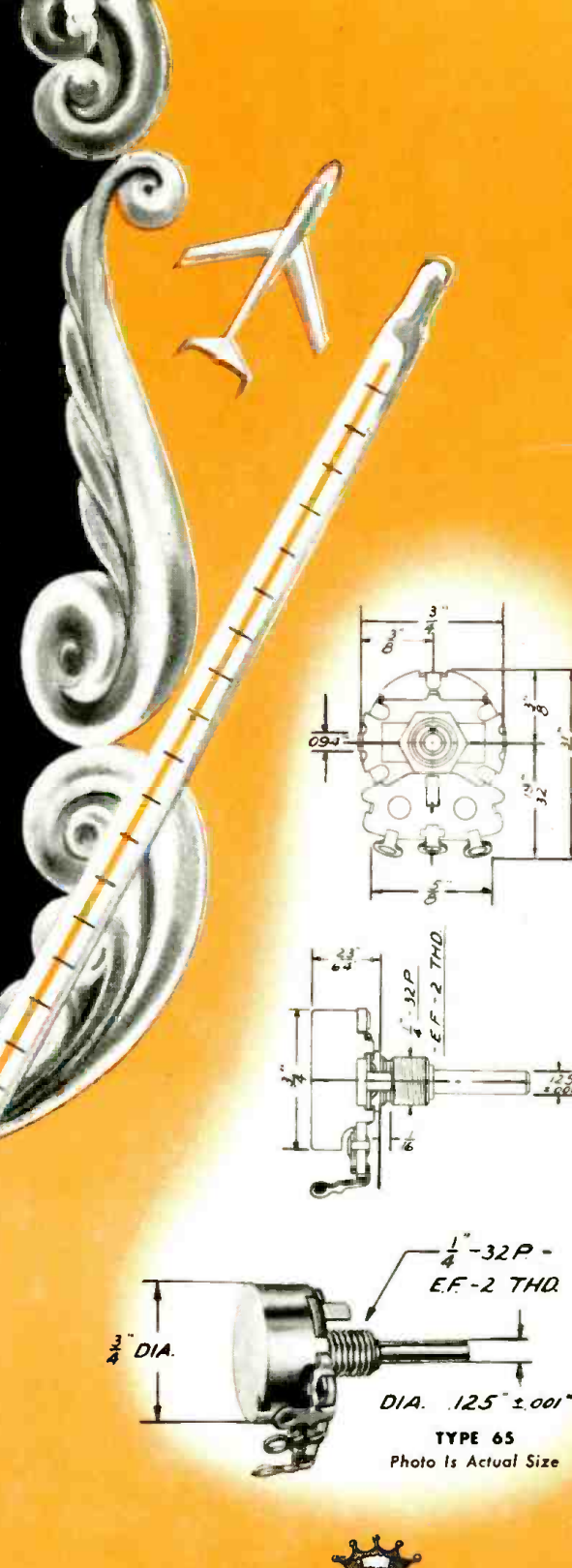

CHICAGO TELEPHONE SUPPLY Corporation

ELKHART • INDIANA

REPRESENTATIVES
 S. J. Hutchinson, Jr.
 401 North Broad Street
 Philadelphia 8, Pennsylvania
 Phone: Walnut 2-5369
 W. S. Harmon Company
 4057 McClung Drive
 Los Angeles 8, California
 Phone: Axminister 3-6219
In CANADA
 C. C. Meredith & Co.
 Streetsville, Ontario

SOUTH AMERICA
 Jose Luis Pantet
 Buenos Aires, Argentina
 Montevideo, Uruguay
 Rio de Janeiro, Brazil
 Sao Paulo, Brazil
OTHER EXPORT
 Sylvan Ginsbury
 8 West 40th Street
 New York 18, N. Y.

meets JAN-R-19

VARIABLE WIRE WOUND RESISTORS TO ALL SPECIFICATIONS IN JAN-R-19

TYPES NOW AVAILABLE

JAN TYPE	CTS TYPE	WATT RATING
RA 20A	252 (without switch)	2
RA 20B	GC-252 (with switch)	2
RA 25A	25 (without switch)	3
RA 25B	GC-25 (with switch)	3
RA 30A	25 (without switch)	4
RA 30B	GC-25 (with switch)	4

Exceptionally good delivery cycle due to tremendous precision mass production facilities.

Please give complete details on your requirements when writing or phoning for further information.

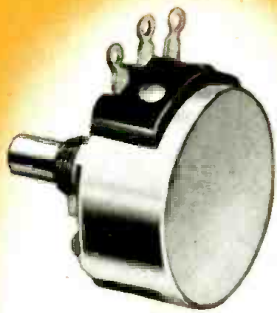

JAN Type RA 20A
2 Watt (CTS Type 252)

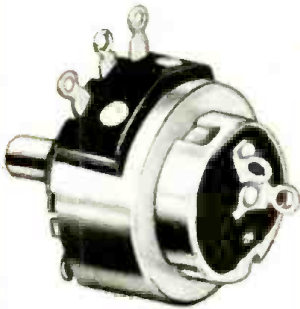

JAN Type RA 20B
2 Watt (CTS Type GC-252)

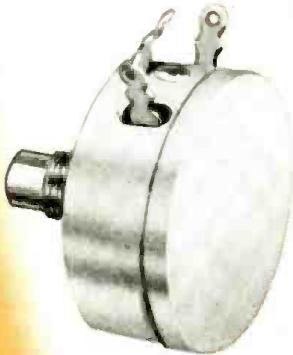

JAN TYPE RA 25A
3 Watt (CTS Type 25)

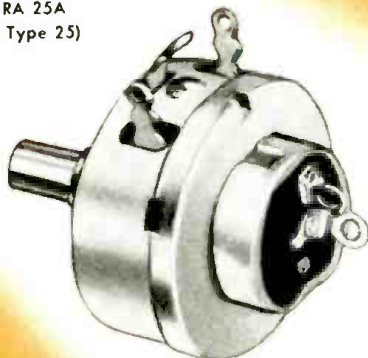

JAN Type RA 25B
3 Watt (CTS Type GC-25)

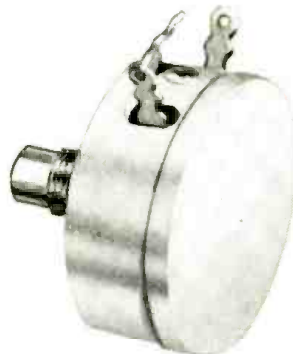

JAN Type RA 30A
4 Watt (CTS Type 25)

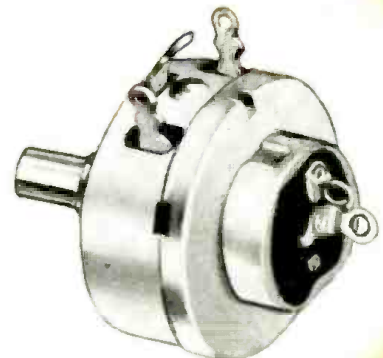

JAN Type RA 30B
4 Watt (CTS Type GC-25)

ILLUSTRATIONS ARE ACTUAL SIZE.



CHICAGO TELEPHONE SUPPLY Corporation

ELKHART • INDIANA

REPRESENTATIVES

S. J. Hutchinson, Jr.
401 North Broad Street
Philadelphia 8, Pennsylvania
Phone: Walnut 2-5369

W. S. Harmon Company
1638 South La Cienega Blvd.
Los Angeles, California
Phone: Axminster 3-6219

IN CANADA
C. C. Meredith & Co.
Streetsville Ontario

SOUTH AMERICA

Jose Luis Pontet
Buenos Aires, Argentina
Montevideo, Uruguay
Rio de Janeiro, Brazil
Sao Paulo, Brazil

OTHER EXPORT

Sylvan Ginsbury
8 West 40th Street
New York 18, N. Y.

A COMPLETE LINE OF VARIABLE RESISTORS (COMPOSITION AND WIRE WOUND) FOR MILITARY APPLICATIONS:

Specialists in Precision Mass Production of Variable Resistors

FOUNDED 1896

Super-Gain TV Antenna

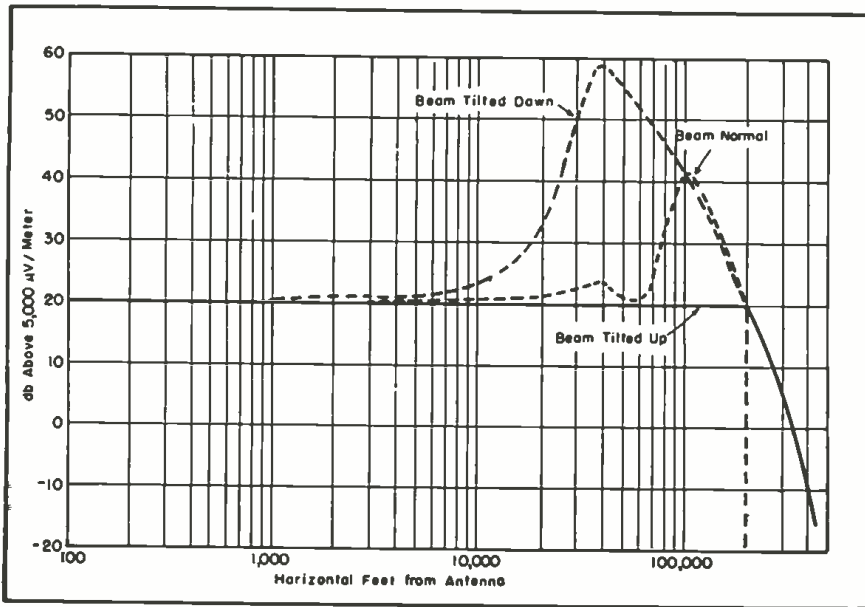

Figure 1

Optimum design antenna field strength. Frequency 195 mc; transmitting antenna 500'; receiving antenna 30' and power 225 kw erp.

Figure 2

Twelve-bay antenna feed system. M1 and M2 are $\lambda/4$ matchers (6 to 51.5 ohms). M1 is the insulation matcher; E, expansion joint; P, the phasing section; M3, 2:1 $\lambda/4$ matcher (51.5 to 103 ohms); M4, 1:2 $\lambda/4$ matcher (25.7 to 51.5 ohms). All unlabeled lines are 51.5 ohms.

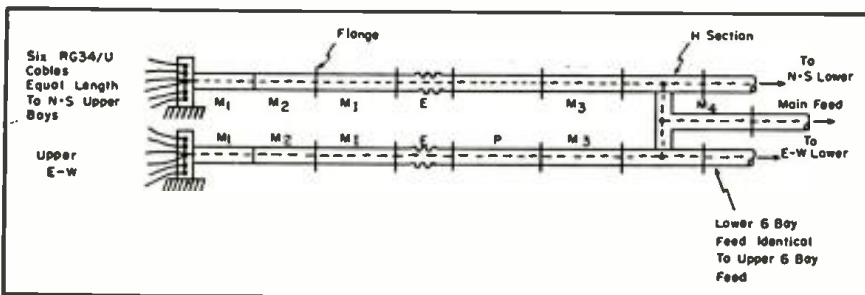
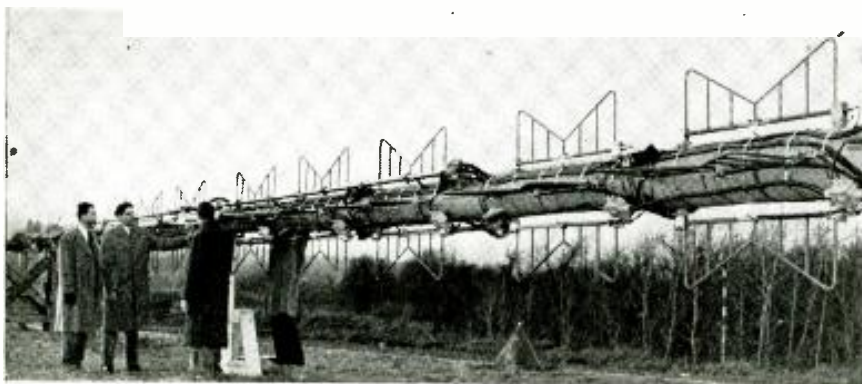

Figure 3

Completely assembled 12-bay antenna.



To DESIGN and produce a super-gain antenna, it is necessary to consider several factors, one which is sway. Based on our previous analysis,¹ a 2° sway would have to be tolerated. This requirement would limit the beam width to 4°, suggesting an in-phase design of 12 bays. Additional mechanical and electrical specifications which it was found should be met are:

- (1) Similarity of all bays to reduce manufacturing and assembly costs.
- (2) Possible use of already designed components.
- (3) Block building scheme of electrical and mechanical assembly to simplify test and shipping.
- (4) Simplified feed system.

These four factors have been found to represent economical and time-saving features. Further, dependability is increased as time-tried components are used, and in addition the replacement problem is simplified.

By making use of an existing standard 6-bay TV antenna and adding below a special 6-bay antenna, it was found possible to produce an overall 12-bay² unit which would meet the generalized design specification, a 2:1 matcher being used to match the two parallel feed lines in a single T. This design featured the use of superturnstile wideband radiators. A comparison of this type of radiator bay, with an equivalent four dipoles spaced around a tower, showed that gain for gain, the bat wings afford a substantial reduction in wind loading. Further, the increased bandwidth of the superturnstile type antenna was found to simplify the deciding problem.

The possibility of deliberately tilting the beam downward to insure better coverage and provide more safety factor was reviewed, but it was found that the added complications were not warranted. The gain in close in coverage was found to be unnecessary and while safety for the fringe area was increased, the likelihood of reaching maximum beam tilt (at 115 mph indicated) was small. Even under this condition, there was but a 3-db signal reception decrease. On the other hand, it was found that a specially-designed antenna with contoured vertical beam for optimum design would greatly increase the complexity of feed design and prevent the use of standard existing feed assemblies. Since this involved a quantity of 48 feeders, the problem was

¹TELEVISION ENGINEERING; May, 1951.

Engineering

by M. E. HIEHLE *

Hughes Aircraft Company

Part 11 . . . Generalized Design Factors Which Must Be Met in Choice of Final Electrical and Mechanical Specifications and Test Procedures Required to Evaluate the Completed Structure.

quite extensive. The design was thus boiled down to a 12-bay in-phase antenna utilizing as many standard parts as could be used.

Design Problems

While the foregoing emphasizes the use of known standard items, this does not mean that all engineering problems can be solved through their use. To the contrary, because of the large antenna size, several new problems were found to prevail:

(a) With the large diameter of bottom pole size, the opposing bat-wing radiators had to be spaced quite far apart; approximately quarter-wave. This posed two problems: Would the turnstiled pattern be affected and how could the input impedance of the bay be corrected? Unless each bay is uniformly excited as to power phase and magnitude, the overall antenna gain will drop and the vertical beam will be tilted. Analysis showed that the pattern was relatively unaffected with the large batwing spacing. After a careful test, a correct spacing was determined together with a slight modification of a mounting clamp, allowing the use of standard radiators for each of the large pole diameters.

(b) Although both lower and upper six bay groups were similar, manufacturing tolerances and the general permissible electrical tolerance was such that trouble from power and phasing still existed. This could be corrected through use of some type of matching section separately adjustable for each six-bay group. A simple matcher design was built consisting of a flanged length of standard 51.5 ohm $1\frac{1}{8}$ " coax. However, the standard disk insulators were not permanently fastened to the inner conductor, but located in position

by means of two stiff helical springs concentric on the inner conductor, one on each side of the insulator. These insulators could be located in any required position and fixed there with the springs. With this matcher, a standing-wave ratio up to 1.3 could be flattened by locating the disk insulators properly.

(c) By proper matching, the power distribution could be equalized between upper and lower bays. However, it was still possible to experience phase-shift trouble with resultant beam cocking. To compensate for off-phasing an adjustable phasing section was required. Trombone sections were found to be too large and bulky. A solid dielectric line was found to be best for our purpose. This line, because of the dielectric, had a slower velocity of propagation than standard line:

$$V_a = \frac{V_s}{\sqrt{\epsilon}} \quad (1)$$

where, V_a is the velocity of propagation of the dielectric line, V_s the velocity of air line, and ϵ the dielectric constant of insulation. The material finally used was *textolite*,³ which is similar to teflon and polystyrene, but with improved mechanical properties. The dielectric constant of the insulation is 2.66 and loss factor .0007. To maintain the impedance match, the inner conductor of the standard line was necked down through the dielectric material. Making this dielectric length adjustable permitted beam tilt correction because of phasing.

(d) The standard six-bay TV antenna is turnstiled; that is, two sets of radiating elements are physically located at right angles and fed electrically in phase quadrature. While the usual and standard designed TV antennas re-



Figure 4
Station wagon and pickup antenna.

quire phase quadrature, the actual antennas have two separate equal length feed lines to each of the crossed radiators. Phasing of 90° is supplied external to the antenna. This method is used to take advantage of the simple design bridge diplexer. Because a single-line input antenna greatly decreases installation cost (one line instead of two) it was decided to locate the quadrature phasing on the antenna. This required a special *slot* diplexer to mix the aural and visual transmitters; so called *slot* because of a slot or hole rejection for the aural transmitter frequency. This decision also helped the physical layout of transmission lines on the antenna, since one line was eliminated. The actual phasing was accomplished using reduced velocity transmission line, previously described. The dielectric length was made such, that for a given length of dielectric, the phasing was equal to 90° , plus the phase shift of an equivalent length of standard air line. This allowed mechanically equal lengths of transmission line, but electrical quadrature phasing. The phasing sections also took over the job of beam tilt adjustment eliminating the special sections as required in (b).

(e) The long length of the antenna with its long lengths of transmission line posed additional problems. Differential expansion between the steel mast and copper transmission line has been found to amount to some $\frac{1}{4}$ " under power operation on a hot day. In addition, the sway of the antenna in the wind alternately flexes the transmission line. Since it was desired to anchor the transmission lines at the two junction box ends, a special expansion section was used. Previous designs with sliding fingers and rubber boots or similar sealed methods failed electrically in the fingers. The expansion section used consisted of a corrugated flexible metal

*G.E.
²G.E. 1422.

³Formerly with General Electric, engaged in the engineering of the WHAS super-gain antenna.

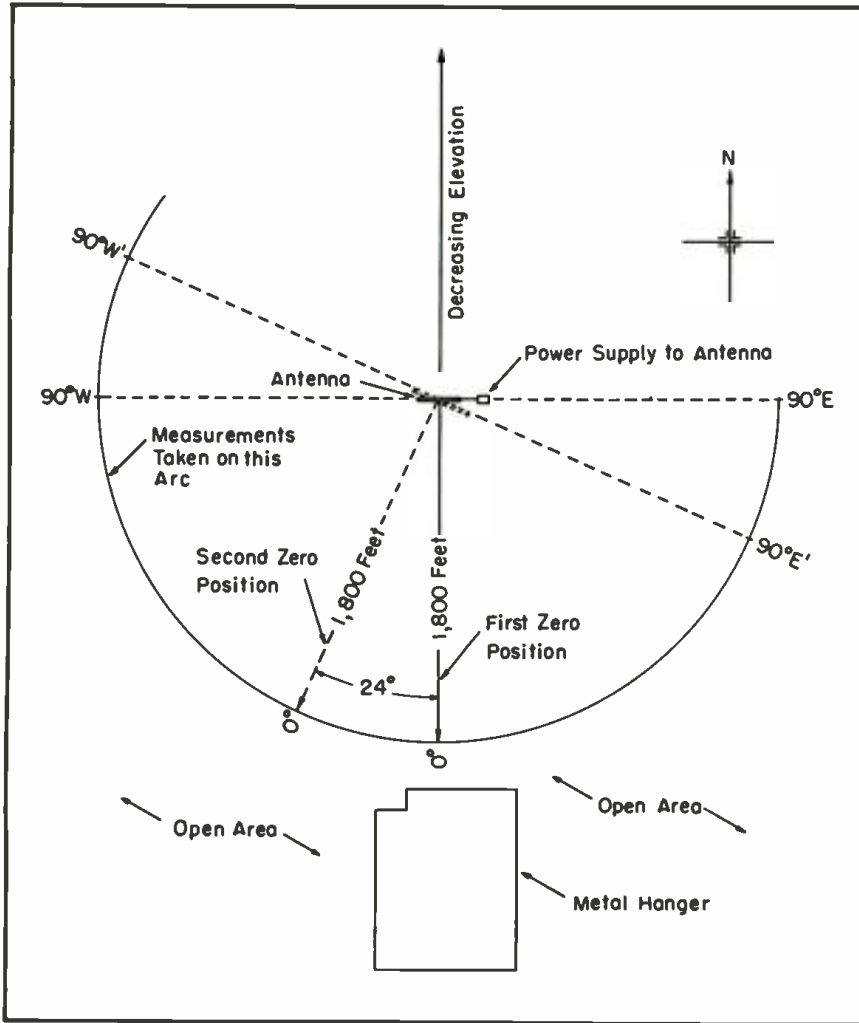

Figure 5
Layout of pattern measurement area.

condition. A life of some 700,000 cycles was obtained.

(f) In the complete antenna feed system (Figure 2) one set of radiators (all bays) labeled N-S were fed directly from the center H feed. The other set labeled E-W were fed through an identical mechanical length feed, but with an additional electrical 90° phasing. The design of the H section itself provided for 51.5 ohms, so that standard commercial elbows could be used. All matching was made in straight sections of line which could be easily fabricated. To facilitate construction and alignment, swivel flanges were used throughout.

(g) With the transmission line system anchored to the pole at two places (Figure 2), two different types of transmission line clamps were used. The first, as an anchor clamp immediately below the junction box, consisted of a large contact area clamp. The second type was used as a guide clamp, and to allow for sliding of the transmission line, was designed oversize with rubber inserts cemented to the metal clamp. Careful design of the clamps and their location served to prevent too much relative motion between clamp and rubber which would result in tearing of the insert.

(h) Because of the overall antenna length (88') a field joint in the pole was made at approximately the center to simplify shipping. The actual break divided the antenna into two six-bay units and facilitated testing.

Complete test of the super-gain antenna included pressure test, high pot, and *vsur* measurement of all components of the feed system. In the test the upper six bays and lower six bays were also checked as separate units: in accordance with standing instructions, as follows: (1) High pot; (2) double bridge resistance check, testing each cable individually; (3) pressure test on sealed coax; (4) radiator sleet melter high-pot, resistance and operational check; (5) impedance and *vsur* measurement over complete high channel; (6) insulator matchers adjusted from impedance measurement calculations; (7) *vsur* final run.

Following this check, the two sections of the antenna were assembled together and the field joint tack welded for overall test.

To check gain calculations and beam tilt, a complete vertical pattern of the

(Continued on page 23)

hose brazed to lengths of a standard outer conductor. The corrugations of the bellows increased the inductance per unit length of line increasing the surge impedance, which was compensated for by enlarging the inner conductor to increase the capacitance. Special precautions were taken to de-

crease the end effects of the expansion joint and the resulting *vsur* was found to be less than 1.05 up to 200 mc. Mechanically, several bellows were endurance tested to failure. The deflection during test corresponded to simultaneous occurrence of maximum wind and extreme temperature, a highly unlikely

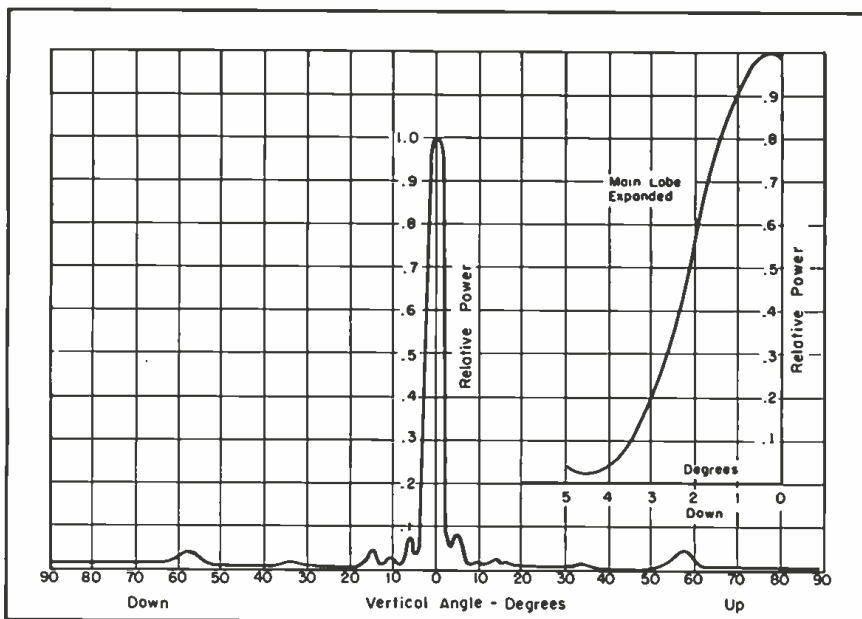

Figure 6
Measured 12-bay vertical pattern; channel 9.

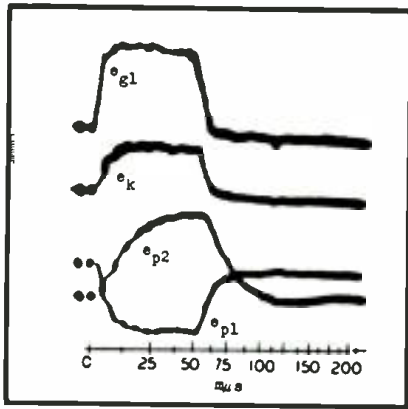

Figure 1 (above and right) Circuit and response of the regenerative cathode-coupled clipper.

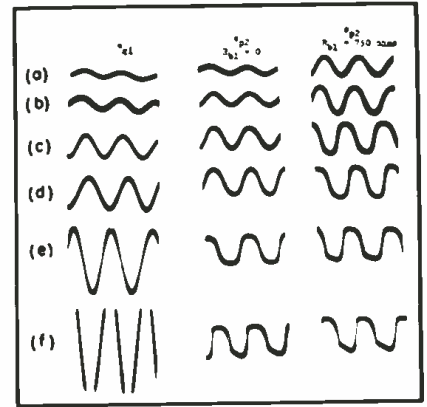
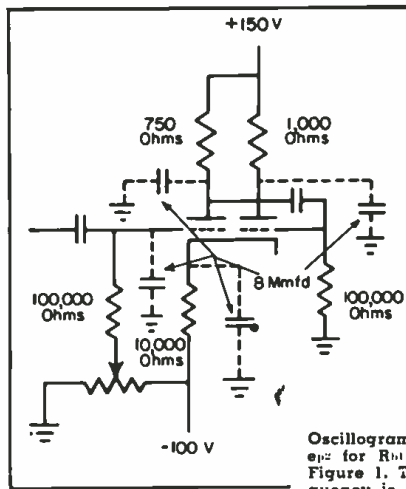

Figure 2 Oscilloscopes of the input voltage e_{g1} and the output voltage e_{p2} for R_{b1} of zero and of 750 ohms in the circuit shown in Figure 1. The magnitudes of e_{g1} are given as rms values; frequency is 5 mc. Voltage at (a) is .5; (b) 1; (c) 2; (d) 3; (e) 6, and (f) 12.

Cathode-Coupled Clipper Response Speed

by PHILIP F. ORDUNG and HERBERT L. KRAUSS

Dunham Laboratory, Yale University

Concluding Installment . . . Which Discloses That Limiting Speed Is Determined Primarily by The Time Constant of The Output Circuit, and Clipping Action May Be Improved by The Use of Regeneration, But the Ultimate Speed of Response Is Not Affected.

THE DYNAMIC TESTS disclosed that with the essentially rectangular input pulse that was used, the output voltage waveform is determined primarily by the time constant of the output circuit. Therefore the application of regenerative feedback, which has the effect of narrowing the transition interval, should have no appreciable effect on the speed of response at the output terminal. This is verified in Figure 1, which shows the regenerative circuit and the resulting waveforms. The rise and decay times in this plot are the same as those of Figure 2,* where no feedback was used. On the other hand, if the rise and decay times of the input voltage are so long that they, rather than the transient response, control the rate of change of output voltage, the use of positive feedback will give sharper output pulses. Also, the output voltage may be driven through its full range with smaller input voltages when the transition interval is narrowed by the

use of regeneration. Both of these effects are illustrated in Figure 2.

Clipping Performance

Figures 1 and 2* show that the transient build-up time of the clipper output voltage, either with or without regeneration, is approximately 50 millimicroseconds. With a sinusoidal input voltage this clipper should be able to operate reasonably well at frequencies up to 5 mc, the upper limit depending upon the waveform requirements. The

performance of the circuit of Figure 1 as a sine-wave clipper was tested at 5 mc, both with and without regeneration. The input and output voltage waveforms are shown in Figure 2 for various levels of input voltage, with values of 0 and 750 ohms for R_{b1} . It will be noted that with the regenerative circuit the clipper is driven to full output with smaller input voltages, but that the waveform with large (12 volts) input signals is not improved by the addition of feedback.

When large input voltages are used at the higher frequencies some distortion of waveshape may be encountered because of the capacitance between the input grid and the cathode. When the negative half-cycle of the sine wave is supplied to the input grid, tube 1 is cut off at a predetermined level of grid voltage and, according to the theory previously given, the plate current of tube 2 should remain constant until the input voltage again rises to the cutoff point. However, if the input signal is

Figure 3 Circuit used for analysis.

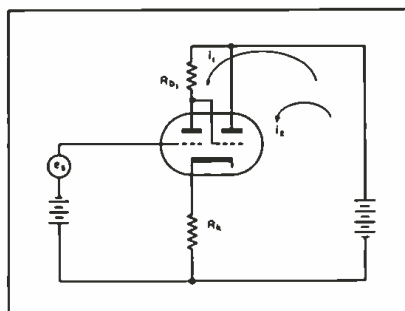

*TELEVISION ENGINEERING, May, 1951.

Metal Cup Ceramic Capacitors

METAL CUP CERAMIC CAPACITORS that are hermetically sealed against atmospheric humidity, have been introduced.

Capacitors are made in 2 basic sizes of metal shells: type B01 to B08 capacitors are $\frac{3}{8}$ " in diameter; type B11 to B18 capacitors are $\frac{15}{16}$ " in diameter. Internally and externally threaded mounting stud designs are available in both groups as are single and double solder lug terminals. Series B01 to B08 capacitors are rated at 500 volts *dc* working while series B11 to B18 capacitors are available in 3 voltage ratings, 500, 1,000, and 1,500 volts *dc* working.—Data available in bulletin No. 603; Herlec Corp., 422 N. 5th St., Milwaukee, Wis.



Herlec metal-cup ceramic capacitors

Hermetically Sealed Standoffs

A HERMETICALLY-SEALED STANDOFF that is said to provide a bypass to ground through the shortest possible path, has been announced. Concentric electrode configuration provides short path by making connection to the outer electrode at the plane of the chassis, which results in a low and uniform series inductance. Both location and length of leads are fixed.

Provided are electrical shielding by means of the grounded metal case. Post terminal provides a tie point for several connections.

For threaded mounting installation. Available in standard capacitance values in 10, 33, 47, 68, 82, 100, 680, 1000 and 1500 mmfd. Voltage rating is 500 volts *dc*.—Style 326; Erie Resistor Corp., Erie, Penna.

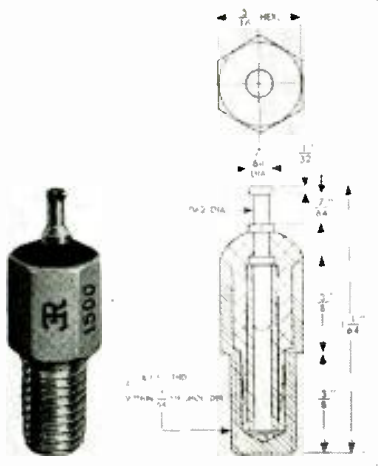

Electrically-Controlled Variable Inductor

A VARIABLE INDUCTOR that is electrically controlled, and variable over a range of 100 to 1 or 200 to 1 has been developed. It is claimed to maintain a high *Q* at high frequencies.

Characteristics are attained by the use of separate control and signal windings, arranged on a ceramic core.

Alternating or direct current variations through the low power control winding produce corresponding variations in the inductance of the unit's signal winding.—Incredutors; C. G. S. Laboratories, Inc., 391 Ludlow St., Stamford, Conn.



C. G. S. Increductor

Flexible Shafts and Couplings

FLEXIBLE SHAFTS AND COUPLINGS, for remote-control and power-drive work, are now available. Shaft, or core, consists of wires wrapped helically in layers, each layer being wound in the opposite direction from the preceding layer.

May be used for focuser control, tuner control, etc.—Kupfrian Manufacturing Co., 545 Prospect Ave., Binghamton, N. Y.

Ion Trap

A UNIFORM-FIELD ION TRAP has been announced. Trap, whose field pattern can be adjusted with one hand, is a beam bender made of one piece, permanently magnetized *Cunife* that can not be put on backwards; requires no manual clamping.—E-Zee-On; The Indiana Steel Products Co., Valparaiso, Ind.

Half-Wave Dipoles

HALF-WAVE DIPOLE ANTENNAS for both transmission and reception have been announced.

Antennas consist of two coaxially arranged elements, each cut to approximately one-quarter wavelength and center fed with 72-ohm transmission line. One element is designated as the whip; the other, the skirt. The skirt folds back over a supporting pipe. Whip and skirt elements terminate in a central supporting member, the grounding plate, at which point the elements are fed at the current loop in a half-wave pattern. The entire assembly is vertically mounted by means of the staff tube. Concealed in the staff is a 72-ohm solid dielectric cable or short length of *aircore* transmission line feeder.—Communication Products Co., Inc., Broadway and Clark St., Keyport, N. J.

Lavite Ferrites

LAVITE FERRITES, a compound of a complex crystalline structure, formed by special treatment of selected metallic oxides, is now available.

It is said to have high permeability and low electrical losses, high saturation, and higher *Q*.

May be used in television circuits (horizontal output transformer cores, permeability tuning cores and deflection yokes), and in *if* transformers.—D. M. Steward Mfg. Co., Chattanooga, Tenn.

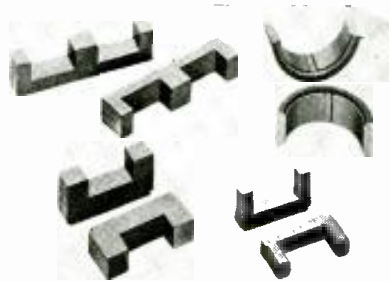

Steward Lavite Ferrites

Thin Electrical Steel

THIN ELECTRICAL STEEL, that it is said can be operated at very high inductions, 20% higher than any nickel-iron alloy, has been developed.

Material is intended for use in wound-type transformers and reactors which operate at 400 cycles. Its minimum permeability at 18 kilogausses is said to be 1800.

Steel is an iron-silicon alloy, with a density of 7.65 grams per cu cm, a volume resistivity of 47 microhm-cm or 282 ohms/mil ft and a lamination factor of 95% solid. Supplied in 4-mil thicknesses and 12 $\frac{3}{8}$ " wide coils.—Tran-Car T-O-S; Armco Steel Corp., Middletown, Ohio.

Self-Insulated Terminals

INTEGRAL, ONE-PIECE ASSEMBLIES combining a metallic portion that grips both the wire and the wire insulation with a single staking operation has been announced. Terminal insulator is of specially-formulated nylon.

Terminals are claimed to feature a longer electrical creepage path, due to built-in air gap between terminal insulator and wire insulation; deep socket for wire insulation; high resistance to heat and chemical attack by oils and solvents.—Self-Insulated Sta-Kon Terminals; The Thomas and Betts Co., Inc., 82 Butler Street, Elizabeth, N. J.



Super-Gain Antennas

(Continued from page 20)

antenna was taken. This required a little different setup than the usual rotation of antenna under test. The overall length of the 12-bay antenna was 88' and the weight 4 tons; thus any simple pedestal on which the antenna could be rotated was just out of the question. For sufficient accuracy of measurement, a tolerance of $\pm 1/8^\circ$ had to be maintained over the critical main lobe and first few minor lobes, imposing additional requirements on the pedestal.

Because of these severe requirements, the antenna was fixed in position upon five-foot horses and the pattern obtained by a series of measurements taken at a fixed radius around the antenna. To have an accurate pattern measurement, it has been found that the pickup device must be located far enough away so that radiation from all sections of the antenna arrive very nearly in phase. Practically, if there is no lag greater than 45° , a sufficient degree of accuracy can be maintained. For a frequency of 200 mc and an antenna length of 88', this represents a 1,600' minimum distance, at which point the pattern may be measured. To take a 180° pattern, a space then, of 1,600' by 3,200' was needed with the added requirement that the area behind the antenna be reflectionless. Further, the area had to be uniformly level, otherwise the pickup would vary. The area finally used was a decommissioned airport, although several pilots did not know seem to be aware of this fact. Before the antenna was taken to the test site, the area was chained and surveyed for angle, and a base line layed out for the antenna. After assembling the two six-bay sections, the site was resurveyed and a slight correction factor used since the antenna was not set perfectly on the base line. (At a 1,600' radius, a 1° arc corresponds to 28'; thus, quite accurate measurements could be made.)

The test oscillator consisted of a modified crystal controlled 50 watt FM communications transmitter, grid modulated at 800 cycles. This reduced the power output to 20 watts at about 75 per cent modulation. Power was supplied by a small 500-watt gas engine generator and the voltage was held constant by a special voltage regulator to insure constant transmitter output. The pickup antenna was a folded dipole matched into a 1/100 amp fuse⁴ used as a bolometer.

⁴Littlefuse.

⁵Terman, F. E., *Radio Engineer's Handbook*.

CORNELL-DUBILIER

and *Faradon**



You can now get the complete line of Faradon* capacitors, made exclusively with Cornell-Dubilier dependability, through all Authorized C-D Distributors.

Write for complete technical data.
Cornell-Dubilier Electric Corporation,
Dept. TV-6, South Plainfield, N. J.



ONSISTENTLY DEPENDABLE
CORNELL-DUBILIER
CAPACITORS

Plants in South Plainfield, N. J.; New Bedford, Worcester, and Cambridge, Mass.; Providence, R. I., Indianapolis, Ind.; Fuquay Springs, N. C.; and subsidiary, The Radiart Corp., Cleveland, Ohio

To increase the pickup, a 60° corner reflector was used, giving a gain of about 13 db compared to the dipole alone. Measured front to back ratio was 35 db, and front-to-side ratio much less. These last factors proved insufficient for later tests.

Antenna gain over a dipole for an omnidirectional antenna with vertical symmetry may be expressed as

$$G = \frac{0.61}{\int_0^{\pi/2} P\theta \cos \theta d\theta} \quad (2)$$

where, $P\theta$ is the relative power pattern and θ is measured from the maximum intensity. In evaluating the integral, ten complete sets of data were taken from -90° to $+90^\circ$. Half of these curves were taken using the east-west radiators and half using the north-south radiators. Measurements were made with the corner reflector pickup antenna mounted on a station wagon at a height of 12' (Figure 4) and driving a station wagon along a semi-circle. The large number of repeat measurements were

(Continued on page 24)

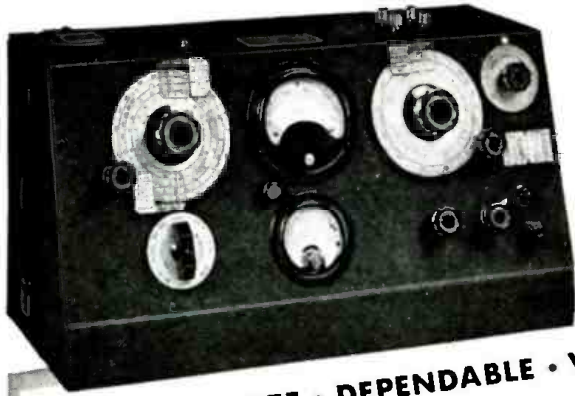

The **Q-METER**
TYPE 160-A

ACCURATE • DEPENDABLE • VERSATILE

For the measurement of Q, inductance, and capacitance, the 160-A Q-Meter is the universal choice of radio and electronics engineers. Its wide frequency coverage from 50 kc. to 75 mc. is an outstanding feature which makes possible the accurate and rapid evaluation of components and insulating materials at the actual operating frequency.

SPECIFICATIONS

OSCILLATOR FREQUENCY RANGE:
50 kc. to 75 mc. 8 self contained ranges.
OSCILLATOR FREQUENCY ACCURACY:
± 1%, 50 kc.-50 mc. ± 3%, 50 mc.-75 mc.
Q-MEASUREMENT RANGE: Directly calibrated in Q, 20-250. "Multiply-Q-By" Meter also at x2.5, extending Q-range to 625.
Q-MEASUREMENT ACCURACY: Approx-

mately 5% for direct reading measurement, for frequencies up to 30 mc. Accuracy less at higher frequencies.
CAPACITANCE CALIBRATION RANGE:
Main capacitor section 30-450 mmf, accuracy 1% or 1 mmf. whichever is greater. Vernier capacitor section ± 3 mmf., zero, -3 mmf. calibrated in 0.1 mmf. steps. Accuracy ± 0.1 mmf.

Write for literature containing further details

BOONTON RADIO

BOONTON, N.J. U.S.A.

Corporation



NO. 1 SOURCE

MILO RADIO



LEADING BRANDS
ELECTRONIC TUBES
and EQUIPMENT
for ALL BROADCAST
and INDUSTRIAL APPLICATIONS
—For IMMEDIATE DELIVERY!

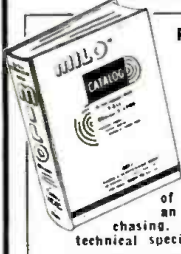

**PURCHASING AGENTS!
CHIEF ENGINEERS!**
Send For This!
**FREE 1053 PAGE
MILO CATALOG!**

Write today on your company letterhead for your copy of our gigantic buying guide — an invaluable aid in your purchasing. Completely illustrated, with technical specifications. Address Dept. TV.

The **NATION'S GREATEST STOCK!**
CONDENSERS • RESISTORS • TRANSFORMERS
CONNECTORS • SWITCHES • RHEOSTATS
RELAYS • PLUGS • JACKS • CHASSIS
TUBES, etc.

★ For PROMPT, PERSONAL ATTENTION
PHONE • WRITE • WIRE—or TELETYPE!

MILO RADIO
& **ELECTRONICS CORP.**

200 GREENWICH STREET, NEW YORK 7, N.Y.
Phone BEekman 3-2980 • Teletype NY1-1839

Remember . . .

They're thinking

TELEVISION

when they're reading

TELEVISION ENGINEERING

Advertising pays dividends!

**WHEN YOU CHANGE
YOUR ADDRESS**

Be sure to notify the Subscription Department of TELEVISION ENGINEERING, 52 Vanderbilt Avenue, New York 17, N. Y., giving the old as well as the new address, and do this at least four weeks in advance. The Post Office Department does not forward magazines unless you pay additional postage, and we cannot duplicate copies mailed to the old address. We ask your cooperation.

(Continued from page 23)

made to average out errors in maintaining correct path for the station wagon.

In taking measurements on the major lobe, from approximately + to - 4°, reflections from a large metal airplane hanger (Figure 5) directly behind the zero line caused erratic readings to be obtained. The waves reflecting off the metallic hanger added to or subtracted from the direct forward traveling wave depending on their phase relationship. Because of the finite front to back and side ratio of the pickup antenna, complete cancellation did not occur, the effects scalloping the major lobe. However, the effects sufficiently distorted the pattern, so a new zero line was determined 24° west, and the antenna shifted accordingly and had to be re-measured over the affected part of the pattern. The average of the readings are shown plotted in Figure 6. (In the Figure 4 plot, shown in the first part of this paper, there appeared the calculated pattern with the chief difference occurring in the nulls.) Mechanically integrating the power curve resulted in a power gain of $G = 14.55$. This figure, however, was not the gain to input terminals, since it did not include the intra-connecting feed-line losses. The actual loss was calculated for the type of feed used, which consisted of 65' of RTMA standard 15/8" copper line and 15.25' of RG 34 U cable; the total was a power loss factor of .872 or final gain figure of 12.7.

Impedance and *vsur* measurements were attempted with the antenna horizontal and ten feet above ground (2 wavelengths). This method did not prove satisfactory because of reflections from the ground. A V shaped counterpoise directly under the antenna greatly reduced reflections but was not of sufficient area or accurate enough to completely reduce ground effects. Final measurements were made with the antenna raised to a vertical position.

The antenna was broken at the field joint and the two sections slipped on one trailer. At the WHAS transmitter site in Louisville, the antenna was re-assembled and the field joint completely welded. Prior to erection, a recheck pressure test, deicer test, and *vsur* on the antenna in horizontal position were made. The antenna was completely painted and then erected by raising through the center of a 521' tower. In this way, no assembly of a critical TV electrical system was necessary on the top of the tower. Final check out and subsequent operation of the antenna disclosed a performance that justified the use of a super-gain antenna.

TeleVision Engineering, June, 1951

Industry Literature

Insulation Manufacturers Corp., 565 West Washington Blvd., Chicago 6, Ill., have published eight bulletins covering heat resistant Class II silicone electrical insulation materials. Described are the uses, advantages, and technical properties of diellex-silicone varnished or glass tubing and sleeving, (250); Incor silicone treated glass tying cord, (400); Macallen silicone bonded mica segment plate, (511); Macallen silicone bonded flexible mica, (527); Dow Corning silastic tape type R, (680); Dow Corning silicone varnished for impregnating, (680A); Vartex silicone resin coated glass cloth and tape, (750); and insulation classes (800).

The Halldorson Co., 4500 Ravenswood Ave., Chicago 40, Ill., has made available a catalog, 19, that lists a line of television transformers, including isolation, stepdown, filament and voltage-regulating types.

Allen B. DuMont Laboratories, Inc., Television Transmitter Division, Clifton, N. J., has prepared two bulletins covering the Acorn 500 watt transmitter, No. TTD-T101, and the Oak 5-kw transmitter, No. TTD-T102.

National Information Committee on Lighting, 1410 Terminal Tower, Cleveland, Ohio, has prepared a 21-page report, *Lighting and the Nation's Welfare*, which describes production, office, protective, public safety and educational lighting.

Polarad Electronics Corp., 100 Metropolitan Ave., Brooklyn 11, N. Y., has issued a 10-page catalog describing laboratory instruments, including a spectrum analyzer, microwave signal sources, video amplifier, and laboratory power supplies.

Phillips Manufacturing Co., 3175 W. Touhy Ave., Chicago, Ill., has published a 21-page handbook detailing vapor degreasing of metal parts.

Punch-Lok Co., 321 N. Justine St., Chicago 7, Ill., has released a 12-page catalog, 300, on the punch-lok method and its applications. Listed are the standard clamps, locking tools, and special fittings available.

International Resistance Co., 401 N. Broad St., Philadelphia 8, Pa., has prepared a 12-page bulletin, B-1, on type BT advanced fixed composition resistors: 1/3, 1/2, 1 and 2 watts. Detailed are the commercial ratings, temperature characteristics, voltage coefficient, humidity, load life and frequency, with charts and graphs.

Synthane Corp., Oaks, Pa., has released a folder covering systems of grade specifications as drawn up by industry and various government agencies for the selection of the proper grade of laminated plastic sheets, tubes and rods. A table includes a description of the grade for each of 28 combinations of form and material for tubes and rod stock.

Hupp Corp., Globe Stamping Division, 1250 W. 76th St., Cleveland 2, Ohio, has published a 12- and a 4-page report on the scope of their metal fabricating service.



HICKOK *new model* **640**
OSCILLOGRAPH

STABLE • VERSATILE
OUTSTANDING RANGE

For Industrial and Electronic Laboratories

The new HICKOK Model 640 Oscilloscope with its exceptional design features and characteristics provides an outstanding versatile instrument for the engineer in observing regular recurring or transient phenomena.

Model 640

Wide Band Amplifier: Frequency response DC, 0 to 4.5 mc. (down 3 db.)

Vertical DC and AC Amplifier: 10 MV per inch with sensitivity switch in high position. 25 MV per inch in low position.

Frequency Response: 0 to 1,000,000 cycles, (3 db point), in high position 0 to 4,500,000 cycles, (3 db point), in low position.

Maximum Input Potential, 1000 volts peak
Input Impedance; 2 megohms, 50 mmf.

Horizontal Amplifier: Deflection Factor—Direct: 20 volts RMS per inch.

Full Gain Setting; 50 millivolts RMS per inch.
Frequency Response; 0 to 200,000 cycles, (3 db down).

Test Signals: Line Frequency, 3 volts RMS per inch.

Sawtooth available from front panel. Direct connection to both horizontal and vertical deflection plates.

Linear Time Base: Recurrent and Driven Sweep; 2 cycles to 30,000 cycles.

Provision for external capacities for slower frequency sweeps of 10 seconds and slower. Sweep Speeds; Faster than 0.75 inch per microsecond.

Television Fixed Frequencies; 30 and 7,875 for observing blanking and sync waveforms in the horizontal and vertical circuits of TV receivers.

Synchronization at line or 2-times line frequency.

"Z" Axis Modulation: Capacitively coupled to the grid of the cathode ray tube. 15 volts will blank trace fully at normal intensity.

Shielded, Shock Mounted, Built-in Calibrating Voltages, Excellent Stability and Expandable Sweep (6 times expansion) are several additional features of this highest quality instrument. Write for further information today. Price \$355. Subject to change without notice.

THE HICKOK ELECTRICAL INSTRUMENT CO.
10528 DUPONT AVENUE • CLEVELAND 8, OHIO

THE STANDARD OF QUALITY FOR OVER 40 YEARS

Sarkes Tarzian, Inc., Bloomington, Ind., have published a report describing their manpower and equipment facilities at their plants in Indiana, Hawthorne, N. J., Philadelphia, Pa., and Batavia, Ill., where tuners, trimmers, metallic rectifiers, and picture tubes are produced.

Sprague Electric Co., North Adams, Mass., has released two engineering bulletins, 103B and 102F, with revised standards for Ceroc 200 and Ceroc T high-temperature magnet wires.

Centralab, 900 E. Keefe Avenue, Milwaukee 1, Wis., has released 11 bulletins on ceramic capacitors, printed electronic circuits and switches.

The Astatic Corp., Conneaut, O., has prepared a catalog (51) describing TV and FM boosters, microphones and stands, phono pickups and cartridges, needles, recording heads and related equipment.

The Heli-Coil Corp., 17-23 Thirty-Fifth Street, Long Island City 1, N. Y., have prepared a 16-page bulletin with design data on helical-wire thread inserts, and the use of these inserts in the protection and repair of tapped holes.

Detail drawings and text are offered to explain how these inserts are used as original manufacturing components to protect tapped threads in aluminum, magnesium, plastics, iron, steel and wood against stripping, wear, corrosion, seizing and galling.

Video Roll-Off Network

A VIDEO ROLL-OFF NETWORK designed to provide the standardized bandwidth required when performing operating measurements, has been developed.

Frequency characteristic is said to provide a 6 db rolloff at 3 mc, with reference to the low frequencies. Circuit said to provide a rise time of approximately 0.175 microsecond without overshoot. Circuit is a three mesh, 73-ohm constant impedance network. Featured is a switch which removes the network and restores the original wide band characteristics of the scope, and in-and-out connectors for inserting the network in the line.—*Type V-103; The Daven Co., 191 Central Ave., Newark 4, N. J.*

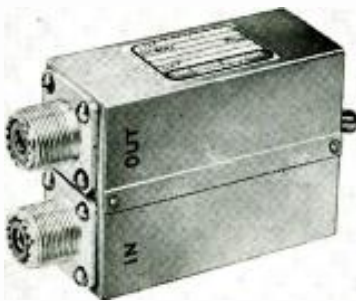

Daven video roll-off network

Waveguide Tuner and High Power Terminations

WAVEGUIDE TUNERS for tuning out discontinuities in high-power systems or tuning systems where low leakage is essential, have been developed. Consists of hybrid waveguide tee with movable contacting shorts placed in both shunt and series arms. Equipment is said to permit the reduction of *vswr's* as high as 20:1 to values of less than 1.02, and is designed for use in tuning out residual *vswr* of loads, antennas, bolometer and crystal mounts. Sizes (type 880A E-2; one model shown below): 3" x 1½", 2" x 1", 1½" x ¾", 1¼" x ¾", 1" x ½", .702" x .391".

Power-dissipating terminations, designed for use as a dummy load for high-power transmitters, in testing vacuum tube characteristics and transmitter output, have also been announced. Rectangular waveguide section contain a high loss material, tapered for low *vswr*.—*HP 912A; Hewlett-Packard Co., 395 Page Mill Rd., Palo Alto, Calif.*



Magnetic Film Recorder and Reproducer

A SYNCHRONOUS magnetic film recorder and reproducer is now available.

Model is said to have a frequency response flat to 9000 cycles at 16-mm speed, or 15,000 cycles at 35-mm speed. Same amplifier and film transport system are used for both 16-mm and 17.5-mm magnetic film. Only the idlers and drive sprockets are changed to accommodate either film.—*Model S5; Stancil-Hoffman Corp., Hollywood, Calif.*

Telejector

A PORTABLE PROJECTION SET is now available. Included is 750-watt, 16-mm motion picture projector, with built-in right angle picture throw, and a fold-away screen. Screen is the same size as the picture tube of a 12½-inch TV receiver and is masked to simulate the exact effect of viewing in the home. Space is provided in the screen compartment for a 1200' reel of 16-mm film. Projector contains own sound track amplifier and loudspeaker.—*Telejector; Audio and Video Products Corp., 1650 Broadway, New York 19, N. Y.*

Microphone Preamp

A MICROPHONE PREAMPLIFIER for use when performers are 6' to 10' from the microphone has been developed. Includes a high gain multiple-shielded transformer that is said to increase the signal-to-noise ratio 10½ db over conventional preamps.

Featured is a single 12AY7, providing two stages of amplification. Unit is built on a plug-in chassis. Weighs 4½ pounds, and is 2¾" x 10¼" x 6 3/16"—*101-BX; Cinema Engineering Co., 1510 W. Verdugo Ave., Burbank, Calif.*

Montage Amplifier

A MONTAGE AMPLIFIER which permits vertical, horizontal and wedge wipes, and preset superpositions, has been announced.

The montage amplifier and control panel allow two-signal self-keyed or three-signal keyed insertions of sponsors' products or advertising material.

To assure proper positioning and picture composition, a locating signal may be fed to the studio camera viewfinder. Horizontal, vertical and wedge wipe action may be stopped at any point.—*Type TV-35-B, TC-34-A; G.E., Syracuse, N. Y.*

Synchronized Sound and Light

A DEVICE that synchronizes sound with light abstractions is now available. A TV camera may be focused on a 20" x 16" translucent screen and the sound supplied by inserting a phono plug. Effects are produced by interweaving distortions of filamentary images from multiple reversible concave mirror systems in color or monochrome.

Unit housing is 24" x 24" x 13" deep. It may also be used for rear projection work.—*Telecon; Musicolor, Inc., 840 North Michigan Ave., Chicago, Ill.*

Random Noise Unit

A MICROWAVE MEGANODE that provides a primary random noise for the L-band, has been announced. May be used for measurement of noise figure, receiver gain and calibration of standard signal source. Specifications are: waveguide, RG-69/U; flange, UG-117/U; noise power output, at 20° C., -15.84 db; and range, 1200 to 1400 mc.—*Kay Electric Co., Pine Brook, N. J.*

Volt-Ohm-Milliammeter

A VOLT-OHM-MILLIAMMETER, 5¾" w x 8¾" h x 2½" d with a 5" lucite meter case, has been announced.

Provides 20,000 ohms-per-volt *dc* and 5000 ohms-per-volt *ac*. Unit features: volts *ac* and *dc*, 2.5, 10, 50, 250, 1000 and 5000; output, 2.5, 10, 50, 250, 1000; milliamperes *dc* 2.5, 10, 50, 250, 1000; microamperes, *dc*, 0 to 50; amperes, *dc*, 0 to 10; *db*, -30 to +55 in 5 ranges; ohms, 0 to 1000 (5-ohm center scale), 0 to 10,000 (50-ohm center scale), 0 to 1 meg (5000-ohm center scale), and 0 to 100 meg (500,000-ohm center scale).—*Hickok Electrical Instrument Co., 10529 Dupont Ave., Cleveland 8, Ohio.*

RF Power Output Test Equipment

RF POWER OUTPUT equipment for testing transmitting tubes has been developed. Tests air-cooled tubes having a power output of between 20 watts and 4000 watts, and at any one of six fixed frequencies, 2.5, 7.5, 15, 20, 30 and 60 mc.

Unit contains separate, variable, regulated power supplies to provide for anode, screen grid and control grid voltages. Anode power supply is said to have a maximum output of 1.5 amperes at 6000 *r* and is said to be regulated within 1% from no load to full load, and at any output voltage down to 200.—*Buck Engineering Co., Inc., 37-41 Marcy St., Freehold, N. J.*

Microwave Test Scope

A FIVE-INCH SCOPE designed especially for microwave installations has been announced.

Has a vertical sensitivity *ac* input of 0.075 volt *rms* per inch. Vertical amplifier frequency response, is claimed to be 20 cycles to 3 mc.

Features a compensated attenuator which it is claimed will attenuate voltages by as much as 1,000 to 1, without frequency discrimination. RC probe provides a high impedance input to prevent loading of the circuit under test.

Output stages of both the horizontal and vertical amplifiers are direct coupled.

Resistance coupling is used and there is no positive slope to the frequency response curve. The response is said to fall off gradually and the slope can be used to view signals containing frequency components up to 7 mc.

Vertical amplifier, sweep, and low-level horizontal stages are supplied with *dc* operating potentials from an electronically-regulated power supply.

To aid in amplitude measurements of voltages under test, a voltage calibrator is included which may be varied in seven steps, from .3 volt to 300 peak-to-peak volts.—*Type ST-2C; G. E. Commercial Equipment Division, Syracuse, N. Y.*

Cosine Yoke

(Continued from page 11)

in tubes 16" and smaller the *pin-cushioning* is not considered serious, since over-scanning the tube slightly makes the effect negligible, but in larger pictures correction of the distortion is necessary.

In one line of chassis¹ using 20.5" rectangular picture tubes, two small permanent bar magnets have been mounted on a ring circling the bell of the picture tube. These magnets correct the pin-cushioning at the top and bottom of the picture by pulling the top and bottom of the picture outward.

Pin-cushioning along the sides has been found to be negligible. The positions of the pin-cushioning correction magnets are illustrated in Figure 6.

Polarity Diplexing

(Continued from page 14)

or vertical axis is exactly parallel to the wave front of the incident wave.

Experimentally, it has been found possible to obtain satisfactory operation¹ through the use of a combination of polarity diplexing and a small frequency separation. It is necessary to shift each transmitter slightly from the normal adjustment; one moved about 3 mc higher in frequency and the other moved 3 mc lower. This has resulted in an effective frequency separation of 6 mc, which, together with the diplexing, provided an effective cross-talk level of -30 db or better and consequently, negligible interference. One station has reported successful operation during the last nine months, using this technique applied to an *stl* circuit.

Clipper Response

(Continued from page 21)

coupled to the cathode through the grid-cathode capacitance, the cathode potential may be decreased somewhat while the input signal swings to its lowest point. As a result, the plate current of tube 2 will tend to increase by a small amount even after tube 1 is cut off, and the output voltage will drop to a lower level than would be predicted from the static theory. This effect is quite evident in the oscillograms for 12 volts input in Figure 2.

Acknowledgement

Credit is due D. L. Oestreicher and S. M. North for constructing the apparatus and performing most of the experimental work for this report. This research project was sponsored jointly by the Office of Naval Research and the U. S. Signal Corps under contract N7 onr-28808 and W36-039-SC-33649, respectively.

TeleVision Engineering, June, 1951

Browning

INSTRUMENTS Engineered for Engineers

SWEEP CALIBRATOR



MODEL GL-22A

A versatile source of timing markers for accurate measurement of sweep intervals with oscilloscopes and synchroscopes.

- Positive or negative markers of 0.1, 1.0, 10, 100 micro-seconds variable to 50 volts.
- Variable width and amplitude gate for blanking or timing.
- Markers from external trigger or internal generator. May be synchronized with triggers up to 100 KC. repetition rate.
- Voltage regulation to timing circuits.

Write for free bulletin.

POWER SUPPLY



MODEL TVN-7

The basic unit of a microwave signal generator. Square-wave modulator for low-powered velocity-modulated tubes.

- Cathode voltage continuously variable 28-480 volts. Provision for 180-300 volt range.
- Reflector voltage range 15-50 volts.
- Provision for grid pulse modulation to 60 volts, reflector pulse modulation to 100 volts.
- Square-wave modulation variable from 600 to 2500 cycles.
- Provision for external modulation.

Write for free bulletin.

LABORATORY AMPLIFIER



MODEL TAA-16

High gain audio amplifier feeding a-c volt-meter for measurement of standing wave ratios with slotted lines.

- 500-5000 cycles with broadband selective control on front panel.
- Sensitivity: Broadband 15-microvolts; selective 10 microvolts.
- Meter scales 0-10 and standing-wave voltage ratio.
- Panel switch for bolometer voltage application.
- Master gain control switch for attenuation factors of 1, 10, and 100.
- Stable electronic power supply.

Write for free bulletin.

FM MODULATION MONITOR



MODEL MD-25

For monitoring modulation of fixed or mobile FM transmitters in bands from 30-162 mc. to comply with FCC limitations of carrier frequency swing and reduce adjacent-channel interference.

- Coverage 30-40, 40-50, 72-76, 152-162 mc.
- Flasher indicates peak modulation (peak carrier deviation).
- Meter indicates peak swings of modulation to 1 kc.
- Sensitivity: signal measurements with approximately 1 millivolt at antenna input.

Write for free bulletin.



BROWNING
Laboratories, Inc.
Winchester, Mass.
ENGINEERED FOR ENGINEERS

In Canada, address
Measurement Engineering Ltd.
Auriprior, Ontario

Group Subscription Plan

You Save Half of the Subscription Price if
Four or More Orders, Including Your Own,
Are Properly Entered on This Form

TELEVISION ENGINEERING

52 Vanderbilt Avenue, New York 17, N. Y.

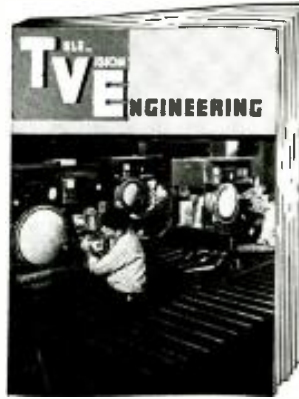

Two years (24 issues) at the rate of \$3.00 each. This rate applies only on 4 or more subscriptions when occupations are given.) Regular cost is \$3.00 for one year.

USE COUPON BELOW

Name

Address

City..... Zone..... State.....

Occupation..... Title.....

Department in which employed

Operation Production Research

Employed by.....

Nature of Business.....

(State if TV Manufacturer, TV Broadcast Station, etc.)

Name

Address

City..... Zone..... State.....

Occupation..... Title.....

Department in which employed

Operation Production Research

Employed by.....

Nature of Business.....

(State if TV Manufacturer, TV Broadcast Station, etc.)

Name

Address

City..... Zone..... State.....

Occupation..... Title.....

Department in which employed

Operation Production Research

Employed by.....

Nature of Business.....

(State if TV Manufacturer, TV Broadcast Station, etc.)

Name

Address

City..... Zone..... State.....

Occupation..... Title.....

Department in which employed

Operation Production Research

Employed by.....

Nature of Business.....

(State if TV Manufacturer, TV Broadcast Station, etc.)

Business or professional classifications are required to complete our records. Each subscriber should write one of the following classifications in space indicated. Use separate sheet of paper for additional names.

CHIEF ENGINEER ENGINEER EXECUTIVE
PURCHASING AGENT DEPARTMENT MANAGER

State your classification if not listed.

This Group Sent in by—

Name

Address

VWOA News

THREE NEW MEMBERS are now on the VWOA roster: Howard S. Pyle, Mercer Island, Washington; A. A. Haas, Mount Vernon, N. Y., and James B. Donohue, Elgin, Ill. Howard began his career back in '17 when he obtained his First Class, First Grade radio-telegraph license, and sailed on the SS Rush in the Seattle-Alaska service. Following that he operated aboard the SS Spokane, with the Marconi W T Company. This assignment was followed by a tour of duty with the U. S. Navy at Tatoosh Island, Washington. He then went aboard the USS Eastern Chief as radio electrician first class and later became chief radio electrician. Following his release from naval duty in June, '19, he signed on the SS City of Seattle with the Marconi W/T, running in the Alaskan service. From this post he was transferred to the coast station at Julian, Alaska. He resigned in September to reenter the navy and was assigned to the naval station NVH in Ketchikan, Alaska, as CRO. From there he moved to NPO, and in Dec. '21, he was discharged with honorable discharge. In '22 he received an appointment as U. S. Radio Inspector III at Detroit. He left this post in '23 to join the SS City of Cleveland on the Lakes and shortly thereafter went to WGO, where he became chief operator. In '26 he resigned this position and moved westward again to follow the sea aboard such ships as the SS Ruth, Dorothy and Emma Alexander. In '35 he started installing radio range and communications stations for the CAA and the U. S. Bureau of Air Commerce. Currently he is with the CAA as an electronics engineer, with headquarters in Seattle. . . . Old timer A. A. Haas began operating in April '21, with IWT and later with Federal Telegraph. During '30 he embarked on a program of developing and manufacturing harbor marine radiotelephone equipment. During War II he was engaged in the manufacture of electronic equipment and at present is still in that business. . . . James B. Donohue started his tour in wireless around February, '26, when he first attended the old radio operators school at 326 Broadway, N. Y. C. After graduating and receiving his license to pound brass, instead of going to sea aboard a merchant vessel, he enlisted in the U. S. Coast Guard as a radioman third class. Spent thirteen years aboard such boats as the SS Illinois, Minnesota and others plying the Mississippi from New Orleans to St. Louis. In '43 he joined the Illinois State Police to continue pounding brass at Elgin, Illinois, where he is living at present.

Tele-Vision Engineering, June, 1951

Miniaturization

(Continued from page 13)

frequency function of the simple *RLC* parallel circuit. For example, a ceramic consisting of two parts of barium titanate may peak to a dielectric constant of approximately 10,000 at a temperature of 30° C and decrease very rapidly as the temperature is either decreased or increased.

To achieve a capacitance which is relatively constant with temperature variations, a number of agencies have utilized a technique which is analogous to stagger tuning the resonant circuits of a broadband amplifier. Specifically, the National Bureau of Standards has fabricated a capacitor of thirty-seven titanate plates, each of which is 0.005" thick. No two of the plates are alike. The ceramic material of each was designed chemically to provide a dielectric constant peak at a particular temperature, so that the composite unit contains peaks at intervals of 5° throughout a range of from -60° C to +120° C.

The success already achieved in the design and production of ceramic capacitors, and the ever-increasing number of ceramic compounds being made available indicate that the ceramic unit will be widely used in future electronics equipment.

Miniaturized Resistance Controls

During research on methods and materials which might be used on ultra-small variable resistors, it was found that inorganic substances were quite effective for applications where maximum stability and high operating temperatures are required. One manufacturer[†] found that the silicones were excellent for this purpose. As a result, he was able to produce a series of tiny units ($\frac{3}{4}$ " diameter) in resistance ranges from 250 ohms to 10 megohms. Specifically, these resistors feature the use of silicone Fiberglass, with the resistance element designed to withstand high temperatures constantly encountered in aircraft and similar applications. The control, developed especially for the military, has been found to remain stable during severe temperature and humidity changes.

The features of this control have also been included in a larger-size unit,^{††} $1\frac{1}{8}$ " in diameter. Also available in ranges from 250 ohms to 10 megohms, it is usable in equipment subject to wide changes in temperature and humidity.

[†]Chicago Telephone Supply Corp., CTS 65.
^{††}CTS 95.



The Finest of Laminated Materials . . .

We are providing manufacturers with a complete line of precious metals laminated to non-precious base metals made to their exact specifications within the following limitations:

SHEET STOCK: Maximum width—5"
Minimum width— $\frac{1}{4}$ "
Thickness—down to .003"

TUBING: Maximum diameter 1" x .050" wall

WIRE: All sizes down to .0045" diameter also squares, rectangular and odd shapes.

In addition to laminated materials we also furnish alloyed gold and silver in sheet, wire or tubing form.

The many varied applications of our materials cannot be listed here, but you are cordially invited to inquire for information regarding your requirements.



The Home of IMPROVED Service

The IMPROVED SEAMLESS WIRE COMPANY
INCORPORATED 1898
775 Eddy Street, Providence 5, Rhode Island

for
SPECIAL
insulation
problems of
Polyethylene
AND **Vinyl**

... we offer our facilities for special compounds, special design, extrusion and fabrication. Consult:

GERING
PRODUCTS
INC.

Extruded Products Div.

Pioneers in Electronic Insulation
DEPT. TV
KENILWORTH, N. J.

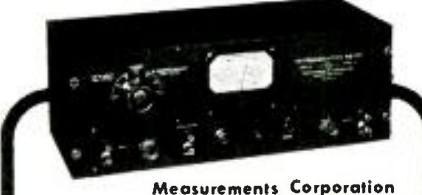

Measurements Corporation
MODEL 31

INTERMODULATION METER

- Completely Self-Contained
- Direct Reading For Rapid, Accurate Measurements

To insure peak performance from all audio systems; for correct adjustment and maintenance of AM and FM receivers and transmitters; checking linearity of film and disc recordings and reproductions; checking phonograph pickups and recording styli; adjusting bias in tape recordings, etc.

The generator section produces the mixed low and high frequency signal required for intermodulation testing. A direct-reading meter measures the input to the analyzer section and indicates the percentage of intermodulation.

MEASUREMENTS CORPORATION
BOONTON NEW JERSEY

FIELD TESTED Installation Information on



**TV
and
FM**

RECEIVING ANTENNAS

TV... FM Antenna Installation

by **Ira Kamen**
TV Consultant
and **Lewis Winner**

Editorial Director,
Bryan Davis Pub. Co., Inc.;
Editor, Service and TeleVision Engineering

The only practical book on the all-important item in TV and FM reception... based entirely on actual experiences in the most active TV and FM areas in the country.

Over 35,000 words of vital data with over 130 photos and drawings.

Ten chapters covering:

Installation Tools
Antenna Installation Procedures
Securing 12-Channel Coverage
HF Antenna Installations
TV Interference
Fringe Reception
Master Antenna Systems
FM Antennas
Installation Business Practices
Tricks of the Trade

The first book in which you'll find complete design and installation information on every type of TV and FM receiving antenna.

Contains detailed illustration and subject index for rapid reference.

Available direct or through your distributor **\$2.00**
Postpaid
Send coupon below to your distributor or direct to:

Bryan Davis Publishing Co., Inc.
(Book Dept.)
52 Vanderbilt Avenue, N.Y. 17, N.Y.

Please send me a copy of "TV-FM Antenna Installation," postpaid, for which I am enclosing \$2.00.

(Please Print)

NAME

ADDRESS

CITY AND STATE

TV Safety

(Continued from page 15)

but may shatter the tube or bring the arm in reach of high-voltage circuits. Power should always be turned off before removing larger-type tubes. Third-degree burns can result by accidentally coming in contact with a soldering iron or a source of high voltage.

First Aid Treatment: For a *first-degree* burn, involving only reddened or inflamed skin, baking soda or Unguentine should be applied. For a *second-degree* burn, where the skin is blistered, baking soda, a wet compress, tannic acid jelly, foille jelly, olive oil, or tea can be applied. For *third-degree* burns, where the flesh is charred, baking soda, a wet compress, tannic acid or foille spray *only* should be used. It may be necessary to treat the victim for severe shock. He should be kept as relaxed, warm and comfortable as possible until the doctor arrives.

Cuts from Flying Glass

Safety Precautions: The ordinary 10-inch picture tube has an implosive force of approximately 2½ tons; larger tubes have considerably more. Serious and sometimes permanent injury can result when a tube shatters because of a mechanical defect or rough handling. Serious cuts can also be obtained when smaller tubes break or shatter when being forced from their sockets.

There are five rules which will reduce the chance of injury when handling picture tubes:

(1) When installing or removing a picture tube, goggles should be worn to protect your eyes. An accidental implosion could cause permanent loss of one or both. (Canvas gloves also are recommended.)

(2) When lifting or carrying the tube, the main weight should be supported by the hell, not by the stem.

(3) Tubes should never be placed on a work bench or floor where they may be kicked or where tools may be dropped against them. They should be placed bulb-end down on the bench. A layer of Kimpack or soft cloth should be inserted between the face of the tube and the bench top. No foreign or metallic particles should be present; they can scratch the face.

(4) Idle or unused tubes should be parked in their proper cartons and placed in the storage room or in a safe part of the shop.

(5) Before discarding old picture tubes, they should be placed in the carton, fully packed, with only the tube socket protruding. A hole should be drilled in the center of the tube socket

and the tip of the seal broken with a pair of long-nose pliers. This admits air slowly and prevents an implosion. Or, the old tube can be sealed in its shipping carton and a crowbar driven through the top of the container. (The tube can also be disposed of by using a metal ash can with a plunger operated through the top.)

Treatment: Minor cuts and lacerations should be treated normally, cleansing the wound with alcohol and using medicated bandages. Excessive bleeding should be checked with pressure (tourniquet or similar method) until the doctor arrives.

Hazards in Remote Gear Setups

TV remote crews often use aluminum ladders to set up remote equipment, string coax cable, mount microwave gear, etc. Extreme caution must be exercised in placing and moving these ladders to prevent their coming in contact with *any* electrical power line. The same precautions must be observed when working with or mounting microwave equipment on tall metal flood-light towers, building parapets, and other locations where overhead or exposed power lines are present.

Credits

The author should like to thank RCA, DuMont, and Capelhart-Farnsworth for material assistance in the preparation of this article.

ADVERTISERS IN THIS ISSUE

TELEVISION ENGINEERING
JUNE, 1951

THE BIRTCHE CORPORATION.....	31
Agency: Crossley & Jeffries, Inc.	
BOONTON RADIO CORP.....	24
Agency: Frederick Smith	
BROWNING LABORATORIES, INC.....	27
Agency: Engineered Advertising	
CHICAGO TELEPHONE SUPPLY CORP.....	16, 17
Agency: Hurton Browne, Advertising	
CORNELL-DUBILIER ELECTRIC CORP.....	23
Agency: Relss Advertising, Inc.	
ALLEN B. DU MONT LABORATORIES, INC.	Back Cover
Agency: Austin C. Lescauroua & Staff	
GERING PRODUCTS, INC.....	29
Agency: Ira S. Kahn Co.	
GUARDIAN ELECTRIC.....	31
Agency: Kennedy & Co.	
HICKOK ELECTRICAL INSTRUMENT CO.....	25
Agency: The White Adv. Co.	
IMPROVED SEAMLESS WIRE CO.....	29
Agency: Knight & Gilbert, Inc.	
MEASUREMENTS CORPORATION.....	29
Agency: Frederick Smith	
MILO RADIO & ELECTRONICS CORP.....	24
Agency: H. W. Hauptman Co.	
SPRAGUE ELECTRIC CO.....	Inside Front Cover
Agency: The H. P. Bridge Co.	
STACKPOLE CARBON CO.....	Inside Back Cover
Agency: The H. P. Bridge Co.	
U. S. TREASURY DEPT.....	2
WELLS SALES, INC.....	32
Agency: Turner Adv. Agency	

THIS IS IT! THE RELAY

WITH *Interchangeable Coil*
FOR A WIDE RANGE OF RADIO APPLICATIONS

GUARDIAN Series 200 Interchangeable

COIL and CONTACT

Switch Assembly

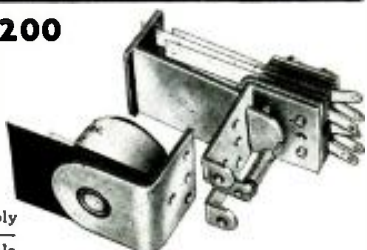

Two basic parts—a coil assembly and a contact switch assembly—comprise this simple, yet versatile relay. The coil assembly consists of the coil and field piece. The contact assembly consists of switch blades, armature, return spring and mounting bracket. The new Guardian Midget Contact Assembly which is interchangeable with the Standard Series 200 coil assembly, is also available in either single pole, double throw; or double pole, double throw.

CONTACT SWITCH ASSEMBLIES

Cat. No.	Type	Combination	
		Single Pole Double Pole	Double Throw Double Throw
200-1	Standard		
200-2	Standard		
200-3	Contact Switch Parts Kit		
200-4	Standard	Double Pole	Double Throw
200-M1	Midget	Single Pole	Double Throw
200-M2	Midget	Double Pole	Double Throw
200-M3	Midget Contact Switch Parts Kit		

13 COIL ASSEMBLIES

A.C. COILS*		D.C. COILS	
Cat. No.	Volts	Cat. No.	Volts
200-6A	6 A.C.	200-6D	6 D.C.
200-12A	12 A.C.	200-12D	12 D.C.
200-24A	24 A.C.	200-24D	24 D.C.
200-115A	115 A.C.	200-32D	32 D.C.
		200-110D	110 D.C.
		200-5000D	

*All A.C. coils available in 25 and 60 cycles

GUARDIAN ELECTRIC

1615-G W. WALNUT STREET CHICAGO 12, ILLINOIS

A COMPLETE LINE OF RELAYS SERVING AMERICAN INDUSTRY

New BIRTCHEr TUBE CLAMP FOR MINIATURE TUBES

POSITIVE PROTECTION AGAINST LATERAL AND VERTICAL SHOCK!



The *New Birtcher Type 2 Tube Clamp* holds miniature tubes in their sockets under the most demanding conditions of vibration, impact and climate. Made of stainless steel and weighing less than 1/2 ounce, this *New clamp* for miniature tubes is easy to apply, sure in effect. The base is keyed to the chassis by a single machine screw or rivet . . . saving time in assembly and preventing rotation. There are no separate parts to drop or lose during assembly or

during use. *Birtcher Tube Clamp Type 2* is all one piece and requires no welding, brazing or soldering at any point.

If you use miniature tubes, protect them against lateral and vertical shock with the *Birtcher Tube Clamp (Type 2)*. Write for sample and literature!

Builder of millions of stainless steel locking Type Tube Clamps for hundreds of electronic manufacturers.

The BIRTCHEr Corporation

2027 HUNTINGTON DRIVE • LOS ANGELES 32

Over 5000 ENGINEERING RESEARCH projects, representing annual expenditures of over \$50-million, are now active in the engineering schools of the country, according to a report published in the '51 edition of the *Review of Current Research*, published by the Engineering College Research Council of the American Society for Engineering Education. Copies of the publication, at \$2.25 each, are available from the secretary of the council at Room 7-204, 777 Massachusetts Ave., Cambridge 39, Mass. . . . Sprague Electric has purchased part of the main plant of the former Holden-Leonard woolen mill in Bennington, Vermont, to manufacture high-temperature magnet wire of the *Ceroc 200* and *T* types. . . . A vest pocket TV tube selector, listing more than 100 TV picture tube types, has been published by Sylvania Electric. . . . *Ideco*, division of the Dresser Equipment Co., Dallas, Texas, is now building a pair of towers, 1017' and 1057' high, for WTMJ and WBEN. The WTMJ tower will accommodate an 11-bay TV antenna, as well as microwave discs. . . . A picture-tube instrument-bonus-program campaign has been inaugurated by Thomas Electronics, Inc. The plan provides for certificates to those purchasing picture

Briefly Speaking . . .

tubes, which are redeemable in part or as complete payment, for Simpson *ac-dc* volt-ohm-milliammeters. . . . Robert B. Dome's book, *Television Principles*, will be published by McGraw-Hill. . . . Du-Co Ceramics Co., Saxonburg, Pa., have tripled their production facilities for the mixing, pressing, extruding, drying, firing and machining of cera-

At a recent meeting of the Sales Managers' Association of Philadelphia, where the Howard G. Ford award plaque, for outstanding contributions to improvement in distribution, was presented to Sylvania Electric. Left to right: Richard H. DeMott, chairman and president, SKF Industries, Inc., and president of the Sales Managers' Association; Robert H. Bishop, vice president in charge of Sylvania sales; D. A. Prouty, chairman of the Howard G. Ford Award Committee; Don G. Mitchell, Sylvania proxy, who accepted the award; Howard G. Ford, founder of the Ford Award; and Max F. Balcom, Sylvania board chairman.



mic parts. . . . The products formerly produced by the Helder Metal Products Corp. are now being made by the Helder Manufacturing Co., division of Helder Bushing and Terminal Co., Inc., 225 Bloomfield Ave., Bloomfield, N. J. . . . A 112-page book detailing time study, motion economy, methods, plant layout, materials handling, wage incentives, maintenance, and human relations, has been published by the Industrial Management Society, 35 E. Wacker Dr., Chicago 1, Ill. The book contains the complete transcripts of the talks delivered at the 14th annual time and motion study and management clinic sponsored by the society. . . . The government service division of the RCA Service Co. recently demonstrated before the military a series of developments, including color television. . . . Milo Radio and Electronics Corp., 200 Greenwich St., New York 7, N. Y., are now distributors of the Westinghouse line of industrial tubes. . . . The Jensen trade name, *bass-reflex*, has become a public domain phrase, according to an announcement from the manufacturer. . . . Haydu Brothers Co. have received three prime contracts from the Signal Corps for special purpose receiving and transmitting tubes.

SEGMENTED DEFLECTION YOKE CORES



This popular 4-segment design is highly efficient. It is easy to handle in TV production work and assures a minimum of breakage. 2-segment types are also available.

STACKPOLE *Ceramag*® ... THE CERAMIC CORES THAT SET THE QUALITY STANDARDS

The tremendous advance in the use of metallic oxide (non-metallic) cores has been due in large part to Stackpole powder molding experience which paved the way to fully dependable units in production quantities. Stackpole Ceramag Cores assure lower losses with higher operating efficiency, lower operating temperatures, lighter weight, smaller sizes, maximum permeability, less corona effect and minimum cost. Ceramag cores are made in two grades for high and low flux densities.

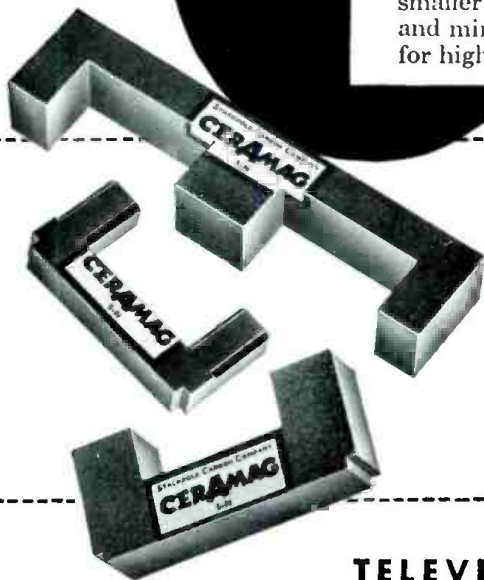

"U" and "E" CORES FOR FLYBACK TRANSFORMERS

Permeability of these Stackpole Ceramag Cores is of the order of 10 to 1 by comparison with conventional iron cores. They are materially smaller, have higher resistance and operate much cooler due to the absence of eddy current losses. Many special types are regularly produced.

TELEVISION IMAGE W-I-D-T-H CONTROL TYPES

These Stackpole Ceramag Cores assure remarkably higher standards of efficiency for TV horizontal image deflection circuits. In areas where there is a low line voltage, they give ratios of from 1 to 8 or more compared with 1-5 for previous high permeability types.

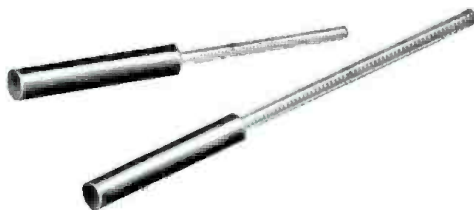

Electronic Components Division

STACKPOLE CARBON COMPANY, St. Marys, Pa.

~~FOCUSING CONTROLS,
COILS, OR P.M. FOCUSERS~~

the new **DUMONT**
AUTOMATIC-FOCUS
Teletron

**Completely
Eliminates-**

- FOCUSING COIL
- FOCUSING CONTROLS
- MECHANICAL FOCUSING DEVICES



Provides-

- AUTOMATIC FOCUSING AT ALL TIMES
- FINE OVERALL FOCUS
- RECTANGULARS WHETHER ELECTROSTATIC OR ELECTROMAGNETIC

Available soon in other sizes

DUMONT *Teletrons**

FOR COMPLETE TECHNICAL INFORMATION — WRITE:

TUBE DIVISION — ALLEN B. DU MONT LABORATORIES, INC., CLIFTON, N. J.

*Trade-mark.