

TELEVISION ENGINEERING

F. J. Jones

JULY, 1950

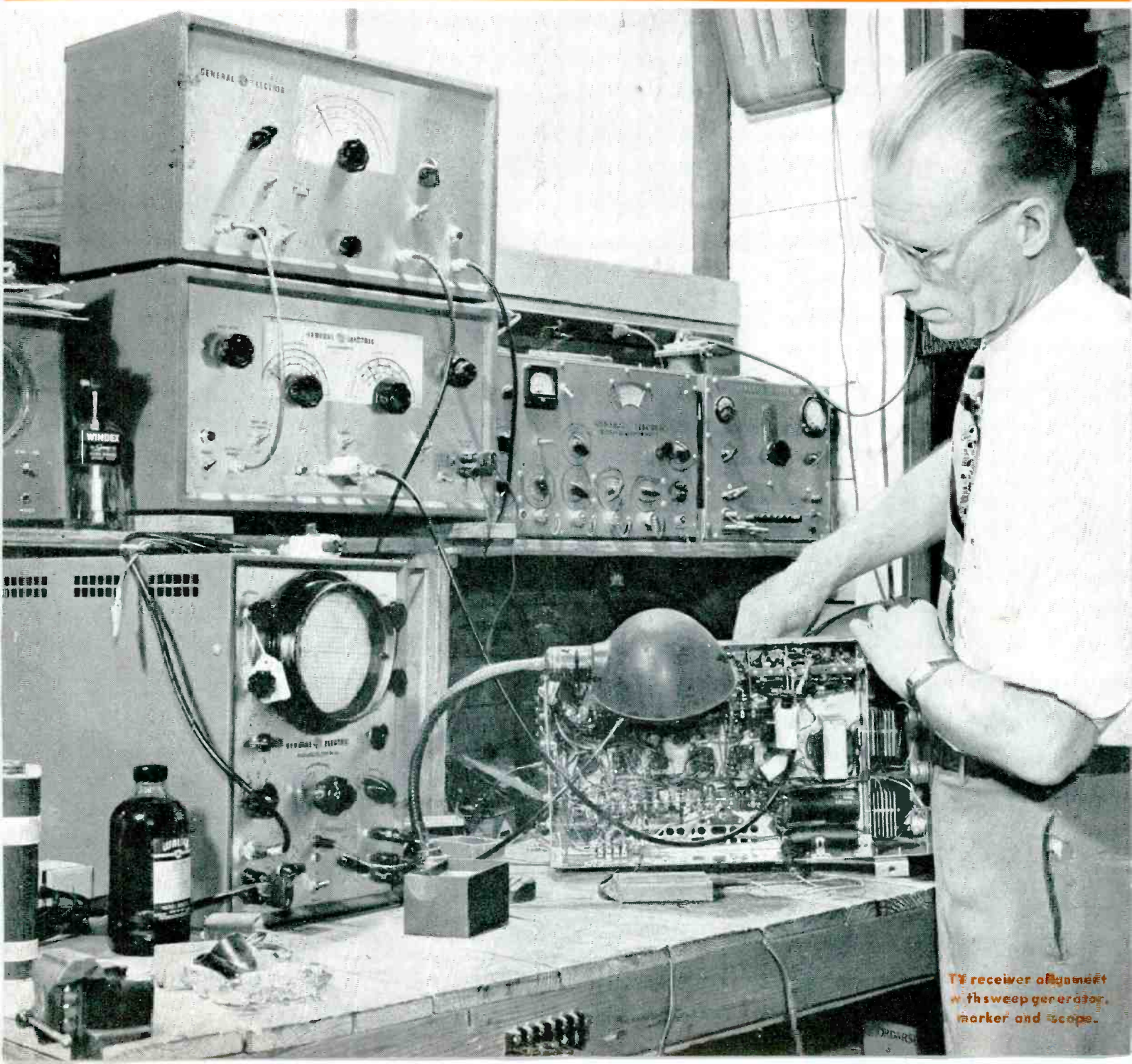

TV receiver alignment with sweep generator, marker and scope.

Another successful start with **DU MONT**

WHBF-TV

ROCK ISLAND, ILLINOIS

Channel 4

Another Television station with an eye to the future! WHBF-TV now goes on the air with Du Mont equipment assuring dependable, economical operation with all the advantages of the Du Mont "Grow As You Earn" system of equipment expansion. Air-cooled tubes, finest TV transmitter engineering and quality workmanship stand for low-operating expense characteristic of Du Mont TV transmitting equipment.

WHBF-TV operates on Channel 4 in Rock Island, Ill., covering the Quad Cities Area. We take this opportunity to congratulate WHBF-TV and welcome it to the ranks of the ever-increasing commercial TV stations of America.

Remember, it's smart business to investigate Du Mont first — and then compare.



DU MONT

First with the Finest in Television

TELEVISION ENGINEERING

Including Radio Engineering, Communications and Broadcast Engineering. Registered U. S. Patent Office.
Research . . . Design . . . Production . . . Instrumentation . . . Operation

VOLUME 1

JULY, 1950

NUMBER 7

A VHF Match Meter.....	<i>Peter G. Sulzer</i>	4
Instrument for 10 to 250-Mc Indicates Magnitude of Reflection Coefficient of an Impedance.		
Simplified Methods for the Calculation of H and T Attenuation Pads.....	<i>Charles J. Leipert</i>	7
Attenuation Pad Table System for 1 to 46 db Permits Rapid Determination of Values of Nets		
Optics in TV Receiver Projection.....	<i>David T. Armstrong</i>	8
Review of Systems, Including Plastic Assembly Using Spherical-Mirror Corrector-Lens Arrangement.		
TV Tube Developments.....		11
Circuitry for Wide-Angle, Short-Metal 16GP4 Which Features Reduced Power Input for Both Horizontal and Vertical Deflection.		
Bandspreading and Scale Equalization for RC Tuning Networks.....	<i>C. F. Van L. Weiland</i>	12
New Approach, Using Continuous Selector-Type Circuit, Affords Elongation of Scales by Three Times.		
Quality Control-Limit Charting Techniques.....	<i>L. Lutzker</i>	16
Use of Statistical Tables Determines Proper Limits Which Should Be Placed on Control Charts for Defects.		
An Analysis of Single and Double Sideband Transmission.....	<i>G. Edward Hamilton and R. G. Artman</i>	22
Graphical Study of Double and Single Methods as Applied to TV Transmission.		

MONTHLY FEATURES

Viewpoints.....	<i>Lewis Winner</i>	3
TV Tube Developments.....		11
Production Aids.....		18
Instrument News.....		21
Personals.....		29
Veteran Wireless Operators' Association News.....		30
Industry Literature.....		31
Briefly Speaking.....		32
Advertising Index.....		32

Cover Illustration

A laboratory TV receiver alignment setup using a sweep generator, marker and 'scope.
(Courtesy General Electric)

Editor: LEWIS WINNER



Published monthly by Bryan Davis Publishing Co., Inc., 52 Vanderbilt Avenue, New York 17, N. Y. Telephone: MURRAY Hill 4-0170.



Bryan S. Davis, President. Paul S. Weil, Vice-Pres.-Gen. Mgr. Lewis Winner, Editorial Director. F. Walen, Secretary. A. Goebel, Circulation Manager.

Mid-West Representative: Stuart J. Osten, 333 N. Michigan Ave., Chicago 1, Illinois. Telephone: Dearborn 2-3507
 Eastern Representative: I. I. Brookman, 52 Vanderbilt Avenue, New York 17, N. Y.
 East-Central Representative: James C. Munn, 2253 Delaware Drive, Cleveland 6, Ohio. Telephone: ERview 1-1726.
 Pacific Coast Representative: Brand & Brand, 1052 West 6th Street, Los Angeles 14, Cal. Telephone: Michigan 1732.
 Suite 1204, Russ Building, San Francisco 4, Cal. Telephone: SUTter 1-2251.

Reentered as second-class matter February 7, 1950 at the Post Office at New York, N. Y., under the act of March 3, 1879. Subscription Price: \$3.00 per year in the United States of America and Canada; 50c per copy. \$4.00 per year in foreign countries; 60c per copy.

The Aro Book Depot: Wellington, New Zealand. McGill's Agency: Melbourne, Australia.

TELEVISION ENGINEERING is indexed in the Engineering Index.

Entire Contents Copyright 1950, Bryan Davis Publishing Co., Inc.

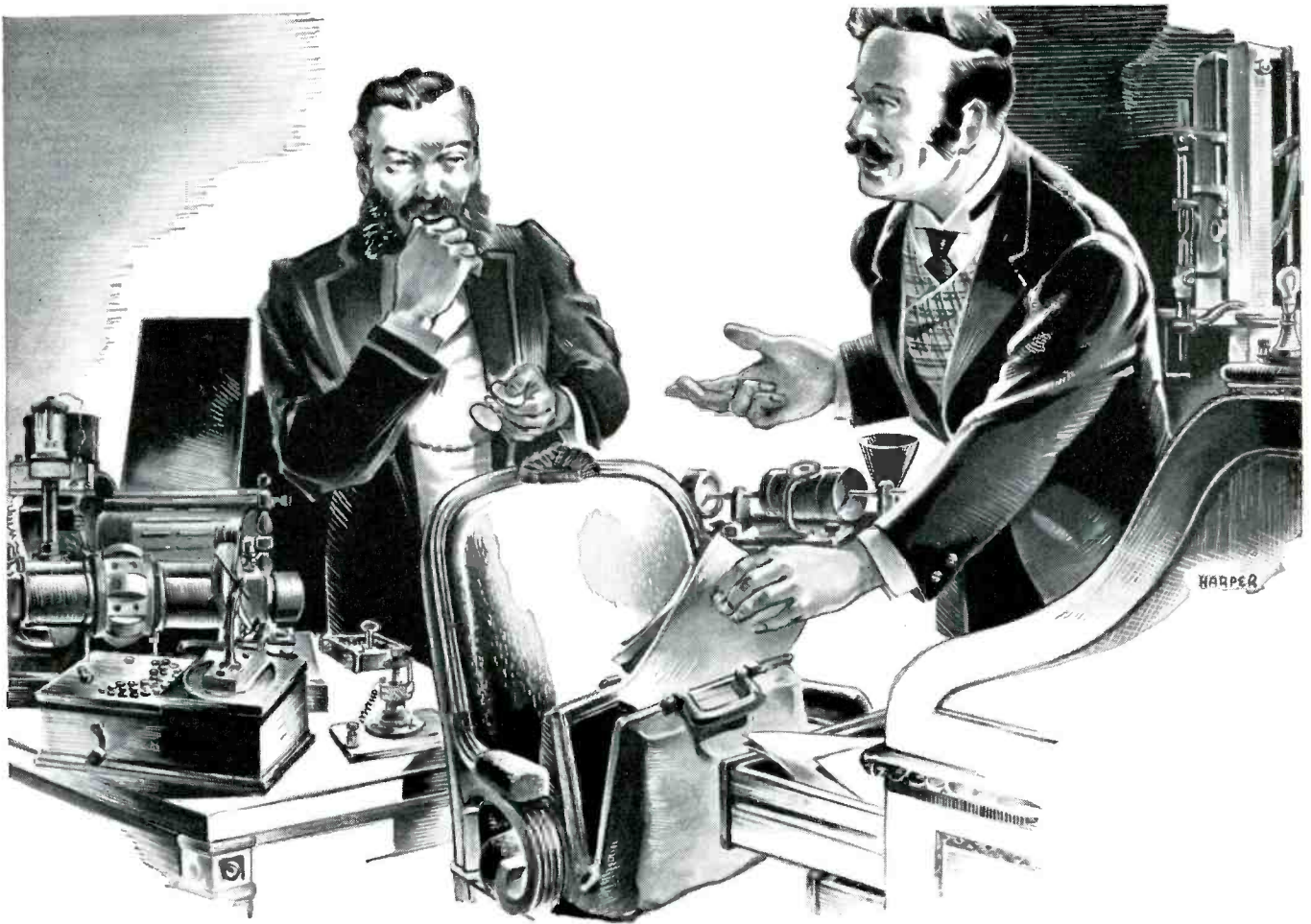

The mistaken young man who quit the patent office . . .

Back in the 1880's, a young man quit the patent office. It was a perfectly good job except for one thing: There wasn't any future in it. You could, as he explained, walk through the place and see for yourself that just about every possible thing had been invented.

He was, of course, just as wrong then as he would be today almost seventy years later. In a world where nothing is impos-

sible and many things are still unknown, progress is limited largely by lack of imagination.

In electronics alone, a "normal" quarter of a century's development has been crowded into the past half dozen years. And patent requirements of this single industry probably equal the total work of the patent office when this mistaken young fellow resigned.

SPRAGUE

SPRAGUE ELECTRIC COMPANY
North Adams Massachusetts

PIONEERS IN

ELECTRIC AND ELECTRONIC DEVELOPMENT

Sprague Telecaps*, the first truly practical phenolic molded paper tubulars, introduced a new era in trouble-free small capacitor performance, whether under "normal" or exceptionally difficult operating or "shelf" conditions.

*T.M. registered

Revolutionary new dry electrolytic capacitors to match television's exacting needs are another Sprague pioneering development. Conservatively rated up to 450 volts at 85°C., these long-life electrolytics are outstandingly stable.



Sprague Subminiature Paper Capacitors, hermetically sealed in metal cases with glass-to-metal solder-seal terminals, are designed to be as good as, and often better than, larger units.



TELEVISION ENGINEERING

LEWIS WINNER, Editor

July, 1950

Ultrahigh Coverage

IN EVALUATING THE RANGE possibilities of the ultrahighs, it has been found necessary to chart very carefully the obstruction or hill results, for the shadow effect has been found quite serious. In studying this condition during terrain tests at Bridgeport, with KC2XAX, the NBC 529-535 mc 1-kw unit as the transmitting medium, field observers have found that where the veryhighs may provide adequate service to about 95% of the locations within the normal service area, ultrahigh variables can pull the coverage down to 75% or less. The field studies have also revealed that foliage must be considered, too, in the ultrahigh reception picture. Tests in Bridgeport disclosed that in many locations where foliage became heavy, signals began to drop.

Thus far, the ultrahighs have been found to provide a more reliable service in the flat areas, while results in the hilly spots have been often unpredictable.

Many have become quite concerned about these problems, feeling that these straight-line peculiarities will interfere seriously with wide-scale acceptable coverage. The boys are also disturbed about the enormous powers that appear to be required to spread the signals around effectively. One group has become so perturbed about this situation that they are suggesting the use of other regions in the veryhigh bands as a possible substitute for the proposed ultrahigh scheme. There is one band that the government controls, this group has revealed, that would be ideal for the program. This is the band between 216 and 328 mc, which has possibilities for 17 channels. According to those who have investigated the present uses of this band, neither the military nor the civil groups, to which the band has been assigned, would suffer at all, if the channels were released for TV use.

The FCC is aware of this condition and it is hoped that it will be possible to release the band and thus provide what appears to be an effective solution to a thorny problem.

World-Wide Scanning

WITH TV now on its way to becoming quite a project in many countries throughout the world, the question of line-age has become significantly vital. In an effort to simplify and provide an answer to universal scanning possibilities, it has been proposed that 15,700 be established as a common line-scan frequency, with tolerances to be fixed.

The proposals, offered by Balth. van der Pol, director of the International Radio Consultative Committee, stated that the new suggested standard would permit a single world system of television, providing a workable compromise between the 525-line 30-frame system used in

this country and the 625-line 25-frame standard fostered by most European countries.

The new line-frequency concept has been looked on favorably by the U.S. reps on the CCIR group.

It is expected that the early months of '51 may witness a decision on this important point.

Acoustic Materials

IN TV STUDIO design work, application of acoustic materials, particularly for those large movable areas, have been receiving especially close attention.

Exceptionally active in this field has been the Bureau of Standards, who since the earliest days of the acoustic materials industry, have conducted an extensive program of research and development involving all phases of architectural acoustics. This work has included the measurement of sound absorption and transmission for a wide variety of materials, the development of new types of sound-isolating structures, theoretical and experimental studies of sound absorption and transmission processes and the development of new instruments and techniques for acoustic measurements.

Recently, a review of some of the results of these new studies has been compiled and published in official letter circulars. In the latest issue of the Bureau's *Technical News Bulletin*, some of these facts have been presented. Offered, for instance, are data on currently available sound absorption processes, types of acoustic materials, prefabricated materials, acoustic plasters, sprayed-on materials, baffles, paintability, reverberation chambers, etc.

Here is a valuable assortment of information which should become a library favorite of many.

The Heaviside Centennial

IN THE WORLD OF SCIENCE, there has been one whose remarkable achievements have stirred everyone and will probably continue to do so forever.

His bold, monumental essays have become classics and the bases of a myriad of projects in the video and sound arts. This year, his centennial anniversary is being celebrated, and in tribute a new edition of his outstanding work . . . *Electromagnetic Theory* . . . has been published, a work in which appears words and words of scientific wisdom.

The reading of these scintillating manuscripts for the first time, or even as a repeat, will be found immensely rewarding and revealing. For in these papers, there will be found basic concepts which are truly brilliant and which, everyone agrees, have contributed so much to our progress in all facets of living.

To that scientist, *Oliver Heaviside*, the world is truly indebted.—L.W.

A VHF

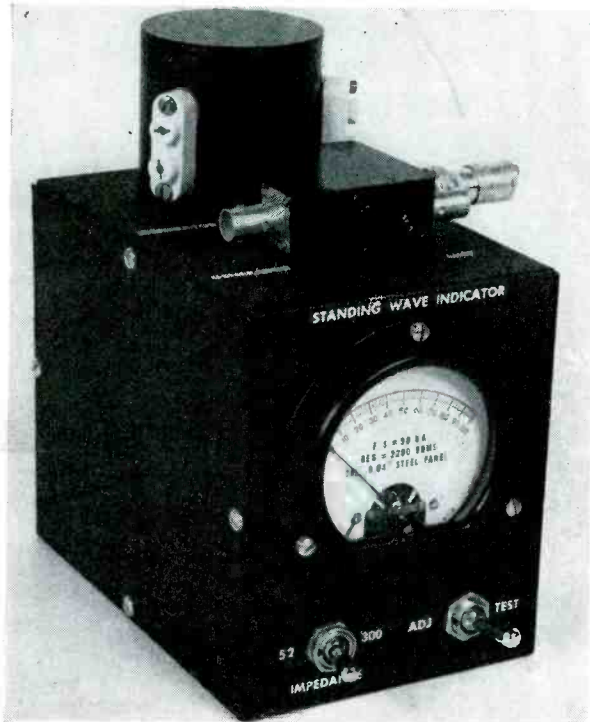

View of the vhf match meter

IN ADJUSTING antenna systems, or receiver and transmitter coupling circuits, it is frequently required to measure the match obtained to a given transmission-line impedance. This is particularly true with television equipment, where reflections must be minimized. Although such measurements can be made with a slotted line, the equipment is bulky at *vhi*, and requires a considerable amount of manipulation. Thus some form of compact, direct-reading match meter is desirable.

Theory

The conditions sufficient for the use of a network as a match meter have been derived by Korman.¹ Briefly,

these are: (1) the network will produce a null when terminated in \bar{Z}_0 , the impedance with respect to which measurements are being made; (2) the impedance \bar{Z}_0 will be seen looking back into the test terminals; and (3), the network will be linear, bilateral, and passive. One network meeting these requirements, the Wheatstone bridge, is shown in Figure 1(a).

To show that the bridge will indicate reflection coefficient, the bridge-unbalance voltage \bar{V} (a vector quantity) can be written in terms of a constant generator voltage \bar{V}_g and the load voltage \bar{V}_l .

$$\bar{V} = \bar{V}_1 - \frac{\bar{V}_g}{2} = \frac{\bar{V}_g}{2} \frac{\bar{Z}_1 - \bar{Z}_0}{\bar{Z}_1 + \bar{Z}_0} \quad (1)$$

If we let $\frac{\bar{V}_g}{2} = \bar{V}_b$, where \bar{V}_b is the bridge-unbalance voltage when $\bar{Z}_1 = 0$ or ∞ , then

$$\frac{\bar{V}}{\bar{V}_b} = \frac{\bar{Z}_1 - \bar{Z}_0}{\bar{Z}_1 + \bar{Z}_0} = \bar{\rho} \quad (2)$$

where $\bar{\rho}$ is the reflection coefficient of \bar{Z}_1 . If the voltmeter is not sensitive to phase, as is usually the case, then

$$|\bar{\rho}| = \frac{\bar{V}}{\bar{V}_b} \quad (3)$$

If the voltage-standing-wave ratio S is desired, one can employ the relation

$$S = \frac{1 + \bar{\rho}}{1 - \bar{\rho}} = \frac{1 + \frac{\bar{V}}{\bar{V}_b}}{1 - \frac{\bar{V}}{\bar{V}_b}}$$

It will be noted from (3) that a voltage ratio must be read. This is most easily accomplished with a simple meter by maintaining the input voltage constant and reading the output voltage. Since most generators contain a finite impedance, provision must be made for switching the indicating instrument from the normal (null-indicating) position to the input terminals, so that compensation may be made for varying

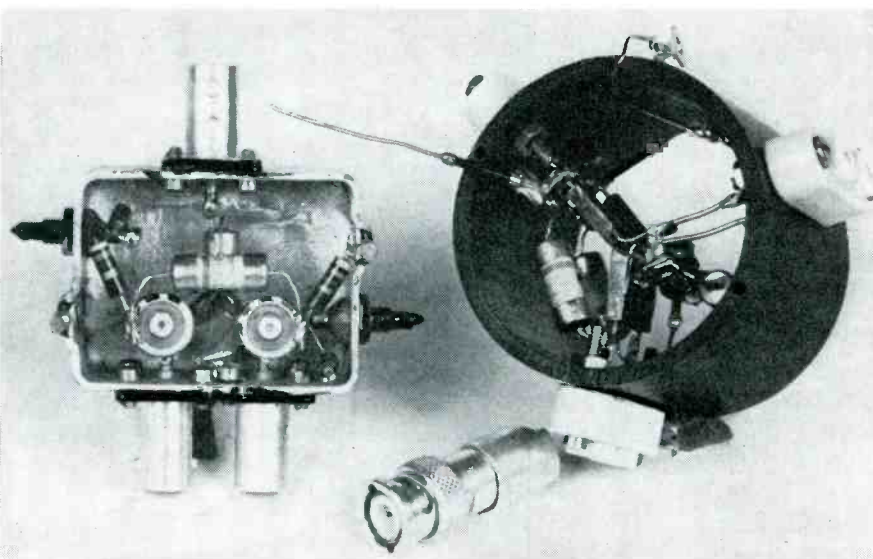

Mechanical details of the bridge.

Match Meter

Instrument, for 10 to 250-mc Range, Employing Wheatstone-Bridge Principle, Found Capable of Indicating Magnitude of Reflection Coefficient of an Impedance. Unit Can Be Placed Between Low-Powered RF Source and Antenna, Transmission Line or Circuit to Be Checked. Measurements Can Be Made With Respect to Two Impedances: 52 Ohms, Unbalanced, and 300-Ohms, Balanced.

by PETER G. SULZER

Electronic Scientist
Ionospheric Research Section, Central Radio Propagation Lab.
National Bureau of Standards

terminal impedances during measurement.

For balanced lines the double bridge of Figure 1(b) is applicable. Here the readings of the voltmeters, V_1 and V_2 , are added. It is of interest to note that this circuit bears a superficial resemblance to the magic tee.²

Errors

Experience has shown that match meters^{3,4} are subject to various errors,

particularly at *vhf*. These errors usually result from residual reactances in the bridge arms, or from voltmeter imperfections such as low input impedance or calibration inaccuracy. The subject is a complicated one, and will not be considered at length here. It can be stated, however, that by using symmetrical construction it is possible to obtain a null over the entire frequency range when the bridge is terminated in Z_0 . Thus, when adjusting the unknown

impedance for a match, changes tending to produce a null will be in the proper direction, which is a highly desirable condition.

Construction

A schematic diagram of a *vhf* match meter which was found capable of indicating the magnitude of the reflection coefficient of an impedance appears in Figure 2. There are three basic parts

Figure 1

In (a) appears a Wheatstone bridge network. A double bridge applicable to balanced lines is shown in (b).

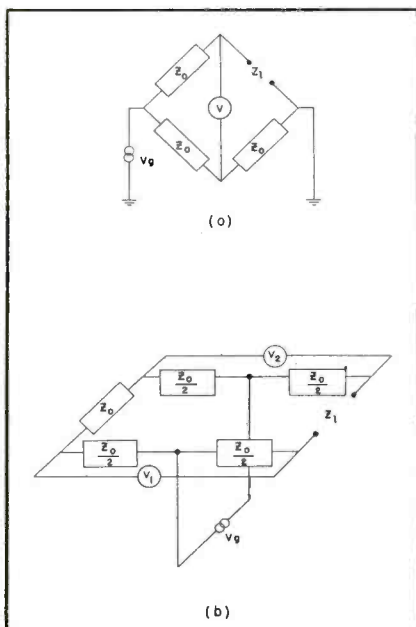
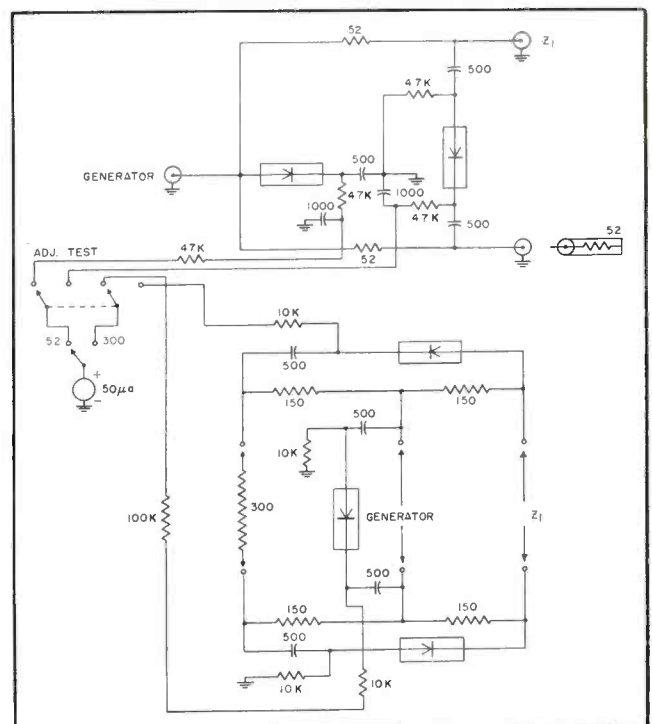

Figure 2
Circuit of the vhf match meter. Crystal diodes are 1N34. Capacitors are silver-mica button type.



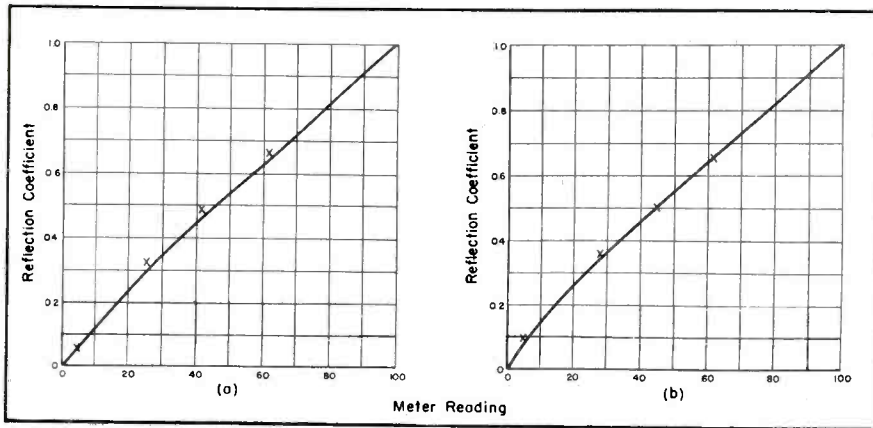

Figure 5

Plot showing results of calibration techniques. The solid lines were obtained by voltmeter calibration. X points were obtained by a resistance-substitution approach. At (a) are the results for a 52-ohm bridge and at (b) appear the results of a 300-ohm bridge, both calibrated at 50 mc.

in the instrument: the 52-ohm bridge, the 300-ohm bridge, and the meter with its associated switches. The voltmeters reading the input and null voltages consist of crystal diodes plus a *dc* microammeter, which is switched from the input diode to the null diode during measurement. The balanced bridge contains two crystal diodes as null indicators, with their *dc* outputs connected in series.

In Figure 3 is a view of the instrument proper. The small pill-boxes atop the cabinet contain the bridge circuits. Mechanical details of the bridges themselves are shown in Figure 4; the use of symmetry should be noted. In both bridges the standard arm is connected with the same type of fitting used at the test terminals. Thus, connector errors tend to cancel. As a further precaution the bridge arms are shielded with copper foil to decrease their inherent inductance.

Calibration

Two methods are available for calibrating the unit. The first consists of comparing the bridge-null-voltmeter with an accurate voltmeter which may, for convenience, be connected across the generator terminals. In this manner a proportional scale may be drawn, with full-scale deflection corresponding to a reflection coefficient of unity.

The second method utilizes equation (3), with calibration obtained by connecting selected high-frequency type resistors across the test terminals. In using this method the meter switch should be turned to *test*, with the test terminals left open, and the generator (which should be capable of supplying a maximum of five volts across a 50-ohm load) adjusted for full-scale deflection. This establishes the correct value of \bar{V}_R ,

which must be maintained constant at *all* times. The meter switch must then be turned to *adj*, and the reading, which is proportional to \bar{V}_R , noted. The calibrating resistor should then be connected across the test terminals, and the generator readjusted, if necessary, to obtain the same input voltage as before. Then the meter switch can be returned to *test*, and the reading, which corresponds to the known reflection coefficient of the resistor, recorded. The reflection coefficient of the resistor can then be calculated from (2).

Both methods were used in plotting Figure 5. The solid lines were obtained by voltmeter calibration, while the points were obtained by the resistance-substitution method.

As a precaution against stray pickup a shielded generator should be used. This is particularly important when making measurements of balanced, unshielded transmission lines. A balanced generator must be used with the balanced bridge to avoid *longitudinal* currents in the line connecting the generator to the instrument.

Measurements made of devices with known reflection coefficients have indicated a maximum error of 0.1 over the frequency range from 10 to 250 mc.

Results

The procedure used in measuring an unknown impedance is essentially the one employed in the second method of calibration. That is, the generator is set to the desired frequency and the input voltage required to produce full-scale indication under open-circuit conditions is noted. During all subsequent tests the input voltage is maintained constant at this level.

Figure 6 reveals the results of tests of two antenna systems. In one part (A) is a plot of standing-wave ratio versus frequency for a 32-element beam antenna. The (B) plot illustrates the reflection coefficient versus frequency for a ground-plane antenna designed for operation at 200 mc. The improvement obtained by folding the driven element can be readily seen.

Figure 6

Results of tests of two antenna systems. The plot in (A) covers swr versus frequency for a 32-element beam. In (B) we have a plot of the reflection coefficient versus the frequency for a ground-plane antenna designed for operation at 200 mc. At (a) are the results for the unipole and (b) for the folded unipole.

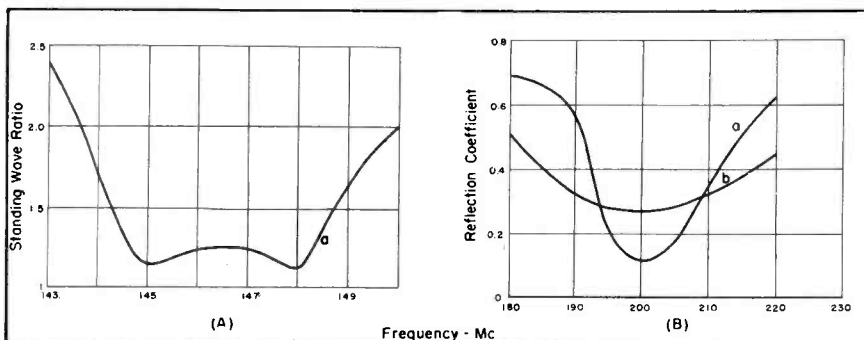

References

- ¹Korman, Nathaniel I., *Note on a Reflection-Coefficient Meter*, Proc. IRE; Sept., 1946.
- ²Montgomery, C. G., *Technique of Microwave Measurements*; McGraw-Hill, 1947.
- ³Pattison, Jr., H. O., Morris, Robert M., and Smith, John W., *A Standing-Wave Meter for Coaxial Lines*, QST; July, 1947.
- ⁴Morrison, J. F., Younker, E. L., *A Method of Determining and Monitoring Power and Impedance at High Frequencies*, Proc. IRE; Feb., 1948.

Simplified Methods for Calculation of H and T Attenuation Pads

IN SOUND WORK, it is often necessary to reduce levels with the aid of fixed resistor networks, such as are included in *H* and *T* attenuation pads. To afford a maximum transfer of energy, a proper match must be established with the proper resistor values. Affecting such a match with the necessary resistors requires the use of a rather complex series of formulas and involved solution procedures.

In an effort to streamline this problem, the table method was studied. It was found possible to set up one set of tables which, with a few simplified formulas, could be used to locate values for the *T* and *H* pads.¹

To determine values for the *H* pad, the Y (Y^k) member of the special table is first consulted. As an example, let us suppose we wanted a pad with an impedance of 200 ohms input and 200 ohms output, with a 2 db attenuation drop. On the table we find that the Y^k factor, for 2 db, is 2.17. In a multiplication process, the value 2 db is multiplied by 200 Z and then by 2.17, resulting in a total of 268 ohms for the Y member. Instead of solving for four X members, we merely solve for one of them, for they are of equal value. Now, we check the X^k column, and opposite 2 db we obtain a factor of .15. We then divide our 2 db loss, which we want, into the 200-ohm impedance, which is 100. In turn, we multiply this value by .15, and we have our result of 15 ohms.

The T Pad

The *T* type pad is a bit simpler to build than the *H*, because it has two

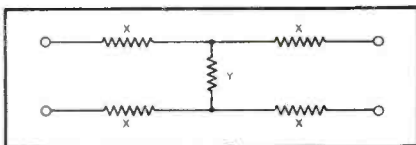

Figure 1
Circuit for H pad with unknown values.

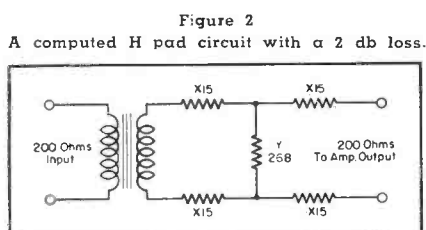

Figure 2
A computed H pad circuit with a 2 db loss.

less resistors in its makeup. It has a good overall frequency response. If we are concerned with a 200 to 200-ohm impedance *T*-type attenuation pad, with a 30 db loss, it is only necessary to note the two X members on one side of the line. When working this X member problem, the quantity 2 is dispensed with, because we have halved the number of X members. Thus, by merely multiplying our impedance by the factor (from the table) we can find the proper value of the X members, which are two in number. Checking the X^k column, opposite 30 db, we find the factor .939. To find our result the impedance is multiplied by this factor: $200 \times .939 = 187.8$ for the two X members.

The Y member can now be computed as cited: $(2Z) Y^k$. In the Y^k column, opposite 30 db, we find .0316. This factor, multiplied by 200 and then by 2, provides the answer 12.64, for the Y member.

To check the accuracy of these results, we can add the X and Y members

¹In high-level circuits, wattage requirements must be watched closely. It is normally wise to allow a margin of 50% for maximum dissipation.

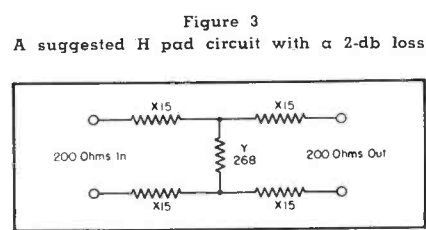

Figure 3
A suggested H pad circuit with a 2-db loss.

by CHARLES J. LEIPERT

which approximate the figures. For example, the last *T* pad problem had an X member value of 187.8, while the Y value was 12.64 ohms. Adding both figures gives us the value of 200.44 ohms, our input and output impedance, proof that the results check within a reasonable degree of accuracy.

It will be noted that as the attenuation factor is increased (the db loss) the resistance of the X members is increased and that of the Y members decreased. Or, taking it another way, as the attenuation factor is decreased, the Y member resistance increases, while the resistance values of the X members decrease.

Formulas for the *H* pad:

$$X = \frac{Z(K-1)}{2(K+1)} = \frac{Z}{2}(X^k)$$

$$K = \frac{1'}{1}$$

(Continued on page 28)

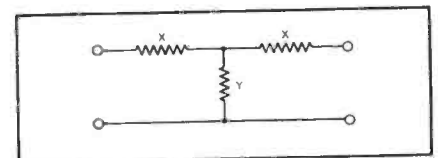

Figure 4
A T-pad circuit with unknown values.

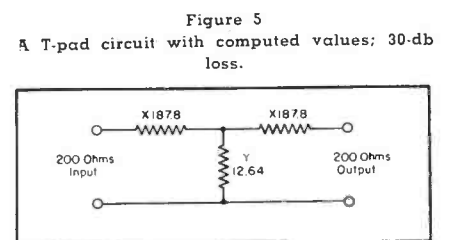

Figure 5
A T-pad circuit with computed values: 30-db loss.

OPTICS in TV

Receiver Projection

Review of Systems Now Available, Including Spherical-Mirror Corrector-Lens Plastics Assembly, Which Utilizing a 2.5" Tube and a Magnification of 8, Provides a 15" x 20" Picture. Two Dish Sizes Used, 8" and 11", to Provide Throws of 37", 40" and 52".

by DAVID T. ARMSTRONG

WITH LARGER AND LARGER PICTURES quite the current vogue in receiver design, the methods available to provide such increased reproduction are being probed more carefully than ever. As a result of this trend projection systems, with its enlarged screen possibilities, appear to have returned to a favored spot on many developmental calendars.

At present, there are two optical assemblies available for use in home-projection receivers, the optical barrel¹ and the *folded* Schmidt system.²

The optical-barrel system is the oldest reflecting method, which features use of straight Schmidt optics. It has been found possible to secure many picture sizes with this approach, from 15" x 20" for home use to 15' x 20' for theatres. A special tube, the 5TP4, has been employed in the home system, the basic features of which are illustrated in Figure 2.

In the second system, a smaller tube, with a face of 2½", has been employed.

The optical systems in projection setups, have in the main, used a combination of lenses and mirrors, with the Schmidt system requiring nothing more than a spherical light-collecting mirror and a flat corrector lens.

In studying mirror-lens structures, one group, members of a plastics divi-

sion of a chemical manufacturer³, found that they could produce a spherical mirror and a corrector lens as a one-piece unit, which appeared to offer many features such as rigid construction and a high optical efficiency. The system was also found to provide maximum light transmission and excellent contrast range because of the accuracy to which the spherical mirror and corrector plate could be finished.

In view of the assembly design, the aperture of the optic is wide and quite close to the optimum aperture, usually represented by 0.5.

To afford focusing, movement of the entire plastic assembly with the tube in place, has been provided. Three screws, fitting into six holes in the corrector plate, and processed with threads calcu-

lated to provide a ratio of 64 to 1, have been included to provide vernier focusing adjustment.

The assembly can be covered by a black buckram shroud to prevent loss of light and to minimize the effect of spurious reflections from surrounding surfaces or from tubes.

Design Considerations

In the installation of an optical system, it has been found necessary to consider such factors as the diameter of the dish or light collecting mirror. This should be relatively large, since the efficiency of the system is a function of the light gathering power of the spherical mirror. In the plastics development it was decided to make this diameter in two sizes, 8" and 11". (In the barrel system the dish is 14" and in the folded arrangement, it is 6.7")*

The size of the clearance hole in the corrector lens has also been found to be quite important. This must be kept as small as possible because this hole represents an optical loss for the rays of light cut off, since there is no corrector lens in this area. At the same time, the hole must be made sufficiently large to accommodate the focusing and deflecting coils, located at the neck of the tube. The clearance hole in the

Figure 1
Conventional refractive projection system. Lens design could be simplified by using cathode-ray tubes with flat faces. The lens diameter is approximately the tube face diameter divided by the f number. The focal length is approximately equal to the tube face diameter.

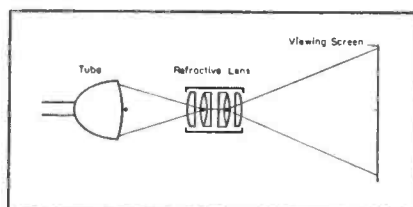

¹RCA, ²Norelco Protelgram,
³Imperial Chemical Industries, Ltd.

An all-plastic projection television assembly.
 (Courtesy, Imperial Chemical Industries (N.Y.) Limited)

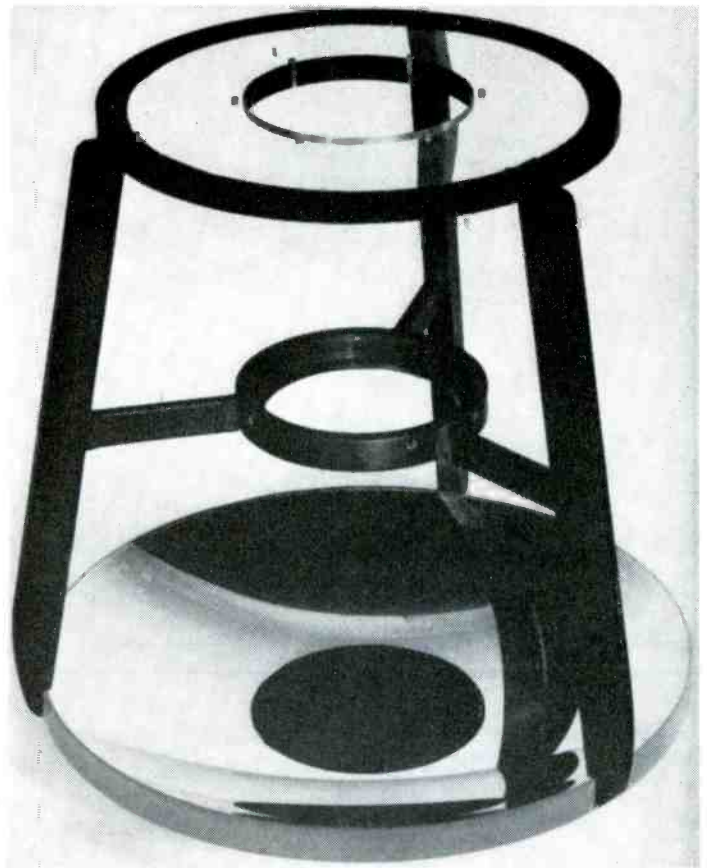

plastics system has been made in three sizes: 2.75", 3.625", and 4".

Research has also shown that the diameter of the blacked out portion in the spherical mirror is a function of the tube face. The area blacked out corresponds to the effective light emitting area on the tube face. The purpose of the blacked-out area is to improve image contrast by preventing reflection of light back upon itself, as a result of what is known as a *normal* in optics. Since this represents a loss in the light-collecting power of the mirror, the hole must be as small as possible. At the same time the amount of light emitted by the tube face is an important factor in the efficiency of the optical system. It has been found that some compromise must be made on these points. Incidentally, the central area of the mirror with a diameter equal to the tube face cannot be utilized in a Schmidt system.

Face Diameter Considerations

One particularly important factor which must be considered in projection system design is the diameter of the tube face. This diameter determines the initial size of the picture, the number of magnifications necessary to pro-

duce a required picture, and the size of the projection assembly that must be used.

Projection Tube Types

Many projection specialists have in-

Figure 2
 Basic components of the straight Schmidt system as used in RCA and GE receivers. Optical barrel is tilted 7°. Mirror which heads light beam is at about 48°.

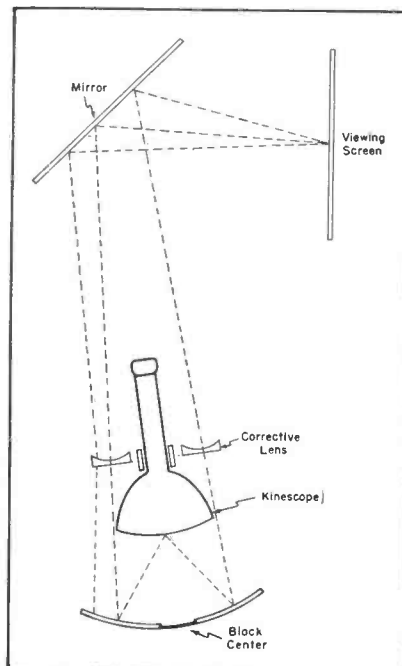

dicated that the 3NP4 is too small to provide enough light to utilize all the possible efficiency of a straight Schmidt system, and some have stated that the 5TP4 is too large since it requires a dish diameter that does not make for compactness. In addition, the size of the blacked-out portion of the mirror presents too great a loss of light.

Inquiry among tube manufacturers revealed that the cost of producing a small tube such as the 3NP4 was high because of the micron tolerances involved, while tubes like the 5TP4 were not too appropriate because of their low overall efficiency in the optical system.

The manufacturers seemed to be of the opinion that tubes with face diameters of 3.5" to 4" could be produced much more economically and would provide much higher efficiencies than the previously made types.

As a result of this survey, the plastic assembly was designed to accommodate tubes 3.5" and 4" in diameter,⁴ as well as the 3NP4. The latter type was included because it is generally available and found to have wide acceptance.

⁴At present there are no 3.5" or 4" projection type tubes on the market, but there are many tubes of this type on the design boards.

*A rule of thumb suggests a mirror diameter about three times the tube face diameter.

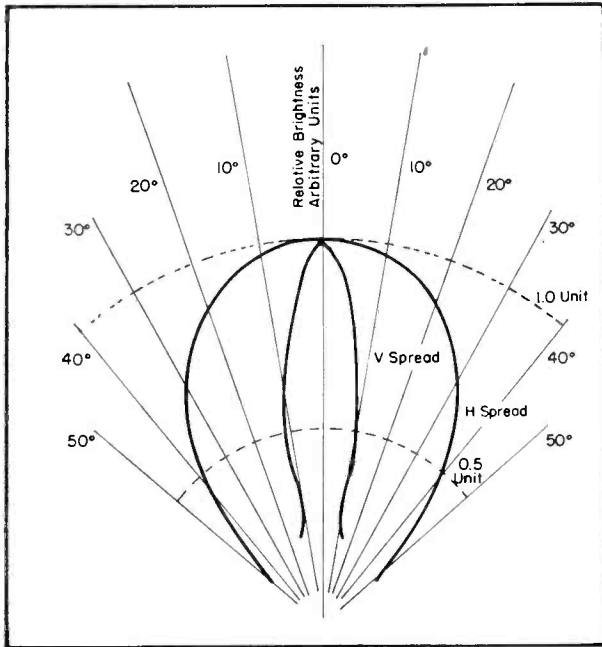

Figure 3
Polar distribution graph. This diagram indicates the relative light distribution of the directional television screen. Two lobes are shown. The smaller one represents the vertical brightness distribution pattern and the larger lobe represents the horizontal brightness distribution spread. On the center axis at 0° there will be a definite amount of brightness at one unit from the screen. Let us assume that one unit represents 10'. As we move to the left 10° off center we find that we have to move in a little toward the screen to see the picture with the same brightness as we did on the center axis at 10°. At 20° we have to move in a little closer, say perhaps to 9', to see the image as well as we did at 10° on the 0 axis.

Magnification Factors

The magnification factor required in the barrel system to produce a 15" x 20" picture is 6, whereas a factor of 10 is required in the folded system to produce a 13.5" x 18" picture. In the plastics optical system, using a 2.5" tube, a magnification of 8 can provide a 15" x 20" picture, while a magnification of 6" produces a 12" x 16" picture. (Theoretically, a Schmidt system corrector lens may be corrected for but one image magnification value.)

Assembly Data

In designing a system using the plastics optical method, it has been found necessary to consider the data detailed in Table I at left.

Since the picture-tube face is an essential part of the optical system it has been found necessary to specify the face plate dimensions required for each separate projection assembly. These data appear in Tables II, at the left.

Screen Sizes

The screen problem has also been considered and the developers of the plastics method have evolved two types of screens, 12" x 16" and 15" x 20". The screens have an abraded front surface which should be toward the viewer. They are lenticulated on the other side to provide horizontal spread. The viewing angles achieved with these screens has been found to be 80° in the horizontal and slightly more than 20° in the vertical. The light intensity is approximately equal over the entire viewing angle. The screen has been found to have a light gain of about 4 over a perfect diffuser.

Figure 4

Method of folding the Schmidt system into a compact system, which involves the use of an additional inclined mirror. The optical efficiency of this system has been found to be relatively high because there is no loss in the corrector lens or loss attributable to leads and coils.

(Courtesy, North American Philips Company)

(Figure 3 diagram courtesy Imperial Chemical Industries (N. Y.) Limited)

**8/37 = 8" dish; 37" throw. 11/40 = 11" dish; 40" throw. 11/52 = 11" dish; 52" throw.

	8/37**	11/40**	11/52**
Size of the projected picture.....	12" x 16"	12" x 16"	15" x 20"
Throw distance from the dish.....	37	40	52
Effective aperture (0.5 is ideal).....	0.8	0.86	0.78
Nominal picture-tube diameter.....	2.5	4.0	3.5
Size of tube face raster.....	1.42 x 1.89	—	—
Number of magnifications.....	8	6	8
Diameter of spherical mirror.....	8	11	11
Size of blacked-out hole in dish.....	2.5	4.0	3.5
Diameter of corrector lens.....	7	10	10
Clearance hole in corrector plate.....	2.75	4.0	3.625
Overall length of projection assembly.....	8.7	11.7	11.8
Weight of assembly without tube.....	25 ounce	50 ounce	51 ounce

Above: Table I

	8/37**	11/40**	11/52**
Outer tube face radius (convex).....	4.173 ± 1%	6.0 ± 1%	5.75 ± 1%
Inner tube face radius (concave).....	4.094 ± 1%	5.84 ± 1%	5.59 ± 1%
Thickness of the tube face.....	0.080	0.160	0.160
	± 0.002	± 0.002	± 0.002
Refractive index (precise value not critical)	1.52	1.53	1.47
Nominal picture-tube diameter.....	2.5	4.0	3.5
Minimum diameter of undistorted surface..	2.375	3.5	3.2
Maximum clearance diameter for tube locating ring.....	2.6	4.1	3.625

Above: Table II

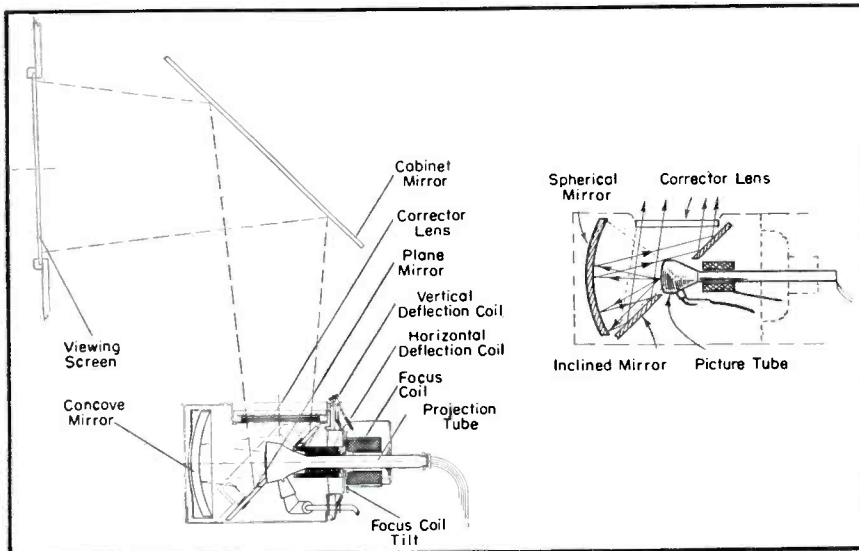

TV TUBE *Developments*

Circuit Developed for Wide-Angle Short-Metal 16GP4, Features Reduced Power Input for Both Horizontal and Vertical Deflection. Total Power Required to Develop Maximum Anode Voltage of 14,000 (No Load) and Full Scanning Found to Be Between 40 and 45 Watts With B of 350 V, or About 50% Less Than Present Systems.

by P. B. LEWIS

Figure 1
Deflection and high-voltage circuit for 16GP4.

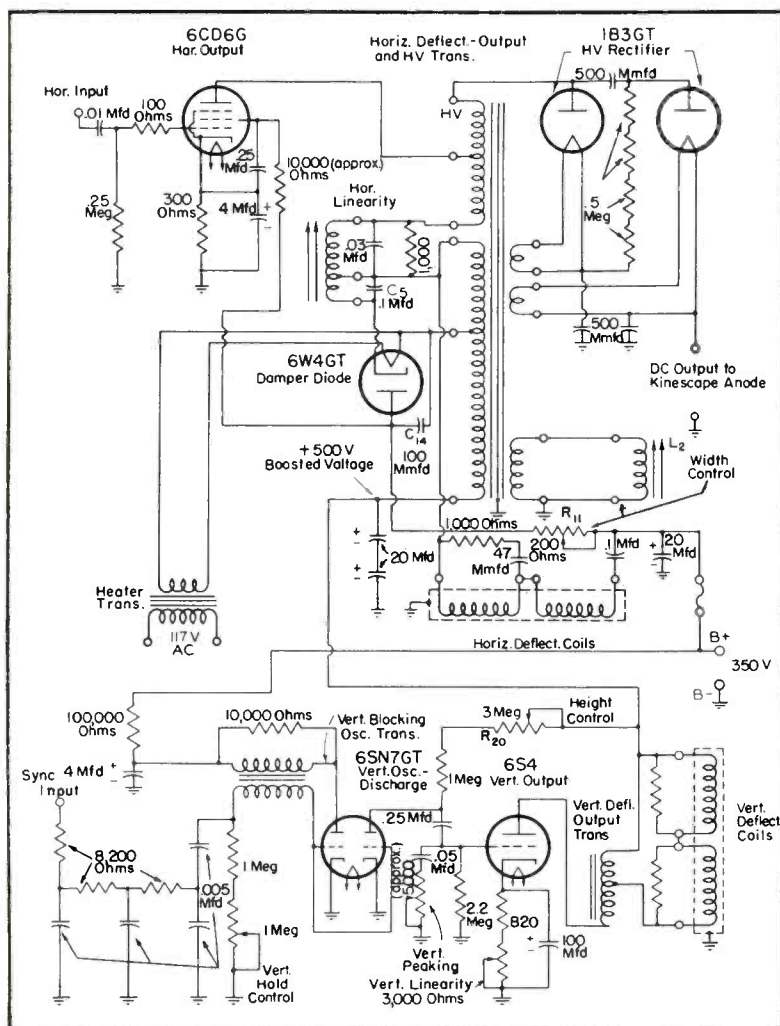

WITH THE TREND to wide-angle 70° picture tubes has come a need for circuitry which can provide substantially increased deflection power. Specifically, the 70° tube has been found to require about twice as much power as the 53° type, which it is rapidly replacing.

Recently, a circuit providing such a higher deflection power was evolved. In this circuit, shown in Figure 1, the horizontal-deflection circuit uses a single 6CD6G as the horizontal-power-output tube. To maintain circuit efficiency, the 6CD6G must be cut off rapidly and kept cut off during the retrace interval. Rapidity of cutoff is helped in this circuit by using a peaking resistor in series with the charging capacitor to increase the negative swing of the grid driving voltage. If additional negative driving voltage is required to maintain cutoff throughout the retrace interval, feedback peaking may also be used. A negative pulse suitable for feedback peaking may be obtained from a terminal of the horizontal-deflection-output transformer, when the connection between the width control and a terminal of the transformer is grounded, as shown.

When the driving voltage for the 6CD6G is obtained from a combined blocking-oscillator-discharge-tube circuit, cutoff is usually rapid enough so that series peaking is not necessary.

With a sawtooth voltage of about 90 peak-to-peak, good performance can be obtained without either series or feedback peaking. With a small amount of feedback peaking, however, circuit efficiency can be slightly improved. Because excessive feedback peaking may cause instability or phase shift in the horizontal oscillator, it is advisable to determine the component values for the feedback circuit experimentally.

The 6CD6G must be protected against damage, in the event that there is a loss of grid driving voltage. Protection can be obtained by selecting a cathode resistor of proper value. After the value of the screen-dropping resistor, which will keep the screen dissipation within its rating, has been determined, the cathode resistor can be selected so that the tube plate dissipation is limited to 37.5 watts under no-drive-voltage conditions. Although the dc plate dissipation rating of the 6CD6G is 15 watts, the tube has been found capable of withstanding up to 2½ times

(Continued on page 26)

Bandspreading and

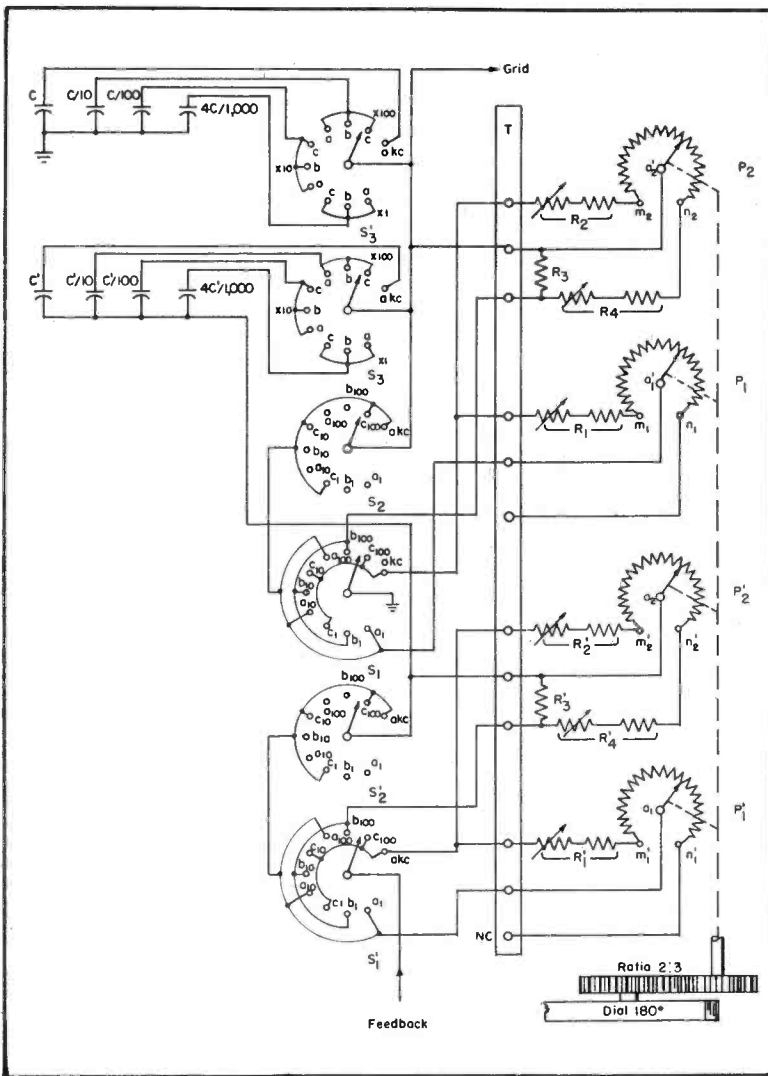

Figure 1
Continuous selector type circuit developed by the author. Ten positions afford coverage from 10 cps to 25 kc.

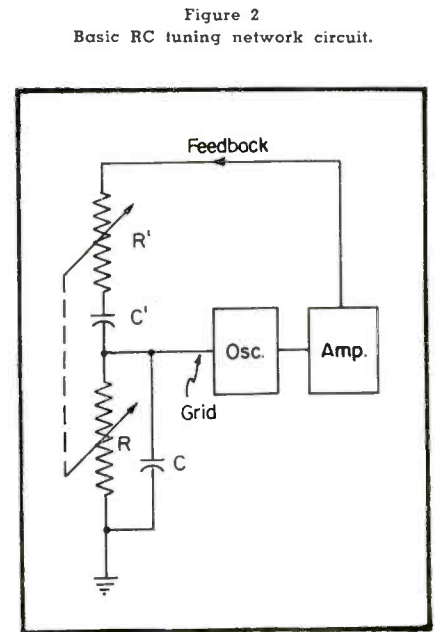

Figure 2
Basic RC tuning network circuit.

IN INSTRUMENTATION activities, the recording of the measured results is quite a factor, providing that all-important end-result report. In reading the instrument scales, which provide this valuable information, it is often difficult to ascertain critical values, because of the scale structure. In many instances, there is no provision for detailed, intermediate notations, or extended scale readings.

Bandspreading has been attempted in an effort to solve the problem. In one approach, unequalized bandspreading* has been employed.

By splitting two variable impedances r , or c , of each of two tuning circuits of a conventional rc tuning network (Figure 2) in equal halves and ganging the resulting four halves together, it

has been found possible to secure bandspreading over three sub-scales by:

- Placing the two variable halves of each tuning circuit in series
- Tuning each circuit with one-half of the tuning impedance only
- Placing the two half-tuning elements of each circuit in parallel.

Frequency Reading Relationship

With such a method the relationship between the frequency readings on

three resulting sub-scales *A*, *B* and *C*, corresponding to the three foregoing arrangements, *a*, *b* and *c*, will be one of 1:2:4. This is the result of a natural relationship between the series, single unit, parallel connection of two equal impedances, or 4:2:1, reversed by the reciprocal form of the basic tuning equation:

$$cps = \frac{159}{K \text{ ohms} \cdot mfd} \quad (1)$$

By making the ratio, from maximum to minimum tuning impedance, 2.5:1

*U. S. Patent 2,507,582.

Scale Equalization For RC Tuning Networks

New Approach Using Continuous Selector-Type Circuit Found to Afford Elongation of Scales by Three Times. Method Also Provides Increased Spread at the High-Frequency End of the Scale.

by **C. F. VAN L. WEILAND**

and maintaining this ratio for the foregoing *a*, *b* and *c* conditions it has been found possible to produce a set of three sub-scales for unequalized band-spreading, as illustrated in Figure 3. These scales, as a unit, which form a complete decade assembly suitable for direct reading of frequencies, represent the case of resistance tuning using rheostats of straight-line frequency characteristic.

Unequalized Method Advantages

The unequalized method has been found to offer five advantages:

- (1) Simplicity, a minimum of parts and wiring being required.
- (2) Replacement of the three sub-scales *A*, *B* and *C*, because of their direct and simple inter-relationship, by one single scale. The *B* scale has been found to be convenient for this purpose. Here a divider of 2 has been ap-

plied to arrive at the *A* scale and similarly, a multiplier of 2 to obtain the *C* readings.

- (3) Due to their simplicity, it has been found that the three sub-scales can be pre-designed from calculated tuning curves and made to track accurately in the final instrument. This will be found particularly true for the 100 to 10,000 cps mid-frequency range where no correction for phase shift is necessary.
- (4) The use of one pair of tuning capacitors of equal value for the frequency spectrum, covered by a complete set of sub-scales *A* through *C*. Because of the decade nature of the scale structure, it has been found that the next pair of tuning capacitors introduced into the circuit for ascending frequency readings need be but one-tenth of the capacity value of the capacitors previously inserted in the circuit. In other words, the system has been found to permit the use of mul-

tipliers of 1, 10, 100, etc., in a rather simple manner.

- (5) The principle, with minor variations, has been found applicable also to capacitor tuning.

Unequalization Disadvantages

The unequalized-scale approach has also been found to have several disadvantages:

- (1) Repetition of frequency readings, i.e., 20 to 25 on the scales *A* and *B*, and 40 to 50 on scales *B* and *C*, which amounts to a loss of scale length.
- (2) Necessity of returning the dial pointer to the beginning of each one of the three sub-scales, after completing the readings on the previous sub-scale, resulting in a loss of tuning time and unnecessary equipment wear. The method was also found to exclude, more or less, for practical considerations, the use of the slow moving slide-rule type vernier dials.

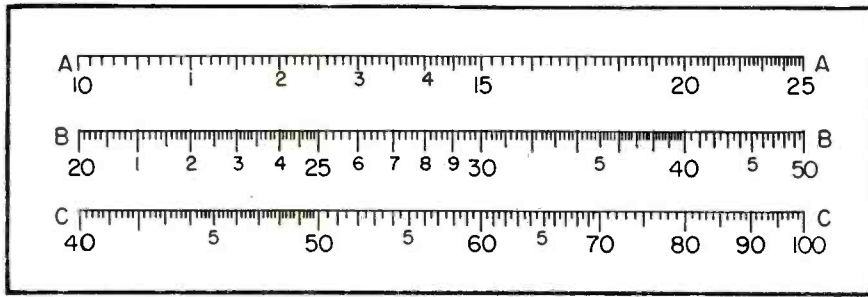

Figure 3

Scale for unequalized bandspreading.

(3) Crowding of scale readings when using the least expensive and easiest to calibrate and reset tuning elements, having a straight-line resistance characteristic. This crowding has been found most evident at the highest frequency readings.

$F_{a\max}$ and $F_{a\min}$, $R_{a\max}$ and $R_{a\min}$, of course, represent the maximum and minimum frequency readings and tuning resistances for the A scale.

For this particular case the corresponding resistance values for the B scale are always $\frac{1}{2}$ of those for the A scale, and the corresponding values for the C scale are $\frac{1}{2}$ of those obtained for the B scale. The frequency ratios for the B and C scale, in this case, are the same as the frequency ratio for the A scale. That is,

$$S_a = S_b = S_c = 2.5 \text{ (or slightly over)}$$

When the total sweep of the potentiometer arm, that is used for tuning, equals unity and σ represents the decimal fractions of this total, then the tuning resistance may be represented by

$$R_{ta} = 2R_p \left(\frac{1}{S_a - 1} + \sigma \right) \quad (3a)$$

It will be noted that this equation represents a straight line between the maximum and minimum values of the tuning resistance between $\sigma = 1$ and $\sigma = 0$ as ordinates. Because the frequencies are inversely proportional to the tuning resistances, and ascending frequency readings are presented from

left to right on the scales (Figure 3), it appears that in plotting the tuning resistance curve the maximum tuning resistance ($\sigma = 1$) should preferably be located at the left extreme of the abscissa. The tuning resistances for the B and C scales will thus be found to be one-half and one-quarter of the corresponding values of the A scale.

Unequalized System Design Data

In designing the unequalized system, the following mathematical considerations were probed: With R_p representing a portion of the resistance of each one of the four potentiometers used for tuning and S_a representing the ratio between the maximum and minimum readings on the sub-scales which, for this particular case, was found to be invariably 2.5 (or slightly over to provide some small overlap between scales, if desired) . . .

For minimum frequency ($F_{a\min}$)

$$R_{a\max} = 2R_p S_a \frac{1}{S_a - 1} \quad (1a)$$

For maximum frequency ($F_{a\max}$)

$$R_{a\min} = 2R_p \frac{1}{S_a - 1} \quad (2a)$$

Partially Equalized Bandspreading*

By adhering to resistance tuning and employing potentiometers instead of rheostats for tuning, it has been found possible to eliminate the first and second disadvantages cited previously. Use of the third or the clockwise terminals, n_2 , of the potentiometers, P_2 (Figure 1), for tuning on the B scale, only, was found to solve the problem. The A and C scales can remain unchanged, they being tuned between the m terminals and the potentiometer arm, a . Therefore, ascending frequency readings on these scales from left to right will be found to correspond to a counter-clockwise rotation (decreasing tuning resistance) of the potentiometers. When the lowest tuning resistance, i.e., highest reading on the A scale has been reached, the tuning from there on will be found to occur at the n_2 and n'_2 points of the potentiometers, P_2 and P'_2 , for this reversed single-unit tuning. Clockwise rotation of the potentiometer arms, a , corresponds to decreasing tuning resistance for increasing frequency readings from right to left on the B

*U. S. Patent Pending.

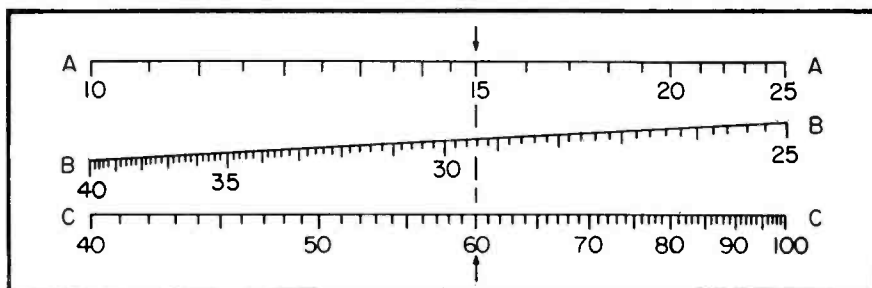

Figure 4

Scale for partially-equalized bandspreading.

scale, i.e., the scale registering the readings for single-unit tuning.

Elimination of Repeat Readings

To eliminate the repetition of frequency readings, and yet retain the same pair of tuning capacitors for tuning throughout the complete decade scale, i.e., sub-scales *A* through *C*, the tuning resistance appearing in the tuning circuit at the low frequency end of the *B* scale must be of the same value as the tuning resistance at the end of the *A* scale. Likewise, the frequency at the high end of the *B* scale must correspond to the low frequency end of the *C* scale. In other words, the tuning resistances for the high end of the *B* scale and the low end of the *C* scale must be of equal value. This procedure has been found to equalize the resistance values in the transition from *A* to *B* scale, and from the *B* to *C* scale at the transfer points, thus eliminating the first and second disadvantages. It should be noted that the tuning resistances involved in the transition process, although of the same value, are not the same resistances physically. They are taken from different terminals of the same potentiometers.

Potentiometer-Gear Ratios

If these potentiometers have a value of 20,000 ohms each and a 300° rotation, and a 180° slide rule dial is used for the tuning, we find that with a gearing having a 3:2 ratio between the dial shaft and the potentiometer shaft, the sweep of the potentiometer arm available for tuning will be 3/2 times 180° or 270°. This corresponds to a tuning resistance of 18,000 ohms available from each one of the four potentiometers, leaving 2,000 ohms of each unused. It is assumed that this unused portion of the potentiometer resistances appears in equal parts of 1,000 ohms, each adjacent to the *m* and *n* terminals of the potentiometers, *P*₁, *P*₂, and *P*'₁ and *P*'₂. Consequently, this resistance will form a portion of the fixed resistances in the tuning circuit.** When adjustable fixed resistors are used, such as *R*₁, *R*₂, *R*₃, etc., all the unused portions of the potentiometer resistance do not have to be equal or evenly distributed, because, in the case of straight-line resistance characteristics, the resistance increment of *R*_p will be the same for all potentiometers, and any difference between the fixed units at any location can be equalized by adjustment of the fixed resistors. It has been found that the constant resistance increment of

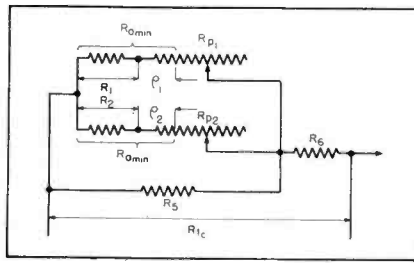

Figure 5
Equivalent circuit for completely equalized tuning circuit for the *C* scale shown in Figure 4.

the tuning potentiometers will also make re-setting easier in the case of de-calibration of a completed instrument. Making the fixed resistances in the circuit adjustable actually can be considered as a refinement and not a necessity.

Max-Min Resistances

With a tuning resistance, *R*_p, of 18,000 ohms the maximum resistance of the series connection, from the equation (1a) will be found to be 60,000 ohms. And, likewise, from equation (2a) the minimum tuning resistance for the *A* scale will be found to be 24,000 ohms. This appears at the high frequency tuning end of this scale and consequently, as explained previously, the resistance for tuning the low frequency end of the *B* scale must also be 24,000 ohms. This resistance must be supplied from the *n*₂ and *n*'₂ terminals of the potentiometers, *P*₂ and *P*'₂, functioning as single units. Likewise, the maximum resistance for tuning the *C* scale at minimum frequency reading equals one-quarter of the corresponding *A* scale resistance, i.e., 60/4 or 15,000 ohms. This in its turn again is equal to the minimum resistance of the *B* scale at this transfer point. This, of course, can also be arrived at by considering that the scale ratio of the *B* scale, *S*_b, equals 8/5. As the maximum resistance for this scale is 24,000 ohms, it follows again that the minimum resistance for same must be 5/8 times 24,000 ohms or 15,000 ohms.

Resistor Values

The correct values of the resistors, *R*₃, *R*₄ and *R*'₃, *R*'₄, for padding the tuning potentiometers, to obtain the maximum and minimum values in reversed

**In the subsequent analysis, this resistance is designated as *r*, with or without further identity; such as the terminals, *n* and *m*, and potentiometer points with or without primes.

single unit tuning, can be arrived at from the following equations:

$$R_k = R_p \left\{ \sqrt{\left(\frac{2}{(s_a - 1)(s_b - 1)} + \frac{1}{4} \right) - \frac{1}{2}} \right\} \quad (1b)$$

from which *R*₄ or *R*'₄ can be found by subtracting *r*_{min} and *r*'_{min}, respectively.

The shunt resistors can be found from:

$$R_3 \text{ or } R'_3 = R_k \frac{2 R_p}{S_b R_k (S_a - 1) - 2 R_p} \quad (2b)$$

A set of scales for this method of partially equalized bandspreading are illustrated in Figure 4. They can be designed from the tuning equation:

$$R_{tb} = \frac{R_3}{1 + \frac{R_3}{\sigma R_p + R_k}} \quad (3b)$$

By studying these scales it will be noted that the use of a vernier slide-rule type dial can be considered justifiable, in this case, because of the three continuous parts into which a decade spectrum of the range of the instrument is broken up. Depending upon the speed and the practicability of the scale and multiplier selector system, it is evident that any desired frequency within the range of the instrument can be tuned quickly, without much traveling of the dial pointer. Furthermore, a quick reading over the full range becomes available by setting the dial pointer at a point somewhere near the middle of the scale, as indicated by the dotted line in the Figure 4 scale. As an illustration, let us suppose that ten selector points were available and multipliers from 1 to and including 1,000 were applied. Without moving the pointer, on the scale of Figure 4, it will be found possible to secure readings of 15, 29.4, 60, 150, 294, 600, 1,500, 2,940, 6,000 and 15,000 cps. This will be possible without resetting of the dial pointer and with the use of one, or perhaps two selector switches as will be explained in a subsequent discussion.

[To Be Concluded in August Issue.]

Quality Control-Limit

Quality control in a life-test room. Here performance of completed receivers is checked against consumer-acceptance standards at various extremes of line voltages and over extended time periods. Variations in line voltage to simulate extreme conditions of under-and-over-voltage line conditions in the home are controlled by the voltage control boxes shown on the floor in front of the receivers under test.

(Courtesy DuMont)



IN ORGANIZING A QUALITY-CONTROL program,¹ there is one factor which demands particular attention, and that is the control chart. Upon the information included on such a chart, an extremely effective program of policing activity can be planned. For instance, if a point, representing the number of defects in a sample of five should fall inside the established control limits, no specific action would be required. But, if a point should fall outside the control limit, the inspector would have to be alerted to watch the next thirty points. And, if in the succeeding thirty points, another point should fall outside the control limit, a detailed control procedure would have to be used. In such a plan, it usually becomes necessary to cue all of the personnel along the line, which normally includes, in addition to the inspector, the riveting line supervisor, process inspection supervisor, line supervisor, factory engineer, methods engineer, and the factory inspection manager. The latter has quite a job to perform. Should the trouble exist in the riveting section, the factory inspection manager becomes responsible for stopping the process in order to:

(a) Protect the rivet line against undue cost of repairing a poorly manufactured product.

(b) Protect process inspection from the cost of continuous 100% inspection.

(c) Protect other lines from which inspection has been withdrawn in order to cope with 100% inspection of riveting.

Limits for the Control Chart for Defects

In the interest of accuracy, convenience, and economy of labor, it is desirable to compute control limits after each set of 80 consecutive points have been plotted. The control limits will apply to the subsequent set of 80 points and will be computed from the data of the preceding 80 points. However, when the control chart is being installed for the first time on a job, limits must be calculated at the following intervals:¹

(a) After the first 20 points have been plotted.

(b) After the first 40 points have been plotted.

(c) After the first 80 points have been plotted.

(d) After each subsequent set of 80 consecutive points have been plotted.

¹A paper detailing the general aspects of quality control, prepared by Lutzker, appeared in the February, 1950, issue of TELEVISION ENGINEERING.

The control limits in those initial computations will apply to the subsequent group of points and will be determined from the preceding group of points.

Procedure

There are eight steps to be followed in the computation:

(1) A first estimate of the process average \bar{c} , is computed by dividing the total number of defects observed by the total number of samples of 5 in which those defects were found.

(2) This value of \bar{c} is then located in Table 1 and the upper and lower test limits recorded for this process average.

(3) The number of defects in the individual samples of 5 are then compared and an observation made of what points, if any, either exceed the upper test limit (UTL) or fall below the lower test limit (LTL).

(4) It is then necessary to eliminate those samples from the data which have a defect number that is greater than the UTL, or less than the LTL.

(5) Now, \bar{c} must be recomputed, in accordance with step 1, excluding those

Charting Techniques

Series of Statistical Tables Provide Means of Determining the Proper Control Limits Which Should Be Placed on The Control Charts for Defects.

by **L. LUTZKER**, Quality Control Engineer, Allen B. DuMont Laboratories, Inc.

points that fall above the *UTL* or below the *LTL*.

(6) Then we must find the test limits corresponding to the newly computed \bar{c} .

(7) Steps 3 to 6 are then repeated until no individual sample yields a defect number that falls above or below the upper and lower test limits, respectively.

(8) In the final step, it is necessary to find the upper and lower control limits (*UCL* and *LCL*) that correspond to the final value of \bar{c} obtained in step 7.

Notes

If the process average for a given process improves to a point where the value of \bar{c} is lower than .20 defects per sample, the sample size and time interval between samples must be doubled.

Test limits can be set so that the probability, that a sample drawn from the uniform product of process average quality will yield a number of defects greater than the upper test limit or less than the lower test limit, can be held between .002 and .005.

Control limits can be set so that the combined probability, that a sample

drawn from uniform product of process average quality will yield a number of defects greater than the upper control limit or less than the lower control limit, can be held between .02 and .05.

\bar{c}	<i>UTL</i>	<i>LTL</i>	<i>UCL</i>	<i>LCL</i>
.20	2.2	0	1.3	0
.21	2.2	0	1.4	0
.22	2.3	0	1.4	0
.23	2.4	0	1.4	0
.24	2.4	0	1.5	0
.25	2.5	0	1.5	0
.26	2.5	0	1.5	0
.27	2.6	0	1.6	0
.28	2.6	0	1.6	0
.29	2.7	0	1.6	0
.30	2.7	0	1.7	0
.35	2.9	0	1.8	0
.40	3.2	0	1.9	0
.45	3.4	0	2.1	0
.50	3.7	0	2.2	0
.55	3.7	0	2.3	0
.60	3.8	0	2.5	0
.65	3.9	0	2.6	0
.70	3.9	0	2.6	0
.75	4.1	0	2.7	0
.80	4.3	0	2.9	0
.85	4.4	0	2.9	0
.90	4.5	0	3.1	0
.95	4.7	0	3.2	0
1.00	4.8	0	3.2	0
1.05	4.9	0	3.3	0
1.10	4.9	0	3.4	0
1.15	5.1	0	3.5	0
1.20	5.2	0	3.6	0
1.25	5.4	0	3.7	0
1.30	5.5	0	3.8	0
1.35	5.6	0	3.9	0

\bar{c}	<i>UTL</i>	<i>LTL</i>	<i>UCL</i>	<i>LCL</i>
1.40	5.7	0	3.9	0
1.45	5.8	0	4.1	0
1.50	5.9	0	4.2	0
1.55	5.9	0	4.3	0
1.60	6.1	0	4.4	0
1.65	6.2	0	4.4	0
1.70	6.3	0	4.5	0
1.75	6.4	0	4.6	0
1.80	6.4	0	4.7	0
1.85	6.5	0	4.8	0
1.90	6.7	0	4.9	0
1.95	6.8	0	4.9	0
2.00	6.9	0	4.9	0
2.05	6.9	0	5.1	0
2.10	7.1	0	5.1	0
2.15	7.1	0	5.2	0
2.20	7.2	0	5.3	0
2.25	7.4	0	5.4	0
2.30	7.5	0	5.5	0
2.35	7.5	0	5.5	0
2.40	7.6	0	5.6	0
2.45	7.7	0	5.7	0
2.50	7.8	0	5.7	0
2.55	7.9	0	5.8	0
2.60	7.9	0	5.9	0
2.65	8.1	0	5.9	0
2.70	8.1	0	6.1	0
2.75	8.2	0	6.2	0
2.80	8.3	0	6.2	0
2.85	8.4	0	6.2	0
2.90	8.5	0	6.3	0
2.95	8.6	0	6.4	0
3.00	8.7	0	6.5	0
3.05	8.8	0	6.5	0
3.10	8.9	0	6.6	0
3.15	8.9	0	6.7	0
3.20	9.1	0	6.8	0
3.25	9.1	0	6.9	0
3.30	9.2	0	6.9	0
3.35	9.3	0	7.1	0
3.40	9.4	0	7.1	0
3.45	9.5	0	7.2	0
3.50	9.6	0	7.2	0

Table 1 (above and right)
Test and control limits

(Continued on page 28)

Production Aids

Impulse-Test Cathode-Ray Oscillograph

A CATHODE-RAY OSCILLOGRAPH has been developed to permit impulse-testing of high-voltage transformers, insulators, lightning arrestors, and other equipment designed to withstand surge potentials of great amplitude.

Employing a sealed-off high-vacuum *crt* and means for external photographic recording, the unit may be used with any standard impulse-test installation. Can be triggered by a sample of the test impulse. Also contains a pulse generator to trigger external circuits. An accurate quantitative measurement of the test impulse is provided by metered voltage calibration of deflection along the Y axis of the instrument and time calibration, said to be accurate within 0.1%, along with the X axis.

Permanent records are obtained with a 35-mm oscillograph-record camera employing an *f*/1.5 coated lens. A data card and color-selector mirror are arranged to permit simultaneous viewing and recording of waveforms appearing on the screen of the cathode-ray tube.

Driven, logarithmic sweeps may be initiated from an external signal, internal signal, by manual push-button, or from any point in the cycle of the 60-cycle line voltage. Sweep duration is adjustable in steps from 0.5 to 1000 microseconds. Delay of the sweep with respect to the trigger output of the instrument, is continuously variable from 0.5 to 15 microseconds, permitting detailed display of any portion of the impulse waveform.

Bandwidth of both the X and Y axes is said to be essentially uniform from *dc* to 25 megacycles. There is no distortion of pulses having a rise time of 0.01 microseconds or greater.—*Type 293; Instrument Division, Allen B. DuMont Laboratories, Inc., Clifton, N. J.*

Small Parts Welders

CONDENSER TYPE SMALL PARTS WELDERS are now being produced in standard automatic and single-purpose automatic types. Standard models produced in 100, 200 and 250-mfd sizes in split-shot and dual types. Tweezers, pencil and plier facilities available. Bench electrodes model feature tweezer-weld electrodes.—*Federal Tool Engineering, Inc., 532 Mulberry St., Newark 5, N. J.*

Federal Tool small parts welder.

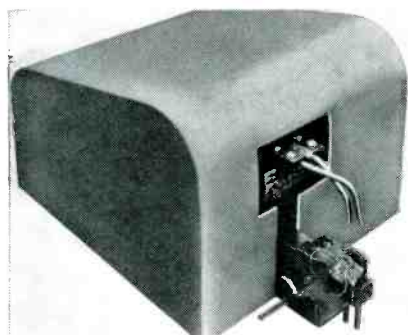

Miniature Insulated Terminals

MINIATURE INSULATED TERMINALS are now available in three lengths of dielectric and with voltage breakdown ratings up to 5800 volts.

The smallest terminal has an over-all height of $\frac{3}{8}$ " including terminal. Insulators are grade L-5 ceramic, silicone impregnated for maximum resistance to moisture and fungi—*Type X1980XA; Cambridge Thermionic Corporation, 442 Concord Ave. Cambridge 58, Mass.*

Shock Testing Machine

AN IMPACT SHOCK machine with a platform which will handle equipment as large as 36" x 36" x 30" high, weighing up to 150 pounds, is now available. Steel-sheathed blocks, attached to the underside of the platform, are said to penetrate the sand at the end of the drop to give a single deceleration pulse without rebound. The number and arrangement of blocks governs the decelerating force and the duration of the pulse. Calibration curves show the relation between height of fall, maximum deceleration, and duration of deceleration pulse for various arrangements of control blocks. Decelerations up to 100 *G* can be obtained.

Machine is 10'6" high, requires floor space 4'2" x 5'1", and weighs 3000 pounds, complete.—*Type 150 VD; The Barry Corp., 179-5 Sidney St., Cambridge 39, Mass.*

Small Wire Terminal Block

TERMINAL BLOCKS have been designed for use with small wires only, maximum of AWG 18 stranded and 16 solid. Block allows two wires to be clamped into position with positive contact. Requires loosening of one screw, inserting the stripped wire between the clamping members and retightening the screw.

Body of terminal block is molded in solid form from a general purpose thermosetting material. Screws nest in a blind hole. Any number of terminals per block, from one to twenty-two inclusive, may be had, factory assembled.—*Type E; Curtis Development and Mfg. Co., 3266 North 33rd St., Milwaukee 16, Wis.*

AUTOMATIC TUBE-CARTON PACKAGING

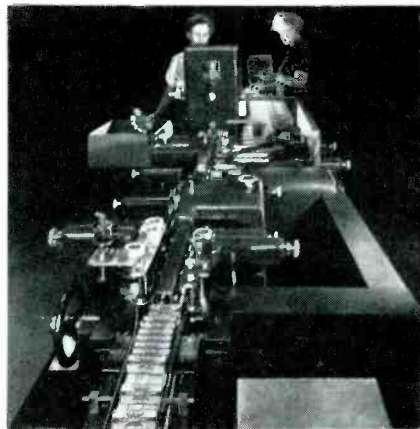

Automatic packaging machinery recently installed at the Raytheon Manufacturing Company's receiving tube division. Machinery has a boxing capacity of 50,000 to 60,000 tubes in a normal day. Tubes are automatically packed and type number imprinted by this machine all in one question.

Voltage Reference Standards

A LINE OF VOLTAGE standards said to offer a more usable reference than the standard cell since their current capacity is appreciable and since the operating temperature is not critical, is now available.

Units are sealed and said to be guaranteed to maintain rated output for a period of six months.

Dual output terminals are provided, either of which has a capacity of 50 ma; internal impedance of one output (*A*) is 8.5 ohms, of second output (*B*) 700 ohms. Output *B* is protected by its internal impedance so that shorting for an indefinite period of time will not damage the unit. Since outputs are floating with respect to the chassis, a separate chassis ground is provided by the metal binding post.

After a thirty minute stabilization period, all standards are said to have the following specifications in common: Input voltage range . . . 100-130 *vac*, 45 to 800 cycles; regulation accuracy . . . $\pm 0.5\%$; ripple . . . less than .5%; temperature range . . . 60-100 F.—*Type VS50-50; Sorenson & Company, Inc., 375 Fairfield Avenue, Stamford, Conn. Catalog B1049 contains further data.*

Locked-Flange Bobbins

COIL BOBBINS are now being made with plastic-coated cores, and the flanges locked in place on this core by the plastic.

Plastic-coated core is said to make coil bobbins 15 to 20% stronger, and increase the bobbins' insulating qualities and moisture resistance. Spiral-wound, this core can be made any size, any shape—round, square, or rectangular—and to any *id* or *od*.

Vulcanized fibre flanges are said to be strong, and are more certain to lay flat during winding, and not bulge with winding pressure. Flanges are said to make possible the elimination of cotton interweaves, and allow more ampere turns with the same watt input. Flanges can be supplied in any desired shape, and with any combination of slots or holes for terminal wiring, and can be furnished flat, recessed, or embossed.—*Precision Paper Tube Co., 2045 W. Charleston St., Chicago 47, Ill., or Plant 2, 79 Chapel St., Hartford, Conn.*

Precision Paper coil bobbins.



Field Tested Antenna Installation Information

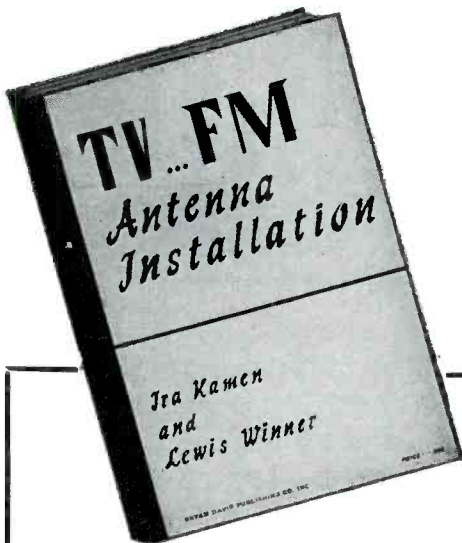

Over 35,000 words of vital data . . .
With over 130 photos and drawings . . .
Detailed illustration and subject index for rapid reference.

✓✓ "The best book on the market at this time dealing with the problem of television antennas and antenna installation . . . If more Service Men would read this book, it would help them considerably in making better installations and providing better television reception for their customers."—M. J. Shapp, President, Jerrold Electronics Corp.

✓✓ "Will recommend it to all the Service Men and technical people I meet."—Charles Cahn, Field Service Engineer, Bendix Radio.

✓✓ "Well organized and illustrated, very complete and up-to-date, carefully detailed. It will definitely improve the ability of the man who studies it and therefore is mighty useful to a firm like ours."—Hamilton Hoge, President, United States Television Mfg. Corp.

✓✓ "Will certainly fill a long-felt need for some practical information . . . sincerest congratulations."—George P. Adair, Former Chief Engineer, FCC, and now Consultant in Washington, D. C.

✓✓ "A thorough-going compendium of the installing art . . . Going to recommend it highly to our Service Control Department and our service organizations."—Ernest A. Marx, General Manager, Television Receiver Sales Div., Allen B. DuMont Laboratories, Inc.

✓✓ "Informative and extremely well written."—R. Morris Pierce, President and General Manager, WDOK.

✓✓ "Most complete analysis of the antenna installation problem I have seen as yet."—A. T. Alexander, Service Manager, Motorola, Inc.

✓✓ "First really good publication I have found on the subject."—E. K. Jett, Former FCC Commissioner and now Vice-President, WMAR.

✓✓ "I have just finished looking through your book . . . and find it very interesting and informative."—A. James Ebel, Director of Engineering, Peoria Broadcasting Co.

✓✓ "The Radio-Television Division of the Massachusetts Trades Shops Schools has just decided to incorporate the book within its curriculum . . . The book will be issued to all future television starting classes at the school."—Donald M. Bearse, Purchasing Agent, Massachusetts Trades Shops School, Boston.

TV-FM Antenna Installation

by **IRA KAMEN**

Manager, TV Dept.
Commercial Radio Sound Corp.

and **LEWIS WINNER**

Editorial Director,
Bryan Davis Pub. Co., Inc.;
Editor, SERVICE and TELEVISION ENGINEERING

The *only practical book* on the key link to TV and FM reception . . . based entirely on actual, roof-top experiences in the most active TV and FM areas in the country.

The *first book* in which you'll find complete design and installation information on every type of TV and FM receiving antenna and accessory.

10 Fact-Packed Chapters on . . .

Installation Tools	Fringe Reception
Antenna Installation Procedures	Master Antenna Systems
Securing 12-Channel Coverage	FM Antennas
HF Antenna Installations	Installation Business Practices
TV Interference	Tricks of the Trade

At your Jobber or Order
Direct . . . \$2.00 Postpaid

BRYAN DAVIS PUBLISHING CO., INC., Book Dept.
52 Vanderbilt Avenue, New York 17, N. Y.

Send me a copy of TV . . . FM Antenna Installation, post-paid, for which I am enclosing \$2.00.

(Please print)

NAME

ADDRESS

CITY AND STATE

Before Any Other Consideration

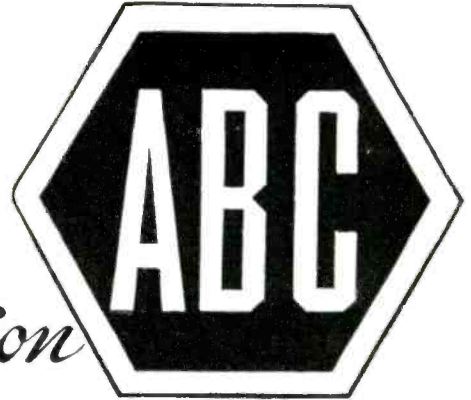

Integrity of Circulation

OF THE several factors that enter into the use of published media, the distribution of the advertisers' sales messages, as governed by the selection of media, can of itself decide the success or failure of the advertising investment. That is why integrity of circulation is the first consideration with experienced space buyers.

The emblem shown above stands for the FACTS that make it possible for advertisers to select the right media and to know what they get for their money when they invest in publication advertising. It is the emblem of membership in the Audit Bureau of Circulations, a cooperative and nonprofit association of 3300 advertisers, agencies and publishers.

Working together, these buyers and sellers of advertising have established standards for circulation

values and a definition for paid circulation, just as there are standards of weight and measure for purchasing agents to use in selecting merchandise and equipment. In other words, A.B.C. is a bureau of standards for the advertising and publishing industry.

A.B.C. maintains a staff of specially trained auditors who make annual audits of the circulations of the publisher members. Information thus obtained is issued in A.B.C. reports for use in buying and selling space. All advertising in printed media should be bought on the basis of facts in these reports.

This business paper is a member of the Audit Bureau of Circulations because we want our advertisers to know what they get for their money when they advertise in these pages. Our A.B.C. report gives the facts. Ask for a copy and then study it.

SOME OF THE AUDITED INFORMATION IN A.B.C. BUSINESS PAPER REPORTS

SEND THE RIGHT MESSAGE TO THE RIGHT PEOPLE

Paid subscriptions and renewals, as defined by A.B.C. standards, indicate a reader audience that has responded to a publication's editorial appeal. With the interests of readers thus identified, it becomes possible to reach specialized groups effectively with specialized advertising appeals.

- How much paid circulation.
- How much unpaid circulation.
- Prices paid by subscribers.
- How the circulation was obtained.
- Whether or not premiums were used as circulation inducements.
- Where the circulation goes.
- A breakdown of subscribers by occupation or business.
- How many subscribers renewed.
- How many are in arrears.

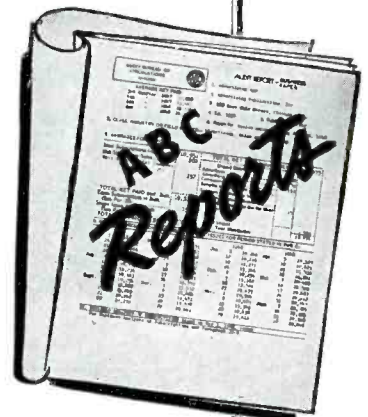

TELEVISION ENGINEERING

A.B.C. REPORTS — FACTS AS THE BASIC MEASURE OF ADVERTISING VALUE

Instrument News

Direct-Reading Capacitor Analyzer

A LABORATORY-TYPE CAPACITOR ANALYZER for determining capacitance values between 5 mmfd and 12,000 mfd; insulation resistance from 1.1 to 12,000 megohms; also leakage current, dielectric strength, and percentage power factor, is now available.—*Shallcross Manufacturing Co., Col-lingdale, Pa.*

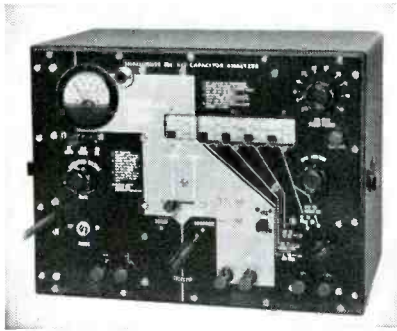

Shallcross capacitor analyzer.

Lab Tube Tester

A LAB-TYPE INSTRUMENT has been designed to test sub-miniature and TV tubes.

Tube tester scale reads directly in microhms. Has a separate meter to permit adjustment of line voltage while tube is under test. Provision is made for inserting a plate milliammeter to read plate current of the tube under test.—*Model 539, The Hickok Electrical Instrument Company, 10529 Dupont Avenue, Cleveland 8, Ohio.*

Incremental Inductance Bridge

AN INCREMENTAL INDUCTANCE BRIDGE for accurate testing of components under load conditions has been developed. Has an impedance range of one millihenry to 1,000 henries in five ranges. The inductance values are read directly from a four dial decade and multiplier switch. Range can be extended to 10,000 henries through the use of an external resistance.

Inductance accuracy is said to be within $\pm 1\%$ through the frequency range from 60 to 1,000 cycles.

On the 1,000-henry range, the *dc* is limited to 20 ma, and on the 100-henry range, the *dc* is limited to 200 ma.—*Type 1110; Freed Transformer Co., Inc., 1718-36 Weirfield Street, Brooklyn 27, New York.*



Freed inductance bridge.

UHF/VHF Standard Signal Generator

STANDARD-SIGNAL GENERATORS for the *uhf* and *vhf* bands are now available.

Models cover 50 to 250 mc, and 250 and 920 mc.

Both models use butterfly tuning elements, and coaxial, 50-ohm output systems. Output range is from 0.5 microvolt to 1 volt, open circuit. Frequency dial is direct reading to $\pm 1\%$. Leakage and residual output voltage cannot be detected with receivers of 2-microvolt sensitivity.

Internal amplitude modulation at 1000 cycles is provided and external modulation between 30 cycles and 15 kc can be applied. For applications where incidental FM must be negligible, two external modulators are available, designed to operate at the output terminal of the generator, i.e., on the output side of the attenuator. With an amplitude modulator (type 1023-A), audio modulation up to 80% can be produced at carrier frequencies up to 250 mc, and with a crystal diode modulator (type 1000-P6), television video modulation can be produced over the entire carrier frequency ranges of the generator.—Types 1021-AV (*vhf*) and 1021-AU (*uhf*); General Radio Co., 275 Massachusetts Ave., Cambridge 39, Mass.



G-R uhf/vhf signal generator.

Stabilized DC Indicating Amplifier

STABILIZED *DC* INDICATING AMPLIFIERS have been developed for low-level *dc* measurements as direct-reading microvoltmeters or micro-microammeters. Amplifiers are supplied either as voltage or current type, with choice of zero-left or zero-center built-in 4" indicating meter.

Both gain and zero point are said to be stabilized by a combination of *ac* amplification and *dc* null-balance feedback so that trimmer controls are unnecessary. Manufacturer states that the voltage amplifier can be used with sources up to 10,000 ohms resistance, and the current type with sources of 100,000 ohms and higher.

Basic range of the voltage amplifier is 0 to 50 or -25 to $+25$ microvolts, with scale multipliers of 1, 2, 4, 10, 20 and 40; the current amplifier, 0 to 1000 or -500 to $+500$ micro-microamperes, with multipliers of 1, 2, 5, 10, 20, 50, 100, 200, 500, 1000 and 2000. Response time of both models is said to be 2 to 3 seconds. Output at recorder connector for full-scale input on any range is 10 millivolts at output impedance of 500 ohms.—*Leeds & Northrup Company 4934 Stenton Avenue, Philadelphia 44, Pa.*

VHF-UHF Noise Generator

A CALIBRATED BROADBAND NOISE SOURCE which permits direct measurement of the noise factors of *rf* amplifiers and receivers operating in the 100 to 1000-mc range is now available.

A coaxial diode placed in a terminated 50-ohm transmission line is employed to generate noise power. A front panel control is provided for adjustment of the diode filament voltage, the resulting plate current being indicated on a *dc* milliammeter calibrated to read noise factor directly in db, when the noise output of the receiver under test is doubled in power.—*Type 904; Polytechnic Research and Development Co., Inc., 202 Tillary Street, Brooklyn 1, New York.*



Polytech noise generator

Electrostatic Voltmeters

ELECTROSTATIC VOLTMETERS, in portable and panel types, operating on the attraction or repulsion between two electrical surfaces, are now available for the measurement of high voltage outputs where no current can be drawn.

Useful to check the charge of capacitors, potential of *crt*, TV circuits, ionization chambers, etc.

Instruments have double pivoted movements. Mirrored scale is 5" long with hand-drawn divisions. Movement is shielded.

Furnished in single ranges, full scale from 120 to 12,000 volts and multi-ranges from 120/240 to 1000/3000/7500 volts.—*Cole Instrument Co., 1320 South Grand Ave., Los Angeles 15, Calif.*



Cole electrostatic voltmeter.

An Analysis of Single and Double Sideband Transmission

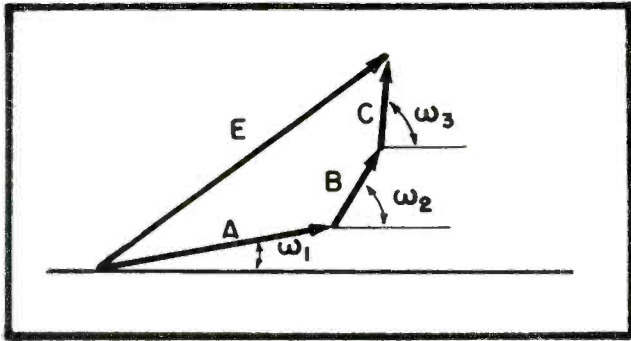

Figure 1

Rotating vectors representing the sum of three waves of different frequencies at one particular instant.

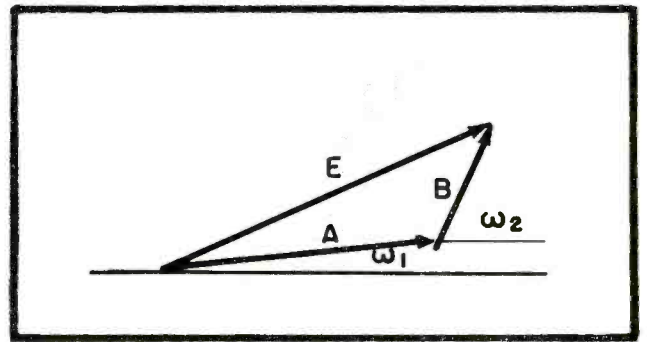

Figure 3

Rotating vectors representing the sum of two different frequencies, where A is the carrier and B the upper sideband.

TRANSMISSION of television signals involves the use of double sidebands for modulation frequencies between 0 and .75 mc. and single sidebands for modulating frequencies between 1.25 and 4.5 mc. For modulating frequencies between .75 and 1.25 mc, the lower sideband energy must be reduced from maximum (equal to upper sideband at .75 mc) to zero at 1.25 mc.¹

In Figure 1 appears the rotating vectors which represent the sum of three waves of different frequencies where A is the carrier, B the upper sideband, and C the lower sideband. This representation is for the general case where the upper and lower components are present in an amplitude-modulated envelope: the vectors are also present in an amplitude-modulated envelope. The vectors shown may be expressed in terms of the resultant (E) as follows:

$$E_x = A \cos W_1 t + B \cos W_2 t + C \cos W_3 t$$

$$E_y = A \sin W_1 t + B \sin W_2 t + C \sin W_3 t$$

$$E^2 = E_x^2 + E_y^2$$

Upon expansion this results in the expression

$$E^2 = A^2 + B^2 + C^2 + 2AB \cos (W_1 - W_2)t + 2BC \cos (W_2 - W_3)t + 2AC \cos (W_1 - W_3)t \quad (1)^*$$

Letting $\ell = W_2 - W_1 = W_1 - W_3 =$ modulating frequency
Or $2\ell = W_2 - W_3$

Equation (1) may now be reduced to:

$$E^2 = A^2 + B^2 + C^2 + 2AB \cos \ell t + 2BC \cos (2\ell)t + 2AC \cos \ell t \quad (1A)$$

For the double sideband case, vector B and vector C are equal in magnitude, and are equal to $M/2 \cdot A$, where M is the modulation factor, and lies between 0 and 1

$$\left(B = C = \frac{M}{2} A \right)$$

Substituting this factor in terms involving B and C, we have

$$E^2 = A^2 + \frac{M^2 A^2}{2} + 2MA^2 \cos \ell t + \frac{M^2 A^2}{2} \cos (2\ell)t$$

However, since: $\cos 2X = 2 \cos^2 X - 1$, $\cos (2\ell)t = 2 \cos^2 \ell t - 1$

$$E^2 = A^2 + 2MA^2 \cos \ell t + M^2 A^2 \cos^2 \ell t \quad (2)$$

To determine the resulting character of the demodulated signal when applied to a linear detector, it is necessary to extract the square root, resulting in the expression

$$E = A + MA \cos \ell t \quad (3)$$

This envelope is described graphically in Figure 2. The crest of the envelope occurs when

$$\cos \ell t = 1, E_{\text{crest}} = A + MA.$$

The trough of the envelope occurs when

$$\cos \ell t = -1, E_{\text{trough}} = A - MA.$$

¹See papers on TV Transmitter Lower Sideband Measurements, by the authors, in which this condition was reviewed generally; April and May, 1950, TELEVISION ENGINEERING.

The peak-to-peak amplitude of the modulation component = $E_{\text{crest}} - E_{\text{trough}}$
or $A + MA - A + MA = 2MA$.

For the case where only the carrier and upper sideband are present, equation (1a) may be reduced to

$$E^2 = A^2 + B^2 + 2AB \cos \ell t \quad (4)$$

since the lower sideband may be neglected. This is shown graphically in Figure 3.

To determine the resulting demodulated signal when the envelope (expressed in equation 4) is applied to a linear detector, it is necessary to extract the square root. This may be accomplished by use of the binomial theorem, which states that

$$(a + b)^{\frac{1}{2}} = a^{\frac{1}{2}} + \frac{1}{2} a^{-\frac{1}{2}} b - \frac{1}{8} a^{-\frac{3}{2}} b^2 + \frac{1}{16} a^{-\frac{5}{2}} b^3 - \frac{5}{128} a^{-\frac{7}{2}} b^4 + \frac{7}{256} a^{-\frac{9}{2}} b^5 - \dots$$

Substituting equation (4) in this series, and letting

$$A^2 + B^2 = a$$

$$2AB \cos \ell t = b$$

$$E = (a + b)^{\frac{1}{2}}$$

we have the following equation

*Everitt, Communication Engineering, page 407.

Mathematical Study of Double and Single Sideband Transmission Systems Reveals That Attenuation Can Vary Between Approximately 6 and 7 Db, Depending on Modulation Factor, and in The Instance of Double Sidebands the Detector Need Respond Only to Modulating Frequencies. Infinitely-Wide Detector System Found Necessary for Single Sideband Transmission to Reproduce Faithfully all Modulation Components.

by **G. EDWARD HAMILTON**

and

R. G. ARTMAN

Eastern Division TV Engineer
American Broadcasting System

Chief TV Engineer
Midland Broadcasting Co. (WMBC)

$$E = \frac{A^2 + B^2}{2} + \frac{AB \cos \epsilon t}{(A^2 + B^2)^{\frac{1}{2}}} - \frac{(AB \cos \epsilon t)^2}{2(A^2 + B^2)^{\frac{3}{2}}} + \frac{(AB \cos \epsilon t)^3}{2(A^2 + B^2)^{\frac{5}{2}}} - \frac{5}{8} \frac{(AB \cos \epsilon t)^4}{(A^2 + B^2)^{\frac{7}{2}}} + \frac{7}{8} \frac{(AB \cos \epsilon t)^5}{(A^2 + B^2)^{\frac{9}{2}}} - \frac{21}{16} \frac{(AB \cos \epsilon t)^6}{(A^2 + B^2)^{\frac{11}{2}}} + \frac{33}{16} \frac{(AB \cos \epsilon t)^7}{(A^2 + B^2)^{\frac{13}{2}}} - \dots$$

As explained for the general case, $M = \frac{A}{B}$ ∴

$$E = A \left[\frac{1}{2} \sqrt{M^2 + 4} + \frac{M \cos \epsilon t}{\sqrt{M^2 + 4}} - \frac{M^2 \cos^2 \epsilon t}{\sqrt{(M^2 + 4)^3}} + \frac{2M^3 \cos^3 \epsilon t}{\sqrt{(M^2 + 4)^5}} - \frac{5M^4 \cos^4 \epsilon t}{\sqrt{(M^2 + 4)^7}} + \frac{14M^5 \cos^5 \epsilon t}{\sqrt{(M^2 + 4)^9}} - \frac{42M^6 \cos^6 \epsilon t}{\sqrt{(M^2 + 4)^{11}}} + \frac{132M^7 \cos^7 \epsilon t}{\sqrt{(M^2 + 4)^{13}}} - \dots \right]$$

$$\frac{E}{A} = \left[\left(\frac{1}{2} \sqrt{M^2 + 4} - \frac{M^2}{2\sqrt{(M^2 + 4)^3}} - \frac{15}{8} \frac{M^4}{\sqrt{(M^2 + 4)^5}} - \frac{105}{8} \frac{M^6}{\sqrt{(M^2 + 4)^{11}}} \right) + \left(\frac{M}{\sqrt{M^2 + 4}} + \frac{3M^3}{2\sqrt{(M^2 + 4)^5}} + \frac{35}{4} \frac{M^5}{\sqrt{(M^2 + 4)^9}} + \frac{1155}{16} \frac{M^7}{\sqrt{(M^2 + 4)^{13}}} \right) \cos \epsilon t - \left(\frac{1}{2} \frac{M^2}{\sqrt{(M^2 + 4)^3}} + \frac{5}{2} \frac{M^4}{\sqrt{(M^2 + 4)^7}} + \frac{315}{16} \frac{M^6}{\sqrt{(M^2 + 4)^{11}}} \right) \cos 2\epsilon t + \left(\frac{1}{2} \frac{M^3}{\sqrt{(M^2 + 4)^5}} + \frac{35}{8} \frac{M^5}{\sqrt{(M^2 + 4)^9}} + \frac{693}{16} \frac{M^7}{\sqrt{(M^2 + 4)^{13}}} \right) \cos 3\epsilon t - \left(\frac{5}{8} \frac{M^4}{\sqrt{(M^2 + 4)^7}} + \frac{63}{8} \frac{M^6}{\sqrt{(M^2 + 4)^{11}}} + \dots \right) \cos 4\epsilon t + \left(\frac{7}{8} \frac{M^5}{\sqrt{(M^2 + 4)^9}} + \frac{231}{16} \frac{M^7}{\sqrt{(M^2 + 4)^{13}}} + \dots \right) \cos 5\epsilon t \right] \quad (5)$$

It is to be noted that terms involving the higher order harmonics have been included in the derivation, so that the lower order harmonics (where more distortion occurs) may be more accurate. To evaluate equation (5) it is necessary to substitute values of M between the limits of zero and one, the

results of which are shown in the data for the *dc* component, fundamental, and second, third, fourth and fifth harmonics.

In Figure 4 appear table 1 data plotted in a series of curves of per cent harmonic content with respect to the fundamental for different values of modulation factor, M .

A comparison of the linear detector output for the double-sideband and single-sideband transmission systems, considering only the peak fundamental components, results in the following conclusions:

$$\frac{\text{Double sideband response}}{\text{Single sideband response}} = \frac{MA \cos \epsilon t}{\frac{AB \cos \epsilon t}{\sqrt{A^2 + B^2}}}$$

The following identities are useful in solving the foregoing equations

$$\begin{aligned} \cos^2 X &= \frac{\cos 2X + 1}{2} \\ \cos^3 X &= \frac{\cos 3X + 3\cos X}{4} \\ \cos^4 X &= \frac{1}{8} \cos 4X + \frac{1}{2} \cos 2X + \frac{3}{8} \\ \cos^5 X &= \frac{1}{16} \cos 5X + \frac{5}{16} \cos 3X + \frac{5}{8} \cos X \\ \cos^6 X &= \frac{1}{32} \cos 6X + \frac{3}{16} \cos 4X + \frac{15}{32} \cos 2X + \frac{5}{16} \\ \cos^7 X &= \frac{1}{64} \cos 7X + \frac{7}{64} \cos 5X + \frac{21}{64} \cos 3X + \frac{35}{64} \cos X \end{aligned}$$

Figure 2

Graphical representation of equation (3).

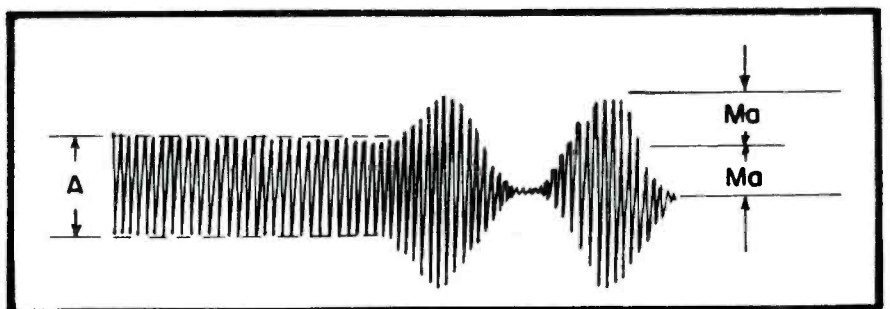

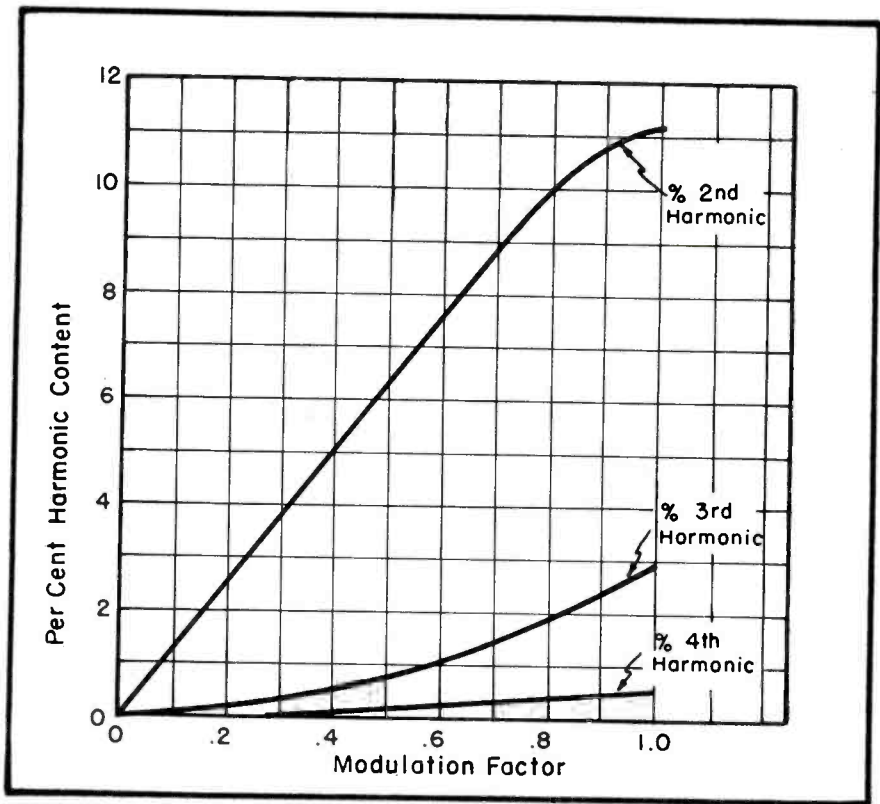

Figure 4

Curves illustrating the effect of modulation percentage with respect to the harmonic content introduced by linear detection of a single sideband transmission system.

Table 1
Evaluation of Equation 5 For Different Modulation Factors

DC Value of M	Fundamental Component	2nd Harmonic	2nd Harmonic Distortion %	3rd Harmonic	3rd Harmonic Distortion %	4th Harmonic	4th Harmonic Distortion %	5th Harmonic	5th Harmonic Distortion %	
1	1.0643	.485	.0544	11.2	.0141	2.91	.00289	.596	.000826	.17
.9	1.0505	.438	.0473	11.	.0113	2.58	.00246	.557	.000706	.161
.8	1.6403	.392	.0399	10.2	.00742	1.89	.00164	.420	.000432	.11
.7	1.032	.344	.0295	8.6	.00487	1.42	.000988	.287	.000209	.061
.6	1.0404	.297	.0222	7.5	.00333	1.12	.000600	.202	.000124	.0418
.5	1.0148	.247	.0155	6.28	.00182	.737	.000291	.118	.0000335	.0135
.4	1.0102	.199	.00987	4.96	.00098	.498	.000120	.0604	.0000169	.0085
.3	1.0045	.150	.00565	3.77	.00042	.280	.000039	.026	.00000297	.00198

Since $B = \frac{M}{2} A$, we have

$$\frac{d s b}{s s b} = \sqrt{M^2 + 4}$$

M	Ratio	db
1	2.23	6.98
.9	2.19	6.84
.8	2.15	6.66
.7	2.12	6.54
.6	2.08	6.36
.5	2.06	6.28
.4	2.04	6.20
.3	2.02	6.12

Thus, it will be noted that attenuation will vary between approximately 6 and 7 db, depending on the modulation factor, and that in the double-sideband case, the detector need respond only to the modulating frequencies. However, in the case of single sideband transmission, an infinitely wide detector system is required to faithfully reproduce all the modulation components. When we consider that the modulation of the higher frequency components (video information) occurs between the levels of approximately 75 and 25%, as shown in Figure 5(b), the harmonic content is so low as to be negligible, and linear detectors with restricted bandwidth are satisfactory.

*This paper was prepared while the authors were at Allen B. DuMont Labs, where Hamilton served as head of the TV RF Development Section and Artman was a senior development engineer in the TV RF Development Section.

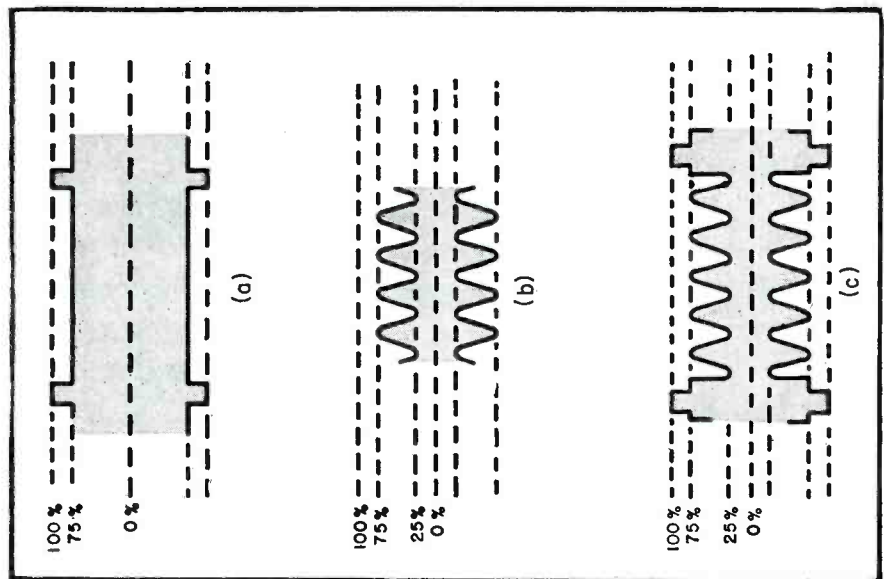

Left, center: Table 1

Evaluation of equation 5 for different modulation factors

Left: Figure 5

Transmitter output waveforms occurring during measurement of sideband amplitude: (a) "Black Picture" operation, (b) sine wave modulation, (c) synthetic video signal modulation.

It's EASY to install "Payroll Savings"

... and 20,000 companies' experience proves it pays!

If you've put off installing the Payroll Savings Plan in your company because you feel it would be "a lot of work," then this advertisement is certainly for you! Because it's really very simple to give your employees the advantages of investing in U. S. Savings Bonds the easy, automatic, "Payroll" way.

HERE'S ALL YOU NEED TO DO

Appoint one of your top executives as Savings Bond Officer. Tell him to get in touch with your State Director, Savings Bonds Division, U. S. Treasury Department. Here's what happens . . .

The State Director will provide application cards for your employees to sign—plus as much promotional material and personal help as necessary to get the Plan rolling in your company.

Those employees who want Savings Bonds indicate on the applications: how much to save from their pay; what denomination of Bonds they want; and the inscription information to appear on the Bonds.

Your payroll department arranges to withhold the specified amounts, arranges to get the Bonds, and delivers them to the employees with their pay.

The Bonds may be obtained from almost any local bank or from the Federal Reserve Bank or may be issued by the company itself upon proper certification by the Federal Reserve Bank or Branch in the company's District.

THAT'S ALL THERE IS TO IT!

In case you're skeptical as to how many of your employees would like to have Payroll Savings, canvass your plant—and be prepared for a surprise. (Remember that pay-check withholdings for Bonds are *not* a "deduction"—the employee takes home his Bonds with his pay.) One leading manufacturer, who had professed little faith in the Plan, found his eyes opened when he asked the people in his plant whether they would like to obtain Bonds in this way. Within only six months after he installed the

Plan, half his employees signed up. A prominent aircraft manufacturer, whose company had used the Plan for some time, was not aware of its potentialities until his personal sponsorship increased participation by 500% among his company's employees.

THE BENEFITS ARE BIG— FOR EVERYONE

The individual employees gain security—they know that the Bonds they hold will return \$4 for every \$3 at maturity. The company gains from

the resultant increased stability and efficiency of its workers. The whole nation gains because Bond sales help stabilize our economy by spreading the national debt and by creating a huge backlog of purchasing power to boost business in the years ahead.

Is it *good policy* to deprive your company of Payroll Savings—even one more pay day? Better at least have a talk with your U. S. Savings Bonds State Director, get the answers to your questions, and *know for sure*.

The Treasury Department acknowledges with appreciation the publication of this message by



TELEVISION ENGINEERING

This is an official U. S. Treasury advertisement prepared under the auspices of the Treasury Department and The Advertising Council.



Group Subscription Plan

You Save Half of the Subscription Price if Four or More Orders, Including Your Own, Are Properly Entered on This Form

To the Publishers of

TeleVision Engineering, 52 Vanderbilt Avenue, New York 17, N. Y.

Please enter two-year subscriptions (24 issues) for each of the undersigned for which payment is enclosed at the rate of \$3.00 each. (This rate applies only on 4 or more subscriptions when occupations are given.)
Regular cost is \$3.00 for one year.

Name

Address

City..... Zone..... State.....

Occupation..... Title.....

Department in which employed

Operation Production Research

Employed by

Nature of Business.....

(State if TV Manufacturer, TV Broadcast Station, etc.)

Name

Address

City..... Zone..... State.....

Occupation..... Title.....

Department in which employed

Operation Production Research

Employed by

Nature of Business.....

(State if TV Manufacturer, TV Broadcast Station, etc.)

Name

Address

City..... Zone..... State.....

Occupation..... Title.....

Department in which employed

Operation Production Research

Employed by

Nature of Business.....

(State if TV Manufacturer, TV Broadcast Station, etc.)

Name

Address

City..... Zone..... State.....

Occupation..... Title.....

Department in which employed

Operation Production Research

Employed by

Nature of Business.....

(State if TV Manufacturer, TV Broadcast Station, etc.)

Business or professional classifications are required to complete our records. Each subscriber should write one of the following classifications in space indicated. Use separate sheet of paper for additional names.

CHIEF ENGINEER ENGINEER EXECUTIVE
PURCHASING AGENT DEPARTMENT MANAGER

State your classification if not listed.

This Group Sent In By —

Name

Address

Tube Developments

(Continued from page 11)

this value for a short period. Because the plate dissipation will increase in proportion to the square of the plate current, the fuse in the plate supply circuit should not be relied on to protect the tube against damage when there is a loss of driving voltage.

Width-Control Considerations

There are two components functioning as width controls in this circuit: width control, L_2 , which is connected to terminals 1 and 2 of the horizontal output transformer, and a 200-ohm variable resistor, R_{11} , which is in series with the B supply for the deflection circuits. Either of these controls may be used. The use of the L_2 width control permits changing the picture width approximately 10 per cent with a change in anode voltage of approximately 300 volts. The use of the 200-ohm variable resistor provides a picture width change of approximately 15 per cent, but produces an accompanying anode voltage change of approximately 15 per cent. In this type of circuit, where the vertical deflection power is the boosted voltage taken from the horizontal deflection circuit, it will be found that picture height as well as width will change when the resistor is varied. Consequently, where the initial adjustment of aspect ratio is made, a 3-megohm height control, R_{20} , must be used.

The width-control resistor also provides a means of compensating for the normally encountered changes in line voltage by controlling the power input to both deflection circuits. Under conditions of low-line voltage, when an increase in picture size is required, adjustment of the variable resistor provides not only an increase in picture size, but also an increase in anode voltage. Because the variable is not bypassed, the power dissipated in it is the product of the *rms* current squared and the resistance. The *rms* current, which must be measured with a thermal-type meter, is greater than the direct current.

Plate Pulse Voltage

During the retrace interval, a positive voltage pulse of 5,500 is impressed on the plate of the horizontal-power-output tube. A portion of this pulse is fed back to the control grid through the grid-plate capacitance of the tube and associated wiring. This pulse opposes the action of the negative peaking pulse and, if it is too large, will prevent the maintenance of plate-current cutoff during the retrace interval. To minimize

BIRTCHEr

STAINLESS STEEL - LOCKING TYPE

TUBE CLAMPS

Stainless Steel

Corrosion Proof



83 VARIATIONS

Where vibration is a problem, Birtcher Locking TUBE CLAMPS offer a foolproof, practical solution. Recommended for all types of tubes and similar plug-in components.

More than three million of these clamps in use.

FREE CATALOG

Send for samples of Birtcher stainless steel tube clamps and our standard catalog listing tube base types, recommended clamp designs, and price list.

THE BIRTCHEr CORPORATION
5087 HUNTINGTON DR. LOS ANGELES 32



HOTEL STRAND

**ATLANTIC CITY'S
IDEAL CONVENTION HOTEL**

Exceptional Convention Facilities adaptable to small, medium or large groups. Ample Meeting, Banquet and Exhibition Rooms. Wonderful location on Boardwalk opposite Steel Pier, the center of Atlantic City. Write Convention Manager TODAY.

The Strand features Spacious Colorful Lounges — Open and Inclosed Solaria — Salt Water Baths in Rooms — Garage on premises. Courteous Personnel.

**When in Atlantic City visit
FAMOUS FIESTA LOUNGE**

"Food for Epicures"

Exclusive Penna. Avenue and Boardwalk

the effect of this feedback pulse, the wiring must be dressed to reduce grid-plate capacitance in the external circuit as much as possible. In addition, the value of the charging capacitor should be as large as practical so that the signal fed back through the interelectrode capacitance will have little effect upon the driving circuit.

If the plate-to-ground insulation or spacing of the 6CD6G is inadequate, the 5,500-volt pulse impressed on the tube plate during retrace will cause ar-over and corona. To minimize these undesirable effects, it is necessary to use soldered joints which are smooth and free from projecting points.

Power Supply and Shielding

Series power feedback has been used to increase the overall circuit efficiency and reduce the *B*-supply voltage required. With a *B*-supply voltage of 350, the boosted voltage of approximately 500 results. The circuit arrangement also provides a current of approximately 18 milliamperes at 500 volts for the discharge and vertical-deflection circuits. Changes in the load on the 500-volt supply, due to the discharge and vertical-deflection circuits, will affect the distribution of currents in the horizontal output tube and diode damper, and will require a change in transformer ratio to maintain good linearity.

Shielding of the complete horizontal-deflection and high-voltage system has been found necessary because radiation of harmonic frequencies may interfere with nearby AM and FM receivers, as well as with *r/f* and *i/f* circuits in the television receiver itself. This shielding must also isolate the horizontal oscillator and driver circuits from the horizontal-output and high-voltage circuits to prevent self-oscillation caused by stray capacitive coupling of the retrace pulse back to the oscillator. It is possible to use one ventilated metal enclosure for the entire horizontal system, provided the enclosure is arranged with a partition to provide the necessary isolation of the oscillator. This arrangement eliminates the need for a separate shield for the oscillator and permits access to all tubes with the removal of a single shield.

The high-voltage output, necessary for the anode, is supplied by a voltage-doubling circuit. Before the circuit is put into operation, it is important to test the high-voltage capacitors for leakage at full rated working voltage.

*Based on copyrighted notes prepared by the tube department of RCA.

EMSCO

FREE-STANDING SQUARE RADIO TOWERS

**Engineered for
Maximum Safety
Minimum Maintenance**

Emsco square self-supporting towers are conservatively engineered according to RMA standards to provide for wind pressures up to 50 lbs.-per-sq.-ft. Several planes of torque bracing prevent twisting of towers. Square cross section with lacing of all four sides provides an extremely strong, rigid structure. Hot dip galvanizing insures long life, low maintenance and maximum electrical conductivity. Standard square self-supporting towers available in heights to 500 feet with 30, 40 or 50 lb. RMA design. Whether your tower requirements be 40' or 1000', there is an Emsco tower engineered for your needs. Write for new bulletin.

Shown here is an Emsco Type 2RT 120-foot 40 lb. RMA design tower installed for Southwestern Bell Telephone Co. in Dallas, Texas. →

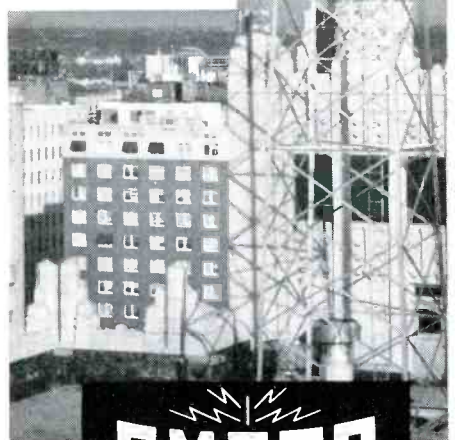

EMSCO
TOWERS OF
STRENGTH

EMSCO DERRICK & EQUIPMENT COMPANY
LOS ANGELES, CALIFORNIA
Houston, Texas • Garland, Texas

Attenuation Pads

(Continued from page 7)

$$Y = 2Z \frac{K}{K^2 - 1} = 2Z (Y^k)$$

$$K = \text{Anti-Log} \frac{db}{20}$$

$$Y = \frac{K}{K - 1}$$

Formulas for the T pad:

$$X = Z \frac{K - 1}{K + 1} = Z (X^k)$$

$$Y = 2Z \frac{K}{K^2 - 1} = 2Z (Y^k)$$

$$X^k = \frac{K - 1}{K + 1}$$

Db	K I/I	Y ^k	X ^k
1	1.122	4.48	.0566
2	1.159	2.17	.15
3	1.413	1.43	.17
4	1.58	1.055	.223
5	1.778	.829	.28
6	1.995	.667	.333
7	2.24	.563	.3805
8	2.51	.473	.43
9	2.82	.409	.476
10	3.16	.352	.52
11	3.55	.308	.56
12	3.98	.269	.598
13	4.47	.235	.635
14	5.01	.208	.667
15	5.62	.184	.699
16	6.31	.162	.726
17	7.05	.1445	.753
18	7.94	.1282	.776
19	8.91	.1144	.789
20	10.00	.1011	.818
21	11.21	.09	.836
22	12.58	.08	.853
23	14.12	.0711	.868
24	15.85	.0636	.881
25	17.75	.0565	.894
26	19.95	.0505	.906
27	22.40	.0448	.914
28	25.10	.04	.923
29	28.20	.0356	.93
30	31.60	.0316	.939
31	35.50	.0282	.951
32	39.90	.0251	.951
33	44.60	.0225	.955
34	50.00	.0201	.96
35	56.20	.01785	.965
36	63.00	.0159	.968
37	70.80	.01415	.972
38	79.30	.0126	.975
39	89.10	.0125	.978
40	100.00	.01	.98
41	112.00	.00892	.982
42	126.00	.00792	.984
43	141.00	.00708	.9855
44	158.00	.00631	.9875
45	178.00	.00562	.989
46	200.00	.005	.99

(When using these tables, the input and output impedances are to be considered as identical.)

Table 1
Table and formulas (above) for calculating values in H and T type attenuation pads.

Quality Control

(Continued from page 17)

\bar{c}	UTL	LTL	UCL	LCL
3.55	9.7	0	7.3	0
3.60	9.8	0	7.4	0
3.65	9.9	0	7.5	0
3.70	9.9	0	7.5	0
3.75	9.9	0	7.6	0
3.80	10.1	0	7.7	0
3.85	10.1	0	7.8	0
3.90	10.2	0	7.8	0
3.95	10.3	0	7.9	0
4.00	10.4	0	8.1	0
4.05	10.5	0	8.1	0
4.10	10.6	0	8.2	0
4.15	10.7	0	8.2	0
4.20	10.8	0	8.3	0
4.25	10.8	0	8.4	0
4.30	10.9	0	8.5	0
4.35	10.9	0	8.5	0
4.40	11.1	0	8.6	0
4.45	11.2	0	8.7	0
4.50	11.3	0	8.7	.1
4.55	11.3	0	8.8	.1
4.60	11.4	0	8.9	.1
4.65	11.4	0	8.9	.1
4.70	11.5	0	9.1	.2
4.75	11.6	0	9.1	.2
4.80	11.7	0	9.2	.2
4.85	11.8	0	9.2	.2
4.90	11.9	0	9.3	.3
4.95	11.9	0	9.4	.3
5.00	11.9	0	9.5	.3
5.05	12.1	0	9.5	.3
5.10	12.2	0	9.7	.4
5.15	12.2	0	9.7	.4
5.20	12.3	0	9.8	.4
5.25	12.4	0	9.8	.4
5.30	12.5	0	9.9	.5
5.35	12.6	0	9.9	.5
5.40	12.7	.1	10.1	.5
5.45	12.8	.1	10.1	.5
5.50	12.8	.1	10.2	.6
5.55	12.9	.1	10.3	.6
5.60	12.9	.2	10.3	.6
5.65	13.1	.2	10.4	.7
5.70	13.2	.2	10.5	.7
5.75	13.2	.2	10.5	.7
5.80	13.3	.3	10.6	.7
5.85	13.4	.3	10.7	.8
5.90	13.5	.3	10.8	.8
5.95	13.5	.3	10.8	.8
6.00	13.6	.4	10.9	.9
6.05	13.7	.4	10.9	.9
6.10	13.8	.4	11.1	.9
6.15	13.9	.4	11.1	.9
6.20	13.9	.5	11.1	.9
6.25	13.9	.5	11.2	1.1
6.30	14.1	.5	11.3	1.1
6.35	14.1	.5	11.4	1.1
6.40	14.2	.6	11.5	1.1
6.45	14.3	.6	11.5	1.1
6.50	14.3	.6	11.6	1.2
6.55	14.4	.7	11.7	1.2
6.60	14.5	.7	11.7	1.2
6.65	14.6	.7	11.8	1.2
6.70	14.6	.7	11.9	1.3
6.75	14.7	.8	11.9	1.3
6.80	14.8	.8	12.1	1.3
6.85	14.8	.8	12.1	1.3
6.90	14.9	.9	12.2	1.4
6.95	14.9	.9	12.2	1.4
7.00	14.9	.9	12.3	1.4

\bar{c}	UTL	LTL	UCL	LCL
7.05	15.1	.9	12.4	1.4
7.10	15.1	.9	12.4	1.5
7.15	15.2	.9	12.5	1.5
7.20	15.3	1.1	12.6	1.5
7.25	15.4	1.1	12.6	1.5
7.30	15.5	1.1	12.7	1.6
7.35	15.5	1.1	12.8	1.6
7.40	15.6	1.1	12.8	1.6
7.45	15.7	1.2	12.9	1.6
7.50	15.8	1.2	12.9	1.6
7.55	15.8	1.2	13.1	1.7
7.60	15.9	1.2	13.1	1.7
7.65	16.1	1.3	13.2	1.7
7.70	16.1	1.3	13.3	1.7
7.75	16.2	1.3	13.3	1.8
7.80	16.2	1.3	13.4	1.8
7.85	16.3	1.3	13.4	1.8
7.90	16.4	1.3	13.5	1.8
7.95	16.4	1.4	13.6	1.9
8.00	16.5	1.4	13.7	1.9
8.05	16.6	1.4	13.7	1.9
8.10	16.7	1.4	13.8	1.9
8.15	16.7	1.5	13.9	1.9
8.20	16.8	1.5	13.9	1.9
8.25	16.9	1.5	13.9	1.9
8.30	16.9	1.5	14.1	2.1
8.35	17.1	1.6	14.1	2.1
8.40	17.1	1.6	14.2	2.1
8.45	17.2	1.6	14.3	2.1
8.50	17.3	1.6	14.3	2.2
8.55	17.3	1.7	14.4	2.2
8.60	17.3	1.7	14.5	2.2
8.65	17.4	1.7	14.5	2.2
8.70	17.5	1.8	14.6	2.3
8.75	17.6	1.8	14.7	2.3
8.80	17.6	1.8	14.7	2.3
8.85	17.7	1.9	14.8	2.4
8.90	17.8	1.9	14.8	2.4
8.95	17.9	1.9	14.9	2.4
9.00	17.9	1.9	14.9	2.5
9.05	18.1	1.9	15.1	2.5
9.10	18.1	2.1	15.1	2.5
9.15	18.2	2.1	15.2	2.6
9.20	18.2	2.1	15.2	2.6
9.25	18.3	2.1	15.3	2.6
9.30	18.4	2.1	15.4	2.7
9.35	18.4	2.2	15.4	2.7
9.40	18.5	2.2	15.5	2.7
9.45	18.6	2.2	15.6	2.8
9.50	18.6	2.3	15.6	2.8
9.55	18.7	2.3	15.7	2.8
9.60	18.8	2.3	15.8	2.8
9.65	18.9	2.4	15.8	2.9
9.70	18.9	2.4	15.9	2.9
9.75	18.9	2.4	15.9	2.9
9.80	19.1	2.4	16.1	2.9
9.85	19.2	2.5	16.1	3.1
9.90	19.2	2.5	16.2	3.1
9.95	19.3	2.5	16.2	3.1
10.00	19.4	2.6	16.3	3.1

Table 1 (left and above)
Test and control limits

Bibliography

- ASTM Manual on Presentation of Data*, American Society for Testing Materials, Philadelphia; 1940
- Croxton, F. E., and Cowden, D. J. *Applied General Statistics*; Prentice-Hall, Inc.; New York, 1939
- Freeman, H. A., Friedman, M., Mosteller, F., and Wallis, W. A., *Sampling Inspection*, McGraw-Hill Book Co.; New York, 1948

Personals

Glen H. Browning, president of Browning Laboratories, Inc., recently received an honorary degree of Doctor of Science from Cornell College, Mount Vernon, Iowa.

Browning, who graduated from Cornell College in 1921, was president of his class and was awarded Phi Beta Kappa. He was also awarded a Lydia C. Perkins scholarship to Cruft Laboratory, graduate work, at Harvard University.



Glenn H. Browning

Samuel Freedman, formerly new developments engineer and in charge of sales engineering for DeMornay Budd, Inc., of New York and California, has organized the Technical Products and Services Company, Gillespie Airport, Santee, California.

Freedman, during World War II, headed submarine electronics at the New London, Conn., submarine base. He was demobilized as a Commander, USNR, in charge of planning at the Navy Electronics Laboratory in San Diego, August, 1946.

In his new assignment, Freedman will compile literature and catalogs on new developments for schools and laboratories, which include improvement of the use of the spectrum by single sideband and toroidal filter channelizing techniques, the use of helical wave coils to replace waveguides in broad-band applications, etc.



Samuel Freedman

Al Isberg, KRON-TV's chief engineer, has been elected chairman of the San Francisco Chapter of the IRE. *J. R. Whinnery*, associate Professor of Electrical Engineering at the University of California, was elected vice chairman and *Allan R. Ogilvie*, plant manager, Remler Co., secretary-treasurer. Elected to the board of directors were *William R. Hewlett*, *Herman Held*, *W. G. Wagener* and *Leonard Black*.



Al Isberg

Ben Farmer has been appointed sales manager of The Rauland Corp., 4245 North Knox Ave., Chicago 41, Ill.



Ben Farmer

Rodney D. Chipp, director of engineering for the DuMont TV network, has been elected chairman of the IRE New York section.

Other officers elected include: vice chairman, *J. H. Mulligan, Jr.*; secretary, *H. T. Budenbom*; and treasurer, *H. S. Moncton*.



R. D. Chipp

Mel Byron is now chief engineer of Electronic Instrument Co., Inc., 276 Newport Street, Brooklyn 12, N. Y.



Mel Byron

Gilbert E. Gustafson, vice president in charge of engineering at Zenith Radio, recently received an honorary degree in electrical engineering from Stevens Institute of Technology.

WHEN YOU CHANGE YOUR ADDRESS

Be sure to notify the Subscription Department of TELEVISION ENGINEERING, 52 Vanderbilt Avenue, New York 17, N. Y., giving the old as well as the new address, and do this at least four weeks in advance. The Post Office Department does not forward magazines unless you pay additional postage, and we cannot duplicate copies mailed to the old address. We ask your cooperation.

AT CINCINNATI IRE MEETING

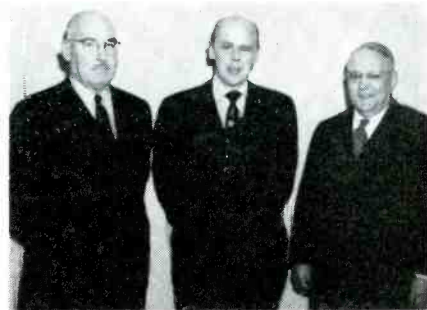

Above: Ray Guy, IRE prexy; J. D. Reid, Regional 5 IRE Director; and J. Hunter, Past IRE Director of Region 5, at the recent fourth annual spring technical conference of the Cincinnati IRE section, during which over 350 attended. Below, left: E. W. Ulm, of Sylvania, who presented a paper on the applications of germanium rectifiers, at the conference. Below, right: Robert P. Wakeman, of Allen B. DuMont Labs, who discussed an integrated nationwide TV allocation plan at the meeting. Others at the meeting included D. W. Pugsley of G. E., describing 41-mc i's and Frank Bingley of Philco, who reviewed applications of recent developments of the communications theory, including the art of sampling, to color TV.



IN CHICAGO AT THE NAB MEETING



Charles E. Denny, and Jacob A. Young, of WERC, Erie, Pa., discussing with David Newborg, RCA, Cleveland Office, the RCA tape recorder which features finger-tip push-button controls (shown just below the lower spool).

EMPIRE STATE ANTENNA

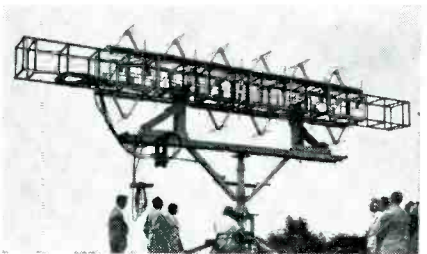

TV antenna, one of five designed for the multiple video and FM antenna system, now being installed on the Empire State Building, N. Y. City, on a revolving turret during recent tests by RCA engineers at a site near Camden, N. J.



Officers

LEE DE FOREST, *Honorary President*
WILLIAM J. MCGONIGLE, *President*
E. N. PICKERILL, *2nd Vice President*
WM. C. SIMON, *Secretary*
R. J. IVERSEN, *Assistant Secretary*
C. D. GUTHRIE, *Treasurer*

Board of Directors

GEORGE H. CLARK CAPT. FRED MULLER
A. J. COSTIGAN HARADEN PRATT
C. D. GUTHRIE WILLIAM C. SIMON
WILLIAM J. MCGONIGLE GEORGE E. STERLING

Personals

ERO ERICKSON, now a radio supervisor of the Illinois State Police, with headquarters in Chicago, reports that he is quite busy supervising and pounding brass at WQPC on a very fast circuit in the civil net of the Interzone Service. Ero was recently elected to the office of secretary of the Chicago Mobile Radio Club. In a postscript to ye secretary, Ero asks if any old brass pounders can recall KMA. How about it? . . . A. G. Cooley, who started way back in '16, aboard the SS Admiral Evans, is now with us as a life member. AGC has had a striking record of achievements since the early days. In '18 '19 he worked at Puget Sound Navy Yard station NPC, Seattle KPA and NVL. After that he served aboard the SS West Hazeltine, West Arrow, and then at many other ships, until '22, when he became interested in facsimile. Since '35 he has been with the *N. Y. Times* as manager of the Times Facsimile Corp. . . . Another new member in our ranks, Irving Strobing, has informed us that he saw service in the Phillipines in the Army at WVAH in August '41. Then he went to WTA and WTA/WVDM where he sent the last message from Corregidor before the Japs arrived. From May 6, '42 until Sept. 5, '45 he was a prisoner of war. After being liberated he was assigned to WAR in Washington, where he was stationed from October '45 to '46. Until '49 he was attached to the Army Security Agency, part time in Washington and some overseas. Since May, '49, he has been classified as totally disabled. . . . George D. Burns of Thornwood, N. Y., is now a VWOAer. He began his radio days in September '17, when he saw service aboard such ships as the El Sol, US Army Transports, Concord and Lexington of the National Signaling Co., and the Canadian Flag SS Turret Crown. . . . N. E. Blackie, who lives at Redondo Beach, Calif., sends 73's to all the old timers. He is now with the Navy at the Long Beach Naval Shipyard, as supervisor of the

Twenty-six years ago with VWOA veterans: Tony Tomburino reporting to E. N. Pickerill, then chief radio officer of the S. S. Leviathan, in November, 1924.



electronic shop. He's also a ham, W6WNZ. . . . J. Christianson is at Rocky Point, L. I., with the A. T. & T. long-wave station, which is used only during magnetic disturbances. . . . The last word we received from S. W. Fenton was that he was still in Greece and expected to be there for another 18 months. . . . W. E. Rice, reporting from his home in Arlington, Va., states that he is now with WWDC, Washington. His early days as a wireless operator began back in '17 and for ten years he was at the key. . . . Steve A. F. Wallis has changed his address to Denver, Colo., but for the time being he will be found sailing aboard the SS Alcoa Partner. . . . Veteran member George E. Sterling, recently reappointed as FCC Commissioner for a seven-year term, has become a member of the best-seller circle, with the publication of that popular 800-odd page *Radio Manual*,

of which he is co-author. Commenting on this new volume to ye editor, J. B. Epperson, chief engineer of Scripps-Howard Radio, Inc., said that this new, comprehensively revised and enlarged edition (first edition appeared in '28) is destined to become even more popular than its predecessors. Containing more than twice as much material as the previous edition, it covers the theory and application of the entire radio field in a very thorough manner. Covered are broadcast studio and control room equipment, broadcast transmitters, FM transmitters, amplifiers and oscillators, and AM. Detailed, too, are the subjects of propagation, antennas, radio equipment for the emergency services, and marine navigational aids, wherein are described the operation of radar and loran equipments. There is also complete coverage of the laws which govern the operation of all types of radio stations, and the rules governing commercial radio operators. Epperson reported that, as in past editions of the Sterling Manual, simple and effective words have been used rather than vigorous mathematical treatments. The book is abundantly illustrated with curves and photographs. Robert B. Monroe, CBS radio engineer, served as co-author of the book, which has been published by Van Nostrand.

Members: This is you news page. When your are promoted, transferred or if other important incidents occur during your days on land or sea, let us hear about it. Send along a picture, too. Address such communications to your Secretary.

Always IN LINE



GUARDIAN CENTERING MAGNETS and FOCUS COILS Insure Better Positioning of the Pattern in Popular TV Sets...

GUARDIAN CENTERING MAGNETS

The Guardian Centering Magnet compensates magnetically for any misalignment of the electronic beam of the focus coil assembly. Eliminates manual adjustment of the raster.



GUARDIAN FOCUS COILS

Over a million Focus Coils have rolled off Guardian's production lines into TV sets of leading manufacturers. With more than 75 types established as Guardian standard, speedy delivery to meet today's replacement needs is a matter of routine. Write.

GUARDIAN ELECTRIC

1615 W. WALNUT STREET

CHICAGO 12, ILLINOIS

A COMPLETE LINE OF RELAYS SERVING AMERICAN INDUSTRY

KULKA

TERMINAL BLOCKS

FOR ELECTRONIC EQUIPMENT AND LIGHTING FIXTURES

Simplify your wiring work...
Eliminate splicing... Stop leaks and shorts... Increase insulation...
Reduce assembly costs...
Make lasting connections.

Blocks come in 4 sizes—with 1-23 terminals. Brass screws and solder lugs. Lugs in several styles for all sizes—also eyeleted to block. Marker strips imprinted or plain, or blocks engraved.

GET CATALOG 7

KULKA ELECTRIC MFG CO Inc.
30 SOUTH ST. MT. VERNON, N. Y.

Technology Instrument Corp., 1058 Main St., Waltham, Mass., have released *Laboratory Report No. 1*, covering low frequency characteristics of the 320-A phase meter by Walter W. Granstein. Described is a method of measuring phase angle difference between two electrical signals.

Cleveland Electronics, Inc., 6618 Euclid Avenue, Cleveland 3, Ohio, have published a radio and TV replacement speaker catalog, 127 M, listing a line of auto, TV and radio speakers in *pm* and *em* models. Also featured are weatherproof speakers and TV lightning arresters.

Write to Bill Allen for a copy of the catalog.

National Union Radio Corp., Orange, N. J., has released a *TV Picture Tube Reference Guide*, listing 12 electrostatic-deflection and 73 electromagnetic-deflection type tubes.

Guide provides information necessary to show differences between various tube types. Bulb outline drawings with dimensions as well as basing diagrams are included. Other significant data relative to anode terminal type and location, dimensions of outer conductive coating, ion trap field, focus coil, and length of neck on electromagnetic types will be found.

Data are based largely upon RTMA registrations and data sheets published by the Joint Electron Tube Engineering Council.

The Aerovox Corp., New Bedford, Mass., has released an issue of the *Aerovox Research Worker* with a report on pulse modulation.

Industry Literature

Standard Transformer Corp., 3580 Elston Ave., Chicago 18, Ill., has published the seventh edition of the Stancor TV catalog and replacement guide, form 338. A twenty-six page booklet, it lists specifications and list prices of all Stancor transformers and related components for TV replacement or conversion, indexed for use in 618 TV chassis and receiver models made by 64 manufacturers.

The General Radio Co., 275 Massachusetts Ave., Cambridge 39, Mass., has released a 24-page catalog describing a variety of products including variacs, decade-resistance units, rheostat-potentiometers, variable air capacitors, decade-inductor units, band-pass filters, wave filters, lab instruments (wavemeters, *uhf* wavemeters, capacitance and inductance bridges, oscillators), friction-drive and gear-drive precision dials, dial plates, microphone hummers, power cords, switches, binding posts, coaxial elements, etc.

The Polychemicals Department of Dupont, Wilmington, Del., has published a bulletin, No. 12, describing the *Tejlon* story, in which chemical and electrical applications are detailed.

Chicago Rivet & Machine Co., 9600 W. Jackson Blvd., Bellwood, Ill., has released a 12-page industrial catalog which contains list of tubular and split types of rivets as well as machines used in the various types of assemblies.

Hunter Spring Co., 1 Spring Ave., Landsdale, Pa., has published a four-page bulletin which describes the four major forms of the neg'ator, an elastic member which is said to possess either constant or negative force-deflection characteristics.

In describing the four forms... extension spring; type A motor; type B motor; and clamps... engineering drawings show how each is constructed and how it operates. Fifteen photographs complete the story by showing the properties of this device have been applied.

The section describing the extension spring explains how the neg'ator can have either zero or negative gradient. It also shows *live* and static applications involving the constant-force characteristic. Static application depicted is counter-balancing; electric motor brush springs constitute the *live* use.

The section on the type A motor describes how a constant torque can be obtained with a spring motor.

The type B motor section describes how increased torque can be obtained with the same material used in the A motor.

Unistrut Products Co., 1013 West Washington St., Chicago 7, has published a 24-page catalog, No. 600, on racks.

Catalog includes 46 photographs of typical rack applications. Complete drawings of the various sizes of Unistrut metal channel and basic fittings recommended in the building of most Unistrut racks are also incorporated.

"UA" SERIES CONNECTORS FOR AUDIO CIRCUITS

MANY NEW FEATURES
TO RMA SPECIFICATIONS
AND STANDARDS



UA-3-32 Receptacle



UA-3-11 Plug



UA-3-31 Receptacle

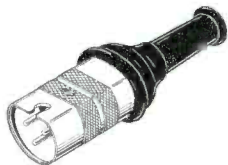

UA-3-12 Plug

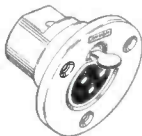

UA-3-13 Receptacle



UA-3-14 Receptacle



UA-3-42 Receptacle

UA-3-32 Also Available

First in the Field with the Latest and the Best!

This achievement of Cannon Electric applies to this new series of audio connectors for the radio industry as well as to other developments such as steel firewall connectors and guided missile plugs, etc.

The UA Series has all of the superior features of the Type P and XL Series and in addition the following: (1) Gold plated contacts for long life; (2) double-protection rubber relief collar and bushing; (3) stronger and better latchlock; (4) flat-top polarization for finger-touch action; (5) steel plug shell and steel insert barrel.

Three 15-amp. contacts; 1500 volts min. flashover; 1/2" cable entry.

Sold through Cannon Electric Franchised Jobbers. Ask for UA-1 Bulletin.

Address Cannon Electric Development Company, Division of Cannon Manufacturing Corporation, 3209 Humboldt Street, Los Angeles 31, California. Canadian offices and plant: Toronto, Ontario. World Export: Frazer & Hansen, San Francisco.



Briefly Speaking . . .

SOUND RECORDING via tape, may soon have a unique standard, in the form of a lateral frequency record and reference tape, which will be available only from the NAB, under whose supervision it will be recorded, inspected, numbered and registered. . . . The silver anniversary of the Chicago section of the IRE is now being celebrated and will be climaxed during the sixth National Electronic Conferences, September 25 to 27, which will be held at the Edgewater Beach Hotel in Chicago. . . . Closed-circuit TV has become quite a feature in New York TV-film production work. With a system known as the Vidicom, using the Vidicon camera for monitoring, complete films of TV shows are now being processed. The method involves the use of three of the miniature pickup cameras, each synchronized with specially adjusted motion picture cameras. Using an intercom system to each cameraman and an automatic changeover system to each film camera, a film control director can make cuts from one camera to another. Each film camera can be automatically turned on or cut off from the monitor board. . . . A seminar on image orthicon tubes was held recently at the NBC studios in Chicago under the joint sponsorship of Allied Radio Corp. and RCA. Ralph Johnson reviewed the construction and adjustments of the tube before an audience of 50 engineers affiliated with midwestern TV stations. Chet Wharfield of Allied's Broadcast Division was host at the meeting. . . . Construction work for the new multi-station TV and FM tower, atop the Empire State Building in New York, is now under way. It is expected that the installation will take about twelve months to complete. . . . Andy Ring is now president of The Association of Federal Communications Consulting Engineers, succeeding Glenn D. Gillett. George C. Davis has been named vice president; James C. McNary secretary; Frank G. Kear treasurer. J. B. Epperson of Scripps-Howard Radio, Carl C. Smith of United Broadcasting and Comdr. T. A. M. Craven have become members of the group. . . . Max F. Balcom, chairman of the board of Sylvania, was recently named chairman of the RTMA Reorganization Committee. J. J. Kahn, Standard Transformer Corp. prexy, has been appointed vice chairman. . . . David B. Smith, Philco vice president, has been elected vice director of the RMA Engineering Department, which is headed by Doc Baker. . . . A 24-page technical bulletin, describing the resistance of nickel and its alloys to corrosion by caustic alkalis, has been published by the International Nickel Company, Inc., 67 Wall Street, New York 5, New York. . . . A 12-page booklet describing sound equipment has been released by the Racon Electric Company, Inc., 52 East 19th Street, New York 3, New York. . . . A new building will soon be constructed for Bendix Radio, the additional space to be devoted exclusively to the production of TV receivers. The building, a two-story structure, is expected to be about 500 feet long and 72 feet wide. . . . Robert G. Scott has been named head of the Commercial Engineering Department of the Allen B. Du Mont Laboratories. This department provides technical assistance in the application of Du Mont picture tubes in initial equipment. . . . Thomas J. Bernard has been appointed assistant director of public relations of the RCA Victor Division.

AMPERITE

Studio Microphones
at P.A. Prices

Ideal for
BROADCASTING
RECORDING
PUBLIC ADDRESS

"The ultimate in microphone quality," says Evan Rushing, sound engineer of the Hotel New Yorker.

- Shout right into the new Amperite Microphone—or stand 2 feet away—reproduction is always perfect.

- Not affected by any climatic conditions.

- Guaranteed to withstand severe "knocking around."



Models
RBLG—200 ohms
RBHG—Hi-imp.
List \$42.00



"Kontak" Mikes
Model SKH, list \$12.00
Model KKH, list \$18.00

Special Offer: Write for Special Introductory Offer, and 4-page illustrated folder.

AMPERITE Company, Inc.

561 BROADWAY • NEW YORK 12, N. Y.

Canada: Atlas Radio Corp., Ltd., 560 King St. W., Toronto

ADVERTISERS IN THIS ISSUE

TELEVISION ENGINEERING

JULY, 1950

AMPERITE CO.	32
Agency: H. J. Gold Co.	
AUDIT BUREAU OF CIRCULATIONS	20
BIRTCHEER CORPORATION	29
Agency: W. C. Jeffries Company	
CANNON ELECTRIC DEVELOPMENT CO.	32
Agency: Dana Jones Co.	
ALLEN B. DUMONT LABORATORIES, INC.	
Inside Front Cover	
Agency: Austin Lescaurba & Staff	
EMSCO DERRICK & EQUIPMENT CO.	25
Agency: The McCarty Co.	
GENERAL RADIO CO.	Inside Back Cover
Agency: The Banta Press	
GUARDIAN ELECTRIC CO.	31
Agency: Kennedy & Co.	
KULKA ELECTRIC MFG. CO., INC.	31
Agency: L. D. Blehart Co.	
RADIO CORPORATION OF AMERICA	Back Cover
Agency: J. Walter Thompson Co.	
SPRAGUE ELECTRIC CO.	2
Agency: The Harry P. Bridge Co.	
HOTEL STRAND	29
Agency: Atlantic Coast Resort & Hotel Publicity Bureau	
U. S. TREASURY DEPT.	25

Here's a NEW G-R Catalog of QUALITY PARTS & ACCESSORIES



GENERAL RADIO announces a new Parts Catalog listing all of the parts, components and accessories manufactured by G-R . . . the first catalog of its kind printed in a number of years.

Here you'll find complete specifications of the entire line of G-R high-quality parts and accessories, and a number of simplified unit instruments. Included are knobs, dials, plugs, and jacks, fixed and variable air condensers, attenuators, coaxial elements, decade inductors and resistors and capacitors, filters, simple bridges, amplifiers and oscillators, rheostats and potentiometers, U-H-F Wavemeters, and dozens of other essentials.

For thirty-five years G-R parts have been used by the leading manufacturers, designers and custom-builders as integral parts of all types of communications and electronic equipment.

You'll find many items of interest. We'll be glad to send you a copy immediately if you'll fill in the coupon below.



GENERAL RADIO COMPANY

275 Massachusetts Ave., Cambridge 39, Mass.

NEW YORK

CHICAGO

LOS ANGELES

GENERAL RADIO CO., 275 Mass. Ave.,
Cambridge 39, Mass.

(6)

Please send me a copy of the NEW G-R PARTS CATALOG.

Name

Street Address

City Zone State

Announcing— the RCA-5826 . . .



. . . a major advance in studio-type image orthicons

A NOTABLE PRODUCT of RCA leadership in tube research and engineering—the new RCA-5826 image orthicon provides important refinements over previous types of television camera tubes for studio use.

The new RCA-5826 combines exceptionally high sensitivity, a resolution capability of better than 500 lines, high signal-to-noise ratio—about twice that of outdoor camera types—and improved gray-scale rendition in the vicinity of the “blacks.”

Having the same spectral response as the companion outdoor pickup type RCA-5820—a response closely approaching that of the eye—this new studio camera tube permits portrayal of colors in nearly their true

tone gradation. The use of the RCA-5826 in the studio and the RCA-5820 outdoors facilitates the combination of indoor and outdoor pickups on the same program . . . improvements that are automatically extended to every receiver.

ANOTHER new RCA tube . . .

... the RCA 6AX5-GT Heater-Cathode Type Full-Wave Vacuum Rectifier: Designed to operate from a common 6.3-volt heater supply in ac-operated sets or auto receivers. Has the same heating time as other heater-cathode types, thus permitting the use of filter capacitors having lower peak voltage ratings than required for filament-type rectifiers. Delivers 125 ma. at 350 volts to a capacitor-input filter.



THE FOUNTAINHEAD OF MODERN TUBE DEVELOPMENT IS RCA



RADIO CORPORATION of AMERICA
ELECTRON TUBES

HARRISON, N. J.