

ELECTRONIC INDUSTRIES



The search for new materials . . .

F W Preziosi Grp Hd
2921 Soutter Ave SE
Cedar Rapids Iowa
126500 Collins Radio
D5
21
B-
83

MODERN ELECTRONIC MATERIALS
Noise in reed switches
Design for a microwave power meter
DECEMBER 1964



RELIABILITY
TOTAL CAPABILITY IN
PRECISION RESISTANCE



MFF—Epoxy coated. Meets electrical and environmental requirements of Char. B, C, D, E; MIL-R-10509E, but is dimensionally smaller.

MFH—Hermetically sealed in ceramic tube. Meets requirement G; MIL-R-10509E.

MF—Transfer molded in epoxy. Meets all requirements of Char. B, C, D, E, MIL-R-10509E.



**Need metal films fast?
Rely on DALE capability**

Dale Metal Film Resistors are yours—fast—with three coating choices. Sizes from 1/10 to 2 watts let you meet a broad range of requirements within MIL-R-10509. Check the chart at right for proof of Dale's capability to supply parts that meet every electrical and environmental requirement of the Mil. Spec.—especially the low TC's difficult to obtain elsewhere (25 p.p.m. is standard with us). The same special metal alloy used in Dale ultra-high reliability wirewounds for the *Minuteman* Program is vacuum deposited on Dale Metal Film Resistors. Following film stabilization at elevated temperatures, terminating bands are deposited under vacuum to insure optimum film-to-lead contact and low noise. Matched coating and encapsulating materials, including undercoat applied immediately after film deposition, protect precise value and assure product homogeneity. Weldable leads, EIA color banding and reel packaging available. From design through delivery—Dale Metal Film Resistors are your most reliable choice.

SPECIALS—ASK US

Special constructions, non-helixed units, special mountings, networks—just name it and we'll go to work.

Write for Catalog A

| GENERAL SPECIFICATIONS—TYPE MF* | | | | |
|---------------------------------|----------|---------------|-------------------------|---------------------|
| DALE TYPE | MIL TYPE | 125° C RATING | RESISTANCE RANGE | DIMENSIONS (L x D.) |
| MF-1/10 | RN-55 | 1/8 watt | 100 ohms to 200K ohms | .250 x .093 |
| MF-1/8 | RN-60 | 1/8 watt | 49.9 ohms to 550K ohms | .406 x .140 |
| MF-1/4 | RN-65 | 1/4 watt | 49.9 ohms to 1 Megohm | .593 x .203 |
| MFS-1/2 | RN-70 | 1/2 watt | 49.9 ohms to 2 Megohms | .750 x .250 |
| MF-1 | RN-75 | 1 watt | 49.9 ohms to 6 Megohms | 1.093 x .375 |
| MF-2 | NA | 2 watts | 99.8 ohms to 15 Megohms | 2.250 x .375 |

Tolerance: ±1% standard; ±.5%, ±.25%, ±.1% available.

| ENVIRONMENTAL SPECIFICATIONS* | | |
|---|---------------------|----------------------------------|
| Dale MF Resistors are manufactured to the environmental specifications of MIL-R-10509E. Characteristic D, C, or E apply depending on T.C. Code specified at purchase. | DALE T.C. CODE | APPLICABLE CHAR. OF MIL-R-10509E |
| | T-1 (100 P.P.M./°C) | D |
| | T-2 (50 P.P.M./°C) | C |
| | T-9 (25 P.P.M./°C) | E |

*Specifications for MFF and MFH are similar, but vary dimensionally.



DALE ELECTRONICS, INC.

1304 28th Avenue, Columbus, Nebraska

A subsidiary of THE LIONEL CORPORATION

Also Made and Sold by Dale Electronics Canada, Ltd., Toronto, Ontario, Canada

Circle 98 on Inquiry Card



Service—A Bridge To Electronic Conversion

CONTINUED ELECTRONIC GROWTH, as previously noted, depends upon how well our electronic skills could be adapted to serve industrial and consumer needs. Thus far electronic companies have met with mixed success in these areas.

Military products frequently are too highly engineered and costly for commercial use. Some industry sources feel that much defense-aerospace technology cannot be converted to civilian use.

We believe that this situation may prevail only for the near term. Longer-range prospects have yet to be explored. In the past decade, the partnership among the Federal government, industry, and educational institutions has transformed many billions of dollars into a stockpile of "Electronic technology."

Closer study shows that this stockpile includes both technical knowledge as well as corporate capabilities. These subdivide further into facilities and personnel—chiefly engineers and technicians. Now the problem is: Can ways and means be found effectively to utilize this knowledge and engage these trained hands and brains to serve other industries?

Some electronic companies have proved that such a transition is possible. Possession of these facilities and skills enabled them to explore and develop new markets. A vocational-bridge technique can be used to move smoothly from one market area into another. This involves the creation of a consulting or research and development type service which in turn becomes a springboard that leads to the development of new components, equipment, and systems.

Aerojet-General's Atlantic Division was redirected from defense operations. It now designs and develops materials handling systems, using electronic components, for industry and government. Engineers and

technicians identify and resolve problems to help reduce costs of systems used in making, supplying and distributing products.

Atlantic's reorientation has led to several new projects involving design, construction, installation, maintenance and financing. Its potential customers, who gross about \$200 billions annually, include manufacturers, transporters, wholesalers, retailers and government agencies, such as post offices.

Some companies now offer their services to other electronic contractors and to industry-at-large. For instance, Physics International studies radiation effects on large sub-systems in its 1-Mev, 100,000-amp pulsed X-ray facility.

On a much smaller scale, two engineers recently inaugurated a difficult-to-find-but-we'll-locate-it-for-you information retrieval service called American Utilities Corp. They inform scientists and engineers about unusual devices and materials available from all parts of the world.

Today some government contractors still lack products directly convertible to commercial applications. We suggest that they consider re-evaluating their situation in terms of their technological knowledge and capabilities. They should seek to analyze the problems of potential customers in other industries where their special knowledge might be applied. With first-hand information they then could develop new consulting, research and development, or other support services that would be both meaningful and marketable.

The time to start is now. To wait or to simply stockpile knowledge and capabilities is pointless and profitless. If your company is long on capabilities but short on customers, remember, The marketplace will not come to you—you must go to it!

Bernard F. O'Connell

All from Sprague!

Make the right move... specify Sprague SOLID TANTALUM CAPACITORS!

| | | | | |
|---|---|--|--|--|
|  <p>TYPE 150D Metal-Encased Hermetically-Sealed TANTALEX® CAPACITORS (polarized)</p> |  <p>TYPE 151D Metal-Encased Hermetically-Sealed TANTALEX® CAPACITORS (non-polarized)</p> |  <p>STYLE CS12 Metal-Encased TANTALEX® CAPACITORS to MIL-C-26655A (insulated case)</p> |  <p>STYLE CS13 Metal-Encased TANTALEX® CAPACITORS to MIL-C-26655A (insulated case)</p> |  <p>TYPE 155D Metal-Encased Hermetically-Sealed TANTALEX® CAPACITORS (for high vibration)</p> |
|  <p>TYPE 172D Metal-Encased Hermetically-Sealed TANTALEX® CAPACITORS (for 'cordwood' modules)</p> |  <p>TYPE 250D Metal-Encased Hermetically-Sealed HYREL® ST CAPACITORS (for Minuteman Program)</p> |  <p>TYPE 350D Metal-Encased Hermetically-Sealed HYREL® ST CAPACITORS (polarized)</p> |  <p>TYPE 351D Metal-Encased Hermetically-Sealed HYREL® ST CAPACITORS (non-polarized)</p> |  <p>STYLE CSR12 Metal-Encased TANTALEX® CAPACITORS to MIL-C-39003 (uninsulated case)</p> |
|  <p>STYLE CSR13 Metal-Encased TANTALEX® CAPACITORS to MIL-C-39003 (insulated case)</p> |  <p>TYPE 180D Metal-Encased Hermetically-Sealed TANTALEX® Feed-Thru CAPACITORS</p> |  <p>TYPE 164D Metal-Tube Axial-Lead RED-TOP® TANTALEX® CAPACITORS (polarized)</p> |  <p>TYPE 166D Metal-Tube Axial-Lead RED-TOP® TANTALEX® CAPACITORS (non-polarized)</p> |  <p>TYPE 167D Metal-Tube Single-ended RED-TOP® TANTALEX® CAPACITORS (polarized)</p> |
|  <p>TYPE 168D Metal-Tube Single-ended RED-TOP® TANTALEX® CAPACITORS (non-polarized)</p> |  <p>TYPE 165D Film-Jacketed TANTALEX® CAPACITORS (for 'cordwood' modules)</p> |  <p>TYPE 154D Molded-Case Bullet-nose® TANTALEX® CAPACITORS</p> |  <p>TYPE 190D Molded-Case Rectangular-Shaped TANTALEX® CAPACITORS (for printed boards)</p> |  <p>TYPE 160D Film-Jacketed Axial-Lead TANTALEX® CAPACITORS (Hearing Aid Type)</p> |
|  <p>TYPE 161D Film-Jacketed Single-ended TANTALEX® CAPACITORS (Hearing Aid Type)</p> | | | | |

Number 1 in Solid Tantalum Capacitors Across the Board!

Pioneer in the development of tantalum capacitors, Sprague has the largest and most complete research and production facilities in the capacitor industry. That's why Sprague, with its unmatched experience, is

your *dependable* source of supply!

For additional information, write Technical Literature Service, Sprague Electric Company, 233 Marshall St., North Adams, Mass., indicating the types in which you are interested.

*Trademark

SPRAGUE COMPONENTS

CAPACITORS
TRANSISTORS
RESISTORS
INTEGRATED CIRCUITS
THIN-FILM MICROCIRCUITS

PULSE TRANSFORMERS
INTERFERENCE FILTERS
PULSE-FORMING NETWORKS
TOROIDAL INDUCTORS
ELECTRIC WAVE FILTERS

CERAMIC-BASE PRINTED NETWORKS
PACKAGED COMPONENT ASSEMBLIES
BOBBIN and TAPE WOUND MAGNETIC CORES
SILICON RECTIFIER GATE CONTROLS
FUNCTIONAL DIGITAL CIRCUITS



*Sprague® and ® are registered trademarks of the Sprague Electric Co.

Editorial: Service—A Bridge to Electronic Conversion 1

STATE-OF-THE-ART FEATURE:

The Search for New Materials J. Hunter 38

DESIGN/DEVELOPMENT:

Computer Solutions Aid Rectifier Filter Design W. Austin & K. Angel 54
 Engineer's Notebook #75 . . . Frequency Changes in Octaves . . . D. W. Moffat 58
 An Appraisal of Cermet Potentiometers S. Schneider 59
 Advances in Controlled Environment Areas . . L. M. Taylor, H. O. Wolp & D. Detwiler 63
 Dynamic Noise Generation in Reed Switch Contacts . . J. J. Vitola & J. P. Breickner 66

MEASUREMENT/TEST:

Designing a Simple Microwave Power Density Meter
 J. Choder, N. Farhat & R. F. Schwartz 90

PROFESSIONAL GUIDELINES:

Reliability Goals Depend on New Materials S. Feldman 100

WHAT'S NEW

| | |
|--|---|
| Brighter Color TV Screen is Result of New Phosphor 57 | Multi-Computer Control System 109 |
| Home TV Recording Gets Closer 106 | Management Control System 115 |

DEPARTMENTS

| | |
|---|--------------------------------|
| Highlights 5 | Letters 31 |
| Radarscope 10 | Editor's Notebook 74 |
| Coming Events 16 | New Tech Data 76 |
| Washington Trends 20 | Measurement News 89 |
| Snapshots of the Electronic Industry 22 | Employment News 98 |
| Marketing: Fact & Figure Roundup 27 | New Products 116 |

COVER

This photomicrograph shows aluminum oxide as a fiber. In this fiber form it has exhibited tensile strengths as high as 3 million psi. These crystals are grown from the vapor phase by melting aluminum in an atmosphere of hydrogen and water vapor. The aluminum

vapor then reacts with the oxygen in the water vapor to form the crystals, which have a high degree of crystalline perfection. This work is being done at General Electric Co., Valley Forge, Pa.

*STATE-OF-THE-ART: up-to-the-moment capability in each area of electronic technology



6 Reasons Why SPRAGUE is a Major Resistor Supplier

FILMISTOR® PRECISION FILM RESISTORS



metal-film, molded case

Distinct limited temperature coefficients and low tolerances to meet exacting application requirements. Rugged end cap construction for long-term stability and reliability. Superior resistance to humidity and mechanical damage. Surpass MIL-R-10509E requirements. Send for Bulletin 7025B.



deposited-carbon, molded case

Approach precision wirewounds in reliability and stability, yet are smaller in size and have lower self-inductance. Low, controlled temperature coefficient. Dense molded case provides outstanding humidity protection. Send for Bulletin 7000A.



deposited-carbon, conformal coated

Full rated load operation at 70 C with no wattage derating. Assured uprated loads at lower operating temperatures. Ideal for circuitry where small size, humidity resistance, and close tolerance ($\pm 1\%$) are required. Send for Bulletin 7005A.

Circle 61 an Inquiry Card

ACRASIL® PRECISION/POWER WIREWOUND RESISTORS



silicone-encapsulated

Combine the best features of both precision and power wirewound types. Resistance tolerances to $\pm 0.05\%$. Unusually tough encapsulation protects against shock, vibration, moisture, fungus. Meet MIL-R-26C requirements. Smaller than conventional wirewounds, yet greater in stability. Send for Bulletin 7450.

Circle 62 an Inquiry Card

BLUE JACKET® VITREOUS ENAMEL POWER WIREWOUND RESISTORS



All-welded end cap construction with special vitreous coating for long-term dependability. Axial-lead style for conventional wiring or on printed boards. Tab terminals for higher wattage applications. Meet MIL-R-26C requirements. Send for Bulletins 7400B, 7410D, 7411A.

Circle 63 an Inquiry Card

KOOLOHM® CERAMIC-SHELL POWER WIREWOUND RESISTORS



Exclusive ceramic-insulated resistance wire permits "short-proof" multilayer windings for higher resistance values. Standard and non-inductive designs. Non-porous ceramic shell for moisture protection and electrical insulation. Axial-lead, axial-tab, and radial-tab styles. Send for Bulletins 7300B, 7305, 7310.

Circle 64 an Inquiry Card

GLASS-JACKETED POWER WIREWOUND RESISTORS



Ferrule terminals soldered to metallized ends of glass casing for true hermetic seal. Virtually failure-proof, even in extremely corrosive industrial and salt atmosphere. Standard and non-inductive windings. External meter-multiplier types also available. Send for Bulletins 7350, 7420, 7421.

Circle 65 an Inquiry Card

STACKOHM® POWER WIREWOUND RESISTORS



Flat silhouette permits stacking of resistor banks in close quarters. Aluminum thru-bar simplifies mounting and conducts heat from resistance element. Vitreous enamel protective coating. Meet MIL-R-26C performance requirements. Send for Bulletin 7430.

Circle 66 an Inquiry Card

For complete technical data, write for engineering bulletins on the resistors in which you are interested to: Technical Literature Service, Sprague Electric Company, 233 Marshall Street, North Adams, Massachusetts.

4 SR-155-63 R2



'Sprague' and '©' are registered trademarks of the Sprague Electric Co.

New Bridge Design For Safe, Accurate, Easy Measurement of 'Lytic Capacitors



The Sprague Model 1W2A Capacitance Bridge introduces new, improved technical refinements as well as restyling for added attractiveness and ease of operation. Built by capacitor engineers for capacitor users, it incorporates the best features of bridges used for many years in Sprague laboratories and production facilities.

Precision Measurements over Entire Range from 0 to 120,000 μF

The internal generator of the 1W2A Bridge is a line-driven frequency converter, and detection is obtained from an internal tuned transistor amplifier-null detector, whose sensitivity increases as the balance point is approached. It has provision for 2-terminal, 3-terminal, and 4-terminal capacitance measurements, which are essential for accurate measurement... $\pm 1\%$ of reading + $10\mu\text{F}$... of medium, low, and high capacitance values, respectively.

No Damage to Capacitors

The model 1W2A Capacitance Bridge will not cause degradation or failure in electrolytic or low-voltage ceramic capacitors during test, as is the case in many conventional bridges and test circuits. The 120 cycle A-C voltage, applied to capacitors under test from a built-in source, never exceeds 0.5 volt! It is usually unnecessary to apply d-c polarizing voltage to electrolytic capacitors because of this safe, low voltage.

Complete Specifications Available

For complete technical data on this precision instrument, write for Engineering Bulletin 90,010A to Technical Literature Service, Sprague Electric Company, 233 Marshall Street, North Adams, Massachusetts.

488P-128-63

Circle 60 an Inquiry Card

THE SEARCH FOR NEW MATERIALS 38

The state-of-the-art in the electronic industries will advance only as quickly as new materials become available, or new uses for existing materials are found. This report describes some of the materials that will influence the equipment and components of the future.

COMPUTER SOLUTIONS AID RECTIFIER FILTER DESIGN 54

Many of the approaches now available to analyze capacitor-input-filter rectifier circuits are extremely inaccurate and require a considerable expenditure of time. Tables derived from a computer analysis can be readily used to find average current, peak current, and average dissipation of these circuits.

AN APPRAISAL OF CERMET POTENTIOMETERS 59

The cermet technology, used at first for fixed resistance elements alone, has grown to include trimming and precision potentiometers. This article compares the characteristics of cermets with those of wirewound and conductive plastic units.

ADVANCES IN CONTROLLED ENVIRONMENT AREAS 63

The new Federal Standard 209 has had great impact on the electronic field. The Standard's concepts and between-the-line implications are described along with methods of achieving the required environments.

DYNAMIC NOISE GENERATION IN REED SWITCH CONTACTS 66

Since reed switch noise voltages are now being specified for reed relays, a means of minimizing this noise is sought. But, before this is done, how and why reed switches generate this voltage must be investigated.

DESIGNING A SIMPLE MICROWAVE POWER DENSITY METER 90

In recent years there has been a demand for a convenient instrument to indicate when the microwave power density is "safe" at a given point. Present instruments have some drawbacks. The instrument described here eliminates some of the difficulties while using a standard gas-filled bulb.

RELIABILITY GOALS DEPEND ON NEW MATERIALS 100

Our electronic and space future depends largely on new materials. A sophisticated system is only as good as the materials in it. General R & D funds have tripled, mostly for materials, on which whole new industries have been founded.

• A REPRINT of ANY ARTICLE in this issue is available from **ELECTRONIC INDUSTRIES Reader Service Department, 56th & Chestnut Streets, Philadelphia, Pa. 19139**



New Materials



Cermet Potentiometers

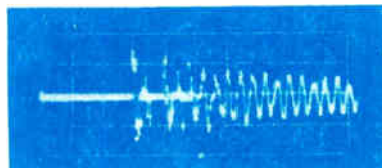

Reed Switches

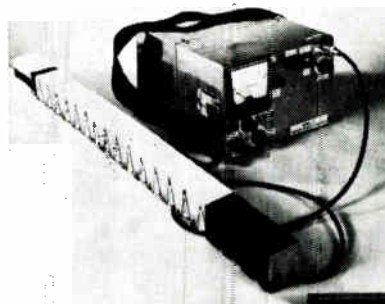

Microwave Power Meter

Reliability Goals

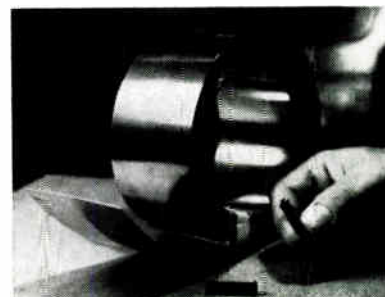

VIDEOSCAN THE CRT RECORDER THAT SETS NEW RECORDS IN HIGH FREQUENCY DATA ANALYSIS

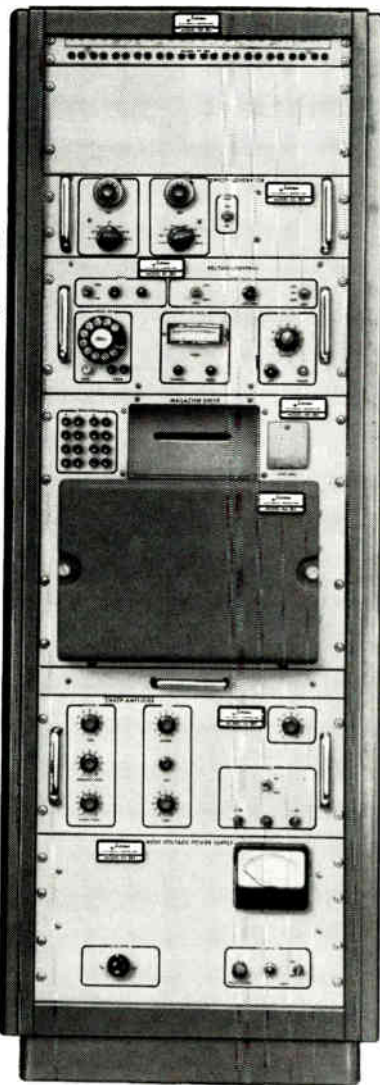

This precision, high-speed Interstate VIDEOSCAN combines images from a high-resolution cathode ray tube with galvanometer traces onto single, moving 12-inch film or paper... providing a detailed, permanent recording for data analysis that up to now was impossible.

- Records at spot-image-speeds as high as 200,000 inches-per-second
- Resolution of 500 line pairs on 10 inches of recording media
- Cathode Ray Tube record is linear, flat to 20 kc in the swept axis, and intensity modulated via a 4-mc video amplifier, making it useful to 30-ips paper speed with a spot size of less than 4 mils
- Allows visual monitoring of the tube face while recording
- Provides record identification
- Designed with auxiliary modules—sweep generator, sweep amplifier, recording magazine and video patch panel—for wide range of applications

Interstate's VIDEOSCAN provides an extremely accurate method of signal analysis, pulse rate or pulse shape analysis, high frequency vibration analysis, telemetry signal analysis, high frequency phenomena display, radar visual recording, coordinated time base display and facsimile and video recording.

Read the full story of VIDEOSCAN in a new Interstate brochure. Write or check reader service card for your copy.

 **Interstate** ELECTRONICS CORPORATION
707 EAST VERMONT AVENUE, ANAHEIM, CALIFORNIA
Telephone 714-772-2222, TWX 714-776-0280
A Subsidiary of Interstate Engineering Corporation Worldwide Representatives

**ELECTRONIC
INDUSTRIES**

SHELBY A. McMILLION,
Publisher

BERNARD F. OSBAHR,
Editor

CREIGHTON M. MARCOTT
Executive Editor

JOHN E. HICKEY, Jr.
Managing Editor

SMEDLEY B. RUTH
SIDNEY FELDMAN
Associate Editors

JOHN J. HUNTER
ROBERT J. BRAMLETT
Assistant Editors

DR. ALBERT F. MURRAY
Consulting Editor

ELMER KETTERER, Art Director
ANNE AXE, Editorial Assistant
ANN LAVENDER, Research Assistant
MAE MOYER, Reader Service
IDA GOOD, Editorial Secy.

EDITORS-AT-LARGE

Eastern Region

ELMER T. EBERSOL,
100 East 42nd St.
New York 17, N. Y.
(Area Code 212) OXford 7-3400

Western Region

J. PHILIP GEDDES
198 S. Alvarado St.
Los Angeles 57, Calif.
(Area Code 213) DUNkirk 7-1271

Defense/Space

CHARLES R. WILHIDE,
Pentagon News Room
The Pentagon
Washington, D. C.

WASHINGTON NEWS BUREAU

1093 National Press Bldg.
(Area Code 202) 393-3474
TWX—202 965-0675

GEORGE BAKER, Mgr.
NEIL R. REGEIMBAL

BUSINESS DEPARTMENT

ELMER DALTON
Advertising Promotion
& Circulation Manager

EDWARD G. SHAUD, Jr.
Marketing Manager

ARA H. ELOIAN
Production Manager

See Advertisers Index on page 129 for
Regional Sales Managers.

Chilton Company—G. C. BUZBY, President.
Executive Vice Presidents: R. E. McKenna,
G. T. Hook. Vice Presidents: P. M. Fahren-
dorf, L. V. Rowlands, M. E. Cox, E. B.
Terhune, Jr., R. W. Case, Jr., J. H. Kofron.
Treasurer: Stanley Appleby. Secretary: J. A.
Montgomery. Other Directors: C. A. S.
Heinle, G. E. Cameron, T. C. Campbell,
H. W. Barclay, W. A. Phair; Assistant
Treasurer: J. Miades; Assistant Secretary:
I. C. Holloway.

JOHN H. KOFRON
Chilton Research Director

ELECTRONIC INDUSTRIES, December, 1964.
Vol. 23, No. 12. A monthly publication of
Chilton Company, Executive Editorial &
Advertising offices at Chestnut & 56th Sts.,
Phila., Pa. 19139. (Area Code 215) SHER-
wood 8-2000. Controlled circulation postage
paid at Philadelphia, Pa. \$1 a copy; Refer-
ence Issue (June), \$5.00 a copy. Sub-
scription rates U. S. and U. S. Posses-
sions: 1 yr. \$10.00; 2 yrs. \$18.00. Canada
1 year, \$12.00; 2 yrs. \$20.00. All other
countries 1 yr. \$18.00; 2 yrs. \$30.00.
Copyright 1964 by Chilton Company. Title
Reg. U. S. Pat. Off. Reproduction or re-
printing prohibited except by written au-
thorization.

MORE POWER TO YOU!

More watts to the dollar

- **Watts** — two powerful new Sierra Signal Sources — Models 470A-500 (200-500 mc) and 470A-1000 (470-1000 mc) — deliver 60 to 80 watts across their complete frequency ranges.
- **Dollars** — at \$2,650, whether you measure your power as “average,” “typical” or “nominal,” either of these Sierra 470's buys more watts for your dollar than anything we know in the market today.

More performance to the pound

- **Solid-state design** — reduces weight to 35 pounds, size to 0.72 cubic foot.
- **Circuit stability** — assures rock-steady output for testing and calibrating VHF-UHF power measuring equipment.

More competitive features to the inch

- Direct-reading, two-range wattmeter, and front panel calibration controls
- Oscillator current metering (grid & plate)
- Transistorized power supply and modulator
- Automatic protection against no-load or under-load conditions

Complete specs await you on these new Sierra Power Signal Sources; you might also sample the specs on new Sierra Transistor Testers, Cable and Line Fault Locators, and Wave Analyzers. You'll get all the technical information you need from Sierra/Philco or directly from your Sierra Sales Representative.

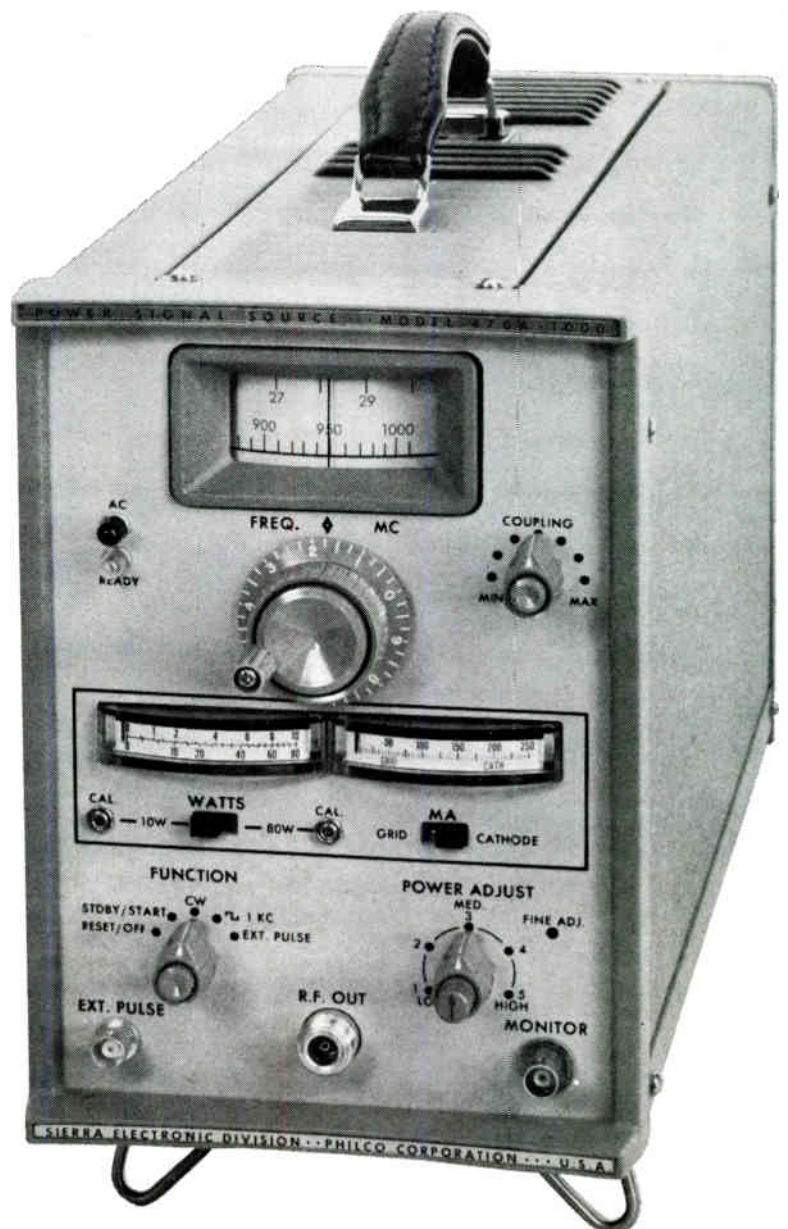

SIERRA ELECTRONIC DIV.
OF
PHILCO
A SUBSIDIARY OF *Ford Motor Company*

Sierra Electronic Division / 3879 Bohannon Drive / Menlo Park, California

WHAT HAPPENS TO MATERIALS
WHEN THEY COME IN CONTACT
WITH FC-75 COOLANT?

nothing

They're cooled of course—and how! 3M Brand Inert Liquid FC-75 does *nothing* but take heat away! How?—high density, *low* surface tension and viscosity, low boiling point for evaporative cooling.

While FC-75 is working, it's also the most compatible coolant possible. Neither affects metals, plastics, elastomers, chemically or electrically, or is affected in turn by them! This means almost complete retention of dielectric properties, even above maximum temperature limits of other dielectric coolants. FC-75 coolant retains its high electric strength of 35 KV when it changes from liquid to vapor.

Protection against thermal or electrical overload is greatly increased. FC-75 stays stable, no matter what materials it's in contact with; won't sludge or gum.

But in one way FC-75 and its companion liquid FC-43 do "affect" material. They permit extensive miniaturization by removing up to 40 times more heat through boiling than oil type coolants. Some transformers, for example, have been trimmed 4 to 1 in volume, 2 to 1 in weight!

For details on non-explosive, non-flammable, odorless FC-75 and FC-43, write Chemical Division, Dept. KCQ-124, 3M Company, St. Paul 19, Minn.

3M MINNESOTA MINING & MANUFACTURING CO.

Analyzing current developments and trends affecting the State-of-the-Art of technologies throughout the electronic industries

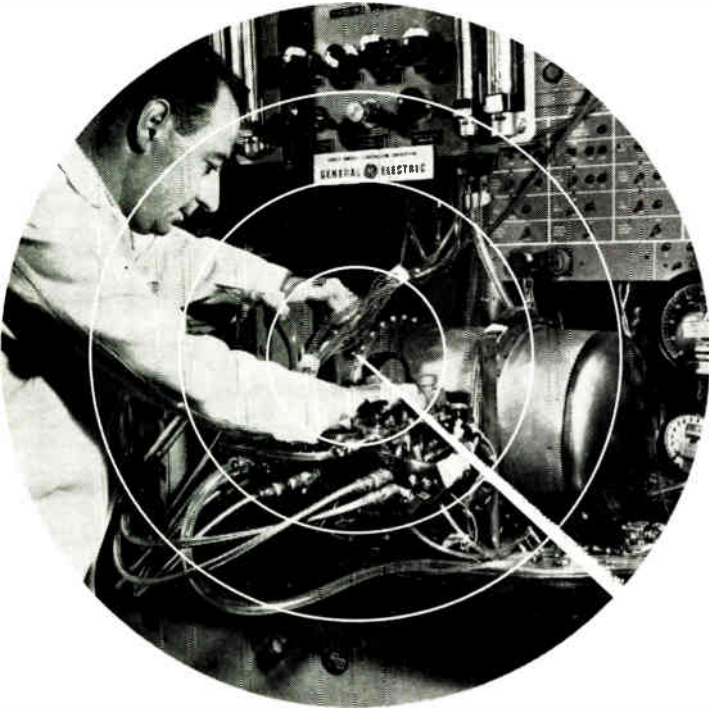

FUEL CELL BATTERY FOR GEMINI

Nicknamed "The Rock" by test engineers, General Electric fuel cell battery was put through 46-day test, simulating 750 GEMINI orbits. It is one of two such fuel cell batteries that will furnish up to two kilowatts of electric power. The cells will also produce drinking water. Lowering coolant temperature extended life of the battery.

OXIDE ISOLATION between active devices in solid silicon microcircuits can be obtained through a new, non-critical and economical method, according to engineers of the Philco Corp. Dr. George L. Schnable, Philco Lansdale (Pa.) Division, said completely flat wafers containing oxide-isolated silicon regions can be produced without precision lapping or polishing. Among steps in the new process are oxidation of the silicon wafer, depositing of a polycrystalline silicon wafer on one side, and oxidation and photoengraving of a pattern of isolation cuts in the oxide on the single-crystal side of the wafer.

ULTRASONIC CONTROL can be used on laser output, according to engineers at United Aircraft Research Laboratories, in research for the Army. Researchers have found that propagation of focused ultrasonic energy in a solid-state laser causes periodic fluctuations in refractive index. Fluctuations can act as a Q-spoiler to gate high-gain laser output without lossy elements in the laser's feedback interferometer cavity. "Ultrasonic Control of Laser Performance," (AD 605 940N) (\$3.00—Microfiche 75¢).*

INFORMATION SYSTEM that records computer-generated data directly on microfilm at high speeds has been developed by Stromberg-Carlson Division of General Dynamics. The system accepts data from a computer, translates and records it on film at 62,500 characters per second. It can produce a minimum of 50,000 filmed documents in one 8-hour shift, according to Stromberg engineers.

OMNIDIRECTIONAL ANTENNA capable of radiating all frequencies from 2mc to 30mc has been introduced by Granger Associates of Palo Alto, Calif. The antenna is designed for shore-to-ship, ground-to-air and short-wave uses. Broad bandwidth, according to Granger engineers, permits free selection of optimum frequency for sending to any distance. It has a VSWR no greater than 2:1. Gain is 4 to 7 db at elevation angles suitable for transmission at medium and long ranges.

SUPERCONDUCTING MAGNET, 32,800 gauss, with 10-inch diameter bore, has been built by Avco-Everett Research Laboratory for Argonne National Laboratory. Believed to have the largest bore of any existing high-field magnet, it will be used at Argonne for the new 12.5 Bev Zero Gradient Synchrotron to measure particle energies and study properties with great accuracy, reports Avco.

DATA STATION that can scan documents, read punched cards, print at high or low speeds, and punch and read paper tape has been introduced by Honeywell EDP Division. The station is designed as a remote terminal for a computer system. Its optical scanning unit can read documents encoded in a special bar code at a 50 character-per-second speed. Engineers report that principal users will be insurance, manufacturing, retail, petrochemical, financial and transportation firms.

COMPUTER PARTNERSHIPS scored more points in medicine. A UNIVAC 1107 at the computing center of Case Institute of Technology, Cleveland, has been linked to a research project at Highland View Hospital of Western Reserve University. The distance is 10 miles and the linkage is an ordinary telephone line. At Highland View each patient generates 10,000 data items each week. Evaluation time for such heavy data loads has been trimmed from several weeks to within one day, in some cases within seconds. A unique partnership between engineering and medicine will soon enable doctors to check thousands of school children for heart diseases through computers, according to Northwestern University Professor John E. Jacobs. As director of Northwestern's Bio-Medical Engineering Center, he reports that four projects are underway to computerize diagnosis of heart ailments.

INFRARED INSPECTION of resistors detects hidden flaws and prevents incipient failures through a new Thermograph technique. First developed by Dr. Riccardo Vanzetti, now of Raytheon Co., the technique couples an oscilloscope to a Thermograph output. This unusual "camera," designed by Barnes Engineering Co., Stamford, Conn., detects minute temperature variations through IR energy they emit.

MULTI-PROCESSING capability is the chief feature of a new system developed by Philco Corp. Labeled Philco 213, the system can include as many as four processors for simultaneous related or independent problems. Each processor, reports Philco, can address any character or word up to two million words of memory. Access time to any word in main memory is less than 900nsec.

FERRITE DEVICES—the first practical type ever built for the TE₀₁ mode circular waveguide—are reported by Sperry Microwave Electronics Co. The research, for the U. S. Air Force, was done in two 6% frequency bands centered at 9.375gc (X band) and 35gc (K band). Among the devices were duplexers, isolators, variable attenuators and controllable phase shifters.

MEMORY SYSTEM, with a one-microsecond cycle time, using silicon semiconductors and high-speed miniature ferrite cores has been introduced by RCA Electronic Components and Devices. The system has a 32,768 word capacity and a 72 bit capacity. System will operate from -40° to +80°C with no stack temperature controls or current compensation.

BEAM-LEAD SUPPORT

Photomicrograph shows an ultrahigh speed logic circuit made by a new beam-leaded structure devised by Bell Labs. The lead structure provides strong mechanical support as well as electrical connection to semiconductor devices and circuits. Leads are made of gold about 10 microns thick. Structure provides good isolation.

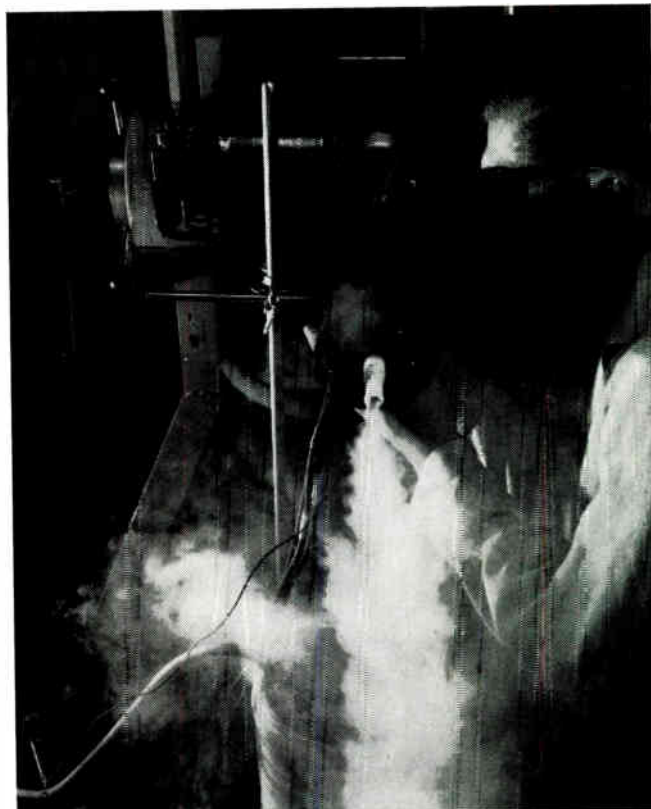
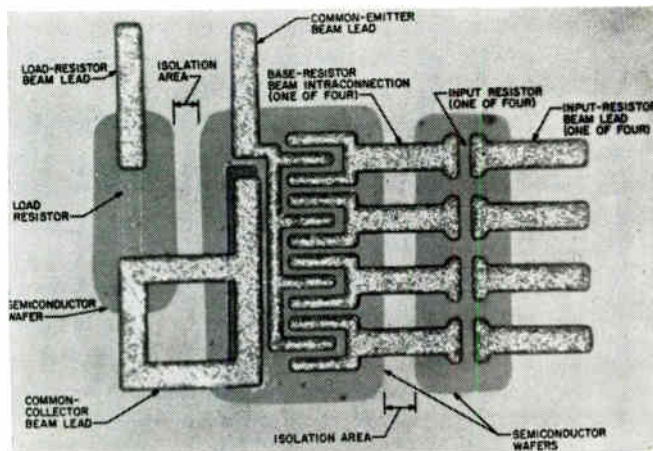

INTENSITY CONTROL OF LASER

Magnetic field can control ruby laser intensity at extremely high frequencies, reports Honeywell Research Center, Minneapolis. Gary Otto, amid nitrogen vapor, readies apparatus for firing light burst at resonance absorber (silver cylinder). Method could permit transmission of 100,000 times more data than current microwave systems.

ULTRA-HIGH RESOLUTION electron microscope capable of resolving two points two one-hundred-millionths of an inch apart (5 Å) has been introduced jointly by Perkin-Elmer Corp. and Hitachi, Ltd. The instrument (Model HU-11B) has already revealed the lattice of a gold crystal, which has a 2.04 Å spacing. Developers report that an important feature of the HU-11B is its new vacuum system which keeps the specimen clean. Electron optical range is 400 X to 250,000 X. An image intensifier (HII-2) boosts magnification to 10,000,000 X.

RADIATION EFFECTS on various materials showing promise for use in electronic and space applications are being studied by Battelle Memorial Institute. On polymers, Battelle reports current studies show that materials with a high degree of cure, high molecular weight, good heat resistance, and little or no additive, such as plasticizer, show such promise. In many cases radiation resistance is improved in vacuum because of lack of oxygen, which is usually the major factor in polymer deterioration. "Radiation Effects State of the Art," (AD 603 708N) (\$4.00—Microfiche \$1.00).*

(MORE RADARSCOPE on Page 12)

*Office of Technical Services, U. S. Department of Commerce, Washington, D. C., (20230).

MONOLITHIC CIRCUITS, newly developed, can replace multichip circuits now used in the CP667 computer, report engineers for the Univac division of Sperry Rand Corp. In Navy sponsored research, it was found that both types have a failure mode with wire bonds. A higher failure rate, however, can be expected from multichips owing to the greater number of bonds. Tests show that monoliths approach the standard needed for multichips in CP667. "Integrated Circuit Study," (AD 605 432N) (\$4.00—Microfiche \$1.00).*

ELECTRON BEAM MACHINE that welds in a normal atmosphere rather than in a vacuum has been developed as a production tool by the Hamilton Standard division of United Aircraft Corp. Beam is formed and controlled in a vacuum and then released to atmospheric pressure through a staged orifice system. Beam is generated at 175,000v. so that power density of the beam will not dissipate before doing its work. Helium and argon are used to shield refractory metals against oxidation.

AUTOALARM SYSTEM developed by Naval engineers can detect electromagnetic interference above a predetermined level within a given radius, producing a visible or audible signal. Device is useful for detecting potential sources of broadband electromagnetic interference, such as ignition systems, which can affect telemetry communication. System consists of a control unit, broadband antennas, and multicouplers. "Ignition Interference Autoalarm System," (AD 425 361N) (\$1.25).*

ANECHOIC CHAMBER FOR GODDARD

Giant two-foot square absorbers, 70 in. long, line walls and doors of anechoic chamber at NASA's Goddard Space Flight Center. Absorbers, developed by B. F. Goodrich, are believed to be the largest. The chamber is vertical and has a radome with a directional antenna above. Radio Engineer John Steckel checks satellite Explorer-B mockup.



ORGANIC SEMICONDUCTORS, their synthesis, purification, and electrical measurement, are current research efforts by Quantum, Inc., for the U. S. Air Force. Considerable progress has been reported; preliminary conductivity measurements were carried out on synthesized materials, two carbene dimers, and certain derivatives of the carbenes. Researchers report that the materials show significant conductivity properties. "Organic Semiconductor Development," (AD 601 862N) (\$1.75—Microfiche 75¢).*

TELEPHONE ENGINEERS have converged on the University of Colorado and four other universities to study problems in telephone communications that do not yet exist. Bell Telephone System is certain that the future will bring extensive changes, but no one knows what. Object of the one-year course is to train engineers in fundamentals, with emphasis on engineering and mathematical methods instead of apparatus design. Bell says the real test won't come next year, but in the decades to come.

EFFECT OF FEDERAL R&D was outlined recently by Luther H. Hodges, Secretary of Commerce, at a conference of Midwestern Governors. Mr. Hodges stated that about one-half of the annual rate of increase in gross national product of the U. S. is attributable to technological change and the multiplying effect of technology on efficiency of labor and machinery. He said the need for cooperation among Federal, State, and business principals in technology is apparent when we realize that Federal funds support about 75% of all R&D. Most is for defense (44%), space (14%), atomic energy (7%), and health (5%).

TECHNOLOGICAL CHANGE and multiplying effect of technology on efficiency of labor and machinery contribute about one-half the annual rate of increase in U. S. gross national product, remarked Secretary of Commerce Luther H. Hodges. He observed that the strongest moving force in U. S. economy is the nation's brainpower. He feels there is great need for cooperation among federal, state, and business principals in technology. This is especially true since federal funds support about 75% of all R&D in the nation today. Most of this is for defense (44%), space (14%), atomic energy (7%), and health (5%).

(More RADARSCOPE on Page 14)

*Office of Technical Services, U. S. Department of Commerce, Washington, D. C.. (20230).

NEW! BASIC CONNECTOR GUIDE DESTINED FOR 'MOST-READ' LIST! SEND FOR YOUR FREE COPY TODAY!



Newly-published, enlarged, enriched edition of the Catalog about the connectors that started it all! Started all the industry thinking of connectors as sophisticated components, not just hunks of "hardware"! Frankly, they laughed when we sat down first to tell them about ELCO VARICON* Connector Series 01; but billions of reliability-proven contacts later, you have the laugh on them. For you who have used them in countless rack-and-panel and cable applications know how versatile, adaptable, economical they are, regardless of your requirements. But we haven't stopped improving them just because of that. Now, many models of this UL-approved line even have vinyl-clad covers for more steadfast insulation. Plus other major and minor refinements almost imperceptible to the eye, yet significant to your production and performance requirements. So here it is, the new ELCO VARICON* Connector Series 01 Catalog, only 28 pages from cover-to-cover, yet a complete "dictionary" of what a standard, miniature connector should be like, and look like, and act like. Counting getting it to you, it stands us about a dollar (plus hundreds of thousands on product research and development); but it's yours for the asking because we know that once you receive it, you'll study it; and once you study it, you'll specify these unique, fork-design connectors, with 4 coined mating surfaces, for now and evermore. If you think the Reader Service Card isn't fast enough for you, why not call, write, wire or TWX us direct and we'll get a copy into your hands before you can say "ELCO VARICON* Connector Series 01 is a 'must' for every design, project, circuit, systems, evaluating, specifying and purchasing engineer from here to the moon!" Where, incidentally, ELCO VARICON* Connectors were the first to land with our first successful moon-shot. P.S. Limited supply for the first to reply.

ELCO CORPORATION, Main Plant and Offices: Willow Grove, Pa. 19090; 215-659-7000; TWX 510-665-5573. ELCO Pacific: W. Los Angeles, Cal. 90064. ELCO Midwest, Chicago, Ill. 60645. Representatives, Branches, Subsidiaries, Joint Ventures, Licensees Thruout World.

*TRADE-MARK

RADARSCOPE

New signal generator / frequency meter
generates
10 kc-500 mc

measures
10 kc-1000 mc



- Unique synthesizer provides high resolution
- High stability—1 part in 10⁷
- Digital Nixie readout
- Precision attenuator
- All Solid State

Gertsch Model SSG-1 combines, for the first time, voltage accuracy with the traditional Gertsch frequency accuracy in one compact unit. This all solid state Signal Generator/Frequency Meter has a range of from 10 kc to 500 mc with direct digital control and readout.

Provides increments as small as 1 cps in the range from 10 kc to 50 mc...as small as 10 cps from 50 to 500 mc. Stability throughout the total range is 1 part in 10⁷. Even higher stability is obtainable by driving the system with a higher precision 1 mc oscillator.

Direct frequency display is provided by Nixie readout, with digital dial-in of frequency. Output may be set to 0 dbm and adjusted 0 to -130 db with a continuously variable calibrated attenuator. Internal amplitude modulation to 50% at 400 or 1000 cps is available by means of front-panel control, and there is provision for external AM modulation to 10 kc. Non-harmonically related spurious signals are at least 60 db down.

Measures frequency from 10 kc to 1 Gc.

This range is extendable to 10 Gc by means of an accessory harmonic generator-mixer assembly.

For complete details and applications assistance, contact your nearest Gertsch representative, or the address below, requesting Bulletin SSG-1.

SPECIFICATIONS

FREQUENCY

Range . . . 10 kc to 500 mc
 Stability . . . 1 part in 10⁷
 Resolution . . . 1 cps—10 kc to 50 mc
 10 cps—50 mc to 500 mc
 Display . . . Digital (Nixie)
 Adjust . . . Digital

AMPLITUDE

Output Level . . . 0 db (50 ohm)
 Attenuation
 Range . . . 0 to -130 db
 Accuracy . . . ±2 db into 50 Ω load

MODULATION (Amplitude)

Frequency . . . 400 or 1000 cps Internal
 to 10 kc External
 Range . . . 0 to 50%

PRICE: \$12,500.00

MODULAR TEST SET for radar moving target indicator (MTI) has been developed by Westinghouse Defense and Space Center. Designed for use with fixed, tactical, or shipboard radars, the lightweight unit measures sub-clutter visibility of an MTI at the radar's transmitted or intermediate frequency. Through interchangeable frequency converters, the transistorized set is able to monitor frequencies from UHF through the S-band.

OPTICAL RELAY DEVICE, light-controlled, solid-state, capable of switching extremely weak signals for spacecraft multiplexing uses, has been developed by IBM. Device uses light energy as signal carrier rather than electrical or magnetic fields. Relays of this sort, according to IBM researchers, may find wide use in telemetering equipment used for probing outer space. It has a sampling rate capability of 10,000 signals per second.

ELECTRONIC 'SENTRY' to warn of excessive forces of vibration on all types of industrial machinery has been developed by the RayData Corp., Columbus, Ohio. The system, called "G Switch," consists of two components: an explosion-proof transducer located on the machine, and a control unit containing a trip-level control adjustable from one to ten "Gs," an adjustable time delay and an output relay.

HIGH-SPEED MEMORY "years ahead of thin-film achievements" has been developed and tested by Philco Corp. Engineers report they have done it with conventional, off-the-shelf hardware. Robert M. MacIntyre, supervisor of data processors section, Philco Aeronutronic Division, Newport Beach, Calif., describes it as a 10-mc non-destructive read-out memory of 1,024 words, 48 bits per word.



Ask your Metrics Sales Representative about the new Singer Time Pay and Lease Programs—

**THE SINGER COMPANY
 METRICS DIVISION**

3211 S. LA CIENEGA BLVD., LOS ANGELES, CALIFORNIA • TELEPHONE (213) 870-2761 • TWX 213 836-0466

Design and production of PANDRAMIC • SENSITIVE RESEARCH • EMPIRE • GERTSCH instruments for measurement

NEW 30,000,000 WATT RADAR SYSTEM!

L/UHF dual-frequency, pencil-beam radars pioneer new concepts in super power research systems

LTV Continental Electronics Division is systems contractor for two unique radar systems now in operation at White Sands Missile Range: the AN/FPA-22 and the AN/FPA-23. Each system is powered by two Continental 30 megawatt transmitters: one L-band, one UHF. Peak transmitter power is 30 megawatts; average power is 30 kilowatts. Pulse width for both systems is $1\mu s$ and $10\mu s$. Pulse forming lines are triggered by ignitrons; timing pulses come from an exciter/synchronizer. Both techniques are outgrowths of other LTV Continental Electronics contracts.

Electronics for the two systems are almost identical: the AN/FPA-22 uses an 84-foot dish antenna, the AN/FPA-23 uses a 30-foot dish.

The AN/FPA-22 UHF system has a range of 1100 nautical miles: the AN/FPA-22 L-Band system, 2000 nautical miles. The AN/FPA-23 UHF system has a range of 440 nautical miles: the AN/FPA-23 L-Band system, 710 nautical miles.

Other Continental radar transmitters have been used at Trinidad, Prince Albert, all transmitters at all three BMEWS sites, MIT El Campo Laboratory, Stanford University and Nike-Zeus R & D sites. Earlier radar work led to the development of the AN/FPT-5 transmitter for MIT Millstone Hill Laboratory. Among many other notable achievements, this transmitter bounced signals off Venus in 1958.

For information on these and similar super power radar projects, write Department 20, Continental Electronics Manufacturing Co., P. O. Box 5024, Dallas, Texas 75222.

LTV Continental Electronics
A DIVISION OF LING-TEMCO-VOUGHT, INC.

*UHF waveguide, filter,
transmission line and
mode suppressors*

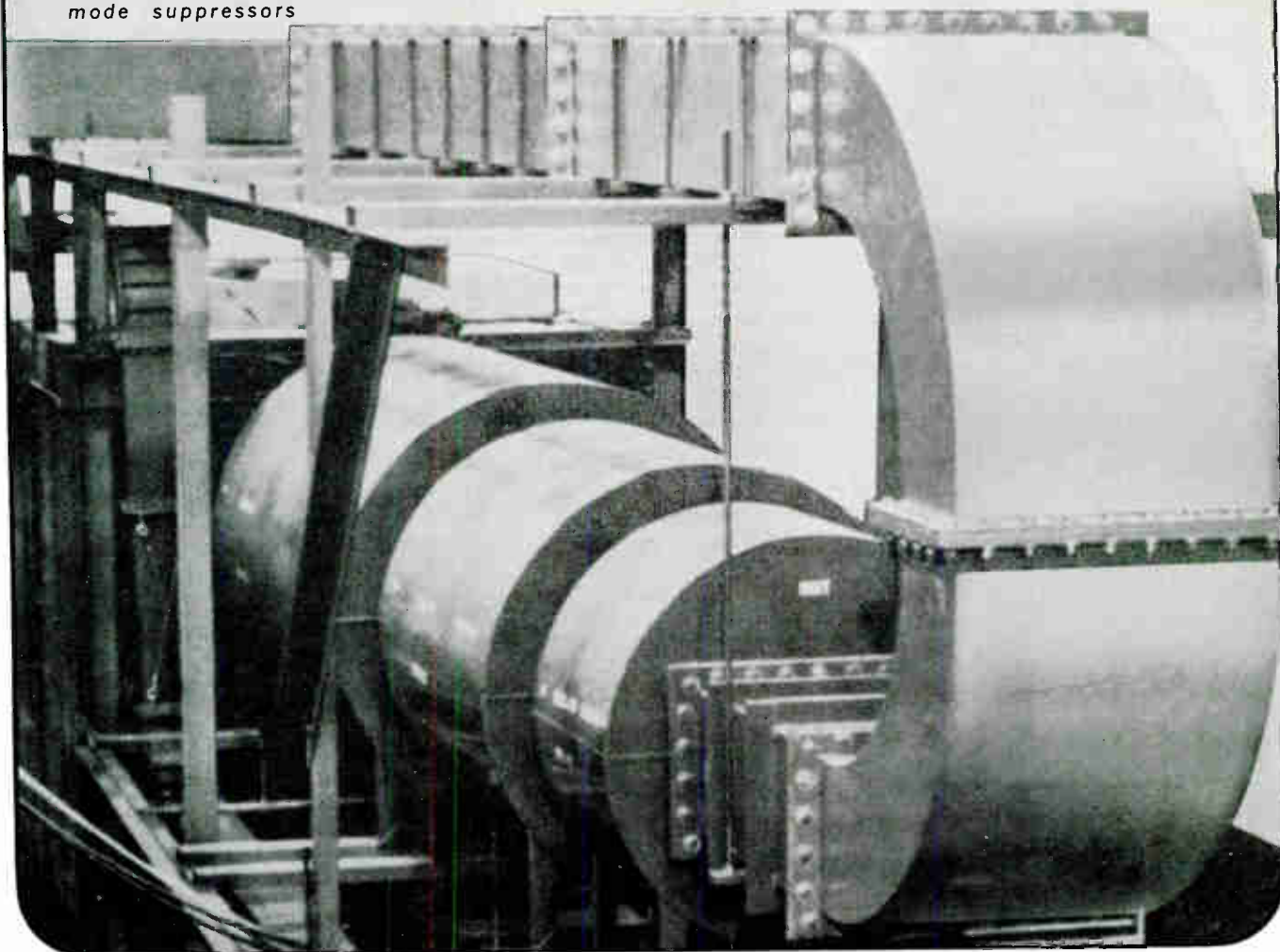

COMING EVENTS

January

- Jan. 6-8: 13th Annual Ind. Elect. & Control Instrumentation Conf., IEEE, ASME, ISA; Phila., Pa.
 Jan. 12-14: 11th Annual Symp. on Reliability and Quality Control, IEEE, ASQC; Fontainebleau Hotel, Miami Beach, Fla.
 Jan. 31-Feb. 5: IEEE Winter Power Mtg., IEEE; Statler-Hilton Hotel, New York, N.Y.

February

- Feb. 3-5: 6th Winter Conv. on Military Electronics, IEEE; Ambassador Hotel, Los Angeles, Calif.
 Feb. 15-17: 5th Electrical/Electronic Trade Show, ERC, ERA; Denver Auditorium Arena, Denver, Colo.
 Feb. 17-19: Int'l Solid State Circuits Conf., IEEE, Univ. of Pa.; Phila., Pa.

March

- Mar. 22-25: IEEE Int'l Conv., IEEE; Coliseum & N.Y. Hilton Hotel, New York, N.Y.
 Mar. 31-Apr. 4: Electronic Parts Distributors Show, EISC; N.Y. Hilton & Americana Hotels, New York, N.Y.

'65 Highlights

- IEEE Int'l Conv., Mar. 22-25; Coliseum, New York Hilton, New York, N.Y.
 WESCON, Western Electronic Show & Conv., Aug. 24-27, IEEE, WEMA; Cow Palace, San Francisco, Calif.
 NEREM, Northeast Research & Eng. Mtg., Nov. 3-5, IEEE, Boston, Mass.

April

- Apr. 5-6: Rubber & Plastics Industries Conf., RPI; Sheraton-Mayflower Hotel, Akron, Ohio.
 Apr. 6-8: Railroad Conf., IEEE, ASME; Penn-Sheraton Hotel, Pittsburgh, Pa.
 Apr. 13-15: Nat'l Telemetering Conf., IEEE, AIAA-ISA; Shamrock Hilton Hotel, Houston, Tex.
 Apr. 14-15: 1965 Electronics & Instrumentation Conf. & Exhibit, IEEE-ISA; Cincinnati Gardens, Cincinnati, Ohio.
 Apr. 21-23: Southwestern IEEE Conf. & Elec. Show, IEEE; Dallas Memorial Auditorium, Dallas, Tex.
 Apr. 21-23: 1965 Int'l Nonlinear Magnetics Conf., IEEE; Sheraton Park Hotel, Washington, D.C.
 Apr. 27-29: American Power Conf., IEEE; Sherman Hotel, Chicago, Ill.

May

- May 4-6: 5th Annual Packaging Industry Conf., IEEE; Milwaukee Inn, Milwaukee, Wisc.
 May 5-7: 1965 Microwave Theory & Techniques Symp., IEEE; Jack Tar Harrison Hotel, Clearwater, Fla.
 May 5-7: Electronic Components Conf., IEEE-EIA; Marriott Motor Hotel, Washington, D. C.

The top part of the image shows a schematic diagram of a multicoupler system. Two transmitters, labeled 'XMTR 1' and 'XMTR 2', are connected to a central rectangular unit. This unit is connected to a large, triangular antenna structure. Below this is a photograph of the internal components of the multicoupler, showing various vacuum capacitors and other electronic parts mounted on a metal chassis.

| | |
|-----------------|---------------|
| Type | UCSV 250 |
| Capacity | 125 to 250 PF |
| Voltage | 10 KV PK |
| Current (16 mc) | 40 Amps RMS |
| Type | JCSF 80 |
| Capacity | 80 PF |
| Voltage | 10 KV |
| Current (16 mc) | 30 Amps RMS |
| Type | CVDA 1000 |
| Capacity | 25 to 1000 PF |
| Voltage | 7.5 KV |
| Current (16 mc) | 125 Amps RMS |
| Type | UCSX 1000 |
| Capacity | 25 to 1000 PF |
| Voltage | 7.5 KV |
| Current (16 mc) | 45 Amps RMS |

NEW H-F MULTICOUPLER USES JENNINGS VACUUM CAPACITORS TO ACHIEVE HIGH Q

Jennings vacuum capacitors are used in the reactive filter network of Granger Associates Model 520F multicoupler. The multicoupler connects two h-f transmitters to a single broadband antenna, permitting both to transmit simultaneously without interference or interaction and without significant insertion loss. The high frequency range of 2 to 32 megacycles is divided into two channels, separated by an extremely narrow open band, to accommodate each transmitter. Jennings capacitors provide the low dissipation factor and high Q characteristics which make this close channel operation possible.

In addition the vacuum capacitors offer extra high voltage and current ratings at high ambient temperatures to provide a very comfortable margin of safety.

A high degree of reliability was required because the capacitors are used under oil in a sealed enclosure. Jennings vacuum capacitors met these requirements with ease. No field problems have ever occurred which could be related to either electrical or mechanical fault in the Jennings capacitors.

This proven application is only one of the hundreds in which Jennings vacuum capacitors have solved difficult circuit design problems. For any capacitive problem involving high power rf generating devices examine the advantages of Jennings capacitors. They have an unequalled record of exceptional performance in all sections of high power transmitters, dielectric heating equipment, antenna phasing equipment, electronic equipment from cyclotrons to electron microscopes.

At your request we will be happy to send more detailed information about our complete line of vacuum capacitors.

RELIABILITY MEANS VACUUM | VACUUM MEANS

Jennings[®]

JENNINGS RADIO MFG. CORP., 970 McLAUGHLIN AVE., SAN JOSE 8, CALIF., PHONE CYpress 2-4025

A REMARKABLE NEW RELAY



FROM POTTER & BRUMFIELD

**Versatile P&B relay
can be made to step,
count, sequence, home,
switch, read-out . . .**

all with singular reliability

**INHERENT RELIABILITY
DUE TO
RELAY'S INDIRECT ACTION**

The GM is a reliable, low cost, impulse/sequencing relay providing a choice of switching elements which make it practical for an extremely wide range of applications.

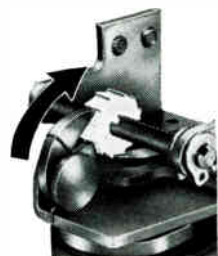

Contact action, except in the case of auxiliary contacts, takes place during the drop-out of the armature. The motive power is the armature's return spring, a constant force providing

smooth, dependable results.

As drop-out occurs, a pawl engages a 10 or 12-step ratchet, advancing it one position. This action turns a shaft which results in contacts being opened or closed and/or results in advancing the movable contact arm of a printed circuit board switch.

**PRINTED CIRCUIT BOARD
CAN BE USED FOR
10 OR 12-STEP SWITCHING**

A uni-directional printed circuit board with either 10 or 12 stations can be attached to the basic GM structure.

Contacts are rated to 250 milliamps. The movable arm advances one position each time the armature drops out.

A pulse of only 20 milliseconds will effect switching.

If sufficient coil power is available, two sets of regular contact arms and two sets of auxiliary contacts may be used in conjunction with the printed circuit board.

Regular cam-activated contacts as well as auxiliary contacts are rated to 3 amperes, 115 volts ac, 60 cycles non-inductive. GM coils may be either ac or dc powered.



**LET US HELP YOU
WITH YOUR SEQUENCE
SWITCHING PROBLEMS**

GM relays have been field tested for more than a year in a number of applications, most notably in automatic vending equipment. They are readily adaptable to remote television set controls, self-interrupting and homing circuits and many others.

Perhaps this relay will prove to be a reliable, inexpensive solution to your switching problems. Please call us, or get in touch with the P&B representative in your area.

ENGINEERING DATA

GENERAL:

Description: Impulse/sequencing relays. GM = 2 Form C contacts. GM with auxiliary contacts = 4 Form C contacts.

Expected Life: 500,000 mechanical operations.

Breakdown Voltage: 1000 volts rms between all elements and ground.

Temperature Range: AC: -45°C to +45°C (intermittent duty only). DC: -45°C to +75°C.

Operate: AC: 78% or less of nominal voltage @ +25°C. DC: 75% or less of nominal voltage @ +25°C.

CONTACTS:

Arrangements: GM: Two Form C (ratchet operated). GM with auxiliary contacts: Two Form C (auxiliary), and two Form C (ratchet operated).

Special: Modification of GM with 10 or 12-position uni-directional printed circuit stepping switch.

Ratings: GM: to 3 amps 115 volts AC 60 cycle (non-inductive). GM with auxiliary contacts: to 3 amps 115 volts AC 60 cycle (non-inductive). GM with 10 or 12-position printed circuit stepping switch: 250 MA.

COILS:

Voltage: AC: to 230 volts, 60 cps. DC: to 110 volts.

Power: AC: 9 voltamps maximum. DC: 2.5 watts minimum, 4 watts maximum.

Duty: AC: 50% coil duty cycle - 5 minutes maximum on, 5 minutes minimum off. DC: Continuous @ 4 watts at 25°C.

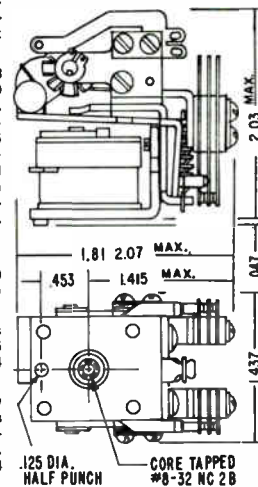

*Now available at leading
electronic parts distributors.*



POTTER & BRUMFIELD

Division of American Machine & Foundry Company, Princeton, Indiana
In Canada: Potter & Brumfield, Division of AMF Canada Ltd., Guelph, Ont.

DECEMBER

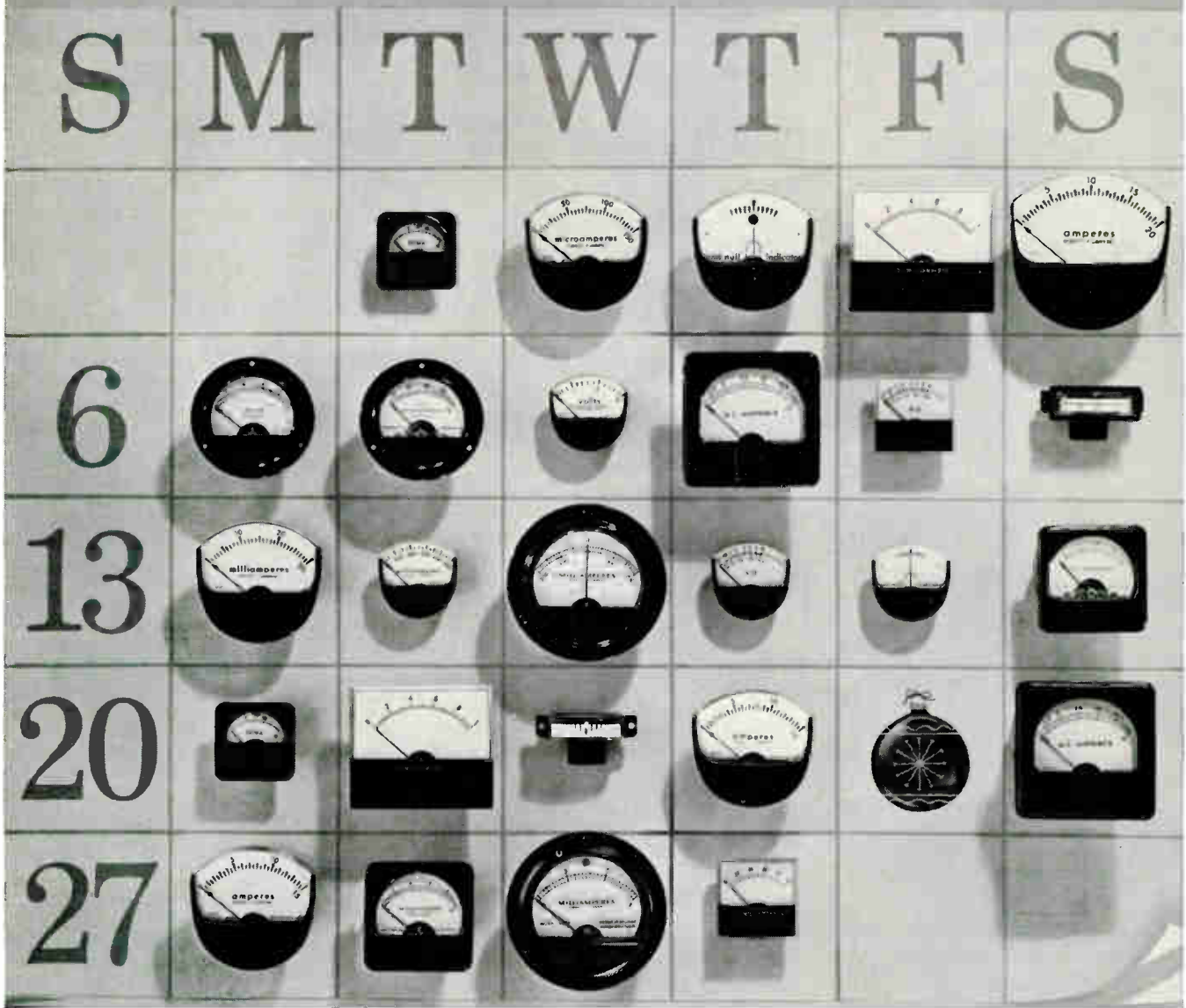

Day in, day out, there's a Honeywell meter to do the job

Meet the Honeywell line. Quality meters. In every shape and size imaginable. Big meters. Miniature meters. Edgewise meters. Contemporary-styled, medallion-shaped meters (Medalist). New square-shaped meters with uncluttered dial faces for easy readout. Ruggedized meters that shrug off vibration, are impervious to moisture, dust, fumes. You can get quick, off-the-shelf delivery of any standard Honeywell meter by ordering direct from your Honeywell distributor. For the name of the distributor nearest you (or a copy of our latest catalog) write: Honeywell, Precision Meter Division, Manchester, N. H. 03105. In Canada, Toronto 17, Ontario.

Honeywell

SPLIT SCREEN STORAGE

WITH A TEKTRONIX OSCILLOSCOPE
(for stored or conventional displays)

FOR ONLY \$1035

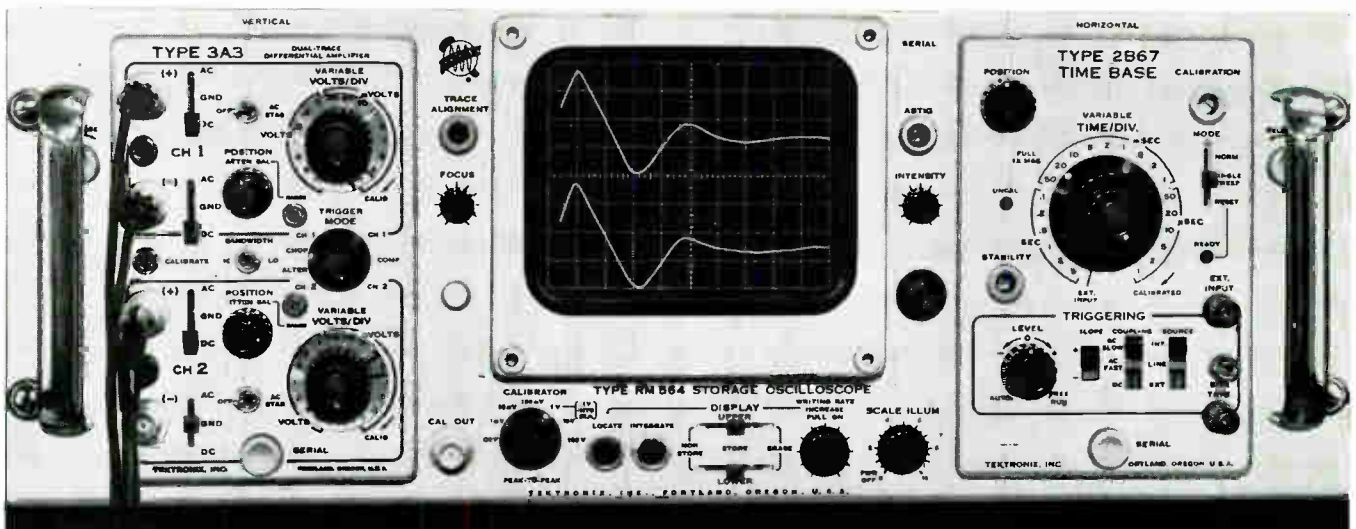

SAVES FILM, JUST STORE AND ANALYZE
ACCEPTS COMBINATIONS OF 17 PLUG-IN UNITS
SAVES SPACE, ONLY 7 INCHES RACK HEIGHT
OPERATES SIMPLY AND RELIABLY

Display shows ability of the Type RM564 to store single-shot events. Waveforms represent displacement of leaf springs due to imparted shocks given them during test. Split-Screen Facility—with independent storage and erase of upper and lower half of the crt—permits easy comparison of test waveforms to a reference display.

| | |
|---|--------|
| Type RM564 Storage Oscilloscope | \$1035 |
| Type 2B67 Time-Base Unit | 210 |
| Type 3A3 Dual-Trace Differential Amplifier Unit | 790 |
| Cabinet Model also available | 950 |

15 other plug-in units available—
Oscilloscope prices without plug-in units
U. S. Sales Prices f.o.b. Beaverton, Oregon

CALL YOUR FIELD ENGINEER FOR A DEMONSTRATION — 8-PAGE SPECIFICATION BOOKLET AVAILABLE

Tektronix, Inc. / P.O. BOX 500 • BEAVERTON, OREGON 97005 • Phone: (Area Code 503) Mitchell 4-0161 • Telex: 036-691
TWX: 503-291-6805 • Cable: TEKTRONIX • OVERSEAS DISTRIBUTORS IN 25 COUNTRIES
TEKTRONIX FIELD OFFICES in principal cities in United States. Consult Telephone Directory
Tektronix Australia Pty., Ltd., Melbourne; Sydney • Tektronix Canada Ltd., Montreal; Toronto
Tektronix International A.G., Zug, Switzerland • Tektronix Ltd., Guernsey, C. I. • Tektronix U. K. Ltd., Harpenden, Herts



NASA PROGRAM DIGEST DUE—The agency expects to roll its Research and Technology Program Digest this month. The digest, NASA reports, will list some 3000 tasks to be done with current funds, titles of tasks, and where they are to be carried out. Parts of the Digest—Flash Index—will be available to industry on request.

DOD INDUSTRY BRIEFINGS—“On-again-off-again” briefings for business, industry and labor, are on again. They were delayed this summer to avoid charges of political design during election campaigning. Now, unclassified seminars are slated for Los Angeles on March 3-4. Other dates are: New York City, March 16-17; Chicago, March 31-April 1; Dallas, April 14-15; Washington, D. C., April 28-29.

DOD TESTING NEW FORMS—In what seems “an endless task,” DOD is pushing to simplify paper work and procurement forms. A testing program now in effect involves “Request for Quotation,” “Solicitation and Offer,” “Award/Contract,” and “Modification of Solicitation or Contract.” The new forms (4) are supposed to eliminate 20 current forms.

RADAR NET BLANKETS U. S.—Federal Aviation Agency has extended its high-altitude radar net to all airspace in continental U. S. All 22 FAA control centers will be supplying “area positive control” (APC). This means long-range radar monitoring of *all* aircraft between altitudes of 24,000 and 60,000 feet.

ANTHROPOMORPHIC DUMMY

“Andy,” one of three anthropomorphic dummies aiding in simulated flights of NASA’s Apollo mooncraft, is getting his electronic brain, which consists of 13 tiny sensing and transmitting devices. He has another instrumentation package, an accelerometer/3-demodulator, in his chest. Instrumentation by Fairchild Controls.

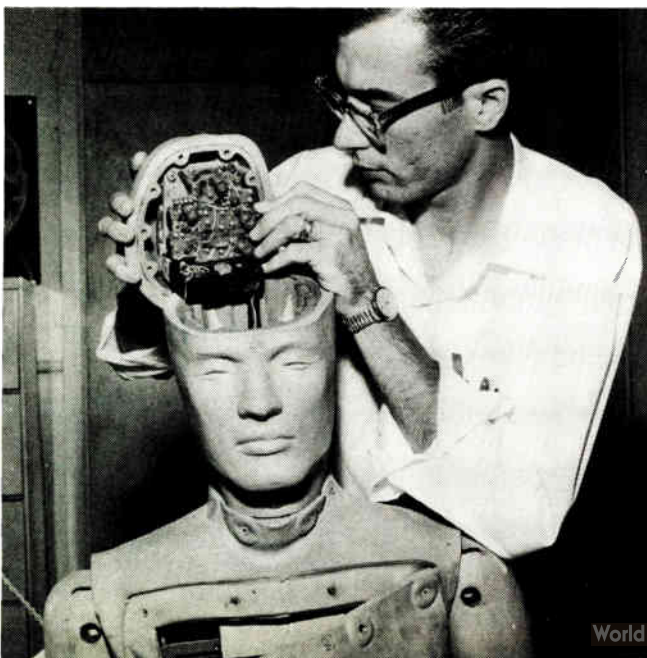

BUDGET BUSINESS PRIORITY—Almost all federal agencies are deep into budget estimating for fiscal 1966. Word from an electronic division of one agency is that more and more R&D funds will come in big chunks to prime contractors, who will be less inclined to use sub-contractors. Less hardware will be produced for military and government.

MATERIALS EMPHASIZED—Space and military leaders are pointing up four areas of materials development “crucial to U. S. Aerospace program of the 1970s.” They are: (1) acquisition of new basic knowledge toward new materials or use of existing materials; (2) exploration of new materials in advance of specific system needs; (3) evaluation of new materials for potential uses; and (4) investigation of economical manufacturing processes, techniques, and equipment.

FLIGHT ACTIVITY RISE—Growing need for a National Airspace System to move aircraft safely and efficiently was noted by Najeeb E. Halaby, Federal Aviation Agency administrator. To help meet a possible 40% growth in flight activity by 1975, Mr. Halaby expects to see automation of the entire en route air system and all significant terminal areas.

EDUCATIONAL TV STATIONS—E. William Henry, chairman of Federal Communications Commission, predicted that we will have more than 200 educational television stations by 1970. He noted that the nation now has 293 radio and 93 ETV stations on the air.

MORE SCIENCE ADVICE—The 89th Congress will get more technical and science guidance than any Congress in history. Besides the established Senate and House committees on technical problems, Congress has called upon the National Academy of Sciences to advise it of national problems involving research. For the first time in 101 years of history NAS is asked to give continuing advice to Congress.

NEW FEDERAL HELP OFFERED—A task force set up by Pres. Johnson offers advice to manufacturers hurt by lack of government orders. On request, the task force will (1) prepare programs for creation of, or expansion of, industries; (2) conduct conferences on contracting requirements and possibilities; and (3) arrange for federal manpower training programs. Sec. McNamara says bluntly that defense spending will decline as a percentage of gross national product, and manufacturers must adjust to it.

FOR THOSE IN COMMAND OF THE SITUATION...

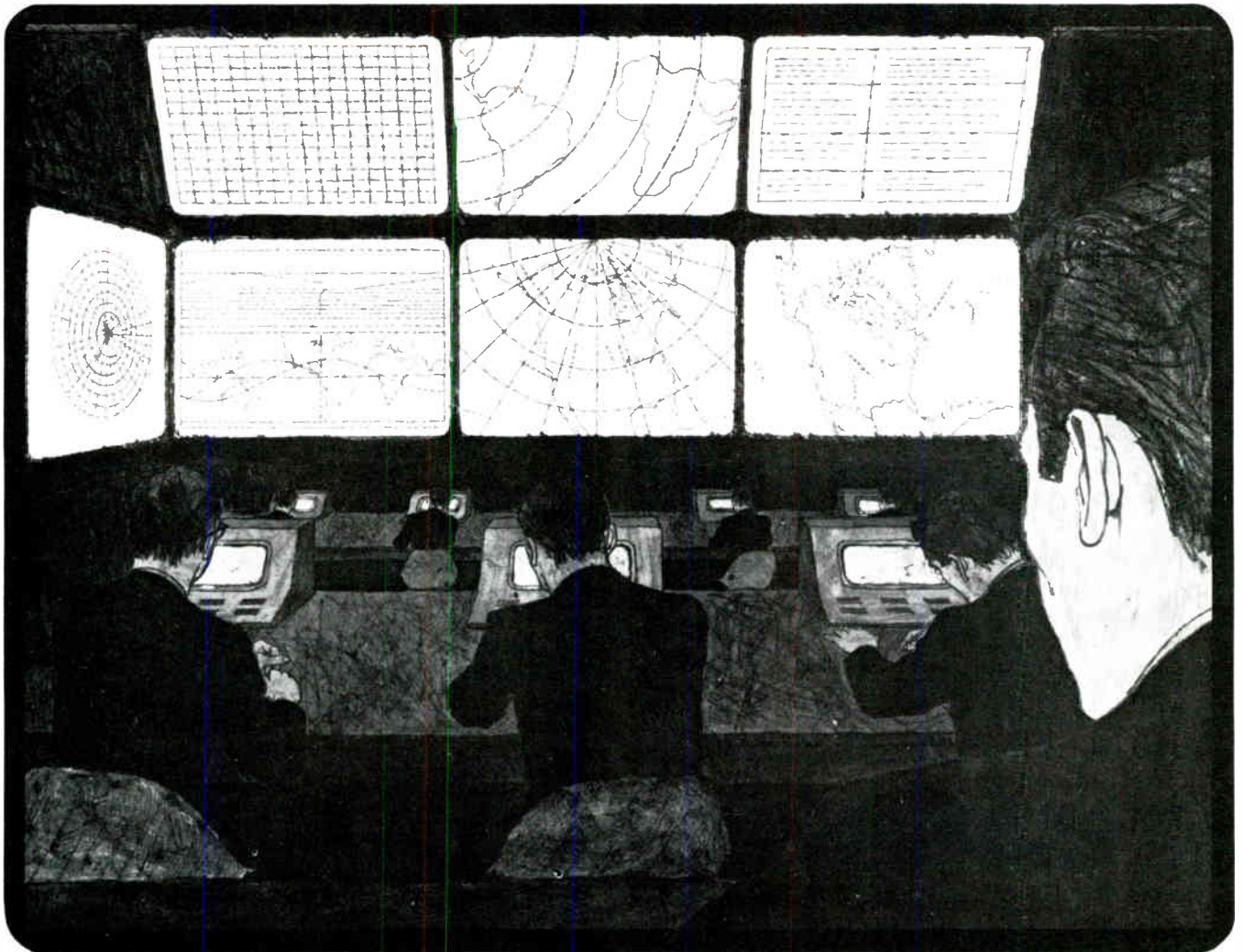

...AN LTV DISPLAY SYSTEM...

To provide fresh, vital... two and three dimensional tracking data projected against any reference background... in color... with wide range choice of symbology... at the near real time speed now possible with the new LTV 7000 electro-mechanical projectors*...

This is a brief insight into an LTV display system... indispensable FOR THOSE IN COMMAND OF THE SITUATION...

More than 70 versatile LTV display systems are in operation for missiles, satellite and space tracking, shipboard CIC, air defense and battlefield command.

Contact LTV today for information about complete "Dynamic Plotting Projection Displays" in all sizes for air, sea or land installations. LTV Military Electronics Division, P. O. Box 6118, Dallas, Texas 75222.

LTV MILITARY ELECTRONICS
A DIVISION OF LING-TEMCO-VOUGHT, INC.



***THE NEW LTV 7000 HIGH SPEED DISPLAY SYSTEM PROJECTOR PLOTTER**

Full-scale excursion time 60 milliseconds
Adjacent symbols per sec. 20
Random symbols per sec. 10
Dimensions: 12" long 7" wide 11³/₄" high

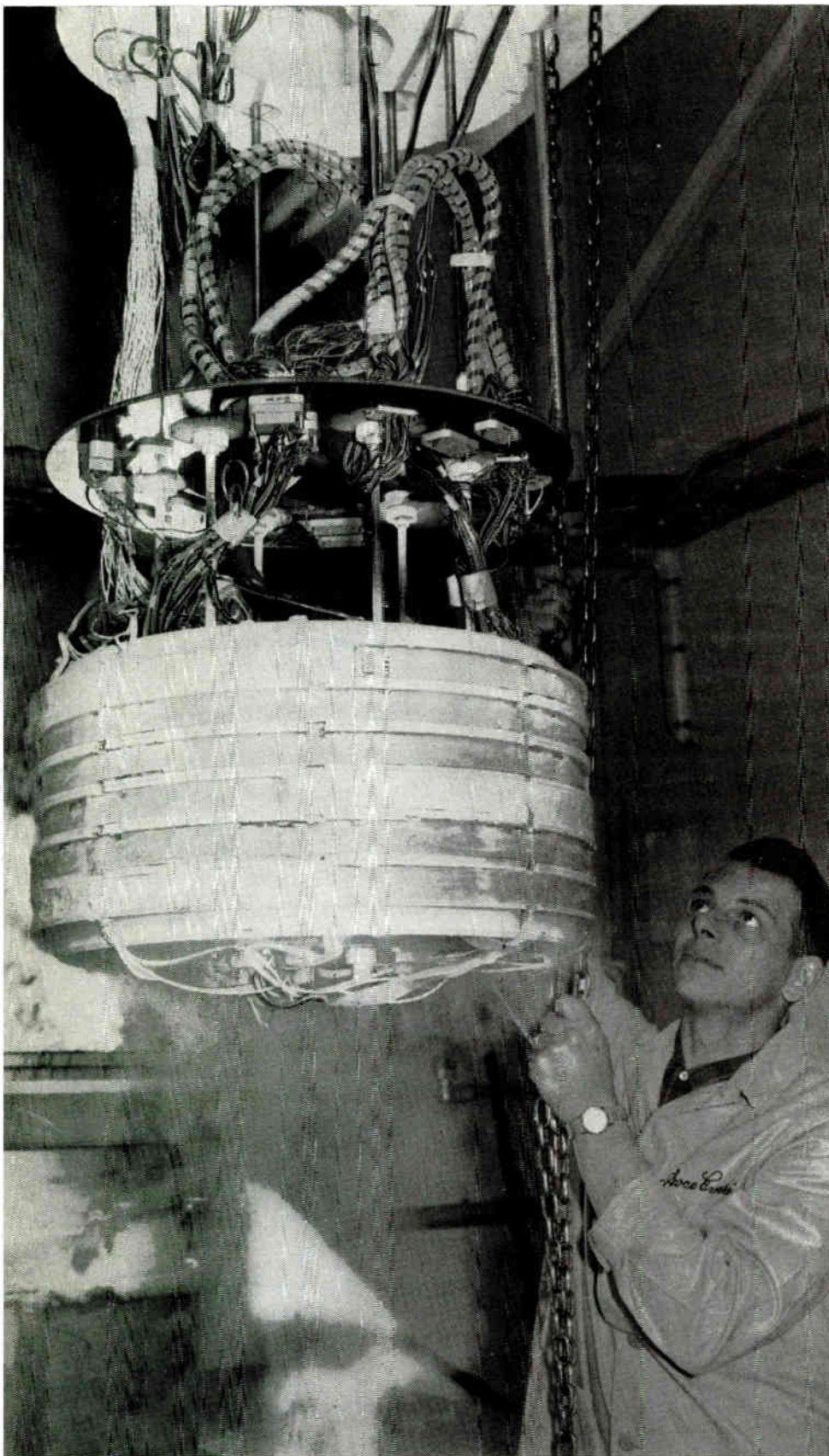

ELECTRONIC SNAPSHOTS

The Changing
STATE-OF-THE-ART
in the electronic industries

▼ SABRE SYSTEM

An important part of American Airlines' SABRE reservations system is this desk-size electronic console. Through use of this console an agent can request a seat on a specific flight from the reservations center at Briarcliff Manor, N. Y. If flight requested is not available, alternate flights are immediately indicated to the reservations agent by lights.



▲ SUPERCONDUCTING MAGNET

A 32,800 gauss, 10 inch-diameter superconducting magnet is lifted from its container of liquid helium coolant after a test run at Avco-Everett Research Laboratory in Everett, Mass. The magnet, designed by Avco, will be used by Argonne National Laboratory (Argonne, Ill.) in connection with Argonne's new atom smasher—the 12.5 Bev Zero Gradient Synchrotron.

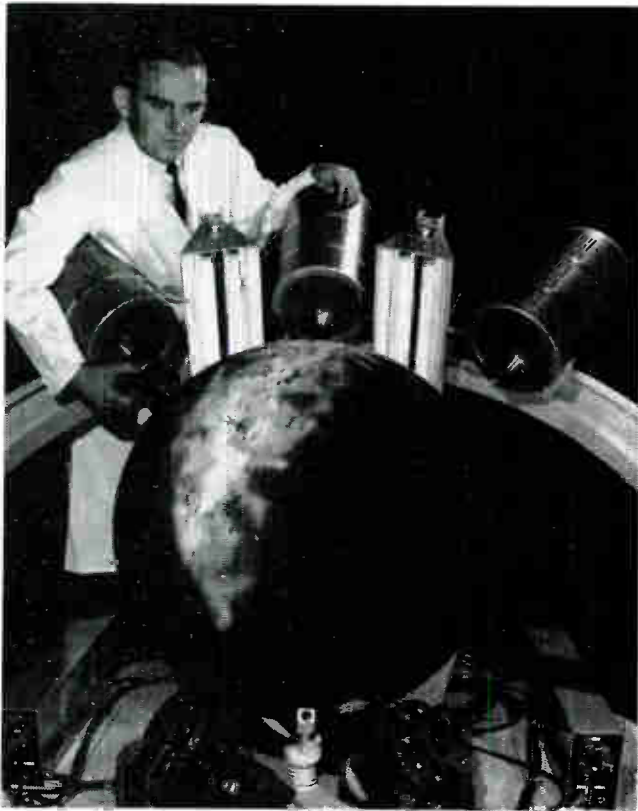

▲ "TV STAR STUDIO"

This "star studio" was developed by the Astronautics division of General Dynamics Corp. (San Diego) to simulate views of the solar system as seen from a spacecraft window. Thomas Martin adjusts three TV cameras which scan a star-field map of the sky. Scenes viewed by the cameras will be projected on three windows of a spacecraft simulator to provide actual flight sensations to research scientists.



▲ EXTREMELY SHARP BEAM

Extreme sharpness and directivity of a laser beam is demonstrated in this experimental gas laser in operation at the Westinghouse Research Laboratories in Pittsburgh, Pa. Using a mixture of helium and neon gases, the laser produces a continuous beam of coherent light. This coherent light is of the type used for experiments in laser communications, distance measurement (ranging), guidance and mapping.

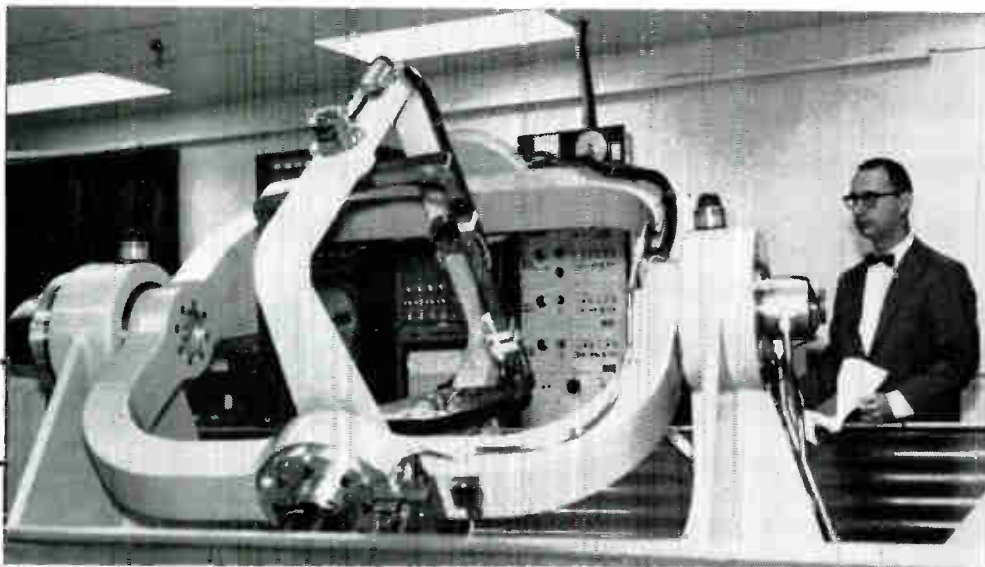

▲ SIMULATED SPACE FLIGHT

Engineering supervisor R. Gelman inspects ground-based, three-axis simulator at General Electric's Reentry Systems Dept. in Phila. This system, coupled with a GE-235 computer, an analog computer and an "on-board" flight computer, will carry out a simulated space flight in "real-time." The three computers will exchange information and control the "flight" of the vehicle throughout its simulated journey. The hybrid system takes advantage of the best features of both the analog and digital computers to provide a flexible and economical system.

▼ COMMUNICATIONS CENTER

An installer at Stromberg-Carlson division of General Dynamics (Rochester, N. Y.) makes adjustments on XY switching equipment which will serve several locations in the Republic of Iraq. System is mounted in a van to provide mobility. Three such mobile centers have been delivered and will be used at sites where permanent telephone exchanges will be constructed sometime in the future.

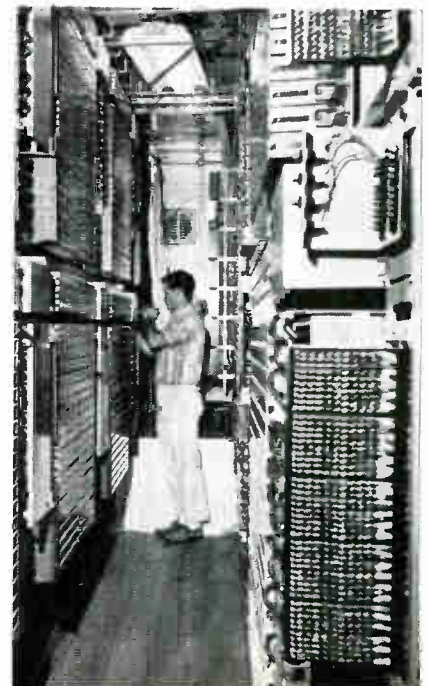

ETERNA ETER



The Industry's Broadest Line of Cermet Potentiometers and Trimmers

**BORN RELIABLE AT 650°C • NO CHANCE FOR CATASTROPHIC FAILURE
• BEST HIGH TEMPERATURE CHARACTERISTICS • RESOLUTION
APPROACHING INFINITY • EXCELLENT STABILITY • LOW NOISE • WIDE
RESISTANCE RANGE • LOW INDUCTANCE**

ALL CTS CERMET POTENTIOMETERS AND TRIMMERS FAR EXCEED MIL-R-94B
TEMPERATURE AND STABILITY SPECIFICATIONS AND MEET APPLICABLE SPECIFICATIONS
OF NEW MIL-R-22097, AND MIL-R-23285 (NAVY).

CTS is an old hand at precision mass production of military, industrial, and commercial type variable
resistors. (Over one billion produced since 1922.) This extensive experience, plus many years of
cermet development, enables us to produce in volume the industry's broadest line of cermet poteni-
ometers and trimmers. You may specify any of these controls in volume quantities and be assured
of high quality and prompt delivery.

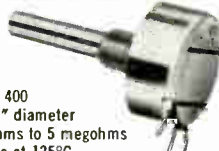
CERMET POTENTIOMETERS

| | | | |
|--|--|--|--|
|  <p>Series 600 1/2" diameter 100 ohms to 5 megohms 1/2 watt at 125°C Max. operating temp. 175°C VOLUME PRODUCTION SINCE 1959</p> |  <p>Series 400 1-3/64" diameter 100 ohms to 5 megohms 2 watts at 125°C Max. operating temp. 175°C VOLUME PRODUCTION SINCE 1961</p> |  <p>Series 500 3/4" diameter 100 ohms to 5 megohms 1 watt at 125°C Max. operating temp. 175°C VOLUME PRODUCTION SINCE 1961</p> |  <p>Series 660 3/8" diameter 100 ohms to 500K ohms 1/4 watt at 125°C Max. operating temp. 175°C VOLUME PRODUCTION SINCE 1963</p> |
|--|--|--|--|

CERMET TRIMMERS

| | | | |
|--|---|--|--|
|  <p>Series 180PC 1-1/4" x 19/64" x 21/64" 100 ohms to 1 megohm 1 watt at 125°C Max. operating temp. 200°C VOLUME PRODUCTION SINCE 1961</p> |  <p>Series 600PC 1/2" diameter 100 ohms to 5 megohms 1/2 watt at 125°C Max. operating temp. 175°C VOLUME PRODUCTION SINCE 1962</p> |  <p>Series 180WL 1-1/4" x 19/64" x 5/16" 100 ohms to 1 megohm 1 watt at 125°C Max. operating temp. 200°C VOLUME PRODUCTION SINCE 1960</p> |  <p>Series 170 1/2" x 1/2" x .260" 100 ohms to 1 megohm 3/4 watt at 85°C Max. operating temp. 150°C VOLUME PRODUCTION SINCE 1961</p> |
|  <p>Series 171 1/2" x 1/2" x .225" 100 ohms to 1 megohm 3/4 watt at 85°C Max. operating temp. 150°C VOLUME PRODUCTION SINCE 1961</p> |  <p>Series 385 11/32" diameter 100 ohms to 500K ohms 1/8 or 1/4 watt at 125°C Max. operating temp. 175°C VOLUME PRODUCTION SINCE 1962</p> |  <p>Series 172 1/2" x 1/2" x .190" 100 ohms to 1 megohm 3/4 watt at 85°C Max. operating temp. 150°C VOLUME PRODUCTION SINCE 1962</p> |  <p>Series 660PC 3/8" diameter 100 ohms to 500K ohms 1/4 watt at 125°C Max. operating temp. 175°C VOLUME PRODUCTION SINCE 1963</p> |

**DATA SHEETS ARE AVAILABLE GIVING COMPLETE ELECTRICAL
AND MECHANICAL SPECS ON ALL CERMET PRODUCTS.**

INAL ?

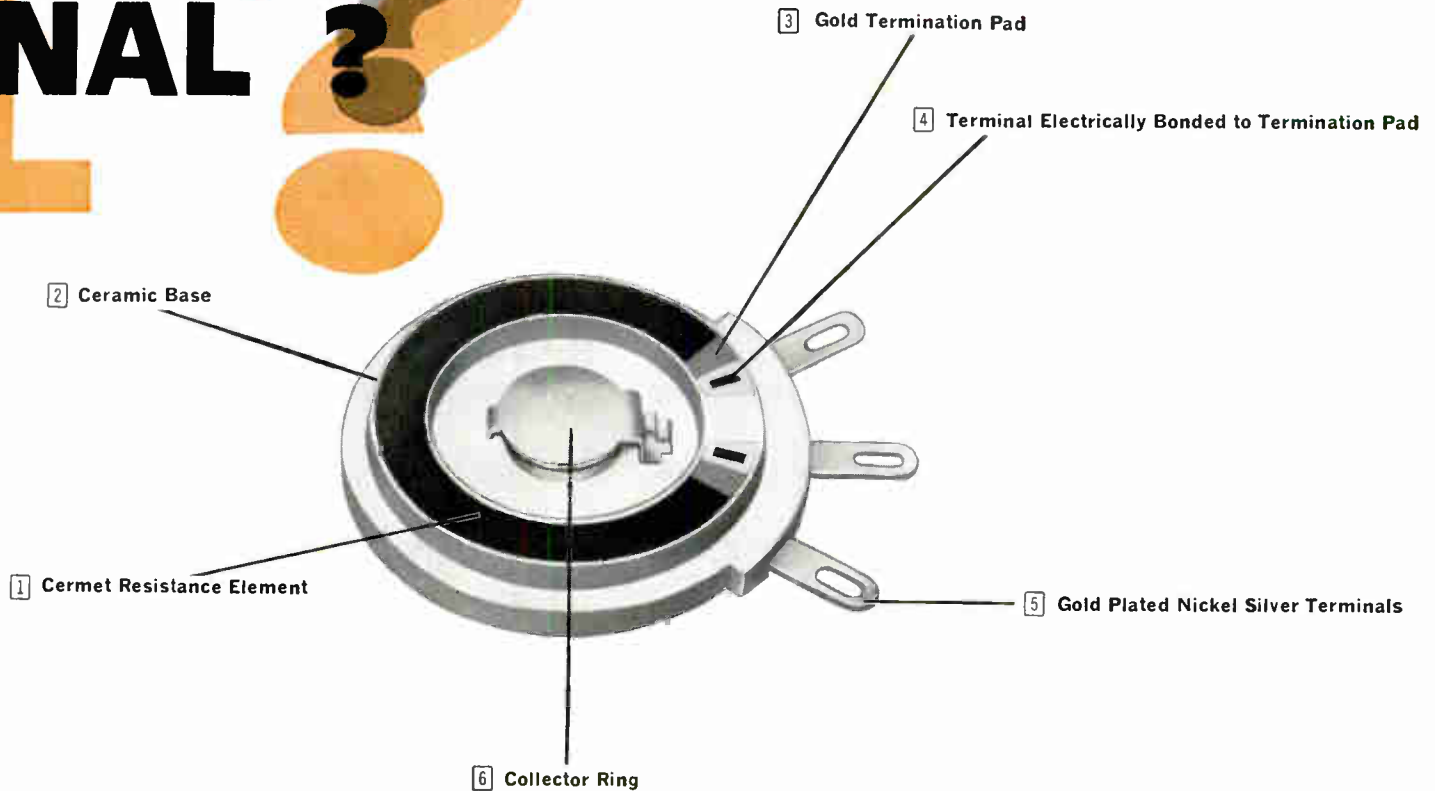

In five years of volume production

our Cermet Element (fired at more than 650°C) has more than withstood application challenges requiring:

- extreme stability and reliability under severe environmental conditions
- temperature extremes
- high loads
- resolution approaching infinity
- radiation exposure

Here, point by point, is why:

- 1 **Cermet Resistance Element** is fired to ceramic base.
- 2 **Ceramic Base** serves as built-in heat sink.
- 3 **Gold Termination Pad** diffuses with cermet resistor, becomes part of substrate after firing.
- 4 **Terminals Electrically Bonded** to fired on termination pad with high temperature conductor.
- 5 **Gold Plated Nickel Silver Terminals** rigidly anchored to ceramic substrate.
- 6 **Collector Ring** for contactor is integrally connected to center terminal to avoid series connections.

Elements can't separate from substrate during varying environmental conditions. Thermally bonded cermet resistors are a virtually indestructible combination of a matrix of inorganic material and precious metal alloys after firing.

Sales Offices and Representatives conveniently located throughout the world.

Principal Products

Variable Resistors
Selector Switches
Loudspeakers
Trimming Potentiometers
Microminiature Components
& Circuit Packages

Subsidiaries

CTS of Asheville, Inc., Skyland, N. C.
CTS of Berne, Inc., Berne, Indiana
CTS of Paducah, Inc., Paducah, Kentucky
Chicago Telephone of California, Inc.,
South Pasadena, Calif.
CTS of Canada, Ltd., Streetsville, Ontario
CTS Microelectronics, Inc., Ridgefield, Conn.
CTS Research, Inc., Lafayette, Ind.



Founded 1896

CTS CORPORATION
Elkhart, Indiana

World Radio History

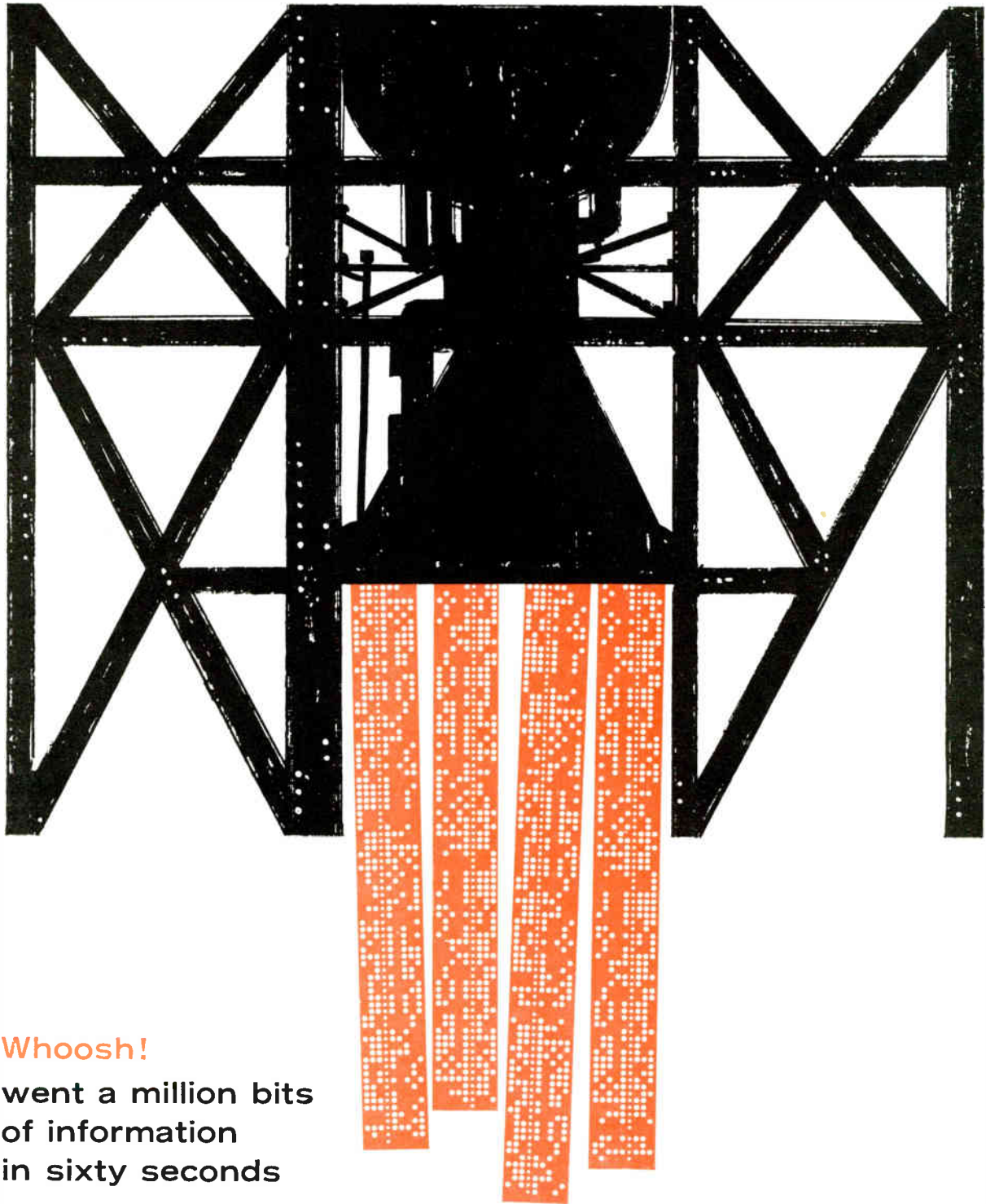

Whoosh!
went a million bits
of information
in sixty seconds

... of a typical rocket engine firing test. And this high-speed digital data system gets them all—*accurately*. The system samples 15,000 channels per second, conditions, amplifies and digitizes analog information from any one of three rocket engine firing bays and records the result on an IBM 729-IV digital tape recorder in computer-compatible format for entry into an “off-line” computer. It has an input capability of 20 high-level and 80 low-level channels. Additional output equipment includes an FM tape recorder, analog oscillo-

graphic recorder, digital printer and visual data displays.

Perhaps you don't have a rocket engine test stand from which you wish to acquire data, but you do have other problems in the data acquisition and processing, telemetry, or range timing instrumentation fields where Astrodata's vast experience in dynamic information handling and hybrid computer techniques can help you. Write for your free copy of our 20-page brochure “Astrodata's Systems Experience.”



ASTRODATA

P.O. Box 3003 ■ 240 E. Palais Road, Anaheim, California ■ 92803

AUGUST TV, RADIO SALES, RADIO PRODUCTION RISE

Unit distributor sales of monochrome television sets and radios, excluding auto sets, were up substantially for August, reports Electronic Industries Association's Marketing Services Department.

Production of monochrome TV was off slightly for August, compared to August 1963, but production of radio sets was up substantially over the same month last year. Yearly sales and production of TV and radio sets were running well ahead.

Distributor sales of monochrome TV sets totaled 562,182 units in August, compared to 549,421 in August 1963, and sales for the first eight months of 1964 totaled 4,562,438, well ahead of the 3,954,670 total for the same period of 1963.

Sales of radio sets, excluding auto sets, totaled 869,500 for August, compared to 849,274 units for August 1963. Radio sales for January-August 1964 were also ahead of last year—5,683,274, compared to 5,482,987 units for the comparable 1963 period.

Total production of television sets, including black-and-white and color, was 705,807 for August and the total for the first eight months of 1964 was 5,716,025 units.

Of the total television sets produced in August, 564,821 units were monochrome and 140,986 were color. Of the black-and-white units produced in August, 555,743 were all-channel.

SWEDEN MARKET OFFERS FUTURE FOR U.S. EXPORTS

A report by Skandinaviska Banken and the U. S. Embassy in Stockholm describes growing market for sophisticated electronic products in Sweden.

Sweden's electronic output is estimated at \$120 million, with a 20% annual growth in sight. The country relies heavily on imports for products of high reliability, which is the decisive selling point rather than price. Sweden-made equipment depends largely on imported components.

Imports into Sweden of electronic products of all types in 1963 was about \$110 million. Excluding home and consumer appliances, the total was \$60 million, of which the U. S. accounted for about 30-35%. The report says that U. S. dominance is growing in industrial measuring equipment. U. S.'s 1963 share of such sales was well over 40%.

The report discloses that imports from the U. S. and other nations outside the European Free Trade Association (EFTA) are dutiable from 10 to 17%. Some electronic products are admitted duty free.

MOBILE TV STUDIO TRAINS STUDENTS



Learning to operate new Sylvania 800V closed circuit TV camera is a high school student of Darien, Conn. Camera is among equipment installed in mobile studio delivered to Darien schools by Sylvania. Studio is touring state to film ETV subjects for Darien.

CONTROLS SALES REPORTED RISING IN SOME INDUSTRIES

Sales of instruments and controls, particularly solid state systems, are "on the upswing in the industrial instrumentation and process control industries." That was the big message at the Instrument Society of America's 19th Annual Conference and Exhibit in New York City.

Biggest areas in capital spending for industrial electronic instruments cited by ISA are in chemical and electric utility industries. However, greater growth is anticipated in iron and steel, pulp and paper, and water treatment industries, among others.

At present, electronic equipment may represent about 25% of the annual \$650 million process control/instrument market, according to Dr. Louis T. Rader, vice president and general manager of industrial electronics, General

Electric Co. He cited a Stanford Research Institute report predicting that dollars spent for electronic instruments and controls may equal dollars spent for pneumatic equipment by 1970.

Yet in 1960 the \$450-million process control market scarcely included any electronic equipment, said Edwin E. Parker, general manager, GE Instrument Department. Complaints against electronic equipment included: high cost and low reliability, plus continued traditional industry dependence upon proven pneumatic, hydraulic, mechanical, electrical and electro-mechanical systems.

ELECTRONIC INDUSTRIES PRAISED FOR EXPORT ROLE

The electronic industries were praised for contributing to the 27% increase in U. S. exports in the past 3½ years by Daniel L. Goldy, National export expansion coordinator.

Before the Electronic Industries Association's Fall Conference in Boston, Mr. Goldy said that the government's export expansion drive has helped lift U. S. sales abroad from \$19.6 billion in 1960 to a current annual rate of \$24.6 billion.

He pointed out that the growing two-way flow of trade in the electronic industries indicates how the nation is moving toward a global economy. In the past four years, U. S. electronic exports have been doubling to where they are nearly \$1 billion a year.

TV TUBE SALES UP IN UNITS, BUT GO DOWN IN DOLLARS

Factory sales of television picture tubes for August 1964 totaled 781,922 units, an increase over 767,528 for August 1963. Total dollar value was only \$13,514,078, compared to \$14,473,630 for August 1963, reports the Electronic Industries Association's Marketing Services Department.

Unit sales of TV picture tubes for January-August 1964 totaled 5,955,233, compared to 5,840,272 units for the same eight months of 1963; but again, the \$105,495,505 value for the eight-month period of 1964 was below the \$108,899,650 in sales for the 1963 period.

Unit factory sales of receiving tubes in August totaled 33,891,000 units, a decline from 35,826,000 units reported for August 1963. Sales for the January-August 1964 period totaled 237,609,000 units, down from the 261,168,000 units reported for the same period in 1963.

ANNOUNCING

TWO NEW COMPUTERS WITH FLIP CHIP™ INTEGRATED CIRCUITS

PDP-8



- 1.6 μ sec cycle time
- 3.2 μ sec add time
- 12 bit word length
- 4096 word memory (expandable to 32,768 words)
- Fortran
- Field tested software
- 625,000 words/sec maximum transfer rate
- Reader punch and typewriter included

\$18,000

PDP-7



- 1.75 μ sec cycle time
- 3.50 μ sec add time
- 18 bit word length
- 4096 word memory (8,192 words directly addressable, expandable to 32,768 words)
- Field tested software including Fortran II
- 570,000 words/sec maximum transfer rate
- 300 cps paper tape reader
- 63.3 cps paper tape punch

\$45,000

OPTIONAL EQUIPMENT AVAILABLE

- | | |
|-----------------------------|------------------------------|
| IBM compatible tape | Analog I/O |
| DEC tape | Data communication equipment |
| CRT displays with light pen | Bulk storage drums |
| Card equipment | Printers and plotters |

digital
EQUIPMENT
CORPORATION

MAYNARD, MASSACHUSETTS

Washington, D.C. • Parsippany, N.J. • Los Angeles • Palo Alto • Chicago • Ann Arbor • Pittsburgh • Huntsville • Orlando • Carleton Place, Ont. • Reading, En land • Munich, W. Germany • Sydney, Australia

FLIP CHIP IS A TRADE MARK OF DIGITAL EQUIPMENT CORPORATION

DO YOU HAVE A LOW POWER SOURCE APPLICATION?

Motorola's New Low-capacitance "0-pf" Transistor Is Fastest At Micro-power Logic Levels!

Until now, micro-power circuits using the best available devices have been severely limited to switching speeds in the 10 to 20 kc range. Today, these same circuits, designed with the new Motorola silicon NPN 2N3493 0-pf* micro-power transistor, can operate in the 1 mc range . . . an improvement factor of 50 to 100 times!

A new Motorola fabrication process has made possible the development of what is probably the world's smallest transistor junction . . . a transistor whose capacitance virtually approaches the "zero" point ($C_{tc} = 0.2$ pf, $C_{te} = 0.3$ pf — case capacitance $\cong 0.3$ pf) . . . permitting faster switching speeds at lower power levels than ever before!

Actually, the capacitance of the 2N3493 "0-pf" device is *so low* that other circuit considerations (stray capacitance, wire length, etc.) have now become the circuit speed limiting factors.



Write for the new Designer's* Data Sheet for the Motorola "0-pf" 2N3493 transistor. It includes limit curves directly applicable to "worst case" switching circuit designs as well as sufficient information to permit the design engineer, in most cases, to design his circuits entirely from the data sheet alone.

If power, weight, and space are problems in *your* application, Motorola's new "0-pf" annular epitaxial passivated 2N3493 transistor could very well be the answer. Contact your nearest Motorola semiconductor district office or distributor for evaluation units today, or write Technical Information Center, Box 955, Phoenix, Arizona 85001.

ELECTRICAL CHARACTERISTICS

| | |
|------------------------------|--------------------------------------|
| BV_{CEO} | 12 V MIN |
| BV_{CBO} | 8 V MIN |
| BV_{EBO} | 5 V MIN |
| $h_{FE} @ 10 \mu A / 0.5 V$ | 25 MIN |
| $h_{FE} @ 100 \mu A / 0.5 V$ | 40 MIN (20 MIN @ $-55^{\circ}C$) |
| $h_{FE} @ 500 \mu A / 0.5 V$ | 40-120 |
| $f_T @ 1 mA / 3 V$ | 400 MC MIN |
| $C_{ob} @ 3 V$ | 0.7 pf MAX† |
| $C_{ib} @ 0.5 V$ | 0.7 pf MAX |



4-Lead
TO-18 Pkg.

† Includes 0.3 pf can capacitance

* Trademark of Motorola



MOTOROLA[®]
Semiconductors

641-B112

...and for Mobile UHF Communications Equipment with greater power in a smaller package, there's the new Amperex 8509, instant-heating version of the renowned 5894



LETTERS

to the Editor

Calibration and Measurement . . .

Editor, ELECTRONIC INDUSTRIES:

Reference is made to your editorial regarding measurements and your invitation to those Companies with calibration and measurement capabilities "for hire" to notify you of the facilities available.

The enclosed "Catalogue of Instrument Services" gives full information on our facilities and capabilities. As you will see, we handle just about any type or make of equipment and our Primary References are directly referred to either National Research Council Ottawa or to N.B.S. in the U.S.A. In addition to calibration and measurement facilities, a complete capability for repair and overhaul is also provided.

Aside from the interest of Canadian readers in our facilities, it is felt they will be of considerable interest to U.S.A. manufacturers who sell their products in Canada but cannot afford to maintain complete service facilities in this country. Much equipment is shipped to and fro across the border for repair, and this is costly to the Canadian customer and also very time consuming. Also warranty repairs can most often be made here at less cost and in shorter time than shipping to U.S. plants, and the customer in addition gets better service and is more receptive to purchasing from U.S. sources when he can get service in Canada.

We already are providing repair service here for a number of U.S. companies and would welcome the opportunity to provide such services for more companies, thus directly benefitting the Canadian customer and the U.S. manufacturer.

P. Hobley, Manager,
Instrument Services Department
RCA Victor Company, Ltd.
1001 Lenoir St.
Montreal 30, Canada

Can You Help?

Editor, ELECTRONIC INDUSTRIES:

We manufacture the PENGUIN amphibious vehicle using a body molded from fiberglass reinforced plastic.



Take the Amperex 5894, a twin tetrode widely recognized by communications equipment designers and end-product users alike for its overall superiority. Take the Amperex instant-heating Harp Cathode, the same Harp Cathode that is now proving its exceptional qualities in the rapidly growing Amperex family of instant heating communication tubes. Put the two together and the advantages to designers of transistorized communications equipment—whether its back-pack or land safety—are unbeatable.

Like the famous 5894, the new 8509 is designed for use as an RF power amplifier, oscillator, modulator and frequency multiplier. It features high-gain, unflinching uniformity and extreme reliability.

Unlike the 5894, however, and thanks to its Harp Cathode, the 8509 has an operational warm-up time of only 0.5 second thus insuring an ideal marriage with transistorized circuitry, and the reduction of battery power supply-size without sacrificing either power output or equipment efficiency.

Under Typical Class C Telegraphy ICAS operation as a Push-Pull RF Power Amplifier, the 8509 will deliver a Power Output of 96 watts at 250 mc. At reduced ratings the tube may be operated up to 500 mc.

For complete data on the new 8509 and other Amperex instant-heating communication tubes for mobile applications, write: Amperex Electronic Corporation, Tube Division, Hicksville, Long Island, New York 11802.

Amperex
IN CANADA: PHILIPS ELECTRONIC DEVICES LTD., TORONTO 17, ONTARIO

Circle 17 on Inquiry Card

ELECTRONIC INDUSTRIES • December 1964

A problem which you may be able to help us with is this: we need to check the thickness of the fiberglass moldings after they are extracted from the mold, to see that they are to the specified thickness. The molded parts are deep in section, and difficult to measure in all places with mechanical gaging devices. Thickness varies between 3/32 in. and 5/8 in., although it is the thinner sections which are more difficult to measure. A tolerance of $\pm 10\%$ of reading would be quite adequate.

Is there a commercially available device for measuring such thicknesses? A device which measures by dielectric, induction or magnetic effects are some possibilities which come to mind.

M. T. Turner,
Purchasing Agent

Pengor Limited
P. O. Box 640
Carleton Place, Ontario

Errata

Figures 4 & 5 were inadvertently not included in the article, ". . . Microwave Spectrum Analyzers" appearing on page 102, etc., of our November issue. These two figures are shown below.

A complete reprint of this article is available from us. Write to Readers Service Department, Electronic Industries, 56th & Chestnut Sts., Philadelphia, Pa. 19139.

PERFORMANCE SPECIFICATIONS FOR A COMMERCIAL SWEPT-IF SPECTRUM ANALYZER*

Frequency Range: 10 Mc to 90 Gc—usable to 140 Gc
Sensitivity: —115 dbm to —40 dbm, depending on frequency band.
(S + N = 2 N)
Dispersion Range: 10 kc to 80 Mc (25 kc to 100 Mc optional)

Resolution Range: 1 kc to 80 kc
*Polarad Model SA84WC used as representative example.

Fig. 4: Representative Performance of commercially-available Spectrum Analyzer of the Swept-If Type

PERFORMANCE SPECIFICATIONS FOR A COMMERCIAL SWEPT-FRONT-END SPECTRUM ANALYZER

Frequency Range: 10 Mc to 91 Gc
Sensitivity: —105 db to —40 dbm, depending on frequency band
(S + N = 2 N)

Dispersion Range: 10 kc to 2 Gc
Resolution Range: 1 kc to 100 kc

*Polarad Model 2994 used as representative example.

Fig. 5: Representative Performance of Commercially-Available Spectrum Analyzer of the Swept-Front-End Type

Opportunities for

Design & Development Engineers in Electronic Signal Processing

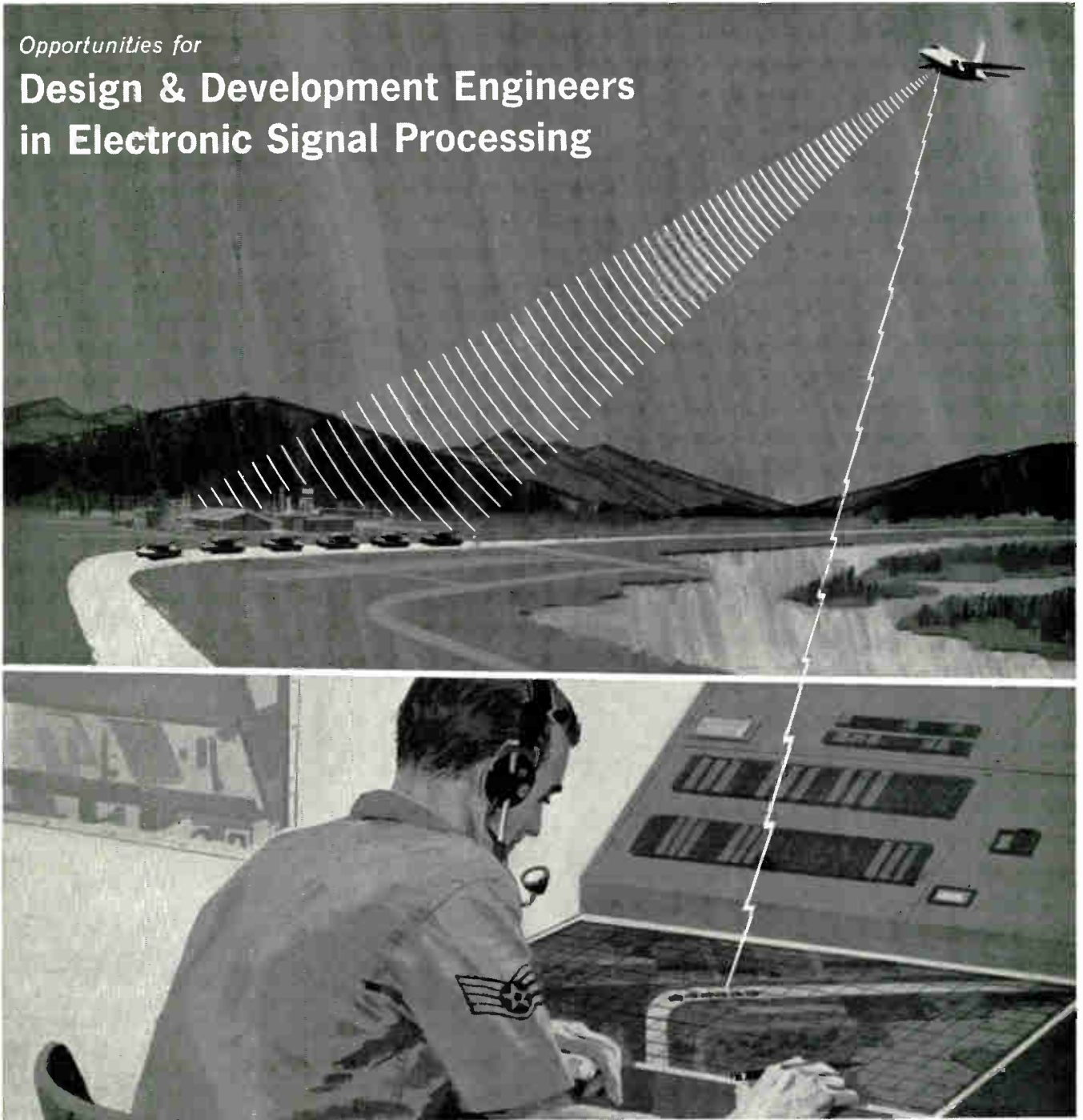

Design and development activities in the field of Electronic Signal Processing are rapidly expanding today at HUGHES Aerospace Divisions.

Development of systems utilizing advanced correlation and matched filter techniques for *High-Resolution Radar*, *Acoustic Detection & Classification* and *Pulse Doppler Radar* is being accelerated.

Specialists in Signal Processing, Circuit Design, Mechanical Design, Packaging Design, Performance Analysis and Project Engineering will be interested in the outstanding assignments now available.

Graduate engineers with experience in wide-band video amplifiers; high-resolution cathode ray tube circuits and applications (including ultra-linear sweep, gamma correction and dynamic focus); high-voltage power supplies; low-jitter timing circuitry; high-speed analog sampling circuitry; precision film transports; ultra-high speed film development; scan conversion systems; synthetic array radar systems; imagery recording, or similar fields—are invited to submit resumes.

For immediate consideration
please write:

Mr. Robert A. Martin
Head of Employment
HUGHES Aerospace Divisions
11940 W. Jefferson Blvd.
Culver City 66, Calif.

Creating a new world with electronics

HUGHES

HUGHES AIRCRAFT COMPANY
AEROSPACE DIVISIONS

An equal opportunity employer

U. S. CITIZENSHIP REQUIRED



Special Report From AMP On **PROGRAMMING DEVICES**

Programming devices defined and explained

*How programming devices function in
switching applications*

AMP is the one complete source of programming devices

*Design factors contributing to the reliability
of programming systems*

In this modern age of electronic control and data acquisition, the ability to make and change circuit connections quickly and easily is becoming increasingly important.

In the following pages we have attempted to define a number of industrial, commercial and military uses for programming systems and to show how AMP has developed a complete line of such devices to help solve the ever-growing complexity of switching applications.

Circle 67 on Inquiry Card for information on Universal Patchcord Programming Systems

Circle 68 on Inquiry Card for information on Card Programming System

Circle 69 on Inquiry Card for information on Pinboard Programming Systems

Circle 70 on Inquiry Card for information on Coaxial & Shielded Patchcord Programming Systems

PROGRAMMING DEVICES DEFINED AND EXPLAINED

Any change in the function of electrically controlled equipment necessitates a change in the electrical/electronic circuitry for that equipment. This change can be effected in many ways, ranging from the simple flip of a switch to major rewiring of the equipment, depending on the complexity of the system. Whatever the method, however, re-routing of circuit paths almost always involves an electro-mechanical change.

Basically, programming devices are manually operated switches that permit, through proper patchcord, pin or contact selection, nearly infinite switching combinations. Such devices may be used as simple or complex switches, or as large connectors interconnecting a main body of equipment to peripheral components.

SIMPLIFIED SWITCHING

Simplified switching is normally defined by the number of poles and throw positions required by a particular switching application. The following illustrates the use of A-MP* SYSCOM* patchcord programming systems in simple switching:

| SWITCH TYPE | AMP SYSTEM SIZE | NO. FRONT BOARDS |
|-----------------------|-----------------|------------------|
| 816-pole single-throw | 1632 Contacts | 1 |
| 544-pole double-throw | 1632 Contacts | 2 |
| 408-pole triple-throw | 1632 Contacts | 3 |
| 816-pole triple-throw | 3264 Contacts | 3 |

Combinations of the above systems may be used and still be considered examples of simplified switching.

Patchcord programming systems can be used as large connectors. This function is particularly useful in interconnecting various sections of equipment. When using this system as a connector the rear bay is used as one half and the front board as the other half of the connector. Programming systems offer two distinct advantages over conventional multiple connectors:

1. Large number of contacts. Systems are available with 240 through 5304 contacts, as compared with connectors whose contact force and tolerance buildups restrict capacity.
2. Long contact life. Programming systems are designed for thousands of insertions and withdrawals, whereas pin and socket connectors need be designed for only 500 to satisfy military specifications.

COMPLEX SWITCHING

Programming devices are used quite often in electronic equipment that requires the patching of one signal many times on one front board. An example of this is in data acquisition systems where the signal is carried from transducers (strain gauges, accelerometers) to signal conditioning equipment (voltage and temperature references, amplifiers, etc.) to analog-to-digital converters to recording equipment. Following is a simplified block diagram of multiple-use signal flow:



Where one signal is patched many times, variable contact resistance can degrade it beyond usability. Chance of signal loss is also greater when many patches are used. In complex switching applications, therefore, consistently low contact resistance and reliability are critical, regardless of the type of programming device employed.

HOW PROGRAMMING DEVICES FUNCTION IN SWITCHING APPLICATIONS

In the programming of circuits for multi-use equipment, such as rolling mills, control systems, automatic test equipment, ground support equipment or teaching devices, circuit paths must be established in the shortest possible time to minimize labor and downtime costs. Consequently, the need for quick, reliable, flexible switching devices is critical in these applications.

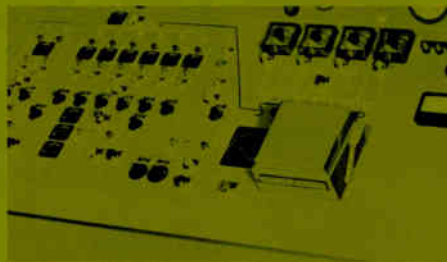

The baking industry is a case in point. Mixing a batch of cookie or cracker dough means blending tons of various dry and liquid ingredients several times a day. In such large scale operations a computer usually controls the actual production. But the inputs determining a specific blend of ingredients originate from a card programming system which routes hundreds of pre-programmed circuits.



Consider the switching problems faced by engineers in the modernization of a multiple cell rocket propulsion laboratory that includes many pieces of control, calibration, recording, detection and data analyzing equipment—all of which had to be made available to every test cell and monitored in a master control room. The downtime required to set up the necessary interconnections for each test program would have consumed several days, had not programming systems with pre-programmable patchboards been installed throughout the test facilities.

To cite just one more example, this time in the medical field, a large metropolitan hospital designed and built a machine to simulate physiological conditions such as blood pressure, temperature and respiratory data for recognition by interns and resident physicians. The complexity of this machine required a semi-automatic method for setting up the specific pathological inputs. The problem was solved by installing a card programming system, using punch cards, each of which contained encoded information representing a given disease.

Thus, we see that uses for programming devices are as broad as there are equipment applications for them. The range is,

in fact, almost infinite, encompassing relatively simple applications like programming function generators for a design engineer to sophisticated data acquisition programs requiring thousands of switching operations. To meet these specialized needs, four basic types of programming devices have been created. All are represented in AMP's Programming Devices product line.

TYPES OF PROGRAMMING DEVICES AVAILABLE

Although all programming devices perform the function of a large switch, mechanically they may be grouped into three categories: *patchcord systems*—universal, coaxial and shielded types—with fixed or removable front boards; *card systems* with tabular punch cards as the medium of control; and *pinboard systems*—Matrix and Universal types—with pins as the medium of control.

AMP IS THE ONE COMPLETE SOURCE OF PROGRAMMING DEVICES

The growing use of programming systems in such diverse fields as automation on the assembly line, mixing processes in the food and chemical industries, and military and commercial data processing and analysis has directed our concentrated research and development toward the creation of an entire line of programming products, manual to completely automated devices. These are designed to cover every possible area and meet the most complex circuit switching requirements.

PROGRAMMING SYSTEMS

Of all these devices, the various A-MP Patchcord Programming Systems have the most varied and complex uses. These are subdivided into the following classifications: I. Universal Systems (a) Panel Mount; (b) Rack Mount; (c) Anti-Vibration; (d) Airborne; and (e) Fixed Panels. II. Coaxial Systems (a) Panel Mount; and (b) Fixed Panels. III. Shielded Systems (a) Panel Mount; and (b) Fixed Panels.

Other A-MP Programming Devices are: IV. Card Programming Systems (a) Desk Top; and (b) Rack Mount. V. Pinboard Programming Systems (a) Matrix; and (b) Universal.

I. UNIVERSAL SYSTEMS

A-MP Universal Patchcord Systems and Panels are designed for low and medium frequency switching applications. Because of the many different applications, for which these are used, there cannot be a definite line of demarcation in choice of systems.

The systems all have an over center camming action combined with "zero entry" patchboards. The camming provides the AMP patented double wiping action which assures clean, reliable and minimum contact resistance between the patchcords and contact springs. The "zero entry" eliminates the possibility of contact damage when the patchboard is engaged.

a. Panel Mount Systems.



These systems are designed, in a number of sizes, for vertical mounting on the

face of racks or panels. They range in size from 240 to 5304 contacts. Other sizes can be furnished to meet customer requirements.

Panel Mount Systems are highly versatile in their programming performance and permit rapid interchange of circuits with assurance of complete reliability.

b. Rack Mount Systems.

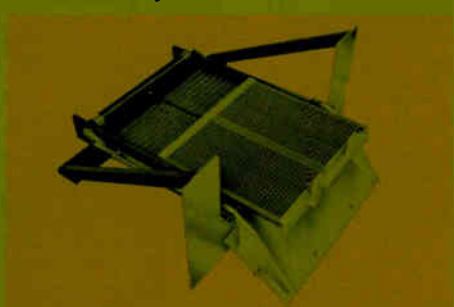

The A-MP Rack Mount Systems have the same performance characteristics and programming versatility as the panel mount type. However, they are mounted horizontally within a cabinet, console, or desk, and require up to 50% less panel area than vertically mounted systems. The specially designed frame and actuating mechanism permit easy access for rapid programming changes.

The four standard sizes ranging in size from 680 to 1632 contacts require only 8 $\frac{3}{4}$ " of rack height and fit any standard 19" wide E. I. A. rack. These systems are rigidly constructed for maximum durability and are easily integrated with equipment styling. An optional drawer slide permits "post patching" (individual patchcord change) without circuit interruptions to any program.

c. Anti-Vibration Systems.



The two Universal Anti-Vibration Systems (806 and 1280 contacts, respectively) are designed to withstand the highest extremes of vibration and shock. All frames and other protective components are made of stainless steel with the exception of an aluminum dust cover for the smaller system.

d. Airborne Systems.

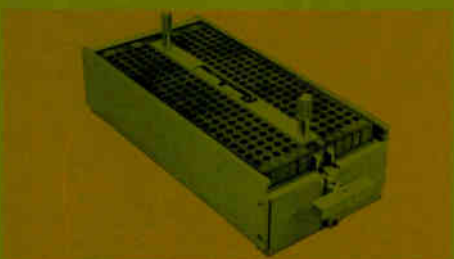

Utilizing 240 and 408 contacts, these programming systems are light and compact, and are designed for high resistance to shock, vibration and other severe environmental conditions.

e. Fixed Panels.



Fixed programming panels in eight sizes with 120 to 4896 contacts meet a large variety of programming needs. These panels have non-removable patchboards and are designed for infrequent changes in programming. Except for the non-interchangeability of patchboards, A-MP Fixed Panels serve needs comparable to those of the programming systems.

II. COAXIAL PROGRAMMING SYSTEM



Coaxial Programming Systems and fixed panels are designed for high frequency, low level applications where each input must be individually shielded. These systems use coaxial contacts and patchcords to maintain low cross-talk and VSWR and permit, for the first time, the change of thousands of individual coaxial connections at one time. Hybrid systems and panels containing both universal and coaxial contacts are available. (The Standard sizes range from 506 to 3036 contacts.) The system's actuating mechanism is slightly different from the universal and shielded systems in that it provides parallel entry of the patchboard before the camming action. Redundant contacts, coupled with AMP's exclusive double wiping action, assures clean, reliable and low-resistance contact between patchcord tip and rearboard spring. The contact design also allows patching after the system has been engaged, so that all of the connections do not have to be broken in order to make minor changes in programming.

III. SHIELDED PROGRAMMING SYSTEMS

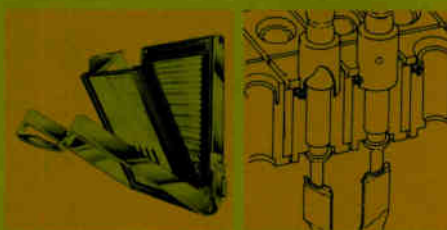

Shielded Programming Systems and Panels, with 112 to 3600 contacts, are for medium and high frequency low-level applications. Programming boards, as well as rear frame spring assemblies, are fully insulated and shielded. This reduces cross-talk and effectively restricts outside interference.

Both the programming boards and rear boards have individual nylon cells spaced

$\frac{3}{8}$ " on centers and are surrounded by interlocking shields. This arrangement provides an effective ground barrier around each patchcord tip and contact spring.

The standard patchcord for shielded systems and panels is made of sub-miniature coaxial cable. The shields of all patchcords within a patchboard are commoned to the interlocking shield of the board.

Similar to the universal type, both patchboard systems and fixed panels are available.

IV. CARD PROGRAMMING SYSTEM



The A-MP Card Programming System consists of 960 single-pole, single-throw switches which are actuated by a single operating lever and controlled by tabulating cards. It translates the punched information on each card into electrical outputs which control the equipment involved. The use of pre-punched tabulating cards simplifies equipment programming and reduces the chance of operator error. These systems may be used for data readout, as well as programming of multi-use equipment.



These systems are available in rack-mount or desk-top types. Both contain long-life gold over nickel plating of contact springs and pads and both provide optimum reliability through the use of AMP's double-wiping action. Interlocks prevent false output. A semi-automatic card ejector simplifies operation by partially ejecting the card when the operating lever is brought to "load" position.

V. PINBOARD PROGRAMMING SYSTEMS

The two types of pinboard programming systems—Matrix and Universal—combine to complement both the patchcord programming systems and the card programming systems. They both have simplicity, flexibility and economy. In both, circuit switching is done with a simple pin.

The matrix pinboard lends itself to such applications as semi-fixed digital memories, control of sequencing devices, automated process control and test equipment programming. The universal pinboard is used

for specialized programming and more complex switching functions.

a. Matrix Pinboards.

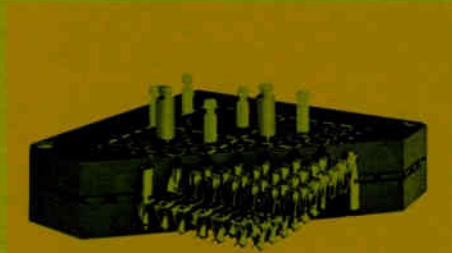

The matrix pinboard is made of two bus type contact strips arranged on X and Y coordinates. These strips are connected by either shorting or diode pins. By connecting inputs to the horizontal strips and outputs to the vertical contact strips, it is possible to connect any input to any output. It is also possible to connect all inputs to the one output or all outputs and inputs together.

Programming templates are available for simplification of programming.

b. Universal Pinboards.

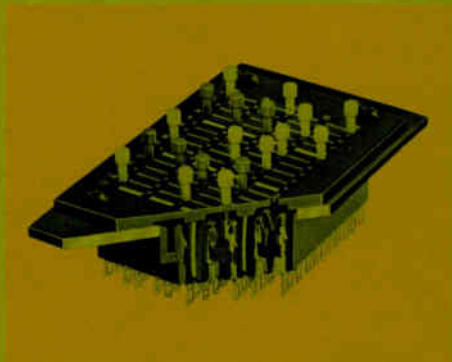

This type of pinboard consists of a specified number of single-pole, single-throw normally open switches each of which operates independently of the others. It is ideally suited for highly specialized programming or switching which is beyond the capabilities of the Matrix Pinboard. A good example is digital programming of the inputs of an analog computer.

In the Universal Pinboard, circuit-commoning functions are readily accomplished through the use of appropriate, permanent wiring installed on the rear of the board by the user. Contact springs of phosphor bronze, plated with gold over nickel, can be interconnected in any desired configuration. Panels can be made with as many matrices as may be required in a wide variety of sizes. Standard size boards range from a 15 x 5—75-hole type to a 15 x 40—600 type.

RELIABILITY IN PROGRAMMING SYSTEMS

Because of the magnitude of the circuitry handled by programming devices and the rugged environments in which many of them operate, reliability is a vital concern to the systems designer who must select them. In a single line-to-line pin and socket connector, electrical performance of the assembled unit is determined by the sum of the mechanical properties of the contacts. Multiply these properties by the hundreds of connections routed by a single patch-

board system, for example, and you will begin to appreciate the important role that reliability plays in any programming device.

Through proper choice of materials, superior design of the various elements and insistence on close quality control in every step of the manufacturing procedure, a high degree of reliability is achieved. Factors which contribute to the reliability of A-MP programming products are:

DOUBLE-WIPING CONTACT ACTION

Since the majority of programming systems operate on low level or "dry" circuits, the areas of electrical contact must be absolutely free from contamination by oxides or dust. In all A-MP Patchboard Systems and Panels and Card Programming Systems gold over nickel plating eliminates oxide contamination. AMP's patented double-wiping action of the contacts assures that the mating surfaces will be pre-cleaned.

In the removable front board of A-MP Patchboard Systems, the operating mechanism of the system causes the patchcord pins to wipe the mating chevron springs as shown in the illustration below. The patchcord pin travels the length of the chevron to a point of maximum travel, then recedes to its previously wiped operating position. This action completely removes lint, dust and other contaminants from the contact areas to assure positive contact.

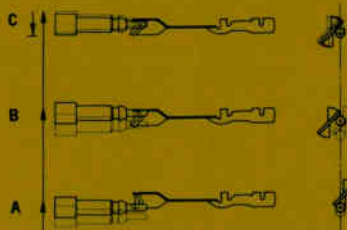

The same reliability feature has been designed into the A-MP Card Programming Systems to insure positive sensing. In this case, the spring loaded stop block causes the card tray to return a fraction of an inch so that the spring contacts rest on a pre-cleaned portion of the contact pads.

GOLD OVER NICKEL PLATING

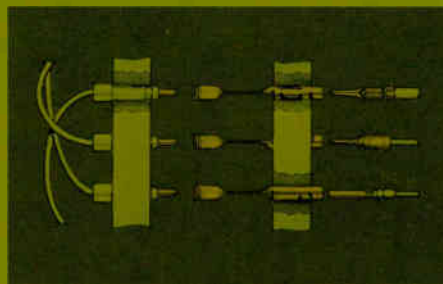

The overall reliability of any electrical system depends on the mechanical integrity of its various connections. In all critical circuits, minimal contact resistance is essential. Gold is universally recognized as the best plating element because of its exceptionally high conductivity and corrosion resistance. The average contact resistance between a gold plated patchcord pin and contact spring is .002 ohms. This

value is stable down to low microvolt levels. AMP plating investigations show that copper oxides will migrate through gold. As a barrier against such migration, a nickel sub-plating is used as standard. Gold over nickel plating, checked to a tolerance of a millionth of an inch by an exclusive AMP X-ray technique, is used for all A-MP contact springs.

POSITIVE REAR-BOARD WIRING

In the interface between programming systems and the electronic equipment they control, serviceability, minimum contact resistance and reliability are essential. Depending on individual requirements, the user has a choice of two A-MP products: The LANCELOK* terminal or AMP's "53" Series Taper Pin. Both wiring devices provide simplified insertion and removal, low millivolt drop and maximum dependability.

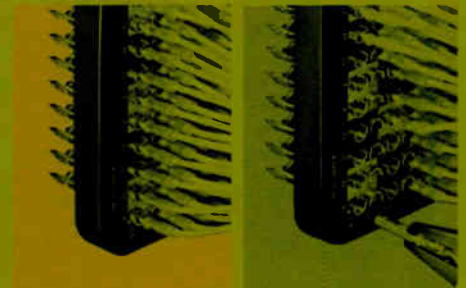

The materials and design of the LANCELOK Terminal and spring receptacle provide multiple contact areas which result in low contact resistance. An integral spring lock provides a minimum of 20 pounds retention between the terminal and contact spring. These devices are especially effective in programming systems that are subjected to severe vibration and shock.

The A-MP "53" Series Taper Pins permit high, uniform retention and excellent electrical stability. These terminals are well suited to both critical and non-critical wiring applications, and—like the LANCELOK Terminal—are available either pre-insulated or non-insulated.

Gold over nickel plating in critical circuits, rear-board wiring flexibility, double-wiping contact action, and the choice of quality construction materials previously discussed, are just part of the AMP reliability story. Other factors, such as application tooling designed to match the terminals, simplicity of design to minimize the number of parts, and AMP's superior crimping technique must also be mentioned as contributing to the high reliability standards of A-MP Programming Systems.

In this report we have outlined some of the more distinctive and exclusive features of A-MP Programming devices. These features have evolved from intensive, continuous research based on sound fundamentals, to meet the new, more varied and, in most cases, more complex programming needs.



A-MP® products and engineering assistance available through subsidiary companies in: Australia • Canada • England • France • Holland • Italy • Japan • Mexico • West Germany

IBM 12-pole wire contact relays give you 200 million operations ...at 45¢ per pole

Low price. High performance. Plug-gable. Fast delivery. And more.

Solderless connections, multiple coils, compactness and standardized mountings give you...lower manufacturing costs...lower initial product costs...lower product servicing costs.

IBM 12-pole relays start at \$5.40, 4-poles at \$2.90, latch relays at \$8.45. (Even less in quantity.) And, they're available for fast delivery.

Use these IBM wire contact relays for counting, logic switching, shift registers...communications, process control data processing, and many others.

Here's what you get with an IBM relay: Long life—up to 200 million operations; high operate speed—as fast as 4 ms; fast release time—under 5 ms; versatile contact arrangements—4, 6 and 12 PDT, Form C, 4

and 6 PDT latch; maximum reliability—1 error per over 400 million contact closures at 48 VDC is attainable; variable coil voltages—up to 100 VDC; contact rating—3 amp steady state.

Send for your copy of our wire contact relay catalogue; IBM Corporation, Industrial Products Division, 1000 Westchester Ave., White Plains, N.Y. 10604. Overseas, contact your local IBM World Trade Corporation office.

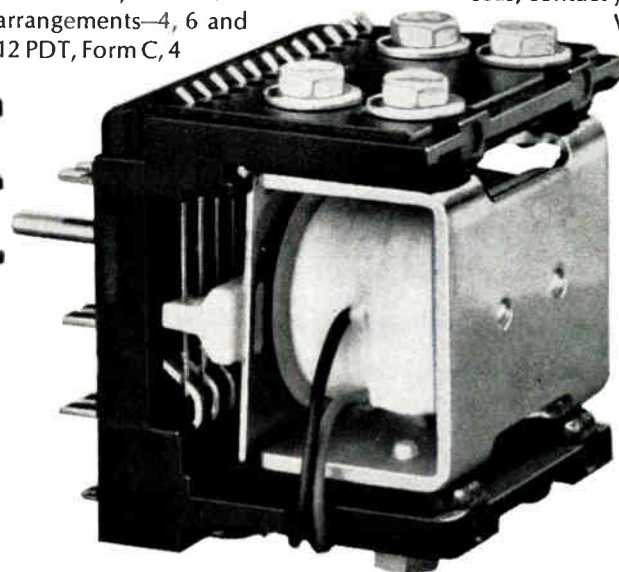
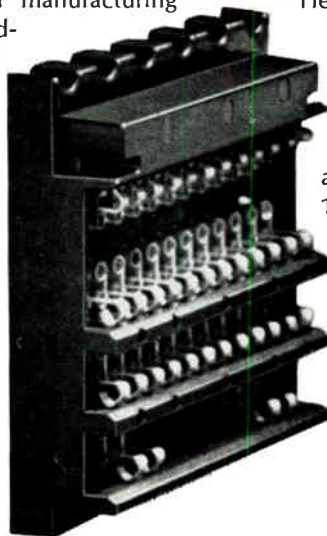

SEMICONDUCTOR COMPOUNDS
SUPERCONDUCTORS
FERRITES
GLASS MATERIALS
CIRCUIT-BOARD MATERIALS
ORGANIC SEMICONDUCTORS
SEMIMETALS
REFRACTORY MATERIALS
PLASTIC MATERIALS

The state-of-the-art in the electronic industries will advance only as quickly as new materials become available, or new uses for existing materials are found. This report describes some of the materials that will influence the equipment and components of the future.

By JOHN J. HUNTER,
Assistant Editor, ELECTRONIC INDUSTRIES

The Search for New Materials

ELECTRONIC
INDUSTRIES

STATE-OF-THE-ART
FEATURE

THE AIM OF THIS ARTICLE is to up-date the engineer on the many materials that are available, and to disclose some of the materials that will undoubtedly be used extensively in the future.

The materials industry *per se* consists of about a dozen major manufacturers, not hundreds as might be expected. This industry is fiercely competitive, and much of the information pertaining to the composition of the products is of a proprietary nature. Hence, many of the manufacturers were reluctant to disclose any detailed information about the processes used to produce the materials which in turn produce the finished product. Many of the companies visited by Electronic Industries hinted that a number of breakthroughs in materials are imminent, but they would not disclose the material nor the products that would probably result.

We will discuss eight major categories of materials: semiconductor compounds; superconductors; glass materials; circuit-board materials; organic semiconductors; semi-metals; refractory materials; and plastic materials.

Improvements in elemental semiconductor technology, the epitaxial technique, and the advances in microelectronics have produced a great deal of interest in certain semiconductor compounds. These compounds fall into two atom groups: III-V and II-VI. At present, however, the greatest number of applications use the compounds contained in III-V. These compounds have interesting properties, they are all semiconductors, and they have a close relationship to the semiconducting elements of the IV compounds.

III-V Compounds

To better understand the chemical properties of the III-V compounds, a short review of their elec-

tron characteristics is given. The atom groups III of the periodic table combine with group V to form crystalline semiconducting compounds. The chemical compounds have a 1 to 1 atomic ratio between the III and V atoms which occupy the sides of the crystal lattice. The outer (valence) electrons combine to form molecules and crystals. The III groups have one valence electron less than group IV, and the V group have one electron more. The semiconducting properties of these materials are characterized by high electron mobility, and small energy gap.

Semiconducting compounds of the III-V group that have received a great deal of attention are listed in table 1. Although all the compounds in this group offer distinct advantages as semiconductor materials, gallium arsenide (GaAs) seems to have the best combination of characteristics.

Gallium Arsenide

Gallium arsenide offers high energy gap, high electron and hole mobility, low effective mass, and a relatively high dielectric constant. With these properties, GaAs devices operate at high frequencies, high speeds, and high temperatures. The theoretical temperature capabilities of GaAs are well worth noting. Gallium arsenide can operate in normal environments without the elaborate cooling devices needed for other semiconductors. Hence, dense packaging with reduced cooling would be practical.

Some of the uses to which GaAs are being applied follow.

Varactor Diode

The varactor or variable capacitance diode has a nonlinear capacitance-voltage relationship, plus a very low leakage conductance and spreading relationship. Properties which make GaAs a useful material for varactors are high electron mobility, good energy gap and low dielectric constant. Due to variations of their capacitance with applied voltage, varactors



A new thermoelectric material, consisting of an alloy of germanium and silicon, produces a great amount of electricity directly from high-temperature heat. Tests performed by its developer, RCA, indicate that a generator using a sq. ft. platelike arrangement of the material heated to 1000°C could produce 10 kw.



Synthetic quartz crystal grown by Bell Telephone Laboratories.



Dr. John H. Lupinski, of GE, demonstrates new conducting polymers, visible in photo as black strips of special plastic material painted on an ordinary white plastic insulator. Electric current flows through thin polymer strips and lights a small bulb.

using GaAs are good for r-f amplification, harmonic generation, frequency-conversion reactive tuning, subharmonic generation, and parametric amplifiers.

Significant improvements have been noted when the GaAs varactor diodes are used as microwave diodes and parametric amplifiers. GaAs extends the frequency range of the microwave diode to a cut-off of 300gc.

Tunnel Diode

For tunnel diodes, GaAs has certain advantages. In the tunneling process, a small energy gap (E_G) is most desirable. But with a small E_G the normal diode current is large and may swamp the tunnel current. Consequently, a compromise is needed to attain a large ratio of tunnel current to normal current. The large energy gap and small effective masses of electrons and light holes make GaAs the most promising semiconductor compound for this application.

Tunnel diodes using indium antimonide (InSb) are ruled out because at room temperature the forward current is too small for practical use. However, these devices operate very well at reduced temperatures. Because of the small effective masses of their electrons and light holes, InSb is ideally suited for investigating the anomalies in high magnetic fields.

When using GaAs for tunnel diode applications, its operating limitations must be defined if degradation is to be avoided. The GaAs tunnel diode offers

advantages such as higher voltage ranges than germanium diodes; high oscillator outputs; high operating frequencies; and high peak-to-valley current ratios. Being a majority carrier, the tunnel diode should be capable of high-speed operations. Unfortunately, the failure rate with these units at high-speed operation is very high. The use of these diodes is therefore limited to amplifier and oscillator circuits where a wide voltage swing is required.

Photodiodes

One of the greatest uses for photodiodes is converting sunlight into electrical energy (solar cells). Consequently the spectral sensitivity of the photodiodes in the visible range is of interest. Two factors influence the maximum attainable efficiency: the number of electron hole pairs created by the photons and the voltage of the photodiode at the point of maximum power output. Both these quantities depend on the size of the energy gap. As the energy gap grows, the part of the solar spectrum that contains photons with sufficient energy to create electron hole pairs decreases. On the other hand, photovoltage grows as the energy gap increases. Thus, maximum efficiency must be attained at a certain energy gap.

It is generally agreed that energy gaps between 1.1 and 1.6 are suitable for photodiodes. This means that GaAs and indium phosphide (InP) with gaps of 1.4 and 1.25, respectively, would have advantages over silicon which is currently the most used photodiode material. Of the two, GaAs with a sunlight

Table 1: ELECTRICAL CHARACTERISTICS OF VARIOUS SEMICONDUCTOR COMPOUNDS

| Semiconductor | Energy Gap (Electron Volts) | Approx. Max. Device Temp. (°C) | Dielectric Constant (air = 1) | Electron Mobility (cm ² /volt-sec.) | Hole Mobility (cm ² /volt-sec.) |
|----------------------------|-----------------------------|--------------------------------|-------------------------------|--|--|
| Gallium Arsenide (GaAs) | 1.4 | 450 | 11.1 | 10,000 | >450 |
| Gallium Antimonide (GaSb) | 0.68 | 100 | 14.0 | 4,000 | ~1,400 |
| Aluminum Antimonide (AlSb) | 1.6 | 500 | 10.1 | >400 | >400 |
| Aluminum Arsenide (AlAs) | 2.16 | 900 | — | ~1,200 | ~200 |
| Indium Arsenide (InAs) | 0.33 | ~ -75 | 11.7 | ~33,000 | 460 |
| Indium Antimonide (InSb) | 0.18 | ~ -196 | 15.9 | 80,000 | ~1,000 |
| Indium Phosphide (InP) | 1.25 | 400 | 10.8 | 5,300 | ~150 |

efficiency of 12% has proven the most efficient. The best InP could do is 2%. But neither of these two have the sunlight efficiency of silicon, which is 15%. The maximum sensitivity for GaAs lies at 8500 Å. The half-way points lie at 5600 and 9100 Å.

Both InSb and indium arsenide (InAs) photo-diodes are suitable for infrared detectors since their maximum sensitivity lies at long wavelengths. Their effective range is to about 7 microns.

A GaAs pn junction has been reported which provides several watts of infrared power at room temperature. The spontaneous-type source permits response time of a few nanoseconds. The large signal rise time for the optical output decreases with current density. With the present state-of-the-art, the device operates with a 2% conversion efficiency at room temperature; at liquid nitrogen temperature, the efficiency is 12%.

Lasers

The injection laser (laser diode) emits light when a high current is passed through a pn junction of semiconductor material. The light is given off by electrons which convert their energy to light after they pass through the junction.

Light emission using GaAs material occurs in the infrared at 9000 Å when operating at room temperature and 8450 Å at -190°C (liquid nitrogen). The bandwidths are 210 Å and 170 Å respectively. Other diodes which extend the range to longer wavelengths include indium phosphide (0.91 microns) and indium arsenide (3.1 microns).

Scientists at MIT's Lincoln Laboratory are reported to have achieved injection luminescence over the length of a 400 micron bar of indium antimonide (InSb). They disclosed observing coherent emission of 50 microns measured in the direction of the current. This order of magnitude is larger than either gallium arsenide or indium arsenide lasers.

The injection laser can be used to pump high-power crystal lasers. Crystal lasers absorb very narrow bands. Thus, much of the radiation from the usual light sources is wasted. Tuning is possible by varying the composition of the alloys.

Transistors

The possibility of using III-V compounds for transistors has been under investigation for a number

of years. The two most important transistor parameters that have to be considered are maximum operating temperature and high-frequency cut-off. The frequency cut-off for bipolar transistors is determined by electron and hole mobilities and the dielectric constant of the material.

The materials GaAs, InP, and aluminum antimonide (AlSb) operate at higher temperatures than either germanium or silicon, but only GaAs has a higher frequency cut-off. The compounds InAs and InSb would produce transistors with higher frequencies, but they do not operate at room temperature.

II-VI Compounds

The greatest applications for the semiconductor compounds in this group fall into two categories: photoconductive and photovoltaic devices. The photoconductive devices handle more power than photoelectric devices, but the photoelectric devices are faster. Of the materials available for photoconductive cell use, cadmium sulfide and cadmium selenide offer the most advantageous characteristics.

Cadmium Sulfide and Selenide

In terms of cell operation, the differences between these two compounds are considerable. A few of these differences are shown in Table 2. Both the cadmium sulfide and cadmium selenide cells operate between 70° and 80°C. The sensitivity of the cadmium selenide cell, however, falls sharply as temperature increases. This eliminates it for high power applications. Cadmium selenide is a more sensitive material than cadmium sulfide. Therefore, it has more sensitivity for a given set of conditions, all other variables being equal. For uses where rise and decay characteristics are critical, cadmium selenide must be used. Cadmium selenide is faster due to the higher energy level of the recombination and trapping centers of this material.

Cadmium selenide is more sensitive to infrared than cadmium sulfide, since its peak response is located nearer the infrared region of the spectrum. Heat radiation, therefore, has more effect on cadmium selenide.

SUPERCONDUCTORS

Superconducting materials fall into two classes: hard and soft. The soft class consists of pure elements

such as mercury, tin, and lead. They are characterized by sharp transition from superconducting to normal state at some critical temperature. The hard class consists of alloys and compounds. Generally, alloys are ductile and easily handled; compounds are brittle and have fixed properties that are hard to alter.

The most significant difference between the hard and soft types is the manner in which the magnetization goes to zero as the applied field reaches a critical value. The soft superconductor carries the current on a thin surface layer. The hard type is made of discrete, quasi-ideal filaments which are separated by zones of normal conductors. Thus, high fields can penetrate it.

Alloys and Compounds

The hard superconductors drastically increase the range of magnetic fields and current levels at which superconductive behavior can be obtained. Generally, in a given alloy system, if the composition is varied a change in critical current and critical field results. The current density can also be affected by the heat treatment and amount of cold work given the material during the fabrication process. Cold-worked materials with high internal stresses usually show higher current carrying capacities than annealed materials.

The most commonly used alloy at this time is

of 185,000 gauss. When this compound was first introduced a few years ago, its uses were limited by its mechanical hardness. The problem was solved by a deposition process developed by RCA. This process, along with improved substrates, has produced a vapor deposited ribbon with current densities in the superconducting layer of 200,000 to 300,000 amperes/sq. cm. at 100 kilogauss. The vapor-deposited ribbon also eliminates the problem of current degradation in high magnetic fields. The ribbon is superconducting as deposited and requires no further heat treatment.

A high-permeability magnetic alloy which should find use in transformers and inductors is Hipernik. Developed by Westinghouse, it is a soft magnetic alloy of 50% nickel and 50% iron. It is said to have an initial permeability of 10,000 to 15,000 oersteds/-gauss and a maximum permeability of 10,000 to 200,000 with low hysteresis loss throughout the range of operating flux densities.

An investigation of transition metal alloys having crystal structures favorable for superconductivity has resulted in the discovery of two new superconducting compounds— $\text{Mo}_3\text{Al}_2\text{C}$ at 10°K and Mo_2BC at 5.4°K . According to their developer, Lawrence Radiation Laboratory (LRL), the role of crystal structure, generally assumed to be secondary in determining the superconductive properties of a material, seems to be open to question. The transforma-

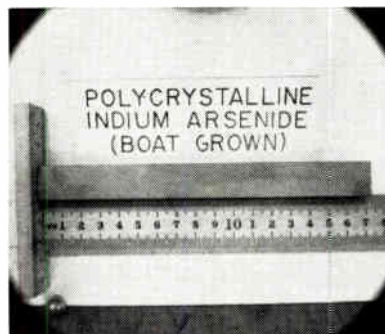

niobium-zirconium (Nb Zr). This compound, when used in $\frac{1}{2}$ -in. bore magnets, has produced 50 to 60 kilogauss fields. An alloy of niobium-titanium used in $\frac{1}{8}$ -in. bore magnets developed a field of 100 kilogauss. The niobium-titanium wire is best suited for superconducting magnets above 50 kilogauss. One such wire, Westinghouse's HI-120, is a superconductor as processed and requires no heat treatment to make it superconducting. This eliminates the special coil formers and insulation systems needed for functions over wide temperature ranges (extreme hot to extreme cold).

One of the most widely used superconducting materials is niobium-stannide (Nb_3Sn). This compound of niobium and tin can support substantially high currents in high fields. The compound Nb_3Sn remains superconducting up to 18°K . Experiments at 4.2°K show it to remain superconducting in fields

of molybdenum carbide (MoC) from hexagonal to cubic was found to be accompanied by a 7°K change in transition temperature. Such large changes cannot be accounted for by the normal electron-to-atom ratio, but must be controlled by lesser-known parameters, such as band structure and electron density of states at the Fermi surface. Since these parameters are related to crystal structure, the importance of the atomic arrangement must not be ignored. Other systems also suggested by LRL which might exhibit such a change are the high-temperature hexagonal-to-cubic transformation in the niobium-aluminum-carbon (Nb-Al-C) and tantalum-aluminum-carbon (Ta-Al-C) systems. In these, the hexagonal phase is not superconducting above 4.2°K . But a high temperature quench should stabilize the cubic form which should be superconducting at a temperature above 4.2°K .



A superconductive magnet, producing 107,000 gauss, is lowered into a vapor-shrouded bottle of liquid helium by Frank Kolondra of RCA. The magnet will enable small and medium-sized laboratories to carry out experiments which are now possible only in large installations.

Table 2: CHARACTERISTICS OF CADMIUM SULFIDE AND SELENIDE

| Characteristic | Cadmium Sulfide | Cadmium Selenide |
|------------------------|-------------------|--------------------|
| Sensitivity | High | Very High |
| Dark Current | Low at Room Temp. | High at Room Temp. |
| Peak Spectral Response | 5300-6300 Å | 6800-7400 Å |
| Temp. Variations | Fairly Stable | Very Unstable |
| Breakdown Voltage | High | Medium |
| Life Test Stability | Good | Fairly Good |
| Response Time | Slow | Fast |

This is a photomicrograph of a glazed AlSi base alumina ceramic with an applied pattern in gold (dark sections). This new process of applying the conductive gold material was developed by American Lava. It offers superior strength and high temperature properties. With this process, line width and line spacing of 1 mil are possible.

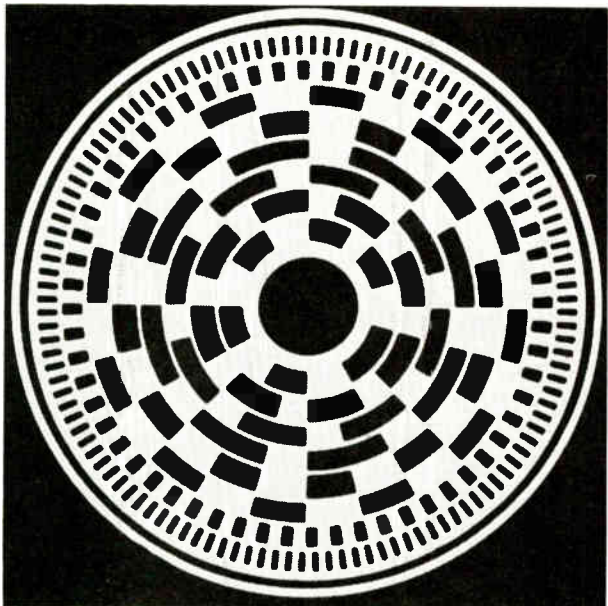

MATERIALS (Continued)

FERRITES

Ferrites fall into two general categories: soft and hard magnets. The soft magnets, which have crystals of spinel structure, have low coercivity.

For the upper frequency range, Ni-Zn is finding great application. This ferrite, along with Mn-Zn-Fe are very linear. Some typical characteristics for these ferrites follow: Ni-Zn has an initial permeability of 50-4000 and a frequency range of 10 mc-100kv; Mn-Zn-Fe has an initial permeability of 1500-6000 and a frequency range of 500kc-5kc.

GLASS MATERIALS

Of the materials available to the electronic component manufacturer, glass is probably the most versatile. It is used in resistors, fixed capacitors, trimmer capacitors, inductors and delay lines. In addition, special-type glass such as photosensitive, sintered, high temperature, getter, electronically conductive, radiation resistant, gamma-ray sensitive, fibrous, and glass-ceramics have advanced the state-of-the-art to a degree not thought possible a few years ago.

Thin-Film Substrates

Substrates for thin-film circuits are probably one of the most important and demanding uses for glass. The thin-film circuit is an assemblage of passive and active circuit elements in thin form deposited on an electrically inert substrate. The substrate must have little or no effect on the film circuit elements.

What appears to be two simple requirements turns into a fabrication nightmare when we consider some of the properties of the important thin-film materials (Table 3). Substrates must tolerate the processing temperatures required for film deposition and match the expansion coefficient of the film reasonably well. In addition, it must have a low dielectric loss, good chemical durability, and high thermal conductivity. The substrate can contain no impurities, such as alkali, which will adversely affect circuit performance.

The degree of smoothness a substrate must have depends on the roughness sensitivity of the thin-film material. Vapor-deposited thin-film capacitors are quite sensitive to surface imperfections. Resistors, on the other hand, are not affected by minor surface imperfections. But, as can be seen from Table 3, only the palladium-based (Pd) cermet resistor films can be used on unpolished surfaces.

Glass Substrates

A variety of substrate materials are available. They include glasses, ceramics, glazed ceramics, single crystals, dielectric coated metals, glass-ceramics, and organic polymers. Of these, glass is most extensively used. The properties of the most important substrate glasses are described in Table 4. Maximum service

This alumina substrate is a high-strength, dense material with a specific gravity of 3.7. It is composed of 96% Al_2O_3 . The micrograph shown here demonstrates the highly crystalline and dense nature of the material. It also shows the tight packing and lamellar nature of the grain structure. The material is, therefore, impervious to water absorption, one of the arch enemies of the electronic component.

(Photo: International Resistance Co.)

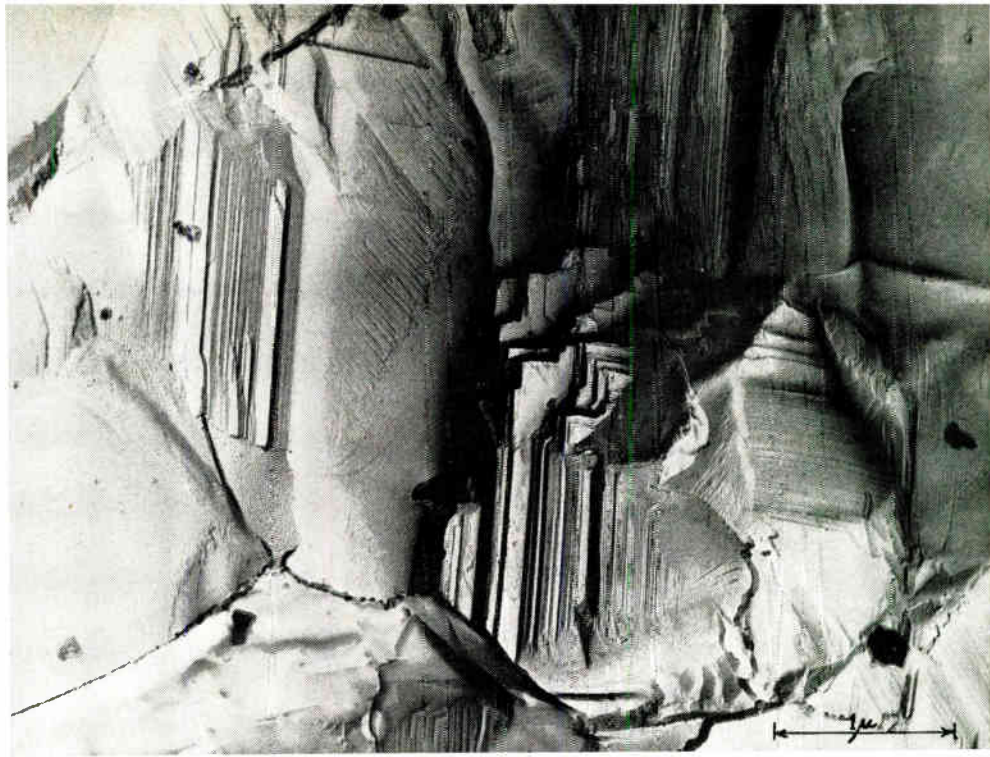

temperature is near the annealing point. Thermal conductivity of glass at 25°C ranges from 0.002 to 0.004 cal/cm/sec./°C and increases by about 10% for a 100°C temperature rise. Dielectric strength is measured as one minute life at the cited voltage for a 2mm sample at 60 cps. Data in Table 4 are valid only for the conditions stated, and do not extend to other conditions or materials.

The barium aluminosilicate glass described in Table 4 has a smooth virgin surface and is well suited for substrates.

Ceramic Substrates

The ceramic substrate has a higher softening temperature and higher thermal conductivity than glass. The high thermal conductivity property, however, exists only in highly pure alumina and beryllia. The presence of minor additives decreases thermal conductivity drastically. Voids in the material do not appreciably decrease the thermal conductivity. The effects of impurities on thermal conductivity noted for beryllia also occur in alumina, as described in Table 5.

The manufacturing process has a direct effect on the surface smoothness of ceramics. Normal smoothness is in the range of 20 to 50 microinches, although 2 microinches can be attained by careful polishing. Polishing to this factor increases the chances for deep imperfections. To overcome this problem, glazed alumina and beryllia substrates were developed. These substrates combine the thermal conductivity of ceramics with the smoothness of glass. They permit greater power loading, film control, and component performance. Although the expansion coefficient of a glazed substrate depends on the ceramic, the other important properties are determined primarily by the composition and thickness of the glaze.

Other Substrates

A number of other materials have been considered as substrates. These include glass-ceramics, single crystals, dielectric coated metals and plastics. The latter may have some special uses but are not generally suited to thin-film circuitry. Dielectric coated metals have been investigated for magnetic-film

memory substrates and for some superconductive film devices.

Glass-ceramics are ceramic materials made by controlled crystallization of glass. They have higher use temperatures than most glass, and thermal conductivities about double that of glass. The photo-sensitive glass-ceramics can be chemically machined into intricate shapes. Two such glass-ceramics are Pyroceram and Fotoceram, both produced by Corning Glass.

Sapphire crystal substrates combine all the desired substrate properties into one material. Widespread use, however, is prohibited by their very high cost.

From the substrate materials available, it is generally agreed that glasses or glazed ceramics have the best combination of properties. The surface in contact with the thin-film circuit will probably be glass, and interactions between the film elements and substrate surface will depend on the chemistry and physics of surfaces.

Laser Glass Materials

Some of the properties of the better glass compositions are shown in Table 6. The position of the emission peak varies somewhat around 1.06 microns, although the variation within a glass system is less than 50 Å. Fluorescence emission peak intensities measured with a continuous high-pressure xenon arc lamp vary from 20 to over 500. The borate glasses are lowest; the silicates cover a wide range; the phosphates, fluorides, and germanates are intermediate; the tellurites are highest although their high expansion coefficients make sample preparation very difficult.

The borate glasses have short lifetimes. This, coupled with the low fluorescence intensity, indicates that a quenching process is operative. This quenching effect of boron is also found in the borosilicate

Table 3: SOME PROPERTIES OF IMPORTANT FILM MATERIALS

| Film Type | Deposition | Processing Temperature (°C) | Expansion Coefficient (ppm/°C) | Roughness Sensitivity | Impurity Sensitivity |
|--|-------------|-----------------------------|--------------------------------|-----------------------|----------------------|
| Nickle Chromium (Ni-Cr) | evaporation | 350 | 13.5 | moderate | alkali |
| Chromium Silicon Oxide (Cr-SiO) | evaporation | 425 | not known | — | alkali |
| Tantalum (Ta) | sputtering | 350 | 5 | moderate | alkali |
| Tin Oxide (SnO ₂) | chemical | 650 | 4.6 | slight | alkali |
| Palladium (Pd-cermets) | paint | 600 | 10 | none | alkali |
| Silicon Oxide (SiO) | evaporation | 200 | 2 | high | no |
| Tantalum Oxide (Ta ₂ O ₅) | anodization | 100 | not known | moderate | no |
| Permalloy (Ni-Fe) | evaporation | 350 | 12.5 | high | no |

Table 4: PROPERTIES OF GLASS SUBSTRATE MATERIALS

| Glass Type | Soda Lime | Alkali Zinc Boro-silicate | Lime Alumino-silicate (alkali free) | Lime Alumino-silicate (alkali free) | Barium Alumino-silicate (alkali free) | Alkali Boro-silicate | 96% Silica | Fused Silica |
|---|-----------|---------------------------|-------------------------------------|-------------------------------------|---------------------------------------|----------------------|------------|--------------|
| Annealing Point, °C | 512 | 542 | 866 | 710 | 650 | 565 | 910 | 1050 |
| Softening Point, °C | 696 | 720 | 1060 | 910 | 872 | 820 | 1500 | 1580 |
| Thermal exp. coef. 10 ⁻⁶ /°C | 9.2 | 7.2 | 3.5 | 4.6 | 4.5 | 3.25 | 0.8 | 0.56 |
| Thermal Conductivity cal/cm/sec/°C @ 25°C | 0.0023 | — | — | 0.0032 | — | 0.0027 | 0.0038 | 0.0034 |
| Density, g/cm ³ | 2.47 | 2.57 | 2.48 | 2.63 | 2.76 | 2.23 | 2.18 | 2.20 |
| Dielectric const. (1 mc) @ 25°C | 6.9 | 6.6 | 5.9 | 6.4 | 5.8 | 4.6 | 3.9 | 3.9 |
| Loss Tangent (1 mc) @ 25°C | 0.01 | 0.0047 | 0.0024 | 0.0013 | 0.0011 | 0.0062 | 0.0006 | 0.00002 |
| Log Volume Resistivity (ohm-cm) @ 250°C | 6.4 | 8.3 | 13.6 | 14.1 | 13.5 | 8.1 | 9.7 | 11.8 |
| Dielectric Strength @ 25°C, kv (RMS) | 0.35 | 2.0 | >10 | >10 | >10 | 2.0 | 7.0 | >10 |

Note: values shown for Lime Aluminosilicate are maximum and minimum limits.

MATERIALS (Continued)

glasses and, to a lesser extent, for aluminum in aluminosilicates.

Glass Sealing Materials

The basic requirements for a glass sealing material are: A coefficient of thermal expansion which closely matches the glass in question; a capability of producing an adherent oxide film; and a surface to which glass will set and adhere when raised to a high temperature. The thermal expansion coefficient must be such a value that it will seal to the hard glasses.

To date, the most popular glass sealing material is the F-15 Alloy. F-15 Alloy is the ASTM designation for an iron-nickel-cobalt alloy which contains nominally 29% Ni, 17% Co, and 53% Fe.. Texas Instruments has improved on this alloy by developing a new composite material. This material consists of a layer of copper which is clad on both sides with F-15. The copper core forms 60% of the total material thickness. The copper layer provides a significant increase in thermal conductivity. This allows transistors to be operated at higher than normal power

levels. With this material, transistors are said to operate at three times the normal power level with no corresponding increase in junction temperature. The major uses for this material is for transistor eyelets and headers.

ORGANIC SEMICONDUCTORS

Organic semiconductors are solids with a considerable number of carbon bonds which support electrical conduction. They fall roughly into two groups: the molecular crystals, such as anthracene, and polymers which are used in plastics.

The borderline between conductivity and nonconductivity is approximately 10⁻¹⁰ reciprocal ohm-cm. Most organic compounds fall into the 10⁻¹⁰ to 10⁻¹⁴ region, making them good electrical insulators.

General Electric has announced the development of a new family of plastics that have conductivities as high as 10⁻³. The significance of this can be seen by comparing this rating with that of two conductors, graphite and copper. Graphite is a particularly good non-metallic conductor which is rated in the vicinity of 10⁴; copper's conductivity is 10⁵. Thus, the new conducting polymers rank about midway between the most common insulators and the most common conductors.

(Continued on page 46)

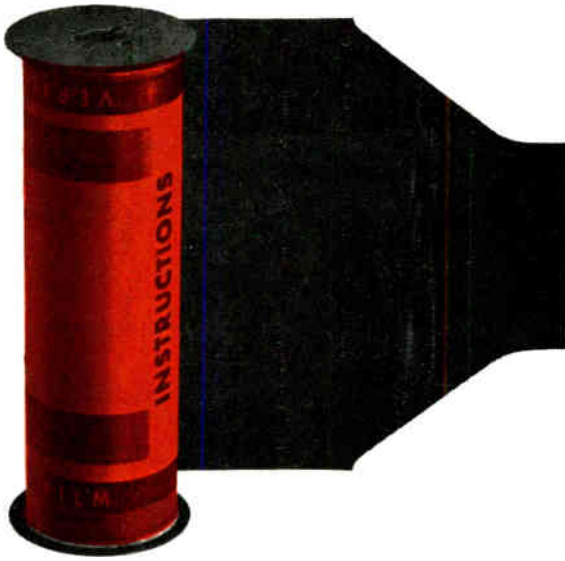

**ANYTHING YOU CAN PUT ON FILM...YOU CAN DISPLAY ON THIS IEE READOUT
(EVEN COLORS)**

NUMBERS, LETTERS, WORDS, SYMBOLS, COLORS • There is literally no limitation to the display versatility of IEE readouts. As miniature rear-projectors, they operate by back-lighting display symbols arranged on film and projecting the selected message on a non-glare viewing screen. Each IEE readout contains 12 lamps for 12 separate messages which may be displayed individually or in combination. You may specify virtually any type or combination of messages that are photographically reproducible: numerals, letters, digits with polarity or decimal points, words and multi-digits, mode/word indications, multiple words, colors for emphasis, and any symbols.

SINGLE-PLANE PRESENTATION FOR VISUAL CRISPNESS • IEE readouts combine the advantages of a new high-brightness lens system and the all-important single-plane presentation for visual clarity. The result is unmistakable readability—at wide angles, long distances, in bright light—without filters, screens, or shades of any kind.

UNLIMITED UNIT LIFE • IEE readouts contain no moving parts; hence, cannot wear out. The conventional MS or commercial lamps used in these readouts provide up to 30,000 hours of operation per lamp and are as easily replaceable as a flashlight bulb.

CLICK, IT'S IN; CLICK, IT'S OUT For quick, easy lamp replacement or complete message exchange, specify IEE Series 220 front plug-in readouts. These miniature rear-projection readouts ($\frac{5}{8}$ " maximum character height) plug in and out to provide front panel accessibility, permit permanent wiring and eliminate flexible cables.

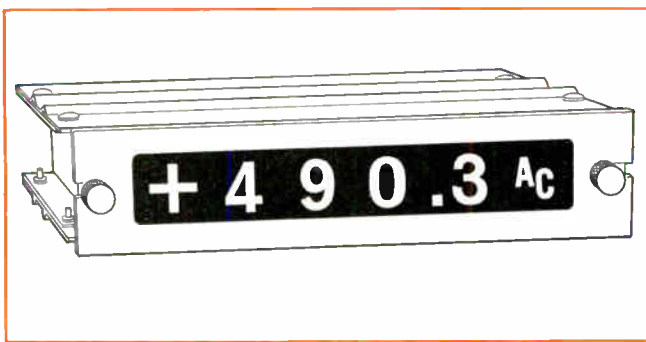

Typical assembly shows six Series 220 readouts with common viewing screen. Display inserts with individual screens or with bezels also available.

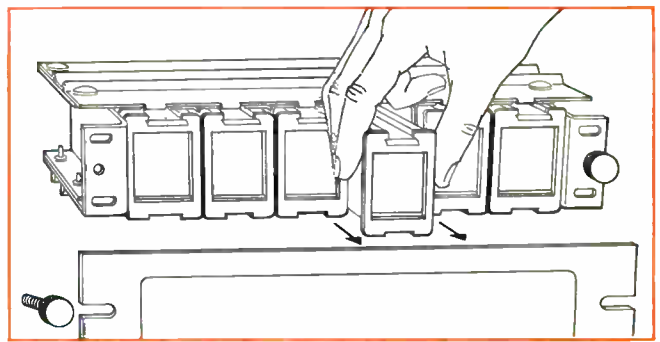

Individual Series 220 readout insert clicks out for lamp replacement or exchange of insert for new message displays. Permanently wired base remains in assembly.

IEE one-plane rear-projection readouts are available in several sizes offering maximum character heights from $\frac{5}{8}$ " to $3\frac{3}{8}$ ". Your inquiry will bring the comprehensive new "Readout Display Selector Guide" which includes specifications and other technical information on the entire IEE line of readout devices.



INDUSTRIAL ELECTRONIC ENGINEERS, INC.

7720 Lemona Ave., Van Nuys, Calif.
Representatives in Principal Cities

• Phone: (213) 787-0311

• TWX: (213) 781-8115

Table 5: PROPERTIES OF CERAMIC SUBSTRATE MATERIALS

| Ceramic Type | Dense Alumina 85% Al ₂ O ₃ | Dense Alumina 94% Al ₂ O ₃ + CaO + SiO ₂ | Dense Alumina 96% Al ₂ O ₃ + MgO + SiO ₂ | Dense Beryllia 98% BeO | Dense Beryllia 99.5% BeO |
|--|---|---|---|---------------------------|-----------------------------|
| Softening Temp. (°C) | 1100 | 1500 | 1550 | 1600 | 1600 |
| Thermal exp. coef. (10 ⁻⁶ /°C) | 6.5 | 6.2 | 6.4 | 6.1 | 6.0 |
| Thermal Conductivity, cal/cm/sec/°C @ 25°C | 0.060 | 0.073 | 0.084 | 0.50 | 0.55 |
| Density, g/cm ³ | 3.40 | 3.58 | 3.70 | 2.90 | 2.88 |
| Dielectric const. (1Mc) @ 25°C | 8.3 | 8.9 | 9.3 | 6.3 | 6.4 |
| Loss Tangent (1Mc) @ 25°C | 0.0058 | 0.0018 | 0.0028 | 0.0006 | 0.0006 |
| Log Volume Resistivity (ohm-cm) @ 300°C | 10.7 | 12.8 | 10.0 | 13.8 | >14 |
| Dielectric strength @ 25°C and 60 cps volts/mil | 230 | 230 | 230 | 255 | 260 |

TABLE 6: PROPERTIES OF GLASS COMPOSITIONS

| Glass Former System | Emission Peak μ | Emission Peak Intensity | Lifetime μ sec. | Linewidth |
|---------------------|---------------------|-------------------------|---------------------|-----------|
| Silicates | 1.066 ± 0.002 | 50-410 | 1000-150 | 240-480Å |
| Phosphates | 1.057 | 79-208 | 310-180 | 290 |
| Borates | 1.066 | 20-46 | 100-53 | 350 |
| Fluorides | 1.058 | 99-153 | 600-420 | 270 |
| Tellurites | 1.068 | >500 | 159 | 280 |
| Germanates | 1.070 | 140-236 | 413-160 | 350 |

MATERIALS (Continued)

The process for making this family of conductive plastics consists of converting suitable polymers into polycations associated with negative TCNQ ions. Control of conductivity is realized by introducing certain amounts of neutral TCNQ.

In the past, attempts to produce useful conducting materials were made by filling normal polymers with finely divided conducting particles of lampblack or metal. It is difficult to produce a range of conductivities in such materials, and the bulk addition of the large amounts of organic filler generally degrades the mechanical properties of the polymer. Electrically-conducting powders also have been produced from organic materials. These, however, lack structural strength or chemical stability even at room temperature. The new GE polymers possess the desirable mechanical properties of normal polymers and are stable at temperatures to at least 100°C.

The new materials can be applied in liquid form to produce a conductive coating on the surface of common insulators. This would allow it to be used in certain types of printed circuits. The polymers can be used as a kind of adhesive paste to solder in attaching parts in an electrical circuit. Laboratory tests indicate they will conduct electricity indefinitely without undergoing change.

SEMIMETALS

Semimetals have properties intermediate between metals and semiconductors. Metals are good conductors because they contain many free electrons. Semiconductors and semimetals carry holes, which occur when electrons are missing from the crystal configuration. Semiconductors are poor conductors because the number of missing electrons and abundance of holes do not correspond. Semimetals, on

the other hand, have an equal number of holes and electrons.

Two semimetals that have been extensively investigated are bismuth and antimony. These two elements are quite similar. The atoms of each have five outer electrons, and they crystallize in the same form. The high mobility of the electrons and holes in bismuth are of particular interest. This high mobility permits fairly high conductivity and great sensitivity to a magnetic field. Bismuth has only a millionth as many electrons as copper, yet its resistivity is only 100 times higher.

The uses for semimetals vary. Semimetal regulators operate at super cold temperatures in the cryogenic range (-450°F). The electron energies at 0°C are still as strong as before, but the shell electrons do not escape. The electrons have a stronger tie with the other electrons.

REFRACTORY MATERIALS

Refractory materials have a number of high-temperature applications. Two of the actively used materials are tungsten and molybdenum, although tantalum, columbium, vanadium, and niobium have certain advantages.

Tungsten and molybdenum and their alloys are available in powder, pellet, rod, wire, and ingot, billet or electrode forms. The latter three are important because they can be pressed, sintered, machined, or otherwise shaped into hitherto unheard-of sizes, shapes, and forms. Most refractory metal powders can be isostatically pressed and sintered to practically any shape within the dimensional capabilities of existing equipment. All metal power combinations containing tantalum, titanium, hafnium, or
(Continued on page 48)

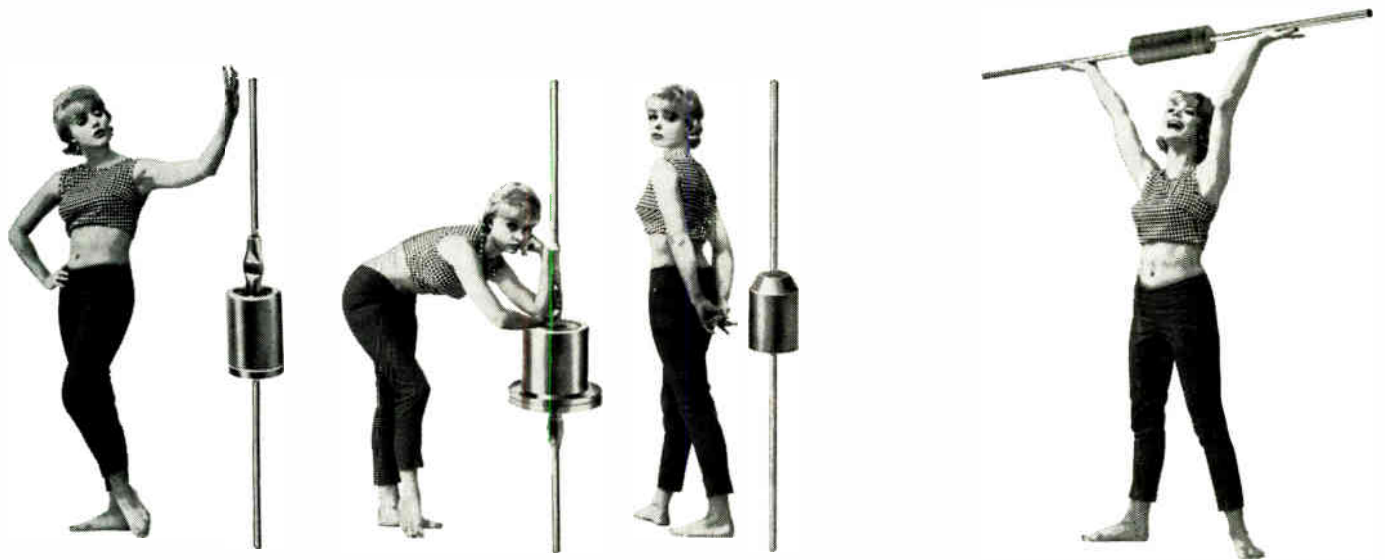

A Rectifier was a Rectifier was a Rectifier is a Glass-Amp®

Flangeless, top hats, plastics and some studs are now obsolete. New GI Glass-Amp rectifiers replace and outperform 222 commonly used JEDEC and Military types



| | | | | |
|--------|--------|--------|--------|--------|
| 1N4001 | 1N4002 | 1N4003 | 1N4004 | 1N4005 |
| 1N4006 | 1N4007 | 1N4008 | 1N4009 | 1N4010 |
| 1N4011 | 1N4012 | 1N4013 | 1N4014 | 1N4015 |
| 1N4016 | 1N4017 | 1N4018 | 1N4019 | 1N4020 |
| 1N4021 | 1N4022 | 1N4023 | 1N4024 | 1N4025 |
| 1N4026 | 1N4027 | 1N4028 | 1N4029 | 1N4030 |
| 1N4031 | 1N4032 | 1N4033 | 1N4034 | 1N4035 |
| 1N4036 | 1N4037 | 1N4038 | 1N4039 | 1N4040 |
| 1N4041 | 1N4042 | 1N4043 | 1N4044 | 1N4045 |
| 1N4046 | 1N4047 | 1N4048 | 1N4049 | 1N4050 |
| 1N4051 | 1N4052 | 1N4053 | 1N4054 | 1N4055 |
| 1N4056 | 1N4057 | 1N4058 | 1N4059 | 1N4060 |
| 1N4061 | 1N4062 | 1N4063 | 1N4064 | 1N4065 |
| 1N4066 | 1N4067 | 1N4068 | 1N4069 | 1N4070 |
| 1N4071 | 1N4072 | 1N4073 | 1N4074 | 1N4075 |
| 1N4076 | 1N4077 | 1N4078 | 1N4079 | 1N4080 |
| 1N4081 | 1N4082 | 1N4083 | 1N4084 | 1N4085 |
| 1N4086 | 1N4087 | 1N4088 | 1N4089 | 1N4090 |
| 1N4091 | 1N4092 | 1N4093 | 1N4094 | 1N4095 |
| 1N4096 | 1N4097 | 1N4098 | 1N4099 | 1N4100 |

in the same range. Already Glass-Amp's superiority has been demonstrated... Since being introduced this year, over 3 million units have been delivered—with millions more on the way.

Value-engineered Glass-Amp is a glass-to-metal, hermetically sealed rectifier with a fully insulated body, a surge rating of 50 amps and handles a full amp at 100°C



with a PRV to 1000 volts.

Glass-Amps for commercial use come off the same production line as the Ultra Hi-Rel

units which meet the high reliability standards of MIL R-38100A (the outgrowth of the Minute Man specifications).

Remember, all you darlin' engineers:— A rectifier by any other name is not the same.

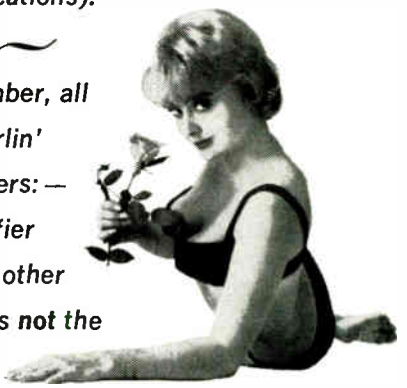

Specify GI Glass-Amp Rectifiers.

Want to see some curves, full data? Write to me, GI Ginny, General Instrument Corp. 600 West John Street Hicksville, N. Y.



MATERIALS (Continued)

columbium cannot be sintered in a hydrogen atmosphere because of the formation of hydrides. A vacuum furnace, however, may be used for those combinations which form hydrides.

Molybdenum is classified as a hard metal. Compared to tungsten, however, it is softer and more easily worked. Molybdenum's melting point of 2625°C exceeds that of tungsten. It is mechanically strong and its electrical conductivity is one-third of copper. Its thermal conductivity is less than half that of copper.

Molybdenum can be rolled into sheets or drawn into wire. In these forms it can be bent cold or stamped into simple shapes. It can be machined readily with ordinary tools and can be welded very satisfactory to iron and nickel, but not so readily to itself. It oxidizes during heating in air.

Both tungsten and molybdenum are often alloyed with other metals. One such alloy, tungsten and rhenium, has high temperature strength and room-temperature ductility. Other characteristics include higher recrystallization temperatures than with pure tungsten, freedom from second-phase dispersion, and improved characteristics after welding. Alloying tungsten and rhenium produces a metal with greater strength at all temperatures than tungsten in its pure state.

CIRCUIT-BOARD MATERIAL

A weldable circuit-board foil must have a strong bond between the foil and substrate; the foil must be etchable with standard techniques; the foil must have electrical conductivity compatible with the requirements of the electronic circuit; and the foil must be weldable.

Materials such as nickel, F-15 alloy, and Monel are used in weldable circuit-board uses. These materials, however, only offer a compromise when the above four must be met. For example, nickel has good welding characteristics but it is difficult to etch and bond to conventional insulating substrates. One approach to solving this problem using the materials systems concept has been developed by Texas Instruments. This approach uses a three-layer foil system. The top layer is a thin cladding of nickel. The second layer is steel, representing the major portion of the total thickness. The third is a thin layer of aluminum.

Each of these materials has a specific function. The nickel provides a weldable surface. It has a low electrical resistivity which helps keep the welding current confined to the upper layers of the foil. The nickel also alloys easily with conventional lead materials. The steel layer provides a thermal barrier to any heat generated in the upper layer. This helps prevent heat damage to the substrate. The aluminum layer provides high bond strengths to the conven-

tionally used epoxy glass substrates.

This particular setup is intended primarily for integrated circuits which have flat, gold-plated F-15 Alloy leads.

PLASTIC MATERIALS

The role plastic compounds play in electronics is so large it would be impossible to describe them all in this report. There are, however, some uses where plastics offer distinct advantages over other materials.

Plastic Insulators

Of particular importance for electrical insulation is the development of systems using thermosetting plastics. The thermosetting plastics, unlike the thermoplastics, do not soften when exposed to high temperatures. Instead, they reach the point of thermal degradation of the molecular structure first. Some of the more common thermosetting polymers are epoxy, polyester, phenolic, melamine, and silicon resins. For most insulation uses, such as potting, encapsulation, molding, high-voltage insulation, etc., these polymers are superior to the thermoplastic types. This is principally due to their greater thermal stability and retention of physical properties at high temperatures.

Low Friction Plastics

Plastics have distinct advantages when used in areas of high friction such as bearings. Three of the most common plastic materials used for this application are nylon, Teflon and polyethylene. These materials maintain a high coefficient of sliding friction under adverse conditions with less lubricant than that needed for other materials. Teflon, for instance, exhibits a coefficient of sliding friction with no lubricant that exceeds any other combination.

Acknowledgements

We would like to thank the following for their contributions:

American Lava Corp., Chattanooga, Tenn.
American Society for Testing and Materials, Phila., Pa.
Apparatus & Optical Div., Eastman Kodak Co., Rochester, N. Y.
Carborundum Co., Latrobe, Pa.
Corning Glass Works, Corning, N. Y.
Dow Corning Corp., Midland, Mich.
Eagle-Picher Research Lab., Miami, Okla.
Engelhard Industries, Newark, N. J.
E. I. Du Pont De Nemours Co., Wilmington, Del.
Franklin Fibre-Lamitex Corp., New York, N. Y.
International Resistance Co., Phila., Pa.
Monsanto Chemical Co., St. Louis, Mo.
RCA, David Sarnoff Research Center, Princeton, N. J.
Sel-Rex Corp., Nutley, N. J.
Sylvania Chemical and Metallurgical Div., a sub. of General Telephone & Electronics, Towanda, Pa.
Synthane Corp., Oaks, Pa.
Texas Instruments Incorporated, Dallas, Tex.
C. L. Guettel, Driver-Harris Corp., Harrison, N. J.

References:

Hickey, J. E., "Gallium Arsenide: What is its Status?" *Electronic Industries*, Vol. 22, No. 2.
Journal of Applied Physics, Vol. 35, No. 3, Part 2.
Madelung, O., *Physics of III-V Compounds*, John Wiley & Sons, Inc., 1964.
Ruth, S. B., "Magnetics Research Turns Up New Designs, Applications," *Electronic Industries*, Vol. 23, No. 2.
Trautwein, J. W., "Choosing Photoconductive Cells," *Electronic Industries*, Vol. 23, No. 10.

• A REPRINT of ANY ARTICLE in this issue is available from ELECTRONIC INDUSTRIES Reader Service Department.

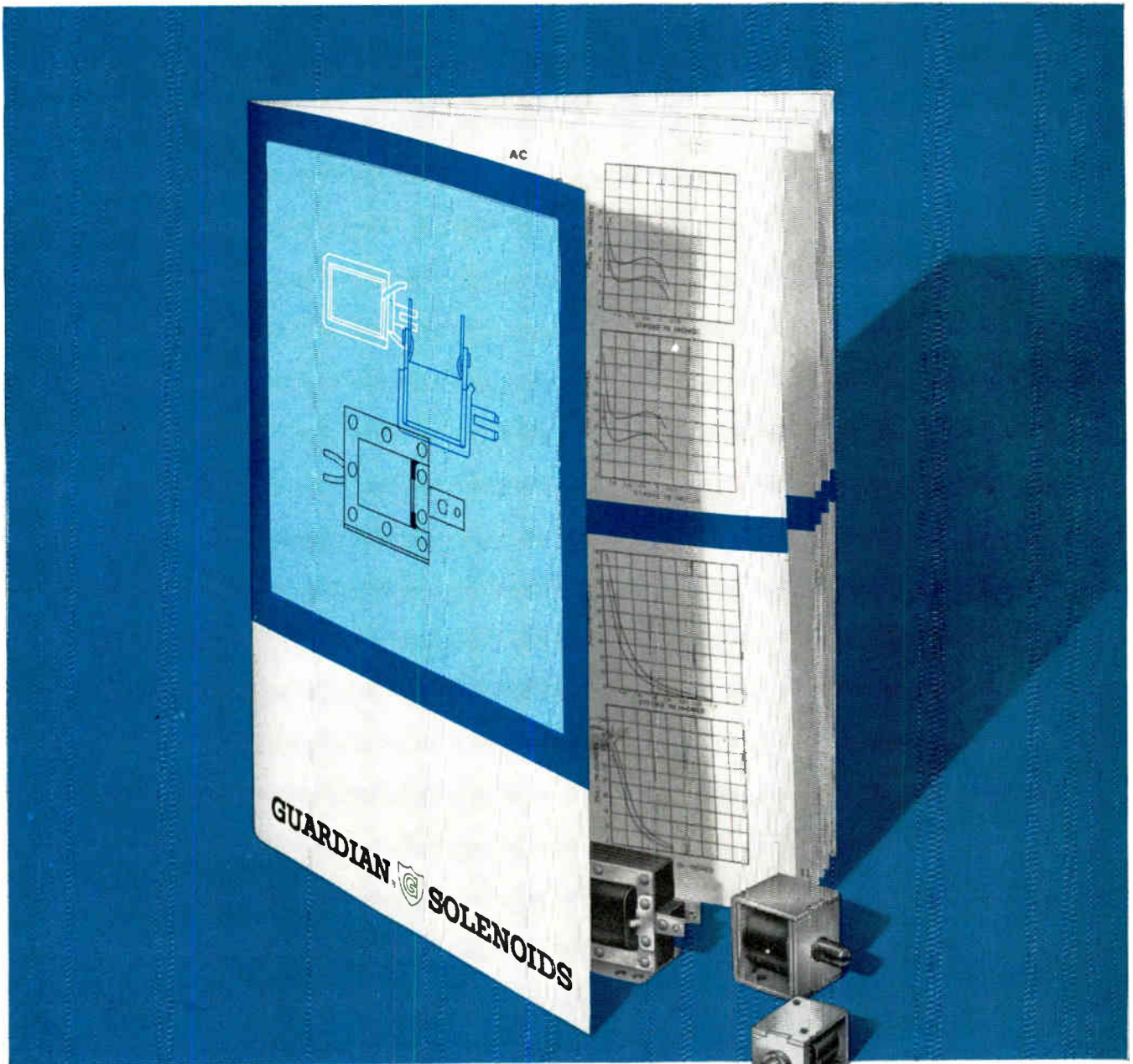

FREE TECHNICAL MANUAL

CHOOSE YOUR SOLENOID FROM THE WIDEST SELECTION EVER OFFERED

Used to be that solenoid selection was a chore—and a mighty uncertain one at that. Even after you were finished, you still weren't sure you had the right solenoid—since most information was incomplete or inconclusive.

But no more, because Guardian's new 28-page solenoid selection manual solves this problem for good. It gives full information on how to select a solenoid. Plus dimensional drawings, complete specs and "HOT" and "COLD" pull charts for the many general purpose and

power-type solenoids that make up Guardian's standard line. Even information on custom-engineered solenoids is available, in case one of our hundreds of standard modifications shouldn't fit your job. In short, here is everything you need for quick, accurate solenoid selection.

Best of all, this manual is free and sent without obligation of any kind. Write for your copy today to Guardian Electric Manufacturing Company, 1550 West Carroll Avenue, Chicago, Illinois 60607. Write Dept. EI 412.

GUARDIAN ELECTRIC

MICROWATT SWITCH... the ONLY way

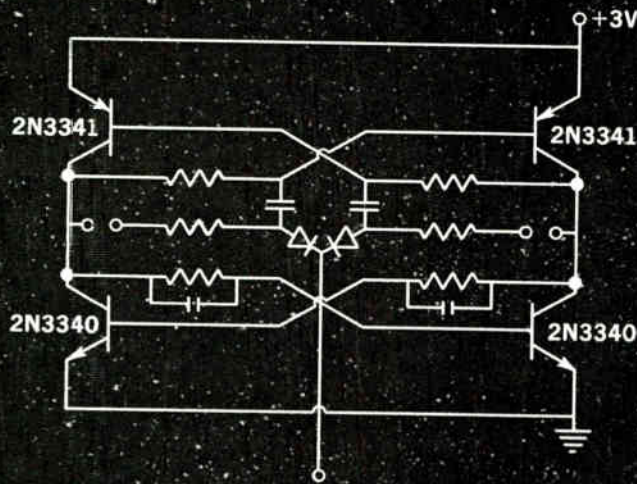

The answer to more in-flight computation
—microwatt switches in a complementary circuit
Sperry has developed the industry's first.

**EVALUATE
SPERRY**



Send for Sales
Representative

Circle 40
on Inquiry Card



Microwatt
Specification
Sheet

Circle 41
on Inquiry Card



All
Products
Bulletin

Circle 42
on Inquiry Card

Ten microwatts per flip flop. The 2N3340 (NPN) and 2N3341 (PNP) represent the industry's first complementary switching transistors specified at microwatt levels. These devices are ideal for ultra low power gating, counting, control, data handling circuits and systems. The total delay and rise time is typically 40 nsec. at 50 μ A. Get complete specifications in data sheets 2N3340 and 2N3341, or contact Sperry. Eastern Regional Office: 69 Hickory Drive, Waltham, Massachusetts; Midwest Regional Office: 3555 West Peterson Ave., Chicago 45, Illinois; Western Regional Office: 1680 North Vine Street, Hollywood 28, California. Sales Representatives: Orbit Electronics, 250 Carroll Street, Fort Worth, Texas; Perrott Associates, Incorporated, 2321 East South Street, Orlando, Florida. Keep in touch — with **SPERRY SEMICONDUCTOR, Norwalk, Connecticut.**

SPERRY

DIVISION OF
SPERRY RAND
CORPORATION

400 fast answers to relay problems



Big Ohmite Factory Stocks Back Up Your Distributor With 429 Models and Variations

Relays for aircraft . . . relays for industrial controls . . . relays for machine tool controls . . . relays for mobile communications . . . relays for programming controls . . . relays for temperature control instruments . . . relays for vending machines . . . relays for welding equipment . . . relays with UL and Canadian Standards Association approvals.

These are just some of the requirements you can meet fast from Ohmite's big off-the-shelf selection.

Many of these relays are not available from stock anywhere else: enclosed, plug-in latching type; open and

enclosed 4-pole relays; thyatron-operated types; above and through-chassis enclosed types; multi-use terminals for solder, push on, or plug mounting.

Try Ohmite for your special relay needs, too. Ohmite has industry's fastest growing line.

Write for revised Catalog 700. Includes selection guide, all stock relays, specifications, and data on "specials."



OHMITE
MANUFACTURING COMPANY
3613 Howard Street, Skokie, Illinois 60076
Phone: (312) ORchard 5-2600

RHEOSTATS • POWER RESISTORS • PRECISION RESISTORS • VARIABLE TRANSFORMERS • TANTALUM CAPACITORS • TAP SWITCHES • RELAYS • R.F. CHOKES • SEMICONDUCTOR DIODES



Wear this glorious medal

Everybody craves recognition... you do, and so do we. So let's help each other. We're asking you to display a certain kind of engineering courage that is the mark of a Crusading Engineer. In return we'll award you this glorious medal with our deepest and sincerest appreciation.

Here's our problem. We've got a line of electronic counters that, by spec and performance, are better buys than anything Beckman or Hewlett-Packard make. We just figured that would automatically get us the big share of the business. We were wrong. Oh, we're doing all right (an easy third in sales) but we haven't exactly pushed those other two big companies into complete bankruptcy.

We don't want your sympathy... just a bit of recognition. Sure, we know it takes a little extra courage to consider CMC when there are those two other "big name" brands around. So all we ask is that you have the guts to compare our specs and performance against those other guys'. If you do, there's a good chance you'll see why we honestly believe we make the world's best counters... and maybe next time you need a counter you'll buy a CMC counter.



To honor your courage we'll decorate you with this Crusading Engineers' medal to bolster your morale during battle. If more men follow your lead, soon it won't take courage to recommend CMC... it'll take courage **not** to.

Now that you know we exist, keep your eyes and ears open. As one of the "hottest" young electronics outfits in the business we're making big plans. We are going to compete with high-powered H-P and big, bad Beckman right up and down their full line. But that's news for later.

Right now, act! Join the crusade. Write for our stimulating technical catalog and earn your medal. Just think how proud your kids will be.

12976 Bradley • San Fernando, California • Phone (213) 367-2161 • TWX 213-764-5993

COMPUTER MEASUREMENTS COMPANY IS A LEADING DESIGNER AND MANUFACTURER OF ELECTRONIC INSTRUMENTATION TO COUNT, MEASURE, AND CONTROL.

New from **E-I**

High Voltage Glass-Bonded Ceramic Seals

PATENTS PENDING



Compare!

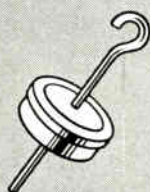

GLASS-TO-METAL SEAL ...
2500 V.

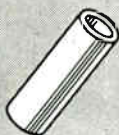

CERAMIC PART

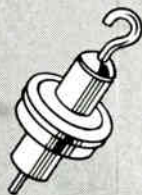

GLASS-BONDED CERAMIC SEAL ...
10,000 V. PLUS

Meet High Voltage Requirements —AT LOWER COST!

ELECTRICAL INDUSTRIES announces new Glass-Bonded Ceramic Seals (Glass-Ceramic-Metal) which are produced at considerably lower cost than conventional ceramic-to-metal types. Designed to provide an economical solution to problems involving high voltages, E-I Glass-Bonded Ceramic Seals can be supplied in a range of sizes to meet specific requirements. Consult our engineering department for design assistance.

GLASS-BONDED CERAMIC SEALS vs. GLASS-TO-METAL SEALS COMPARATIVE DATA FOR SEALS ILLUSTRATED

PEAK VOLTAGE

| GLASS-TO-METAL SEALS | GLASS-BONDED CERAMIC SEALS |
|----------------------|----------------------------|
| 2500 V. | 10,000 V PLUS |

SURFACE RESISTANCE

| GLASS-TO-METAL SEALS | | | | GLASS-BONDED CERAMIC SEALS | | | |
|----------------------|---------|-----------|---------|----------------------------|---------|-----------|---------|
| Temp. °F. | Megohms | Temp. °F. | Megohms | Temp. °F. | Megohms | Temp. °F. | Megohms |
| 150 | ∞ | 350 | 32 k | 150 | ∞ | 350 | ∞ |
| 200 | ∞ | 400 | 5 k | 200 | ∞ | 400 | ∞ |
| 250 | ∞ | 450 | — | 250 | ∞ | 450 | 1800 k |
| 300 | 200 k | 500 | — | 300 | ∞ | 500 | 800 k |

A Division of Philips
Electronics and
Pharmaceutical
Industries Corporation



ELECTRICAL INDUSTRIES
MURRAY HILL, NEW JERSEY 07971 — Telephone: (201) 464-3200

PATENTED IN THE U.S.A., NO. 3,035,372; IN CANADA, NO. 523,390; AND IN THE UNITED KINGDOM, NO. 734,583; OTHER PATENTS PENDING.

Computer Solutions Aid Rectifier Filter Design

Engineers who must analyze capacitor-input-filter rectifier circuits face a problem. Many of the approaches now available are extremely inaccurate and require a considerable expenditure of time. Tables derived from a computer analysis can be readily used to find average current, peak current, and average dissipation of these circuits.

AN ACCURATE AND RAPID ANALYSIS of capacitor-input-filter rectifier circuits has long been a problem in design engineering. Many of the approaches available to circuit engineers are inaccurate and time consuming. This article presents tables and equations which can be readily used to find average current, peak current, and average dissipation of these circuits. Calculations for this analysis were programmed into and performed by an RCA-501 computer.

* * *

For analysis of rectifier circuits with this method, the following must be known: input voltage (\bar{E}) expressed as the peak value of the applied RMS sinusoidal voltage; desired average voltage (\bar{E}) across the load resistance (R_L) and the filter capacitor (C) in parallel; equivalent resistance (R_s) in series with each plate

of the rectifier during conduction; and diode permeance (G) expressed as the value of $I/E^{3/2}$ (in this expression, E and I are equal to any static voltage and current values representing the "drop point" of the diode). These circuit values are then inserted into the tables and equations presented below. This approach needs no operational curves for the diode.

Fig. 1 shows the half-wave rectifier circuit used as the basis for the equations and tables. Currents and dissipation for full-wave and voltage-doubler circuits can be readily found by representing each circuit in half-wave equivalent sections similar to Fig. 1.

In this analysis, it is assumed that increasing the value of C will not greatly affect circuit regulation.¹ But, this assumption is practical if the voltages used in the application

are within the operating range of electrolytic capacitors. Suitable values of C can be found as follows:²

$$\begin{aligned} CR_L &\geq 6 \text{ for a full-wave rectifier} \\ CR_L &\geq 12 \text{ for a half-wave rectifier} \\ CR_L &\geq 24 \text{ for a voltage doubler} \end{aligned} \quad (1)$$

At conduction angles from $-\phi$ to $+\phi$, the voltage equation for the rectifier circuit is given by

$$\bar{E} \cos \omega t \Big|_{-\phi}^{+\phi} - \bar{E} = e_r + e_d \quad (2)$$

In terms of the instantaneous current i , the voltage equation becomes

$$\bar{E} \cos \theta - \bar{E} = i R_s + \left(\frac{1}{G}\right)^{2/3} \quad (3)$$

where $\theta = \omega t$ when $-\phi \leq \theta \leq \phi$.

Possible Solutions

When R_s is assumed to equal zero in Eq. 2 (a theoretical situation because every transformer has some internal resistance), several mathematical solutions are possible. For

An RCA-501 computer was used to perform the calculations for this analysis.



By WAYNE AUSTIN,

Engineer, RCA
Electronic Components and Devices,
Harrison, N. J.,

and KARL ANGEL

Engineer, RCA
Broadcast and Communications Products Div.,
Meadowlands, Pa.

example, it is possible to integrate the instantaneous current expression and then apply Simpson's rule. Another approach would be the use of a gamma-function solution. But, in practical cases where R_s does not equal zero, average current can be found only by a trial and error method or by a plot of the equation. Both of these methods are tedious, and require much time and effort.

A practical method to reduce equation complexity is to eliminate some of the variables by normalizing. First, the rectification of efficiency η is represented by

$$\eta = \frac{\bar{E}}{E} = \cos \phi \quad (4)$$

Eq. 3 may then be rewritten as follows:

$$\alpha = \left[\frac{i}{G \bar{E}^{3/2} (1 - \eta)^{3/2}} \right] R_s G \bar{E}^{1/2} (1 - \eta)^{1/2} + \left[\frac{i}{G \bar{E}^{3/2} (1 - \eta)^{3/2}} \right]^{2/3} \quad (5)$$

where α is defined as $\frac{\cos \theta - \eta}{1 - \eta}$.

If the above equation is normalized* with respect to the peak-steady-state current \bar{I} , the result is

$$\alpha = i' R' + i'^{2/3} \quad (6)$$

Although the above procedure is not the most straightforward method to normalize the equation, the reasons for using this approach are explained later.

In many practical uses of rectifier circuits, it is also desirable to know the dissipation of the diode rectifier, even though this rating is protected by the current and voltage ratings. Instantaneous dissipation (ρ) of a diode can be found from either:

$$\rho = e_d i \text{ or } \rho = \left(\frac{i}{G} \right)^{2/3} \cdot i \quad (7)$$

TABLE 1
Normalized Average Current (\bar{I})

| R' | ϕ - Degrees | | | | | | | | |
|------|------------------|--------|--------|--------|--------|--------|--------|--------|--------|
| | 10° | 20° | 30° | 40° | 50° | 60° | 70° | 80° | 90° |
| 0 | .5886 | .5875 | .5856 | .5829 | .5795 | .5751 | .5699 | .5634 | .5564 |
| 0.1 | .5196 | .5187 | .5170 | .5147 | .5117 | .5079 | .5033 | .4979 | .4916 |
| 0.2 | .4669 | .4661 | .4646 | .4626 | .4599 | .4565 | .4525 | .4477 | .4421 |
| 0.3 | .4251 | .4243 | .4230 | .4211 | .4187 | .4157 | .4120 | .4077 | .4027 |
| 0.4 | .3908 | .3901 | .3889 | .3872 | .3850 | .3823 | .3790 | .3750 | .3704 |
| 0.5 | .3622 | .3616 | .3605 | .3589 | .3569 | .3544 | .3513 | .3477 | .3434 |
| 0.6 | .3379 | .3373 | .3363 | .3349 | .3330 | .3306 | .3278 | .3244 | .3205 |
| 0.7 | .3169 | .3164 | .3154 | .3141 | .3123 | .3102 | .3075 | .3044 | .3007 |
| 0.8 | .2986 | .2981 | .2972 | .2960 | .2943 | .2923 | .2898 | .2869 | .2834 |
| 0.9 | .2825 | .2820 | .2812 | .2800 | .2784 | .2765 | .2742 | .2714 | .2682 |
| 1.0 | .2682 | .2677 | .2669 | .2658 | .2644 | .2625 | .2603 | .2577 | .2546 |
| 2.0 | .1800 | .1797 | .1792 | .1785 | .1775 | .1764 | .1749 | .1732 | .1712 |
| 3.0 | .1369 | .1367 | .1363 | .1358 | .1350 | .1342 | .1331 | .1318 | .1303 |
| 4.0 | .1110 | .1108 | .1105 | .1100 | .1095 | .1088 | .1079 | .1069 | .1057 |
| 5.0 | .09354 | .09338 | .09313 | .09276 | .09228 | .09169 | .09097 | .09012 | .08910 |
| 6.0 | .08096 | .08083 | .08061 | .08030 | .07989 | .07937 | .07875 | .07801 | .07714 |
| 7.0 | .07145 | .07133 | .07114 | .07086 | .07050 | .07005 | .06951 | .06886 | .06809 |
| 8.0 | .06398 | .06388 | .06371 | .06346 | .06314 | .06274 | .06225 | .06167 | .06099 |
| 9.0 | .05796 | .05787 | .05771 | .05749 | .05720 | .05684 | .05654 | .05587 | .05526 |
| 10.0 | .05300 | .05291 | .05277 | .05257 | .05230 | .05197 | .05157 | .05109 | .05053 |

TABLE 2
Normalized Average Dissipation (\bar{W})

| R' | ϕ - Degrees | | | | | | | | |
|------|------------------|---------|---------|---------|---------|---------|---------|---------|---------|
| | 10° | 20° | 30° | 40° | 50° | 60° | 70° | 80° | 90° |
| 0 | .4905 | .4893 | .4873 | .4846 | .4810 | .4765 | .4712 | .4649 | .4577 |
| 0.1 | .3963 | .3953 | .3938 | .3915 | .3867 | .3851 | .3808 | .3758 | .3700 |
| 0.2 | .3301 | .3294 | .3281 | .3263 | .3239 | .3210 | .3174 | .3133 | .3085 |
| 0.3 | .2813 | .2807 | .2796 | .2780 | .2760 | .2736 | .2706 | .2671 | .2630 |
| 0.4 | .2439 | .2433 | .2424 | .2411 | .2394 | .2372 | .2346 | .2316 | .2281 |
| 0.5 | .2144 | .2139 | .2131 | .2119 | .2104 | .2085 | .2063 | .2037 | .2006 |
| 0.6 | .1905 | .1901 | .1894 | .1883 | .1870 | .1854 | .1834 | .1811 | .1784 |
| 0.7 | .1709 | .1705 | .1699 | .1690 | .1678 | .1665 | .1645 | .1625 | .1600 |
| 0.8 | .1545 | .1542 | .1536 | .1528 | .1517 | .1504 | .1488 | .1469 | .1447 |
| 0.9 | .1407 | .1404 | .1398 | .1391 | .1381 | .1369 | .1355 | .1338 | .1318 |
| 1.0 | .1288 | .1286 | .1281 | .1274 | .1265 | .1254 | .1241 | .1225 | .1207 |
| 2.0 | .06577 | .06563 | .06539 | .06505 | .06461 | .06406 | .06430 | .06262 | .06172 |
| 3.0 | .04150 | .04141 | .04126 | .04105 | .04077 | .04043 | .04002 | .03953 | .03897 |
| 4.0 | .02916 | .02910 | .02899 | .02885 | .02865 | .02842 | .02813 | .02780 | .02740 |
| 5.0 | .02189 | .02184 | .02176 | .02166 | .02151 | .02133 | .02112 | .02087 | .02057 |
| 6.0 | .01718 | .01715 | .01709 | .01700 | .01689 | .01675 | .01658 | .01638 | .01616 |
| 7.0 | .01394 | .01391 | .01386 | .01379 | .01370 | .01359 | .01345 | .01329 | .01310 |
| 8.0 | .01158 | .01156 | .01152 | .01146 | .01139 | .01129 | .01118 | .01105 | .01089 |
| 9.0 | .009817 | .009796 | .009762 | .009713 | .009650 | .009571 | .009476 | .009364 | .009234 |
| 10.0 | .008451 | .008433 | .008404 | .008362 | .008308 | .008240 | .008158 | .008062 | .00795 |

RECTIFIER CIRCUITS (Continued)

In terms of i' , the equation then becomes

$$\rho = i'^{5/3} G \mathcal{E}^{5/2} (1 - \eta)^{5/2} \quad (8)$$

The equation for normalized instantaneous dissipation ρ' is then given by:

$$\rho' = \frac{\rho}{G \mathcal{E}^{5/2} (1 - \eta)^{5/2}} = i'^{5/3} \quad (9)$$

Computer Program

Although the equations are simplified by the above approach, there still is no explicit solution for the problem and current values must be found by trial and error. For reasons of speed and accuracy the entire problem was programmed for the RCA-501 computer. Solutions for a wide range of variables are presented in Tables 1 to 3. Desired parameters of actual rectifier circuits can be easily found by substitution of these values into the appropriate equations presented below.

In the computer program, dissipation and current solutions were summed to find average current and

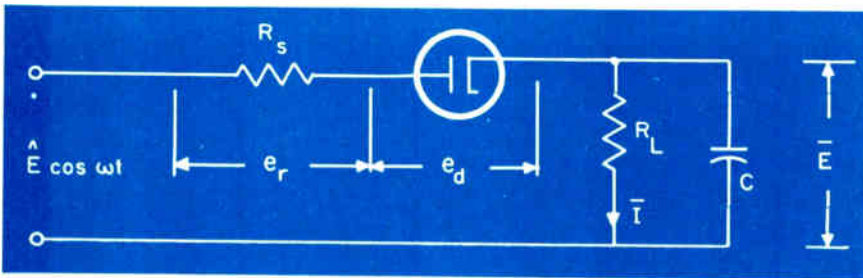

Fig. 1: The half-wave rectifier circuit used as the basis for the equations and tables.

average dissipation. Normalized peak currents (\hat{I})' were included in the instantaneous solutions for the cases where θ was equal to zero.

Tables 1 to 3 contain solutions for the normalized average current \bar{I} , average dissipation W' , and peak current \hat{I} , respectively, for nine values of ϕ and 20 values of R' . The conduction angle was divided into 40 increments for each value of ϕ and R' . Although the computer supplied a total of 14,760 answers, only 380 answers are needed for the solution of significant current and dissipation values.

*Addition of the symbol ' indicates normalized value.

Circuit Equations

The terms R' and ϕ do not obviously represent the actual circuit values found in a typical rectifier problem. Thus, the following circuit equations are presented for practical uses.

Normalized resistances R'_{ss} and R'_{hs} , which denote steady-state and hot-switching conditions respectively, are given by

$$R'_{ss} = R_s G \mathcal{E}^{1/2} (1 - \eta)^{1/2} = R_s G (\mathcal{E} - \bar{E})^{1/2} \quad (10)$$

$$R'_{hs} = R_s G \mathcal{E}^{1/2} \quad (11)$$

The conduction angle ϕ is given by

$$\phi = \cos^{-1} \frac{\bar{E}}{\mathcal{E}} = \cos^{-1} \eta \quad (12)$$

Average current \bar{I} is given by

$$\begin{aligned} \bar{I} &= \bar{I}' G \mathcal{E}^{3/2} (1 - \eta)^{3/2} \frac{\phi}{\pi} \\ &= \bar{I}' G (\mathcal{E} - \bar{E})^{3/2} \frac{\phi}{\pi} \end{aligned} \quad (13)$$

Average dissipation W' is given by

$$\begin{aligned} W' &= W' G \mathcal{E}^{5/2} (1 - \eta)^{5/2} \frac{\phi}{\pi} \\ &= W' G (\mathcal{E} - \bar{E})^{5/2} \frac{\phi}{\pi} \end{aligned} \quad (14)$$

Peak-steady-state current \hat{I} is given by

$$\begin{aligned} \hat{I} &= \hat{I}' G \mathcal{E}^{3/2} (1 - \eta)^{3/2} \\ &= \hat{I}' G (\mathcal{E} - \bar{E})^{3/2} \end{aligned} \quad (15)$$

Hot-switching current \hat{I}_m is given by

$$\hat{I}_m = \hat{I}' G \mathcal{E}^{3/2} \quad (16)$$

Although the term \hat{I}' appears in both Eq. 15 and 16, the value of \hat{I}' is not the same for both equations. R'_{ss} must be considered when \hat{I} is determined for the peak-steady-state current solution, but R'_{hs} must be considered for hot-switching current.

As already mentioned, normalizing with respect to peak-steady-state current for this circuit is not obvious.

TABLE 3
Normalized Peak Current (\hat{I})

| R' | All ϕ |
|------|------------|
| 0 | 1.0000 |
| 0.1 | .8721 |
| 0.2 | .7764 |
| 0.3 | .7016 |
| 0.4 | .6411 |
| 0.5 | .5912 |
| 0.6 | .5491 |
| 0.7 | .5130 |
| 0.8 | .4818 |
| 0.9 | .4544 |
| 1.0 | .4304 |
| 2.0 | .2840 |
| 3.0 | .2141 |
| 4.0 | .1725 |
| 5.0 | .1448 |
| 6.0 | .1250 |
| 7.0 | .1101 |
| 8.0 | .09837 |
| 9.0 | .08897 |
| 10.0 | .08125 |

But, as a result of normalizing with $G \mathcal{E}^{3/2} (1 - \eta)^{3/2}$ instead of $G \mathcal{E}^{3/2}$, the normalized peak current is not a function of ϕ .

In addition, the range of numerical values for \bar{I} and W' is quite small for variations in ϕ . Also, exclusion of the integrating factor $\left(\frac{\phi}{\pi}\right)$ from the normalized values of \bar{I} and W' helps to maintain a small variation with respect to ϕ . As a result, the accuracy of computation when using the tables is greatly improved.

Use of Data

Usefulness of the equations and tables is shown by the following example which uses the 5U4-GB, a full-wave vacuum tube. For this analysis, as well as for other analyses using the computed data, operation curves are not needed. But, the reader may check the results of this calculation with the curves published for the 5U4-GB.

In this example, it is desired to find \bar{I} , \hat{I} , \hat{I}_m , and W' for a full-wave rectifier at 60 cps. The following data are known: $E_{RMS} = 450$ v., $\bar{E} = 460$ v., and $R_s = 67$ ohms. The first step is to find G , the diode perveance, from a published "drop

WHAT'S NEW

Brighter Color TV Screen Is Result of New Phosphor

point" for the diode. For the 5U4-GB, the values, $E = 50$ v. and $I = 275$ ma., are then substituted into the perveance equation, as follows:

$$G = \frac{I}{E^{3/2}} = \frac{0.275}{50^{3/2}} \\ = 0.78 \times 10^{-3} \text{ a./v.}^{3/2} \quad (17)$$

The rectification efficiency η is given by

$$\eta = \frac{\bar{E}}{1.414 E_{RMS}} = \frac{460}{(1.414)(450)} = 0.725$$

The conduction angle is given by $\phi = \cos^{-1} \eta$ or $\cos^{-1} 0.725 = 43.5^\circ$ (18)

The values for η and ϕ are then substituted into Eqs. 10 and 11. As a result, R'_{ss} is found to be 0.69 and R'_{hs} to be 1.32.

The values for R'_{ss} (0.69) and ϕ (43.5°), are then referred to the tables, and the following values are readily found: the normalized average current $\bar{I} = 0.32$; the normalized average dissipation $W' = 0.165$; and the normalized peak-steady-state current $\hat{I} = 0.515$. From Table 3, the normalized hot-switching current corresponding to a value for R'_{hs} of 1.32 is found to be 0.368.

Desired circuit parameters are found by substitution of the above values in Eqs. 13 to 16. The current is found by Eq. 13 to be 138 ma/plate or 276 ma for full-wave operation. The dissipation is found by Eq. 14 to be 12.7 w/plate or 25.4 w for full-wave operation.

The filament dissipation must be included to find the total dissipation in the tube. The filament power is 5 v. times 3 a., or 15 w. As a result, total tube dissipation is 15 plus 25.4 or 40.4 w. Finally, the peak-steady-state current (\hat{I}) and the hot-switching current (\hat{I}_m) are found to be 0.93 a. and 4.6 a., respectively, by substitution in Eqs. 15 and 16.

Bibliography

1. Schade, O. H., "Analysis of Rectifier Operation," *Proceedings of the I.R.E.*, Vol. 31, No. 7, July, 1943, pp. 341-361.
2. Kauzmann, A. P., "Determination of Current and Dissipation Values for High-Vacuum Rectifier Tube," *RCA Review*, Vol. VIII, No. 1, March, 1947.

• A REPRINT of ANY ARTICLE in this issue is available from ELECTRONIC INDUSTRIES Reader Service Department.

A NEW RED-EMITTING PHOSPHOR—europium activated yttrium orthovanadate, $YVO_4:Eu$ —has been developed that is reportedly superior in both color and brightness to commonly used silver activated zinc cadmium sulfide, $(Zn, Cd)S:Ag$.

The new phosphor is the development of scientists at General Telephone and Electronics Laboratories in Bayside, New York. Color picture tubes using the new phosphor are in production at Sylvania Electric Products, Inc. for Sylvania color TV receivers.

The cathodoluminescent spectrum of $YVO_4:Eu$ shows (Fig. 1) that the light emitted from it is concentrated in an intense, relatively narrow band peaking at 619 nanometers. The luminescence from $(Zn, Cd)S:Ag$, on the other hand, is spread over a very wide wavelength interval, starting somewhere in the yellow green region of the spectrum and extending into the infra-red. Although the sulfide phosphor peaks in the same region as the $YVO_4:Eu$, the latter has the redder aspect to the eye.

It has been the luminosity of the

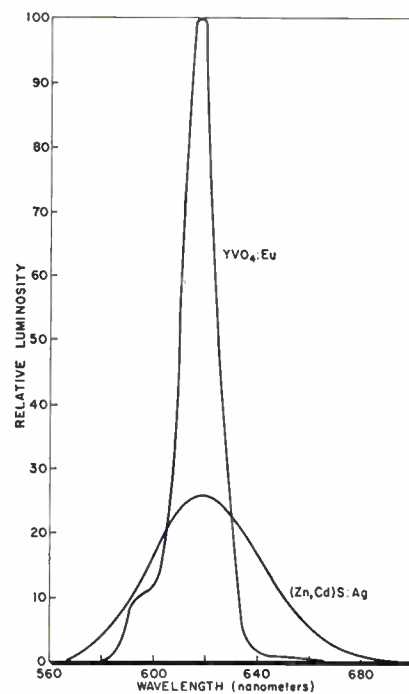

sulfide-red which has limited the brightness of the color tube. To obtain proper color balance, the green and blue phosphors used in conjunction with it had to be deliberately deadened. Thus, brightness, especially on the black and white field, was severely sacrificed for this color balance.

Calculation of the color coordinates of the emission from $YVO_4:Eu$ shows it to have to the eye the appearance of a pure spectral red corresponding approximately to 612 nanometers. By comparison, the sulfide is more orange. Hence, use of $YVO_4:Eu$ makes a wider gamut of derived colors available for color television.

The superiority of europium activated YVO_4 over silver-activated zinc-cadmium sulfide extends to the accuracy with which they present highlights on the screen; that is, to the manner in which they respond to increasing electron beam current density, especially at high values. The brightness of the vanadate phosphor increases linearly with beam current density, while the increase from the sulfide is sublinear and shows a tendency to saturate (Fig. 2). Thus, proper color balance is maintained over the entire range of beam currents so that whites no longer tend to shift to blue or green when highlights are presented.

Fig. 1 (left). Fig. 2 (below).

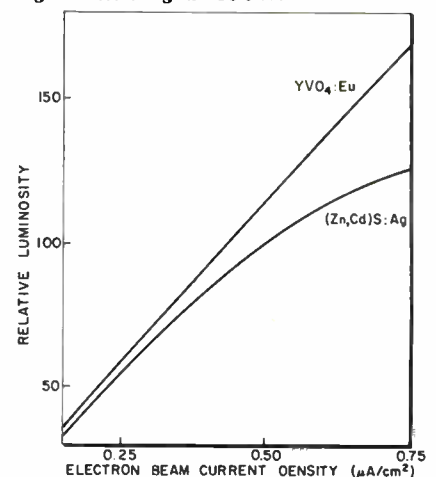

ENGINEER'S NOTEBOOK

#75 Frequency Changes in Octaves

IT IS CONVENIENT to describe outputs and other functions of frequency in terms of octave changes. Probably the most popular is the 6db per octave roll-off rate of a single R-C section. If you have a low pass R-C section, you know that, well beyond the corner frequency, each time you double the frequency the attenuation increases 6 db.

Even with such a simple relationship between frequency and attenuation, it takes time to work a problem. For instance, suppose a low pass R-C section attenuates 10 db at 22kc. What will be the attenuation at 350mc? You've probably done a problem similar to this one many times: simply multiply 6db by the number of octaves between 22kc and 350mc. But first you have to determine the number of octaves. The choice was either say, "Two times 22 is 44," then, "two times 44 is 88, two times 88 is 176," and so on, or determine the frequency ratio and then ask, "Two raised to what power gives that ratio?" That power, when computed, is the number of octaves.

A far simpler way to convert frequency change to octaves is to use this nomogram. Simply locate the known frequency and the number of octaves on the appropriate scales, and draw a straight line through them. That line will cross the third scale at the new frequency. If the new frequency is higher than the original, use the right hand side of the OCTAVES scale.

Only one decade is covered in the first scale, so that accuracy will not

be sacrificed. Multiply that scale by whatever power of 10 is necessary and then multiply the FINAL FREQUENCY scale by the same power of ten.

EXAMPLE

To solve the preceding problem, locate 2.2 on the *Starting Frequency*

scale and, since that point is to represent 22kc, consider all numbers on the *Final Frequency* scale to be multiplied by 10^4 . Therefore 350mc is located at 3.5×10^4 . A straight line drawn between these two frequencies shows, where it crosses the middle scale that there are 14 octaves between 22kc and 350mc.

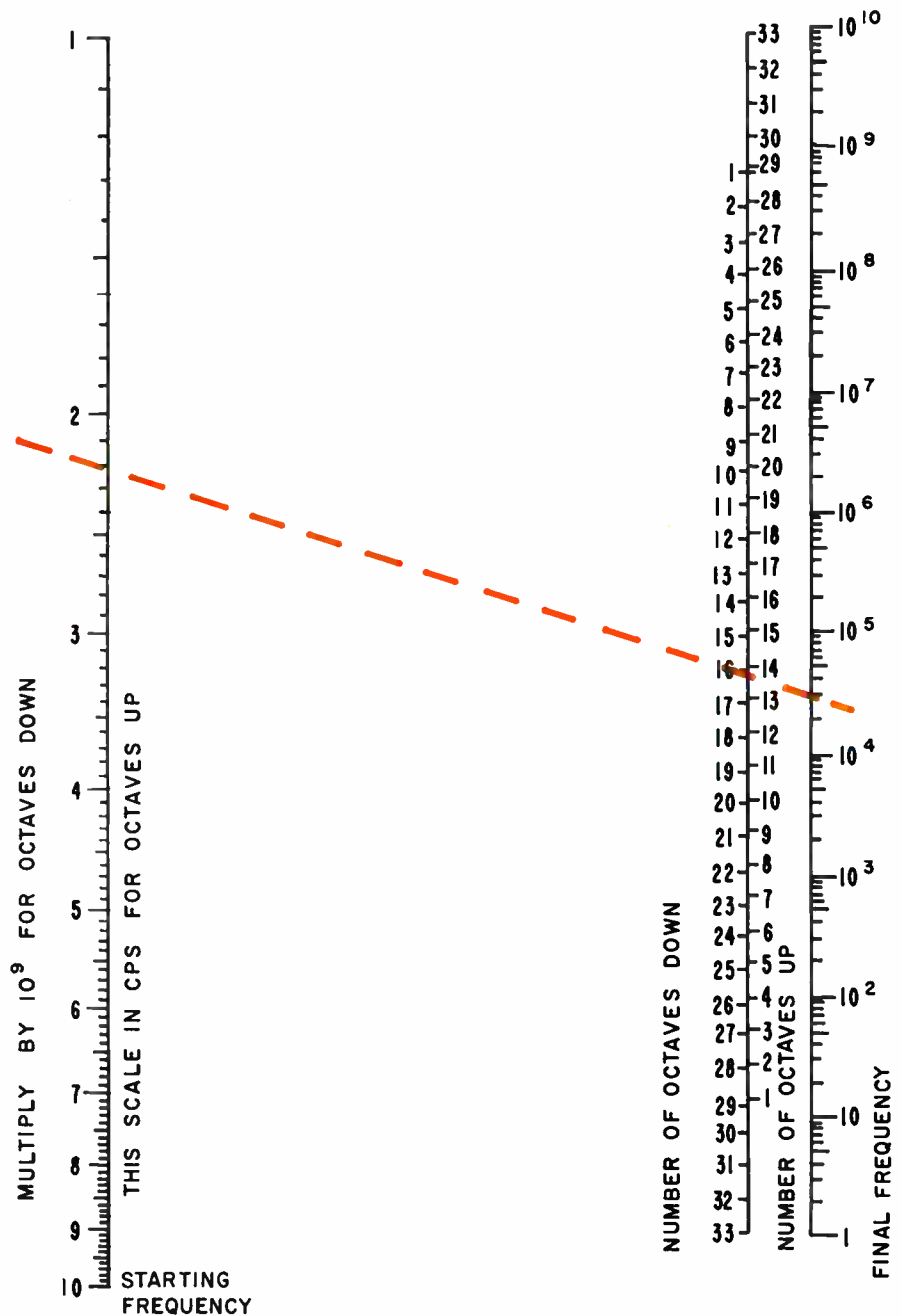

By **DONALD W. MOFFAT**
3333 Stadium Court
San Diego, Calif. 92122

An Appraisal of Cermet Potentiometers

The cermet technology, used at first for fixed resistance elements alone, has grown to include trimming and precision potentiometers. This article compares the characteristics of cermets with those of wirewound and conductive plastic units.

By **STANLEY SCHNEIDER**, Engineering Manager, Helipot Division, Beckman Instruments, Inc., Fullerton, Calif.

In this article we will discuss technology used in potentiometers and resistance devices—Cermets. Since there are other “Cermets” on the market today, we will limit our discussion to the technology used at the Helipot Division of Beckman Instruments, Inc. In addition to a brief description of our manufacturing processes, three areas of interest will be emphasized:

- (1) The capabilities of Cermet versus wirewounds and conductive plastics.
- (2) New tests and operational procedures necessitated by this material.
- (3) Appraisal of our present state-of-the-art.

* * *

Steatite is one of the family of ceramics including alumina, forsterite, zirconia and porcelain. It is made from raw materials including talc (a mined inorganic material containing magnesium oxide and silicon dioxide), zinc stearate, waxes and water. Processing includes mixing, ball milling, sizing, blending, and drying into a dry powder with a closely-controlled bulk density factor.

From here, we may form the ceramic base (or substrate) in either of two ways. A die cavity can be filled with a certain volume of powder, and under regulated pressure, a punch pressed into the cavity to form the part. Or, an extrusion cylinder can be filled, a piston pressed into it, and the powder forced through an extrusion die. The part is then fired in a programmed kiln at about 2400°F. Shrinkages of about 8 to 20% occur during firing—yet by our previous control on both the press operation and the steatite powder, we can hold tolerances in the thousandths.

Resistive Element

Using a silk screen method, a mixture of specially-prepared glass and precious metals (such as gold, platinum, etc.), suspended in a liquid carrier, is ap-

plied to the substrate and fired at temperatures between 1400°-2000°F. There are three major points here:

- (1) The same screen pattern and wire mesh, and the same dimensional substrate position is used for all resistance values on identical models; thus, the resistive material is always the same thickness.
- (2) For a given physical setup, the resistance value is varied by a change in mixture preparation—choice of metals, and metal content.
- (3) Although the resulting material is black, there is no carbon content.

Firing of the resistance material bonds the glass and metal alloy integrally to the steatite. End terminations and various tap or shorting sections are then silvered on to the resistance element, and again fired at temperatures above 1000°F.

The next process is the heart of our precision Cermet—linearizing, or “tailoring,” the element

to both linearity and total resistance needs. Using a machine, linearity is greatly improved by automatically removing resistance material (thereby increasing resistance) to a pre-set pattern. After tailoring, leads are attached to the cermet element end terminations. The unit is then bonded to the housing, and the final assembly operations performed.

Capabilities

Major products ideally suited to this technology are precision pots in both rotary and translatory designs, trimming pots, and fixed resistors. The high wattage feature and the ability to obtain a wide range of resistance values in short lengths and small total areas with good resolution features allow extreme miniaturization in cermet trimming pots.

An outstanding capability of Cermet for precision units is the obvious capability of improved resolution

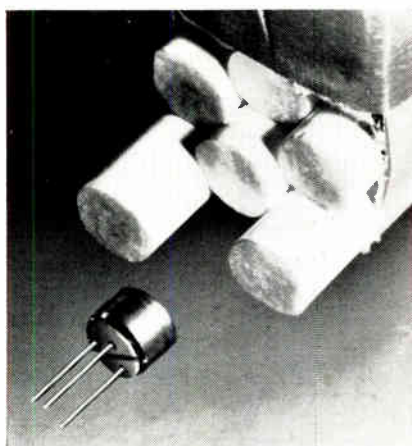

Model 61 Helitrim 1/4 in. dia. trimming pot.

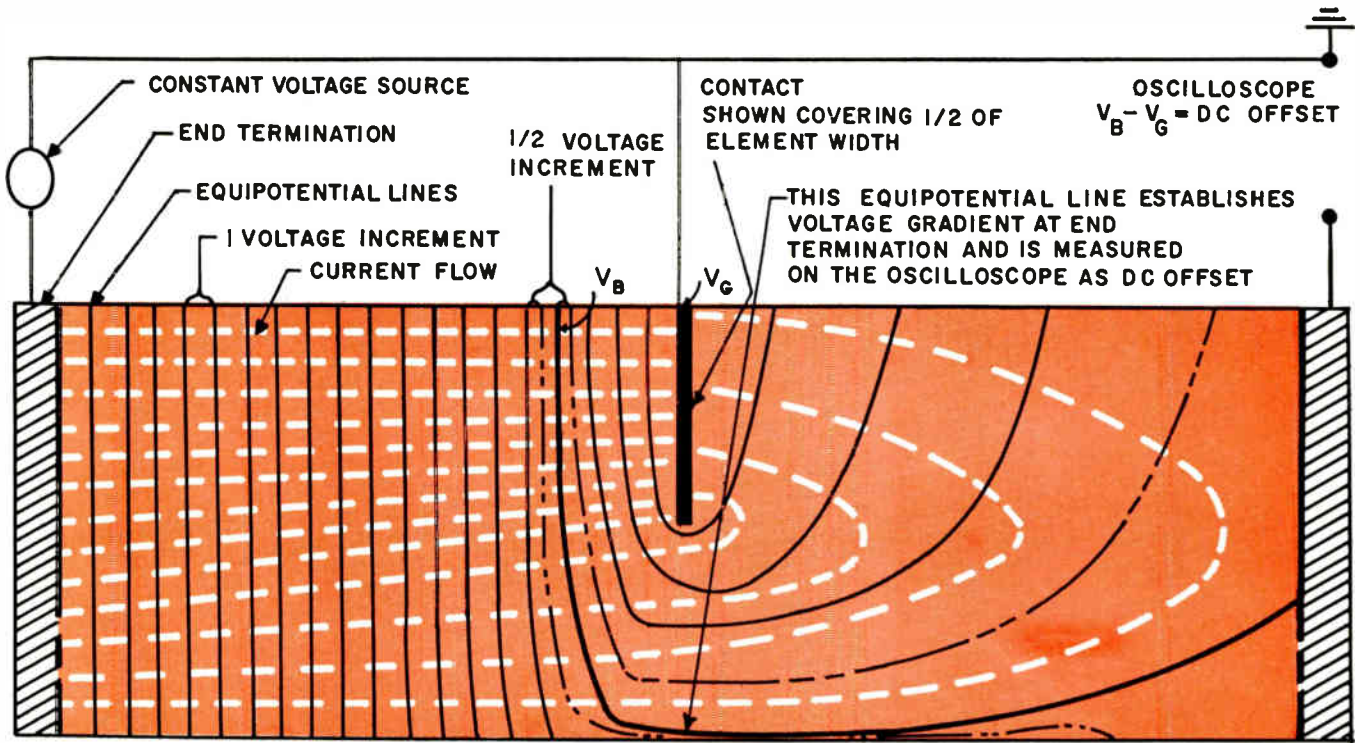

Fig. 1: Dc offset current paths in cermet using a standard noise test circuit.

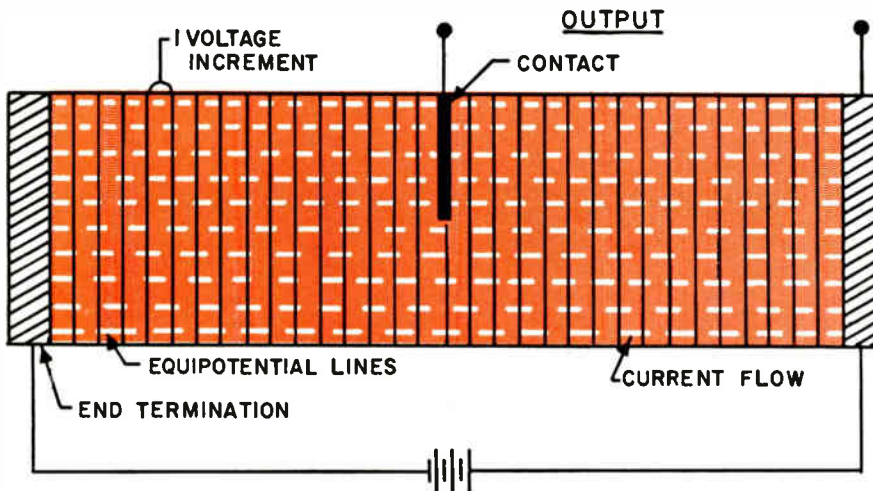

Fig. 2: Current and voltage distribution in an ideal potentiometer circuit.

TABLE 1
SINGLE-TURN POTENTIOMETER COMPARISON

| Characteristic | Cermet | Wirewound | Conductive Plastic |
|--------------------------------|-----------|-----------|--------------------|
| AC Performance | Excellent | Good | Excellent |
| End Resistance | Excellent | Very Good | Good |
| Jump-Off Voltage | Very Good | Excellent | Good |
| Linearity | Excellent | Excellent | Excellent |
| Resistance Tolerance | Excellent | Excellent | Excellent |
| Resolution | Excellent | Poor | Excellent |
| Tempco | Excellent | Excellent | Very Good |
| Wattage | Excellent | Good | Good |
| High Temperature | Excellent | Very Good | Very Good |
| Humidity | Excellent | Very Good | Good |
| Noise: Initial | Good | Excellent | Good |
| Noise: Operational | Excellent | Poor | Excellent |
| Resistance Stability | Very Good | Very Good | Good |
| Rotational Life | Excellent | Good | Excellent |
| Setting Stability | Excellent | Good | Excellent |
| Vibration, Shock, Acceleration | Excellent | Very Good | Excellent |
| Integral Resistors | Excellent | Poor | Very Good |
| Shorted Segments | Excellent | Good | Excellent |
| Taps | Excellent | Excellent | Excellent |

(essentially infinite). Other stand-out capabilities are its immunity to catastrophic failures, high temperature and wattage capacity, chemical and electrical resistance to water vapor and most other liquids. Also, it has a long life, during which it has little degradation in functions such as linearity, total resistance, noise, and electrical angle. It is also well suited to dither operation, since there is almost no wear on the resistance element. Major wear is in a contact designed to retain its mechanical configuration with the resistance element during life. Integral resistors can be made with matching temperature coefficients for use in both precision and trimming pots.

Since Helipot also makes both wirewound and conductive plastic units, we chose these two technologies to compare with our Cermet. Table 1 represents our opinion of the relative capabilities of Cermet versus wirewound and conductive plastic.

A. C. Performance

Both Cermet and conductive plastic are capable of satisfactory operation into the mc region. Wirewounds

are limited to the low a-f range due to the capacitance from resistance wire to core, and the slight inductive effects of the coil.

End Resistance

In wirewound, end resistance is variable, as either the "tap" method, or the "peel back" method introduces a lead resistance that is a function of the resistance value.

By using an overlaid fired-on silver termination in our Cermets, end resistance is almost "zero" (less than 0.05 ohms). And, it is the same for all resistance values. Conductive plastics exhibit a higher, and resistance dependent, end resistance.

Linearity

At present, all three types of units appear comparable. Cermet and conductive plastic have a slight edge in their capabilities to "linearize" or "tailor" the elements, rather than relying on "yield" percentages of wirewounds. Also, resolution in wirewounds becomes an absolute barrier to very high linearities.

Resistance Range

Extreme range of both Cermets and conductive plastics over wirewounds is exemplified by both our 1 1/16-in. precision pot and our series 50 trimming pots with resistances from 10 ohms to the megohm range, compared to a maximum in wirewounds of 100K.

Resistance Tolerance

All three types appear comparable, although Cermet and conductive plastic again have the capability of being "tailored" for total resistance. Since Cermet has better resistance stability than conductive plastic, we rate Cermet a plus over both conductive plastic and wirewound.

Resolution

Cermet and conductive plastic both have almost infinite resolution, as compared to the resistance dependent, stepped, resolution in wirewounds. Since there is some "granularity" in both non-wirewound types, in theory there is a limit to our "infinite" resolution. But, with practical measuring devices and accuracies, in a properly formulated

TABLE 2

| FEATURES | DIFFERENCE FROM WIREWOUND | TEST PROCEDURE |
|---|--|--|
| DC OFFSET (Only important in rheostat connected uses. Will not occur in voltage divider circuits, even with some slider loading.) | Due to the area type resistance element, current paths are not unidirectional but can flow crosswise to the element as well as lengthwise. When current is drawn through the slider in a rheostat-connected circuit, some of the current paths bypass the contact and then return, so the resultant IR drop is measured as an offset voltage. It is relatively constant over the full electrical angle. | Connect in standard NAS 710 noise circuit. With the slider stopped at one or more positions on the active element, measure the maximum electrical displacement in ohms or mv. This offset in our Cermet units is about 1% of total resistance. |
| END RESISTANCE | Constant low value for all resistance ranges compared to wirewound's resistance dependent values. Due to possibility of burnout, when using the low scale on ohmmeters, measure as a voltage ratio, and convert to equivalent resistance. | Make voltage divider measurement. Do not use ohmmeters. |
| JUMP-OFF VOLTAGE AND END POINT | Harder to locate. | In position measuring device, slowly move in discrete steps from end termination on to active element, and record voltage ratios. The position indicating either a relatively large voltage step or the first smaller valued step that approximates the slope of the function should be selected as the "end point" and "jump-off voltage" recorded. Without reversing direction, a mirror image procedure going on to the end termination should be used at the opposite end. |
| TAPS | Taps (such as center-tap) are generally voltage taps, and as such their electrical position must be measured as a voltage position. (For example, two resistance measurements between a tap and each end termination will not sum to the total resistance as measured from termination to termination.) Also, the mechanical position of the voltage output equal to the tap voltage will be different than the resistance null position between the tap and the slider. Use all voltage measurements. | Determine position by measuring equivalent voltages at tap and slider output, or null galvanometer between tap and slider output. Do not use resistance null measurement. |
| NOISE | Noise in Cermets is an entirely different "brand" of noise than that customarily associated with wirewound pots. (1) The noise is repeatable. (2) It is a function of the element resistance value. (3) It is low frequency noise. Filters eliminating dc to 100 CPS outputs will practically eliminate noise. (4) Its dc component (dc offset) is consistent throughout life, and shows minor degradation during life and environmental exposures. | Can be measured in standard NAS 710 noise circuit, but measurement limits must be changed. It is also strongly recommended that more realistic circuits (similar to operational use) be specified. |

CERMET POTENTIOMETERS

(Concluded)

and processed Cermet element, we challenge measurement of "resolution"! Actually, "voltage" resolution is of prime importance in trimming potentiometer use and in nulling circuits in precision use, while travel resolution is important in the majority of precision uses.

Temperature Coefficient

Although the Cermet tempco appears to have a wider spread than the best of the wirewound, it covers a much greater range of resistance values, and closer matching tempcos can be supplied as special. Wire having ± 10 ppm/ $^{\circ}\text{C}$ tempco will usually result in a final wirewound pot tempco of ± 50 ppm/ $^{\circ}\text{C}$, as compared to ± 100 ppm/ $^{\circ}\text{C}$ of Cermet over a range of 300 ohms to 250K. Other wire tempcos go to 800 ppm/ $^{\circ}\text{C}$, while Cermet maximums appear at ± 400 ppm/ $^{\circ}\text{C}$. Conductive plastics usually exhibit a high negative tempco of about -300 to -1000 ppm/ $^{\circ}\text{C}$.

Hi-Temp Exposure and Operation

This is one of the outstanding capabilities of Cermet over both wirewound and conductive plastic. Operation at 572 $^{\circ}\text{F}$ (300 $^{\circ}\text{C}$) is feasible for short periods, and 392 $^{\circ}\text{F}$ (200 $^{\circ}\text{C}$) is the standard upper operating limit for some of our trimming pot models. Operation of our precision models above 302 $^{\circ}\text{F}$ (150 $^{\circ}\text{C}$) is only limited by the temperature limitation on the lubricants used. Wirewounds and conductive plastics are generally limited to 257 $^{\circ}\text{F}$ (125 $^{\circ}\text{C}$).

Noise

Wirewound units exhibit good initial noise when shipped from the manufacturer's plant. But, it has long been a curse of our industry that they do not always remain that way. In the NAS 710 Noise Test, wirewounds exhibit transient, non-repeatable, high noise spikes under a variety of tests and environments. Storage deterioration is common; one report listed noise level failures after movement from one room to another! A major factor in Cermets

and conductive plastics is the repeatability of the noise. Another major factor is the small change in noise level during operational and environmental life. (See also comments on dc Offset.)

Resistance Stability

Cermet and wirewound are about equal in the intermediate temperature range. But, as temperatures move above 150 $^{\circ}\text{C}$ towards 200 $^{\circ}\text{C}$, the Cermet not only still maintains good stability, but essentially becomes the only one of the three types to operate at this extreme. Temperature and electrical load tests over 10,000 hrs. have shown Cermet units to remain within 0.5% to 1.0% with most of the shift within the first 100 hrs.

Rotational Life

In this category, both Cermets and conductive plastics are far superior to wirewound units in total operational life. They have minimum degradations and absence of catastrophic failures.

Vibration, Shock, Acceleration

We rate the three types of elements equal, as these features are more dependent on mechanical design than on the type of element. Higher frequency and acceleration values appear probable in both Cermet and conductive plastic in contrast to wirewounds. In wirewounds possible catastrophic failure of the small diameter resistance wire may occur in these environments.

Shorted Segments

For years, wirewounds have had unsatisfactory shorted segments, both in performance and manufacturing difficulties. On Cermets, the accurately placed, fired-on, silver-glass segments result in low resistance, reliable, easily made shorted segments. Similar methods are available for conductive plastics with equivalent results.

Taps

Although all three are listed as excellent, Cermet and conductive plastic can provide a voltage tap with "zero" width, as compared to the finite width in wirewound taps. In uses where the function must go

through voltage nulls at finite tap points, the "broad" tap in wirewounds results in a linearity error as the contact passes over this position. In the non-wirewound voltage taps, although there will always be some finite resistance between tap and slider contact, the voltage between the tap and slider can be zero. "Current taps," with zero resistance between slider and tap terminal, can also be provided in both non-wirewound types.

New Tests and Operation

With the development of Cermet pots, as well as other non-wirewound types, certain new features result in changes in test procedures and operation.

Table 2 lists the new or revised feature, the essential difference from wirewound, and the applicable test or operational procedure recommended.

DC Offset

Fig. 1 shows the method of measuring and an analysis by curvilinear squares of the cause for dc Offset. When used as a pot, the element will have current flow between the end terminations. And, there is essentially no current flow through the wiper contact. All equipotential lines will be about parallel and equally spaced, as in Fig. 2, and no dc offset exists.

It should be noted that the dc offset is not a contact-resistance phenomenon. It exists because of the geometry of the element and the measuring circuit used.

It is also important to note that local variations in linearity or variations in the width of the element due to tailoring for linearity will cause short term variations in the dc offset. These again do not represent changes in contact resistance, but appear as such in this noise circuit. These variations are related to the smoothness of the linearity curve.

From comparison of Figs. 1 and 2, it can be seen that the apparent contact resistance measured in the MIL-R-12934C circuit is completely and only a function of the test circuit. It has no existence in *true* potentiometric use, whereas *true* contact resistance would appear.

Advances in Controlled Environment Areas

The new Federal Standard 209 has had great impact on the electronic field. The Standard's broad concepts and between-the-line implications are described along with methods of achieving the required environments.

By **LEONARD M. TAYLOR,***
HARRY O. WOLF
and **DOUGLAS DETWILER**

Air Control, Inc.
Washington & Noble St.
Norristown, Pa.

EVERY TIME ENGINEERS in the controlled atmosphere industry feel they've matched the needs of the electronic production engineer, they usually find that the needs have grown since they last looked.

A good example of this is the new Federal Standard 209. This categorizes the various levels of work station and clean room performance necessary for government work. It also standardizes many of the equipment testing procedures. Although Standard 209 does clear up the maze of confusing regulations that preceded it, it still does not quite satisfy the growing needs and wants of the electronics industry.

* * *

The Standard classifies controlled atmosphere equipment in three basic performance categories. *Class 100*—where the maximum number of particles is 100/cu. ft. of 0.5 microns with no particles 5.0 microns or larger. *Class 10,000*—where the maximum number of particles per cubic foot, 0.5 microns, is 10,000 and the maximum number of particles over 5.0 microns is 65. *Class 100,000*—where the maximum number of 0.5 micron particles per cubic foot is 100,000 and a maximum of 700 particles of 5.0 microns or larger.

* Since writing this article, Mr. Taylor has joined Kullick and Soffa.

Need More Classifications

This breakdown into three classes might have been sufficient three or possibly two years ago. But today's quality control standards have become very critical. So much so, that many engineers in the industry feel that at least three other classifications should be made. There are many new types of production activities which should require less than 50 dust particles, 0.5 microns or larger per cubic foot. And there are many others that, although they do not necessarily require the state-of-cleanliness mentioned in Class 100, they should certainly not be performed in an atmosphere as contaminated as the 10,000 classification permits.

Another important consideration of the 209 Standard is that it does not consider particles of 0.3 or smaller. Delicate prototype work and various types of research can be affected by dust particles of 0.3 and 0.4 micron sizes.

It is true that there is a very large error in the counting of particles below 0.5 microns in size. But it is not that great, that a sensible margin of error can not be allowed. It is often felt that if 0.5 micron size particles are held to a minimum, then quantities 0.3 micron sizes will be held to the same proportionate low level. This is not necessarily accurate.

Fig. 1: The air flow in laminar flow work station (left) flows through work area in straight, uniform layers. Previous units (right) were irregular.

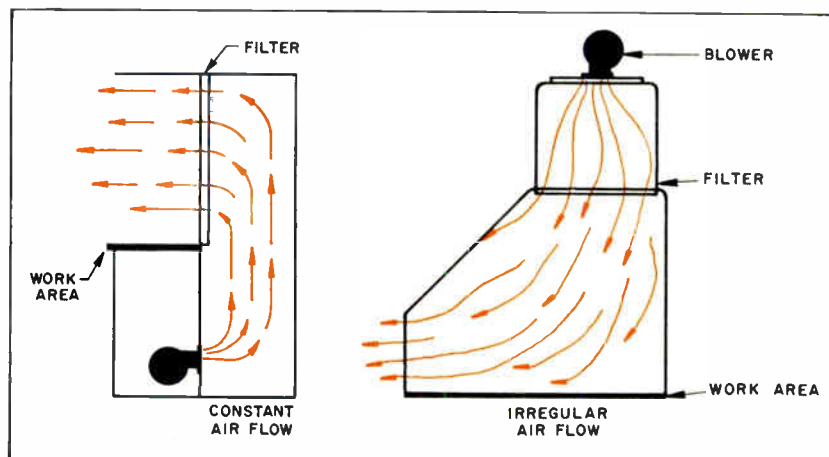

A high efficiency laminar flow unit based on the orbital flow system.

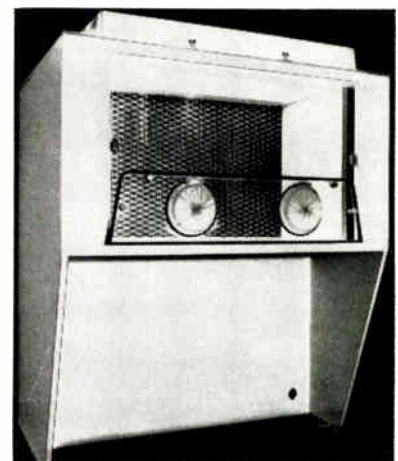

CONTROLLED ENVIRONMENT (Continued)

An area where Standard 209 does shed a great deal of light is in the required procedures for testing clean rooms and controlled atmosphere work benches. But again, there are several points in which the Standard is vague.

In laminar flow work rooms and benches, for example, one of the filter tests calls for the use of 0.3 micron size smoke particles in combination with an aerosol smoke photometer. There is no actual test criteria mentioned. Many different types of tests can be set up, as long as they use 0.3 micron size smoke, and as long as they "scan the entire 'HEPA' filter surface. . . ." The main problem is that a number of widely varying aerosols are now being used, as well as several different photometers.

Other forms of testing, such as with tobacco smoke, DOP smoke particles, and stannous chloride particles are presently being used, but with little regard for precise particle control or exact concentration control upstream from the filter.

A major problem with many of the smoke tests is that some smoke particles tend to quickly agglomerate and form much larger particles, distorting the results of the test. This is particularly true of tobacco smoke.

New forms of tests for all types of filter leakage are presently being intensely researched. Efforts are being made to (1) achieve better control of particle size, concentration and distribution just upstream from the filter, (2) develop contaminants for testing that are more uniform in size and characteristics, and (3) produce testing equipment and methods that offer more constant reliability.

The test requirements in Federal Standard 209 should be clarified to standardize on the aerosol, the photometer, the probe used for picking spots of high concentration, and the particle size and distribution of at a pre-determined spot just upstream from the filter.

Fig. 2: Laminar flow work stations are available with either horizontal or vertical air flow direction. Horizontal flow, with its flexibility and economy, is most widely used.

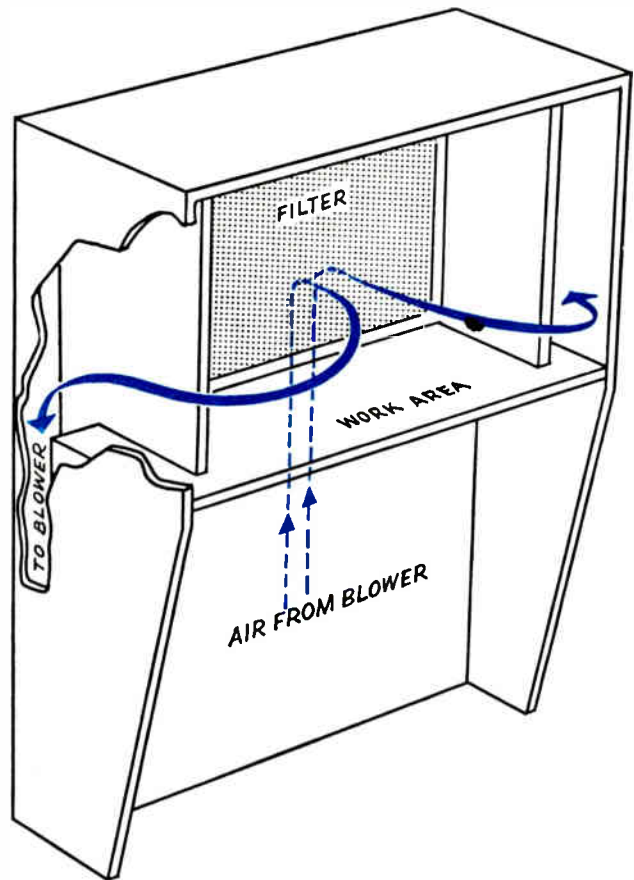
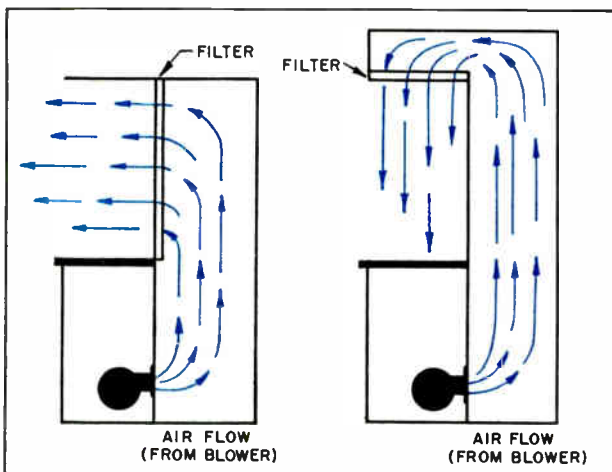

Fig. 3: The highest efficiency in laminar flow work stations is found in units using a re-circulating air flow.

Standard 209 also describes necessary levels of temperature and humidity. Temperature control, when applicable, must be maintained at a specified temperature within a range of 67° to 77° F., within $\pm 5^\circ$ in less critical areas and up to 0.5° in temperature sensitive applications. If the specified temperature is, for example, 71°F., temperatures in less critical operations could fall as low as 66°F., or go up as high as 76°F. On more critical work the allowable temperature variation would be 70.5°F. to 71.5°F.

The set standard for maximum relative humidity is 45%. Humidity controls must be capable of holding a specified relative humidity within $\pm 10\%$ for general applications.

Laminar Flow Principle

An advance in clean room and work station design was the recent development of the laminar flow principle. With the laminar flow system, the atmosphere passes "through" the work area in uniform laminar movement. There is no measurable turbulence or any major variation of the air movement. Contaminants that enter the work area are supported by the moving layers of air and are carried out of the work area. As a result, dust "fall-out" is virtually eliminated.

The types of laminar flow work stations can be broken down in two ways. One is by direction of

TABLE 1.
VARIOUS METHODS OF ACHIEVING CLEAN ROOM CLASSES

| | Existing Facilities | Upgraded Facilities | New Construction | | | |
|---------------|--|--|---|---|--|--|
| | Nonlaminar Air Flow and Laminar Flow Rooms and Work Stations | Using Laminar Air Flow Work Stations | Laminar Air Flow Work Stations Used in Uncontrolled Areas | Laminar Air Flow Work Stations Used in Controlled Areas | Laminar Air Cross-Flow Type Rooms | Laminar Air Grating Floor Type Rooms |
| Class 100 | All Laminar grating floor rooms, work stations and first work locations in cross-flow rooms will meet requirements. | Area inside work stations will meet requirements. | Area inside work stations will meet requirements. | Area inside work stations will meet requirements. | First work locations will meet requirements. | Entire room work area will normally meet requirements. |
| Class 10,000 | Some Nonlaminar Air Flow rooms and work stations may meet requirements. Most areas in Laminar cross-flow rooms should meet requirements. All laminar grating flow rooms and laminar flow work stations will meet requirements. | Nonlaminar Air Flow rooms with laminar work stations may meet requirements depending upon quality of room and number of work stations. Area inside work stations will meet requirements. | Area inside work stations will meet requirements. | Room area may meet requirements depending upon quality of area and number of work stations. Area inside work stations will meet requirements. | Most areas in room will meet requirements. | Entire room work area will normally meet requirements. |
| Class 100,000 | Most Nonlaminar Air Flow rooms and work stations will meet requirements. All laminar flow rooms and work stations will meet requirements. | Poor quality Non-laminar Air Flow rooms with laminar work stations may meet requirements depending upon number of work stations. Area inside work stations will meet requirements. | Area inside work stations will meet requirements. | Room area will normally meet requirements depending upon number of work stations. Area inside work stations will meet requirements. | Most areas in room will meet requirements. | Entire room work area will normally meet requirements. |

air flow. The air can be drawn in either a horizontal or a vertical direction. Horizontal is the most common, since it is cheaper and flexible. Vertical flow often offers other possibilities not found in horizontal flow.

The other method of classifying laminar flow work benches is by a type of air flow circulation. The conventional type takes air from the ambient atmosphere pre-filters it, and then draws it through a final "HEPA" filter into the work area. The orbital flow type of work station on the other hand, re-circulates the air through the system, filtering the same air again and again. Depending upon the design of the work station, 0% to 20% make-up air is drawn out of the ambient atmosphere.

Filter and Gasket Leakage

Among the other developments, which have increased the efficiency of controlled atmosphere stations, has been the new system which prevents leakage through the gasket seal around the filter. Instead of trying to prevent leakage through the gasket seal, it reverses it, drawing it down into the blower system.

Because the work area in a clean bench is so close to the filter, even slight leakage, either through

faults in the filter or through the gasket seal, can create a serious problem. In a clean room operation, leakage is diluted by surrounding "cleaned" air. This is not the case in the laminar flow work station. Here contaminants in leakage pass through the work area in concentrated, undiluted form—there is no fall-out.

With the sophistication of the basic design of all types of clean atmosphere equipment, the internal fixtures in work benches have been revamped. The result is a smoother, better plotted air flow with less turbulence and less air power wasted. A moving slug of air contains a certain amount of internal pressure. Much of this pressure is used to push the air through the filter. But every obstruction to this air flow (even an exceptionally rough surface on air duct walls) absorbs some of the pressure. The same is true of any unnecessary bends in the air flow. Since there are less obstructions in today's units, the pressure on the final filter is more constant, more measurable. And besides reducing internal pressure, obstructions create turbulence.

New filters, filtering materials, and filtering methods are now being researched. The problem not yet solved is that of "concentrated spot leakage" due to minute imperfections in the filter. But its solution is only a matter of time.

Since reed switch noise voltages are now being specified for reed relays, a means of minimizing this noise is sought. But, before this is done, how and why reed switches generate this voltage must be investigated.

Dynamic Noise Generation In Reed Switch Contacts

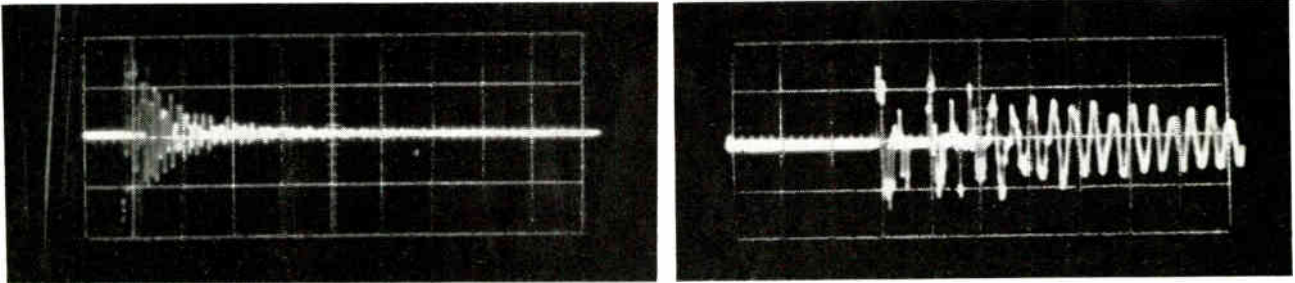

Fig. 1: Typical Contact Noise. Scope traces are 0.5 ms/cm-0.001 v/cm (left) and 0.1 ms/cm-0.002 v/cm (right).

OPERATION OF THE CONTACTS IN REED RELAYS generates a dynamic contact noise which is peculiar to this type of switch. With the growing use of reed relays in low level applications, any form of dynamic contact noise becomes very significant.

This article illustrates noise characteristics of miniature reed switches and presents an introduction to the theoretical considerations of the mechanisms present. This allows a better understanding by the designer and user of reed switching devices.

* * *

In general, noise is any spurious signal introduced

into a circuit either from components within the circuit or from some outside source. Noise from outside the switching device will vary with individual uses and can usually be eliminated by shielding. Thus, the noise of interest here is any spurious signal produced by the relay contact mechanism itself. Shielding would be ineffective with such noise.

The reed relay is unique in that the contact arm and armature are one and the same unit. This presents a case of a conductor moving thru a magnetic field and, therefore, "generating" a current.

In addition to noise caused by the generator effect, most of the noise produced in the contact members is due to magnetostriction.

The contact noise consists of a damped oscillatory wave which occurs after the contacts have closed and stopped bouncing but are still vibrating, Fig. 1.

The most important considerations in noise measurement are shielding from external noise and sensitivity of the recording apparatus. In the circuit shown in Fig. 5, all vertical deflection connections were made through a shielded conductor. Using this circuit gives the noise with respect to $t = 0$ at the application of coil voltage. The vertical sensitivity available must be at least 0.005v/cm. A decade amplifier can also be used for increased sensitivity. The resistance R_1 serves to load the vertical input of the oscilloscope when the reed is open and can be any convenient value from 100 to 10,000

Type of reed relay used for noise measurement.

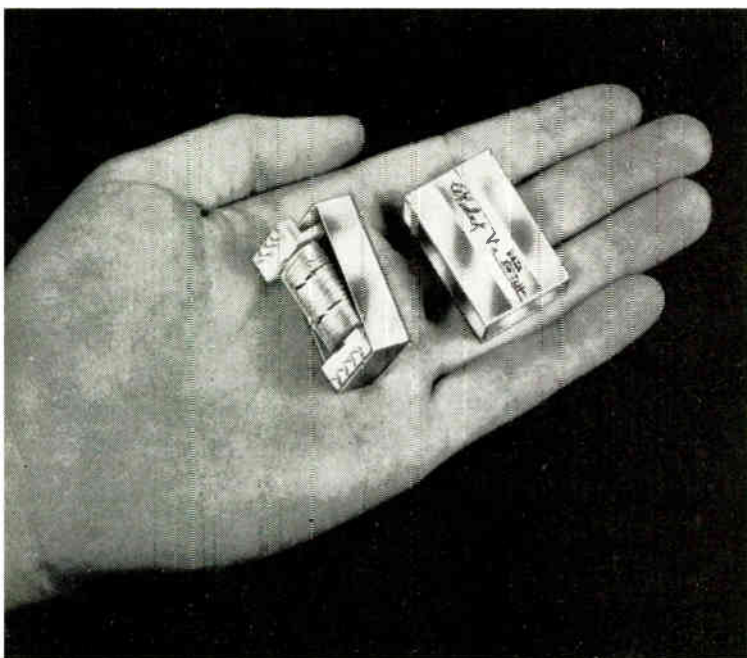

By **JACK J. VITOLA**,
Senior Project Engineer,
and **JOHN P. BREICKNER**
Project Assistant,
Wheelock Signals, Inc.,
Long Branch, N.J.

ohms. Its value has negligible effect on reed noise, Fig. 2.

Different types of commercially available reeds, designated Type 1, 2, 3 and 4 were chosen to determine the effects of various parameters on noise.

Reed Type

Fig. 3 shows a comparison of the noise output trace of the reed switch types used in this study. All traces are on the same time and voltage scales; the reeds shown are of about 50 ampere-turns.

From Table 1, the maximum peak-to-peak noise level shown is about 3.5mv for a Type 4 switch while the minimum noise level is about 1.5mv for Type 1. Duration of the noise is defined as the time from the beginning of the noise voltage to its decay to instrument level. It varies from a high of 3.0ms for a Type 4 reed switch to a low of 1.0 ms for Types 1 and 3.

It is apparent from Fig. 3 and Table 1 that the noise amplitude and duration depend upon the construction of the reed switch⁵.

Reed Operate Ampere Turn Value

In general, the higher operate ampere-turn reed switches will produce less noise than low ampere-turn reeds. The low ampere-turn values have a higher compliance and thus a tendency towards greater vibration. This effect is shown in Fig. 4. Type 3 reed switches were used. They were 24 and 48 operate ampere-turns respectively. The lower ampere-turn switch produces 8 mv noise with a duration of 2.3 ms. The higher produces 3.0 mv with a duration of 1 ms.

Applied Coil Ampere-Turn Value

Change in applied coil ampere turns has some effect upon noise level as seen in Fig. 6. This is a result of the limit to the speed with which the contacts can move in closing. As long as the ampere-turn level supplied by the coil is below saturation, the contact noise will vary with coil ampere turns. Once the saturation point is reached, the noise level will no longer increase. This point is the same for all reeds with similar blade cross section and is about 90 ampere turns in a coil 0.9 in. long with an inner diameter of 0.2 in. and outer diameter of 0.3 in.

Constancy of Operation

Fig. 7 gives examples of reeds recorded for several operations. There appears to be little or no variation in the noise trace for each reed. Thus, repeated pulsing or operation of a particular reed will continue to give almost identical noise output waveforms.

Frequency Analysis

Frequency components of the waveforms under study were determined by applying Fourier Analysis methods. Frequency of the fundamental was 23 kc for one particular type.

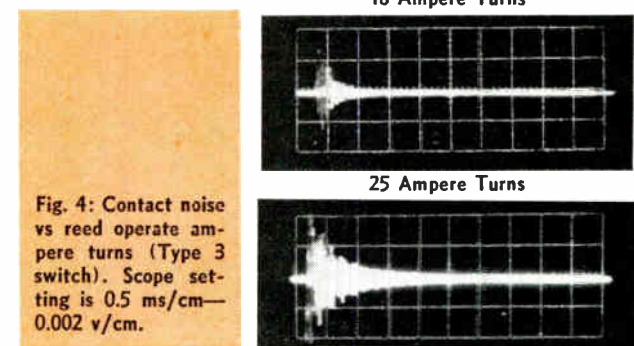
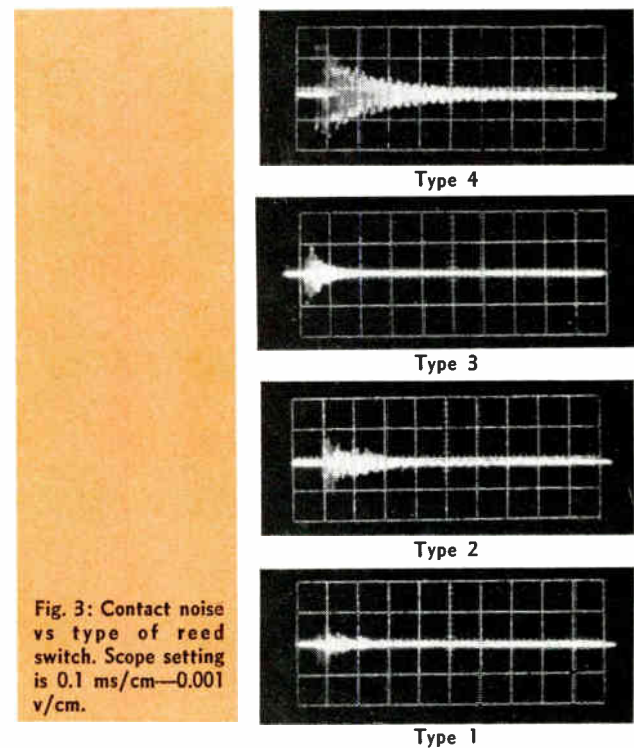
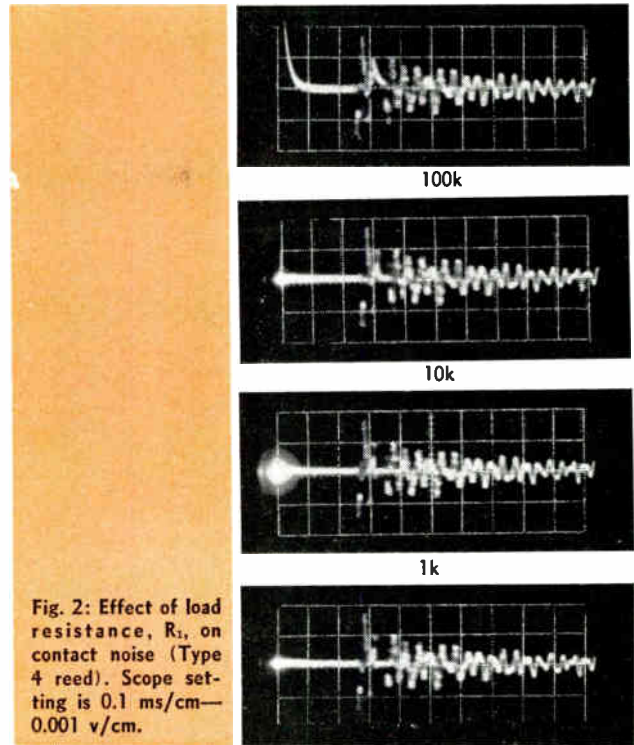

NOISE GENERATION (Concluded)

Fig. 5: Contact noise measurement circuit.

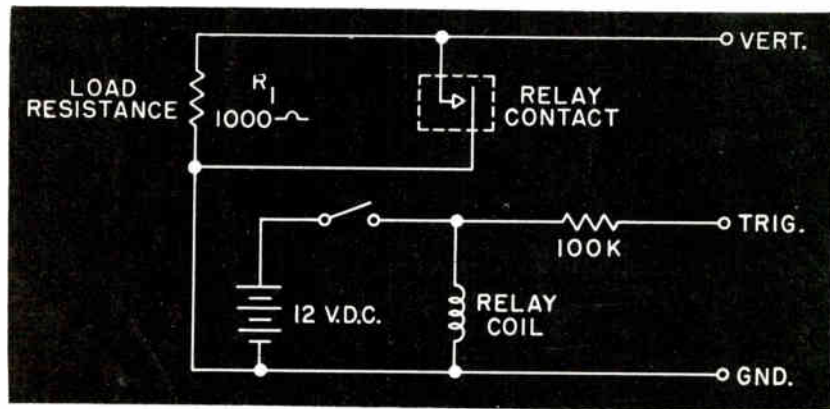

Flexural Vibration

Since the reed members can be bent elastically into different shapes, it is known at the outset that a multi-frequency system is present. It is also known that the vibrations are primarily flexural so that the resulting deformation is in bending. Frequency of the vibration modes is given by¹:

| Type | Max. Peak-to-Peak Noise Level (mv) | Duration (ms) |
|------|---------------------------------------|---------------|
| 1 | 1.5 | 1.0 |
| 2 | 2.0 | 1.3 |
| 3 | 2.6 | 1.0 |
| 4 | 3.5 | 3.0 |

$$\omega = \frac{(cl)^2}{l^2} \sqrt{\frac{EI}{\gamma a}} \quad (1)$$

where

E = Young's Modulus.

I = Section Moment of Inertia.

γ = Density of the beam.

a = Cross sectional area.

l = Length of beam.

(cl) = Constant determined by the end conditions of the beam and is given by:

$cl \approx \pi (n - \frac{1}{2})$ for a simple cantilever

and $cl \approx \pi (n + \frac{1}{4})$ for an end propped cantilever

where n is the mode in question.

• A REPRINT of ANY ARTICLE in this issue is available from ELECTRONIC INDUSTRIES Reader Service Department.

Each contact arm vibrates as an end-propped cantilever⁵. Using $cl = 15.5$ in Eq. 1 and the physical parameters for the reed switch giving the noise characteristics as shown in Fig. 3, Type 4, the fundamental frequency of vibration is found to be about 23 kc. This agrees with the previous "Frequency Analysis" for this switch.

Noise Produced by Generator Action

The contact arm of the reed switch moves through the magnetic field of the surrounding coil during operation. This action generates a voltage across the contacts as a result of the well-known generator effect. The voltage produced is given by:

$$e = Blv \times 10^{-8} \text{ volts} \quad (2)$$

where

B = flux density through reed members (gauss).

l = length of the reed members (cm).

v = velocity of reed members (cm/sec).

Using the parameters of Type 4 reed switch in Fig. 3, we can apply Eq. 2 as follows:

(1) Flux density

For the coil used in the noise measurements, the value of B was measured to be 20 gauss and taken to be constant throughout the reed members. This value is somewhat high since leakage flux is also included. But, for the sake of simplification, the worst possible case will be taken at all times, giving a somewhat larger voltage result than the actual case.

(2) Conductor Length

The worst case in this situation is where the reed members are considered to be connected and moving together in one piece 1.4 cm in length.

(3) Velocity of Members

The largest possible velocity would be that at which the conductor moves through the combined excursion of both reeds; i.e., their contact gap, x , in a time interval of about 0.5 msec.

$$v = \frac{x}{t} = \frac{6.5 \times 10^{-3}}{5 \times 10^{-4} \text{ sec}} = 13.0 \text{ cm/sec}$$

(4) Voltage Generated

$$e = Blv \times 10^{-8}$$

$$e = 20 \times 1.1 \times 13 \times 10^{-8}$$

$$e = 3.7 \mu\text{v}$$

(5) Evaluation

The evaluation found above is the worst case of the maximum possible emf produced by the generator effect of the reed contact members in the Type 4 switch. From Table 1, the maximum peak-to-peak noise level was 3.5 mv. Significance of this difference between the calculated value of 3.7 μ v and the measured value of 3.5 mv indicates that the noise must be produced by another method in addition to the generator effect.

Noise Produced by Magnetostriction

Voltages are produced in magnetostrictive materials when they are sufficiently strained. Closure of the reed switch produces a sinusoidal strain on the reed members when they are vibrating in an end propped mode. This results in a voltage produced along the length of each reed. It occurs at the frequency of vibration as previously determined.

Vignes² has determined the following relationship for generated voltage along the axis of the member at a distance r from its effective center and per unit length:

$$E_r = (R - r) \frac{dB}{dt} \times 10^{-8} \text{ volts} \quad (3)$$

where

R = radius of the member (cm),

t = time (sec),

B = magnetization within the member in a circumferential direction caused by a strain in a longitudinal direction given by:

$$B = B_s \frac{\epsilon}{\epsilon_s} \quad (4)$$

where

B_s = saturation value of the flux density (gauss)

ϵ = strain

ϵ_s = strain necessary to cause saturation.

Since the voltage generated per unit length varies from a maximum at the center to zero at the circumference, then for $r = 0$, the measured voltage can be given by:

$$E_{rms} = \frac{E_r}{3} \text{ v./unit length} \quad (5)$$

Conclusion

Reed Contacts produce a noise signal when closed but still vibrating. The frequency is dependent upon the mechanical resonance determined by the configuration of each individual reed and the simple theory of bending for reeds in the end propped mode. Amplitude of the noise is in agreement with the predictions of magnetostrictive effects.

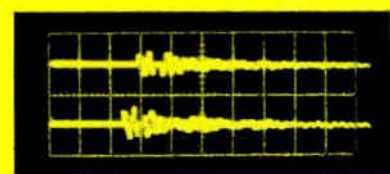

Top trace 8v and bottom trace 10v.

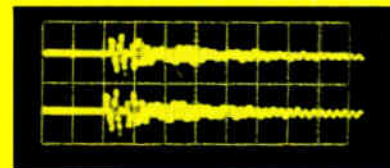

Top trace 12v and bottom trace 14v.

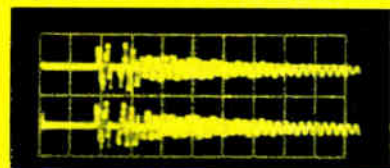

Top trace 16v and bottom trace 18v.

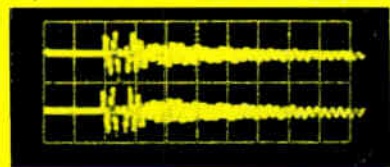

Top trace 20v and bottom trace 22v.

Fig. 6: Contact noise vs applied coil ampere turns (Type 3 switch—25 ampere turns). Scope setting is 0.1 ms/cm—0.01 v/cm. Coil voltage is shown below each illustration.

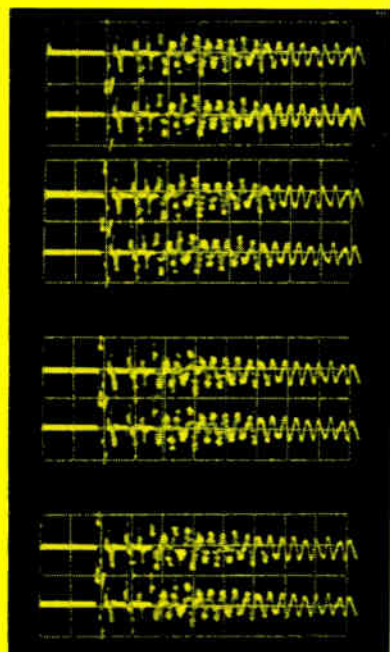

Fig. 7: Constancy of contact noise vs operation (Type 4 switch, 26 ampere turns). Scope setting is 0.1 ms/cm—0.005 v/cm. Coil voltage is 12 vdc.

References

- (1) Peek, R. L. and Wagar, H. N., "Switching Relay Design," Van Nostrand, N. Y., 1955.
- (2) Vignes, I., "Magnetostrictive Electricity in Strain Gauges," *The Review of Scientific Instruments*, Vol. 27, No. 12, Dec. 1956, pp. 1012-1014.
- (3) "Iron-Nickel Alloys for Magnetic Purposes," International Nickel Co., N. Y., 1953, Fig. 9, p. 16.
- (4) Peek, R. L., "Magnetization and Pull Characteristics of Mating Magnetic Reeds," *The Bell System Technical Journal*, March 1961, pp. 524-546.
- (5) Ballinger, Dale O., "Applications and Characteristics of Dry Reed Relays," *Eleventh National Conference on Electromagnetic Relays*, p. 3.

All You Add Is Weightlessness

The Gemini Mission Simulator precreates the sounds, circumstances, faults, smells, temperature conditions and instrument readings of a Gemini orbital rendezvous flight—with the exception of gravity effect.

Designed, developed, and produced for NASA's Manned Spacecraft Center by a McDonnell simulator team who fully understands the training problem and whose skills span many disciplines—celestial mechanics, kinematics, electronics, electrical and mechanical engineering, computer programming, engineering psychology, equipment design, and fabrication—the Gemini Mission Simulator makes possible integrated mission training for both flight crews and ground operations personnel.

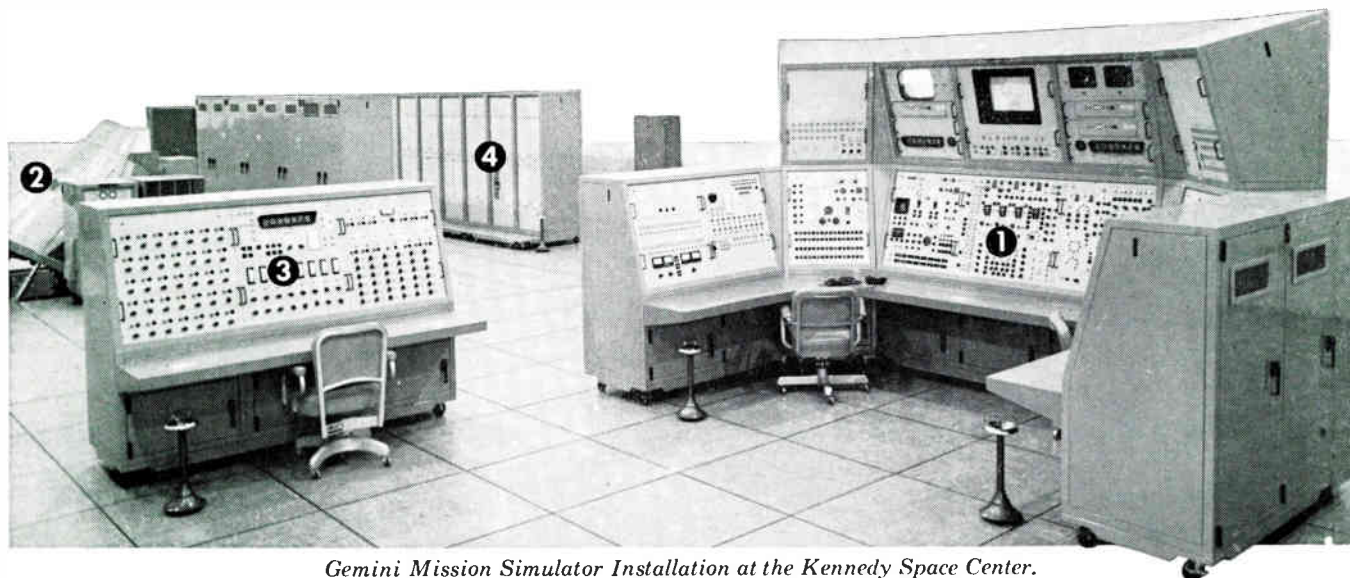

Gemini Mission Simulator Installation at the Kennedy Space Center.

The **Instructors Station ①** permits monitoring of all instruments and controls and allows the introduction of flight control, environmental control, and communication systems malfunctions. It provides crew and instrument panel TV monitors, digital communications with the simulated on-board computer, and the capability for creating realistic noise and communication distortion.

The interior of the **Crew Station ②** is a visual and tactile duplicate of the Gemini Spacecraft cabin. The Crew Station is hydraulically mounted to tilt the cabin for crew comfort.

The Gemini Mission Simulator is one of the products and systems currently being provided by the McDonnell Electronic Equipment Division to industrial and military agencies in the fields of automatic check-out, simulation, training, guidance and control, and space communication. For a brochure describing "Skill in Electronics" at McDonnell, write:

The **Telemetry Control Console ③** enables telemetry processing, monitoring, and fault introduction, before transmission to the operational ground stations, as necessary for ground station operator training.

Peripheral Equipment ④ includes power supplies, audible noise generation equipment, communications subsystems, telemetry systems and other units external to the **Computer Complex** (not shown) which synthesizes the manual data insertion unit and the digital command system. All equipment is solid state and modular.

MCDONNELL ELECTRONIC EQUIPMENT DIVISION

DEPT. 946 • BOX 516 • ST. LOUIS, MISSOURI 63166

APPLYING ELECTRONICS AS AN INTERDISCIPLINARY SCIENCE

CLARE

Military-Type Relays

for maximum **RELIABILITY***
in adverse environment

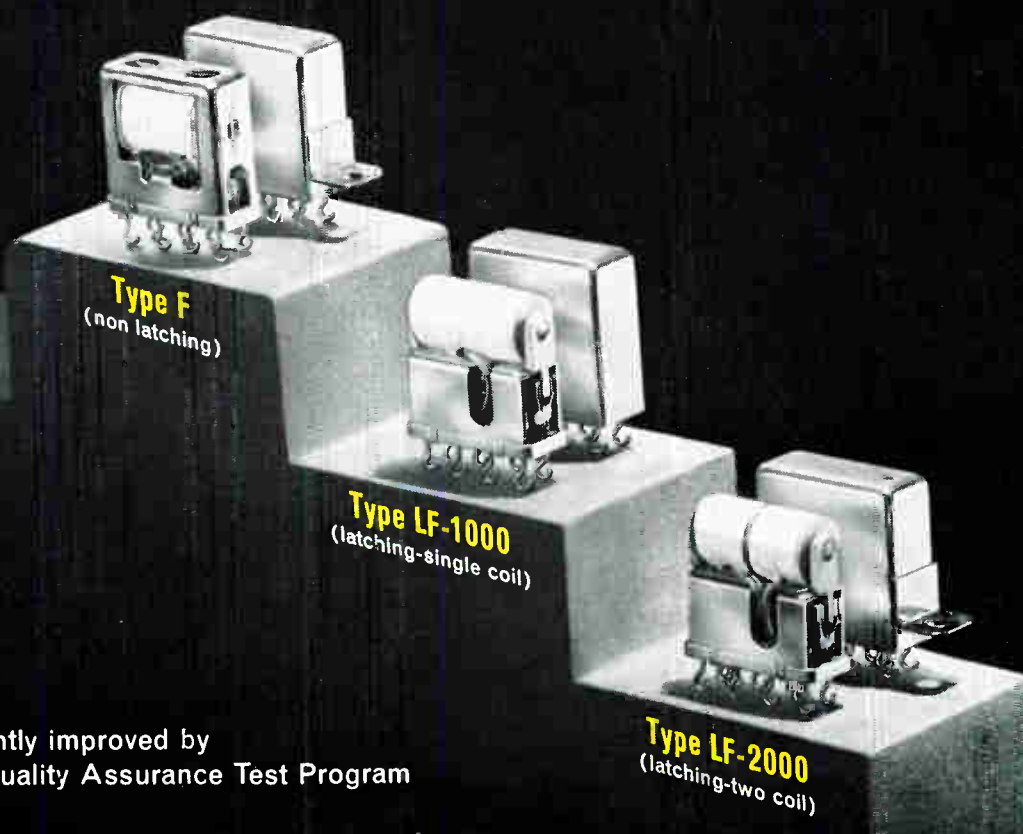

*
Constantly improved by
Clare Quality Assurance Test Program

Small, lightweight Clare Military-Type Relays not only meet the rigid specifications of MIL-R-5757D... they actually surpass them. They provide the highest standards of reliability ever obtained from large-volume, production line relays. Yet they are available at competitive prices and for prompt delivery.

How is this possible? The Clare Quality Assurance Test Program continually analyzes sample lots... tests them to failure... to learn the cause of breakdown, whether it be materials, processes or people. If necessary, corrections are then made to produce ever-increasing reliability.

So, whether your requirement is for Type F Relays (for non-polarized, single-side-stable, single coil operation), or Type LF Relays with magnetic latching (for

polarized, bi-stable, single or double-coil operation), these relays give assured reliability and maximum contact life at high or low load level... under extreme conditions of shock, vibration and temperature. Available with either welded or soldered enclosures.

FOR FULL INFORMATION

Address:
C. P. Clare & Co.,
Group 12D7,
3101 Pratt Blvd.,
Chicago, Illinois
60645.



Relays and
related control
components



**When
connections
must not fail**

Wire-Wrap®

**machines assure
reliability**

In today's highly specialized tracking and guidance systems, an intermittent electrical connection means serious trouble. Solderless wrapped connections stay tight permanently. That is why Gardner-Denver "Wire-Wrap" tools are so often used for such wiring. More than 37 billion of these connections, without a single reported field failure, have proved it.

Get full details

Write for Bulletins 14-1, 14-3, 14-121

Solderless wrapped connections made with "Wire-Wrap" tools help assure reliability for this panel—part of the guidance system of a major missile project.



Miniaturization is easy with "Wire-Wrap" tools and machines that make connections on terminal spacings as small as .100"—using 30- or 32-gauge wire.



For automatic wiring of modular panels, "Wire-Wrap" machines programmed with punched cards provide maximum flexibility for immediate engineering changes and circuit modifications.

Why **Wire-Wrap**® tools and machines assure complete connection reliability

Made in less than a second (at a tremendous savings of cost and time) Solderless connections wrapped with "Wire-Wrap" tools stay tight for keeps. The reasons:



Metal to Metal Contact. Solderless connections made by "Wire-Wrap" tools, scrape off surface film from wire and terminal at each point of contact. Solid state diffusion strengthens connection as it ages.



Gastight Contact Areas. These solderless connections remain gastight when exposed to severe changes of temperature and humidity, and are unaffected by atmospheric corrosion.



High Pressure Contact. Initial wrapping pressure may go as high as 100,000 psi. The cold flow of wire causes pressure to drop to a value greater than 29,000 psi, where the metal stabilizes and pressure remains constant.

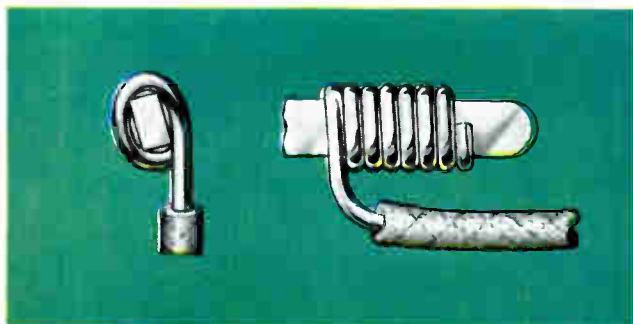

Mechanical Stability. Connections stay tight and mechanically stable under assembly and material handling. Connections are not subject to embrittlement caused by changes in metallurgical structure, since the solderless method requires no heat.



SEE WHAT AIR IS DOING NOW...SEE
GARDNER - DENVER

Gardner-Denver Company, Quincy, Illinois

World Radio Hist. Circle 27 on Inquiry Card

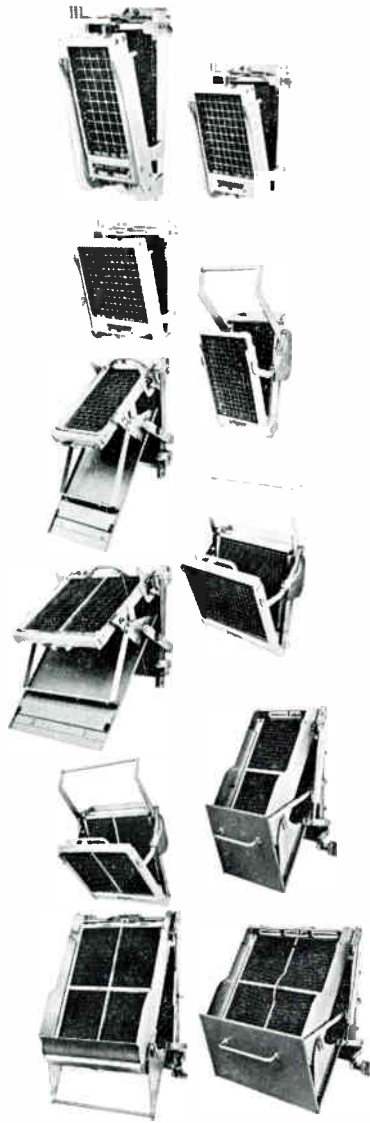

ENGINEERED TO MEET YOUR NEEDS

Eleven sizes of precision MAC Panel Plugboard Programming Systems plus a complete line of plugwires and hardware provide one source for reliable, flexible program control.

MAC Panel's Plugboard Programming Systems range in size from 200 to 5120 positions, and are designed and engineered to assure rugged construction, flush mounting capabilities and ease of plugboard insertion. Each system consists of a precision engineered receiver, lightweight molded phenolic or diallyl phthalate plugboard and a complete line of plugwires. Whether your requirements call for special design applications or for a system to fit standard racks, MAC Panel assures you of quality and guaranteed satisfaction. See your MAC Panel representative or write for specifications.

MAC PANEL COMPANY
HIGH POINT, NORTH CAROLINA



EDITOR'S NOTEBOOK

AT TRADE SHOWS Pilot radio Corp. displays a 4-foot hollow bronze statue of a by-gone female opera star with her mouth open. After a recent show, exhibitors heard metallic noises when the statue was moved. Investigation revealed that 68¢ had been tossed into the diva's mouth, apparently as a kind of "wishing well."

A GIANT STEP FORWARD in shoe manufacturing may develop through radar. Comtek, Inc., Woburn, Mass., is working on a process to use intense radar beams to "weld" seams and attach soles, toes and heels. Basis of the process may be a new modular magnetron developed by Comtek.

TIMING DEVICE, one-half cubic inch in size, with no moving parts, that can be set from 8 to 48 hours, and work reliably after one year storage, is near development, according to Bissett-Berman Corp. under a contract with the U.S. Army Munitions Command, Picatinny Arsenal. The tiny device is possible, reports the Santa Monica, Calif., firm because of their new electrolytic cell (E-cell), about the size of a kidney bean.

UNIQUE PACKAGING being tried out on sensitive electronic instruments by Hewlett-Packard allows a 20-lb. device to be test-hurled 20 feet several times without damage to the contents. In *Post Pak* packaging, by Crown Zellerbach, consisting of special corrugated and polyethylene cushioning, tests include dropping on corners on to concrete from a height of 3 ft. Five years ago damage claims for H-P instruments were one in 200. Now, they are about one in 5,000.

RADIO TRANSCEIVER may reduce pilot dependence on visual ground signals during ramp maneuvers. Developed by Granger Associates of Palo Alto, the G/A miniature transceiver permits ramp director to talk with pilot on assigned VHF during airport operations. Advantages, reports Granger, are: talk not confined to limited visual signals; pilot can direct his attention to craft; ramp director need not be seen by pilot. Transceiver, size of a small transistor radio, has a 15 mw signal good beyond 2000 feet. Three mercury cells run the unit for about 80 hours.

PROJECT YO-YO, developed by Westinghouse Electric Corp., a new marine cargo handling system for ships at sea, allows a crane to rise and fall with a heaving ship. Deck motion is detected by a sensor and is signaled to the crane control where positions of deck, cargo load, and crane are compared and corrections are made instantly, allowing the crane to lower the load lightly onto the pitching deck.

ELECTRONIC DEVICES to aid the blind, under development at Stanford Research Institute, include a kind of optical range finder, which would detect objects in a blind person's path. A hearing device, or a tactile sensation in the hand might provide warning. Still in early stages is an "optical probe," of hand size, that will scan an ordinary printed page permitting the blind to "read." Light from black printing would generate signals in piezoelectric bimorph reeds under a reader's fingertips.

DATA PROCESSING is helping the St. Louis Police Department in its fight against crime. Recently installed IBM 7040-7740 system is designed to assist in crime detection and control. Patrolmen, detectives and neighboring law agencies now have immediate access to vital information. Anything from suspected stolen cars to suspicious persons, modis operandi, and so forth, can be retrieved in seconds.

PIRATE RADIO OPERATORS anchored five miles off England think they have found a way to "break the back" of the nation's broadcasting monopoly—BBC. Listeners enjoy the commercials, which the British government bans, and the disc jockey music. BBC and government are doing a slow burn but all they can do is rale and harass water-borne "Radio Caroline." The station operates two 20 KW transmitters and sells time for up to \$300 a minute. Britain's commercial TV network charges \$7,000.

FOILED BY PHONE, a young Belgian "thief" got entangled with a phone identification device developed by Bell Telephone Manufacturing Co. of Antwerp. Seems he stole a famous 17th Century Rubens from Brussels Royal Museum of Fine Arts. The culprit called the museum several times, to arrange ransom for the \$200,000 oil. The curator recognized the caller's voice on the third call. He pressed a plunger, dialed I, and "froze" the call circuit, even if the caller had hung up. Police cars keyed in with the Belgian phone system, sped to the booth and made the arrest.

the only thing
NOT UNIQUE
about the
610B
is the name
ELECTROMETER

The Keithley 610B Electrometer measures more parameters over broader ranges than any other dc test instrument! One compact measuring system now gives you the capability to investigate:

VOLTAGE—20 microvolts to 100 volts, without circuit loading (10^{14} ohms input resistance)

CURRENT— 10^{-15} ampere to 0.3 ampere

RESISTANCE—2 ohms to 10^{14} ohms

CHARGE— 10^{-13} coulomb to 10^{-5} coulomb

In addition, this neat package has only 200 microvolts per hour zero drift. That's ten times better than you can expect from any other tube electrometer, and it approaches the stability of costly vibrating reed devices. Unique, too, is the 610B's 1% meter accuracy, and its .005% unity gain output for impedance matching. An extra large 6-inch taut-band meter and two easy-to-read dials accent ease and convenience of operation.

The remarkably superior 610B replaces the 610A . . . and sells for the same price . . .

\$565

Send for Engineering Note
on 610B Electrometer

other electrometers

Model 610BR
Rack mounting 610B \$585
Model 621
37 ranges, line operated. \$390
Model 600A
54 ranges, bat. operated. \$395
Model 603
50 kc bandwidth amplifier. \$750

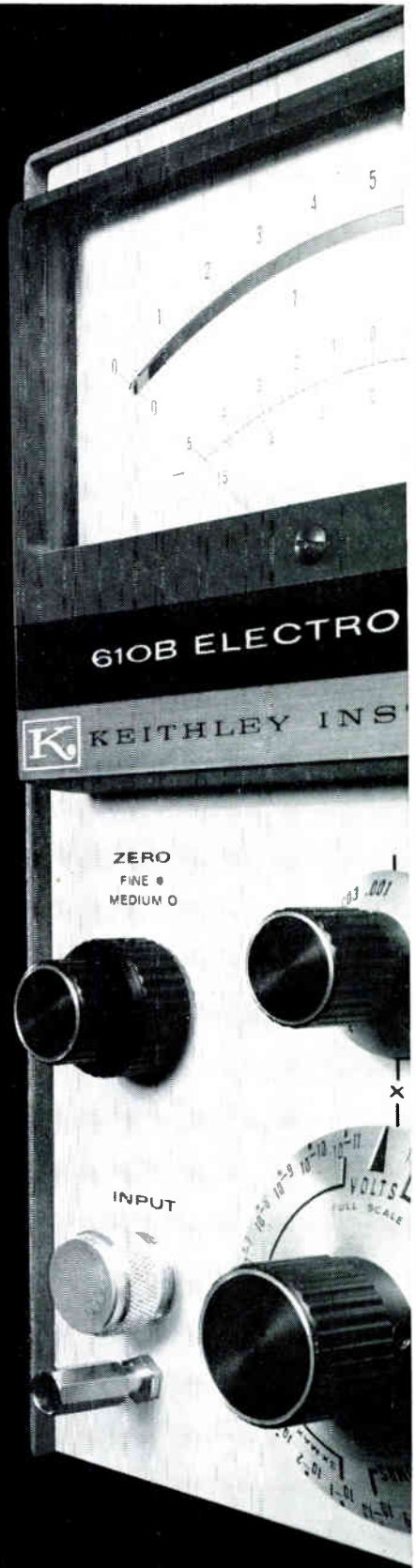

**KEITHLEY
INSTRUMENTS**

12415 Euclid Avenue • Cleveland 6, Ohio

dc microvoltmeters • differential voltmeters • high voltage supplies

"... STATE-OF-THE-ART information on Components and Equipment."

Slide Rule

This electronic slide rule is designed for rapid calculation of the reactance and either Q or dissipation factor of capacitors and inductors. It may also be used to find the resonating capacitance and inductance for a given frequency and for the design of filter networks. The slide rule is offered free by writing on company letterhead to Boonton Electronics Corp., 59 Pomeroy Road, Parsippany, N. J.

Integrated Circuits Chart

Schweber's Guide to the Selection of Fairchild Integrated Circuits is arranged both alphabetically and numerically in chart form. This guide makes it easy to select any component from an extremely complex line. The chart is a 6-page folder, measuring 8½ x 11 in., and is perforated for notebook insertion. Copies may be obtained by writing on business letterhead to Schweber Electronics, Westbury, N. Y.

Gold Plating Process

Bulletin 678 describes the characteristics, operating conditions and uses of a new electroless gold plating process. Developed for uses where electrical connections in the plating bath are disadvantageous, the new process, trade-named Electroless Au, produces pure (99.9%) dense deposits to any practical thickness. The process has excellent covering power even in deep recesses and narrow cavities. Applications included: isolated PC, micro-circuitry, micro-connectors, small cavity transistors and swab coating for repair work. Sel-Rex Corp., 75 River Rd., Nutley, N. J.

Circle 110 on Inquiry Card

Air-Bearing Fan

This brochure describes an air-bearing fan in which the shaft never touches the bearings while operating. The brochure clearly details operation of the new fan, which is 4-11/16 in. sq. and fits many aerospace, electronics, and commercial uses. The shaft, an instant after the fan is started, lifts away from its sleeve and rotates solely in air. Because there is no bearing wear, the new fan has almost limitless life, and is unaffected by temps. up to its max. rating. IMC Magnetics Corp., 6058 Walker Ave., Maywood, Calif.

Circle 111 on Inquiry Card

Nut Selector Chart

This nut selector chart is designed as a comprehensive guide to the selection and spec. of precision-turned brass, aluminum and stainless steel nuts. The new chart includes complete information about nut types, thread sizes, dimensions and materials. Fischer Special Mfg. Co., 446 Morgan St., Cincinnati, Ohio.

Circle 112 on Inquiry Card

Potentiometer Catalog

This 44-page catalog describes precision potentiometers, trimmers and dials. The 1964-65 catalog contains photographs, drawings and detailed specs. on the complete line of potentiometer products. In addition to data on wire-wound single-turn and multi-turn models, standard cermet and conductive plastic precision potentiometers are included. Helipot Div., Beckman Instruments, Inc., 2500 Harbor Blvd., Fullerton, Calif.

Circle 113 on Inquiry Card

Heat Dissipators

Catalog No. 364 is a short-form listing of a wide selection of semiconductor heat dissipators and heat dissipating tube shields. More than 200 separate products and product variations are shown and described in brief in the new booklet. International Electronic Research Corp., 135 W. Magnolia Blvd., Burbank, Calif.

Circle 114 on Inquiry Card

IR Detector Chart

This chart simplifies the selection of an optimum-performance detector which is compatible with a specific spectral requirement. It clearly indicates the type of detector required for coupling with selected semiconductor injection lasers and emitters. The chart illustrates within the 0.5 to 14μ spectral range the absolute detectivity of visible and infrared detectors superimposed over a background of atmospheric absorption and transmission. Infrared Dept., Lansdale Div., Philco Corp., Lansdale, Pa.

Circle 115 on Inquiry Card

Power Supply Design Aid

Application Bulletin SRZD-102 describes circuits that use zener diodes in series-regulated power supplies. Heretofore zener diodes were used in the shunt circuit configuration in power supplies, causing great power losses. However, the circuits shown in this technical bulletin illustrate how super/reg™ zener diodes can be used to design the more efficient series regulators. Semi-Conductor Div., Trio Laboratories, Inc., Plainview, L. I., N. Y.

Circle 116 on Inquiry Card

Integrated Circuit Computer

Data is available on a computer that uses integrated circuits. The SDS 92 is a low-cost, high-speed general-purpose computer designed for applications such as real-time system control, direct digital control, data communication systems, peripheral processing for larger computers, nuclear pulse height analysis, and repetitive, high-speed computation. It has a 1.75μsec. memory cycle time and an input/output transfer rate of 572,000 words/sec. Core memory is expandable to 32,768 words. Scientific Data Systems, Inc., 1649 17th St., Santa Monica, Calif.

Circle 117 on Inquiry Card

Oscilloscope Accessories

This 52-page catalog describes oscilloscope accessories. Included are complete descriptions and prices of items which extend oscilloscope utility, performance, and ease of operation. These items range from cameras, probes, and oscilloscope carts to probe tips, cables, and connectors. Catalog layout is designed for ease in selecting accessories to meet exact requirements of oscilloscope users. Tektronic, Inc., P. O. Box 500, Beaverton, Ore.

Circle 118 on Inquiry Card

Microelectronics Brochure

This 20-page brochure describes the capabilities, facilities, and product line of microelectronics. It discusses the designated 6 levels of interconnection which are commonly evaluated by engineers in solving systems packaging problems. Amphol Microelectronics, 2837 S. 25th Ave., Broadview, Ill.

Circle 119 on Inquiry Card

Semiconductor Test Methods

Three application data studies on recommended test methods for silicon semiconductor devices are available. Two of the studies, AD-515 and AD-516, deal with testing of silicon power rectifiers in the 6 and 12a. range and the 25 to 70a. range respectively. Data includes parameters on reverse leakage at rated PRV and the forward voltage drop test. The third in the series, AD-517, offers a recommended test method for silicon zener diodes from 150mw up to the 50w (rated values) series. Parameters include the zener voltage and the dynamic impedance tests. International Rectifier Corp., El Segundo, Calif.

Circle 120 on Inquiry Card

Core Data

Data on cores for the deflection yoke and transformer systems of the new 90° CRT are available. They are made of Ceromag®, a proprietary ferrite. For samples or technical data write: Stackpole Carbon Co., Electronics Div., St. Marys, Pa.

Circle 121 on Inquiry Card

Shielding Materials Brochure

Bulletin PDL-130 describes capabilities for fabricating and supplying magnetic shielding materials. It includes such specialties as deep drawn shield cans, electronic tube shields, hand fabricated shields, shielding foil and strip. An engineering and design check list in the form of a quotation request is included. It provides the prospective materials user with the detailed variables that have to be considered in order to obtain superior performance. The Arnold Engineering Co., Pacific Div., 1551 E. Orangethorpe Ave., Fullerton, Calif.

Circle 122 on Inquiry Card

*built for
20 years of undersea
operation*



Type EB
1/2 watt resistor
shown 2 1/2 times
actual size

Western Electric submarine telephone cable repeaters require the proven dependability of Allen-Bradley hot molded resistors

■ Western Electric faced a unique engineering challenge when building repeaters for a new transoceanic telephone cable — they are designed to operate in the murky world of the ocean bottom for a minimum of twenty years, without failure. For this kind of reliability, each component had to be as close to perfection as humanly possible. Allen-Bradley is proud that the quality of their standard Type EB 1/2 watt, hot molded resistors after some selection and screening enabled them to meet these most exacting requirements.

This outstanding performance of Allen-Bradley fixed resistors is the result of the unique hot molding process — developed and used exclusively by Allen-Bradley. It results in such uniformity from resistor to resistor — year in and year out — that long term resistor performance can be accurately predicted.

Allen-Bradley *can only produce* the top quality resistors that you would receive in return for any order — large or small — which you place with us. The price is right — it represents the care that goes into the making of all Allen-Bradley hot molded resistors. The “quality” reputation is worth more to Allen-Bradley than the orders that could be obtained by tampering with the quality of the resistor. You can be “sure” of “quality” — when you buy from Allen-Bradley.

To use Allen-Bradley quality resistors, when everybody knows that resistors can be bought at a lower price, will, in itself, attach the label of quality to your product. Let us send you our Technical Bulletin 5050: Allen-Bradley Co., 222 W. Greenfield Ave., Milwaukee, Wis. 53204. In Canada: Allen-Bradley Canada Ltd., Galt, Ont.



HOT MOLDED FIXED RESISTORS are available in all standard EIA and MIL-R-11 resistance values and tolerances, plus values above and below standard limits. Shown actual size.



ALLEN-BRADLEY

QUALITY ELECTRONIC COMPONENTS

World Radio History

Motor using field segments of conventional ceramic permanent magnet material

Motor using Allen-Bradley MO5C oriented permanent magnet

motor size reduced one-third without sacrifice in performance

■ The illustration above typifies the size reduction in motor design that the new Allen-Bradley MO5C permanent magnet material makes possible—with no loss in motor performance.

Type MO5C is an oriented ceramic permanent magnet material—yet it can be produced in shapes previously limited to unoriented materials. It possesses a high energy product—2.6 times that of unoriented materials—plus a high coercive force. Thus, the Type MO5C is practical for motors from fractional to multiple horsepower ratings, covering a wide range of speeds.

In addition, the high coercive force of MO5C material makes much shorter magnet lengths possible than with

metallic magnets. Leakage flux is reduced . . . magnetic circuit efficiency is increased.

Allen-Bradley MO5C permanent magnets enable motor field assemblies to be simplified, which may result in cost savings over a construction using a metallic magnet or wound fields.

It will pay you to investigate the unusual economic and design advantages of this new MO5C oriented magnet material. For more complete details, please write for Technical Bulletin B5650A: Allen-Bradley Co., 222 W. Greenfield Avenue, Milwaukee, Wisconsin 53204.

In Canada: Allen-Bradley Canada Ltd., Galt, Ontario.

CHARACTERISTICS—Important characteristics of MO5C are tabulated below at a temperature of 25°C.

| | |
|---|-----------------------|
| Residual Induction (B_r) gauss | 3300 |
| Coercive Force (H_c) oersteds | 2200 |
| Intrinsic Coercive Force (H_c) oersteds | 2300 |
| Peak Energy Product ($B_d H_d$) gauss-oersteds | 2.6×10^6 |
| Reversible Permeability | 1.09 |
| Curie Temperature Deg. C | 450 |
| Temperature Coefficient of Flux Density at B_r , %/°C | -0.19 |
| Temperature Coefficient of Intrinsic Coercive Force, %/°C | +0.25 |
| Specific Gravity | 4.85 |
| Weight Per Cu. In. Lbs. | 0.175 |
| Resistivity Ohm/Cm ² | 10^9 |
| Coefficient of Thermal Expansion per Deg. C Parallel to Orientation | 14.5×10^{-6} |
| Perpendicular to Orientation | 11.0×10^{-6} |

Normal Demagnetization Curves for Type MO5C Permanent Magnets

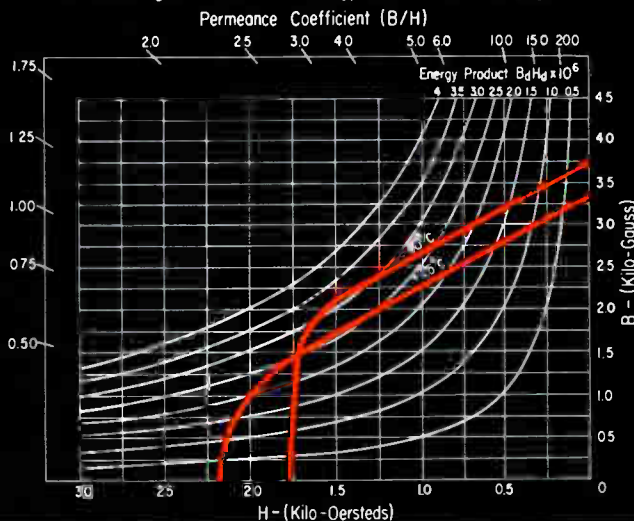

ALLEN-BRADLEY

QUALITY ELECTRONIC COMPONENTS

World Radio History

New Printed Circuit Process Announced by Photocircuits

Glen Cove, N.Y.—A completely new process for the manufacture of printed wiring boards has been announced by Photocircuits Corporation, Glen Cove, N.Y. and Anaheim, Calif., world's largest printed circuit manufacturer.

The patented process, known as "CC-4", is "additive" in that the desired circuit pattern is *added* to the bare insulating base rather than selectively etched from foil clad material. The CC-4 process, developed by the Photocircuits R&D laboratory, utilizes chemical deposition of ductile, fine-grained copper on non-conductive, catalytic adhesive inks which have been selectively applied to an insulating base. The deposited copper has excellent bond strength to the base insulator and is extremely solderable. The thickness of the copper can be suited to the application—as thin as .0001" or up to .060" or more. Research on CC-4 began in 1955 when Photocircuits saw a future need for a lower cost method of manufacturing printed circuits. Various additive processes such as die stamping, electroplating, powdered metal fusing, metal spraying and vacuum deposition were investigated but discarded because of high tool and set-up costs or poor electrical and mechanical characteristics.

The CC-4 process is compatible with artwork and tooling of conventional etched circuit boards, with costs substantially lower since the raw material used is unclad. In addition to cost savings, the new technique offers many advantages not possible with conventional printed wiring. Besides the commonly used base materials such as XXXP, G-10 and polyester glass mat, CC-4 copper circuitry has been applied to flexible films, ceramics, molded plastics and epoxy coated metals. Plated-through holes can be made at very little additional cost with the new process. One or two sided copper boards with plated holes provide low cost printed circuits for commercial applications that have superior solder joints and greatly improved repairability characteristics. Evaluations by large volume users of printed circuits have shown that the superior solderability of CC-4 copper compared to foil results in savings in board assembly.

For further information on the CC-4 process: Photocircuits Corporation in Glen Cove, N. Y. or Photocircuits of California in Anaheim.

First Announcement Made at National Electronics Conference

Announcement of the CC-4 process was made by Photocircuits in a technical paper and company exhibit at the National Electronics Conference in Chicago, Ill.

The paper was co-authored by Robert L. Swiggett, Executive Vice-President, and Frederick W. Schneble, Director of Research and Development. Mr. Swiggett is a member of the Board of Directors and is also a Past-President of the Institute of Printed Circuits.



Robert L. Swiggett

Frederick W. Schneble

CC-4 Process Offers Striking Cost Reductions

The new Photocircuits process resulted from research on substantial cost reduction in printed circuits. Robert L. Swiggett, Executive Vice-President of the firm, pointed out that this breakthrough in manufacturing technology can provide significant dollar savings. "The management of firms with captive printed circuit facilities must re-evaluate 'Make or Buy' decisions to be sure they are not investing in uncompetitive, obsolete techniques" he noted.

A substantial portion of the savings provided by Photocircuits' new process results from the elimination of the cost of applying copper foil to the base laminate. Typically, the difference in price between XXXP clad with one ounce copper and the same grade of material unclad is 22c-25c per square foot. Since raw materials and chemicals in the printed circuit process can run as high as 60-65% of the sales price in large quantity requirements, this difference is quite significant. With the CC-4 process, Photocircuits can produce the finished circuit patterns applied to insulating backing at a total cost equal to that paid for the raw material alone by users of older processes.

Wide Use Seen in Flexible Circuitry

Photocircuits is presently investigating the commercial application of the CC-4 process to the manufacture of flexible circuitry. Glass cloth has been impregnated with CC-4 ink and holes punched in the material. Application of a reverse mask to both sides and CC-4 copper deposition produces a flexible circuit with plated-through holes. The excellent bond strength of the adhesive and the plated-through holes solve a common problem associated with flexible circuits—lifting of terminal areas or destruction of the support material during soldering. Tests have shown CC-4 flexible circuits can be easily soldered and repaired.

CC-4 Licensees Include Western Electric, Grundig

Manufacturing information and patent licenses have been granted by Photocircuits on the new CC-4 process. In the United States, Western Electric Company has a licensed CC-4 facility in operation at Kearny, N. J. Facilities have been installed by several of Photocircuits' foreign licensees such as Ruwel, Fuba, Grundig and Telefunken in Germany and Lares in Italy. Other foreign licensees include Autophon in Switzerland, Cromtryck in Sweden and Mathias and Feddersen in Denmark.



This brand-new one-piece TIMATCH® CONNECTOR with COILGRIP® clamp does things no other connector can do:

It's ready for instant termination.

It's re-usable.

It fits most metal tube sheathed coaxial cable.

It has the Exclusive Coilgrip® Cable Clamp.

A major advance in the connector field that virtually makes all other connectors obsolete—that's Times Wire's new TIMATCH Connector with exclusive COILGRIP Cable Clamp. □ TIMATCH one-piece construction makes it a simple one-step operation to attach connector to semiflexible cable without any further connector assembly. Unpack the connector and it's ready for instant use. □ What's more, you can use TIMATCH and re-use it over and over again. Repeated assembly and disassembly operations won't impair either the RF or physical characteristics of the connector or the cable. □ All components of the connector have been integrally designed into the connector body. With all components matched and pre-positioned during manufacturing process, TIMATCH offers uniform mechanical and electrical characteristics and long-term reliability. □ TIMATCH Connectors are available in all popular sizes. They not only fit Times cables but most other smooth metal tube sheathed coaxial cables. □ For evaluation samples, prices, technical data . . . write to Times Sales Manager on your letterhead.

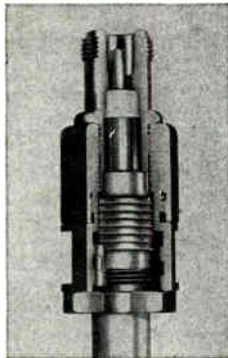

Exclusive COILGRIP Clamp consists of stainless steel coil which is forced by a torsion collar, thus locking the coil on the collar and locking cable in position.

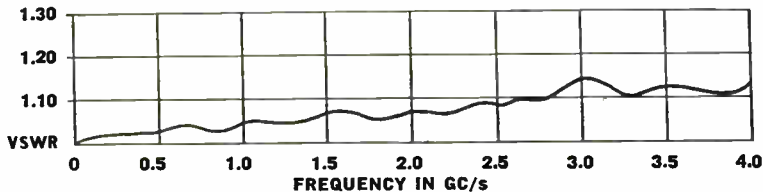

VSWR characteristics of a typical cable assembly with ½ inch Alumifoam cable and a pair of TIMATCH Type N connectors.



DIVISION OF THE INTERNATIONAL SILVER COMPANY, WALLINGFORD, CONNECTICUT

TRANSMISSION SYSTEM DESIGN AND ENGINEERING • STANDARD & SPECIAL PURPOSE COAXIAL CABLE • MULTICONDUCTOR CABLE • COMPLETE CABLE ASSEMBLIES • TEFLON® HOOK-UP WIRE
Copyrighted 1964 *A DuPont Trademark

NEW TECH DATA

Protection Tubes

Bulletin 664 describes miniature thermocouple protection tubes and fittings for use in the construction of ultra miniature thermocouples, thermopiles, and probes. The tubes and fittings come in standardized sizes in inconel, stainless steel and brass. The bulletin shows examples of miniature thermocouple assemblies made with these fittings and protection tubes. Omega Engineering, Inc., P. O. Box 47, Springdale, Conn.

Circle 123 on Inquiry Card

Vacuum Melted Alloy

Data is available on an improved vacuum melted alloy known as Spring Silver. This alloy has high tensile strength and electrical conductance when air hardened. The silver-magnesium-nickel alloy not only offers advantages to the miniature relay field as a combination spring-contact member, but its ability to be hardened after forming lends to its use as a bridging contact member in larger switches which contact under high mechanical forces. Engelhard Industries, Inc., Technical Service Dept., 75 Austin St., Newark, N. J.

Circle 124 on Inquiry Card

Application Notes

This 8-page brochure (200.0) abstracts 47 technical application notes, manuals and reprints written to aid designers in the selection, application and testing of power semiconductors, including the new TRIAC ac switch, gate turn-off switch and light-activated SCR. Other subjects include RFI-less switching with SCRs, fluorescent lamp dimming with SCRs and associated semiconductors, and the solid-state thyatron. General Electric Co., Rectifier Components Dept., Schenectady, N. Y.

Circle 125 on Inquiry Card

Trigger Tube Bulletin

Bulletin DK-1 entitled, "Cold Cathode Trigger Tubes" contains 36 pages on the operation, characteristics, circuits, and uses of cold cathode switching. The technical bulletin shows that trigger tubes, when compared to other active switching devices, have a number of outstanding advantages. These include negligible standby power, no warm-up period, inherently high reliability, ability to withstand severe overloads without suffering irreparable damage, and low cost. Electronics Products Div., Baird-Atomic, Inc., 33 University Rd., Cambridge, Mass.

Circle 126 on Inquiry Card

Flame-Retardant Rubber

Silastic S-2254 is an easy-to-process, economical, flame-retardant silicone rubber stock. The new material burns slowly while subjected directly to flame, but extinguishes itself when the flame is removed, leaving behind a silica ash which is itself a good electrical insulator. The rubber is serviceable from -70 to 500°F or higher. Dow Corning, Midland, Mich.

Circle 127 on Inquiry Card

NEW TECH DATA

Electronic Comparator

Bulletin PIR 64051-1 describes the model 40,488 electronic comparator. This unit performs the function of a form C relay, a mechanical relay comparator module, and a repetitive operation display module. Features of the unit are discussed; schematics of and technical data on the comparator, electronic switch, and track and hold mode are given. Also included are specs. and test performance data. Electronic Associates, Inc., West Long Branch, N. J.

Circle 168 on Inquiry Card

Tube Housings

Two new 2-page bulletins which describe housings for side-view and head-on photomultiplier tubes are available. Model 50 (Bulletin 203) accommodates side-view tubes; Models 51 and 52 (Bulletin 204) house head-on tubes 1½ and 2 in. respectively. Lists and specs. of tubes commonly used with these exposure heads indicate applications of tube housings. Pacific Photometric Instruments, 3022 Ashby Ave., Berkeley, Calif.

Circle 169 on Inquiry Card

Capabilities Brochure

This 20-page capabilities and facilities brochure contains comprehensive descriptions and illustrations of experience in aerospace physics, hypersonic propulsion, special wind tunnel facilities, and electronic components, instruments and systems. Representative projects in specific reentry vehicles, reentry physics, inlet design, hypersonic combustion, plotting systems, and spectrum analysis are also described. General Applied Science Laboratories, Inc., Merrick & Stewart Aves., Westbury, L. I., N. Y.

Circle 170 on Inquiry Card

Torque Motors

This 2-color, 42-page publication describes the fundamentals, characteristics and installation of dc direct drive torque motors, and catalogs standard models available. The first of its 2 comprehensive sections is text, running 12 pages, which relates design features to dc torque motors. The second section contains electrical and physical data for standard line, dc torque motors. Inland Motor Corp., subs. of Kollmorgen Corp., Radford, Va.

Circle 171 on Inquiry Card

Cable Insulation

Data is available on a new multi-purpose vinyl cable insulation called Plastico LO-105. It is U/L and CSA approved, and exceeds their low temp. flexibility test requirements, including voltage breakdown after cold bend. For high temp. internal wiring applications, wires insulated with this compound have many 105°C approvals. Included are U/L 105°C appliance wiring material, rated 600v.; CSA 105°C appliance wiring material, and CSA Type TEW 105°C thermoplastic equipment wiring material. Chester Cable Corp., 131 Oakland Ave., Chester, N. Y.

Circle 172 on Inquiry Card

VICTOREEN DIODES for regulation and reference from 350 TO 30,000 VOLTS



GV1A Series, shown actual size, above, weighs 0.8 gm.



RELIABLE

Victoreen Corotron diodes enhance circuit reliability because they are free from catastrophic failure caused by nominal surges or transients . . . are immune to space radiation, even radiation greater than disaster levels. They are also unaffected by ambient light variations, have a very low TC, and withstand extremes of shock and vibration.



MICROMINIATURE

Victoreen Corotron diodes are compact, lightweight. Corotrons enable designers to use, at high voltages, the same simple circuitry used with Zeners at low voltages. A *single* Corotron diode can be used as a reference, shunt regulator, DC coupling element, or portion of a divider up to 30kV.



LOW POWER CONSUMPTION

Victoreen Corotron diodes minimize power drain, can operate from solar cells and other low power sources. Excellent temperature characteristics, particularly at low currents. GV1A Series is available in any desired nominal voltage from 350 to 2000 volts; other sizes available for higher voltages and currents.



VICTOREEN

THE VICTOREEN INSTRUMENT COMPANY
5806 Hough Ave. • Cleveland 3, Ohio, U.S.A.

2282-A



**VISUAL
INDICATING**

**BODY SIZE
ONLY
.145 x .300
INCHES**

BUSS Sub-Miniature PIGTAIL TRON FUSES

For use on miniaturized devices,— or on gigantic multi-circuit electronic devices.

Glass tube construction permits visual inspection of element.

Smallest fuses available with wide ampere range. Twenty-three ampere sizes from 1/00 thru 15 amps.

Hermetically sealed for potting without danger of sealing material affecting operation. Extreme high resistance to shock or vibration. Operate without exterior venting.

BUSS

Write for BUSS
Bulletin SFB

BUSSMANN MFG. DIVISION, McGraw-Edison Co., St. Louis, Mo. 63107



Actual Size
Only 1-5/8 inches long...
Extends just 29/32 inch
behind front of panel

BUSS Space Saver Panel Mounted Fuseholder

- Fuseholder takes 1/4 x 1/4 inch fuses. Converts to 9/32 x 1/4 inch fuses simply by changing screw type knob. Holder is rated at 30 ampere for any voltage up to 250.

- Also available in military type which meets all requirements of MIL-F-19207A.

BUSS

Write for BUSS
Bulletin SFH-10

BUSSMANN MFG. DIV., McGraw-Edison Co., ST. LOUIS, MO. 63107

BUSS: 1914-1964, Fifty years of Pioneering....

NEW TECH DATA

Power Supply Module

Data is available on a new system by which a number of independently regulated loads may be operated from one bulk dc power source. This regulation module is said to provide new operating economies to dc power users, since all power may be drawn from one economical, high capacity, power supply. More data available from Ramm Rectifier Co., 449 Wales Ave., Bronx, N. Y.

Circle 128 on Inquiry Card

Numerical Display

Data is available on the Transindicator numerical display, a device that is a completely packaged readout with a wide temp. range and bright display. The numerical display is available in 2 models: ND-100 is used as a building-block module in timing, industrial control and computer systems, as well as all other applications where an exceptionally clear display and wide angle or vision are desired. The ND-200 incorporates a latching storage feature enabling sampling, storing and statistically displaying BCD data presented to its input during a dynamic high-speed operation. Transitrone Electronic Corp., Wakefield, Mass.

Circle 129 on Inquiry Card

Power Supply Catalog

New application notes, including some which are particularly useful for constant-current operation, an up-dated glossary of power supply terms, and expanded explanations of regulated power-supply capabilities are contained in catalog B-648. Special indexing and clarified specification presentation make this catalog valuable to engineers and purchasing agents. Kepco, Inc., 131-38 Sanford Ave., Flushing, N. Y.

Circle 130 on Inquiry Card

Ultrasonic Switch

Publication LC-10 describes a new ultrasonic switch that senses the presence, without contact, of a variety of both opaque and transparent solids, liquids and metals. Two methods of operation are possible: direct and reflective beam. Applications include counting, sorting, positioning and monitoring operations—all unaffected by environments such as dust, smoke, steam, amb. light, and vibration. The publication is illustrated with application sketches, including the use of reducers and parabolic reflectors. Cutler-Hammer Inc., 436 N. 12th St., Milwaukee, Wis.

Circle 131 on Inquiry Card

Reliability Report

This 12-page brochure gives an evaluation of zener diode reliability data accumulated over a 12-month period from 30 lots of 1w. zener devices. The results are presented in tabular and graphic form, along with an explanation of significant test results. Technical Information Center, Motorola Semiconductor Products Inc., P.O. Box 955, Phoenix, Ariz.

Circle 132 on Inquiry Card

Counter Bulletin

Bulletin 762 describes a counter designed for direct mechanical connection to a drive shaft. The HZ762 provides an electrical signal after a preset number of drive shaft revolutions. The counter can be set to 9999. Setting is easily done by means of a pushbutton for each digit wheel. A key is provided to lock the setting to prevent unauthorized changes. It can be arranged to provide 2 modes of operation: batch or "one cycle" counting; and continuous counting. Typical applications are cut-off devices, measuring lengths, packaging, reversing of rotary tables, metering, etc. Eagle Signal Div., E. W. Bliss Co., 736 Federal St., Davenport, Ia.

Circle 133 on Inquiry Card

Miniature Switches

Illustrated bulletin 001 describes a new line of high-speed micro-miniature switches. The MMS micro-miniature switches are capable of switching in less than 1msec. from the instant of current application. The bulletin contains a complete characteristics chart with electrical, mechanical and environmental testing data included. Aerospace Components Div., Atlas Chemical Industries, Inc., Valley Forge, Pa.

Circle 134 on Inquiry Card

Glass Regulators Bulletin

Bulletin B-123 lists the characteristics and specs. for approx 100 EIA registered glass silicon voltage regulators. These units use the regulating action of the reverse-current characteristics of silicon diodes. A wide variety of zener voltages are listed with specified reverse current characteristics, making it possible to select diodes for many uses directly from the data given. National Transistor Div., 500 Broadway, Lawrence, Mass.

Circle 135 on Inquiry Card

Brushless DC Motors

A comprehensive data sheet on the TQ series of brushless dc torque motors is available. Motors in the series have a continuous torque rating of 6 oz.-inc., and angular motion of $\pm 25^\circ$ and weigh 3.8 oz. Aeroflex Laboratories, Inc., South Service Rd., Plainview, L. I., N. Y.

Circle 136 on Inquiry Card

High Temperature Materials

Data is available on a new family of high temp. materials called "Fuseram." The materials are designed as an inexpensive replacement for alumina and other electrical ceramics when used for substrates and structural insulating materials. The general qualities and characteristics of the material are said to be comparable to all but the highest grade ceramics. "Fuseram" is a natural replacement for ceramics in instances where these materials are over-specified due to the lack of any less expensive insulating material. The Fusite Corp., 6000 Fernview Ave., Cincinnati, Ohio.

Circle 137 on Inquiry Card

Fabricated Goods

Anaconda Fabricated Metal Products (BG-5) is a general catalog containing information on parts made of copper, brass, bronze, nickel silver, iron, stainless steel, steel, and aluminum. Anaconda American Brass Co., 414 Meadow St., Waterbury, Conn.

Circle 138 on Inquiry Card

Slip Ring Applications

Slip Ring Forum is the first of a series of application newsletters. The Forum is a continuing series devoted to discussions of useful information on slip ring design and applications, which is sent without charge to qualified engineers. Breeze Corp., Inc., 800 Liberty Ave., Union, N. J.

Circle 139 on Inquiry Card

Circuit System

This 23-page catalog describes the Veroboard®, the basis of a new circuit system. Veroboard is a high-grade synthetic resin bonded paper laminate with a number of copper strips bonded to it. These strips are pierced with a regular matrix of holes. Components are placed across the board according to circuit plan, inter-connections being made by the copper strips. This simple format enables PC techniques to be used without the delays and high costs associated with this type of work. Vero Electronics, Inc., 48 Allen Blvd., Farmingdale, N. Y.

Circle 140 on Inquiry Card

Feed-Thru Capacitors

The RC210 series of 50a. feed-thru capacitors mount in a single mounting hole. Capacitance values and voltages range from 0.15µfd @ 250vac to 1.5µfd @ 100vdc. Further data available from RF Interonics, Inc., 15 Neil Court, Ocean-side, N. Y.

Circle 141 on Inquiry Card

Moving Coil Galvanometers

A comprehensive 28-page catalog entitled, "Notes on Moving Coil Galvanometers" describes the theory and application of the units. It is a useful guide to the design, production and application of galvanometers. Leeds & Northrup Co., 4901 Stenton Ave., Phila., Pa.

Circle 142 on Inquiry Card

...New Developments in Electrical Protection

BLOCKS for BUSS FUSES

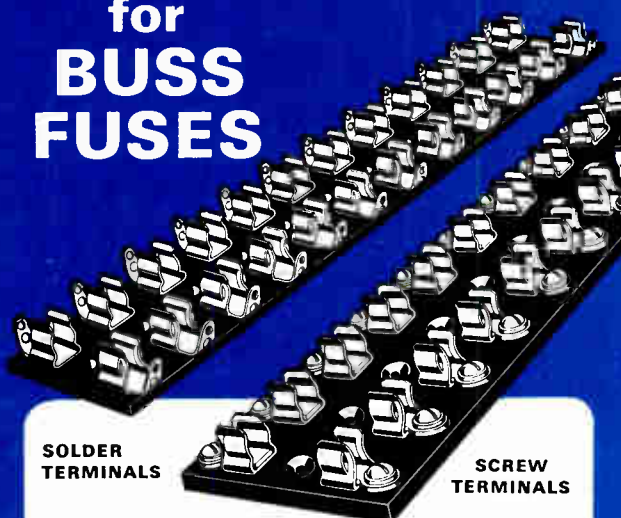

SOLDER TERMINALS
SCREW TERMINALS

Above standard types available in any number of poles — From 1 to 12... plus other types for every application.....

BUSS

Write for BUSS
Bulletin SFB

BUSSMANN MFG. DIV., Wallace-Sullivan Co., ST. LOUIS, MO. 63107

GMW FUSE
and HWA
FUSEHOLDER



FUSE SIZE
ONLY .370 x .250
INCHES

BUSS VISUAL INDICATING

Sub-Miniature FUSE-HOLDER COMBINATION

For space-tight applications. Fuse has window for inspection of element. Fuse may be used with or without holder.

Fuse held tight in holder by beryllium copper contacts assuring low resistance.

Holder can be used with or without knob. Knob makes holder water-proof from front of panel.

Military type fuse FM01 meets all requirements of MIL-F-23419. Military type holder FHN42W meets all military requirements of MIL-F-19207A.

BUSS

Write for BUSS
Bulletin SFB

BUSSMANN MFG. DIVISION, Wallace-Sullivan Co., St. Louis, Mo. 63107

Circle 33 on Inquiry Card

Circle 33 on Inquiry Card

NEW TECHNICAL DATA

Plastics Bulletin

Bulletin D-400, 16 pages, describes thermosetting molding compounds, bonding and coating resins, Hetron® fire-retardant resins for reinforced plastics, foundry resins, and Hetrofoam® polyols for fire-retardant rigid foams. Characteristics, typical properties and applications are all covered in the illustrated bulletin. Durez Plastics Div., N. Tonawanda, N. Y.

Circle 173 on Inquiry Card

Switch Literature

This brochure illustrates 5 basic selector switch modules that provide from 200 to 1000 switch combinations. Cherry Electrical Products Corp., P. O. Box CB438, Highland Park, Ill.

Circle 174 on Inquiry Card

Alumina Ceramics

Copies of the Alumina Ceramic Manufacturers Assoc. Standards book are available. Contained within this descriptive 12-page second edition are the fully described properties of high alumina ceramics. Also, general manufacturing procedures and many product uses are included. Diamonite Products Mfg. Co., Shreve, Ohio.

Circle 175 on Inquiry Card

Computer Grade Capacitor

Bulletin 2238, 12 pages, describes the type 556 computer-grade, axial-lead aluminum electrolytic capacitor. Operating temp. range is -40 to 105°C; voltage ratings are from 3 to 150vdc. Capacitance values are from 4 to 560 mfd. The capacitor uses a new header and seal to reduce weight loss and provide against electrolyte leakage. Sangamo Electric Co., Springfield, Ill.

Circle 176 on Inquiry Card

Ferrite Switch Cores

Ferrite switch cores, particularly designed for magnetic logic application, are described in Bulletins 894, 895 and 896. These bulletins provide complete performance specs. for 120, 150 and 250 mil cores, including material characteristics, definitions, and performance curves at various temps. of operation. Ferroxcube Corp. of America, Saugerties, N. Y.

Circle 177 on Inquiry Card

Circuit Modules

Data is available on 5 circuit modules—diode matrix 44 8040, single shot 8055, flip-flop 8070, power control 1 8081, and power control 2 8082. Series 8000 electronic circuit modules make up a 1mc product line that is designed to operate over a temp. range of 0 to +55°C. Bryant Computer Products, 850 Ladd Rd., Walled Lake, Mich.

Circle 178 on Inquiry Card

Calibration Systems

AC/DC calibration systems are detailed in this 2-color technical data sheet (15-54). Included are 6 different systems complete with mechanical and electronic specs. as well as system applications. Cohu Electronics, Inc., Kintel Div., Box 623, San Diego, Calif.

Circle 179 on Inquiry Card

Wire and Cable Catalog

The 12-page illustrated catalog describes a complete line of audio wire and cable. The catalog lists in sequence all types of single and multiconductor audio cables, pertinent construction details, and electrical characteristics. Phalo Corp., Dept. A., Shrewsbury, Mass.

Circle 180 on Inquiry Card

Soldering Machines

This bulletin describes wave soldering machines for printed circuits. It includes features and specs. of 2 new models plus information on fixtures and accessories. Copies are available from Leeson Corp., Coil Winding Machinery Div., Newton Branch, 26 Farwell St., Newtonville, Mass.

Circle 181 on Inquiry Card

Contact Springs

With O.D.'s from 0.40 to 0.500 in. and typical heights from 0.125 to 0.562 in., this new line of miniature non-inductive contact springs is ideal for diode and PC uses. The new design features 50% compression, long-life repeatability, and high-pressure follow-up. Additional data available from Servometer Corp., 82 Industrial East, Clifton, N. J.

Circle 182 on Inquiry Card

DC Tachometer

CRO 9610 001 is a magnetic compensated dc tachometer. This unit has a linearity of 0.05% and is especially designed for high accuracy, reliability, and long life. More data available from Kearfott Div., General Precision Aerospace, 1150 McBride Ave., Little Falls, N. J.

Circle 183 on Inquiry Card

Rotary Actuator

Bulletin F-9554-5 describes the NYLC line of rotary electromechanical actuators. This series of actuators was originally developed for the aerospace industry to replace actuators of greater size and weight. This brochure contains information on travel limit actuators, torque limit actuators, drive motors, thermal overload protection, gear trains and other items of interest. Photographs are shown of 8 variations. Wiring diagrams and various useful charts are also included. Electro-Mechanical Products Div., Barber-Colman Co., Rockford, Ill.

Circle 184 on Inquiry Card

Available at these Distributors

EAST

- Binghamton, N. Y.**—Federal Electronics
P. O. Box 208/PI 8-8211
- Philadelphia 23, Penn.**
Almo Industrial Electronics, Inc.
412 North 6th Street/WA 2-5918
- Pittsburgh 6, Penn.**—Radio Parts Company, Inc.
6401 Penn Avenue/361-4600
- Newton 58, Mass.**—Greene-Shaw Company
341 Watertown Street/WO 9-8900
- Clifton, N. J.**—Eastern Radio Corporation
312 Clifton Avenue/471-6600
- New York 36, N. Y.**—Harvey Radio Company, Inc.
103 West 43rd Street/JU 2-1500
- Baltimore 1, Md.**—Radio Electric Service Company
5 North Howard Street/LE 9-3835

SOUTH

- Birmingham 6, Ala.**—Forbes Distributing Company, Inc.
2610 Third Avenue, South/AL 1-4104
- West Palm Beach, Fla.**—Goddard, Inc.
1309 North Dixie/TE 3-5701
- Richmond 20, Va.**—Meridian Electronics, Inc.
1001 West Broad Street/353-6648

MIDWEST

- Detroit 3, Mich.**—Glendale Electronic Supply Company
12530 Hamilton Avenue/TU 3-1500
- Battle Creek, Mich.**—Electronic Supply Corporation
94 Hamblin Ave./P.O. Box 430
Phone: 965-1245
- Minneapolis 18, Minn.**—Admiral Distributors, Inc.
5305 Cedar Lake Road, St. Louis Park/545-0223
- Indianapolis 25, Ind.**—Graham Electronics Supply, Inc.
122 South Senate Avenue/ME 4-8486
- Cleveland 1, Ohio**—The W. M. Pattison Supply Co.
Industrial Electronics Division
777 Rockwell Avenue/621-7320
- Chicago 30, Ill.**—Merquip Electronics, Inc.
4939 North Elston Avenue/AV 2-5400
- Cincinnati 10, Ohio**—United Radio, Inc.
1308 Vine Street/241-6530
- Kansas City 11, Mo.**—Walters Radio Supply, Inc.
3635 Main Street/JE 1-7015
- St. Louis 17, Mo.**—Electronic Components for Industry Co.
2605 South Hanley Road/MI 7-5505

WEST

- Dallas 1, Texas**—Adleta Company
1907 McKinney Ave./RI 1-3151
- Houston 1, Texas**—Harrison Equipment Company, Inc.
1422 San Jacinto Street/CA 4-9131
- San Diego 1, Cal.**—Electronic Components of San Diego
2060 India Street, Box 2710, 232-8951
- Los Angeles 16, Cal.**—Radio Products Sales, Inc.
1501 South Hill Street/RI 8-1271
- Los Angeles, Cal. 90022**—Kierulff Electronics
2585 Commerce Way/OV 5-5511
- Mountain View, Cal.**—Kierulff Electronics
2484 Middlefield Road/968-6292
- Denver, Colo.**—L. B. Walker Radio Company
300 Bryant Street/WE 5-2401
- Seattle 1, Wash.**—C & G Electronics Company
2221 3rd Avenue/Main 4-4355
- Phoenix, Ariz.**—Midland Specialty Co., Inc.
1930 North 22nd Ave./258-4531
- Albuquerque, N.M.**—Midland Specialty Co., Inc.
1712 Lomas Blvd., N.E./247-2486
- Tucson, Ariz.**—Midland Specialty Co., Inc.
951 South Park Ave./MA 4-2315

Ask for a complete catalog

DELCO RADIO 
DIVISION OF GENERAL MOTORS, KOKOMO, INDIANA

400V 1.0A 2.5A SILICON TRANSISTORS

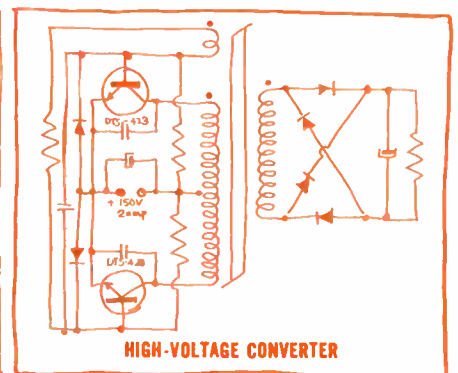
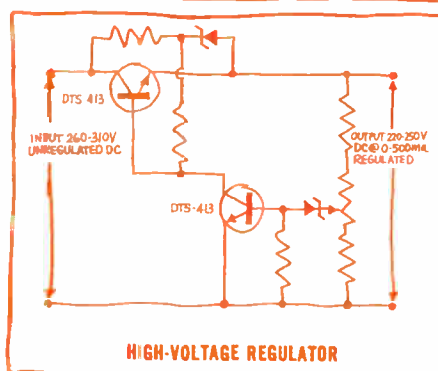
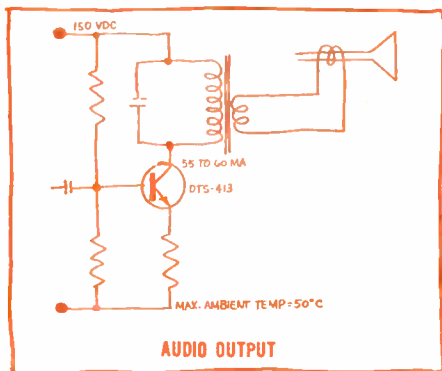
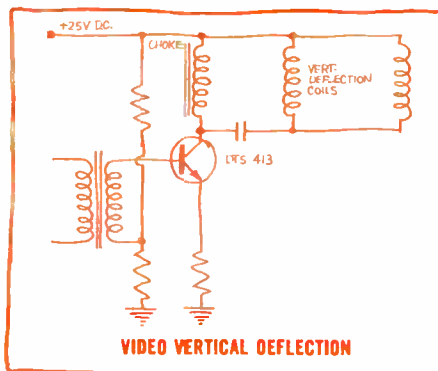
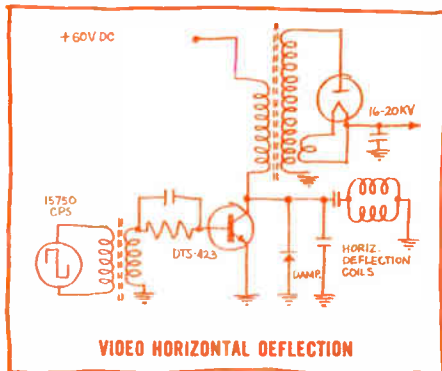

INEXPENSIVE

From Delco Radio, today, come two new silicon power transistors that transcend the known limits of semiconductor cost and capability. ■ **V_{ce0} 400V at less than three cents a volt—even in sample quantities!** ■ The DTS-413 and DTS-423 open the door to a host of new ideas, new circuits, new products and product improvements. ■ As an example, practical—and immediate—applications are both vertical and horizontal TV outputs. Large-screen all-transistor TV is, for the first time, technically and economically practical. ■ Delco's achievement also permits a reduction in current, reduction in size of other components, and a hike in efficiency in circuits where high energy output is needed. ■ High punch-through voltage, high frequency response, and low saturation resistance are provided by the silicon element itself, which is fabricated by our unique triple sequential diffusion process. ■ Complete freedom from "purple plague" and exceptional resistance to thermal and mechanical shock are a result of ultrasonic bonding of aluminum to aluminum base and emitter contacts. ■ Contact us right now for data sheets and prices. Be one of the first to take advantage of these Delco Radio high-voltage silicon power transistors.

| SYMBOL | PARAMETER | TYPE | CONDITIONS | DTS-413 | | | DTS-423 | | |
|-----------------------|---|--------------|---|---------|---------|------|---------|---------|-------|
| | | | | MIN. | TYPICAL | MAX. | MIN. | TYPICAL | MAX. |
| h _{rc} | Current gain | DTS-413 | I _c =0.5A, V _{ce} =5V | 20 | | | DTS-413 | 1A | |
| | | DTS-413 | I _c =1.0A, V _{ce} =5V | 15 | | | DTS-413 | 150°C | 150°C |
| | | DTS-423 | I _c =1.0A, V _{ce} =5V | 30 | | 90 | DTS-423 | -65°C | -65°C |
| V _{ce(Sus.)} | Sustaining voltage | DTS-413, 423 | I _c =50ma, I _a =2ma | 325 | | | | | |
| V _{ce(Sat.)} | Collector to emitter saturation voltage | DTS-413 | I _c =0.5A, I _a =0.05A | | 0.3 | 0.8 | | | |
| | | DTS-423 | I _c =1.0A, I _a =0.10A | | 0.3 | 0.8 | | | |

FIELD SALES OFFICES
UNION, NEW JERSEY*
Box 1018 Chestnut
Station
(201) 687-3770

DETROIT, MICHIGAN
57 Harper Avenue
(313) 873-6560

PALO ALTO,
CALIFORNIA
201 Town & Country
Village
(415) 326-0365

SANTA MONICA,
CALIFORNIA
726 Santa Monica Blvd.
(213) 870-8807

SYRACUSE, NEW YORK
1054 James Street
(315) 472-2668

CHICAGO, ILLINOIS*
5151 N. Harlem Ave.
(312) 775-5411

General Sales Office: 700
E. Firmin, Kokomo, Ind.,
(317) 452-8211—Ext. 500

*Office includes field lab and
resident engineer for applica-
tions assistance.

DELCO RADIO
DIVISION OF GENERAL MOTORS, KOKOMO, INDIANA

Is Your Knowledge of **Computer Fundamentals** &

TEST YOUR SKILLS IN THESE ELECTRONICS GROWTH AREAS

Engineers and technicians at General Electric, North American Aviation, ITT, General Dynamics, Raytheon, Philco, Douglas Aircraft, Continental Device, Automatic Electric, and other leading companies have selected 5 initial subjects in these areas for their own personal development.

Test **your** knowledge of these fundamental subjects. Here are some sample questions from comprehensive examinations being used in the electronics industry to measure performance in these areas. Try them yourself.

INTRODUCTION TO TRANSISTORS

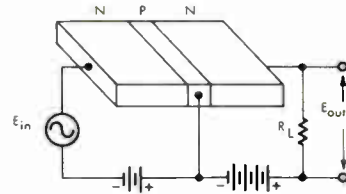

29.

- (a) The NPN transistor circuit illustrated above operates as a(n) _____.
- (b) With reference to the circuit shown above, **MATCH** the items below on the left with those on the right by placing one letter in each blank:
- | | |
|----------------------------|---------------------|
| A. base-collector junction | 1. high impedance |
| B. emitter-base junction | 2. input impedance |
| | 3. low impedance |
| | 4. output impedance |

PERT

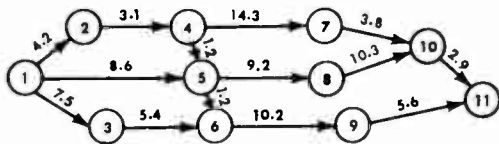

12. Examine the network you have just constructed.

- (a) Identify the critical path by giving the sequence of events along the path: _____.
- (b) Give the T_E which you calculated for the ending event of the network _____ weeks
- (c) It is now reported that activity 6-9 cannot be completed in less than 11.8 weeks. Will it still be possible to meet T_L ? yes no
- (d) If the changes mentioned in (c) above would make it impossible to plan completion of the project by the time the allotted span has run out, what can he do to replan so that he does meet the schedule?

BASIC TRANSISTOR CIRCUITS

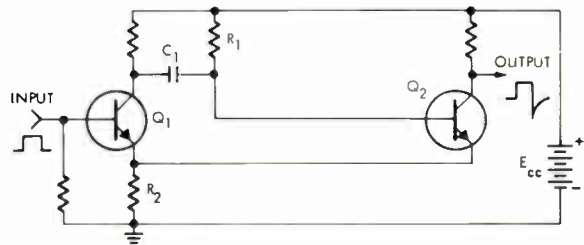

27.

- (a) The schematic diagram above shows an emitter-coupled one-shot _____.
- (b) In the stable state Q_1 is on off and Q_2 is on off.
- (c) The positive pulse turns on Q_1 which in turn: cuts off Q_2 turns on Q_2 .
- (d) When C_1 discharges, Q_2 is: cut off turned on.
- (e) When Q_2 conducts, drawing current through R_2 , Q_1 becomes _____ biased.

COUNTING SYSTEMS & BINARY ARITHMETIC

3. PERFORM THE FOLLOWING ARITHMETIC CONVERSIONS.

- (a) **CONVERT** the decimal numbers 85 and 35 into binary equivalents and
- (b) **ADD** their binary equivalents, then
- (c) **CONVERT** the sum back to decimal
- (d) **CONVERT** the decimal number 26 into its binary equivalent and
- (e) **SUBTRACT** it from the binary sum you found in (b)
- (f) **CONVERT** the result back to decimal
- (g) **CONVERT** the decimal number 20 into the form it would have been in number systems with a base of 2 _____ 5 _____ 8 _____.

BOOLEAN ALGEBRA (in development)

SHOW the Karnaugh map of the function $AB\bar{D} + \bar{A}\bar{C}\bar{D} + B\bar{C}\bar{D} + \bar{A}B + \bar{A}CD$ by **SHADING** the appropriate boxes in the diagram below:

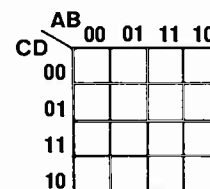

The Karnaugh map shows that the minimum inputs required for this function are _____.

Project Management Techniques Competitive?

CAN YOU REALLY AFFORD THE TIME TO UPGRADE YOUR KNOWLEDGE IN THESE ELECTRONICS GROWTH AREAS ?

PROGRAMMED INSTRUCTION COULD BE THE ANSWER FOR YOU—TAKE A LOOK AT THE PERFORMANCE DATA:

Most people **can't** take the time to search the literature, return to school, or take lengthy correspondence courses. So thousands of engineers and technicians are turning to PROGRAMMED INSTRUCTION, a new teaching technique based upon the findings of behavioral psychologists.

You are led through a carefully designed and tested self-instructional program in which the subject matter is carefully structured and presented in increasingly complex steps which assure that you will attain maximum learning in minimum time. This is why Programmed Instruction is "an ideal way to train engineers in technical subjects — they learn 10% to 25% more in half the time," according to Russell S. Pease, Engineering Consultant at Du Pont.

With the 5 subjects now available as the initial courses in a new programmed instruction series, you can master an entire subject in a day—and score 90% or better on a comprehensive final exam.

For example, when engineering members of the American Materials Handling Society took the PERT program at home in their spare time, they averaged 12.2 hours to complete the program and scored 90.1% on the final exam. Here is their individual performance data:

| Job Title | Fore-man | Ops. Mgr. | Proj. Eng. | Supervisor | | Pers. Mgr. | Chief Eng. | Traffic Mgr. |
|-------------|----------|-----------|------------|------------|------|------------|------------|--------------|
| Education | H.S. | B.S. | M.S. | H.S. | H.S. | B.A. | B.S. | B.S. |
| Time (hrs.) | 11.3 | 10.5 | 9.4 | 13.3 | 19.0 | 13.8 | 11.3 | 9.5 |
| Age (yrs.) | 36 | 22 | 44 | 48 | 52 | 47 | 47 | 50 |
| Score (%) | 94 | 97 | 97 | 94 | 92 | 87 | 80 | 79 |

FOLLOW THESE THREE SIMPLE STEPS:

To rate your own performance and skill needs in these subjects:

- 1) **Send for your 10-day review copies of the self-instructional programs.**
- 2) **Try the final examination included with each program.**
- 3) **If you are convinced that the skills imparted by the program are valuable, honor the enclosed invoice. Otherwise, return the programs and completed exams and pay nothing.**

Name _____

Title _____

Address _____

City _____ State _____

Company _____

My check or company purchase order is enclosed.

Bill me or my company directly.

Clip and send this coupon to:

Please send me the programs designated below. At the end of 10 days, I'll either send the indicated price, plus a few cents for packing and postage, or return the program and my completed final examination and owe nothing.

| TITLE | PRICE | |
|--|---------|--------------------------|
| PERT | \$12.50 | <input type="checkbox"/> |
| Introduction to Transistors | 9.50 | <input type="checkbox"/> |
| Basic Transistor Circuits | 9.50 | <input type="checkbox"/> |
| Counting Systems and Binary Arithmetic | 7.50 | <input type="checkbox"/> |
| Applied Electricity | 12.50 | <input type="checkbox"/> |

BASIC SYSTEMS INCORPORATED 2900 BROADWAY / NEW YORK, N. Y.

ELECTRONIC INDUSTRIES • December 1964

Circle 35 on Inquiry Card

87

EVERYTHING

from a to d

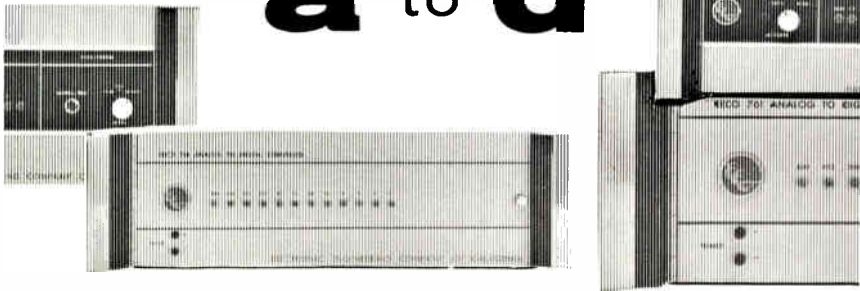

Now yours from EECO in 2 complete converter lines

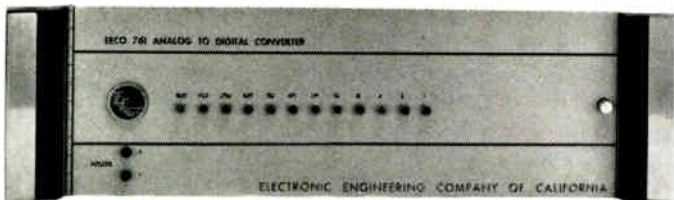

Series 761

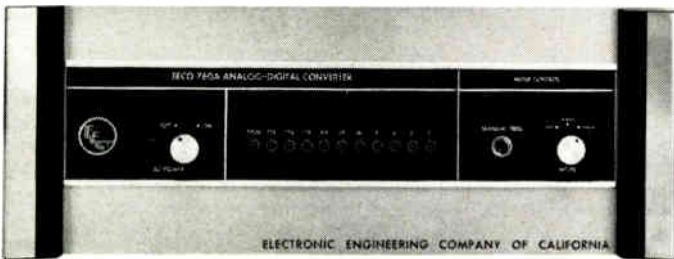

Series 760A

Take your pick—lower cost EECO 761 models with some quality features even high priced units don't have...or the greater speed, accuracy and sophistication of EECO 760A instruments.

Starting at \$1,800, EECO 761 models provide all solid-state construction...15,000 to 25,000 conversions/sec...choice of output—binary (up to 11 bits) or BCD (to 3 decimal digits and sign), parallel or serial...automatic and external command modes...and much more.

For higher speed systems, select an EECO 760A model with greater resolution and speeds of 44,000 to 60,000/sec...increased accuracy.

The big news is versatility...with selection from literally hundreds of models. By changing circuit cards or adding modules, EECO can provide exactly what you want—within your price range. With either series you can get: sample and hold with 100 nanosec aperture...capability to measure low-level signals...input impedance to 100 megs...and a second output register for added buffering into your system. And, in 760A models, you can also have multiplexing or digital-to-analog conversion built right into the unit.

Want versatility and value in A-to-D converters? Look to EECO for a wide range of data handling equipment (multiplexers, converters, memories, buffers)...timing products...automatic programming equipment...test instrumentation...and complete timing and data systems.

Write...wire...or phone



Electronic Engineering Company of California

1601 EAST CHESTNUT AVE. • BOX 58 • SANTA ANA, CALIF. • KIMBERLY 7-5501

MOBILE TELEPHONE



Improved mobile telephone system control head, developed by ITT Kellogg Telecommunications Division of ITT Corp., designed for use by Bell system and other telephone companies. It provides fully automatic, semiautomatic, and manual modes of operation for flexible mobile telephone service, says ITT.

SPRAGUE PROGRAM TO SPUR MICROCIRCUIT GROWTH

Sprague Electric Company has begun a broad program to promote microcircuit growth in which the basics of semiconductor device physics are coupled with those of modern network theory. This was revealed by Dr. John L. Sprague, senior vice president of engineering.

Object of the program is to produce rapidly a specific network transfer function to meet customer circuit needs, and to find a coherent approach to design and fabrication of integrated microcircuits.

An advanced development group has been set up for the program in the firm's microelectronics department, headed by Norton Cushman. The group will be headed by Dr. Robert S. Pepper, on a year's leave from University of California at Berkeley. Consultants for the program are: Dr. James H. Mulligan, Jr., Dr. Robert F. Cotellessa, and Professor Sidney S. Shamis, all of the department of electrical engineering of New York University.

NEW IEEE GROUP

The Industry & General Applications Division of the IEEE will become the I&GA Group on January 1, 1965, by approval of the Institute's Executive Committee.

The Division was formed in 1963 by the joining of the Industry Division and the General Applications Division, both set up under the original AIEE in 1948.

TESTING THERMAL CONDUCTIVITY

A new instrument developed by 3M, St. Paul, Minn. provides a highly accurate means of measuring heat transmission through a variety of basic materials, including metals, ceramics, plastics, glass, resins, and other solids. The unit uses a steady-state comparative method of measuring this quantity where the thermal conductivity of an unknown material is compared with that of a known material. It provides an accuracy of $\pm 5\%$.

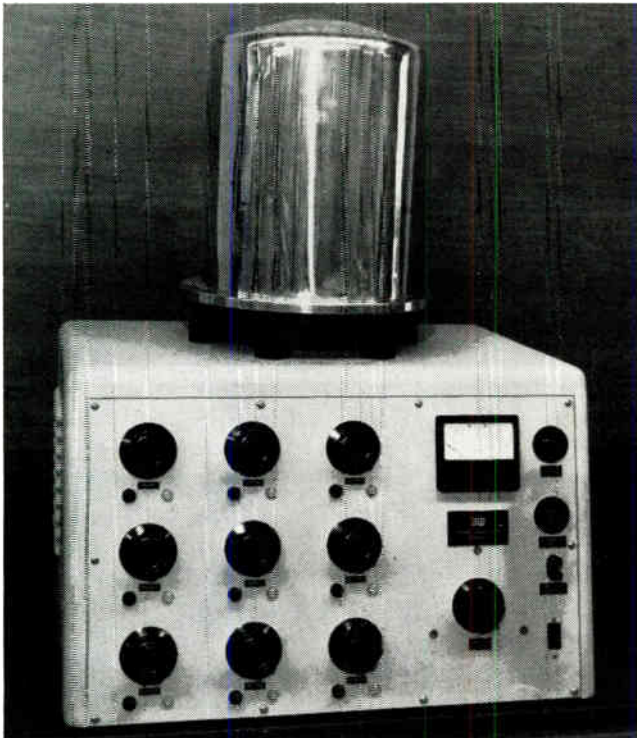

Using an electronic instrument called a "boomer," scientists from Edgerton, Germeshausen & Grier are surveying the surface contours and sub-surface geological structure of 160 square miles of the English Channel's ocean floor between Dover and Calais.

The "boomer" consists of a shipboard power unit which generates and transmits high-energy electrical pulses to a transducer towed underwater. The pulses are transmitted repetitively as fast as two per second, causing the transducer to emit powerful sound pulses that penetrate as much as 7000 ft into the layers of rock and sediment under the ocean floor, below waters more than three miles deep.

A new international unit of time was authorized on Oct. 8 at the Twelfth General Conference of Weights and Measures in Paris. It is an atomic definition of the second, temporarily based on an invariant transition of the cesium atom in expectation of a more exact definition in the future. This new definition replaces the definition of a second based on the annual orbit of the earth around the sun.

Significant in the action taken is that the accuracy of time measurements is increased to one part in one hundred billion—200 times greater than formerly achieved by astronomical means. Also, these measurements can be accurately determined in a few minutes compared to years heretofore.

Does Weston's new trade-in program for users of wire diameter automatic gaging equipment herald a new concept in electronic test instrument marketing? Weston's program has been initiated to acquaint owners of the older, vacuum-tube Microlimit Diameter Gages with the new transistorized models.

A new vernier-scale electric micrometer has a scale that enables the observer to easily read ratings to one part in a thousand, without the use of judgement of where the pointer is between graduation. The scale length, equivalent to $41\frac{7}{8}$ in., results from a secondary scale which enlarges the primary measurement into a scale by 10 times, regardless of the pointer position in the initial range. The instrument, developed by Phaostron Instrument & Electronic Co., So. Pasadena, Calif., has a 0-1ma range with 1μ a divisions.

A rapid (72-hour) instrument repair service in Columbus, Ohio, has been inaugurated by Contronics, Inc., 123 East Chestnut Street. Such service applies to products of Amprobe, Weston, General Electric, Simpson, Triplet, RCA, Hickok, Westinghouse and JBT, and includes repair and calibration certified to $\frac{1}{2}\%$ accuracy and traceable to NBS standards.

BEARING SOUNDS

This ultrasonic system allows factory mechanics to listen for wear in machine bearings and schedule replacements before breakdowns. A product of Delcon Corp., Palo Alto, Calif., the fully transistorized systems consist of an 11 in. long, stainless steel contact probe with high-gain, pre-amp circuitry responsive to ultrasonic energy in the 30 to 50 kc range. The ultrasonic translator detector (worn by operator) translates these h-f sounds into recognizable audible counterparts, giving clues to bearing distress before breakdowns.



In recent years there has been a demand for a convenient instrument to indicate when the microwave power density is "safe" at a given point. Present instruments have some drawbacks. The instrument described here eliminates some of the difficulties while using a standard gas-filled bulb.

Designing a Simple Microwave Power

**ELECTRONIC
INDUSTRIES**
**STATE OF THE ART
FEATURE**

IT IS GENERALLY AGREED now that 10 mw/cm^2 is the maximum average power density level in the microwave region to which a man should be exposed, and that levels between 1 and 10 mw/cm^2 are safe for inter-

mittent exposure. The presence of several microwave signals simultaneously, as might occur at some radar sites, creates the possibility of an integrated power density level exceeding the tolerance limit, even though those of the contributing signals considered singly may not. Also, it has been claimed that at high peak power levels there may be biological effects of microwaves other than those caused by simple heating.

An instrument capable of reading peak and average power density over the range of frequencies commonly used in radar was the object of the work leading to the instrument described below.

* * *

In the present work a small dc-excited neon or

argon bulb (NE51 or AR9) is the detecting element. Electromagnetic waves impinging upon the ionized gas change its parameters, which in turn changes the "impedance" of the bulb. According to how the bulb is connected and how the output is processed we may obtain a measure of the peak or average value of the impinging power. Two models of instruments were built to do this. In the first (Model I) the pulse height, width, and duration time of an impinging pulsed R-F signal were measured yielding enough information to obtain the average value. In the second instrument (Model II) the average value was obtained directly. In both instruments provision was made to obtain the average value of a CW signal.

Glow-Discharge Detector

The glow-discharge detector has never come into vogue because of its alleged lack of linearity and reproducibility. These are not serious drawbacks, at least in our application. In addition, the glow-discharge detector has a number of characteristics to commend it, as follows:

1. It is small; it causes virtually no perturbation of the field;
2. It is electrically rugged as compared to Hall probes, crystals, and bolometers;

The work reported here was supported by the U. S. Army Signal Corps under Contracts DA 36-039-SC-85177 and DA 36-039-SC-87251. *Now with American Electronics Laboratories, Colmar, Pa.

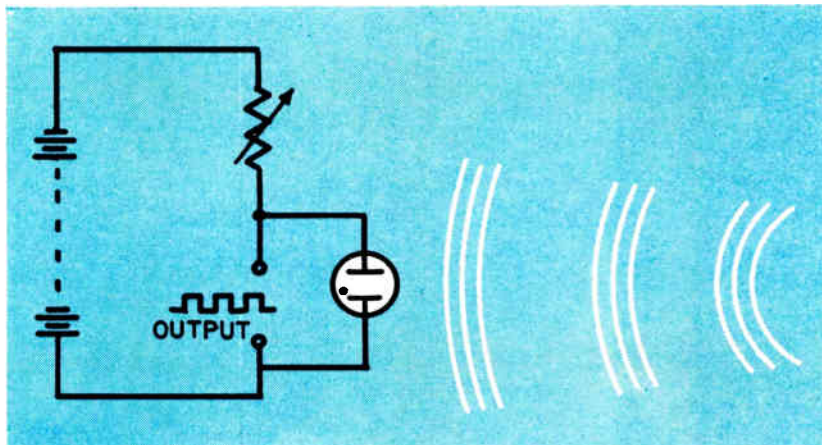

Fig. 1: The basic circuit for pulse power detection is shown in the sketch. A gas-filled bulb such as a neon or argon bulb is used as the detecting device. This type of detector features low cost, is rugged, has broadband response, does not need a collector or antenna, and has a very good range of sensitivity.

By JEROME CHODER,* NABIL FARHAT, PhD
and RICHARD F. SCHWARTZ, PhD

Moore School of E. E.
University of Pennsylvania
200 So. 33rd Street
Philadelphia, Pa. 19104

Density Meter

3. It requires no additional antenna or collector in contrast to crystals and bolometric elements;

4. It is quasi-omnidirectional, and with modification probably could be made completely omnidirectional;

5. It has a range of sensitivity comparable to the best of other devices;

6. It has a broadband frequency response.

The drawbacks are as follows:

1. The output signal as a function of impressed power density is non-linear (see comments below);

2. The response falls off at higher frequencies as predicted by theory;

3. The application of pulsed microwave power does not result in an exact replica of the pulse envelope;

4. Results vary from glow-lamp to glow-lamp due to the fact that in the tubes used, there was no quality control on those factors which are important here.

These points merit some discussion. The non-linear behavior is observed as a "saturation" effect. The output voltage of the detector is given by $v=AS^k$ where A and K are constants and S is the power density. For low power levels the exponent k is fixed, being roughly 0.75 to 0.80 for all gases tested, but at higher levels its value decreases. This effect can be taken care of in the calibration of the instrument.

The drop-off in response at higher frequencies is an effect that places an upper-bound on the frequency of use. The drop-off for the tubes tested began around 5.4 gc and continued to the highest frequency tested. It is believed that the drooping characteristic can be modified by adjusting the various parameters to give uniform response over a wider frequency range.

The limitations on pulse response are highly dependent on the tube type used and depend upon the gas and its pressure. Rise times of less than a microsecond have been reported.⁴

The drawback arising from poor quality control is one which can be overcome. If it is decided to

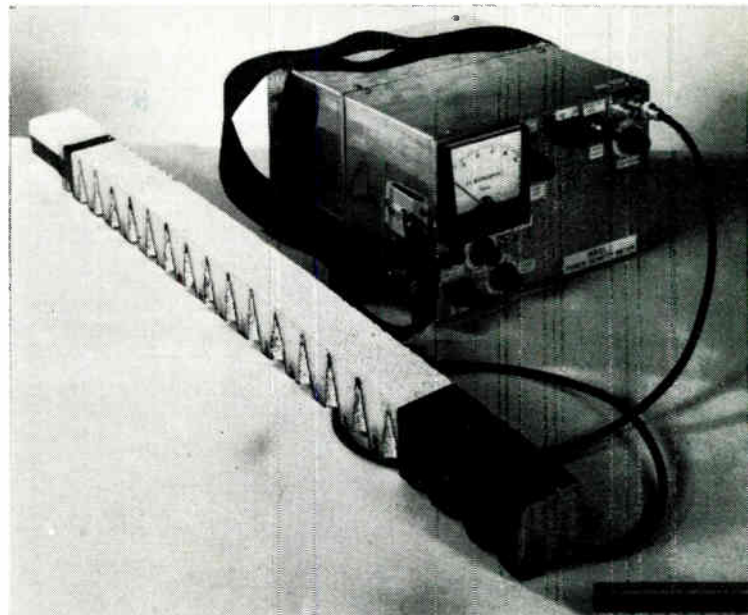

The first power density meter built is battery operated. Bulb is at the far end of the absorbing material. Material shields cable from the field to prevent any perturbation.

commercially manufacture an instrument using the glow-discharge detector, it will be necessary to make the detection properties uniform from tube to tube.

Detector Circuit Configuration

The basic circuit for pulse power detection is shown in Fig. 1. It is clear that the external circuit, including the long leads of the probe, plays a role in the pulse response. In the models developed a compromise between various factors was found.

In Fig. 1 incident CW power density will cause a small dc change superimposed on a large dc value. A bridge arrangement was found to be more suitable for observing this change as shown in Fig. 2. In this arrangement the incident R-F power unbalances the bridge. In the early experiments R_1 was a glow-discharge tube, shielded from the external radiation, nearly identical to the detector tube. We found that this arrangement was sensitive to drift and that an ordinary resistor, as shown, could be used to better advantage.

The basic block diagram for Model I is shown in Fig. 3. The gas tube current is supplied by a battery with adjustable series resistors. When the instrument is operated for pulse power density measurement, the output signal will be passed through an adjustable attenuator to provide the range in amplitude required, and an amplifier to supply the drive needed for the detecting circuits. Three pieces of information are then abstracted from the signal: the pulse width, the pulse repetition rate, and the peak value. From these data the average power density may be obtained by taking the product of all three.

The basic block diagram of Model II is shown in Fig. 4. As with Model I, the functional aspect is emphasized. The initial stages of this instrument

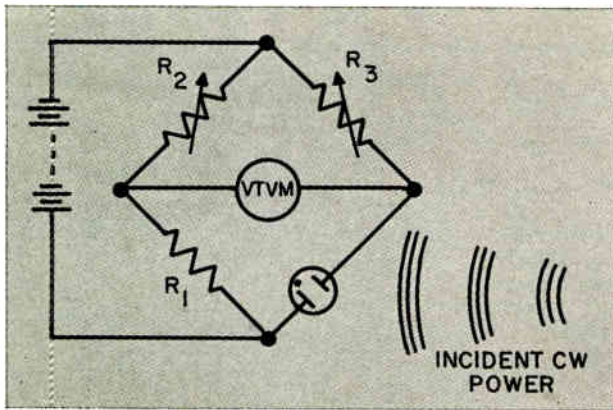

Fig. 2: Bridge arrangement is better for observing incident CW power density than the basic circuit shown in Fig. 1.

MICROWAVE METER (Continued)

are similar to those of Model I. The peak detecting circuit likewise is the same. The average-value detector, however, differs in being a modification of the usual peak detector circuit. The advantage sought was to eliminate having to multiply three factors to obtain the average value, and to provide direct averaging of the effects of more than one microwave source.

The peak detector is an adaptation of the circuit called "peak" or "quasi-peak" in the literature in accordance with the choice of relative charge and discharge time constants. Its fundamental form is shown in Fig. 5.

D is a semiconductor diode usually chosen to:

1. have as sharp a break as possible in the I-V characteristic,
2. provide as low a value of resistance as possible in the forward direction,
3. provide a high value of reverse resistance, and
4. have good reverse recovery characteristics.

C is an integrating capacitor which, after the imposition of a number of pulses, becomes charged very nearly to the peak voltage value of these pulses,

Power density meter Model II permits reading the average value of the field directly without any calculations.

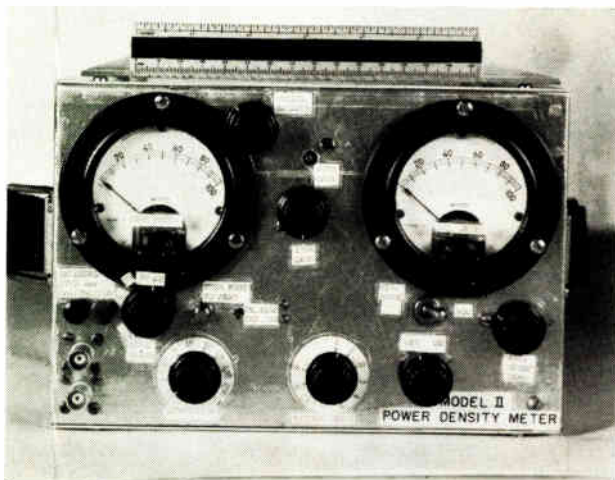

provided the resistor R has been chosen so as not to provide too great a discharge in the interpulse intervals. The values of R and C in the present instrument were chosen to function well for durations, at the peak value, of greater than 0.5 μ sec. at repetition rates greater than 500 pulses/sec.

The width detection circuit is shown in Fig. 6. A Schmitt trigger circuit is used to generate a constant amplitude pulse of the same width as the original pulse. This pulse controls the "on" time of a ramp generator causing its peak output to be proportional to the width of the applied pulse. The final amplitude of the ramp is measured by the peak reading circuit.

The output of the Schmitt trigger circuit triggers a saturating monostable multivibrator, in Fig. 8. The output of this circuit is a constant length pulse of amplitude determined by the battery voltage. This pulse is of such polarity that when the dc component is removed and the signal is applied to the peak detecting circuit, the meter reading is proportional to the repetition rate.

Average Value Detector

The average value is obtained by using a circuit which resembles the peak detector, Fig. 7. However, the choice of parameters is such that the capacitor no longer charges to the peak voltage value of the impressed pulses. Rather, there is a voltage developed across the capacitor that is about proportional to the restored dc component of the pulse. The function could have been performed by a more conventional dc restorer (or clamping) circuit, but various considerations led to the present solution.

There is little that needs to be added to the description of CW measurement given previously. The bridge circuit shown in Fig. 2 is conventional and no great difficulties were experienced. The VTVM used as a bridge detector follows normal circuit techniques of commercial instruments. The input impedance of the circuit is greater than 1 megohm at all ranges. The VTVM circuit is also used to read the peak detector output.

Gas Tube Selection

The rise time, sensitivity, and pulse shape of the output of the gas tubes checked vary with the tube current and the ac impedance seen by the tube. The circuits following the gas tube fix this ac impedance but permit a range of variation of the current to allow different tubes to be used, since tube characteristics vary markedly even within tubes of the same type.

For accurate operation the tube output voltage pulse shape must resemble the original microwave power modulation envelope (ideally rectangular). The output pulse shape will vary with the tube current, but for most tubes tested there is some value of tube current for which the output pulse shape is

Fig. 3: The basic block diagram for Model I power density meter indicates the circuitry required in the instrument. Three pieces of data are abstracted from the signal: pulse width, pulse rep. rate, and peak value. From this we can obtain the average power density of the field.

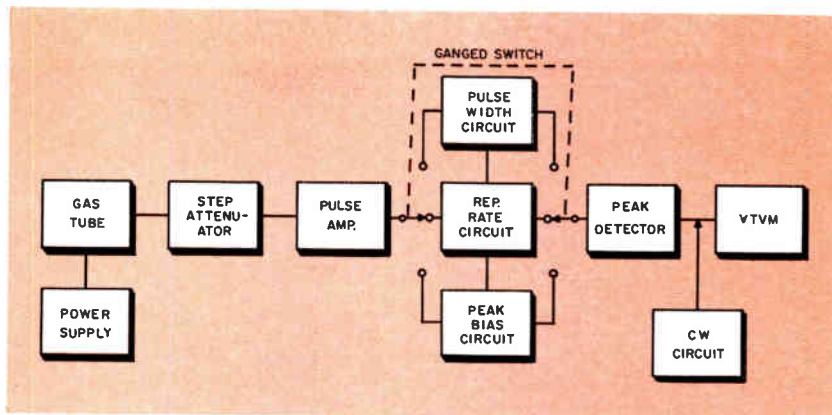

satisfactory. To reduce battery drain, tubes yielding good pulse shapes at low currents are preferred.

When the tubes were used with the circuits of the instruments, the initial slope of the output pulse varied little with tube dc current. Thus, the rise time of the pulse was noted only after an otherwise satisfactory pulse shape (i. e. a flat top) was obtained. This, together with sensitivity considerations, provided additional means for tube selection.

The procedure outlined above was followed with a variety of tubes in a free field at 2.85 gc for incident peak power densities on the order of 1 mw/cm². No change in pulse shape was observed due to changes of frequency over the frequency range tested.

No significant change in pulse shape was observed as power density was varied up to about 20 mw/cm² peak. Tests in confined fields simulating higher free field power density indicate that the pulse shape changed somewhat at higher power densities.

Single Signal Performance

The models were subjected to tests to ascertain their performance. Under controlled free field conditions Model I indicated peak values, pulse widths, and repetition rates over a frequency range of 1.0 to 5.8 gc. Model II was designed to indicate peak and average power density over the same frequency range. There was no reason to expect a sharp departure from uniform response below 1.0 gc. At the higher end of the spectrum, theory predicts the dropping off of the response.

At higher power levels the constants in the power-law response given previously change from the values determined at low levels. Each tube requires a cali-

bration curve to supply the correct peak power density in terms of the indicated reading. A similar correction is necessary for CW indication. Table 1 summarizes the performance.

Note that gas tube parameters are listed separately and that in general the measuring circuits are capable of greater resolution in pulse measurement than the gas tube is capable of yielding. Certainly, the 2 μsec. rise time limitation imposed by the tube is not as short as the circuit is capable of detecting, nor is 2 μsec. a particularly realistic value in terms of usual pulse parameters. However, there were some experiments in which shorter gas-tube rise times were observed. All of the factors governing the rise time are not yet understood. It is supposed, however, that it will be possible to consistently get much better rise time response when all of these unknowns are identified and brought under control.

The probable errors listed have not been carefully cataloged and represent a best guess on performance. It is possible that the error may be much less.

Combined Signal Performance

The Model I Power Density Meter was subjected simultaneously to two pulsed signals both having nominal PRFs of 1000 pps and nominal pulse widths of 8 μsec, one at 4.0 gc, the other at 1.0 gc. The pulse peak as measured by the power density meter fluctuated between 38 and 42 mv. Next, the pulse peak was observed when each signal was present alone. The corresponding readings on the meter were 34 mv and 22 mv which add up to 56 mv, a value larger than the peak measured when both signals are pres-

Fig. 4: The initial stages of Model II are similar to those of Model I. The average-value detector differs in being a modification of the usual peak detector circuit. This eliminates having to multiply three factors to obtain average value.

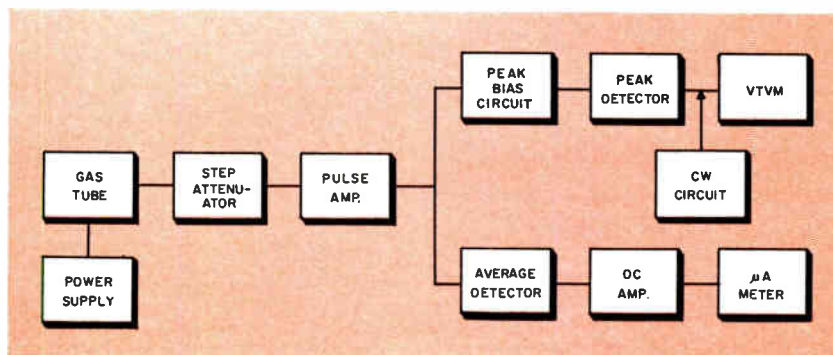

• A REPRINT of ANY ARTICLE in this issue is available from ELECTRONIC INDUSTRIES Reader Service Department.

Change colors
of clear
miniature
lamps

AT WILL!
AT ONCE!

with
SILIKROME™
COLORED FILTERS

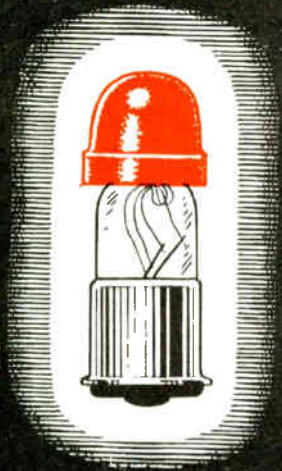

- EASILY SLIPS OVER LAMP
- ELASTOMERIC, UNBREAKABLE, REUSEABLE
- HIGH UNIFORMITY AND STABILITY OF COLOR
- IMPERVIOUS TO CONTAMINENTS

Send for further technical information.

APM-HEXSEAL CORP.

SILIKROME™
DIVISION

41 Honeck St., Englewood, N. J.
Tel.: (201) LO 9-5700

SEAL WITHOUT REDESIGN WITH HEXSEALS*
SEELSKREWS* SEELBOLTS* SEELRIVITS*
RUBRGLAS-SEELS* SILIC-O-RINGS*

*Trade Mark

MICROWAVE METER (Continued)

TABLE 1

Performance Summary for Single Signals

| Gas Tube | |
|---|--|
| Operating Current | 1.25 ma (nominal) |
| Rise Time (10% to 90%) | 2 μ sec |
| Frequency Range | |
| High Freq. | 5800 mc (down approx. 50% in response) |
| Low Freq. | approx. uniform down to 1000 mc; probably unchanged to 100 mc |
| Directional Response | $\left(\frac{\text{min. response}}{\text{max. response}} \right)$ 0.58 (electrodes parallel to E-field) |
| Circuits | |
| | Model I |
| Rectangular Pulse Input Characteristics | |
| Duty Factor | 0.001 to 0.025 |
| PRF | 500 to 2000 pps |
| Pulse Width | 2.5 to 10 μ s |
| Pulse Amplitude | 30 mv to 219 v |
| Pulse Rise Time (10% to 90%) | 0.5 to 2.0 μ s |
| Range of dc Input (CW operation) | 0.5, 1.0, 5.0, 10.0 v full scale |
| | Model II |
| | 0.001 to 0.025 |
| | 2.5 to 20 μ s |
| | 50 mv to 25.6 v |
| | 0.5 to 2.0 μ s |
| | 0.5, 1.0, 5.0, 10.0 v full scale |
| Probable Max. Error at Room Temp. | |
| Amplitude | $\pm 10\%$ |
| Repetition Rate | $\pm 10\%$ |
| Pulse Width | $\pm 10\%$ |
| Average Value | $\pm 10\%$ |

TABLE 2

Performance for Two Pulse Sources Applied

| Applies to Model No. | Condition | Indication |
|----------------------|---|--|
| I and II | 2 sources have about the same peak power level | peak reading $\left\{ \begin{array}{l} \leq \text{sum of peaks} \\ \geq \text{larger peak} \end{array} \right.$ |
| I | same | width reading $\left\{ \begin{array}{l} \leq \text{sum of widths} \\ \geq \text{wider pulse width} \end{array} \right.$ |
| I | same | rep. rate reading $\left\{ \begin{array}{l} \leq \text{sum of rep. rates} \\ \geq \text{higher rep. rate} \end{array} \right.$ |
| II | same | av. reading = average of two sources |
| I and II | One source has power level much different from other, causing large difference in gas tube output | peak reading $\left\{ \begin{array}{l} \leq \text{sum of peaks} \\ \geq \text{larger peak} \end{array} \right.$ |
| I | same | width reading = width of higher ampl. pulse |
| I | same | rep. rate reading = rep. rate of higher ampl. pulse |
| II | same | av. reading = average of larger ampl. pulse |

Note: Each source itself satisfies the instrument requirements and yields on-scale readings; how-

ever, superposition may result in off-scale readings.

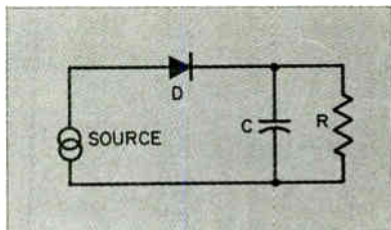

Fig. 5 (above): Sketch shows the fundamental form of the peak detector circuit.

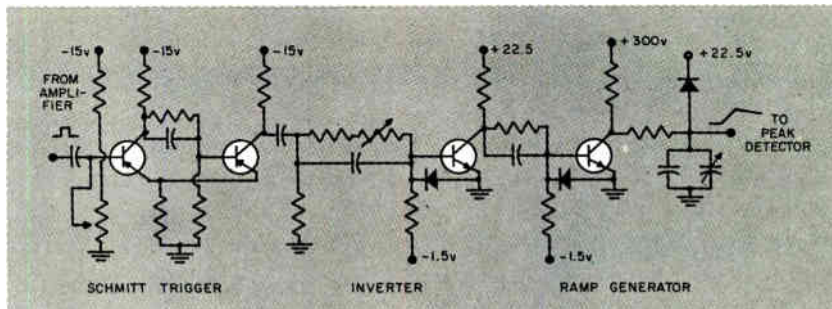

Fig. 6 (right): The pulse width detector

ent. The discrepancy is believed to be due to the fact that the two signals are not synchronous, a fact verified by measuring the repetition rate when the two signals were present. The reading was around 1600 pulses/sec.

By nature the averaging technique will give the time average of signals with rapidly varying pulse widths and repetition rates and integrate gas tube voltages due to more than one source of microwave power. However, both the design of Model II and the gas tube's characteristics limit the applicability of the technique. In the average semiconductor diode the displacement from the origin of the virtual break point in the I-V characteristic causes an amplitude-dependent error in the average reading. Since multiple power sources may produce similar average power densities while grossly different peak power densities are present, the previously-mentioned error may result in a disproportionate addition of the effect of the two sources. Model II tends to *reduce* the effect of the smaller amplitude pulse in producing the average reading.

The gas tube output voltage is not generally linear with power density. As a result, the peak output voltage must be known so that the tube calibration chart can be used to obtain the peak power density. This value must also be used in computing average power density after reading the average meter on

Model II in accordance with the following formula:

$$\text{avg. pwr. density} = \frac{\text{peak pwr. density} \times \text{avg. meter reading}}{\text{avg. range switch indication} \times \text{peak meter reading}}$$

Since the peak detector gives an indication only greater than or equal to the higher amplitude pulse, for multiple sources, and this is the number that is used to find peak power density and hence to compute average power density, the correct tube sensitivity for a lower amplitude pulse will *not* be used. The shape of the tube characteristics will cause Model II to *overemphasize* the average value of the smaller amplitude signal. The error will depend upon the shape of the gas tube characteristics in the region of operation.

Conclusions

Several conclusions can be drawn regarding the gas-tube technique when integrated into an instrument. It is apparent that the technique does work within certain limits and the two models are but two embodiments of the general concept. Further R & D should diminish the significance of the limitations.

On the positive side of the ledger we have a portable, broadband, omnidirectional instrument, using no antennas, sensitive to any polarization (but not necessarily equally so), rugged electrically, and capable of being calibrated to read power density with certain limitations. As compared to existing instruments the present technique has some merit. Field-intensity-reading instruments are much more complicated, require antennas, and are not very portable. Two commercial power density instruments work with interchangeable directional antennas to cover the band; a third one, while using only one broadband antenna, still has directional characteristics. With respect to commercial power density meters, the Model I is novel in that it provides information on peak power density pulse width and repetition rate in addition to average power density.

The authors would like to acknowledge the assistance of Mrs. Ping Tsao in this work.

References

1. Mumford, W. W., "Some Technical Aspects of Microwave Radiation Hazards," *Proc. IRE*, 49, p. 427; February 1961.
2. *Radar Electronic Fundamentals*, War Dept., United States Gov't. Printing Office, p. 74; 29 June 1944.
3. Reich, H. J. (editor), *Very High Frequency Techniques*, Vol. II, McGraw-Hill Book Company, New York, p. 607; 1947.
4. Schwartz, R. F., et al., "Study of Power Density Measurement Techniques," Final Report, Contr. DA 36-039-SC-85177, Moore School Report No. 62-12, University of Pennsylvania; 31 January 1962.

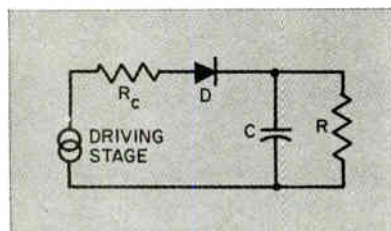
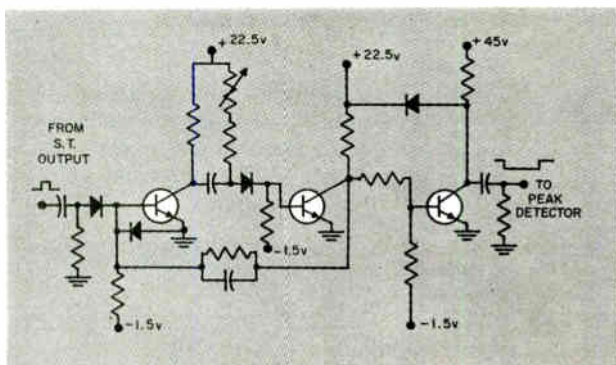
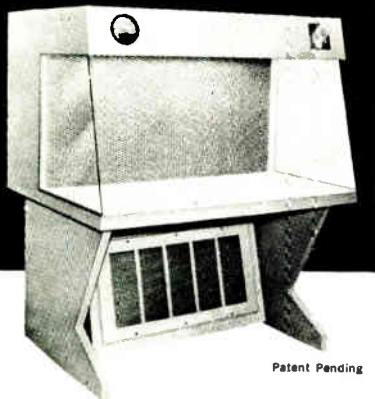

Fig. 7 (left): The average value detector circuit resembles the peak detector.

Fig. 8 (below): The repetition rate detector is a saturating monostable multivibrator.



REDUCE Vibration 90% WITH "ATCOR" LAMINAR FLOW ULTRA-CLEAN BENCHES



Patent Pending

**Provides clean air
for several benches
simultaneously from
one generator**

- new design eliminates 90% of all normal vibration usually caused by blower motor
- air generator can be wheeled out of clean area for repairs
- HEPA filter 99.97% efficient on all particles 0.3 micron or larger
- full HEPA filters, no center strip to disrupt Laminar Flow
- fluorescent overhead lighting provides 150 FC
- magnehelic gauge standard on all models
- available work areas from 2' to 12' wide x 2' to 6' high
- 100 to 150 velocity of Laminar Flow
- plastic laminated exterior
- vibrator reduction feature available on all Model G ultra-clean benches

Complete details available from:



**ATMOS-TECH
CORPORATION**

Route 9, Woodbridge, N. J.

Designers and Manufacturers of
Environmentally Controlled Enclosures

Circle 38 on Inquiry Card

NEW TECH DATA

Data Acquisition Concept

Information is available on a new data acquisition concept which offers a number of advantages over conventional approaches. The system will save several hundred pounds of wire alone in an airborne application. Other advantages over conventional systems include greater reliability, lower cost, and the ability to continuously monitor large amounts of data. Electronic Specialty Co., 4561 Colorado Blvd., Los Angeles, Calif.

Circle 162 on Inquiry Card

Plastic Film Capacitors

This catalog gives complete specs for a line of instrument grade, plastic film capacitors. Each capacitor description is supplemented with characteristic curves. In addition, a separate section lists prices. Midwec, Oshkosh, Nebr.

Circle 163 on Inquiry Card

Particle Detector

Product bulletin 216 describes the model 216 ultrasonic particle detector, which uses ultrasonic techniques. These techniques permit non-destructive testing of transistors and other semiconductor devices for foreign particles, detached leads, and similar defects within the device case. Foreign particles as small as 50-100 micrograms are detectable by this technique, as are other mounting and mechanical defects which are not detected in electrical tests of the device. Delcon Corp., 943 Industrial Ave., Palo Alto, Calif.

Circle 164 on Inquiry Card

Integrated Circuits

Data is available on 3 new monolithic integrated circuits for use in DTL logic circuits. Offered in either a TO-5 can or a flat pack, the new units are the RC221, a dual 2-input NAND/NOR gate, the RC222, a single 3-input NAND/NOR gate, and the RC229, a dual 3-input NAND gate. Designed primarily for commercial and industrial uses, the RC-221 and 222 feature high speed with a turn-on time of 22nsec. and a turn-off time of 24nsec. Raytheon Co., 350 Ellis St., Mountain View, Calif.

Circle 165 on Inquiry Card

Harness Fabrication Catalog

This 40-page illustrated catalog describes the Ty-Rap method of harness fabrication. It includes specs. for clamps, straps, tools and accessories. The new catalog fully describes the various types of Ty-Rap devices, how and where they are used, and includes full-size illustrations of each. The Thomas & Betts Co., 36 Butler St., Elizabeth, N. J.

Circle 166 on Inquiry Card

Capacitor Bulletin

Bulletin UY01 describes a line of micro-miniature ceramic fixed capacitors in an enclosure 7/64 in. sq. and 1/16 in. thick. The new line has capacities that range from 0.5 to 62pf. JFD Electronics Corp., 1462 62nd St., Brooklyn, N. Y.

Circle 167 on Inquiry Card

new...

Malco

MULTI-CRIMP RING AND SPADE TERMINALS



Malco's new "Multi-Crimp" Terminals offer the electronics industry extreme versatility in wire crimp operations. Wire sizes from 12 AWG through 18 AWG and 16 AWG through 24 AWG can now be crimped with one terminal for each range. In either case, this is accomplished with one setting of the Malromatic high speed crimp machine.

You need only *one* terminal with *one* machine setting to crimp *five* wire sizes!

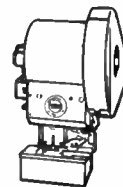

MALROMATIC
CRIMP MACHINE

The new "Multi-Crimp" terminal line includes a wide variety to meet your most exacting requirements plus heavy duty types for larger wire sizes.

REQUEST BULLETIN 605

Malco MANUFACTURING COMPANY, INC.

4037 W. LAKE ST., CHICAGO, ILLINOIS 60624
Circle 39 on Inquiry Card

ELECTRONIC INDUSTRIES • December 1964

RESCUE RADIO



Vest pocket size two-way radio, developed by Sylvania Electric Products Inc., is now being tested by the Navy as a rescue aid for downed airmen. Handset emits a signal on a distress frequency as soon as a flier's parachute opens. It has a built-in antenna, rechargeable battery, uses thin-film circuits, and weighs less than 22 oz.

NEW TECHNIQUE ELIMINATES 'KEEP ALIVE' ELECTRODES

New techniques can eliminate "keep-alive" electrodes from microwave system crystal protector tubes, report engineers at Westinghouse Electronic Tube Division. This insures protection for touchy elements, such as mixer crystals, from random high-power signals even though power is off in the entire system, they say.

The new techniques stem from a new approach to the use of radioactive isotopes in transmit-receive (TR) devices.

Crystal protector tubes have been tested at S- and X-band ranges. Westinghouse engineers expect the tubes ultimately will result in improved performance of transmit-receive devices because of a built-in improvement in life and stability.

NEW BIOMEDICAL UNIT BASED ON MIT COMPUTER

A commercial version (LINC) of the biomedical computer developed by Massachusetts Institute of Technology has been introduced by Digital Equipment Corporation.

According to the company, the compact LINC (Laboratory Instrument Computer) not only speeds routine operations in biomedical research, but makes possible wholly new techniques for investigating and analyzing data.

Features, Digital reports, include: front mounted controls, indicators, and connectors, plus a built-in cathode ray tube display.

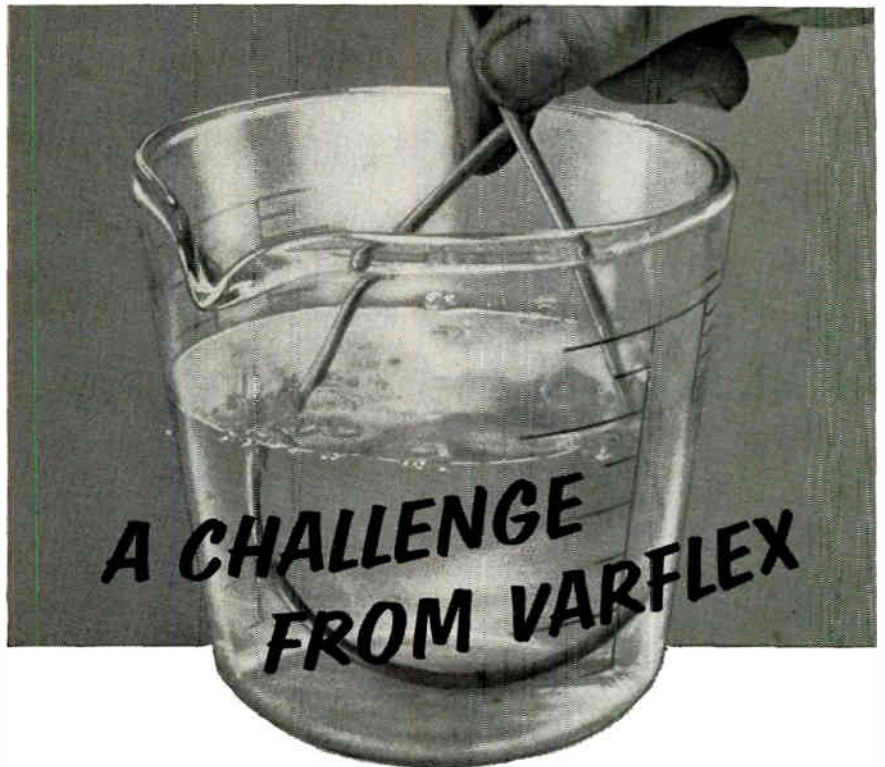

GIVE *Varglas* **ACRYLIC** (CLASS B SLEEVING) the "Acid Test"...

... or any tests you can think of for organic solvents, oils and water. Even to alkalis it exhibits surprisingly strong resistance.

Put the heat on it. Subject it to temperatures up to 150°C. over a long period. Go even further: expose it to 225°C. for 15 minutes. There will be no softening, flowing, blistering, or loss of dielectric strength. Like all Varflex products, Varglas Acrylic is made to exceed Government, IEEE and NEMA standards by far.

Made of modified acrylic resin on Fiberglas braid, this sleeving is compatible with polyester, acrylic, epoxy, phenolic, and formvar enamels. It can be ordered in a full range of sizes and coding colors.

You'll find our service on the same high level as our products: immediate off-the-shelf shipment or on special production, one week.

VARFLEX CORPORATION, 308 N. Jay Street, Rome, N. Y.

SEND FOR FREE FOLDER OF

ACTUAL TEST SAMPLES

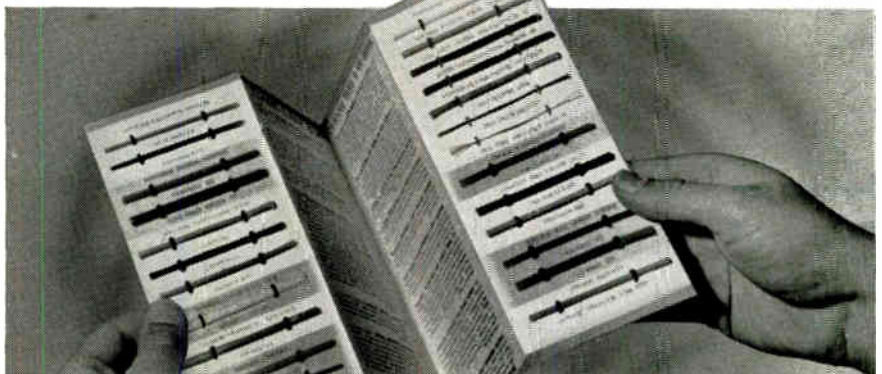

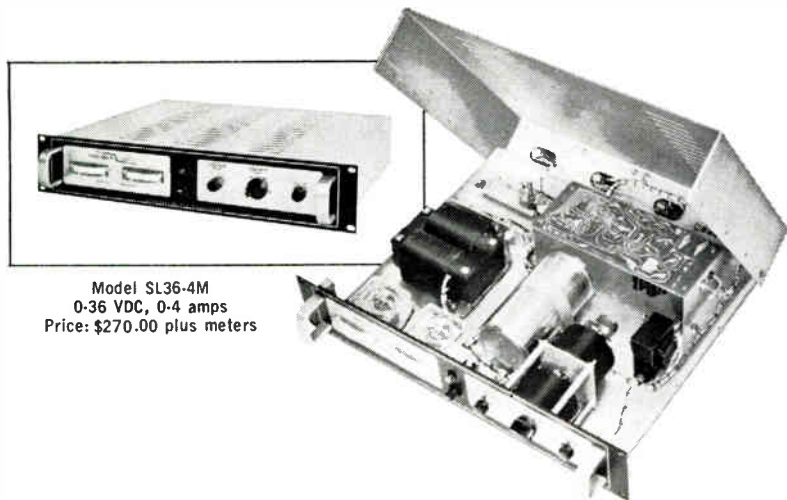

Model SL36-4M
0-36 VDC, 0-4 amps
Price: \$270.00 plus meters

All new, low cost, All-Silicon Magitran® "SL" variable power supplies for systems applications.

The new Magitran "SL" series provides the high stability, high temperature operation and other benefits of silicon power supplies at costs lower than most available germanium equivalents. These all-new ERA units have been specially designed and priced for systems applications. The use of optional current and voltage meters makes them suitable for general laboratory applications as well. This flexibility plus exceptionally low prices makes these Magitran units your *best buy* in high current variable power supplies. Write today for new literature.

SPECIFICATIONS

Input Voltage Range: 105-125 VAC
Input Frequency Range: 50-400 cps
Regulation Line: $\pm 0.01\%$ or 5 mv
Regulation Load: 0.05% or 8 mv
Long Term Stability: Less than 8 mv,
constant line, load and temperature
Ripple: Less than 1 mv, RMS
Transient Response: Less than 50 μ sec
Operating Temperature: -20°C to $+65^{\circ}\text{C}$
Temperature Coefficient: 0.01%/°C or 2 mv

Short Circuit Protection with automatic
recovery
Automatic Overload Recovery
Remote Sensing
Parallel and Series Operation
Vernier Voltage Control
Output Terminals (Ungrounded): Location,
rear
Reverse Voltage Protection
Cooling: Convection

| MODEL | VOLTAGE VDC | CURRENT | PANEL SIZE | PRICE |
|----------|---------------|---------------|------------|--------|
| SL36-2 | 0-36 VDC | 0-2 amps | 3½" x 9½" | \$215. |
| SL36-2/2 | 0-36 VDC Dual | 0-2 amps Dual | 3½" x 19" | 415. |
| SL36-4 | 0-36 VDC | 0-4 amps | 3½" x 19" | 270. |
| SL36-8 | 0-36 VDC | 0-8 amps | 5¼" x 19" | 335. |
| SL36-12 | 0-36 VDC | 0-12 amps | 7" x 19" | 435. |

Note: Add \$30.00 and suffix M for current and voltage meters.
(Model SL36-2/2 add \$60.00)



Also DC Power Modules, Inverters, Converters,
Frequency Changers, Special Test Equipment.

ELECTRONIC RESEARCH ASSOCIATES, INC.

DEPT. EI-12, 67 FACTORY PLACE • CEDAR GROVE, N. J. • (201) CEnter 9-3000

SUBSIDIARIES: ERA Electric Co. • Advanced Acoustics Co. • ERA Dynamics Corp. • ERA Pacific, Inc.

ONE-THIRD OF R&D WORKERS IN DOD WORK, STUDY SHOWS

A major step has been completed in a three-phase study of the structure and dynamics of the nation's multi-billion-dollar defense research and development industry.

Conducted for the Office of Defense and Research Engineering, of DOD, by Stanford Research Institute, study is concerned mostly with non-technological factors affecting R&D environment. First-phase results will be tested during the study's second phase, scheduled for completion early in 1965. Some conclusions from phase one are contrary to conventional notions.

Phase one reports, tentatively, that one-third of the national R&D workforce (1,000,000 to 1,500,000) are on DOD projects. One-half are salaried workers, while one-fourth are scientists and engineers. Of the estimated \$6 to \$7 billion spent yearly for defense R&D, three-fifths are for wages and salaries, indicating heavy reliance on human skills.

While the West Coast and the Northeast receive more than 70% of prime R&D contracts, these regions also receive two-thirds of material procurement of the prime contract dollar. A large defense R&D firm moving into an area with no defense R&D industry will import two-thirds of its workforce for a least 10 years.

There is considerable movement of workers from one defense R&D firm to another, but comparatively little between defense and non-defense firms.

DEFENSE MARKETING SEMINAR

The coming decade will see a revolution in management techniques. A primary emphasis will be on marketing, to re-orient the electronic industries to the changes in the military procurement picture.

A series of marketing seminars will be conducted by the firm of marketing consultants, J. M. Beveridge & Assoc., 7406 Earldom Ave., Playa del Rey, Calif., 90292 during the winter of 1964-1965.

The next seminar series in the first part of the year is: Los Angeles, the Sheraton-West Hotel—February 16-17; and in New York, Biltmore Hotel, on February 25-26.

Registrants are being accepted on a first-come basis. Write directly to the firm for further information.

1mc and 5mc logic now the **same price**

TYPICAL

EXAMPLE

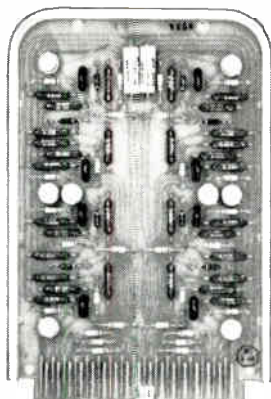

1mc S-PAC
BASIC FLIP-FLOP
(4 circuits)

was \$78.50
now **\$62.25**

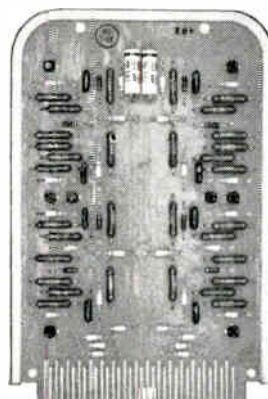

5mc S-PAC
BASIC FLIP-FLOP
(4 circuits)

was \$119.00
now **\$62.25**

1mc S-PAC prices reduced 20%*

5mc S-PAC prices reduced 40%*

IN ADDITION: Quantity discounts are offered in unit order increments of 1-10, 11-25, 26-75, 76-200, 201-500, and 501-1000.

IN ADDITION: New one year accumulated dollar volume discounts (up to 40%) are automatically applied as purchases accumulate.

Write for new price list and catalog.

*Average reduction. All prices effective November 16, 1964 and subject to change without notice.



3C DISTRICT SALES OFFICES: NEEDHAM, MASS.; SYRACUSE, N.Y.; CON-
MACK, L.I., N.Y.; LEVITTOWN, PA.; CLEVELAND, OHIO; SILVER SPRING,
MD.; DES PLAINES, ILL.; ORLANDO, FLA.; ALBUQUERQUE, N.M.; PALO
ALTO, CALIF.; LOS ANGELES, CALIF.; HOUSTON, TEX.; HUNTSVILLE, ALA.

COMPUTER CONTROL COMPANY, INC.
OLD CONNECTICUT PATH • FRAMINGHAM, MASSACHUSETTS

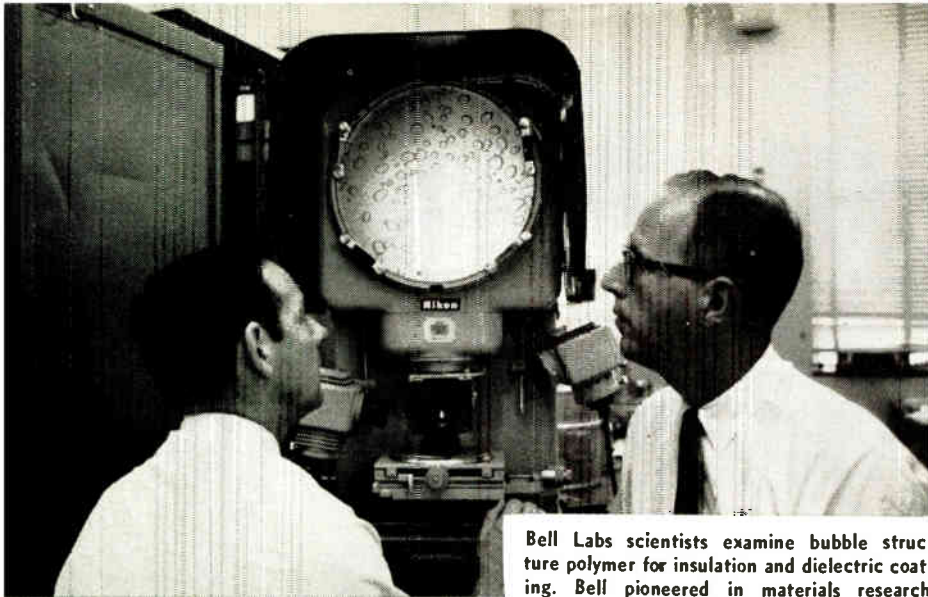

Bell Labs scientists examine bubble structure polymer for insulation and dielectric coating. Bell pioneered in materials research.

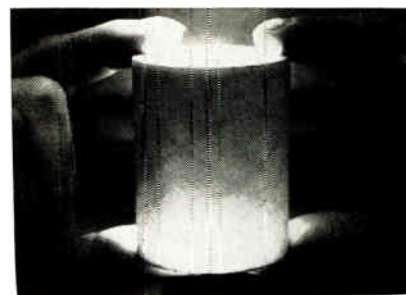

Glass-epoxy filament tubing by Micarta Division of Westinghouse, also a research pioneer.

Reliability

By **SIDNEY FELDMAN**

Associate Editor
ELECTRONIC INDUSTRIES

Our electronic and space future depends largely on new materials. A sophisticated system is only as good as the materials in it. General R&D funds have tripled, mostly for materials, on which whole new industries have been founded.

A MAJOR TURNING POINT IN MATERIALS was the March 1960 report of the National Academy of Sciences-National Research Council, a Congressionally-chartered, quasi-official organization. Its Committee on the Scope and Conduct of Materials Research surveyed U. S. industrial, academic, and governmental materials R&D activities "to identify any critical gaps." It concluded, in part:

"Important national security programs, particularly those in defense, atomic energy, and space are currently up against a *materials barrier*. The properties of most presently available materials are inadequate for the high-performance end-items that must withstand severe temperature, pressure, radiation, corrosion, and stress environments."

Lags were noted in the development of new metals, new ceramics, new plastics. Such delays had adversely affected development of nuclear-propulsion systems and space vehicles, better missiles, rocket motors, naval vessels, and electronic devices for which theoretical designs then existed.

Materials Mismatch

This report called attention to the glaring mismatch of many "old" materials which could not fulfill properly most requirements for "new" materials in projected systems for previously uncharted environments in defense, aerospace and oceanography.

The NAS-NRC report underscored the truism that reliability is neither designed nor inspected into systems. It further urged government and industry to do their homework in basic materials, with improved management. Defense and aerospace systems designers and contractors were reminded of the homely concept that the most super-sophisticated system is only as good as the materials used to make it.

Congressional funds for R&D have since triggered the continuing ferment along the basic frontier of electronic innovation: materials. General R&D funds, for various government agencies, have tripled from about \$5 billion in 1953 to about \$15 billion currently, and may then double to about \$30 billion by 1970.

In the wake of these expended funds for R&D in various engineering fields and sciences has come an onrush of materials and related information. Many industrial, commercial, government and academic laboratories were subsidized, organized or expanded. These units keep probing the properties of matter: chemical, electrical, mechanical, physical, and thermal.

New Technologies

Whole new areas of technology and industry are growing up with waves of new materials developments. These applications include newly evolving electronically useful crystals, organics, cryogenics, solid state, adhesives, metals, alloys. The metallizing of thin layers on surfaces under extremely high vacuum conditions is indicative of the processing revolution in matter that parallels the materials revolution. Corplan Associates, an affiliate of IIT Research Institute, Chicago, recently identified the developing technology of engineered materials as an emerging potential billion-dollar-industry.

Solid state physics is one area where materials technology is shaping electronic systems while also reshaping the corporate structures of companies. Discrete components are being packaged into subassemblies, and microcircuits. In turn, components makers are becoming circuit creators, and circuit creators are becoming components makers. Both ends are meeting in the middle. Some microcircuit makers

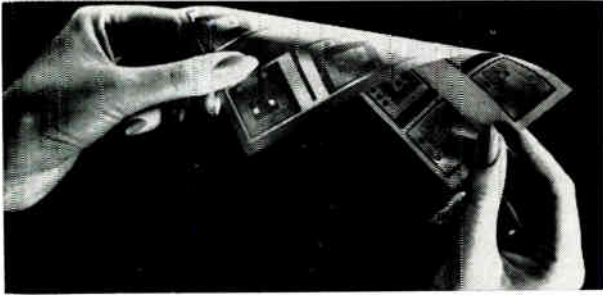

Film-thin copper-clad laminates for space-saver multi-layer printed circuits made by Synthane Corp., a leading company in laminates.



A few of many tape wound cores of Magnetics Inc. Firm specializes in high permeability magnets, alloys, control systems.

Goals Depend on New Materials

are *integrating upward*, from materials into circuits. Others are *integrating downward*, from circuits into materials.

Magnetics Inc., which specializes in high-permeability magnets, first integrated up to circuit design, and then integrated down to materials design. These moves were cited by Arthur O. Black, president, who believes "the role of components suppliers will tend to diminish as integrated circuits become more readily available."

He adds, "Within our own specialty, we can now produce superior magnetic alloys from which we make cores, from which we make static control devices, from which we make complete industrial control systems." These products are sold at all levels of manufacture.

Magnetics Inc. controls quality and cost of each item, from basic material to the completed static control system. Its powder metallurgy approach enables it to create variations of present alloys, or develop completely new alloys to meet customers' needs. Chemical-etching techniques are combined with the firm's ability to produce a wide range of electronic alloys. These technical capabilities enable Magnetics Inc. to pursue market needs into miniaturization and microcircuits.

Broad Flexibility

Thus the company offers broad flexibility within its narrow specialization. It can sell to companies with which it might otherwise compete. "Present developments make us feel we are on the right track," observes Mr. Black. Other components makers also are integrating their operations. Statham Instruments more fully controls the manufacture of products, from materials on up. And Yardney Electric Corp. is developing and producing more critical components for its batteries.

Such small electronic companies are doing what some large firms long have been doing. Old-line electrical-electronic firms which integrated certain operations, from materials through systems, include

General Electric, Westinghouse, and Sylvania, among others. They also have divisions which profitably sell materials to outside companies.

American Telephone and Telegraph Co. also pioneered in materials research at Bell Telephone Laboratories, which guides manufacturing and procurement activities of its Western Electric supply arm. AT&T, like the Defense Department and National Aeronautics and Space Administration, seeks reliable, long-lived products that minimize maintenance and maximize performance. Improved materials are the keys to such achievements.

However, any product made the same way but utilizing new materials that are lighter, stronger, lower cost and better is considered as a "new product." Ultimately, improved qualities of materials will enable designers to give wings to their dreams—making practical new approaches to defense, aerospace and oceanography systems.

Engineers in Alien Areas

Waves of materials developments cause ripples in other areas of electronic technology and business. In recent years electronic engineers working on advanced systems need to know more about formerly alien areas, such as metallurgy. These engineers also have become more involved in studying structural inter-relationships of design and materials. Here, for example, newer configurations of electronic packages may require special metals, special cooling or coolants.

Some materials developments seemingly unrelated to electronic interests nevertheless have vital bearings. It is little known, for instance, that a chemistry breakthrough—in polymers and monomers—speeded development of the Polaris nuclear submarine missile which, in turn, opened new markets for varied electronic equipments and systems.

As materials push the state of their art, they also push the need for new standards and tests. There is need to ascertain thermal stability, moisture resistance, low and high temperature flexibility, outstand-

NYTRONICS

delivers high reliability ceramic capacitors in 24 hours

Over 500,000 in Stock!

- ★ 89 standard values from 5.6 pf to 470,000 pf.
- ★ Meets MIL-C-11015 requirements.
- ★ Subminiature components.
- ★ Rugged, epoxy-encapsulated.
- ★ Highest reliability and performance.

MIL-CAP in CK05 and CK06 case styles are 0.200" and 0.300" square by 0.100" thickness; capacitance range — CK05, 47 pf to 1,000 pf; CK06, 1,200 pf to 10,000 pf — both $\pm 10\%$ and $\pm 20\%$ capacitance tolerance; capacitance change $\pm 15\%$ maximum over temperature range of -55°C to 150°C . Working voltage 200 VDC, insulation resistance 100,000 megohms at 25°C , 1,000 megohms at 150°C . Dissipation factor $2\frac{1}{2}\%$ maximum at 1 kc.

HY-CAP offers capacitance range 10,000 pf to 470,000 pf with maximum capacitance change of $\pm 12\%$ over temperature range of -55°C to $\pm 125^{\circ}\text{C}$. Case size range from 0.225" to 0.650" width, 0.175" to 0.325" height and 0.100" to 0.125" thickness; working voltage 100 VDC; dissipation factor $2\frac{1}{2}\%$ maximum at 25°C .

DECI-CAP has greatest capacitance range available in cordwood envelope. Molded 0.100" diameter by 0.250" long; capacitance range 5.6 pf to 27,000 pf; capacitance tolerances 5%, 10%, and 20%; capacitance change $\pm 7\frac{1}{2}\%$ from 5.6 pf to 470 pf and 15% maximum from 560 pf to 27,000 pf over temperature range of -55°C to 125°C ; working voltages 200 VDC from 5.6 pf to 470 pf and 100 VDC from 560 pf to 27,000 pf; insulation resistance 20,000 megohms minimum and dissipation factor $2\frac{1}{2}\%$ maximum at 25°C .

FOR COMPLETE
ENGINEERING DATA, WRITE DEPT. O,
OR PHONE (AREA CODE 201) 464-9300

NYTRONICS

550 Springfield Ave., Berkeley Heights, N. J.

Design leaders
STANDARD components to meet
CUSTOM requirements

NEW MATERIALS (Continued)

ing durability, insulation compatibility, chemical resistance, among other parameters. However, data among materials makers may not be comparable directly, since facts and figures may not have been obtained under the same test procedures.

Yet the need for tests long has kept pace with the need for materials themselves. In 1960, two years after NASA had been Congressionally-chartered, three members of Lockheed Missile & Space Div., among others, urged establishment of a broad program to test space-age materials under actual and simulated conditions. Other groups, such as Aerospace Industries Association, annually issue advisories on technical requirements including materials.

Higher Standards Needed

Some sources feel that Congress and even certain technical groups still do not fully appreciate need for finer, higher standards as the least-recognized defense-aerospace-oceanography frontier. Dr. Allen V. Astin, director, National Bureau of Standards, has observed, "It is entirely possible that the nation that excels in the science of precision measurement will lead the world in technological as well as military strength." He noted that the Space-Atomic Age greatly heightened need to improve measurement techniques and establish reliable scales for very high temperatures and very minute calibrations.

It is noteworthy that a byproduct market for electronic and other equipment has been developed in test and measurement instruments, including non-destructive testing of materials. Equipments here include X-ray, electronic (sound) vibrators, infrared cameras, electron microprobes and microscopes, and electron computers for simulations and studies, among others.

In this total materials-to-systems environment, reliability engineering has become a rallying point of several engineering and management disciplines. Involved here are quality controllers, standards engineers, value engineers, test and evaluation engineers all working with materials/process engineers and purchasing agents.

Broad assignments of materials/process engineers include internal duties: evaluation of materials, development/improvement processes, and external duties: dealings with vendors and sub-contractors, including product/system service failure analysis, plus internal/external duties: preparation of specifications, technical consultation with company and customer engineers and designers of systems, from airplanes to hydrofoils, and so on.

Technical-management-marketing relationships are becoming more involved here. In part, they are outer-directed from the Pentagon and NASA—the biggest buyers, specifiers and shapers of electronic technology, business and destiny.

Future Survival Affected

Variations of corporate approaches to developing and utilizing materials will affect future survival and success of electronic companies. Major prime contractors have broad in-house capabilities, centering around R&D laboratories, with certain materials specialties, and information-retrieval facilities or sources.

One approach is the Air Force-sponsored Electronic Properties Information Center (EPIC) at Hughes Aircraft, discussed in box below.

Prime contractors will likely continue to obtain materials from sub-contractors for two main reasons. No company can be proficient in all materials technologies. Primes often will have to procure materials from smaller specialists, such as Magnetics, Inc., from glass-to-metal seal specialists, from solder specialists. And primes will buy from big, broad specialists with department - store - type capabilities, such as DuPont and Union Carbide in chemicals, and metallurgy firms, such as Asarco and others. Moreover, primes are *encouraged* to patronize subs by DOD directives and Small Business Administration "set aside" requirements. Small sub-contractors are not necessarily fully "protected," but they may have a better chance to compete.

Ultimately, materials are measured in terms of economy, value, profits—as well as performance. Reliability engineering, hotly fostered by DOD and NASA, seeks to develop mathematical probability that products will operate for given periods of time. But the most valuable byproduct here is close economic control of engineering. One estimate cites annual maintenance costs for advance defense electronic equipment may extend from 50% to 1,000% of initial cost. Wags paraphrase this as: not the initial cost, but the high cost of maintenance.

Materials Managements

Yet management is the overall dimension in materials. Many new R&D electronic laboratories and companies have formed a Materials Management Department. The American Management Association says experts estimate that every dollar saved

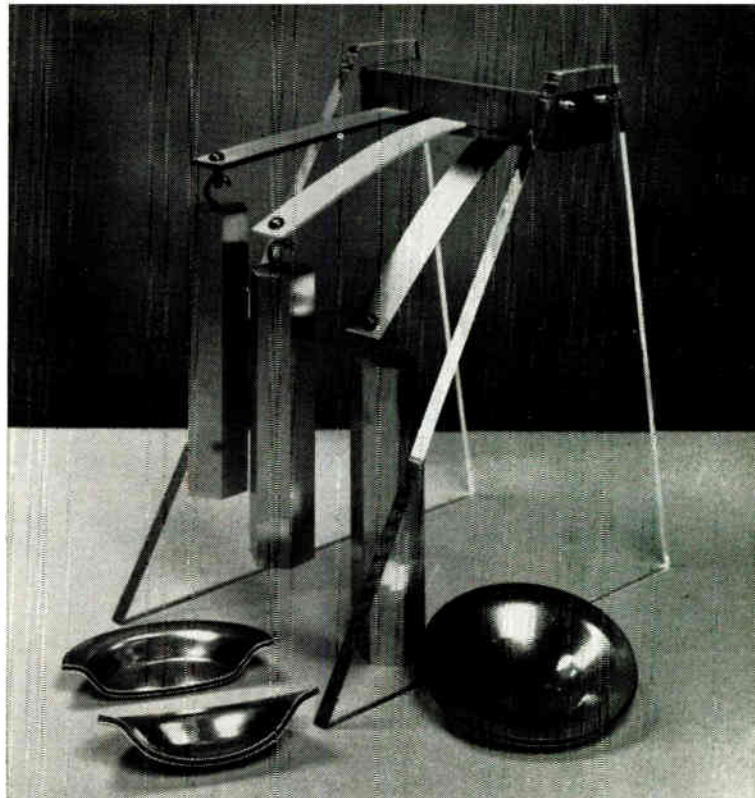

Bell Labs aluminum-polyethylene laminate (left), polyester glass mat (center) and cold-rolled steel subjected to same weight. Bottom are samples of deep-drawn aluminum-polyethylene.

through sound materials management equals about \$10-\$12 in increased sales, with a probable 9% profit margin. It notes that ultra-modern materials management should reduce or eliminate many wasteful practices, such as inadequate or overadequate materials supplies and improper deliveries.

Advanced electronic companies practice "Rhochemicals," endeavoring effectively to manage materials flow by integrating all functions, from raw materials to finished goods. The contribution and cost of each function also are measured in terms of total company operation. Purchased material control here involves qualified suppliers selected from an approved list.

Distinctions must be drawn between limited quantities of rare earths, noble metals, and highly refined or ultra-pure materials used in special or limited quantities, and metals such as copper and aluminum which are used more broadly. (Continued)

THE ORGANIZATIONAL APPROACH TO MATERIALS DATA

R&D INFORMATION ON MATERIALS was once in short supply, but now it is almost overwhelming. The problem is how to assimilate and disseminate the flood of information.

As part-solution, the Air Force Materials Information Center of the Air Force Materials Laboratories financially supports technical information analysis centers. These collect and index materials data in highly specialized fields.

Among these operations is the Electronic Properties Information Center (EPIC), headed by H. Thayne Johnson, at Hughes Aircraft Co., Culver City, Calif. It covers nine major categories: semiconductors, insulators, ferroelectric dielectrics, metals, ferrites, ferromagnetics, electroluminescent materials, thermionic emitters, and superconductors.

Since EPIC was organized in June 1961, it considered about 175,000 items and has included more than 16,000 thus far. EPIC has mailed more than a half-million data sheets and

reports internationally. EPIC's full index to 13,500 publications will be published February 1965 under: "Electronic Properties of Materials: A Guide to the Literature."

Other sources of information on materials includes The Institute for Materials Research, recently reorganized as part of the National Bureau of Standards in Washington, D.C. This Institute produces and distributes selected references.

The Institute contributes to the National Standard Reference Data Program by developing data on bulk properties of materials and devising measurement techniques for determining these properties. Its divisions include areas of analytical chemistry, polymers, metallurgy, inorganic materials, reactor radiations, and cryogenics.

Also, The American Society for Testing and Materials, in Philadelphia, offers information on research and standards for materials.

alpha metals

solder notes

An open forum on solder, solder preforms, fluxes, special alloys and ultra-high purity metals, with questions selected by the Alpha Research and Development Department from extensive correspondence, personal inquiries, and Alpha Seminars and Clinics. We invite you to submit your own solder and soldering problems to Alpha for review, without obligation.

Alpha Metals, Inc., 56 Water Street,
Jersey City, N. J. • (201) 434-6778
Los Angeles, Calif. • Alphasoy Corp. (Div.) Chicago, Ill.
Alpha Metals, Inc. (U.K.) Ltd. London, England



Q. Is pre-tinning necessary prior to soldering?

A. No, pre-tinning is merely an optional step, useful when working with difficult-to-solder metals, or for use where mild fluxes are mandatory. Strong fluxes can be used in the pre-tinning operation (with complete residue removal), although their use is not always permissible when soldering the final assembly. Pre-tinning can also be done by electroplating.

Q. How can we promote better solder spreading?

A. By using a more chemically active flux that will efficiently clean the base metal surfaces. Care should be used in checking the affinity of the flux for metal. It should be lower than the solder affinity for the metal, so that the molten solder will spread easily while displacing the flux.

Q. Why do copper soldering bits erode so rapidly and what can be done to reduce this erosion?

A. Copper is soluble in molten tin and during soldering the tin in the tin-lead solder dissolves or erodes the copper bits. The solubility of copper in tin increases with higher temperature. Thus hot irons erode more rapidly. Erosion can be minimized by keeping iron temperatures as low as possible and can be eliminated by the use of iron clad tips.

Q. What is meant by solder dewetting and how can I eliminate it?

A. When the solder is forcefully brought into contact with a metallic surface which has not been adequately prepared, as in dip soldering, the solder upon normal cooling will withdraw and appear in droplet form similar to water on a freshly waxed surface. The surface left behind usually has a silvery appearance which should not be interpreted as wetting. This usually results from the poor surface condition of the base metal to be soldered and indicates the necessity of a good pre-soldering cleaning operation or stronger fluxes. Dewetting can be most easily recognized if molten solder is allowed to drain off the surface.

Q. I have prepared the surfaces of my printed circuit boards for soldering and now desire to store the boards for future use. How can I preserve the solderability of the printed circuit boards?

A. To preserve solderability and prevent oxidation and contamination, Alpha #828 "Protectocoats" are most effective. These materials are formulated for rapid evaporation and leave a coating (non-activated) which is completely compatible with any of Alpha's rosin base fluxes. If a non-rosin base flux is to be used, Alpha #563 rosin flux remover can easily remove the Protectocoat. In addition, Alpha #828 will not cure with time to form a detrimental barrier to the proper wetting of the flux and solder. The Protectocoat may also be applied to damp surfaces (since it will displace water traces) and still yield a coating that adheres well.

4383

NEW MATERIALS (Continued)



Arthur O. Black, president of Magnetics, Inc., strongly believes "the role of components suppliers will tend to diminish as integrated circuits become more readily available." Firm first integrated up to circuit design, and then down to materials design. Mr. Black feels he is on the right track.

Dr. Allen V. Astin, head of National Bureau of Standards, observes that "It is possible that the nation that excels in precision measurement will lead the world in technology and in military strength." Many people still do not fully appreciate the need for finer and higher standards.



Can Be Costly

In either case, high brainpower or high machine-power, use of materials can be costly. Hence, new approaches and controls are being introduced. General Electric's Jet Engine Department, for example, utilizes an automatic data processing Mechanized Materials Management system in annually buying and moving some \$180 million worth of purchased items. Eventually, a G. E. 225 computer automatically may select suppliers.

Perspective on materials is offered by Nathan E. Promisel, chief materials engineer and director of the Materials Division, Navy Bureau of Naval Weapons. He oversees all facets of work on materials and processes for underwater, air and space vehicles and equipment. He heads the Materials Group of the NATO Advisory Group for Aeronautic R&D. He is attached to the Federal Science Council's Materials Committee. In his recent Gillett Memorial Lecture, sponsored by the American Society for Testing and Materials and Battelle Memorial Institute, Mr. Promisel concluded:

"Today we are at that exciting stage where we not only design the structure but, hopefully, are almost ready to design the material itself, describe it adequately in a specification and custom-make it for the particular application. For many important applications, this is the route to maximum efficiency, performance and economy. The degree to which we succeed depends vitally on how sophisticated and understanding we are in our testing, and the effort we can bring to bear on this near-Herculean task."

Circle 46 on Inquiry Card

SYLVANIA EXPANDS LABS WITH RF 'DARK ROOM'

A radio frequency anechoic chamber for antenna testing will be the newest Sylvania R&D facility in Buffalo, N. Y., according to plans announced by Sylvania Electric Products, Inc., subsidiary of General Telephone & Electronics Corp.

Such a chamber, also known as a radio frequency "dark room," is usually built mostly of spike-shaped absorbers. It simulates free space conditions in that no stray electromagnetic radiations or effects of natural disturbances can penetrate its walls. Also eliminated are echoes from equipment within the range. The absorbent material can absorb and dissipate radio signals between 1,000mc and 100gc.

First use of the range will be for advanced development and testing of a new satellite antenna for the Air Force.

MICROFILM PRINTER SPEED IS 62,500 CHARACTERS/SEC.

Stromberg - Carlson (San Diego, Calif.), a division of General Dynamics, has disclosed a new computer microfilm printer which speeds record retrieval and saves several costly data handling steps. The new printer, called S-C 4400, can print at speeds up to 62,500 alphanumeric characters per second.

Operating directly from a computer or from computer-generated magnetic tapes, the S-C 4400 translates digital signals into words, numbers and symbols. The output is recorded automatically, page by page, on 16mm or 35mm microfilm. When operating the printer with a computer, there is no need to produce magnetic tape, reports S-C engineers. Paper output need is eliminated in many operations since selected pages can be produced on paper from the 4400's film output.

ENGRG. MANAGEMENT STUDY

A 10-day short course in Engineering and Management will be presented by the Department of Engineering and the Graduate School of Business Administration at UCLA from January 25 to February 4, 1965.

Course fee is \$450, which includes enrollment, books, class materials, dinner and ten lunches. Write to Reno R. Cole, Coordinating Professor, Room 6266, Engineering Building II, University of California, Los Angeles, California 90024.

DO-IT-YOURSELF MAGNETIC SHIELDS

*Cut Quickly—
Wrap Easily*

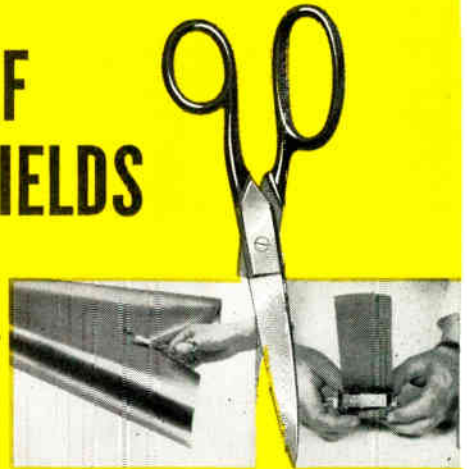

With ordinary scissors, cut flexible Co-Netic and Netic foil to any size or outline. Your component is quickly wrapped and protected—within seconds. Component performance is dramatically enhanced. Co-Netic and Netic foils stop degradation from unpredictable magnetic fields. When grounded, they also shield electrostatically. Foils are not significantly affected by dropping, vibration or shock, and do not require periodic annealing. Available in thicknesses from .002" in rolls 4", 15", and 19-3/8" wide. High attenuation to weight ratio possibilities. Widely used in experimental evaluation and production line operations for military, commercial and industrial applications.

MAGNETIC SHIELD DIVISION

Perfection Mica Company

1322 N. ELSTON AVENUE, CHICAGO 22, ILLINOIS

ORIGINATORS OF PERMANENTLY EFFECTIVE NETIC CO-NETIC MAGNETIC SHIELDING

Circle 47 on Inquiry Card

NOW! LOW COST SCOPE PHOTOGRAPHY

using your present
POLAROID®
Land camera

Never before has oscillography been so inexpensive. Use your present Polaroid Automatic 100 Land Camera with the brand new Beattie-Coleman Polexa camera adapter that clamps onto any standard 5" bezel. Incorporates auxiliary optics which permit recording at 1:0.85 ratio. Camera's electric eye controls exposure. Also accepts most 35mm SL reflex cameras. Entire unit swings away for view of CRT. Write today



\$159⁰⁰
Less
Camera



**BEATTIE
COLEMAN
INC.**

1046 NORTH OLIVE STREET, ANAHEIM, CALIFORNIA. (714) 774-4503

OSCILLOTRON®
POLEXA CAMERA ADAPTER

A New Advance In the Coil Winding Art!

PRECISION ANCHOR-LOK LEAD WIRE & TAP ANCHORING STRIPS

Here are the production and cost reducing advantages you gain:

- Positive anchor
- Lower material costs
- Only one strip needed per anchor
- Only one strip needed for tap on winding
- Elimination of markers
- Increased winder production
- Complete penetration of impregnation
- Less irritation of operator's fingers
- Infinite storage life
- Lower labor costs
- Faster lead extraction
- Less build up
- No gumming of saw blades

Anchor-Lok Strips are furnished in .015 fish paper in 30-yd. reels, .010 colored cellulose acetate in 50-yd. reels and .010 DuPont Nomex in 50-yd. reels.

Samples are available! Request them. The only information needed is material required and spacing between wires. Also request prices and reprint: A New Method For Winding Coils.



PRECISION PAPER TUBE COMPANY

1049 SOUTH NOEL AVE., WHEELING, ILL. (Chicago Suburb)
Telephone: (Area Code 312) 537-4250
OTHER PLANTS IN HARTFORD, CONN. AND CLEVELAND, O.

Circle 49 on Inquiry Card

How to use catalog 700 FOR ALL IT'S WORTH!

Check Cambion first:
Most SPECIALS are our STANDARDS

Chances are, that "special" part you need is already standard in the CAMBION® line of over 15,000 guaranteed electronic components. Find out in seconds by easy reference to 176-page Catalog 700: it shows 80 solder terminals (and terminal boards), 82 insulated terminals, 74 coil forms, 26 coils and chokes, 44 connectors, 59 hardware items — lists hundreds of standard variations in these and other product categories. Your Authorized CAMBION Distributors offer you the advantages of local availability. If you still need a special, CAMBION is best equipped to make it. For engineering aid, product samples or additional free copies of full-line Catalog 700 — just write today to Cambridge Thermionic Corporation, 412 Concord Ave., Cambridge, Massachusetts 02138.



CAMBION®

Standardize on CAMBION...The Guaranteed Electronic Components

Circle 50 on Inquiry Card

WHAT'S NEW

Home TV Recording Gets Closer

AFTER THE FIRST FLURRY OF INTEREST in home video recording, triggered by a press showing early this year by Cinerama, licensee of Telcan of Britain, excitement pretty well died down. It soon became evident that claims of a video recorder that would sell for under \$200 were premature. The market for such equipment is known to be present; but the technology had a long way to go. And, Telcan has recently been reported to be out of business.

On the heels of the Telcan announcement, Fairchild's Winston Research Corporation in Los Angeles showed a laboratory model of a stationary-head video recorder that performed considerably better than the Telcan unit but still admittedly had a number of bugs. Fairchild stated that it wouldn't market the recorder but would try to find a licensee among the radio-TV manufacturers. Cost was estimated at something over \$500 but under \$1000.

Recently, Fairchild announced the availability of an industrial video tape recorder and showed it along with their other products to government and industrial leaders in Washington. Its cost is around \$5000, depending on accessories. But, Fairchild has been negotiating with several possible licensees for a home video recorder utilizing the same principles as the industrial version but in the \$350 to \$500 selling range. Degradation of picture and sound quality would reportedly be only slightly poorer than the industrial version and entirely satisfactory for home viewing. The before and after photographs shown here give an idea of the quality of the recording on the industrial instrument.

Fig. 1: Lab prototype of Industrial TV Video Recorder.





Fig. 2: (a) This picture was photographed from live program.



Fig. 2: (b) Recorded picture played back on TV recorder.

The laboratory recorder utilizes $\frac{1}{4}$ in. instrument grade tape. It travels at 120 inches per second and has four tracks (scanned during four passes) for a total of one hour of recording on an $11\frac{1}{2}$ in. reel containing 9000 feet of $\frac{1}{4}$ in. wide, 0.5 mil Mylar base tape. Cost of the tape is about \$20 per reel—thus \$20 per hour of recording. Fairchild believes that with eight tracks, which they are working on in the laboratory, and at a 60 in. per second speed which will be used on the home recorder unit, an hour of recording will cost only \$5.00.

It takes eight seconds at present to turn the tape around between passes on the four tracks. This is expected to be shortened to about one second.

The industrial video recorder, demonstrated, had 195 lines of resolution, and the scanning lines were not interlaced. The production unit will have the lines interlaced.

The recorder can receive inputs from either a video tv camera or from a tv monitor receiver. Any standard television receiver can be used by incorporating a simple adapter. Audio input is zero dbm into 600 ohms. Signal-to-noise ratio for video is 40 db peak-to-peak signal-to-rms noise; for audio is 40 db rms signals-to-rms noise. Video bandwidth is 1 kc to 2 mc; audio is 50 cps to 6 kc. In the home video unit, a clock timer will be included. (Continued)

Designed for
printed circuit use!

MINIATURE PLUGS AND JACKS

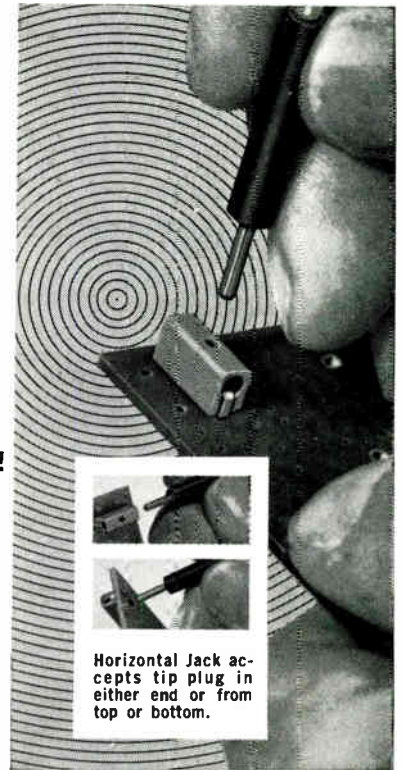

Horizontal Jack accepts tip plug in either end or from top or bottom.

Operating voltages to 1500 V RMS... up to 5 amps current carrying capacity!

Extremely compact — highly resistant to extremes of shock, vibration, temperature and moisture, these tiny Johnson Tip Plugs and Jacks are ideal for limited space applications! Bodies molded of tough, low-loss plastic per MIL-P-17091. Available in 10 colors, including basic colors for MS16108C coding applications. Contact resistance: less than 2 milliohms. Capacitance between two adjacent jacks: less than 1 mmf. at 1 Mc.

Series 105-751 Horizontal Jack — Unique design accepts .080" diameter tip plug in either end, or from top or bottom. Formed silver-plated beryllium copper contact. 2 terminals.

Series 105-851 Vertical Jack — Mounts through single .052" hole, requires minimum mounting area. Silver-plated, machined beryllium copper contact.

Series 105-771 Sub-Miniature Tip Plug — For use with miniature jack. .080" diameter tip. Nickel-plated, machined brass body. Solder type lead connection.

Series 105-881 Long Handle Tip Plug — Identical to tip plug above, but with 4" molded plastic body for ready access to "hard to reach" test points.

Components Catalog Available—Write today on company letterhead!



E. F. JOHNSON CO.

3007 TENTH AVE. S.W. • WASECA, MINN.

CAPACITORS • TUBE SOCKETS • CONNECTORS
PILOT LIGHTS • INSULATORS • KNOBS AND
DIALS • INDUCTORS • HARDWARE

Other Connectors — Johnson also manufactures standard connectors including Tip Plugs and Jacks; Metal-Clad and Rapid-Mount Jacks; Banana Plugs and Jacks; Binding Post. Voltage breakdowns to 12,500 volts DC. Jacks designed for fast, easy mounting — plugs for solderless connection. Current catalog provides full specifications on complete line.

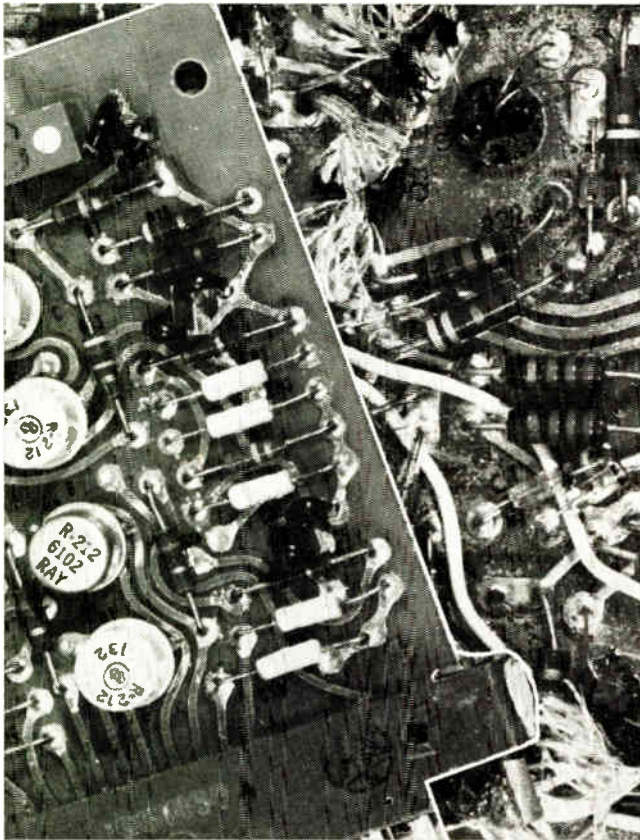

LEFT: NORCOTE coated board stripped with NORCOTE stripper
RIGHT: Conventional coated board after stripping

NORCOTE*

FAST DRYING COATING

- For printed circuit boards and electronic equipment
- Moisture and fungus resistant
- NORCOTE granted Bureau of Weapons Design Specification WS1308, which may be used as alternate for MIL-V-173B Varnish

CHARACTERISTICS

| | |
|--------------------------------------|---|
| Low Temperature Stability | Meets MIL-V-173B |
| Application | Spray, Dip or Brush |
| Finished Film | Clear, transparent, free from defects |
| Dielectric Strength | 702.5 Volts per root mean square |
| Thermal Shock and Bending | Meets MIL-V-173B |
| Insulation Resistant | 100 times minimum MIL-V-173B |
| Fungus Resistant | Meets MIL-V-173B |
| Low Temperature Resistance | Tested at -55° C for 2 hours with no defects noted |
| Moisture Resistance | Tested totally immersed in water for 24 hours with no defects noted |

Write for FREE SAMPLES and BROCHURE

*Developed by Nortronic Division, Northrop Corporation

Manufactured and Sold By:

Southland Chemical Co.
P. O. Box 1255/Costa Mesa, Calif.
Telephone: (714) 546-5622

Circle 52 on Inquiry Card

Home TV Recording (concluded)

Contrary to popular belief, limitation on video quality, according to Fairchild engineers, is no longer based on magnetic tape development. Fairchild's contribution is primarily in the recording heads, and it is claimed that the limitation on quality is at this point. Fairchild claims a two-year lead in head development and expects many improvements in heads in the future. As critical as the head is, Fairchild's head will reportedly sell for about \$5.00 and will have about 1500 hours of life.

Fairchild claims five or six patents pending on their video recorder. These include noise reducing circuits where they obtain about 45 db versus as previous 25 db; wow and flutter reducing circuits; a system for multiplexing the audio on the video signal; head design; and several tangential patents.

REPRINTS

REPRINTS

of "DESIGN GUIDE for ELECTRONIC-OPTICAL SYSTEMS"

4-page, 4-color wall chart of information for design engineers is available free-of-charge from **ELECTRONIC SPECIALTY CO.** Advertising Department, 4561 Colorado Blvd., Los Angeles, Calif. 90039

Time to investigate the BIG DIFFERENCE in HOWARD Gear Motors



Because all of the vital components of Howard Gear Motors are Howard-made in our own manufacturing divisions, you get all of the benefits of Total Quality Control: Gear units made with fine-watch precision. Universal, induction and shaded pole motors built to the industry's most exacting specifications. Motor-and-gear combinations that meet every service condition. This is the BIG difference in Howard Gear Motors, the difference it will pay you to investigate.

HOWARD INDUSTRIES, Inc.

1760 STATE STREET RACINE, WISCONSIN

Sales offices and representatives in principal cities. Consult the Yellow Pages.

Circle 53 on Inquiry Card

MULTI-COMPUTER CONTROL SYSTEM

A MULTI-COMPUTER CONTROL SYSTEM for complete "push-button" automation of central station power plants has been developed by Bailey Meter Co., Wickliffe, Ohio. Designated as Bailey 700 Multi-Computer Control, the new solid-state electronic system uses three different types of Bailey computers—programmed digital logic, reflex digital control and analog.

The system has simplified programming by using a number of computers. Each computer is designed to perform specific functions. One or more programs may be used in each. These are all coordinated, but operate simultaneously and independently.

A new unit-management concept is introduced with the multi-computer system. All functions, indications, and controls are centralized in an operator-oriented console making possible a greater coordination in the operators' supervision of the unit. Result of the new concept is greater safety to equipment and personnel, improved reliability, and reduced primary equipment downtime and maintenance costs.

The central station operator can select any degree of automatic plant control necessary. He can start the complete plant by pushing a start button, or he can place any portion of the controls on manual operation if needed.

Subloops operate simultaneously and are essentially independent of each other. Co-ordinated supervision of operation is accomplished through the unit-management system, which provides continuous control of all functions.

The Bailey 700 Multi-Computer Control includes an operator-oriented control console and many systems cabinet assemblies.

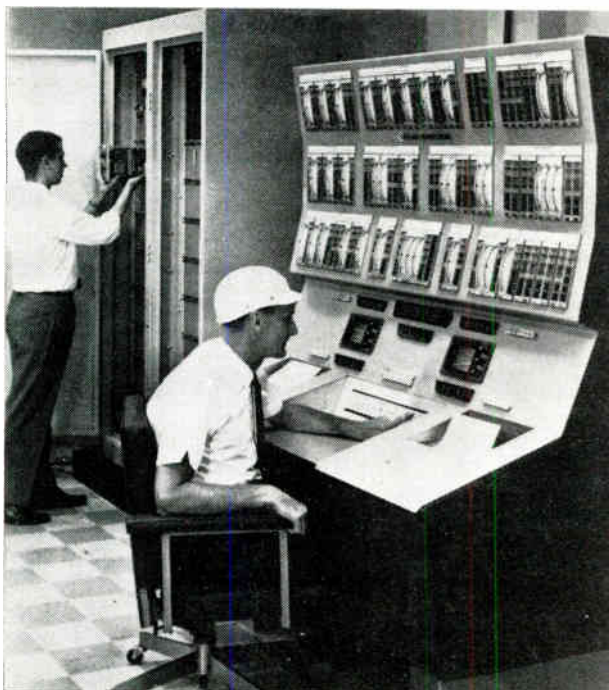

(More What's New on Page 115)



eliminate
hand
plotting
of data

Now you can afford

the convenience and accuracy of automatic data plotting with an X-Y recorder. This new unit offers all the specifications and features necessary to insure the ease of operation usually found on'y in recorders twice the price.

- 8½" x 11" or 11" x 17" chart size
- Zener reference voltages which eliminate periodic battery replacement
- Front panel switch allows easy chart paper insertion
- 100 K input impedance
- 0.25% accuracy
- Built-in electronic time base
- 1 mv/in. maximum sensitivity, switch selectable in 5 steps to 10 v/in.
- Electric pen lift
- Snap-on pen assembly
- Model HR-96T (8½" x 11") \$1050
- Model HR-98T (11" x 17") \$1150



houston instrument corporation

4950 Terminal Avenue / Bellaire, Texas 77401 / MObawk 7-7403
Cable: HOINCO / TWX 713-571-2063

Circle 54 on Inquiry Card

BY-BUK

PRINTED CIRCUIT DRAFTING AIDS

Time Saving Shapes and Narrow Tape for Making Printed Circuit Master Drawings



"KWIKY-DOT" overlapping Donuts and solid Discs for quick and easy application.

Pressure-sensitive Teardrops, Twin Pods, T's, and Corners.

Black non-stoin, non-smudge narrow tape in 15 or 60 yd. rolls from 1/32" wide. Also red translucent and black on white.

WRITE FOR HANDY CROSS REFERENCE CHART, PRICE LIST AND FREE SAMPLES.

BY-BUK COMPANY

4314 W. Pico Blvd. • Los Angeles 19, Calif.

Telephone 937-3511 • Long Distance Area Code 213

Same Day Shipment is Our Usual Service

Circle 55 on Inquiry Card



**It takes
only small change**



to buy new Stangard trimmer capacitors

Put the squeeze on trimmer capacitor costs! Specify new Stangard capacitors for such non-military instrument and commercial applications as bridges, frequency standards, calibrators, spectrum analyzers, signal generators . . . even radio, TV and FM applications. Stable Stangard trimmers eliminate additional hardware and fixed ceramic temperature compensating capacitors and simplify circuit design when used to replace threaded tubular ceramic trimmers. Stangards have a greater sensitivity than comparable units in this low cost price range. • You can choose from a wide range line, too. Stangard trimmers with glass dielectrics are available in panel mounting and in printed circuit units in four capacitance ranges. Panel mount and printed circuit units are also available with ceramic dielectrics for greater capacitance.

NOTE THESE STANGARD ADVANTAGES:

- Extremely low cost without sacrifice of quality.
- Smooth adjusting torque.
- Vinyl encapsulation provides additional mechanical protection under shock and vibration stress.
- Inherent structural strength.
- No derating over -55 to $+125^{\circ}\text{C}$ operating temperature range.
- Special dielectrics provide outstanding high Q's.

WRITE FOR BULLETIN STD 64

Stangard units shown actual size

DISTRIBUTED BY
**JFD ELECTRONICS
CORPORATION**

Components Division

JFD ELECTRONICS CORPORATION, 15th Ave. at 62nd St., Brooklyn, N. Y. 11219
JFD NORTHEASTERN, Ruth Drive, P. O. Box 228, Marlboro, Mass. 07152
JFD NEW YORK-NORTHERN, Damiano Pl., P. O. Box 96, New Hartford, N. Y. 13503
JFD MID-ATLANTIC, 313 E. Broad St., Palmyra, N. J. 08065
JFD MID-ATLANTIC-MARYLAND, P. O. Box 7676, Baltimore, Maryland 21207
JFD MIDWESTERN, 5330 W. Hermione St., Chicago, Illinois 60646
JFD MIDWESTERN-OHIO, P. O. Box 8086, Cincinnati, Ohio 45208
JFD WESTERN, 9 Morlan Place, Arcadia, California 91006
JFD CANADA LTD., 51 McCormack Street, Toronto, Ontario, Canada
JFD ISRAEL LTD., Industrial Area B, Bldg. 23, Azur, Israel
DUCON CONDENSER PTY., LTD., Christina Road, Villawood, N.S.W., Australia
LCC STEAFIX, 128 Rue de Paris, Boite Postale 51, Montreuil-sous-Bois, Seine, France
MURATA MANUFACTURING CO., LTD., Nagaoka Otokuni, Kyoto, Japan
STANDARD TELEPHONE & CABLES LTD., Footscray, Sidcup, Kent, England

Variable Trimmer Piston Capacitors ■ Metalized Inductors ■ LC Tuners ■ Ceramic Fixed and Variable Capacitors ■ Fixed and Variable Distributed and Lumped Constant Delay Lines

Circle 56 on Inquiry Card
World Radio History

**FIRST CLASS
PERMIT NO. 36
PHILA., PA.**

BUSINESS REPLY MAIL
No Postage Stamp Necessary If Mailed in U.S.A.

POSTAGE WILL BE PAID BY

ELECTRONIC INDUSTRIES

P. O. Box 9801

Philadelphia, Pa. 19140



**FIRST CLASS
PERMIT NO. 36
PHILA., PA.**

BUSINESS REPLY MAIL
NO POSTAGE STAMP NECESSARY IF MAILED IN UNITED STATES

POSTAGE WILL BE PAID BY

ELECTRONIC INDUSTRIES

Chilton Company

Chestnut & 56th Sts.

Philadelphia, Pa. 19139



Att: Circulation Dept.

FREE!

Use this card for:

- Catalogs, Bulletins, Literature
- New Tech Data for Engineers
- Information about new Products

NAME

TITLE

COMPANY

DEPT. MAIL STOP

ADDRESS

CITY, STATE & ZIP

Please send me the items I have circled.

| | 1-A | | | | | | | | | | | | EI-229 | | | | | | | | | | | | DECEMBER 1964 | | | | | | | | | | | | | | | | | | | | | | | | | | | | | | | | | | | | | | | | | | | | | | | | | | | | | | | | | | | | | | | | | | | | | | | | | | | | | | | | | | | | | | | | | | | | | | | | | | | | | | | | | | | | | | | | | | | | | | | | | | | | | | | | | | | | | | | | | | | | | | | | | | | | | | | | | | | | | | | | | | | | | | | | | | | | | | | | | | | | | | | | | | | | | | | | | | | | | | | | | | | | | | | | | | | | | | | | | | | | | | | | | | | | | | | | | | | | | | | | | | | | | | | | | | | | | | | | | | | | | | | | | | | | | | | | | | | | | | | | | | | | | | | | | | | | | | | | | | | | | | | | | | | | | | | | | | | | | | | | | | | | | | | | | | | | | | | | | | | | | | | | | | | | | | | | | | | | | | | | | | | | | | | | | | | | | | |
|---|-----|---|---|---|---|---|---|---|----|----|----|----|--------|----|----|----|----|----|----|----|----|----|----|----|---------------|----|----|----|----|----|----|----|----|----|----|----|----|----|----|----|----|----|----|----|----|----|----|----|----|----|----|----|----|----|----|----|----|----|----|----|----|----|----|----|----|----|----|----|----|----|----|----|----|----|----|----|----|----|----|----|----|----|----|----|----|----|----|----|----|----|----|----|----|----|----|----|----|----|-----|-----|-----|-----|-----|-----|-----|-----|-----|-----|-----|-----|-----|-----|-----|-----|-----|-----|-----|-----|-----|-----|-----|-----|-----|-----|-----|-----|-----|-----|-----|-----|-----|-----|-----|-----|-----|-----|-----|-----|-----|-----|-----|-----|-----|-----|-----|-----|-----|-----|-----|-----|-----|-----|-----|-----|-----|-----|-----|-----|-----|-----|-----|-----|-----|-----|-----|-----|-----|-----|-----|-----|-----|-----|-----|-----|-----|-----|-----|-----|-----|-----|-----|-----|-----|-----|-----|-----|-----|-----|-----|-----|-----|-----|-----|-----|-----|-----|-----|-----|-----|-----|-----|-----|-----|-----|-----|-----|-----|-----|-----|-----|-----|-----|-----|-----|-----|-----|-----|-----|-----|-----|-----|-----|-----|-----|-----|-----|-----|-----|-----|-----|-----|-----|-----|-----|-----|-----|-----|-----|-----|-----|-----|-----|-----|-----|-----|-----|-----|-----|-----|-----|-----|-----|-----|-----|-----|-----|-----|-----|-----|-----|-----|-----|-----|-----|-----|-----|-----|-----|-----|-----|-----|-----|-----|-----|-----|-----|-----|-----|-----|-----|-----|-----|-----|-----|-----|-----|-----|-----|-----|-----|-----|-----|-----|-----|-----|-----|-----|-----|-----|-----|-----|-----|-----|-----|-----|-----|-----|-----|-----|-----|-----|-----|-----|-----|-----|-----|-----|-----|-----|-----|-----|-----|-----|-----|-----|-----|-----|-----|-----|-----|-----|-----|-----|-----|-----|-----|-----|-----|-----|-----|-----|-----|-----|-----|-----|-----|-----|-----|-----|-----|-----|-----|-----|-----|-----|-----|-----|-----|-----|-----|-----|-----|-----|-----|-----|-----|-----|-----|-----|-----|-----|-----|-----|-----|-----|-----|-----|-----|-----|-----|-----|-----|-----|-----|-----|-----|-----|-----|-----|-----|-----|-----|-----|-----|-----|-----|-----|-----|-----|
| 1 | 2 | 3 | 4 | 5 | 6 | 7 | 8 | 9 | 10 | 11 | 12 | 13 | 14 | 15 | 16 | 17 | 18 | 19 | 20 | 21 | 22 | 23 | 24 | 25 | 26 | 27 | 28 | 29 | 30 | 31 | 32 | 33 | 34 | 35 | 36 | 37 | 38 | 39 | 40 | 41 | 42 | 43 | 44 | 45 | 46 | 47 | 48 | 49 | 50 | 51 | 52 | 53 | 54 | 55 | 56 | 57 | 58 | 59 | 60 | 61 | 62 | 63 | 64 | 65 | 66 | 67 | 68 | 69 | 70 | 71 | 72 | 73 | 74 | 75 | 76 | 77 | 78 | 79 | 80 | 81 | 82 | 83 | 84 | 85 | 86 | 87 | 88 | 89 | 90 | 91 | 92 | 93 | 94 | 95 | 96 | 97 | 98 | 99 | 100 | 101 | 102 | 103 | 104 | 105 | 106 | 107 | 108 | 109 | 110 | 111 | 112 | 113 | 114 | 115 | 116 | 117 | 118 | 119 | 120 | 121 | 122 | 123 | 124 | 125 | 126 | 127 | 128 | 129 | 130 | 131 | 132 | 133 | 134 | 135 | 136 | 137 | 138 | 139 | 140 | 141 | 142 | 143 | 144 | 145 | 146 | 147 | 148 | 149 | 150 | 151 | 152 | 153 | 154 | 155 | 156 | 157 | 158 | 159 | 160 | 161 | 162 | 163 | 164 | 165 | 166 | 167 | 168 | 169 | 170 | 171 | 172 | 173 | 174 | 175 | 176 | 177 | 178 | 179 | 180 | 181 | 182 | 183 | 184 | 185 | 186 | 187 | 188 | 189 | 190 | 191 | 192 | 193 | 194 | 195 | 196 | 197 | 198 | 199 | 200 | 201 | 202 | 203 | 204 | 205 | 206 | 207 | 208 | 209 | 210 | 211 | 212 | 213 | 214 | 215 | 216 | 217 | 218 | 219 | 220 | 221 | 222 | 223 | 224 | 225 | 226 | 227 | 228 | 229 | 230 | 231 | 232 | 233 | 234 | 235 | 236 | 237 | 238 | 239 | 240 | 241 | 242 | 243 | 244 | 245 | 246 | 247 | 248 | 249 | 250 | 251 | 252 | 253 | 254 | 255 | 256 | 257 | 258 | 259 | 260 | 261 | 262 | 263 | 264 | 265 | 266 | 267 | 268 | 269 | 270 | 271 | 272 | 273 | 274 | 275 | 276 | 277 | 278 | 279 | 280 | 281 | 282 | 283 | 284 | 285 | 286 | 287 | 288 | 289 | 290 | 291 | 292 | 293 | 294 | 295 | 296 | 297 | 298 | 299 | 300 | 301 | 302 | 303 | 304 | 305 | 306 | 307 | 308 | 309 | 310 | 311 | 312 | 313 | 314 | 315 | 316 | 317 | 318 | 319 | 320 | 321 | 322 | 323 | 324 | 325 | 326 | 327 | 328 | 329 | 330 | 331 | 332 | 333 | 334 | 335 | 336 | 337 | 338 | 339 | 340 | 341 | 342 | 343 | 344 | 345 | 346 | 347 | 348 | 349 | 350 | 351 | 352 | 353 | 354 | 355 | 356 | 357 | 358 | 359 | 360 | 361 | 362 | 363 | 364 | 365 | 366 | 367 | 368 | 369 | 370 | 371 | 372 | 373 | 374 | 375 | 376 | 377 | 378 | 379 | 380 | 381 | 382 | 383 | 384 | 385 | 386 | 387 | 388 | 389 | 390 | 391 | 392 | 393 | 394 | 395 | 396 | 397 | 398 | 399 | 400 |

SPECIAL PRIORITY REQUEST

For immediate need of a call by a sales representative, write numbers in box → (do not circle above)

NEW

Change of Address

Company _____

Mail Stop/or _____

Dept., Div. _____

Street _____

City _____ State _____ Zip _____

OLD

PASTE WRAPPER IMPRINT OR WRITE COMPLETE OLD ADDRESS

ELECTRONIC INDUSTRIES

Source Date

Co. Code

File No.

Function Industry

Title Unit

| |
|--|
| |
| |
| |
| |
| |

1. Do you wish to continue receiving ELECTRONIC INDUSTRIES? Yes _____ No _____

Signature _____ Title _____

2. Check—ONE—box for your PRIME FUNCTION

| Pres., V.P.'s, Chiefs, Directors, Dept. Heads, Mgrs. & Asst. | | | DESIGN ENGINEERING | | | | | | | | | | | | | | | | | |
|--|------------------------|--------------------------|--------------------|------------|-----------|---------|------------------------------------|-------------|------------|------------|-----------------|------------|-------------|-----------|------|-------|------------|-------|------------------------|------------|
| Corporate Management | Engineering Management | Manufacturing Management | Circuits | Components | Equipment | Systems | Research & Development Engineering | Application | Evaluation | Mechanical | Quality Control | Production | Reliability | Standards | Test | Value | Purchasing | Sales | Co. Copies & Libraries | All Others |
| A | B | C | D | E | F | G | H | J | K | M | N | P | R | S | T | V | W | X | Y | Z |

3. Check—ONE—box for your plant's PRIME nature of business

MANUFACTURING INDUSTRIES

- (01) Computers, Data Processing & Peripheral Equipment Mfr.
- (02) Communication Systems & Equipment Mfr.
- (03) Consumer Electronic Equipment Mfr.
- (04) Industrial Control Systems & Equipment Mfr.
- (05) Navigation & Guidance System Mfr.
- (06) Test Measurement & Instrumentation Mfr.
- (07) Aircraft, Ground Support, Missile, Space Vehicle & Undersea Access & Equipment Mfr. not covered in other product classifications
- (08) Component Mfr.
- (09) Sub-System Assembly Mfr. (Modules, Assembled Circuits)

- (10) Materials & Hardware Mfr.
- (11) Industrial Co. Using or Incorporating Any Electronic Equipment in Their Manufacturing, Research or Development Activities. (Other than Electronic Co.)

NON MANUFACTURING INDUSTRIES

- (12) Commercial Users of Electronic Equipment
- (13) Independent Research, Test & Design Laboratories & Consultants (Not Part of a Manufacturing Company)
- (14) Government Agencies & Military Agencies
- (15) Distributors, Mfr. Representatives
- (16) Education & Libraries
- Other (explain) _____

4. This Address is (check most applicable)

 Mfg. Plant (*) Mfr's R&D Lab. (&) Other (explain) _____

If address shown is your home, where is your company located? City _____ State _____

NEW Subscription Order

Company _____

Mail Stop/or
Dept., Div. _____

Name _____

Company
Address _____

City _____ State _____ Zip _____

ELECTRONIC INDUSTRIES

| | |
|----------------------|---|
| Source Date | |
| Co. Code | |
| File No. | |
| Function Industry | I |
| Title Unit | I |

1. I wish to receive ELECTRONIC INDUSTRIES

Signature _____ Title _____

2. Check—ONE—box for your PRIME FUNCTION

| Corporate Management | DESIGN ENGINEERING | | | | | | | Research & Development Engineering | Application | Evaluation | Mechanical | Quality Control | Production | Reliability | Standard | Test | Value | Purchasing | Sales | Co. Copies & Libraries | All Others |
|----------------------|------------------------|-----------------------------|----------|------------|-----------|---------|---|---------------------------------------|-------------|------------|------------|-----------------|------------|-------------|----------|------|-------|------------|-------|------------------------|------------|
| | Engineering Management | Manufacturing Management | Circuits | Components | Equipment | Systems | | | | | | | | | | | | | | | |
| A | B | C | D | E | F | G | H | J | K | M | N | P | R | S | T | V | W | X | Y | Z | |

3. Check—ONE—box for your plant's PRIME nature of business

MANUFACTURING INDUSTRIES

- (01) Computers, Data Processing & Peripheral Equipment Mfr.
- (02) Communication Systems & Equipment Mfr.
- (03) Consumer Electronic Equipment Mfr.
- (04) Industrial Control Systems & Equipment Mfr.
- (05) Navigation & Guidance System Mfr.
- (06) Test Measurement & Instrumentation Mfr.
- (07) Aircraft, Ground Support, Missile, Space Vehicle & Undersea Access & Equipment Mfr. not covered in other product classifications
- (08) Component Mfr.
- (09) Sub-System Assembly Mfr. (Modules, Assembled Circuits)

- (10) Materials & Hardware Mfr.
- (11) Industrial Co. Using or Incorporating Any Electronic Equipment in Their Manufacturing. Research or Development Activities. (Other than Electronic Co.)

NON MANUFACTURING INDUSTRIES

- (12) Commercial Users of Electronic Equipment
- (13) Independent Research, Test & Design Laboratories & Consultants (Not Part of a Manufacturing Company)
- (14) Government Agencies & Military Agencies
- (15) Distributors, Mfr. Representatives
- (16) Education & Libraries
- Other (explain) _____

4. This Address is (check most applicable)

- Mfg. Plant (*)
 - Mfr's R&D Lab. (&)
 - Other (explain) _____
- If address shown is your home where is your company located? City _____ State _____

FREE!

Use this card for:

- Catalogs, Bulletins, Literature
- New Tech Data for Engineers
- Information about new Products

NAME TITLE

COMPANY DEPT.

ADDRESS

CITY, STATE & ZIP

SPECIAL PRIORITY REQUEST

For immediate need or a call by a sales representative, write numbers in box (do not circle above) →

| | | | | | | | | | | | | | | | | | | | |
|-----|-----|-----|-----|-----|-----|-----|-----|-----|-----|-----|-----|-----|-----|-----|-----|-----|-----|-----|-----|
| 1 | 2 | 3 | 4 | 5 | 6 | 7 | 8 | 9 | 10 | 11 | 12 | 13 | 14 | 15 | 16 | 17 | 18 | 19 | 20 |
| 21 | 22 | 23 | 24 | 25 | 26 | 27 | 28 | 29 | 30 | 31 | 32 | 33 | 34 | 35 | 36 | 37 | 38 | 39 | 40 |
| 41 | 42 | 43 | 44 | 45 | 46 | 47 | 48 | 49 | 50 | 51 | 52 | 53 | 54 | 55 | 56 | 57 | 58 | 59 | 60 |
| 61 | 62 | 63 | 64 | 65 | 66 | 67 | 68 | 69 | 70 | 71 | 72 | 73 | 74 | 75 | 76 | 77 | 78 | 79 | 80 |
| 81 | 82 | 83 | 84 | 85 | 86 | 87 | 88 | 89 | 90 | 91 | 92 | 93 | 94 | 95 | 96 | 97 | 98 | 99 | 100 |
| 101 | 102 | 103 | 104 | 105 | 106 | 107 | 108 | 109 | 110 | 111 | 112 | 113 | 114 | 115 | 116 | 117 | 118 | 119 | 120 |
| 121 | 122 | 123 | 124 | 125 | 126 | 127 | 128 | 129 | 130 | 131 | 132 | 133 | 134 | 135 | 136 | 137 | 138 | 139 | 140 |
| 141 | 142 | 143 | 144 | 145 | 146 | 147 | 148 | 149 | 150 | 151 | 152 | 153 | 154 | 155 | 156 | 157 | 158 | 159 | 160 |
| 161 | 162 | 163 | 164 | 165 | 166 | 167 | 168 | 169 | 170 | 171 | 172 | 173 | 174 | 175 | 176 | 177 | 178 | 179 | 180 |
| 181 | 182 | 183 | 184 | 185 | 186 | 187 | 188 | 189 | 190 | 191 | 192 | 193 | 194 | 195 | 196 | 197 | 198 | 199 | 200 |
| 201 | 202 | 203 | 204 | 205 | 206 | 207 | 208 | 209 | 210 | 211 | 212 | 213 | 214 | 215 | 216 | 217 | 218 | 219 | 220 |
| 221 | 222 | 223 | 224 | 225 | 226 | 227 | 228 | 229 | 230 | 231 | 232 | 233 | 234 | 235 | 236 | 237 | 238 | 239 | 240 |
| 241 | 242 | 243 | 244 | 245 | 246 | 247 | 248 | 249 | 250 | 251 | 252 | 253 | 254 | 255 | 256 | 257 | 258 | 259 | 260 |
| 261 | 262 | 263 | 264 | 265 | 266 | 267 | 268 | 269 | 270 | 271 | 272 | 273 | 274 | 275 | 276 | 277 | 278 | 279 | 280 |
| 281 | 282 | 283 | 284 | 285 | 286 | 287 | 288 | 289 | 290 | 291 | 292 | 293 | 294 | 295 | 296 | 297 | 298 | 299 | 300 |
| 301 | 302 | 303 | 304 | 305 | 306 | 307 | 308 | 309 | 310 | 311 | 312 | 313 | 314 | 315 | 316 | 317 | 318 | 319 | 320 |
| 321 | 322 | 323 | 324 | 325 | 326 | 327 | 328 | 329 | 330 | 331 | 332 | 333 | 334 | 335 | 336 | 337 | 338 | 339 | 340 |
| 341 | 342 | 343 | 344 | 345 | 346 | 347 | 348 | 349 | 350 | 351 | 352 | 353 | 354 | 355 | 356 | 357 | 358 | 359 | 360 |
| 361 | 362 | 363 | 364 | 365 | 366 | 367 | 368 | 369 | 370 | 371 | 372 | 373 | 374 | 375 | 376 | 377 | 378 | 379 | 380 |
| 381 | 382 | 383 | 384 | 385 | 386 | 387 | 388 | 389 | 390 | 391 | 392 | 393 | 394 | 395 | 396 | 397 | 398 | 399 | 400 |

1-B EI-229 DECEMBER 1964

**FIRST CLASS
PERMIT NO. 36
PHILA., PA.**

BUSINESS REPLY MAIL
No Postage Stamp Necessary If Mailed in U.S.A.

POSTAGE WILL BE PAID BY
ELECTRONIC INDUSTRIES
P. O. Box 9801
Philadelphia, Pa. 19140

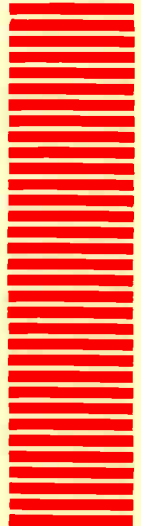

**FIRST CLASS
PERMIT NO. 36
PHILA., PA.**

BUSINESS REPLY MAIL
NO POSTAGE STAMP NECESSARY IF MAILED IN UNITED STATES

POSTAGE WILL BE PAID BY
ELECTRONIC INDUSTRIES

Chilton Company
Chestnut & 56th Sts.
Philadelphia, Pa. 19139

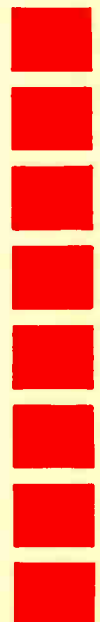

Att: Circulation Dept.

MANAGEMENT CONTROL SYSTEM

A SYSTEM WHICH PROVIDES A MODERN METHOD OF recording production, procurement, and material planning data, and monitors inventory and production transactions, was recently given its first public demonstration by Burroughs Corp. Also demonstrated publicly for the first time was the new Burroughs disk file, an on-line subsystem which can provide electronic access to any record in an average of one-fiftieth of a second. One disk module can contain 9.6 million characters of information.

The ACTION manufacturing control system—a B283 computer and disk file system—allows inquiries into the production and inventory records on the file through inquiry teletype typewriters. It will print out an inventory report containing four balances: on hand, on order, received and available.

The system maintains a complete file of manufacturing information, combining exception reporting with automatic follow-up. With minimum paperwork, it reports quickly when an action must be taken—such as when inventories are rising or when replacement parts are needed.

The system also monitors all inventory and production transactions as they are fed to the computer program. It signals any variation from the standards established by management.

Even while the computer is processing a work load, the disk file and transmission equipment can give instant access to information from any location where an inquiry typewriter or Dial TWX station exists. Up to 120 typewriter stations can be installed "on line" in any plant to the disk file system. Also, any private line standard teletype stations can be hooked up to the system through normal transmission lines.

Inquiries to the ACTION system can be made through TWX by dialing or phoning the computer number. Any one of over 66,000 installed TWX stations throughout the country can communicate with the disk files with only a minor modification.

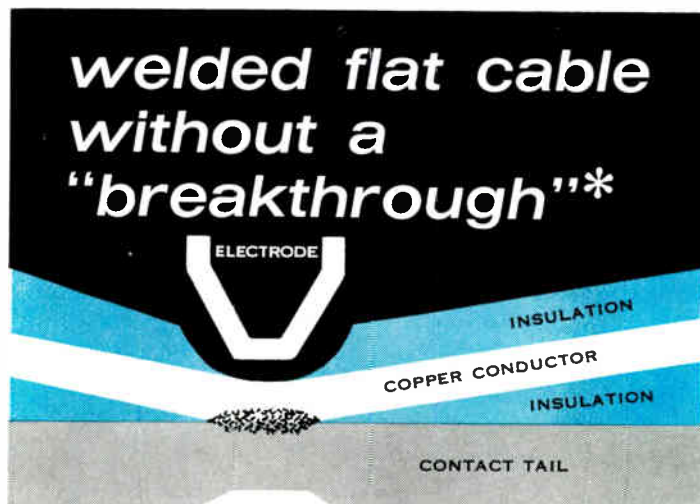

welded flat cable
without a
"breakthrough"*



*Four years
proven
performance

FLEX-WELD technique

- Terminations to all types of connectors without stripping
- Field proven in high reliability missile applications
- Custom fabrication of flat cables and inter-connection assemblies.



FLEX-WELD DIGITAL SENSORS INC.

4127 NORTH FIGUEROA ST. • LOS ANGELES, CALIF. 90065
PHONE: (213) 223-2333 • TWX: 213-226-1230

Circle 57 on Inquiry Card



DRAKE "Tynlite" LAMP HOLDERS & INDICATOR LIGHTS

Save
Space...
Save
Money...



Here are the ideal units for space saving. They make it easy to miniaturize all kinds of devices — dial lighting, instrument indicators, scale lighting on transistor radios, toys and novelties, are a few examples.

DRAKE "Tynlite" Midget Screw Lampholders are only 1/8 as large as standard units (with lamp installed). "Tynlite" Midget Indicator Lights are among the smallest available — supplied complete with replaceable lamp and entirely insulated from housing. You can choose either plastic dome lens or flat cap, lettered or numbered.

You can save both space and money with these skillfully engineered subminiature units — get full information now!

★ Send for "Tynlite" Data Sheets 6202 (Indicator Lights), 6208 (Lampholders), quick reference catalog of the big DRAKE Miniature Lighting line



DRAKE

MINIATURE
LIGHTING
SPECIALISTS

4626 NORTH OLCOTT AVENUE • CHICAGO 31, ILLINOIS

Circle 58 on Inquiry Card

... advancing the STATE-OF-THE-ART in Components & Equipment.

TRANSISTORS

DC beta of each transistor is 100 and is matched for the pair to 10% or better.

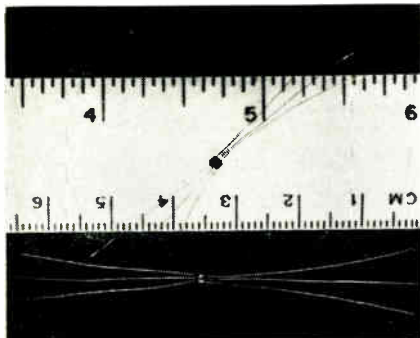

In the Model NS 7070 device, 2 carefully matched transistors, which operate as μ a.-level differential amplifiers, are mounted on each side of a ceramic block. Enclosure size is 0.065 x 0.065 x 0.080 in. The base-emitter voltages differ less than 5mv. The change in base-emitter voltage differential is 10μ v max./ $^{\circ}$ C within the temp. range from -55 to $+125^{\circ}$ C. National Semiconductor Corp., Danbury, Conn.

Circle 185 on Inquiry Card

LOW-LEVEL FETs

Feature zero offset voltage and max. on-resistance of 35 Ω



These 4 new field-effect transistors are designed specifically for low level choppers and multiplexers. They feature 3na max. gate current and typical gate-to-drain capacitance of 10pf. Transconductance is typically 40,000 micromhos. Typical cut-off freq. is 300mc. Because these new switches are voltage-operated, no drive transformer is needed for most uses. Crystallonics Inc., 147 Sherman St., Cambridge, Mass.

Circle 187 on Inquiry Card

PHASE-SENSITIVE VOLTMETER

Allows vector voltage measurements in the presence of gross harmonic content.



Model 211 measures vector components over a wide freq. span and in the presence of harmonics and extraneous freqs. Heretofore these measurements were limited to discrete freq. due to the limitations of filtering techniques. New circuit techniques and principles make possible this new domain of measurements. Freq. range is adjustable from 300cps to 10kc. Dytronics Co., Inc., 5566 N. High St., Columbus, Ohio.

Circle 189 on Inquiry Card

SNAP SWITCH

Mechanical life exceeds 20 million operations; rated at 10a.

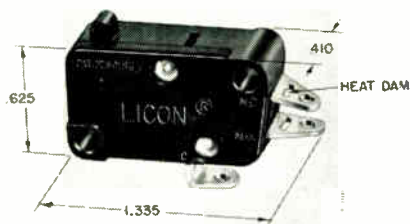

The type 23 series miniature snap-action is 125/250vac resistive. Operational to 180 $^{\circ}$ F, it is available in SPDT (form C), normally open (form A), or normally closed (form B) contact arrangements. A "heat dam" slot to eliminate the flow of solder and flux inside the case is provided on solder terminal models. The type 23 is available with screw or quick connect terminals. Integral roller and straight lever actuators are available. Licon, div. Illinois Tool Works Inc., 6615 W. Irving Park Rd., Chicago, Ill.

Circle 186 on Inquiry Card

ELECTROLYTIC CAPACITORS

Aluminum electrolytic units are rated at 1 to 330 μ f and up to 160v.

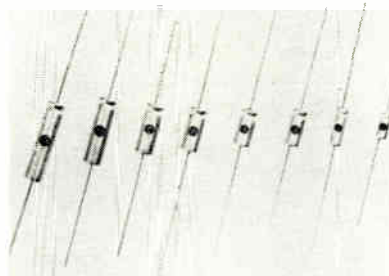

The 77F miniature capacitor line has a $\pm 20\%$ capacitance tolerance. They coincide with the international preferred number series. In the preferred number series, each nominal capacitance value is selected so that the max. allowed by its tolerance coincides with the min. capacitance allowed for the next higher rating. Thus, the range is covered by a min. number of capacitors. This eliminates multiple ratings and simplifies the circuit designers job of selecting the proper capacitor. They operate from -40° C to $+85^{\circ}$ C. General Electric Co., 392 E. Stratford Rd., Winston-Salem, N. C.

Circle 188 on Inquiry Card

VARIABLE SPEED MOTORS

Provide smooth stepless power over a wide speed range without torque loss.



This line of dc shunt reversible motors are ideally suited to motor-controller uses. Self ventilated and totally enclosed models are offered, rated 1/6 or 1/7 hp at 3600 RPM, 1/12 or 1/15 at 1800 RPM. Face mounting or base mounting are available. Separate armature and field leads permit variation of the armature voltage while the field voltage remains constant. This produces effective control of the shaft RPM without sacrificing torque. Carter Motor Co., 2760A W. George St., Chicago, Ill.

Circle 190 on Inquiry Card

NEW PRODUCTS

SILICON DC POWER

Ratings from 1v. to 100v.; may be adjusted $\pm 10\%$. Input: 105-125vac.

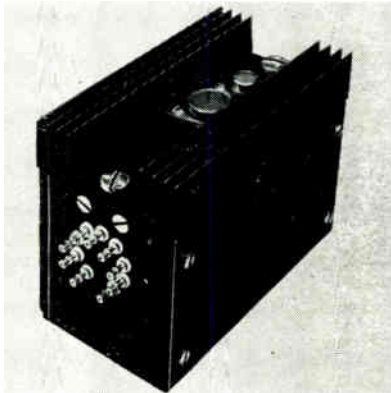

The Series 20-S Power Supply Modules feature remote sensing, remote voltage adjust, automatic current limiting, and all silicon semiconductors in a high temp.-quick maintenance package. It operates from 50-400 cps. Standard model is 5 $\frac{5}{8}$ in. overall with modifications available for special uses. Dressen-Barnes Electronic Corp., 250 N. Vinedo Ave., Pasadena, Calif.

Circle 191 on Inquiry Card

PRESSURE TRANSDUCER

Plastic extruder unit operates at +750°F without forced cooling.

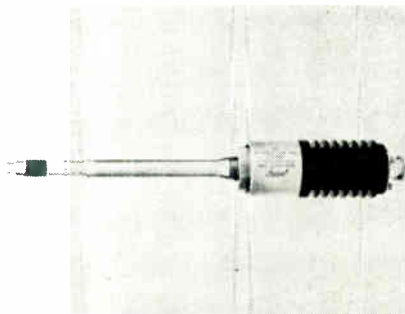

Incorporating the Model PG3297C transducer into thermoplastic extrusion machines provides exacting control over melt pressures, assuring consistent quality and higher production yield. The instrument fits into standard thermocouple wells, without any modification of the extrusion machine. This transducer uses advanced high-temp. construction and natural convection cooling. Specs: ranges, 0-1000; 2500; 5000; and 10,000 psig; linearity and hysteresis error, less than $\pm 1\%$ FS; thermal sensitivity shift, less than 0.01%/°F; thermal zero shift, less than 0.01%FS/°F; excitation, 5vdc or ac; full scale output, 20mv min. at rated excitation. Statham Instruments, Inc., 12401 W. Olympic Blvd., Los Angeles 64, Calif.

Circle 192 on Inquiry Card



GLOBE A. C. CENTRIFUGALS COOL WITH SLINGSHOT FORCE

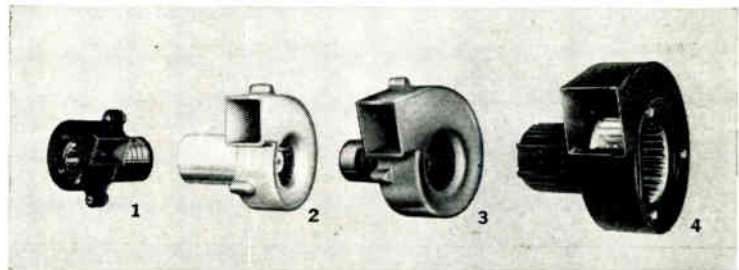

PERFORMANCE

- 1 1" wheel. 115 v.a.c., 400 cps. Overall length 2.48". Weight 4 oz. Part Number 19A565.
- 2 1 $\frac{1}{2}$ " wheel. 115 v.a.c., 400 cps. Overall length 3.30". Weight 16 $\frac{1}{4}$ oz. Part Number 19A690.
- 3 2" wheel. 115 v.a.c., 400 cps. Overall length 3.77". Weight 18 $\frac{3}{4}$ oz. Part Number 19A694.
- 4 3" wheel. 115 or 208 v.a.c., 50 or 60 cps. Overall length 6" max. Weight 3 $\frac{1}{2}$ lb. Part No. 19A1540.

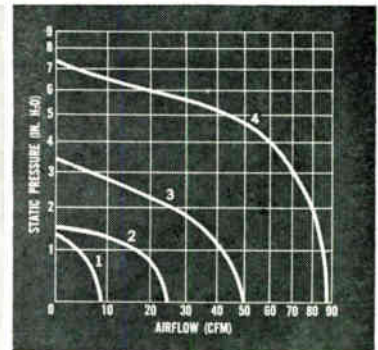

For economical cooling and pressurization, obtain a Globe proposal the next time you need standard or special centrifugal blowers. Globe makes single and double styles, for military or commercial applications. We also make a.c. and d.c. vaneaxial, tubeaxial, and multistage blowers and fans. Request Bul. CB. **Globe Industries, Inc., 2275 Stanley Avenue, Dayton, Ohio, 45404, U.S.A., Tel.: 513 222-3741.**



Switch to the Best

- 6000 volt peak flashover at 60 cps
- 20 ampere current carrying capacity
- Current carrying members heavily silver plated
- Low loss silicone impregnated steatite stators and rotors

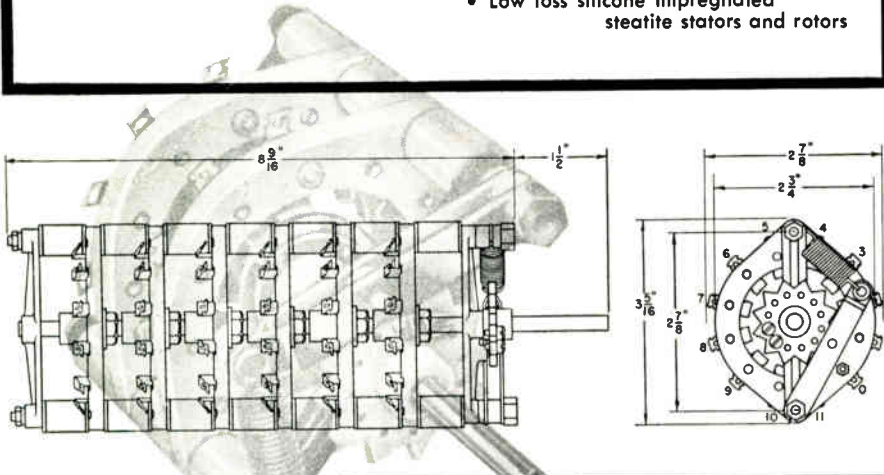

MODEL 86 SHORTING SWITCH



RADIO SWITCH CORPORATION

MARLBORO, NEW JERSEY
Telephone: HOpkins 2-6100

- Coin silver contact shoes
- White glazed steatite spacers
- Nylon detent wheel
- Black anodized aluminum die cast support brackets
- Stainless steel detent arm

Circle 71 on Inquiry Card

NEW PRODUCTS

SWEEPING OSCILLATOR

Sweep width is continuously variable from 300mc to less than 200kc.

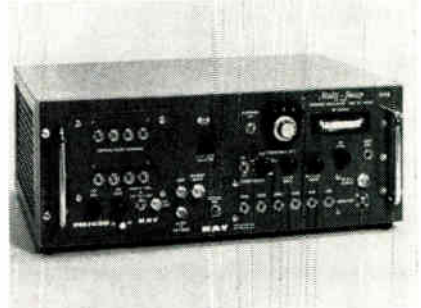

The Multi-Sweep 159-B is a wide range video-vhf sweeping oscillator and freq. marker. It provides a full 1 to 300mc of swept-freq. output by electronic freq. modulating techniques. The oscillator provides a linear freq. sweep, flat age'd output, and a complete marker system. Eight fixed markers are available at customer specified freqs. The unit may be swept at repetition rates above 30kc, or be driven by an external varying dc signal to function as a voltage-controlled oscillator. Kay Electric Co., 14 Maple Ave., Pine Brook, N. J.

Circle 193 on Inquiry Card

THERMOCOUPLE AMPLIFIER



MODEL 190

for

- RECORDER PREAMPLIFIERS
- OVEN CONTROLS
- GLASS FURNACES
- BEARING MONITORS
- METER PREAMPLIFIERS
- DC SHUNT AMPLIFIER

A new concept in solid-state DC amplifiers; no tubes, no transistors, no choppers. Typical gains 4000, $\pm 5 \mu\text{v}$ null stability; ten-year life. Price only \$84.00; quantity discounts, immediate delivery.

Request Technical Bulletin No. 19..



ACROMAG

INCORPORATED

15360 TELEGRAPH ROAD DETROIT, MICHIGAN, 48239
TELEPHONE (313) 538-4242 TELETYPE 313-538-4536

Circle 72 on Inquiry Card

INSTRUMENT TRANSFORMERS

*Shield effectiveness of 5×10^{-7} pf.
Common mode rejection is 140db.*



The 8300 Series of highly shielded instrument transformers are in 2 laydown packages for PC board mounting. One configuration, having a single Mu-metal can, is magnetically shielded to provide min. attenuation of 35db; the other, with double Mu-metal can, is shielded for min. attenuation of 60db. Max. freq. response ranges from 5 cps to 20kc at the 3db level, depending upon model. The high-isolation transformers are available with inductance of 4.4 to 4000 h. on the primary winding and 27 to 4000 h. on the secondary. James Electronics, Inc., 4050 N. Rockwell St., Chicago, Ill.

Circle 194 on Inquiry Card

TOGGLE SWITCH

Features 2-circuit, 10a. contacts. Provides min. of 10,000 to 40,000 operations.



Type T2106 measures 15/32 in. dia. x 1-9/32 in. long overall. The 2-position maintained contact toggle switch is suited for miniaturized electric-electronic equipment requiring a true snap-action switch. It is rated at 10a. resistive at 120vac or 28vdc. A patented cam-roller snap-action mechanism provides greatest contact pressure just before contact transfer. This insures excellent feel, virtually tease proof operation, and withstands 50 G shock tests. Controls Co. of America, Control Switch Div., 1420 Delmar Dr., Folcroft, Pa.

Circle 195 on Inquiry Card

KILOVOLT METER

Offers a voltmeter ranging to 100kv; full scale dc accuracy of $\pm 1\%$ ($\pm 2\%$ ac).



This instrument is fully transistorized and features a precision 6 in. mirror scale meter. Stabilized, anti-drift circuitry results in sensitivity of a few μ a. Panel mounted trimmers provide for convenient recalibration if required. The instrument uses fast spike bypass circuitry and automatic, voltage coefficient compensator for the multipliers. Special high voltage probes are supplied with the instrument: one for the 5 and 10kv ranges, and another for the 50 and 100kv ranges. Accuracy of the probes is $\pm 2\%$ for the lower ranges and $\pm 4\%$ for the higher. Industrial Instruments Inc., 89 Commerce Rd., Cedar Grove, N. J.

Circle 196 on Inquiry Card

ELECTRONIC INDUSTRIES • December 1964

Slash YOUR production costs! with **KÄHLE** AUTOMATIC EQUIPMENT

— FOR PRODUCTION, ASSEMBLY,
CONTROL, INSPECTION, TESTING

Typical KAHLE cost-saver designed and built for a leading miniature lamp manufacturer. Automatically assembles stem and bulb, then seal-molds, exhausts and tips-off the lamp...

CAPACITY
OVER 2,000
UNITS
PER
HOUR!

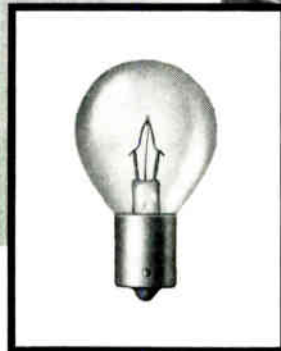
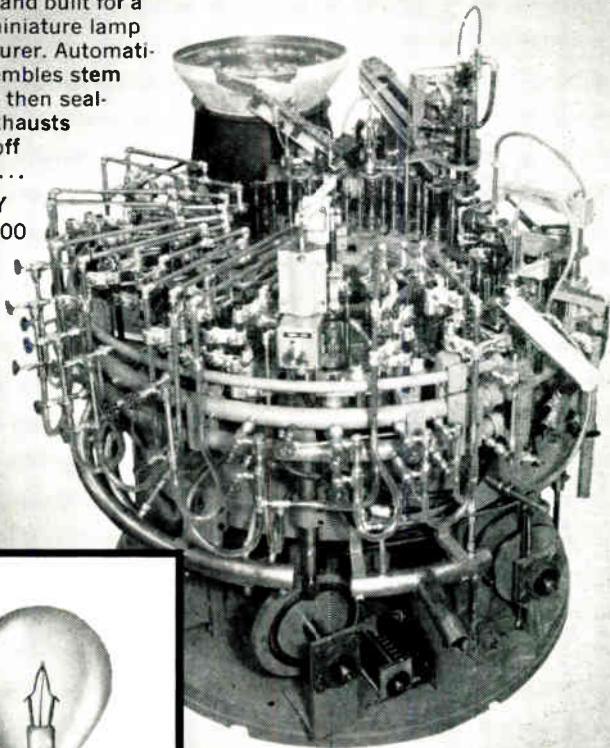

— KAHLE did it here!

KAHLE Servos and Feedbacks detect rejects prior to completion of assembly

Instrumentation feedbacks and servos can be supplied that will reject faulty parts prior to assembly and product finishing... saving materials and time in production.

KAHLE Machines are Customer-approved under actual operating conditions

Your equipment is run in our factory, using your materials in the presence of your engineers; the machine is not shipped to you unless you approve it!

CONSULT KAHLE—Save time and money by letting professionals build your specialty production equipment for automation!

KÄHLE

Designers and Builders
of Automatic Equipment
for High Speed Production
for Over 30 Years

Kahle Engineering Company

3318 HUDSON AVE., UNION CITY, N. J.

Telephone: UNion 7-6500 (Area Code 201)

Circle 73 on Inquiry Card

119

NEW

DIGITEC DIGITAL VOLTMETER & PRINTER



Model 201MN

- 0.1% or 0.2% FS Certified Accuracy.
- Readings from 0.1 MV to 1000 V DC.
- Floating or Grounded Input.
- Reliable Silicon Transistor Circuit.
- Individually Calibrated & Certified.
- BCD 1-2-4-8 Coded Output in Parallel Form.

\$1215

complete system

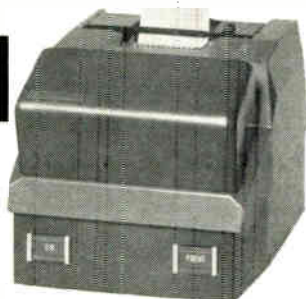

Model 600

- BCD 1-2-4-8 Parallel Input (+6 V or +12 V).
- Prints 2 Banks of 4 Columns.
- Automatic Negative Sign Print.
- 48 Line/Minute Print Rate.
- Uses Standard 2 1/4" Paper Tape.
- Remotely "Programmable".

ALSO AVAILABLE

- Coded Output on All DigiTec Instruments.
- Time, Identification and Serializing Accessories.
- Printer to Provide Addition and Subtraction Functions.

UNITED SYSTEMS CORPORATION

918 Woodley Road, Dayton 3, Ohio (513) 254-3567

Stocking Representatives throughout the World.

JUST PUBLISHED
New 32-page color catalog!
Write for your copy.

Circle 74 on Inquiry Card

NEW PRODUCTS

TUBE SHIELD

For use with JAN sockets; reduces bare bulb temp. by 20°C.

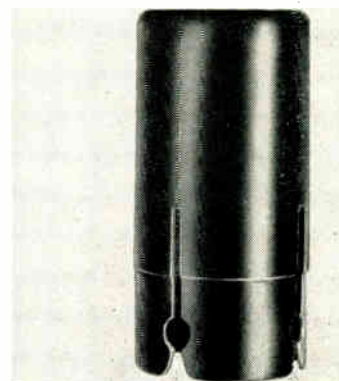

Type F shield meets and exceeds the requirements of Mil-S-9372C. It also meets the dimensional requirements of MS-24233. It snaps on to a standard Mil-S-12883/2A socket for 7-pin tubes and Mil-S-12883/3A for 9-pin tubes. Excellent heat dissipation is provided by a flexible beryllium copper liner which grasps the tube envelope and provides a direct heat path to the shield body. This liner is heat treated and allows full contact with the tube, even after repeated insertions and withdrawals. Atlee Corp., 2 Lowell Ave., Winchester, Mass.

Circle 197 on Inquiry Card

TIME CODE GENERATOR

Multiple-code unit handles modified IRIG code, PARSET code or Huachuca code.

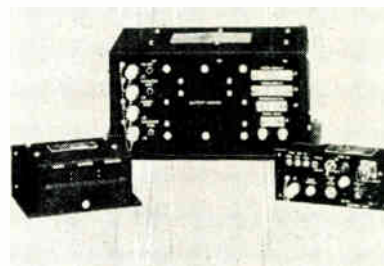

Convenient switch-selection of 3 different codes are a feature of this Time Code Generator for airborne uses. This time code generator requires no change in circuit boards or re-wiring to accomplish changes in codes. It is a precision time-of-day encoder that provides a visual presentation by means of Nixie indicators. The clock section is a crystal oscillator in a temp.-controlled oven and is accurate to 1 part in 10⁵. Clock pulses are generated in serial form and converted to the selected code format by scan matrices. The A. W. Haydon Co., Waterbury, Conn.

Circle 198 on Inquiry Card

AUGAT

Test Socket and Accessories for "Flat Pack" Integrated Circuits

8075 SERIES

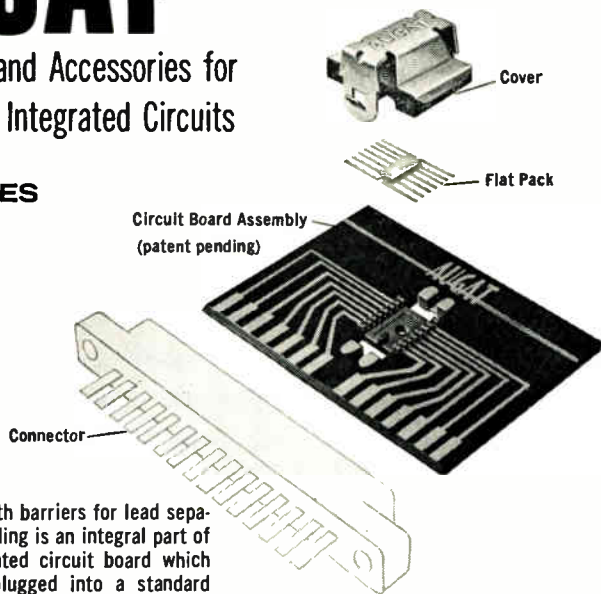

A molded insert with barriers for lead separation and fast loading is an integral part of a glass epoxy printed circuit board which in turn may be plugged into a standard fifteen-pin printed circuit connector for test purposes. Unique snap-action cover design insures positive contact, low contact resistance, firm retention of package and removal of Flat Pack without lead damage. Accepts any size package up to 1/4" x 3/8", any number of leads up to 14. Also supplied without cover for lead soldering or welding.

For details, write for data sheet 364.

AUGAT INC.

39 Perry Avenue, Attleboro, Mass.

Circle 75 on Inquiry Card

PULSE GENERATOR

Features 40mc repetition rate, $\pm 10v$. output, 5nsec. rise and fall time.

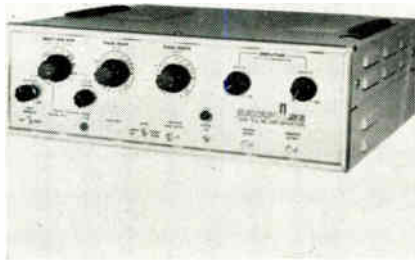

Model 109 pulse generator features high speed capability and full control of all major pulse parameters. Other features include single or double pulse operation, 10nsec. to 50msec. pulse width, and 10nsec. advance to 50msec. delay. Repetition rate is continuously variable from 4 cps to 40mc. Repetition rate jitter is less than 0.05%. Delay and width jitter is less than 0.1%. Waveform aberrations are less than 5% at amplitudes of 3v. and higher. The unit is rated for operation with amb. temps. from 0° to 50°C. Datapulse Inc., 509 Hindry Ave., Inglewood, Calif.

Circle 199 on Inquiry Card

CONNECTOR

Designed for hybrid integrated and printed circuit applications.

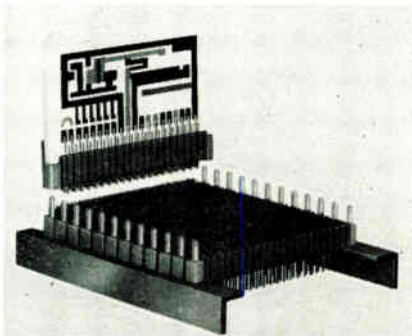

The Series 8208 ZIG-ZAG™ connector is a new microminiature connector. High density is achieved via corrugated side configuration of connector, from whence connector derives its name. Connector halves can be sliced in even 0.100 in. segments from molded 5 in., 96-contact size down to 2. Interlocking end sections are provided for mounting and polarizing guides. Contacts may be patterned on 1 side, both sides or have dual terminations on the PC cards. Connectors may be used in single rows or stacked. Both plug and receptacle are 1-piece construction. Standard sizes are from 2 to 96 contacts, in even multiples. Sizes above 50 contacts require multi-stacking. Elco Corp., Willow Grove, Pa.

Circle 200 on Inquiry Card

YOKE SPECIFYING PROBLEM?

ASK AN EXPERT...

A SYNTRONIC DEFLECTION YOKE SPECIALIST



Since we make more types of yokes than anyone else, it's natural enough for our team of experts to know more about yoke design, application engineering, and quality control.

Specifying can be a challenging problem, and with this in mind, we put our experience at your disposal. Don't hesitate to call or write us when you're puzzled as to the right deflection yoke for your display.

syntronic

INSTRUMENTS, INC.

100 Industrial Road, Addison, Illinois
Phone: Area 312, 543-6444

Circle 77 on Inquiry Card

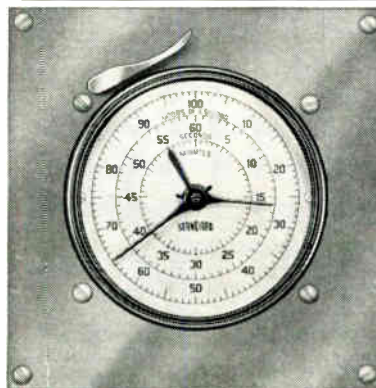

THE ONE TIMER WITH ALL THE FEATURES

- Portable, Panel or Wall Mounting
- Scale Divisions from 1/1000 sec. to 1/5 sec.
- Totalize from .360 sec. to 60 min.
- Accuracy range from $\pm .0002$ to $\pm .1$ sec.

Since 1932 Standard Electric Time Company has been developing and manufacturing units for the precise measurement of elapsed time. Accuracy, rugged construction and long life are Standard features.

For full details request free 20 page catalog No. 257.

| Model | Scale Divisions | Totalizes | Accuracy |
|---------|-----------------|-----------|------------------|
| S-100 | 1/5 sec. | 6000 sec. | $\pm .1$ sec. |
| S-60 | 1/5 sec. | 60 min. | $\pm .1$ sec. |
| SM-60 | 1/100 min. | 60 min. | $\pm .002$ min. |
| S-10 | 1/10 sec. | 1000 sec. | $\pm .02$ sec. |
| S-6 | 1/1000 min. | 10 min. | $\pm .0002$ min. |
| S-1 | 1/100 sec. | 60 sec. | $\pm .01$ sec. |
| MST-100 | 1/1000 sec. | 6 sec. | $\pm .001$ sec. |
| MST-500 | 1/1000 sec. | 30 sec. | $\pm .002$ sec. |

THE STANDARD ELECTRIC TIME COMPANY
89 LOGAN STREET • SPRINGFIELD, MASSACHUSETTS

Circle 78 on Inquiry Card

2 NEW MAGNETIC SHIELDING PRODUCTS

1. SHIELD MU

Tape
and Foil



SHIELDMU is a new, high permeability, fully processed, ready-to-use material for shielding sensitive electronic and electrical components from stray magnetic fields.

IT OFFERS:

- 2 to 3 times more shielding efficiency than material currently available
- an easy way to form shields in place around inductive components to save space, time, expense
- ductility without significant degradation of magnetic shielding properties
- 4 levels of permeability performance; availability in a number of thicknesses, widths and continuous lengths

2. SHIELD FLEX

Flexible Tubing

SHIELDFLEX is especially designed to: isolate conductors from external magnetic fields; contain the magnetic field generated by current carrying conductors; provide electrostatic shielding.

IT OFFERS:

- production economy since cable can be run through a length of Shieldflex for complete magnetic and mechanical protection.
- optimum shielding efficiency equivalent to that expected from high permeability shield structures
- 39 db attenuation in a 1 oersted, 60 cps field
- space economy since conductors can be routed very close to components or other conductors.

Write, wire or call for full details on SHIELDMU and SHIELDFLEX.

MAGNETIC METALS

MAGNETIC METALS COMPANY

21ST & HAYES AVE., CAMDEN, N.J. 08101
Phone: 609-964-7842 TWX: 609-964-6772

■ Transformer Laminations ■ Motor Laminations ■ Tape Wound Cores ■ Powdered Molybdenum Permalloy Cores ■ Electromagnetic Shielding ■ Metallurgical Services ■

Circle 79 on Inquiry Card

NEW PRODUCTS

VARIABLE DELAY LINE

Continuously variable 1.0 to 15 μ sec. delay range with infinite resolution.

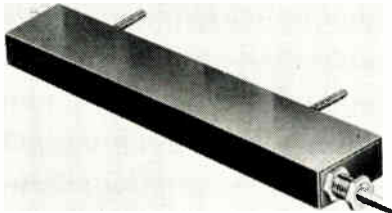

Input impedance of Model 73-85 is 1200 Ω , and pulse attenuation is less than 6db into a 20K Ω load. It will delay pulses of 2.5 μ sec. duration or greater with differentiation. Approx. 10 rotations of the control covers the entire delay range. When the shaft is locked, temp. co-efficient of delay is less than 60 ppm $^{\circ}$ C. The Model 73-85 contains no sliding contacts and will meet most military environmental requirements. Overall dimensions are 7 $\frac{1}{4}$ x 1 x 1 $\frac{3}{8}$ in. ESC Electronics Corp., 534 Bergen Blvd., Palisades Park, N. J.

Circle 201 on Inquiry Card

SWITCH COMPARATOR

Improves sweep frequency measurement techniques.



Model TC-3 improves the efficiency of production line testing. Unlike previous comparators, the TC-3 provides 2 reference traces with which the unit under test is compared, thus providing an instant go-no-go scope display. The comparator covers between 0 and 1200mc. The switches can be snapped out of the unit and moved closer to the unit under test. This enables the use of shorter test leads, resulting in greater accuracy. While it is designed for 50 Ω operation, plug-in heads make it easily adaptable to other impedances. Jerrold Electronics Corp., 15th & Lehigh Ave., Phila. 32, Pa.

Circle 202 on Inquiry Card

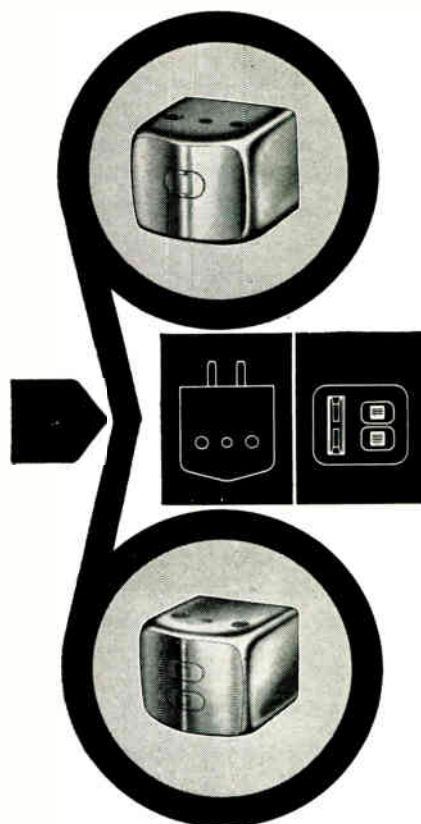

NORTRONICS ANNOUNCES... New Line of Tape Heads!

Nortronics now offers a completely new line of laminated core heads, available in either Standard or Premium versions. The Premium heads, exceptional in quality and performance—yet moderately priced—have highly polished metal faces with hyperbolic contours which provide more intimate tape-to-gap contact, yet greatly reduce oxide buildup and the need for frequent head cleaning. In addition, the Premium series offers deposited quartz gaps; fine laminated, precision-lapped, low loss core structures; and extended high frequency response at slower tape speeds. The Standard heads, recommended for non-critical, low-cost applications, have hyperbolic, all-metal faces and provide excellent high frequency performance.

COMPLETE NEW LINE TOOLED FOR HIGH PRODUCTION!

This new line includes two and four-track mono and stereo R/P heads, two and four-track mono and stereo combination erase-R/P heads, and three and four-channel in-line heads for $\frac{1}{4}$ inch tape. All heads are available in six standard impedances and your choice of mount—base, side, rear and no mount.

For complete information on Nortronics' new line of tape heads, write for Form #7177.

Nortronics

8149 Tenth Ave. N., Minneapolis, Minn. 55427

Circle 80 on Inquiry Card

Life before the PVB

Mr. Sy Rubín—Quality Assurance Manager of United Aero Test Laboratories, Deer Park, N. Y.—describes his working life before and after our Model 300 PVB (Portametric Voltmeter Bridge).



"Before the PVB, the same measurement capabilities would have cost us thousands."

"We're one of the largest testing labs in the country with complete metrology labs on the East and West coasts. As we grow, our calibration work keeps increasing. Invention of the PVB saved an outlay of many thousands of dollars. For \$750, we answered many of our needs in this single portable instrument.

"I use the PVB for all dc calibrations on the order of a half percent. We calibrate our environmental chambers with it using a certified thermocouple. It's also handy for digital voltmeters, to assure one digit resolution, and for ac measurement with thermal transfer equipment.

"For anyone with calibration responsibilities, I'd say the PVB has the all-round usefulness of an MD's little black bag." *ESI, 13900 NW Science Park Drive, Portland, Oregon (97229)*

In a single battery-operated unit, the PVB combines the functions of a potentiometric voltmeter, voltage source, ammeter, guarded Kelvin double bridge, resistance comparison bridge, ratiometer and electronic null detector. Accuracy: $\pm 0.02\%$ of reading or 1 switch step on virtually all ranges.



esi

Electro Scientific Industries, Inc.
Circle 81 on Inquiry Card

NEW PRODUCTS

PRESET COUNTERS

Offer input freq. of 0 to 100kc;
have a sensitivity of 10mw RMS.

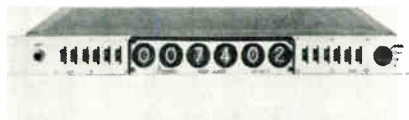

The Anadex preset counters are designed to perform control functions such as high-low alarm systems, time control, quantity control, etc. Other uses include limit detection, process control, and generation of precise time intervals. Four counter models are available: single preset with Nixie display, single preset without Nixie display, dual preset with Nixie display, and dual preset without Nixie display. Models are available with from 3 to 8 digits. Anadex Instruments Inc., 7833 Haskell Ave., Van Nuys, Calif.

Circle 203 on Inquiry Card

CONNECTOR SPACE PLATE

Leak rate below 0.001 micron cu. ft./hr. at one atmosphere differential.

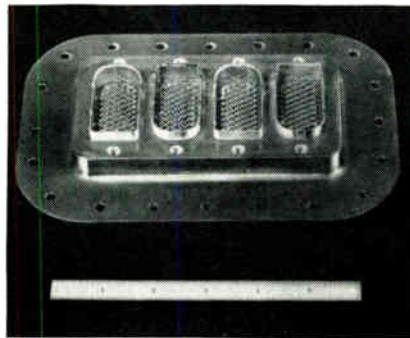

Four hermetically sealed DRS type rectangular receptacle connectors are included in the unit which measures about 5 x 8 in. It is capable of operating at temps. from -65° to 300° F. Each of the four receptacle units contains 49, size 20 pin contacts with solder pots. Contacts will withstand 1500VAC (RMS) at sea level. Contact current rating is 7.5a. for each size 20 contact. Keyways eliminate the possibility of misalignment. They are available in 6 clocking positions to meet any combination of multiple plate use. The Deutsch Co., Electronic Components Div., Municipal Airport, Banning, Calif.

Circle 204 on Inquiry Card

**PROVE YOUR
DIGITAL
SYSTEMS DESIGN
WITH FACILOGIC®
FREE 30-DAY
TRIAL OFFER**

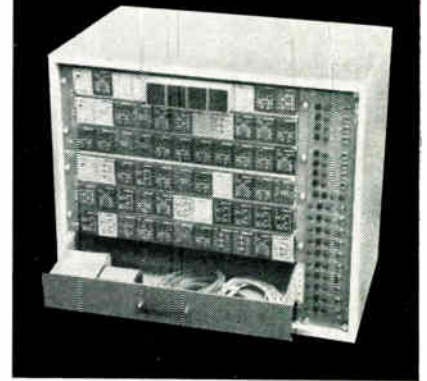

Now, thanks to the new Facilogic® modular breadboarding system, you can prove your paper designs immediately . . . just select and plug in standard breadboard circuit modules as desired . . . patchcord interconnect as required . . . front or back . . . works like an electronic erector set . . . provides the fastest, most efficient breadboard checkout of digital designs available today.

Facilogic kit is supplied complete . . . ready-for-use . . . including pre-wired bench cabinet, 18-switch panel, power supply, patchcords, and 33 standard plug-in modules . . . each with one to four basic digital circuits . . . all standard circuits available . . . NAND, NOR, AND, OR . . . blank modules for your special circuits available.

That's not all! A complete line of matching encapsulated modules is available from stock . . . you can convert breadboard-proved designs into production systems immediately . . . without system debugging.

Facilogic . . . purchase or lease . . . all leasing charges applied to purchase . . . special leasing plan includes 30-day in-plant trial FREE. Limited number of kits available.

**THE ROBACK
CORPORATION**
Harman-Kardon Data Systems Division
Huntingdon Valley, Pennsylvania
215 ORchard 6-4000

Circle 82 on Inquiry Card

PROVEN



... Only 160 Milliwatts
Operates
High Sensitivity
Mercury Wetted
Reed Relay

SERIES 3002 Hg REED RELAYS

- Contacts: 1 to 5 Pole — Form A
1 pole — Form C
- Coil Rating: 200mw for 1 pole
to 1500 mw for 5 poles
- Coil Voltages: 6 to 120VDC
- Contact Rating: to 50W
- "Cradled Reed" design

NEW CATALOG describes the complete line of Wheelock Proven Glass Reed Relays. Includes capabilities, limitations, application data, mechanical and electrical specifications.



Wheelock

273 Branchport Ave.
Long Branch, N. J.
201-222-6880

Circle 83 on Inquiry Card

NEW PRODUCTS

H-F MEASURING SYSTEM

System consists of a 50mc counter-timer and a 15cc transfer oscillator plug-in.



This h-f measuring system measures freqs. over the entire range of dc to 15cc. Measurements over entire range retain counter accuracy. This is achieved with a combination of AFC and phase lock for CW signals. Phase lock holds over a $\pm 0.01\%$ shift of the measured signal. Fine tuning without AFC is provided to determine AM and FM modulation characteristics and measure pulsed r-f freq. Systron-Donner Corp., 888 Galindo St., Concord, Calif.

Circle 207 on Inquiry Card

STUD WELDER

Welds fasteners to thick or thin metal without burn-through or distortion.

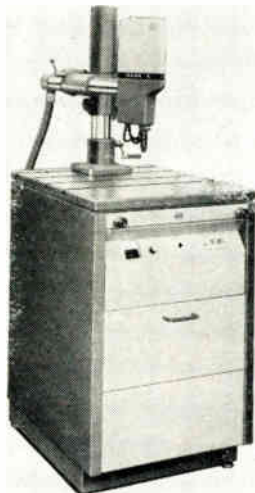

The Mark 4 operates on the stored energy principle. It requires no flux, ferules, special wiring or metal preparation. Studs are welded flush without fillet or protrusion. Handling studs, fasteners, or attachments up to $\frac{1}{4}$ in. dia., the unit welds to steel, stainless steel, various aluminums (including 6061-T6), titanium, brass, copper, dovar, inconel, tungsten, and plated metals. It features integrated controls and easy column adjustment for fast, accurate operation. Omark Industries, Inc., Portland, Ore.

Circle 208 on Inquiry Card



Symbol
of
Superiority

IN PRECISION WIRE-WOUND RESISTORS

- CLOSER TOLERANCES
- BETTER STABILITIES
- LOWER TEMPERATURE COEFFICIENTS
- PROVEN RELIABILITIES



SUB-MINIATURE RESISTORS

Series "EP" (Sub-Miniature) — Solves many space and weight problems. Typical size: .125" x .125". Diameters to .080" and lengths to .125". Available in axial or combination axial-radial leads.

STANDARD RESISTORS

Series "EP" (Standard) — Choice of over 40 standard sizes — all reflecting the performance superiority of Kelvin precision wire-wounds. Resistance as low as .01 ohm. Resistance tolerances to .005%. Temperature coefficients to 1 PPM.



PRINTED CIRCUIT RESISTORS

Series "PC" — For mass production assembly and optimum space utilization. Available in special "high density" (rectangular) packaging and standard round configurations.

HIGH STABILITY RESISTORS

Series "O" — Used where resistance matching or accurate voltage division is required over long periods of time. Heavily utilized in A to D converters, analog computers, differential voltmeters and guidance computers for military applications. Long term resistance stability of .003% maximum per year and standard TC of 10 PPM. Available in all standard physical sizes down to .187" x .375".



FAST RISE TIME RESISTORS



Series "RT" — Ideal in fast switching circuits. Exceptional high frequency performance with rise times in the range of 50 to 100 nanoseconds, depending on style and resistance value.

RESISTOR NETWORKS

Custom resistor, diode and capacitor combination networks. Built to meet special requirements. Used as voltage dividers, summing and integrator networks, binary resistive networks and other network applications. Ratio tolerances to .0005%, TC tracking as close as 1 PPM to military requirements.

OTHER FEATURES OF ALL KELVIN RESISTORS

- Standard leads are both weldable and solderable
- All welded internal construction
- Non-inductive windings
- Vacuum encapsulated with high temperature epoxide material
- Special winding technique for assured stability

Write for complete new catalog.



KELVIN

5919 Noble Avenue, Van Nuys, Calif.
(213) 873-3430

Circle 84 on Inquiry Card

STANPAT

REPETITIVE SYMBOLS
& DRAWING DETAILS

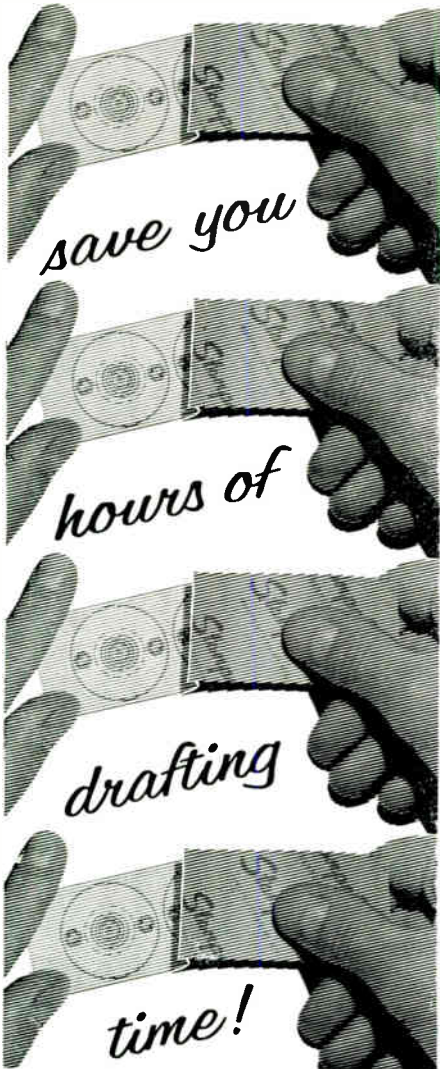

If your engineering designs require four or more repetitive drawings, STANPAT triacetate sheets, preprinted with your own symbols, can be applied in seconds rather than drawn in hours.

The STANPAT formula gives permanent adhesion without ghosting. Your own drawing details reproduce crisp and clean everytime on all types of tracing media. Excellent for microfilm reproduction . . . non-reflective surface receptive to both pencil and ink.

Write today and find out how STANPAT can save you hours of routine drafting time. Literature and samples on request, or enclose your symbols for quote.

*faithfully serving the engineer
for over two decades*



STANPAT
PRODUCTS INC.
Whitestone 57, N.Y., Dept.C12
telephone: 212-359-1693

Circle 85 on Inquiry Card

NEW PRODUCTS

ALUMINUM OXIDE CAPACITORS

*Performance equals foil-tantalum types,
but with higher volumetric efficiency.*

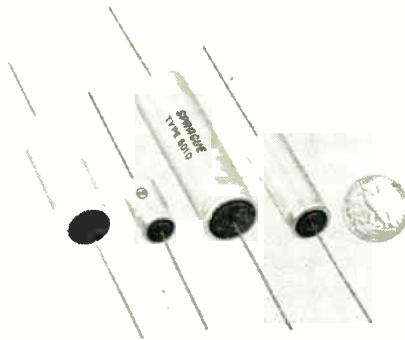

This new series of aluminum oxide capacitors, operable from -55°C to $+85^{\circ}\text{C}$, are in the Extralytic® capacitor family. Known as Type 601D, the units should be of special interest to designers who have used parallel-grouped tantalum packages. The new capacitors provide higher capacitances in single units that are smaller and lighter. With this series it is possible to obtain $13,000\mu\text{f}$ @ 5vdc in a case 1 in. dia. x $3\frac{5}{8}$ in. long. Sprague Electric Co., 233 Marshall St., No. Adams, Mass.

Circle 209 on Inquiry Card

HIGH-POWER SCR

*Features compression-bonded
joints and integral heat sinks.*

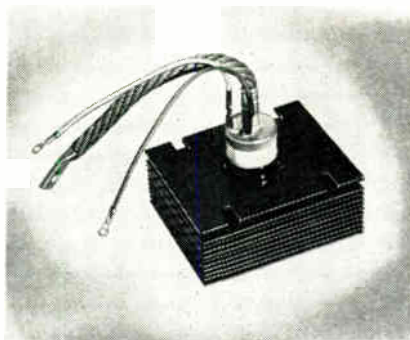

The JEDEC 2N3430 series of high-power devices include the use of compression bonding encapsulation (CBE) and an integral heat sink design. The CBE construction eliminates solder joints by using high pressure contacts to maintain electrical and thermal contact between the SCR wafer and the base. The device has a max. current rating of 400a. rms or a half-wave average rating of 250a., and is available with forward blocking voltages from 50 to 1Kv. Westinghouse Semiconductor Div., Youngwood, Pa.

Circle 210 on Inquiry Card

PROVEN



... AT 30g VIBRATION,
50g SHOCK

SERIES 262 MINIATURE REED DELAY

- Meets Crystal Can Relay Standards for Shock and Vibration
- Single Pole Unit Weighs Only .2 Ounces
- Coil Ratings: 125 to 600 mw
- Contact Rating: 4 W
- Coil Voltages: 6 to 48 VDC
- "Cradled Reed" Design

NEW CATALOG describes the complete line of Wheelock Proven Glass Reed Relays. Includes capabilities, limitations, application data, mechanical and electrical specifications.



Wheelock
273 Branchport Ave.
Long Branch, N. J.
201-222-6880

Circle 86 on Inquiry Card

GLASS ENCLOSED

AMPERITE

Thermostatic DELAY RELAYS

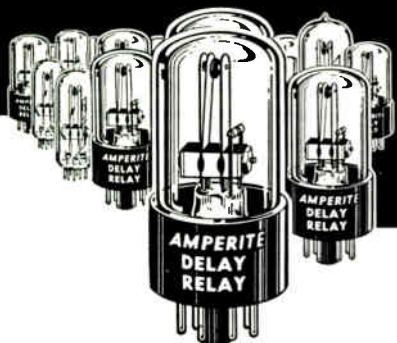

Offer true hermetic sealing—assure maximum stability and life!

Delays: 2 to 180 seconds . . . Actuated by a heater, they operate on A.C., D.C., or Pulsating Current . . . Being hermetically sealed, they are not affected by altitude, moisture, or climate changes . . . SPST only—normally open or normally closed . . . Compensated for ambient temperature changes from -55° to $+80^{\circ}$ C. . . Heaters consume approximately 2 W. and may be operated continuously . . . The units are rugged, explosion-proof, long-lived, and—inexpensive!

TYPES: Standard Radio Octal, and 9-Pin Miniature.
List Price, \$4.00

PROBLEM? Send for Bulletin No. TR-B1

AMPERITE

BALLAST REGULATORS

Hermetically sealed, they are not affected by changes in altitude, ambient temperature (-50° to $+70^{\circ}$ C.), or humidity . . . Rugged, light, compact, most inexpensive.

List Price, \$3.00

Write for 4-page Technical Bulletin No. AB-51

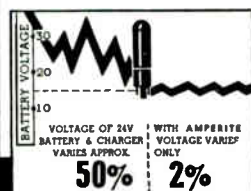

AMPERITE

600 PALISADE AVE., UNION CITY, N.J.
Telephone: 201 UNION 4-9503
In Canada: Atlas Radio Corp., Ltd.,
50 Wingold Ave., Toronto 10

Circle 87 on Inquiry Card

NEW PRODUCTS

MULTIPLEX SWITCH

Operates with positive logic from dc to 10kc either synchronous or asynchronous.

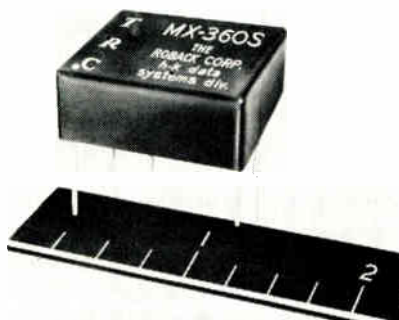

The MX-360S is an encapsulated, solid-state, silicon multiplex switch which provides high speed switching from -25° C to $+125^{\circ}$ C. Designed to meet all requirements of Mil-E-5272C, the miniature switch weighs 0.5 oz. and measures 1.2 x 0.8 x 0.5 in. (0.5 cu. in.). Eight such switches can be accommodated on a single standard size circuit card. It accommodates analog voltages ranging from -15 v. to $+15$ v. and control inputs from $+6$ v. to $+12$ v. The Roback Corp., Harman-Kardon Data Systems Div., Ambler, Pa.

Circle 205 on Inquiry Card

INPUT SINE CONVERTER

Dynamic Converter offers versatility of 5 instruments in 1.

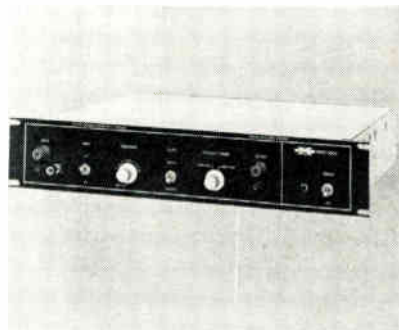

The SD-103 is a versatile new vibration test instrument. The phase coherent unit accepts a wide variety of repetitive input waveforms and produces a sinewave output of the exact freq., phase locked with the input signal. The DISC performs the following 5 distinct functions: rotating machinery vibration analysis; tracking function generation; freq. to dc conversion; constant output amplification; and signal conditioning. It features all solid-state design, variable triggering modes, wide freq. range, and small size and lightweight. Spectral Dynamics Corp., 8159 Engineer Rd., P. O. Box 671, San Diego, Calif.

Circle 206 on Inquiry Card

ANOTHER



STATE-OF-THE-ART CAPABILITY

SOLID STATE

PHASE SHIFTERS

Here's a typical example

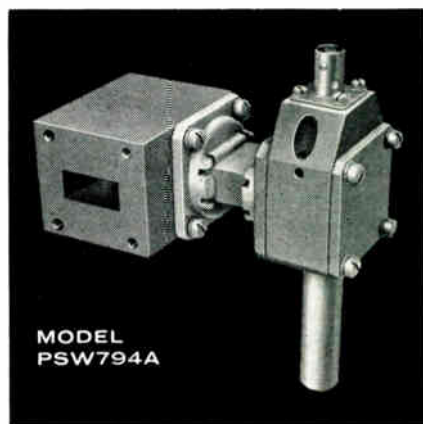

The new AEL Model PSW794A Phase Shifter represents a major state-of-the-art development in this field.

Check these features . . .

- Solid state, 180°, X-Band.
 - Typically one nanosecond speed of phase shift change over X-Band.
 - No hysteresis effect in phase shift.
 - Low VSWR—maximum of 1.3:1.
 - 1.5 db typical insertion loss through entire phase shift range.
 - Less than 0.1 Watt drive power required.
 - Dynamic phase shift range exceeds 180°.
- Let AEL provide you with the custom Phase Shifter to meet your exact requirements. Send us your specifications . . . we will reply with our quote.



American Electronic Laboratories, Inc.
P.O. BOX 552, LANSDALE, PENNA.
(215) 822-2929

Circle 88 on Inquiry Card

ELECTRONIC INDUSTRIES • December 1964

Eisler a name to remember in machinery for electronics

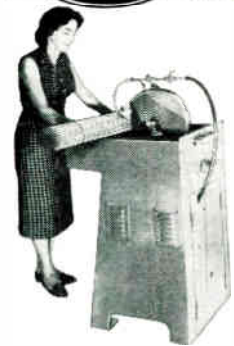

At left: Largest assortment of wet and dry type Glass Cutters.

Below: An Eisler precision vertical Spot Welder designed exclusively for welding electronic components. Sizes from 1/2 to 7 1/2 KVA



Write us today for full particulars!

EISLER ENGINEERING CO., INC.
Charles Eisler Jr., President
770 South 13th Street, Newark 3, N.J.

Circle 76 on Inquiry Card

for Micro-Miniature Masks!
ARE YOU GETTING MAXIMUM RESOLUTION?
ON HIGH RESOLUTION PLATES FROM ORIGINAL ART WORK?

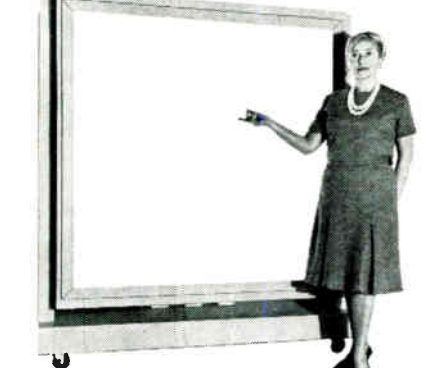

Stock Sizes from 4" x 5" to 44" x 44"
Larger Sizes Built to Specification
IF NOT . . . YOU NEED THE ARISTO TRANS-LUMINATOR

Equipped With:
Aristo FYG-54 Lamps—This is a narrow band source peaking at 518mμ. It gives greater precision and dimensional stability in producing microphotographs from large originals, and is superior to conventional or improvised sources in speed, accuracy, uniformity, coolness, cleanliness, and economy.
Or Aristo B-3642 Lamps—For exposing photo resists. Peaking at 365mμ and 420mμ, this source matches the sensitivity response of these materials. It provides Faster, Cooler, Cleaner reproductions of printed circuits, and is 3 to 15 times faster than conventional sources consuming only a fraction of their power.

For details write: Dept. T

ARISTO GRID LAMP PRODUCTS INC.
65 Harbor Road, Port Washington, Long Island

Circle 89 on Inquiry Card

NEW PRODUCTS

TAPE READER

The 120 character/sec. reader reads data from 5, 6, 7, or 8 level tape.



The Model 464 is completely asynchronous. The reader operates in either direction at full speed. Tape reels mounted directly on the reading unit minimize rack space. Precious metal, corrosion resistant form C contacts, assure positive hole-no-hole identification and allow introduction of bit accountability techniques. The non-return to zero feature can appreciably simplify system logic. A wide range of tapes may be processed even though they exceed EIA hole-to-hole and edge-to-hole tolerances. Tally Corp., 1310 Mercer St., Seattle, Wash.

Circle 211 on Inquiry Card

PHOTOCONDUCTIVE CELLS

Voltage ratings to 300v. and light resistances down to 250Ω @ 2 ft. candles.

The 5M series offer up to 2w. of power dissipation. They are available in 8 types of cadmium sulphide and cadmium selenide sensitive materials in a hermetically-sealed metal case 0.490-in. dia. Automatic TV brightness control is one of the many uses. Clairex Corp., 8 W. 30th St., New York, N. Y.

Circle 212 on Inquiry Card

FILM POTENTIOMETER

Resistance range of 1KΩ-250KΩ (±10%). 2% to 0.05% independent linearity.

Model 177S is a multi-gang precision-film potentiometer. The unit is available in both linear and non-linear special and standard models. It has a 350° electrical function angle (±3°); 356° electrical contact angle (+2°, -3°); 3w. power dissipation (at 25°C) and a choice of taps at locations to suit. Operating temp. is -55°C to +150°C, and dielectric strength is 750v RMS. Computer Instruments Corp., 92 Madison Ave., Hempstead, L. I., N. Y.

Circle 213 on Inquiry Card

The most widely used readout system...

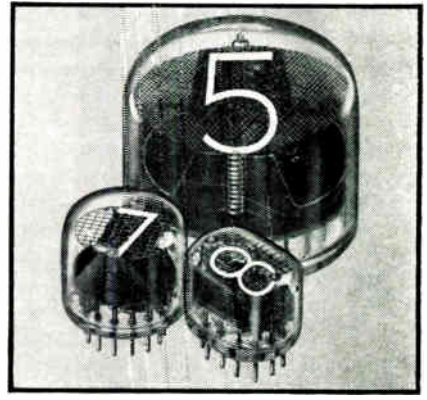

SPECIFY LONG-LIFE

NATIONAL[®] READOUT TUBES*

9 reasons why...

- 1 Far more gas tube engineering experience than any other manufacturer.
- 2 Bright, clear, distinct readout.
- 3 Long-life . . . 300,000 hours life and more.
- 4 Uniformity . . . both initial and long term . . . no variation in color or intensity from number to number, tube to tube.
- 5 Non-fading.
- 6 Choice of shapes . . . round or rectangular.
- 7 Wide range of character sizes (.310" to 2.0").
- 8 Simple, rugged, attractive display.
- 9 Low initial cost.

For full details, request readout tube technical data.

*Manufactured under license from Burroughs Corporation

NATIONAL ELECTRONICS, INC.

A subsidiary of Eitel-McCullough, Inc.
Phone: (312) 232-4300 • Geneva, Illinois, U.S.A.

Circle 90 on Inquiry Card

SCR Proportional Power Controller



REMOTE CONTROL SIGNAL LOAD LINE

Phaser, SCR power controller for industrial and OEM use, controls AC or DC loads up to 40 KVA. (Custom models have capacities to 150 KVA.) Output is smoothly variable from zero to full line voltage by external control signal. Manual bias control is optional. May also be controlled by on-off switch.

Current Ratings Available: 10, 20, 30, 40, 60, 85 amps.

Line Voltages: 115, 208, 230/115, or 480/240 single ph. 60 cy.

Response Rate: 1 cycle of line frequency.

Compact Size: Approx. 9" x 6½" x 7"

Output: Zero to full line voltage (AC or DC) proportional to control signal.

APPLICATIONS

- Industrial furnace and oven control
- Electrical heating control
- Motor speed control
- Light dimming

Specialists in:
HIGH - PERFORMANCE PROGRAMMING AND CONTROL •
INFRARED HEATING • AC AND DC POWER CONTROLLERS



**CONTROLS
DIVISION**

RESEARCH, INCORPORATED
BOX 6164NM MINNEAPOLIS, MINN. 55424

128 Circle 94 on Inquiry Card

NEW PRODUCTS

SAMPLER-ATTENUATOR

Levels the output of a sweep osc. and provides 60db power control.

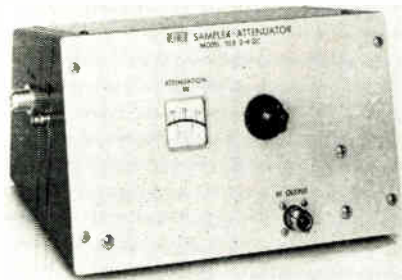

With the new Model 1150 series, the output from sweep oscillators may be leveled and attenuated at the load, thereby eliminating perturbations caused by interconnecting cables and components. Power variation with freq. from max. power down at least 20db is ± 0.5 db, and at min. power is typically less than 1.5db. Insertion loss is less than 5db. Five models are available in the new series covering the following ranges: 1-2, 1.4-2.5, 2-4, 3.5-6.75, and 4-8gc. Alfred Electronics, 3176 Porter Dr., Palo Alto, Calif.

Circle 214 on Inquiry Card

METAL-FILM POTENTIOMETER

Meets Mil-R-22097B Char. C environmental specs.; available from 100 to 7.5 Ω .

Type HT250-6 Mechatrim[®] trimmer potentiometer is designed for mounting on a panel or in a can by means of solder or cement. This flange-mounted unit also provides a pressure seal up to 1 atmosphere in circuit use where external resistance adjustments are required. Mechatrol, 1200 Prospect Ave., Westbury, L. I., N. Y.

Circle 215 on Inquiry Card

FIELD-EFFECT TRANSISTOR

Features $10^{10}\Omega$ dc input resistance; operating temp., -55°C to $+175^{\circ}\text{C}$.

The FI-100 is an insulated gate switch/amplifier. This P-channel M-O-S FET offers high stability and reliability because of the Planar II process incorporated into the device. Features include: storage temp. -55°C to $+200^{\circ}\text{C}$; voltage controlled, enhancement mode operation; high voltage: $\text{BV}_{\text{DSS}} = 50\text{v.}$; stable leakage; $\text{I}_{\text{DSS}} = 50\text{pa}$ (typical); stability under both positive and negative gate bias. Fairchild Semiconductor, div. of Fairchild Camera and Instrument Corp., 545 Whisman Rd., Mountain View, Calif.

Circle 216 on Inquiry Card

DELAY LINES

there's
no
match

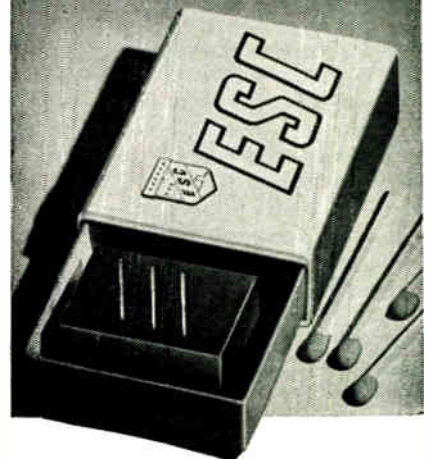

to our packaging techniques
for delay lines and filters

Thousands of standard delay lines and filters are available from ESC — yet, the increasing requirements for smaller high-density packaging often dictate custom designs — ESC engineers will work with you to develop prototypes to your exact specifications. Our latest filter fits comfortably in a match box (1" x .72" x .62") — or in your circuit.

MINIATURE FILTERS FOR SONAR

Provides 60 db minimum attenuation at 1.9 x Fc. Ripple .5 db maximum. Maximum insertion loss 1 db. Operating temp. -20°C to $+85^{\circ}\text{C}$. Size 1" x .72" x .62".

Circle 91 on Inquiry Card



MINIATURE COMPUTER DELAY LINES

P. C. Board Mounting; delays from 10 nanosec. to 160 nanosec. or greater. 200 and 400 Ω impedance with a maximum pulse attenuation of 0.5 db — pulse rise time of 3 nanosec. to 40 nanosec. max. depending upon delay.

Circle 92 on Inquiry Card



A miniature transponder line in only 6 cubic inches. Other lines for Beacons, Tacans and Vortac Systems.

Circle 93 on Inquiry Card



ESC

ELECTRONICS CORP.

534 BERGEN BOULEVARD
PALISADES PARK, N. J.
PHONE: 201-947-0400

This index is published as a convenience.

No liability is assumed for errors or omissions.

| | |
|---|--------------------|
| A | |
| Acromag Inc. | 118 |
| Allen-Bradley Co. | Insert fol. p. 76 |
| Alpha Metals, Inc. | 104 |
| American Electronic Laboratories, Inc. | 126 |
| American Machine & Foundry Co. Potter & Brumfield Division | 17 |
| AMP Incorporated | Insert fol. p. 32 |
| Industrial Sales Division | Inside Back Cover |
| Amperex Electronic Corporation Tube Division | 30, 31 |
| Amperite | 126 |
| APM-Hexseal Corporation | 94 |
| Aristo Grid Lamp Products Inc. | 127 |
| Astrodata Inc. | 26 |
| Atmos-Tech Corporation | 96 |
| Augat Inc. | 120 |
| B | |
| Basic Systems Inc. | 86, 87 |
| Beattie Coleman Inc. | 105 |
| Bussmann Mfg. Division McGraw-Edison Co. | 82, 83 |
| By-Buk Company | 109 |
| C | |
| C. P. Clare & Co | 71 |
| Cambridge Thermionic Corporation | 106 |
| CMC-Computer Measurement Company | 52 |
| Computer Control Company, Inc. | 99 |
| CTS Corporation | 24, 25 |
| D | |
| Dale Electronics, Inc. | Inside Front Cover |
| Delco Radio | 84, 85 |
| Digital Equipment Corporation | 28 |
| Digital Sensors Inc. | 115 |
| Drake Mfg. Co. | 115 |
| E | |
| Eisler Engineering Co., Inc. | 127 |
| Elco Corporation | 13 |
| Electrical Industries | 53 |
| Electronic Engineering | 88 |
| Electronic Research Associates, Inc. | 98 |
| Electro Scientific Industries, Inc. | 123 |
| Engineered Electronics | 9 |
| ESC Electronics Corporation | 128 |
| G | |
| Gardner-Denver Company | 72, 73 |
| General Instrument Corporation | 47 |
| Globe Industries, Inc. | 117 |
| Guardian Electric Mfg. Co. | 49 |
| H | |
| Honeywell Precision Meter Division | 18 |
| Houston Instrument Corporation | 109 |
| Howard Industries, Inc. | 108 |
| Hughes Aircraft Company Aerospace Division | 32 |
| I | |
| IBM Corporation Industrial Products Division | 37 |
| Industrial Electronic Engineers, Inc. | 45 |
| Interstate Electronics Corporation | 6 |
| J | |
| Jennings Radio Mfg. Corporation | 16 |
| JFD Electronics Corporation | 110 |
| Johnson Co., E. F. | 107 |

| | |
|---|------------|
| K | |
| Kahle Engineering Company | 119 |
| Keithley Instruments | 75 |
| Kelvin | 124 |
| L | |
| Ling-Temco-Vought, Inc. Continental Electronics Division | 15 |
| Military Electronics Division | 21 |
| M | |
| Mac Panel Company | 74 |
| Magnetic Metals Company | 122 |
| Malco Mfg. Company | 96 |
| McDonnell | 70 |
| Minnesota Mining & Mfg. Co. Chemical Division | 8 |
| Motorola Incorporated Semiconductor Division | 29 |
| N | |
| National Electronics, Inc. | 127 |
| Nortronics Company, Inc., The | 122 |
| Nytronics Incorporated | 102 |
| O | |
| Ohmite Mfg. Co. | 51 |
| P | |
| Perfection Mica Company Magnetic Shield Division | 105 |
| Photocircuits, Inc. | 79 |
| Potter & Brumfield Division American Machine & Foundry Company | 17 |
| Precision Paper Tube Company | 106 |
| R | |
| Radio Corporation of America Semiconductor Division | Back Cover |
| Radio Switch Corporation | 118 |
| Research Incorporated | 128 |
| Roback Corporation, The | 123 |
| S | |
| Sierra Electronic Division Philco Corporation | 7 |
| Singer Company, Metrics Division Gertsch Instruments | 14 |
| Southland Chemical Company | 108 |
| Sperry Rand Corporation Sperry Semiconductor | 50 |
| Sprague Electric Company Capacitor Division | 2 |
| Resistor Division | 4 |
| Standard Electric Time Company | 121 |
| Stanpat Products Inc. | 125 |
| Syntronic Instruments, Inc. | 121 |
| T | |
| Tektronix, Inc. | 19 |
| Times Wire & Cable | 80 |
| U | |
| United Shoe Machinery Corporation Fastener Division | 130 |
| United Systems Corporation | 120 |
| V | |
| Varflex Corporation | 97 |
| Victoreen Instrument Company, The | 81 |
| W | |
| Wheelock Signals, Inc. | 124, 125 |

REGIONAL SALES MANAGERS

Philadelphia 19139—56th & Chestnut Sts.
(Area Code 215) SHERWOOD 8-2000
JOSEPH DRUCKER
ROBERT Q. HINCKLE, Jr.

New York 17—100 East 42nd St.
(Area Code 212) DXford 7-3400
GERRY PELISSIER
HUGH ROBINSON

Boston (10), Mass.—10 High St.
(Area Code 617) Lliberty 2-4460
ROBERT G. SMITH

Chicago (11)—540 N. Michigan Ave.
(Area Code 312) 467-9660
JOHN W. BERNHARDT
PHILIP T. CLARK

Cleveland (15)—601 Rockwell Ave.
(Area Code 216) SUpperior 1-2860
ROBERT COBURN

Los Angeles (57)—198 S. Alvarado St.
(Area Code 213) DUnkirk 7-1271
GEORGE F. KELLEY
BURT UNDERWOOD

San Francisco (3)—1355 Market St.
(Area Code 415) 861-7107
DON MAY

Atlanta (9)—1776 Peachtree St. N.W.
(Area Code 404) 861-7107
JOHN W. SANGSTON

Dallas (6)—Meadows Bldg.
Expressway at Milton
(Area Code 214) EMerson 3-6426
HAROLD E. MOTT

EUROPEAN SALES OFFICES

London, S. W. (1)—67/68 Jermyn St.
St. James
MAX F. HOLSINGER

United International Industrial Press
Eitelstrasse 32
4 Dusseldorf—Rath, Germany
MAX F. HOLSINGER

FAR EAST SALES OFFICE

Tokio Marunouchi, Japan
C. P. O. Box #1572, Room 814
Tel.: 211-3506-3509
Togin Bldg.
CLARENCE T. SAKAGUCHI

ANNUAL INDEX

of articles that have
appeared in

ELECTRONIC INDUSTRIES

during 1964

is now available.

Write to:

Reader Service Dept.
ELECTRONIC INDUSTRIES,
56th & Chestnut Sts.
Phila., 39, Pa.

USE OF PHYSICS PRINCIPLE EXTENDS RADIOACTIVE LIFE

Westinghouse research scientists have found a way to prolong the lives of radioactive atoms with physical means and a new physics principle.

Traditionally, atomic lifetimes have been beyond man's control—unaffected by heat, pressure, or other changes in environment. Like the speed of light or the acceleration of gravity, they were generally regarded as fixed constants of Nature. Only one atom, beryllium-7, has ever been known to disobey this orderly scheme of things.

Now, researchers control radiation that the atomic nuclei normally emit. They trap the radiation before it can fully escape, force some of the nuclei to reabsorb it and then re-emit it later on. The over-all effect is to lengthen the average lifetime of the decaying atoms by as much as three %.

The Mossbauer effect, a recently discovered phenomenon in physics, was used to observe the changes in nuclear lifetime. Radioactive tin-119 and iron-57 were the atoms employed.

NOW—you can be sure BEFORE PW BOARD Production...

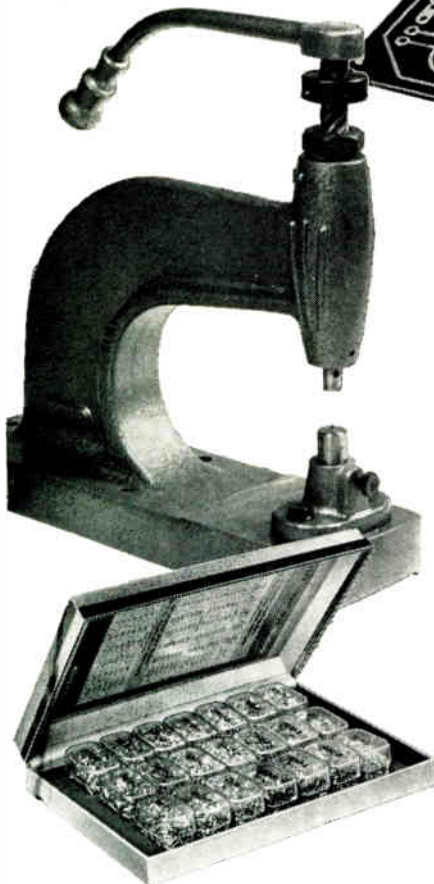

with the New **UNITED Hand Eyeleter and Electronic Eyelet Selection Kit!**

Best way to be sure you've selected the right eyelets for your specific PW Board requirements is by prototype — but lack of suitable hand-setting tools has imposed serious restrictions until now! The new Model S-5 United Hand Setter provides what old plier and hand-drive tools lacked: adequate reach and the ability to set very small eyelet sizes. Combine this efficient new tool with the United Eyelet Selection Kit (with its 21 standard sizes and lengths, which are capable of meeting virtually all PW Board requirements) and you'll be able to produce prototype models of practically any single-sided or double-sided board you're planning for production . . . quickly and easily!

For complete information, phone the United Office in your area . . . or write direct to Fastener Division, United Shoe Machinery Corporation, Shelton, Connecticut.



United Eyelets
FASTENER DIVISION
United Shoe Machinery Corporation
2258 River Road, Shelton, Connecticut

BRANCHES: ATLANTA, GA. • BOSTON, MASS. • CHICAGO, ILL. • CINCINNATI, CLEVELAND, OHIO • DALLAS, TEXAS • SUN VALLEY (LOS ANGELES), CALIF. • LYNCHBURG, VA. • MILWAUKEE, WISC. • NASHVILLE, TENN. • NEW YORK, N.Y. • ST. LOUIS, MO.

TV BRIEFING



Television Briefing console is checked out by Army Capt. Edgar Hickson at RCA's Camden, N. J., plant. The console looks like a miniature TV studio and includes transistorized TV camera, microphone, lighting and picture monitors. Console will be used in the Pentagon to televise situation reports over a closed circuit.

AIR FORCE MARKS CHANGES IN DEFENSE PROCUREMENT

Continued "revolutionary" changes in defense procurement are underscored by Robert H. Charles, assistant secretary of the Air Force, Installations and Logistics. He reports that Defense Department studies of hundreds of items bought competitively for the first time show minimum average savings of 25% as compared to non-competitive purchases.

In contrast to the technical end of the business, there has been little price competition to spur better management of costs. Only 18% of Air Force contracts were price-competitive, while 82% were not. The extent of cost-plus-fixed-fee contracts in the Air Force has been reduced from 46.8% in Fiscal Year 1961 to below 15% currently. The extent of price competition has been increased from 14.9% to 21.2%.

Major reductions in overhead personnel, including engineers, are being reported among large government contractors.

EQUIPMENT, MATERIALS, PARTS & COMPONENTS

7" TV test tube—\$6.99. Tubes—6146—\$2.95; 6211 (12AU7 equiv.) 39¢, 3 for \$1. Germanium diodes, tested, equiv. 1N34, 1N60 etc., 30 for \$1. Tophat silicon rectifiers, 750 MA—1000 piv 75¢. Transistors, tubes, resistors, condensers etc., bargain priced. Free catalog.

Arcturus Electronics, Dept. E1
502-22nd St., Union City, N. J. 07087.

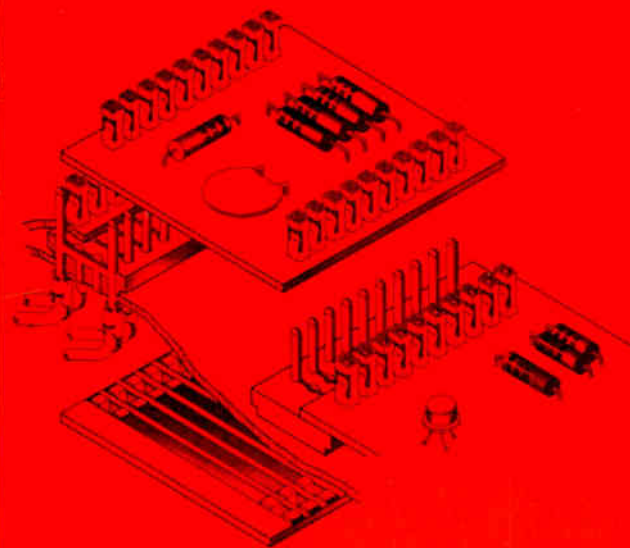

Horizontal mounting utilizing feed through posts.

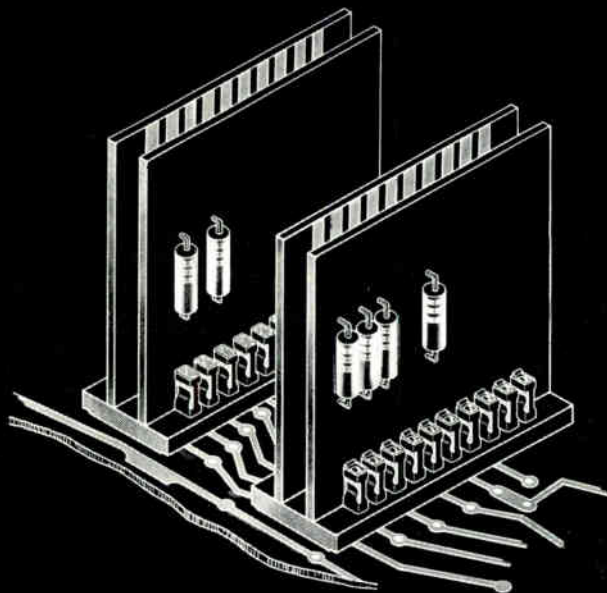

Vertical mounting utilizing incremental connectors.

Flexibility across the board

Here's a two-piece connector that offers unlimited design potential in printed circuit and modular applications. Plan the layout any way you want—horizontal, vertical, end-to-end. The AMPMODU* Interconnection System not only gives you *reliable* interconnections, but its sound contact design and adaptability to automated assembly techniques reduce installed costs in the bargain.

Male contacts are available as incremental connectors or as feed-through posts to accept TERMI-POINT* clip applications and other automated wire terminations. Female contacts come in strip form for automatic staking to printed circuit boards. They are designed to overcome mating misalignments, can be mounted with center-to-center densities up to .100 inch.

Reliability is increased by the contact design which features redundant cantilever beams with built-in anti-overstress protection. In addition, modular circuits can be conveniently job-lot assembled on a true production line basis . . . no need to solder or test until they're all assembled.

Before you start working on that new design, check these features:

- Lowest per line cost
- Compatible with TERMI-POINT Terminals and tools
- Automatic staking of contacts to board
- Reliability—simple spring contact and built-in anti-overstress
- Versatility—for boards $\frac{1}{32}$, $\frac{1}{16}$, $\frac{3}{32}$ -inch thick
- Flexibility—contacts mounted vertically or horizontally

Why not design it with the AMPMODU Interconnection System and get all these benefits at the lowest installed cost? Write today for complete details.

*Trademark of AMP INCORPORATED



A-MP* products and engineering assistance are available through subsidiary companies in: Australia • Canada • England • France • Holland • Italy • Japan • Mexico • West Germany

Circle 96 on Inquiry Card

World Radio History

THIS NEW RCA TRANSISTOR CAN OPEN NEW MASS MARKETS FOR YOU

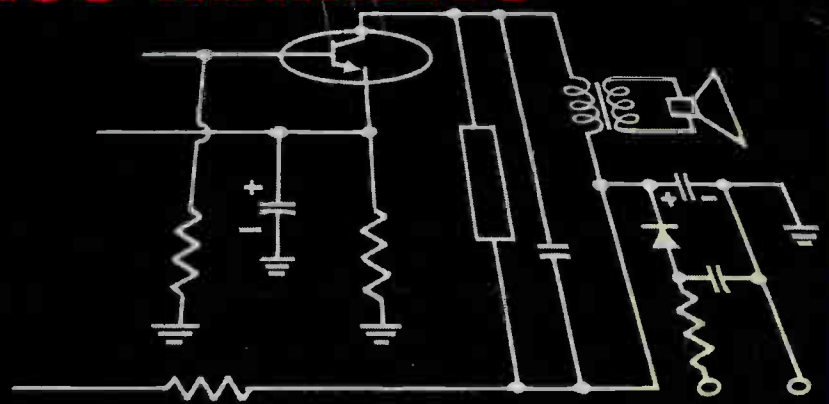

Clock radios

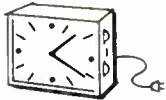
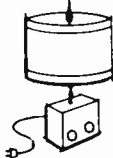

Table-lamp radios



Cigarette-box radios



Direct plug-in radios

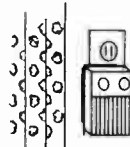

Picture radios

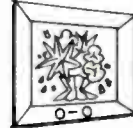

Low-cost phonographs

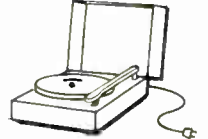

Think of the vast array of new merchandising ideas now possible with these new RCA transistors.

Now, with new RCA consumer semiconductor devices, you can turn out highly compact, all-solid-state line-operated radios and phonographs with the built-in reliability of solid state devices. With this new semiconductor complement, you can design line-cord radios into almost anything; unit size is limited only by speaker dimensions. Superb tone quality and instant play feature add sales appeal to both radios and phonographs.

Key to the circuits is the new RCA-40264. This silicon power transistor designed for operation from high-voltage power supplies now makes possible line-operated one-watt output stages. This new device offers high breakdown voltage (300 volts minimum), making ac/dc line-operated output stages a practical reality. And you can get one-watt output with less than 10% distortion.

In addition to the 40264, the radio kit consists of:

RCA-40261 and 40262 germanium p-n-p drift-field high-gain transistors for use in converter and IF amplifier stages make possible a minimum number of stages (one IF).

RCA-40263 germanium p-n-p alloy junction transistor with extremely high beta and exceptional linearity of characteristics for use in low-level a-f amplifier and driver stages.

RCA-40265 diffused-junction single-ended silicon rectifier specifically rated for use in line-operated power supplies.

Get full information on the RCA circuits and kits of semiconductor devices that can put you into scores of new markets. It's all in our new pamphlet 1CE-313. Order a copy today from your RCA Field Representative or by writing: RCA Commercial Engineering, Section E-J-12, Harrison, N.J.

AVAILABLE THROUGH YOUR RCA DISTRIBUTOR

RCA Electronic Components and Devices, Harrison, N. J.



The Most Trusted Name in Electronics

Circle 97 on Inquiry Card
World Radio History