

# ELECTRONIC INDUSTRIES

---

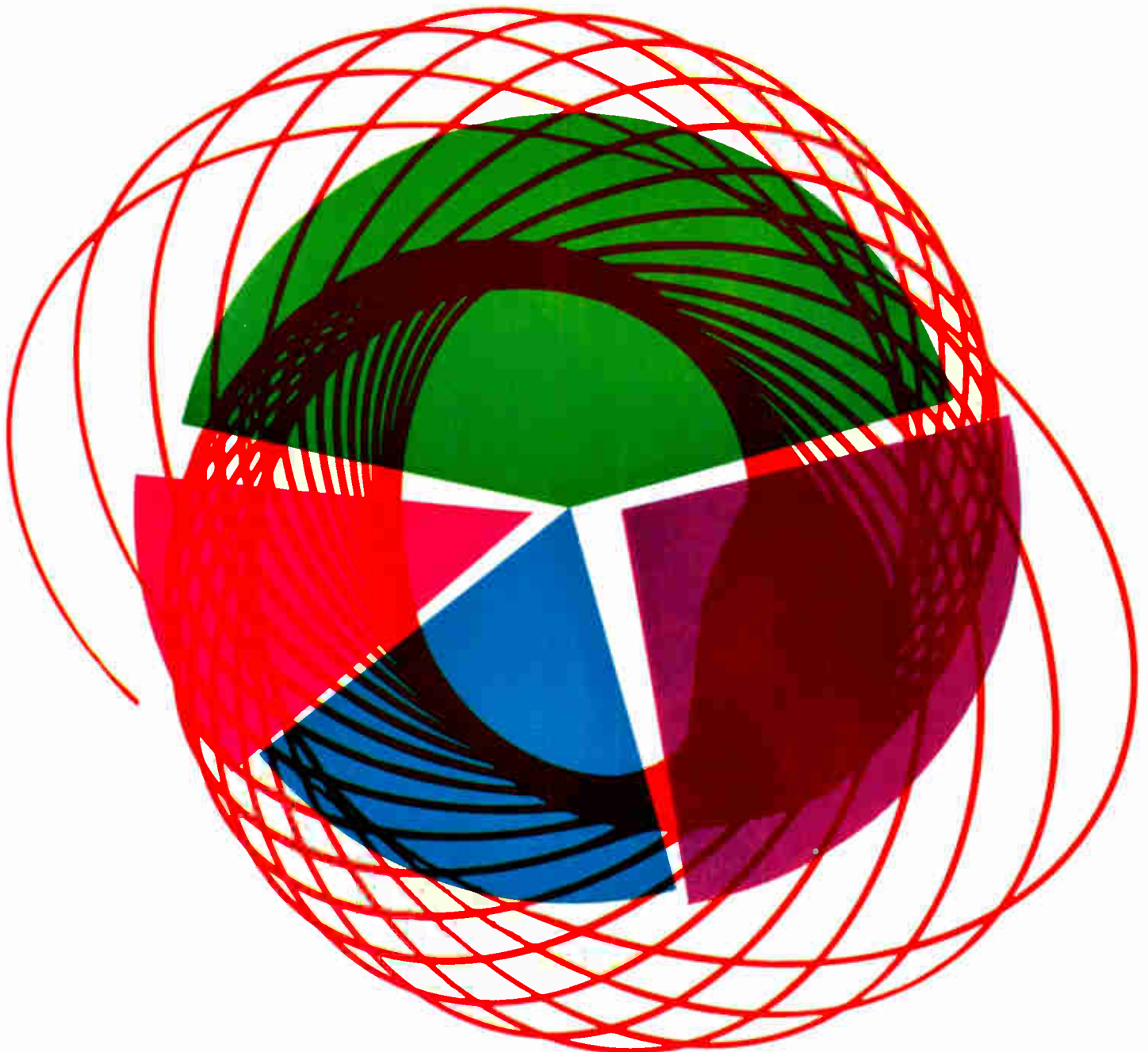

**JANUARY 1964**

**ELECTRONIC MARKETS IN REVIEW**

**Protecting computer memories**

**Minimizing high-gain amplifier feedback**



**HI-FI**



Transistor output; matches any PP transistor to 4, 8, 16  $\Omega$  speaker. Primary 48, 36, 12  $\Omega$  C.T.; 20  $\Omega$  to 20 KC; 40 watts.

**MINIATURE MIL TYPE**



Metal case hermetically sealed to MIL-T-27B. Gold Dumet leads spaced on 0.1 radius, for printed circuit application.

**CHOPPER**



Magnetic shielded plus electrostatic shield for voltage isolation of  $2 \times 10^6$ . Primary 200K C.T. to within 0.1%. Secondary 50K.

**HIGH POWERED AUDIO**



Low distortion 2.5 KW output transformer. PP 450 TH's 18,500 ohms C.T. to 24.6 ohms, 20 KV hipot. 520 lbs.

**CATHODE FOLLOWER OUTPUT**

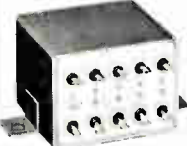

Provides equal voltages to 5 loads. Primary inductance maintained to 5% with 20% change in DC unbalance and 30% change in AC voltages.

**"SPECIAL" CUSTOM BUILT AUDIO TRANSFORMERS TO YOUR SPECIFICATIONS**

**HI-FREQUENCY CARRIER TO MIL-T-27B**



Electrostatically shielded, humbucking,  $\pm 30$  dbm level. Within .5 db 250 cycles to 110 KC. 600/135: 600 centertapped to .1% tolerance.

**HYBRID TRANSFORMER**



Two transformers each 600  $\Omega$  primary, 40K  $\Omega$  C.T. secondary 250 cycles to 5 KC within  $\pm 4$  db 40 db isolation over band.

**MICROMODULE**



Life tested per micromodule specs: no failures. 10K  $\Omega$  C.T. to 10K  $\Omega$ , 100 mw from 400  $\Omega$  to 20KC.

**SUBMINIATURE MOLDED TRANSFORMER**

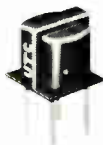

Grade 3 with printed circuit leads for transistor application. 150  $\Omega$  to 150  $\Omega$  at 10 dbm level. Size  $\frac{1}{2} \times \frac{1}{2} \times \frac{1}{2}$ "; weight 5 grams.

**BOLOMETER TRANSFORMER**



Primary 10 ohms, secondary 530K ohms, 230:1 ratio, response from  $\frac{1}{2}$  cycle to 25 cycles. 120 db magnetic shielding, plus full electrostatic shielding.

**ULTRA-MINIATURE**



Electrostatically & magnetically shielded output transformer  $\frac{3}{16}$  D. x  $\frac{1}{4}$ " H. Pri. 15K CT, Sec. 8K CT; max. level 50 mw; audio range response. To MIL-T-27B, grade 4.

Exceptional quality and reliability is provided in all UTC designs. Over 30 years of engineering knowledge and experience substantiated by extensive field performance assure the highest quality and most reliable components in the industry. Complete environmental testing facilities are incorporated to prove out new designs. Full analysis and evaluation of materials are conducted in UTC's Material and Chemical Laboratories. Rigid quality control measures coordinated with exhaustive statistical findings and latest production procedures results in the industry's highest degree of reliability. Range covered in Audio Transformers is from 0.1 cycles to 400 MC . . . microwatts to 50 KW.

**MILITARY AND COMMERCIAL TYPES FOR EVERY PHASE OF THE ELECTRONICS ART**

- POWER TRANSFORMERS • AUDIO TRANSFORMERS • INDUCTORS • PULSE TRANSFORMERS • ELECTRIC WAVE FILTERS • LUMPED CONSTANT DELAY LINES • HIGH Q COILS • MAGNETIC AMPLIFIERS • SATURABLE REACTORS • REFERENCE UNITS

Write for catalog of over 1,200 UTC HIGH RELIABILITY STOCK ITEMS IMMEDIATELY AVAILABLE from your local distributor.



**UNITED TRANSFORMER CORP.**

150 VARICK STREET, NEW YORK 13, N. Y.

PACIFIC MFG. DIVISION: 3630 EASTHAM DRIVE, CULVER CITY, CALIF.  
EXPORT DIVISION: 13 EAST 40th STREET, NEW YORK 16, N. Y. CABLE: "ARLAB"

## **FINANCIAL INCENTIVES FOR ENGINEERS**

INCENTIVE TYPE CONTRACTS are now being awarded to electronic contractors instead of fixed price and cost plus fixed-fee (CPFF) contracts.

Does this mean that the Department of Defense (DOD) will use incentive contracting more extensively? We believe it will. And prime contractors may be expected to share incentive payments with their sub-contractors.

This program would be most effective if these financial incentives were extended to the engineers who are the creative force in the aerospace-defense industry.

This suggestion may be considered special pleading. But it is not. The U. S. Army established the precedent more than a half century ago when it offered two bicycle mechanics the first incentive contract. The Wright Brothers, working under that contract back in 1908, achieved the first sustained and controlled airplane flight over the sand dunes of Kitty Hawk, N. C.

In 1961, DOD Secretary Robert S. McNamara and Assistant DOD Secretary (Installations & Logistics) Thomas D. Morris, reinstated a broad procurement policy of incentive contracts. They seek to counteract the tripling of cost-plus-fixed-fee (CPFF) contracts, which rose from 13% of procurement dollars in 1951 to 39% in 1961.

In effect, DOD — and the National Aeronautics and Space Administration (NASA) — are offering a challenge to aerospace-defense contractors. Contractors who create products and systems that are more reliable, less costly, perform better, and are delivered on or ahead of schedule, will be rewarded.

Most government contractors and their engineers believe they have been doing a good job. But, for many, the profit margins are too low. Present margins are from 2% to 5%. These could be raised to 15% with the new incentive program.

Incentive contracts promise both graduated rewards as well as penalties for poor performance. Engineers, who participate, could expect to share losses — as well as benefits — under incentive contracts.

Achieving higher profits under the incentive contract program will not be easy. Designs will have to be predicated upon costs as well as performance considerations. Here, value engineering and improved cost analysis programs will be useful to the engineer in meeting objectives.

Today's electronic engineers will find this new form of contracting an exciting challenge. The engineer who masters this challenge will earn financial rewards.



**Only from Sprague!**

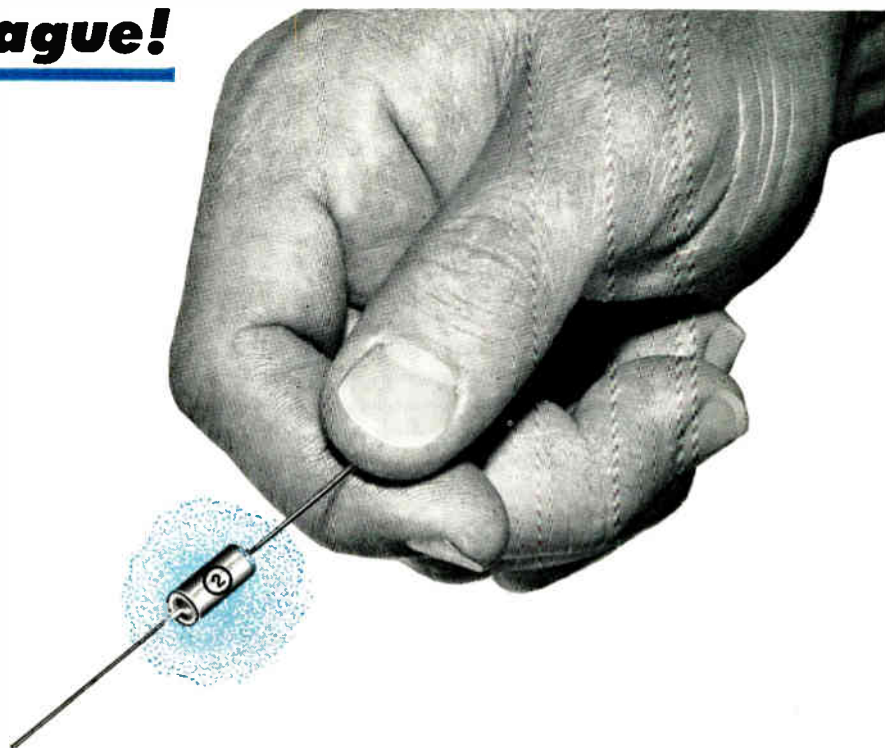

**Improved Type 150D Solid-Electrolyte**  
**TANTALEX® CAPACITORS**  
with **PERFORMANCE CHARACTERISTICS**  
**NEVER BEFORE POSSIBLE!**

■ **DISSIPATION FACTOR CUT BY ½**—Not more than 3% at 20 VDC and up, permitting even higher a-c ripple currents!

■ **LOWER IMPEDANCE AT HIGH FREQUENCY**—With impedances in fractional ohmic values in the megacycle range, Type 150D admirably meets the stringent requirements of high-speed computers.

■ **LOWER LEAKAGE CURRENTS**—Previous limits have been dramatically reduced; in some instances by as much as a factor of three.

■ **INCREASED CAPACITANCE STABILITY**—Capacitance change with temperature is now less than ½ the previous guaranteed values. Capacitance change with life is almost insignificant.

■ **NEW HIGHER VOLTAGE RATINGS**—50, 60, 75 and 100 volt ratings are now available, with associated surge voltages higher than any presently offered in the industry.

**NEW ULTRA-MINIATURE TYPE 172D**

New end-seal design makes possible two tiny sizes (.085" dia. x .250" long, and .127" dia. x .375" long) for "cordwood" packaging to supplement standard-sized Type 150D ratings in case size "A".

*For complete technical data on Type 150D and 172D Tantalex Capacitors, write for Engineering Bulletins 3520E and 3523, respectively, to Technical Literature Service, Sprague Electric Company, 233 Marshall Street, North Adams, Massachusetts.*

**Popular ratings of Type 150D Capacitors are available for fast delivery from your Sprague Industrial Distributor**

**SPRAGUE COMPONENTS**

CAPACITORS  
TRANSISTORS  
RESISTORS  
MICROCIRCUITS  
INTERFERENCE FILTERS

PULSE TRANSFORMERS  
PIEZOELECTRIC CERAMICS  
PULSE-FORMING NETWORKS  
TOROIDAL INDUCTORS  
ELECTRIC WAVE FILTERS

CERAMIC-BASE PRINTED NETWORKS  
PACKAGED COMPONENT ASSEMBLIES  
BOBBIN and TAPE WOUND MAGNETIC CORES  
SILICON RECTIFIER GATE CONTROLS  
FUNCTIONAL DIGITAL CIRCUITS



'Sprague' and '©' are registered trademarks of the Sprague Electric Co.



# ELECTRONIC INDUSTRIES

January 1964  
Vol. 23, No. 1

## EDITORIAL FEATURES

|   |                                   |
|---|-----------------------------------|
| EDITORIAL: FINANCIAL INCENTIVES FOR ENGINEERS .....       | 1                                 |
| REVIEW AND FORECAST FOR THE ELECTRONIC INDUSTRY .....     | 24                                |
| THE PRESSING NEED FOR BETTER MARKETING DATA .....         | S. Feldman 42                     |
| WHAT'S NEW .....  | 56                                |
| Memory Making Process ... 56                              | Single-Frequency Gas Laser ... 56 |
| Multi-Frequency Transducers ... 59                        | Coordinate Measurer ... 61        |
| 1000°F Wire and Cable ... 146                             | High-Speed Light Pen ... 146      |
| Fluorescent Lights for Cars ... 152                       |                                   |
| ELECTRONIC DEVICES MAKING STRIDES IN METALWORKING .....   | S. Ruth 62                        |
| MINIMIZING FEEDBACK IN H-F TRANSISTOR AMPLIFIER .....     | C. B. Parker 68                   |
| SOLVING FOR TRANSIENTS IN R-C NETWORKS .....              | A. Goodman 72                     |
| NEW DESIGNS IN UHF-TV TUNERS .....                        | Staff Report 75                   |
| ENGINEER'S NOTEBOOK #70 ... POWER TUBE EQUATIONS ...      | R. A. Henderson 77                |
| UNDERSTANDING ACOUSTIC ENCLOSURE SYSTEMS .....            |                                   |
| A. Oppenheim & S. Wasserman                               | 78                                |
| DESIGNING BANDPASS FILTERS .....                          | E. C. Johnson 86                  |
| <b>ELECTRONIC SYSTEMS</b> .....                           | <b>113</b>                        |
| PROTECTING COMPUTER MEMORIES AGAINST POWER FAILURES ..... |                                   |
| D. M. Bowers & A. E. Conley                               | 114                               |
| <b>PROFESSIONAL GUIDELINES</b> .....                      | <b>137</b>                        |
| GIVING A TALK?—SOME USEFUL SUGGESTIONS .....              | F. J. Galvin 138                  |

## DEPARTMENTS

|  |     |
|--|-----|
| Highlights .....                             | 5   |
| Radarscope .....                             | 10  |
| Coming Events .....                          | 17  |
| Washington Trends .....                      | 21  |
| Marketing: Fact & Figure Roundup .....       | 37  |
| Snapshots of the Electronic Industries ..... | 52  |
| Circuit-Wise .....                           | 71  |
| New Products .....                           | 96  |
| New Tech Data .....                          | 122 |
| Editor's Notebook .....                      | 132 |
| Letters .....                                | 133 |



COVER: "Pie" chart illustrates graphically the breakdown of the electronic industry into four main sections: Military-government, Industrial, Consumer and Replacement Parts. A comprehensive statistical analysis of these various segments begins on page 24.

**Now from Sprague!**

# SEPT<sup>®</sup>

## SILICON PLANAR EPITAXIAL TRANSISTORS 2N2217 thru 2N2222

| TO-5 (P <sub>D</sub> =.8W)<br>TO-18 (P <sub>D</sub> =.5W)         | 2N2217<br>2N2220 | 2N2218<br>2N2221 | 2N2219<br>2N2222 |
|---|------------------|------------------|------------------|
| BV <sub>CBO</sub>   | 60 V (min.)      | 60 V (min.)      | 60 V (min.)      |
| I <sub>CBO</sub> @ 50V  | 10nA(max.)       | 10nA(max.)       | 10nA(max.)       |
| h <sub>FE</sub> @ I <sub>C</sub> =150 mA                          | 20-60            | 40-120           | 100-300          |
| V <sub>CE</sub> (SAT)<br>@ I <sub>C</sub> =150 mA                 | .4 V(max.)       | .4 V(max.)       | .4 V(max.)       |
| C <sub>ob</sub> @ 10 V  | 8 pF             | 8 pF             | 8 pF             |
| f <sub>T</sub> @ V <sub>CE</sub> = 20 V<br>I <sub>C</sub> = 20 mA | 400mc(typ.)      | 400mc(typ.)      | 400mc(typ.)      |

Sprague N-P-N SEPT<sup>®</sup> Transistors are designed for optimum emitter perimeter-to-area ratio, providing outstanding gain uniformity from 0.1 mA to 500 mA and f<sub>T</sub> (typ.) of 400 mc. Sprague epitaxial techniques guarantee high BV<sub>CEO</sub> (30V) and low V<sub>CE</sub> (SAT) (.24 V @ 150 mA).

**SEPT<sup>®</sup> TRANSISTORS FILL A WIDE RANGE OF APPLICATIONS AS SWITCHES, CORE DRIVERS, AND AMPLIFIERS!**

For application engineering assistance, write to Transistor Division, Sprague Electric Co., Concord, N. H. For technical data, write for Engineering Bulletins 32,000, 32,005 and 32,010A to Technical Literature Service, Sprague Electric Co., 233 Marshall St., North Adams, Mass.

### SPRAGUE COMPONENTS

TRANSISTORS  
CAPACITORS  
RESISTORS  
MICROCIRCUITS  
INTERFERENCE FILTERS

PULSE TRANSFORMERS  
PIEZOELECTRIC CERAMICS  
PULSE-FORMING NETWORKS  
TOROIDAL INDUCTORS  
ELECTRIC WAVE FILTERS

CERAMIC-BASE PRINTED NETWORKS  
PACKAGED COMPONENT ASSEMBLIES  
BOBBIN and TAPE WOUND MAGNETIC CORES  
SILICON RECTIFIER GATE CONTROLS  
FUNCTIONAL DIGITAL CIRCUITS



'Sprague' and '®' are registered trademarks of the Sprague Electric Co

# ARTICLE HIGHLIGHTS

of this issue

## Electronic Devices

### Making Strides in Metalworking

62

Equipment covered here includes electron beam machines which use high velocity electron bombardment to cut and weld; magnetic forming machines which use high intensity magnetic fields to form pieces to shape; ultrasonic equipment which makes use of the ultrasonic frequencies to clean and drill; and, the newest of all, the laser, to cut, weld and melt.

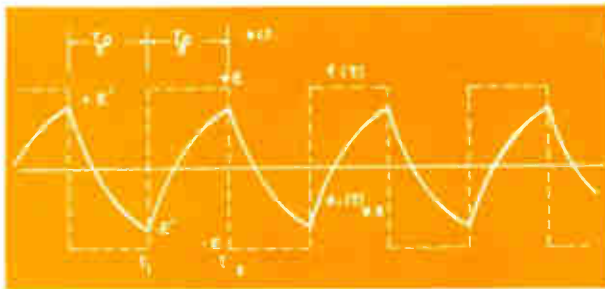
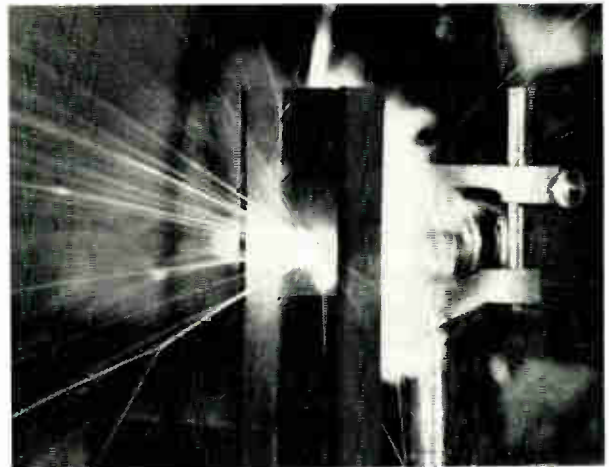

### Solving for Transients in R-C Networks

72

When a square wave is applied to an R-C network which is in a quiescent state ( $t=0$ , the capacitor has no charge) the initial transient will trigger the circuit. A solution to this problem can be found by extensive lab tests. A simpler approach is this method, using LaPlace Transforms.

## New Designs in UHF-TV Tuners

75

TV manufacturers swing into production of all-channel receivers in April. Designs of the new UHF-TV Tuners are largely completed.

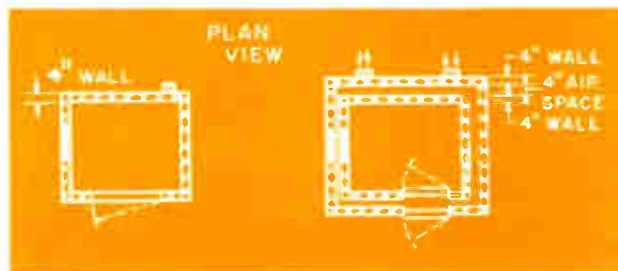
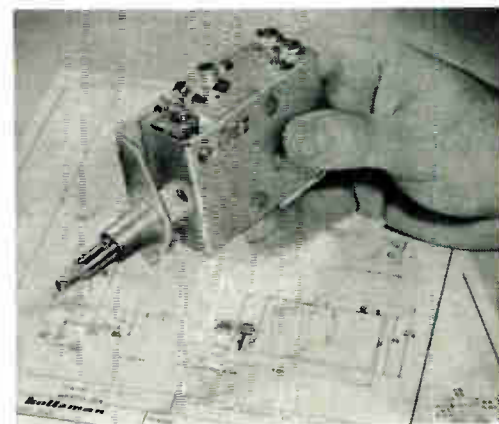

### Understanding Acoustic Enclosure Systems

78

There are three general types of acoustic rooms—anechoic, reverberant, and quiet. Combination rooms can also be built, for instance, the "soft-hard" room. The choice of construction depends on the measurements to be made.

## Giving a Talk . . .

### Some Useful Suggestions

138

A well-prepared technical presentation can sell your product or project. Here are a few guides that will make this job easier, and assure a professional job.





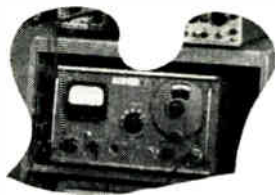

## The Piece that Fits

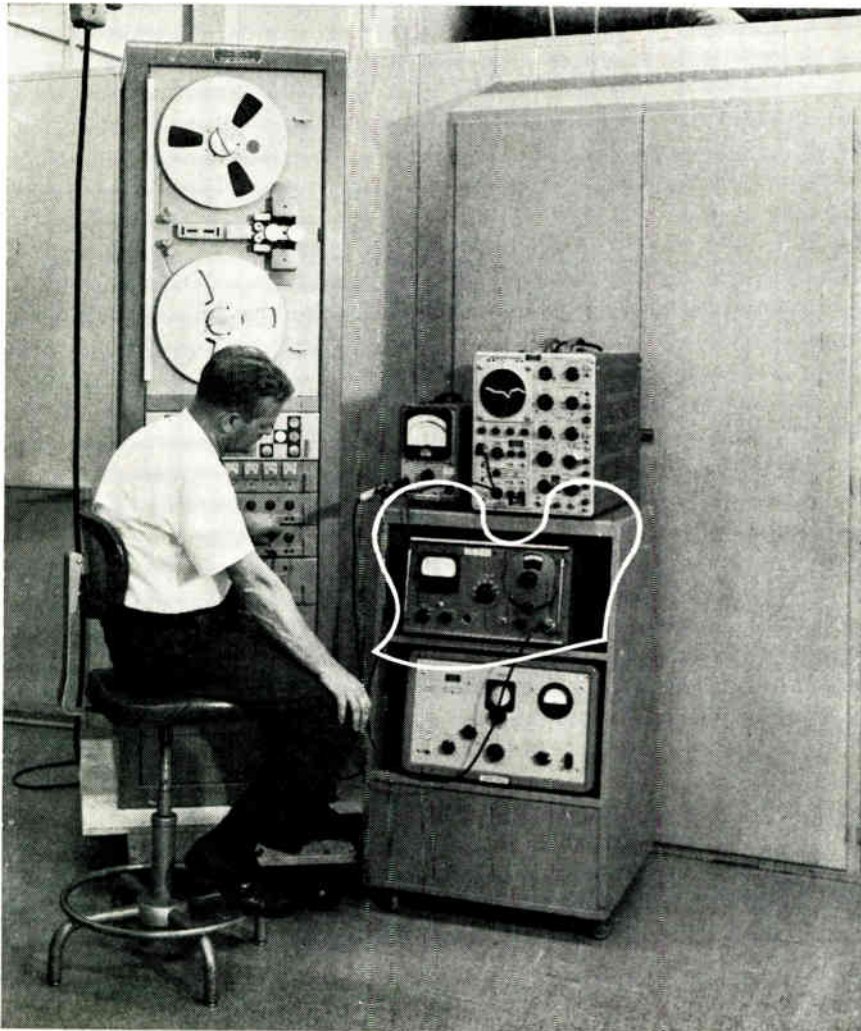

Photo courtesy of Ampex Corporation

### In the Laboratory

Down in the Systems Evaluation Lab, Ampex engineers systematically probe the performance of complex tape recording systems. One prime source of reliable test data is a Sierra Model 158A H.F. Wave Analyzer.

Covering a range of 500 kc to 10 mc, Model 158A can measure both the fundamental and harmonic levels of a frequency. It seems custom-built to fit the Ampex picture. The instrument is easy to use. It's precise. Its selectivity permits specific narrowband signal-to-noise determinations.

More reasons why Model 158A fits the laboratory scene?

- The 1-megohm impedance of its input probe limits loading down the circuit under test.
- Two input-level attenuators extend its fine tuning control over signals from -80 dbm to +42 dbm at 600 ohms.

Sierra's Model 158A clearly belongs in the most sophisticated professional laboratories. Ampex uses it to perform a number of important functions. For the full story on how it can fit your picture, send for the new technical bulletin. Or contact your nearest Sierra sales representative.

Sierra Electronic Division / 3879 Bohannon Drive / Menlo Park, California

**SIERRA ELECTRONIC DIV.**  
OF  
**PHILCO**  
A SUBSIDIARY OF *Ford Motor Company*

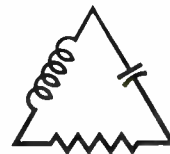

SHELBY A. McMILLION,  
Publisher  
BERNARD F. OSBAHR,  
Editor

CREIGHTON M. MARCOTT  
Executive Editor

JOHN E. HICKEY, Jr.  
Senior Technical Editor

SMEDLEY B. RUTH  
SIDNEY FELDMAN  
Associate Editors

JOHN J. HUNTER  
ROBERT J. BRAMLETT  
Assistant Editors

DR. ALBERT F. MURRAY  
Consulting Editor

ELMER KETTERER, Art Director  
SOL MEDNICK, Cover Design  
ANNE AXE, Editorial Assistant  
ANN LAVENDER, Research Assistant  
MAE MOYER, Reader Service  
IDA GOOD, Editorial Secy.

#### EDITORS-AT-LARGE

##### Eastern Region

ELMER T. EBERSOL,  
100 East 42nd St.,  
New York 17, N. Y.  
(Area Code 212) OXford 7-3400

##### Western Region

J. PHILIP GEDDES,  
198 S. Alvarado St.,  
Los Angeles 57, Calif.  
(Area Code 213) DUnkirk 7-1271

##### Defense/Space

CHARLES R. WILHIDE,  
Pentagon News Room  
The Pentagon  
Washington, D. C.

##### WASHINGTON NEWS BUREAU

1093 National Press Bldg.  
(Area Code 202) 393-3474  
TVX—202 965-0675

GEORGE BAKER, Mgr.  
NEIL R. REGEIMBAL  
DAVID R. HEINLY

##### BUSINESS DEPARTMENT

ELMER DALTON  
Advertising Promotion  
& Circulation Manager  
EDWARD G. SHAUD, Jr.  
Marketing Manager  
GORDON HERNDON  
Production Manager  
ARA H. ELOIAN  
Asst. Production Manager

See Advertisers Index on page 151 for  
Regional Sales Managers.

Chilton Company—G. C. BUZBY, President  
Executive Vice Presidents: R. E. McKenna,  
G. T. Hook. Vice Presidents: P. M. Fahr-  
endorf, L. V. Rowlands, M. E. Cox, E. B.  
Terhune, Jr., R. W. Case, Jr., J. H. Kofron.  
Treasurer: Stanley Appleby. Secretary: J. A.  
Montgomery. Other Directors: C. A. S.  
Heinle, G. E. Cameron, T. C. Campbell,  
H. W. Barclay, W. A. Phair; Assistant  
Treasurer: J. Miades; Assistant Secretary:  
I. C. Holloway.

JOHN H. KOFRON  
Chilton Research Director

ELECTRONIC INDUSTRIES, January, 1964.  
Vol. 23, No. 1. A monthly publication of  
Chilton Company, Executive Editorial &  
Advertising offices at Chestnut & 56th Sts.,  
Phila., Pa. 19139. (Area Code 215) SHer-  
wood 8-2000. Controlled circulation postage  
paid at Philadelphia, Pa. \$1 a copy; Refer-  
ence issue (June), \$5.00 a copy. Sub-  
scription rates U. S. and U. S. Posses-  
sions: 1 yr. \$10.00; 2 yrs. \$18.00. Canada  
1 year, \$12.00; 2 yrs. \$20.00. All other  
countries 1 yr., \$18; 2 yrs. \$30.00.  
Copyright 1964 by Chilton Company. Title  
Reg. U. S. Pat. Off. Reproduction or re-  
printing prohibited except by written au-  
thorization.

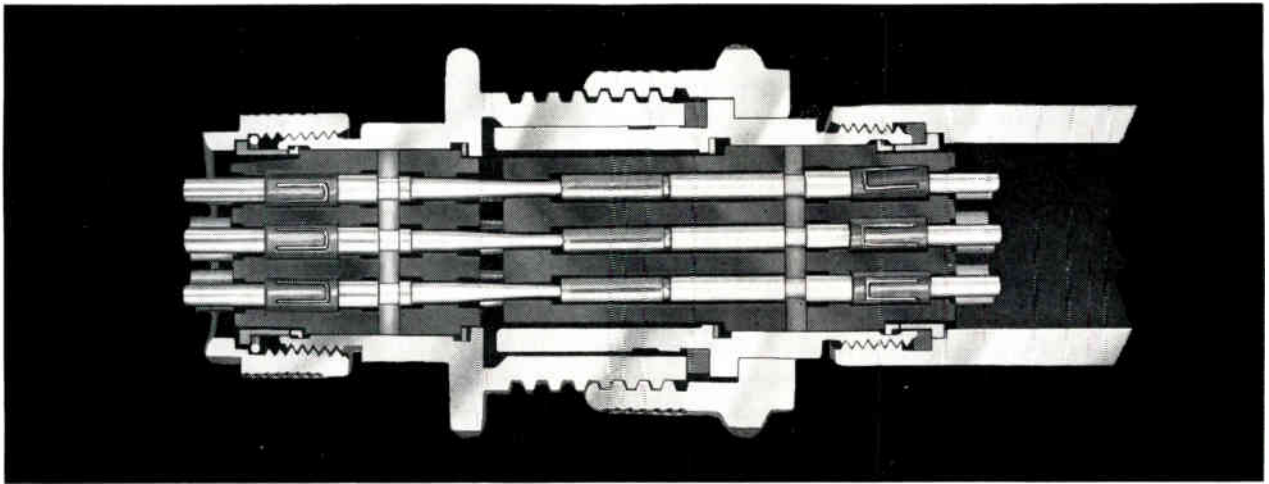

**RELIABLE TIME-SAVING CONNECTOR ASSEMBLIES** . . . for any application requirement. Dependable Mod III inserts are now available with Pyle Star-Line® Neptune Series plugs and receptacles for No. 18 through No. 4/0 contacts.

The Mod III insert offers crimped, collet-retained, rear-released contacts, and is intermateable with Mod I and II inserts.

The crimped contacts of Mod III are snapped-in from the rear of the insert, and are retained by collets designed for low insertion and high retention forces. The contacts

may be easily removed from the rear of the insert with an expendable plastic tool supplied with each connector.

Mod III combines the advantages of the center resilient contact seal plus front and rear rigid insulators. The contact insulator assembly insures a reliable seal at the periphery of the insert and around each contact to provide unmatched environmental resistance.

A wide selection of insert configurations and accessory hardware—including that with 360° RFI shielding capabilities—is available for your requirements. Learn more about Mod III, send for Technical Bulletin No. 4. 



CONNECTOR DIVISION, THE PYLE-NATIONAL COMPANY, 1334 NORTH KOSTNER AVENUE, CHICAGO 51, ILLINOIS  
 Also manufactured in Canada by: Pyle-National (Canada) Ltd., Clarkson, Ontario

# Pyle-National

ELECTRICAL CONNECTORS LIGHTING EQUIPMENT CONDUIT FITTINGS

## A REMARKABLE NEW RELAY

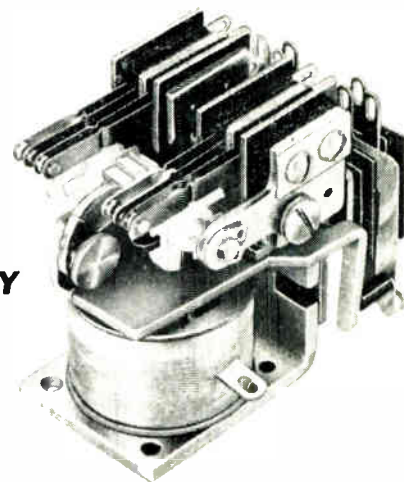

# Versatile P&B relay can be made to step, ...all with singular reliability

### **INHERENT RELIABILITY DUE TO RELAY'S INDIRECT ACTION**

The GM is a reliable, low cost, impulse/sequencing relay providing a choice of switching elements which make it practical for an extremely wide range of applications.

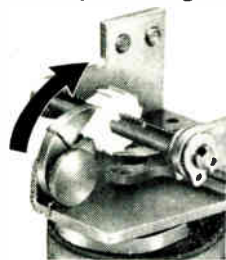

Contact action, except in the case of auxiliary contacts, takes place during the *drop-out* of the armature. The motive power is the armature's return spring, a constant force providing smooth, dependable results.

As drop-out occurs, a pawl engages a 10 or 12-step ratchet, advancing it one position. This action turns a shaft which results in contacts being opened or closed and/or results in advancing the movable contact arm of a printed circuit board switch.

This precise stepping of the ratchet shaft allows for wide variations of the relay's structure making the GM possibly the most versatile relay in the P&B line.

Contact operation during the *pull-in* of the relay can also be obtained through the use of auxiliary contacts activated by levers attached to the back of the armature.

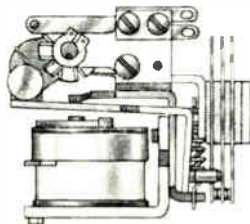

### **THREE TYPES OF SWITCHING ACTION MAY BE USED**

Three different kinds of contact action can be used on the GM to effect switching. First, contact arms extending over the ratchet shaft are opened or closed by cams. Contact arrangements up to 6PDT (providing sufficient coil power is available) can be used in this manner. Second, a 10 or 12-step printed circuit board may be used with or in lieu of the contact arms. Third, two Form C auxiliary contacts may be employed.

### **PRINTED CIRCUIT BOARD CAN BE USED FOR 10 OR 12-STEP SWITCHING**

A uni-directional printed circuit board with either 10 or 12 stations can be attached to the basic GM structure. Contacts are rated to 250 milliamps. The movable arm advances one position each time the armature *drops out*.

A pulse of only 20 milliseconds will effect switching.

If sufficient coil power is available, two sets of regular contact arms and two sets of auxiliary contacts may be used in conjunction with the printed circuit board.

Regular cam-activated contacts as well as auxiliary contacts are rated to 3 amperes, 115 volts ac, 60 cycles non-inductive. GM coils may be either ac or dc powered.





...FROM POTTER & BRUMFIELD

# count, sequence, home, switch, read-out

## GM SERIES MAY BE USED FOR BINARY OR DECADE COUNTING

The GM is an impulse/sequencing relay. This makes it particularly useful in counting applications. A counting wheel or read-out drum added to the ratchet shaft will turn one position each time the relay is activated. Care must be observed in this design because of the flywheel effect on the shaft, sometimes caused by these appendages. However, our applications engineers will be happy to evaluate your particular requirements.

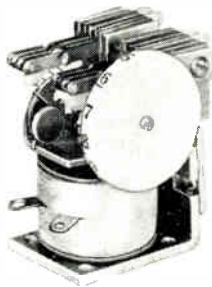

## GM RELAYS ARE USED IN WIDE VARIETY OF APPLICATIONS

GM relays have been field tested for more than a year in a number of different applications, most notably in automatic vending equipment. These relays are readily adaptable to coin-counting devices, remote television set controls, self-interrupting and homing circuits and many others.

They may be provided as open relays or, in some instances, with a dust cover having octal-type plug-in terminals.

This amazingly versatile, highly compact relay is inexpensive, too. Single lots of standard 24-volt dc GM relays without auxiliary contacts (DPDT) are priced only \$7.15. The same relay with auxiliary contacts (DPDT/DPDT): \$10.20.

## LET US HELP YOU WITH YOUR SEQUENCE SWITCHING PROBLEMS

Almost daily we discover new design possibilities with the GM Series. Perhaps this relay will prove to be a reliable, inexpensive solution to your switching problems. Please call us, or get in touch with the P&B representative in your area.

### ENGINEERING DATA

#### GENERAL:

**Description:** Impulse/sequencing relays. GM=2 Form C contacts. GM with auxiliary contacts=4 Form C contacts.  
**Expected Life:** 500,000 mechanical operations.  
**Breakdown Voltage:** 1000 volts rms between all elements and ground.  
**Temperature Range:** AC: -45°C to +45°C (intermittent duty only). DC: -45°C to +75°C.  
**Operate:** AC: 78% or less of nominal voltage @ +25°C. DC: 75% or less of nominal voltage @ +25°C.

#### CONTACTS:

**Arrangements:** GM: Two Form C (ratchet operated). GM with auxiliary contacts: Two Form C (auxiliary), and two Form C (ratchet operated). Special: Modification of GM with 10 or 12-position unidirectional printed circuit stepping switch.  
**Ratings:** GM: to 3 amps 115 volts AC 60 cycle (non-inductive). GM with auxiliary contacts: to 3 amps 115 volts AC 60 cycle (non-inductive). GM with 10 or 12-position printed circuit stepping switch: 250 MA.

#### COILS:

**Voltage:** AC: to 230 volts, 60 cps. DC: to 110 volts.  
**Power:** AC: 9 voltamps maximum. DC: 2.5 watts minimum, 4 watts maximum.  
**Duty:** AC: 50% coil duty cycle—5 minutes maximum on, 5 minutes minimum off. DC: Continuous @ 4 watts at 25°C.

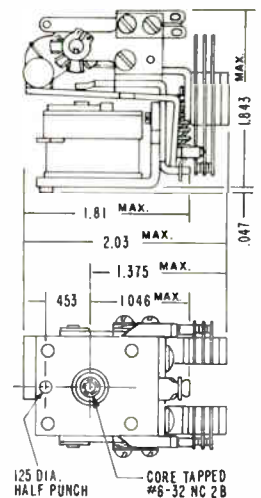

STANDARD P&B RELAYS ARE AVAILABLE AT LEADING ELECTRONIC PARTS DISTRIBUTORS



# POTTER & BRUMFIELD

DIVISION OF AMERICAN MACHINE & FOUNDRY COMPANY

PRINCETON, INDIANA

IN CANADA: POTTER & BRUMFIELD, DIVISION OF AMF CANADA LIMITED, GUELPH, ONTARIO

# RADARSCOPE

Analyzing current developments and trends throughout the electronic industries that will shape tomorrow's research, manufacturing and operation

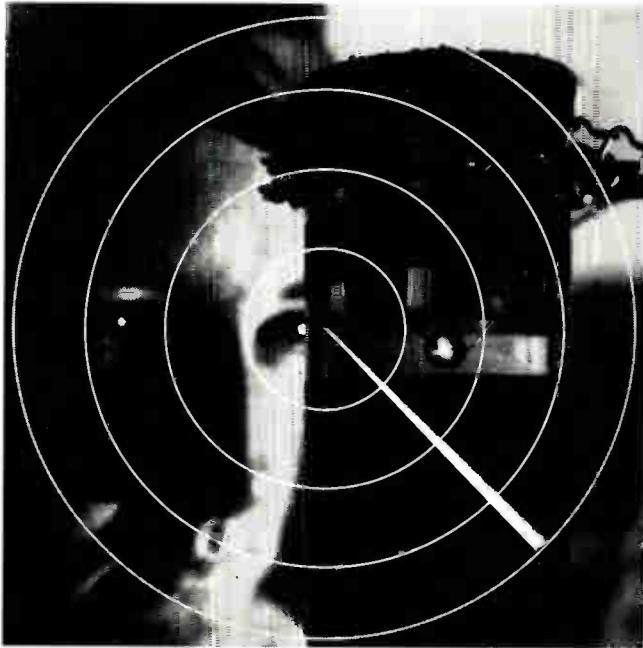

## EXPERIMENTS SEEK LASER MATERIALS

Bright spot in container is light emitted by a polished n-type cadmium sulphide crystal doped with indium chloride. Westinghouse Defense/Space Center, performing the injection experiments, is seeking new semiconductor laser materials. Under a forward bias signal, injection occurs and radiation is emitted at about 5000 Å.

**ELECTRONIC VOICE MACHINE** that says "Mary" may unlock secrets of human speech. Philco scientists have designed an experimental "Single-Forman Word-Synthesizer." It is capable of generating words of up to four phonemes in length. (A phoneme is the smallest speech unit, like the "p" in pin, that distinguishes one word from another.) Scientist Louis R. Focht reports that the device can also control pitch inflection and voice quality.

**FOUR-WAY DOPPLER SONAR** that automatically plots a ship's position continuously has been demonstrated by Raytheon Co. Believed to be the first use of the Doppler effect with sound in marine navigation, the device was tested successfully aboard Raytheon's test boat near Newport, R. I. Aside from classified military advantages, the device will permit fishermen to return to choice fishing spots. It will simplify finding damaged cable lines and laying of buoys. If a man goes overboard, the ship can retrace exact course and pick up the man. Sound waves are beamed to the ocean floor in four directions of the compass.

**OPTICAL-FREQUENCY SYSTEM** that performs angular tracking of laser-illuminated targets has been developed by Westinghouse Defense and Space Center. It is the optical-frequency equivalent of a microwave-frequency tracking radar. The system consists of an optical laser transmitter and a monopulse optical receiver. The receiver contains a pair of diffused-junction silicon detectors. The system can measure line-of-sight angles in azimuth and elevation, with respect to boresight axis, from a single pulse. The transmitter operates at 1.06 micron, using a neodymium-doped calcium tungstate laser. Laser output is 0.1 joule per pulse. Pulse repetition frequency reaches 40 pulses/sec. with air as the only coolant.

**FAST ELECTRONIC PEN** for recording signals and pulses oscillating up to 10 kc/s has been developed by a Stanford University engineer. The unique pen writes perfect hand at 100 feet per second by squirting ink on paper in tiny droplets two thousandths of an inch in diameter. Present mechanical styli used for recording signal traces can't record oscillations much faster than 100 per second.

**NEW OPTICAL MASER MATERIAL**—magnesium fluoride doped with nickel ions—emits IR photons and generates vibrations, called phonons, in the crystal lattice. The material "lases" at a wavelength determined partly by vibrations of the crystal lattice near the Ni ions and partly by electronic states of the ions. In previous lasers, wavelength of emitted light is determined by electronic transitions. The discovery is reported by L. F. Johnson, R. E. Dietz, and H. J. Guggenheim, all of Bell Telephone Laboratories. Part of the excitation energy is converted to vibration energy by the birth of a phonon.

**TEST EQUIPMENT DEVELOPMENT** has not kept up with prime aircraft and missile equipment. Dr. R. L. San Soucie, vice president of Emerson's Electronics and Space Division, declared there is a crisis in checkout equipment. He offers some remedies. Determine maintenance needs in early stages of a program; increase stress on central programmer for checkout systems with related function "building blocks"; improve thought given to combining human and machine control; fault isolation should be pointed at the module rather than the piece-part level, since integrated circuits will make this a requirement in five years; evaluate integration of general purpose computers with program controlled checkout for some roles.

**SENDING VOICE IN DIGITAL FORM**, as developed by Lenkurt Electric Division of General Telephone & Electronics, will allow Government transmission of secure voice messages around the world. A new high-speed data system 27A Duobinary-DataTel, with a speech scrambler, can send digital signals at 2,400 bits per second. This is also with substantially improved voice quality. Scrambler turns voices into digits, codes digits at the transmitter, then decodes and reconverts digits into voices at receiver.

**COMPUTER-SIMULATED DEVICE TECHNIQUES** to read blurred or garbled text is a current project by RCA for the U. S. Army. The project mostly concerns techniques to give character recognition devices the ability to read text which contains words unintelligible except for the context in which they appear. Language and data characteristics, and local traits of the text output, will be used in a computer-simulated device designed to sort out and read the garbled words logically. RCA hinted that techniques from the study also may be put to a number of other data device uses. These include automatic proofreading and word hyphenation for computer-typesetting systems, among others.

### INERTIAL NAVIGATION SYSTEM

Technician at Litton Guidance/Control Systems checks readout unit from LN-3 inertial navigation system tested in Pan Am DC-8. Sub-assemblies, from left: computer; position indicator; navigator control unit; gyro-stabilized platform with outlets on adapter. Over 213,000 miles, 50% of flights had less than 2.5 mile error.

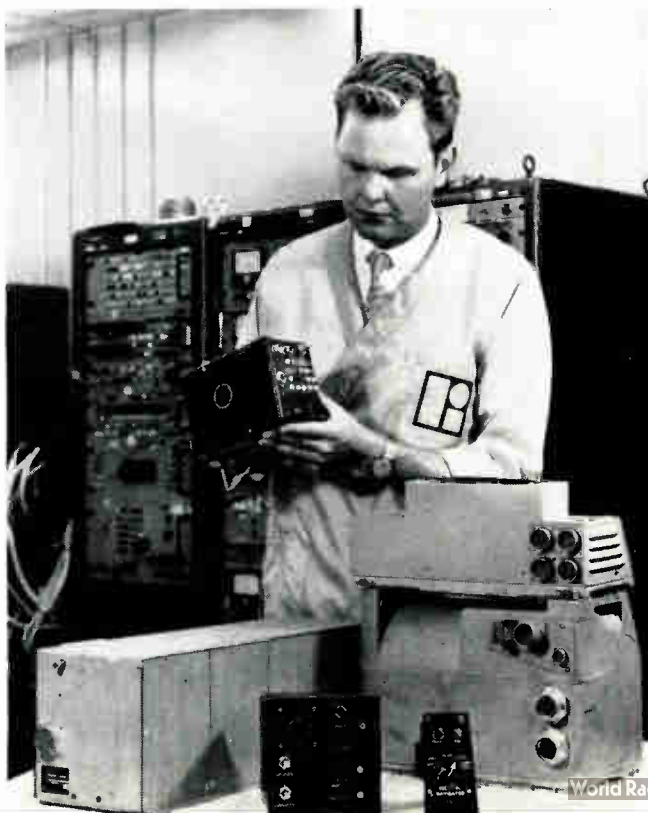

### COMPUTER GETS SHAKEDOWN

Guidance computer for Centaur space craft is little more than a blur under severe shaking during vibration test at Librascope Division of General Precision, Inc. Vibration, shock, and other environmental tests simulate launch and flight conditions. The small computer will guide Centaur on orbital and interplanetary probes.

### MEDICAL ELECTRONICS

**MEDICAL ELECTRONICS** is still viewed rather skeptically by many members of the medical profession, we found at the recent "Conference in Engineering Medicine and Biology" in Baltimore. The majority of the physicians we talked to conceded the eventual benefits of medical electronics, but were sharply critical of the way that electronic equipment is being sold to the medical profession. Dr. John Kennedy of Wesleyan University pointed out that equipment is being sold that has never been tested and that doctors are coming to look on even the most reliable equipment with some suspicion. What is needed, he says, is a 'consumers research organization' that will evaluate the equipment for the medical profession. This view was supported by Richard Rogers, an engineer in the medical department at Johns Hopkins. He complained that electronic manufacturers make their equipment "look pretty" in order to attract doctors and hospitals to purchase it, but that the resulting high costs are "revolting" to medical people. The theme of high costs was repeated many times in our conversations. One of the physicians we talked to put it very succinctly. "Electronic engineers make the very naive assumption that you cannot put a value on human life. But for us in the medical profession, this is simply not so. There are many, many things that we could do, given unlimited funds. The fact is, that the amount of money that we have to spend is very definitely limited, and we have to be sure that it is well spent." Under present conditions, doctors feel confident in dealing only with a handful of well-known suppliers. There is an enormous missionary job to be done, in gaining the confidence of the medical profession.

(More RADARSCOPE on Page 13)



## More *new* UNIFETs from Siliconix

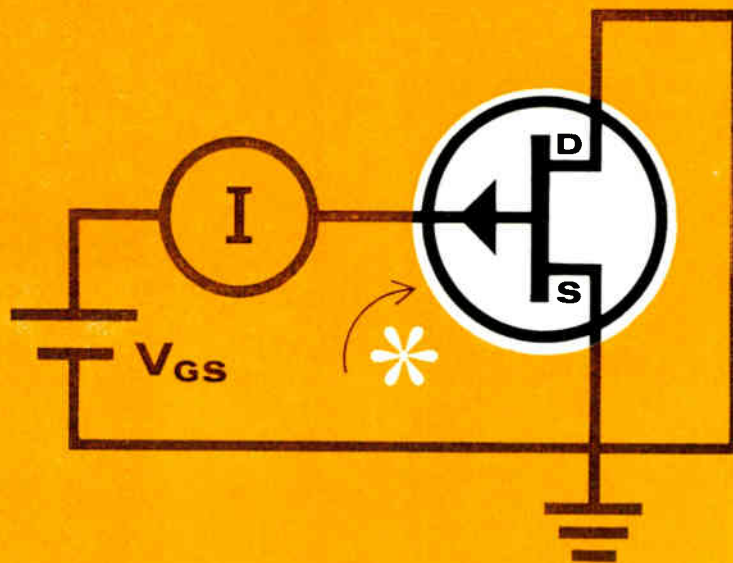

SILICONIX 2N3112 AND 2N3113 UNIPOLAR FIELD-EFFECT TRANSISTORS  
TYPICAL CHARACTERISTICS

|        | $I_{GSS}$   | $g_{fs}$     | $I_{DSS}$  | $V_P$ | $C_{is}$ | Package |
|--------|-------------|--------------|------------|-------|----------|---------|
| 2N3112 | 50 pa (Max) | 70 $\mu$ mho | 80 $\mu$ a | 2.0v  | 2.5pf    | T0-18   |
| 2N3113 | 50 pa (Max) | 70 $\mu$ mho | 80 $\mu$ a | 2.0v  | 1.4pf    | FlatPac |

**\* $I_{GSS}$  IS LESS THAN 50 PICOAMPS!**

HERE'S A UNIPOLAR FIELD-EFFECT TRANSISTOR WITH DC INPUT RESISTANCE SO HIGH YOU HARDLY KNOW IT'S THERE; GREATER THAN 100 GIGAOHMS AT  $V_{GS} = 5v$ . PARAMETER SHIFT WAS NEGLIGIBLE AFTER 100,000 OPERATING HOURS. PACKAGE: T0-18 OR A NEW LITTLE FLATPAC — AN ALUMINA/GLASS SANDWICH THAT'S ONLY 50 MILS THICK. AVAILABILITY—NOW, FROM STOCKING REPS AND DISTRIBUTORS. WRITE FOR PERFORMANCE AND PRICE DATA.



**Siliconix incorporated**

1140 West Evelyn Ave. • Sunnyvale 14, California  
Telephone 245-1000 • Area Code 408 • TWX 408-737-9948

# RADARSCOPE

**AS AERONAUTICS GOES, SO GOES ELECTRONICS**, if we may be permitted a somewhat loose paraphrase. John Stack, a Republic Aviation engineer and vice president, warns that national economy may suffer if we lose world leadership in commercial aircraft making. Stack referred to the coming of the British-French Mach 2.2 Concorde supersonic airliner. This in effect "forces a decision on the U. S. to choose between action to preserve or give up our commercial aircraft industry." The decision to "go supersonic is, in effect, already made for us."

## OCEANOGRAPHY OVERTAKING SPACE

effort was the forecast picture painted by Rear Adm. Edward C. Stephan, chairman of the Navy's Deep Submergence Systems Review Group in Washington. He said the DSSRG has suggested to Secretary of Defense McNamara that a special engineering group be approved for separate funding and that the Office of Special Projects should become the initial managing body for combined oceanographic efforts.

## INERTIAL NAVIGATION SYSTEMS

costs in the future can be trimmed through efficient use of microelectronics, says W. F. DeBoice, scientist at North American's Autonetics. He cites two conditions. The industry needs new ideas to allow microelectronic devices to do the major share of electronic functions. And we must use systems engineers' "intimate knowledge of system requirements" in concept and design of microelectronic devices. Quantity output of analog semiconductor integrated circuits as standard items can cut cost by factor of 5 to 10 from cost of the same devices produced as custom items.

## PRECISION INSTRUMENT ACCURACY

can be hampered by gradual dimension change or distortions in metal parts. Frank C. Holden, head of Mechanical Metallurgy at Battelle Memorial Institute, said that concern over dimensional instability of materials is growing among instrument makers. Holden reported that creep as small as "a few microinches per inch a year can cause enough drift in an instrument to require resetting in a few months. Precision of present instruments is now better than the stability of the materials from which they are made. Further development will be limited unless we make progress in material stability." Battelle proposes a research program on mechanisms, fabrication and heat treating techniques.

## THE RAMAN EFFECT BY LASER

has been done for the first time according to Bell Telephone scientists. Dr. H. Kogelnik and Dr. S. P. S. Porto think the technique will offer a less costly way to dig into the structure of matter and get new data. To get the six watts needed to produce the Raman spectra, the scientists placed a vial of liquid sample in the cavity of a continuous helium-neon laser working at 6328 Å. Liquid samples were of carbon tet, carbon disulphide and benzene. Scientists believe the technique can be used to study non-absorbing non-turbid liquids and for Raman spectroscopy of gases. They think it will also aid in study of the physics of Raman scattering in detail.

## ELECTRONIC PATIENT MONITORING

in hospitals may relieve nurses and other staffers of some duties. Dr. Daniel Howland of Ohio State University feels that because of special equipment generated for man-in-space programs, devices are available for telemetering physiological data. Interest in using such systems in patient care is growing. He cautions that "problems of remote patient care become important in research, as well as in engineering design and operation. We must be sure that displays convey data a staff monitor needs for medical action."

(More RADARSCOPE on Page 15)

## SUCCESSFUL LASER EXPERIMENT

Physicists Dr. Mani L. Bhaumik (left) and Dr. Leonard J. Nugent adjust temperature of new cholate laser developed by Electro-Optical Systems, Inc., Pasadena. The laser uses previously unknown five ligand europium compound in solution. Coherent emission was achieved at 6130 Å with thresholds at or near 1,800 joules.

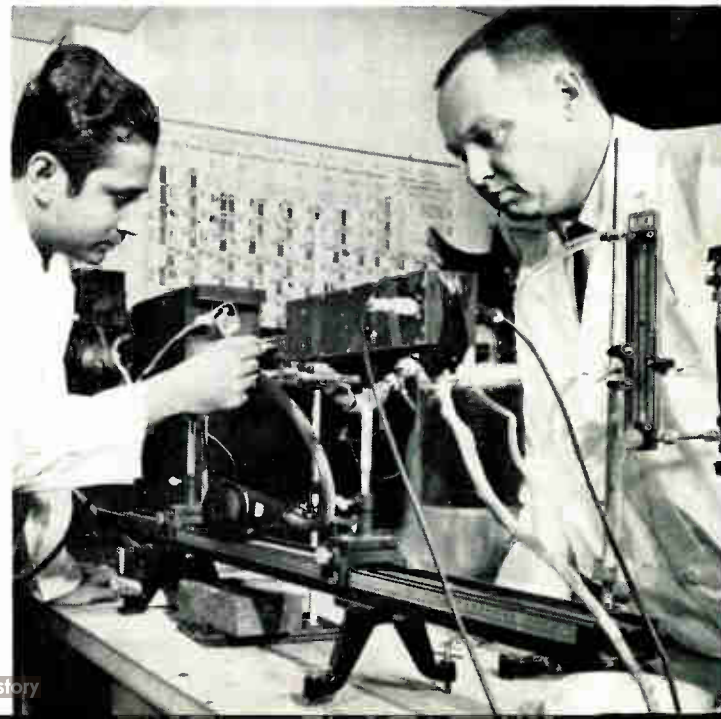



**Have you heard the one about the heavy-duty connector that got dragged over 10 miles of rough road and still worked perfectly?**

Probably you haven't. Mostly because it was our QWLD connector that was involved, and you aren't likely to find any of our competitors talking it up.

It really happened. A missile unit was moving to a new firing position ten miles away. In the dismantling of the equipment, someone forgot to secure a length of cable to which was attached half of our heavy-duty connector. After being dragged and bounced over ten miles of concrete highway and dirt road to the new location, the connector mated and performed perfectly.

We were not too surprised. Designed especially for rugged

environments in which an electrical failure would be unthinkable, our QWLD is well suited for missile launching equipment, ground radar, power and control circuits, and for mining, oil field and countless other applications.

It can be positively mated even in blind locations. It is waterproof. It features closed entry socket contacts and self-ejecting coupling action. The QWLD comes with standard solder or solderless contacts. A variation has provisions for grounding one contact to the shell.

For additional information write us, Bendix Scintilla Division, Sidney, New York.

**Scintilla Division**



Circle 8 on Inquiry Card

World Radio History



# RADARSCOPE

**SOVIET SCIENCE EFFORT** has been reshuffled so that all decision-making power is aimed toward a unified technical policy. So concludes a political scientist, Mrs. Jeanne P. Taylor, at Battelle Memorial Institute. She observes that some Soviet changes are experimental and limited in application. But, "few Soviet scientific, technical, or educational institutions will remain untouched by the realignment." They are concentrating their decision-making powers to: "establish a system of priorities not subject to last minute adjustment; ensure communication and coordination at all levels; facilitate rapid translation of scientific and technological achievements into products."

**ULTRASONIC TECHNIQUES** can determine strength-integrity of ceramic-metal bonds. Tests at IIT Research Institute, Chicago, show that 2-D images of  $\frac{1}{8}$ ,  $\frac{1}{16}$ , and  $\frac{1}{32}$ -inch diameter laminar defects in zirconia-inconel bonds have been obtained. An acoustic image converter system was used. Acoustic sensitivity and resolution of the system is so fine that defects 300 to 500 microinches thick are detected.

**USE OF LASERS IN MAPPING AND GEODESY** is being explored by the Army Corps of Engineers. Army spokesmen say lasers might be used to measure between points on earth, air-to-ground, and space-to-ground. The study is directed by Geodesy, Intelligence and Mapping Research and Development Agency (GIMRADA) at Ft. Belvoir. Among problems being checked out are physical limits of laser distance measure, beam characteristics and photoelectrical phase measuring.

**MICROMINIATURE CIRCUITS** are closer to reality. Army's Harry Diamond Laboratories have made and operated two 30-mc 1F amplifier stages from thin-film passive components. Each circuit included a coil and transistor. The units had power gains of 15.1 db and 14.7 db with a bandwidth of 10 mc. A spark-erosion machine was used in depositing the films. The device cut slots down to 0.010 in. through 12 stainless steel masks with only 0.0003 in. variation. Thin metal film resistors, deposited from a vapor of nickel and chromium are expected to be more stable than screen-printed carbon resistors. Thin-film capacitors, with a silicon monoxide dielectric and electrodes of aluminum, showed capacitances of 0.0011  $\mu\text{f}$ . This is a capacitance of 0.0097  $\mu\text{f}/\text{cm}^2$ , a value near the upper limit for such capacitors.

**ERROR-CORRECTING CODES** for high-speed digital systems is now in basic research at Sylvania. Aim of the study, for the Air Force, is high information and low error-rate data transmission. Electric or electromagnetic fields can alter pulses sent between computers over long distance lines. Disturbances also can change pulses sent from a computer memory to central processor or peripheral equipment. Altered pulses can cause serious errors. Dr. James E. Storer, director of Sylvania's Applied Research Laboratory, said that a way to overcome the problem is to send the same signal a dozen times in succession.

**METAL - OXIDE - SEMICONDUCTOR-TRANSISTORS**—p-type—by Fairchild Semiconductor, show great promise for integrated digital circuits. Called MOST's, the active element is simple in structure and its gate input impedance beyond  $10^{15}$  ohms allows large fan-out. Input capacitance is about 2 pf. In making the field-effect hole-conducting MOST's, two adjacent p-type islands are diffused into a n-doped wafer. Thin  $\text{SiO}_2$  insulating layer is grown over the area between diffused p regions. Away from the active area the oxide is kept thick to reduce capacitance. Contact holes to the p regions are etched through the  $\text{SiO}_2$ . Then metal is vacuum deposited on the  $\text{SiO}_2$  and etched into a pattern of gate, drain and source electrodes. Level shifting is not needed in direct coupling of MOST's.

## TRANSPONDER FLIGHT SHAKEDOWN

Six-pound Type-C transponder by General Dynamics has been tested for vibration and environment under conditions greater than in launch or space flight. Transmitter-receiver worked at  $0^\circ$  to  $60^\circ\text{C}$ , 50 g acceleration, combined sinusoidal and random vibration equal to 18 g. The transponder, for Air Force Glotrac, is solid-state.



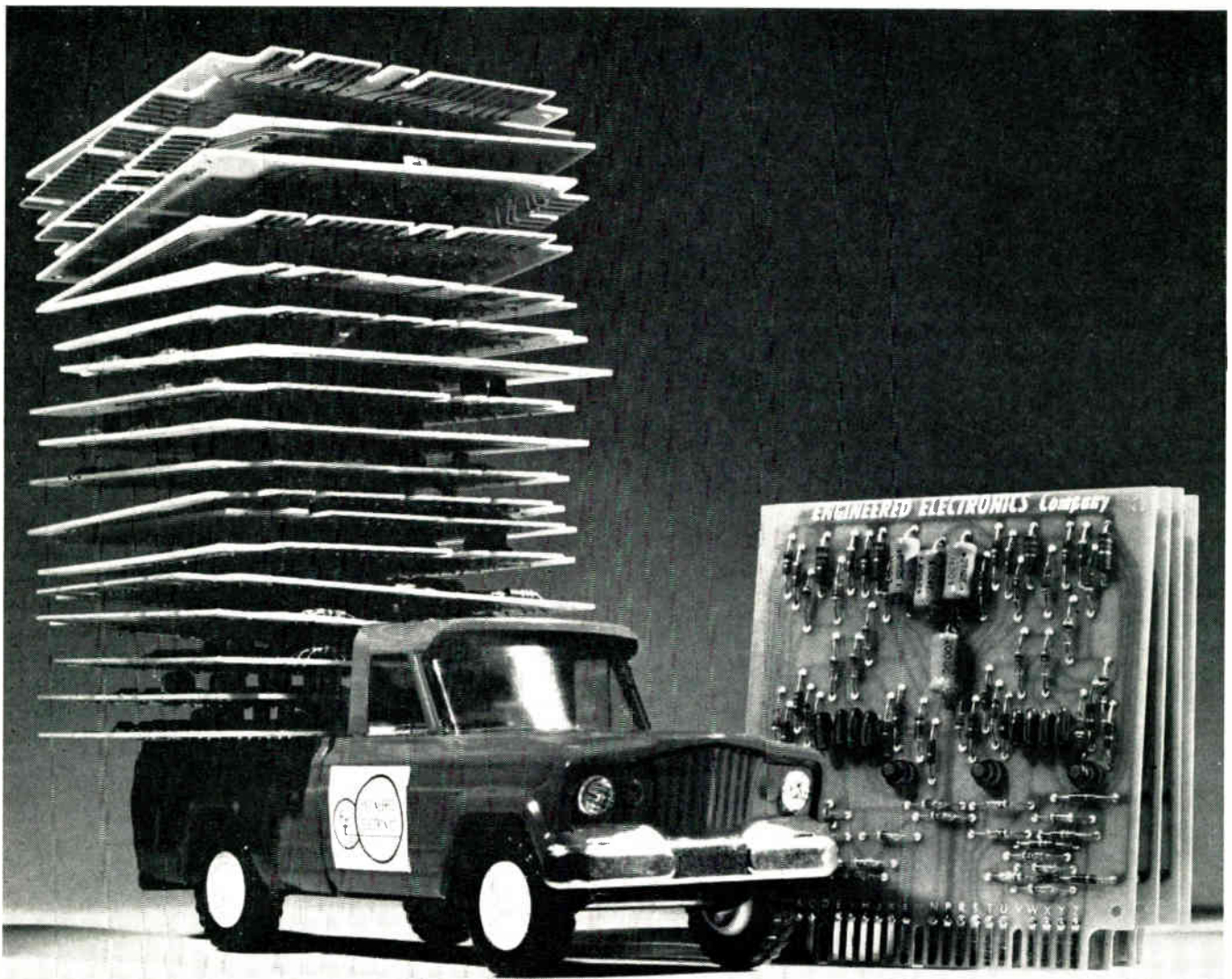

## NOW IT'S A FAMILY OF FIFTY-TWO!

**ECo's off-the-shelf G-Series digital circuits with speeds to 10 Mpps**

Now there are 52 economical G-Series circuits—52 packaged, proven and guaranteed answers to your module needs. Because this family is divided into four compatible frequency sub-groups (10 Mpps, 5 Mpps, 1 Mpps and 100 Kpps), you can get exactly the speed you want and you pay only for the speed you use. You also get a simpler system.

G-Series modules are suitable for both synchronous and non-synchronous use. They feature standard signal levels and standard input impedances, and offer you exclusive integral protection against power-supply shorts. In addition, the cards are keyed for error-free insertion and are repairable.

Whatever you need in digital circuits, you'll save time and money by checking ECo first. ECo offers you the nation's largest selection of catalogued modules—

six complete families, more than 300 module types in all. And any of these modules that fails to live up completely to its published specifications will be repaired or replaced free. Now, more than ever, your widest and wisest choice is ECo.



SEND  
TODAY  
FOR  
FREE  
CATALOG  
G-53

Fifty-six pages packed with product information, schematics, system design data and applications information.



ASK FOR FREE  
BREADBOARD  
DEMONSTRATION

Want to try out your design ideas on the ECo high-speed system breadboard? Just write or call us and

ask for a demonstration in your plant. Borrow the breadboard equipment, too, if you wish. Under our 5-year-old loan plan, you can use it up to 30 days free!

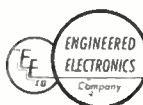

**ENGINEERED ELECTRONICS Company**

1441 East Chestnut Avenue, Santa Ana, California  
Telephone: 547-5651 Cable Address: ENGELEX



# COMING EVENTS

## JANUARY 1964

Jan. 22-24: 19th Annual Instrumentation Symp. for the Process Industries; Texas A & M College, College Sta., Tex.

Jan. 27-30: 20th Annual Technical Conf., SPE; Chalfonte-Haddon Hall Hotel, Atlantic City, N. J.

## FEBRUARY

Feb. 2-7: IEEE Winter Power Mtg., IEEE; Statler-Hilton Hotel, New York, N. Y.

Feb. 3-7: Int'l Conf. on Materials, ASTM; Sheraton Hotel, Philadelphia, Pa.

Feb. 4-6: 19th Annual Conf. and Exhibit of the Reinforced Plastic Div., SPI; Edgewater Beach Hotel, Chicago, Ill.

Feb. 5-7: 5th Winter Conf. on Military Electronics (MILECON), PTG-MIL; Ambassador Hotel, Los Angeles, Calif.

Feb. 19-21: Int'l Solid-State Circuits Conf., IEEE, Univ. of Pa.; Sheraton Hotel, Philadelphia, Pa.

## '64 Highlights

IEEE Int'l Conv., Mar. 23-26, Coliseum, New York Hilton, New York, N. Y.

WESCON, Western Electronic Show and Conv., Aug. 25-28, IEEE WEMA; Sports Arena, Los Angeles, Calif.

Nat'l Electronics Conf., Oct. 19-21, IEEE, et al; McCormick Place, Chicago, Ill.

NEREM, Northeast Research & Eng. Mtg., Nov. 4-6, IEEE; Boston, Mass.

## MARCH

Mar. 2-6: 15th Conf. on Analytical Chemistry & Applied Spectroscopy; Penn Sheraton Hotel, Pittsburgh, Pa.

Mar. 16-20: Western Metal & Tool Expos. and Conf., American Soc. of Tool & Mfg. Engineers and ASM; Pan Pacific Auditorium, Los Angeles, Calif.

Mar. 23-26: IEEE Int'l Conf.; Coliseum and New York Hilton, New York, N. Y.

Mar. 31-Apr. 2: ASM Gulf Coast Metal-Working Exh. & Conf., ASM; Shamrock-Hilton Hotel, Houston, Tex.

## APRIL

April 6-8: Int'l Conf. on Nonlinear Magnetism (INTERMAG), IEEE; Shoreham Hotel, Washington, D. C.

Apr. 13-15: 3rd Symp. on Microelectronics, IEEE; Chase-Park Plaza Hotel, St. Louis, Mo.

April 19-25: Int'l Conf. & Exhibit on Aerospace & Electro-Technology, IEEE, et al; Westward-Ho Hotel, Phoenix, Ariz.

## More than a mile of continuous-loop tape?



A good country mile, and then some! There's 7,200 feet of continuous-loop tape coiled for action in the trim, bench-top housing of that KRS DATA-STACT™ Portable Instrumentation Recorder . . . (the only portable that can reproduce while recording data from DC to 100 kc at six selectable tape speeds, and deliver true instrumentation-quality recording at complete-system prices ranging from \$2,500 to \$7,000).

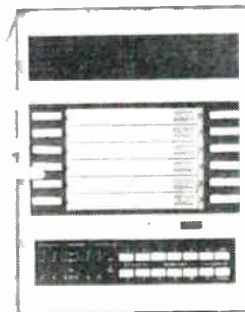

### But where's the 7,200 feet?

You'll find it in that stack of six KRS STACTape™ Cartridges. Each holds a two-channel, 1,200-foot continuous-loop roll of ¼-inch magnetic tape. Used sequentially, the six cartridges provide 7,200 feet of two-channel data-logging capacity; simultaneously, they can record up to 1,200 feet of 12-channel data.

### No mechanical adjustments?

None! Extreme simplicity of the DATA-STACT Recorder eliminates the critical parts that cause adjustment headaches. Result is an instrumentation recorder that gives you reliable performance with little or no maintenance; and, you don't need an EE to operate it.

™ Trademarks of KRS Electronics

For more of the story behind the recorder that packages 7,200 feet of magnetic tape in a 17" x 12½" x 12½" case, write for Instrumentation Division Bulletin DR-2.

Dept. E.I., KRS Electronics, 4035 Transport Street, Palo Alto, California





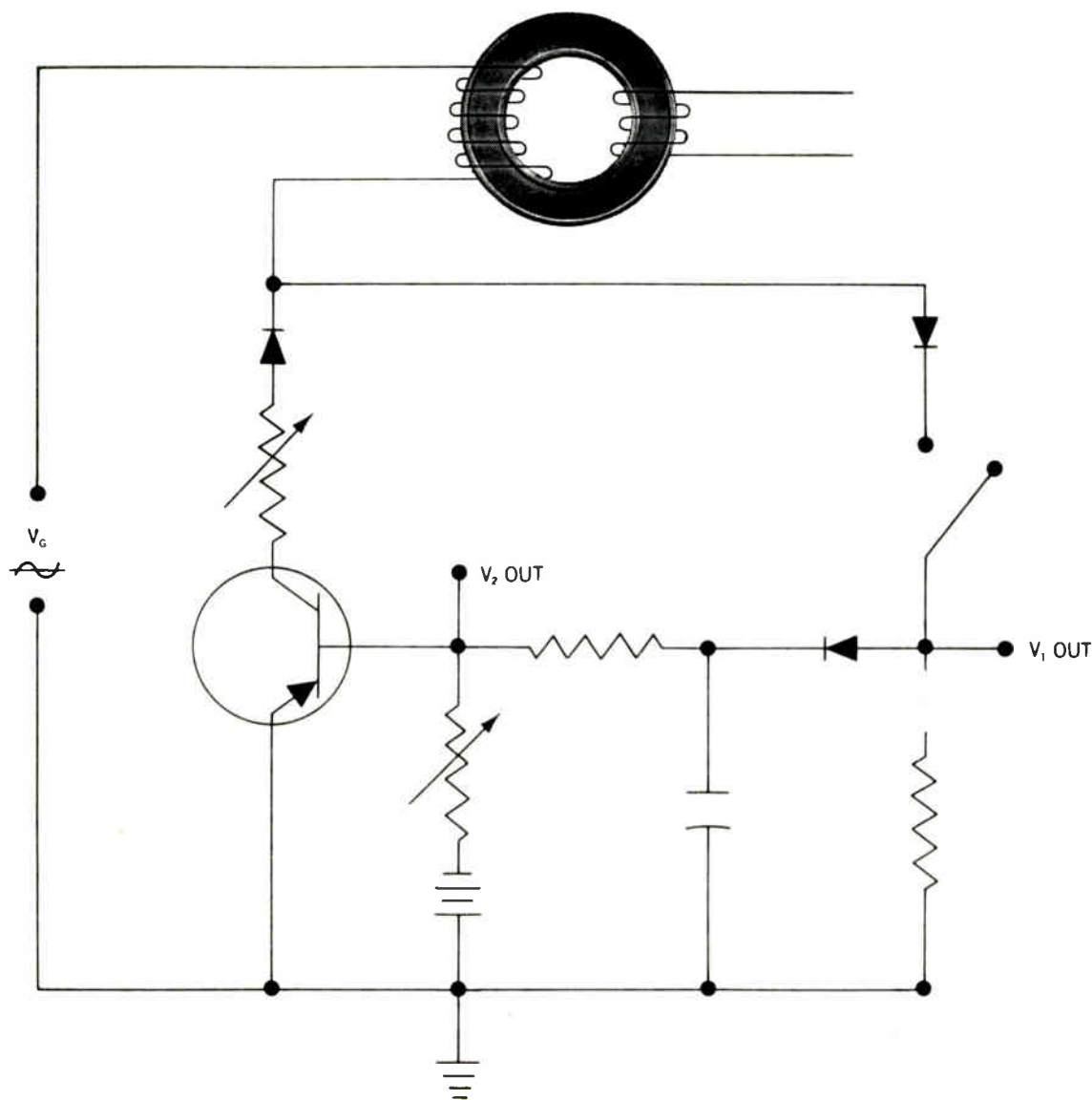

## HOW TO GET 2 MINUTES TIME DELAY WITH 1% ACCURACY

HERE'S AN ADVANCED DESIGN that uses alternate positive and negative volt-second signals to pulse an Orthonol® core to produce time delays up to 2 minutes with 1% accuracy. Key to extreme accuracy in this bi-directional trigger technique: the nearly ideal rectangular loop characteristics of Magnetics Inc.'s Orthonol® that permit switching sharply from the unsaturated to the saturated state.

What makes the circuit superior to mechanical devices, commonly used r-c circuits or magnetic core circuits of the past? Just this. Trigger pulses can come from any constant frequency source. The circuit is symmetrical; hence, compensating for effects of variations in temperature, voltage and frequency.

And because the circuit features solid state devices, high reliability is assured.

Useful for electronic counters and timers where accuracy and reliability are paramount, the circuit can also be applied to converting low level analog signals to frequency signals. By using the storage capacity (volt-second capacity) of the Orthonol® core, high sensitivity for any desired frequency range can be achieved.

For specific information about this circuit and the Magnetics Inc. cores that make it possible, write to *Magnetics Inc., Dept. EI-1, Butler, Pa.*

**MAGNETICS inc.**

University surveys indicate:

# STARTING SALARIES OF ENGINEERS ARE DECEPTIVELY HIGH

By James M. Jenks



TWO SEPARATE STUDIES of the salaries made by college graduates appear to contradict the commonly held belief that engineers today make out better financially than their classmates who major in non-technical subjects.

Both surveys were conducted by large universities. The first polled graduate engineers; the second, company executives. And both resulted in identical findings! That is, the average engineer today — despite a deceptively high starting salary—climbs fast but not far.

The need for technically trained men in recent years has exceeded the supply to such an extent that companies have been forced to bid for their services—to actually set-up “recruiting” offices on college campuses all over the country. Thus, starting salaries have gone up and up. But the income ceiling for these technically-trained men is lower than that for managerial personnel.

*Despite the substantial head start engineers have, the differential in money earned over a ten-year period averages out at \$7,000 more for the management man.*

And from the tenth year on, the administrator’s salary obviously outstrips that of the engineer by a wider and wider margin.

This, of course, is not to say that engineering students would be wise to shift to the study of business administration—or that working engineers face a bleak future. Quite to the contrary, the continuing growth of technology means that men with technical backgrounds are as ideally qualified for the highest rewards industry has

to offer—if they also have a knowledge of the underlying principles of business.

## FREE...“FORGING AHEAD IN BUSINESS”

If you want to avoid the thorny barriers to success—if you’re ambitious, determined to move up fast—send today for the Institute’s 48-page descriptive booklet, “Forging Ahead in Business”.

It explains what a man must know today to make \$15,000 or more a year . . . what he must do to accumulate this knowledge. It tells why men of equal ability fare so differently in the race for better jobs and bigger salaries. It analyzes the causes of failure . . . the reasons for success. And it outlines an executive-training program which is so complete and so scientific that each day subscribers are brought a little closer to a mastery of business procedures.

There’s no charge for “Forging Ahead in Business.” And no obligation . . . other than the obligation to read it thoughtfully, and decide for yourself whether the training it describes is meant for you. To obtain your complimentary copy, simply fill out and return the coupon. It will be mailed to you promptly.

**ALEXANDER HAMILTON INSTITUTE**  
235 East 42nd Street, New York 17, New York

**ALEXANDER HAMILTON INSTITUTE**  
Dept. 530, 235 East 42nd Street  
New York 17, New York

In Canada: 57 Bloor St., W., Toronto, Ontario

Please mail me, without cost or obligation, your 48-page book, “Forging Ahead in Business.”

Name . . . . .

Firm Name . . . . .

Business Address . . . . .

Position . . . . .

Home Address . . . . .

40



*Mach 5...Mach 10...and Beyond*

## STEVENS *Certified* THERMOSTATS

Up where the "wild blue yonder" becomes inky black, you can't afford to gamble on precise, reliable temperature control. And that's the natural domain of Stevens Thermostats. They are compact and lightweight... withstand high G's... are utterly reliable even under wide temperature swings. For Stevens Thermostats are a product of creative engineering... coupled with the most stringent environmental testing and quality control programs in the industry. If space is your dimension, take the measure of Stevens Thermostats *first*.

*2° to 6°F Differential Standard  
1° to 4°F Differential Special*

*\* Maximum spread of 6°F including differential and tolerance.*

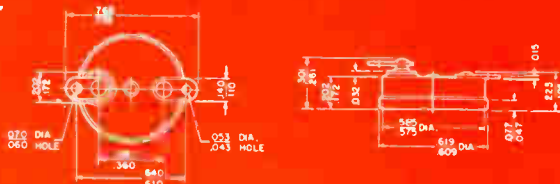

STEVENS *manufacturing company, inc.*  
P. O. Box 1007 • Mansfield, Ohio



**THERMOSTATS**

\* 6°F is difference between maximum open and minimum close.

World Radio History



# WASHINGTON TRENDS

**SPACE SPENDING STRENGTHENS**—Federal spending on space programs already is building muscle under President Johnson. For two reasons. Mr. Johnson is a firm and long-time believer in the need for high-level defense spending. This is especially true in space and in electronics research. Too, the White House is now going through its traditional honeymoon period that every new chief executive enjoys for a time. (During these periods of extreme harmony, legislators tend to give the President just about everything asked, and vice versa.) Since Mr. Johnson took office, the Congress is showing some signs of putting back some funds for defense and space that it had trimmed out not too long ago.

**RESEARCH—MORE OR LESS?**—Does the Government spend enough on research? Eight top level men from the executive branch told a congressional committee recently that \$15 billion spent every year on Federal research is not enough. In some areas, the deficiency is alarming, they feel. None conceded that there is any duplication among U. S. agencies in research. Congress jumped when it learned that 15 cents of every dollar Washington spends for some sort of research. Legislators, understandably, want to know if the nation really gets its money's worth from tens of thousands of Federal research programs going on every year. Bureau of Budget, ever helpful, suggests that agency heads improve liaison with Congress and explain kind of research being conducted and why.

**DISARMAMENT CONVERSION STRESSED**—A Senate subcommittee looking in on unemployment is told by a Hughes Aircraft official that we must prepare *now* for gradual change of defense industries to civilian output. The subcommittee, worried about 5 million jobless, is told that a meaningful change-over from defense to consumer production would do more than eliminate unemployment. Conversion would actually cause firms to wonder where to find the workers needed to do all the jobs that will be generated. Lawrence A. Hyland, Hughes vice president and general manager, urges Washington to invest now in advanced systems and technologies. Areas Hyland stresses are anti-sub warfare, communications, education aids, air-traffic control, medical electronics, anti-missile defense, cryogenics, microelectronics, and solar energy. The payoff will be "a vigorous economy, employment gains, and a larger tax base, which will repay the investment."

**GLOBAL COMMUNICATIONS NET GAINS**—The late President Kennedy endorsed a single global space communications network after a report from the U. S. Delegation to Geneva meetings of the International Telecommunication Union (ITU). Chairman Joseph McConnel gave Kennedy the report barely two days before his death. Kennedy had termed the Geneva meeting "one of the most successful of its kind in recent times." The ITU meeting, with full U.S.S.R. participation, allocated frequencies for satellites, and for weather and navigational vehicles. President Johnson is expected to share Kennedy's enthusiasm for the project.

**AFTER THE MOON COMES MARS**—While a U. S. man on the moon is still some years away, scientists are talking about a jaunt to Mars. It seems the more they talk about it, the farther apart they get. Latest estimates put a man on the red planet in 20 years. Space scientist H. H. Koelle says lack of money and of a workable propulsion system will keep U. S. earthmen off Mars until the 1980s. (What'll keep the Soviets off?) Some think Mars landings are feasible by 1975. Dr. Jerome B. Wiesner, science adviser to the late President Kennedy, moves the first U. S. Mars landing back to 2000 A.D. So, take your choice.

**EXCESS PROFITS DOWN, SAYS U. S.**—Better Federal buying policies seem to have cut excess profits that firms must repay to the Government through contract renegotiations. Lawrence E. Hartwig, Chairman of the Renegotiation Board, says that more than \$870 million in excess profits have been recovered by the Board since starting in 1951. An added \$1,179 million has been recovered or saved through voluntary refunds and price cuts by Government contractors. The Board checks contracts exceeding \$1 million, with 90% of the work involving defense contracts.

**RADIO-TV CENSORING VOTED DOWN**—A House subcommittee has shorted out an FCC plan to censor TV and radio commercials. The subcommittee vote is read by some as a clear-cut sign of congressional feeling against FCC's attempts to dictate size, time and frequency of commercials. Mail from broadcast engineers and station executives has been running heavily against the FCC move. Actually, Congress bases opposition on "the FCC's grab for Federal power it does not currently wield." Whether commercials should be censored seems less important to Capitol Hill.

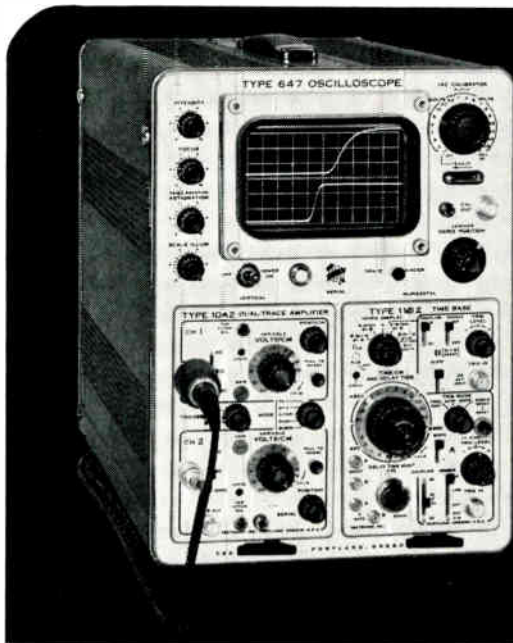

# DC-TO-50 MC, 10 MV/CM Solid-State Oscilloscope

*for accurate, reliable measurements  
... even in difficult environments.*

*The type 647 Oscilloscope and plug-in units add new convenience to display and measurement of high sensitivity, wide-band, dual trace applications.*

*Adaptable and versatile, the oscilloscope retains accuracy, within stated specifications, under extensive temperature variations . . . fluctuating line voltages . . . difficult conditions.*



### TEMPERATURE

Non-Operating —55°C to +75°C. Operating —30°C to +65°C.

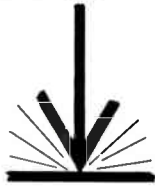

### SHOCK

Non-Operating 20 G's max, 2 shocks, each direction, along each of 3 major axes.



### HUMIDITY

Non-Operating meets Mil-Std-202B, Method 106A, except freezing, vibration, through 5 cycles (120 hours).

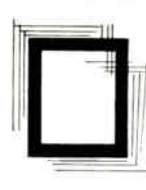

### VIBRATION

Non-Operating or Operating 0.025" pk-pk, 10-55-10 cycles, (4 G's max), 1 min cycles, 15 min each major axis.

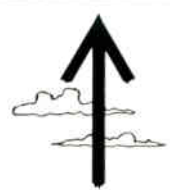

### ALTITUDE

Non-Operating 50,000 ft. Operating 15,000 ft. 50-to-400 cps line freq.

## Type 647 Features

with 10A2 and 11B2  
Plug-In Units

■ 100 v—130 v line voltage. No calibration changes with line fluctuations. 50-to-400 cps line frequency. Low power—185 watts, approximately. Convection cooled—no fan needed.

■ Dual-trace operation. 10 mv/cm sensitivity. Dc-to->50 Mc passband. Less than 7-nsec risetime.

■ 6-cm by 10-cm display area. Internal, no-parallax graticule. Controllable graticule illumination. 14-kv accelerating potential.

■ Bright line automatic triggering.  $\pm 10$  external trigger attenuator, (on main time-base triggering). 'Ground' input positions on each vertical channel.

■ 2 time bases, independent triggering. Sweep rates to 0.1  $\mu$ sec/cm. 10X sweep magnifier.

■ Sweep delay 50 sec to 1  $\mu$ sec. Single-sweep operation. Wideband (>50 Mc) triggering. External horizontal input.

■ 1-kc voltage calibrator, (crystal controlled). Push-button trace finder. Dc-coupled Z-axis amplifier. Current-probe calibrator.

|  |        |
|--|--------|
| Type 647 Oscilloscope . . . . .                            | \$1225 |
| (without plug-ins)   |        |
| Type 10A2 Dual-Trace Unit . . . . .                        | \$675  |
| Type 11B2 Time-Base Unit . . . . .                         | \$825  |
| 2 P6008 Probes . . . . .                                   | \$ 70  |
| <small>U. S. Sales Prices f.o.b. Beaverton, Oregon</small> |        |

*Dual-trace display shows input and output pulses of an amplifier at 10 nsec/cm— with trigger source from channel 2 only, for convenient and accurate time relationship between traces. Upper trace is amplifier output. Lower trace is applied step function.*

**FOR MORE INFORMATION—OR TO  
ARRANGE A DEMONSTRATION—  
PLEASE CALL YOUR TEKTRONIX  
FIELD ENGINEER.**

**Tektronix, Inc.**

P.O. BOX 500 • BEAVERTON, OREGON 97005 • Phone: (Area Code 503) Mitchell 4-0161 • Telex: 036-691  
TWX: 503-291-6805 • Cable: TEKTRONIX • OVERSEAS DISTRIBUTORS IN 25 COUNTRIES  
TEKTRONIX FIELD OFFICES in principal cities in United States. Consult Telephone Directory

Tektronix Australia Pty., Limited, Sydney, New South Wales • Tektronix Canada Ltd., Montreal, Quebec and Toronto, Ontario  
Tektronix International A.G., Zug, Switzerland • Tektronix Limited, Guernsey, Channel Islands • Tektronix U.K. Ltd., London, England



**EVEN  
IN  
BRIGHTEST  
LIGHT**



**NEW IEE READOUTS  
READ SHARP & CLEAR**

**IEE READOUTS NOW 4-TIMES BRIGHTER** • Rear-projection IEE one-plane readouts now have a new brightness-building lens system (Pat. Pend.). With this system, they provide character brightness at least 4-times greater than possible before. IEE's greater brightness makes for visual crispness and unmistakable clarity at wider angles, longer distances; great readability even under most adverse high ambient light conditions.

**4-TIMES BRIGHTER WITH CONVENTIONAL LAMPS** • IEE readouts operate with the same standard MS and commercial lamps normally used. Greater brightness is achieved with lenses, not with lamps. For example, our previous models using 6.3 v lamps gave a light level averaging about 20 foot-lamberts, as bright or brighter than competitive devices. The new readout, operated with *identical lamps* at rated voltage, gives rated lamp life and averages over 75 foot-lamberts!

**NEW OPTICAL  
PRINCIPLE  
IN READOUT DESIGN**

Three of the four lenses in the new IEE Series 10 readouts are now basically square to permit greater usable lens area in limited space. This increase in size permits the new lenses to collect twice the light while requiring only half the magnification. The two factors combined provide 4-times the brightness of older units.

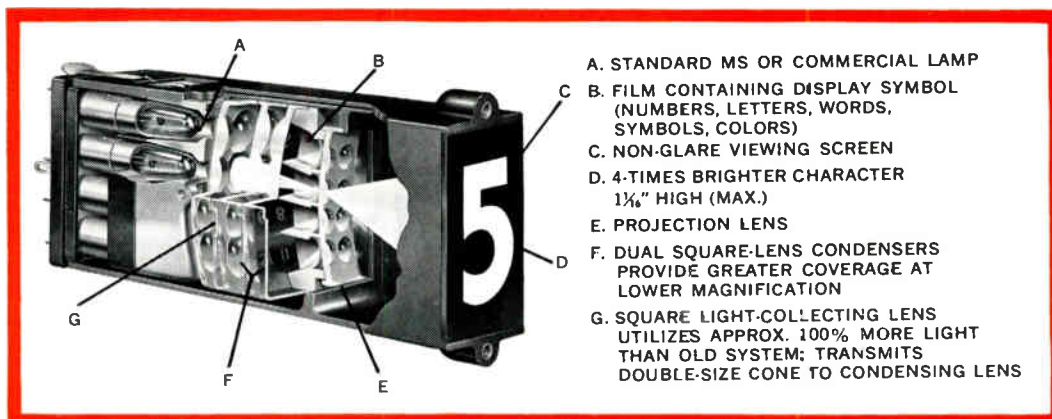

- A. STANDARD MS OR COMMERCIAL LAMP
- B. FILM CONTAINING DISPLAY SYMBOL (NUMBERS, LETTERS, WORDS, SYMBOLS, COLORS)
- C. NON-GLARE VIEWING SCREEN
- D. 4-TIMES BRIGHTER CHARACTER 1 1/8" HIGH (MAX.)
- E. PROJECTION LENS
- F. DUAL SQUARE-LENS CONDENSERS PROVIDE GREATER COVERAGE AT LOWER MAGNIFICATION
- G. SQUARE LIGHT-COLLECTING LENS UTILIZES APPROX. 100% MORE LIGHT THAN OLD SYSTEM; TRANSMITS DOUBLE-SIZE CONE TO CONDENSING LENS

**LONGER LAMP LIFE, TOO!** • If optimum readout brightness is not your prime requirement, operate the IEE readout at reduced voltage. You'll still get *double brightness* plus *10-times the lamp life* (up to 30,000 hours from 6.3 v lamps operated at 5.3 v).

**UNIQUE DISPLAY VERSATILITY** • All Series 10 IEE readouts (shown actual size above) are now equipped with the new brightness-building lens system. These readouts also continue to offer the unique display versatility of all IEE rear-projection readouts. 12 lamps provide:

- INDIVIDUAL NUMERALS & LETTERS
- DIGITS WITH POLARITY
- WORDS & MULTI-DIGITS
- MODE/WORD INDICATIONS • MULTIPLE WORDS
- COLOR EMPHASIS • ANY SYMBOLS

IEE one-plane rear-projection readouts are available in several sizes offering maximum character heights from 3/8" to 3 3/8". Your inquiry will bring the comprehensive new "Readout Display Selector Guide" which includes specifications and other technical information on the entire IEE line of readout devices.



**INDUSTRIAL ELECTRONIC ENGINEERS, INC.**

5528 Vineland Avenue, North Hollywood, California • Phone: (213) 877-1144 • TWX: (213) 769-1636

© 1963 IEE

Representatives in Principal Cities



# REVIEW AND FORECAST FOR THE ELECTRONIC INDUSTRY

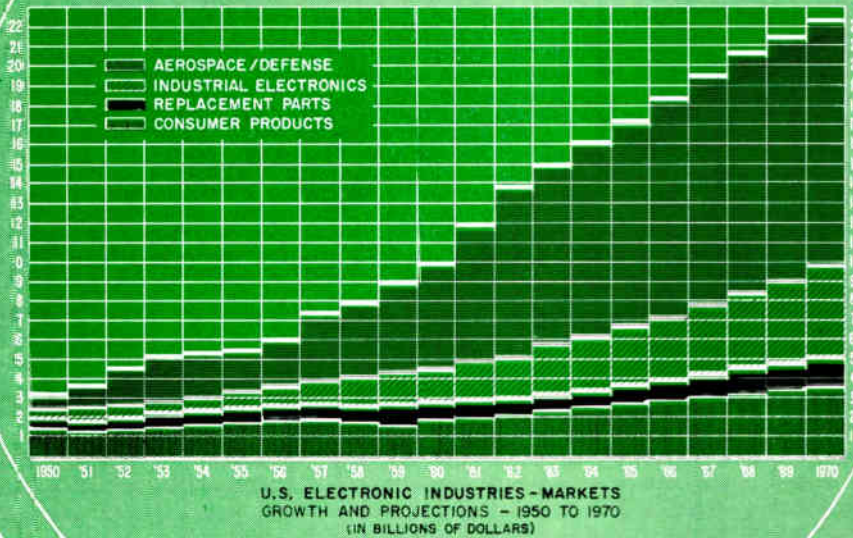

From an estimated total output of \$15.3 billion in 1963, the electronic industry may rise to a total of \$22 billion or more by 1970. The industry's growth rate may begin to recede slightly as we near the end of the sixties, but there should be record sales years up to and beyond 1970.

**HARDLY MORE THAN A STRIPLING**, the electronic industry already ranks fifth among the nation's leading industries. Still another leading industry—aerospace—is also largely electronic.

Other front-rank industries are also supplied to a large extent by the electronic industry, including auto and chemical industries. There is, in fact, hardly an area of our industrial and national economy that has not been influenced in some way by the growth of electronics.

To be sure, the electronic industry is growing. But, there may be just a few less Federal dollars to go around as we go on toward the next decade. We may actually find a completely different market facing us by 1970.

## GENERAL MARKET ROUND-UP

Total electronic factory sales for 1963 have been charted at about \$15.3 billion. This figure includes everything in electronics from a Tiros antenna to a personal transistor radio.

We will see another record year in 1964, though perhaps a bit lower in growth rate. We can look for a record 16-billion-dollar-plus market in electronics by next Christmas. With some imagination, we can even look ahead and see a string of record years to and beyond 1970.

Still the biggest plunger of the electronic market is Uncle Sam. The Federal Government paid out about \$9.2 billion to industry for its electronic products in 1963. It

also spent nearly \$2 billion for electronic research and development (R&D).

Aside from anticipated cutbacks in defense spending, military and space contracts will continue as the major spending for electronic hardware in 1964. The figure for aerospace and defense, plus NASA and FAA, is expected to exceed \$10 billion this year. Of this figure, DOD may spend \$8.3 billion, and NASA \$1.6 billion.

U. S. industry itself took up about \$2.7 billion of our electronic market in 1963 to help lift the nation's gross national product (GNP) to nearly 600 billion. The industry market was mostly computers, industrial controls, and communications equipment throughout all industry.

Sales of industrial electronic products have by-passed consumer sales. The industry market should bring about \$3 billion for 1964, up about \$300 million over 1963. By far the largest share—70% to 80%—will continue to go into the pockets of computer makers.

While industry was buying its electronic systems, U. S. families from some 60,000,000 homes went out and bought about \$2.5 billion in TV sets, radios, phonographs, electronic cookers, and a host of other status symbols. The residue of the \$15 billion was \$675 million for replacement parts.

Though the consumer market forecast for 1964 is about \$2.6 billion, the rate of consumer sales growth remains slower than either the industrial or the Federal Government markets. The consumer market, nevertheless, is expected to continue its plodding dollar-volume rise as time goes on.

## CRYSTAL-BALLING THE INDUSTRY'S FUTURE

From this point on everything is strictly crystal ball.

Spending for all U. S. Federal aviation, defense and space currently accounts for a grand total of about \$60 billion—that's for everything. This is about one-tenth of our gross national product (GNP). Total DOD budget for 1964 fiscal is down to about \$47 billion and somewhere near 20% of this is earmarked for electronic products.

For the next several years military spending as a part of GNP will likely decline bit by bit each year, though probably never coming near bottom in our lifetime. The growth rate of electronics in general may begin to slow down a little as we approach the end of the sixties.

Predictions for total electronic sales growth up to 1970 vary between \$18 billion (we're nearly there now!) and \$30 billion. Someone said even \$50 billion is conceivable! Most forecasts fall somewhere between \$20 billion and \$23 billion.

Our guesstimate is for \$22 billion in total electronic output for 1970. Though military spending may decline a little each year, government spending, especially in space activity, will still be comparatively large. Helping to hold up the curve will be slight and gradual increases in consumer sales, replacement parts and an expected acceleration in component sales.

By far the greatest help will come from sales directly to industry, which by 1970 should begin to soar. Again, the field mostly responsible for this expected growth will be computers, industrial controls and EDP in general. Another important factor will be industrial communications and global communications through satellites and other means.

By 1966 we can look for consumer sales at a round \$3 billion, while industry keeps widening the gap at about \$3.5 billion. Sales to industry should keep on rising until the yearly total reaches more than \$5 billion for 1970. After that the sky may be the limit. Consumer sales in the same year may approach \$4 billion.

With replacement parts pulling in an expected \$1.4 billion by that year, and government electronics hitting some \$12 billion, the government will no longer account for around 60% of the total market as it does now. Federal share of the electronic market by then may be around 55% or less.

## ACCELERATION OF COMPONENT SALES

Mingled with, and overlapping government, industry and consumer spending were component sales of nearly \$4.2 billion produced by about 2,000 firms. This includes a sizable portion of replacement parts also. Components include the usual active and passive items—tubes, semiconductors, transistors, resistors, capacitors, inductors—plus a good part of the new and upcoming microelectronics field.

Although sales in industrial and special power tubes, especially microwave items, are making seven-league strides in some categories, receiving tubes remain on a

## WE THOUGHT YOU'D LIKE TO KNOW . . .

. . . that in 1963 about 6,200 electronic firms (including nearly 100 mergers and acquisitions) had some 800,000 workers on the payrolls. This was nearly 2% of the total available U. S. labor force, which is around 50,000,000, excluding agricultural.

This group of workers, which may be closer to a million workers in another year or two or three, turned out a record \$15.3 billion in direct-from-the-factory electronic hardware. They did it on a rough average of about \$100/week take-home pay.

Of some 100,000 engineers and scientists engaged in R&D and/or production and design engineering with these firms, at a median salary of nearly \$11,000 per annum, some 15,000 are unionized. Nearly 300,000 electronics workers are said to be so organized also.

Between engineers, production and non-production workers, total electronic wages and salaries, not including executive and upper echelon, may have been \$6.5 billion or more. Average dollar output per employe is estimated at \$17,000.

Average engineer starting salaries are estimated at just above \$600 a month, or about \$7,300 to \$7,500 a year.

somewhat bumpy plateau. Receiving tube unit sales for 1963 are estimated at 365 million units. The market for 1964 is expected to be about the same with a dollar value of a little more than \$300 million. Supporting the receiving tube market at the moment, in effect, is the continuing delay in transistorizing some consumer items. Also propping up tubes is the big replacement market which will be around for a long time but will have slight dips as years go by.

In components, semiconductors continue their phenomenal growth in use and in sales, though profit margins seem to be shrinking a little. Some firms have left the semiconductor business, while others have plunged into it. In 1964, sales of transistors may run to 390 million units for close to \$400 million. Semiconductor diodes and rectifiers should be able to sell about 585 million units for a total sales of more than \$300 million.

As the electronic industry moves ahead to the end of this decade, the pace will begin to slacken a bit and the rise curve will not be so pronounced. In other words, the growth rate will not be linear. There may be some trade-off as the rate in government spending is trimmed back and industrial and consumer sales fill in. In some circles, a definite trend toward a plateau in the late twenty-billions is expected after 1970.

Components are seen going up the curve to a very possible \$6.25 billion or more by 1970, passing the five-billion mark in 1967 along the way. This rise in component output and sales, aided to a great degree by rapidly advancing microelectronics, will help immeasurably to keep the industry curve going ever upward.

**COMPONENT ACCELERATION TO 1970**  
(IN BILLIONS OF DOLLARS)

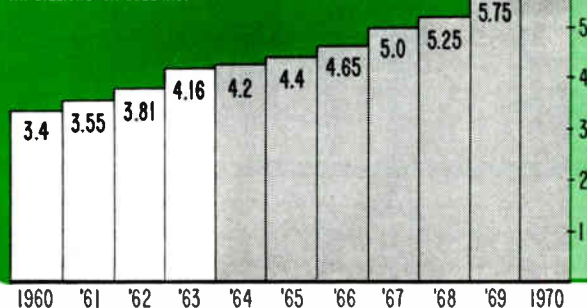

Components, including all active and passive types, as well as microminiature circuits and components, reached just over \$4 billion in 1963. By 1970, the component market, fed by growing microcircuitry and integral circuits, should rise to \$6 billion.

# OVER TEN BILLION A-B HOT MOLDED RESISTORS

*and not even one catastrophic failure*

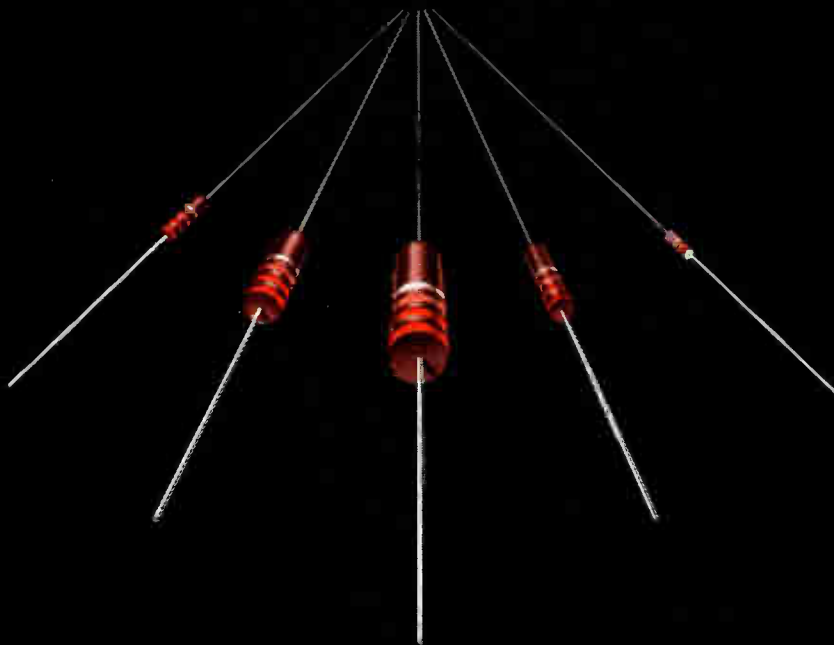

ALLEN-BRADLEY HOT MOLDED FIXED RESISTORS,  
SHOWN ACTUAL SIZE, ARE AVAILABLE IN ALL STANDARD EIA  
AND MIL-R-11 RESISTANCE VALUES AND TOLERANCES

■ Such an outstanding record of resistor performance—accumulated over some twenty-five years—clearly demonstrates the all around reliability of Allen-Bradley hot molded resistors. It is more conclusive proof of the total reliability of the A-B resistors than could be produced by any massive testing program. The unique Allen-Bradley hot molding process results in such uniformity from resistor to resistor—year after year—that long term performance can be accurately predicted.

Because the many years of use in the most critical applications have established the reputation of Allen-Bradley hot molded resistors for their stable characteristics and

conservative ratings, they are generally “required” in today’s critical military and industrial electronic circuitry.

Let your own circuitry benefit from the reliability that’s based on more than ten billion field proven resistors—without a single failure. For detailed specifications on Allen-Bradley’s resistors, please send for Technical Bulletin 5050. You also should have Publication 6024, which briefly describes the full line of A-B quality electronic components. Allen-Bradley Co., 102 W. Greenfield Ave., Milwaukee, Wisconsin 53204.

In Canada: Allen-Bradley Canada Ltd., Galt, Ontario.



## ALLEN-BRADLEY

QUALITY ELECTRONIC COMPONENTS



## EXPORTS AND IMPORTS

Helping to keep the industry on an upward trend is the growing foreign market for U. S. electronic products. In 1963, U. S. firms shipped out nearly \$1 billion in electronic goods to overseas buyers. Exports for 1964 may reach beyond \$1.4 billion. Exports were mostly in communications equipment, detection and navigation systems, EDP systems and computers, television equipment, test instruments and semiconductors. The same will probably be for 1964 and onward.

A trend to keep an eye on is the growing influx of foreign products into the U. S., with Japan on the front horse. Rising foreign imports, together with domestic dollar-squeezing, is making substantial inroads in some industry profits.

Although semi-official figures for 1963 and 1964 imports total \$340 million and about \$420 million respectively, imports of foreign electronic hardware may reach 10% of our total domestic output for 1964. If this holds true, total imports for this year may hit \$1.6 billion.

If our Federal Government decides to lower the tariff wall some more, then the all-out battle for the dollar will begin in earnest. Certain parts of our electronic industry will find themselves in trouble.



Exports of electronic products are growing steadily as nations find both more uses and more money to buy them. Exports in 1964 may reach near \$1.3 billion. Imports, apparently mostly Japanese, also are growing steadily. One forecast has a total of \$422 million for 1964. Still another says 10% of total U. S. electronic output, or about \$1.6 billion.

## THE FUTURE OF COMPUTERS

Computers and data processing equipment brought in \$1.45 billion in 1963. At year's end there was an estimated 12,000 EDP units and systems in service for all uses.

This field makes up the largest part of the industrial segment of total electronic sales. In 1964, sales of computers and systems to industry may, in fact, account for about 80% of the industrial market.

The field is expected to gross

Sales of computers and EDP equipment is the largest part of the industrial market. By 1970, this should also be the case as total sales rise toward a predicted \$8 billion. The majority will be sold directly to industry; others will go to the U. S. Government, to business, and especially for the export market.

U.S. COMPUTER MARKET AND SALES (IN BILLIONS)

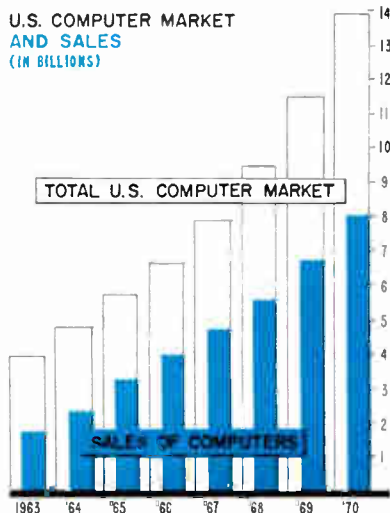

## WORKERS In Federal Projects

Some 36% of the workers in the electronic industry are now in some form of government contract work. By 1970, the Labor Department predicts, this number will rise to 42%. The department also says the demand for production workers will decrease in relation to the need for skilled engineers and technicians.

So-called non-production workers accounted for only 19% of the electronic work force in 1950. By 1961, the number had already risen to 40%. The shift to non-production workers is due largely to increased emphasis on R&D, by government and industry.

about \$2.2 billion in computer equipment in 1964. At the end of the year there may be as many as 15,000 to 16,000 general purpose digital computers in use for all purposes in the U. S.

The complete EDP market for 1963—including hardware, software, and services—has been estimated by one source at more than \$3 billion. Add to this nearly \$2 billion in additional income from units and systems already in place and in use and we get a grand total of about \$5 billion for the complete EDP year.

Data and statistics projecting the rise of computers and general EDP sales to 1970 average out at about \$8 billion for computers and hardware and nearly \$14 billion in total

gross income from all EDP markets and sources.

Sales in any EDP category beyond computer hardware and actual electronic equipment do not reflect growth within the electronic industry markets.

## RESEARCH AND DEVELOPMENT

In 1963, an estimated \$2.1 billion was spent for electronic R&D among the Federal Government and industry, plus colleges and other private institutions. The U. S. Government paid about \$12.3 billion for all of its military and space R&D in 1963. (Some sources say that the government will have spent some

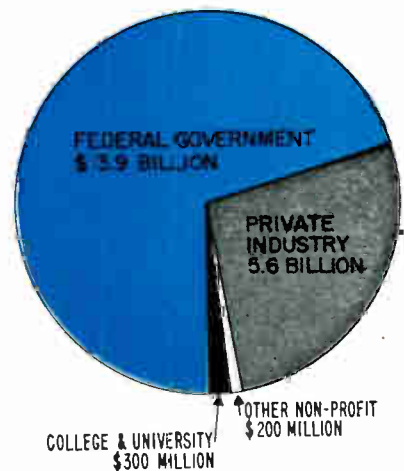

Total outlay for all R&D in 1964 may be about \$20 billion, with the Federal Government using nearly \$14 billion worth. Some \$5.6 billion will be paid for by industry. Colleges and other non-profit institutions will take up the residue. The electronics component of the whole R&D pie may be \$2.4 billion in 1964.

# ASTRODATA

## ADVANCED SOLID STATE AMPLIFIERS FOR YOUR CONTROL AND INSTRUMENTATION APPLICATIONS

Astrodata advanced design instrumentation amplifiers raise state-of-the-art standards to higher levels for measurement... conditioning... monitoring... indicating... control.

Many standard options are available to adapt these amplifiers to your individual requirements.

For custom designs, Astrodata's extensive experience provides a well-qualified capability for satisfying your specific performance needs.



**Model 884 Wideband (dc-150kc) Floating, Guarded Amplifier...**  
**Model 885 Wideband (dc-10kc) Differential Amplifier...**

high-gain/high-performance amplifiers for low-level wideband systems. Completely transistorized, these state-of-the-art amplifiers use field-effect transistors in place of the mechanical choppers to achieve lowest drift rate, low power consumption and maximum reliability. Standard gain steps include "OFF," 3, 10, 30, 100, 300 and 1,000. Continuously adjustable 10-turn vernier control is available as a standard option. An optional  $\pm 10$  ma or  $\pm 100$  ma output current (at  $\pm 10$  volts), supplied from low output impedance, can be supplied to drive A to D converters, multiplexers, galvanometers or tape recorders. The Model 885 provides a choice of transfer characteristics, including (A) Maximally Flat Amplitude (Butterworth) for widest frequency response in high-level multiplexed, galvanometer or tape recorder systems, or (B) Linear Phase (Bessel) for fastest settling time and overload recovery time in low-level multiplexed systems.

Both models have built-in power supplies, feature drift less than  $2\mu\text{v}$  per week, noise less than  $4\mu\text{v}$  rms, linearity better than 0.02%.

**Model 117 100-volt Operational Amplifier** for analog control or computer systems.

OUTPUT:  $\pm 100$  volts  
 at  $\pm 50$  ma  
 BAND WIDTH: dc to 200kc  
 GAIN: Greater than  $10^6$   
 NOISE REFERRED TO INPUT: 2 mv rms  
 INPUT RESISTANCE: 3 megohms at dc, 1 megohm above 5 cps



**Model 133B Dual-Channel Galvanometer-Driver Amplifier** provides 18 independent amplifier channels in 7 inches of panel space.

GAIN RANGE: Zero to 4, with ten-turn, continuously variable, locking control  
 INPUT IMPEDANCE: 10,000 ohms  
 FREQUENCY RESPONSE:  $\pm 0.5$  db from dc to 20 kc  
 OUTPUT LIMITING:  $\pm 100$  ma maximum output current prevents galvanometer overload or burnout.



**Model 880 Differential Amplifier** for low-level, low-frequency systems.

BANDWIDTH: dc to 100 cps; also available with switch-selected active filters.  
 LOW NOISE: less than  $1\mu\text{v}$  rms  
 GAIN RANGE: 50-1000  
 MOUNTING: Portable case or 8-in standard rack mounting frame



**Model 112 Chopper-Stabilized Operational Amplifier.** Versatile, modular for analog control systems.

BANDWIDTH: dc — 250 kc  
 Long-term stability, constant gain-bandwidth  
 OPEN LOOP GAIN: Adjustable from  $10^7$  to  $2 \times 10^8$  for constant gain-bandwidth.  
 Offset adjustable to zero ( $\pm 1$  mv. nom. range)  
 VOLTAGE OFFSET DRIFT: Less than  $6\mu\text{v}$  per hour  
 INPUT CURRENT: Less than 1 na



**Model 120 Nanovolt Amplifier** gives you high-gain/low-noise amplification for seismic transducer signals, cryogenic studies, thermocouple or strain gage signals.

GAIN RANGE: 200 to 1,000,000  
 BANDWIDTH: dc — 100 cps  
 NOISE: 0.05 $\mu\text{v}$  rms referred to input  
 INPUT RESISTANCE: 1 megohm  
 OUTPUT LEVEL: 0 to  $\pm 5$  volts at  $\pm 5$  ma

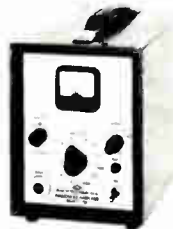

**Model 121 Nanovoltmeter** provides 0.1  $\mu\text{v}$  full scale bridge balance detector or thermocouple indicator for standards and calibration work, in the field as well as in laboratories.

FULL SCALE RANGES:  $\pm 0.1 \mu\text{v}$  to  $\pm 100$  mv  
 INPUT RESISTANCE ALL RANGES: 1 megohm  
 Built-in Overload Indicator  
 Self-Contained Batteries and AC Power Pack



Contact your Astrodata engineering representative for a demonstration... or write today for technical literature giving complete specifications.



**ASTRODATA INC.**

P.O. Box 3003 • 240 East Palais Road • Anaheim, California 92803

Phone (714) 772-1000 TWX 714-776-3760

\$14 billion by the time all the late figures are tallied.)

Total R&D for the whole nation cost something near \$18 billion, including about \$5.4 billion in industry, plus colleges and institutions.

Some sources expect R&D to drop off in some technical areas in 1964, while others say it will continue to rise slowly. A current forecast for R&D in 1964 puts out an estimate of nearly \$20 billion for the nation. This figure includes Federal R&D spending at \$13.9 billion, industry at \$5.6 billion, and some \$500 million dispersed among colleges, universities and non-profit institutions.

From the 1963 total cost of \$2.1 billion in electronic R&D, the trend may rise to about \$3.5 billion by 1967, and to as much as \$5 billion by 1970.

Median expenditures for electronic R&D in 1963 average around \$2.1 billion. As new developments and research bring forth new technologies for expanding markets, electronic R&D may rise to \$3.5 billion in 1967. Government, industry and private institution costs for electronic R&D may reach nearly one-quarter of the electronic market of \$22 billion by 1970—or about \$5 billion.

## YOUNG TECHNOLOGIES IN A YOUNG MARKET

Newer technologies, not yet significant in terms of sales volume, should become money earners in the near future. Let's have a brief look at some of them.

**LASERS**—Most current dollar marks for lasers are in R&D. The field could burgeon into a 100-million-dollar industry by the end of 1964, with yearly sales touching on \$300 million by 1965 or 1966. At present, something less than \$50 million is being spent on the laser field, largely Federally funded. This also includes some industrial sales of laser equipment, crystals, power supplies, and amplifiers for other firms to do more R&D.

Current estimates on the low end put lasers in a \$400 million to \$500 million industry by 1970. With large-scale development in communications and industrial tooling, the laser market could hit \$1 billion by that year.

**INFRARED**—This once dormant and now growing technology is placed at about \$250 million in 1963. Some projections put IR at \$500 million by 1965. Principal growth factors to consider for both lasers and IR, of course, are space activity, specialized communications, plus the upgrading of reliability in these fields now siphoning off from current government R&D. Growth applications will be mostly in space and in general industry.

**MEDICAL ELECTRONICS**—Sales of equipment and instruments in this industry average around \$250 million a year with a slow but steady rise in progress. Sales in this field are expected to rise only slightly as more doctors and hospitals are introduced to the field. Such developments as electronic bedside patient monitoring systems, special heart and brain measuring instruments, all tied in with computer technology, may help the market.

**CRYOGENICS**—Yet to make a big splash in the electronic industry, this fairly new field does enjoy an estimated \$560 million in dollar volume currently. This, however, is for the entire field, including the chemical, mechanical and structural, as well as the electronic segments of its market. At present, the electronics segment is believed to be the lesser of the four. Our guess would put electronic cryogenics at considerably less than \$100 million.

**BIONICS**—In such far out fields as bionics there is little to report in the way of market data and sales volume. These and allied fields, at best, are nearly 100% experimental, except for money spent on relatively standard equipment and parts with which to carry on mostly basic research, with some development slowly oozing out.

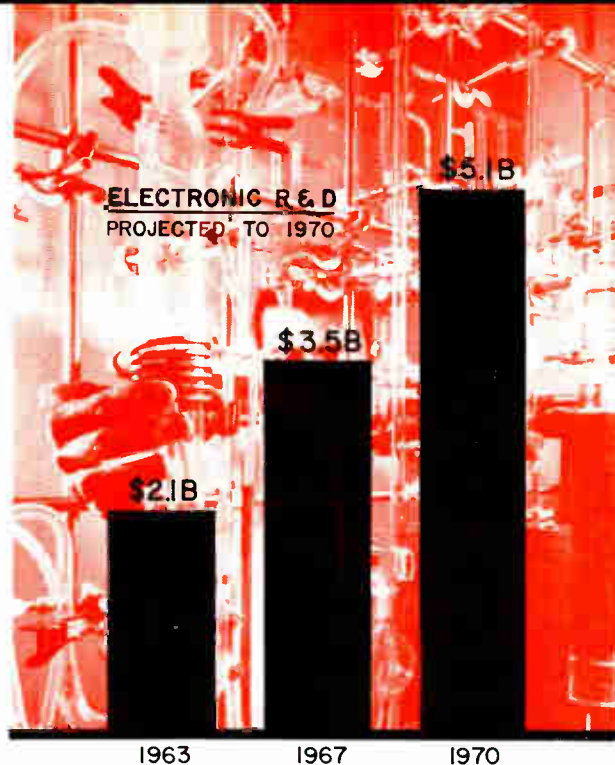

## MICROELECTRONIC CIRCUITS

Microelectronics and integral circuits and packages continued to make lengthy strides of their own throughout 1963 in development, sales and applications. Current estimates of total sales of microcircuit packages and components is around \$157 million for 1963.

The field now includes thin-film hybrid, integrated, and micromodule circuits, plus discrete components and molecular electronics applied to those circuits. Total sales of such components and circuits for 1964 may go beyond \$220 million. Numbers of units are tough to nail down.

Microelectronics is probably the fastest growing electronic field, having a profound effect on the industry so far. The uses and applications this field has found in the computer industry alone are legion. Several sources put sales for microcircuits and components at about \$543 million by 1967, a billion by 1970, and over \$1.4 billion by 1972.

## INTEGRAL CIRCUITS AND PACKAGES

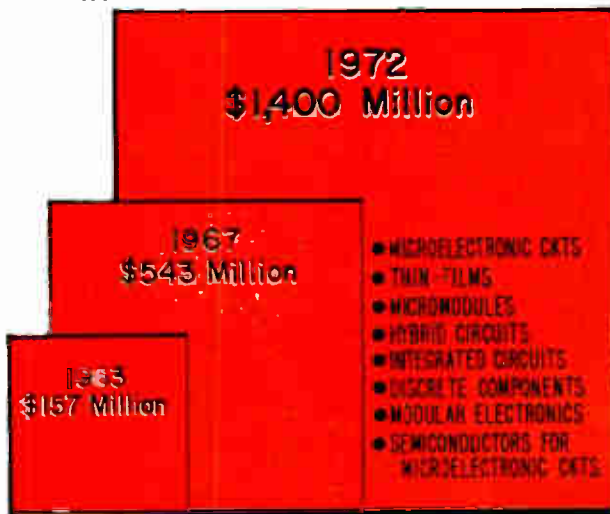

Integral circuits and packages, consisting of all new microminiature circuits and devices, are a comparatively small \$157 million in 1963. As developments and applications increase, sales are seen rising to \$543 million in 1967, and to \$1,400 million by 1972.



**now  
the  
best  
is even  
better,  
by  
design...**

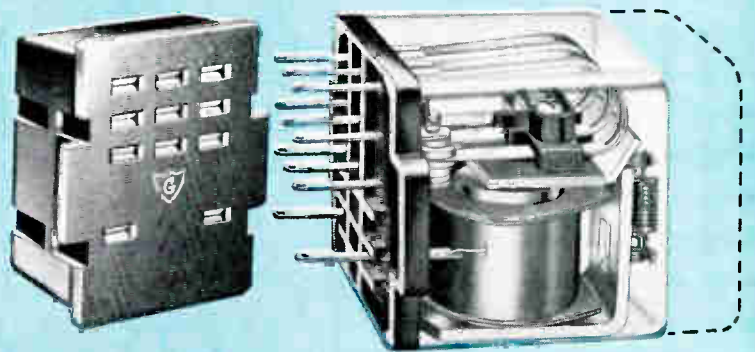

**WE'VE CUT THE SIZE — WE'VE CUT THE COST**

What a relay! More than eleven-sixteenths shorter than our series 1210, yet it does an even bigger job. How? Strictly by design. Look what we've eliminated! By using the terminal panel as the male plug, we've eliminated the radio-type plug, extra wiring, and sub-assembly between relay and plug. A new snap-in socket eliminates cover and plug mounting screws. New Uni-Guard switch design eliminates contact terminal solder connections. And a new snap-lock cover does away with wire retainers. We've even eliminated air space between terminal block and socket, with a solid flush fit that guards against shorting due to metal particles. Over 35 separate production line operations are out the window—and along with them, the production costs. The 1220 relay is yours now for less than \$2.00 in quantities. Why pay more for less? Write today for the full facts.

**NEW "UNI-GUARD" ONE-PIECE SWITCH ELIMINATES INTERNAL SOLDER CONNECTIONS:**



*In the sophisticated new 1220 relay design, the continuous-loop moving blades are mechanically quick-connected directly to the relay terminal panel. This greatly reduces contact circuit resistance—as well as the relay price. Now less than \$2.00!*



**GUARDIAN  
ELECTRIC**

GUARDIAN ELECTRIC MANUFACTURING COMPANY • 1550 W. Carroll Avenue, Dept. EI-41, Chicago 7, Illinois

# TECHNOLOGY FORECAST FOR 1964

## ELECTRON DEVICES

**TRANSISTOR** costs per unit should decrease as competition stiffens. In fact, manufacturers will automate many assembly functions in order to cut costs and remain in competition.

Because of an FCC ruling on UHF, the sale and use of silicon diodes for UHF-TV tuners will surely rise, and Si planar transistors will find more uses due to a growing knowledge of surface effects. Previously, because of the effects of Si oxide on the Si surface, it had been difficult to obtain stability in a pnp type. More multi-purpose transistors will be developed.

More semiconductor vendors are expected to shift with the technology and enter the microcircuit business. Microcircuits will be made for more than just the "custom" market. Look for microcircuits to be developed which will operate at much higher frequencies.

For integrated circuits, some manufacturers have found it more practical to use a greater number of active components since they require less area in a functional block. Thus integrated circuits will be designed using more active components and less passive ones.

**THIN-FILM** costs will decrease with increasing technical and fabrication competence. The value of thin-film hybrid circuits will be recognized by many and usage will increase. This will also tend to decrease costs. Work will continue toward producing diffused inductors despite the feeling by many that it is impossible. Will there be a breakthrough this year? We think so, if only a small one.

**ELECTRON TUBE** reliability has improved and will continue to improve this year. Performance characteristics of tubes are being upgraded continuously. Use of special purpose tubes—used heavily in military and space programs—will increase this year. Compactrons will find increasing use in TV sets this year. Despite the adverse publicity it has received from some sources, it has shown to be more reliable than the two or three tubes it replaces. In short, tubes will continue to be used for many applications.

**LASER** developments should continue to come thick and fast this year. There is a great deal of research (both basic and applied) being done in this field and it should produce many new developments soon. Some predict—with good reason, we think—that this may become a new sub-industry.

Lineup of 50 various components represents number of components which can be replaced by the integrated circuit held in the tweezers. In fact, a tiny dot of material in the center of the device performs the functions of the 50 components. Photograph courtesy of Westinghouse, Elkridge, Md.



The influence of micro-miniaturization and military requirements is reflected in this 2500 pf capacitor which is 0.1 in. thick x 0.2 in. sq.

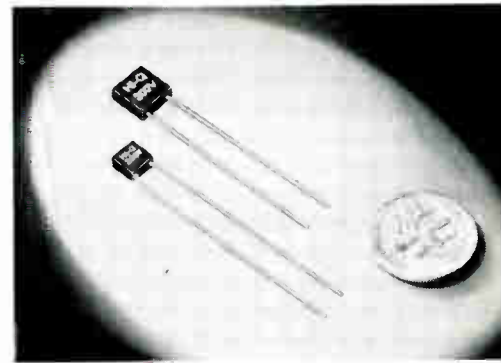

## MATERIALS

**CERAMICS** are still among the most useful insulating materials for electronics because of their ability to withstand high temperatures, high voltages, and compressive stresses. Their disadvantage has been poor machinability. Efforts are now underway to develop machinable ceramics and to find organic substitutes.

Work is being done also to reduce firing shrinkage in ceramics. This should lead to higher dimensional accuracy. Hot pressing of ceramic oxides in graphite dies is one method being used to reduce sintering shrinkage.

**FERROELECTRIC MATERIALS** have been found useful in converting thermal energy to electricity directly as the search goes on for new sources of energy. Barium titanate is the principal composition, with zirconates and niobates as possible alternatives.

**MAGNET WIRE** business is fiercely competitive, and manufacturers get little or no return from R&D on improvements. As an example, we have heard it said that not one magnet wire maker has done any research in the superconducting field. They are relying on published works of researchers. With minor exceptions, magnet wire insulation is ahead of insulations in other fields.

**PRINTED CIRCUIT BOARDS** are still meeting with a large amount of public resistance and misgivings in consumer products. At least two TV set makers are capitalizing on this fact by offering "hand-wired" circuits.

The boards generally used in consumer items suffer from poor stability and lack of flexibility. While not necessarily the fault of board manufacturers—price being the real culprit—they get the blame. Look for the quality of printed circuit boards in consumer products to improve in the near future without a noticeable price hike.

**LASER CRYSTALS** of cerium dioxide and magnesium oxide are expected to result in high-powered lasers. These new crystal materials will permit higher radiation power.

Laser action has been generated in an indium antimonide diode. The diode is placed in a high magnetic field and cooled to liquid helium temperatures. These lasers have been operated in pulsed modes by varying diode current or magnetic field. Wavelength of the radiations is about 5.2 microns. This should lead to a greater range of solid state lasers.

**THIN FILM BATTERIES** are expected to be announced in the very near future. They will be incorporated in thin film devices, thus making them self-powered. Batteries will be capable of powering pico-power circuitry and will be "built-in" as a part of the thin film circuit process.

## SOURCES OF STATISTICAL DATA

Battelle Memorial Institute  
Control Data Corp.  
Dept. of Commerce, BDSA, Electronics Div.  
Department of Labor  
Economic Index & Surveys, Inc.  
Lionel D. Edie & Co.  
Electronic Industries Association  
ELECTRONIC INDUSTRIES Marketing Department  
Goodbody & Co.  
Industry Survey/Standard and Poors  
International Resistance Co.  
National Aeronautics and Space Administration  
National Science Foundation  
Sprague Electric Co.  
Value Line Investment Survey

FACTORY SHIPMENTS OF ELECTRONIC COMPONENTS

Figures for 1961 and 1962 are taken from reports from the Business and Defense Services Administration (BDSA) of the U. S. Department of Commerce.

Figures for 1963 are ELECTRONIC INDUSTRIES estimates based on BDSA yearly and Quarterly reports.

|  | 1961           | 1962           | 1963           |   | 1961           | 1962           | 1963           |
|--|----------------|----------------|----------------|---|----------------|----------------|----------------|
| <b>CAPACITORS</b>  | <b>300,736</b> | <b>348,904</b> | <b>399,100</b> | <b>TRANSFORMERS AND</b>   |                |                |                |
| Paper dielectric   | 62,387         | 56,465         | 53,000         | <b>REACTORS</b>   | 181,002        | 221,613        | 263,700        |
| Film dielectric  | 27,390         | 24,990         | 25,200         | Other than Toroidal   | 153,949        | 189,258        | 225,600        |
| Metallized paper, film and dual dielectrics  | 14,740         | 31,714         | 51,000         | Toroidal  | 27,053         | 32,355         | 38,100         |
| Electrolytic aluminum  | 52,116         | 59,492         | 67,000         | <b>POWER AND SPECIAL</b>  |                |                |                |
| Tantalum electrolytic  | 61,963         | 70,077         | 78,900         | <b>PURPOSE TUBES</b>  | 284,519        | 313,837        | 384,900        |
| Mica, glass, vitreous, fixed   | 22,466         | 36,730         | 46,000         | High vacuum tubes   | 65,630         | 73,340         | 81,300         |
| Ceramic, fixed   | 31,613         | 37,135         | 42,000         | Gas and vapor tubes   | 26,907         | 26,517         | 23,800         |
| Variable — mica, ceramic, glass, air   | 28,061         | 32,301         | 36,000         | Klystrons   | 50,406         | 58,855         | 68,000         |
| <b>COMPLEX COMPONENTS</b>  | <b>37,961</b>  | <b>67,202</b>  | <b>160,000</b> | Magnetrons  | 40,105         | 40,481         | 41,400         |
| Circuit packages and modules, including integrated circuits, molecular circuits, active and passive component packages, and others |                |                |                | Forward and backward wave tubes   | 44,231         | 55,065         | 64,000         |
| <b>CONNECTORS</b>  | <b>190,228</b> | <b>248,588</b> | <b>299,000</b> | Light sensing and emitting tubes  | 82,960         | 85,794         | 88,600         |
| Coaxial  | 26,518         | 30,398         | 34,000         | Beam deflection, decade counters, mechanical transducers, orbital beam, reference cavities, radiation detection tubes, and others | 13,852         | 15,635         | 17,800         |
| Cylindrical  | 70,472         | 90,067         | 100,000        | <b>RECEIVING TUBES</b>  | 326,812        | 321,425        | 319,250        |
| Multiple contact   | 48,967         | 67,183         | 87,000         | Subminiature  | 21,173         | 24,061         | 27,000         |
| Fusion sealed (except coaxial)   | 4,968          | 9,134          | 14,000         | Miniature   | 206,509        | 210,054        | 214,500        |
| Printed circuit  | 14,154         | 22,188         | 30,000         | Standard glass (G & T)  | 85,234         | 76,797         | 69,750         |
| Special purpose and miscellaneous  | 25,149         | 29,618         | 33,000         | Metal, ceramic, lock-ins, others  | 13,896         | 10,513         | 8,000          |
| <b>QUARTZ CRYSTALS</b>   | <b>28,353</b>  | <b>36,647</b>  | <b>47,100</b>  | <b>TELEVISION CRTs</b>  | <b>248,952</b> | <b>240,194</b> | <b>238,000</b> |
| Clip-mounted, hermetically sealed, glass or metal case   | 14,914         | 15,453         | 17,400         | <b>SEMICONDUCTOR</b>  |                |                |                |
| Pressure and wire mounted, hermetically sealed   | 13,226         | 19,496         | 26,500         | <b>DEVICES</b>  | 546,822        | 571,181        | 584,000        |
| Unsealed, plastic and others   | 213            | 1,698          | 3,200          | Diodes and rectifiers   | 162,500        | 184,503        | 182,000        |
| <b>RELAYS — ELECTRONIC</b>   | <b>182,146</b> | <b>200,951</b> | <b>220,800</b> | Germanium   | 52,828         | 40,814         | 33,200         |
| Clapper, rotary, plunger or solenoid (except telephone)  | 97,157         | 96,894         | 99,500         | Silicon   | 109,672        | 125,336        | 132,800        |
| Telephone types  | 30,730         | 27,065         | 24,000         | Selenium and copper oxide   | (no figure)    | 18,353         | 16,000         |
| Crystal can types  | 14,522         | 24,980         | 35,000         | Special and light sensitive types   | 86,084         | 83,223         | 95,000         |
| Stepping switches  | 11,094         | 13,552         | 15,500         | Voltage regulator diodes  | 29,823         | 32,510         | 35,500         |
| Thermal and others including coaxial, dry reed, mercury wetted, motor driven   | 26,887         | 38,460         | 48,300         | Voltage reference diodes  | 5,029          | 6,683          | 8,500          |
| <b>RESISTORS</b>   | <b>285,680</b> | <b>350,840</b> | <b>409,200</b> | Multi-layer devices, controlled rectifiers, PNP diodes, and related items   | 11,174         | 16,056         | 21,000         |
| Fixed, composition   | 55,741         | 67,873         | 80,000         | Microwave diodes, variable capacitance diodes   | 9,614          | 11,995         | 13,500         |
| Fixed, deposited carbon, borocarbon  | 29,454         | 30,664         | 32,000         | Tunnel diodes   | 951            | 1,487          | 2,200          |
| Fixed, metal film  | 14,169         | 26,694         | 30,500         | Light sensitive semi-conductors, solar cells, IR detectors, photo cells, and others   | 14,680         | 14,592         | 14,300         |
| Fixed, wire wound  | 38,634         | 54,079         | 70,000         | Transistors   | 316,238        | 303,455        | 307,100        |
| Variable, non-wire wound   | 53,400         | 61,060         | 68,500         | Germanium   | 214,481        | 186,075        | 162,300        |
| Variable, wire wound   | 73,168         | 87,037         | 101,700        | Silicon   | 101,757        | 117,380        | 144,800        |
| Attenuators, voltmeter, etc.   | 6,450          | 4,549          | 3,500          |   |                |                |                |
| Varistors, thermistors, bolometer and others   | 14,664         | 18,884         | 23,000         |   |                |                |                |

● A REPRINT of this article is available from ELECTRONIC INDUSTRIES Reader Service Department



...from the publishers of

**PRODUCT DESIGN & DEVELOPMENT**

**a new working solution to the**

**"how to sell the OEM puzzle"**

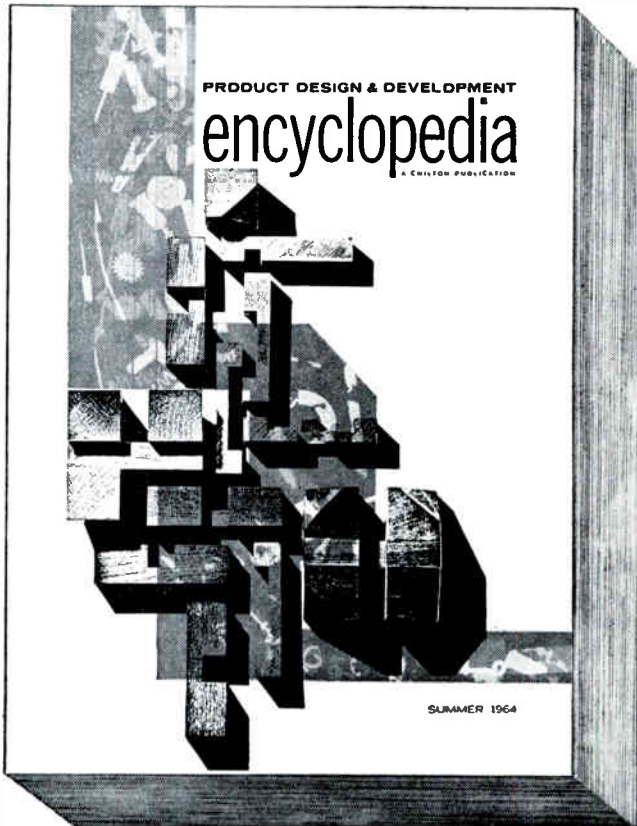

To be published for the first time in July, 1964 . . . A compendium of engineering data on more than 3500 materials, component parts, R&D equipment items, and descriptions of technical literature for the product designer. All arranged in chapter form by major product classification, all indexed and cross-indexed by product and by manufacturer, all products fully illustrated. All to give 63,000 product designer subscribers a single source of technical product information, in quick easy-to-search format, for year-around reference.

Technical product information, presented in encyclopedia fashion, will include performance characteristics, operating data, specifications, dimensions, availability information, and applications in the following major product areas: A. Materials B. Shapes & Forms C. Finishes & Coatings D. Hardware E. Electrical & Electronic Components F. Hydraulic & Pneumatic Components G. Mechanical & Power Transmission Components H. Research & Development Equipment.

For more information on how you can use this vehicle to reach PD&D's active (700,000 reader inquiries a year) audience, please call or write this office, or contact your nearest PD&D representatives.

**PRODUCT DESIGN & DEVELOPMENT**  
A CHILTON PUBLICATION

CHESTNUT at 56th STREET, PHILADELPHIA 39, PA. • SHERWOOD 8-2000 • Area Code 215

# Who says all females are alike?

All females are supposed to be unpredictable, unreliable, and hard to handle.

Here's one that isn't. It's the "better half" of Amphenol's new Ultra-Mate\* connector.

## GO/NO-GO RELIABILITY

The Ultra-Mate connector is more than predictable. You can bet your life on it—which is exactly what astronauts do each time they soar away from the launch pad. Ultra-Mate will mate *only* if every pin fits snugly into every socket. No mis-connection intermittencies.

## EASY TO HANDLE, TOO

Ultra-Mate gets its go/no-go reliability from the female half's hard faced, closed entry receptacle. Ultra-Mate is the only truly environmental, space age connector that combines a hard dielectric with *front* servicing. Any stubby-fingered technician can assemble or disassemble an Ultra-Mate connector in mere seconds.

How did we do it?

Take a close look at the female Ultra-Mate. You'll see 55 funnel-shaped openings, one for each contact. These hard-dielectric entryways guide contact-pins smoothly into their sockets. Like Figure 1 at the right. If pins are bent out of line, the connector halves just won't mate.

Now, look a little closer. See those tiny slots fanning out of each entryway? These are the secret of Ultra-Mate's front release system.

Only the standard removal tool will fit into these slots. No wrong-size contacts. No oversize test prods. Ultra-Mate is idiot-proof. And it's fast. Contact positions are clearly marked in front of the dielectric.

## MIL-C-26500 PERFORMANCE

For the first time, an environmental connector combines tamper-proof safety and service features with MIL-C-26500 performance. Ultra-Mate also meets the requirements of MIL-C-38300, a recently issued Air Force specification that retains the rigid environmental and temperature standards of MIL-C-26500, but specifies either a hard closed-entry or soft dielectric. It also employs, as does MIL-C-26500, front removal of contacts and incorporates new reliability requirements never included in connector specifications to date.

Here's what you get with a fully pressurized Ultra-Mate connector:

1. Operates continuously, with current load, at 200°C ambient.

2. Undamaged by 50 g's shock.
3. Withstands thermal shock, 5 cycles between -55°C and +260°C.
4. Carries 1,500 volts RMS submerged in salt water while pressure is alternated between sea level and 75,000-ft. altitude equivalents.
5. Handles 1,000 volts RMS at altitudes up to 110,000 feet.
6. Insulation resistance exceeds 5,000 megohms.
7. Unaffected by exposure to hydraulic fluid, lubricating oil, ozone, and moisture.

## ULTRA-MATE AVAILABILITY

You can specify Ultra-Mate connectors now in all basic sizes referenced in MIL-C-26500. Bayonet or threaded couplings. Any Amphenol Sales Engineer can give you the complete specs and engineering data. Or, write to: Dick Hall, Vice-President, Marketing, Amphenol, 1830 S. 54th Avenue, Chicago 50, Illinois.

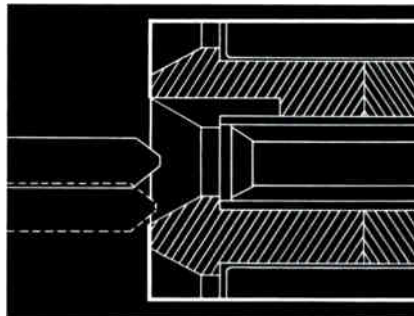

Figure 1. Slight misalignment is self-corrected by the beveled entry of the Ultra-Mate connector. Badly bent pins will prevent mating until they are replaced.

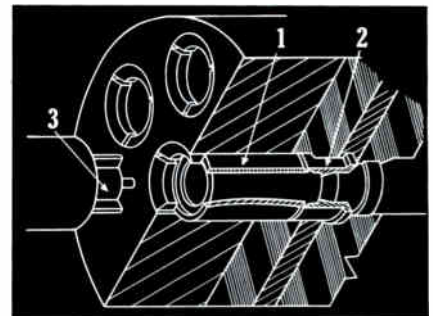

Figure 2. Standard removal tool depresses activation sleeve (1) which spreads tangs of retention clip (2) apart. Tool (3) never directly touches clip.

\*Ultra-Mate is a Trademark of Amphenol-Borg Electronics Corporation



A DIVISION OF AMPHENOL-BORG ELECTRONICS CORPORATION



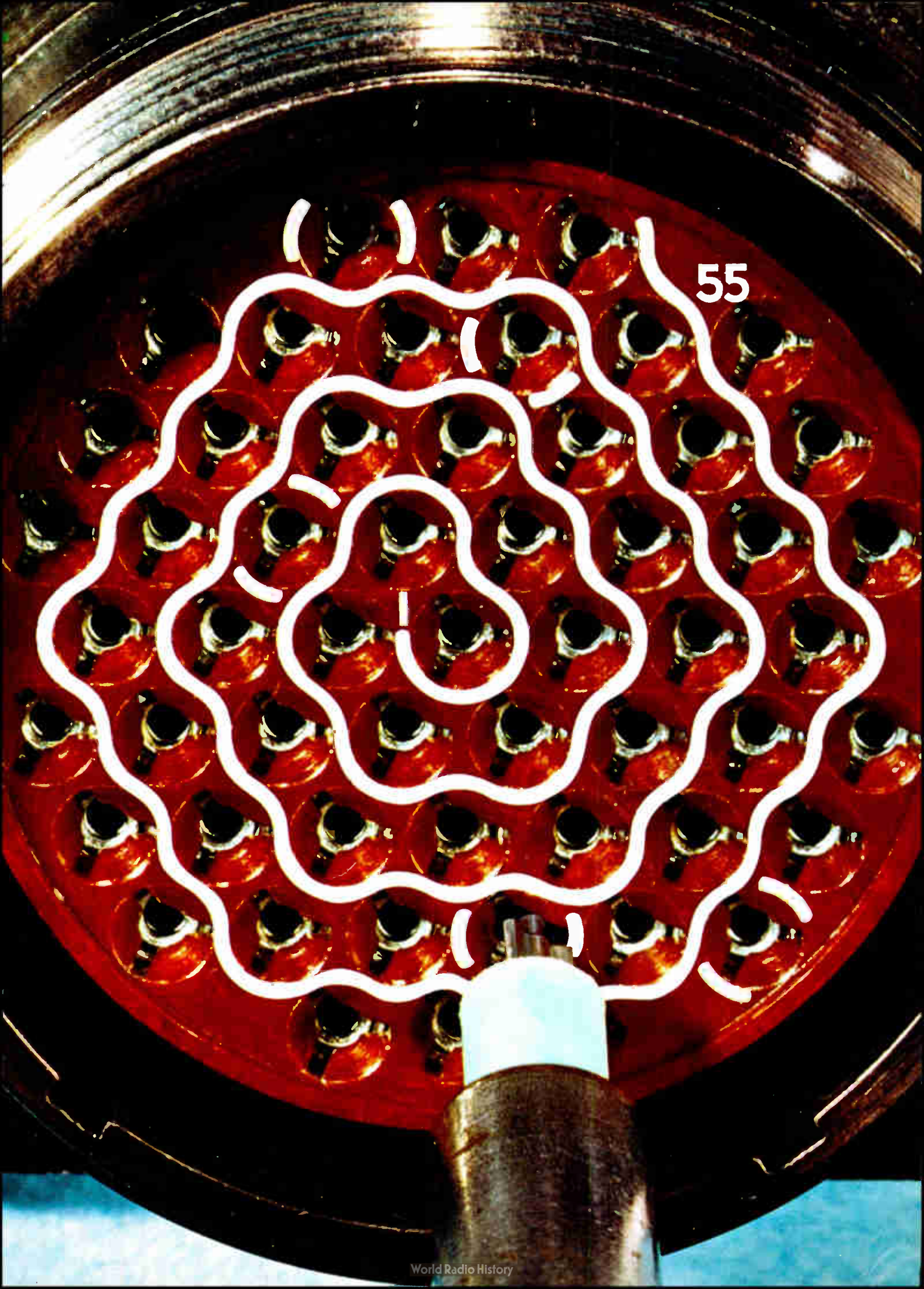

55





**american beauty**

A-mer'i-can Beau'ty (a-mēr'i-kān bū'tī), *n.* Brand of electric soldering irons used



in most U.S. industrial soldering departments. Manufactured since 1894 by American Electrical Heater Company. **a-vail'a-ble** (ā-vā'l'ā-b'l), *adj.* Ready; handy. Example: A. B. Soldering Irons —available from qualified distributors throughout civilized world. (You can always get *genuine* A. B. replacement parts.)

**one** (wūn), *adj.* Single in kind. As in American Beauty's motto, "Made in one quality only—the best".

**va-ri'e-ty** (vā-rī'ē-tī) *n.* A varied assortment. As in American Beauty Irons, available in dozens of different models, sizes and types.

**in'de-struct'i-ble** (in'de-strūk'tī-b'l), *adj.* Not destructible. For example, it is common for A. B. Irons to give 100% service after decades of daily use.

**min'i-a-ture** (mīn'ī-ā-tūr), *n.* On small scale; as in *B-Series* electric soldering irons developed by American Beauty for electronics and missiles industries. (Illustrated on facing page.)

**par'a-gon** (pār'ā-gōn), *n.* A type of perfection; as in American Beauty's "Paragon" Quality Soldering Tips; outlast previous tips up to 10 to 1; retin themselves; no scal-

319 **electric soldering irons**

ing; drip-proof; freeze-free. **spec'i-fi-ca-tion** (spēs'i-fī-kā'shūn), *n.* Designation of particulars; such as "contract specifications" in electronics industry. Soldering "specs" are often so high that equipment of American Beauty quality is used to keep rejects at minimum.

**feel** (fēl), *n.* Feeling; perception by sensations. An important factor in choosing soldering irons, some of which are used



delicately as a writing pen, often under magnification.

**com'fort** (kūm'fōrt), *n.* Freedom from pain or trouble. For example, among soldering workers, those using A. B. Irons, which are scientifically balanced, heat insulated, comfort contoured.

**au-thor'i-ty** (ō-thōr'ī-tī), *n.* One appealed to in support of opinions, actions. *Authority* for authentic, technical information on soldering equipment is your American Beauty Distributor.

**dem'on-stration** (dēm'un-strā'shūn), *n.* Showing of product's merits. As, demonstration of any American Beauty product; available *immediately* by contacting your A. B. distributor.

**cat'a-log** (kāt'ā-lōg), *n.* Articles arranged in order; as in American Beauty's new 24-page catalog. (For yours, write American Electrical Heater Company, 6110 Cass



Avenue, Detroit 2, Michigan.)

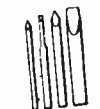

"Paragon" Quality Tips

Modern soldering iron is a precision instrument. Shown: American Beauty B-2000; 7" long; weighs 3 oz.; produces 750°F. heat at 22 1/2 watts. (Resistance wire in heating element is finer than human hair.)



# MARKETING

## Facts and Figures Round-Up

### COLOR TV, STEREO TO PACE CONSUMER SALES GAIN IN '64

A small gain was registered in consumer electronic products in 1963. Color television, after finally coming into its own in 1962, left a wake of soaring sales in 1963. Both years found more firms producing color sets. Although one vendor still makes and supplies about 99% of all color tubes, others are trying their hand at production and a few are expected to market their own tubes in the latter half of 1964.

After April 1964, all new TV receivers will be equipped to receive UHF as well as current VHF stations. TV set makers are working toward this deadline under an FCC ruling. The ruling states, in effect, that all new TV sets must be able to receive both UHF and VHF stations.

Television receiver sales, both black and white and color, for 1963 are at about 7,200,000 units, up from some 6,800,000 in 1962. The market is just about saturated, some say; more than 90% of U. S. households have at least one TV receiver.

The field is now well into the second sets and replacement markets. On this basis, 1964 should see a slight rise in TV sales volume to about 7,300,000 units at nearly \$1.4 billion. An outstanding sales rise is unlikely. Black and white sets are expected to drop.

The balance of the projected market will be made up by expanding color sales. If current predictions hold true, we may expect about 500,000 or more color sets to be sold in 1964.

Total sales of stereo and monaural phonograph products in 1963 were around 5,400,000 units. Projection for 1964 puts total unit sales at 5,600,000, including phonographs in TV sets.

Rising sales of color TV and stereo phonographs have set the pattern for slightly higher though subdued sales in consumer electronic products through 1964 to a predicted \$2.6 billion. The total for 1963 is about \$2.5 billion.

### GENERAL PRECISION STARTS FRANCHISED COMPUTER SALES

A complete line of computers will be marketed by franchised salesmen for the first time in computer history, according to General Precision. This is a method long and profitably employed to sell autos and appliances.

The nationwide network of representatives will market GP's three low-cost computers to business, industry and to science and educational institutions, according to George C. Ensslin, vice president, Commercial Computer Division, Information Systems Group.

### CONSUMER MARKET FORECAST \$2.6 Billion for 1964

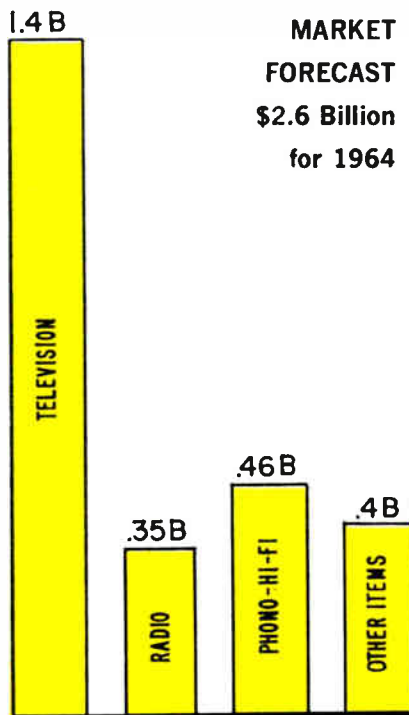

Market data and estimates from a number of sources indicate a possible rise in the consumer electronic market to about \$2.6 billion in 1964. Biggest climber in the market is expected to be TV receivers, which may hit around \$1.4 billion. There will be a slight drop-off in radios, while phonographs rise.

### MISSILE CONTRACT INCLUDES 'FIXED PRICE' AGREEMENT

While fixed price is not a new contract form, it has not been commonly used in defense contracts for complex missile systems.

The ultimate objective of the DOD for several years has been to shift to fixed-price contracts as early as possible in the contracting cycle. A new contract of some interest to both aerospace industry and the Federal Government has been agreed on between the Army and the Martin Company. Under the contract (\$13,350,000) Martin will build a specific number of PERSHING missiles at a firmly established price.

Prior PERSHING contracts (as with most major weapon systems) have been based on some form of cost-reimbursable agreements. These were either cost-plus-fixed-fee (CPFF) or cost-plus-incentive-fee (CPIF).

Martin views the fixed-price contract as a challenge. It offers a chance, through good performance, to earn more profit.

### MSC 'FIRES' NEW BUYING PLAN FOR BETTER GOODS, LESS COST

In recent requests for a vibration system, NASA's Manned Spacecraft Center, Houston, Tex., included new procurement methods aimed at higher quality hardware at more favorable prices to the U. S.

Proposed procurement is being made under a Two-Step Formal Advertising method. In former actions, MSC usually asked firms to submit proposals in one document covering a problem's technical and business aspects.

Step One of the new method calls for technical details only, with no cost information. The bidder may submit multiple proposals offering several solutions to the problem.

In Step Two, companies found technically acceptable will be asked to submit another proposal through formal invitation. The lowest responsible bidder will get the jobs, says NASA.

MSC also asks firms to include in technical proposals data on skills and competence. There must also be a resume of experience of persons who will do the work, plus a description of work now underway. MSC also asks for data on past experiences and performances.

The successful contractor also must tell NASA if he is thinking of subcontracting. The contractor also will have to indicate the internal priority he will assign to the job, number of workers employed, and necessity for overtime.

### SARKES TARZIAN TO FIGHT JAPANESE TV TUNER PRICES

Sarkes Tarzian, president of Sarkes Tarzian, Inc., has vowed to meet Japanese prices in the rising import market.

As one of the big four in TV tuner manufacturers, Mr. Tarzian has made a number of comments on the use of Japanese-made tuners by three major set makers.

"We're going to fight them," he said of Japan's prices and imports.

He said his company has made "no deal" with any Japanese tuner firm.

### 16 U.S. SURPLUS OFFICES TO BECOME SURPLUS IN 1964

Department of Defense buys billions in hardware. It also sells excess supplies. Such unneeded materials, especially electronics, are sold through 34 regional Defense Surplus Sales Offices.

By year's end, 16 of the offices will be declared surplus. By January, they will cease to be and only 18 offices will be left throughout the U.S.

# HERE'S A SWITCH

1500 watts inductive  
2000 watts resistive

Delco's silicon 2N2580 series



Switch ultrahigh voltages at peak power levels with Delco Radio's family of silicon transistors—2N2580, 2N2581, 2N2582, 2N2583.

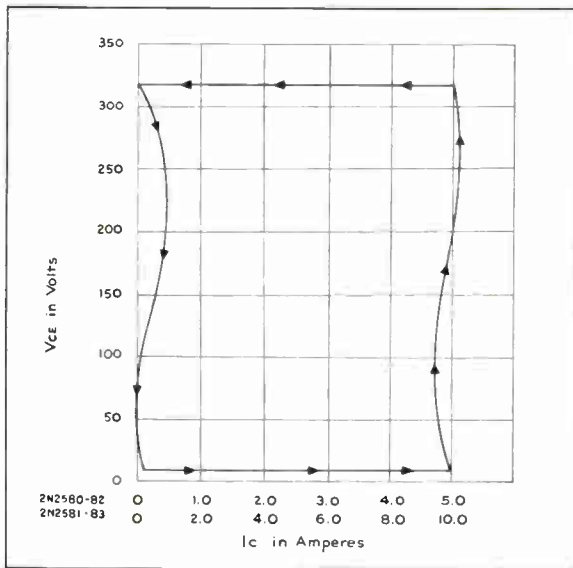

Typical inductive switching curve

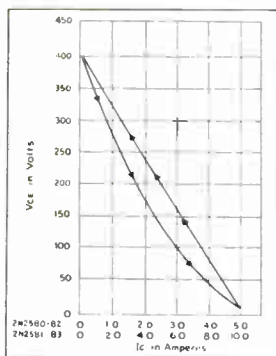

Typical resistive switching curve

Each transistor features a maximum sustaining voltage (VCE sus.) of 325V, and has VCBO, VCEX and VCEO ratings of either 400 or 500 volts in either of two gain ranges.

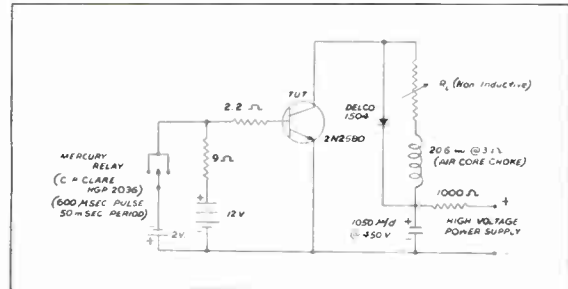

Test circuit—inductive load

Inductive or resistive loads can be switched at full rated collector current (up to 10 amperes) within the 325-volt safe operating area—with freedom from secondary breakdown.

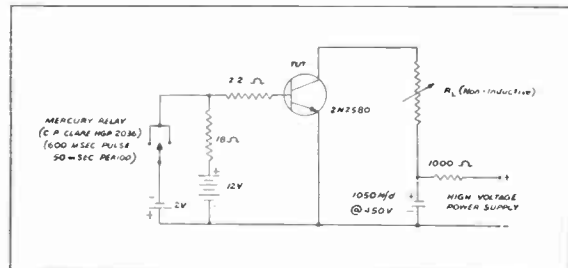

Test circuit—resistive load

All 2N2580 series transistors are available now at new reduced prices. For complete data, contact your Delco Radio semiconductor distributor or any of the sales offices listed below.

Union, New Jersey  
324 Chestnut Street  
Murdock 7-3770  
AREA CODE 201

Palo Alto, California  
201 Town & Country Village  
Davenport 6-0365  
AREA CODE 415

Syracuse, New York  
1054 James Street  
Granite 2-2668  
AREA CODE 315

Detroit, Michigan  
57 Harper Avenue  
Trinity 3-6560  
AREA CODE 313

Santa Monica, California  
726 Santa Monica Blvd.  
Upton 0-8807  
AREA CODE 213

Chicago, Illinois  
5151 N. Harlem Ave.  
775-5411  
AREA CODE 312

General Sales Office: 700 E. Firmin, Kokomo, Ind., Gladstone 2-8211—Ext. 500 • Area Code 317

**DELCO**  
RADIO

Division of General Motors, Kokomo, Indiana



# DON'T try all these tests on any other resistor!

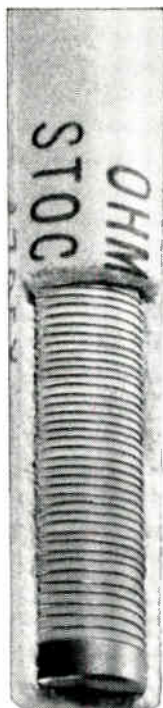

10-watt unit  
enlarged 2½ times

**OHMITE Series 99**  
Insulated, Axial Lead Wire-Wound Resistors  
"molded" in vitreous enamel  
...a new development in protective coatings.

- Proved by over 10,000,000 unit-hours of load-life testing to date.
- Meet MIL-R-26C requirements.
- 1, 2, 3, 5, 10-watt sizes.
- Get the whole story on this important development. Write for Bulletin 103.

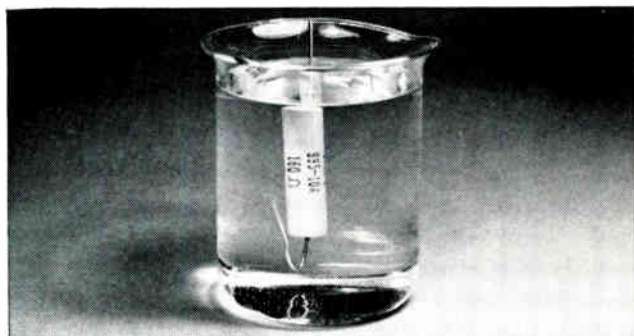

**SOAK IT IN SOLVENT!** Soak a Series 99 resistor in any organic solvent used in degreasing and flux removal. Then try to rub off the markings. You can't; they're part of the coating.

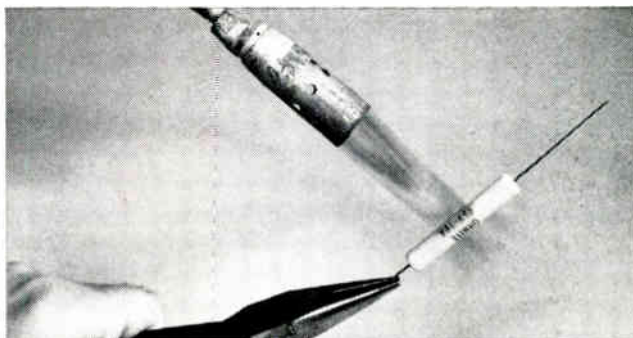

**TORCH IT!** Withstands temperatures of 1500°F without a sign of deformation. No other vitreous-enamelled resistor will stand 1500°F without burning, softening, or dripping away. There's absolutely no effect on markings either.



**ABRADE IT!** Use a glass fiber eraser, for example, on the markings. Rub them hard. Nothing happens. The markings don't come off, because they are vitreous ceramic, fired into the molded vitreous coating.



**BEND THE LEAD** at the resistor body! There's no damage. Conventional (dipped) vitreous-enamelled resistors have a meniscus at this point which ruptures, damaging the coating. Series 99 (molded) have no meniscus.

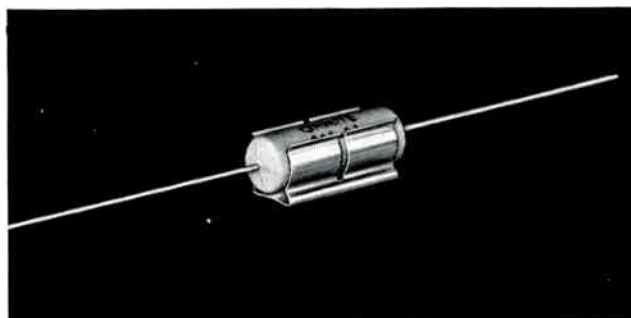

**CLIP IT!** Insert a molded Series 99 resistor into a metal clip. Don't baby it. The hard coating which provides 1000 VAC insulation won't cut, chip, or scratch. On a metal chassis, heat-sink action may increase wattage rating as much as 100%.



**OHMITE**  
MANUFACTURING COMPANY  
3662 Howard Street, Skokie, Illinois 60076  
Phone: (312) ORchard 5-2600

RHEOSTATS • POWER RESISTORS • PRECISION RESISTORS • VARIABLE TRANSFORMERS  
TANTALUM CAPACITORS • TAP SWITCHES • RELAYS • R. F. CHOKES • SEMICONDUCTOR DIODES

# CAUTION

We're out of stock on about 3 per cent of these



*Actually* a 3 per cent out-of-stock situation isn't

bad — at least not when you have the largest *inventoried* zener diode line in the industry. Specifically, it means only slightly more than 100 out of over 4000 type numbers are temporarily in short supply.

But what's important is that Motorola's *on-the-shelf, ready-for-shipment* inventory of zener diodes (over 3 million units in all) can fill your needs immediately 97 percent of the time! We keep the inventory that big so we can ship *what* you want, *when* you want it, for sure.

And about those occasional hard-to-get items — we worry mightily about them. In fact, we worry about them so much that most of the units get back *into* stock before you even know we had a problem in the first place.

The point is, when you need a zener diode (or a dozen, or a hundred, or a thousand) — either industrial or Mil-type — check with Motorola first. Chances are excellent you'll have to look no further.

Want an extra copy of Motorola's latest Zener Diode Selection Chart? Just drop us a line on your company letterhead. Meantime, tear out these pages and refer to them on your next zener buy.





 **MOTOROLA**  
Semiconductor Products Inc.

BOX 955 • PHOENIX, ARIZONA 85001 • A SUBSIDIARY OF MOTOROLA INC.

Circle 23 on Inquiry Card

| Military Types          | Nominal Zener Voltage | 1/4 WATT            |                          | 400                 |
|-------------------------|-----------------------|---------------------|--------------------------|---------------------|
|                         |                       | INDUSTRIAL (NOTE 1) | INDUSTRIAL -5% TOLERANCE | INDUSTRIAL (NOTE 2) |
| ALLOY JUNCTION TYPES    | 2.4                   | 1/4M2.4AZ           |                          |                     |
|                         | 2.7                   | 1/4M2.7AZ           |                          |                     |
|                         | 3.0                   | 1/4M3.0AZ           |                          |                     |
|                         | 3.3                   | 1/4M3.3AZ           |                          | 1N746               |
|                         | 3.6                   | 1/4M3.6AZ           |                          | 1N747               |
|                         | 3.9                   | 1/4M3.9AZ           |                          | 1N748               |
|                         | 4.3                   | 1/4M4.3AZ           |                          | 1N749               |
|                         | 4.7                   | 1/4M4.7AZ           |                          | 1N750               |
|                         | 5.1                   | 1/4M5.1AZ           |                          | 1N751               |
|                         | 5.6                   | 1/4M5.6AZ           |                          | 1N752               |
|                         | 6.2                   | 1/4M6.2AZ           |                          | 1N753               |
|                         | 6.8                   | 1/4M6.8AZ           |                          | 1N754               |
| 7.5                     |                       |                     | 1N755                    |                     |
| 8.2                     |                       |                     | 1N756                    |                     |
| 9.1                     |                       |                     | 1N757                    |                     |
| 10                      |                       |                     | 1N758                    |                     |
| 12                      |                       |                     | 1N759                    |                     |
| DIFFUSED JUNCTION TYPES | 6.8                   | 1/4M6.8Z            | 1N4099                   | (NOTE 3) 1N957      |
|                         | 7.5                   | 1/4M7.5Z            | 1N4100                   | 1N958               |
|                         | 8.2                   | 1/4M8.2Z            | 1N4101                   | 1N959               |
|                         | 9.1                   | 1/4M9.1Z            | 1N4103                   | 1N960               |
|                         | 10                    | 1/4M10Z             | 1N4104                   | 1N961               |
|                         | 11                    | 1/4M11Z             | 1N4105                   | 1N962               |
|                         | 12                    | 1/4M12Z             | 1N4106                   | 1N963               |
|                         | 13                    | 1/4M13Z             | 1N4107                   | 1N964               |
|                         | 15                    | 1/4M15Z             | 1N4109                   | 1N965               |
|                         | 16                    | 1/4M16Z             | 1N4110                   | 1N966               |
|                         | 18                    | 1/4M18Z             | 1N4112                   | 1N967               |
|                         | 20                    | 1/4M20Z             | 1N4114                   | 1N968               |
|                         | 22                    | 1/4M22Z             | 1N4115                   | 1N969               |
|                         | 24                    | 1/4M24Z             | 1N4116                   | 1N970               |
|                         | 27                    | 1/4M27Z             | 1N4118                   | 1N971               |
|                         | 30                    | 1/4M30Z             | 1N4120                   | 1N972               |
|                         | 33                    | 1/4M33Z             | 1N4121                   | 1N973               |
|                         | 36                    | 1/4M36Z             | 1N4122                   | 1N974               |
|                         | 39                    | 1/4M39Z             | 1N4123                   | 1N975               |
|                         | 43                    | 1/4M43Z             | 1N4124                   | 1N976               |
|                         | 47                    | 1/4M47Z             | 1N4125                   | 1N977               |
|                         | 51                    | 1/4M51Z             | 1N4126                   | 1N978               |
|                         | 56                    | 1/4M56Z             | 1N4127                   | 1N979               |
|                         | 62                    | 1/4M62Z             | 1N4129                   | 1N980               |
| 68                      | 1/4M68Z               | 1N4130              | 1N981                    |                     |
| 75                      | 1/4M75Z               | 1N4131              | 1N982                    |                     |
| 82                      | 1/4M82Z               | 1N4132              | 1N983                    |                     |
| 91                      | 1/4M91Z               | 1N4134              | 1N984                    |                     |
| 100                     | 1/4M100Z              | 1N4135              | 1N985                    |                     |
| 110                     | 1/4M110Z              |                     | 1N986                    |                     |
| 120                     | 1/4M120Z              |                     | 1N987                    |                     |
| 130                     | 1/4M130Z              |                     | 1N988                    |                     |
| 150                     | 1/4M150Z              |                     | 1N989                    |                     |
| 160                     | 1/4M160Z              |                     | 1N990                    |                     |
| 180                     | 1/4M180Z              |                     | 1N991                    |                     |
| 200                     | 1/4M200Z              |                     | 1N992                    |                     |

| TEMPERATURE COMPENSATED REFERENCE DIODES  | POWER RATING | NOMINAL ZENER VOLTAGE | SERIES TYPE NO.   | TEMPERATURE RANGE (°C)                 |
|---|--------------|-----------------------|-------------------|--|
|   |              |                       |                   |  |
|  | 400 mW       | 6.2                   | 1N821 to 1N827A   | -55 to +100                            |
|   |              |                       |                   | 8.4                                    |
|  | 500 mW       | 9.0                   | 1N935 to 1N939B   | 0 to +75<br>-55 to +100<br>-55 to +150 |
|   |              |                       |                   | 11.7                                   |
|  | 750 mW       | 9.3                   | 1N2620 to 1N2624B | 0 to +75<br>-55 to +100<br>-55 to +150 |
|   |              |                       |                   | 11.7                                   |

NOTES: 1. Standard tolerances of 5, 10, and 20% are available — no suffix is  $\pm 20\%$  tolerance; "10" suffix is  $\pm 10\%$  tolerance and "5" suffix is  $\pm 5\%$  tolerance.



# 10N

| MILLIWATT  | 3/4 WATT   | 1 WATT   |  | 1 1/2 WATT   | 10 WATT  |   | 50 WATT  |   |  | Nominal Zener Voltage                  |
|--|--|--|--|--|--|---|--|---|--|--|
|  | <br>*Surmetic  |  |  |  |  |   |  |   |  |  |
| MEETS SPECS OF MIL-S-19500-127                                     | INDUSTRIAL (NOTE 3)                                      | INDUSTRIAL (NOTE 2)                                      | MEETS SPECS OF MIL-S-19500-115                                 | INDUSTRIAL (NOTE 3)                                      | INDUSTRIAL (NOTE 2)                                      | MEETS SPECS OF MIL-S-19500-272                                    | INDUSTRIAL (NOTE 3)                                      | MEETS SPECS OF MIL-S-19500/114                                    | INDUSTRIAL (NOTE 3)                                      |  |
| 1N746A<br>1N747A<br>1N748A   |  | 1N3821<br>1N3822<br>1N3823                               | 1N3821A<br>1N3822A<br>1N3823A                                  |  | 1N3993   | 1N3993A   |  |   |  | 2.4<br>2.7<br>3.0<br>3.3<br>3.6<br>3.9 |
| 1N749A<br>1N750A<br>1N751A<br>1N752A<br>1N753A<br>1N754A           |  | 1N3824<br>1N3825<br>1N3826<br>1N3927<br>1N3828<br>1N3829 | 1N3824A<br>1N3825A<br>1N3826A<br>1N3827A<br>1N3828A            |  | 1N3994<br>1N3995<br>1N3996<br>1N3997<br>1N3998<br>1N3999 | 1N3994A<br>1N3995A<br>1N3996A<br>1N3997A<br>1N3998A<br>1N3999A    |  |   |  | 4.3<br>4.7<br>5.1<br>5.6<br>6.2<br>6.8 |
| 1N755A<br>1N756A<br>1N757A<br>1N758A<br>1N759A                     |  | 1N3830   |  |  | 1N4000   | 1N4000A   |  |   |  | 7.5<br>8.2<br>9.1<br>10<br>12          |
| REVERSE POLARITIES AVAILABLE IN ALL 10 AND 50 WATT DIFFUSED TYPES. |  |  |  |  |  |   |  |   |  |  |
| MEETS SPECS OF MIL-S-19500-117                                     |  | (NOTE 3)   |  | (NOTE 3)   | MEETS SPECS OF MIL-S-19500/124                           |   |  |   |  |  |
| 1N962B   | 1N3680   | 1N3016<br>1N3017<br>1N3018<br>1N3019<br>1N3020<br>1N3021 | 1N3016B<br>1N3017B<br>1N3018B<br>1N3019B<br>1N3020B<br>1N3021B | 1N3785<br>1N3786<br>1N3787<br>1N3788<br>1N3789<br>1N3790 | 1N2970<br>1N2971<br>1N2972<br>1N2973<br>1N2974<br>1N2975 | 1N2970B&RB<br>1N2971B<br>1N2972B<br>1N2973B<br>1N2974B<br>1N2975B | 1N2804<br>1N2805<br>1N2806<br>1N2807<br>1N2808<br>1N2809 | 1N2804B&RB<br>1N2805B<br>1N2806B<br>1N2807B<br>1N2808B<br>1N2809B | 1N3305<br>1N3306<br>1N3307<br>1N3308<br>1N3309<br>1N3310 | 6.8<br>7.5<br>8.2<br>9.1<br>10<br>11   |
| 1N963B<br>1N964B<br>1N965B<br>1N966B<br>1N967B<br>1N968B           | 1N3681<br>1N3682<br>1N3683<br>1N3684<br>1N3685<br>1N3686 | 1N3022<br>1N3023<br>1N3024<br>1N3025<br>1N3026<br>1N3027 | 1N3022B<br>1N3023B<br>1N3024B<br>1N3025B<br>1N3026B<br>1N3027B | 1N3791<br>1N3792<br>1N3793<br>1N3794<br>1N3795           | 1N2976<br>1N2977<br>1N2979<br>1N2980<br>1N2982<br>1N2984 | 1N2976B<br>1N2977B<br>1N2979B<br>1N2980B<br>1N2982B<br>1N2984B    | 1N2810<br>1N2811<br>1N2813<br>1N2814<br>1N2816<br>1N2818 | 1N2810B<br>1N2811B<br>1N2813B<br>1N2814B<br>1N2816B<br>1N2818B    | 1N3311<br>1N3312<br>1N3314<br>1N3315<br>1N3317<br>1N3319 | 12<br>13<br>15<br>16<br>18<br>20       |
| 1N969B<br>1N970B<br>1N971B<br>1N972B<br>1N973B<br>1N974B           | 1N3687<br>1N3688<br>1N3689<br>1N3690<br>1N3691<br>1N3692 | 1N3028<br>1N3029<br>1N3030<br>1N3031<br>1N3032<br>1N3033 | 1N3028B<br>1N3029B<br>1N3030B<br>1N3031B<br>1N3032B<br>1N3033B | 1N3797<br>1N3798<br>1N3799<br>1N3800<br>1N3801<br>1N3802 | 1N2985<br>1N2986<br>1N2988<br>1N2989<br>1N2990<br>1N2991 | 1N2985B<br>1N2986B<br>1N2988B<br>1N2989B<br>1N2990B<br>1N2991B    | 1N2819<br>1N2820<br>1N2822<br>1N2823<br>1N2824<br>1N2825 | 1N2819B<br>1N2820B<br>1N2822B<br>1N2823B<br>1N2824B<br>1N2825B    | 1N3320<br>1N3321<br>1N3323<br>1N3324<br>1N3325<br>1N3326 | 22<br>24<br>27<br>30<br>33<br>36       |
| 1N975B<br>1N976B<br>1N977B<br>1N978B<br>1N979B<br>1N980B           | 1N3693<br>1N3694<br>1N3695<br>1N3696                     | 1N3034<br>1N3035<br>1N3036<br>1N3037<br>1N3038<br>1N3039 | 1N3034B<br>1N3035B<br>1N3036B<br>1N3037B<br>1N3038B<br>1N3039B | 1N3803<br>1N3804<br>1N3805<br>1N3806<br>1N3807<br>1N3808 | 1N2992<br>1N2993<br>1N2995<br>1N2997<br>1N2999<br>1N3000 | 1N2992B<br>1N2993B<br>1N2995B<br>1N2997B<br>1N2999B<br>1N3000B    | 1N2826<br>1N2827<br>1N2829<br>1N2831<br>1N2832<br>1N2833 | 1N2826B<br>1N2827B<br>1N2829B<br>1N2831B<br>1N2832B<br>1N2833B    | 1N3327<br>1N3328<br>1N3330<br>1N3332<br>1N3334<br>1N3335 | 39<br>43<br>47<br>51<br>56<br>62       |
| 1N981B<br>1N982B<br>1N983B<br>1N984B<br>1N985B<br>1N986B           |  | 1N3040<br>1N3041<br>1N3042<br>1N3043<br>1N3044<br>1N3045 | 1N3040B<br>1N3041B<br>1N3042B<br>1N3043B<br>1N3044B<br>1N3045B | 1N3809<br>1N3810<br>1N3811<br>1N3812<br>1N3813<br>1N3814 | 1N3001<br>1N3002<br>1N3003<br>1N3004<br>1N3005<br>1N3007 | 1N3001B<br>1N3002B<br>1N3003B<br>1N3004B<br>1N3005B<br>1N3007B    | 1N2834<br>1N2835<br>1N2836<br>1N2837<br>1N2838<br>1N2840 | 1N2834B<br>1N2835B<br>1N2836B<br>1N2837B<br>1N2838B<br>1N2840B    | 1N3336<br>1N3337<br>1N3338<br>1N3339<br>1N3340<br>1N3342 | 68<br>75<br>82<br>91<br>100<br>110     |
| 1N987B<br>1N988B<br>1N989B<br>1N990B<br>1N991B<br>1N992B           |  | 1N3046<br>1N3047<br>1N3048<br>1N3049<br>1N3050<br>1N3051 | 1N3046B<br>1N3047B<br>1N3048B<br>1N3049B<br>1N3050B<br>1N3051B | 1N3815<br>1N3816<br>1N3817<br>1N3818<br>1N3819<br>1N3820 | 1N3008<br>1N3009<br>1N3011<br>1N3012<br>1N3014<br>1N3015 | 1N3008B<br>1N3009B<br>1N3011B<br>1N3012B<br>1N3014B<br>1N3015B    | 1N2841<br>1N2842<br>1N2843<br>1N2844<br>1N2845<br>1N2846 | 1N2841B<br>1N2842B<br>1N2843B<br>1N2844B<br>1N2845B<br>1N2846B    | 1N3343<br>1N3344<br>1N3346<br>1N3347<br>1N3349<br>1N3350 | 120<br>130<br>150<br>160<br>180<br>200 |

### MAXIMUM ZENER VOLTAGE VARIATION ( $\Delta V_z$ ) IN VOLTS

| .003 TO .006   | .007 TO .009     | .010 TO .014 | .015 TO .019    | .020 TO .029 | .030 TO .039 | .040 TO .059    | .060 TO .089 | .090 TO .119    | .120 TO .149 | .150 TO .239 |
|----------------|------------------|--------------|-----------------|--------------|--------------|-----------------|--------------|-----------------|--------------|--------------|
| —              | 1N827<br>1N827A  | —            | 1N825<br>1N825A | —            | —            | 1N823<br>1N823A | —            | 1N821<br>1N821A | —            | —            |
| —              | —                | 1N3157       | —               | 1N3156       | —            | —               | 1N3155       | —               | 1N3154       | —            |
| —              | —                | —            | 1N3157A         | —            | 1N3156A      | —               | 1N3155A      | —               | —            | 1N3154A      |
| 1N938<br>1N939 | —                | 1N937        | —               | —            | 1N936        | —               | 1N935        | —               | —            | —            |
| —              | 1N939A<br>1N939B | 1N938A       | —               | 1N937A       | —            | —               | 1N936A       | —               | 1N935A       | —            |
| —              | —                | —            | 1N938B          | —            | 1N937B       | —               | —            | 1N936B          | —            | 1N935B       |
| 1N945          | 1N944            | —            | 1N943           | —            | —            | 1N942           | 1N941        | —               | —            | —            |
| —              | 1N945A           | —            | 1N944A          | —            | 1N943A       | —               | —            | 1N942A          | —            | 1N941A       |
| —              | —                | 1N945B       | —               | 1N944B       | —            | 1N943B          | —            | —               | 1N942B       | 1N941B       |
| 1N2624         | 1N2623           | 1N2622       | —               | —            | 1N2621       | —               | 1N2620       | —               | —            | —            |
| —              | 1N2624A          | 1N2623A      | —               | 1N2622A      | —            | —               | 1N2621A      | —               | 1N2620A      | —            |
| —              | —                | 1N2624B      | 1N2623B         | —            | 1N2622B      | —               | —            | 1N2621B         | —            | 1N2620B      |
| —              | —                | —            | 1N3582          | —            | —            | 1N3581          | 1N3580       | —               | —            | —            |
| —              | —                | —            | —               | —            | 1N3582A      | —               | —            | 1N3581A         | —            | 1N3580A      |
| —              | —                | —            | —               | —            | —            | 1N3582B         | —            | —               | 1N3581B      | 1N3580B      |

2. No suffix denotes  $\pm 10\%$  tolerance. A suffix is  $\pm 5\%$  tolerance. 3. Standard tolerances of 5, 10, and 20% are available - no suffix is  $\pm 20\%$  tolerance; A suffix is  $\pm 10\%$  tolerance and B suffix is  $\pm 5\%$  tolerance.



The scramble for better market statistics is more hectic than ever. Growing electronic markets are out-running statisticians' abilities to generate accurate data. Amid statistical hair-pulling we find guestimates ranging from ultra-conservative understatement to wild and futuristic forecasts — overhung by a critical need for more meaningful data.

## THE PRESSING NEED FOR BETTER MARKETING DATA

NOT LONG AGO ONE ECONOMIST described the electronic industries as a bunch of companies that include "the nation's most glamorous scroungers for market statistics!"

This description begets a widely varied though technically inter-related group of industries whose factories in 1963 shipped some \$15 billion worth of electronic products in entertainment goods, components, industrial gear, defense and aerospace hardware.

Still, the picture can be tempered with a closer look at problems unique to electronic firms which more often are interested in the state-of-the-art than in the state of statistics. At one end of the electronics market spectrum, radio and TV set manufacturers know precisely their nearly-saturated, well-tabulated replacement markets.

At the other end, market researchers are frustrated trying to size-up still-developing markets—in lasers, cryogenics or microminiature circuits. Valid statistics cannot be determined since some evolving technologies may be little more than laboratory breadboards and prototypes.

However, market data are needed as pictures, maps and compasses to help show the status of electronics companies. Such statistics help answer vital questions such as, "What are the electronic industries?" "Where are they now?" "Which changes are shaping up?" "How fast?" "How slow?"

### Good Figures Encourage Firms

Statistics which indicate growing markets encourage companies to seek a bigger share, or switch into expanding markets. For example, based upon projected Federal funding of oceanography and anti-submarine warfare, Aerojet-General Corp. recently formed its Oceanic Products Division. Forecasts of shrinking markets may influence a company to cut down, or to cut out.

Managements are "decision machines." They transform statistics and other inputs into decision outputs: whether to hire or fire engineers and others:

whether to increase or decrease plant facilities. Yet each company weighs figures in its own way.

More advanced firms think in terms of "market data." Sophisticated firms collect and act only upon "useful information." Super-sophisticated firms, often the top computer manufacturers or computer-oriented firms, may use their own thinkers or hire consultants to use "mathematical models" of marketing situations. Often, combinations and permutations of these approaches are used.

Lest some managements cynically believe that "figures lie and liars figure," they could do well to recall a more cautious statistical approach. The 20th century statistician-economist, Robert S. Weinberg, manager of market research for IBM, is guided by words of the 14th century British philosopher, William of Ockham. The advice was: entities are not to be multiplied unnecessarily. That is, in the absence of real data, make the fewest number of assumptions possible.

### Inter-related Markets

So guided, Mr. Weinberg looks at \$15 billions worth of electronics factory output in 1963, but sees only groups of inter-related markets. Rather than desiring a world of statistics, he roughly estimates the mathematical order of markets. "Is the market 1, or 100? Is it 10, or 10,000—or somewhere in between?" Then he looks more closely only at a particularly interesting segment of the market.

Technical-minded, hardware-oriented electronics company managements generally seem to understaff and underfinance their marketing operations. Smaller and medium-size firms often lack marketing planners, and leave much or most of the burden on their sales managers—who are supposed to be selling.

By **SIDNEY FELDMAN**

Associate Editor  
ELECTRONIC INDUSTRIES

Frank W. Mansfield, director of Marketing and Research, Sylvania Electric Products, Inc., ranks electronic statistics as "varying virtually from 100% correct, down to those statistics not worth the paper they're written on." Mr. Mansfield is also chairman of the Advisory Committee of EIA's Marketing Services Department.



Robert S. Weinberg (below), Manager of Market Research for IBM Corp. As a market analyst, he feels that businessmen do not fully use many available government statistics. He uses countless government reports to determine how his firm's products can help fulfill needs in 92 distinct industry categories.

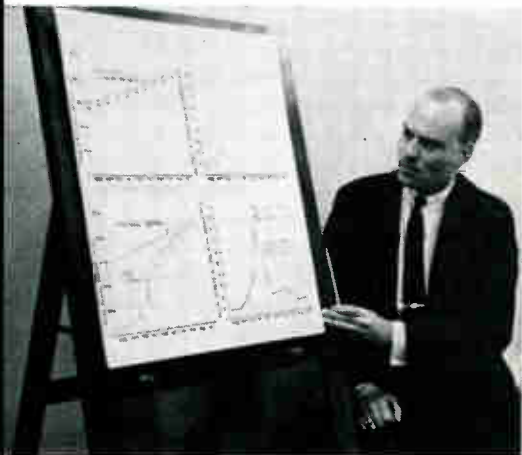

Above, James D. Secrest (left) EIA Executive Vice President, and H. B. McCoy (right) EIA Tariff Consultant, talk about trade bill testimony to Robert C. Sprague, Chairman, EIA Electronic Imports Committee and President of Sprague Electric Co.

EIA adheres to strict codes. It treats survey responses as highly secret. No data are released if three or fewer firms report in a certain category, or if one firm controls 50% or more of a certain market.

Market consultants are not generally well-regarded. Some sources accuse some consultants of gathering trade gossip and re-writing the trade press. Consultants dare not ask \$100,000 to \$200,000 for substantial market surveys, since many small electronics firms don't even net that much annually. (We lack statistics to prove any of these statements.)

The electronic industries depend heavily upon the U. S. Government for business, as well as business statistics. Some groups charge that the Federal Government denies electronics its rightful separate status, even though Electronic Industries Association (EIA)

currently ranks electronics as the nation's fifth largest industry. In the S.I.C. (Standard Industrial Classification) the central clearing house for industrial statistics, electronics is *lumped* under Group 36 (electrical machinery, equipment and supplies); Group 19 (ordnance and accessories); Group 39 (miscellaneous) and Group 35 (non-electrical machinery).

#### Not in Top S.I.C. 20

One critic of S.I.C. is Dr. Neil Jacoby, dean, University of California at Los Angeles, Graduate School

**Clare now offers...**

# the Type BA Relay

with Vibration Resistance:

**100g through 4000 cps!**

Shock Resistance:

**125g for 11 milliseconds!**

**and remarkable reliability!**



FROM LEFT:

- BA6A Six-pole round relay can
- BA1B Single-pole round relay can
- BA1C Single-pole printed circuit board module

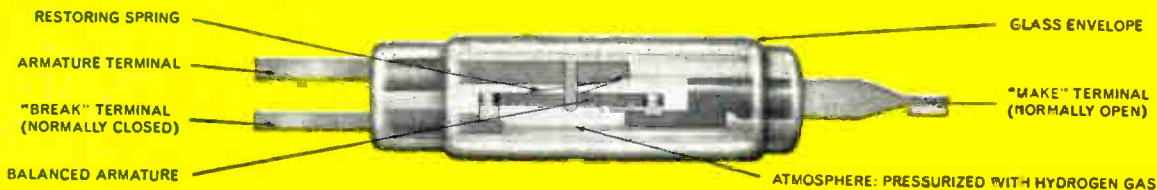

Meeting or exceeding any known specifications for shock and vibration resistance, and offering reliability of a very high order, Clare Type BA Relays can meet your most exacting design requirements.

Precise balancing of the armature in each BA Switch Capsule makes possible vibration and shock resistance characteristics greater than 100g through 4000cps, and greater than 125g for 11ms, when hard mounted.

The remarkable reliability of the Type BA Relay is directly attributable to the fact that each switch is assembled in a super-clean atmosphere and sealed in glass under pressure to guarantee a true hermetic seal, thus eliminating the possibility of contact contamination.

Circle 24 on Inquiry Card

Three packages (6-pole round enclosure, single-pole round enclosure, and single-pole module for printed circuit board application) are available.

For detailed problem analysis and engineering assistance, write Group 1D7, Application Engineering, C. P. Clare & Co., 3101 Pratt Blvd., Chicago 45, Ill.

For comprehensive design data sheet on Clare Type BA Relays, write for Data Sheet 753, or use Reader Service Card.



Relays and related control components



## MARKET DATA (Continued)

of Business Administration. He says, "S.I.C. does not list electronics among its 20 two-digit major industrial groups. Indeed, even the finer three-digit classification of manufacturing establishments into more than 200 different groups, contains only one heading of 'Electronic Components and Accessories' within the 'Electrical Equipment, Machinery, and Supplies' industrial group."

S.I.C.'s classification of electronics may cause serious consequences in forthcoming foreign trade tariff negotiations under the Trade Expansion Act. EIA urges that the Tariff Commission not follow S.I.C. in lumping electronic items with heavy electrical equipment. EIA contends both groups should be kept apart and not be equated for trade agreement trade-offs.

The Western Electronic Manufacturers Association (WEMA) long has contended that until electronics is afforded a two-digit S.I.C., "industry statistics will remain estimates and of very little value." Proponents of S.I.C., including a few persons high in EIA circles, believe electronic and electrical statistics never will be parted, if the Department of Commerce Bureau of Census people have their way. They argue, "Once you separate out electronics, you muddy-up past records and future trends."

One knowledgeable observer on this point is Frank W. Mansfield, director of marketing and research, Sylvania Electric Products Inc., subsidiary of General Telephone and Electronics Corp. He says, "S.I.C. needs to be updated, with a new seven-digit code for each new type of electronic product. Such classifications can be determined by the best technical and business talents in the electronic industries." He notes that BuCensus will report such seven-digit statistics in its census every five years.

To help resolve the S.I.C. debate, ELECTRONIC INDUSTRIES magazine developed its approach called E.I.C. (Electronic Industries Classification) discussed elsewhere in a box.

### 'Statistical Inbreeding'

Electronic market data may suffer from *statistical inbreeding*. In the microwave field, for example, the same basic components may be multiplied in price successively, as they are integrated into equipment, systems and sub-systems.

EIA Marketing Services people feel this situation can be rectified by getting participants to change whatever they want surveyed. A good census of end-products (from equipments through systems) is broken-down into a set of components. This pro-

cedure is considered forward and backward, to avoid duplication.

Statistical inbreeding is denied to prevail in most EIA categories. A spokesman for EIA says, "Manufacturers like to start out with the perfect statistical report, often forgetting how crude even electronic hardware prototypes can be. We start with the least common denominator, then require at least two years to perfect a data collecting program. Our microwave program is still in transition, and becoming more sophisticated."

Among reasons why the ancient Romans said, "He who begins to count, begins to err" are *improper definition* and *untrue disclosure*. Confusion stirs within an engineer trying to pigeonhole an answer to a survey questionnaire asking about a Hall Effect power meter for microwave, for instance. He wonders how to classify his answers. Semiconductors? Test and measurement instruments? Microwave? Radar, anyone?

Further, EIA has documented the *myth* that certain defense funds were being mis-counted as industrial electronics expenditures. This matter was cited by this author who addressed the IRE Convention in March 1962. EIA figures now show that about a half-billion-dollar market was improperly defined. That is, some 22%, or about \$500 million of the industrial electronics market, actually represented funds from the U. S. Government for defense, aerospace uses—and not from U. S. industries for industrial uses.

### Today's Customer, Tomorrow's Competitor

*Commercial incest* is common among many electronics companies which sell to and compete with each other. Confesses one marketing man, "Our dilemma is that today's customer may be tomor-

## ELECTRONIC INDUSTRIES MARKETING ASSISTANCE PROGRAM

ELECTRONIC INDUSTRIES magazine's Marketing Assistance Program (M-A-P) consists of six basic marketing tools: (1) Census of electronic plant locations listed on IBM cards; (2) Marketing map of U. S. electronic plants; (3) Market studies by a headquarters research staff and 250 field interviewers; (4) Computer center for processing reader inquiries; (5) Direct mail service program; and (6) Marketing statistics.

The entire program is based on the ELECTRONIC INDUSTRIES CLASSIFICATION (E.I.C.), which lists electronic products under 2,926 distinct classifications, and the Census of Electronic Manufacturers.

The census is the only one of its type in the electronic industry. It contains information on the employment, products manufactured and other marketing data of over 6,100 plant locations. These plants represent the operations of more than 4,200 individual companies and account for about 96% of the total annual sales of electronic products.

These M-A-P services are available to electronic manufacturers.

# DALE SURGE ARRESTERS

...better protection against  
micro-fast transient overvoltage

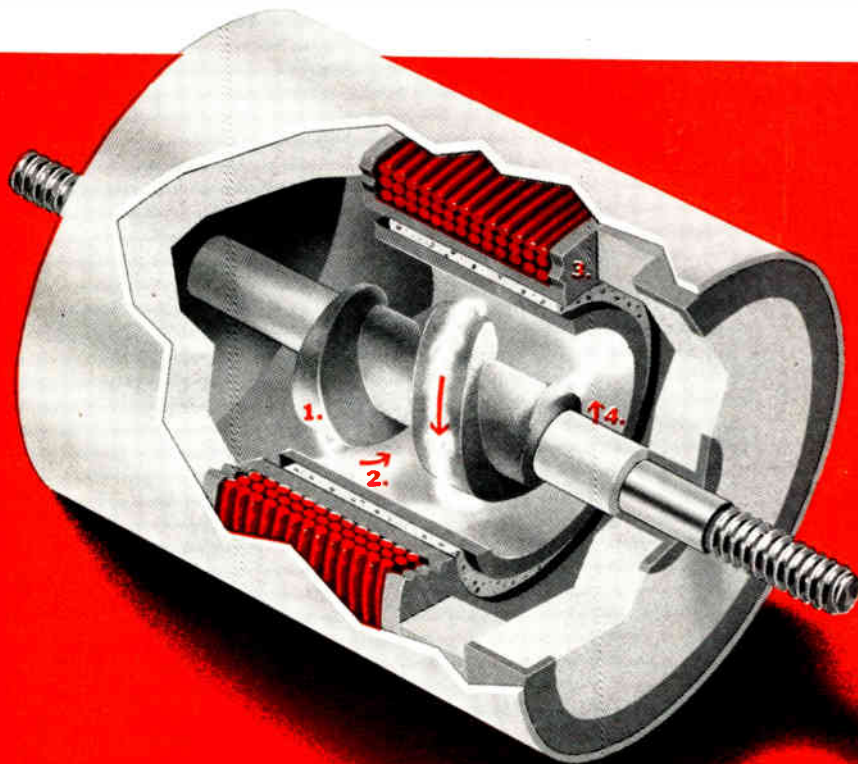

## HERE'S HOW DALE SURGE ARRESTERS WORK:

Arc is initiated between top of spiral electrode (1) and cylindrical electrode (2); Coil (3) is energized. Magnetic force of coil causes spark to rotate down tapered spiral electrode, lengthening it to breaking point (4) before excess current is drawn. Presence of radioactive isotope pre-ionizes air to assure unchanging breakdown voltage.

**THE** exclusive design\* of Dale Surge Arresters provides voltage surge by-pass capabilities both more efficient and more reliable than conventional spark gap arresters. Developed as part of an extensive transient voltage research program, the new Dale Surge Arresters have significant applications in power supplies to protect silicon rectifiers and to protect underground cables and other devices where transient voltages may be of damaging magnitude. Key to the effectiveness of the Dale Surge Arrester is a tapered spiral electrode (see drawing) which lengthens the spark gap—breaking it before excessive current is drawn. Since the air within the arrester is pre-ionized by the presence of a radioactive isotope, the level of breakdown voltage has only minor variance—providing a device which is continually capable of dissipating micro-fast transient overvoltages. When considering methods of transient voltage protection—both from the standpoint of protective ability and cost—Dale Surge Arresters are your most practical choice.

\*Patent Pending

## TWO TYPES AVAILABLE

**LA-8** Enclosed in dust-proof case. Will by-pass 10 current surges rising to 15,000 amps peak in 5 microseconds and containing total charge of 21 coulombs without damage to arrester or equipment attached and with less than 20% change in original DC breakdown voltage. May be mounted in any position. Spark gap arc-over voltage factory adjustable from 1500 to 4000 VDC  $\pm$  20%.



**LA-9** Hermetically sealed with soft solder (Melting point above 220° C). Will by-pass up to 100 current surges of 300 amps peak with 2x4 millisecond wave shape with no damage to arrester and equipment attached and less than 20% change in original DC breakdown voltage. May be mounted in any position. Factory adjustable from 500 to 5000 VDC  $\pm$  20%. (10% tolerance available).



Both LA-8 and LA-9 have insulation resistance in excess of 1000 megohms and will not drop below 10 megohms during or after rated number of current surges.

**DALE**

**DALE ELECTRONICS, INC.**

1304 28th Avenue, Columbus, Nebraska

A subsidiary of THE LIONEL CORPORATION

Also Made and Sold by Dale Electronics Canada, Ltd., Toronto, Ontario, Canada

SEE OUR SPECIFICATIONS IN  
VSMF  
THE MICROFILM CATALOG FILE

## MARKET DATA (Continued)

row's competitor. To what extent do we dare to reveal statistics to be ethical today, but cut our throat tomorrow?

Engineers, purchasing agents or other electronic people answering market research surveys may react differently. Some may refuse to reveal proprietary or *imagined proprietary* knowledge, while others may fear to reveal their ignorance or confusion. Such conflicts befuddle statistical results.

EIA adheres to strict codes. It treats survey responses as highly secret, under confidential procedures for reporting and tabulating statistics. No data are released if three or fewer companies report in a certain category, or if one firm controls 50% or more of a market. EIA still lacks sufficient cooperators to survey the microwave antenna and instrument fields, mainly because they're dominated by a few firms.

EIA and other private collectors of market data are at the mercy and whim of voluntary participants. On the other hand, all firms are legally obligated to answer BuCensus five-year-surveys. Although EIA represents some 400 manufacturers in an industry comprising more than four thousand makers and suppliers, its members often account for the lion's share of total sales dollars. EIA still encourages survey participation by all companies in the field, but extrapolates to estimate the total market when it lacks 100% response.

### Each Firm Gets All Data

Thus far, each firm that takes part in any EIA survey receives all group statistics, whether or not it is an EIA member. This situation is being re-considered:

1) One group wants EIA to continue picking up the tab—along with the statistics—in the interests of broader participation for greater accuracy.

2) Another group wants EIA to stop playing *statistical Santa Claus* and dump freeloaders who participate without paying. This group argues that payment would make recipients appreciate results more.

EIA eventually may charge all survey participants who are not association members. Such a move may mean limiting surveys only to those areas where statistical accuracy is reasonably assured. Statistically speaking, the smaller the statistical sample—the greater the probable need for fudging and finagling. Certain consultants, who either won't invest the money to collect a wide statistical sample, or who may receive a poor survey response, often are driven

to what tradesmen call rearranging or *massaging the figures*.

In all statistics of the electronic industries, modest allowance should be made for that ugly tax called *inflation*. In terms of the 1939 dollar being worth 100 cents, the dollar in October 1963 was worth only about 45 cents. Statistics even can make the dollar be worth more, relatively, by using a later base year. Thus, the Bureau of Labor Statistics uses 1957-59 as base years, which now shows the dollar in October 1963 to be worth 93 cents.

In short, the estimated \$15 billion worth of electronic goods in 1963 is not really and *absolutely* \$7.3 billion more than the estimated \$7.7 billion in electronic sales reported for 1957.

### Can Statistics Be Trusted?

How meaningful are electronic market data? Can they be trusted?

For an appraisal we consulted Mr. Mansfield, as chairman of the Advisory Committee of EIA's Marketing Services Department. He ranks electronic statistics as *varying virtually from 100% correct, down to those statistics not worth the paper they're written on!*

Consumer electronics statistics, the oldest yet next to the smallest segment in electronics (after replacement parts) are most accurate. Mr. Mansfield says, "I'm prepared to defend EIA radio, phonograph, black/white TV data down to 2% to 3% accuracy. However, these figures do not include GE sales of its new 11-inch portable TV set, though GE promises to report all figures at the end of 1963, and monthly thereafter." Note: there's no accurate accounting yet for color TV, a field dominated by RCA.

Foreign imports into the U. S. also obscure consumer electronic statistics. "We don't know just what percentage of consumer products *assembled* in the U. S. use foreign-made—chiefly Japanese—electronic parts, from tubes through sub-assemblies." Mr. Mansfield continues, "We obtain the range of parts and products imported through U. S. Tariff Commission statistics, but we can't account for the whole equaling the sum of the parts."

In counting components, Mr. Mansfield says, "Our electronic tube statistics are pretty good. We still get fairly accurate results by adding tube imports, which equal about 10% of domestic production. Only a few U. S. companies reprocess tubes."

EIA also monitors the impact of semiconductors on electron tube sales, even as microminiature circuits loom on the horizon. However, Mr. Mansfield observes, "We can't quite measure the transistor impact on electronics broadly or consumer electronics specifically." *(Continued on page 49)*



# L I C O N<sup>®</sup>

**this...**



The Licon type 16  
"Double-Break"  
Subminiature Switch

**makes  
these...**

Licon type 04 lighted  
pushbutton Switches

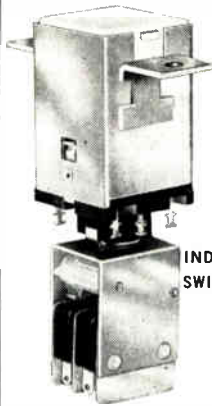

INDICATOR  
SWITCHES

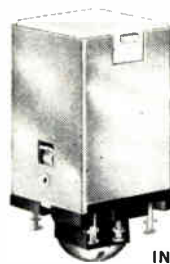

INDICATORS



SOLENOID  
HELD SWITCHES



FULL SCREEN



HORIZONTAL SPLIT



VERTICAL SPLIT



TRI-SPLIT



QUAD-SPLIT

**reliable**

The most reliable\* panel indicators and switches you can use . . . in a wide selection of

- projected or translucent colors
- display screens • circuitries
- mountings • actuations
- environmental types

Send for facts catalog and list of distributors.  
Request sample/demonstration on your letterhead

\*20 million mechanical cycles



**LICON**

DIVISION ILLINOIS TOOL WORKS INC.

6615 W. IRVING PARK ROAD • CHICAGO, ILLINOIS 60634

IN CANADA: CANADA ILLINOIS TOOLS LTD. • 67 SCARSDALE ROAD • DON MILLS, ONTARIO, CANADA

## MARKET DATA (Concluded)

### U. S. Data Reports Favored

Marketing men, including Mr. Mansfield, favorably regard two particular government agency reports on electronics. First is the "Estimated Factory Shipments of Electronic Components by U. S. Producers," derived from the Quarterly Survey of Production Capabilities for Electronic Parts, conducted by the Electronics Division, Business & Defense Services Administration, U. S. Department of Commerce. (Such work was done by the former Electronics Production Resources Agency (EPRA).)

Second is the special business survey made every five years by the Bureau of the Census, covering years ending in "3" and "8." These *bench mark* statistics about the electronics industries in 1963, however, will be released quite late, sometime in the next 18 months.

*Marketing* research has become more important, though most electronics companies still are more concerned about *market* research, or market statistics. *Market* research measures quantitatively. *Marketing* research qualitatively studies, analyzes and defines marketing problems such as distribution, pricing and sales forecasting.

Big, rich old-timers like General Electric have been conducting marketing research for more than 30 years, having pioneered in the electrical appliance field. But many small, even certain medium-size electronics firms, may lack market researchers let alone marketing researchers. So the double load of making sales and thinking about marketing falls on their sales people.

### Scrounge for Statistics

Accordingly, such sales managers have to scrounge for statistics. Being optimists by nature, they grope and guess at growing markets. At best, however, sales managers know how much worth of goods their firm sold last year. They even may have an idea of what their nearest competitor(s) sold. If only they knew what all their competitors sold.

Each company's sales manager, or marketing director, wishfully assigns himself his company's *share of the market*. Simple arithmetic at this point would reveal that the sum of all the competitors' God-given share of the market easily exceeds 100% of the actual market. Still, each salesman or sales representative now most likely has a larger allotted sales quota than he had last year.

Yet all competitive efforts interact in the marketplace. Planners, like Mr. Weinberg of IBM, view the marketplace as a focal point of many potentials

and variables: technology (invention and production), costs of doing business, pricing, numbers and types of customers, and other factors. In pondering some 90 market areas, he uses a computer to keep track of some 810 inter-reactions whenever certain market influences are modified. Where few statistics are involved, computers are usually uneconomical.

Later in the 1960's, as certain missiles phase out and big systems are mainly refined, electronics firms may face contracting defense markets. Aerospace markets will continue to involve high-engineering, but low-production runs. Such trends should further propel electronics firms deeper into our economy.

### Defense-Dollar Survey

Already, the Defense Department has arranged with both BuCensus and the Institute for Defense Analyses to survey the distribution of the defense dollar. DOD will use these and other survey results to establish an "early warning system" to alert businesses and communities to plan for changes in procurement. (Some prime and major sub-contractors heavily involved in government work largely project all their manpower, facilities and financing plans on the basis of the number and duration of contracts in-house. Such firms deal with their own type of defense marketing and market research.)

As a market analyst, Mr. Weinberg feels that businessmen do not fully use many available government statistics. He uses countless government reports, among others, to determine how his firm's products can help fulfill needs in 92 distinct industry categories. He uses materials such as: BuCensus County Business Patterns, Annual Survey of Manufacturers; Department of Treasury Statistics of Corporate Tax Returns, and similar publications.

EIA says it serves the expanding industrial electronics market "as specific products develop marketing patterns." Yet only as late as last September's EIA Fall Conference, its Industrial Electronics Division was authorized and financed to explore electronic applications in other industries. ELECTRONIC INDUSTRIES magazine editorially hailed this decision as "long overdue."

Meanwhile, other trade associations recognize the electronic industries' need for a broad variety of industrial statistics and rush to fill this vacuum. EIA's charter and scope are somewhat uncertain here, which enables others to make inroads. Perhaps this change in trade association relationship presages the gradual transition of surviving electronics companies into our industrial economy.

● A REPRINT of this article is available from ELECTRONIC INDUSTRIES Reader Service Department

Report from  
**BELL  
 LABORATORIES**



New armorless deep-sea cable (upper right) is of simpler construction, and has lower transmission losses than previous cables of the same overall diameter (lower left). Unlike armored cable, it twists very little during laying.

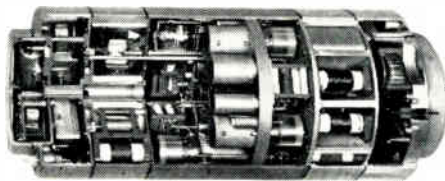

New type of deep-sea amplifier amplifies signals 100,000 times. A 3500-mile route requires 180 such amplifiers, including more than 36,000 electronic components. Each component is designed for stability and reliability far in excess of the requirements for land systems.

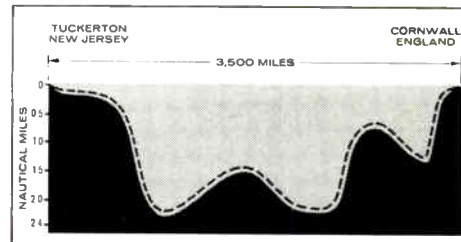

New approaches to cable laying—taking into account the dynamic characteristics of the cable, the motion of the ship, and the contours of the ocean bottom—make it possible to use a minimum length of cable to follow the mountains and valleys of the ocean floor. Care is taken to avoid mechanical strains and deformations that might cause changes in transmission performance.

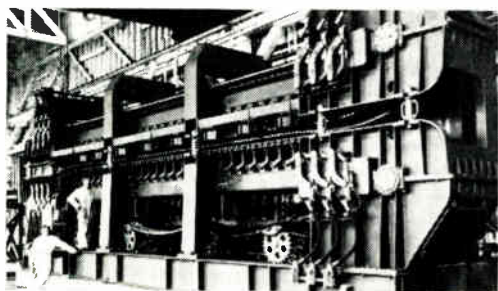

New type of shipboard cable engine holds both small-diameter cable and large-diameter amplifiers between flexible tracks. The engine pays out cable and amplifiers smoothly at a constant rate, permitting close implementation of the engineering approaches discussed above.



To energize the amplifiers, a new highly reliable 6000-volt d.c. shore-based power supply was developed. It sends precisely regulated current along the same coaxial conductors that carry the communication channels, despite varying earth potentials between the continents or islands on which the terminals are located.

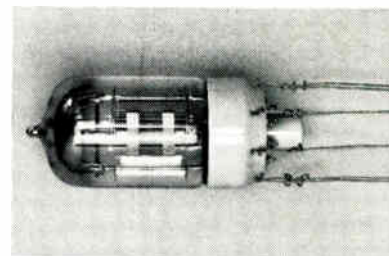

New high-vacuum tube so designed that its characteristics will not change significantly over a twenty-year life-span. Essential to this long-life performance is a new cathode material consisting of nickel with two percent tungsten and two hundredths of one percent magnesium.

## Latest ocean cable system made possible by new developments

These new developments, along with others, and the scientific advances behind them, made possible our most recent telephone cable system across the Atlantic Ocean. In service beginning October 14, 1963, it transmits 128 simultaneous two-way telephone conversations. In 1964, a cable of this kind

will be laid between Hawaii and Japan, providing an extension across the Pacific Ocean of the telephone cable system now in service to Hawaii.

**BELL TELEPHONE LABORATORIES**  
 World center of communications research and development





# ALFRED 1 to 18 Gc Sweep Signal Generators

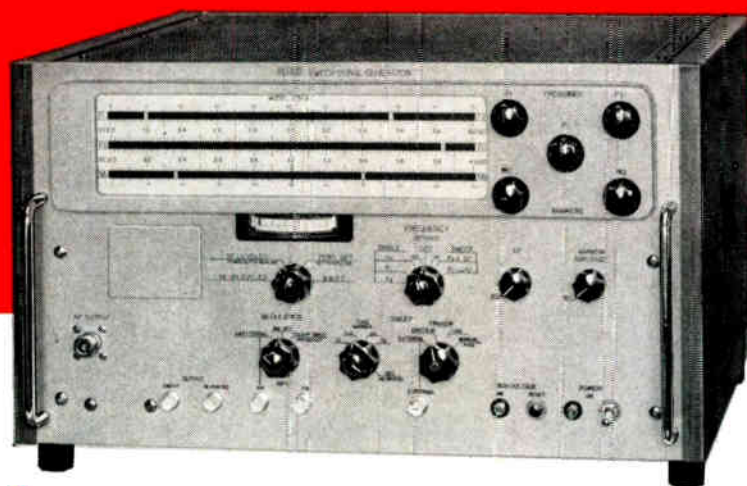

*much more*

## THAN SWEEP OSCILLATORS

### □ Known Power Output

Front panel *power set meter* gives accurate indication of calibrated output power.

### □ Drift Free, Leveled Output

Closed loop leveling, now using low VSWR barretters gives uniquely flat leveling. Use of two barretters in a balanced bridge essentially eliminates power drift.

### □ Two Sweep Modes

Broadband sweep covers the entire band or any part of the band. Symmetrical sweep (0 to  $\pm 5\%$ ) is available about independently selected center frequency  $F_c$ .

### □ Three Single Frequencies

Three single frequencies (indicated on slide rule dial with 1% accuracy) can be selected with front panel switch for CW or modulated operation.

### □ Three Frequency Markers

Frequency markers provide frequency calibration for oscilloscopes or recorders. The  $F_c$  marker frequency is the center frequency of the symmetrical sweep.

### □ Two Series Available

Model 630A series, which includes the power set meter, covers 1 to 18 Gc. Model 630D series (1 to 8 Gc) incorporates a *calibrated attenuator with 60 db range*.

#### BRIEF SPECIFICATIONS

| MODEL | FREQUENCY RANGE | LEVELED OUTPUT POWER | LEVELED POWER VARIATION | RESIDUAL FM | PRICE   |
|-------|-----------------|----------------------|-------------------------|-------------|---------|
| 631A  | 1-2 Gc          | 50 mw                | $\pm 1/2$ db            | 60 Kc peak  | \$3490. |
| 632A  | 2-4 Gc          | 50 mw                | $\pm 1/2$ db            | 100 Kc peak | \$3290. |
| 633A  | 4-8 Gc          | 10 mw                | $\pm 1/2$ db            | 160 Kc peak | \$3390. |
| 635A  | 8.2-12.4 Gc     | 10 mw                | $\pm 3/4$ db            | 200 Kc peak | \$3490. |
| 637A  | 12.4-18 Gc      | 10 mw                | $\pm 3/4$ db            | 200 Kc peak | \$3790. |

**FREQUENCY STABILITY** Better than 0.01% per degree C.  
**SINGLE FREQUENCY**  $F_1$ ,  $F_2$  and  $F_0$  continuously adjustable, panel switch selected.

**FREQUENCY MARKER** Three markers  $M_1$ ,  $M_2$ , and  $F_0$  adjustable over entire range.

**SWEEPS** Broadband, 2% to 100% of full range. Symmetrical, 0 to  $\pm 5\%$  about center frequency  $F_0$ .

**SWEEP TIME** 10 msec. to 100 sec.

**SWEEP TRIGGER** External; Free running; Line; Manual (single sweep).

**AMPLITUDE MODULATION** Internal 800 to 1200 cps square wave; External.

COMPLETE DATA AVAILABLE—Alfred's policy is to publish complete specifications and guarantee them as stated. For detailed information on Series 630 Sweep Signal Generators, contact your Alfred engineering representative or write to us.

## ALFRED ELECTRONICS

3176 Porter Drive • Stanford Industrial Park • Palo Alto, California  
Phone: (415) 326-6496

# SNAPSHOTS... OF THE ELECTRONIC INDUSTRIES

## COMPACT PACKAGE

Heavy solar probe concept developed by Honeywell's Aeronautical Div. is disclosed in this scale model. Space vehicle will measure particles and magnetic fields in the solar atmosphere.

An ionization chamber is mounted on the boom at the left and a magnetometer on the one at the right.

Paddles contain solar cells.

Antenna at the bottom is for communication with earth.

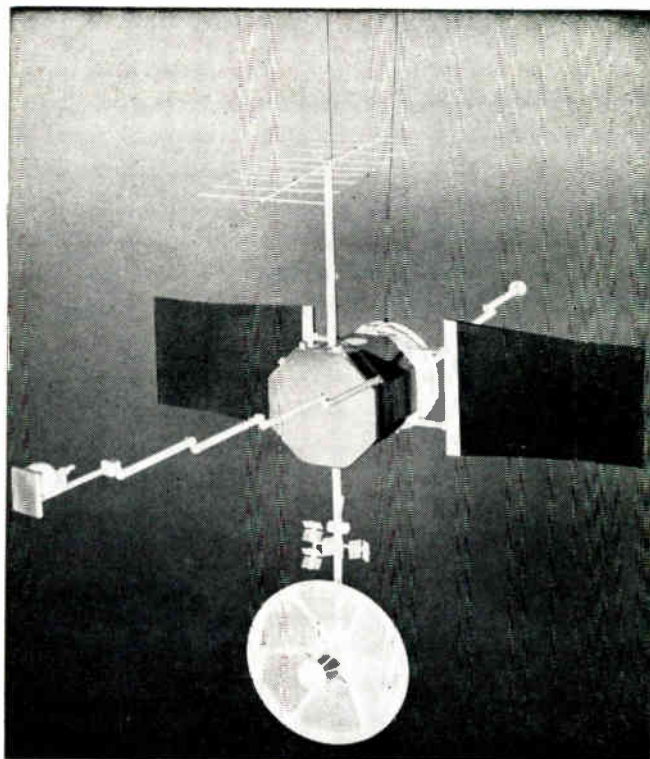

## SPACECRAFT RADAR

Engineer (above) examines interrogator and transponder which are part of a coherent radar system developed by the Aerospace Div. of Westinghouse. Called PRADOR (PRF RANGing DOpler Radar), it measures velocity, or closure rates, by sensing doppler frequency shift, and measures distance by range tracking.

## TV TRACKING SYSTEM

R. Q. Dunn (l) and F. X. O'Donnell check airborne TV tracking system (right) before delivery to Lincoln Laboratory. Developed by Norden, Norwalk, Conn., the system was especially designed to track automatically, during night hours, missiles returning from space.

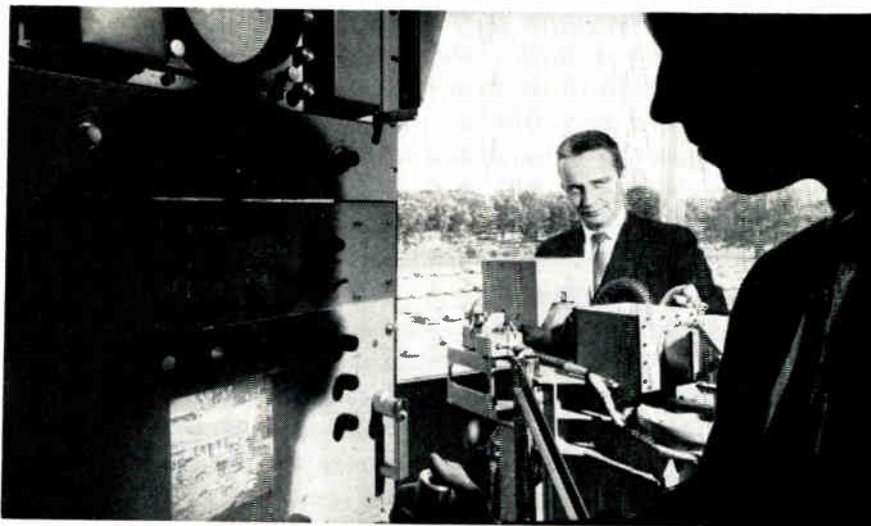

## POWER KLYSTRON

Amperex Electronic Corp. (Hicksville, L. I., N. Y.) engineer inspects new power klystron designed for UHF television broadcasting and tropospheric scatter uses. Designated the YK1001, this 4-cavity, ceramic and metal klystron uses permanent magnet focusing and air cooling.

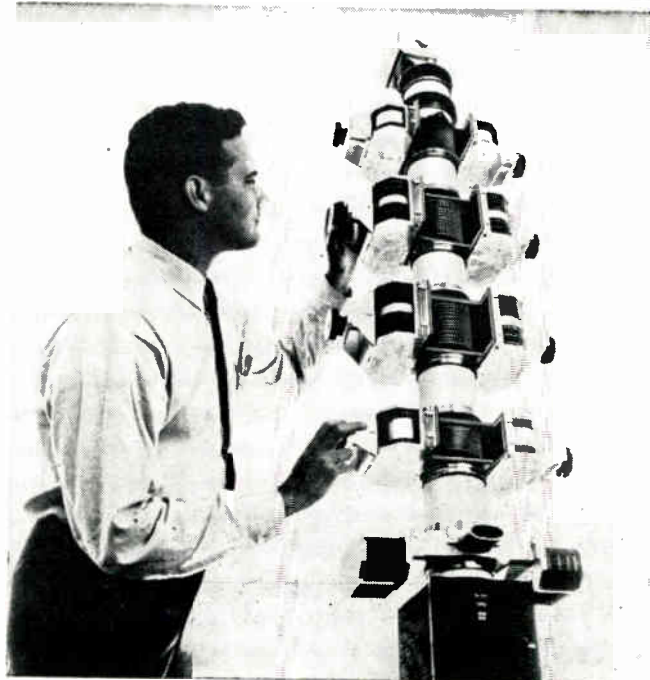



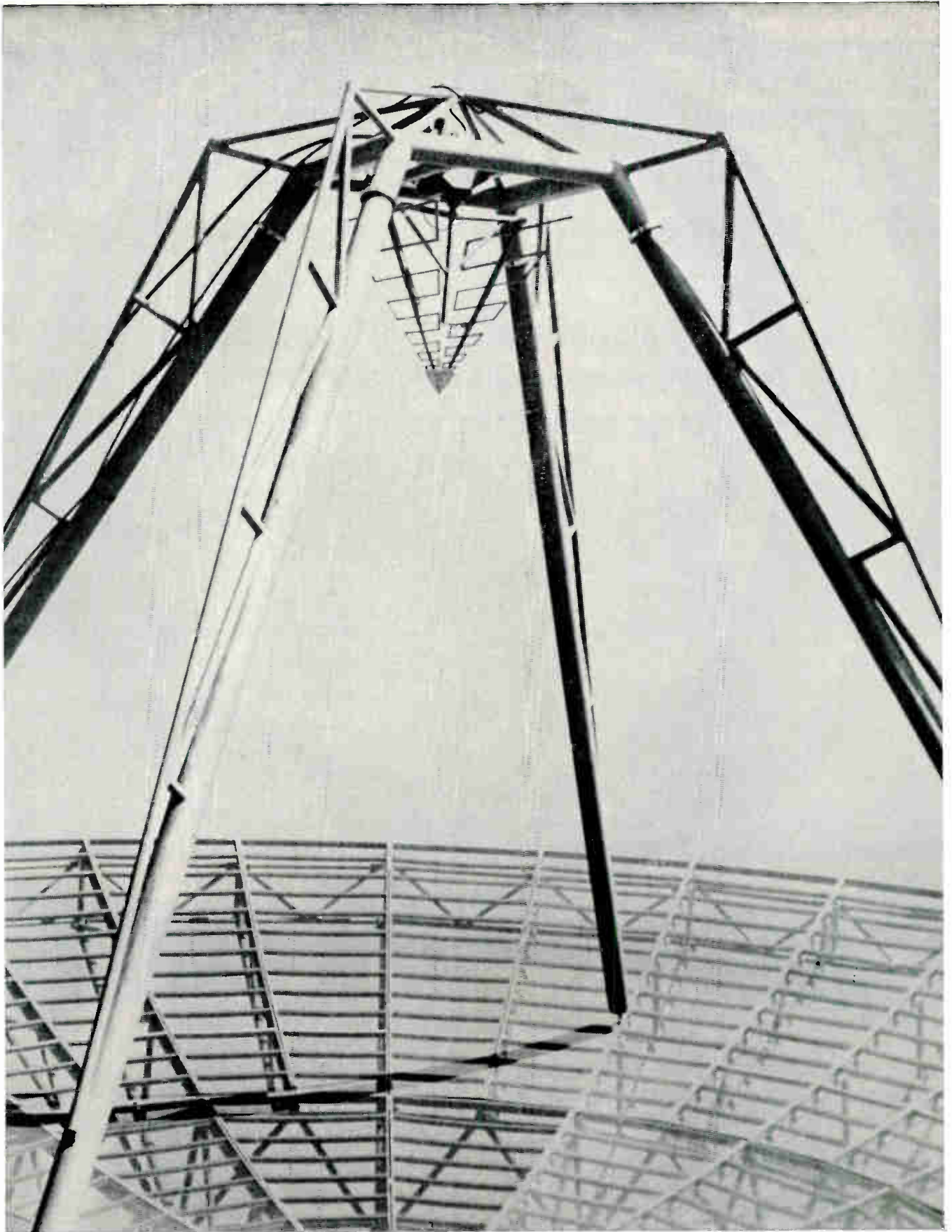

#### UNIDIRECTIONAL ARRAY

Trapezoidal, non-planar log periodic feed can be used with an antenna or as an antenna itself. Developed by Antenna Systems, Inc., Manchester, N. H., it features unidirectional polarization with a feed arrangement that is balanced to eliminate beam squint.



# WHAT'S NEW

## MEMORY MAKING PROCESS

A PROCESS FOR MAKING MINIATURE INTEGRATED MEMORIES of thin sheets that are stacked, laminated, and cured in the manner of plywood has been developed by scientists at RCA's Research Center in Princeton, N. J.

The process makes use of tissue-thin layers of the ferrite material used in present standard core memories.

Experimental memory units made with the new process have shown gains in achieving either high speed or large capacity in memories of very small size and potentially lower-cost construction.

The method lends itself to fabrication of either central or auxiliary memory units with various combinations of size, speed, and capacity. For example, one experimental laminated memory unit, suitable for auxiliary or "scratch-pad" use in a computer, stores 256 bits of information in a package smaller than an aspirin tablet and processes the information at a rate of 10 million bits/sec.

RCA scientists have also built an experimental high-capacity laminated unit which can store 16,384 bits of information in a space measuring 1 x 3 in. on the surface and only 5 one-thousandths of an inch thick. With further development, it is believed



Dr. R. Shahbender inspects thin ferrite sheets which will become a computer memory when laminated and cured. Unit shown here will store 16,384 bits of information in a total volume only 1 x 3 inches square and 5 one-thousandths of an inch thick.

that units of this type may be able to store more than 10 million bits of information at one time in a space equal to that occupied by a pack of chewing gum.

The lab units store and read out complete coded words rather than individual "letters" represented by single bits of stored information. They use one or two memory cells per unit of information, depending upon whether high storage capacity or high processing speed is desired.

## SINGLE-FREQUENCY GAS LASER

A MINIATURE HELIUM-NEON GAS LASER that emits only a single frequency of visible red light has been devised at Bell Telephone Laboratories. The discharge tube is 2 in. long and 0.04 in. in diameter. It operates continuously at room temperatures on dc.

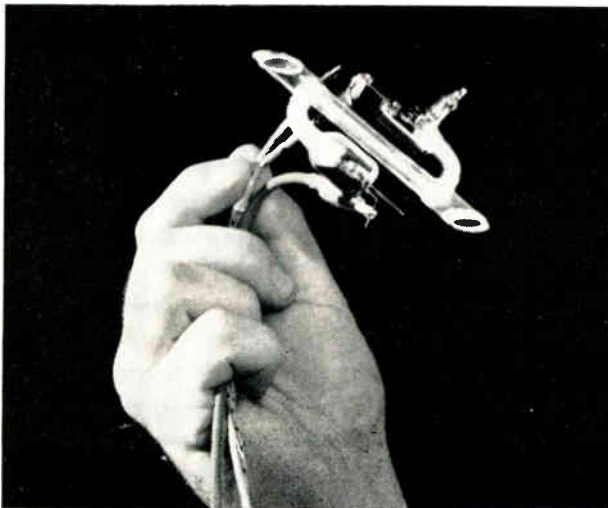

The power output of the laser is  $\frac{1}{2}$ mw. Its wavelength is 6328Å.

Previous gas lasers, because of their large size, can oscillate at many optical frequencies simultaneously. The new lasers, because of their short length, oscillate at one frequency. They are much less susceptible to vibration, thus simplifying the problem of frequency stability.

One of the lasers was used as a sweep-frequency local oscillator in an optical heterodyning experiment. Varying the spacing between the end mirrors caused the laser to oscillate at any one frequency within a 1500mc range centered at 473gc. To tune the laser over this frequency range, one of the end mirrors need be moved less than 12 millionths of an inch. This is accomplished smoothly and precisely with a piezoelectric transducer attached to one mirror.

When placed in an appropriate optical cavity, this miniature gas laser oscillates at only one frequency of visible red light. The laser operates at room temperature.

# A transistor that can switch up to 4500 watts in microseconds with reliability?

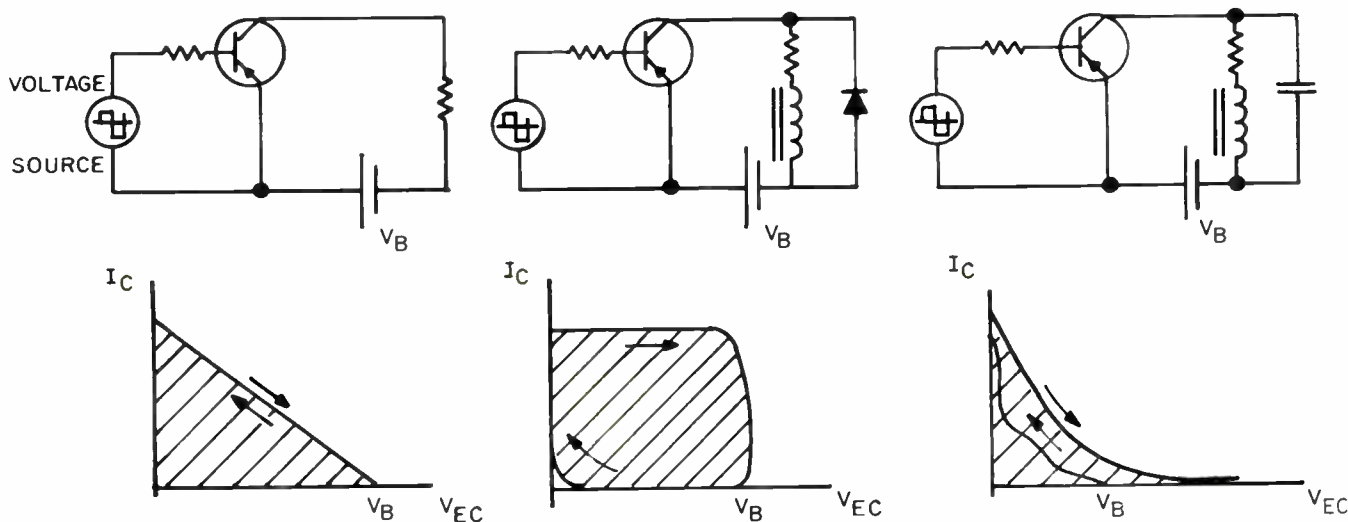

## Definitely—use SOAR!

The new SOAR (Safe Operating Area) principle now makes it easy for you to specify the exact transistor for switching or DC applications. The current procedure of rating transistors for switching is the parameter method. The new SOAR principle defines what these parameters mean in actual switching capabilities.

With selection based on parameters alone, some transistors may fail during switching, even though the analytical prediction (based on those parameters) may indicate safe operation. A given transistor type has a spread of switching capability to withstand certain circuit conditions, but single parameter values do not indicate this spread. This means that you (or the manufacturer) either overspecify—in effect derate the unit to ensure safe operation—or select by parameter and hope the failure rate conforms to the prediction.

Safe switching is now a reality as the transistor operates within the SOAR envelope. This envelope defines the region which encloses all of the points representing the simultaneous values of the collector current and the collector-to-emitter voltage which the transistor can safely handle during

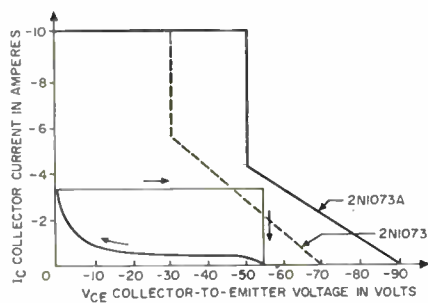

switching into any load. Exact conditions are specified for base current, switching time, junction temperature and average power dissipation.

To show just how easy SOAR is to use, here's an example. Assume the maximum circuit conditions in a clamped inductive load switching application are:  $I_C = -3.5$  A,  $V_{CE} = -55$  V, repetition rate = 1 cps (square wave, duty cycle 0.1%),  $P_{C(av)} = 2$  mW,  $T_A = 85^\circ\text{C}$ ,  $\theta_{C-A} = 14.2^\circ\text{C/W}$  (case-to-ambient),  $t_f = 2$   $\mu\text{sec}$ ,  $t_r = 60$   $\mu\text{sec}$ ,  $I_B = \pm 0.8$  A, driving source output resistance =  $3\Omega$ . In this example, the load line does *not* fall within the 2N1073 SOAR but *does* fall within the 2N1073A SOAR. Therefore, the 2N1073A is the proper transistor for safe switching.

Use the Bendix® SOAR principle and arrive at the right transistor type on the first try. If you'd like more information on SOAR, and SOAR envelope data on our 33 DAP® transistors, contact your nearest Bendix sales/service office or your Bendix franchised stocking distributor.

## Bendix Semiconductor Division

HOLMDEL, NEW JERSEY



Burbank, Calif.—(213) 939-3961; Chicago—(312) 637-6929; Dallas—(214) 357-1972; Detroit—(313) Jordan 6-1420; Holmdel, N. J.—(201) 747-5400; Minneapolis—(612) 824-7270; San Carlos, Calif.—(415) LYtel 3-7845; Syracuse, N. Y.—(315) 474-7531; Waltham, Mass.—(617) 899-0770; Export—Cable: Bendixint, New York, N.Y. (212) 973-2121; Ottawa, Ontario—(613) TAIBot 8-2711.

*To condition low level  
transducer and thermocouple  
signals to 5 volts DC*



**SELECT A PROVEN  
STATHAM SIGNAL AMPLIFIER**

Statham's miniaturized solid-state signal amplifiers provide the stability and ruggedness required in aerospace applications. All feature high common mode rejection. Signal output is isolated from the signal input and power. Four categories of reliable, high accuracy amplifiers are available:

**CA17 SERIES.** Strain gage carrier amplifier with built-in AC transducer excitation.

**SA15 SERIES.** Strain gage amplifier featuring integral DC power supply.

**SA9 SERIES.** Amplifier for general purpose low level DC applications.

**SA16 SERIES.** Thermocouple amplifier with built-in reference junction.

For specifications, write Statham Instruments, Inc., Los Angeles 64.





# WHAT'S NEW

## "MULTI-FREQUENCY" TRANSDUCERS

A NEW TECHNIQUE known as "Multi-Frequency" cleaning updates the production cleaning of all types of components. Made by Crest Ultrasonics Corp., Trenton, N. J., the new cleaner uses a new and different type of transducer. The transducer is a rugged device which can be operated 24 hrs. a day, 7 days a week at temperatures in the range of the boiling point of water.

In the system, the transducer is randomly excited causing it to vibrate at various fundamental frequencies, plus their harmonics. By combining together, these frequencies provide the highest possible cleaning energy within the tank.

Since each of the individual transducers vibrates in its own modes, it is not necessary to critically match each unit. This reduces the costs of building large size transducerized tanks. It also reduces the difficulties of field repairs. The designs permit transducers to be placed on the sides or bottoms of the tank. In very large systems it is possible to have transducers on opposite sides of the tanks radiating toward each other without harmful effects. For installations with existing tanks, immersible modular units can be mounted either on the bottom or sides of the tanks.

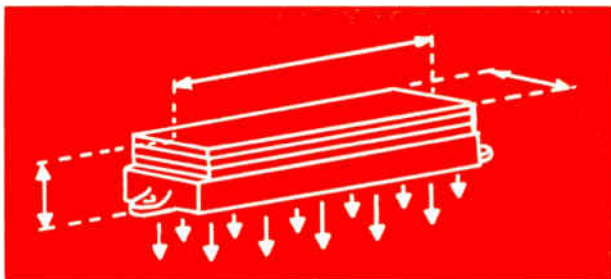

Sketch of the "Multi-Frequency" transducer shows its vibrational modes—thickness—width—length and diagonals.

The vibrating element of the transducer is a high temperature titanate element, rectangular in shape. A number of these elements are bonded together, at elevated temperatures, with thick metal baffle plates making up an individual transducer. The radiating area is about 15 in<sup>2</sup>.

Since all of the transducers are wired in parallel, the operation of one modular unit does not affect the others. Through these designs, the "Multi-Frequencies" are generated at the same time within the tank, resulting in better cleaning action.

MORE WHAT'S NEW ON PAGE 61



Actual Size

## NEW 1/2-SIZE CRYSTAL CASE RELAY MODEL 902 (DPDT)

Meets requirements of MIL-R-5757D

Rigid frame construction

Positive contact wiping action

High-temp. coil wire rated +220°C

Size: .80"L x .40"H x .40"W

Weight: 0.3 ounce

Contact arrangement: Form C

Coil rating: 6, 12, 26.5, 48 VDC (others available)

Contact rated load: low level dry circuit to 2 amps  
resistive to 26.5 VDC

Contact life: 100,000 operations at rated loads

Vibration: 0.1" D.A. or 20G peak, 10 to 2000 cps

Temperature: -65°C to 125°C

Shock: 50G for 11 milliseconds

Dielectric strength: 1000 volts RMS except 500 volts RMS  
from coil to case and across open contacts

Terminals: Plug-in, hook-type and 3" leads

Corrosion resistant materials used throughout

Produced with meticulous care under white room  
conditions and rigid quality control procedures

This new relay is reliable! It is constructed of precision made parts to exacting tolerances for uniformity of production, and provides consistent, dependable performance. Available from factory shelf stock and from stock in our Los Angeles and New York offices. Ordering references for 1/2-size Crystal Case Relay with hook terminals and bracket mounting, 26.5 VDC is Catalog No. 90210320.

For technical information call Aerospace Products, or write for Bulletin 1073.  
Telephone: 242-5000, Area Code 412. TWX 412-642-4097, TELEX 086748.



UNION SWITCH & SIGNAL DIVISION  
PITTSBURGH 18, PA./Westinghouse Air Brake Company

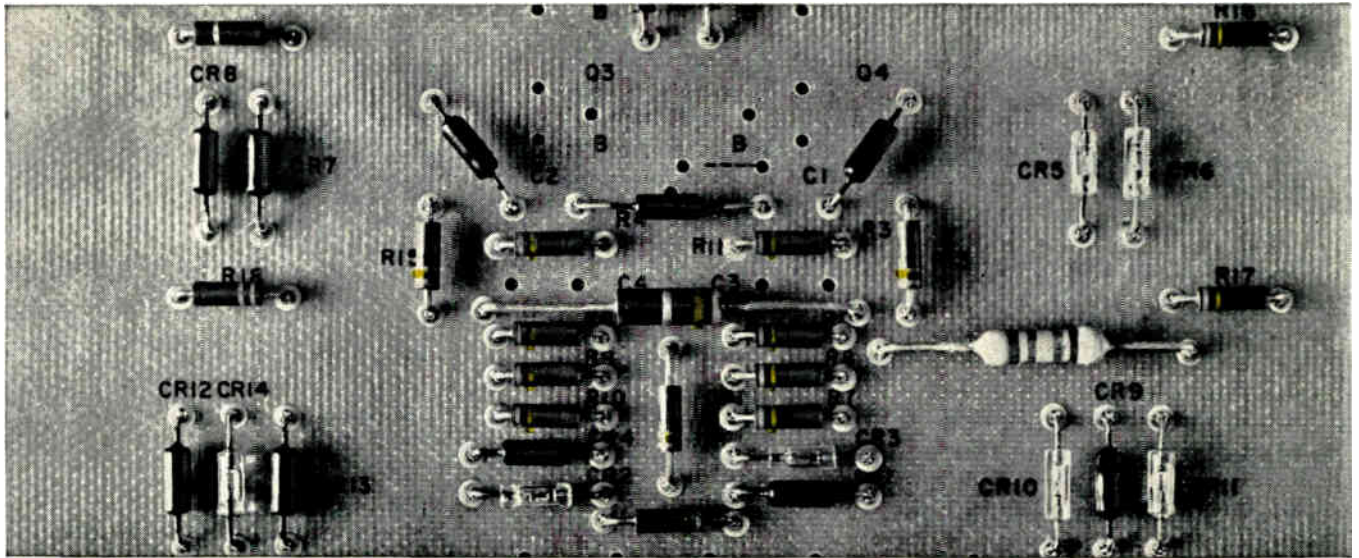

45 hours . . . \$750.

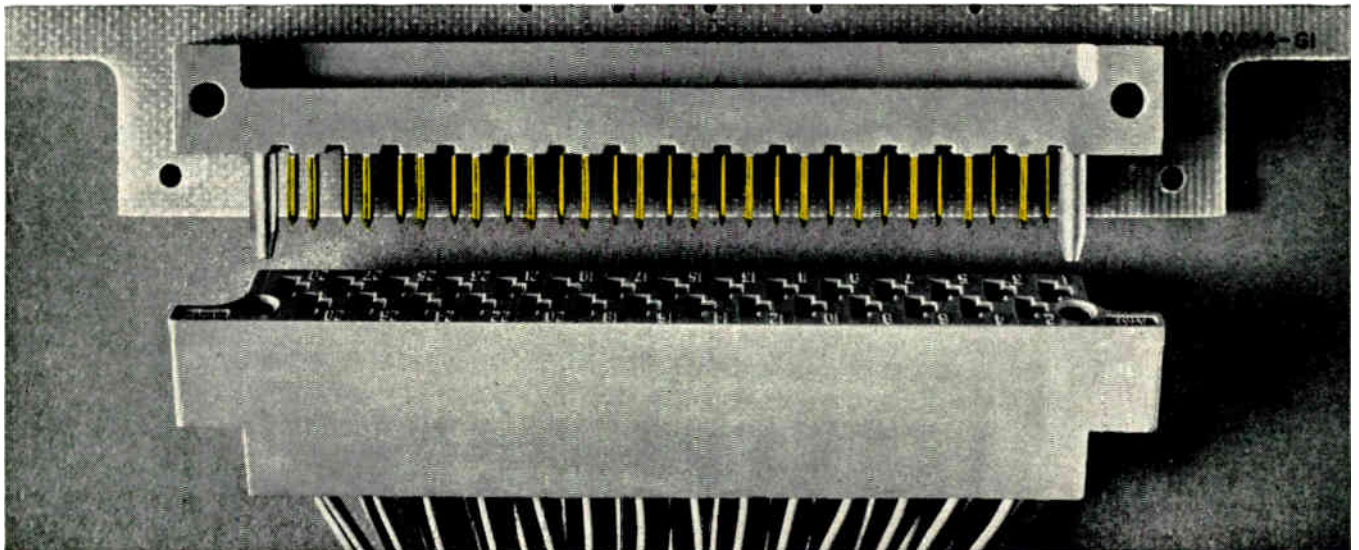

## Doesn't it deserve the best connector ?

You bet it does! And the best going is the AMP-BLADE\* Connector you see above. Here's why:

**Staked Down Construction.** Each male tab is mechanically staked to the board. This rigid staking eliminates all board warpage problems. Joins male housing solidly to board. Assures intimate contact between board paths and male contacts.

**Molded Male Tab Housing.** Male tabs, encapsulated into the housing, assure correct alignment with receptacle contacts. This eliminates any possibility of mismatching, leading to plating wear, environmental problems and poor contact.

**Large Areas of Contact.** Receptacle contacts provide 3 "long" areas of contact with male tab. This eliminates "rocking" and plating wear. Special contact spring assures uniform contact pressures. Stabilizing boss controls receptacle float in housing.

**Crimp, Snap-in Design.** Receptacle contacts are terminated automatically at rates up to 4,000 per hour. Precision crimping with automatic machines assures

unvarying mechanical and electrical uniformity, lowest possible installed costs. Snap-in assembly means no unused contacts. You pay for only those contacts you need.

**Gold Plating.** .000030" gold over .000030" nickel contact plating is standard. Never an option or extra. Control by X-ray measurement assures uniformity in thickness and prevents metal creep and oxide buildup.

You can count on AMP-BLADE Connectors to deliver smooth, uninterrupted current flow in your most advanced solid state designs. But don't take our word for it. Find out for yourself. Our test reports tell the story in facts and figures that make interesting reading for any design engineer. Send today for your free copy.

**AMP**  
INCORPORATED  
Harrisburg, Pennsylvania

INDUSTRIAL  
SALES  
DIVISION

AMP products and engineering assistance are available through subsidiary companies in: Australia • Canada • England • France • Holland • Italy • Japan • Mexico • West Germany

\*Trademark of AMP INCORPORATED.



# WHAT'S NEW

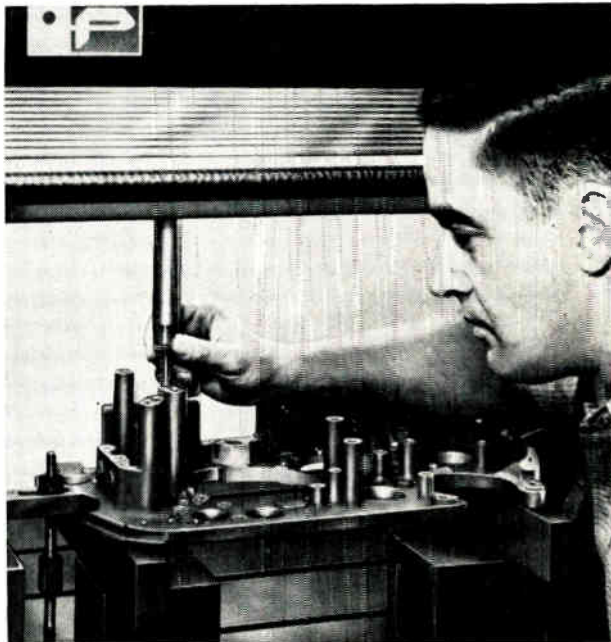

PICOMM measures with a 1-mil accuracy the relationship of coordinates and contours in fabricated metal equipment. Decimal readout is provided in six digits.

## COORDINATE MEASURER

THE POTTER INSTRUMENT COORDINATE MEASURING MACHINE (PICOMM) is an electro-mechanical device that measures to 1 mil the relationships of coordinates and contours in fabricated metal equipment. It is used for location and inspection of points, holes, and surfaces.

The unit needs no set-up masters, gauge blocks or dial indicators. Clear decimal readout of both X- and Y-coordinate locations is provided by indicators. An optional printer is available. Independent push-button reset of X- and Y-indicators permits setting a reference zero at any point within the part-measurement area. Direction switches permit direct positive dimensional readings in any direction from the selected floating-zero point.

The piece to be measured is positioned on the work table and clamped. A probe tip is selected, depending on the surfaces or holes to be checked, and inserted into the probe mount. The probe is moved manually to a position selected as a convenient reference point, and both X- and Y-reset pushbuttons are pressed. The probe is then moved to each measuring point in sequence, and the X- and Y-coordinate readings are recorded or compared with standards at each point. Potter Instrument Co., Inc., Plainview, N. Y.

MORE WHAT'S NEW ON PAGE 146

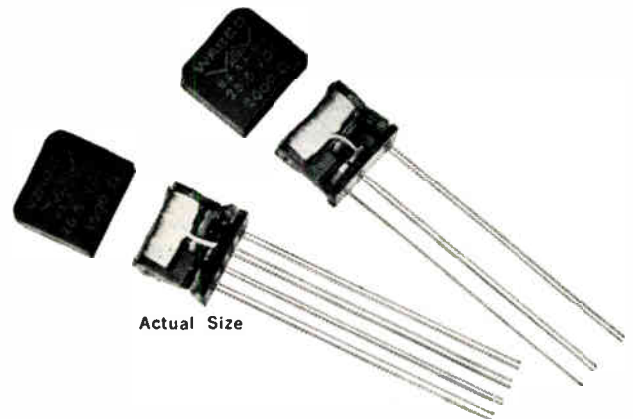

## NEW 1/6-SIZE CRYSTAL CASE RELAYS MODELS 900 (SPDT) and 901 (DPDT) Meets requirements of MIL-R-5757D Self-mounting to printed circuit boards 0.1" grid spaced terminals

Balanced rotary type armature  
Positive contact wiping action

High-temp. coil wire rated +220°C

Large coil provides greater coil power

All welded rigid frame construction

Corrosion resistant throughout

Size: .500"L x .230"W x .430"H

Weight: 0.15 ounce

Coil rating: 6, 12, 26.5, 48, 76 VDC (others available)

Contact arrangement: Form C

Contact rated load: low level dry circuit to  
1.0 amp resistive at 26.5 VDC

Contact life: 100,000 operations at rated load

Terminals: 1/2" or 1/4" leads, or solder hook

Vibration: 0.1" D.A. or 20G peak, 10 to 2000 c.p.s.

Shock: 50G for 11 milliseconds

Temperature: -65° C to 125° C

Produced with meticulous care under white room conditions and rigid quality control procedures

These relays are reliable! They are constructed of precision made parts to exacting tolerances for uniformity of production, and provide consistent, dependable performance. Available from factory shelf stock and from stock in our Los Angeles and New York offices. Ordering references for 1/6-Size Crystal Case Relays with 1/2" leads, 26.5 VDC coil rating: Model 900-Catalog No. 90030301; Model 901—Catalog No. 90130301. For technical information call Aerospace Products, or write for Bulletins 1076 (Model 900) and 1077 (Model 901). Telephone: 242-5000, Area Code 412. TWX 412-642-4097, TELEX 086748.



**UNION SWITCH & SIGNAL DIVISION**  
PITTSBURGH 18, PA./Westinghouse Air Brake Company



Equipment covered here includes electron beam machines which use high velocity electron bombardment to cut and weld; magnetic forming machines which use high intensity magnetic fields to form pieces to shape; ultrasonic equipment which makes use of the ultrasonic frequencies to clean and drill; and, the newest of all, the laser, to cut, weld and melt.

## **ELECTRONIC DEVICES MAKING STRIDES IN METALWORKING**

THE USE OF ELECTRONIC EQUIPMENT FOR METALWORKING purposes is growing every year. Operations which were undreamed of a few short years

ago are now being accomplished by lasers, magnetic metalforming, ultrasonics and electron beam equipment.

Power of the laser as a metalworking tool is illustrated here. This Raytheon Co. laser delivers 350 joules of power.

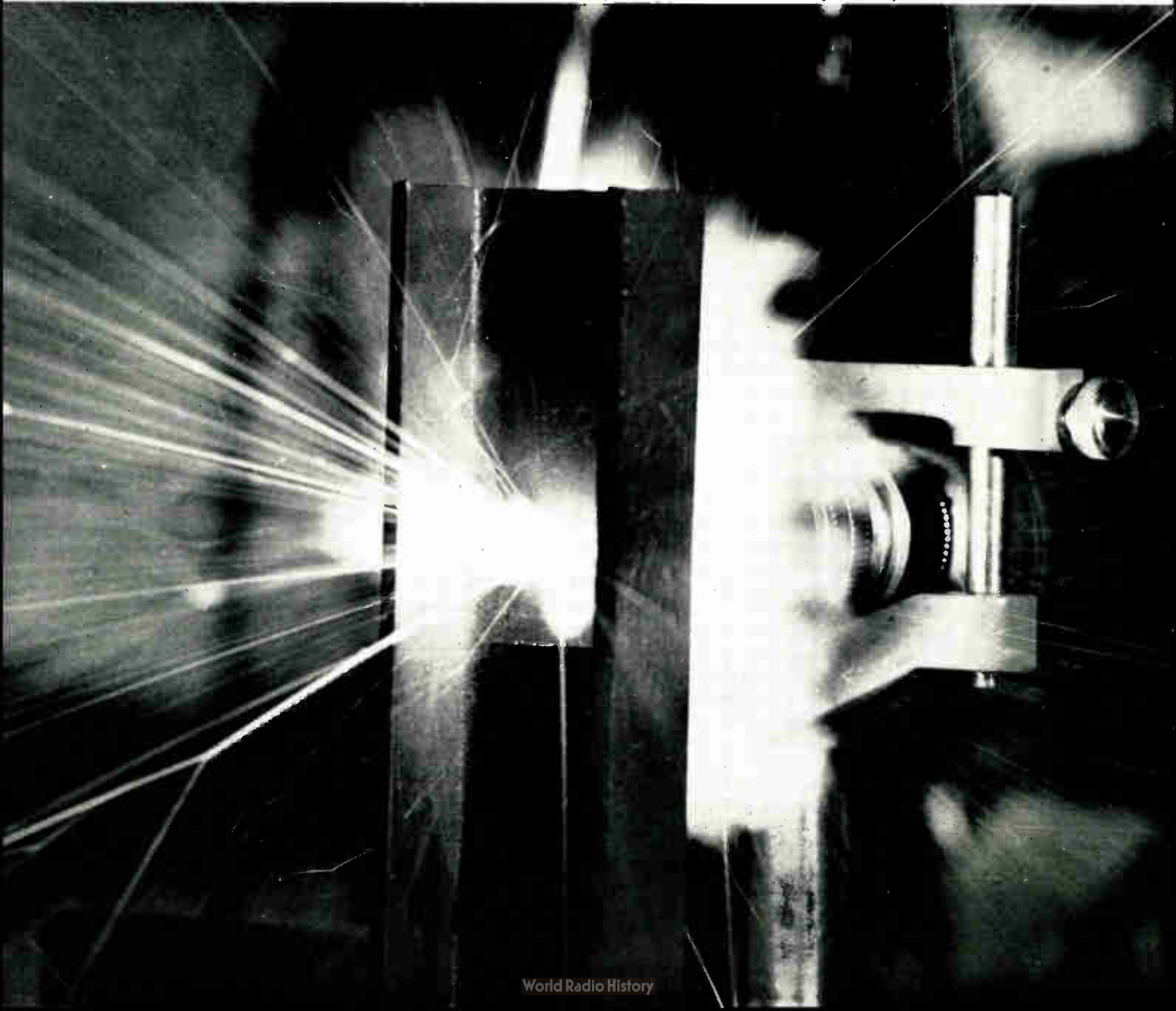

Electronics is making it possible to do many metal-working jobs faster and better than before. And as space age needs become more stringent, it is indeed fortunate that this equipment is available. Let's look at this equipment, its uses and its future.

\* \* \*

The electron beam has graduated from the laboratory stage to take its place as a useable tool for welding and machining operations. Electron beam machines use the very high temperatures resulting from impact and absorption of a stream of high-velocity electrons to weld, and to remove material by vaporization.

### Advantages of Electron Beams

The electron beam machine is particularly well suited for welding operations. Some characteristics of electron beam processes which make them useful are:

1. They permit release of very high energy into small areas for controlled, brief periods of time. Thus, a bond may be made with low total thermal energy input; materials can be fused without much heat being transferred to adjacent components.

2. Neither fluxes or filler materials are needed. This, plus the fact that the weld is performed in a vacuum, means that corrosion and contamination are minimized.

3. The beam is easily and precisely controlled. Cross-sectional diameter of the beam can be varied from tenths of a thousandth of an inch up to many thousandths. Also, the beam power input can be varied from less than a watt to kilowatts using a pulsed or continuous mode. The process is easily automated due to these features.

4. A good electrical contact is provided. The interface between welded metals is minimized or eliminated. This means that current flowing through the completed junction sees a low resistance.

5. Set-up or high pressure contact is not needed.

6. The completed joint is strong and presents a high resistance to vibration, stress and fatigue damage.

7. Components in a package can be outgassed, vacuum dried, baked, welded and then backfilled with an inert gas to minimize possible dielectric changes within the internal circuitry. These operations can be done in the same chamber as the weld process.

By **SMEDLEY B. RUTH**

Associate Editor  
ELECTRONIC INDUSTRIES

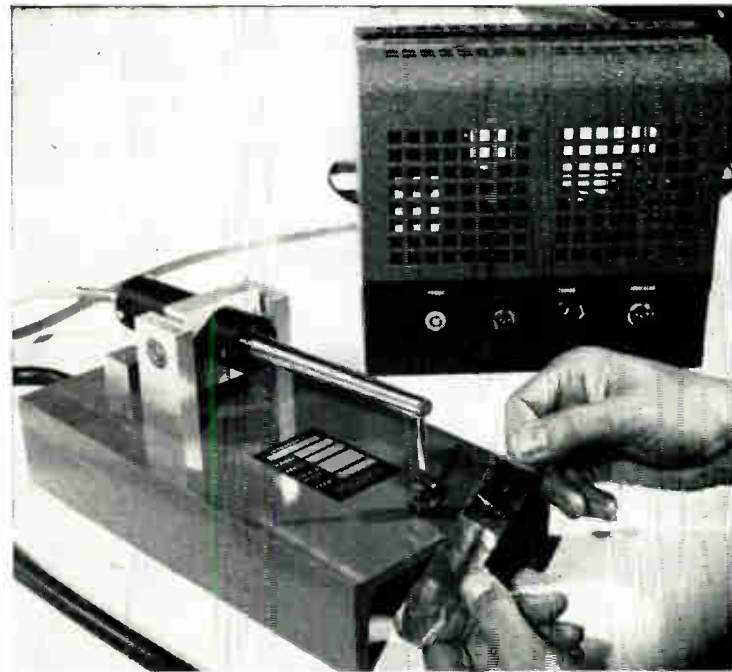

Ten watt ultrasonic welder, made by Gulton Industries, Inc., is capable of spot welding foil thicknesses ranging from 0.00025 to 0.002 in. Welder uses h-f vibrations to weld.

8. A variety of materials can be welded successfully. Even space age metals such as tantalum, tungsten, columbium and molybdenum can be easily welded.

### Operation

Electron beam welding is done by producing an electron space charge, accelerating the electrons and then focusing the beam on a workpiece. An EB welding system is shown in Fig. 1. Electrons are produced in an electron gun by heating a hairpin tungsten filament to about 2500°C. This highly negative cathode is surrounded by a cup shaped grid which is negatively biased with respect to the filament. Regulation of this bias serves to control beam intensity. The electron gun also contains an anode at ground potential with an aperture in the center through which the highly accelerated electrons pass. Electron acceleration is provided by the adjustment of the high potential difference between the anode and the cathode. The beam is focussed by a variable strength electromagnetic lens. A magnetic deflection coil is used to direct the beam over the surface of the work as desired.

### Applications

Electron beam machines are versatile. Their beams may be used in welders, evaporators, zone refiners, melters, heat sources, annealing furnaces, and micro-

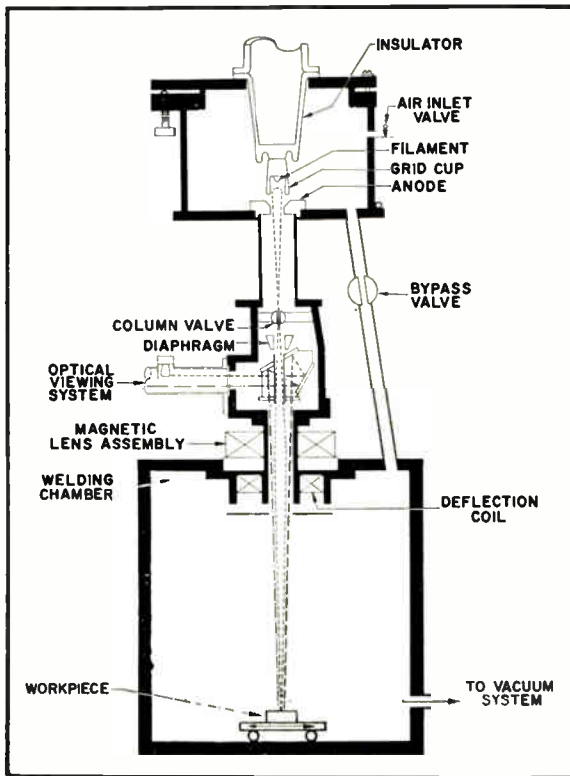

Fig. 1: Hamilton-Zeiss electron beam welding system welds by producing an electron beam space charge, accelerating the electrons and then focusing the electron beam on a workpiece.

## ELECTRONIC METALWORKING (Continued)

probe analyzers and microscopes. They are used to form junctions in thermoelectric and semiconducting materials, to protect refractory alloys from oxidation by coating them with pure iridium, and to repair close-tolerance parts that otherwise might have to be scrapped. They are also used to etch micro-components, scribe thin films, drill and cut precision holes, and encapsulate electronic components.

Future uses may include the micro-storage of information, the modification of the properties of semiconductors and the building, modifying and repairing of spacecraft in outer space. Many industries are interested in the process so we can look for a constant flood of new uses.

### Disadvantage

One disadvantage of the electron beam welder is the need for a vacuum chamber. Several companies are working on this problem. One approach is to bring the beam into an inert gas atmosphere. Alloyd Electronics Corp., Cambridge, Mass. and G.E. are both researching this possibility.

Martin Co. is experimenting with a perforated wall hollow cathode while North American Aviation gets more mobility out of its system by using a sliding seal concept.

## Ultrasonic Equipment

There are various machines available for metalworking which base their operation on the use of ultrasonics. These machines use ultra sound to weld, clean, grind, solder, drill, cut, boach, shape, slice and engrave.

High precision is possible through the use of ultrasonics since the work is not heated, stressed, or distorted in any way. Ultrasonic machining is faster and cheaper than most normal methods when working extremely hard or abrasive materials. Also, a relatively unskilled worker can operate the equipment.

Ultrasonic processes use an abrasive slurry which is pounded against the material at an ultrasonic rate. Contact of this slurry with the material causes the material to be cut away. Size of the abrasive grit used determines the fineness of the cut. The finer the grit used, the finer the cut. A coarser grit will make a coarser cut, but it will also cut faster.

An added advantage of ultrasonic machining is its ability to cut very hard substances such as steel,

Fig. 2: Three basic coil designs permit a wide range of uses.

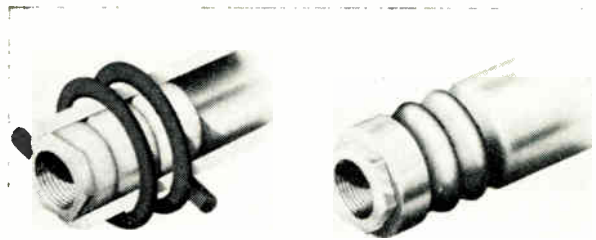

Work coil surrounds workpiece. Forming force shrinks, compresses or collapses workpiece. Used for swaging or crimping.

Work coil inside of workpiece. Forming force expands workpiece. Used for expanding workpiece into die, hub or bushing, or for enlarging the diameter of tubing along its length.

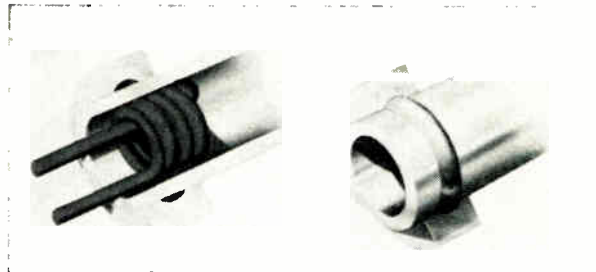

Work coil adjacent to workpiece. Forming force exerts unilateral pressure on workpiece. Can be used to form, dimple, blank or emboss by pressing the workpiece against a die.

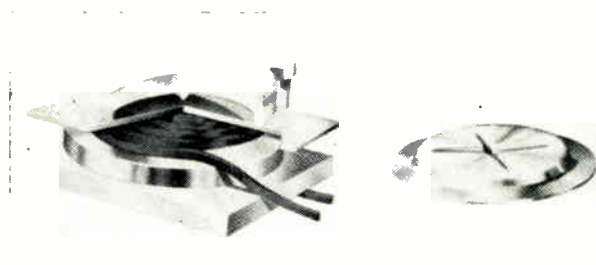



tungsten carbide and ceramics. It is ineffective against soft materials.

### Magnetic Metalforming

Magnetic metalforming machines are being used in many operations involving materials possessing electrical conductivity. And, even materials which are not good conductors may be formed by using good conductors as a sheath or plating.

These machines use magnetic impulses to swage and expand tubular shapes as well as to coin, shear, and form flat stock. The Magneform machine, made by General Atomic Div. of General Dynamics Corp., San Diego, produces fields with flux densities of over 300,000 gauss by discharging a capacitor through a coil over a period of 10-20  $\mu$ sec. This corresponds to a forming pressure of 50,000-psi. Actually there is no theoretical limit to the maximum energy which can be built into the equipment. It is felt that forming pressures in excess of 500,000 psi are possible.

In the magnetic metalforming process, contact is made with a workpiece through the magnetic field. There is no actual contact. Thus, forming may be done through the walls of a nonconducting sheath. This makes it possible to maintain the workpiece in a superclean or other special environment—an often necessary factor when doing space age work.

In operation, electrical energy is stored in capacitors and then discharged rapidly through a coil. This establishes a pulsed, high-intensity, magnetic field which induces a current in a workpiece of conductive material placed in, around or near the coil. The induced current field interacts with the coil field to produce a force on the workpiece.

If the coil surrounds the workpiece, the force compresses, collapses or shrinks it. If the coil is inside the workpiece, the force expands it. If a flat coil is used, a uniform, unidirectional outward force results. This is shown in Fig. 2.

### Lasers

The new "exotic" of the electronic industry is the laser. Better known for its possible use for communications, it could revolutionize metal processing methods. It will be used to weld, cut and melt metals. It may also be used to guide boring tools. Sperry Gyroscope Co. of Canada Ltd. is currently developing a precision boring system for the USAF. The laser will measure and control six bore characteristics: diameter, roundness, taper, camber, bell-mouth and surface-finish. Accuracy will be 8 millionths of an inch for bore diameters from 0.05 in. to 0.09 in.; and 5 millionths of an inch for diameters from 0.09 in. to 0.25 in.

For welding uses the laser can operate in any

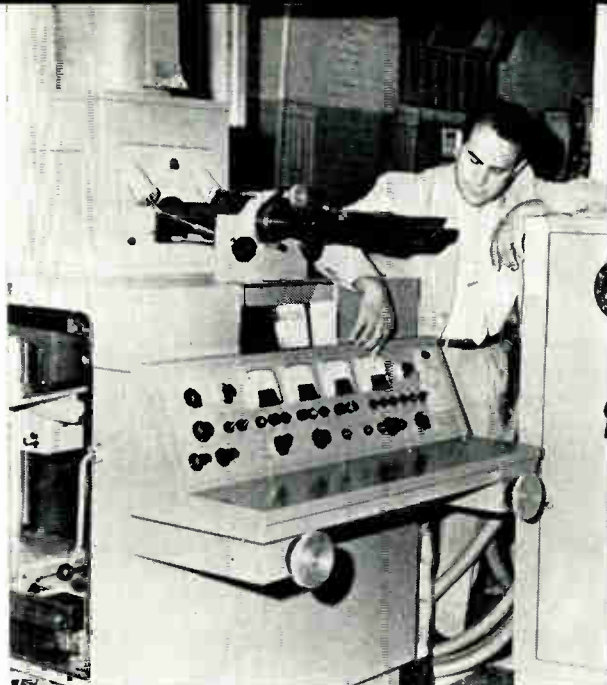

L. M. Cirami inspects 6 kw electron beam welder installation at Kerns Mfg. Corp., Long Island City, N. Y. The Hamilton-Zeiss machine will handle parts up to 36 in. in diameter. Space age materials such as tantalum, tungsten, columbium and molybdenum can be successfully welded with this machine.

transparent atmosphere—a vacuum, inert gas or air. It does not need a vacuum chamber. It can attain fusion temperatures in all metals and it is easily and accurately focused to a small diameter. Its short pulse duration may allow it to weld refractory metals with little or no grain growth.

The laser is still being developed and much work remains before it sees extensive use. But, it is a tool to be reckoned with.

### Acknowledgements

The author would like to thank the following companies for their contributions to the article:

Acoustica Associates Los Angeles, Calif.  
Advanced Kinetics, Inc. Costa Mesa, Calif.  
Aerojet Gen. Corp. Azusa, Calif.  
Alloyd Electronics Corp. Cambridge, Mass.  
Blackstone Corp. Jamestown, N. Y.  
Connecticut Valley Chemicals Inc. New York, N. Y.  
Delcon Corp. Palo Alto, Calif.  
Field Emission Corp. McMinnville, Ore.  
General Atomic Div. of General Dynamics Corp. San Diego, Calif.  
Gulton Industries, Inc. Metuchen, N. J.  
Hamilton Standard Corp. Div. of United Aircraft Corp. Windsor Locks, Conn.  
Hughes Aircraft Co. Culver City, Calif.  
Mikros, Inc. Portland, Ore.  
Niagara Machine & Tool Works Buffalo, N. Y.  
Peck Stow Wilcox Co. Southington, Conn.  
Peer, Inc. Benton Harbor, Mich.  
Raytheon Co. Manchester, N. H.  
Sheridan-Gray, Inc. Torrance, Calif.  
Stewart Engineering Co. Santa Cruz, Calif.  
F. J. Stokes Corp. Phila., Pa.  
Temescal Metallurgical Corp. Berkeley, Calif.  
TRG Inc. Syosset, N. Y.  
The Ulmer Co. Oceanside, Calif.  
Universal Instruments Corp. Binghamton, N. Y.  
Weldmatic Div. Unitek Corp. Monrovia, Calif.  
Whitney Metal Tool Co. Rockford, Ill.

● A REPRINT of this article is available from ELECTRONIC INDUSTRIES Reader Service Department

## COPY CAT



### **TAPE COPY STATION FOR ATLANTIC MISSILE RANGE**

Six 1.5-mc Mincom CM-100 Recorder/Reproducers form the backbone of an extremely complex tape copy station delivered to the Atlantic Missile Range. This station makes possible for the first time as many as five first-generation copies of prime data tapes in one operation. In addition to the six CM-100's, it also includes two 600-kc Mincom G-100's, two degaussers, and an advanced monitor alarm system policing forty-two 1.5-mc channels. The station is the result of Mincom's long experience with frequency responses of better than 1 mc — an outstanding reliability record since 1955.

**Mincom Division** **3M**  
COMPANY

2049 South Barrington Avenue, Los Angeles 25,  
425 13th Street N.W., Washington 4, D. C.





**7" Direct-View DST—RCA-C73983**—The ability to store information for many seconds at initial brightness levels makes the C73983 highly suitable for use in display systems employing very slow scanning speeds such as long-range radar, slow-scan TV, and sonar. A selective erasing feature permits the displayed information to be retained at full brightness until it is to be replaced by new information. The C73983 provides a 5¼-inch-diameter display having sufficient brightness to permit viewing in well-lighted areas.



**10" Direct-View DST—RCA-4412**—The ability to store information for many seconds while continuously presenting it in a large non-flickering display makes the 4412 a highly recommended tube for special electronic display systems. The range of possible applications in which the 4412 may be used is extended to the most sophisticated military-airborne equipment by an extremely rugged tube structure.



**5" Direct-View DST—RCA-7268**—High brightness and an adjustable rate of information decay make the 7268 highly useful for the display of information under daylight-viewing conditions in airborne fire-control radar systems. This tube provides a full 4-inch-diameter display having excellent uniformity and positional accuracy under the severe environmental conditions encountered in airborne military equipment.

## RCA DISPLAY STORAGE TUBES

### A Line Tailored to Your Application

Reliability, high resolution, and writing speeds tailored to your application make RCA Display Storage Tubes ideal for data readout, sonar, radar, or your special electronic display system. Offering a wide choice of levels of brightness and resolution in half-tone display, most of these tubes are ruggedly designed to withstand severe environmental conditions of altitude, temperature, humidity, vibration, and shock.

RCA's Display Storage Tube line offers you a choice of display area, single or multiple writing guns, and electrostatic or magnetic deflection. Ask about them locally at your authorized RCA Industrial Tube Distributor.

**RCA FIELD OFFICES—OEM SALES:** Newark 2, N. J., 32-36 Green St., (201) 485-3900 • Chicago 54, Ill., Suite 1154, Merchandise Mart Plaza, (312) 527-2900 • Los Angeles 22, Calif., 6801 E. Washington Blvd., (213) RA 3-8361 • **GOVERNMENT SALES:** Harrison, N. J., 415 South Fifth St., (201) 485-3900 • Dayton 2, Ohio, 224 N. Wilkinson St., (513) 461-5420 • Washington 6, D. C., 1725 "K" St., N.W., (202) FE 7-8500 • **INTERNATIONAL SALES:** RCA International Div., Clark, N. J., (201) 382-1000

**ALSO AVAILABLE FROM YOUR AUTHORIZED RCA INDUSTRIAL TUBE DISTRIBUTOR**

**SEND FOR NEW RCA DISPLAY STORAGE TUBE BOOKLET, 1G1144**

This booklet, 1G1144, contains information on RCA's Display Storage Tube line. It is available by writing: Commercial Engineering, Section A-50-Q, RCA Electronic Components and Devices, Harrison, N. J.

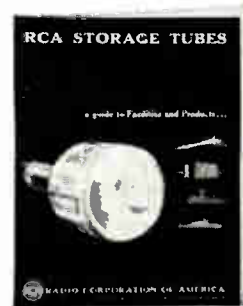

**The Most Trusted Name in Electronics**

Circle 35 on Reader Inquiry Card



# MINIMIZING FEEDBACK IN HIGH-FREQUENCY TRANSISTOR AMPLIFIERS

Oscillations and regeneration through ground currents can cause trouble in high-gain, high frequency transistorized amplifiers. Proper circuit design and packaging can minimize unwanted feedback. This article supplies the details.

PROBLEMS WITH OSCILLATION and regenerative feedback are often encountered in high-gain transistorized amplifiers. In many cases the trouble can be traced to ground currents which create unwanted feedback between the various stages of the amplifier. This article presents a discussion of this problem and suggests circuit configurations and layout techniques which minimize the problem.

\* \* \*

As an aid to understanding the problem of ground circuit feedback currents, the basic signal current paths of a common-emitter transistor amplifier stage are shown in Fig. 1. The input signal current  $i_b$  causes a collector current  $i_c$  to flow. The sum of the collector current and the base current is equal to the emitter current  $i_e$ , according to the usual equations. An equivalent circuit is shown in Fig. 2. For our discussion, reactive elements are not essential and thus, this simplified circuit will do. As seen from this circuit, there are two basic current paths: (1) the input base-emitter loop, and (2) the collector-emitter loop. To prevent unwanted feedback due to ground currents, the signal currents must flow only in those paths which are essential for operation of that amplifier stage. Using this rule as a guide, we can construct a circuit which has the necessary bias and dc current paths and also has the correct connection of bypass, coupling, and decoupling networks to minimize the signal currents flowing in the ground and power leads.

## Typical Circuit

A typical 3-stage amplifier is shown in Fig. 3. This amplifier has the usual connection of the coupling and bypass capacitors. This circuit configuration contains several of the basic errors leading to regen-

erative feedback; generally, several additional decoupling networks are needed. First, the emitter bypass capacitors, while providing the desired low impedance path across the emitter resistors, do not complete the ac collector-emitter current loops by the shortest path possible. This current has to flow through the ground circuit, through the power supply and its impedance, and then through the positive power lead to the load resistor of the stage.

Thus, the current from each stage has to flow through ground circuit and power supply impedances which are common to the other stages, thereby creating unwanted feedback signals. As seen from Fig. 2, the equivalent generator  $r_m i_b$ , not the power supply, generates the signal currents in the load. Hence, signal currents through the power supply are not necessary.

In addition to the ground currents which flow due to collector-emitter signals, there is a second ground current due to base-emitter signals. This current may be from an input signal source or from the previous stage of the amplifier. For proper operation of the stage, it is necessary only that the input signal current flow through the base-emitter junction. Since the return path for this current is through the ground circuit, it can cause undesired signal coupling to other stages.

A third source of ground currents is through the output load to ground. The load frequently is located away from the amplifier, and the power supply ground lead is used for completing the load circuit. Thus, the output signal currents, the highest signals in the amplifier, must flow through common ground circuit impedances to complete the circuit for the collector-emitter current loop. A similar but much less severe effect is noted for the loading created by

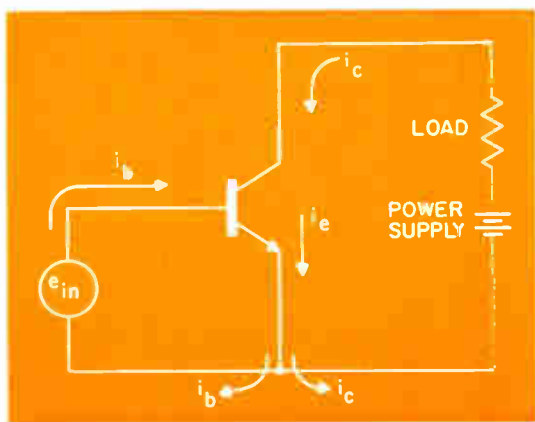

Fig. 1 (left):  
The basic signal current paths  
of a common-emitter  
transistor amplifier stage  
are illustrated.

Fig. 2 (right):  
The equivalent circuit  
of Fig. 1 is shown  
to aid in understanding  
the two basic current paths.

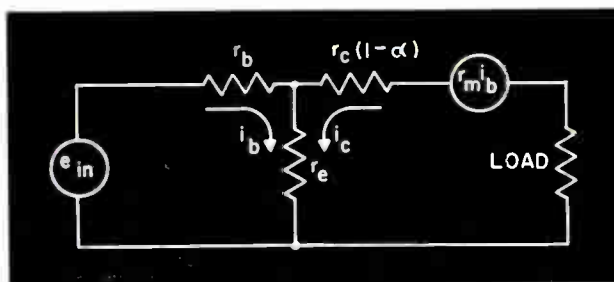

Fig. 3:  
A typical 3-stage amplifier  
is shown containing  
several basic errors  
that will lead  
to regenerative feedback.

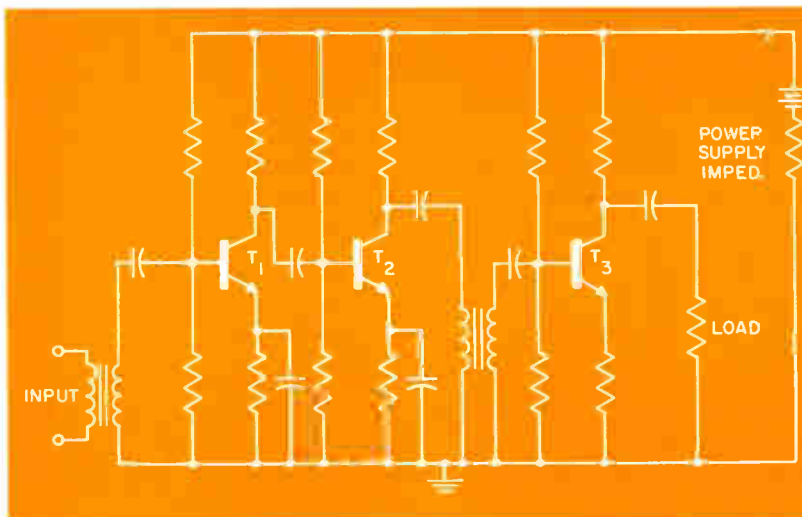

Fig. 4 (below):  
The circuit in Fig. 3  
has been rearranged  
to eliminate most  
of the signal currents  
in the ground and power leads.

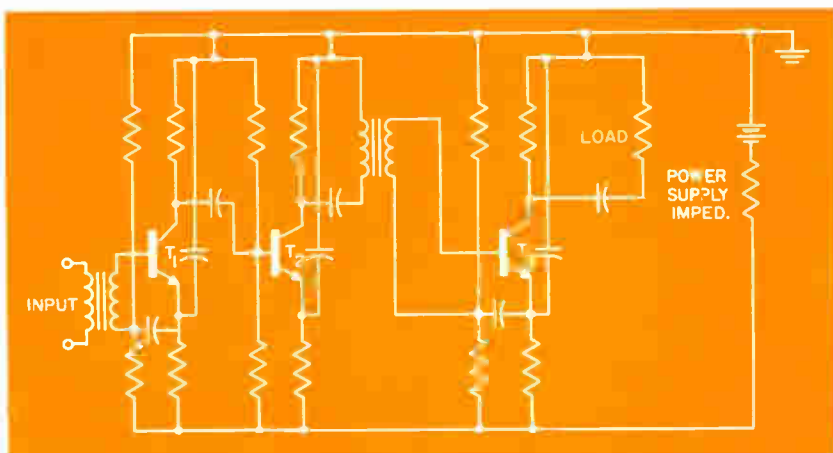
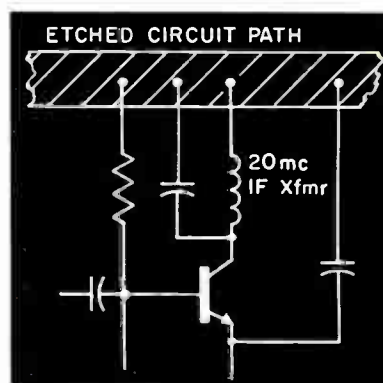

Fig. 5 (below):  
Signal currents flow  
in the main power lead  
for a short distance  
even though the components  
are connected according to schematic.



By **C. B. PARKER**  
Group Engineer  
General Dynamics/Pomona  
Pomona, Calif.

## MINIMIZING FEEDBACK (Continued)

the networks, which supply bias to the bases of the transistors.

### Circuit Revisions

The circuit of Fig. 4 shows how the components can be rearranged to eliminate most of the signal currents in the ground and power leads. The diagram also indicates how some of the component connections should be grouped before tying them off to the power or ground conductors.

The first change is in the connection of the emitter bypass capacitors. Since this capacitor provides the path for closing the collector-emitter current loop, it should be connected from emitter to the plus terminal of the battery, rather than across the emitter resistor and is physically connected directly to the plus end of the collector load resistor. At frequencies where the bypass is effectively a short circuit, the collector-emitter current loop is completed without having signal current flow in the power or ground conductors or through the battery impedance. This circuit change removes the major source of ground current feedback signals.

The second circuit change is in the primary connections of the coupling transformer between the second and third stages. The ground return end of the primary should be returned to the plus terminal of the collector load resistor, thereby keeping collector signal currents out of the power system leads. In this example it was assumed that the primary of the transformer could not carry the dc collector current and therefore capacitive coupling was needed. If this is not the case, the transformer primary should be connected directly as the collector load.

Fig. 6: A slight change in the circuit board of Figure 5 will reduce stray coupling to other amplifier stages.

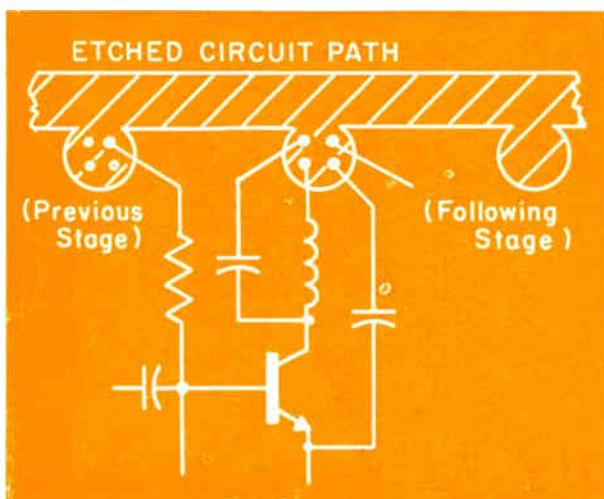

The third change is in the secondary connection of the interstage transformer. This revised circuit keeps signal currents from flowing into the base bias network. The location of the coupling capacitor is such that the shortest path possible is supplied for the base-emitter loop current. Another advantage is that there is no signal power lost in the bias resistors and thus, the circuit has higher power gain. This connection also allows the use of lower value resistors in the bias network, giving improved temperature stability. A similar reconnection of the transformer secondary is used at the input stage.

The fourth change re-defines the system ground to be the positive power supply terminal rather than the negative. The main reason for this change is that the signal currents which are delivered to the load *with respect to ground* do not have to flow through the power system leads to complete the collector-emitter current loop. This change can be significant where high power signals are delivered to the load which would otherwise flow through the power supply impedance, creating a feedback signal to the previous stages.

Even after the above circuit changes are made, there are still some ground circuit signal currents. The collector signal current from the first stage, which flows into the bias network for the second stage, must flow through power and ground leads to close the circuit for the collector-emitter loop of stage one. Also, the base-emitter signal of stage two, after passing through the emitter bypass capacitor, must flow through the positive power lead back to the previous stage to complete the circuit for stage one collector-emitter currents. These currents are generally a factor of ten to one hundred less than the other signal currents in the circuit and are generally small enough to be neglected. However, it is sometimes necessary to add a separate decoupling network for the power to the first stage of the amplifier.

In high frequency circuits it may also be necessary to add a bypass capacitor directly across the power supply terminals at the circuit, especially if the source of power is located remotely so that long power cables are used.

One final change that often helps is to connect the power into the circuit at the point nearest to the output stage, rather than near the input stage. Because of the gain of the amplifier, the remaining ground currents which flow are larger at the output stage. If the power connections are made at the output end of the circuit, these currents do not flow back through common ground and power leads near the sensitive input stage.



## Layout Considerations

The above circuit changes illustrate the basic reconnection of the parts to minimize unwanted feedback. When working with h-f circuits such as i-f amplifiers, also be careful about where the individual stages connect to the power and ground supply leads, since the stray inductance increases the impedance of these leads. With such circuits it is desirable to make each stage a complete ac circuit, so that little or no signal current flows in any ground or power lead that is common between stages. Obviously, there are limitations, but the practice of connecting components to the most convenient power or ground point is to be avoided. The packaging layout should

be made so that the components can be connected to power and ground at the correct points.

In a recent 20 mc i-f amplifier design, an improvement in stability was clearly shown when the collector circuit connections were rearranged as in Figs. 5 and 6. In Fig. 5, signal currents flow in the main power lead for a short distance even though schematically the components are connected at the correct point. By a slight change in the etched circuit in Fig. 6, this source of stray coupling to the other stages was eliminated.

● A REPRINT of this article is available from ELECTRONIC INDUSTRIES Reader Service Department

# CIRCUIT-WISE

## BISTABLE MULTIVIBRATOR

BECAUSE OF THEIR INHERENT MEMORY CAPABILITIES, tunnel diodes can be readily used in the design of bistable multivibrator circuits. A practical example of a set-reset bistable multivibrator circuit is shown in Fig. 1.

This circuit has a maximum repetition rate of 200mc, an  $R_B$  resistance of 29.2 ohms, an equivalent load-line resistance  $R_{B3}$  of 27.5 ohms, and an equivalent supply voltage  $V_{B3}$  of 542 millivolts.

Material abstracted from "RCA Tunnel Diode Manual" (TD-30).

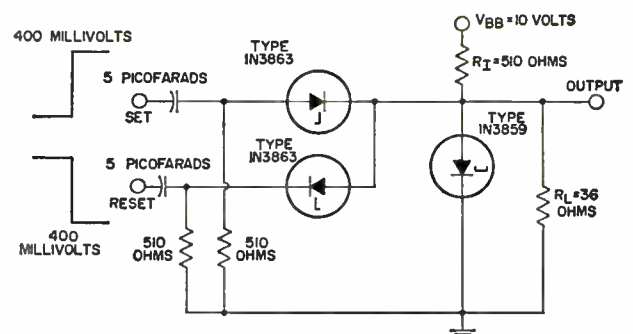
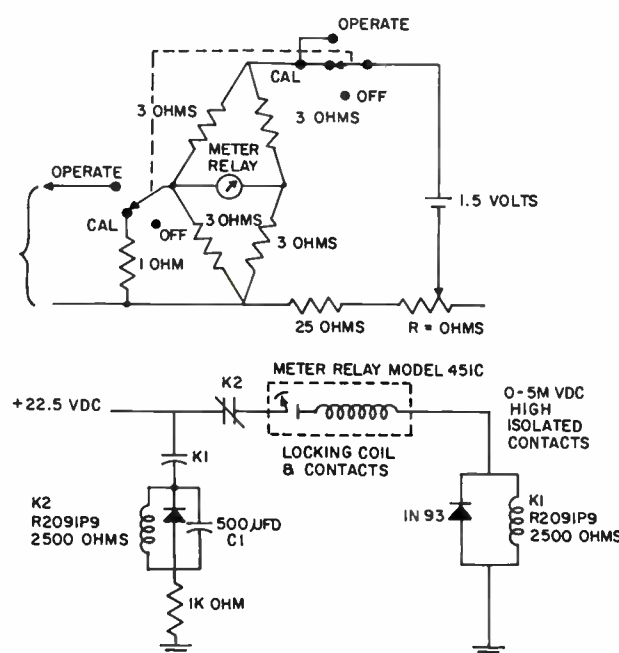
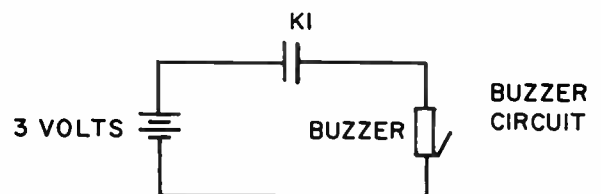

Fig. 35b. Practical set-reset bistable multivibrator circuit.



## CONTINUITY TESTER

HERE IS A SIMPLE-TO-OPERATE GO-NO GO continuity tester that provides the operator with the convenience of a buzzer indication. It features the low current drain requirements of a bridge, at the same time giving the accuracy of a meter. Automatic reset is also provided for operator ease.



The drawings show the three basic sections of the device: Bridge circuit, meter relay circuit, and the buzzer circuit.

Supplied by A. SILVERZWEIG, Supervising Engineer, Missile and Space Div., General Electric Co., 3198 Chestnut St., Philadelphia 1, Pa.

## RC NETWORKS (Concluded)

$$H \left( t - (n-1) \frac{T_o}{2} \right) \quad (6)$$

Eq. 6, the output waveform is an infinite series of terms. Each term of the series alternates in polarity and is delayed from the preceding term by half a period

$$\left( \frac{T_o}{2} \right).$$

Eq. 6 has a form similar to that of Eq. 1, essentially a superposition of terms delayed by successive half periods with the exception that in Eq. 6 successive like polarity terms diminish in magnitude.

An evaluation of Eq. 6 by direct substitution at successive integral half periods will show that the series rapidly converges to the steady state condition.

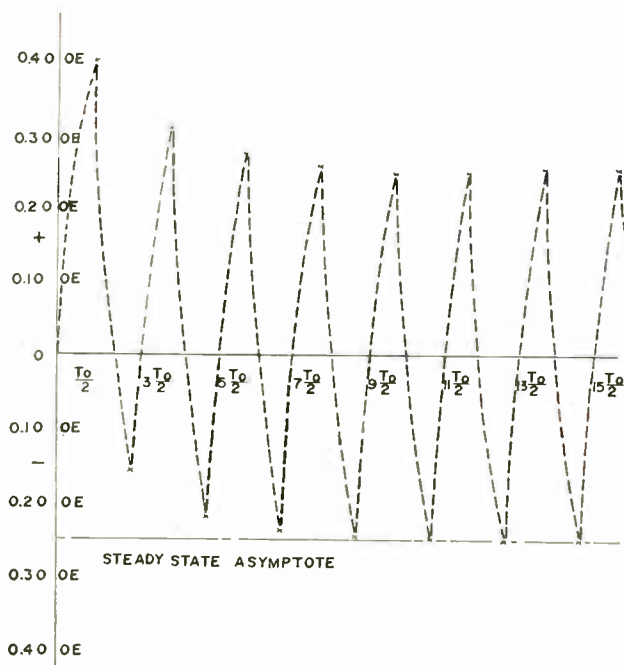
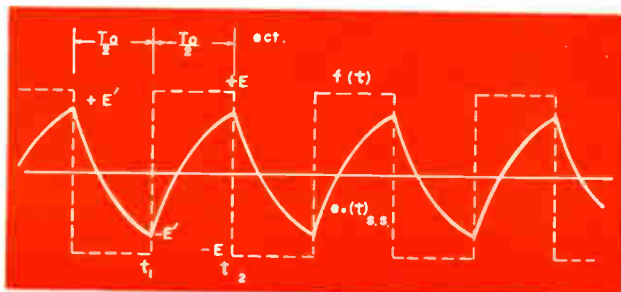

Fig. 4: Successive half period summations of Equation 6.

Fig. 5: Steady state input-output voltage waveforms.



● A REPRINT of this article is available from ELECTRONIC INDUSTRIES Reader Service Department

Table 1 shows the schedule used to evaluate Eq. 6 at successive integral half periods.

The final column of Table 1 is the summation of  $n$  terms of Eq. 6 as a function of  $n$  integral half periods  $\left( \frac{n T_o}{2} \right)$ .

The above summations are plotted versus their respective half periods in Fig. 4.

Constants which were assumed in the above problem are  $f = 1$  kc,  $R = 1$  meg ohm, and  $C = 0.001$   $\mu$ f. The steady state convergence occurs in about 15 half periods which is about 7.5 msec.

### Steady State Condition

When the steady state condition is reached, the output waveform will be as is shown in Fig. 5. The law of conservation of energy requires that the energy above the zero axis be exactly equal to that energy below the zero axis ordinate. Since the input waveform is a symmetrical square wave and because of the above equal energy postulate, we can anticipate that the steady state output waveform will be equally symmetrical and have magnitudes of  $\pm E'$  at successive half periods.

The complete solution for the output waveform, Eq. 6, shows that the terms are simple exponentials. For the steady state case, we can write that:

$$E_f = E_o + E_{max} \left[ 1 - e^{-\frac{t}{RC}} \right] \quad (7)$$

where:  $E_f$  = final voltage

$E_o$  = initial voltage

$E_m$  = peak to peak input voltage

Referring to Fig. 5 we will make use of the interval  $(t_2 - t_1) = \frac{T_o}{2}$  in order to solve for the magnitude of  $\pm E'$ .

$$\text{At } t_1, E_o = -E' \quad (8a)$$

$$\text{At } t_2, E_f = +E' \quad (8b)$$

Eqs. 8a and 8b are substituted into Eq. 7 as follows:

$$E' = -E' + \left[ E + E' \right] \left[ 1 - e^{-\frac{T_o}{2RC}} \right] \quad (9)$$

Eq. 9 is then solved for  $E'$ :

$$E' = E \frac{\left[ 1 - e^{-\frac{T_o}{2RC}} \right]}{\left[ 1 + e^{-\frac{T_o}{2RC}} \right]} \quad (10)$$

Substituting:

$$\frac{T_o}{2} = \frac{0.001}{2} \text{ sec.}$$

$$R = 10^6 \text{ ohms}$$

$$C = 0.001 \times 10^{-6} \text{ f.}$$

into eq. 10, the magnitude of  $E'$  is found to be:

$$E' = 0.245 E \text{ volts} \quad (11)$$

Fig. 4 shows that this value is asymptotically approached after about 15 half periods of the input square waveform.

# NEW DESIGNS IN UHF-TV TUNERS

The entire TV receiver industry must begin production of all-channel TV receivers in April. Designs of the new UHF tuners that will be included in those receivers are now largely completed.

AS THE DEADLINE APPROACHES for TV receiver manufacturers to switch to production of all-channel television receivers, the technical designs of the tuners have been pretty well finalized.

The majority of independent tuner manufacturers will be using variable capacitance tuning. This includes Standard Kollsman, General Instrument, and Sarks Tarzian. Oak Manufacturing Co. of Crystal Lake, Ill., has designed their tuner around variable inductance tuning.

The relative merits of each may be somewhat academic. The critics of variable inductance tuning point out the "scratchiness" of previous variable inductance tuners, while on the other side their opponents point out that variable capacitors, too, have a noisy characteristic due to their wiper action. The relative merits—if any—will be resolved by extensive field use.

As presently designed, the UHF tuners are aimed squarely at the lowest possible price, as would be expected in the highly competitive TV receiver industry. None of the present tuners include an r-f amplifier, nor any means of pre-selection. This is a problem which will be dealt with when sufficient numbers of receivers are in field use.

The accepted configuration is for the UHF tuner to be a separate unit—it may or may not be mounted on the VHF tuner itself—operating on the Channel 1 position of the VHF tuner. With the UHF tuner in operation, the r-f amp and mixer stage of the VHF unit function as i-f amplifiers, providing two additional stages of i-f amplification.

While various attempts have been made to use replaceable strips—and further attempts may still be made—the majority of

some vacuum tube tuners available today, but the emphasis is shifting strongly to semi-conductors. In the case of at least one manufacturer, the vacuum tube type tuners have been discontinued completely; E. D. Chalmers, Chief Engineer of Oak Manufacturing states flatly, "No vacuum tube has any future in UHF!"

The vacuum tubes suffer particularly in regard to the radiation problem. The full seriousness of this problem will not be

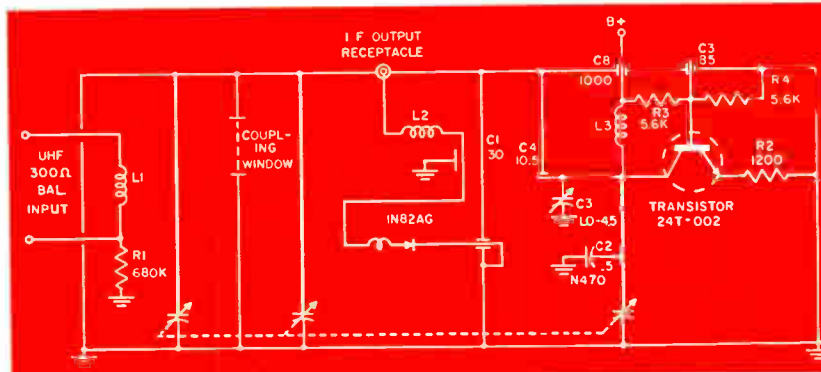

Standard-Kollsman's UHF television tuner uses variable capacitance tuning.

tuner manufacturers favor a continuous tuning arrangement. This creates some problems in selectivity and various companies are working on mechanical band spread features—gears and vernier adjustments—which will simplify the tuning problem.

Early efforts at designing UHF tuners used vacuum tubes as the active elements. There are still

known until UHF tuners are in the field, but it is safe to say that the vacuum tube will need heavy shielding to meet the FCC radiation regulations.

Another problem, that of microphonics, is virtually eliminated with the transistor, and this is another sound reason for their inclusion in UHF tuners.

(Continued on page 76)



## UHF-TV TUNERS (Concluded)

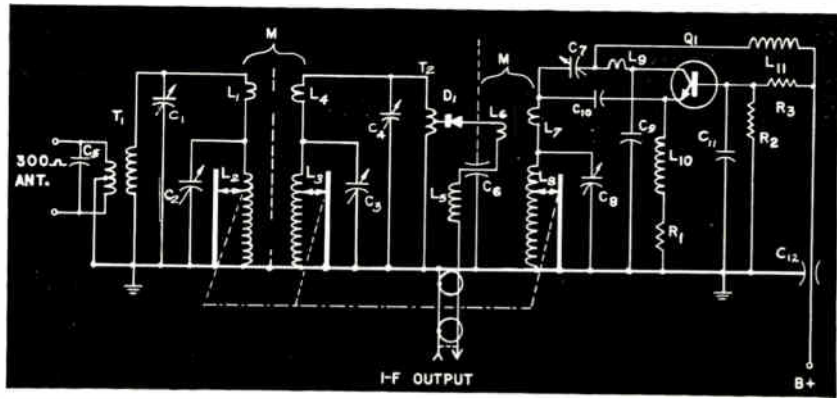

Certain advantages are claimed for the transistor in minimizing drift. Oscillator drifts on the order of 500KC and less have been measured for 2 min. interval after power is applied.

Some previous attempts have been made at designing tuners that would receive both VHF and UHF, but there is no serious effort at this time.

At this point, all tuner manufacturers have to keep their attention glued on the competitive situation. The technical advantages of one design over another have yet to be established—and probably will not be established until there is adequate information

from the field—so that buyers' judgments are apt to be made almost solely on the basis of price at this point.

Most TV receiver manufacturers are buying tuners from a number of different tuner manufacturers.

### Impasse in the Market

For the moment, the tuner manufacturers are marking time, impatiently, waiting for the orders that must come in order for the receiver manufacturers to meet the FCC deadline.

But the receiver manufacturers on the other hand are awaiting some sign from the dealers

Oak Manufacturing Co., in contrast to most other independent tuner manufacturers, uses variable inductance tuning in their UHF tuner.

that the public is willing to pay the extra price at this time for the UHF tuner.

The dealers, in turn, are interested primarily in selling sets. The UHF feature, when combined with a bow-tie antenna and installation costs, can represent an added expense to the consumer in the neighborhood of \$50, which may be just enough to kill the sale.

(There have been some pleasant surprises in regard to the antenna problem. Most UHF-VHF sets include a small rotatable loop antenna. They have been found to be surprisingly efficient in many close-in areas.)

The problem for the tuner manufacturers is one of scheduling. It takes three to four months to set up facilities for volume production and testing. Virtually all the tuners manufactured are on written specifications from the TV receiver manufacturers, so production cannot begin until the orders are in hand.

The FCC has reaffirmed its decision that no VHF-only sets will be manufactured beyond that April 1964 deadline. If matters stand as they are much longer, a severe bottleneck in the availability of tuners is a certainty.

### UHF-TV SHOWS DX-ING POSSIBILITIES

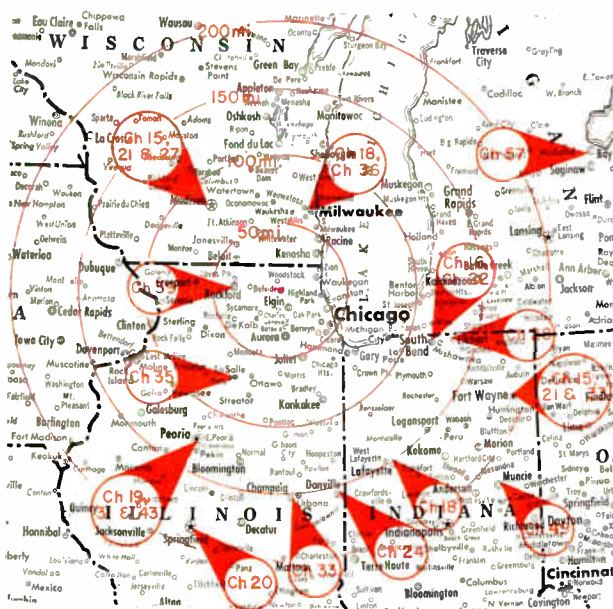

On the wall in the Engineering Dept. of Oak Manufacturing Co. in Crystal Lake, Ill. (50 mi. from Chicago) is a map just like this, showing the 6-state area for some 200 miles around. With a 12-bay antenna on the roof and using their tuner they have received "usable" pictures from all the UHF TV channels indicated. No additional boosters were used. This capacity for long-distance reception and the availability of a great number of stations promises an exciting TV experience for the U. S. consumer.

# ENGINEER'S NOTEBOOK

## #70 POWER TUBE EQUATIONS

IN CLASS C AMPLIFIERS the grid is biased beyond cutoff, and then driven with a sine wave voltage. Thus, plate current flows in pulses of less than 180° of the cycle.

The exact angle is usually a compromise; low enough for good plate efficiency, but not so low as to require excessive driving power. One-half of the pulse duration is  $\theta$ .

The pulse shape  $\alpha$  is often considered to be the 3/2 power. However, the  $\alpha$  of some tubes may exceed 2.

Each plate current pulse has a maximum value  $I_{bm}$ , an average value  $I_b$ , and a peak, fundamental frequency magnitude  $I_{plm}$ . Terman, calculated ratios of these currents *versus*  $\theta$ , and presented them as curves.

### Class C Amplifier

The curves for ratio  $I_b/I_{bm}$  and  $I_{plm}/I_b$  are almost straight lines over their normally used sections.<sup>1, 2</sup> Therefore, they can be approximated by simple, straight-line equations.

For instance:

$$\frac{I_b}{I_{bm}} = \frac{2 + \theta}{209 + 76\alpha} \quad (1)$$

can be used between  $\theta$  limits of 30° and 90°

$$\frac{I_{plm}}{I_b} = 2 - \frac{0.018}{1.57 + \alpha} (\theta - 32) \quad (2)$$

for  $\theta$  limits 50° and 90°. (Terman suggests 60° to 75° in most cases.)

### Frequency Multiplier

Theta still refers to the fundamental frequency; however, the plate circuit is now tuned to the desired harmonic frequency (second, third, or fourth).  $I_{pm}$  has subscripts 2, 3, or 4 to designate the peak value of these harmonic currents. Eq. 1 is still valid.

For the Doubler:

$$\frac{I_{p2m}}{I_b} = 2 - \frac{0.048}{1.47 + \alpha} (\theta - 22) \quad (3)$$

for  $\theta$ 's between 40° and 75° (Terman suggests 45° to 60°).

For the Tripler:

$$\frac{I_{p3m}}{I_b} = 2 - \frac{0.10}{1.96 + \alpha} (\theta - 19) \quad (4)$$

for the  $\theta$ 's between 37° and 65° (Terman suggests 40° to 60°).

For the Quadrupler:

$$\frac{I_{p4m}}{I_b} = 2.2 - \frac{0.156}{2.77 + \alpha} (\theta - 7) \quad (5)$$

for  $\theta$ 's between 30° and 50° (Terman suggests 35° to 45°).

Plate Efficiency:

This is given by:

$$\eta = 50 \times \frac{E_{pm}}{E_{bb}} \times \frac{I_{plm}}{I_b} \quad (6)$$

where  $E_{pm}$  is the peak (r-f) voltage across the plate circuit, and  $E_{bb}$  is the dc plate voltage,  $\eta$  is efficiency in percent.

By combining Eqs. (2) and (6), the efficiency of the amplifier is:

$$\eta = 100 \times \frac{E_{pm}}{E_{bb}} \left[ 1 - \frac{0.009}{1.57 + \alpha} (\theta - 32) \right] \quad (7)$$

Eq. (6) may also be combined with Eqs. (3), (4), or (5), for the various multiplier efficiencies.

Ratio  $I_{plm}/I_{bm}$ :

This ratio is not a straight line. A workable amplifier equation can be made by multiplying Eqs. (1) and (2). However, it is simpler to solve Eqs. (1) and (2) independently, and then multiply the results. Similar combinations can be made for the multipliers.

Amplifier Example:

Assume  $\alpha = 1.5$ ,  $\theta = 70^\circ$ ,  $E_{pm}/E_{bb} = 0.9$

$$\frac{I_b}{I_{bm}} = \frac{2 + 70}{209 + 114} = 0.223$$

$$\frac{I_{plm}}{I_b} = 2 - \frac{0.018}{1.57 + 1.5} (70 - 32) = 1$$

$$\frac{I_{plm}}{I_{bm}} = 0.223 \times 1.78 = 0.397$$

$$\text{Eff.} = 100 \times 0.9 \left[ 1 - \frac{0.009}{1.57 + 1.5} (70 - 32) \right] = 80\%$$

Further simplification of all of these equations is possible when  $\alpha$  is known. For the usually assumed 1.5 value, Eq. (4), for example, reduces to:

$$\frac{I_{p3m}}{I_b} = 2 - 0.0289 (\theta - 19)$$

Accuracy:

For the  $\theta$  limits given, these equations are within 3% of the curves.

### References

1. Terman, F. E., *Electronic and Radio Engineering*, Fourth Ed., McGraw-Hill Book Co., Inc.
2. Henderson, R. A., "Charts Ease Amplifier Calculations," *Electronic Industries*, Dec. 1959.



By ROY A. HENDERSON

Engineer  
Radio Corp. of America  
Missile & Surface Radar Div.  
Moorestown, N. J.

There are three general types of acoustic rooms—anechoic, reverberant, and quiet. Combination rooms can also be built, for instance, the "soft-hard" room. The choice of construction depends on the measurements to be made.

# UNDERSTANDING ACOUSTIC ENCLOSURE SYSTEMS

THE TYPES OF ROOMS OR ENCLOSURES in which noise can be measured and/or contained, or rooms that can be used for acoustic shelters, may be classified in three broad categories:

1. Anechoic (echo free) Chambers
2. Reverberant (live) Rooms
3. Quiet (dead) Rooms

There are, of course, many combinations of these three, such as "Convertible" Rooms, "Semi-Anechoic" Rooms, etc.

The successful design of Anechoic Chambers, Reverberant Rooms and Quiet Rooms involves the interaction of many factors. For example, in an Anechoic Chamber not only must the "Anechoic" features of the interior of the chamber be considered, but also the surrounding walls must be made to block noise from outside of the enclosure.

We will limit ourselves to those characteristics which make the room Anechoic, Reverberant, or "Quiet."

\* \* \*

## Anechoic Chambers

Rooms without echoes (Anechoic Chambers) are used for free field studies, as well as to test machinery, audio devices, musical instruments or any other device whose acoustic radiation pattern is to be studied.

The anechoic properties are derived from the acoustical absorbers which line the four walls, ceiling and floor of the chamber. These absorbers are usually constructed in the shape of wedges, fabricated from glass fiber boards (Fig. 1). The size and shape of these elements determine the "cut-off" frequency of the room—the lowest frequency at which the anechoic element will absorb 99% of all acoustic energy incident upon it.

Establishing "free field" conditions means making it possible to duplicate the non-reflective conditions of the outdoors. This can be done in an Anechoic Room because the walls of these rooms provide 99% absorption at their surfaces, thereby giving a 20 db reduction for all reflected noise at the walls.

The Anechoic Chamber presents an ideal condition for measuring Sound Pressure Level (SPL), which is the acoustic energy per unit area at a point relative to the noise source. SPL is found by making 8, 12 or 20 measurements on the surface of an imaginary sphere, using appropriate correction factors. These measurements are then converted to power ratios, added, corrected, then reconverted to be used as an average SPL.

Accurate directivity pattern can be established for specimens in Anechoic Chambers. A knowledge of the directivity pattern is important:

Suppose it were desired to orient a fan inside an equipment console so that it would create the least disturbance to the surrounding area. In this case, if we were to find that the noise was radiated in one direction more than in others, we would mount the fan *inside* the console so that the direction of maximum noise would be pointed away from personnel or would be acoustically shielded from them.

Fig. 2 is recommended wedge sizes designed for a modular Anechoic Chamber. These sizes have been designed to produce the most economical wedge, i.e., the largest cross-section and optimum length using the material with the most desirable physical characteristics.

Because wedges line the floor of the chamber, a surface must be supplied to support personnel and equipment without destroying the acoustic properties of the room. This is usually done by using a floor of metallic grating, or intermeshed steel cables erected as a platform.

Because standing waves (regions of high and low sound pressure levels) cannot exist in a properly selected Anechoic Chamber, Pure Tone studies can

By **ARTHUR OPPENHEIM**  
Research Engineer  
and **SEYMOUR WASSERMAN**  
Chief of Eng'g. Services  
Industrial Acoustics Co., Inc.  
341 Jackson Ave.  
New York, N. Y.





Fig. 1: Acoustical absorbers made from glass fiber boards in the shape of wedges provide 99% absorption in anechoic rooms.

be conducted. Pure Tones may be produced by high speed machinery, whistles, sirens, and audio equipment, etc.

Psychological, or more appropriately, psycho-acoustical tests can also be conducted within an Anechoic Chamber. Since these rooms generally provide a very high reduction of noise from outside the chamber, as well as providing non-reflective surfaces within the chamber, subjects can be allowed to listen to sounds without resorting to earphones, or worrying about interfering reflections or extraneous noises.

### Reverberant Rooms

Rooms having walls with very low absorption properties and relatively large decay rates for sounds within them, are called Reverberant (or "live") Rooms.

As important as the directivity pattern of equip-

ment, described above, is the total radiated Sound Power Level (PWL), or the acoustic energy of the source.

PWL is proportional to mechanical energy. By knowing the total radiated PWL, it is possible to predict the noise that will be produced by the device within its normal environment.

A Reverberant Room can be built of either prefabricated sheet metal panels having all solid surfaces which are properly stiffened to give the reverberation time desired, or other materials having highly reflective surfaces, such as Transite, etc. Fig. 3 shows the absorption coefficients obtained in a skewed-walled room constructed with solid sheet metal acoustically filled panels.

If a device has a relatively constant acoustic output, the Sound Pressure Level (SPL) will be essentially uniform and constant throughout this type of room. In a Reverberant Room, the total radiated

## ACOUSTIC ENCLOSURES (Continued)



| ITEM | TEST #  | RECOMMENDED WEDGE SIZES   | CUT-OFF FREQUENCY |
|------|---------|---|-------------------|
| #1   | I.62.25 |  | 90 C.P.S.         |
| #2   | I.59.67 |  | 100 C.P.S.        |
| #3   | I.61.43 |  | 125 C.P.S.        |
| #4   | I.61.42 |  | 150 C.P.S.        |
| #5   | I.61.44 |  | 200 C.P.S.        |
| #6   | I.61.36 |  | 250 C.P.S.        |

Fig. 2: Recommended wedge sizes for modular anechoic chamber.

Fig. 3: Sketch of skewed-walled reverberant room. Table below is for solid sheetmetal acoustically filled panels.

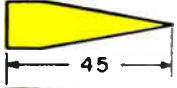
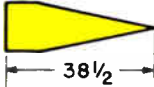
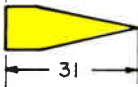
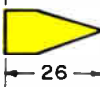

### Typical Reverberant Room Absorption Coefficients

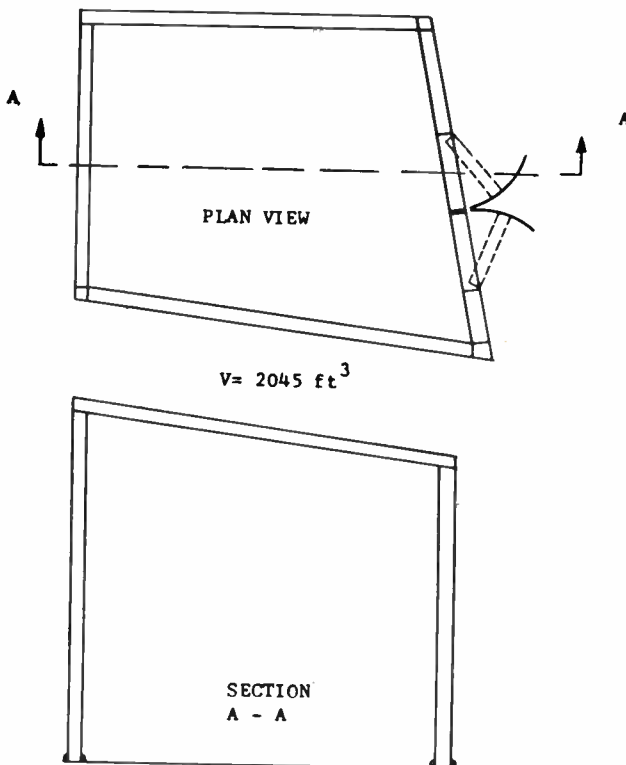
| Octave Band Freq. - C.P.S. | Meas. Abs. Coeff. ( ) |
|----------------------------|-----------------------|
| 75 - 150                   | 0.056                 |
| 150 - 300                  | 0.056                 |
| 300 - 600                  | 0.040                 |
| 600 - 1200                 | 0.031                 |
| 1200 - 2400                | 0.029                 |
| 2400 - 4800                | 0.040                 |
| 4800 - 9600                | 0.045                 |

acoustic power, or Sound Power Level (PWL) of devices such as motors, gear trains, electronic equipment, etc., whose acoustic energy is distributed over a wide range of frequencies can be learned with a few measurements.

Having placed the test specimen within the Reverberant Room, the PWL can be computed from the following formula:

$$PWL = SPL + 10 \log V - 10 \log T - 19 \text{ db} \dots Re 10^{-12} \text{ watts}$$

Where:

$V$  = Total room volume in cubic feet.

$T$  = Reverberation (decay rate) time of room (sec.) measured with a high speed level recorder, or

estimated from the formula,  $T = \frac{0.049V}{S \bar{\alpha}}$

$SPL$  = Sound Pressure Level measured in db.

$S$  = area of the bounding surfaces (ft.<sup>2</sup>).

$\bar{\alpha}$  = average absorption coefficient of the boundary walls (see Fig. 3).

Since "V" and "T" are essentially constant for any given room, the Power Level can be obtained directly from the Sound Pressure measurements once the room has been "calibrated."

Because of the reflective walls, some of the following precautions are used when specifying this type of room to insure a satisfactory reverberant room:

- No 2 walls should be parallel to each other.
- No 2 room dimension should be alike.
- The device should be placed on the floor or near any wall, usually never in the exact center of the room.

d. The test specimen, and/or the recording microphone should be rotated about the room to avoid measuring the effects of a standing wave.

e. Tables, stationary equipment, etc., should be constructed adjacent to, or on the room's walls.

f. Rotating vanes are sometimes used to "break-up" the standing waves. However, the noise produced by the turning equipment should be at least 10 db below the noise from the device under investigation at the frequencies being studied.

### Quiet (Dead) Rooms

The Acoustic Enclosure most widely used in industry is the Quiet Room. They are available in many designs. The room most widely used is made of prefabricated panels which are composed of: an outer solid sheet metal surface, an interior perforated metallic surface, and an acoustical fill sandwiched between the metal sheets. Doors (with acoustical seals and proper hardware), windows (double-paned and acoustically sealed), ventilation system (with silencers), and floors (structurally reinforced for intended usage and isolated to reduce vibratory im-

pulses from or to the surrounding area) all form a part of the basic room's structure.

Sound Isolation Rooms (Quiet Rooms) can either be single-walled, or multi-walled. Table 1 of Fig. 4 shows some typical attenuation data for a 4-in.-thick single-walled room and double-walled room. It should be noted that other thicknesses and masses can be used, depending upon the amount of acoustic performance desired.

The 4-in.-thick perforated panel, described above, also exhibits good absorption coefficients.

It is the combination of attenuation and absorption of the panels used which yields the final acoustical properties of the room. Some of the reasons for the wide use of this type room are:

1. To isolate noisy mechanisms within quiet areas.
2. To provide quiet areas within noisy environments.
3. To approximate an anechoic environment in the upper frequency range by choosing walls of a proper thickness and using carefully chosen room dimensions and measurement positions.
4. For easy construction around a moving assembly line, providing both a quieter operation as well as a measurement station for making acoustic checks as the items are manufactured.
5. In the Psychoacoustic area, to reduce the area noise and keep it from distracting the subject.

By creating an area having a low ambient, or background, noise, a device can be acoustically analyzed. Suppose, for instance, a motor was found to have a bad bearing. Sound Pressure Level measurements can be taken and compared to a motor known to be in good operating condition. Thereby an acoustic comparator can be set up to evaluate this type of equipment.

Also, fatigue, or shake table endurance tests can be conducted within these rooms without disturbing or exposing the adjacent areas to high noise levels.

To increase the flexibility of test enclosures for sound pressure readings and total radiated sound power measurements, a special convertible "soft-hard" room has recently been developed. Featuring simple convertibility, the room is "soft," or not very reflective, in its usual state, but can be converted for testing equipment under reverberant conditions. To make the room a "hard" or reverberant chamber, sheet steel panels with built-in handles are installed over the absorbent walls.

Table 3 is intended as a general guide towards the selection of the type of Acoustic Enclosure for each indicated usage and/or measurement shown. It should be obvious that in many cases a compromise choice may be needed due to the multitude of tests required or due to the economics of the situation.

Table 3 is intended as a general guide towards the selection of the type of Acoustic Enclosure for each indicated usage and/or measurement shown. It should be obvious that in many cases a compromise choice may be needed due to the multitude of tests required or due to the economics of the situation.

Table 3 is intended as a general guide towards the selection of the type of Acoustic Enclosure for each indicated usage and/or measurement shown. It should be obvious that in many cases a compromise choice may be needed due to the multitude of tests required or due to the economics of the situation.

**Table 1**  
Sound Attenuation Characteristics of Typical Quiet Rooms

| Octave Band Freq.—CPS | Single Walled Attenuation Decibels | Double Walled Attenuation Decibels |
|-----------------------|------------------------------------|------------------------------------|
| 37.5 - 75             | 20                                 | 26                                 |
| 75 - 150              | 27                                 | 30                                 |
| 150 - 300             | 39                                 | 46                                 |
| 300 - 600             | 49                                 | 54                                 |
| 600 - 1200            | 53                                 | 60                                 |
| 1200 - 2400           | 56                                 | 72                                 |
| 2400 - 4800           | 56                                 | 72                                 |
| 4800 - 9600           | 54                                 | 68                                 |

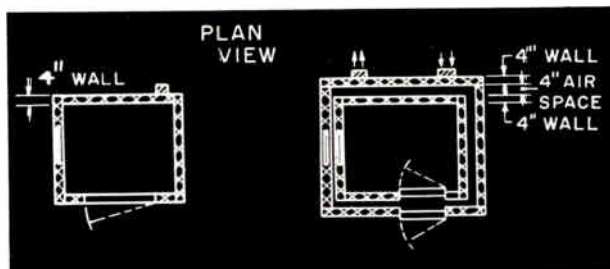

Fig. 4: Plan view of a single and double-wall quiet room. Tables 1 and 2 pertain to these types of rooms.

**Table 2**

| Absorption Coefficients of a Typical 4" Thick Quiet Room Panel |                        |
|--|------------------------|
| Frequency—CPS  | Absorption Coefficient |
| 125  | 0.70                   |
| 250  | .99                    |
| 500  | .99                    |
| 1000   | .99                    |
| 2000   | .94                    |
| 4000   | .83                    |
| Average Noise Reduction Coefficient (NRC)                      | 0.95                   |

**Table 3**

| Type of Measurement and/or Use: | Anechoic  | Reverberant    | Quiet          |
|---------------------------------|-----------|----------------|----------------|
| Directivity Patterns            | Excellent | Poor           | Good           |
| Acoustic Power                  | Poor      | Excellent      | Poor-Good      |
| Level                           |           |                |                |
| Pure Tone                       | Excellent | Poor-Good      | Good           |
| Free Field                      | Excellent | Poor           | Poor-Good      |
| Diffuse Field                   | Poor      | Excellent      | Poor           |
| Reverberation                   | Poor      | Excellent      | Poor           |
| High Intensity Noise Generation | Poor      | Excellent      | Poor-Good      |
| "Machine" Enclosure             | *         | Poor           | Excellent      |
| Production Measuring Station    | *         | Excellent      | Good-Excellent |
| Comparison Analysis             | Excellent | Good-Excellent | Excellent      |
| Control Booth                   | *         | Poor           | Excellent      |
| Psycho-Acoustic Research        | Excellent | Poor           | Good-Excellent |

(\*Not Practical)

● A REPRINT of this article is available from ELECTRONIC INDUSTRIES Reader Service Department



Do you still know how to use the primary tool of your profession—math? Here is the article that will bring you up to date . . . . it is concise, yet comprehensive, ranging from elementary concepts of algebra to the abstract formalisms of differential equations and theory of a complex variable. Emphasis is placed on applications of this tool.

# MATHEMATICAL MODELS FOR ENGINEERS

Cover Story

THE PURPOSE OF THIS ARTICLE is to present a survey of the main mathematical techniques used by engineers today. The scope will be comprehensive, ranging from elementary concepts of algebra and arithmetic manipulations to the abstract formalisms of differential equations and theory of functions of a complex variable.

Algebra is essentially the manipulation of letters and symbols. For engineers such manipulations form a bridge between a conceptual or verbal problem definition and the definitive quantitative computations needed for problem solution.

The basic concept is the equation, a statement of equality of two quantities. The laws of nature are form of equation; manipulation of of equations to *solve* for the desired pertinent computational task. recognize the relationship of the equa-

# FREE

Reprints available

of this

18 Page Review

on

Practical Applications of

Mathematical Tools

By Dr. **RAYMOND S. BERKOWITZ**

Associate Professor  
Moore School of E. E.  
University of Pennsylvania  
200 So. 33rd Street  
Philadelphia 4, Pa.

by calculator.



A REPRINT OF THIS ARTICLE CAN BE OBTAINED  
by writing on company letterhead to  
The Editor  
ELECTRONIC INDUSTRIES  
Chestnut & 56th Sts., Phila. 39, Pa.

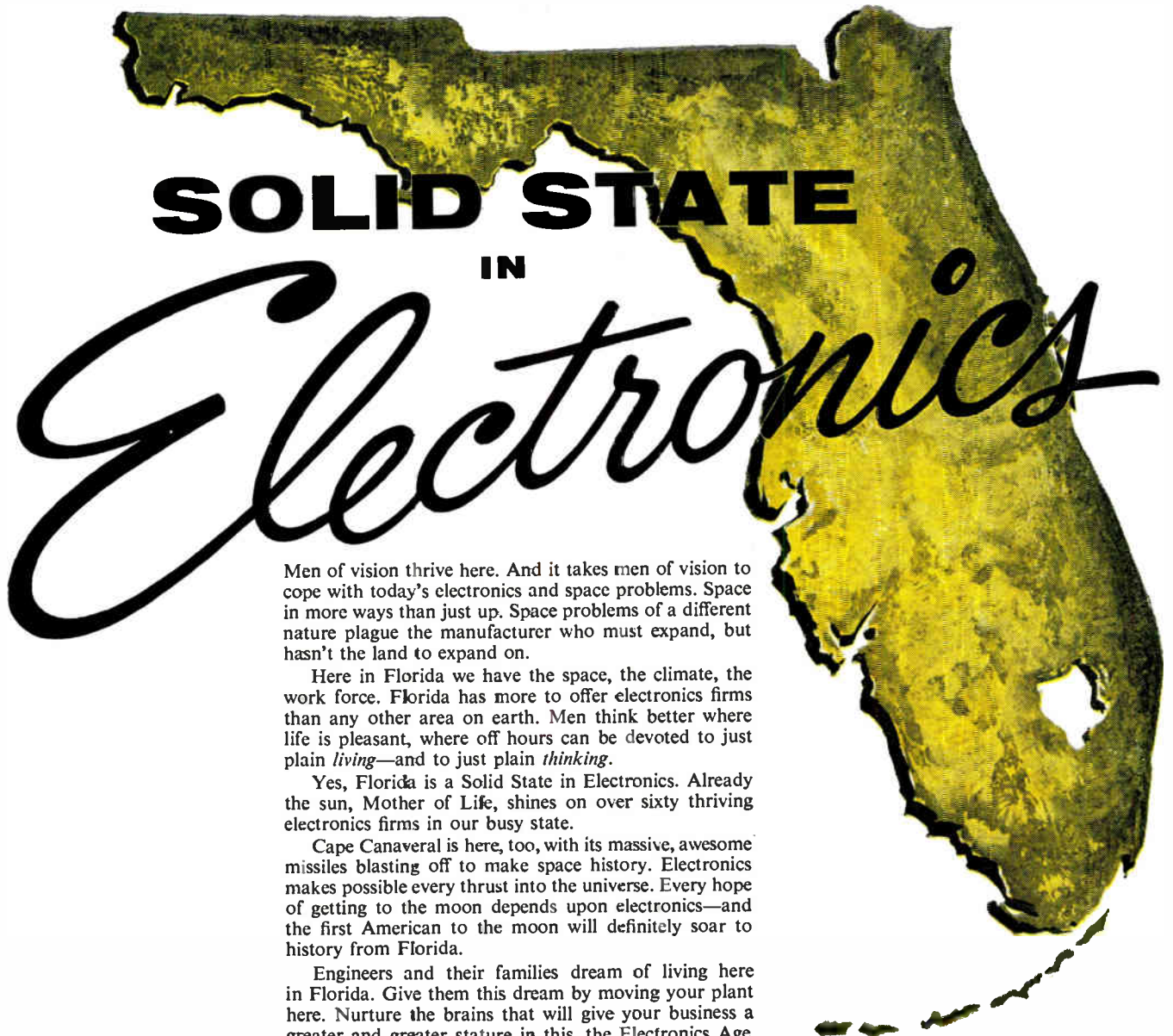

# SOLID STATE IN Electronics

Men of vision thrive here. And it takes men of vision to cope with today's electronics and space problems. Space in more ways than just up. Space problems of a different nature plague the manufacturer who must expand, but hasn't the land to expand on.

Here in Florida we have the space, the climate, the work force. Florida has more to offer electronics firms than any other area on earth. Men think better where life is pleasant, where off hours can be devoted to just plain *living*—and to just plain *thinking*.

Yes, Florida is a Solid State in Electronics. Already the sun, Mother of Life, shines on over sixty thriving electronics firms in our busy state.

Cape Canaveral is here, too, with its massive, awesome missiles blasting off to make space history. Electronics makes possible every thrust into the universe. Every hope of getting to the moon depends upon electronics—and the first American to the moon will definitely soar to history from Florida.

Engineers and their families dream of living here in Florida. Give them this dream by moving your plant here. Nurture the brains that will give your business a greater and greater stature in this, the Electronics Age.

For complete details of the many advantages Florida offers the Electronics Industry, write us. Let us tell you why some of the greatest names in electronics have impressive plants here in Florida.

## FLORIDA'S ASSURANCE POLICY

"You have my personal assurance of a sunny business climate here in Florida. You have positive assurance of every aid and assistance possible from our Florida Development Commission and from the overwhelming majority of our businessmen, industrialists, and financiers. We have everything to make your large or small enterprise healthy and successful. Write, wire, or phone us TODAY. The only thing better than a FLORIDA vacation is having your plant here."

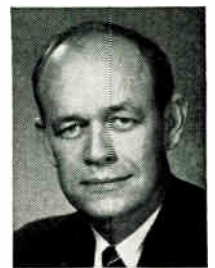

FARRIS BRYANT  
Governor

Investigate

# Florida

... A 12 BILLION DOLLAR MARKET

Ask about free film "Profile of Progress" FLORIDA FOR CONVENTIONS—Write for free information on Florida's wonderful facilities for your group meeting.

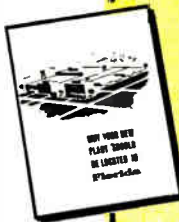

Mr. Wendell Jarrard, Chairman  
FLORIDA DEVELOPMENT COMMISSION  
Box 4321C • Tallahassee, Florida

Please send me brochure, "Why Your New Plant Should Be Located In Florida," containing the facts about FLORIDA's opportunities for New Industry, the 11 BILLION DOLLAR CONSUMER MARKET, Labor, Climate, Schools, Natural Resources, Favorable Tax Structure.

Name.....

Firm Name.....

Address.....

City.....Zone...State.....



The Hughes/NASA Syncom stands still at 6875 mph to talk to a billion people.

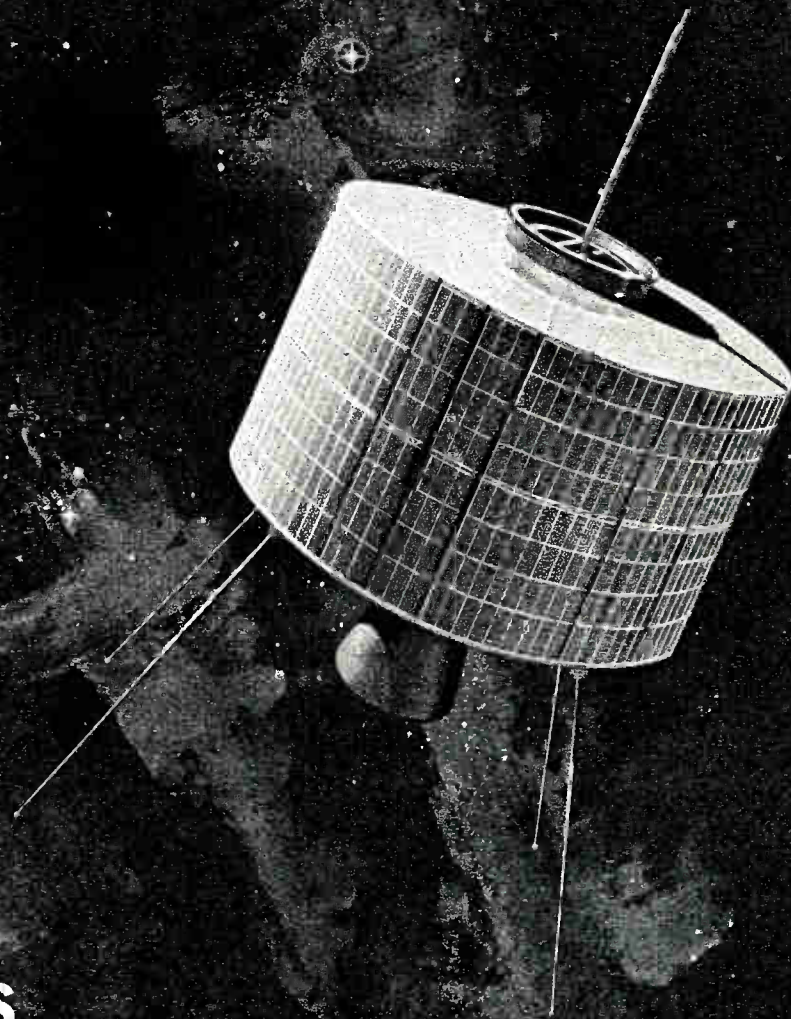

## **CIRCUIT DESIGNERS... is your appointment in space with Hughes?**

Today, Hughes is one of the nation's most active aerospace/electronics firms. Projects include: F-111B PHOENIX Guided Missile System, TOW Anti-Tank Missile, SURVEYOR Lunar Spacecraft, SYNCOM, VATE, ARPAT, POLARIS, Hard Point Defense and others. This vigor will assist the qualified engineers and scientists towards more and better opportunities for both professional and personal growth.

Many immediate openings exist. The engineers selected for these positions will be assigned to the following design tasks: the development of high power airborne radar transmitters, the design of which involves use

of the most advanced components; the design of low noise radar receivers using parametric amplifiers; solid state masers and other advanced microwave components; radar data processing circuit design, including range and speed trackers, crystal filter circuitry and a variety of display circuits; high efficiency power supplies for airborne and space electronic systems; telemetering and command circuits for space vehicles, timing, control and display circuits for the Hughes COLIDAR (Coherent Light Detection and Ranging).

If you are interested and believe that you can contribute, make your appointment today.

For immediate consideration, please airmail your resume to:

**Mr. Robert A. Martin**  
**Head of Employment**  
**Hughes Aerospace Divisions**  
**11940 W. Jefferson Blvd.**  
**Culver City 35, California**

*Creating a new world with electronics*

**HUGHES**

HUGHES AIRCRAFT COMPANY  
**AEROSPACE DIVISIONS**  
An equal opportunity employer.  
U. S. CITIZENSHIP REQUIRED



# NOW...SAVE UP TO 88% IN CAPACITOR SPACE...

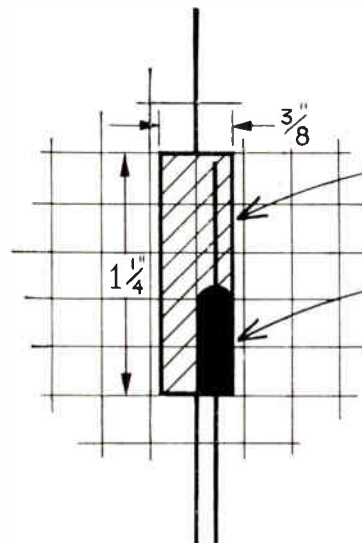

*Typical 50 µf 6V aluminum electrolytic capacitor in cross-section*

*Equivalent-rated Kemet Special C-Series solid tantalum capacitor (B1 case size)*

**C-Series Features:** Moisture-resistant, self-extinguishing epoxy cases • Ideally suited for welded module construction and point-to-point wiring • Extremely low leakage current, low dissipation factor, high capacitance stability • +85° C operation at full rated voltage • Capacitance range: .10 to 330 microfarads; 6 to 50 volts • Polar type

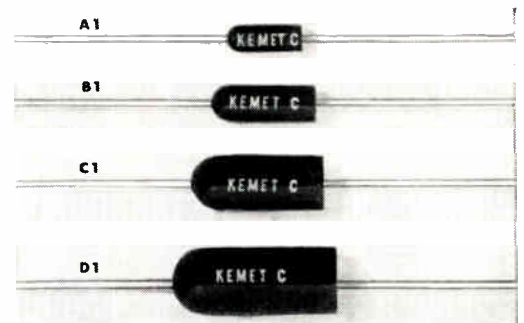

**...and outperform aluminum electrolytics... with low cost KEMET Special C-Series Solid Tantalum Capacitors!**

Here's a real breakthrough for circuit designers! You shrink circuit boards...you expand reliability to the *solid* tantalum level—thanks to our advanced production techniques. You get so much *more* with our lower-priced Special C-Series that it's now practical and economical to use them instead of aluminum electrolytics.

Get the facts. You'll agree the Special C-Series opens up a new approach to highly compact circuitry for many quality uses!

"Kemet" and "Union Carbide" are registered trade marks of Union Carbide Corporation



**ELECTRONICS**

Send coupon for complete data. (Check—attach to business letterhead)

**KEMET DEPARTMENT**  
 Union Carbide Corporation  
 Linde Division  
 11901 Madison Ave.  
 Cleveland 1, Ohio

Please send new technical bulletin No. 5 covering KEMET Special C-Series Solid Tantalum Capacitors

Have a representative call me

NAME \_\_\_\_\_

TITLE \_\_\_\_\_

41-1

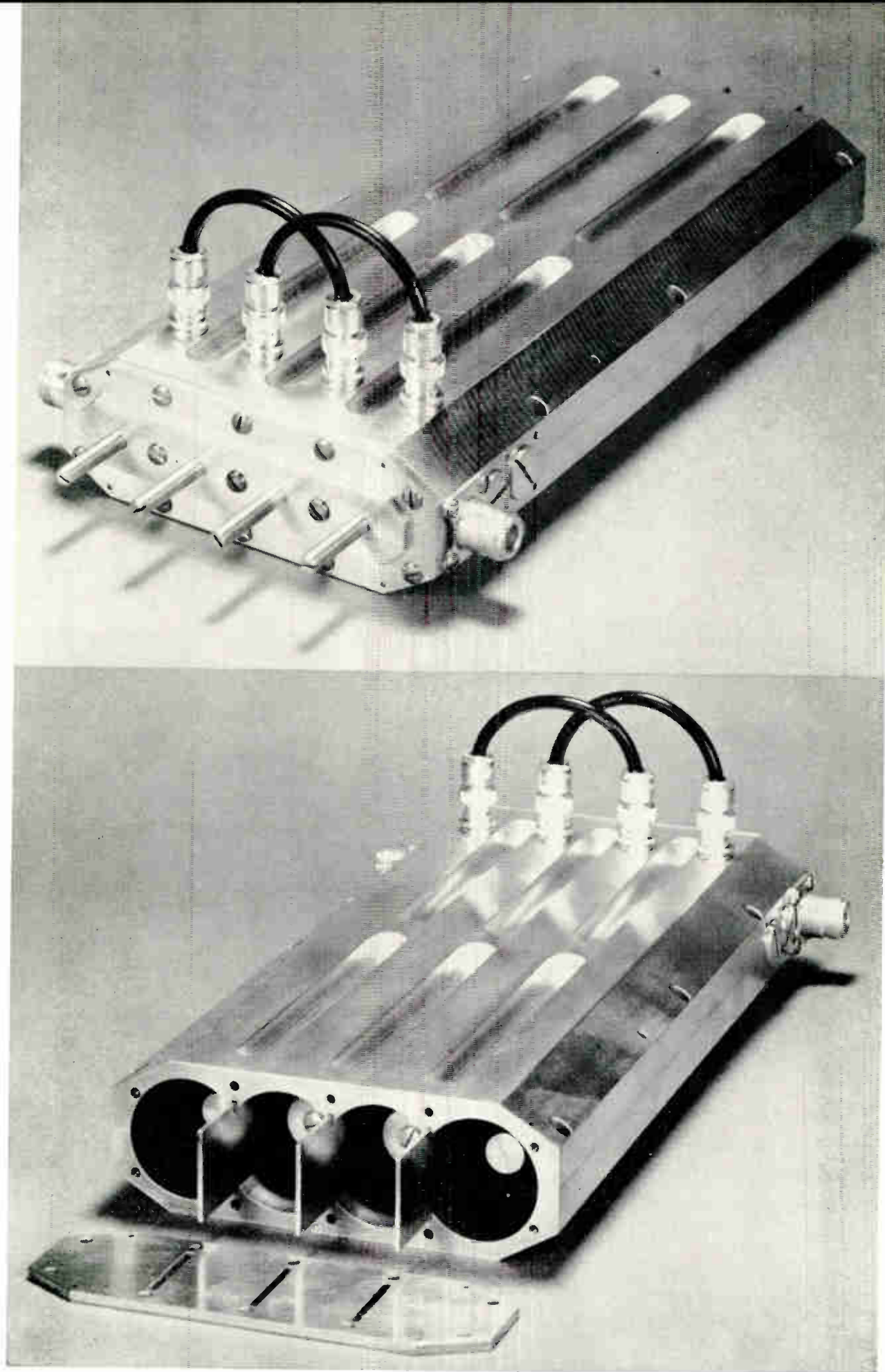

Spurious couplings in a bandpass filter can be deleterious or highly desirable.

Classical filter design omits spurious couplings, but this article brings them under control of the filter designer, providing him with another tool for general bandpass filter design.

IN BANDPASS FILTERS made of coupled resonant elements, with spurious couplings, the elements may consist of tuned circuits, line sections or cavities; or mixtures of these. Spurious couplings are all those among, but not between, adjacent resonant elements (resonators).

The bandpass filter, made of tuned circuits in cascade, is derived from the ladder network, Fig. 1a. The same matrix describes both networks, Figs. 1b and 1c. This matrix is shown in Eq. 1.

The derived coupled resonator filter, Fig. 1c, shows how the normal filter characteristic is altered when more spurious couplings are added. Three couplings can exist in the three-resonator filter and six in the four-resonator filter, Fig. 2.

Fig. 2 will deal only with the symmetrical case. Terminating resistances  $R$ , are the load and source resistances reflected into the end resonators by the usual coupling circuits. Normalization with respect to  $R$  will be used to produce "universal" curves. These curves describe characteristics of filters with spurious couplings.

These couplings may exist as unwanted results of an imperfect physical design or they may be introduced into a filter to achieve certain wanted characteristics not heretofore associated with filters of this type. From the analysis, it appears that the most significant result of those couplings is to add one or more peaks of attenuation near the pass band, similar to what can be obtained at the lower frequencies in an  $m$ -derived filter. Neglecting losses, these peaks approach infinite attenuation. They may be positioned along the frequency axis so as to increase the utility of this class of filter.

These couplings can be harmful or useful, depending upon their magnitude and phase. The points of infinite attenuation are predictable mathematically.

Experimental four-cavity filter with extra couplings introduced between alternate cavities. Filter plate has been removed (lower photo) to show tuning posts and sliding "gates" which adjust coupling between adjacent cavities.

NEW DEVELOPMENTS IN ...

## DESIGNING BANDPASS FILTERS

They may be placed close to the edge of the pass band in order, for example, to increase the slope of the filter skirt or to attenuate a certain frequency close to the pass band.

All coupling inductances have been expressed as fractions of the "normal" coupling inductances  $M$ . Reference will be made to " $g$ " and " $k$ " couplings to describe the couplings, Fig. 2. Thus " $g$ " and " $k$ " are the ratios of spurious to normal coupling inductances.

### Effects of Dissipation

Following Belevitch<sup>1</sup>, effects of uniform dissipation in each of the meshes may be taken into account by adding a small real term to frequency variable  $Y$ . In what follows,  $Y$  is the total mesh reactance normalized to the source and load resistance  $R$ . That is,  $Y = (\omega L - 1/C) / R$ . It will be seen that adding  $-jr / R$  to  $Y$  wherever it appears reduces the  $Q$  factor of all inductances in the filter from  $\infty$  to the value  $\omega L / r$ . Effects of dissipation have been taken into account in the input and output resonators since all dissipation in these may be considered to be lumped in the terminating resistances. Adding a small real term to the inductive reactances can be said then to affect only the center mesh, if the terminating resistors are readjusted accordingly.

### Triple Resonator Filter

This circuit, Fig. 2a, will exhibit the maximally flat characteristic for  $g = 0$  (no spurious couplings) when the coupling reactances,  $\omega_0 M$  are equal to the terminating resistance  $R$ . The transfer function has



By EINAR C. JOHNSON

Asst. Supt. Radio Div.  
U.S. Naval Air Development Center  
Johnsville, Pa.



## FILTER DESIGN (Continued)

been derived (Eq. 2) for the filter shown in Fig. 2a using these assumptions. Derivation of Eq. 2 will be found in App. I.

Both sides of the equation have been effectively divided by 4. This is needed if the transfer characteristic is to approach unity in the pass band (hence zero db). Further, if the filter were removed and the source  $e_1$  with internal resistance  $R$  were to be connected to the load resistance  $R$  then the maximum output voltage possible would be equal to  $e_1/2$ . Thus, the vertical axes of the graphs show insertion loss in db.

A single value of  $Y$  corresponds mathematically to

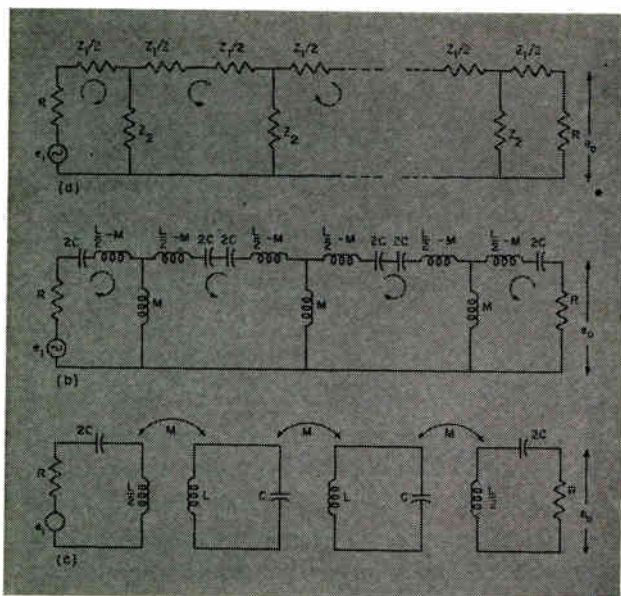
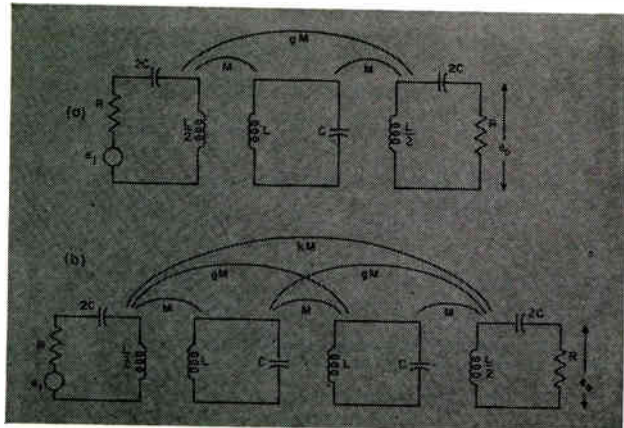

Fig. 1 (a): This recurrent ladder network becomes a bandpass filter when  $Z_1$  and  $Z_2$  are as shown in (b) middle figure. (b) Ladder network converted to bandpass filter. (c) Coupled resonator filter mathematically equivalent to (b) bottom figure.

Fig. 2a: Three resonator filter with spurious coupling between input and output resonators. Three couplings can exist here. (2b) Four resonator filter with three spurious couplings. Six couplings can exist here. Fig. deals only with the symmetrical case.



two values of  $\omega = 2\pi f$ , one of which is  $(-)$  so that only the  $(+)$  value has physical significance. The value of angular frequency corresponding to any value of  $Y$  may be obtained from Eq. 3.

Eq. 2 has been plotted in Fig. 3 for various values of " $g$ ," expressing attenuation or insertion loss in db. Poles of the transfer function occur for zeros of the denominator in Eq. 2, thus where  $Y = 1/g$ . This will be clear from the graphs of Fig. 3. These also show that introducing the infinite attenuation peak degrades the skirts on the opposite side of the pass band from the peak. Also, the peak is associated with a slump in attenuation on the side of the peak farthest from the pass band similar to the  $n$ -derived characteristic. The "normal" filter characteristic (no spurious couplings) for three resonators is shown by the solid line in Fig. 3. Putting  $g = 0$  in Eq. 2 yields the maximally flat or Butterworth characteristic (Eq. 4).

If the sign of " $g$ " is chosen as  $(-)$  in Eq. 2, the curves of Fig. 3 still apply if the sign of  $Y$  along the abscissa is changed. The new curves become mirror images of the curves shown.

Eq. I(3) in App. I gives the phase angle between input and output voltages for the three resonator filter. Phase plots are not given here, as only magnitude is of interest to the filter designer.

### Quadruple Resonator Filter

The transfer function of the quadruple resonator filter has been derived in App. II and is shown in Eq. 5. The filter circuit is shown in Fig. 2b.

The denominator of Eq. 5 is of second degree, hence two poles of the transfer function exist. These are found in App. II to occur where Eq. 6 is satisfied.

When  $k$  is  $(+)$ , the poles will lie on the real frequency axis if  $k = g^2 + 1$ . When  $k$  is  $(-)$ , the poles fall on the real frequency axis. Poles lie on the real frequency for  $k = 1$  and for  $k = g^2$  also (for any value of  $g$ ).

Changing the sign of  $g$  in Eq. 5, and simultaneously changing the sign of  $Y$  leaves no effect upon the attenuation magnitude but the sign of the argument is changed in Eq. II(2) in App. II.

When  $k$  is zero in Eq. 5, only a single peak of infinite attenuation may exist as shown in App. II, Eq. II(5) where Eq. 7 is satisfied.

Thus it is clear that for finite  $k$ , two points of infinite attenuation may exist; while for  $k$  zero, only one point may be found at finite frequencies. These facts are brought out in the plots of Eq. 5 in Figs. 4 through 7 for the four resonator filter.

Fig. 4 compares characteristics of four-resonator

filters having values of "g" couplings with  $k = 0$ . The solid line is the "normal" filter. Effect of "g" couplings is similar to the results obtained with the three resonator filter. Changing the sign of  $g$  will place the infinite attenuation peaks on the opposite side of the pass band. Thus the attenuation peaks can be changed at will in relation to the pass band. In the four resonator filter the minimum value of  $Y$  at which the attenuation peak occurs is unity. As the "g" couplings are increased, the peak of infinite attenuation moves in toward unity  $Y$  and, as  $g$  increases further, the attenuation peak retreats from the center of the pass band. This effect is shown in Fig. 8.

Effects on the filter characteristic curves of changing the relative sign between  $g$  and  $k$  is shown in Fig. 5. This plot should be examined in the light of Fig. 9. Fig. 5 shows that two peaks are possible; or, if unsuitable values of  $g$  and  $k$  are chosen, one may actually degrade the filter curve at all points outside the pass band. When two infinite attenuation points exist, they will be on opposite sides of the pass band in a manner suggesting potential practical application.

Fig. 6 and 7 show the effect on the filter characteristic when "k" coupling is present with no "g" coupling. The curves show that two attenuation peaks are obtained for negative "k", symmetrically disposed about the center of the pass band and that the skirts near the pass band are steeper than the normal filter characteristics. However, for positive "k" there is a degradation of characteristics. When "k" is increased, the two infinite attenuation peaks move closer together and remain symmetrical in relation to the center of the pass band. However, the slump outboard of the attenuation peaks becomes aggravated. Thus "k" couplings, without "g" couplings present, appear also to warrant further study in practical filters.

### Experimental Results

Some practical results have been obtained in the lab with three and four resonator filters using "g" couplings in an otherwise normally adjusted filter. Figs. 10 and 11 show the results obtained with two three-resonator filters having a midband frequency of 20mc using commercially available slug-tuned coils and mica capacitors. Filters were adjusted for maximal flatness and then "g" coupling was introduced between the first and third resonator. The attenuation peak, increased skirt steepness on the peaked side of the pass band and the post peak slump are clearly in evidence. No tests have been made at

Fig. 3: Triple resonator filter characteristics showing effect of various amounts of spurious "g" couplings.

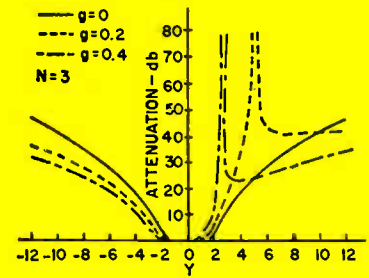

Fig. 4: Quadruple resonator filter characteristics showing effects of various amounts of "g" couplings. No "k" coupling is present.

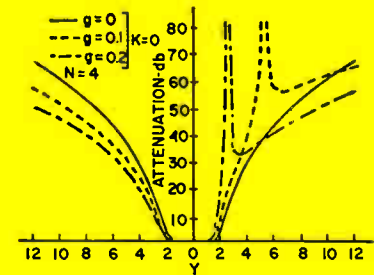

Fig. 5: Quadruple resonator filter characteristics showing effects of various amounts of "k" coupling with a constant value of "g" couplings.

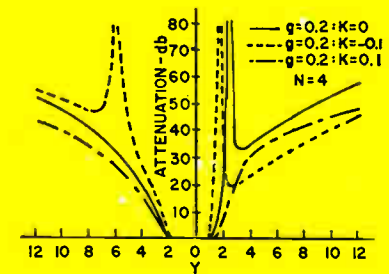

Fig. 6: Quadruple resonator filter characteristics showing effect of changing the sign of the "k" couplings in the absence of "g" couplings.

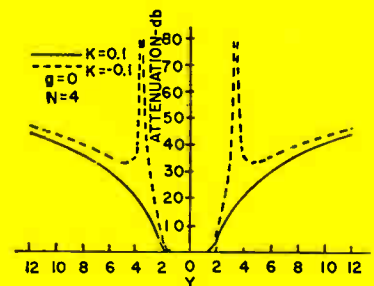

Fig. 7: Same as Fig. 6 but with the value of "k" increased.

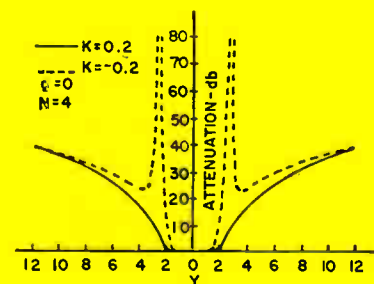
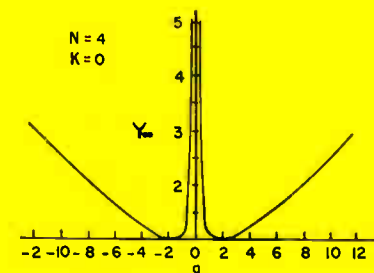

Fig. 8: Graph shows effects of "g" couplings on the value of Y at which infinite attenuation occurs. Quadruple resonator filter, no "k" coupling.



## FILTER DESIGN (Continued)

microwaves where the available unloaded  $Q$ 's of cavities should permit even closer matching of the theoretical curves. There is a difference in symmetry between the  $Y$  plots and plots of frequency versus db as is seen by looking at Eq. 6.

An infinite variety of possible characteristics can be obtained when spurious couplings come under control of the filter designer. However, only a few appear to be useful. The fact that couplings can exist in what is thought to be a properly designed filter make it interesting enough to explore some of the possible filter characteristics which can be produced. This will tell whether these couplings are present to an appreciable degree and so point the way to possible cures. It will also guide the design

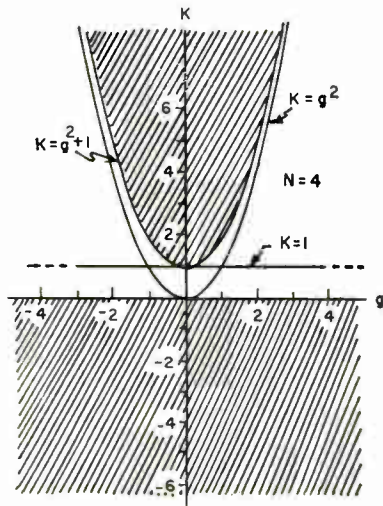

Fig. 9: Showing permissible values of  $k$  and  $g$  to obtain peaks of infinite attenuation on the real frequency axis. Permissible values are those falling on the curves  $k=1$ ,  $k=g^2$  as well as all values falling in shaded areas or their boundaries.

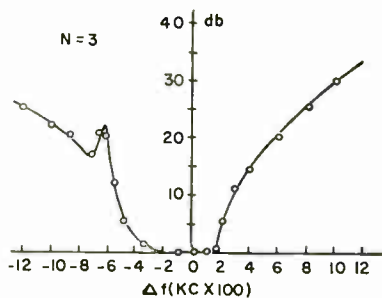

Fig. 10: Experimental result showing effect of "g" coupling in a triple resonant circuit filter. Reference frequency is 20 MC.

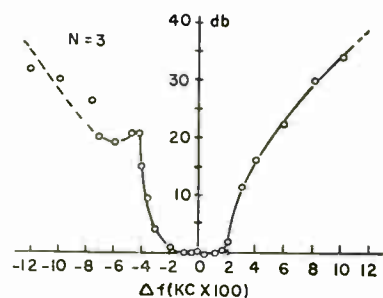

Fig. 11: Same filter as Fig. 9, adjusted for narrower bandwidth. Reference frequency is 20 MC.

Fig. 12: Possible configuration to introduce "g" couplings into a four-cavity filter. Solid lines represent normal cavity filter couplings showing coupling holes. Broken lines show additional holes to introduce "g" couplings. Couplings are adjusted by pruning holes.

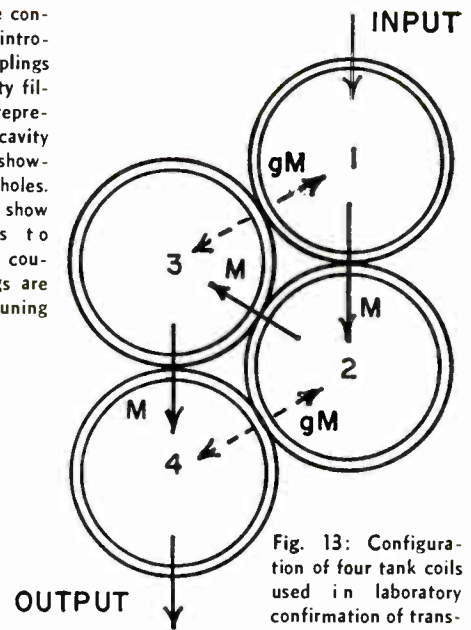
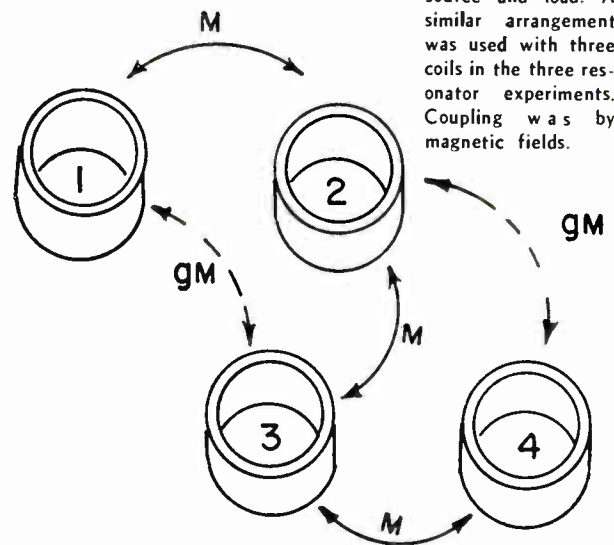

Fig. 13: Configuration of four tank coils used in laboratory confirmation of transfer function poles. Link couplings were used to couple to source and load. A similar arrangement was used with three coils in the three resonator experiments. Coupling was by magnetic fields.



of filters with deliberately introduced spurious couplings for the sake of their desirable effects.

Fig. 12 shows a possible physical configuration of a four-cavity filter arranged to permit "g" couplings. Fig. 13 shows the manner used in the laboratory to obtain "g" couplings in a four-tank circuit filter. The coils were positioned in slots in a base plate.

A more detailed derivation of a more general solution of the 3- and 4-resonator filters can be found in the literature.

The maximally flat characteristic is obtained in the three resonator filter as shown in Fig. 2a. However, for the four resonator filter, grading of the couplings must be used to achieve this condition. In another paper, this author shows that the coupling reactances  $\omega_0 M_{12}$  and  $\omega_0 M_{34}$  (where  $M_{12}$  and  $M_{34}$  are





# Variac<sup>®</sup>

continuously adjustable autotransformers

## ... Hundreds of Models for Thousands of Uses

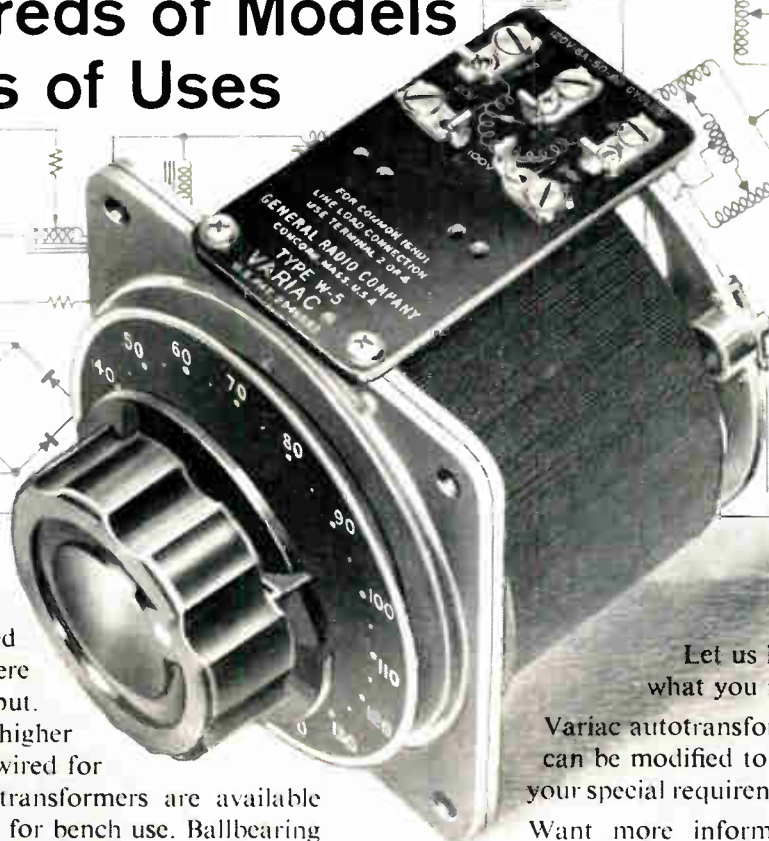

Variac autotransformers are designed in 2-, 5-, 8-, 10-, 20-, 30-, and 50-ampere sizes with either 120-, or 240-volt input. They can be used singly, ganged for higher power with ratings up to 54 kva, or wired for polyphase applications. Variac autotransformers are available cased, uncased, or in portable models for bench use. Ballbearing and motor-driven types can be provided for servo or remote-positioning applications. High-frequency (350- to 1200- cycle service) models are also available. All Variac models have DURATRAK<sup>®</sup> brush contact surfaces to extend life and allow units to withstand initial surge currents up to 10 times rated values.

Duratrak Contact Surface — Patent No. 2,949,592

Let us know what you need:

Variac autotransformers can be modified to meet your special requirements.

Want more information about uses? Write for your free copy of the "Handbook of Voltage Control," a 40-page manual full of theory, applications, and circuits for variable autotransformers.

## GENERAL RADIO COMPANY

WEST CONCORD, MASSACHUSETTS

IN CANADA: Toronto 247-2171, Montreal (Mt. Royal) 737-3673  
IN EUROPE: General Radio Overseas, Zurich, Switzerland

NEW YORK, N. Y., 964-2722  
(Ridgefield, N. J.) 943-3140

CHICAGO  
(Oak Park) 848-9400

PHILADELPHIA, 424-7419  
(Abington) 887-8486

WASHINGTON, D. C.  
(Rockville, Md.) 946-1600

SYRACUSE  
454-9323

DALLAS  
FL 7-4031

SAN FRANCISCO  
(Los Altos) 948-8233

LOS ANGELES  
469-6201

ORLANDO, FLA.  
425-4671

CLEVELAND  
886-0150

Circle 38 on Inquiry Card

For Military and Commercial Applications

## Grayhill Miniature Rotary Tap Switches



These switches are designed to meet military and commercial specifications and ruggedly built to precision standards.

Grayhill No. 5000, No. 12, and No. 24 Series. 1.01" dia. Break 1 amp., 115 VAC, resistive. Carry 5 amps. 1 to 10 decks, 2 to 10 positions per deck—1 or 2 poles per deck—shorting or non-shorting. Life 100,000 cycles. Also No. 24 Series, spring return switch.

Concentric Shaft. No. 6 (1 to 3 decks per shaft—Total 6 decks) and No. 36 Series (1 or 2 decks per shaft. Total 4 decks). 1.01" dia. 2 to 10 positions per deck. Break 1 amp., 115 VAC, resistive. Carry 5 amps. Two switches in one. 1/4" shaft controls 1/2 of the decks, 1/8" shaft controls the other half.

No. 45 Series Midget. .640" dia. Single deck only. 60° indexing. Break 1 amp., 115 VAC, resistive. Carry 5 amps. Life 100,000 cycles.



✓ Switch  
✓ Test  
✓ Connect with GRAYHILL



"N. Gineer"

Grayhill offers a full line of Rotary Tap Switches, Push Button Switches, Test Clips, Binding Posts, and other miniature electrical and electronic components.

ASK FOR CURRENT CATALOG.



Phone: Fleetwood 4-1040  
543 Hillgrove Avenue  
LaGrange, Illinois

"PIONEERS IN MINIATURIZATION"

## FILTER DESIGN (Concluded)

Let  $M_{12} = M_{23} = M_{34} = M$ ;

$M_{13} = M_{24} = gM$ ;  $M_{14} = kM$ ; and  $\omega M = R$ .

The impedance matrix of Fig. 15 is:

$$\bar{Z} = R \begin{bmatrix} 1 + jY/2 & j & jg & jk \\ j & jY & j & jg \\ jg & j & jY & j \\ jk & jg & j & 1 + jY/2 \end{bmatrix}$$

The voltage matrix is:

$$\bar{e} = \begin{bmatrix} e_1 \\ 0 \\ 0 \\ 0 \end{bmatrix}$$

And in the same manner as used previously for the three circuit case we obtain from  $\bar{i} = (\bar{Z})^{-1} \bar{e}$  the current in the ast resonator,  $i_3$ . And as  $e_o = i_3 R$  there results:

$$e_1/2 e_o = - \left[ \frac{Y^3 + aY + b}{W} \right] - j \left[ \frac{cY^4 + dY^2 + qY + t}{W} \right] \quad \text{Eq. II (1)}$$

Where:

$$a = -(3 + 2g^2)$$

$$b = 4g$$

$$c = 1/4$$

$$d = -(2.250 + g^2 + k^2)$$

$$q = 2g(1 + 2k)$$

$$t = 1 + (1 - k)^2 + (1 - g^2)^2 - (1 + 2g^2k)$$

$$W = 2 [kY^2 - 2gY + (1 + g^2 - k)]$$

The relative phase angle between input voltage  $e_1$  and output voltage  $e_o$  is:

$$\text{Phase angle} = \arctan \left[ \frac{cY^4 + dY^2 + qY + t}{Y^3 + aY + b} \right] \quad \text{Eq. II (2)}$$

And the magnitude is:

$$|e_1/2e_o|^2 = \left[ \frac{Y^3 + aY + b}{W} \right]^2 + \left[ \frac{cY^4 + dY^2 + qY + t}{W} \right]^2 \quad \text{Eq. II (3)}$$

Where the same notations apply as in Eq. II(1).

Two poles exist for Eq. II(3). These are obtained from the roots of  $W = 0$  which yields:

$$Y_\infty = \frac{g}{k} \left[ 1 \pm \sqrt{1 - k(1 + g^2 - k)/g^2} \right] \quad \text{Eq. II (4)}$$

When  $k$  is zero:

$$Y_\infty = (1 + g^2)/2g \quad \text{Eq. II (5)}$$

A REPRINT OF THIS ARTICLE CAN BE OBTAINED  
by writing on company letterhead to  
The Editor  
ELECTRONIC INDUSTRIES  
Chestnut & 56th Sts., Phila., Pa. 19139

**NUMBER ONE IN ELECTRICAL CONNECTORS...**



# **2 OUTSTANDING CANNON® PLUG SERIES MEETING REQUIREMENTS OF MIL-C-26482C**

## **KPT SOLDER POT**

- SMOOTHER ENGAGEMENT AND SEPARATION FORCES, INHERENTLY PERFORMING IN A NARROWER RANGE, PROVIDED BY A REVOLUTIONARY BOWSPRING\* SOCKET CONTACT DESIGN.
- HIGHLY CONDUCTIVE LEADED-COPPER, PROBE-PROOF, CLOSED-ENTRY SOCKET CONTACT HAS LOWER MILLIVOLT DROP.
- LOWER COUPLING FORCES REQUIRED ON THE CANNON QUICK CONNECT-DISCONNECT BAYONET LOCK.
- SUPERIOR INSULATORS COMPLETELY MANUFACTURED AND QUALITY-CONTROLLED BY CANNON.
- AVAILABLE IN 7 SERVICE TYPES—7 SHELL STYLES.
- SIZES 8 THRU 24; 2 TO 61 CONTACTS.
- ACCOMMODATES AWG SIZE 26 THRU 16 WIRE.
- 5-KEY POLARIZATION PREVENTS CROSS PLUGGING.
- HIGH STRENGTH IMPACT EXTRUDED HOUSINGS.
- AVAILABLE FOR QUICK DELIVERY THRU CANNON AUTHORIZED DISTRIBUTORS.



## **KPTM CRIMP TYPE**

- IMPROVED RELIABILITY BECAUSE OF SIMPLE ONE-PIECE MOLDED INSULATOR/GROMMET CONSTRUCTION—DUAL SHORE\* OF SPECIALLY COMPOUNDED POLYCHLOROPRENE RUBBER.
- HIGHLY CONDUCTIVE LEADED-COPPER, PROBE-PROOF, CLOSED-ENTRY CONTACT HAS LOWER MILLIVOLT DROP PLUS MEETS REQUIREMENTS OF MIL-C-23216.
- INTEGRALLY-MOLDED POSITIVE STOP PREVENTS CONTACT OVER-INSERTION.
- DUAL SHORE INTEGRALLY-MOLDED INSULATOR/GROMMET FOR DEPENDABLE SEALING OF CONTACTS.
- RAISED BARRIERS AROUND EACH PIN, MATING WITH LEAD-IN CHAMFER AROUND SOCKET, PROVIDE INDIVIDUAL INTERFACIAL CONTACT SEALING.
- REAR HARDWARE FOR KPT/KPTM COMPLETELY INTERCHANGEABLE.
- SEALED IN TRANSPARENT, ENVIRONMENTAL PROOF BAG, WITH COMPLETE ASSEMBLY INSTRUCTION; CONTACTS, WITH SPARES, AND SEALING PLUGS PROTECTED IN SEPARATE VIAL.

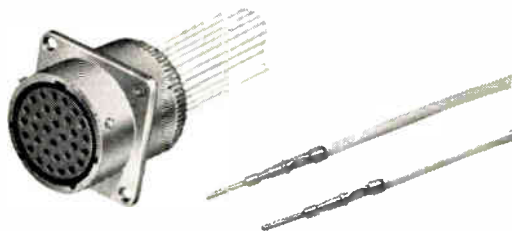

WHETHER YOUR REQUIREMENTS ARE FOR MIL-C-26482C (NAVY) SOLDER POT OR CRIMP TYPE, SPECIFY CANNON, THE WORLD'S LARGEST AND MOST EXPERIENCED MANUFACTURER OF ELECTRICAL CONNECTORS. FOR COMPLETE INFORMATION, WRITE TO:



**CANNON ELECTRIC INC.**

3208 Humboldt Street, Los Angeles 31, California



**A SUBSIDIARY OF INTERNATIONAL TELEPHONE AND TELEGRAPH CORPORATION**

\*TRADEMARK OF ITT CANNON ELECTRIC INC. \*\*CANNON\*\* IS A TRADEMARK REGISTERED IN U.S. PAT. OFF. AND IN OTHER COUNTRIES BY ITT CANNON ELECTRIC INC. © 1964 ITT CANNON ELECTRIC INC.



# NEW PRODUCTS

... For the Electronic Industries

## HERMETIC CONNECTORS

*Hermetic electrical connectors have bussed contacts.*



Bussing the contacts enables standard configuration min. connectors to be used in applications where multiple conductors are common, or where high current is carried. All models use high-compression glass inserts that are guaranteed to less than 0.2 micron cu. ft./hr. at 30 psi differential. Contact identification is permanently imbedded in the glass. They withstand pressures in excess of 1000 psi, temp. to 500°F, and are available in a variety of finishes. The Deutsch Co., Electronic Components Div., Municipal Airport, Banning, Calif.

Circle 100 on Inquiry Card

## TIME-MARK GENERATOR

*Provides marker intervals from 1μsec through 5 sec. intervals.*

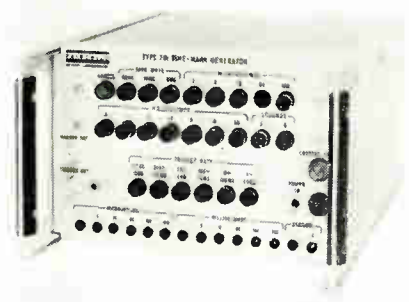

Type 781 is a transistorized time-mark generator. It can be rack or bench mounted. Intervals are 1, 5, 10, 50, 100, and 500μsec.; 1, 5, 10, 50, 100, and 500msec.; and 1 and 5 sec. Rise time is 70nsec. max. at 1μsec. and 500nsec. max. at 5 sec. Sine-wave outputs are 5mC, 10mC, and 50mC. Trigger-pulse repetition rate of 1: 10: 100: 1000: and 100,000 pps. Du Mont Laboratories, div. of Fairchild Camera and Instrument Corp., Clifton, N. J.

Circle 101 on Inquiry Card

## PROGRAMMABLE AC RATIO BOX

*7-digit unit has full ± ratio range and 1.0ppm accuracy.*



The PRB-507T programmable inductive ratio box uses crystal-can relays. Operable from punched cards or tape, it switches in any ratio in the 1.111110 to -1.111110 range with 7-digit resolution. An inverting isolation transformer, which is also programmed by relays, selects the desired positive or negative ratio. A 5 msec. setup time for any ratio permits high-speed operation in automatic checkout apparatus requiring ratios with accuracies of 1 ppm. It operates from 50 to 10kc. North Atlantic Industries, Inc., Plainview, N. Y.

Circle 102 on Inquiry Card

## NAVIGATION INSTRUMENT

*Provides precision range indication of up to 999.8 nautical miles.*



The AIN-102A digital indicator is for distance measuring systems. It is suitable for presentations from DME, doppler radar, and other distance-measuring systems having maximum ranges of less than 1000 miles. The indicator contains 3 synchro repeaters with geared drives to each of 3 independent counter drums. These drums have white numerals on black backgrounds and are illuminated. International Telephone & Telegraph Corp., Nutley, N. J.

Circle 103 on Inquiry Card

## LOGIC DIODES

*For circuits at 50kc or less and diode-capacitor memory.*



The 6RS17D series are high current, high-capacitance units rated 1ma at 1v. The 6RS11D series are low-capacitance units rated 60μa at 1v. Both types are housed in the two, four, or six cell package. Characteristics for 6RS17D: reverse, 2μa @ 12v (20v max.); capacitance, 100-225μmf @ 1mC; forward surge, 20ma; PRV, 100v peak; for 6RS11D: reverse, 1μa @ 12v (20v max.); capacitance 15-40μmf @ 1mC; forward surge, 10ma; PRV, 100v peak. General Electric Co., Rectifier Components Dept., W. Genesee St., Auburn, N. Y.

Circle 104 on Inquiry Card

## CHOPPER TRANSFORMER

*½ primary impedance 10K/2.5KΩ; secondary impedance 50KΩ.*

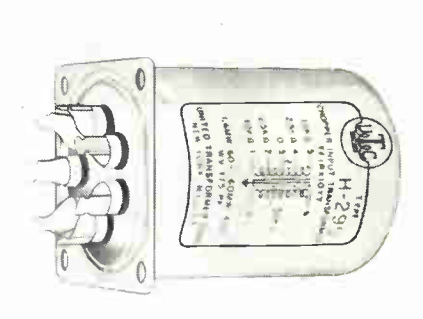

The H-295 chopper transformer is hermetically sealed and manufactured and guaranteed to the new Mil-T-27B specs. Electrical parameters: 60-400 cycles; turns ratio ½ primary to secondary is 2.2/4.4; max. voltage ½ primary: 60 cycles 4/2, 400 cycles 24/12; min. primary inductance is at 1v. 60 cycles 200/50 Hys; primary resistance is 1300/650Ω; secondary resistance is 1900Ω. United Transformer Corp., 150 Varick St., New York 13, N. Y.

Circle 105 on Inquiry Card

Production at  
20,000 psi on  
new Semi-Automated  
Isostatic Press.

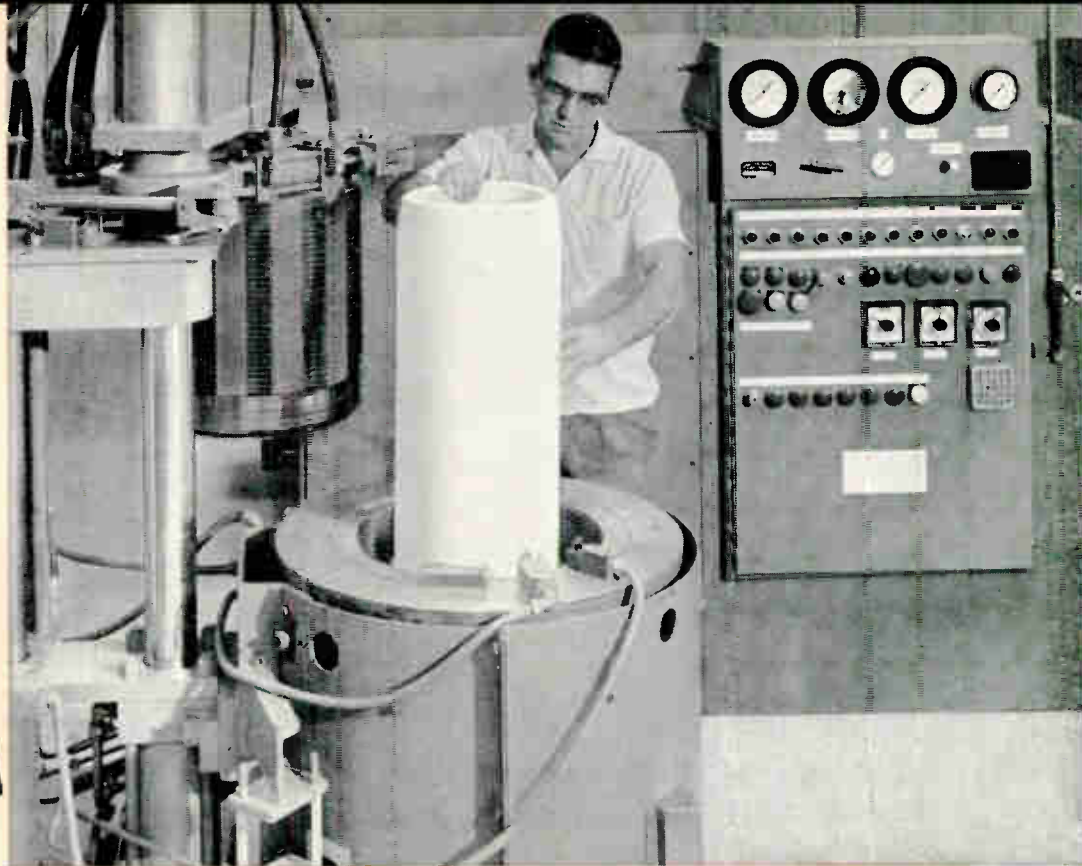

**PROGRESS  
REPORT**

## **ALSiMAG<sup>®</sup> again pioneers with ISO at 20,000 PSI, semi-automated**

### **NEW PRODUCTION FACILITY FOR CERAMICS WHICH:**

- Are large.
- Require maximum density.
- Have certain interior configuration.
- Require great precision in I.D.
- May be fabricated in several ceramic compositions including the high content aluminas.

Inquire for Chart 631

### **EXAMPLES ARE:**

- Radomes.
- Vacuum tube envelopes.
- Microwave windows.
- Antenna insulators.
- Pump plungers.
- Calendar rolls.
- Hold-down bars.

Isostatic presses which form at 20,000 psi at production rates now turn out ALSiMag ceramics of marked uniformity. The specific gravity of these ceramics indicates the better compacted material.

Large ceramics and ceramics with certain internal configuration or those which require great accuracy on internal diameters are usually formed most advantageously by isostatic pressing. In the past there have been certain limitations on this process. Most producers have been limited to around 6,500 psi and production runs have often been rather tedious. The new semi-automated

equipment gives higher production at 20,000 psi and marks a substantial advance.

While equipment pictured is capable of handling ALSiMag ceramics as large as 15"x24", other equipment accommodates multiple set-ups for smaller parts and brings the advantages of 20,000 psi forming pressure and semi-automated production to a wide range of those designs which can best be produced by the isostatic method.

If you will send us your blueprints and outline your requirements, our engineers will be glad to make suggestions.

**American Lava Corporation**

PHONE 265-3411, CHATTANOOGA 5, TENN.

A SUBSIDIARY OF

**3M**  
COMPANY

For service, contact American Lava representatives in Offices of Minnesota Mining and Manufacturing Co. in these cities (see your local telephone directory): Boston: Needham Heights, Mass. • Chicago: Bedford Park, Illinois • Cleveland, Ohio  
Birmingham, Mich. • Laurens, S. C. • Los Angeles, Cal. • Minneapolis, Minn. • Metropolitan New York: Ridgefield, N. J.  
Up-State New York: Newark, N. Y. • Philadelphia, Pennsylvania • Richardson, Texas • South San Francisco, California  
All export except Canada: Minnesota Mining and Manufacturing Co., International Division, 99 Park Ave., New York, N. Y.

Circle 42 *World Radio History*

62nd  
YEAR  
OF  
CERAMIC  
LEADERSHIP



# NEW—THERMA-LINK RETAINERS for YOUR VALUE-ENGINEERED REQUIREMENTS...

Twenty new IERC Therma-Link transistor retainers and heat dissipators are now available. They let you select the lowest-cost combination of mounting, insulation and degree of thermal control you need. There are also five different finishes for space and other environments to choose from. The Therma-Link design provides a wide variety of ways to mount, retain and cool TO-18, TO-5 and TO-8 transistors on heat sinks and printed circuit boards.

Therma-Link retainers typify the continuous additions and improvements to our complete line of heat dissipators—assuring you of greatest value at lowest cost.

*std. Therma-Link-*



*rivet or solder mount*

*with BeO washer-*



*for solder mounting*

*with stud mount-*



*w/wo BeO washer*

*screw mount-*



*use w/wo BeO washer*

## IERC DIVISION

### INTERNATIONAL ELECTRONIC RESEARCH CORPORATION

*a subsidiary of Dynamics Corporation of America*

COMPLETE CATALOG and data on IERC Therma-Link retainers will help you select the best price-to-performance combination you need. Write: IERC Division, 135 W. Magnolia Blvd., Burbank, Calif.

Patented and Patent Pending.



## NEW PRODUCTS

### TRAINING AIDS

*Training time can be reduced 75% and production time 50%.*



The 8 programs and models 102B or 202 Videosonic machine may be used by any electronic manufacturer. The programs, which may also be purchased individually, cover the use and care of small tools, assembly soldering, etched card assembly, component installation, wire installation and dress, harness build and lace, and rework techniques. Hughes Aircraft Co., Videosonic Div., Fullerton, Calif.

Circle 115 on Inquiry Card

### SPECIAL OSCILLATOR

*Covers the freq. from 2 to 2000-cps. Output impedance from 6-6KΩ.*

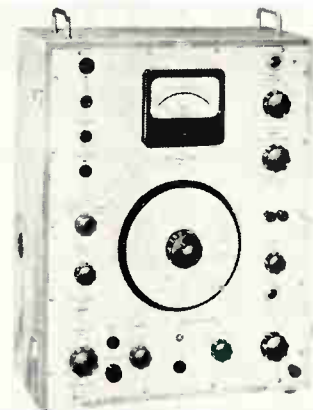

The Model 1017 is a beat-frequency oscillator designed for freq. response and linear measurements in acoustical, electro-acoustical, electronic, and vibration tests. The instrument covers three decades on a large, illuminated, true logarithmic freq. scale. The frequency can be swept continuously—either manually or mechanically—by an external motor drive. Output voltages are from 120μv to 120v full scale. A built-in VTVM shows the RMS signal level at the output terminals. B & K Instruments, Inc., 3044 W. 106th St., Cleveland 11, Ohio.

Circle 116 on Inquiry Card



# NEW PRODUCTS

## HIGH-PRESSURE TRANSDUCER

*Accuracy better than 1%. Ranges from 0-500 to 0-10,000 psi*



The Model 2101 is for absolute or gage-pressure measurement. It combines the effects of linearity, hysteresis, friction, resolution and repeatability. Its high-level ac or dc output can be used for telemetry, control, and actuating systems without further amplification. Specs.: resistance, 2K, 5K, 7.5K and 10K ( $\pm 5\%$ ); resolution, 0.5%; and response time, 10msec. to 63% of applied step. Servonic Instruments, Inc., a subs. of Gulton Industries, 1644 Whittier Ave., Costa Mesa, Cal.

Circle 120 on Inquiry Card

## NIXIE TUBE DRIVERS

*High-density drivers mount directly on tube sockets.*



These 2 Nixie® tube drivers are available in both round and rectangular packs for use with corresponding Nixie tube types. The BIP-8500 and BIP-8501 contain 10 transistors connected in a common emitter configuration and are designed to operate tubes from low-level input signals. The BIP-8200-8203 are binary coded decimal-to-decimal decoders designed to operate tubes directly from 8-4-2-1 binary-coded decimal information. Burroughs Corp., Electronic Components Div., Plainfield, N. J.

Circle 122 on Inquiry Card

## COAXIAL SWITCH

*Internal generator activates switching without an external sync signal.*



The Mega-Switch model KMC 255B is used with a CRO to produce simultaneous displays of 2 related waveshapes. It can be used to superimpose a calibrating reference line on the freq. response display, or to switch in a reference standard to establish tolerance limits. Freq. range is dc to 1Gc. Specs.: vswr, dc-1Gc-1Mc-less than 1.5:1; 500Mc-1Gc-less than 1.4:1; switching rate with external sync, 0.2 to 100cps; with internal sync, 0.5-100cps; impedance 50 $\Omega$ . Kay Electric Co., 14 Maple Ave., Pine Brook, N. J.

Circle 124 on Inquiry Card

## DC-DC SOLID STATE RELAY

*The SPST configuration is actuated by 6-12vdc at 100ma max.*

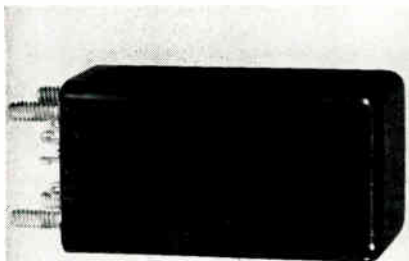

Model 2200 is capable of switching 25 ma to 1a at 50vdc, depending on ambient temp. Forward voltage drop is 2v at 25°C. In off position leakage current is 2 $\mu$ a at 25°C with a load of 50 vdc. There are no moving contacts; contact bounce, contamination, and wear are completely eliminated. Life is virtually unlimited if operated within specs. Max. switching rate is 100cps under full load conditions. Hi-G Inc., Bradley Field, Windsor Locks, Conn.

Circle 121 on Inquiry Card

## CONCENTRIC SWITCH

*Allows potentiometer and switch to be combined in the same unit.*



Add-A-Pot concentric switches are supplied complete and ready for the addition of a potentiometer. It is available up to 3 decks with 2 to 10 positions/deck and shorting or nonshorting contacts. Life expectancy exceeds 100,000 cycles. Initial contact resistance is 0.005 $\Omega$  typical and 0.020 $\Omega$  or less after 25,000 operation cycles. Insulation resistance exceeds 10,000 megohms and dielectric strength is 1Kvac. Grayhill, Inc., 561 Hillgrove Ave., La Grange, Ill.

Circle 123 on Inquiry Card

## INFRARED EMITTING DIODE

*Provides radiation at 0.9 microns in a 30° cone angle.*



The GAE-404 gallium arsenide infrared emitting diode provides more intense radiation at a restricted beam angle than similar devices previously available. It uses a strontium titanate lens and an optical-immersion fabrication technique. Characteristics: operates continuously up to 400ma peak current with a 45% duty cycle; typical power output is more than 10<sup>15</sup> photons/second; modulates freqs. up to 1Gc. Special Products Operations, Lansdale Div., Philco Corp., Lansdale, Pa.

Circle 125 on Inquiry Card

NOW YOU  
CAN GET . . .

**CUSTOMIZED  
FEATURES**

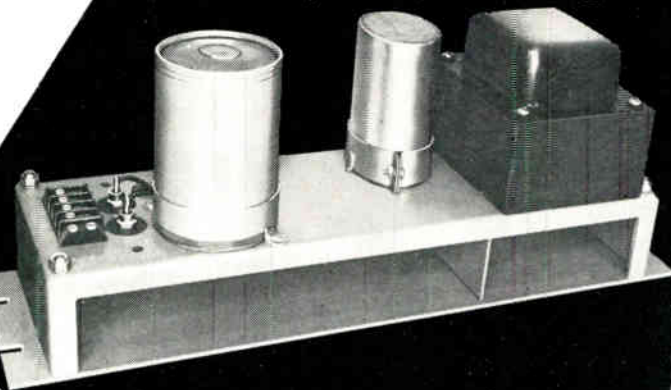

**IN  
ACME ELECTRIC**

# STANDARD POWER SUPPLIES

Why be satisfied with the performance limitations of ordinary power supplies when Acme Electric makes a **standard regulated power supply** with operating features usually obtainable only in specially designed units? This line of Acme Electric power supplies originated as custom designed models, then were simplified and standardized.

## RELIABILITY EVALUATION PROVED BY DESIGN SIMPLICITY

- Continuous duty, constant voltage transformer
  - resonant capacitor with adequate bleeder to discharge after turn-off,
  - computer grade, electrolytic filter,
  - silicon rectifiers,
  - practical positioning of terminal board provides input and output connections in one place,
  - heavy gauge, relay rack panel with components spaced for maximum free air circulation,
  - negligible thermal drift
  - losses and instability of tubes eliminated,
  - zero to full load recovery time, 0.1 second,
  - practically instantaneous recovery under input voltage fluctuation,
  - current limiting protection,
  - ripple voltage RMS less than 1%,
  - efficiency 80% or better,
  - standard rack models in ratings from 50 watts to 2400 watts, 24 to 250 volts dc.
- Write for catalog 174.

**Acme**  **Electric**

**Engineers and Builders of...**

891 WATER STREET, CUBA, NEW YORK  
In Canada: Acme Electric Corp. Ltd.  
50 Northline Rd., Toronto, Ont.

SAA 3722-3038

REGULATED POWER SUPPLIES  
STATIC POWER RECTIFIERS  
VOLTAGE STABILIZERS  
VOLTAGE REGULATORS

## NEW PRODUCTS

### STRIP CHART RECORDER

*Accurately records signals of 2.7mv.  
May be used in gas chromatography.*

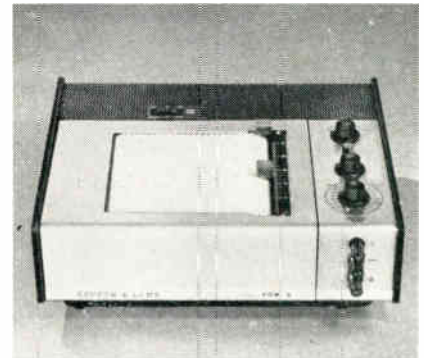

With the VOM-6, work with transducers is greatly simplified. Most transducers can be used directly without further amplification. These include thermocouples, thermistors, platinum resistance thermometers, strain gages, and accelerometers. The unit requires 14½ x 11¾ in. of bench or wall space and weighs 18 lbs. Bausch & Lomb, Rochester 2, N. Y.

Circle 229 on Inquiry Card

### TELEMETRY SYSTEM

*Reconstructs telemetered signals to  
an amplitude accuracy of 0.1%.*

The Model 4400 Digital Decommutator provides accurate decommutation of PAM and PDM signals. It acquires and tracks signal through severe noise. It accommodates 144 channels of data. Building-block concept allows expansion. Beckman Instruments, Inc., 2400 Harbor Blvd., Fullerton, Calif.

Circle 230 on Inquiry Card

### LOGIC BLOCKS

*Four silicon integrated circuits  
for med.-speed, low-power logic.*

All circuits are transistor-logic type. They include a 6-input NAND gate, a 6-input AND/NOT gate, a 4-input set-reset-preset FF, and a 4-input dual-ranked system FF. The NAND gate has a max. worst-case fanout of 5, average propagation delay of 30 nsec. The AND/NOT gate is capable of driving 20 following circuits and has a 50 nsec. average propagation delay and 30mw. dissipation. The R-S FF has a fanout of 4, and max. repetition rate not less than 5mc. The dual-ranked system FF has a 10 circuit fanout and not less than 5mc repetition rate. Honeywell Semiconductor Products Div., Minneapolis, Minn.

Circle 231 on Inquiry Card

# NEW PRODUCTS

## RELAY

Miniature 2 pole, 5a. unit offers 2 coils: 1w. and less than 1/2w.

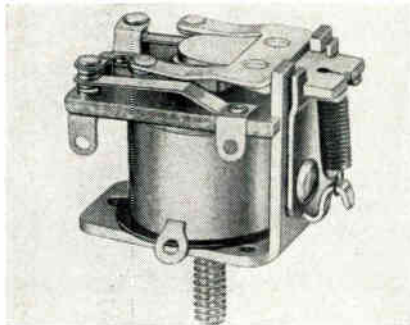

The Series R-11 is a low-silhouette relay with mountings which include single stud, 6-32 x 3/8; 3 screws, 2-56; or PC plug-in. Contact combinations up to DPDT. Guardian Electric Mfg. Co. of Calif., 5755 Camille Ave., Culver City, Calif.

Circle 112 on Inquiry Card

## FERRITE COMPONENTS

Freq., 18.0—26.0Gc; isolation, 20.5db min.; insertion loss 0.5db max.

These super-miniaturized ferrite components, designed for smaller and lighter microwave systems and equipment, are available in waveguide, coaxial and strip types. VSWR is 1.25 max.; bandwidth, 800mc. MicroRadionics, Inc., 14844 Oxford St., Van Nuys, Calif.

Circle 113 on Inquiry Card

## SOLID-STATE CONTROLS

Speed controls for motors in the range of 1/30 to 1/3 hp.

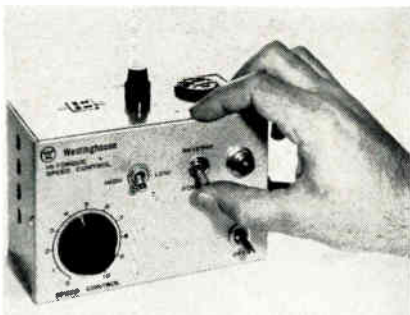

Types 901 and 902 handle dc shunt, dc series and universal (ac and dc) motors to 1/15 and 1/3 hp respectively. They use the characteristics of an SCR with feedback to provide high torque at low speeds. Regulation is very good. Rated input is 115vac, single phase, 50/60 cps. Special Products Dept., Westinghouse Semiconductor Div., Youngwood, Pa.

Circle 114 on Inquiry Card

# ARE YOU PAYING TOO MUCH FOR FABRICATED BOXES?

THIS PART COST

87¢



THIS PART COST

\$1.90

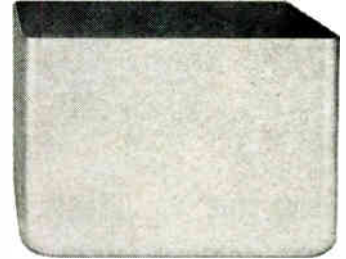

(Both made from .064" aluminum in lots of 1,000)

THIS PART is made by the Zero deep draw process. It costs less than the fabricated part and offers these additional advantages: Uniformity; close tolerances; straight side walls, excellent surface finish; work-hardened side walls. Because it was made from stock tooling, there was no tooling or set-up charge.

THIS PART was fabricated by the conventional notch-fold-weld method. In addition to a higher cost it has these disadvantages: Measurements vary; welds are subject to porosity and failure; warpage caused by weld heat must be straightened. Fixtures and tools must be charged for with a set-up charge for every order.

## NEW 38 PAGE CATALOG LISTS 20,000 STOCK SIZES

Send today for the Zero Deep Drawn Aluminum catalog...lists more than 20,000 sizes and shapes available without tooling costs...quantities of 100 or less shipped in one week from stock!



Write to:

**ZERO MANUFACTURING CO.**

1121 Chestnut Street • Burbank, California 91503  
Factories in Burbank, California and Monson, Massachusetts



GLASS ENCLOSED  
**AMPERITE**  
Thermostatic  
DELAY RELAYS

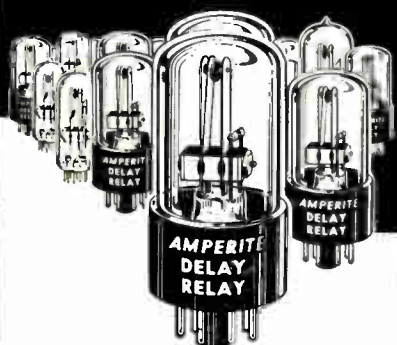

Offer true hermetic sealing  
-assure maximum stability and life!

**Delays: 2 to 180 seconds . . .** Actuated by a heater, they operate on A.C., D.C., or Pulsating Current . . . Being hermetically sealed, they are not affected by altitude, moisture, or climate changes . . . SPST only—normally open or normally closed . . . Compensated for ambient temperature changes from  $-55^{\circ}$  to  $+80^{\circ}$  C. . . Heaters consume approximately 2 W. and may be operated continuously . . . The units are rugged, explosion-proof, long-lived, and—inexpensive!

**TYPES:** Standard Radio Octal, and 9-Pin Miniature.  
List Price, \$4.00

**PROBLEM? Send for Bulletin No. TR-81**

**AMPERITE**  
BALLAST  
REGULATORS

Hermetically sealed, they are not affected by changes in altitude, ambient temperature ( $-50^{\circ}$  to  $+70^{\circ}$  C.), or humidity . . . Rugged, light, compact, most inexpensive.

List Price, \$3.00

Write for 4-page Technical  
Bulletin No. AB-51

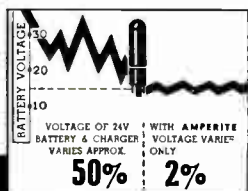

**AMPERITE**

600 PALISADE AVE., UNION CITY, N.J.  
Telephone: 201 UNion 4-9503  
In Canada: Atlas Radio Corp., Ltd.,  
50 WIngold Ave., Toronto 10

Circle 45 on Inquiry Card

**NEW PRODUCTS**

**ILLUMINATED PUSHBUTTON**

*Momentary type, requiring light operating pressure.*



The Series M illuminated pushbutton switch has a contact arrangement of single-pole, single-throw, normally open. Switch ratings: 0.1a., 125v ac; and 0.1a., 30v dc (noninductive); insulation, 1250v ac breakdown. Dialight Corp., 60 Stewart Ave., Brooklyn, N. Y.

Circle 139 on Inquiry Card

**ILLUMINATED INDICATOR**

*Provides 60 multicolor displays in extremely small panel space.*

The Model 6100 provides 10 target areas, each of which may be illuminated in sequence with any of 6 colors. A single unit permits 60 displays in panel area of  $1\frac{1}{4} \times 7\frac{1}{4}$  in. Connections to the lamp circuits are provided through 2 miniature latching connectors; no individual wiring is required. It is for military and government uses. AMF Instrument Div. American Machine & Foundry Co., P. O. Box 929, Alexandria, Va.

Circle 140 on Inquiry Card

**POWER SOURCE**

*Delivers min. power output of 100mw at 12.4—14.0cc*



The MA-8168 solid-state power source is for crystal-controlled transmitter driver applications. It has crystal-control stability  $\pm 1$  part  $10^6$  long term/day. Short term stability is 1 part  $10^6$ /msec. It is guaranteed for 10,000 hrs. min. life. Input power requirements are +28vdc at 300ma; +48vdc at 600ma for the oscillator amplifier stages. Approx. weight is 2.5 lbs. Microwave Associates, Inc., Burlington, Mass.

Circle 141 on Inquiry Card

**VARIABLE RESISTORS**

*Approx. and fine settings are possible in a single-knob unit.*



In type JJV dual-section, hot-molded variable resistor, a unique coupling arrangement allows the approx. resistance setting to idle when backing-off adjustment is being made with the fine-resistance vernier. In this variable resistor, more than 12% of the total rotation is available for the independent vernier adjustment. This 20 times better resolution is obtainable with a single section control. Values to 5 megohms. Allen-Bradley Co., 103-C W. Greenfield Ave., Milwaukee, Wis.

Circle 142 on Inquiry Card

**PHOTO-CONDUCTIVE DETECTOR**

*Sensitive in the 2-15 micron region of the infrared spectrum.*

The QKN1227 has a time constant of less than 1msec., and permits fast scan rates and high resolution. The modular package has an overall diameter of 1.19 in. and a thickness of 0.39 in. Its vacuum-element is mercury-activated germanium, and the window is barium fluoride. Designed for closed-cycle cooling systems, it operates at 35°K. Special Microwave Devices Oper., Raytheon Co., 130 Second Ave., Waltham, Mass.

Circle 143 on Inquiry Card

**FIELD-EFFECT TRANSISTOR**

*Unit provides 50 picoamp max. gate current and very low capacitance.*

These transistors come in 2 packages: the 2N3113 is an alumina/glass sandwich FlatPac with axial ribbon leads of gold-plated Kovar. It is 100 mils in dia., 35 mils thick and passes all normal mechanical and environmental tests per MIL-S-19500. The 2N3112 is in the standard JEDEC TO-18. The 2N3113 has a capacitance of less than 2.0pf; 2N3112 has 3.5pf. Both have a pinch-off voltage range from 1 to 4 volts; transconductance limits are 50 to 115 $\mu$  mhos. Siliconix Inc., 1140 W. Evelyn Ave., Sunnyvale, Cal.

Circle 144 on Inquiry Card

# NEW PRODUCTS

## MINIATURE THERMISTORS

*Dissipation constant, 0.10m/°C. Wire-lead terminations.*

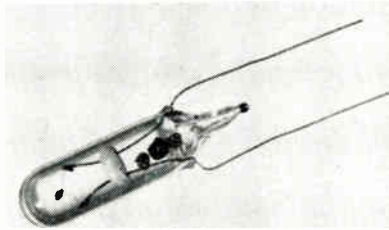

These thermistors are sealed in a glass envelope, under vacuum, and feature high-sensitivity to current variations. Resistance values are from 1KΩ to 680KΩ. The negative coefficient changes resistance from 3% to 6%/°C. Ferrocube Corp. of America, Saugerties, N. Y.

Circle 109 on Inquiry Card

## TUNNEL-DIODE AMPLIFIER

*Center freq. 5.0Gc; bandwidths, 10Mc to 350Mc.*

The Model D65C1 is designed for narrow-band applications. SSB noise figure, including circulator loss, is 4.5db (max.). Short-term gain fluctuations are less than 0.5db, and associated phase changes are less than 0.4 degrees. Sperry Microwave Electronics Co., Box 1828, Clearwater, Fla.

Circle 110 on Inquiry Card

## DIFFERENTIAL TRANSFORMER

*Input power is 28vdc ±3v at 50ma.; features spring loaded sensing coil.*

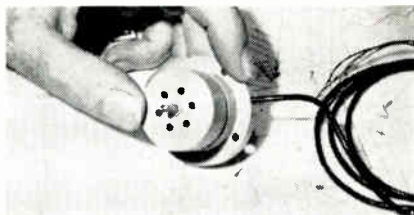

A dc to dc differential transformer, 70-3800-S195, features spring loading of the sensing-core shaft. This permits use where physical connection to the moving surface is impossible. A hardened core extension allows for min. wear when used as a cam follower. When used with a cam, it is intended for airborne applications which now use rotary potentiometers. The unit has a range of ±0.050 in. with linearity of ±0.25% and is available with internal or remote zero adjustment. Output voltage is ±5vdc into 1 megohm or ±1vdc into 1KΩ (no amplifier). International Resistance Co., 401 N. Broad St., Phila., Pa.

Circle 111 on Inquiry Card



**MAKE VHF  
BRIDGE  
MEASUREMENTS**  
with  
**AUDIO EASE**  
(and accuracy)

... not that audio measurements are always smooth sailing, mind you, but it's the region from 1-100 MC that separates the men from the boys.

With the B-801—our *peerless* VHF Bridge, you can make two *terminal, balanced or unbalanced, and three-terminal* measurements, from 1-100 MC, with ±2% accuracy and split-hair resolution, just as easily as you "crank up" the value of a capacitor or resistor on a 1 KC component bridge.

You'll find the B-801 impressively flexible, too. It's perfect for checking transistor parameters, cables parameters, VSWR, amplifier admittance, and truly *informative* component measurements . . . including the shunt capacitance of coils, among many other examples. Hundreds swear by it. No-one, to our knowledge, swears at it.

Speaking of ease, our gallant field force informs us that the B-801 "sells on sight" . . . all right, then—have a look!

### SPECIFICATIONS

- G: 0-100 millimhos  
(10 Ω to 10,000 Ω, 3-digit readout)
- C/L: 0 to plus 230 pf and  
0 to minus 230 pf, with  
vernier resolution of 0.2 pf!
- 1-100 MC, ±2% accuracy

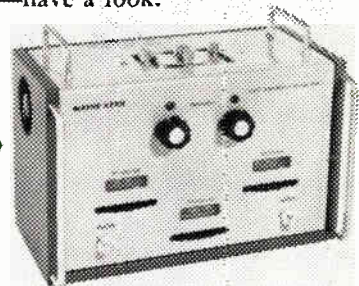

Now for the "clincher"—the price of this irresistible instrument is only \$940! *Buy one!* (After which we'll wave a few seductive accessories under your nose: a low-priced source and detector; precise R, L, and C standards; and a free and handy re-order blank.)

How soon may we show you the B-801 . . . so that you may begin a life of ease?



# WAYNE KERR

## CORPORATION

1633 RACE STREET, PHILADELPHIA 3, PA. LOCUST 8-6820

**INNOVATIONS in INSTRUMENTATION**



# COMBINATION REVERSIBLE SCREWDRIVERS

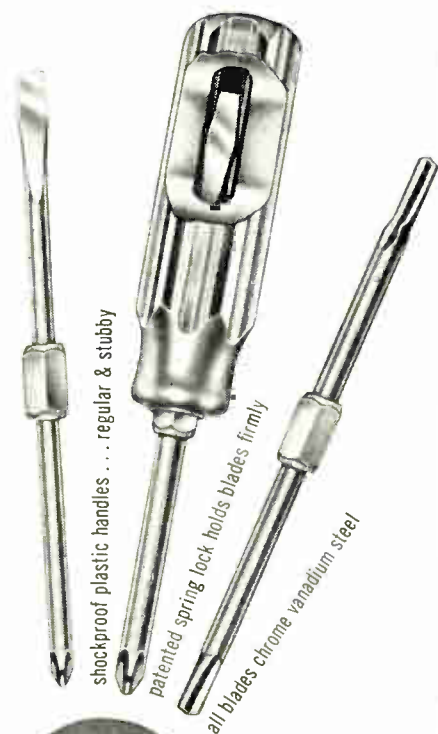

shockproof plastic handles... regular & stubby

patented spring lock holds blades firmly

all blades chrome vanadium steel



from slotted to Phillips reversed in an instant!

## twice as handy

for dozens of maintenance and service jobs around the plant and in the field

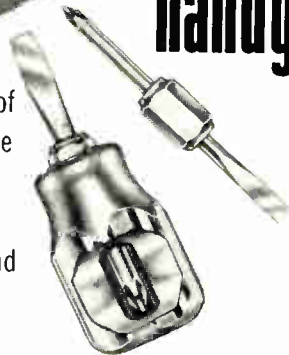

### 9 REVERSIBLE BLADE COMBINATIONS

- ±1 Phillips & 3/16" slotted (Reg. & Stub.)
- ±2 Phillips & 1/4" slotted (Reg. & Stub.)
- ±3 Phillips & 5/16" slotted (Reg.)
- ±1 and ±2 Phillips (Reg.)
- Clutch-Type 3/16" & 5/32" (Reg. & Stub.)
- Clutch-Type 5/16" & 1/4" (Reg.)

handles and blades available separately or in plastic pocket sets from your supplier

# XCELITE

XCELITE INC., 28 Bank St., Orchard Park, N.Y.

Canada: Charles W. Pointon, Ltd., Toronto, Ont.

Circle 47 on Inquiry Card

# NEW PRODUCTS

## MICROWAVE RECEIVER

Operates over the freq. range 10mc-40gc.

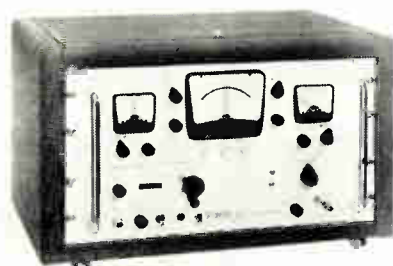

The PRD 915 operates on the parallel i-f substitution technique for attenuation measurements. It allows accurate attenuation measurements, signal generator attenuator calibration, SWR measurements, and low-level noise comparison measurements. It operates on low-level signals without AM of signal source. Input freq. is 30mc (output of mixer). Attenuator has an accuracy of  $\pm 0.05\text{db}/10\text{db}$ . The max. signal level at the mixer output ranges to  $-120\text{dbm}$  with an accuracy of  $\pm 0.20\text{db}/10\text{db}$  increment. PRD Electronics, Inc. 202 Tillary St., Brooklyn 1, N. Y.

Circle 145 on Inquiry Card

## SHIELDING CYLINDERS

Subminiature electromagnetic devices never need periodic annealing.

These precision Netic and Co-Netic cylindrical enclosures function as effective magnetic shields or shunt rings. Concentricity and ID are precision controlled. ID is 0.251, OD, 0.270 and L, 0.250 ( $+0.015-0.000$ ). Both are insensitive to all types of mechanical shock and have negligible retentivity. Magnetic Shield Div., Perfection Mica Co., 1322 No. Elston Ave., Chicago 22, Ill.

Circle 146 on Inquiry Card

## FLEXIBLE INSULATION

Offers good voltage endurance and corona resistance.

"Micanite" brand flexible insulation has Class F capabilities. Glass-backed, hand-laid tapes are in 0.004 and 0.006 in. thicknesses for use in wrapping coils, in motors, generators, and transformers. Sheet insulation is also available in either, with facings of 0.001 in. polyester film or in mica splittings. Micro Div., 3M Co., Dept. W3-522, 2501 Hudson Rd., St. Paul 19, Minn.

Circle 147 on Inquiry Card

## VOLTAGE REGULATOR

Response is approx. 0.1 sec. for line, load, and freq. changes.

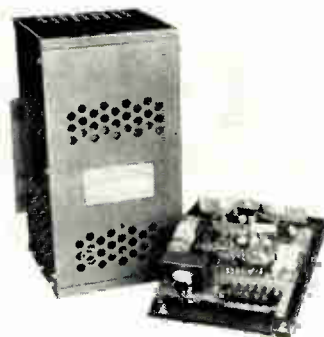

The Solatron 1kva has a regulation of  $\pm 0.25\%$  for  $\pm 10\%$  variations in line and load when operated at its rated output setting. When adjusted to other than rated output,  $\pm 1\%$  regulation is held. The all solid-state unit has an efficiency of 93% at full load; rated output is 120v. nominal. Load range is 0-8.4a. Sola Electric Co., div. of Basic Products Corp., 1717 Busse Rd., Elk Grove Village, Ill.

Circle 148 on Inquiry Card

## CAPACITOR-LEAKAGE TESTER

Gives go/no-go indication if leakage exceeds set value.

The Model TLCI-400 is a completely self-contained capacitor leakage testing system. Capacitors are checked at a rate of up to 2 per second and the leakage of each is compared with a predetermined current value. If the leakage is excessive, visual indication is given on a go/no-go panel lamp, which indicates the location of the defect. Trio Laboratories, Inc., Plainview, L. I., N. Y.

Circle 149 on Inquiry Card

## PICOAMMETER

Provides twenty full-scale ranges from  $3 \times 10^{-12}$  to  $10^{-2}\text{a}$ .

The model 409 high-stability picoammeter features all solid-state circuitry with the exception of a single electrometer-tube input. It also features extremely low zero drift—less than 1%/24 hrs. on most ranges—and a rise time of 1.5 sec. on the  $10^{-12}\text{a}$  range. Unit accuracy is  $\pm 2\%$  of full-scale on the ranges up to  $10^{-8}\text{a}$  and  $\pm 4\%$  beyond. It supplies an output of  $\pm 3\text{v}$  at 1ma. It can be operated on 115 or 230v at any freq. between 50 and 1000 cps. Keithley Instruments, Inc., 12415 Euclid Ave., Cleveland 6, Ohio.

Circle 150 on Inquiry Card



# NEW PRODUCTS

## OPTICAL LIGHT SOURCE

Capable of a continuous optical output of 2.0mw at 25°C package temp.

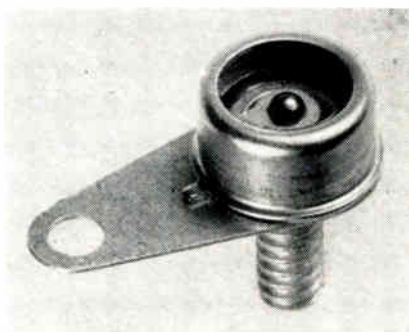

The SNX-110 is a gallium arsenide infrared light source. It produces a 2.0mw output with a forward bias of 2a. Peak optical outputs exceeding 1/4w. have been achieved at a package temp. of -195°C. Wavelength is 0.92 micron at 25°C. Texas Instruments Incorporated, P. O. Box 5012, Dallas 22, Tex.

Circle 106 on Inquiry Card

## ANTENNA

Features a radiating element of etched circuitry; input power of 125w.

The SCA-10 VHF communications antenna is broadbanded for commercial and military use over the range 116 to 152mc with a vswr of less than 2.0:1. The SCA-10 covers not only present, but also proposed future VHF freq. allocations. It meets or exceeds all FAA requirements of TSO C-37B and C-38B. Stoddart Aircraft Radio Co., Inc., 6644 Santa Monica Blvd., Hollywood 38, Calif.

Circle 107 on Inquiry Card

## SELENIUM RECTIFIER

Small all-purpose unit delivers 65ma @ 130v.

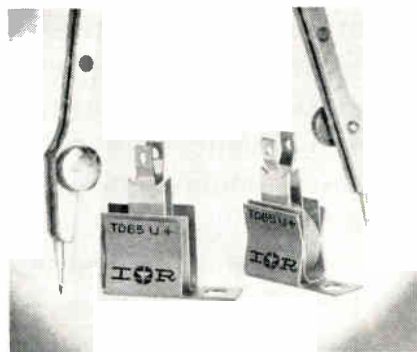

The Type TO65U is rated for 380v peak-reverse voltage; operating temp. is 85°C. Approx. reverse current is 500µa dc; recommended series resistance is 22Ω. It measures 13/32 in. x 5/16 in. (max.). International Rectifier Corp., 233 Kansas St., El Segundo, Cal.

Circle 108 on Inquiry Card

# NEED A 3000 VOLT ZENER DIODE?

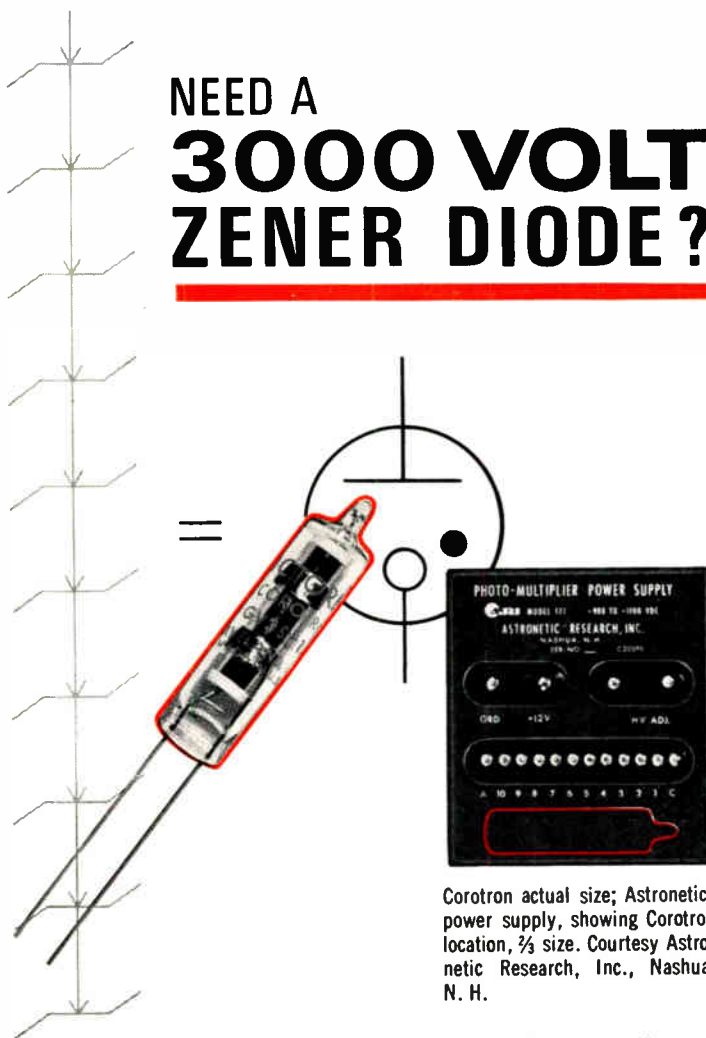

Corotron actual size; Astronetics power supply, showing Corotron location, 1/3 size. Courtesy Astronetics Research, Inc., Nashua, N. H.

You could string together several hundred zeners. Or you could specify *one* Victoreen Corotron. It is the gaseous equivalent of the zener with all the advantages of an *ideal* HV zener diode.

For space research and other rugged applications requiring absolute power supply stability, GV3S Series, shown, provide the ideal reference voltage anywhere in the range of 400 to 3000 volts. They enable circuitry to maintain constant high voltage regardless of battery source voltage or load current variations. Cubage and weight (GV3S Corotron weighs only 4 gm.) are important considerations. So is temperature variation (Corotrons operate from 200°C down to -65°C). Ruggedized versions withstand shock to 2000 G, vibration 10 to 2000 cps.

If you're trying to simplify circuits . . . to cut cost, size and weight . . . to upgrade performance—you need Corotron high voltage regulators. Models are available now from 400 to 30,000 volts. A consultation with our Applications Engineering Dept. will speed up the countdown.

749-A



## VICTOREEN

THE VICTOREEN INSTRUMENT COMPANY  
5806 Hough Avenue • Cleveland 3, Ohio, U.S.A.

Victoreen European Office: P.O. Box 654, The Hague

## NEW PRODUCTS

### MAGNETIC-HEAD PROTECTION

*Reduces wear caused by abrasive particles on magnetic tape.*

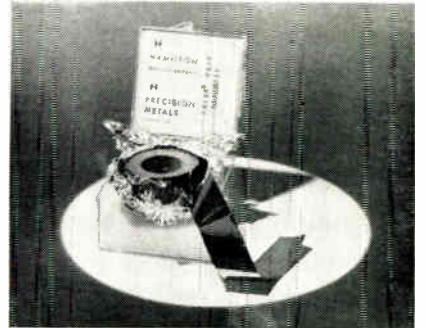

Havar® is a cobalt-base, non-magnetic, corrosion-resistant tape which is passed continuously between the magnetic tape and the computer read-head. It reduces read-head wear caused by abrasive particles on the magnetic tape. It can be passed at a slower rate because of its high resistance to abrasion. Thickness as low as 0.0001 in. can be supplied. Precision Metals Div., Hamilton Watch Co., Lancaster, Pa.

Circle 117 on Inquiry Card

### CERAMIC RINGS

*For the construction of hermetically-sealed switching devices.*

These metalized-ceramic rings can be stacked with a contact ring between each ceramic section, and the complete assembly brazed to provide a hermetic seal that will withstand 10,000 psi. They are constructed with tolerance of  $\pm 0.001$  over the metalized surfaces. They are available in a broad range of sizes. As many as 22 rings can be stacked and brazed simultaneously. Centralab, The Electronics Div. of Globe-Union Inc., P. O. Box 591, Milwaukee, Wis.

Circle 118 on Inquiry Card

### INPUT SCANNER

*Up to 25 various inputs can be scanned and transferred.*

The DY-2901A Input Scanner/Programmer uses 3-wire switching circuits and gold-plated critical contacts for handling mv level signals. High level dc and ac voltages, freq. to 300kc, and resistance signals can also be accurately switched. An internal pinboard programmer provides programming up to 15 functions and any of four measurement delays on each of the 25 input channels, permitting automatic systems operation. Dymec Div. of Hewlett Packard Co., 395 Page Mill Rd., Palo Alto, Cal.

Circle 119 on Inquiry Card

## Subminiature ILLUMINATED PUSH BUTTON SWITCHES and matching Indicator Lights

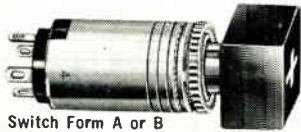

Switch Form A or B  
with 3/4" sq. cap

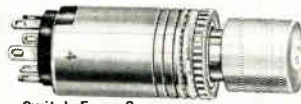

Switch Form C  
with 1/2" rnd. cap



Matching Indicator  
with 3/4" rnd. cap



Matching Indicator  
with 1/2" sq. cap



Request Catalogue No. L-169A. Complete specifications and technical data, including catalog number charts are included therein.

Illust. approx. 75% actual size

DIALCO Switches and Indicator Lights provide almost limitless applications—are flexible in arrangement—economical in price—and feature high reliability.

Switches are the silent, momentary type—requiring 24 oz. (approx.) operating force. Contact arrangements are: S.P.S.T., normally open or normally closed; S.P.D.T. two circuit (one normally open, one normally closed). Ratings: 3 amps, 125V A.C.; 3 amps, 30V D.C. (non-inductive). The switch is completely enclosed and independent of the lamp circuit. The light source is the T-1 3/4 incandescent lamp, available in voltages from 1.35 to 28V. Units are made for single hole (keyed) mounting in panels up to 3/16" thick and mount from back of panel in 1/2" clearance hole. Switch forms for dry circuits are also available.

Other features include: 1/2" or 3/4" interchangeable caps, round or square, rotatable or non-rotatable, in a choice of 7 color combinations.

**DIALCO**®

FOREMOST MANUFACTURER OF PILOT LIGHTS

**DIALIGHT** CORPORATION

60 STEWART AVENUE, BROOKLYN, N.Y. 11237 212 HYACINTH 7-7600

Circle 49 on Inquiry Card

**FREQUENCY  
STANDARD  
PERFORMANCE**  
in  
**Packaged  
Oscillator  
Size**



For additional technical data, WRITE:



PRODUCTS

**THE  
JAMES  
KNIGHTS  
COMPANY**  
SANDWICH, ILLINOIS

**JKTS-1000:** A completely packaged oscillator-oven unit. Performance equal-to or better-than many laboratory frequency standards designed for system and equipment use. SPECIFICATIONS: large diameter, 1 mc, glass-enclosed crystal, together with oscillator-buffer circuitry, voltage regulation and temperature control completely housed in a double proportionally-controlled oven. External and remote trimming. Stability and calibration  $1 \times 10^{-9}$  per day at time of shipment.

Circle 50 on Inquiry Card



## NEW PRODUCTS

### COAXIAL RELAY

*Provides ultra high-freq. switching through coaxial cable.*

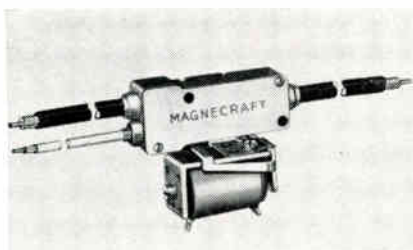

The Class 120 relay affords low loss at VHF. The SPDT gold-plated, heavy-silver cadmium-oxide contacts are supported directly from the cable connectors. Features include low vswr through the UHF, good cross-talk characteristics, fast operation, low operating wattage and 1 million cycles life expectancy. Magnecraft Electric Co., 5577 N. Lynch Ave., Chicago 30, Ill.

Circle 232 on Inquiry Card

### MERCURY WETTED RELAY

*Operates at speeds as high as 1msec. or on power as low as 1.2mw.*

The BW-2 series features form-C mercury switch elements. It is said to provide billions of trouble-free operations—with constant contact characteristics and permanent low-contact resistance—without erosion, bounce or chatter. Max contact ratings: 2a; 50v; 100va; contact resistance, 25 milliohms (typical). Babcock Relays, A div. of Babcock Electronics Corp., 3501 Harbor Blvd., Costa Mesa, Cal.

Circle 233 on Inquiry Card

### MODULAR ENCLOSURES

*Provides full measure protection for electronic equipment.*

The EMCOR special series RFI shielded modular enclosures meet the electrical and mechanical r-f interference shielding requirements of NASA. It is designed primarily for aerospace and missile control uses. The EMCOR III RFI shielded modular enclosure system is designed for much broader application along industrial lines. It meets the electrical requirement of NASA. Tests show that the EMCOR special series maintained adequate attenuation over freq. range of 0.15 to 1000mc. The EMCOR III series also surpassed min. attenuation requirements over the same MC scale. Both series have frame configurations in 19 and 24 in. panel widths. Ingersoll Products, div. of Borg-Warner Corp., 1000 W. 120th St., Chicago 43, Ill.

Circle 234 on Inquiry Card

# The Complete Tube Tester

for ■ **Electronic Research**  
■ **Industrial Electronic Maintenance**

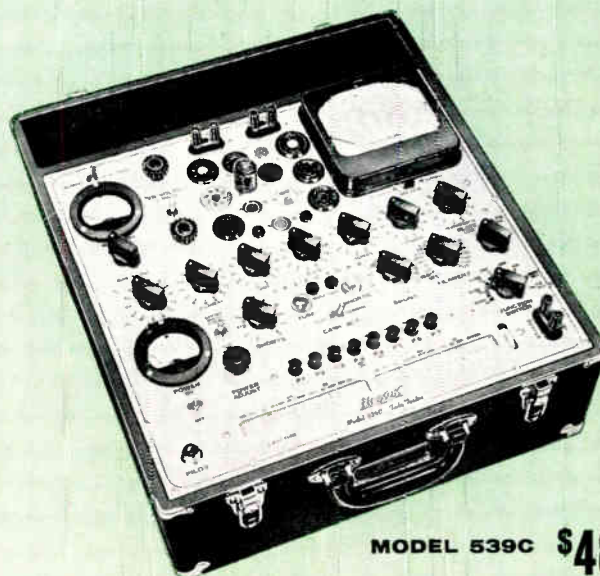

MODEL 539C \$485<sup>00</sup>

**NOW**

**Tests Compactrons,  
Novars, Nuvistors,  
Ten-Pin Types**

The Model 539C is equally at home in the tube research laboratory or on important maintenance assignments. It tests *all* the latest tubes completely and accurately—no paralleled elements. It also tests VR Tubes, low power Thyratrons, "4-digit" types.—All to handbook specifications or under actual operating conditions. 6 Gm ranges—600 to 60,000  $\mu$ hos.



**The HICKOK  
Electrical  
Instrument Co.**

10606 Dupont Avenue  
Cleveland 8, Ohio

Represented in Canada by Stark Electronics, Ajax, Ontario • Internationally  
by Hughes International, Husint, S. A., Culver City, California



# NEW PRODUCTS

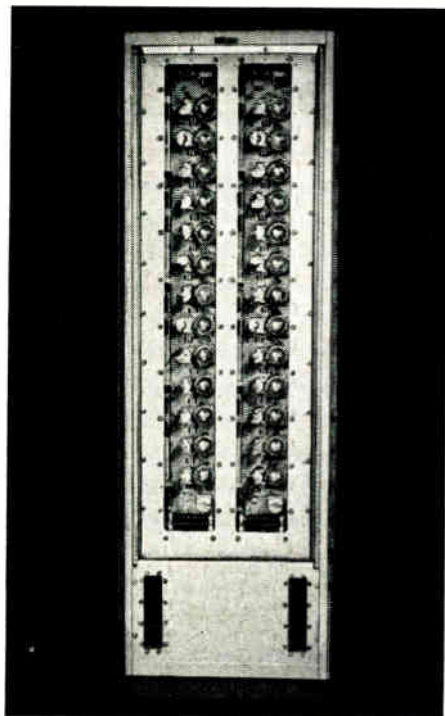

## POWER:

to 100 KW

## BANDWIDTH:

to 300 MC

## FREQUENCY:

to 400 MC

## TUNING:

NOT REQUIRED

## APPLICATIONS:

Sounders, Radiac Systems, Radiation Field Effect Instrumentation, Antenna Test Instrumentation, Spread Spectrum Systems, Electronic Countermeasures, Frequency Diversity, Particle Accelerators . . . and wherever extremely high power and/or broadband transmissions (with low intermodulation and harmonic distortion) are needed.

## SOURCE:

INSTRUMENTS FOR INDUSTRY. The most experienced design and manufacturing organization in this field.

Tell us your application requirement. We have the capability and willingness to meet it, as we have for Industry and the Military.

## CONTACT:

Director of Engineering.



INSTRUMENTS FOR INDUSTRY, INC.  
101 New South Road  
Hicksville, L. I., N. Y., 516-OV-1-7100

Circle 52 on Inquiry Card

## TRANSISTOR ANALYZER

Reads leakage current down to 100 na on a 6 $\mu$ a full-scale meter.

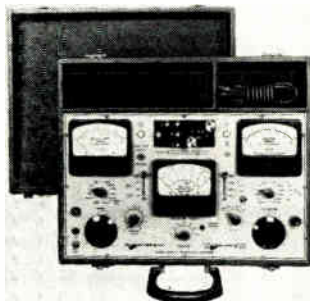

Model 3490-A Transistor Analyzer analyzes both power and signal type transistors at specified voltages and currents. It features continuously adjustable current—up to 30a collector. It allows plotting of transistor characteristic curves along with setting-up nearly any type of transistor test. It tests dc and ac Beta, I<sub>ceo</sub>, I<sub>co</sub>, and I<sub>eo</sub> leakage, and also tests zener diodes, punch through, saturation, floating potential, alpha diodes and rectifiers, and SCRs. The Triplet Electrical Instrument Co., Bluffton, Ohio.

Circle 134 on Inquiry Card

## DATA LOGGING SYSTEM

120-channel scanner capacity and true random scanning.



The Model 6511 includes solid-state circuits, voltage, resistance and time measurements. It readily adapts to measurements of temperature, pressure, acceleration, shock, velocity and electrical quantities for either military or industrial application. Electro Instruments, Inc., 8611 Balboa Ave., San Diego 12, Cal.

Circle 135 on Inquiry Card

## SWITCHING DIODES

Handles several hundred watts of cont. power and peak power in kw range.



The D5020 series consist of a PN junction separated by an intrinsic region, which is a dielectric for reverse voltages and a conductor for forward voltages. Applications include microwave switches, voltage-variable attenuators, low- and high-power duplexers, signal-generator levelers, and modulators. Sylvania Electric Products, Inc., 1100 Main St., Buffalo, N. Y.

Circle 136 on Inquiry Card

## DISSIPATORS/RETAINERS

Case temp. of 0.5w dual-mounted transistors kept below 65°C.

Four LP series heat dissipators and retainers for TO-18 transistors are available. The staggered-finger heat dissipator assembly provides efficient heat dissipation in natural convection as well as forced air. The heat dissipator assemblies measure 1.06 x 1.06 x 1/2 in. and 1.06 x 1.06 x 5/16 in. with mounting configurations for 1 or 2 TO-18 transistors in each size. IERC Div., International Electronic Research Corp., 135 W. Magnolia Blvd., Burbank, Cal.

Circle 137 on Inquiry Card

## PRESSURE TRANSDUCER

Pressure range, 0-5 to 0-5000 psia, g. & d; freq. response, 0-700 cps (flat).

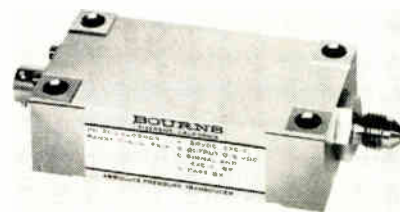

The Model 2320 is a dc-dc variable reluctance unit. It operates from unregulated 28vdc to produce an accurate 0-5vdc signal output directly proportional to the pressure input. Impedance output is 1K $\Omega$  max. Terminal based linearity is  $\pm 0.25\%$ . A circuit clipper eliminates over-voltages. A remote electrical calibration circuit is optional. Bourns, Inc., 1200 Columbia Ave., Riverside, Calif.

Circle 138 on Inquiry Card

# STANDARD AND CUSTOM ELECTROMAGNETIC DELAY LINES

... for your every requirement

A full range of sizes and delay times allows you to select delay lines which satisfy your most exacting requirements. For more sophisticated applications, our engineers will custom-design delay lines to your specifications. Fixed or variable, standard or miniature, lumped constant or distributed constant — ESC, the world's largest producer of electromagnetic delay lines, has them all.

Send for your free  
SHORT FORM CATALOG today!



# ESC

**ELECTRONICS CORP.**

534 BERGEN BOULEVARD  
PALISADES PARK, N. J.  
PHONE WINDSOR 7-0400

Circle 54 on Inquiry Card

## NEW PRODUCTS

### MEMORY-DRIVE DIODES

*Integrated-circuit units have a max. recovery below 90 msec.*

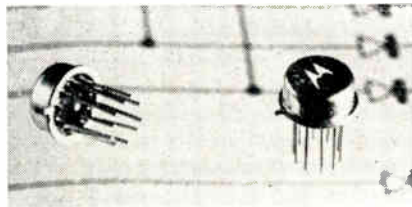

Three multiple-diode devices, incorporating up to 16 interconnected silicon diodes in a single package, are for use as gate-core memory drivers. Types MC1116 and MC1117 contain 9 diodes with common-anode and common-cathode connections respectively. Type MC1118 consist of 16 diodes connected in a series/parallel matrix. The devices are industrial versions of MIL-M-23700/6-8. Each diode has a 40-v. reverse-breakdown rating and a max. forward voltage drop of 1.2v. at 300ma. Motorola Semiconductor Products, P.O. Box 955, Phoenix, Ariz.

Circle 217 on Inquiry Card

### A-D CONVERTERS

*Voltage is 1, 10, 100, and 1000; resistance is 1K, 10K, 100K, and 1000KΩ.*

The Reporter 35 is a solid-state 1-2-4-8 BCD code unit with a max. sensitivity of 1mv. Sampling time is 2.5msec. Variable scale input voltage is 1 to 1000v full-scale ( $\pm 0.1\%$ ,  $\pm 1$  count). Reporter 36 is a 9-bit binary analog-to-digital converter. Both units use advanced computer circuits. Range is  $\pm 10$ vdc (adjustable 9.5-10.5v) and an accuracy of  $\pm 1.5$  count. Harman-Kardon, Inc., Plainview, L. I., N. Y.

Circle 218 on Inquiry Card

### SERVO AMPLIFIERS

*For missile and aircraft systems.  
Input, 28vdc; output, 40v (RMS).*

The C70 3148 series are high-temperature, sub-miniature, completely transistorized servo amplifiers. Except for C70 3148 007, which delivers 0.6w, all others have a rated output of 3.5w. Amplifier gain is regulated by an external resistor in series with the input signal. Specs: signal freq., 400cps ( $\pm 5\%$ ); gain stability,  $\pm 2$ db of nom; operating temp.,  $-55^{\circ}\text{C}$  to  $+125^{\circ}\text{C}$ . Kearfott Div., General Precision Aerospace, 1150 McBride Ave., Little Falls, N. J.

Circle 219 on Inquiry Card

*measures  
.002 microvolts!*



## KEITHLEY MILLI-MICROVOLT METER

The Keithley Model 149 is the most sensitive electronic voltmeter available today, having a signal-to-noise ratio that approaches the theoretical limit. Recommended for use with thermocouples or thermopiles, the Model 149 is also ideal in cryogenics investigations and Hall Effect studies.

Zero suppression up to 100 times full scale adds versatility for the user. Line-operated, the Model 149 can accommodate either a floating or ground-referenced input. Output is 5 v or 5 ma on all ranges. Brief specifications:

- **range:** 0.1 microvolt to 100 millivolts in 13 overlapping 1x and 3x steps
- **noise:** less than  $6 \times 10^{-10}$  v rms with shorted input
- **input impedance:** 10K ohms on 0.1  $\mu\text{v}$  range rising to 10 megohms on 100  $\mu\text{v}$  scale
- **stability:** within 0.01  $\mu\text{v}$  per hour
- **speed of response:** to 90% fs in .5 seconds on most ranges
- **accuracy:** 2% fs on all ranges
- **price:** \$895.00

#### Other MICROVOLT METERS:

Model 150A 1  $\mu\text{v}$  sensitivity \$750.00  
Model 151 100  $\mu\text{v}$  sensitivity \$420.00

*full details in latest catalog...*



**KEITHLEY  
INSTRUMENTS**

12415 Euclid Avenue • Cleveland 6, Ohio

Circle 55 on Inquiry Card



# NEW PRODUCTS

## HEAT DISSIPATING SOCKET

*Provides better than 50% tube envelope temperature decrease.*



The 5NS-3 heat-dissipating Nuvistor socket is for VHF and industrial applications. At an input of 2 watts, the tube envelope temperature rise is 37° above ambient, as compared to an 83° rise with a standard socket. It provides a very low inductance to ground through 1200mc. The socket insulation is 50,000 megohm minimum. Current rating is 1 ampere. Cinch Mfg. Co., 1026 S Homan Ave., Chicago, Ill.

Circle 126 on Inquiry Card

## RELAY

*Available with SP, DP, or triple pole DT contacts; 5 or 10a rating.*

The Series-U relay has standard coil voltages of 6-12-24-48-115 and 230vac; and 6-12-24-48 and 110vdc. It can be obtained in an open type with solder terminals or with a plastic dust cover. The SP and DP enclosed versions have 8-pin terminals; the triple pole has 11-pin terminals. Hart Mfg. Co., Hartford 1, Conn.

Circle 127 on Inquiry Card

## HIGH-POWER TRANSISTORS

*Collector-diode and open-base ratings of 200 and 300v.*

Types 2N3079 and 2N3080 are npn triple-diffused silicon units in a TO-36 package. Continuous collector current rating is 10a. Max. saturation resistance is 0.14 $\Omega$ ; operating junction temp. -65° to +150°C. Min. thermal resistance is 0.7°C. Delco Radio Div., General Motors Corp., Kokomo, Ind.

Circle 128 on Inquiry Card

## POTENTIOMETERS

*High resolution, terminal linearity, and low phase shift.*

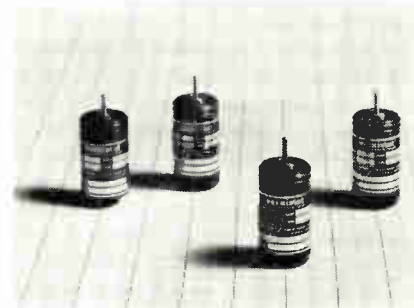

The size 11, 10 $\Omega$  Vernistat® ac potentiometers are available in 4 models (445-448). Max. input voltage at 400cps range from 10v to 30v. Nominal input impedances are 2K $\Omega$ , 4K $\Omega$ , and 3K $\Omega$ , with 10-ohm max. output impedance throughout. Absolute linearity is  $\pm 0.05\%$ ; theoretical resolution is  $\pm 0.13\%$ . The units have no backlash. Perkin-Elmer Corp., Vernistat Div., Main Ave., Norwalk, Conn.

Circle 129 on Inquiry Card



**IEEE  
SHOW  
'64**



**march 23-26  
9:45 A.M. - 9 P.M.**

## TWO BIG SECTIONS

at the  
**NEW YORK  
COLISEUM**  
all 4 floors!

- ELECTRONICS EXHIBITS
- CONVENTION PAPERS

See the finest products of industry,  
hear famous men speak! Just one entrance  
fee lets you visit both sections.

Buses to the N. Y. Hilton every few minutes

PRODUCTS • PAPERS • PEOPLE • PRODUCTS • PAPERS • PEOPLE



# NEW PRODUCTS

## TUBULAR CAPACITORS

Failure rate of 0.000417% meghrs. at 125°C and rated voltage.

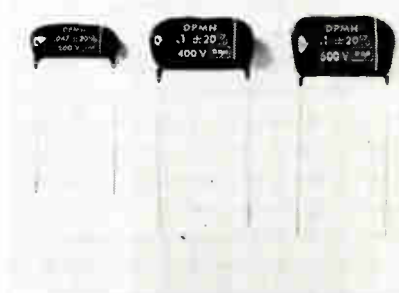

Type DPMH exceeds the environmental requirements of Mil-C-14157. They have undergone over 25 meghrs. of testing with 90% confidence level. The dipped units are available in sizes from 0.340 x 0.690 to 0.900 x 1.56 in., covering a broad capacity-voltage range: 0.001 to 0.47mfd at 200 to 600vdcw. They have radial leads. Cornell-Dubilier Electronics, div. of Federal Pacific Electric Co., 50 Paris St., Newark 1, N. J.

Circle 130 on Inquiry Card

## MICROWAVE POWER SOURCE

Solid-state unit provides a stable 120 mw output at X-band.

At room temperature, the output freq. stability of the VPS-X is maintained at one part in 10<sup>6</sup>, with the power output held to ±1.0db over operating temps. of -25°C to 70°C. Specs: output freq. 8.6 to 10.6gc; bandwidth, 1.0%; supply voltage, 45vdc; input current, 450ma. Varian Associates, 611 Hansen Way, Palo Alto, Cal.

Circle 131 on Inquiry Card

## TAPE TRANSPORT

Std. configuration operation at 112.5ips, 200 and 556bpi.



The TM-3 uses 1/2-in. magnetic tape and has 7-track magnetic head assembly. Standard control electronics are integral with the transport. It is program restriction free on command intervals in a uni-directional or bi-directional program. Start time is 2.0 msec. max. and start distance is 0.120 in. ±0.025 in. Stop time is 1.5 msec. max. and stop distance is 0.090 in. ±0.030 in. Ampex Corp., 401 Broadway, Redwood City, Cal.

Circle 133 on Inquiry Card

## FLAT CAPACITOR

Flat, rectangular configuration for space-tight requirements.

The Flat-Pack has an initial design of 3 x 2 x 5/8 in. and features an extruded aluminum case with epoxy and seals. A typical rating for this size is 25vdc/1500.0 mfd. It lends itself well in computer equipment assembled on racks stacked side by side. Aerovox Corp., New Bedford, Mass.

Circle 132 on Inquiry Card

## ONE GREAT SHOW!

at the

# NEW YORK HILTON

2 floors, including Hilton's main exhibition area

- ELECTRICAL EXHIBITS
- CONVENTION PAPERS

IEEE Members: \$1.00  
Non-members: \$3.00  
Minimum age: 18

Buses to the N. Y. Coliseum every few minutes

- PRODUCTS ● PAPERS ● PEOPLE ● PRODUCTS ● PAPERS ● PEOPLE

# IEEE SHOW '64

march 23-26  
9:45 A.M. - 9 P.M.

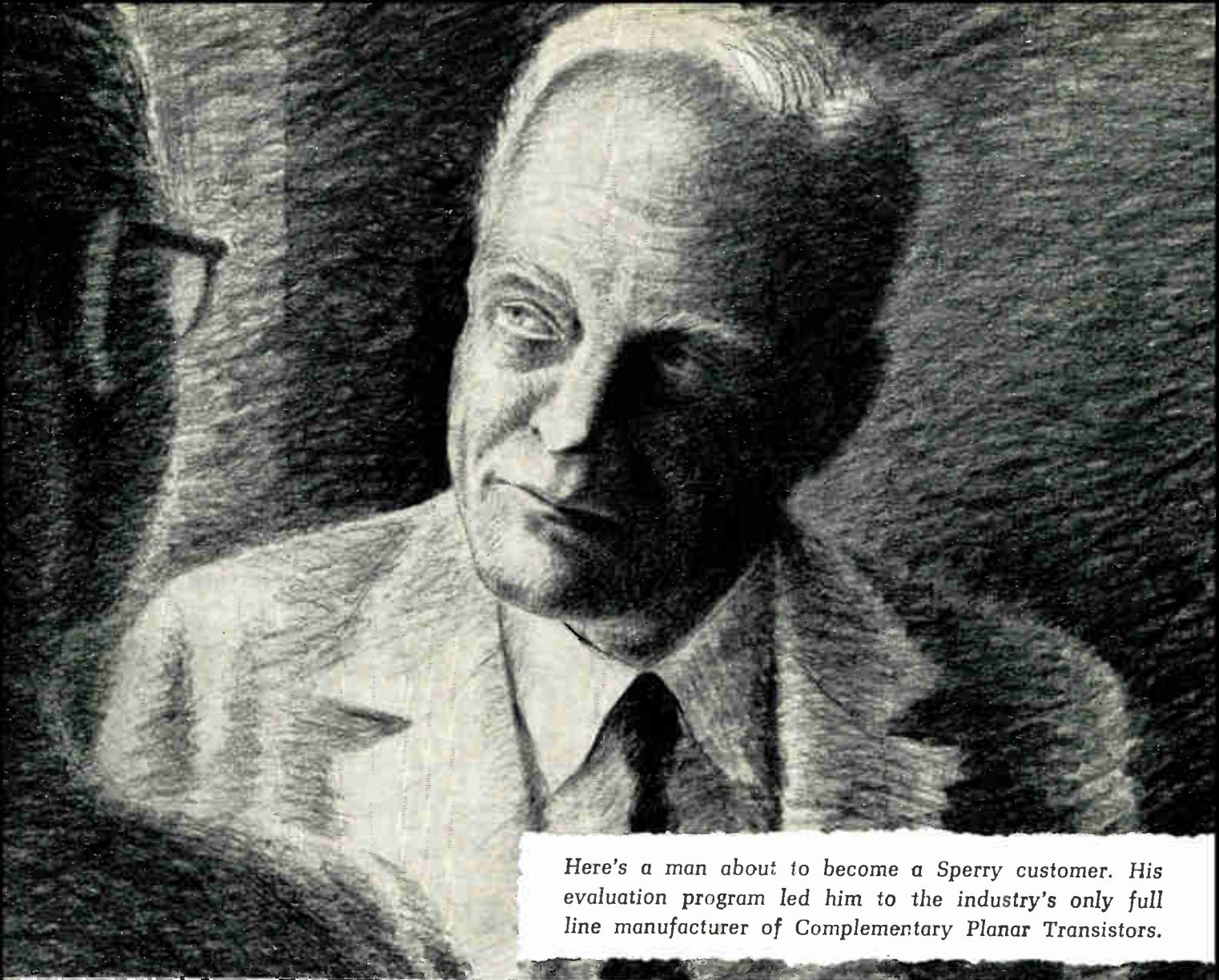

Here's a man about to become a Sperry customer. His evaluation program led him to the industry's only full line manufacturer of Complementary Planar Transistors.

|     | TO-46 Case | MAXIMUM VOLTAGES   |                    |                    | $I_{CBO}$ Max. @ 25°C (μA) | $h_{FE}$ |      |                 | $V_{CE}(SAT)$ |           | $f_T$ |     | TO-46 Case | MAXIMUM VOLTAGES   |                    |                    | $I_{CBO}$ Max. @ 25°C (μA) | $h_{FE}$ |      |                 | $V_{CE}(SAT)$ |           | $f_T$ |
|-----|------------|--------------------|--------------------|--------------------|----------------------------|----------|------|-----------------|---------------|-----------|-------|-----|------------|--------------------|--------------------|--------------------|----------------------------|----------|------|-----------------|---------------|-----------|-------|
|     |            | $BV_{CBO}$ (Volts) | $BV_{CEO}$ (Volts) | $BV_{EBO}$ (Volts) |                            | Min.     | Max. | @ $I_{C1}$ (mA) | Max. (Volts)  | Typ. (MC) |       |     |            | $BV_{CBO}$ (Volts) | $BV_{CEO}$ (Volts) | $BV_{EBO}$ (Volts) |                            | Min.     | Max. | @ $I_{C1}$ (mA) | Max. (Volts)  | Typ. (MC) |       |
| NPN | 2N2459     | 100                | 60                 | 5                  | .002                       | 40       | 80   | 5               | 0.3           | 175       |       | NPN | 2N2461     | 100                | 60                 | 8                  | .002                       | 120      | 180  | 5               | 0.3           | 225       |       |
| PNP | 2N2590     | -100               | -60                | -7                 | -.025                      | 40       | 80   | -5              | -0.4          | 75        |       | PNP | 2N2592     | -100               | -60                | -7                 | -.025                      | 115      | 200  | -5              | -0.4          | 125       |       |
| NPN | 2N2460     | 100                | 60                 | 8                  | .002                       | 70       | 130  | 5               | 0.3           | 200       |       | NPN | 2N2462     | 100                | 60                 | 8                  | .002                       | 170      | 230  | 5               | 0.3           | 250       |       |
| PNP | 2N2591     | -100               | -60                | -7                 | -.025                      | 70       | 135  | -5              | -0.4          | 100       |       | PNP | 2N2593     | -100               | -60                | -7                 | -.025                      | 160      | 275  | -5              | -0.4          | 150       |       |

You put your experience on the line when you specify. Evaluate the table of characteristics shown above. These type numbers represent only a fraction of our full line. Compare the key parameters of the NPN types and see how they are complemented by the PNP types. True Complementary Transistors can help you increase performance with same power (or cut power requirements); reduce number of stages; improve high density packaging. By manufacturing the industry's first full line of complementary transistors, (not just selecting a PNP that is close to an NPN), Sperry Semiconductor once again demonstrates its leadership of PNP low-level silicon devices. Our record of reliability validates our credentials for the future. Question them, inspect them, use them - they can help on your military projects and in your industrial control work. Whether you need volume production or personal attention in custom engineering - contact us. It costs you no more to buy from the leader of PNP small signal silicon transistors. Eastern Regional Office: 69 Hickory Drive, Waltham, Mass.; Midwest Regional Office: 3555 West Peterson Avenue, Chicago 45, Ill.; Western Regional Office: 1680 North Vine Street, Hollywood 28, Calif.  Keep in touch - with SPERRY SEMICONDUCTOR, Norwalk, Connecticut.

**SPERRY**

DIVISION OF  
SPERRY RAND  
CORPORATION

Circle 57 on Inquiry Card



## COMPUTER-GENERATED MOVIES

By using a computer and an S-C 4020 system, scientists can study a satellite tumbling through space. System graphically shows satellite's various attitudes during orbit. The S-C 4020 acts as an animator. It receives mathematically-coded data from the computer and uses an electron beam to create a series of drawings on the face of a CRT. The system was developed by General Dynamics/Electronics.

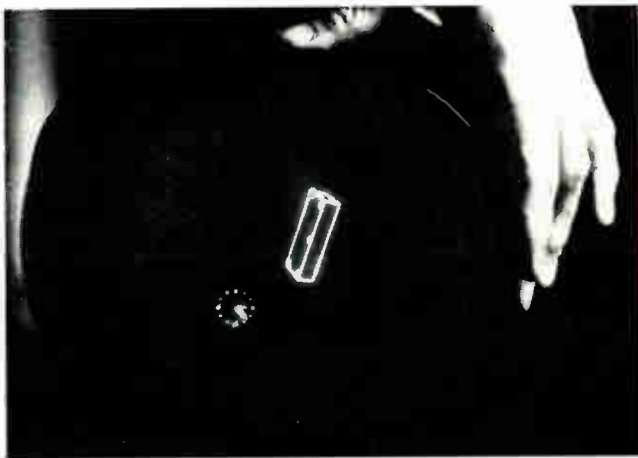

Fairchild Stratos, Washington, D. C., will produce the ADAS system—Auxiliary Data Annotation Sets—for the McDonnell RF-4B reconnaissance aircraft. ADAS is a high-speed computation and display device that integrates and prints geographic and other significant flight data on each frame of film exposed by the aircraft's cameras and other sensing devices. The system facilitates rapid, meaningful photo-interpretation.

IBM is currently developing a system whereby a computer converts shorthand into a typewritten transcript. The system has analyzed the wide paper type of a steno keyboard and typed out a readable script of an actual court trial.

A family of logic circuits that provide a 250mc information rate have been developed for computer systems by Martin, Baltimore. Circuits use standard hardware; speed improvement is a result of combining storage diodes and tunnel diodes. New technique uses a storage diode to give considerable inter-stage current gain with a gain bandwidth, compatible with the tunnel diode, on the order of 10gc.

The RCA 30 Newscom system produces justified and hyphenated typesetting automatically. The pre-programmed system accepts standard teletypesetter tape at the rate of 100 char./sec. and produces up to 18,000 eight-point, 11 pica lines of type on punched-paper tape an hour. The tape can be fed directly into linecasting machines.

North American Aviation's Autonetics Div. has awarded a contract to Motorola, Inc., Phoenix, Ariz., to produce the microelectronic integrated circuit systems of the Monica computers. Monica is a family of small, lightweight, general-purpose digital-data processors combining modular building-block flexibility, high-reliability, and large capacity at low cost.

TNT (Theatre Network Television) has demonstrated Color Eidophor—a closed-circuit, large-screen color TV system—to the Pentagon. The color quality is said to be comparable to that of 35mm color motion-picture film. The system, which is intended for military and civilian uses, was aided by a new TV camera—the Plumbicon—developed by Norelco.

Sylvania Electric Products Inc. has developed an experimental airborne radio system for use if conventional contact between defense installations fail. The system transmits radio signals long distance by using a two-mile wire antenna attached to a flying jet tanker.

The LGP-21 is a fully transistorized, 90-lb. computer that plugs into any standard outlet. It basically consists of arithmetic and control units and a 4096-word memory disc. The system, developed by General Precision's Computer Div., has a standard input/output equipment consisting of a typewriter with paper punch and reader.

## BUG-EYED

This sensor element aids a space-vehicle system that tracks stars. The tracker locks on a star and furnishes guidance signals that position the space vehicle for astronomical observations. The system was developed by ITT Federal Laboratories.

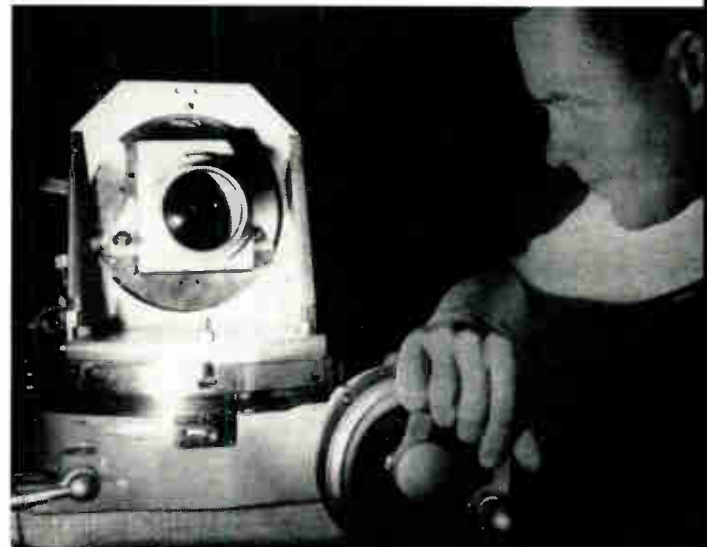



# PROTECTING COMPUTER MEMORIES AGAINST POWER FAILURES

Loss of voltage to the logic circuits that control the write amplifier, for even a few milliseconds, can mean the loss of an entire track of information. This can be avoided by a circuit that cuts off the plate voltage to the write amplifier as soon as voltage failure occurs.

PROTECTION OF STORED INFORMATION in the event of certain types of power failures can be a major problem in a system using magnetic storage devices. For example, loss of voltage to logic circuits which control the write amplifier associated with a magnetic disk (or drum) surface may cause the write amplifier to turn "on," and destroy information previously written onto the surface. In critical uses, it is

essential that protective devices be supplied which can sense such a voltage failure and inhibit the write amplifier from turning "on." These circuits must perform their task in a few  $\mu$ secs., since the bit rates of such storage systems are typically in the megacycle or hundreds-of-kilocycles range.

One such "protection" circuit is described here. It was designed to protect the information stored on

Fig. 1: Destruction circuit "destroys" the +270 vdc in the event of failure of one of the disk file voltages, or any of the voltages supplying the write amp logic.

By DAN M. BOWERS\*  
and ARTHUR E. CONLEY†

Systems Engineering Dept.  
Computer Control Co., Inc.  
Framingham, Mass.

Fig. 2: Destruct circuit operation. Typical waveform at the write amp plate is shown below.

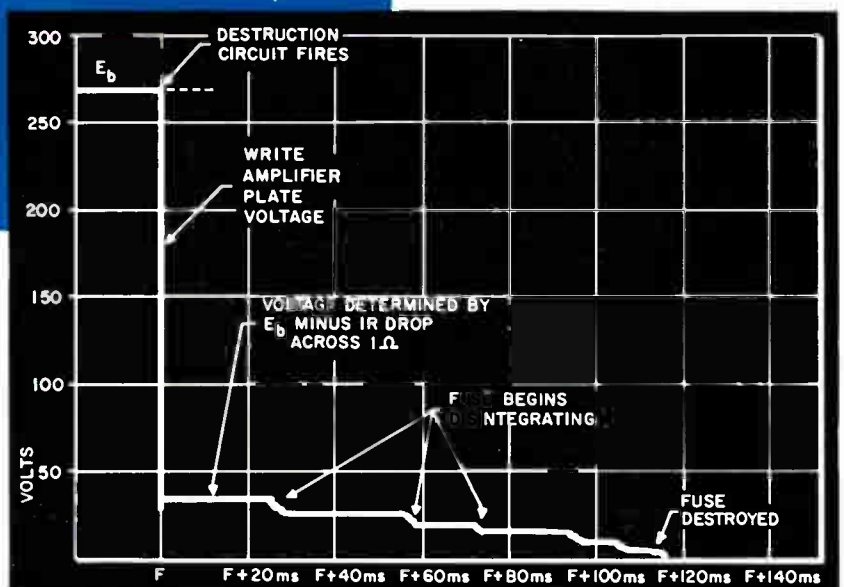
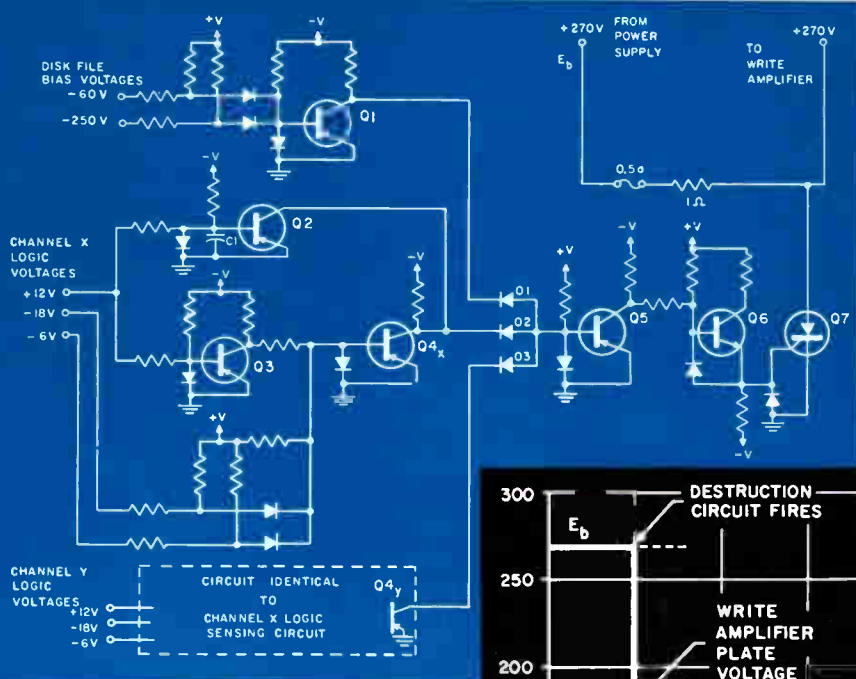

D. M. Bowers

A. E. Conley



a disk storage unit which is part of a large real-time banking system.<sup>1</sup>

Loss of "critical" information in a system such as this could be disastrous. Even if the information could be replaced it could be done only at the expense of much time and effort. Loss of power for only a matter of msec. could mean the loss of an entire track or more of information.

The disk storage (Fig. 1) unit uses vacuum tube write amplifiers. The circuit instantly "destroys" the +270 vdc plate voltage in the event of failure of one of the disk file bias voltages, or any of voltages supplying the logic which controls the write amplifier. Since the plate voltage will be destroyed, or removed, within  $\mu$ secs. of the failure of another voltage, the write amplifier cannot be turned "on" as a result of the voltage failure.

In the normal condition, Q1, Q4<sub>x</sub>, and Q4<sub>y</sub> are all turned "on," holding the "firing buffer" D1-D2-D3 at ground, and keeping Q5, Q6, and Q7 "off." +270 vdc is supplied through a 1/2a. fuse and a small resistor to the write amplifier. Q7 is a high power silicon controlled rectifier.

Failure of either bias voltage, -60 vdc or -250 vdc, will, through the associated diode buffer, turn off Q1 and cause a negative voltage to appear at D1, on the "firing buffer." The "firing buffer" causes Q5 to turn "on," turning "on" Q6 and Q7. Q7 shorts the +270 vdc to ground through the 1-ohm protective resistor, and holds it there until the fuse is destroyed. A typical voltage waveform at the write amplifier plate is shown in Fig. 2.

Failure of any channel X logic voltage will cause Q4<sub>x</sub> to turn "off" (via Q3 in the case of +12 vdc) and trigger the "destruction" circuit through D2 of the "firing buffer."

Sensing circuits are provided for each of three logic voltages in each of two logic channels, X and Y; X and Y are complete duplicates, and are provided for redundancy in system operation. Should one logic channel become inoperative, the system must be capable of operating on the remaining channel alone. For this reason, Q2 is provided to hold D2 at ground, and thus prevent D2 from causing "destruction" when the channel X +12 vdc is absent due to channel X being unused or inoperative. C1 provides the delay necessary for D2 to perform its "destruction" function if the +12 vdc should fail when the X channel is operative. A similar ability is built into the channel Y logic sensing circuits.

## Reference

1. Bowers, D. M.; Lennon, Jr., W. T.; Jordan, Jr., W. F.; and Benson, D. G.; "TELLERTRON: A Real-Time Updating and Transaction Processing System for Savings Banks"; 1962 IRE International Convention Record, Part 4.

\*presently with IBM Corp., Yorktown Heights, N.Y.

†presently with Raytheon Co., Sudbury, Mass.

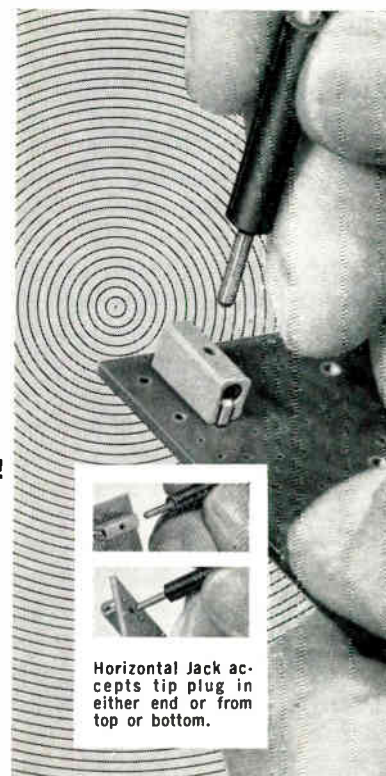

Designed for  
printed circuit use!

## MINIATURE PLUGS AND JACKS

Horizontal Jack accepts tip plug in either end or from top or bottom.

### Operating voltages to 1500 V RMS... up to 5 amps current carrying capacity!

Extremely compact — highly resistant to extremes of shock, vibration, temperature and moisture, these tiny Johnson Tip Plugs and Jacks are ideal for limited space applications! Bodies molded of tough, low-loss plastic per MIL-P-17091. Available in 10 colors, including basic colors for MS16108C coding applications. Contact resistance: less than 2 milliohms. Capacitance between two adjacent jacks: less than 1 mmf. at 1 Mc.

**Series 105-751 Horizontal Jack** — Unique design accepts .080" diameter tip plug in either end, or from top or bottom. Formed silver-plated beryllium copper contact. 2 terminals.

**Series 105-851 Vertical Jack** — Mounts through single .052" hole, requires minimum mounting area. Silver-plated, machined beryllium copper contact.

**Series 105-771 Sub-Miniature Tip Plug** — For use with miniature jack. .080" diameter tip. Nickel-plated, machined brass body. Solder type lead connection.

**Series 105-881 Long Handle Tip Plug** — Identical to tip plug above, but with 4" molded plastic body for ready access to "hard to reach" test points.

Components Catalog Available—Write today on company letterhead!



**E. F. JOHNSON CO.**

3007 TENTH AVE. S.W. • WASECA, MINN.

CAPACITORS • TUBE SOCKETS • CONNECTORS  
PILOT LIGHTS • INSULATORS • KNOBS AND  
DIALS • INDUCTORS • HARDWARE

Other Connectors — Johnson also manufactures standard connectors including Tip Plugs and Jacks; Metal-Clad and Rapid-Mount Jacks; Banana Plugs and Jacks; Binding Post. Voltage breakdowns to 12,500 volts DC. Jacks designed for fast, easy mounting — plugs for solderless connection. Current catalog provides full specifications on complete line.

TI IN4364  
100v, 750 ma

Replaces:  
IN530  
IN537  
IN600  
IN600A  
IN1103  
IN1487  
IN1692

TI IN4365  
200v, 750 ma

Replaces:  
IN531  
IN538  
IN602  
IN602A  
IN1101  
IN1488  
IN1693

TI IN4366  
300v, 750 ma

Replaces:  
IN532  
IN539  
IN603  
IN603A  
IN1102  
IN1489  
IN1694

TI IN4367  
400v, 750 ma

Replaces:  
IN533  
IN540  
IN604  
IN604A  
IN1103  
IN1490  
IN1695

TI IN4368  
500v, 750 ma

Replaces:  
IN534  
IN605  
IN605A  
IN1095  
IN1104  
IN1491  
IN1696

TI IN4369  
600v, 750 ma

Replaces:  
IN535  
IN547  
IN606  
IN606A  
IN1096  
IN1105  
IN1492  
IN1697

**NOW...  
six  
rectifiers  
replace  
forty-three**

Six new Uni-Versatile\* rectifiers combine best specs, best prices of 43 older types.

Now you can directly replace 43 conventional general-purpose rectifiers with six new-generation diffused-junction rectifiers from Texas Instruments. The result: better performance, higher reliability, and significant inventory savings . . . at a price equal to or lower than you are now paying.

Performance is improved. Uni-Versatile rectifiers meet or exceed all the specifications of even the most expensive older devices. In no case is the over-all guaranteed performance of a Uni-Versatile unit matched by its older replaceable counterpart. Through important advances in diffusion technology, low forward voltage drop ( $V_F = 1.0v @ I_o = 0.5 a$ ) has been combined with exceptionally low leakage ( $1.0 \mu a @ 25^\circ C$ ,  $100 \mu a @ 150^\circ C$ , full-rated voltage). Greater efficiency and long-term reliability result. Diffused-junction construction provides high, 35-amp surge-current capability. Reliability is further enhanced by an all-welded, hermetically sealed package.

Costs are reduced. Parts standardization with Uni-Versatile rectifiers offers you significant savings potential in reduced inventory and simplified purchasing. You realize direct savings in component cost as well in 30 of the 43 replacements; in the remaining 13, prices are equal.

Ask your TI sales engineer or authorized distributor for full information on Uni-Versatile silicon rectifiers. Or write for detailed data sheets.

\* *Trademark of Texas Instruments Incorporated*



**TEXAS INSTRUMENTS  
INCORPORATED**

SEMICONDUCTOR-COMPONENTS DIVISION  
P. O. BOX 5012 • DALLAS 22, TEXAS

SEMICONDUCTOR PLANTS IN BEDFORD, ENGLAND • NICE, FRANCE • DALLAS, TEXAS

World Radio History



# FREE! Use These Cards for:

- Catalogs, Bulletins, Literature • Design features of advertised products
- Information about new Products • New Tech Data for Engineers

YOUR NAME ..... TITLE .....

FIRM ..... Mail Stop or Div./Dept. ....

FIRM ADDRESS .....

CITY OR TOWN ..... ZONE ..... STATE .....

|     |     |     |     |     |     |     |     |     |     |     |     |     |     |     |     |     |     |     |     |
|-----|-----|-----|-----|-----|-----|-----|-----|-----|-----|-----|-----|-----|-----|-----|-----|-----|-----|-----|-----|
| 1   | 2   | 3   | 4   | 5   | 6   | 7   | 8   | 9   | 10  | 11  | 12  | 13  | 14  | 15  | 16  | 17  | 18  | 19  | 20  |
| 21  | 22  | 23  | 24  | 25  | 26  | 27  | 28  | 29  | 30  | 31  | 32  | 33  | 34  | 35  | 36  | 37  | 38  | 39  | 40  |
| 41  | 42  | 43  | 44  | 45  | 46  | 47  | 48  | 49  | 50  | 51  | 52  | 53  | 54  | 55  | 56  | 57  | 58  | 59  | 60  |
| 61  | 62  | 63  | 64  | 65  | 66  | 67  | 68  | 69  | 70  | 71  | 72  | 73  | 74  | 75  | 76  | 77  | 78  | 79  | 80  |
| 81  | 82  | 83  | 84  | 85  | 86  | 87  | 88  | 89  | 90  | 91  | 92  | 93  | 94  | 95  | 96  | 97  | 98  | 99  | 100 |
| 101 | 102 | 103 | 104 | 105 | 106 | 107 | 108 | 109 | 110 | 111 | 112 | 113 | 114 | 115 | 116 | 117 | 118 | 119 | 120 |
| 121 | 122 | 123 | 124 | 125 | 126 | 127 | 128 | 129 | 130 | 131 | 132 | 133 | 134 | 135 | 136 | 137 | 138 | 139 | 140 |
| 141 | 142 | 143 | 144 | 145 | 146 | 147 | 148 | 149 | 150 | 151 | 152 | 153 | 154 | 155 | 156 | 157 | 158 | 159 | 160 |
| 161 | 162 | 163 | 164 | 165 | 166 | 167 | 168 | 169 | 170 | 171 | 172 | 173 | 174 | 175 | 176 | 177 | 178 | 179 | 180 |
| 181 | 182 | 183 | 184 | 185 | 186 | 187 | 188 | 189 | 190 | 191 | 192 | 193 | 194 | 195 | 196 | 197 | 198 | 199 | 200 |
| 201 | 202 | 203 | 204 | 205 | 206 | 207 | 208 | 209 | 210 | 211 | 212 | 213 | 214 | 215 | 216 | 217 | 218 | 219 | 220 |
| 221 | 222 | 223 | 224 | 225 | 226 | 227 | 228 | 229 | 230 | 231 | 232 | 233 | 234 | 235 | 236 | 237 | 238 | 239 | 240 |
| 241 | 242 | 243 | 244 | 245 | 246 | 247 | 248 | 249 | 250 | 251 | 252 | 253 | 254 | 255 | 256 | 257 | 258 | 259 | 260 |
| 261 | 262 | 263 | 264 | 265 | 266 | 267 | 268 | 269 | 270 | 271 | 272 | 273 | 274 | 275 | 276 | 277 | 278 | 279 | 280 |
| 281 | 282 | 283 | 284 | 285 | 286 | 287 | 288 | 289 | 290 | 291 | 292 | 293 | 294 | 295 | 296 | 297 | 298 | 299 | 300 |
| 301 | 302 | 303 | 304 | 305 | 306 | 307 | 308 | 309 | 310 | 311 | 312 | 313 | 314 | 315 | 316 | 317 | 318 | 319 | 320 |
| 321 | 322 | 323 | 324 | 325 | 326 | 327 | 328 | 329 | 330 | 331 | 332 | 333 | 334 | 335 | 336 | 337 | 338 | 339 | 340 |
| 341 | 342 | 343 | 344 | 345 | 346 | 347 | 348 | 349 | 350 | 351 | 352 | 353 | 354 | 355 | 356 | 357 | 358 | 359 | 360 |
| 361 | 362 | 363 | 364 | 365 | 366 | 367 | 368 | 369 | 370 | 371 | 372 | 373 | 374 | 375 | 376 | 377 | 378 | 379 | 380 |
| 381 | 382 | 383 | 384 | 385 | 386 | 387 | 388 | 389 | 390 | 391 | 392 | 393 | 394 | 395 | 396 | 397 | 398 | 399 | 400 |

Please send me further information on the items I have circled above.  
 Postcard valid 8 weeks only. After that use own letterhead describing item wanted.

1-B EI-09 JANUARY 1964

## NEW Subscription Order

I wish a new complimentary Subscription to  
**ELECTRONIC INDUSTRIES**

Mail Stop  
 or  
 Div./Dept.

Company Name \_\_\_\_\_

Name \_\_\_\_\_ Position/Title \_\_\_\_\_

Company Address \_\_\_\_\_

City \_\_\_\_\_ Zone \_\_\_\_\_ State \_\_\_\_\_

### IMPORTANT

FOR OUR STATISTICAL RECORDS PLEASE CHECK THE ONE APPROPRIATE CATEGORY THAT BEST DESCRIBES YOUR COMPANY OR DEPARTMENT. Failure to do so will delay your subscription.

- Mfr. of non-military electronic receiving and transmitting equipment.
- Mfr. of non-military electronic instruments, measuring, control and test equipment.
- Mfr. of non-military electronic computers, data processing, analysers, business machines.
- Mfr. of Guided Missiles and Accessories; Aircraft and Accessories, All Types of Military Products and Equipment.
- Mfr. of electronic components, parts, tubes and like products.
- Mfg. Co. (non electronic) using any of the above equip. In mfr., research or development work.
- Broadcasting or telecasting station.
- Commercial communication user (Tel & Tel, Police, Airports, Recording Studio, Etc.).
- Independent research, test, design laboratories and independent consultants—not part of a mfg. Co.
- Gov't Bureaus, Gov't laboratories, Gov't research center, military installation.
- Wholesaler, mfg. representative, service firm.
- University (educational) Public Library.
- Other (Please explain) .....

# FREE! Use These Cards for:

- Catalogs, Bulletins, Literature • Design features of advertised products
- Information about new Products • New Tech Data for Engineers

FIRST CLASS  
PERMIT NO. 2333  
CAMDEN, N. J.

BUSINESS REPLY MAIL

No Postage Stamp Necessary If Mailed in U.S.A.

POSTAGE WILL BE PAID BY

ELECTRONIC INDUSTRIES

The Computer Center

P. O. Box 1970

Camden, New Jersey 08100



FIRST CLASS  
PERMIT NO. 36  
PHILA., PA.

BUSINESS REPLY MAIL

NO POSTAGE STAMP NECESSARY IF MAILED IN UNITED STATES

POSTAGE WILL BE PAID BY

ELECTRONIC INDUSTRIES

Chilton Company

Chestnut & 56th Sts.

Philadelphia, Pa. 19139



Att: Circulation Dept.

# FREE! Use These Cards for:

- Catalogs, Bulletins, Literature • Design features of advertised products
- Information about new Products • New Tech Data for Engineers

FIRST CLASS  
PERMIT NO. 2333  
CAMDEN, N. J.

**BUSINESS REPLY MAIL**

No Postage Stamp Necessary If Mailed in U.S.A.

**POSTAGE WILL BE PAID BY**

**ELECTRONIC INDUSTRIES**

The Computer Center

P. O. Box 1970

Camden, New Jersey 08100

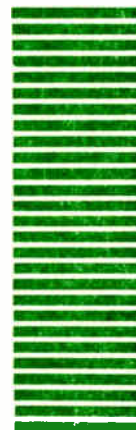

FIRST CLASS  
PERMIT NO. 36  
PHILA., PA.

**BUSINESS REPLY MAIL**  
NO POSTAGE STAMP NECESSARY IF MAILED IN UNITED STATES

**POSTAGE WILL BE PAID BY**

**ELECTRONIC INDUSTRIES**

Chilton Company

Chestnut & 56th Sts.

Philadelphia, Pa. 19139



Att: Circulation Dept.



# FREE! Use These Cards for:

- Catalogs, Bulletins, Literature • Design features of advertised products
- Information about new Products • New Tech Data for Engineers

YOUR NAME ..... TITLE .....

FIRM ..... Mail Stop or Div./Dept. ....

FIRM ADDRESS .....

CITY OR TOWN ..... ZONE ..... STATE .....

|     |     |     |     |     |     |     |     |     |     |     |     |     |     |     |     |     |     |     |     |
|-----|-----|-----|-----|-----|-----|-----|-----|-----|-----|-----|-----|-----|-----|-----|-----|-----|-----|-----|-----|
| 1   | 2   | 3   | 4   | 5   | 6   | 7   | 8   | 9   | 10  | 11  | 12  | 13  | 14  | 15  | 16  | 17  | 18  | 19  | 20  |
| 21  | 22  | 23  | 24  | 25  | 26  | 27  | 28  | 29  | 30  | 31  | 32  | 33  | 34  | 35  | 36  | 37  | 38  | 39  | 40  |
| 41  | 42  | 43  | 44  | 45  | 46  | 47  | 48  | 49  | 50  | 51  | 52  | 53  | 54  | 55  | 56  | 57  | 58  | 59  | 60  |
| 61  | 62  | 63  | 64  | 65  | 66  | 67  | 68  | 69  | 70  | 71  | 72  | 73  | 74  | 75  | 76  | 77  | 78  | 79  | 80  |
| 81  | 82  | 83  | 84  | 85  | 86  | 87  | 88  | 89  | 90  | 91  | 92  | 93  | 94  | 95  | 96  | 97  | 98  | 99  | 100 |
| 101 | 102 | 103 | 104 | 105 | 106 | 107 | 108 | 109 | 110 | 111 | 112 | 113 | 114 | 115 | 116 | 117 | 118 | 119 | 120 |
| 121 | 122 | 123 | 124 | 125 | 126 | 127 | 128 | 129 | 130 | 131 | 132 | 133 | 134 | 135 | 136 | 137 | 138 | 139 | 140 |
| 141 | 142 | 143 | 144 | 145 | 146 | 147 | 148 | 149 | 150 | 151 | 152 | 153 | 154 | 155 | 156 | 157 | 158 | 159 | 160 |
| 161 | 162 | 163 | 164 | 165 | 166 | 167 | 168 | 169 | 170 | 171 | 172 | 173 | 174 | 175 | 176 | 177 | 178 | 179 | 180 |
| 181 | 182 | 183 | 184 | 185 | 186 | 187 | 188 | 189 | 190 | 191 | 192 | 193 | 194 | 195 | 196 | 197 | 198 | 199 | 200 |
| 201 | 202 | 203 | 204 | 205 | 206 | 207 | 208 | 209 | 210 | 211 | 212 | 213 | 214 | 215 | 216 | 217 | 218 | 219 | 220 |
| 221 | 222 | 223 | 224 | 225 | 226 | 227 | 228 | 229 | 230 | 231 | 232 | 233 | 234 | 235 | 236 | 237 | 238 | 239 | 240 |
| 241 | 242 | 243 | 244 | 245 | 246 | 247 | 248 | 249 | 250 | 251 | 252 | 253 | 254 | 255 | 256 | 257 | 258 | 259 | 260 |
| 261 | 262 | 263 | 264 | 265 | 266 | 267 | 268 | 269 | 270 | 271 | 272 | 273 | 274 | 275 | 276 | 277 | 278 | 279 | 280 |
| 281 | 282 | 283 | 284 | 285 | 286 | 287 | 288 | 289 | 290 | 291 | 292 | 293 | 294 | 295 | 296 | 297 | 298 | 299 | 300 |
| 301 | 302 | 303 | 304 | 305 | 306 | 307 | 308 | 309 | 310 | 311 | 312 | 313 | 314 | 315 | 316 | 317 | 318 | 319 | 320 |
| 321 | 322 | 323 | 324 | 325 | 326 | 327 | 328 | 329 | 330 | 331 | 332 | 333 | 334 | 335 | 336 | 337 | 338 | 339 | 340 |
| 341 | 342 | 343 | 344 | 345 | 346 | 347 | 348 | 349 | 350 | 351 | 352 | 353 | 354 | 355 | 356 | 357 | 358 | 359 | 360 |
| 361 | 362 | 363 | 364 | 365 | 366 | 367 | 368 | 369 | 370 | 371 | 372 | 373 | 374 | 375 | 376 | 377 | 378 | 379 | 380 |
| 381 | 382 | 383 | 384 | 385 | 386 | 387 | 388 | 389 | 390 | 391 | 392 | 393 | 394 | 395 | 396 | 397 | 398 | 399 | 400 |

Please send me further information on the items I have circled above.  
 Postcard valid 8 weeks only. After that use own letterhead describing item wanted.

1-B

EI-09

JANUARY 1964

## CHANGE OF ADDRESS

I wish to continue receiving **ELECTRONIC INDUSTRIES**  
 Change my address as indicated.

|  |
|--|
|  |
|  |
|  |

OLD

NEW

Paste wrapper imprint here, or . . .  
 Write in complete old address

Company \_\_\_\_\_  
 Mail Stop or Div./Dept. \_\_\_\_\_  
 Title/Position \_\_\_\_\_  
 Company Address \_\_\_\_\_  
 City \_\_\_\_\_ Zone \_\_\_\_\_ State \_\_\_\_\_  
 Signature \_\_\_\_\_

### IMPORTANT

FOR OUR STATISTICAL RECORDS PLEASE CHECK THE ONE APPROPRIATE CATEGORY THAT BEST DESCRIBES YOUR COMPANY OR DEPARTMENT. Failure to do so will delay your address change.

- Mfr. of non-military electronic receiving and transmitting equipment.
- Mfr. of non-military electronic instruments, measuring, control and test equipment.
- Mfr. of non-military electronic computers, data processing, analysers, business machines.
- Mfr. of Guided Missiles and Accessories; Aircraft and Accessories, All Types of Military Products and Equipment.
- Mfr. of electronic components, parts, tubes and like products.
- Mfg. Co. (non electronic) using any of the above equip. in mfr., research or development work.
- Broadcasting or telecasting station.
- Commercial communication user (Tel & Tel, Police, Airports, Recording Studio, Etc.).
- Independent research, test, design laboratories and independent consultants—not part of a mfg. Co.
- Gov't Bureaus, Gov't laboratories, Gov't research center, military installation.
- Wholesaler, mfg. representative, service firm.
- University (educational) Public Library.
- Other (Please explain) .....

# Attention: Prototype Engineers!

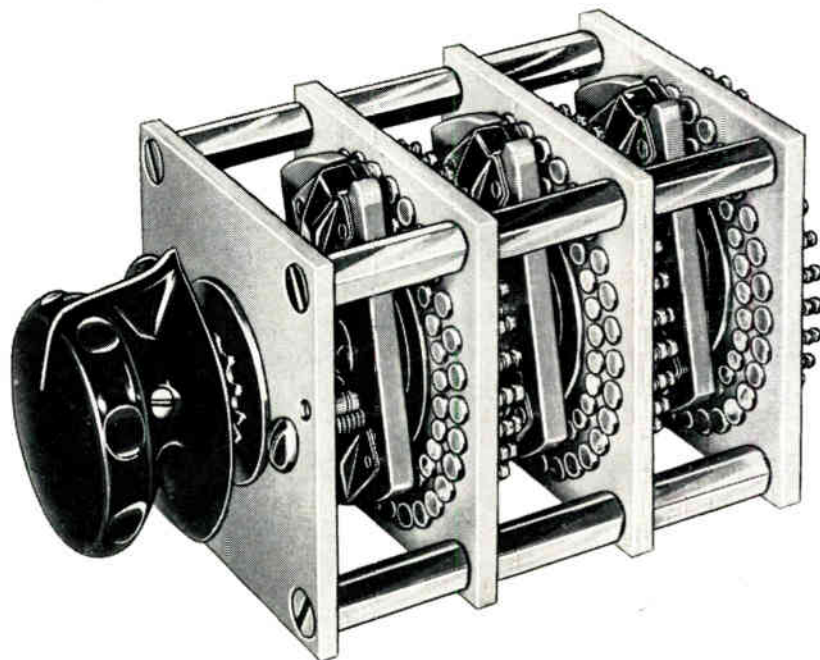

## 48 hours from Daven to you!

### **87 adjustable stop switches that replace 2,001 standard types!**

Daven revolutionizes switch availability by putting the equivalent of 2,001 standard types as close as your telephone. That's 97% of all your switch needs brought right to your door—direct from Daven within 48 hours! Daven does it by designing the characteristics of 2,001 switches into 87 easy-to-stock, easy-to-use adjustable stop switches. The result: instant availability and **maximum flexibility** (you can change the number of switch positions at any time). The cost is the same, or **less**, than its standard counterpart.

Daven adjustable stop switches are built in square configuration, in 1¾" and 2¼" sizes. Like

all Daven switches, their metal parts are fabricated from corrosion-resistant materials . . . plastics are heavily filled with non-organic fibres and are capable of withstanding high temperatures . . . switch contacts and rotor arms are solid silver alloy. Daven's patented knee action, tamper-proof rotor is standard. All applicable paragraphs of MIL-S-3786 and MIL-E-5272 are met and exceeded.

For your new switch catalog, with details on the new adjustable stop switches and a complete Replacement List, write today!

# DAVEN



**LIVINGSTON, NEW JERSEY**  
(Area code 201) **WYman 2-4300**  
**TWX 201 992-7356**  
Cable: **Daven Livingston, N.J.**

# NEW TECH DATA

for Engineers

## Design-Aid Brochure

This design-aid application note, "Safe Operating Area (SOAR)" will aid in specifying the exact transistor to use in switching or dc applications. The design engineer will find that the SOAR principle fills the gap that presently exists between the data sheet and the breadboard. The data includes schematics and equations. The Bendix Corp., Bendix Semiconductor Div., Holmdel, N. J.

Circle 151 on Inquiry Card

## Potentiometer Catalog

Catalog B, 40 pages, describes a complete line of wirewound trimmer potentiometers and precision potentiometers. It contains complete specs., descriptions and dimensional outlines of 15 military grade trimmer potentiometers, 8 commercial grade trimmers plus 13 standard variations of these models. A quick-reference chart precedes the listing to enable easy location of a potentiometer with the size, terminal configuration, resistance range, tolerance, power rating, temp. range and adjustment features required. Dale Electronics, Inc., Box 488, Columbus, Neb.

Circle 152 on Inquiry Card

## Instrumentation Cable

Designers, engineers, and purchasing agents may receive an intensive "short course" in instrumentation cables from "Here Are The Answers to Your Questions on Instrumentation Cable." In question-and-answer form, the 16-page primer details conductor types and sizes, construction, insulations and jackets, identification, shielding, and military specs. A glossary of terms is included. Rome Cable Div. of Alcoa, 685 Alcoa Bldg., Pittsburgh, Pa.

Circle 153 on Inquiry Card

## Accelerometer

A data sheet describing the ultrasensitive ADP (ammonium di-hydrogen phosphate) crystal accelerometer, Model AC-105, is now available. The unit was developed for vibration sensing applications where extremely high sensitivity and broad dynamic range are required. A brief technical description is followed by a listing of important specs. among which is the operating dynamic range of 50 $\mu$ g to 200g. Massa Div., Cohu Electronics, Inc., 280 Lincoln St., Hingham, Mass.

Circle 154 on Inquiry Card

## Readout Device

Electromechanical translation within the Digi-Line™ display is accomplished by energizing the drive motor on computer command. The motor drives a shaft common to all digital positions. The tape containing the coded digital positions works in conjunction with a computer register. When the coded parity bit of the digit position designated meets that in the register, the drive motor stops. Additional data available from Guidance and Control Systems Div., Litton Industries, 5500 Canoga Ave., Woodland Hills, Calif.

Circle 155 on Inquiry Card

## Capacitor Bulletin

Bulletin 2322, 20 pages, covers a complete line of transmitting-type mica capacitors. Complete design reference data on the Mil-C-5B styles CM65 through CM95 and their commercial equivalents are given. Curves and graphs are used wherever practical to clarify important design parameters. Complete listings and ordering information is included. Sanguamo Electric Co., Springfield, Ill.

Circle 156 on Inquiry Card

# ONLY 1<sup>3</sup>/<sub>4</sub>" HIGH



### SPECIFICATIONS of UNIVERSAL COUNTER-TIMER Model CF-250R (Illustrated Above)

**Input Sensitivity:** 10 mv rms (has front panel input sensitivity control for use with high level signals and pulses.)

**Frequency Measurement:** Time bases of 10 sec, 1 sec, 0.1 sec, .01 sec, .001 sec, and .0001 seconds.

Time base reference 100 KC crystal.

Frequency range 0 to 120 KC.

**Period:** Measures period and averages multiple periods of 1, 10, 10<sup>2</sup>, 10<sup>3</sup>, 10<sup>4</sup>, 10<sup>5</sup>, 10<sup>6</sup> (counts 100 KC clock).

Also measures single period with selectable clock intervals of 10<sup>-5</sup>, 10<sup>-4</sup>, 10<sup>-3</sup>, 10<sup>-2</sup>, 10<sup>-1</sup>, 1, and 10 sec.

**Ratio:** Measures ratio of two frequencies times 1, 10, 10<sup>2</sup>, 10<sup>3</sup>, 10<sup>4</sup>, 10<sup>5</sup>, and 10<sup>6</sup>.

**Time Interval:** Measures time interval from 10 microseconds to 11.6 days.

Can be gated by pulses or DC level.

Price: \$995.00



# NEW TECH DATA

for Engineers

## Laser Bulletin

"Optical Properties of Lasers as Compared to Conventional Radiators" is the title of this 12-page bulletin. It discusses such characteristics of radiating sources as spatial coherence, temporal coherence, and surface brightness. CW helium-neon gas laser sources are quantitatively compared with incoherent light sources. Various applications and experiments are explored. Spectra-Physics, Inc., 1255 Terra Bella Ave., Mountain View, Calif.

Circle 157 on Inquiry Card

## Armature Relay

BAR-863 is a 16-page brochure containing comprehensive technical data on standard balanced armature relays. Drawings detailing features of standard configurations—solder hook, plug-in, potted lead and side bracket with 2PDT, 4PDT, and 6PDT contact systems—are given, plus a listing of general, operating, environmental and mechanical characteristics for all standard electrically-held and magnetic-latch balanced armature relays having 5, 10, and 15a contact ratings. Leach Corp., 1123 Wilshire Blvd., Los Angeles 17, Calif.

Circle 158 on Inquiry Card

## Ceramics Catalog

A 16-page catalog includes new products as well as ceramic laboratory ware and industrial ceramics. Design considerations including close and broad tolerance dimensions, decimal equivalent and temp. conversion charts, and the electrical and mechanical properties of the ceramic formulas are described. Saxonburg Ceramics, Inc., Saxonburg, Pa.

Circle 159 on Inquiry Card

## Fuse Catalog

Catalog 15, 36 multi-color pages, lists new types of indicating fuses, mountings for cartridge-type silicon rectifiers, sub-miniature microfuse holders, standard lines of high- and low-voltage fuses, and circuit breakers. This catalog is primarily designed for circuit designer, industrial distributor, and purchasing personnel in the electronics, electrical, and aerospace industries. It provides photos, schematic diagrams, and operating characteristics of all types of circuit-protection devices. Littelfuse, Literature Dept., 1865 Miner St., Des Plaines, Ill.

Circle 160 on Inquiry Card

## Transformer Catalog

A complete, 2-color brochure on Standard, Mil-Spec, and custom transformers is now available. It contains complete listings of a basic line of 60 cycle and 400 cycle units. Valuable engineering data is provided on filament, filament/plate and plate transformers as well as on power supply filter reactors, military standard audio, and pulse/toroidal transformers and reactors, military standard audio, and pulse/toroidal transformers and reactors. Ferranti Electric, Inc., Light Equipment Div., Industrial Park No. 1, Plainview, L. I., N. Y.

Circle 161 on Inquiry Card

## Shift-Register Applications

New developments in shift-register applications, using the Clareed flip-flop control modules as the basic component, are described in this supplement. Three basic shift-register circuits are illustrated: serial-to-parallel conversion, parallel-to-serial conversion, and bi-directional. Basic application information is also included. C. P. Clare & Co., 3101 Pratt Blvd., Chicago, Ill.

Circle 162 on Inquiry Card

# SOLID-STATE UNIVERSAL COUNTER-TIMER

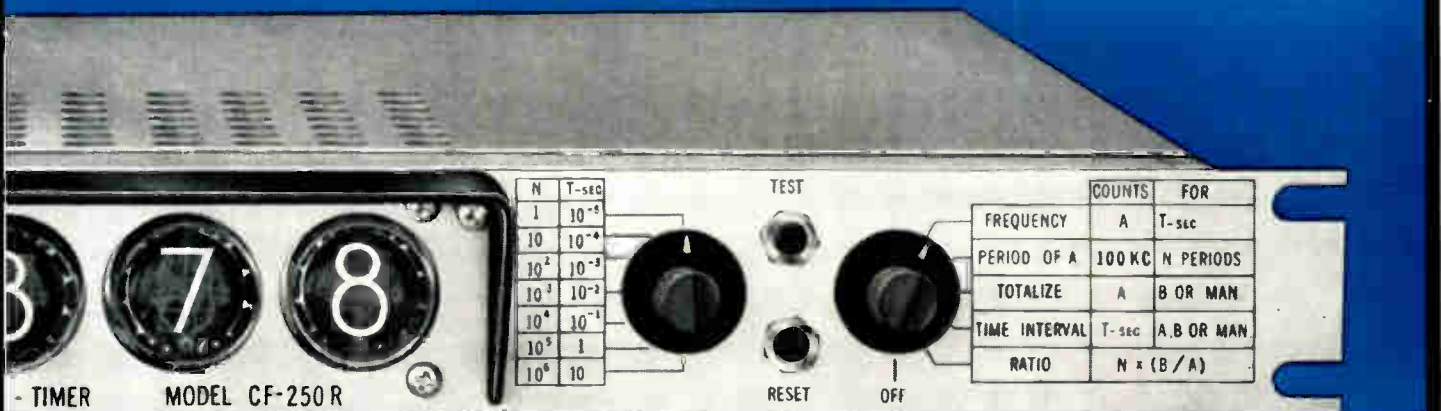

Anadex offers the smallest, most economical, rack-mounted solid-state counters available today. Featuring low power dissipation and high sensitivity, the complete line of counter-timers, variable time base counters, and preset counters provides you with the widest possible range of applications and uses. Write today for new six-page catalog listing detailed specifications.

Frequency Counters, from ..\$625    Preset Counters, from ..\$460  
Variable Time Base Counters,    Universal Counters,  
from .....\$995    from .....\$895

**ANADEX INSTRUMENTS, INC.**

7617 Hayvenhurst Avenue,  
Van Nuys, California  
Phone 213-873-6620  
TWX 213-781-6811



## BUSS FUSEHOLDERS

- LAMP INDICATING SERIES HK AND HJ FOR  $\frac{1}{4}$  x 1 and  $\frac{1}{4}$  x  $1\frac{1}{4}$  INCH FUSES

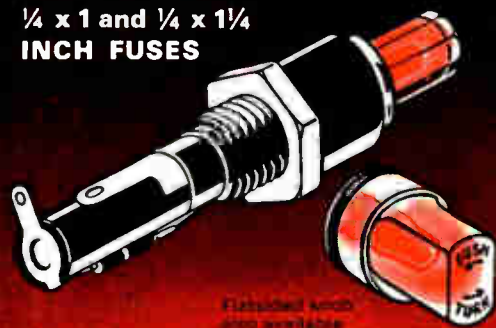

Flashed knob also available

Provides quick, positive visual identification of faulted circuit. Transparent knob permits indicating light to be readily seen.

Bayonet type knob-molded body-strong, coil spring provides positive contact on ends of fuse.

Fuseholder designed to withstand vibration such as occurs in aircraft applications. Terminals held mechanically as well as by solder.

Holder can be used in panels up to  $\frac{3}{16}$  inches thick.

# BUSS

Write for BUSS Bulletin 3FB.

BUSSMANN MFG. DIVISION, McGraw-Edison Co., St. Louis 7, Mo.

## BUSS Sub-Miniature PIGTAIL TRON FUSES

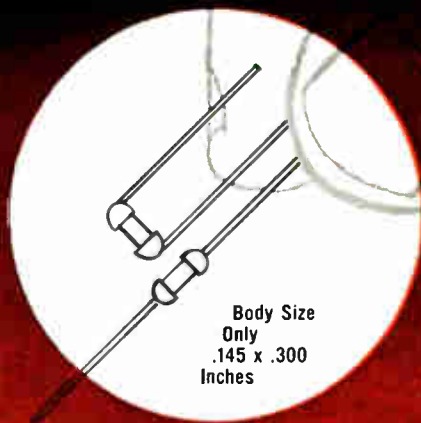

Body Size Only  
.145 x .300  
Inches

Tron fuses are so small they can be used as an integral part of circuit—to protect miniaturized devices—or gigantic multi-circuit electronic devices, without sacrifice of space.

They are hermetically sealed for potting without danger of sealing material affecting operation and have high resistance to shock or vibration. Operate without exterior venting. May be teamed with other components in replaceable unit.

# BUSS

Write for BUSS Bulletin 3FB.

BUSSMANN MFG. DIVISION, McGraw-Edison Co., St. Louis 7, Mo.

Circle 61 on Inquiry Card

Circle 61 on Inquiry Card

# BUSS: 1914-1964, Fifty years of Pioneering...

### Panel Controls

Data Sheet 216 contains technical data and specs. on Coordinated Manual Controls, oil-tight panel controls supplied without transformers and lamps. Available in both indicator and indicator-operator models, they can be used where 2-55v. are available. Basic CMS units are described in catalog 69 from Micro Switch, div. of Honeywell, Freeport, Ill.

Circle 208 on Inquiry Card

### Pump Catalog

Thin-film deposition, space, and R&D application information, plus selection information and complete pump and power-supply specs. are covered in Thinline ion pump catalog B-1234. The pumps, with capacities from 8 liters/sec. to 2400 liters/sec., are featured with a comparison of pump speed calibration curves and mounting dimensions. Ultek, Box 10920, Palo Alto, Calif.

Circle 209 on Inquiry Card

### Reliability Program

This booklet describes Raytheon's integrated quality-control program used in semiconductor manufacture. The fully-illustrated booklet provides photos, master-test programs, acceptance and design tests, and reliability data. Raytheon Co., Semiconductor Div., 350 Ellis St., Mountain View, Calif.

Circle 210 on Inquiry Card

### Power Oscillators

Information is available on 3 power oscillators which are designed for use in antenna evaluation, calibration of power-measuring devices, driving amplifiers, etc. They provide more power than can be obtained from mw signal generators. Model 404 covers the freq. range of 10 to 50mc; model 406 covers 50 to 200mc; model 411 covers from 900 to 1800mc. The power supplies are regulated to 1%. Microdot Inc., 220 Pasadena Ave., So. Pasadena, Calif.

Circle 211 on Inquiry Card

### Facilities Brochure

A new facilities brochure from Carter-Princeton, 178-1 Alexander St., Princeton, N. J., describes the extensive thermoelectric and circuitry capabilities of the company. Brochure was especially produced to give design engineers and engineering management direction in solving problems of cooling, heating, temp. control, and circuitry.

Circle 212 on Inquiry Card

### Coaxial Switch

The Type C switch provides good r-f characteristics up to 1500mc. Typical specs. at 500mc include: vswr 1.1:1; insertion loss 0.1db; isolation 40db. The units are guaranteed for 250,000 operations and can be supplied with 28vdc or 115vac actuating solenoids. Additional data available from Transco Products, Inc., 4241 Glencoe Ave., Venice, Calif.

Circle 213 on Inquiry Card

### Magnet Material

Bulletin 350A describes how new manufacturing techniques have resulted in an increase in the energy product of Hyflux Alnico V-7 magnet material. Alnico V-7 offers an energy product value of 7.5 million. It is said to produce more magnet energy/unit volume or weight than any other mass-produced, permanent-magnet material available. Indiana General Corp., Magnet Div., Valparaiso, Ind.

Circle 214 on Inquiry Card

### Standards Bulletin

A new illustrated booklet, "Standards and Components," describes an extensive line of standard resistors, inductors, and capacitors. It covers, in addition to fixed-value components, decade boxes, attenuators, voltage dividers, and variable inductors. Over 150 different standards are included. General Radio Co., West Concord, Mass.

Circle 215 on Inquiry Card

### Stabistors Booklet

This booklet contains applications for silicon and germanium stabistors. It lists specs., rating and typical characteristics for the 1N3287 germanium stabistor; the 1N816 and SG22 silicon stabistors; the SM72 silicon power stabistor; and EVR1, EVR1A and EVR1B epoxy-encapsulated silicon stabistors. Transatron Electronic Corp., 168 Albion St., Wakefield, Mass.

Circle 216 on Inquiry Card



# NEW TECH DATA

## PC Delay Lines

The type 7 T series printed-circuit delay lines have a rise time less than 8% of total delay; overshoot is less than 3%; and thermal stability is less than 0.005% /°C. Insertion loss is less than 2db for most types with impedance above 200Ω; 3db for most types below 200Ω. Input voltage is 300v. max. for most types. The resolution of the continuously-adjustable taps is less than 0.1nsec. AD-YU Electronics, Inc., 249-259 Terhune Ave., Passaic, N. J.

Circle 170 on Inquiry Card

## Wire Calculator

A graphic calculator, which provides a quick means of determining resistance of Tungsten-25% Rhenium wire at various temps., is available from Hoskins Mfg. Co., 4445 Lawton, Detroit 8, Mich. Particularly useful in applications involving design of high-temp. resistors, heating elements, and TWTs, the calculator covers wire sizes 0.050 to 0.005 in. dia. and temps. from 20°C to 3000°C.

Circle 171 on Inquiry Card

## Relays

Bulletin 707 describes 4PDT version, the GPR relay line by Ohmite Mfg. Co., 3682 Howard St., Skokie, Ill. It provides all the details and includes stock listings of unenclosed relays, standard vacuum-tube-plate types and thyatron-plate types.

Circle 172 on Inquiry Card

## R-F Connectors

Bulletin CK-5 describes subminiature r-f connectors for strip transmission line uses. These Conhex connectors allow direct connection to strip transmission lines. The units feature 0.0001 gold plating over a brass body. Sealectro Corp., 225 Hoyt St., Mamaroneck, N. Y.

Circle 173 on Inquiry Card

## Precision Fans

Brochure 115 describes ac and dc miniature motors which allow up to 195cfm air flow. Mounting and performance can be altered to suit any desired application. Globe Industries, Inc., 1784 Stanley Ave., Dayton, Ohio.

Circle 174 on Inquiry Card

## Circuit Module

Bulletin SP164 lists a complete series of germanium modules in 200kc, 1mc, and 5mc range. Module accessory equipment such as power supplies, module testers, mounting cases, and a new digital-circuit breadboard and training kit are also covered. A simplified chart gives the design engineer quick answers to module loading questions. Packard Bell Computer, 1905 Armacost Ave., Los Angeles 25, Calif.

Circle 175 on Inquiry Card

## Film Reader

"Hermes Junior" translates pictorial information into digital form. It is specifically designed for precise measurement of the X- and Y-coordinates of nuclear tracks on spark or bubble-chamber photographs. It converts this information into numerical modes. The combined optical, mechanical, and electronic features inherent in the film reader are detailed in this technical bulletin. Special Equipments Div., Itek Corp., 223 Crescent St., Waltham, Mass.

Circle 176 on Inquiry Card

## ...New Developments in Electrical Protection

### BUSS quick-acting fuses

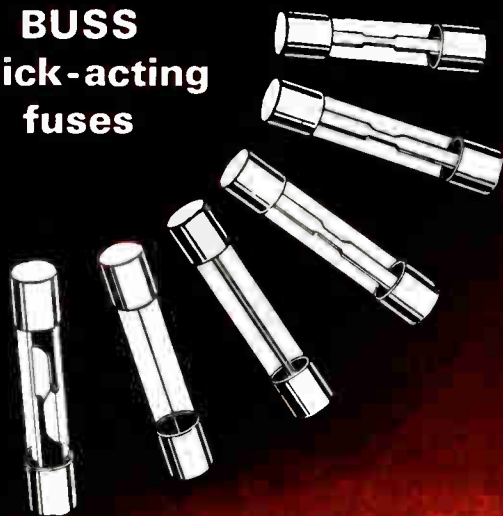

"Fast-Acting" fuses for protection of sensitive instruments or delicate apparatus;—or normal acting fuses for protection where circuit is not subject to starting currents or surges.

# BUSS

Write for BUSS  
Bulletin 578.

BUSSMANN MFG. DIVISION, McGraw-Edison Co., St. Louis 7, Mo.

Circle 61 on Inquiry Card



If you should have a  
special problem  
in electrical  
protection...

... we welcome your request either to quote or to help in selecting the type of fuse or fuse mounting best suited to your particular conditions.

Submit description or sketch, showing type of fuse to be used, number of circuits, type of terminal, etc. If your protection problem is still in the engineering state, tell us current, voltage, load characteristics, etc. Be sure to get the latest information BEFORE final design is crystallized.

At any time our staff of fuse engineers is at your service to help solve your problems in electrical protection and save you engineering time.

# BUSS

Just call  
or write:

BUSSMANN MFG. DIVISION, McGraw-Edison Co., St. Louis 7, Mo.

Circle 61 on Inquiry Card



# NEW TECH DATA

## VHF Power Transistors

Engineering data sheets are available on a new series of pnp germanium transistors for VHF power uses. The ECDC transistors, types 2N2962-2N2965 have a min. r-f power output of 1/2w. at 160mc. Using a type 2N2963 or a type 2N2965 as a driver and 2 type 2N2962 or 2N2964 transistors as final amplifiers, an r-f output greater than 1w. is possible. Types 2N2962 and 2N2963 have a min. of 40v. collector-to-emitter breakdown voltage; types 2N2964 and 2N2965 are specified at 30v. Sprague Electric Co., 233 Marshall St., No. Adams, Mass.

Circle 192 on Inquiry Card

## Copper Clad Material

Grade XXXP871 is paper-base phenolic copper-clad material with good trichloroethylene resistance and a surface resistivity of over 1 million megohms at 100vdc. The material can be cold sheared and punched. In 1/16 in. thickness, the moisture absorption is less than 0.7% after 24 hrs. of immersion. Available in different thicknesses. Spaulding Fibre Co., Inc., Dept. 104, 310 Wheeler St., Tonawanda, N. Y.

Circle 193 on Inquiry Card

## Switch Catalog

Catalog C-64, 24 pages, provides complete engineering drawings, specs. and operating characteristics for snap-action switches. The fully illustrated catalog is available from Cherry Electrical Products Corp., Box 439, Highland Park, Ill.

Circle 194 on Inquiry Card

## Variable Resistors

Catalog 1000, 16 pages, contains complete technical information on Series 45 15/16 in. dia., 1/4 to 1w. commercial composition variable resistors. It contains numerous illustrations, dimensional drawings, electrical and mechanical specs. CTS Corp., Elkhart, Ind.

Circle 195 on Inquiry Card

## Instrument Catalog

Catalog Digest 3-63 provides photos, specs., and operating characteristics for a line of test equipment and accessories. Differential voltmeters, calibrators, thermal transfer standards, etc., are included. John Fluke Mfg. Co., Inc., P. O. Box 7428, Seattle 33, Wash.

Circle 196 on Inquiry Card

## Variable Delay Lines

Data sheet 64037 covers all models of Helidel® variable delay lines. These units are continuously variable, distributed-constant, electromagnetic delay lines that afford precise selection of extremely short time intervals. The data sheet contains a cutaway view of a typical unit, with callouts showing construction particulars. Also included are dimensional drawings, model characteristics, and complete electrical and mechanical specs. Helipot Technical Information Service, 2500 Harbor Blvd., Fullerton, Calif.

Circle 197 on Inquiry Card

## Plastics Design Guide

This brochure contains basic design considerations for fiberglass reinforced plastic parts. Typical qualities, strength-to-weight ratios, reinforcements, resin binders, and other design criteria are covered. A variety of fabricated components developed and produced by CHR for aerospace, electronic, and ground-support applications are illustrated. The Connecticut Hard Rubber Co., 407 East St., New Haven 9, Conn.

Circle 198 on Inquiry Card



## THE NEW SUPER WEE-DUCTOR

An ultra reliable MOLDED SHIELDED r.f. subminiature inductor—available in inductances from 0.1  $\mu$ H to 100,000  $\mu$ H in 73 values.

The SUPER WEE-DUCTOR is shielded for minimum coupling in high density packaging and has extremely low dc resistance. Only 0.410" long and 0.157" in diameter, the SUPER WEE-DUCTOR meets all the requirements of MIL-C-15305B (Amendment #1), Grade 1, Class B, including moisture and immersion resistance and operation from  $-55^{\circ}\text{C}$  to  $+125^{\circ}\text{C}$ .

For complete engineering data, write Dept. WL-10, or phone 201-464-9300. All values available from stock.

**NYTRONICS, INC.**

550 Springfield Ave., Berkeley Heights, N. J.

Design Leaders

STANDARD components to meet CUSTOM requirements

Circle 62 on Inquiry Card



## Are You Designing or Building Under Any of These Specs?

### MIL-E-5400F

airborne electronic equipment

### MIL-E-8189B

guided missile electronic equipment

### MIL-E-16400D

shipboard electronic equipment

### MIL-P-11268D

communication equipment

### MIL-T-21200D

electronic and fire-control systems test equipment

If so, these specifications now authorize the use of Loctite® Sealant (MIL-S-22473B—Sealing Compounds, Retaining, Single-Component, Anaerobic) for staking screws and sealing threads. Insulating varnishes are not acceptable for these functions.

Loctite Sealant prevents loosening from vibration and reduces weight by eliminating locknuts and lockwashers.

Write now for catalog and copy of MIL-S-22473B.

# LOCTITE

CORPORATION

Self-Hardening Resins for Assembling Metal Parts

187 N. Mountain Rd. Newington, Conn. 06111

Circle 63 on Inquiry Card

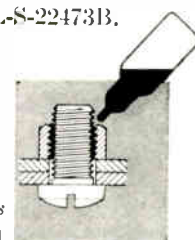

# NEW TECH DATA

## Varactor Diodes

Data is available on the D-4800 series epitaxial passivated silicon varactors, which have thermal bonded junctions and low thermal resistance. The new diodes have a rated max. operating junction temp. of 175°C. Individual characteristics: breakdown voltages from 6-120v.; cutoff freqs. up to 160gc measured at -6v., and junction capacitances from 0.1 pf to 30pf measured at -6v. Sylvania Electric Products Inc., 1100 Main St., Buffalo, N. Y.

Circle 204 on Inquiry Card

## Portable Recorder

The Data-Stack™ DR-2 units record up to 12 channels of regular or double bandwidth data on all 6 cartridges simultaneously. Standard tape speeds are 15/16, 1/8, 3/4, 7/2, 15 and 30 ips. The data contained in this brochure includes photos, specs., and tables of direct and FM recording data. KRS Electronics, 4035 Transport St., Palo Alto, Calif.

Circle 205 on Inquiry Card

## Regulated Power Supply

Model ZA-735 is a transistorized 12vdc, 1a. regulated power supply. It features an overload protection and provision for battery input. Output current is limited above 1a.; however, the supply will sustain a continuous short-circuit, returning to normal when the overload or short is removed. A battery back-up may be incorporated by adding an isolating diode and a 14 to 18v. battery. Engineered Electronics Co., 1441 E. Chestnut Ave., Santa Ana, Calif.

Circle 206 on Inquiry Card

## Log-Voltmeter-Converter

This 2-color brochure contains technical descriptions, schematics and applications of wide-range model HLVC-150 log-voltmeter-converter. A new design principle, which permits accurate measurement of ac or dc voltages or voltage ratios on a true logarithmic scale over a 3160:1 or 70db continuous range is discussed. A dc output is provided for recording. Houston Instrument Corp., 4950 Terminal Ave., Bellaire 101, Tex.

Circle 207 on Inquiry Card

## Generators/Analyzers

This report gives a detailed explanation of what phase lock is, how it works, where it is used. It also shows how it has been incorporated into modular signal generators and a series of spectrum analyzers. Pictorial evidence of the resultant stability and resolution that phase locking provides is also presented. Request on company letterhead to Polarad, 34-20 Queens Blvd., Dept. HR, Long Island City, N. Y.

## Meet the industry's top efficiency team . . .

### Augat's complete line of Component Cradles and Clips

Here's positive, lasting protection against external shock and vibration. Augat cradles are especially designed to clamp sub-miniature and miniature tubes, transistors, resistors, capacitors, diodes, crystals, etc.

They assure longer life of tubes and transistors by reducing temperature through conduction.

Write today for additional information and samples.

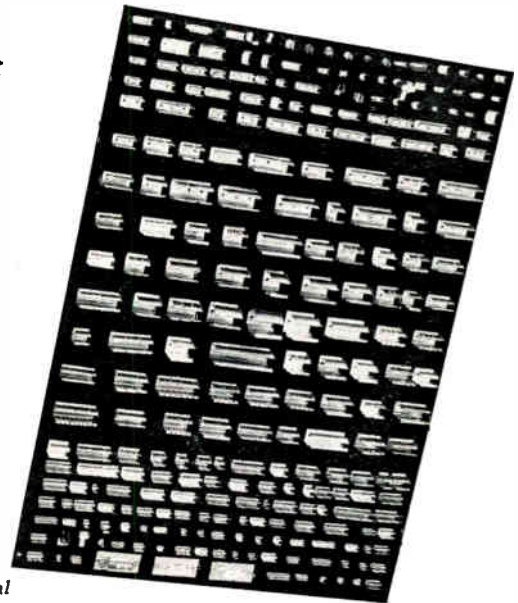

Conform to NAS and MS standards

**AUGAT INC.** 39 Perry Avenue  
Attleboro, Mass.

Circle 64 on Inquiry Card

Specifically Engineered for RF Components!

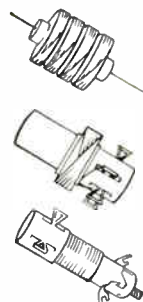

Q-MAX impregnating and coating composition penetrates deeply, seals out moisture, provides a surface finish. Q-MAX imparts rigidity and promotes stability of the electrical constants of high frequency circuits. Effect on the "Q" of RF windings is negligible.

Write for catalog today.

**Q-max Corporation**

MARLBORO, NEW JERSEY

Telephone: 462-3636 (Area Code 201)

Circle 65 on Inquiry Card

## HEATH SERVO PEN RECORDER... TYPICAL VALUE IN A NEW RESEARCH AND TEACHING LAB INSTRUMENTATION SERIES!

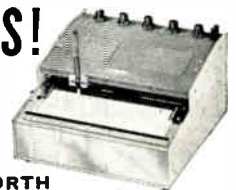

**FEATURES AND PERFORMANCE WORTH FIVE TIMES ITS LOW PRICE!**

Unbeatable value! True potentiometric input. Five adjustable ranges: 10, 25, 50, 100 & 250 mv plus plug-in 5-pin connectors for special ranges. Rapid chart advance; pen lift; paper tear-off guide; optional motor speeds; 10" chart; 1 sec. response. Factory assembled & tested. Write for details on entire Malmstadt-Enke Lab series!

Assembled EUW-20A . . . 20 lbs. . . . \$195.00  
\$19 mo. . . . .



HEATH COMPANY 53-1-1  
Benton Harbor, Michigan 49023

Please send free folder on Lab Series Equipment.

Please send Free Heathkit catalog.

Name \_\_\_\_\_ (please print)

Address \_\_\_\_\_

City \_\_\_\_\_ Zone \_\_\_\_\_ State \_\_\_\_\_

Circle 53 on Inquiry Card



# NEW TECH DATA

## Thermistor Catalog

Catalog SB53 is a designer's guide to rod, disc, washer and bead-type thermistors. In addition to capsule information on each product, the catalog lists data sheets and other product literature available, and offers a synopsis of published technical papers. Victory Engineering Corp., 124-28 Springfield Ave., Springfield, N. J.

Circle 220 on Inquiry Card

## Coaxial Cable

Information is available describing Cuflex, a semi-flexible air-dielectric coaxial cable. The cable has copper outer sheathing, low resistivity, long operating life, and better return losses. Phelps Dodge Electronic Products Corp., 300 Park Ave., New York 22, N. Y.

Circle 221 on Inquiry Card

## Preamplifier

A 2-color data sheet, 2/19-113, on the Kin Tel 458C/N ac/dc preamplifier is available from Cohu Electronics, Inc., Kin Tel Div., Box 623, San Diego 12, Calif. The sheet includes a full-page spec. chart, and a block diagram. Ten wideband gain steps plus vernier provide 20 to 2000 gain, dc to 40kc bandwidth.

Circle 222 on Inquiry Card

## Motors-Controls Bulletin

A condensed corporate bulletin, which illustrates and describes a complete line of motors and controls, is available. Products include filters, timers, switches, solenoids. Controls Co. of America, 2001 N. Janice Ave., Melrose Park, Ill.

Circle 223 on Inquiry Card

## Recorder

"Labgraph," a portable strip-chart recorder has a  $\frac{1}{8}$  sec. full-scale response, and records 4-cycle signals without significant attenuation. It accommodates dc circuits with output impedance of 100K $\Omega$  or less and has a simple linear-motion pen—no strings or pulleys. Esterline Angus Instrument Co., Inc., Box 596E, Indianapolis, Ind.

Circle 224 on Inquiry Card

## Telemetry Transmitter

Bulletin B109 describes an FM telemetry transmitter which operates in the 216-260mc telemetry band. Model 3166 transmitter is a true FM transmitter featuring a separate power supply ground, case ground, and modulation input return. The bulletin gives a general description. Radiation Inc., Melbourne, Fla.

Circle 225 on Inquiry Card

## Condenser Microphones

Tech. Review 163 is a 24-page book on the design and manufacture of min. condenser microphones and methods of checking the properties of RMS voltage-measuring instruments. The handbook outlines methods for making a given microphone look acoustically smaller in a sound field. B&K Instruments, Inc., 3044 W. 106th St., Cleveland 11, Ohio.

Circle 226 on Inquiry Card

## Analyzer/Recorder

This tech. folder describes Type FBS freq. spectrum analyzer/recorder. This monitor scans the tuning range of a receiver and analyzes the signal freq. characteristics in the r-f bands. Special features, general applications, operating descriptions, specs. and capabilities are described. Rohde & Schwarz Sales Co., Inc., P. O. Box 148, Passaic, N. J.

Circle 227 on Inquiry Card

## Solid-State Microwave

The CW-60 is a totally solid-state 6cc unit which uses no tubes or relays. The brochure contains block diagrams and complete descriptions of the terminal, repeater, standby repeater, and standby repeater units. Radio Corp. of America, Broadcast & Communications Products Div., Camden 2, N. J.

Circle 228 on Inquiry Card

## PRESSURE BLOWER



### BL60

1/3 HP  
600 CFM  
4" Inlet  
3" Outlet

BL60 Pressure Blower for tube cooling. Also available in a BL50 with a 5 $\frac{1}{2}$ " inlet and a 3 $\frac{1}{2}$ " outlet, priced as low as \$35.00.

Single units only \$49.95

\$69.95 List.

STANDARD ELECTRIC MFG. CO., INC.  
WEST BERLIN, NEW JERSEY

Circle 66 on Inquiry Card

## Will this Call be Answered?

It will be if you use a

### TELEPHONE ANSWERING SERVICE

Look For This Listing  
In Your Yellow Pages

ASSOCIATED TELEPHONE ANSWERING EXCHANGES INC.  
Members of this organization display this insignia—your assurance of the best Telephone Answering Service. Offices in principal cities—  
"FOR INFORMATION CALL"

Circle 67 on Inquiry Card



## NEW TECH DATA

### Ferrite Plate Memory

Bulletin 6301 describes a high-density, ferrite-plate memory featuring non-volatile and non-destructive readout. Packaged in modular form, the memory is ideally suited for aerospace uses since it does not require precise current or temp. control. The non-destructive readout permits repeated interrogation without loss of stored information. The ferrite modules operate over a min. temp. range of  $-35^{\circ}\text{C}$  to  $+100^{\circ}\text{C}$ . Named Andro®, it has a bit density of 1500 bits/cu. in. Government Marketing Div., American Bosch Arma Corp., Garden City, N. Y.

Circle 199 on Inquiry Card

### Designer's Profile

Brochure CDC-422 contains 12 charts and graphs comparing the features of LEXAN® polycarbonate resin with die cast metals and other thermoplastics. The brochure graphically compares the impact strength, creep, service temp., dimensional change, electrical, stress, cost and other data. The Chemical Materials Dept., General Electric Co., 1 Plastics Ave., Pittsfield, Mass.

Circle 200 on Inquiry Card

### A-D Converter Catalog

A new brochure describes the Series 5020 Analog-to-Digital Converter, a solid-state, high-speed, high-precision dc instrument which provides binary-coded-decimal outputs for driving a variety of output accessories. The illustrated brochure describes, in detail, the operational characteristics and features. Electronic Associates, Inc., Dept. 302, Long Branch, N. J.

Circle 201 on Inquiry Card

### Time-Delay Relay

Literature is available which describes a half-crystal can size, solid-state, time-delay relay, which provides delays ranging from 10msec. to 60 sec. They can be adapted to uses requiring high-speed recycling. Complete electrical and mechanical specs., a timer resistor value chart, sample circuits, and ordering information are included. Branson Corp., 41 S. Jefferson Rd., Whippany, N. J.

Circle 202 on Inquiry Card

### Silicon Chopper Line

Information is available on a new series of chopper PNP silicon transistors. The units are designed for a variety of applications, including telemetry, computers, dc to ac converters, modulators and general instrumentation. Featuring high breakdown voltage, low saturation resistance, and low offset voltage, these choppers are available in TW-5 packages. Hughes Semiconductor Div., 500 Superior Ave., Newport Beach, Calif.

Circle 203 on Inquiry Card



Five custom made seals, each different in size and shape, function and component rubbers. They range from an ordinary laboratory stopper thru engine seals, a miniature hydraulic lifter seal, a drive coupling seal and a splash guard seal. Western seals are both molded and lathe cut, can be found on

coffee pots, in automotive power plants, on Diesel locomotives, in the plumbing industry, as pharmaceutical closures and in fact almost anywhere there is a need for a seal.

If you have a sealing problem, write for information, literature or a visit by our sales engineer in your area.

**WESTERN RUBBER COMPANY**

GOSHEN 12, INDIANA

Molded and Lathe-Cut Rubber Parts for All Industries



Circle 68 on Inquiry Card

*for cleaner signals—*

**DEKORON**

TYPE CMX

**Computer TWIST-EX**

**Thermocouple Extension Wire**

Clear, clean control signals are now readily available when you specify Dekoron Computer Twist-Ex thermocouple extension wire.

Twisted pair construction enables the EDP designer to increase wire density and cut installed costs substantially. Twisted pairs with total coverage shield of Mylar® tape with aluminum backing in contact with bare copper drain wire provides maximum electrostatic and electromagnetic noise rejection.

Dekoron Computer Twist-Ex is also available in cables (lower left) of from 4 to 36 pairs per cable in up to 1000 ft. lengths. Wire insulation and cable jackets are color coded to ISA standards. Engineered to highest standards, Dekoron computer wire products assure cleaner signals and lower installed costs. Samuel Moore & Co., Mantua, Ohio.

TYPE CM

**SAMUEL MOORE**

A-9273A

# NEW TECH DATA

## Paper-Tape Reader

The Model 625 reads up to 25 characters/sec. asynchronously, 55-60 characters/sec. synchronously. It reads 5, 6, 7, or 8 channels without modification. It can be slaved to any devices operating at 25 characters/sec. Tally Corp., 1310 Mercer St., Seattle, Wash.

Circle 183 on Inquiry Card

## Microwave Catalog

Short-form Catalog 164 contains specs. and applications on a line of millimeter microwave components, including ferrite components, circular waveguide components, test and system components, antennas, and power generation and detection equipment. TRG Inc., 400 Border St., East Boston 28, Mass.

Circle 184 on Inquiry Card

## Facility Brochure

"Aluminum Fabricating for Industry," 12 pages, describes design, engineering, drawing, stamping, spinning, assembly, welding and finishing facilities. Photos and descriptions of tools and equipment are also included. American Aluminum Co., 230 Sheffield St., Mountainside, N. J.

Circle 185 on Inquiry Card

## Diode Tester

The Poly-Parameter tester provides manual testing of diodes. The unit has a 5-in. rectangular mirrored scale meter which provides accuracy of 1/2% full scale. An external digital voltmeter can be added. The Eagle-Picher Co., Instruments Branch, 1038 W. Evelyn, Sunnyvale, Calif.

Circle 186 on Inquiry Card

## Power Connectors

Catalog Form 250-963, 16 pages, describes the series 250 miniature rectangular rack and panel power connectors. The series meets Mil-C-8384. Data includes electrical and mechanical specs., outline drawings, and illustrations. Continental Connector Corp., 34-63 56th St., Woodside 77, N. Y.

Circle 187 on Inquiry Card

## Magnetic Alloys

This brochure provides discussions on Heat Treating, and Handling of Magnetic Parts and Measurements of Magnetic Properties and Fabrication. Also included are tables on the properties of magnetic alloys. Wilbur B. Driver Co., Newark 4, N. J.

Circle 188 on Inquiry Card

## Tape-Recorder Head

Data is available which describes the 3K17 recorder head. The half-track monaural record/play-back head is designed for micro-miniaturization. Dimension diagrams, electrical characteristics, and performance curves are given. Michigan Magnetics, Inc., Vermontville, Mich.

Circle 189 on Inquiry Card

## H-F Counter-Timer

Model 1037 is a high-freq. counter-timer. It measures freq. directly to 50mc, and times the signal period in 0.1µsec. units. Oscilloscope input circuits permit precise adjustment of input controls. The bulletin provides photos and specs. Systron-Donner Corp., Donner Div., 888 Galindo St., Concord, Calif.

Circle 190 on Inquiry Card

## Capabilities Brochure

This brochure documents capabilities in the design and development of data systems for space exploration. Included are descriptions of spaceborne and ground-support systems, packaging and mechanical design, circuit design, and reliability. Computer Control Co., Inc., Old Connecticut Path, Framingham, Mass.

Circle 191 on Inquiry Card

**DRG-DTH**

**HAMLIN**  
magnetic reed  
SWITCHES

the largest selection  
ever offered...

The use of magnetic reed switches has been increasing by leaps and bounds, and Hamlin engineers have set the pace with the greatest selection. All standard varieties, of course, plus...

- DRM-001 High Voltages (up to 5000 v)
- DRG-DTH Double Throw (Form C)
- DRR-5 Heavy Duty (up to 50 v amp.)
- DRS-5 Heavy Thrust (in-rush to 15 amp.)
- HRC-1 No-Bounce (Mercury wetted)

and many more designed for special requirements... YOUR specifications. Send for literature.

SEE IT! HEAR IT!

**FREE CARD**  
with magnet  
and switch

**HAMLIN**

Dept. E1 • LAKE AND GROVE STREETS • LAKE MILLS, WIS.

Circle 70 on Inquiry Card

## DI-FORMED PAPER TUBES IMPROVE YOUR COILS ... SAVE MONEY AND PRODUCTION HEADACHES

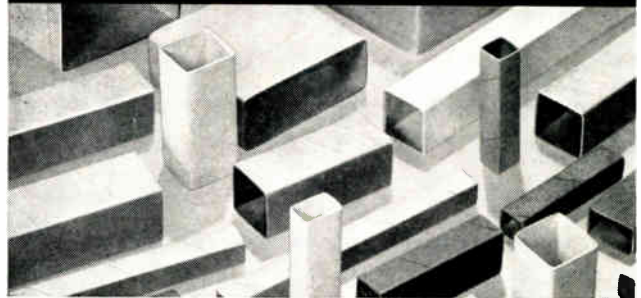

### Here Are the Facts

Di-Formed Tubes feature a special patented Precision Paper Tube construction which produces a completely ridgeless surface, thus eliminating wire pile up and resultant coil shorts.

Side walls are straightened under pressure during the winding operation. The bow being thus controlled permits a perfect fit between mandril and tube as provided by Precision's low-cost Related Mandril Service.

Under the Related Mandril Service, Precision supplies the coil manufacturer with accurately ground steel or aluminum mandrils at a price comparable to commonly used unsatisfactory wood or undersized steel mandrils. *This is not a profit-making service.* Its sole purpose is to give the coil manufacturer these advantages:

1. Provide proper tube support. 2. Facilitate stacking operations. 3. Prevent coil collapse. 4. Save machine and operator fatigue. 5. Permit a smaller core, thus decreasing coil size and eliminating pressing.

Get full details on Precision Di-Formed Tubes and Related Mandril Service. Write, wire or phone today.



## PRECISION PAPER TUBE CO.

1049 S. Noel Ave., Wheeling, Ill. (Chicago Suburb)  
Plant No. 2: 1 Flower Street, Hartford, Conn.

Circle 71 on Inquiry Card

ELECTRONIC INDUSTRIES • January 1964



# NEW TECH DATA

## Polystyrene Brochure

"Shell Polystyrene 345" is an 8-page brochure describing the advantages of Shell Polystyrene and its unique uses in connection with polyurethane blown foam. The brochure gives data on extrusion, vacuum forming and injection molding. It also gives data on the resin's strength retention in contact with polyurethane foams and its resistance to foodstuffs, solvents and ultraviolet light. Shell Chemical Co., Plastics and Resins Div., 110 W. 51st St., New York 20, N. Y.

Circle 177 on Inquiry Card

## Custom Plating Systems

The Module-X™ is a plating installation system offering optimum flexibility and versatility. The modular construction of the system permits unlimited flexibility both for original installation and for later modification. The new system is claimed to provide a custom-engineered plating line at a lower cost than ever possible before. Further information and descriptive literature may be obtained from Sel-Rex Corp., Nutley 10, N. J.

Circle 178 on Inquiry Card

## Tube Handbooks

"Cold-Cathode Trigger Tubes" is a 36-page report on the operation, characteristics, circuits, and applications of cold-cathode switching tubes. It shows that trigger tubes, when compared to other active switching devices, have a number of outstanding advantages. "Dekatrions® Containing Neon" is a 20-page report describing how the 4-5kc range of Dekatrions works and explaining the factors to be considered when choosing the values of the associated circuit components. Baird-Atomic, Inc., 33 University Rd., Cambridge, Mass.

Circle 179 on Inquiry Card

## Ruby Laser

Information is available which describes the "Korad" K-1, which has typical pulse energy output of 20 joules at room temp. It is designed for experimental studies in optical radar, communications, radiation effects, metalworking, micromachining, photography, chemistry, and medicine. The system is compatible with Q-spoiler equipment. Korad Corp., subs. of Union Carbide Corp., 2520 Colorado Ave., Santa Monica, Calif.

Circle 180 on Inquiry Card

## Instruments Catalog

This quick-reference catalog provides descriptions and brief technical specs. for the complete line of amplifiers, test and measuring instruments, insulation test equipment and automatic test equipment. It serves as a handy reference and buying guide for the selection and specification of such instruments as decade boxes, wheatstone and deviation bridges, transistor amplifiers, ac breakdown testers, auto-bridges, capacitor and resistor sorters, etc. Industrial Instruments, Inc., 89 Commerce Rd., Cedar Grove, N. J.

Circle 181 on Inquiry Card

## Infrared Detector

This data sheet describes a 70° wide-angle Servotherm® infrared detector developed for aerospace, military, industrial, and medical uses. The germanium immersed-window type detector withstands amb. temps. of 100°C and over. Included in the data are outline drawings, flake size, and detector configuration. Tables show sensitivities and key electrical specs. Servo Corp. of America, Infrared & Electro-Optics Div., 111 New South Rd., Hicksville, L. I., N. Y.

Circle 182 on Inquiry Card

Big, 16-page, illustrated catalog lists 4700 stock Brady Wire Markers . . . Tech Data, Industrial and Mil specs, types, sizes, prices . . . plus time-saving automatic application methods. Over 200 individual self-sticking markers included for testing. Order your *free kit* now for complete data on Brady's low-cost, flexible wire marking system.

W. H. **BRADY** CO., 749 W. Glendale Ave. • Milwaukee, Wis. 53209  
EST. 1914

Manufacturers of Quality Pressure-Sensitive Industrial Tape Products, Self-Bonding Nameplates, Automatic Machines for Dispensing Labels, Nameplates, Masks and Tape

Circle 72 on Inquiry Card



## HIGH-PRECISION CIRCUIT BOARD DRILLING MACHINE

**42,000**  
Precision  
Holes Per  
Hour with  
Outstanding  
Reliability

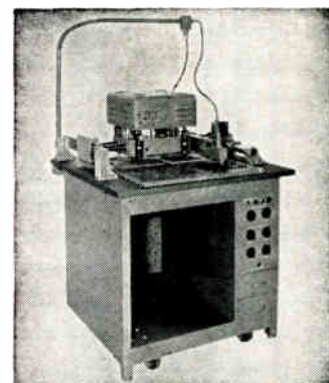

The Quad-Drill is a four spindle precision circuit board drilling machine that is used for both long and short run production. Holes can be produced at the rate of **42,000** per hour while maintaining hole location on each spindle to within .001 inch of true template position. Has many other features that will increase production, cut cost and increase profits on every job. Write for specifications today.

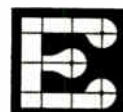

**EXCELLON  
INDUSTRIES**

9522 W. Jefferson, Culver City, Calif.  
Circle 73 on Inquiry Card





New  
**BULOVA**  
 ¼ cubic inch  
 3.5 watt  
**SERVO**  
**AMPLIFIER**

Measuring approximately ¼ cubic inch, the new Servo Amplifier is stable to 125°C. Bulova type 165 AMP operates at a nominal frequency of 400 cps, and provides a power output of 3.5 watts into an effective resistance of 450 ohms (size 11 motor). The unit has a direct push-pull output stage, with an output impedance of 100 ohms (maximum) resistive. Its input impedance is 10,000 ohms resistive constant; its voltage gain is 5000 (±3db) under all environmental conditions and independent of load. The small servo has an operating ambient temperature of -55°C to +125°C maximum, with a storage temperature of -65°C to +150°C. The 165 AMP meets pertinent requirements of MIL-E-5272C.

Price: \$150 for quantities under 10.

The full line of Bulova amplifiers assures superior performance in extreme environments, greater flexibility in system design, maximum savings in volume and weight. Every critical component is manufactured "in-house", maintaining Bulova quality standards, engineering, production and delivery schedules. For detailed specification sheets, write Bulova Electronics, Woodside 77, New York.

INDUSTRIAL/DEFENSE GROUP

**BULOVA**  
 ELECTRONICS DIVISION

Circle 74 on Inquiry Card

## EDITOR'S NOTEBOOK

**COMPUTERS** will make life easier for lawyers. Univac III is doing legal case research for Law Research Service, Inc., and probably others. Attorneys for the defense won't have to spend weeks in law book stacks looking for the case of Johnson vs Smith, 1882. They can get mailed answers to legal queries within 24 hrs., that is, if the mail is on time—and computers are working on the mail sorting problem, too.

**ELECTRONICS IS NOW PROVING** that football players have hard heads. At Northwestern Univ. football helmets were wired with a sensitive, compact Honeywell device. Jolts of more than 5,000 G's were recorded, more than 500 times greater than the 'G' forces an astronaut gets on lift and re-entry. Data on impact was recorded by a Honeywell high-speed, direct-writing oscillograph.

**THE MINIMUM VARIANCE METHOD** will enable NASA's earth-bound computers to fix a trajectory point on the surface of Mars within 17 ft. Current standards of accuracy for Mars and Venus is a few thousand miles one way or the other. Sperry Rand is coming up with the method, set for delivery in July, 1964. A positional accuracy for the moon, with the precision 0.99999999 accuracy, would be within 1 ft.

**COMPUTER-INTERPRETER** will try to decode the language of dolphins (porpoises). The Sperry device, SCEPTRON™, might reach the depths of man-to-dolphin-to-man talk by: evaluating man's attempts to imitate the dolphin; evaluating dolphin's attempts to imitate man and giving him a fish for a nice college try; cataloging dolphin words and acts to correspond with human words.

**SUBSONIC THROBBINGS** from the ocean depths may be whale heartbeats or breathing, according to Dr. R. A. Walker of Bell Labs. At times the sounds hit 40 decibels above background noise. They are about 20 cps, move about randomly, have speeds that vary two to eight knots, and are point sources—not extended like the surf. Subsonic pulses occur in pairs and may support the heartbeat idea. A blue whale has a thousand-pound heart that pumps its 8 tons of blood.

**SOLDERING OF ELECTRONIC EQUIPMENT** has joined a number of other industry chores given to recovered mental patients from a VA hospital in Bedford, Mass. During an eight-year study, more than 500,000 man-hours of dangerous work have been completed by patient-employees, mostly employed by industry in the area, without a single lost-time accident. The survey concludes that former mental patients are more careful and less hostile than their associates who "have not suffered mental illness."

**NEED SOME POINTERS ON MEASURING DC?** Julie Laboratories, Inc., New York, has slated a special series of courses free of charge for qualified engineers, technicians and scientists. The place(s) will be at the New York World's Fair and also at the IEEE meet in March. The two-day courses—25 in each class—include theory of calibration and methods used to measure resistance, voltage and ratio. Technical people from most of the big college and industrial labs around the country have already taken the course, says Loebe Julie, President.

**STRICTLY FOR DANCERS**—Parisian teenage twist addicts are wearing personal earphones on the dance floor to pick up music piped in from a small transmitter in a nearby jukebox. With antennas swinging like beetles, Henri et Marie can get groovy on the same wavelength.

**SPEAKING OF "A SWITCH"**—According to a Pilot Radio survey, men are becoming more fastidious in choosing walnut or cherry in hi-fi sets, while the girls are no slouches when it comes to deciding on technical specs. Nowadays, the survey indicates, the wife cogitates on decibels, frequency ranges and bass reflex construction. She and hubby both detest rock 'n' roll. The survey points out that more than 50% of those interviewed spend as much as \$1200 when it comes time to purchase hi-fi equipment.

**COMPUTERS ARE BURNING WOOD.** A Government-funded program seeking data on fire-safety and solid fuel technology has enlisted GE researchers and a GE 225 system. What they do is build math models of fire so they can burn as many mathematical wood samples as they want. The system analyzes wood size, shape, temperatures and ignition points. There's something to this computer approach to wood-burning—no ashes.

# LETTERS

to the Editor

## "A PR Man—Or What?"

Editor, ELECTRONIC INDUSTRIES:  
Roger d'Aprix's article on technical writing (in the Oct. 1963 issue) has touched familiar chords.

A few days ago I sat before a crisply efficient hospital clerk giving her my wife's vital statistics. Then the girl's questions turned to me—name, address, age, and . . .

"Occupation?"

Speechless, I for a full ten seconds staring at her—and she stared right back.

"It seems silly to tell her that my title is 'Press Relations' . . . shall I say 'Publicity'? No, that doesn't really define it . . . not 'Technical Writer,' either . . . I consider my profession to be that of a writer . . . but on the other hand I spend less than 10 percent of my time writing . . .

"Advertising," I said somewhat uncertainly.

The girl at the typewriter took it in stride, but the experience shook me. I'm seldom asked my occupation. In the course of events I'm introduced as "Publicity Director," "an advertising man," "our new bureau," "editor of some of our publications," etc.

Well, no use elaborating the issue. Roger d'Aprix has laid it out:

A technical writer—or call him what you will—does not automatically evolve from an EE, CE, BS, or AB . . . nor from a background in magazine writing, news or poetry.

The profession has only one requirement. The practitioner must be a storyteller . . . and I use the term in the old-fashioned sense (if there is any other). To management he must talk management language. To engineers, he must write engineering. To security analysts he must speak finance.

Writing speeches, proposals, abstracts, articles, and editing all types of publications . . . all this requires more talent than ordinarily found in any one man. But underlying all these shades of specialization is the necessity of finding and telling a story.

Stephen E. McCallum,  
Product Representative

General Electric Co.,  
Receiving Tube Dept.,  
Owensboro, Ky.

(Continued on page 134)

## give your equipment that custom look by utilizing these EMCOR<sup>®</sup> points of standard modification\*

\*Standard modification—a feature created by Ingersoll Products EMCOR Engineers providing for a variety of available variations for individualized appearances in meeting customers custom enclosure demands.

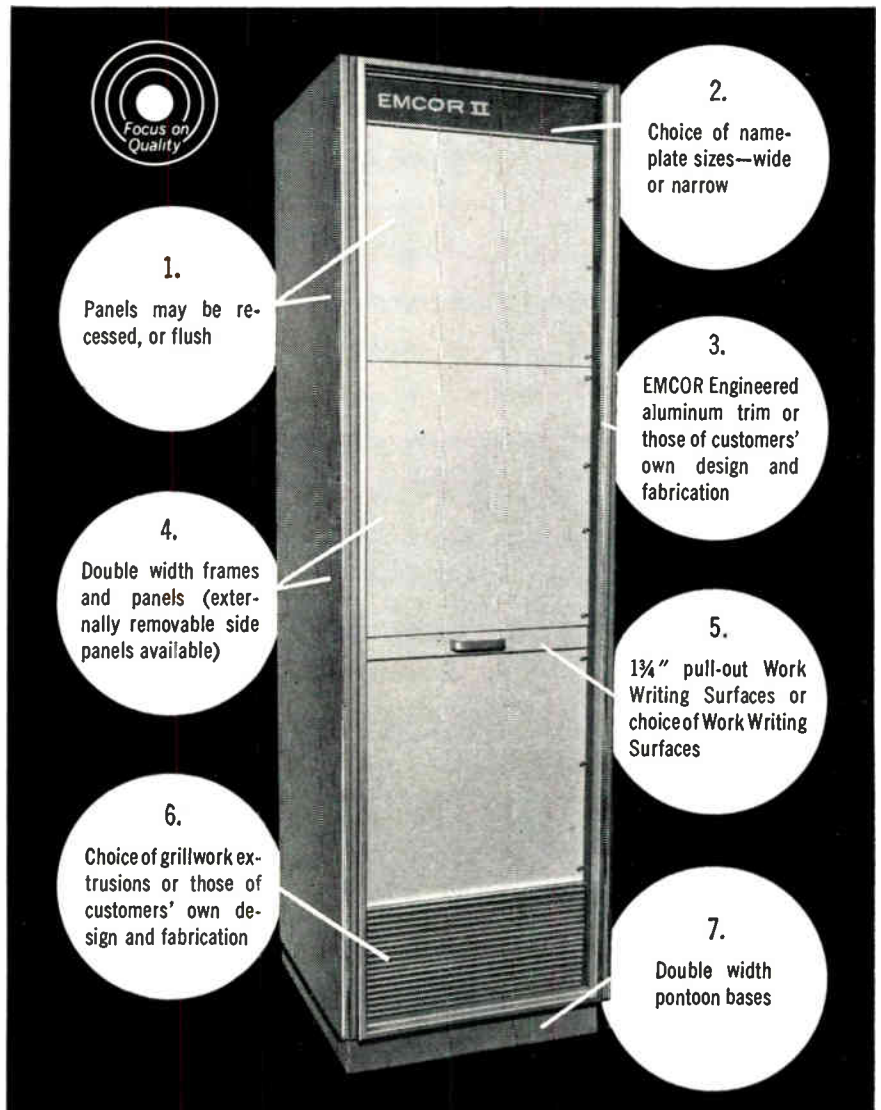

## EMCOR II MODULAR ENCLOSURE SYSTEMS

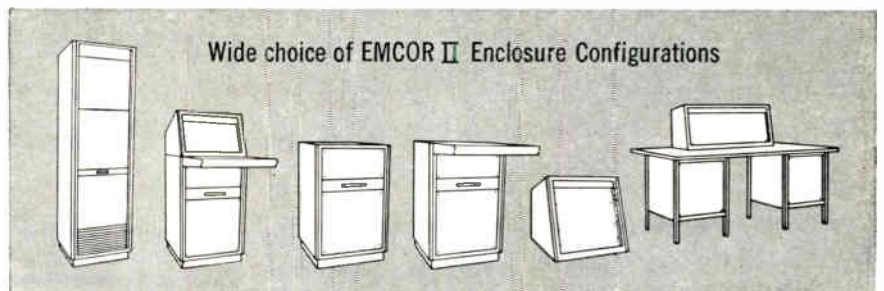

REQUEST  
EMCOR II  
LITERATURE



EMCOR—The Original Modular Enclosure System By  
**INGERSOLL PRODUCTS**  
Division of Borg-Warner Corporation  
1000 W. 120th St. • DEPT. 1245 • CHICAGO, ILL. 60643

Most Ingersoll Products Sales Engineers also represent McLean Blowers for enclosures  
Visit us at IEEE—Booth 4211-4213-4215

**ATTEND** the largest  
annual world  
exhibition  
in the field  
of electronics

**February 7 through 12, 1964**

**Paris, Porte de Versailles**

**INTERNATIONAL  
EXHIBITION  
OF**

# ELECTRONIC

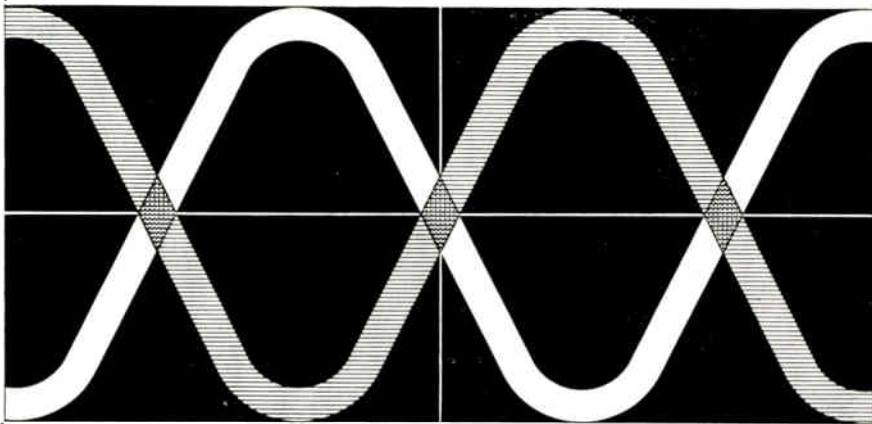

# COMPONENTS

All components, tubes and  
semiconductors,  
test and control  
equipment,  
audio devices



For full  
information  
and literature

SDSA, 23 RUE DE LUBECK  
PARIS 16—PASSY 01-16



## LETTERS

to the Editor

(Continued from page 133)

### "Unionism & Professionalism—"

*Editor, ELECTRONIC INDUSTRIES:*

Your article in the October issue, "Electronic Growth Brings Trouble for Labor," makes the assertion that professionalism and individuality are opposed to unionism and collective bargaining, that engineers must choose between professionalism and collective bargaining, and that professional prestige necessarily declines for a unionized engineer. The manner of presentation of this article indicates a necessary cause and effect relationship between unionism and decline of prestige and loss of professionalism.

The situation in the 1960's contrasts strongly with that of 1946, in that today there is a continuing deficit of engineers; corporations are in strong competition for sound technical help. In this situation, corporations are eager to provide those fringe benefits and improved working conditions which collective bargaining would normally produce. It is the governmental defense and space budget that keeps engineers employed and which causes this competition among corporations for engineering personnel. Today there is such a high demand for engineers that all corporations are forced to offer liberal fringe benefits in order to compete. These fringe benefits are provided, in large part, at the taxpayers expense. There is basically no need for the collective bargaining provided by engineers' unions.

Thus, rather than a necessarily causal relationship between unionism and a declining professional status, one finds that engineering unions in the heavily government-supported electronics industry really have a negligible role to play. It remains to be seen what the role of the engineering union would be if there were heavy cut-backs in defense and space expenditures, thus creating a surplus rather than a deficit of engineers.

C. B. Pearlston, Jr.,  
Supervisor,

Electromagnetic Compatibility  
Northrop Nortronics,  
Hawthorne, California

(Continued on page 135)



**PROVEN RELIABILITY!!**

**THE FREE  
DEPENDS  
POLARIS..**



**WORLD  
ON**

**KELVIN  
PRECISION WIRE-WOUND  
RESISTORS  
ARE A VITAL PART  
OF THE POLARIS TEAM!!**

Kelvin has been an important source on the Polaris program since its inception nearly five years ago. The delivery of more than 500,000 ultra-reliable Kelvin precision wire-wound Resistors has contributed significantly to this program. Now . . . under the stringent demands of the Fleet Ballistic Missile Systems' new "High-Reliability Program," Kelvin is also providing proven reliable resistors as part of the important Polaris A-3 Weapons System.

You can design Polaris "High-Reliability" into your products using Kelvin precision wire-wound resistors.

The same exacting quality control, the high quality materials, the same basic engineering and research used in providing resistors for Polaris is part of regular Kelvin quality and reliability procedures. Each resistor shipped by Kelvin is 100% inspected — assuring unequalled quality in the precision resistor field.

Please write for our catalog or submit your requirements to your local Kelvin representative.

**SUB-MINIATURE TYPES**



**HIGH DENSITY PACKAGING TYPES**



**RESISTOR NETWORKS**



Representatives in principal cities



**KELVIN  
ELECTRIC COMPANY**

New York: Yonkers, 916 McLean Ave., BEvery 7-2500  
5907 Noble Ave., Van Nuys, Calif. TRiangle 3-3430

Circle 77 on Inquiry Card

**LETTERS**

to the Editor

(Continued from page 134)

**"Why Not Quote Prices?"**

Editor, ELECTRONIC INDUSTRIES:

As an engineer who is continually confronted with the specification of components, I would like to register my objections to the advertising methods in common use by the majority of component manufacturers.

In order to specify a particular component, the final decision in most cases is price, all other things being equal. Many manufacturers offer nearly identical products, and many times they are identically priced, tubes or semi-conductors for example. Some prices are considerably out of line with the average, either above or below. When a piece of equipment is designed, the bill of materials cost is generally quite well fixed before design begins. The performance specifications are determined by a number of things, but the budget dictates a large portion of what can be done for a given parts cost. Quite naturally the best performance for the least cost is the object of the game. Here we get back to prices. A particular component looks good on paper as far as specs go. But all too often the price is an unknown quantity. The time lost in contacting a rep or the manufacturer is very costly. As a result many components are not given a fair chance, simply because we cannot afford the time and expense of correspondence or long distance calls. A large percentage of components are not distributor items so their costs are often difficult to obtain.

When a reader requests information about a product through a reader service card, why can't purchasing information be sent with the spec sheets? All manufacturers are not guilty of this practice, but the ones who are can be sure that they lose customers by not making it easy to evaluate their products from the purchasing standpoint. I'm sure many other engineers and purchasing agents have found this problem to be an irritating one.

Richard Jenkins  
Senior Engineer

Holt Instrument Laboratories  
Oconto, Wis.

**A YOKE FOR ANY SCAN  
to your Specifications**

**COMPLETE LINE** of deflection yokes for every military and special purpose—in production quantities or custom designed to your exact requirement.

For engineering assistance with your display problems, call on your nearest

**SYNTRONIC YOKE SPECIALIST** today:

- Boston-New Eng.: 762-3164
- Metropolitan N.Y.: 695-3727
- Upstate N.Y.: 315, 652-7911
- Phila. Area: 789-2320
- Wash.-Balt. Area: 277-1023
- Florida Area: 813, 527-5861
- Los Angeles: 283-1201

*syntronic*  
**INSTRUMENTS, INC.**

100 Industrial Road, Addison, Illinois  
Phone: Kingswood 3-6444

Circle 78 on Inquiry Card

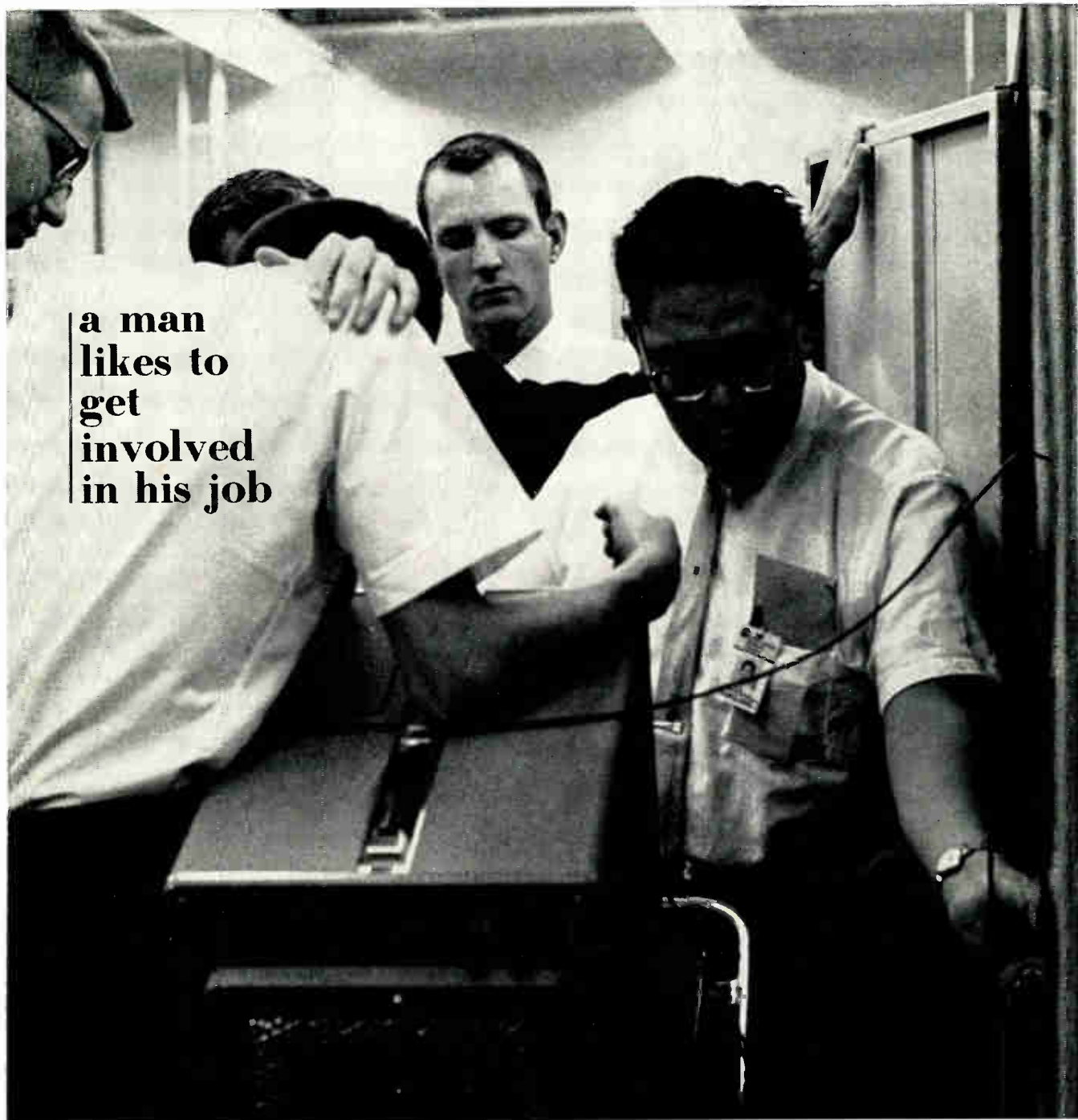

**a man  
likes to  
get  
involved  
in his job**

You have, no doubt, experienced the difference between working on a project and being involved in one. Involvement is what you are offered at Collins.

We're looking for the man who won't be satisfied with being just another engineer on a project. We're looking for the man who puts something of himself into everything he does. We want the man who can come to grips with a problem and solve it. Sometimes alone. Using his knowledge, his experience, his initiative, his imagination, and his creative talents. We're looking for the man who will

give his best to a project, not to impress, but because his professional pride won't let him do anything else.

Maybe this sounds like flag waving. It's not. The scope of our work, the challenges presented in such diverse fields as Data Processing, Space Communication, Avionics, Microwave, Antenna Systems and HF, VHF and UHF Communication to mention a few, offer professionals of this caliber every opportunity for growth, involvement, job satisfaction.

If the kind of men we're looking for sounds like the kind of men you'd like

to work with, you'll want more information on a career with Collins. Write in confidence to our manager of professional employment, Dept. 120.

**COLLINS RADIO COMPANY**  
Cedar Rapids, Iowa • Dallas, Texas  
Newport Beach, California



An equal opportunity employer



# PROFESSIONAL GUIDELINES

Design Engineers  
Development Engineers  
Administrative Engineers  
Engineering Writers  
Physicists  
Mathematicians  
Electronic Instructors  
Field Engineers  
Production Engineers

Reporting late developments affecting the employment picture in the Electronic Industries

## ENGINEER-SCIENTIST SUPPLY DEPENDS ON TOP FACULTIES

Future supply of top quality engineers and scientists can be assured only if we have enough first-rate graduate college and university faculty for teaching, reports National Science Foundation's Walter L. Koltun.

At the 77th annual meeting of the Association of State Universities and Land-Grant Colleges, he said that industry, Government, universities and contract research centers managed by universities, all compete for professional manpower.

Koltun pointed out that the number of bachelor degree graduates since 1910 has followed a simple growth curve, with numbers doubling every 18 years. He predicted no radical change from this trend during the next decade, short of a drastic event in our national society.

Numbers at the doctorate level are much smaller, but have been doubling every 12 years. About two-thirds of all doctorates given within the last 50 years have been in engineering and science. The other third has been in the humanities and other fields. The numbers with the desire and capacity to get degrees at various scholastic levels appear to be established well into the future.

Turning to the relation between R&D and graduate education, he said the wide assumption that the two are closely related is not always fact. Evidence indicates that 30 to 40% of research at universities is not related to graduate education.

If research and graduate education are related, then funds should parallel the number of graduate students. Allowing for increased R&D costs, Federal funds have grown about twice as fast as the number of students in ten years.

A study at two major universities with graduate students in sponsored research during 1959 showed that more than 40% of original research proposals and renewals did not involve grad-

## ENGINEERS BECOMING UP-DATED IN NEW DEVELOPMENTS

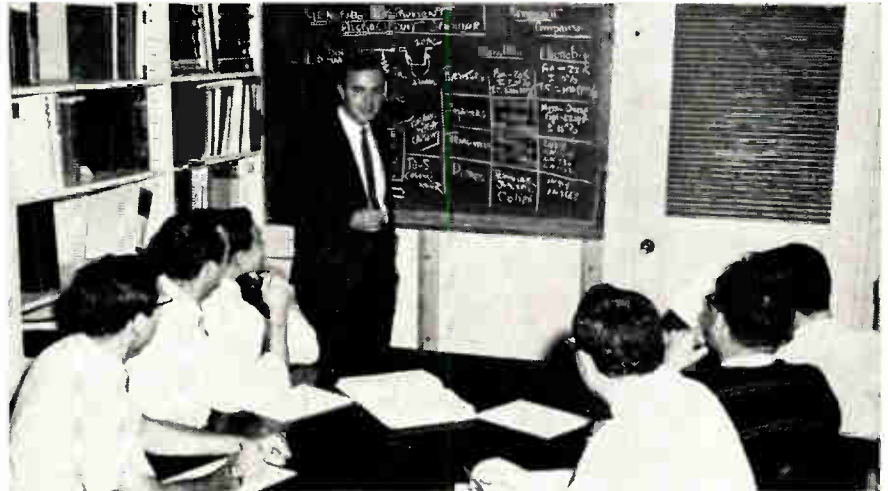

Dr. Jerome Fishel, General Instrument Corp. explains latest developments in microcircuits to staff engineers of Burroughs Research Laboratories during company up-dating seminar.

uate students.

Studies at 27 schools showed the doctoral faculty in 1961 was nearly twice that in 1954. Doctoral degrees granted in 1961, however, were only 10% higher than those awarded in 1954. The basic issue would seem to be stated in these questions:

Should research not related to education be conducted at universities?

Can universities undertake such R&D programs and not decrease the quality of undergraduate and graduate education?

## NATIONAL DEMAND CONTINUES FOR ENGINEERS, SCIENTISTS

Unfilled job openings in late summer and early fall of 1963 were mostly labeled engineering and scientific, according to the Department of Labor.

The Department's latest summary of job conditions in 150 major labor markets, discloses that heaviest demands were concentrated in the electrical, electronic and mechanical engineering fields.

Despite overall demand picture, the report also pointed out that around the nation, demands for chemists, physicists, mathematicians and the natural science occupations declined.

## SEMINARS ON THE JOB UP-DATE ENGINEERS

Time is precious. How can engineers conserve it and yet keep up-to-date on new developments in specialized fields?

Some companies are making a point of holding regular seminars for their engineers. Outside specialists are invited to the seminars to present state-of-the-art information to up-date the staff.

At one such seminar recently at Burroughs Research Laboratories in Paoli, Pa., Dr. Jerome Fishel of General Instrument Corp. presented a talk to about 20 engineers. He covered, in about an hour, a point-by-point status of microelectronic circuitry. Principles of each form of circuitry were presented, its advantages and disadvantages, and preferred applications.

The seminars are good for engineers in companies that provide the time and location for their presentation: they are good for the company.

FOR MORE INFORMATION . . . on opportunities described in this section fill out the convenient resume form, page 140.



# GIVING A TALK? —SOME USEFUL SUGGESTIONS

A well-prepared technical presentation can sell your product or project. Here are a few guides that will make this job easier, and assure a professional job.

MANY ENGINEERS ARE LEARNING, THE HARD WAY, that the difference between the successful idea and the one that is forgotten is often just the personal selling power that the engineer can put behind it.

Sometimes it is the product that you are associated with. Other times you may be "selling" your project to your associates or supervisors.

The task is unfamiliar, but very important. Here are some firm directions that will make the job much easier.

## ORAL PRESENTATION

### Program Content

Clear organization is the first requirement. To achieve this remember:

a. Do not have too many points. If possible, reduce your ideas to three or four principal topics. Group the remaining facts under the main headings.

b. Show a logical relation between main points. Keep moving in the same direction; do not jump back and forth from one point to another.

c. Make your transitions clear. As you progress from one main topic to another, let your audience know about it. Otherwise they may think you're still talking about the preceding material.

### Data Presentation

If your audience can see a diagram of the product or a tabulation of the facts, it makes your job of explaining, and theirs of understanding, much easier. If possible, use flip charts to present this data.

If your audience is familiar with your subject material, begin talking about it immediately. However, if they are unaware of its importance, use a startling statement or an illustration at the beginning of your presentation. This will focus their attention to the point you're trying to stress.

If you want to sell a product or project, you have to show why it's needed. Never assume your audience is sold before you begin. If they were, you and they wouldn't be there. You must show that the information about to be presented will be valuable.



"... a diagram of the product or a tabulation of the facts makes your job of explaining much easier. . . ."

"The aim of a presentation is to secure a clear understanding of the ideas presented, and help others get a firm grasp on certain fundamental facts."

By FRANCIS J. GALVIN

Proposals and Customer Relations Dept.,  
GPL Div., Aerospace Group,  
General Precision, Inc.,  
63 Bedford Rd.,  
Pleasantville, N. Y.

When the information to be presented is not of the workaday variety, you must build the need on the basis of curiosity. Everyone has a latent desire to understand curious or unusual things. Awaken this desire by setting up a situation containing some mysterious element, and suggest that you are about to make the mystery clear.

After you've aroused the audience's interest, you're now ready to present the actual information itself. This will be the longest part of the presentation. At this time you must exercise great care with regard to clarity of organization. Here is an orderly method of arranging your information.

The *initial summary* consists of a preview of the information to be presented. It may be an enumeration of the main points around which you expect to group your facts, or it may be an example containing the single element of your idea. By giving your audience a brief outline of what you are going to present, you clarify the direction of your discussion. For example, if you were going to explain the attributes of a proposed Doppler radar set, you might begin as follows: "To explain the advantages of the proposed Doppler radar set, I shall discuss briefly Doppler theory; second, the detailed physical and electrical characteristics; and last, a final summary of the main points discussed."

The enumeration of main points in the initial summary should parallel the order in which you intend to schedule them. Otherwise you will give the audience a false lead.

The detailed information containing the main points are presented along with related facts and explanations. When possible connect the unknown

with the known. People learn new things by associating them with what they already know. Be sure your presentation moves along in a definite direction; do not let your audience get lost.

The *final summary* consists of a recapitulation of the main points discussed, and includes whatever important conclusions you have made clear. The *final summary* is similar to the *initial summary* but it is usually not quite so brief. It ties together the information presented to give the audience a unified picture.

### Speaking

The manner in which the presentation is delivered depends upon the subject and the audience. In general, talk slowly enough to be understood and rapidly enough to hold interest. Too rapid a rate will confuse your listeners; too slow a rate will put them to sleep. The more difficult the information is to grasp, the slower you should proceed, but at the first sign of inattention, increase the tempo slightly.

There is a limit to the rate at which data may be absorbed in a given period. One of the factors which affects the absorption rate is the data redundancy (familiar data). The information rate, in a technical presentation, should be slow at the start since most of the information will be new. As the presentation progresses, more and more information becomes redundant and the information rate may be allowed to increase until, in the conclusion, when no new material is being presented, the rate can be very high.

### Microphone

A fixed microphone limits the speaker's freedom

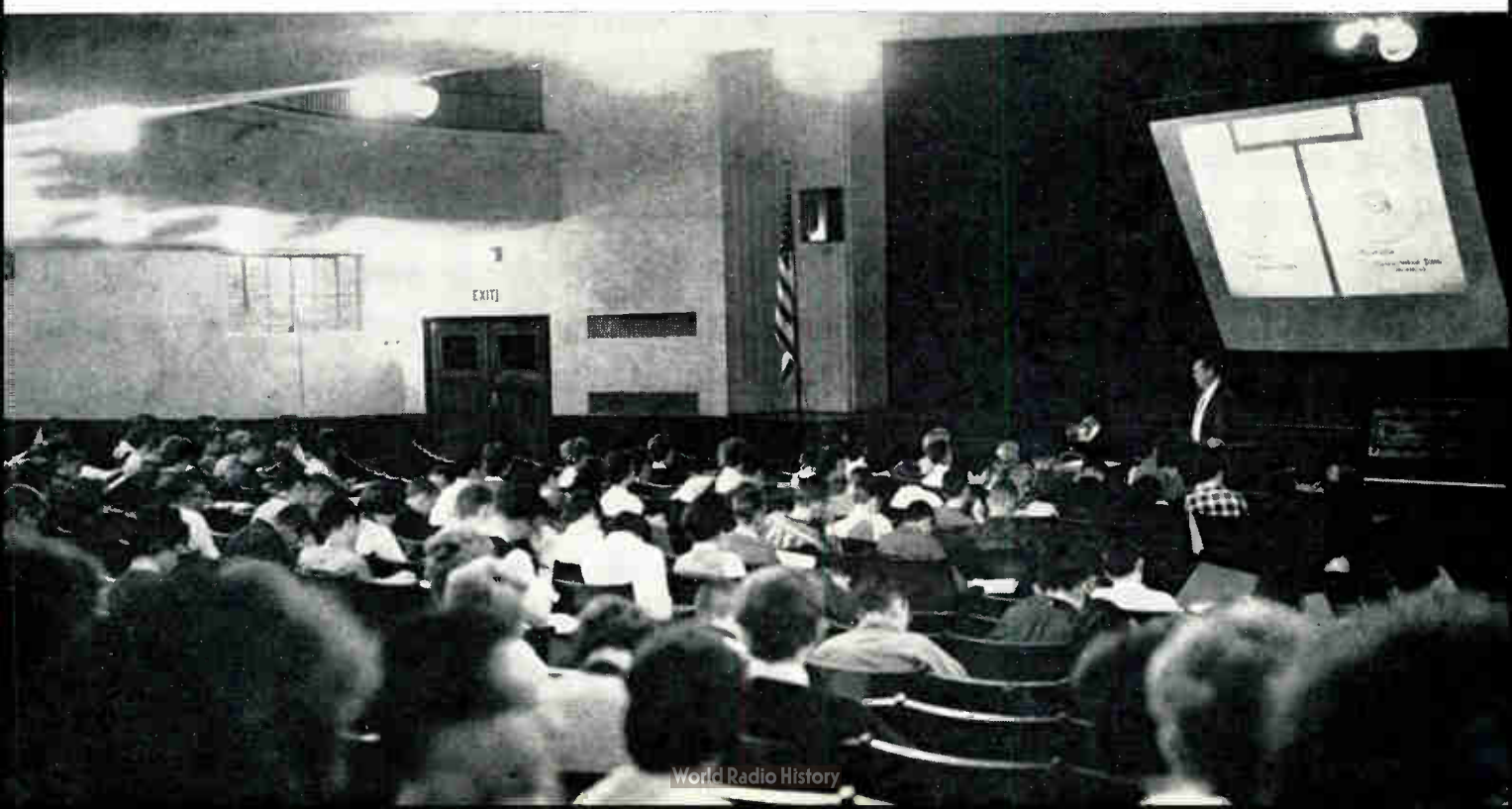

# ELECTRONIC INDUSTRIES Professional Profile

The ELECTRONIC INDUSTRIES Job Resume Form for Electronic Engineers

Name \_\_\_\_\_ Tel. No. \_\_\_\_\_

Street Address \_\_\_\_\_ Zone \_\_\_\_\_

City \_\_\_\_\_ State \_\_\_\_\_

Single     Married     Citizen     Non-Citizen    Date of Birth \_\_\_\_\_

Will Relocate  Yes  No.    If Yes  Another City  Another State

Salary Desired to Change Jobs in present area \_\_\_\_\_

Salary Desired to Change Jobs and relocate in another area \_\_\_\_\_

Professional Memberships \_\_\_\_\_

| College or University | Major | Degree | Dates |
|-----------------------|-------|--------|-------|
|                       |       |        |       |
|                       |       |        |       |
|                       |       |        |       |

## RECENT WORK EXPERIENCE

| Company | Div. or Dept. | Title | Dates |
|---------|---------------|-------|-------|
|         |               |       |       |
|         |               |       |       |
|         |               |       |       |
|         |               |       |       |

## SIGNIFICANT EXPERIENCE AND OBJECTIVES

STATE ANY FACTS ABOUT YOURSELF THAT WILL HELP A PROSPECTIVE EMPLOYER EVALUATE YOUR EXPERIENCE AND JOB INTERESTS. INCLUDE SIGNIFICANT ACHIEVEMENTS, PUBLISHED PAPERS, AND CAREER GOALS.

Mail to: ELECTRONIC INDUSTRIES—Professional Profile—56th & Chestnut Sts.—Philadelphia, Pa. 19139  
 This resume is confidential. A copy will be sent only to those Companies whose number you circle below.

800    801    802    803    804    805    806    807    808    809    810



## GIVING A TALK (Continued)

of movement. Unless he is accustomed to using it, he is likely, in the course of his address, to turn his head toward the screen to call attention to some significant feature, thus producing a noticeable difference in the tone and volume of his voice. A "hang-on" type microphone is preferable.

### Rehearsals

It is most important that technical presentations be rehearsed. Rehearsal allows the presentation to be timed with reasonable accuracy. While in most cases accurate timing may be of small significance, in others it is of considerable importance. If a speaker is to be one of a series of speakers, good timing acquires great importance. Further, if a speaker is to represent his organization, rehearsal before his colleagues allow them to judge the adequacy of his presentation and offer constructive criticism.

## VISUAL PRESENTATION

### Visual Aids

Visual aids support the oral presentation. Each visual aid must stand on its own merit and contain simple, clear, and concise data. When weighing the need for a particular visual aid, ask yourself, "is it needed?" If so, "how well will it convey the message?" After the need for visual aids is established, check the layout of the facilities where the presentation is to be made. This will allow you to determine the type and size of the visuals to be used.

### Slides

*2 x 2 Slides* are an efficient means of visually supporting an oral presentation. Equipment required consists of a slide projector and a projector screen with a minimum viewing area of 30 x 40 inches. A "lenticular" - type screen allows viewing while the room is lighted. If possible, use color slides for they enhance audience interest.

*Lantern slides* give the best results if the audience is too large for the use of illustration-board charts. The charts are first drafted in a size convenient for lettering and then reduced photographically to slide size. The best results in lantern-slide projection is obtained if the room is in complete darkness. This, however, is often difficult or impossible to obtain. The disadvantages of semi-darkness can be greatly overcome if a projector with a high-light output is used. In this case the screen position, in relation to the room lights, is adjusted so that only the projec-

(Continued on page 142)

● A REPRINT of this article is available from  
ELECTRONIC INDUSTRIES Reader Service Department

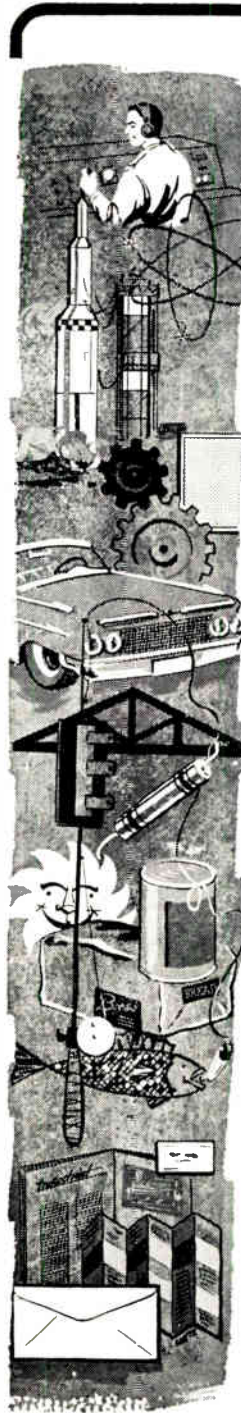

# THERE'S MORE THAN ONE REASON FOR THE LOCATION OF THE MANUFACTURERS OF THESE FINE PRODUCTS IN DAYTONA BEACH

## Florida's Newest Metropolitan Industrial Area

- ORMOND BEACH
- HOLLY HILL
- DAYTONA BEACH
- SOUTH DAYTONA
- PORT ORANGE
- DAYTONA BEACH SHORES

### So, check the facts:

- Strategic Location
- Low-Cost Industrial Sites
- Favorable Taxes
- Ample Power, Water and Fuel
- Ready Manpower Pool
- Minimum Absentee-ism  
(Thanks to a mild year-round climate and clean ocean air with a pollen count of less than one.) Ideal Year-Round Living.
- Fine Transportation System
- An Industry-Minded Community

### Then, write to:



Mr. Robert H. Miles  
Committee of 100  
Daytona Beach Industrial Area  
Dept. IM-4 - Daytona Beach, Florida  
Please send detailed information on  
the Daytona Beach Industrial Area.

NAME \_\_\_\_\_  
TITLE \_\_\_\_\_  
COMPANY \_\_\_\_\_  
ADDRESS \_\_\_\_\_  
CITY \_\_\_\_\_ ZONE \_\_\_\_\_  
STATE \_\_\_\_\_

All inquiries held in strict confidence.

Circle 79 on Inquiry Card

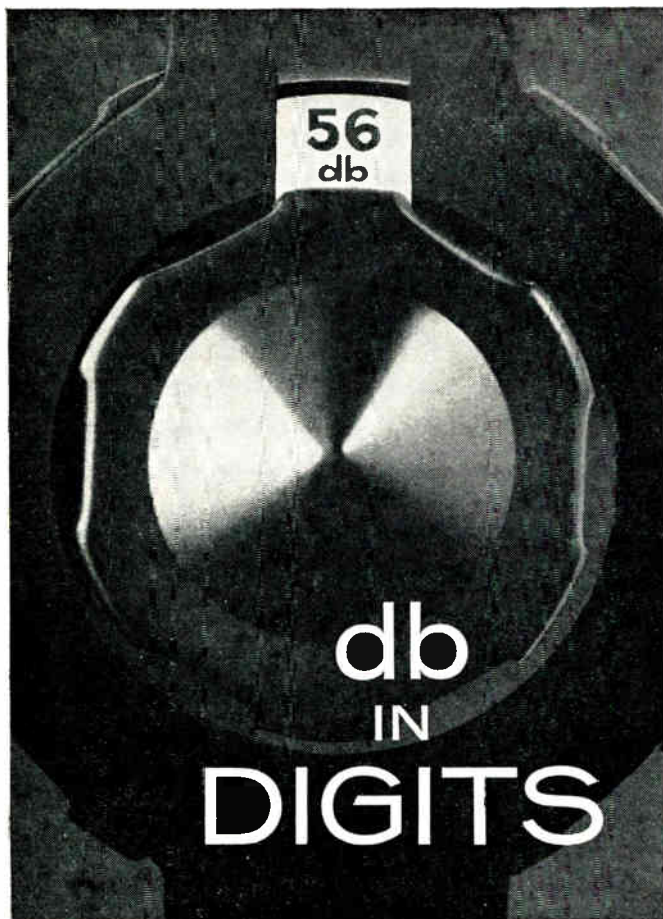

It attenuates any signal from DC to 1250 MC, has an operating range of 0 to 59 db, and provides error-free, digital indication of the db value. The Model No. is TAB-50. Its brand name is Telonic.

This turret attenuator is a unique Telonic design incorporating two concentric dial selectors with 10 db steps to 50 db, and 1 db steps to 10 db. Any db value from 1 to 59 can thus be selected and is indicated exactly by the digital readout. There is no approximation, no interpolation. Each decade and unit attenuation element is an individual pi-pad mounted to a precision machined rotor. Positioning is fast and exact, repetitive settings are always right on the mark.

Specifications are just as impressive: accuracy at 30 mc is  $\pm 2\%$ ; VSWR to 300 MC is 1.2:1, and insertion loss is a low 0.1 db at 30 MC. And if extreme accuracy at high frequencies isn't mandatory, you may elect to use a Telonic Model TEB-50 identical to the TAB-50, but with relaxed specs above 30 MC — at a reduced price of course.

Both of these models are shipped ready for either bench use or panel mounting. Instructions and drilling template are furnished with each unit.

Telonic has, in fact, a wide selection of turret attenuators available for virtually any application. They range from 0 to 1 db in 0.1 db steps to 0 to 110 db in multiple mounts. A complete set of specification sheets on all models is available on request.



**INDUSTRIES, INC.**

60 NORTH FIRST AVENUE  
BEECH GROVE, IND.  
PHONE STATE 7-3231 AREA CODE 317  
TWX 317-635 4748

*Representatives in  
Baltimore, Boston, Chicago, Cleveland, Dallas, Dayton, Denver, Huntsville, Indianapolis, Los Angeles, New York City, Orlando, Philadelphia, San Francisco, Seattle, St. Louis, Syracuse and principal cities throughout the world.*

Circle 80 on Inquiry Card

## GIVING A TALK (Concluded)

tor light falls directly upon it. The projector is operated by an assistant who changes the slides when he receives predetermined signals from the speaker.

Using this screen set-up has one important disadvantage—the speaker cannot stand in front of the screen. If he stands on either side he will not be seen clearly in the semi-darkness. This problem is usually resolved by placing a small table or desk equipped with a hooded desk light in front of the speaker.

### Overhead Projection

Overhead projection is a flexible method of visual communication. The speaker controls the projector

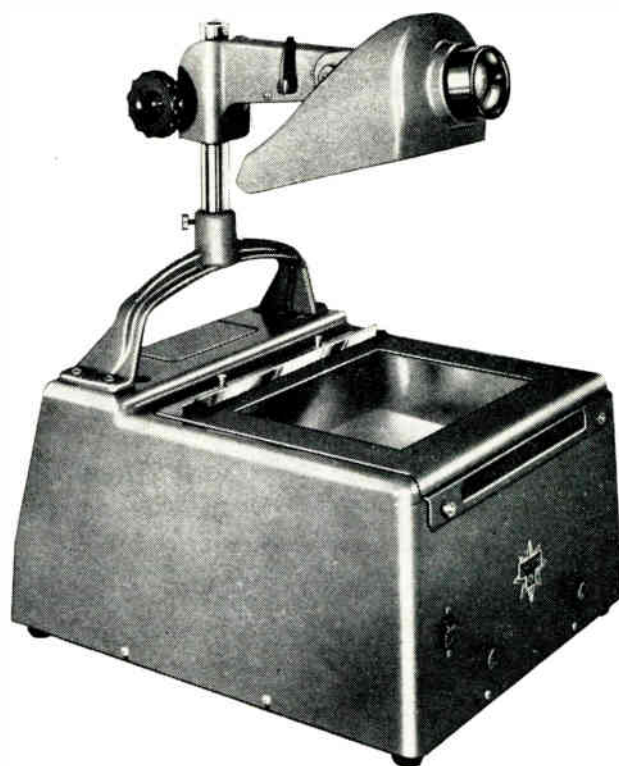

(Photo: Technifax Corp.)

The overhead projector allows projection over the speaker's shoulder. It requires no slide set-up and can be operated in semi-darkness.

and takes a prominent part in the presentation. The projector may be placed close to the screen, allowing transparencies to be projected from the front of the room. Since the image is projected over the speaker's shoulder, he faces his audience at all times and may observe their reactions.

### Flip Charts

Flip charts are an expedient and inexpensive method of preparing visual aids. As the nomenclature implies, they are nothing more than oversized charts. Their large size obviates the need for using projecting equipment. These charts may contain line art,



half-tones, or a combination of both. Lettering on the flip charts is generally done by LeRoy lettering or free hand.

### Summary

The aim of a presentation is to secure a clear understanding of the ideas presented, and help others get a firm grasp on certain fundamental facts. Speech plays an important role in your presentation. People absorb information more easily when it is lively and interesting.

Your principal duties are to make the conclusions clear; to have your presentation understood; and to insure a proper grasp of the content of your presentation. When possible follow these rules:

Keep your presentation short and to the point. The average presentation should not exceed 20 minutes.

The audience will assimilate only a few ideas at a time. Concentrate on the most important points—make them really count.

Make a concentrated effort to avoid self-made distractions. (Remove visuals when no longer applicable.)

If your presentation includes hand-out material, distribute it after the presentation.

Adjust to the audience. If they are familiar with some of the problems, spend less time on these and stress others.

In general, talk loudly and slowly enough to be understood and rapidly enough to hold interest. Avoid distracting mannerisms.

Allow adequate time for a question and answer period.

---

**FEDERAL RESEARCH PROGRAMS** have neglected many state universities and liberal arts colleges, declared a government expert. They also have leaned too heavily on scientific research. The result is neglect of humanities and the undergraduate. Also, research suffers from growing soft, lowered selectivity and blurred targets. Harold Orlans, senior staff member of Brookings Institute governmental studies division, declared that Federal spending has enlarged knowledge, influence, prestige and incomes of scientists. These benefits, however, have not been shared by other institutions in nonscientific fields. The great danger is that at most colleges students will get mass-produced, low-priced and lower quality science degrees. High quality education will be reserved for a minority of favored institutions. Orlans feels that part of the lowered standards in Federal research programs was because of their use by administrators, scientists and Congress as "a politically convenient means to aid higher education."

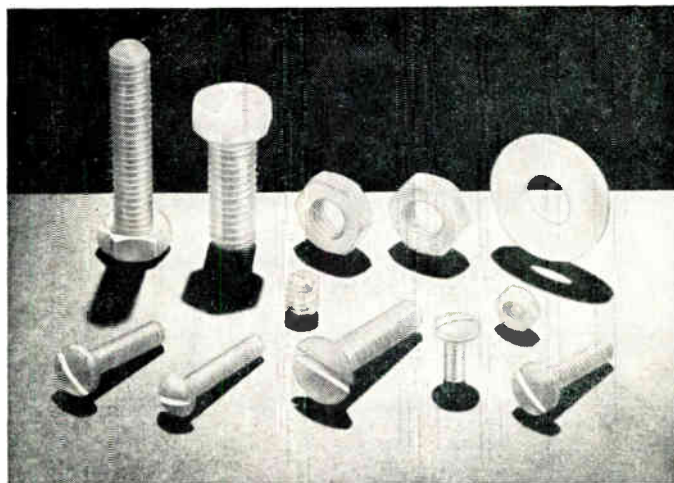

### WHO STOCKS MILLED AND MOLDED NYLON FASTENERS?

We do! As a leading supplier of stainless fasteners to the Aerospace, Electronic and Missile Fields, with the world's largest stock—it was inevitable. For instance, we stock Nylon 101 Fasteners in natural white, both milled and molded. Colors and non-stock items are promptly fabricated from rod, tubular bar, strip, plate, hex and square rod, to meet special coding or design applications. Interested in knowing more about the design possibilities of Nylon Fasteners? Check our BIG CATALOG, or contact our nearest sales office or plant.

**ALLMETAL**® SCREW PRODUCTS COMPANY, INC.

GARDEN CITY, N. Y. / EL SEGUNDO, CALIF.  
NEW YORK CITY / NEWARK, N. J. / BOSTON, MASS. / CHICAGO, ILL. / MTN. VIEW, CALIF.

Circle 8i on Inquiry Card

## ELECTRICAL ENGINEERS

Melpar's Communications and Intelligence Departments have an immediate need for electrical engineers experienced in:

### MICROWAVE RECEIVER DESIGN

These openings include positions of major responsibility for Senior Engineers as well as unusual opportunities for advancement for recent graduates.

Specific problems include parametric amplifiers, varactor techniques, microwave filters, ultrastable programmable oscillators and dual and triple channel balanced receivers for monopulse and guard antenna gating.

For further details, write in strictest confidence, to: John A. Haverfield, Manager—Professional Placement

**MELPAR INC**

A SUBSIDIARY OF WESTINGHOUSE AIR BRAKE COMPANY  
3435 Arlington Boulevard / Falls Church, Virginia  
(a suburb of Washington, D. C.)

an equal opportunity employer

Circle Number 801 Professional Profile, page 140

143



# NCR

## ELECTRONIC ENGINEERS CIRCUIT/SYSTEMS/LOGIC INTEGRATED CIRCUITS

### Character Recognition:

Participate in system design of integrated automatic document handling and character recognition system.

### BS-MSEE

3-5 years experience in one of the following:

- Circuit Design (High speed digital) (Wide band analog circuits)
  - Information Processing System Design
  - Electromechanical Design
- Working knowledge of optics, photoelectronics, principles of information theory and system design theory.  
Salary open.

### Processor and Display Devices:

For high speed analog signal processors and cathode ray display devices.  
Timing circuits, oscillators and digital logic circuits as part of high speed analog and digital signal processing equipment.  
To select digital modules for economical instrumentation of logic. Assist in design of wide band-width signal processing circuits.

### BS-MSEE

3 or more years experience in circuitry design. Logical design and use of digital modules in complex mixed analog-digital system.

### EDP Systems:

A senior level position currently exists at the R & D facilities of NCR in Dayton, Ohio. The individual with whom we are interested in discussing the present opportunity will have a BSEE or MSEE and 3 to 5 years' experience in digital techniques with EDP hardware systems orientation. You are invited to investigate the many advantages of being associated with a major computer manufacturer whose stability is enhanced by previously established compatible products.

Please address inquiries to: Mr. T. F. Wade, Technical Placement The National Cash Register Company, Main & K Streets, Dayton 9, Ohio

*an equal opportunity employer*

## WINGED-SHAPE '400' FAMILY



GE-425, one of new family of four computers. Winged-shape family, known as Compatibles-400, provides 80% greater performance. The new computers are aimed at the replacement trend in 4-year-old transistorized market.

### GE OFFERS FOUR COMPUTERS FOR REPLACEMENT MARKET

Forecasting a growing trend in replacing four-year-old transistorized computers, General Electric's Computer Department has announced four new medium-to-large scale computers.

Known as Compatibles-400 family, the new winged-shape computers are the GE-415, 435, 455 and 465. Each successive computer provides 80% greater processor performance, according to GE.

Lacy W. Goostree, Jr., marketing manager for computers, said that the computers will be marketed across the board to business data processing users. Particular emphasis will be on the replacement market. Markets needing data communications would also be a prime sales target.

According to Goostree, growing demand for data communications systems requires new equipment that can easily be expanded in less time with minimum investment. This is especially true with the need for more powerful data processors.

The new Compatible-400 family was specifically designed to meet these needs, he explained. The winged-shape central processors are designed so new wings can be substituted, or entire new processors replaced on site to take advantage of new developments.

Users will not need complete new systems to expand capabilities.

# NOW

# TRAK Microwave

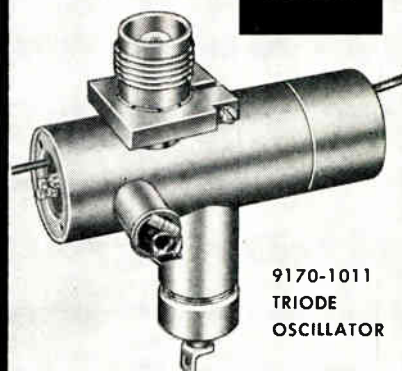

9170-1011  
TRIODE  
OSCILLATOR

## Electronic Tuning at X-Band

The Trak family of X-Band triode oscillators now includes electronic tuning capability which is of particular significance for X-Band projects where AFC or frequency modulation is required. Inquiries are invited regarding developmental models at any frequency between 8.0 and 9.6 Gc with either fixed frequency, manual tuning up to 500 Mc or electronic tuning of 20 Mc minimum.

### TYPICAL SPECIFICATIONS

Part No. 9170-1011.  
Frequency: Manual tuning range, 9.1 to 9.4 Gc.  
Electronic Tuning Range: 20 Mc min.  
Service: CW (FM).  
Power Output: Greater than 3 mw.  
Physical Dimensions: 3/8" diameter by 2 1/4" long, including projections; weight 3 ounces.  
Frequency Stability: Temperature, 75 Kc/°C.  
Shock: 100G.  
Vibration: 15G, 20-2000 cps.  
Output Connector: TNC female (can be provided with UG-39/U waveguide flange).  
Output Coupling: Inductive, adjustable.

## X-Band Triode Oscillators at 7 Stock Frequencies

Trak Type 9170, the first commercially available X-Band triode oscillator, is available in small quantities from stock. Large production orders can be accomplished with 60 days notice.

| FREQUENCY          | PART NO.  | CONNECTOR |
|--------------------|-----------|-----------|
| 8.2-8.7 Gc (CW)    | 9170-1013 | UG-39/U   |
| 8.4 Gc ±50 Mc (CW) | 9170-1010 | TNC       |
| 8.5 Gc ±50 Mc (CW) | 9170-1015 | TNC       |
| 8.5-9.1 Gc (CW)    | 9170-1002 | UG-39/U   |
| 8.5-9.1 Gc (CW)    | 9170-1000 | TNC       |
| 9.1-9.6 Gc (CW)    | 9170-1005 | TNC       |
| 9.1-9.6 Gc (CW)    | 9170-1007 | UG-39/U   |
| 9.1-9.4 Gc (CW)    | 9170-1011 | TNC       |

POWER OUTPUT is 3 mw. minimum.

**SEND FOR** full information. If you're in a hurry **PHONE COLLECT, TAMPA 877-6735.**

## TRAK MICROWAVE CORPORATION

5006 N. Coolidge Avenue Tampa, Florida

Circle 82 on Inquiry Card

## NASA NAMES FIVE TO STUDY SITES FOR ELECTRONICS LAB

A five-man fact-finding group is now looking into locations for the proposed NASA Electronics Research Center. Members will evaluate locations and make a report to James E. Webb, NASA head.

Purpose of the Center is to conduct enough basic and applied research to keep the staff updated on advanced techniques in electronics. A major aim of the Center will be to approve and check out university research and production contracts in behalf of NASA.

The agency had asked for \$5 million for the Center in the 1964 fiscal year. Congress gave NASA \$3.9 million, subject to the needs stated when the committee makes its report. An extra \$1.1 million is laid aside for advanced planning.

## EIA ASKING FCC TO EXTEND RADIATION LIMIT FOR TESTS

The EIA is asking the FCC to extend the temporary 1,000-microvolt-per-meter limitation on radiation from UHF TV receivers. This would give industry time to test out the belief that the use of transistor tuners will cut radiation to the level sought by FCC.

Through its Consumer Products Division, EIA will seek a one-year extension of the 1,000-microvolt allowable radiation level. The limitation is set to be returned to the 500-microvolt level on April 30, 1964, the date on which the all-channel TV law becomes effective.

Fred W. Edwards, Chairman of an EIA Subcommittee on TV tuners, said laboratory data collected by the group strongly indicates that use of transistors instead of tubes in UHF tuners will bring radiation levels within the 500-microvolt limit.

## SINCLAIR NAMED PRESIDENT OF GENERAL RADIO

Donald B. Sinclair, Executive Vice President of General Radio Co., was elected President of that company at a meeting of the Directors. Dr. Sinclair was born in 1910 in Winnipeg, Manitoba, and received his Sc.D. from MIT in 1935. He joined General Radio in 1936 and subsequently became Chief Engineer. In 1955 he was appointed V.P. for Engineering and in 1956 was elected a Director.

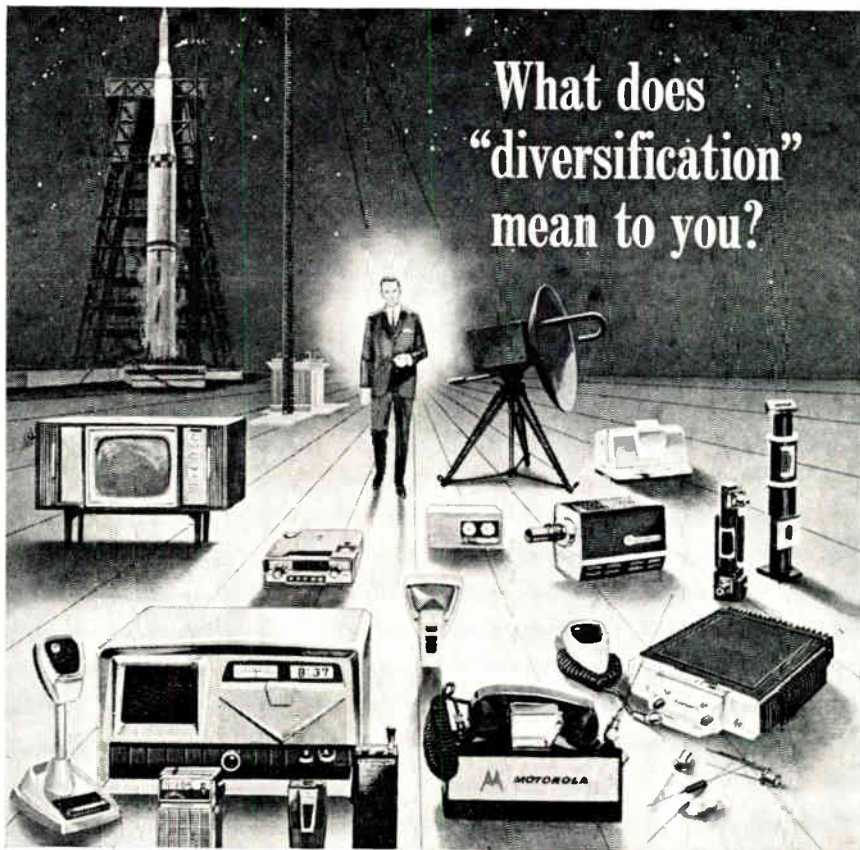

Radar • Radio communications • Microwave • Transistors • VHF/UHF • Missile guidance • Data processing • Every advanced phase of electronic engineering!

Which offers you the greatest challenge? The greatest potential? The greatest reward?

Here at Motorola, exceptional diversification offers you the widest possible choice of the entire state of the art. The horizons are unlimited—and so are the rewards. Engineers are discovering a new sense of achievement and personal fulfillment in selecting the specialized field that parallels their own interests.

You can take your own measure at Motorola. Here you can find the diversification you want. Challenging new assignments. True professional status. Association with highly creative engineering and scientific minds. Unlimited advancement. Write us about yourself today.

LABORATORY MANAGER direct group of engineers and support personnel in complex R & D communications activities, airborne and mobile.

CRYSTAL ENGINEERS advanced R & D in Filter networks, frequency control, phase shift networks, involving quartz crystal applications.

SYSTEMS ENGINEERS advanced R & D in radio communications systems related to Two-way, portable, mobile and radio-telephone equipment.

CIRCUIT DESIGN ENGINEER advanced R & D related to circuit synthesis, Laplace transforms,

magnetics and solid state Physics.

SYSTEM DESIGN analysis and synthesis of complete systems for operation in airborne, missile and spacecraft applications.

EQUIPMENT DESIGN high performance solid-state receivers, transmitters, and data processing equipment for radar, communications, command and control, tracking and telemetry.

FAMILIARITY WITH STATE-OF-THE-ART statistical communications theory, advanced signal processing techniques, solid state r. f. techniques, ultra-reliability, antenna systems, advanced structural and thermal designs.

Excellent opportunities also available in Phoenix, Ariz.

**MR. W. H. HAUSMANN**  
Engineering Personnel Mgr. Dept. A  
4545 Augusta Blvd., Chicago 51, Ill.

**AN EQUAL  
OPPORTUNITY  
EMPLOYER**



**MOTOROLA inc.**



Why  
**MAPICO**  
**iron oxides**  
 for ferrites, above all others?

**Because...**

Mapico pure synthetic iron oxides are unmatched for uniformity... they are subjected to the most precise production controls.

**Because...**

There's range... a Mapico iron oxide raw material is available for every end use area from deflection yokes to temperature compensated cores to hard ferrites.

**Because...**

Mapico iron oxides are made in three typically different particle shapes... each available in several ranges of particle size.

**Because...**

Selection of the right Mapico iron oxide gives controlled electronic characteristics and shrinkage.

**MAPICO**

offers a useful, up-to-date chart on these many oxides with detailed data on particle shapes and other properties.

**WRITE FOR IT TODAY!**



**MAPICO IRON OXIDES UNIT**

**COLUMBIAN CARBON COMPANY**

380 Madison Avenue, New York 17, N. Y.  
 BRANCH OFFICES IN PRINCIPAL CITIES

**COLUMBIAN CARBON COMPANY**  
 380 Madison Avenue, New York 17, N. Y.  
 Please send me the new, up-to-date chart on MAPICO IRON OXIDES FOR FERRITES.

Name.....  
 Position.....  
 Firm.....  
 Address.....  
 City.....Zone.....State.....



**WHAT'S NEW**

**1000°F WIRE AND CABLE**

SPECIALLY-DESIGNED WIRE AND CABLE, designated as "Pyrad-1000™, have been developed to operate at 1000°F with a minimum of space and weight. The wire and cable product is highly flexible, and has no bulky tubing-type jackets. A special process produces an insulation which results in high-temperature resistance, as well as resistance to the vacuum and radiation requirements of space.

The basic construction consists of a stranded nickel-clad copper conductor with a multiple layer inorganic insulation. The outer shield is braided nickel-clad copper. A #20 (AWG) single conductor Pyrad-1000 wire rated at 300 volts RMS has a nominal over the shield diameter of 0.111 in., and weighs under 28 lbs. per 1,000 ft.

This construction may be expanded to include multi-conductor cables by normal cabling techniques.

The materials used in this wire can withstand 1000°F.



Four #20 (AWG) conductors may be insulated, cabled together and shielded, and the nominal diameter of the cable is only 0.233 in. For specific applications, alternate conductor and shield materials may be used, such as pure nickel or stainless steel. To further increase dielectric strength or abrasion resistance, more insulating jackets or shields may be applied.

American Super-Temperature Wires, Inc., Winoski, Vt., a subsidiary of Haveg Industries, Inc., developed the wire.

**HIGH-SPEED LIGHT PEN**

THE TYPE 370 HIGH-SPEED LIGHT PEN is for use with rapid-plotting cathode-ray tube displays. The light pen consists of a photomultiplier tube, high-voltage power supply, amplifier, and flexible light pipe with pen holder.

(Continued)



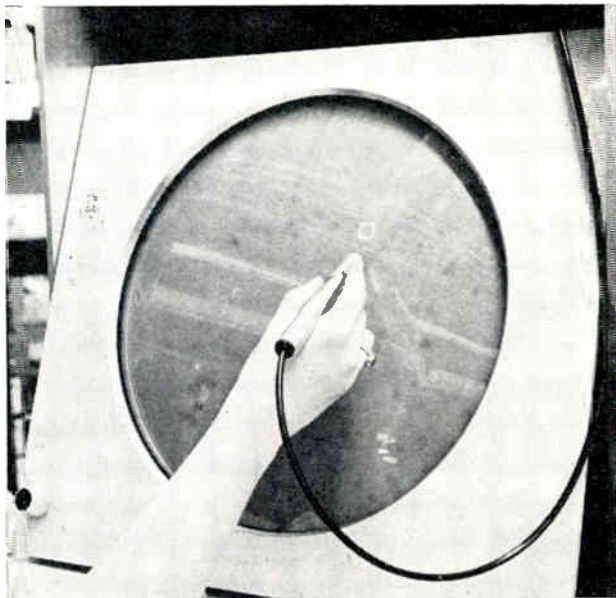

Output-signal rise and fall times are dependent upon the rise and decay times of the phosphor used in the CRT.

A flexible, fiber-optic light pipe permits all electrical components to be stored inside the display, and eliminates electrical noise caused when the pen is subjected to sudden shocks. Other features include a mechanical shutter which prevents selection of unwanted information during pen positioning, and interchangeable light pen tips available in a variety of fixed aperture settings for variable fields of view.

Increased sensitivity and reliability are obtained by photo-multiplication of light signals from the CRT. When used with conventional phosphor displays, the Type 370 is said to have a response time about five times faster than photo-diode systems. This increase in speed permits a greater degree of accuracy in point detection under minimum light intensity levels. Response time is limited only by rise and decay times of the CRT phosphor used. Pen was developed by Digital Equipment Corp., Maynard, Mass.

#### NAVY GETS HUGHES DISPLAY CONSOLES



Detector-tracker display consoles on USS Enterprise. Part of Naval Tactical Data System, consoles show radar data, which operators enter in computer system. Manual plotting is not needed but may be used. Some 20 other ships will be equipped with the consoles designed by Hughes Aircraft Co.



Induction Heating's Most  
Trusted and Creative  
Craftsmen Since 1926

## High Frequency INDUCTION HEATING UNITS

for

- BRAZING
- MELTING
- SOLDERING
- ZONE REFINING
- HEAT TREATING
- CRYSTAL GROWING
- BOMBARDING
- PLASMA TORCH

### ELECTRONIC TUBE GENERATORS

*Kilocycle Frequency Units*

*Megacycle Frequency Units*

*Dual Frequency Units*

- SPARK GAP CONVERTERS
- ACCESSORY EQUIPMENT

FREE APPLICATION ENGINEERING SERVICE—Our engineers will process your work samples and submit recommendations.

WRITE FOR NEW LEPEL CATALOG  
**Lepel** HIGH FREQUENCY LABORATORIES, INC.  
55th St. & 37th Ave., Woodside 77, N.Y.C.  
Chicago Office for Sales & Service: 6246 W. NORTH AVE.

Circle 84 on Inquiry Card

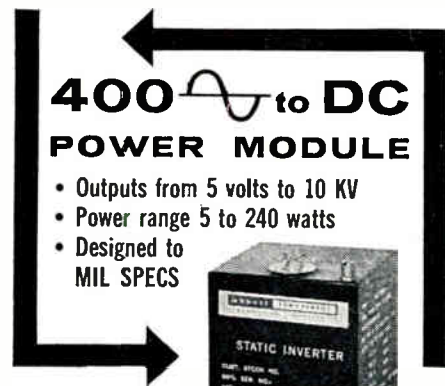

## 400 to DC POWER MODULE

- Outputs from 5 volts to 10 KV
- Power range 5 to 240 watts
- Designed to MIL SPECS



These miniature, solid state modules convert 115 watts 400 cps power to any DC voltage from 5 to 3650 VDC on standard models, with up to 10KV available on "specials." Units are regulated to a close 0.5% for an input change of 105 to 125 VAC. Ripple is only 0.2% RMS. True hermetic sealing is provided to meet the MIL-E-5272C missile environment.

Prices begin as low as \$170.00  
Smallest size: 2 3/4" x 2 3/4" x 3" high  
Delivery: most units from stock

Send for complete 20 page catalog—  
or see EEM pgs. 1255-1259.

**abbott transistor**  
LABORATORIES, INCORPORATED  
3055 Buckingham Rd. • Los Angeles 16  
Direct Dial 213 • REpublic 1-9331

### THREE UNIVERSITIES STUDY SPACE SPENDING EFFECTS

Three universities now have money and a mission from NASA to learn more about the economic effects of space age spending.

Washington University in St. Louis has a grant of \$300,000 to study the impact of space on our national economy. The university will try to lay down methodology for determining space program effects on regional economic growth.

The University of Chicago, has a \$144,000 NASA grant to investigate

the impact of science and technology on economy and public affairs.

A third grant, \$118,000, went to the University of Colorado. The grant will cover study and analysis of socio-economic effects of expansion of space and space-related activities on local communities.

Last September the Denver Research Institute at the University of Denver completed a related study called "The Commercial Application of Missile/Space Technology."

### AFLC ORDERS 9 DATA SYSTEMS



Maj. Gen. C. W. Cecil, Comptroller, Air Force Logistics Command, observes initial tests for a multiple computer order. The \$5.5 million order, placed by AFCL, world's largest user of data processing equipment, calls for nine computing systems. Included are three UNIVAC 1107 Thin-Film Memory computers and six UNIVAC 1050 Systems. They will connect through AUTODIN, the Air Force World-wide communications network.

### ALL-CHANNEL DEADLINE FIRM, FCC TELLS TV SET MAKERS

To dispel any false rumors and misconceptions among the nation's television receiver makers, the FCC this month put out an official statement.

Aimed largely at slow-movers and procrastinators, the statement reaffirms that FCC is committed to UHF and will not abandon it.

FCC states that it intends to enforce the all-channel ruling to the full letter of the law; there will be absolutely no postponing of the law's effective date of April 30, 1964.

### INDUSTRY HELPS ENGINEER ENROLLMENT IN CALIFORNIA

Cooperation between industry and colleges helped increase enrollment in engineering schools in Southern California, a national trend in reverse, said Charles F. Horne, president of Electronic Industries Association.

Mr. Horne, President of General Dynamics/Pomona, Pomona, Calif., said freshmen enrollment in the fall of 1962 rose 11.1% in Southern California. That area has one of the nation's heaviest concentrations of electronics firms. On a national scale, enrollment fell off by 2.3% in academic year 1962-63, he said. The number of bachelor degrees granted in the field dropped six per cent.

When the need is critical . . .

## ALITE<sup>®</sup> MISSILE NOSE CONES

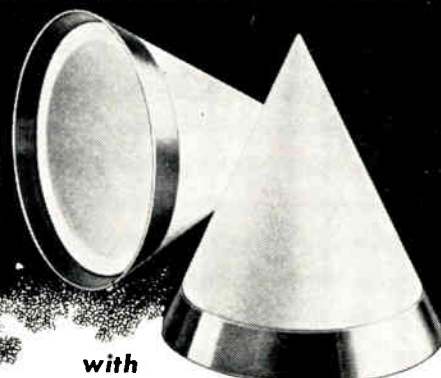

### with MAXIMUM PERFORMANCE CHARACTERISTICS

As requirements become more demanding, high alumina ceramic—with its ability to withstand temperatures in excess of 3000°F — is being used more frequently for missile nose cones.

Increasingly, missile manufacturers are turning to Alite for their alumina nose cones for two principal reasons:

- Alite's capability for the electromagnetic and mechanical design of a nose cone with maximum transmission efficiency and structural reliability.
- Alite's capability for the production of nose cones which are uniformly accurate—physically and electrically—in production lots. Here, not only close dimensional tolerances but also absolute uniformity of high purity ceramic formulations from batch to batch is essential.

Produced under rigid Quality Control procedures, you can rely on Alite high alumina ceramic nose cones' low loss tangent . . . zero water absorption . . . dimensional and chemical stability . . . and high temperature resistance.

Let us review your specific requirements — without obligation: send us prints and other pertinent data. Or, write for free bulletins giving complete information about Alite.

ALITE  
DIVISION



62-J



## EIA OPPOSES FCC RULES FOR COMSAT PROCURING

The Electronic Industries Association opposes FCC's proposed procurement rules for the Communications Satellite Corporation (ComSat).

EIA maintains that the rules would impose undue burdens on FCC, ComSat, common carrier firms, contractors and subcontractors. The Association also insists that the rules would increase cost and time required in carrying out contracts without really helping achieve goals.

EIA reports that firms are not responding favorably to the suggested rules, and further suggests a public hearing.

Among a number of changes, EIA suggests that all R&D contracts in any amount be excluded because they are not compatible with the approach of the proposed rules.

EIA also suggested that FCC allow buyers to negotiate where they consider other methods unfeasible. Congress allows this approach for DOD and other agencies.

A report to the FCC should be required only if one source of purchase is planned, says EIA. There should be a report if purchases are planned from other than low bidders, or if a non-competitive purchase is planned from a corporate affiliate.

EIA also suggests deleting the rule requiring bidders to file mailing lists with the FCC. EIA called this rule burdensome, costly and useless.

## LENS CHECKER

A giant interferometer, designed to speed inspection of optical lenses, the transmission quality of prisms, and the surface quality of wedges and plane mirrors, has been developed by Davidson Optronics Inc. for the Frankford Arsenal, Phila.

The unit uses parallel beams of monochromatic light to test surface quality of optical units, as well as homogeneity. It can detect a surface variation of one/millionth inch.

## EPSTEIN HONORED

At its annual Medal Day Dinner, The Franklin Institute, in Philadelphia, awarded the Edward Longstreth Medal to Dr. Herman Epstein, President of Omnitronics, Inc. The award was given in recognition of Dr. Epstein's development of electrostatic printing techniques used in high-speed printing equipment.

# HIGH VOLTAGE PLUS HIGH CAPACITY IN SPACE SAVING SIZES



Here are the capacitors that provide both high voltage and high capacity in space saving rectangular CP-70 Style cases. . . .

**CMP Type capacitors from Chicago Condenser give a life expectancy far in excess of Mil-C-25A, in reduced case sizes. May be operated to 125°C, voltage ratings from 600 to 50,000 volts, and with capacities of from .05 mfd to 12 mfd. Write for complete catalog and specifications.**



## CHICAGO CONDENSER CORPORATION

3255 West Armitage Avenue, Chicago 47, Illinois

Circle 87 on Inquiry Card



## CUT IT, WRAP IT!

**NETIC AND CO-NETIC MAGNETIC SHIELDS APPLIED IN SECONDS**

Guard against performance degradation from unpredictable magnetic field conditions to which your equipment may be exposed. Economical CO-NETIC and NETIC Magnetic Shielding Foils are adaptable to any size or shape components. Simply cut with ordinary scissors. Available in continuous lengths on rolls up to 15" wide. Furnished in final annealed state.

Co-Netic and Netic alloys are not affected significantly by vibration or shock, assuring components performance repeatability over a wider range of flux intensities. They are also non-retentive and do not require periodic annealing. When grounded, they shield electrostatic as well as magnetic fields. They have many applications in satellite instrumentation and many other magnetically sensitive devices.

## MAGNETIC SHIELD DIVISION

Perfection Mica Co. Phone EVerglade 4-2122  
1322 North Elston Avenue, Chicago 22, Illinois



# ONLY

FROM



## BROADEST BANDWIDTHS OBTAINABLE

# 2-20 Gc

## TWT POWER AMPLIFIERS (2-16 Gc) (10-20 Gc)

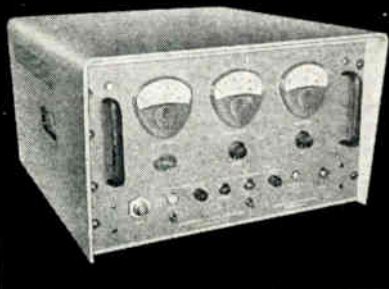

### FEATURES

- One AEL unit replaces several ordinary standard octave units.
- Periodic permanent magnet focusing on all tubes.
- Ruggedly built for long service.
- Continuously variable gain controls.
- CW, pulsed or AM modulated operation.

### CHARACTERISTICS and PRICES

| Model                      | T601                | T602                |
|----------------------------|---------------------|---------------------|
| Frequency                  | 2-16                | 10-20               |
| Min. Power Output, Watts   | 1 <sup>(1)</sup>    | 1 <sup>(2)</sup>    |
| Min. Small Signal Gain, db | 50.0 <sup>(1)</sup> | 30.0 <sup>(2)</sup> |
| Price                      | \$3990.             | \$5250.             |

(1) 5-11 Gc (2) 12-18 Gc

Prices subject to change without notice.  
Write for more information.



**American Electronic  
Laboratories, Inc.**

P. O. BOX 5520, LANSDALE, PENNA. 19446  
(215) 822-2929 Suburban Philadelphia

Circle 89 on Inquiry Card

### FOR CARS THAT 'GO TO SEA'

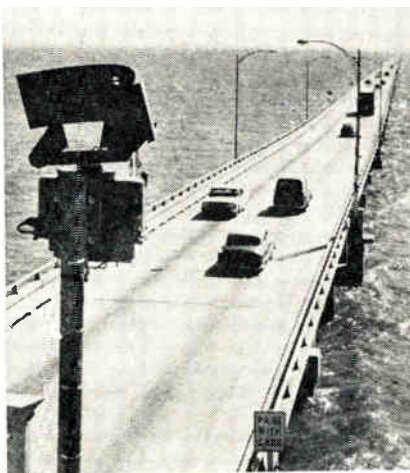

Radar antenna, on mast at left, looks out over world's longest causeway spanning 24 miles of water near New Orleans. Raytheon radars and marine radiotelephones are situated eight miles out from each shore where ships cross the road. The rig is to safeguard motorists in foggy weather, and to keep an eye out for stray barges and other vessels that may drift toward the bridge.

### ELECTRONIC 'BIRD DOG' HELPS ITT RETRIEVE VITAL DATA

An electronic "bird dog" that can ferret out and retrieve data with the instinct of a setter is now in operation at ITT Communications Systems, Inc.

Called a variable-length retrieval system, because it can take library index listings of varying length, the system allows ITT scientists to tap vital data sources in a fraction of the time needed under standard methods.

The system was born out of ITT necessity. Data which once required weeks of search by the firm's 150 engineers can now be retrieved in minutes from their library's 8,000 technical reports.

A unique feature of the computer program is its ability to process un-coded information. It doesn't need symbols and complex abbreviations.

Heart of the ITT program is a two-volume index. This is equal in data capacity to 750,000 standard library index cards. One volume gives complete bibliographic information, plus an abstract of each report. The other provides an index to either the abstracts or individual reports. Information is recorded under seven basic categories.

Built-in safeguards minimize the possibility of major errors. Any undetected mistakes in tape-punching or in the worksheets can be corrected as part of the next computer run, as can changes or errors in indexing.

## RESISTOR APPLICATION NEWS

### NEW METAL FILM RESISTOR OFFERS RELIABILITY PLUS!

Pyromet® Metal Film Resistors  
Proven Superior, Less Costly

The new Pyromet series of metal film resistors developed by Pyrofilm offers **RELIABILITY** unmatched by any other metal film resistor. An improved manufacturing technique, exclusive with Pyrofilm, permits precise control of temperature coefficient and achieves contaminant-free, hermetic sealing of the Pyromet resistor, **RESULT** — perfect leak-free protection eliminating the contamination and leakage problems encountered with metal film resistors of other manufacturers, i.e. varnished, epoxy molded, solder sealed.

Pyromet resistors offer you all the advantages of metal film resistors — with none of the disadvantages. Now you can get **RELIABILITY** with temperature coefficients as low as  $\pm 25$ ppm, voltage coefficient which average less than 1ppm/volt (when measured between one-tenth and full rated voltage), noise levels below -20db (0.1mv/v), and performance well within military specifications. Standard tolerances as low as  $\pm 0.25\%$  are available. Even lower tolerances are available on special order. Further, they can be used at 125°C with indefinite life expectancy and have useful life at 170°C.



NEW Ultra Stable Pyromet METAL FILM RESISTOR

### MANUFACTURING EXCELLENCE

These exclusive, carefully controlled manufacturing processes, under a clean room atmosphere, illustrate why Pyromet resistors are so much more **RELIABLE** than any other metal film resistor available.

- **Resistance Element** — A specially formulated metal alloy is evaporated on a high quality ceramic substrate to assure a stable, firmly bonded film, with a low temperature coefficient.
- **Termination** — Positive electrical and mechanical connection is provided by specially designed end-cap construction.
- **Sealing** — Advanced contaminant-free seal utilizing an exclusive fluxless soldering process insures complete hermetic sealing to a moly-manganese metallized alumina case.
- **Leads** — Standard gold-plated copper leads and end-caps.

For complete specifications,  
write for **PYROMET DATA SHEET.**

## PYROFILM RESISTOR COMPANY, INC.

3 SADDLE ROAD • CEDAR KNOLLS, N. J.  
(201) JEFFERSON 9-7110

Circle 90 on Inquiry Card





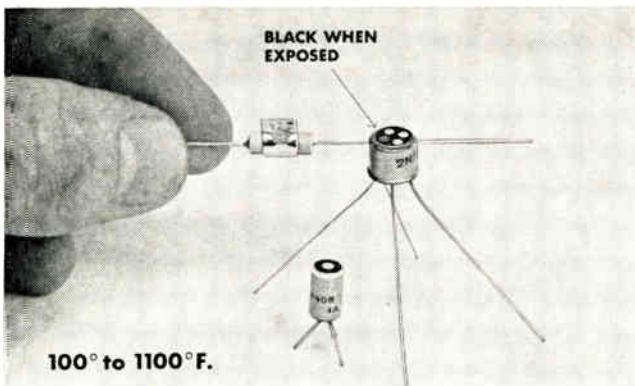

## TEMP-PLATE®

### DETECTS ELECTRONIC OVERHEATING

Overheating is detected in a positive, direct manner by Temp-Plate. Simple, easy to use, immersible and irreversible, Temp-Plate is the little plastic tab that sticks to a unit, turns black at any desired value from 100° to 1100°F. Available in both standard and miniature sizes, in any combinations of activating temperatures, Temp-Plate is impervious to production line handling and ambient temperatures—accurate to  $\pm 1\%$ , it provides for absolute indication of heat damage.

WRITE NOW  
FOR FREE SAMPLE.



**PYRODYNE, INC.**  
11876 Wilshire Blvd.  
Los Angeles 25, California



Openings for qualified fluid components designer for missile and space systems.  
Circle 96 on Inquiry Card

# WHAT'S NEW

## FLUORESCENT LIGHTS FOR CARS

AUTOMOBILES AND PLEASURE BOATS OF TOMORROW may be lighted by fluorescent lamps in addition to miniature incandescent bulbs. This is the prediction of GE's Lamp Div., Cleveland, Ohio.

The device that will do this is a small, transistorized inverter-ballast, weighing 4 oz. The inverter-ballast circuitry consists of a single power transistor and five small electronic components. The circuit, with minor component changes, functions on 6, 12,

Inverter-ballast is shown with other components which comprise the circuit.

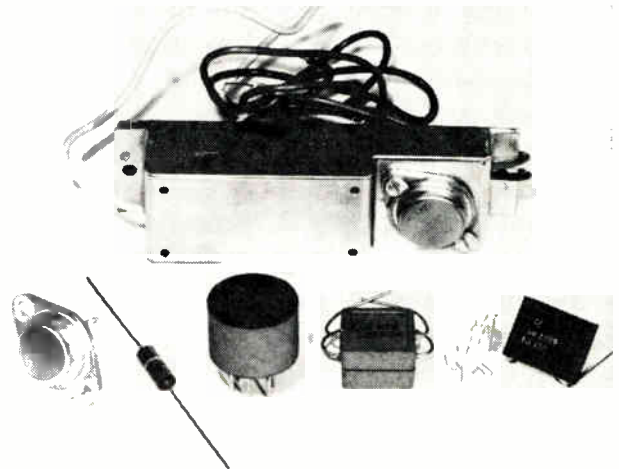

24, 32, 37½, 48, and 60vdc. It will allow fluorescent lamps to operate at freqs. ranging from 7000 to 20,000 cps. High freqs. increases the efficiency of fluorescent lighting systems. With this gain, plus the inherent efficiency advantages of fluorescent lamps over incandescent light sources, the new lighting system may produce up to four times as much light as an equivalent incandescent system, without increasing battery drain.

### EMPLOYMENT OPPORTUNITIES

#### PRODUCT LITERATURE MANAGER

with EE or Physics degree and experience in electronic instruments technical writing needed by growing Midwest manufacturer. Background in marketing and advertising desirable. Position offers challenging opportunity for personal growth. Salary to \$12,000. Send complete resume—will be held in strict confidence.

Box 43973, c/o Electronic Industries  
Chestnut & 56th Streets Philadelphia, Pa. 19139

### \$\$\$ for Circuit Designs

Have you come up with any simple or unique circuit designs lately? Do you think that they would be useful to fellow engineers? If so, why not send them to us for possible publication? We pay our usual space rates for those accepted. Please keep them as concise as possible and send to: Circuit Design Editor, ELECTRONIC INDUSTRIES, 56th & Chestnut Sts., Philadelphia, Pa. 19139

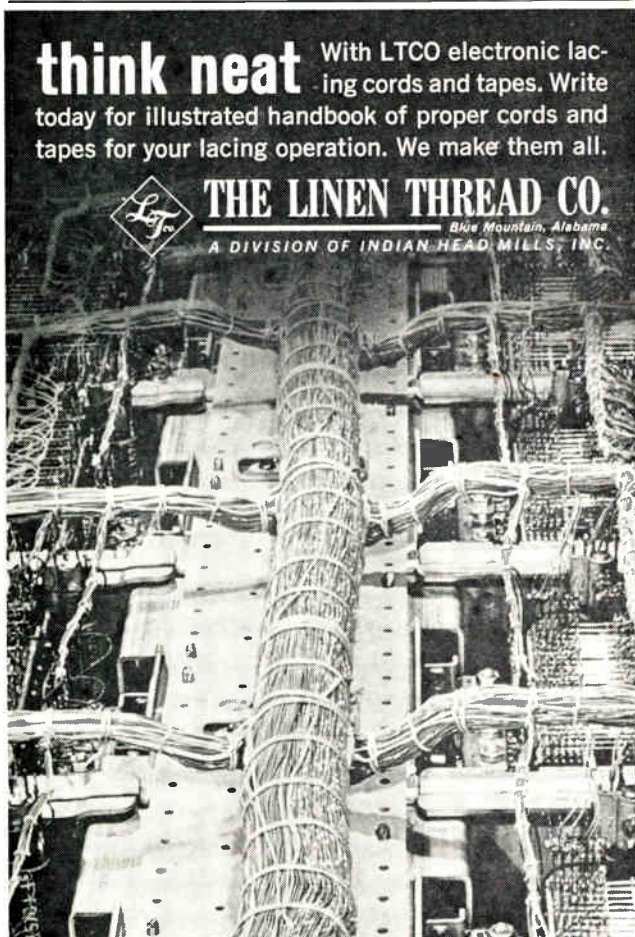

**think neat** With LTCO electronic lacing cords and tapes. Write today for illustrated handbook of proper cords and tapes for your lacing operation. We make them all.



**THE LINEN THREAD CO.**  
Bike Mountain, Alabama  
A DIVISION OF INDIAN HEAD MILLS, INC.

Circle 91 on Inquiry Card



Signal on  
conventional channel  
width  
40mm

Identical signal  
on Mark 280 channel width  
80mm

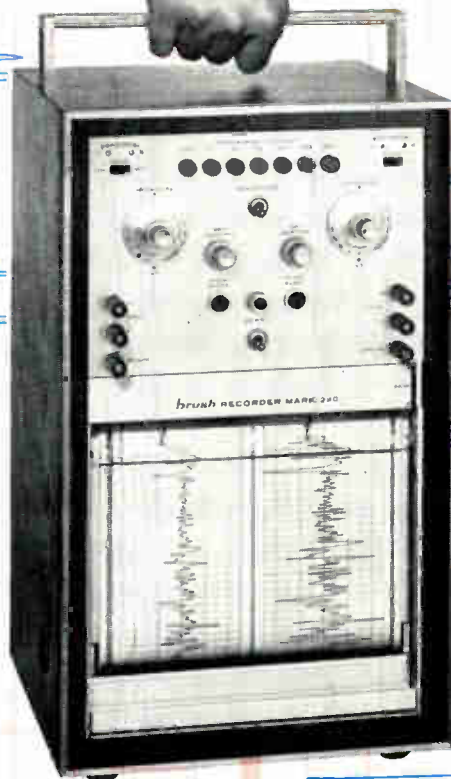

# New! Brush records 35 cps full scale on 80mm

The new portable Mark 280 doubles resolution of traces without sacrificing frequency response! And . . . you get instantaneous rectilinear ink records of unparalleled accuracy and clarity. Forced fluid writing presents traces, at frequencies to 35 cps full scale, on low cost chart paper. Dual channels each have 50 divisions in an 80 mm width, with trace width constant at one-tenth of a chart division. So now, you can easily detect minute signal variations and take *full* advantage of a 1/2% system accuracy. Matched solid-state amplifiers provide a sensitivity of 0.5 millivolts/div. Operating controls include attenuator, pen-position, variable gain and 12 push-button chart speeds. No other recorder can match the total capability of the Mark 280. Write for details.

**brush** INSTRUMENTS  
DIVISION OF CLEVITE 37TH AND PERKINS, CLEVELAND 14, OHIO

# NOW SWITCH WITH **RCA** SILICON CONTROLLED RECTIFIERS

## Here are 16 solid reasons why



Check the outstanding construction and operating features of RCA's two new families of silicon controlled rectifiers... RCA 2N681 to 2N689 and RCA 2N1842A to 2N1850A... all-diffused, SCR's for power control and electrical switching applications in industrial apparatus and military equipment.

| FORWARD CURRENT                     | BLOCKING VOLTAGE |         |         |         |         |         |         |         |         |  |
|-------------------------------------|------------------|---------|---------|---------|---------|---------|---------|---------|---------|--|
|                                     | 25               | 50      | 100     | 150     | 200     | 250     | 300     | 400     | 500     |  |
| 25 Amp (RMS) 16 Amp (Avg)<br>@ 65°C | 2N681            | 2N682   | 2N683   | 2N684   | 2N685   | 2N686   | 2N687   | 2N688   | 2N689   |  |
| 16 Amp (RMS) 10 Amp (Avg)<br>@ 80°C | 2N1842A          | 2N1843A | 2N1844A | 2N1845A | 2N1846A | 2N1847A | 2N1848A | 2N1849A | 2N1850A |  |

These RCA Silicon Controlled Rectifiers are designed for use in your circuits at their full ratings—full current at peak reverse and peak forward blocking voltage. And RCA brings you all these big operating advantages: • Application tested for 100% safety margin on surge current • Very low thermal resistance • Forward voltage drop measured at high current (100 Amps for 2N681 family) • Installation torque capability = 50 inch-lbs • Tight control of firing characteristics • Long term operating stability • 100% aging at maximum ratings and 100% dynamic testing.

Call your RCA Representative today for complete details on these rugged new RCA SCR's... or write RCA Electronic Components and Devices, Commercial Engineering, Section 1-J-1, Harrison, N. J.

Write today for your free copy of this new RCA Application Note SMA 16 "Circuit Factor Charts For Use in Applications With RCA Silicon Controlled Rectifiers"

AVAILABLE THROUGH YOUR RCA DISTRIBUTOR

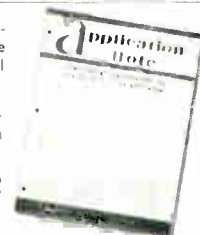

The Most Trusted Name in Electronics