



ELECTRONIC INDUSTRIES

MAY 1963

A logical approach to logic circuits

Simple, economical laser demodulation



Hot...

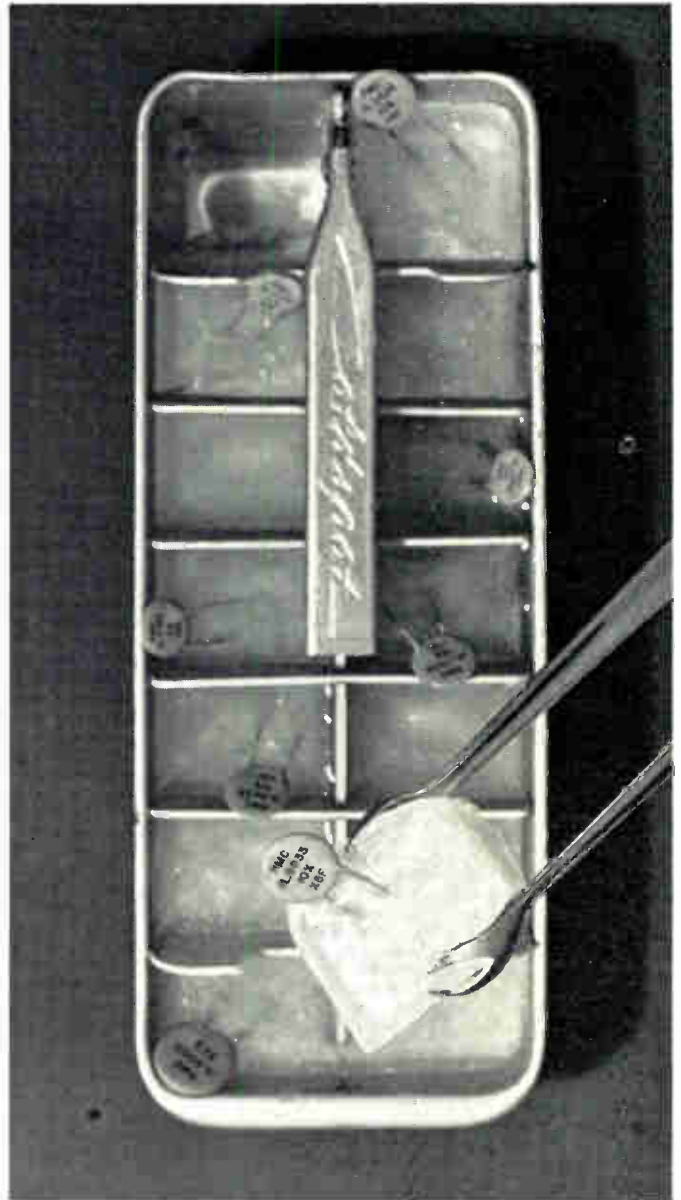

or Cold...

RMC "JL" Discaps remain stable

RMC Type JL Discaps exhibit superior stability in applications where a wide range of temperatures are encountered. For example, between -55° and $+110^{\circ}$ C., the capacity change of Type JL Discaps is limited to $\pm 7.5\%$. These capacitors are rated at 1000 V.D.C. and are manufactured with tolerances of $\pm 10\%$, $\pm 20\%$, $+80\%$ -20% at 25° C.

Write on your letterhead for information on these and other quality RMC Discaps.

DISCAP
CERAMIC
CAPACITORS



RADIO MATERIALS COMPANY

A DIVISION OF P. R. MALLORY & CO., INC.
GENERAL OFFICE: 4242 W. Bryn Mawr Ave., Chicago 46, Ill.
Two RMC Plants Devoted Exclusively to Ceramic Capacitors
FACTORIES AT CHICAGO, ILL. AND ATTICA, IND.

Circle 1 on Inquiry Card

SHELBY A. McMILLION,
Publisher
BERNARD F. OSBAHR,
Editor

ELECTRONIC INDUSTRIES

WHAT ABOUT "OBSOLETE" ENGINEERS?

THE GOVERNMENT has said it, industry spokesmen have said it, and now the engineering community itself is awakening to the fact: Many electronic engineers are "obsolete" in terms of present day technology!

It is an unpleasant thought, this. How, in a young and dynamic industry, does an engineer wear out his usefulness in the short span of ten to twenty years?

There are three sides to this problem. Two of them we can do nothing about, nor would we want to.

We would hardly want to slow the rate of obsolescence of equipment, or components, or ideas, for this is how we measure our progress. Obsolescence concerns us here only because we are talking in terms of people—engineers.

The second aspect of this problem is "specialization." A few years ago the moderately well educated and trained engineer could handle almost any problem that might be given to him. But today the industry is so splintered and specialized that entirely new vocabularies of terms have been compiled to serve just one small area. As a very rough measure, you need only look at the twenty-eight professional groups of the Institute of Electrical and Electronic Engineers.

Would we want to do anything about this specialization? The answer again is—No. Our future progress may well depend upon it.

The third and most significant side of this problem is that of education. Here there is something that can, and should, be done.

Obsolescence of individual skills can be avoided only if engineering education becomes a life-long program that continues until the engineer retires. The idea may sound somewhat radical, but there is no alternative. The only question is how and when it will be done, and who will do it.

Let us look at what we have now. The Bachelor's Degree has become a goal in itself. It opens the doors to industry, to an excellent starting salary, to relative security. In effect, it has become a tool that once purchased retains its usefulness indefinitely.

If the degree, then, is a goal, how can technical obsolescence of engineers possibly be avoided? For each succeeding college class is that much more com-

petent because the field of engineering education itself is moving so rapidly.

A continuing education program is the only answer. And it must have the active cooperation of government, industry and the engineering community. The expenditures will be in time, and money for all concerned.

Through the years the major force in continuing technical education has been the engineering journals, such as *ELECTRONIC INDUSTRIES*, and others in our field. Engineers have been kept up-to-date on significant new developments, trends and new products. The business press is the single largest force in technical education today.

But more must be done. In electronic firms, periodic group retraining must be accepted as necessary to maintain maximum efficiency. Many organizations have organized in-plant classroom instruction or offer direct support for those attending pertinent outside refresher or advanced courses. Such courses are highly commendable and do aid in overcoming the obsolescence battle. However, classical classroom instruction methods have inherent limitations. The individual learning rates of the students tend to limit the progress speed of a given class. Retention of subject matter differs from student to student and this again relates to overall class progress. Ideally, each student should learn as rapidly as he is capable and retain as much as possible.

Over the past two or three years the term "programmed instruction" has appeared more and more in the technical literature. It has grown through the application of behavioral science and offers a means of vastly improving learning rates and retentional ability of both individuals and groups. It is not to be confused with teaching machines, which are frequently used in this type of instruction.

We recently have completed a thorough study of this method of instruction. From our experience in the communications field, we are impressed with its potential, particularly in the area of in-plant training. We would be happy to pass along our findings to firms interested in setting up such programs for their engineers . . .

ELECTRONIC INDUSTRIES

Vol. 22, No. 5

May 1963



MONTHLY NEWS ROUND-UP

Radarscope: What's ahead for the Electronic Industries	4
Coming Events	11
Electronic Shorts	15
As We Go To Press	21
Electronic Industries News Briefs	28
Washington Trends	37
MARKETING: Facts and Figures Round-Up	41
Snapshots . . . of the Electronic Industries	46
Next Month in Electronic Industries	101
International News	198

EDITORIAL FEATURES

EDITORIAL: WHAT ABOUT "OBSOLETE" ENGINEERS?	1
NOW THAT THE WALL STREET WALTZ IS OVER—WHAT? . . . S. Feldman	58
LOOK BEFORE YOU LEAP—WITH R&D BY-PRODUCTS . . . J. K. Slapp	70
HOW DO ENGINEERS KEEP UP-TO-DATE?	79
WHAT'S NEW	92
DESIGNING WITH . . . OPTOELECTRONIC COMPONENTS R. K. McDonald	102
SIMPLE, ECONOMICAL LASER DEMODULATION H. G. McGlees & G. W. Saeger	107
A LOGICAL APPROACH TO LOGIC CIRCUITS . . . J. J. Klinikowski	110
ANTENNAS HAVE BUILT-IN CIRCUITS. J. R. Copeland & W. J. Robertson	115
TRANSISTOR AC REGULATOR FOR X-RAY TUBE CURRENT A. Taylor & K. H. Sueker	121
A SIMPLE VACUUM TUBE MINI-OHMMETER . . . S. S. Meyers	126
ELECTRONIC OPERATIONS	201
FOR SYSTEMS . . . TEST SET DETECTS ALL DIALING TROUBLES . . . F. Lee	202
PROFESSIONAL OPPORTUNITIES	215
WHAT THE ENGINEER SHOULD KNOW ABOUT PERT . . . H. G. Benis	217

DEPARTMENTS

New Tech Data for Engineers	128
New Products	149
Systems & Circuits	156
Systems-Wise	201
Letters	208
Mismatches	212
Industry News	222

SHELBY A. McMILLION,
Publisher

BERNARD F. OSBAHR,
Editor

CREIGHTON M. MARCOTT
Executive Editor

JOHN E. HICKEY, Jr.
Senior Technical Editor

SMEDLEY B. RUTH
ANDREW MITCHELL
Associate Editors

JOHN J. HUNTER
Assistant Editor

CHARLES W. WEBB
ROBERT J. BRAMLETT
News Editors

DR. ALBERT F. MURRAY
Consulting Editor

SIDNEY FELDMAN
Contributing Editor

EDITORIAL PRODUCTION

ELMER KETTERER, Art Director
SOL MEDNICK, Cover Design
ANNE AXE, Editorial Assistant
MAE MOYER, Reader Service
IDA GOOD, Editorial Secy.

EDITORIAL NEWS BUREAUS

Los Angeles—198 S. Alvarado St.
(Area Code 213) Dunkirk 7-1271
J. PHILIP GEDDES, Mgr.

Washington—1093 National Press Bldg.
(Area Code 202) 393-3474
TWX—202 965-0675

GEORGE BAKER, Mgr.
NEIL R. REGEIMBAL
DAVID R. HEINLY

BUSINESS DEPARTMENT

ELMER DALTON
Advertising Promotion
& Circulation Manager

DONALD J. MORAN
Marketing Manager

GORDON HERNDON
Production Manager

See Advertisers Index for Regional Sales
Managers.

Chilton Company—G. C. BUZBY, President
Executive Vice Presidents: R. E. McKenna,
G. T. Hook. Vice Presidents: P. M. Fahr-
endorf, L. V. Rowlands, M. E. Cox, E. B.
Terhune, Jr., R. W. Case, Jr., J. H. Kofron.
Treasurer: Stanley Appleby. Secretary: J. A.
Montgomery. Other Directors: C. A. S.
Hainle, G. E. Cameron, T. C. Campbell,
H. W. Barclay, W. A. Phair; Assistant
Treasurer: J. Miades; Assistant Secretary:
I. C. Holloway.

JOHN H. KOFRON
Chilton Research Director

ELECTRONIC INDUSTRIES, May, 1963.
Vol. 22, No. 5. A monthly publication
of Chilton Company. Executive Editorial &
Advertising offices at Chestnut & 56th Sts.,
Phila. 39, Pa. (Area Code 215) SHerwood
8-2000. Controlled circulation postage paid
at Philadelphia, Pa. \$1 a copy; Direc-
tory issue (June), \$5.00 a copy. Sub-
scription rates U. S. and U. S. Posses-
sions: 1 yr. \$10.00; 2 yrs. \$18.00. Canada
1 year, \$12.00; 2 yrs. \$20.00. All other
countries 1 yr., \$18; 2 yrs. \$30.00.
Copyright 1963 by Chilton Company. Title
Reg. U. S. Pat. Off. Reproduction or re-
printing prohibited except by written author-
ization.



HIGHLIGHTS

of this issue

Now That the Wall Street Waltz is Over—What? page 58

In 1962 electronic stocks danced a light fantastic up the price curve. Securities analysts, otherwise experienced, unwittingly undermined the electronic securities market by offering advice not based on sound analysis of the electronic sales market and technology. They advised managements to sell stock rather than products. Then the ground opened up. Here is a brief history, and some amends being made in 1963.



Wall Street

Look Before You Leap—With R&D By-Products page 70

In the wide range of technologies covered by electronics and aerospace industries, more useful by-products are being generated from industrial research. Developing them is much easier than marketing them successfully. Many firms could have cut their marketing losses substantially—as others might do in the future—if they had followed certain basic rules for by-product evaluation.

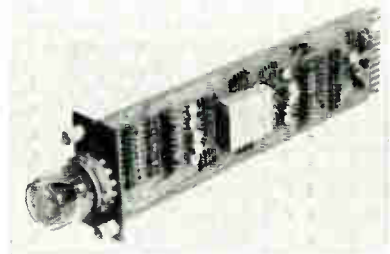

Logic Circuits

How Do Engineers Keep Up-To-Date? page 79

How much time and thought does the average electronic engineer give to his profession in extra activities such as in boning up with technical literature on the job, joining and taking part in professional and technical societies, and attending their local meetings and major conferences and conventions? A recent EI survey offers some eye-raisers.



Optoelectronic Components

Designing With Optoelectronic Components page 102

A wide range of new optoelectronic products offer combinations of electrical characteristics unavailable in conventional all-mechanical or solid-state designs. This article describes a variety of these units—many of which are still in the developmental stage.

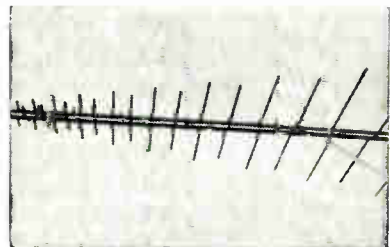

Antennas with Circuits

Simple, Economical Laser Demodulation page 107

A low-priced phototube can do the laser demodulation job in many cases. The tube is an off-the-shelf item and can be placed in a waveguide in much the same manner as a crystal detector is placed in a normal microwave system.

A Logical Approach To Logic Circuits page 110

When most engineers think of logic they usually think of computers. This article will point the way for the use of logic in many other applications. The logic is isolated from the logic system. Then low-cost production methods are applied to both the logic and the system.

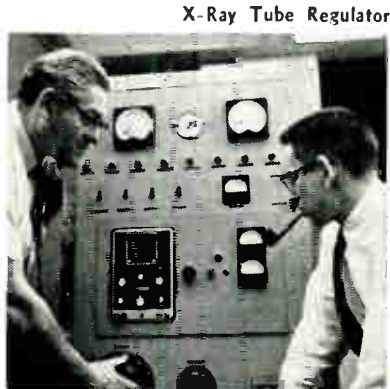

X-Ray Tube Regulator

Antennas Have Built-In Circuits page 115

There are certain advantages in placing circuits right at the antenna. This integration improves the electrical performance and reliability, reduces the number of components used and gives a more compact package. Here is a description of how far this work has gone.

Test Set Detects All Dialing Troubles page 216

This digital telephone dial test set has a built-in automatic self-check which is capable of detecting any possible malfunction in the operating circuits or in the self-check circuits. Testing time for the seven dial parameters is only 2.266 seconds.

RADARSCOPE

Analyzing current developments and trends throughout the electronic industries that will shape tomorrow's research, manufacturing and operation

COPPER CIRCUIT SINTERING developed by Bell Laboratories may replace other circuit manufacture methods. Copper powder, heated to solid without melting, is mechanically bonded to a plastic base to form a conducting circuit. Base also acts as support for other circuits and components. Bell says the technique is simpler and less expensive than chemical etching, spraying and electroplating.

PREDICTIONS OF COMPUTER ROLES in communications and information retrieval were branded as "irresponsible" and "fanatic" by Dr. John R. Pierce, executive research director, Bell Laboratories. He said that the "stupid" computer is unable to understand English and relations between English words, and unable to translate languages as well and as cheaply as people. A computer used for document retrieval, he observed, "would smother the user" under floods of information and misinformation. Pierce said that computers did have their uses in libraries, such as the indexing system programmed at Bell. He also predicted the use of machines for swift data and facsimile transmission for libraries.

ARRAY ANTENNA MODEL TECHNIQUE

Electronic Communications, Inc., has a scale-model system for array antennas to reduce design math and avoid construction of full-scale arrays for test. Shown is 64-in. aluminum tunnel for operating E.C.I. "holey plate" at 70 Gc. Transmitter horn and RF source are at opening of tunnel, lined with microwave absorber.

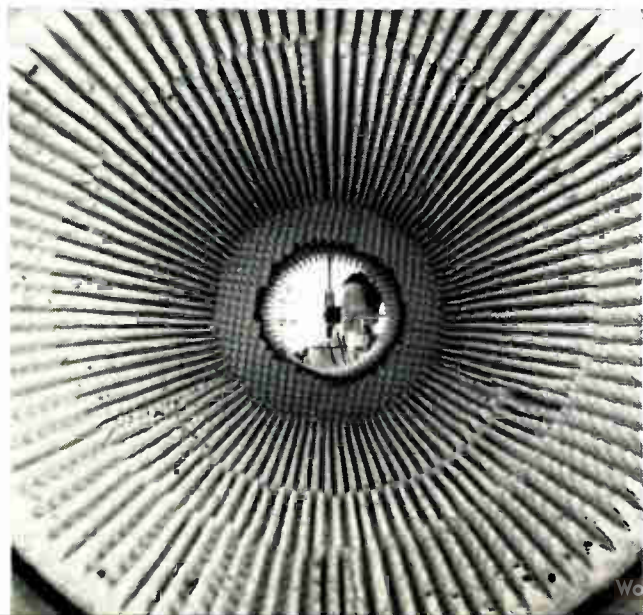

RUBY LASER HAS NO WINDOW under water in the spectral region of 6943 Angstroms, according to a Naval Research Lab study. Lasers had been touted for underwater communications but a fundamental barrier is water's transparency at a specified wavelength. The Navy looked for a transmission window, and found that attenuation was mostly by absorption and that at 6943A the light intensity was reduced by a factor of 10 every 15 feet. At 120 feet the attenuation was 10⁸.

TRANSISTORS TO REPLACE TRANSISTORS and vacuum tubes in integrated digital circuits have been announced by Fairchild Semiconductor, the second firm to do so within a few weeks. The first was RCA. Both claim ease of manufacture, versatility, long life and low cost. Fairchild reports yields up to about 85% in flip-flop circuits using several hundred of the little devices, called metal oxide semiconductor transistors. They have the same utility and simplicity as vacuum tubes, plus lower operating power of regular transistors.

GALLIUM ARSENIDE DIODE FAILURE may be caused by "host atoms" as ions, says a research report now available from OTS, Commerce Department. The report, called "a preliminary hypothesis," in explaining tunnel diode failure, points out that the field in the transition region is quite large in a degenerate junction formed from a wide band gap semiconductor, such as gallium arsenide. If a gallium or an arsenide "host atom" gets out of its normal lattice site, it will meet large forces that may sweep it out of the transition region. Failure would be lessened at liquid nitrogen temperatures.

BRITISH ELECTRONICS EXPORTS TO U. S. totaled \$13.2 million for the first six months of 1962—an advance of 31% over the same six months for 1961, the Commerce Department reports. In the first half of 1962, U. S. electronic products exports to the United Kingdom were up 60% to \$17.6 million from the first half of 1961. Electron tube (and other parts) exports, one-fifth of U.K. electronic product exports to U. S. in June-January 1962, increased 54% from the 1961 level. Substantial gains also were listed in phonograph parts, tape recorders, tape decks, radio testing equipment and high frequency and electronic control equipment.

BIO-MEDICAL ENGINEERING is being explored by some states, chiefly Illinois, as a source of industrial/economic growth. Gov. Otto Kerner reports Illinois is a big spender on the \$25-billion-tab for health in the central states last year. A recent estimate places medical electronics industry in the \$150-million-a-year bracket with multi-potential. Chicago already has the nation's first bio-medical engineering center, at Northwestern University. Research and industry would provide added employment in electronics and a creative challenge to doctors and engineers for revolutions in medical instruments.

ELECTRONIC INDUSTRIES ASSOCIATION says equal pay bill lacks legislative standards. "Serious harm" will be done employer-employee relations unless "standards" are added, said EIA General Counsel John B. Olverson. The bill, in effect, offers another basis for charging employers with unfair labor practice, it proposes a mandatory employment standard that would affect bargaining rights, and gives the Labor Department broad rule-making and investigatory powers far beyond necessity. Olverson said that equal pay also would place many women-worker industries in financial difficulty.

PORTABLE SUPERCONDUCTING MAGNET

Westinghouse Cryogenics has developed a portable superconducting magnet system that combines a 30,000-gauss solenoid, a dewar assembly, and a 120-volt a-c power supply into one unit called Cryopak. The unit costs less than \$2500 and all that is needed to operate it is liquid helium, liquid nitrogen and the 120 volts.

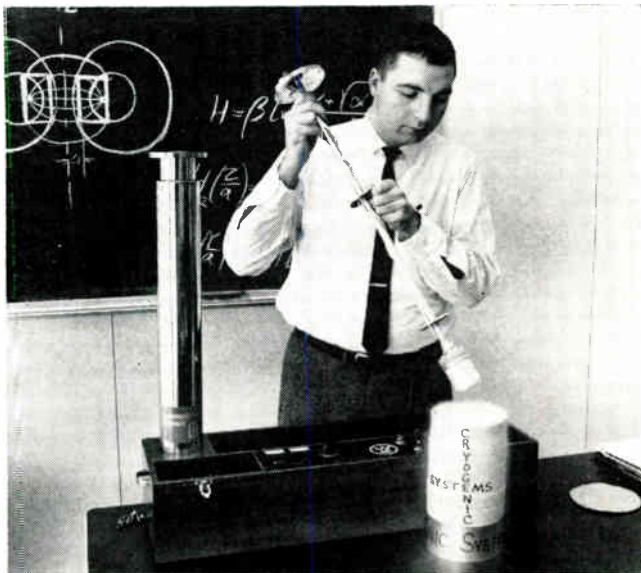

LASER RANGEFINDER RIFLE

Rifle-like Colidar Mark II fires laser beam at 186,000 mps to measure precise target distances. The Colidar (Coherent Light Detection and Ranging) was developed by Hughes Aircraft Co. Short telescope receives light reflection from target. A timing circuit measures distance by computing beam's elapsed time.

THE ELECTRONICS INDUSTRY, now the nation's fifth largest, should move into fourth place by the end of this year according to EIA. EIA's Market Analysts set the dollar volume of sales by all industry segments last year at \$13.1 billion. The total, they predict, will rise to \$15 billion by the end of this year. By the close of 1970 annual sales should climb to \$20 billion.

COLOR TV SALES UPSWING has brought on shortage in color tubes, with RCA as the only current producer and supplier of CRT's for other color set makers. The sudden boom, inspired mostly by RCA/NBC, has put the firm in the role of a tube rationer—fair and equal—until other producers can market a good color CRT. The total number of color sets now in use in the U. S. is estimated at 1,000,000. Projected production for color sets this year is 700,000.

SCIENTISTS AT NBS have demonstrated that lasers can be used as long distance measuring devices. They have obtained interference fringes over a 100 meter optical path, using a helium-neon laser. This means that measurements can probably be made over these long distances with an accuracy of better than one part in 200 million. This is equivalent to having a 100 meter measuring stick with 200 million graduations on it.

(More RADARSCOPE on Page 6)

RADARSCOPE

ENGINEERING ENROLLMENT in 1962 increased 1.6% over 1961, according to the U. S. Office of Education. In 166 colleges with engineering curricula accredited by the ECPD (Engineer's Council for Professional Development) student registration rose from 237,705 in the fall of 1961 to 241,613 in fall of 1962. Enrollments at the doctoral level in 76 institutions tripled in seven years, rising from 3,161 in 1955 to 9,215 in 1962, a 17.3% increase over 1960-61. Enrollments for masters in 142 colleges reached a high of 34,948, an increase of 8.6% over 1960-61. Undergrads went down a bit from 197,661 to 197,450 in 1962.

ELECTRON-BEAM WELDING has advantages over conventional welding, according to the OTS, Commerce Department. It also saves money. Now used in electronics, nuclear, missile and aircraft industries, E-B welding will have wider use in civilian technology. The new method, ideal for microminiaturization problems, permits closer stacking of components and welds as small as .005" dia. Heat damage hazards are reduced since high energy is pin-pointed. High velocity electron stream is directed through an electrostatic or electromagnetic lens. Electrons hit work pieces, develop high heat energy and bond the pieces. A filler metal may or may not be needed.

ADAPTIVE ELECTRONIC TRAINER

Training device developed by Otis Elevator automatically adjusts itself to trainee's efficiency level while simulating operation of real or imagined vehicles (aircraft, spacecraft, submarine). Switches, knobs set over 34,000 performance conditions. Trainee performance is measured by circular error trace display on the oscilloscope screen.



TRACKING SPACECRAFT BY RADAR may be unnecessary, according to Floyd V. Schultz, professor of E.E. at Purdue. Ionized atmosphere (plasma), about 50 miles up and probably throughout space, emits electromagnetic waves when disturbed. The plasma oscillates briefly when a body passes through it, sending electromagnetic waves to the earth, as radar does on the return trip. The object—spacecraft—causing the oscillations could be traced with only an antenna and receiver. Radar gear could be omitted.

ELECTRONIC COMPONENT MAKERS and distributors are cautioned by Business and Defense Services Administration (BDSA), that to avoid delays they must pass on to their suppliers "priority" orders for defense and space programs. Rated orders give preference to contracts on products and materials needed for such programs. Use of ratings is mandatory under Defense Production Act. Reminder letters are being sent by five electronics trade associations at BDSA request.

MICROELECTRONICS TERMINOLOGY is under the lens. Engineers here and abroad view the possibility of an international mother tongue for microscopic electronic components and assemblies. U. S. and foreign engineers in New York recommended that 36 nations take up the study through procedures of the International Electrotechnical Commission (IEC) in Switzerland. The microelectronics language problem has been recognized as the major stumbling block in domestic R&D and marketing in the \$2 billion-per-year business.

UNIFORM PATENT POLICY in government R&D is requested in a bill put forth by Sen. John L. McClellan (D.-Ark.). He points out that government agencies doing R&D in similar areas have different patent policies. The bill would permit the government to take greater rights than a royalty-free license if inventions come within one of five categories such as public health, safety, etc.; the U. S. can also waive greater rights if justified. With other inventions, the private contractor would have presumption to titles that would be overcome only in public interest. In establishing government-wide policy, the bill also contains a high measure of flexibility.

(More RADARSCOPE on Page 8)

our stock answer is

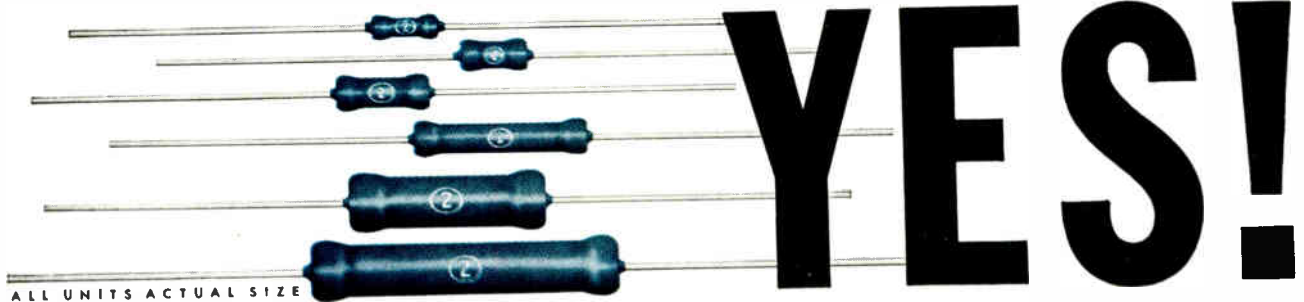

ALL UNITS ACTUAL SIZE

ALL AXIAL LEAD BLUE JACKET RESISTORS

in 1, 2, 3, 5, 7 and 10-watt power ratings are carried in factory stock for immediate delivery. Place your order now with your nearest Sprague District Office or Sales Representative.

Key Sprague Industrial Distributors carry most popular ratings in local stocks.

S P R A G U E S A L E S O F F I C E S

Ariz.	Phoenix, Sprague Electric Co., 3550 N. Central Ave., 279-5435	Mo.	St. Louis, Sprague Electric Co., 3910 Lindell Blvd., JE 5-7239
Cal.	Los Angeles, Sprague Electric Co., 12870 Panama St., UP 0-7531 or EX 8-2791	N. J.	Camden, Sprague Electric Co., 545 Cooper St., W0 6-1776
	San Francisco, W. J. Purdy of Calif., 312 7th St., UN 3-3300	N. M.	Albuquerque, Bowen & Carlberg Co., 2228A San Mateo Blvd., N.E., AM 5-1579
Colo.	Denver, R. G. Bowen Co., Inc., 721 S. Broadway, RA 2-4641	N. Y.	New York, Sprague Electric Co., 50 E. 41st St., OR 9-1195
D.C.	Washington, Sprague Electric Co., 2321 Wisconsin Ave., N.W., 338-7911		Great Neck, William Rutt, Inc., 123 Middle Neck Rd., HU 2-8160
Fla.	Clearwater, Sprague Electric Co., 1152 Cleveland St., 446-3119	N. C.	Winston-Salem, Sprague Electric Co., 928 Burke St., 722-5151
Ill.	Chicago, Sprague Electric Co., 5942 W. Montrose Ave., MU 5-6400	Ohio	Chagrin Falls, Sprague Electric Co., 24 N. Main St., CH 7-6488
Mass.	North Adams, Sprague Electric Co., Marshall St., 664-4411		Dayton, Sprague Electric Co., 224 Leo St., BA 3-9187
	Newton, Sprague Electric Co., 313 Washington St., W0 9-7640	Tex.	Dallas, Sprague Electric Co., 3603 Lemmon Ave., La 1-9971
Mich.	Detroit, ABM Sales Co., 10116 Puritan Ave., UN 2-1300	Utah	Salt Lake City, R. G. Bowen Co., Inc., 463 E. 3rd St., S., EM 3-4528
Minn.	Minneapolis, H. M. Richardson & Co., Inc., 9 E. 22nd St., FE 6-4078	Wash.	Seattle, Sprague Electric Co., 4601 Aurora Ave., ME 2-7761

*For application engineering assistance write:
Marketing Dept., Resistor Division, Sprague Electric Co., Nashua, New Hampshire.*

SPRAGUE COMPONENTS

RESISTORS
CAPACITORS
MAGNETIC COMPONENTS
TRANSISTORS
MICRO-CIRCUITS

INTERFERENCE FILTERS
PULSE TRANSFORMERS
PIEZOELECTRIC CERAMICS
PULSE-FORMING NETWORKS
TOROIDAL INDUCTORS

HIGH TEMPERATURE MAGNET WIRE
CERAMIC-BASE PRINTED NETWORKS
PACKAGED COMPONENT ASSEMBLIES
FUNCTIONAL DIGITAL CIRCUITS
ELECTRIC WAVE FILTERS



'Sprague' and '®' are registered trademarks of the Sprague Electric Co.

RADARSCOPE

FORCE OF MAGNETISM is under study by Prof. Fritz Friedlaender, director of non-linear magnetics research at Purdue University. Smaller, less costly and yet faster computers may result through his research on magnetization direction reversal, which, for example, happens when a current is passed through wires near a computer's magnetic-film memory. Friedlaender's team has come up with a mathematical model to explain the switching behavior in memory cores and magnetic amplifier cores of nickel and iron. He is now trying to apply similar models to other materials.

REFRACTION INDEX READING INSTRUMENT, lightweight, compact, and balloon-raised, is being developed at Air Force Cambridge Research Laboratories to reduce radar error. The device will afford direct readings of atmospheric refraction indices at microwave frequencies. Indices are now found by lengthy computation from heavy air-borne instruments that measure pressure, temperature and moisture.

MAGAZINE MAILINGS BY COMPUTER

RCA 301 computer will expedite monthly mailings of 10 million magazines published by Merkle Press Inc. President E. A. Merkle, right, holds 2400 address plate reel, while G. E. Dashiell, RCA EDP, holds 44,000 name magnetic tape reel. The system will permit address changes within hours of mailings and save thousands of client dollars.



TECHNICAL AID PROGRAM for lagging industries is proposed by the Federal Government, to be run by the Department of Commerce. For fear that large U. S. spending on "glamorous" space and military R&D is leaving plain sisters of the industry behind, the Administration is offering a Civilian Industrial Technology Program. Supporters of the aid venture see hope that it will establish a new-style Government/industry partnership designed to speed science and technology applications in civilian economy. Out of nation's total \$16 billion annual R&D spending, only \$4 billion is channeled to civilian purposes. Only \$1.5 billion (of the four) is directed into projects likely to increase productivity.

PARAMP FOR WEAK RF SIGNALS has been developed with a low noise level that compares favorably with a ruby maser amplifier. Lab men at Lincoln Laboratories found that low noise was achieved by cooling the parametric amplifier in liquid helium at 4.2°K. The "frozen" amplifier may supplant the ruby maser as a weak-signal amplifier because of simplicity, compactness and low cost. The low-noise paramp consists of a five-inch brass tube, a gallium arsenide diode, terminals for RF signals and power, and three slugs to exclude undesired signals. The amplifier operates near 1.3 Gc, but it could be designed for operation beyond 15 Gc.

ENGINEERING OCCUPATIONS, especially those in electronics and space, will be among the fastest growing during the sixties, according to a Report on Manpower Requirements issued by the Department of Labor. The report pointed out a great need for additional personnel in the engineering professions, especially in electrical and electronic engineering. Scientific personnel shortages include mathematicians, physicists, metallurgists, oceanographers, meteorologists and astronomers. There are also unmet demands for technicians in a broad range of engineering and scientific specialties. The 1960 census lists a total of 183,887 electrical engineers in the U. S. The report predicts a need for 75% more engineers by 1970 in the manufacturing areas of scientific and electronics gear, aircraft, spacecraft and missiles.

SPRAGUE LOGIC TRANSISTORS GIVE SUPERIOR LATCH-UP PROTECTION!

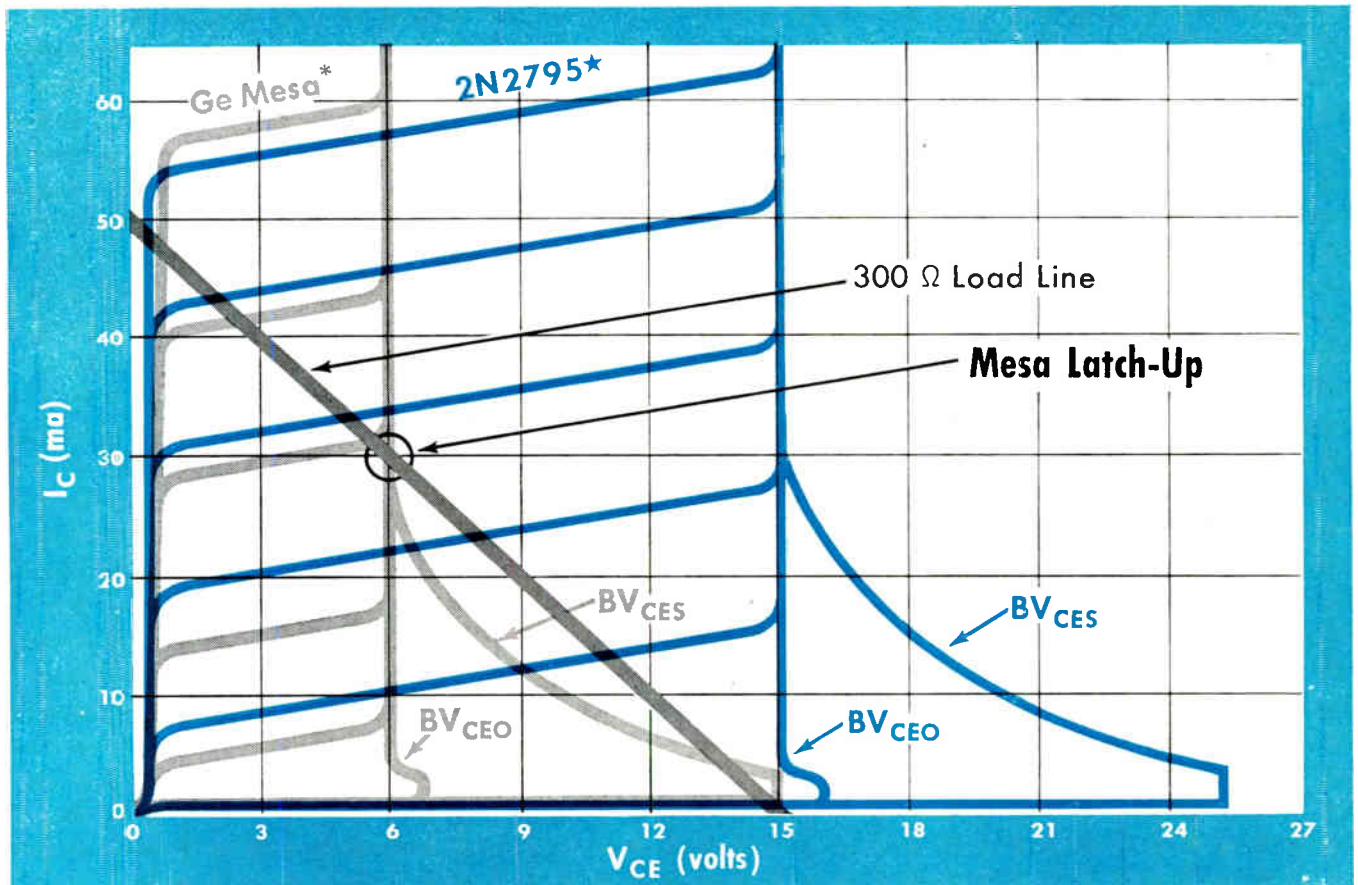

*ratings for most prime germanium mesa types. *based on guaranteed ratings!

For Guaranteed High Voltage Operation at High Speeds, Investigate Sprague ECDC[®] and MADT[®] Transistors

Type No.	f_T (typical)	BV_{CES} (minimum)	BV_{CEO} (minimum)
2N2795	450 mc	25 volts	15 volts
2N2796	450 mc	20 volts	12 volts
2N984	350 mc	15 volts	10 volts
2N979	150 mc	20 volts	15 volts
2N980	150 mc	20 volts	12 volts
2N2048†	250 mc	20 volts	15 volts

(†TO-9 Case)

● For additional information on Sprague High Voltage Logic Transistors, write to the Technical Literature Service, Sprague Electric Company, 233 Marshall Street, North Adams, Massachusetts.

© Trademark, Philco Corp.

SPRAGUE COMPONENTS

TRANSISTORS
CAPACITORS
MAGNETIC COMPONENTS
RESISTORS
MICROCIRCUITS

INTERFERENCE FILTERS
PULSE TRANSFORMERS
PIEZOELECTRIC CERAMICS
PULSE-FORMING NETWORKS
TOROIDAL INDUCTORS

HIGH TEMPERATURE MAGNET WIRE
CERAMIC-BASE PRINTED NETWORKS
PACKAGED COMPONENT ASSEMBLIES
FUNCTIONAL DIGITAL CIRCUITS
ELECTRID WAVE FILTERS



'Sprague' and '®' are registered trademarks of the Sprague Electric Co.

45T-106-63

STEVENS *Certified* THERMOSTATS

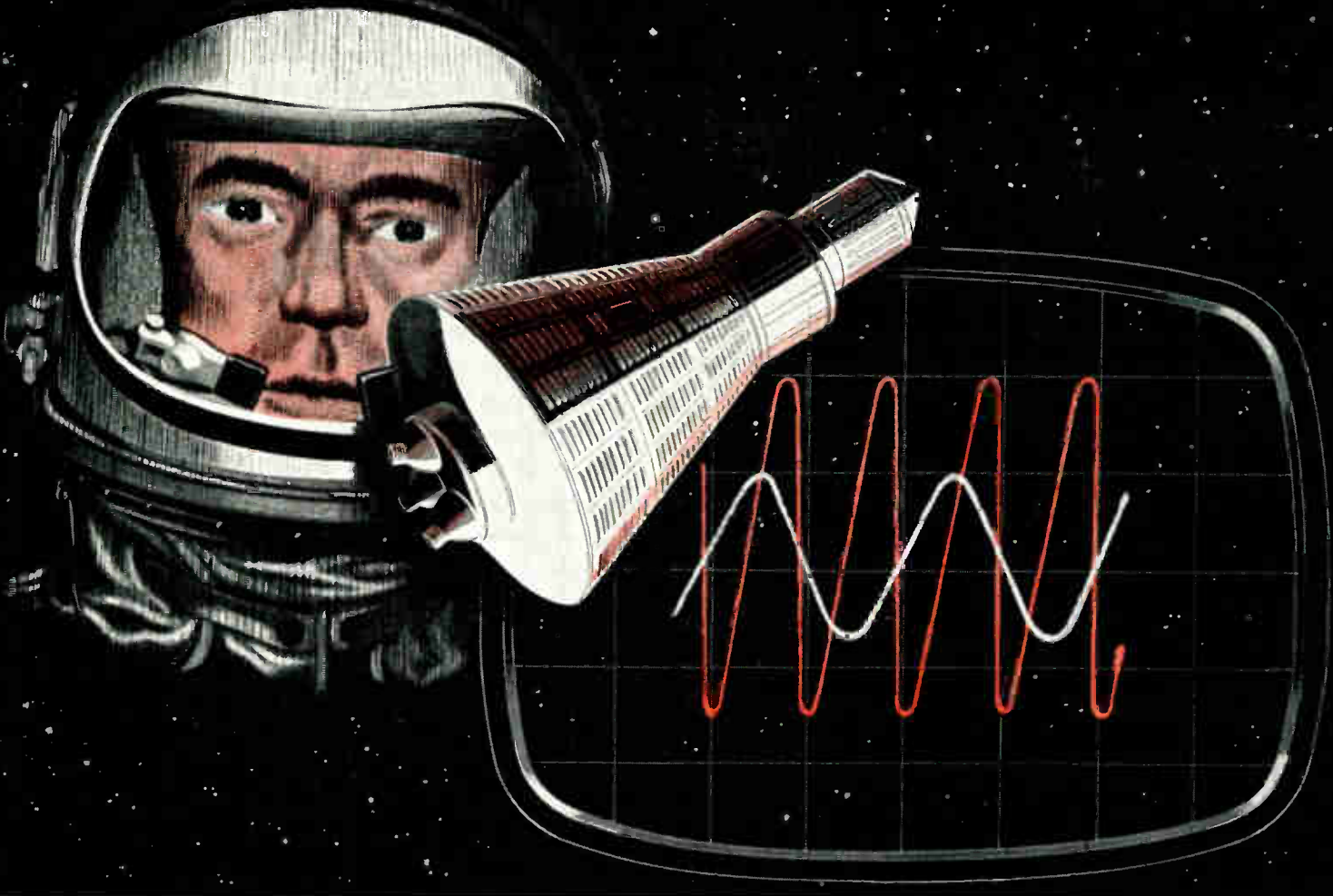

*for electronic and aerospace applications**

If Space is your dimension, take the measure of Stevens *Certified* Thermostats. For in hostile aerospace environments, you can't take a chance on Reliability.

Since Stevens makes the broadest line of bimetal thermostats in the industry, you can get all the special features to fit your special requirements *exactly* right from a *proven*, standard production-line Stemco thermostat, or from a minor modification thereof. This also gets your product off the ground faster . . . by cutting lead time . . . by slashing engineering and development costs.

If reliability, weight, smaller size and cost are considerations, there's only the Stevens *Certified* Thermostat line to consider. Start the countdown sooner by putting us in your supplier orbit.

**Above Stemco Thermostats are designed and manufactured to meet most requirements of applicable MIL specifications.*



Type MX Hermetic
Snap-acting to open on temperature rise only. Highly responsive copper housing. Standard tolerance $\pm 3^\circ\text{F}$ with 2 to 6°F differentials; 1 to 4°F differentials on special order. Temperature 10° to 260°F . Various terminals and mounting brackets. See Bulletin 6100.



Type AX Hermetic
Similar to Type MX but to close on temperature rise. Wide selection of terminals and mounting provisions, highly responsive brass housing. 2° to 6°F differential. Bulletin 3200.



Type C Hermetic
Field-adjustable, positive-acting. Electrically independent bimetal strip type for operation from -10° to 300°F . Also supplied as double thermostat 'alarm' type. Turret terminals or wireleads. For ratings, etc., Bulletin 5000.



Type A Hermetic
Electrically independent bimetal disc and high-response brass case for quick, snap-action control from -10° to 300°F . Various enclosures, terminal arrangements and mounting provisions, including brackets. Bulletin 3000.

A-7192A

STEVENS manufacturing company, inc.
P.O. Box 1007 • Mansfield, Ohio

Circle 4 on Inquiry Card



THERMOSTATS

COMING EVENTS

...in the electronic industry

MAY

- May 13-15: Nat'l. Aerospace Electronics Conf., IEEE, AIAA; Dayton, Ohio
- May 13-15: 6th Nat'l. Power Instrumentation Symp., ISA; Bellevue-Stratford Hotel, Philadelphia, Pa.
- May 15-18: Amer. Acoustical Soc. Mtg.; New Yorker Hotel, New York, N. Y.
- May 16-18: Soc. of Tech. Writers & Publishers Annual Mtg.; Statler-Hilton Hotel, Boston, Mass.
- May 17-18: Symp. on Artificial Control of Biology Systems, IEEE (PGBME); School of Medicine, Univ. of Buffalo, Buffalo, N. Y.
- May 20-22: IEEE Northeastern Dist. Mtg.; Wentworth-By-the-Sea, Portsmouth, N. H.
- May 20-22: ASQC Annual Conv. & Exh.; Hotel Sherman, Chicago, Ill.
- May 20-22: 1963 Electronic Parts Distributors Show & Conf., NEDA, ERA; Conrad-Hilton Hotel, Chicago, Ill.
- May 20-22: 1963 Nat'l. Symp. on Microwave Theory & Techniques, IEEE (PGMTT); Miramar Hotel, Santa Monica, Calif.
- May 20-22: 1963 Nat'l. Telemetry Conf. & Exh., IEEE (PGSET), AIAA, ISA; Hilton Hotel, Albuquerque Nat'l. Bank Bldg., Albuquerque, N. M.
- May 20-23: Int'l. Symp. & Exh. on Humidity & Moisture, ISA, AMS, ASHRAE, NBS, U. S. Weather Bureau; Sheraton-Park Hotel, Washington, D. C.
- May 20-23: Design Eng. Conf. & Show, ASME; Americana Hotel, the Coliseum, New York, N. Y.
- May 21-23: 1963 Spring Joint Computer Conf., AFIPS (IEEE, ACM, Simulation Councils, Inc.); Cobo Hall, Detroit, Mich.
- May 23-24: 1963 Spring Seminar, Amer. Inst. for Design & Drafting; Wayne St. Univ., Detroit, Mich.
- May 27-28: 7th Nat'l. Conf. on Product Eng. & Production, IEEE (PGPEP); Northeast. Univ., Boston, Mass.
- May 27-29: 17th Annual Freq. Control Symp., U. S. Army R & D Lab.; Shelburne Hotel, Atlantic City, N. J.

JUNE

- June 4-5: 5th Nat'l. Radio Freq. Interference Symp., IEEE (PGRFI); Bellevue-Stratford Hotel, Philadelphia, Pa.
- June 4-6: ASM Milwaukee Metalworking Exh. & Conf.; Milwaukee Audit., Milwaukee, Wisc.
- June 4-6: 1st Annual Nat'l. Electronic Packaging & Production Conf. (NEP/CON), "Electronic Packaging & Production," Ind. & Sci. Conf. Management; New York Coliseum, New York, N. Y.
- June 4-6: 1963 AFCEA Nat'l. Conv.; Sheraton - Park Hotel, Washington, D. C.

- June 4-6: Material Handling Inst. Midwest Show, AMHS; McCormick Place Exp. Ctr., Chicago, Ill.
- June 6-7: Mgmt. Eng. Conf., SAM, ASME; Penn-Sheraton Hotel, Pittsburgh, Pa.
- June 9-13: Summer Annual Mtg., ASME; Cosmopolitan Hotel, Denver, Colo.
- June 11: Gen'l. Mtg., Assn. of Electronic Parts & Eqpt. Mfrs.; Chicago, Ill.
- June 13-14: 5th Annual Plastics for Tooling Seminar, SPI Plastics for Tooling Div., Dept. of Ind. Eng., Purdue Univ.; Purdue Univ., Lafayette, Ind.
- June 13-15: Great Lakes Navy R & D Clinic, Ofc. Naval Material, Ohio St. Univ., Battelle Mem. Inst., North American Aviation, Inc., State of Ohio, City of Columbus; Ohio St. Univ., Columbus, Ohio
- June 14-17: 1st Nat'l. Biomedical Sciences Instrumentation Symp., ISA; Union Oil Co. Bldg., Los Angeles, Calif.

'63 Highlights

- ICEAS, Int'l. Conf. & Exh. on Aerospace Support, Aug. 4-9, IEEE, ASME; Sheraton - Park Hotel, Washington, D. C.
- WESCON, Western Electronic Show and Conf., Aug. 20-23, IEEE, WEMA; Cow Palace, San Francisco, Calif.
- NEC, National Electronics Conf., Oct. 28-30, IEEE, McCormick Place, Chicago, Ill.
- NEREM, Northeast Research and Eng. Mtg., Nov. 4-6, IEEE; Boston, Mass.
- June 16-20: Mtg., ANS; Hotel Utah and others, Salt Lake City, Utah
- June 16-21: IEEE Summer Gen'l. Mtg.; Royal York Hotel, Toronto, Ont., Canada
- June 17-20: AIAA Summer Mtg.; Ambassador Hotel, Los Angeles, Calif.
- June 17-21: 4th Biennial Int'l. Gas Chromatography Symp., ISA; Mich. State Univ., E. Lansing, Mich.
- June 17-21: ASEE Nat'l. Conv.; Sheraton Motor Inn, Univ. of Pa., Philadelphia, Pa.
- June 18-20: EIA Annual Conv.; Pick-Congress Hotel, Chicago, Ill.
- June 19-21: 1963 Symp. Anal. Chem., AChS; Univ. of Ariz., Tucson, Ariz.
- June 19-21: 4th Annual Joint Automatic Control Conf., IEEE (PGAC), ISA, ASME, AIChE; Univ. of Minn., Minneapolis, Minn.
- June 21-23: West Gulf Div. Conv., ARRL; McAllen, Tex.
- June 23-28: ASTM 66th Annual Mtg.; Chalfonte-Haddon Hall Hotel, Atlantic City, N. J.

- June 24-26: Annual Mtg., ASHRAE; Hotel Schroeder, Milwaukee, Wisc.
- June 25-28: Int'l. Conv., Data Processing Mgmt. Assoc.; Cobo Hall, Detroit, Mich.
- June 26-27: 10th Annual Symp. on Computers & Data Processing, Denver Res. Inst., Univ. of Denver; Elkhorn Lodge, Estes Park, Colo.
- June 26-29: Annual Mtg., NSPE; Sheraton - Cleveland Hotel, Cleveland, Ohio

INTERNATIONAL

- May 20-24: 3rd Int'l. TV Festival, TV Symp. & Eqpt. Exh.; Montreaux, Switzerland.
- May 22-31: 1st Int'l. Exh. of the Scientific & Tech. Press & Books, Scientific and Technical Publishers Group, French Nat'l. Assoc. of Publishers; Grand-Palais des Champs-Elysees, Paris, France.
- May 27-31: Conf. on the Application of Large Radiation Sources in Industry, IAEA; Salzburg, Austria.
- May 27-June 8: Gen'l. Mtg., Int'l. Electrotechnical Commission; Venice, Italy.
- June 4-10: Conf. on Operating Experience with Power Reactors, IAEA; Vienna, Austria.
- June 12-14: 34th Annual Mtg. & Conv., EIA of Canada; Chantecler Hotel, Adele-En-Haut, Quebec, Que, Canada.
- June 16-19: 4th Int'l. Cong. of Engrs.; Munich, Germany.
- July 1-5: Conf. on New Nuclear Materials Technology, Including Non-metallic Fuel Elements, IAEA; Prague, Czechoslovakia.
- July 22-26: 5th Int'l. Conf. on Medical Electronics, IFME, Univ. of Liege; Palais des Congress, Liege, Belgium.
- Aug. 26-30: Symp. on Radiological Health & Safety in Nuclear Materials, Mining & Milling, IAEA; Vienna, Austria.
- Sept. 2-6: Symp. on Exponential & Critical Experiments, IAEA; Amsterdam, The Netherlands.
- Sept. 13-22: Int'l. Radio, TV & Electronics Exh., FIRATO; R.A.I. Bldgs., Amsterdam, The Netherlands.
- Sept. 15-19: 14th Gen'l. Assembly, Int'l. Sci. Radio Union; Tokyo, Japan.

"CALL FOR PAPERS"

16th Annual Conf. on Eng'g and Medicine & Biology, Nov. 18-20, 1963, Lord Baltimore Hotel, Baltimore, Md. Papers for four tutorial sessions are being sought in the following subject areas: information theory, analog-to-digital conversion, (Continued on page 13)

NEW from



... another capability CUSTOM DESIGNED FILTERS

**prompt delivery
at lowest prices**

Now, American Electronic Laboratories, Inc., a leader in the microwaves field, offers a broad line of custom designed rf filters.

AEL's extensive experience in designing high-pass, low-pass, band-pass and multiplexing filters is available to help solve your critical filter problems. Our highly competent engineering staff utilizes the latest sweep-frequency test equipment to design and test your custom filters.

At right are just a few of the many types of custom designed filters now available from AEL.

Let us solve your filter problems with an AEL-designed filter that provides high quality with peak performance. You will receive prompt delivery. Write today for the AEL FILTER QUESTIONNAIRE, or contact the AEL technical sales representative in your area. We will be pleased to quote on . . . one . . . or a quantity of filters.



**American Electronic
Laboratories, Inc.**

1313 RICHARDSON ROAD, COLMAR, PENNSYLVANIA
just north of Philadelphia

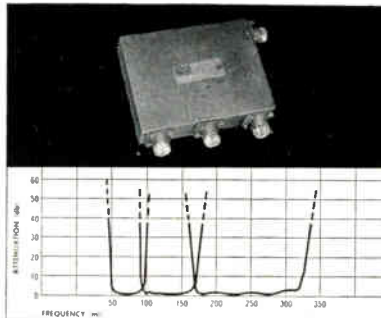

VHF and UHF TRIPLEXER

- Maximum insertion loss of 1.5 db
- 40 db rejection between channels at 15% of crossover frequency
- Typical crossover levels of 5.0 db
- Type N connectors*

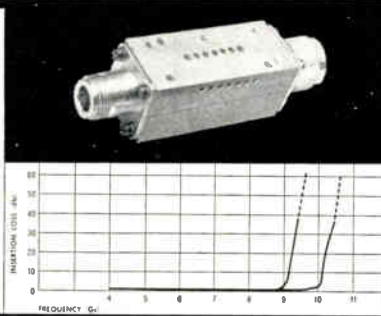

LOW-PASS FILTERS M-DERIVED

- Pass-band insertion loss of 1.0 db max. (0.5 db nominal)
- Stop-band insertion loss of 60 db at 1.10 fc
- Cutoff frequencies at 3 db range from 150 to 11,000 mc
- Type N connector*

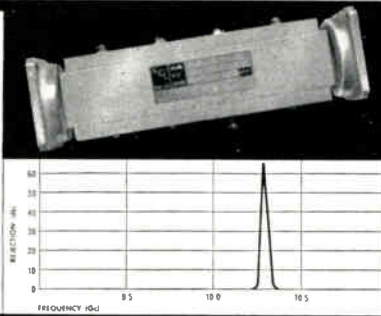

WAVE-GUIDE BAND REJECTION FILTER

- Low pass-band insertion loss of nominally 0.3 db
- Narrow band rejection approximately 1% wide at 3 db points
- 60 db rejection over approximately 0.2% of band
- Available in standard wave-guide sizes up through the X-band

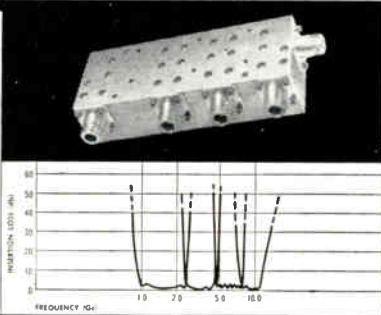

MICROWAVE QUADRUPLER

- Maximum insertion loss of 2.5 db
- 40 db rejection between channels at 15% crossover frequency
- 5.0 db typical crossover level
- Type N connectors*

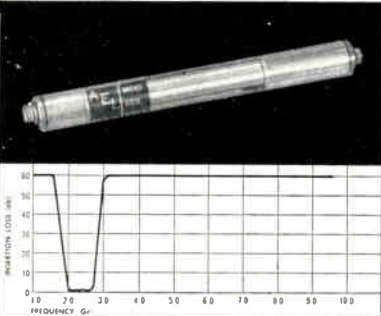

BAND-PASS FILTER (Tubular Design)

- Available in one to seven sections
- Center frequencies within ranges of 500 to 3000 mc as specified
- Bandwidth within range of 5% to 40% as specified
- Low pass-band insertion loss is dependent upon number of sections and band-width

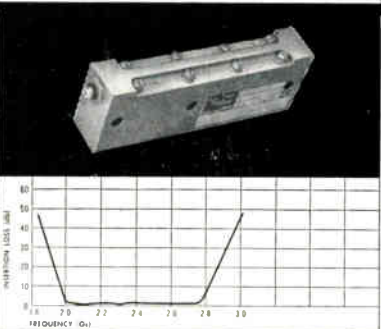

BAND-PASS FILTER (Split-Block Design)

- Pass-band insertion loss of 1.0 db
- Stop-band provides 30 db rejection 10% away from pass-band edges
- Bandwidths available from 10% up to an octave as specified
- Center frequencies from 200 mc to 8000 mc as specified

*Other types of connectors may be supplied upon request.

COMING EVENTS

(Continued from page 11)

muscle physiology and receptor physiology. Papers on the creative evaluation of patient monitoring systems and the details of operation of analog-to-digital conversion systems are being sought for the technical sessions. A full 2-page digest manuscript should be submitted by *Aug. 1, 1963*. Send immediately for an "Application to Present Paper," to: 16th Annual Conference, Jenkins Hall, Johns Hopkins University, Baltimore 18, Md.

ENGINEERING EDUCATION

Short courses of interest to engineers
MOLECULAR DESIGNS

"The Molecular Designing of Materials and Devices" is the title of a two-week summer session at *Massachusetts Inst. of Technology*, to be held *Aug. 5-16, 1963*. Prof. A. R. von Hippel will conduct the course, assisted by 38 specialists from throughout the world. They will lecture on structures, properties and devices, crossing several disciplines in the process. For more information, contact the Director of the Summer Session, Massachusetts Inst. of Technology, Cambridge 39, Mass.

NUCLEAR RADIATION EFFECTS

A program dealing with the effects of nuclear radiation on electrical and electronic equipment will be held as part of the 1963 Summer General Mtg. of *IEEE* to be held in Toronto, Canada, *June 16-21, 1963*. Eight sessions of contributed papers, one of invited papers and a round-table discussion will be featured. The invited speakers are Dr. J. J. Crawford, Jr., of Oak Ridge National Laboratory, and Dr. V. A. Van Lint, of General Atomics. For more information, contact the Program Chairman, R. M. Magee, Bendix Systems Div., Ann Arbor, Mich.

2,000 TO ATTEND SYMPOSIUM

More than 2,000 engineers and scientists are expected to attend the 1963 National Symposium on Space Electronics, to be held at the Fontainebleau Hotel, Miami Beach, Oct. 1-3. In addition to the technical papers to be presented during the first three days, a tour of Cape Canaveral has been arranged for Oct. 4.



Heads off noise at the Bandpass

Out of the run of signals on a line, Sierra's Model 126A Frequency Selective Voltmeter rounds up only the ones you want to measure. It repulses noise and spurious harmonics at the bandpass — a narrow 250 cps wide.

126A rides herd over a roomy 5 to 1620 kc range, keeping a tight rein on accuracy all the way (typical limit of error, ± 0.8 db). It can be a tunable or flat voltmeter depending how you set the selector knob. And it lets you play the range by ear with a switch that broadens the bandwidth to 2500 cps.

\$1,195 corrals everything a 126A has to offer. Except for a 50-megohm probe, which costs \$195, and input transformers for 600, 135, and 75 Ω lines priced at \$75 each. Our new literature surveys Sierra's select herd of prime voltmeters and wave analyzers. Write for it, or have your Sierra sales representative saddle up for a faster-than-by-mail response to your needs.

SIERRA ELECTRONIC DIV.
OF
PHILCO
A SUBSIDIARY OF *Ford Motor Company*

Sierra Electronic Division / 3885 Bohannon Drive / Menlo Park 2, California



THEIRS:
 $A_V = 5$

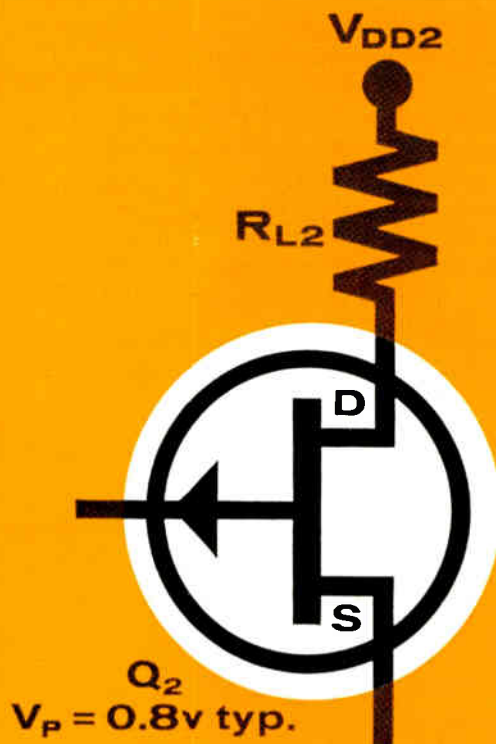

OURS:
 $A_V = 31$

WHY DO LOW PINCH-OFF UNIFETS* GIVE HIGHER VOLTAGE AMPLIFICATION?

BECAUSE A_V IS INVERSELY PROPORTIONAL TO V_P WHEN $V_{DD1} = V_{DD2}$ AND $V_{DS1} = V_{DS2}$. YOU ALSO GET GREATER BIAS STABILITY AND WIDER DYNAMIC RANGE.

AVAILABLE NOW IN FOUR g_m VALUES AS SHOWN. WRITE FOR FILE #841, THE DESCRIPTIVE PAPER ON LOW V_P UNIFET APPLICATIONS.

Low Pinch-off UNIFETs *(Unipolar Field-Effect Transistors) now available:

Typical	2N2841	2N2842	2N2843	2N2844	
V_P	0.8	0.8	0.8	0.8	v
g_m	90	270	800	2000	μmho
I_{DSS}	-50	-150	-450	-1000	μa
NF at 1kc	0.5	0.5	0.5	0.5	db

Pinch-off: 1.7v max.—Gate-drain breakdown: 20v min.—T0-18 package

AMPLIFICATION CALCULATIONS FOR HIGH PINCH-OFF vs. LOW PINCH-OFF UNIFETS

For all UNIFETs, it can be shown that:

$$g_{m0} \dagger = \frac{2.5 I_{DSS} \dagger}{V_P} \text{ within about } 20\%$$

When $V_{DD1} = V_{DD2} = -15v$ and $V_{DS1} = V_{DS2} = -5v$

then $I_{DSS1} R_{L1} = 10v$ and $I_{DSS2} R_{L2} = 10v$

Available voltage amplification, $A_V = g_m R_L$

From these equations, it can be shown that $A_{V1} = \frac{25}{V_{P1}}$ and $A_{V2} = \frac{25}{V_{P2}}$

since $V_{P1} = 5v$ $V_{P2} = 0.8v$

$A_{V1} = 5$ $A_{V2} = 31$

$\dagger g_m$ when $V_{GS} = 0$.

$\dagger\dagger$ Drain-source current when $V_{GS} = 0$.



Siliconix incorporated

1140 West Evelyn Ave. • Sunnyvale 14, California

Telephone 245-1000 • Area Code 408 • TWX 408-737-9948



Sylvania technical specialist Miles Travis inspects electronic security system transmitter unit before shipment to Army NIKE-HERCULES site near Offutt AFB, Neb. System will guard 3,000-ft. perimeter. It includes central monitor facilities, transmitter and receiver units. It was made at Sylvania's Reconnaissance Systems Laboratories, of Mountain View, Calif.

WARNECKE PROPOSES LEASING MILITARY MICROWAVE TUBES

Warnecke Electron Tubes, Inc., which makes microwave tubes, has proposed that the military lease instead of buy these high-priced tubes.

Under such an arrangement, the leasing contractor would be responsible for maintaining and repairing tubes in the field for their lifetimes. Such an arrangement would be an incentive for the contractor to design maximum reliability into the expensive tubes, costing \$500 to \$10,000 each, Warnecke officials say.

Logistics and the carrying of tube inventories would become the contractor's responsibility. The firm also points out that skilled military specialists would not have to be trained to take care of the tubes, providing savings in manpower and training money.

SYSTEMS OF CONNECTORS

Amphenol Connector Div., Amphenol-Borg Electronics Corp., is introducing interconnection systems for complex electronic circuits. The Chicago-based division will even tackle methods of interconnecting thin-film devices and integrated circuitry.

Modular packaging, use of "motherboards," and combinations of interconnection systems and wire form or conventional connectors will be offered. Amphenol-Borg will continue to offer conventional connectors and recommend them where they will best serve a purpose.

ELECTRONIC SHORTS

Bendix Systems Div. has developed a miniaturized "weather pod" (Bendix M-9 MET-POD) to obtain pressure, temperature and precise dewpoint from weather drones and manned subsonic A/C. Measurements are relayed to ground by UHF meteorological telemetry band. Pod is 61 in. long x 4 in. in dia., weighs 19 lb. It can be carried up to 40,000 ft. and through severe storms.

Raytheon has developed a compact terminal landing system for helicopters that brings the craft down through thick "soup" to within 50-100 ft. of touchdown. From there, a high-intensity light makes the landing spot visible. Ground transmitter sends out pulsed signals to 10-lb. "package" in craft which converts them to data that pilot uses to land.

More than 40,000 zener diodes/day are being tested, sorted and processed by an automatic programmed parameter tester at Motorola Semiconductor, Phoenix. Besides testing and sorting the diodes into voltage categories, the device counts the number in each voltage range, which helps production and marketing personnel. The \$120,000 APT performs functions of manual test stations at 3 times the speed.

Diebold, Inc., has ordered 250 closed-circuit TV cameras from RCA for drive-in banking systems. Systems use "hear-see" communications between customers and tellers inside bank. Currency, bankbooks, etc., are exchanged via high-speed pneumatic tubes. "See-yourself-on-TV" feature at drive-in stations is expected to attract children.

Ion Physics Corp., Burlington, Mass., subsidiary of High Voltage Engineering Corp., has operated an electric fan using electricity from solar cells made with its new ion implantation process. The technique uses a beam of boron ions accelerated by a Van de Graaff accelerator to produce a precisely controlled PN junction in a semiconductor material, which converts light into electricity.

General Electric has developed highly stable and efficient UHF transmitters and "zig-zag" panel directional UHF antennas. Frequency shift of the transmitters is 5 parts in 10 million. Stability is inherent in transmitter design and not achieved through corrective circuitry. Non-resonant antenna is made up of rectangular panels each with "zig-zag" radiators spaced a fraction of a wavelength away.

U. S. electronics manufacturers will find it easier to compete in foreign markets if the trend toward tougher anti-monopoly laws overseas continues. Common Market nations have recently taken steps toward U. S. concept of free competition by enacting such laws. And more are being contemplated. These can definitely help U. S. manufacturers in European markets. CM countries may even ban cartels—still legal in Europe.

NASA has selected Northrop Corp., Beverly Hills, Calif., to provide additional industrial support to Jet Propulsion Lab on the Ranger Program through 1964. Northrop will aid JPL in design reviews, reliability studies, documentation, systems testing, checkout and spacecraft launch operations support, Northrop may then be assigned complete spacecraft systems responsibility for Ranger in a Phase II effort, beginning with craft to be launched in 1965.

More than 203,000 TV pictures of the earth's cloud cover were transmitted by TIROS meteorological satellite systems through 1962, NASA officials report. TIROS—TV Infra-red Observation Satellite—was produced by RCA for NASA. TIROS V AND VI continued operating into this year.

General Instrument Corp. has been selected by the AEC to make a thermoelectric generator to produce electricity from unrefined waste of nuclear reactors (mixed fission products). Such generators, which could produce 5-10 w. of useful power, could power undersea devices, communications equipment, automatic unmanned weather stations, navigational beacons and other remote equipment.

General Electric's new solid-state, digital GP computer, GE-235, has dual controller selector option which doubles system peripheral performance over previous (GE) systems. Option provides buffered input/output rate of 112,000 words/sec, plus full-speed card reading and punching capability. GE-235 is fully compatible with earlier systems, GE-215 and GE-225, in programming systems and peripheral equipment.

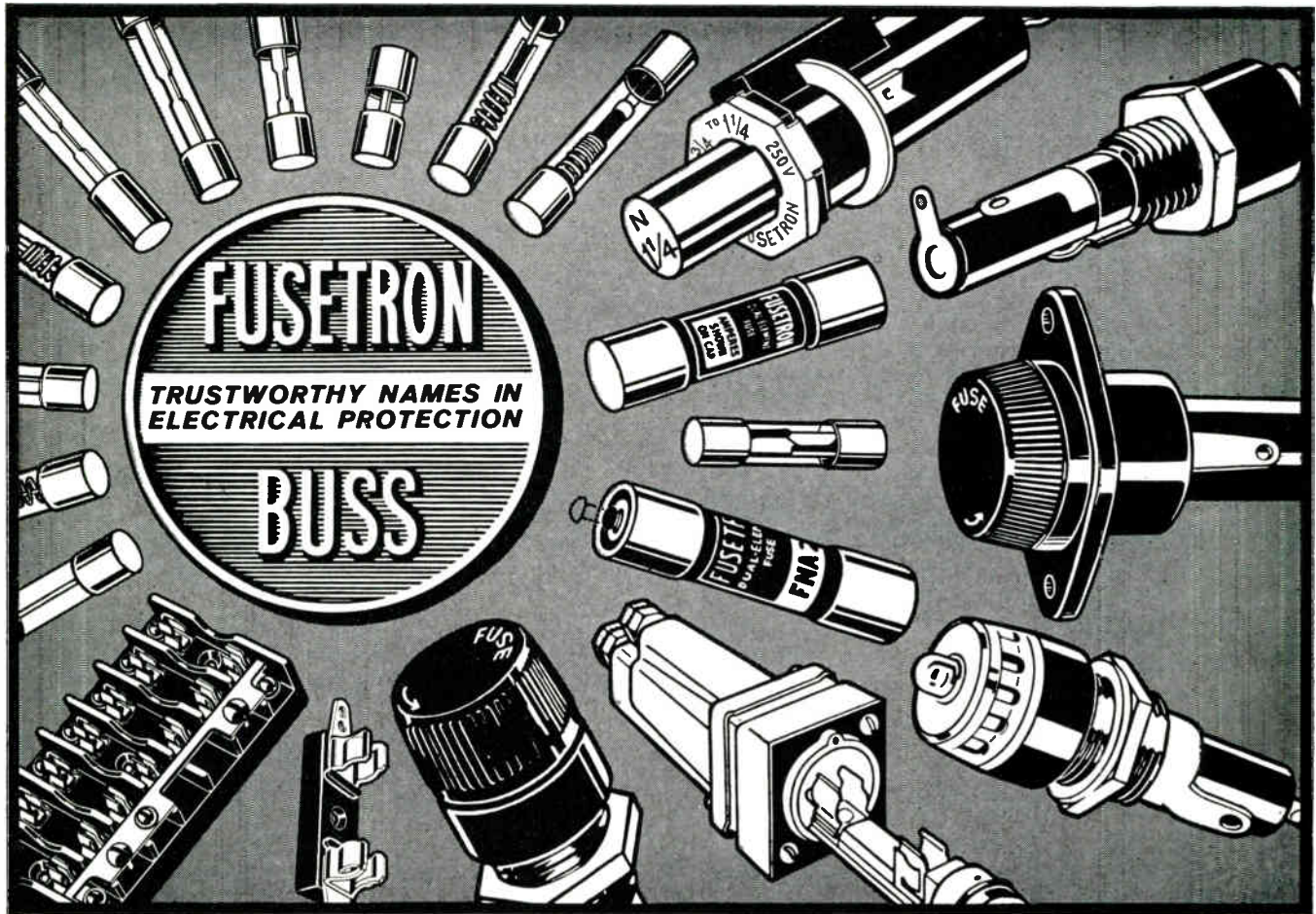

Save Time and Trouble by standardizing on BUSS Fuses—You'll find the right fuse every time...in the Complete BUSS Line!

By using BUSS as your source for fuses, you can quickly find the type and size fuse you need. The complete BUSS line of fuses includes: dual-element "slow-blowing", single-element "quick-acting", and signal or visual indicating types . . . in sizes from 1/500 amp. up—plus a companion line of fuse clips, blocks and holders.

BUSS Trademark Is Your Assurance Of Fuses Of Unquestioned High Quality

For almost half a century, millions upon millions of BUSS fuses have operated properly under all service conditions.

To make sure this high standard of dependability is maintained . . . BUSS fuses are tested in a sensitive

electronic device. Any fuse not correctly calibrated, properly constructed and right in all physical dimensions is automatically rejected.

Should You Have A Special Problem In Electrical Protection . . . BUSS fuse engineers are at your service—and in many cases can save you engineering time by helping you choose the right fuse for the job. Whenever possible, the fuse selected will be available in local wholesalers' stocks, so that your device can be serviced easily.

For more information on the complete line of BUSS and FUSETRON Small Dimension Fuses and Fuse-holders, write for BUSS bulletin SFB.

BUSS

BUSSMANN MFG. DIVISION

MAKERS OF THE COMPLETE LINE OF FUSES OF UNQUESTIONED HIGH QUALITY

McGraw-Edison Co. • St. Louis 7, Mo.

This is the first in a series of reports on connector design specifications.

1

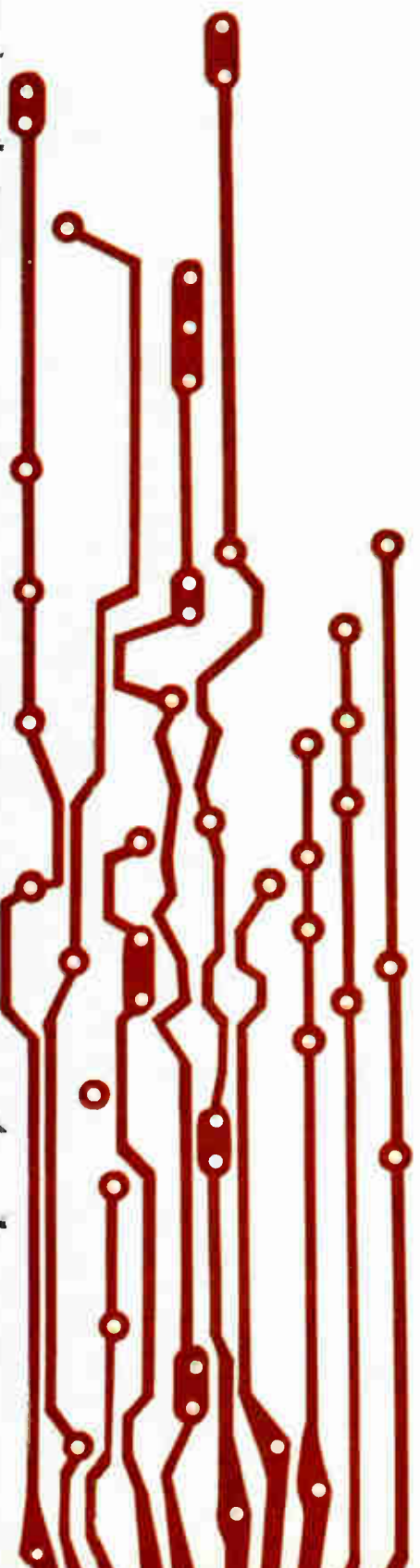

Special Report
From AMP On
PRINTED
CIRCUIT
CONNECTORS

Why use crimp, snap-in type connectors?

Are pre-loaded connectors necessary?

Is there a difference in plating?

Can assembly time and costs be reduced?

Here are the answers to these and other important questions you may have about crimp, snap-in type printed circuit connectors. The information is based on our more than twenty years experience in the development and application of compression-crimping techniques plus accumulated findings and data from the industry's most extensive research and testing facilities.

Circle 67 On Inquiry Card

With today's ever increasing acceptance of the compression crimped connector, it becomes evident that the time of clear choice — to solder or not to solder — is fast passing. Those who choose the obvious advantages of the crimped connector must, if they are to make a fair evaluation, look *within* the category of compression crimped types. As new names enter the field and as connector types multiply, a good searching look at the entire area is almost mandatory.

True, once the decision has been made for the crimped type connector, the user is freed from such problems as the variables in connector performance which ensue from the non-precise nature of solder in its application. He is no longer subject to the anticipated recurrence of cold solder joints, burned insulation, and solder wicking on stranded conductors. Furthermore, because of the ease of removal and insertion of the contacts, he is no longer faced with difficulty in making repairs and the quick circuit changes often necessary in today's modern equipment. Above all, there is considerable time gained through the faster process of compression crimping with automatic machines; this alone adds an incentive in the way of lower applied costs. Bearing in mind all these advantages and the benefits they offer, the choice of a compression crimped type connector still entails serious study of those brands and types available in today's marketplace.

Here, consideration is given to only a few examples typical of our full line of crimp, snap-in type printed circuit connectors. These main categories include the two piece, one piece and one piece right angle types. We shall illustrate only their most distinctive features and those specific benefits which could most vitally affect your printed circuit program. Let's begin by investigating the one feature they all have in common . . . a feature which sets them apart from all other connectors of their type, the mated terminal-tool concept of AMP's compression crimping technique.

The crimping method used in attaching the contacts to the conductors is based on a long established engineering practice of matching the crimping device and the terminal. Nothing is left to chance. Crimping dies are precision made of the finest hard-metal alloys. They are manufactured with exacting care so as to assure a precise crimping configuration through literally millions of operations. The dies are precisely controlled as to the pressures they exert, either by a ratchet device on the hand crimping tool or a pre-calibrated stroke of crimping jaws in automatic application machinery. In either case, the crimping dies fully bottom on the terminal before it can be released. Since the dies to be used are perfectly matched to the terminal to be crimped, positive assurance is given that all such crimps will be precisely identical in appearance and performance. The principles and application of this technique

have set the standards of excellence in the field.

The end result of this controlled crimping action is a homogeneous blending of conductor and terminal barrel and a connection which is extremely resistant to vibration and corrosion and offers maximum conductivity and reliability.

The validity and value of this technique is substantiated by test data which, in many instances, covers continuous and/or long-time periods of testing embracing a twenty year period. It is in addition supported by corroborative findings by independent test laboratories and the military. What happens when the matched tool and terminal team go to work in crimping a printed circuit connector contact?

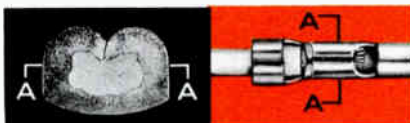

Here you see a typical cross section of the crimped portion in photomacrographic detail. Notice the "cold-flow" action of metals. Voids are almost totally non-existent. The contact barrel and conductor are practically homogeneous. Because of this, the connection is safe from oxidation and contaminants. Tensile strength in this connection approaches that of the wire itself. All this fulfills the first requisite of connector quality and reliability since any connector is only as reliable as the individual connections which make it up. The printed circuit connectors included here are compression crimped type. All the contacts are crimped with AMP matched tooling — your first and most important assurance of reliable performance. Other features, and there are many of them, further add to their performance capabilities.

ONE PIECE, BOARD EDGE CONNECTOR (AMP-LEAF* CONNECTOR)

The printed circuit connector which you see illustrated below is our leaf type. It is a unique one piece connector whose design offers many advantages to producers of high reliability commercial and military equipment. The spring contact is firmly held in place in the one-piece housing by the "snap-in"

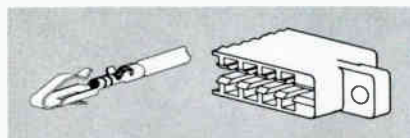

design and detent lance. In this leaf type connector we find the solution to a number of problems quite common to this type application. The contacts have been precisely engineered so that exact pressures are maintained on circuit paths through repeated insertions and extractions. This serves to prevent intermittent contact and avoids excessive wear and tear on circuits paths. The connector can be used with both one and two sided boards. Egg-crate design of the connector block affords protection for individual contacts and prevents flashover.

Because the contacts are easily inserted and extracted, considerable savings are made in the process of assembly. These are savings in addition to those gained by the high speed automatic crimping of the contacts.

Most important of all, contacts for this leaf connector need only be purchased in quantities to satisfy the number of working circuits in the application. *The connector is not pre-loaded. You buy only those contacts necessary for circuit requirements.* There is no waste in contacts which are paid for but not used. This feature alone is responsible for considerable savings and makes a solid contribution to an already substantially lower total applied cost.

ECONOMY LINE—ONE-PIECE, BOARD EDGE CONNECTOR (DUO-TYNE* FLAG CONNECTOR)



The flag-type connector illustrated below is without equal in the industry. An *exclusive* AMP development, it makes possible, in both method and cost, the use of solid state components in commercial electrical/electronic applications. Especially designed to meet the specific quality and reliability requirements of such equipments as appliance controls, vending machine sub-assemblies and other applications in similar functional areas, the AMP DUO-TYNE FLAG connector offers important advantages to the manufacturer of such equipment.

Among its assembly-savings features is a right angle design which permits cabling in close quarters. In addition, it does not require frame mounting to attach the keyed housing to the card cutout. Contacts are recessed to prevent arcing. All sizes and configurations are available with or without mounting ears.

More than any single feature responsible for its success in adapting to solid state construction is its *initial* low cost. Add to this, the low *applied* cost which

is achieved through high-speed compression crimping of contacts with A-MP automachines, and it is easy to see why this connector is one of the most widely accepted members of our connector family.

TWO-PIECE, BOARD-EDGE CONNECTOR (AMP-BLADE* CONNECTOR)

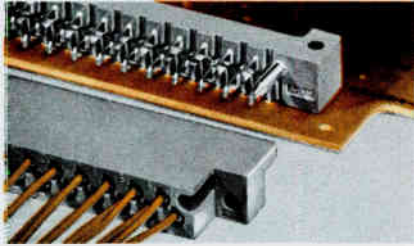

This blade type connector is one of the finest examples of connector design, engineering, and manufacturing available anywhere. The contact is designed to afford three areas of contact . . . an extra margin of redundancy to assure maximum conductivity and reliability. Insertion and extraction forces are precisely controlled to permit easy extraction and re-insertion of contacts for necessary circuit changes or repair.

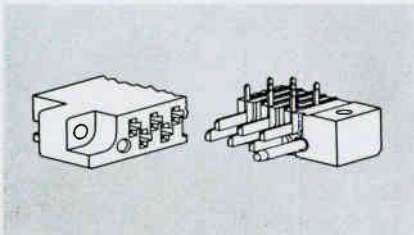

This connector offers an extremely high density potential for connectors of two-piece construction, because the contacts are staggered in their arrangement in the block. Clinched to the board, the staked-down tab housing prevents board warpage and any accompanying misalignment of the contacts. To further assure reliability, the blade type contacts are plated with gold over nickel. This is standard plating . . . not a matter of choice or option, since sound research and testing have proved its superiority. Coupled with special stamping processes, the gold over nickel plating creates a contact surface free of ridges and whorls, prevents metal creep and debilitating oxide insulation build-up, and assures connector performance free of intermittent contact. Everything about its materials, design and function make this connector ideal for applications requiring the highest levels of conductivity and reliability.

The receptacle half of this connector offers the same important advantage to be found in the leaf type connector—there is no pre-loading of the contacts, therefore no wasted contacts. Only those contacts required by circuit design need be purchased. This is again a saving in addition to that created by automatic crimping of the contacts at high production rates.

TWO PIECE—PIN AND SOCKET TYPE, BOARD EDGE CONNECTORS

These connectors are designed to perform under the demanding requirements for printed circuitry in the missile firing and guidance control systems field. When the difference between success and failure of a vital mission depends upon the ultimate reliability of each component part, the printed circuit connector *must* equal or exceed the reliability factor of the printed board itself. These pin and socket connectors do just that; military standard MIL-C-26636 socket contacts are used throughout. AMP gold over nickel plating assures maximum conductivity. The contacts are crimp, snap-in type and can be removed from the socket housing for easy wiring changes. Because of the snap-in feature, you need only use the active circuit lines which you need; there are no pre-loaded housings and wasted contacts. The complete connector can be environmentally sealed depending upon your requirements. The staked down pin housing is ruggedly constructed and prevents board warpage with its attendant problems. In short, the AMP pin and socket, printed circuit board edge connector offers the maximum reliability required in critical circuitry problems. Specifications tell the complete story and these are available through our general offices.

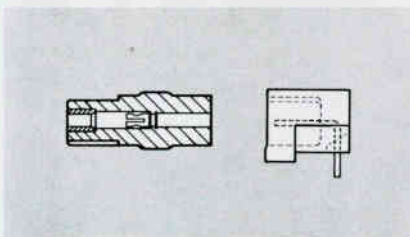
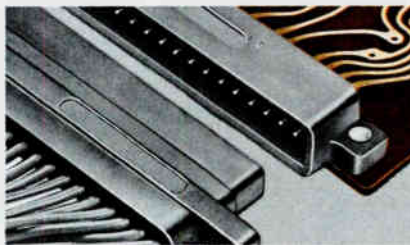

The points we have stressed thus far are those which are immediately evident upon close examination of the product or observing the product in use. There has obviously been no attempt to cover features which are common in the industry—housing materials, keying and polarization, base materials, alpha-numerical coding, etc. There are additional points which are neither common nor plainly discernible, yet, they have played an extremely important part in the development and perfection of the products discussed. These are the AMP Research and Test Laboratories.

THE ROLE OF RESEARCH AND TESTING



Our Research Laboratory is one of the largest and best equipped in the industry. This facility has been especially instrumental in the development of special platings and plating techniques. Among these has been the AMP standard gold over nickel plating which is used on printed circuit connector contacts.



The Testing Laboratory offers the latest in modern equipment including four "white rooms." Here, A-MP products are subjected to rigorous tests of every type; corrosion, heat, cold, vibration, shock and many other real or simulated conditions which exist in the areas of product performances. An exclusive development of this facility has been the X-ray technique of measuring plating thicknesses which enables AMP to control plating in production to the millionth of an inch.

In the AMP Research and Testing Laboratories, continuing programs in every area which might possibly contribute to product improvement and development presently include special studies and research in the effects of radiation on electrical/electronic connections of every type.

* * * * *

We have attempted to show here only the most important reasons why studied consideration should be given to crimp, snap-in type printed circuit connectors. Detailed information concerning the connectors—their construction and specifications, configurations and types available, test data regarding connector performance, and the makeup and behavior of connector plating materials, will be made available to you at your request. AMP facilities including Research, Testing, Engineering and Product Development can be called upon to help you overcome any unusual printed circuit connector problem or to create special connector designs to suit your most unusual requirements. All inquiries for additional information or any specific request for unusual applications will be answered promptly.

Other A-MP Products for Printed Circuits

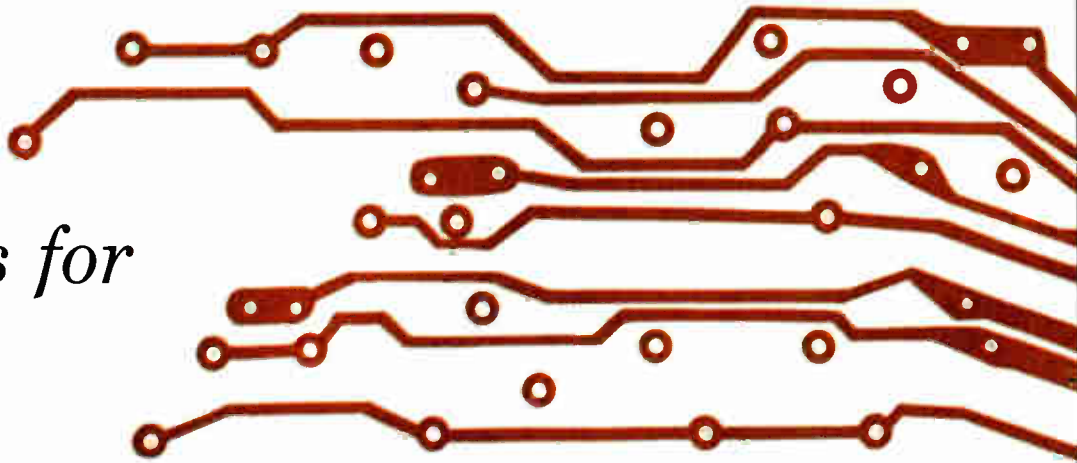

A-MP TEST PROBE RECEPTACLES

A full line of test probe receptacles is offered for testing printed circuits without interrupting operating currents. All types and sizes available include leg mounts of an unusual design—"V" shaped, in order to promote controlled solder wicking for stability and maximum conductivity. Inserts are silver or gold plated to further assure true test-readings. To prevent flashover or shorting, the inserts are recessed in nylon housings which are color coded to facilitate identification of circuits to be tested. Designs available include



both high and low, two and three-legged types, open at both ends for probing from either direction. The three-legged design comes in both standard height for edge of board testing or in the taller size to permit probing in any position on the board where clearance is necessary. All receptacles fit standard .080" test probe.

A-MP REUSABLE COMPONENT TEST RECEPTACLE

Prior to this development, users of printed circuit boards who "burn-in" tested components were faced with certain loss and waste resulting from solder application methods. Solder damaged components, affected readings through lack of connection uniformity, and shortened, by a considerable margin, life expectancy of the board. This new test receptacle overcomes these problems by doing away with the necessity of soldering component leads to



the board. The receptacle *only* is soldered to the board—permanently. Once in place, it accepts leads of varying diameter—.018" to .040"—with insertion and extraction being accomplished by hand. The receptacle can be used over and over again—up to one hundred times. Only one hole size is required to accept the drawn copper receptacle—.089". A rolled lip feature facilitates insertion of component leads, and also acts as a stop when receptacle is inserted in the board. A spring member in the receptacle holds components firmly on the board and assures positive retention for maximum conductivity and true test-readings.

AMP CIRCUITIP* TERMINALS

Essentially a tapered terminal which is crimped to the leads of electronic components the AMP CIRCUITIP* Terminal facilitates the mounting of components onto the printed circuit board. Once inserted, either by hand or automatic machinery, the component tip serves a variety of roles. It is capable of self-retention in the board prior to and during soldering, it makes possible standardization of hole sizes, and it can be applied to the board with or without eyeletting or plated-through holes. In addition, its configuration aids



capillary action, promotes uniform solder fillets, and acts as a heat sink to help dissipate heat and protect components. The terminal is crimped to component leads with a variety of automatic machines whose operations not only include crimping of the terminal but also trimming, tipping, bending of leads, and ejection of terminated components. Other automatic machines include one which applies CIRCUITIP Terminals to *transistor* leads, and another which applies CIRCUITIP Terminals to the *center* of the component leads. Hand insertion tools are available for both single and triple-lead components.



AMP products and engineering assistance are available through subsidiary companies in: Australia • Canada • England • France • Holland • Italy • Japan • Mexico • West Germany

COLOR TV TUBE HAS 1 ELECTRON GUN, NO MATRIX

An inexpensive cathode ray color TV tube which uses only one electron gun and does away with the conventional mechanical matrix has been developed by D. M. Goodman, Senior Research Scientist at New York University.

The patented tube has a target screen of repeating groups of vertical color strips and thin indexing strips. When hit by the scanning beam, the index strips give off short bursts of ultra-violet and X-ray signals. These locate the electron beam on the target screen.

Light pipes attached to the gun pick up the index signals and send them through the tube neck to very rapid gating circuits. These circuits sample incoming color signals.

LASER SYSTEM DOUBLES DATA TRANSFER EFFICIENCY

A laser polarization modulation system which may double the efficiency of information transfer by light beams has been developed by Sylvania Electronic Systems, Buffalo, N. Y.

The 2-channel optical system, with a laser as signal source, uses polarization modulation to produce received signals having twice the power of those of intensity systems. Also, transmission range can be increased 40%.

Light vibrations polarized into definite patterns rotate clockwise and counter-clockwise in a circle. In shifting rotation direction, information is applied to the carrier beam.

In intensity modulation, only half the power is used because of the on-off amplitude variations which modulate the signal. But in the new method, total signal power is usable because polarization, rather than amplitude, is varied.

AS WE GO TO PRESS

BAZOOKA-LIKE RADAR



Sperry Rand's new precision laser radar looks like bazooka battery as engineer R. D. Kroeger examines it. Bending laser beam back and forth with special prisms millions of times/sec. to scan targets returns precise length and width target measurements. Light beam flashes from transmitting telescope (r.) and bounces back into receiving telescope (l.). Two smaller scopes photograph targets and align system.

STATISTICAL MICRO-CIRCUIT RELIABILITY TEST DEvised

A new way to statistically test micro-circuit reliability has been developed by Westinghouse Electric Corp.

In the method, failure factors are determined from a rate-of-failure factor. Each failure factor is evaluated individually, using test data from a unit containing the device. By solving simultaneous equations and comparing with test data, values are found for failure factors in such elements as junctions, leads, volume and surface.

Values can also be determined separately in accelerated testing. With this method, different rates of increase for each factor can be analyzed as applied stress is increased. Or different kinds of stress can be applied and changing patterns of failure observed.

.5 GIGAWATT LASER PULSE ACHIEVED BY KONRAD

A ruby laser pulse with a peak power of .5 gigawatt has been developed by Konrad Corp., Santa Monica, Calif., subsidiary of Union Carbide Corp. The firm expects it will soon achieve pulses in the multi-gigawatt range.

With pulse width of 7 nanosec., peak power was attained by adding a laser power amplifier to a Kerr Cell Q-spoiled laser oscillator. The oscillator produced a sub-microsec. pulse, which was then amplified in a second laser head.

Continued research aimed at further refining the system is expected to achieve peak powers in the multi-gigawatt range.

The oscillator-amplifier system used comprises a carefully aligned combination of multi-megawatt laser oscillator and separate laser amplifier with special trigger coordinating circuits.

For the .5 gigawatt pulse, it is calculated that the electric field in the focused electromagnetic beam is 10^7 v. per cm. The beam is observed to cause ionization of the air in its focal path. A brilliant blue flash results. Spectacular damage of many materials placed at the focal point has been observed.

These components will be among a line of laser devices the company will soon market.

SHIPBORNE SYSTEM HAS ADVANTAGES OF RADAR, TV

A shipboard electronic system that combines the advantages of radar and TV will be built by the Raytheon Co. for the Coast Guard.

First of its type, the new system converts individual radar signals into continuous TV trails of moving ships. In the process, it automatically plots and presents the position, speed and direction of every moving target it sees.

The system also shows the cutter's path itself moving across the screen—giving a true course and speed of all moving vessels in the area. In conventional radar presentation, the radar-carrying ship is shown fixed in the center of the scope.

ELECTRONIC SWITCHING SYSTEM

W. J. Means (ctr.) and M. A. Townsend (l.), of Bell Telephone Laboratories, Holmdel, N. J., examine memory unit of electronic switching system they helped develop. H. F. Priebe (r.) checks system's line data circuits.

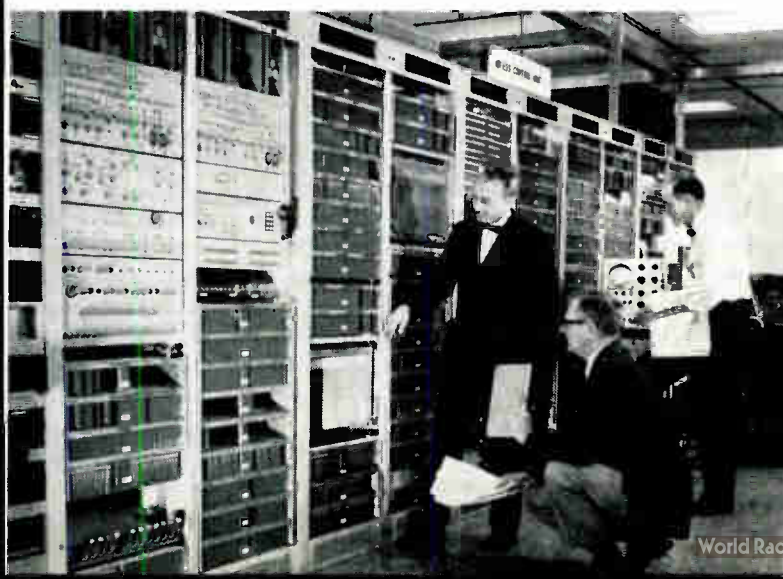

More News on Page 25



Reports are coming in: Sylvania Strap Frame Grid Subminiature Tubes are proving themselves as they are designed into radar, communications equipment, telemetry and other systems. "Greater performance per dollar"—"Higher Class C efficiency than any tube they have seen," are typical field reports from our men. Ready availability and competitive prices, stemming from long experience and mass-production facilities, are other Sylvania advantages.

Sylvania made the first Strap Frame Grid Sub-

miniature, and the line has now expanded to 10—including two 26.5-volt types. Each one, when compared to its nearest conventional counterpart, shows a marked improvement in gain and operating efficiency of both the plate and heater. In addition, subminiature construction offers new ruggedness, stability and radiation immunity—adding up to high reliability. And you're not limited to triodes. Double triodes and pentodes in the Sylvania line can often do the job of two competitive tubes, thus saving space and cost.

Proved in use: Sylvania Strap Frame are practical route to top performance

CIRCUIT DESIGN HELP. New booklet on Strap Frame Grid Subminiature Tubes, complete with individual data sheets, circuits.



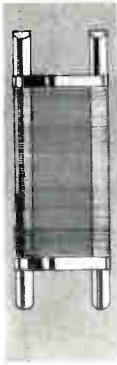

GRID RIGIDITY—KEY TO PERFORMANCE

Conventional grids, with wire wrapped around two vertical "backbones," depend on the windings for sturdiness. If the wire diameter is made small to achieve close cathode-to-grid spacing, the grid becomes extremely delicate and distances may change.

By introducing metal straps between the two backbones, a stretcher is formed whose rigidity depends on the frame and not the winding. Hence the wire can be smaller and closer to the cathode. This precise dimensional control significantly improves Gm, Gm-to-Ib ratio, gain, bandwidth and noise figure. And stability is excellent, even under varying voltages and environmental conditions.

Frame Grid performance is also available in economical miniature tubes for industrial and commercial applications.

Subminiatures and reliability

SUMMARY OF TYPES

SINGLE TRIODES

Type 8070 — 11,000 Gm, 58 Mu. Grounded cathode IF preamp, RF amp and mixer; operable into UHF; low heater power.

Type 8071 — 12,000 Gm, 56 Mu. Grounded grid RF amplifier; operable into UHF; low heater power.

Type 8185 — 19,000 Gm, 42 Mu. RF grounded grid power output amplifier. PO = 3.9 watts at 235 Mc.

Type 8186 — Same as 8185 except for 26.5-V heater.

DOUBLE TRIODES

Type 7692 — 10,500 Gm, 22 Mu. Low heater power; RF & IF cascode preamp, mixer; operable into UHF.

Type 7693 — 13,000 Gm, 40 Mu. Low B+; BTO, multivibrator, trigger; cascode RF & IF amp, mixer; operable into UHF.

PENTODES

Type 8210 — 8,500 Gm, 260 K rp. Sharp cutoff; VHF RF and IF amp, mixer; low Cgp.

Type 8211 — 15,000 Gm, 65 K rp. High gain video amplifier; low-heater power.

EXCLUSIVE:

Strap Frame Subminiatures for 26.5-V operation of all elements

Only Sylvania combines the advantages of Strap Frame Grid and subminiature construction in tubes for mobile applications—able to use 26.5-volt supply without transformers or the problems of series strings. These two new Strap Frame Grid types are:

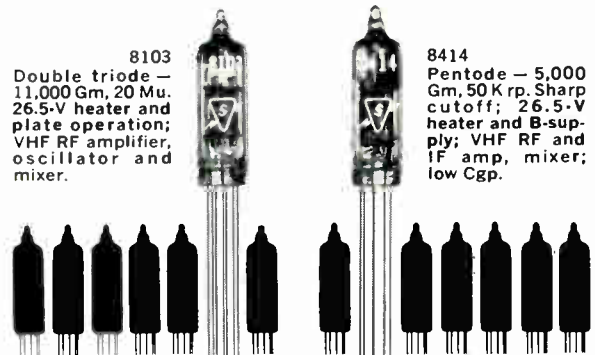

The full line of Sylvania 26.5-volt Gold Brand Subminiature Tubes includes 7 types for 26.5-volt heater operation as well as 7 additional types for 26.5-volt operation of all elements. By eliminating unnecessary system components and circuits, they enhance reliability and facilitate circuit design—they are ideal for use in hybrid circuits with transistors. In addition, these compact tubes have the ruggedness and tested-in reliability to meet the severe requirements of mobile service.

For more information write to Electronic Tube Division, Sylvania Electric Products Inc., Box 87, Buffalo, N. Y.

SYLVANIA

SUBSIDIARY OF
GENERAL TELEPHONE & ELECTRONICS



NEW CAPABILITIES IN: ELECTRONIC TUBES • SEMICONDUCTORS
MICROWAVE DEVICES • SPECIAL COMPONENTS • DISPLAY DEVICES

Circle 9 on Inquiry Card

ANNOUNCING THE VERSATILE NEW **JERROLD** **VIDEO SWEEP GENERATOR** MODEL 1015

for both wide- and narrow-band
response testing from **1 kc to 15 mc**

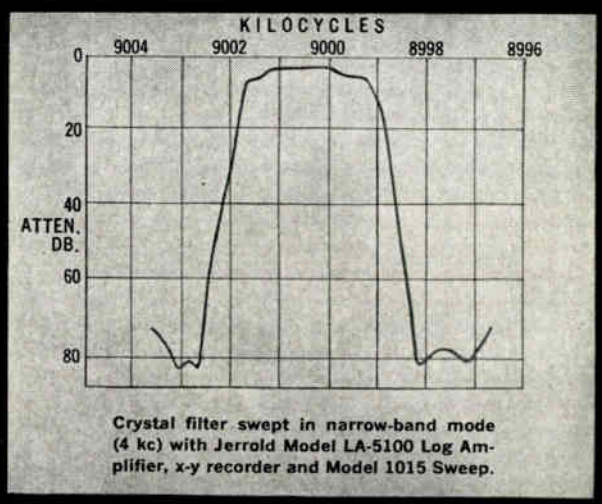
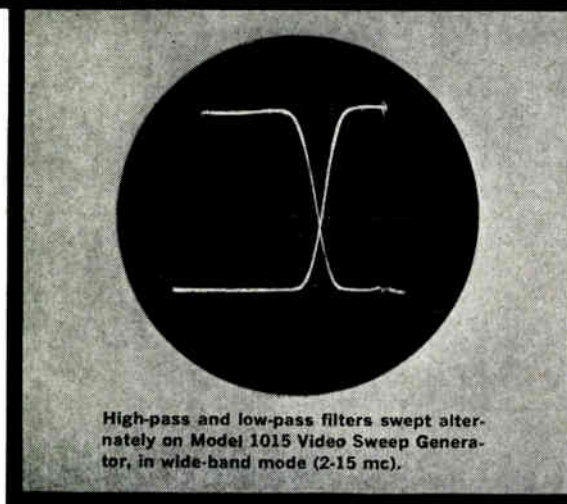

Jerrold is proud to introduce this versatile, highly stable video sweep generator as the latest in its growing line of sophisticated measuring instruments.

Engineered to combine characteristics of a very stable narrow sweep (20 cps residual FM) and a very wide sweep for video applications (10 kc to 15 mc), the Model 1015 provides narrow-band, wide-band, and continuous-wave output modes. Automatic or manual sweeping is provided by a front-panel selector switch. Center frequency is continuously variable from 1 kc to 15 mc in all three modes. In addition to a built-in marker generator on the wide-band range, provision is made for connecting two external marker generators.

For fast quantitative measurements of response that otherwise would involve hours of tedious point-by-point compilation, it will pay you to investigate this stable new video sweep generator. Write for complete specifications. **\$2,540**



FEATURES:

- Wide-band, 0-15 mc; narrow-band, 0-400 kc; CW
- Excellent stability in both narrow and wide modes
- Better than 2v metered output in both modes
- Low residual FM (20 cps on narrow band and CW)
- Continuously variable sweep rate from 60/sec. to 1 per 2½ min.
- Built-in high-output birdie-type marker generator

JERROLD ELECTRONICS CORPORATION
Industrial Products Division

Philadelphia 32, Pa.



A subsidiary of THE JERROLD CORPORATION

SPERRY SYSTEM WARNS PILOT, AVERTS COLLISIONS

Sperry Gyroscope Co., Great Neck, N. Y., has developed an experimental pilot warning and collision avoidance system for the Federal Aviation Agency.

An elementary smaller version can supply range and bearing on an aircraft whose path poses a collision threat, leaving corrective action to the pilot. A more sophisticated heavier

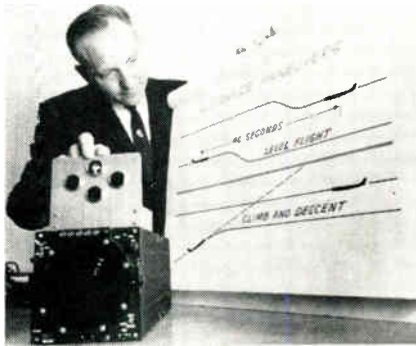

Diagram shows use of system in foreground.

model can evaluate the threat and indicate a maneuver to avoid danger.

The equipment, not yet ready for flight test, would perform sensor, coding, decoding and computing functions.

Equipped aircraft in a given block of airspace would exchange altitude and velocity information via common radar-frequency transponders. As a collision avoidance system, computers on both planes would evaluate the danger and arrive at a consistent pair of solutions.

STATIONARY OCEAN SPACE STATIONS PROPOSED

Floating spacecraft tracking platforms, which will fill partially with water, tilt, and submerge one end 350 ft. below the ocean's surface have been proposed to the Government by General Dynamics/Astronautics, San Diego, Calif.

Called Stable Ocean Platforms (STOP), they would provide tracking and signal receiving stations for manned and unmanned spacecraft and long-range ballistic missile flights. Their stability would nearly equal that of land-based installations.

STOP, 442 ft. long, would overcome one of the major limitations of ships now used for space tracking—rolling and pitching which prevents the precise tracking and communications.

AS WE GO TO PRESS

UHF SILICON TRANSISTOR HAS LOW NOISE, HIGH GAIN

RCA has developed a VHF-UHF silicon transistor with upper frequency limit over 1,000 MC and higher gain and lower noise ratios than achieved in previous transistors of this type.

The device promises to open many applications in military, industrial and space electronics. It will enable communications receivers operating from 100 to 1,000 MC, including military receivers in the 200-400 MC range to be transistorized.

The TA-2333 (developmental) transistor has a typical r-f amplifier noise figure of 4 db at 450 MC. Device noise as low as 2.7 db at 200 MC has been measured.

This kind of VHF-UHF performance is reported to have been achieved by only a few germanium transistors and some special purpose vacuum tubes.

A typical r-f amplifier gain of 15 db, neutralized, over a 15 MC bandwidth has been achieved.

COMPUTER METER PLAN

A computer meter plan which charges a user only for the time used has been devised by the Commercial Computer Div., General Precision, Inc., Burbank, Calif. The rental plan is intended to be used with the general-purpose LGP-30 computer. Hourly rates go down as the total time used each month increases.

TV BANKING



Tellers at Chicago's Union Nat'l Bank are in 2-way "hear-see" communications with drive-in customers seen on monitors. Teller (FG) receives deposit slip from pneumatic tube which sends items between bank and outdoor station in 8 sec. Diebold, Inc., Canton, O., which developed system, has ordered 250 RCA cameras to equip banks.

ELECTRON TUBE STANDARDS

The Electronic Industries Association has published its latest set of tube standards, called *EIA Standards for Electron Tubes* (RS-209-A). It can be obtained for \$12.50 from the association's Engineering Dept., 11 West 42nd St., New York 36, N. Y.

The three-part set, revision of RS-209 and RS-209-1, was formulated by the Electron Tube Council of the Joint Electron Device Engineering Council. Its three sections are: "Dimensional Characteristics of Electron Tubes," "Electron Tube Bases, Caps and Terminals," and "Gauges."

Stable Ocean platform for tracking spacecraft and missiles is shown with insert of hull.

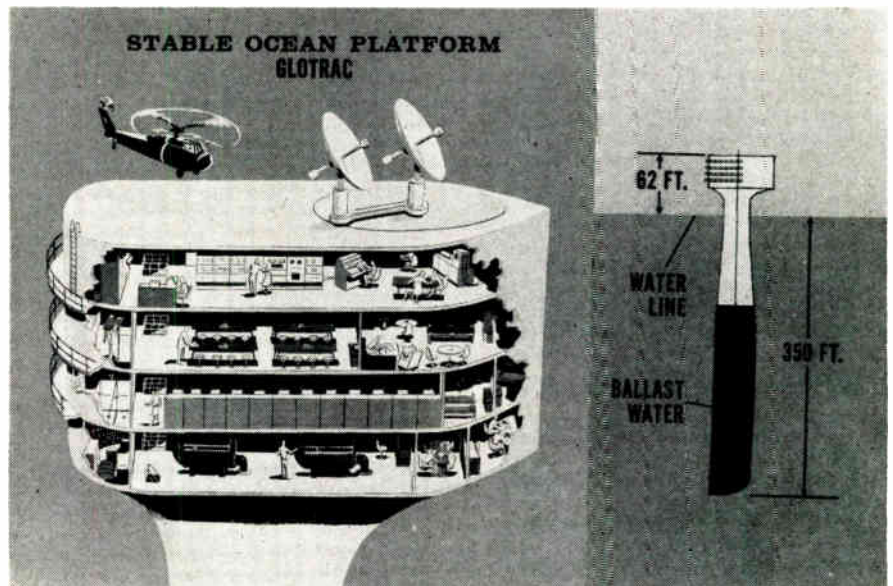

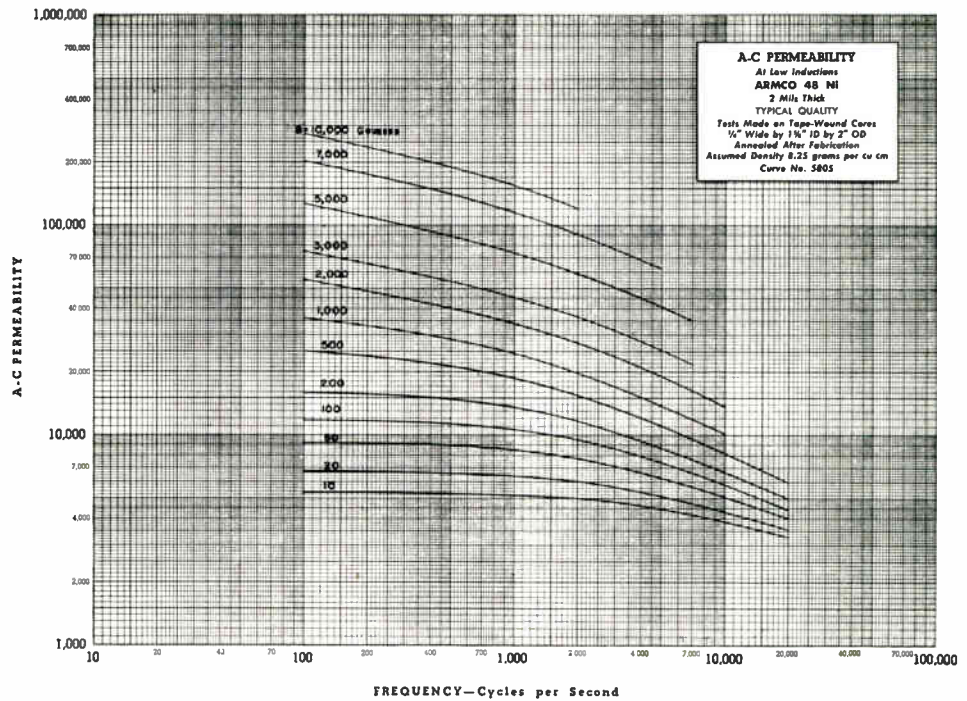

Where You Need High Permeability at Low Inductions, Lower Costs and Up Performance with Armco 48 Ni

For high quality audio and instrument transformers, specialty motors and generators, and other apparatus where high permeability at low inductions is a must, Armco 48 Ni provides a unique combination of advantages.

High Permeability at low and moderate inductions. Its initial permeability is approximately twice that of oriented silicon steels.

Low Hysteresis Loss is assured by precise control in processing this nickel-iron alloy. An exceptionally high Figure of Merit Q , makes it especially suitable for communications equipment.

Extremely Low Coercive Force from a given induction expands the design advantages of Armco 48 Ni. In the low and moderate range, it may be less than 30% of that for silicon steel from the same induction.

Use the advantages of this Armco nickel-iron magnetic alloy to decrease core size and weight as well as energy losses of the equipment you manufacture. Write us for more information on Armco 48 Ni or 48 ORTHONIK®, Armco's square loop Ni-Fe magnetic alloy. **Armco Division, Armco Steel Corporation, Dept. A-1193, P. O. Box 600, Middletown, Ohio.**



Armco Division



...the symbol of quality in Zener Diodes

An Investment In Zener Diode Testing That Pays Off For You!

AQL levels, confidence levels, guardbands and other statistical terms used in quality control have one ultimate purpose. To help assure you that each delivered device will meet established specifications.

But statistics do not do the testing. Rather the delivered quality of the device is assured by the accuracy, efficiency and reliability of the testing procedures and equipment used in final test areas.

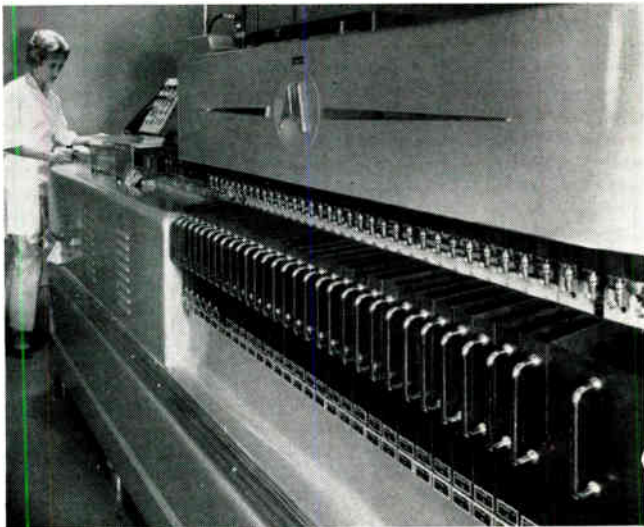

That's why Motorola Mechanization engineers have designed and built many specialized types of automatic final test equipment. One of the latest examples is the new Automatic Parameter Tester used to 100% test axial-lead zener diodes to seven key parameters.

In this one system, some 215 different device categories are tested and classified at a rate of 40,000 units per day. Motorola's APT tester represents two years engineering effort and some \$120,000 in cost.

With such accurate, efficient equipment, made practical by the high volume of devices produced, Motorola has *maximum* assurance that every device entering the quality assurance area meets established specifications. Result... the quality of outgoing units is better than ever! And, indeed, this has been our experience with the introduction of automatic parameter testers used in our Final Test areas.

Just another reason why you can have confidence... at no added cost... in the quality of the zener diodes you buy when they are identified by the symbol 



MOTOROLA

Semiconductor Products Inc.

A SUBSIDIARY OF MOTOROLA INC.

L-43-023

5005 EAST McDOWELL ROAD • PHOENIX 8, ARIZONA

NEWS BRIEFS

Capsule summaries of important happenings in affairs of equipment and component manufacturers

EAST

ELECTRONIC CRYSTALS CORP., Orlando, Fla., subsidiary of **SYSTEMS, INC.**, is building a 7,500 sq. ft. facility at a cost of \$100,000. It will be an addition to the present complex of the parent company at a local industrial park.

UNIVERSAL-CYCLOPS STEEL CORP., specialty steelmaking firm, will install two vacuum arc remelting furnaces at its Titusville, Pa., plant. The furnaces will produce 40-in. dia. ingots weighing up to 50,000 lbs. The furnaces will be controlled by a dual arc system, and the operation programmed by analog program controllers.

POWER COMPONENTS, INC., Scattdale, Pa., will build an 8,500 sq. ft. plant to make semiconductor devices between Scattdale and Mt. Pleasant, in Southwestern Pa. The new plant, besides expanding company facilities for making silicon rectifiers, Zener regulators and variable capacitor diodes, will also provide additional R&D space.

RCA ELECTRON TUBE DIV., Harrison, N. J., has established a **DIRECT ENERGY CONVERSION DEPT.**, responsible for direct energy conversion devices and related materials. These will include thermionic conversion devices, thermoelectric devices for power generation and cooling, solar cells, and superconducting materials and devices.

The **COMPUTER DIV.**, **PHILCO CORP.**, Willow Grove, Pa., has organized an **INSTALLATIONS DEPT.** It will install, maintain and update already installed Philco computer systems.

ESC ELECTRONICS CORP., Palisades Park, N. J., has formed a **FILTER DIV.** to supply custom-designed filters for aerospace and communications equipment. The company now makes custom delay lines for missiles, ground support equipment and computers.

INSTRUMENT SYSTEMS CORP. has opened a 44,000 sq. ft. headquarters plant in Westbury, L. I., N. Y. A corporate headquarters and R&D center, the plant also replaces manufacturing facilities at College Point and Bellmore, L. I. The firm makes precision instruments, microwave and magnetic products.

SUPERIOR MAGNETO CORP., Long Island City, N. Y., has formed a **SEMICONDUCTOR DEVICE DIV.** The firm, which has made ignition systems and components since 1929 has also been manufacturing semiconductor devices for the past year. The new division will soon produce semiconductor rectifiers.

SHIELDTRON, INC., Moorestown, N. J., has merged with **GRANITE STATE MACHINE CO., INC.**, Manchester, N. H., a leading maker of Navy electronic countermeasure antennas and associated control equipment. **SHIELDING DIV.** of the N. J. firm produces r-f shielded enclosures, accessories, clean rooms and anechoic chambers.

HAZELTINE CORP., Little Neck, N. Y., has built an electro-acoustical laboratory and acquired a deepwater test site, both in the Braintree-Quincy, Mass., area. The firm has an electro-acoustical lab in nearby Avon, Mass., employed in developing transducers. The new facilities will also work on sonar equipment for the Navy. The deepwater test facility is a 300 x 400 ft. former granite quarry, over 50 ft. deep, with a floating platform to test acoustical arrays.

ROWE, INC., 58-year-old Clifton, N. J., etching and engraving firm, has formed a division to develop printed-circuit prototypes. The firm will use a camera with 14 and 30 in. lenses, 60 x 80 in. copy board, and a 30 x 30 in. film back to produce circuit patterns accurate within .001 in.

INTERNATIONAL TELEPHONE & TELEGRAPH CORP., New York, N. Y., will acquire **GENERAL CONTROLS CO.**, Glendale, Calif., in an exchange-of-stock transaction, subject to approval of both firms' stockholders.

TELEREGISTER CORP., Stamford, Conn., data transmission service firm, has acquired an 80% interest in **COMPUTER DYNAMICS CORP.**, Silver Spring, Md., a company specializing in computer systems analysis, programming and operating services.

The Navy has selected **HAZELTINE CORP.**, Little Neck, N. Y., as the first firm to develop and produce the "minibuoy" for the Navy's ASW program. This miniature sonobuoy (AN/SSQ-42) will be 3 in. in dia. x 21 in. long. (Standard sonobuoys are 5 x 36 in. or larger.) Reduced size and weight will enable ASW aircraft to carry more than twice as many sonobuoys as they do now. This minibuoy will also let the Navy select the depth at which the hydrophone will be drapped to detect underwater sounds.

E. I. DOUCETTE ASSOC., Chatham, N. J., has formed a **FILM COMPONENTS DIV.** under R. S. Ringer. The new EIDA division is developing a line of quality precision film resistors with hermetic seals and is producing silvered mica elements for special capacitor applications.

LABORATORY FOR ELECTRONICS, INC., Boston, Mass., has established an **ADVANCED COMPONENT OPERATION.** The new group will design and make advance design filters, input and output amplifiers and proportional temperature controllers. It will also absorb LFE's Delay Line Dept., producer of ultra-sonic quartz, mercury and glass delay lines and associated electronic circuitry.

LITTON INDUSTRIES has acquired **WINCHESTER ELECTRONICS, INC.**, Norwalk, Conn., connector manufacturer, in an exchange-of-stock transaction. The Norwalk firm, which has three plants in Connecticut and one in Santa Monica, Calif., and \$10 million annual sales, will operate as part of the Litton **ELECTRONIC COMPONENTS GROUP.**

BURROUGHS CORP. will manufacture its own magnetic ferrite cores for its commercial and defense computer systems. The cores will be produced at the company's **ELECTRONIC INSTRUMENTS DIV.** in Philadelphia to meet needs of Burroughs computer facilities in suburban Philadelphia, Detroit, and Pasadena, Calif.

GULTON INDUSTRIES, INC., Metuchen, N. J., power supply and power conversion equipment manufacturer, has acquired **ELECTRONIC ENERGY CONVERSION CORP.**, New York City and Long Island maker of solid-state power supplies.

NATIONAL RESISTRONICS, INC., Pearl River, N. Y., has established a new division to make precision components for instruments. The division, to be housed in a new facility recently leased by the company in Yonkers, N. Y., will make resistors, networks, and also some instruments of primary standard quality.

COMMUNICATIONS & ELECTRONICS DIV., **PHILCO CORP.**, Philadelphia, Pa. has received a \$750,000 Air Force contract to develop an electronic file data conversion system for type-written and printed documents. It will use a general purpose print reading device that Philco is developing.

TIMELY TECHNICAL PRODUCTS DIV., **FLUOROCARBON CO.**, has moved into a new 20,000 sq. ft. 1-story plant in Pine Brook, N. J. The division, which along with its parent company processes fluorocarbon plastics, will continue to operate its old 8,000 sq. ft. plant in Verona, N. J.

An **INTEGRATED SPACE & LIFE SYSTEMS DEPT.** has been formed by **UNITED AIRCRAFT'S HAMILTON STANDARD DIV.**, Windsor Locks, Conn. Among major programs which will be consolidated into the department are the Project Apollo space suit, the environmental control system for the lunar excursion module, and several NASA bio-scientific programs.

ELECTRO-MECHANICAL RESEARCH, INC., Sarasota, Fla., maker of telemetry equipment, has acquired **ADVANCED SCIENTIFIC INSTRUMENTS, INC.**, Minneapolis, Minn., computer manufacturer. ASI will be operated in Minneapolis as a division of the Florida firm.

FAIRCHILD CAMERA & INSTRUMENT CORP. has changed the name of its **DEFENSE PRODUCTS DIV.**, Syosset, L. I., N. Y., to **FAIRCHILD SPACE & DEFENSE SYSTEMS.** FSDS also has plants in Los Angeles, and Palo Alto, Calif. It produces photo and data handling systems for reconnaissance and mapping, and other electronic, optical and mechanical equipment for aerospace, ground and marine applications.

BENDIX BALZERS VACUUM, INC., a Delaware organization, has been formed to design, build and sell high-vacuum equipment. The firm is owned by the **BENDIX CORP.** and **BALZERS A. G.**, of Switzerland, a firm known for high-vacuum equipment and thin-film technology. Capitalization is \$5 million, with Bendix the major stockholder.

PLATRONICS, INC., has formed a new **GLASS-TO-METAL SEALS MFG. DIV.** Located at the recently completed 20,000 sq. ft. addition to the Platronics plant, Linden, N. J., the new division will produce seals for components, including diodes, transistors, relay headers, crystal bases and capacitors, at 1 million units per day.

RESEARCH ANALYSIS CORP., Bethesda, Md., has established a **SYSTEMS ENGINEERING DIRECTORATE.** Working under an Army contract, it will study engineering of current weapons and those under development.

MID-WEST

HALLICRAFTERS CO., Chicago, Ill., has purchased 17 acres near Wilton, Conn., for its wholly owned subsidiary, **MASON LABS, INC.**, which produces military communications equipment. The facility built there will have R&D and production facilities.

BASIC PRODUCTS CORP. has purchased **DAVENPORT MFG. DIV.**, **DUNCAN ELECTRIC CO.**, Chicago, Ill., and integrated it into its **SOLABASIC RESEARCH DIV.** The acquired division will continue to have its production facilities at 4643 W. Montrose Ave., Chicago. It produces high-voltage ac and dc power supplies and test equipment.

MINNEAPOLIS-HONEYWELL REGULATOR CO. has decided to follow popular practice and call itself just **HONEYWELL.** The legal title is not being changed, but the briefer version will be used in all its public communication, except legal documents such as contracts, checks and stock exchange listings. The firm's telephone numbers will be listed under "H," rather than "M" in 1963. Telephone listings, and stationery have been redesigned accordingly.

CONTROL DATA CORP., Minneapolis, Minn., has announced plans to acquire the **COMPUTER DIV.**, **BENDIX CORP.**, under an agreement between the two firms. The Minneapolis firm will acquire the Bendix division in a cash-stock transaction for
(Continued on page 33)

another "Vitramon" First!

A High Reliability "Darnell Type" Specification for Ceramic Capacitors

S-1003

Here, at last, is *documented* quality assurance for ceramic capacitors. High Reliability Specification S-1003 is a sequential life testing program based on the Ad Hoc Committee Report that assures maximum reliability at a minimum of cost.

S-1003 requires acceptance testing of our "VK" ceramic capacitors for all common and environmental parameters with inspection lots restricted to units of the same size and voltage rating. Each lot produced undergoes a 2000-hour life test, while 10,000-hour life tests are performed on a routine basis.

What does this mean for you? It means that *now* we can offer you high reliability parts better than Mil-C-11015. *Now* we can provide *statistical proof* of maximum failure rates prior to shipment. *Now* we can offer the quality assurance you require without charging the high cost of custom testing.

For the complete story, write for High Reliability Specification S-1003.

© Vitramon, Inc. 1963

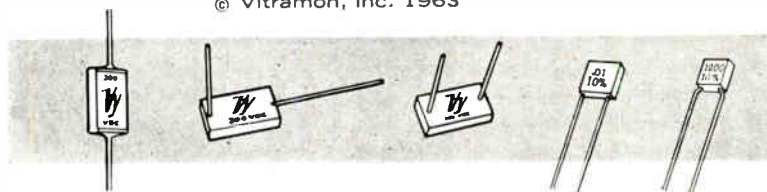

Vitramon
INCORPORATED

Box 544 • Bridgeport 1, Connecticut

**soldering
irons**

319

american beauty

A-mer'i-can Beau'ty (a-mēr'i-kān bū'tī), *n.* Brand of electric soldering irons used

American Beauty
MADE IN ONE QUALITY ONLY... THE BEST

in most U.S. industrial soldering departments. Manufactured since 1894 by American Electrical Heater Company. **a-vail'a-ble** (ā-vā'l'ā-b'l), *adj.* Ready; handy. Example: A. B. Soldering Irons —available from qualified distributors throughout civilized world. (You can always get genuine A. B. replacement parts.)

one (wūn), *adj.* Single in kind. As in American Beauty's motto, "Made in one quality only—the best".

va-ri'e-ty (vā-rī'ē-tī) *n.* A varied assortment. As in American Beauty Irons, available in dozens of different models, sizes and types.

in'de-struct'i-ble (in'de-strūk'tī-b'l), *adj.* Not destructible. For example, it is common for A. B. Irons to give 100% service after decades of daily use.

min'i-a-ture (mīn'ī-ā-tūr), *n.* On small scale; as in B-Series electric soldering irons developed by American Beauty for electronics and missiles industries. (Illustrated on facing page.)

par'a-gon (pār'ā-gōn), *n.* A type of perfection; as in American Beauty's "Paragon" Quality Soldering Tips; outlast previous tips up to 10 to 1; retain themselves; no scal-

electric soldering irons

ing; drip-proof; freeze-free. **spec'i-fi-ca'tion** (spēs'i-fī-kā'shūn), *n.* Designation of particulars; such as "contract specifications" in electronics industry. Soldering "specs" are often so high that equipment of American Beauty quality is used to keep rejects at minimum.

feel fēl, *n.* Feeling; perception by sensations. An important factor in choosing soldering irons, some of which are used delicately as a writing pen, often under magnification.



com'fort (kūm'fōrt), *n.* Freedom from pain or trouble. For example, among soldering workers, those using A. B. Irons, which are scientifically balanced, heat insulated, comfort contoured.

au-thor'i-ty (ō-thōr'ī-tī), *n.* One appealed to in support of opinions, actions. Authority for authentic, technical information on soldering equipment is your American Beauty Distributor.

dem'on-str'a-tion (dēm'ūn-strā'shūn), *n.* Showing of product's merits. As, demonstration of any American Beauty product; available immediately by contacting your A. B. distributor.

cat'a-log (kāt'ā-lōg), *n.* Articles arranged in order; as in American Beauty's new 24-page catalog. (For yours, write American Electrical Heater Company, 6110 Cass Avenue, Detroit 2, Michigan.)



Free A. B. Catalog



"Paragon" Quality Tips

Modern soldering iron is a precision instrument. Shown: American Beauty B-2000; 7" long; weighs 3 oz.; produces 750°F. heat at 22 1/2 watts. (Resistance wire in heating element is finer than human hair.)





***in national defense—the words
“reliability” and “necessity” are synonymous***

■ With the Strategic Air Command at *instant readiness*, any break in communications could seriously impair its total defense capability—and possibly also our national survival. To achieve the unusually high reliability demanded in this critical military application, Electronic Communications, Inc., uses Allen-Bradley Type G controls in the airborne transmitters they build for the SAC.

In the Type G control, the solid resistance element, collector track, terminals, and insulating material are hot molded into a single, solid structure that—for all practical consideration—is indestructible. In addition, molded contact brushes are used—no sliding metal contacts. This design assures a low initial noise factor, which

actually improves with use. There's virtually infinite resolution—so control is always smooth and completely devoid of sudden changes in resistance during adjustment.

A-B Type G potentiometers are rated 0.5 watt at 70°C, and will operate reliably in ambient temperatures from -55°C to +120°C. Also, the operational life exceeds 50,000 cycles with less than 10% resistance change. They can be furnished in maximum resistance values from 100 ohms to 5 megohms. For full details on these quality controls, please write for Technical Bulletin B5201. Allen-Bradley Co., 1342 S. Second St., Milwaukee 4, Wisconsin. In Canada: Allen-Bradley Canada Ltd., Galt, Ontario.

ALLEN-BRADLEY TYPE G HOT MOLDED VARIABLE RESISTORS
Shown Actual Size



TYPE GWEL
WITH ENCAPSULATION



TYPE GWP AND LWP
WITH WATERTIGHT PANEL SEAL



TYPE GWL AND LWL
WITH LOCKING BUSHING



TYPE GWX
WITH LINE SWITCH



Electronic Communications' AN/ART-42 UHF 1 KW AM/FM Transmitter in service with the SAC, and internal view showing use of A-B's Type G controls.

ALLEN-BRADLEY
QUALITY ELECTRONIC COMPONENTS

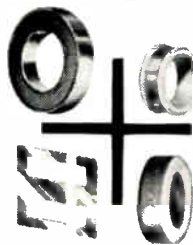
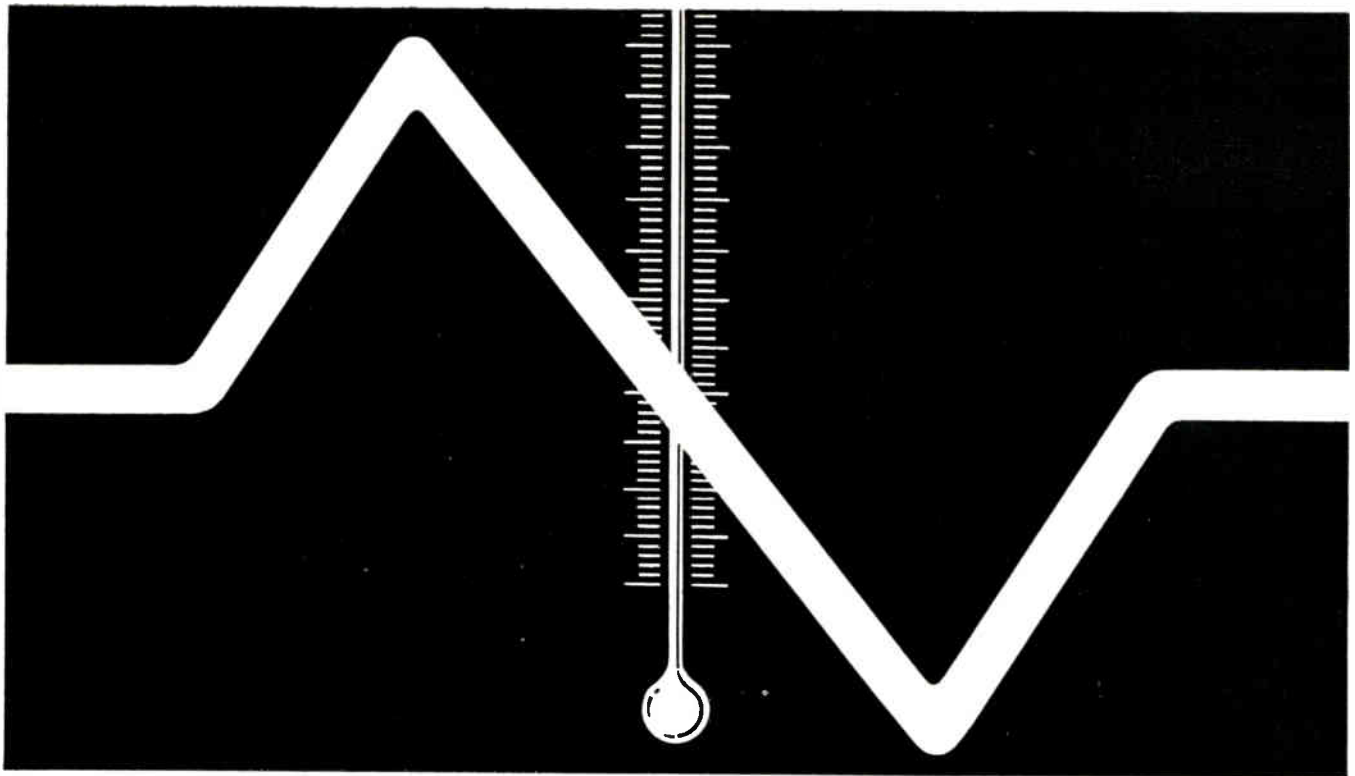

Compensating for temperature extremes? Get more from magnetics

THE CORE: Tape wound cores of Supermendur in GVB or anodized aluminum boxes perform well at temperatures as high as 200°C, and are ideal for many military applications. A good choice for lower frequency filters when *temperature extremes* are encountered may be an inductance stabilized 160 mu moly-permalloy core. When using linear permalloy powder cores with polystyrene capacitors for audio filter networks, you'll find that *temperature fluctuations* have little effect on frequency stability, even when those fluctuations range from -55°C to +85°C. Finding exactly the right core for the application has been known to take development time, many guesses and some costly over-engineering. Best way to solve the problem is to give it to the *man from Magnetics Inc.* next time he's nearby. He likes to help solve brain-teasers that make use of his specialized experience.

THE MORE: Though Magnesil® tape cores have a temperature range as high as Supermendur, the latter has a higher flux density. As a result, Supermendur makes possible size and weight reduction. When using linear permalloy cores with polystyrene capacitors instead of temperature stabilized moly-permalloy and silvered mica capacitors for filters, you can reduce costs as much as 50%—proof that searching for the right components for your specific application can mean real economy and better performance. We can help, since we produce and stock hundreds of laminations, flake, powder, bobbin and tape wound cores. Thus, we can provide the technical data and service often needed in design and selection. If you have a sticky problem now and can't wait to talk to the *man from Magnetics Inc.*, write details on your letterhead to Magnetics Inc., Dept. EI-8 Butler, Pa.

TOTAL ASSISTANCE, SERVICE, SELECTION/GET THE MORE FROM MAGNETICS

MAGNETICS inc.

NEWS BRIEFS

(Continued From page 28)

something less than \$10 million, and will continue producing the Bendix computer line.

DELCO RADIO DIV., GENERAL MOTORS CORP., Kokomo, Ind., has received a NASA contract for 17 binary coded decimal time verification systems for use around the world in the U. S. space program. The systems will automatically check recorded time information received from orbiting spacecraft, verifying when it is correct.

WEST

MICRO-RADIONICS, INC., Van Nuys, Calif., maker of microwave components and ground support test equipment, has acquired **REMANCO, INC.**, Santa Monica, Calif., maker of simulation instruments. Remanco will be integrated into M-R-I's Van Nuys plant, which will then turn out a broadened line of test equipment and instruments.

AUTO DATA, San Diego, Calif., digital instrument firm, has been purchased by **HOUSTON INSTRUMENT CORP.**, Houston, Tex. **CAPITAL SOUTHWEST CORP.**, Dallas small business investment company, financed the transaction.

DANA LABORATORIES, INC., newly founded Santa Ana, Calif., instrument manufacturing firm, is being 40% financed by the **DU PONT CO.**, Wilmington, Del. The funds will be used to make and market aerospace and medical products developed by Dana, including dc amplifiers for test and data gathering systems and a digital voltmeter series for lab and production use. All the instruments are based on solid-state components and circuitry.

MISSION MFG. CO., Houston, Tex., has acquired control of **INTERNATIONAL CONTROLS CORP.**, also of Houston, which makes automatic control systems for petroleum and gas transmission. ICC will be operated as a subsidiary of Mission, which makes tools and other equipment for the petroleum and related industries.

LP ASSOC., INC., a microwave specialty firm, has been formed in Los Angeles. It will make some of its own products and sell certain product lines developed by **QUANTATRON, INC.**, Santa Monica, Calif., microwave firm. The new firm will offer specialized equipment and services in antennas, parametric amplifiers, solid-state frequency multipliers, ferrite devices, pulse modulators, linear accelerator components and in many other areas.

WESTERN DIV., FILTRON CORP., Culver City, Calif., has moved its Northern California plant from Palo Alto to Mountain View. Filtron manufactures RFI components and shielded rooms. Equipment prototype production and testing will be done at the new plant.

KOLLSMAN INSTRUMENT CO., Elmhurst, N. Y.; **FILTRON CO.**, Culver City, Calif.; **INSTRUMENT CORP. OF AMERICA**, a Florida firm and **LEAR-SIEGLER DATA & CONTROL DIV.**, Los Angeles, Calif., have received a team contract award from the Air Force for photo mapping systems. Two initial prototype systems, including mapping cameras, inertial navigation systems, data recording equipment and supporting electronics, will be built. Follow-on quantities were not disclosed. The total project may cost \$50 million.

VITRO CHEMICAL CO. will produce vanadium oxide and related products at its manufacturing plant in Salt Lake City, Utah. Formerly the plant was used solely for processing uranium ore. Now the two operations will be alternated.

The name of **CARAD CORP.**, of Palo Alto, Calif., 95% of whose stock was recently acquired by **POWER DESIGNS, INC.**, of Westbury, L. I., N. Y., has been changed to **POWER DESIGNS PACIFIC, INC.** The eastern firm makes precision low-voltage power supplies, while the Palo Alto company makes high-voltage supplies.

THERMOFIT®

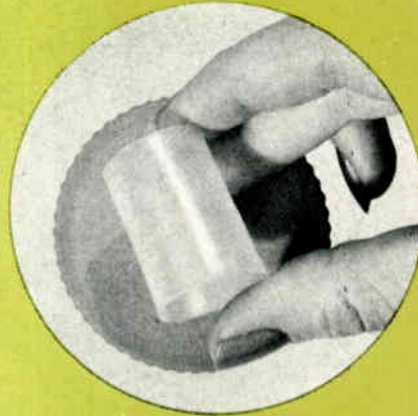

CR THIN WALL



Capacitors

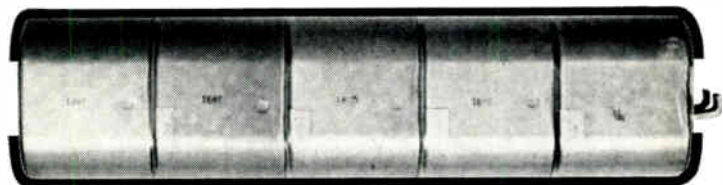

Battery

A CLEAR HEAT SHRINKABLE SEMI-RIGID THIN WALL TUBING

Thermofit CR Thin Wall Tubing is available with expanded diameters of .200" to 2.000" and wall thicknesses of .010" or less. Its high strength and shrink ratio combined with its thin walls and clarity make it an extremely attractive product for encapsulating tantalum and electrolytic capacitors, nickel cadmium batteries and other components requiring a clear protective insulator.



**RAYCLAD TUBES
INCORPORATED**
REDWOOD CITY, CALIFORNIA

A SUBSIDIARY OF **RAYCHEM CORPORATION**

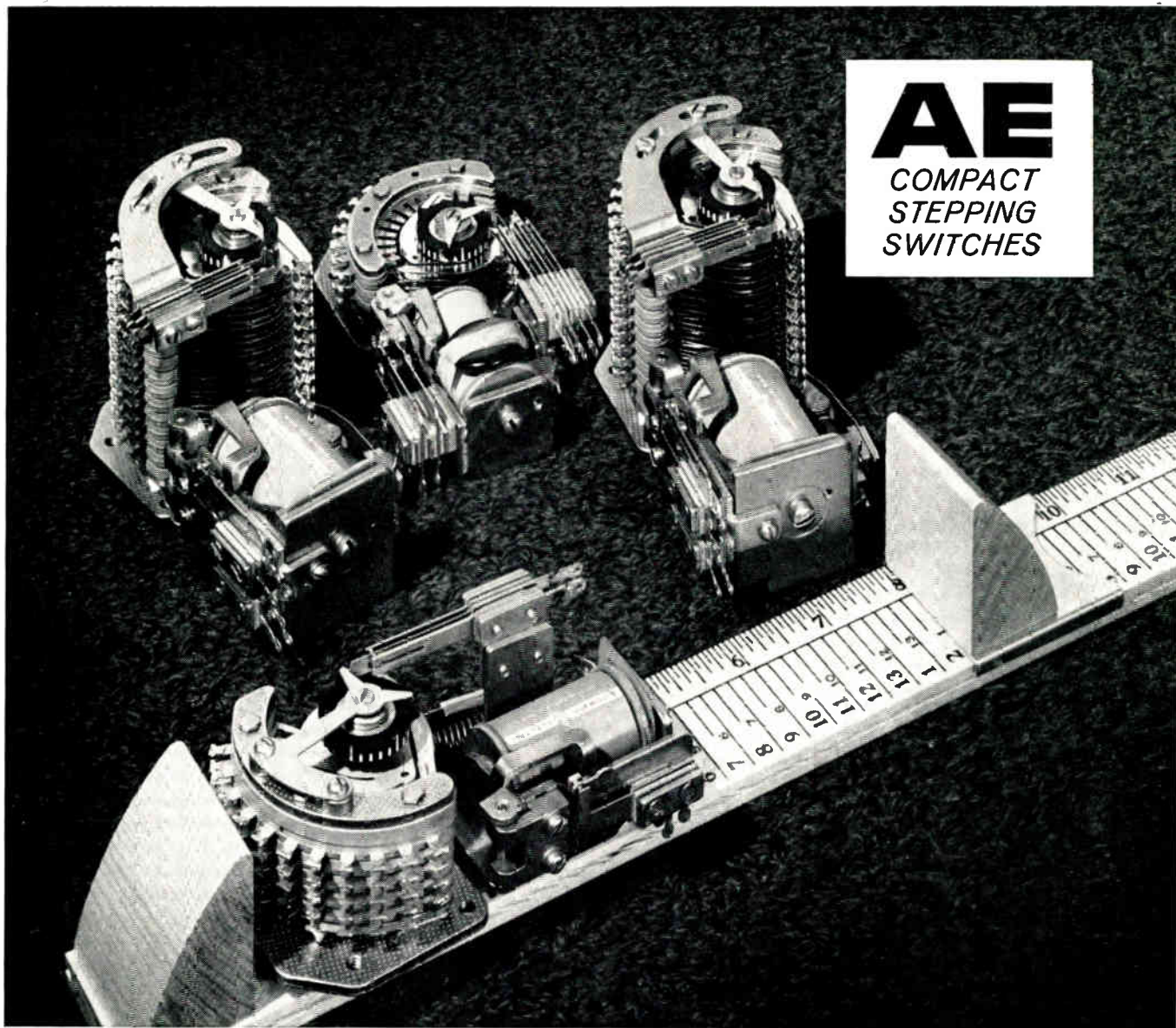

AE

COMPACT
STEPPING
SWITCHES

Four compacts to fill big shoes

If you're in search of a switch to handle a large transfer, cycling or counting job in a small space, you can count on one of AE's four compacts to do the job. For instance, the stepping switches, from left to right in the photo, have these features:

Type 40 (in foreground) is no larger than a pack of king-size cigarettes. It is a decimal switch with up to five bank levels, but only 10 points per level, so no extra steps must be taken when counting decimally.

Type 80 is a larger-capacity version of the Type 40, with from six to twelve 10-point levels.

Type 44 is available with up to eight 10-point levels (with

11 points on all levels where specified).

Type 88 is a larger-capacity version of the Type 44, with from six to twelve 10-point levels (with 11 points on all levels where specified).

All four AE compact steppers offer *positive positioning*—an exclusive design feature that makes overthrow impossible, and *locks* the rotor in the correct position.

AE compact stepping switches are available in numerous variations, many directly from stock.

For full information, ask for Circular 1698-K. Write to the Director, Control Equipment Sales, Automatic Electric, Northlake, Illinois.

AUTOMATIC ELECTRIC

Subsidiary of
GENERAL TELEPHONE & ELECTRONICS



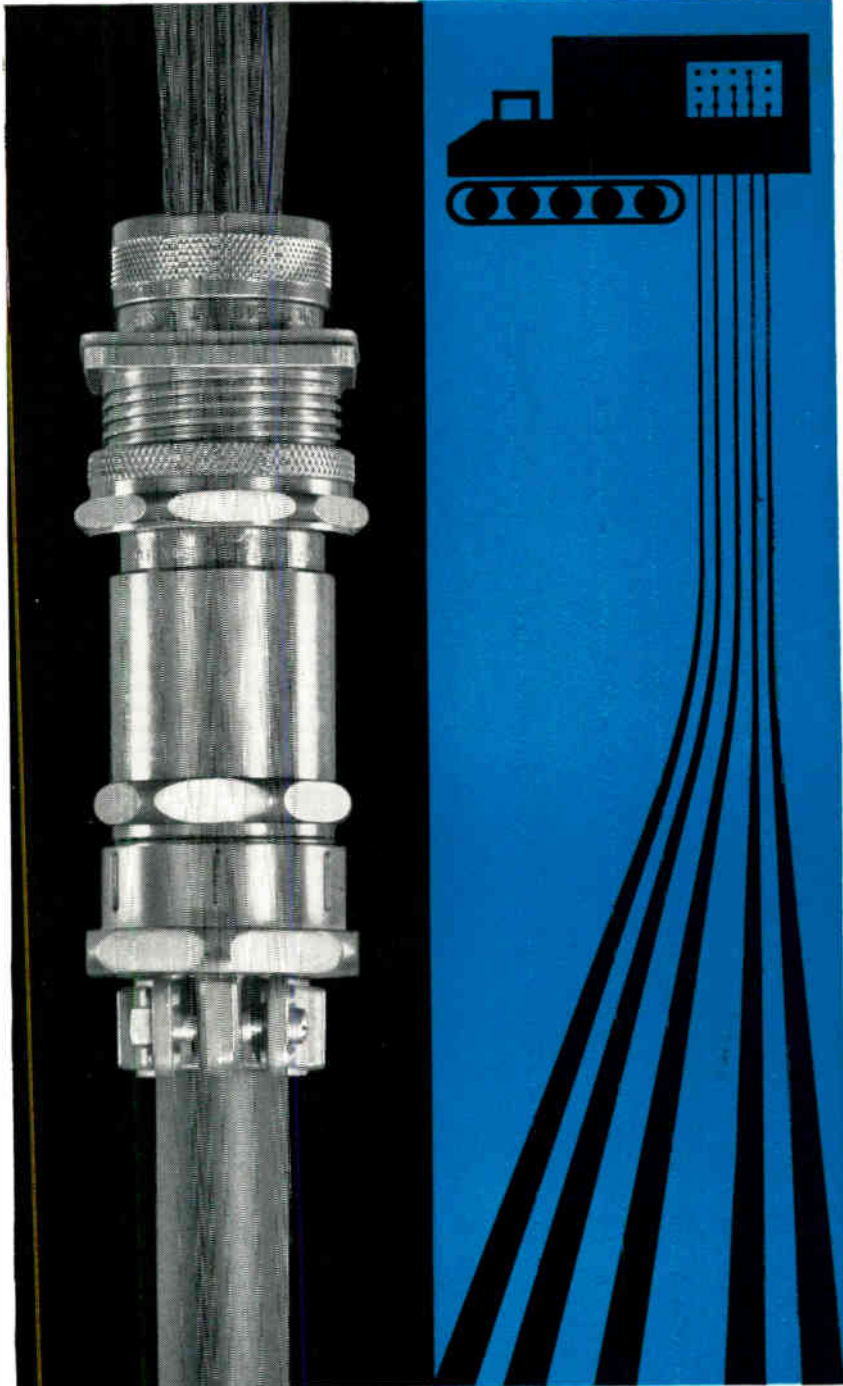

WHERE ENVIRONMENTAL CONDITIONS ARE AT THEIR WORST, PYLE-STAR-LINE® CONNECTORS ARE AT THEIR BEST. Rugged, Neptune Series (ZSM) heavy-duty connectors are designed to withstand the most severe operating conditions . . . to resist shock, vibration, and pressure. These compact, lightweight connectors perform with outstanding reliability under environmental extremes of temperature, humidity, moisture, dust, oil, and corrosive atmospheres.

An extensive variety of contact configurations is offered in MOD I, captive contact, inserts; and MOD II, push-in crimp-type removable contact, inserts.

Now also being offered is MOD III inserts with collet retained, rear entry and release contacts, in sizes No. 18 to No. 4/0.

A wide choice of cable and installation accessories enable these versatile connectors to be easily adaptable for ground support equipment, electronic packaging and cabling, electrical control, power, and communications. Hardware having RFI shielding capabilities is also available.

Design features include: reversible inserts for plug or receptacle shells, positive self-sealing insert construction, closed-entry rigid socket insulators, and closed-entry socket contacts. Power inserts have circuit-breaking capabilities, and are U.L. listed. Years of field-performance have proven Pyle-Star-Line reliability to provide electrical and mechanical capabilities for the roughest and toughest assignments. Write today for complete technical data, and information on our engineering service.



CONNECTOR DIVISION, THE PYLE-NATIONAL COMPANY, 1334 NORTH KOSTNER AVENUE, CHICAGO 51, ILLINOIS

ALSO MFG. IN CANADA BY: PYLE-NATIONAL (CANADA) LTD., CLARKSON, ONTARIO

Pyle-National

ELECTRICAL CONNECTORS LIGHTING EQUIPMENT CONDUIT FITTINGS



rugged CK8167/4CX300A ceramic power tetrode now available from Raytheon!

Maximum Ratings	Class AB ₁		Class C	
	AF Power Amp. or Mod.	RF Linear Pwr. Amp., SSB	RF Pwr. Amp. & Osc.	Plate Mod. RF Pwr. Amp.
E _b (volts)	2500	2500	2500	1500
I _b (amps)	0.250	0.250	0.250	0.200
P _p (watts)	300	300	300	200
P _{g2} (watts)	12	12	12	12
P _{g1} (watts)	2	2	2	2
Typical Operation				
E _b (volts)	2500	2500**	2500**	1500
E _{c2} (volts)	350	350	250	250
I _b (amps)	0.500*	0.250	0.250	0.200
Drive (watts)	0	0	2.8	1.7
P.O. (watts)	800*	400	500	235

*two tubes—push-pull **below 250 mc only

The CK8167/4CX300A is now available from Raytheon. This compact, all ceramic-metal external anode tetrode is designed and manufactured to deliver outstanding, reliable performance under conditions of high temperature and severe shock and vibration. With a full maximum plate dissipation rating of 300 watts and a capability to perform at 500 mc, the Raytheon CK8167/4CX300A is ideal as an RF power amplifier, oscillator, linear amplifier, AF amplifier or modulator.

For complete technical data and sales information please write: Raytheon Company, Industrial Components Division, 55 Chapel Street, Newton 58, Massachusetts. For small order or prototype requirements, see your local Raytheon franchised distributor.

RAYTHEON

Circle 18 on Inquiry Card

NASA COSTS WORRY CONGRESS—Rapidly rising NASA costs worry Congress. Trouble is, all of NASA's programs are rated "essential," and Congress is reluctant to trim any of them—much less to erase any—for fear of slipping behind in the space race. But the widening gap between cash income and outgo in the Kennedy budget is a cause for grave concern, and it is obvious that some cuts in the overall budget for fiscal 1964 will have to be made. What to expect at NASA: A close look by Congress at any NASA programs or projects that duplicate each other, even in part. How NASA has grown: In 1960, the agency's budget was a mere \$800 million. For 1964, it's \$6 billion. By 1970, it may be \$13 billion.

SINGLE BUYER FOR ELECTRONIC PARTS

—Some 100,000 standard electronic-electrical parts and components have been added to the list of items now purchased for all military services by the Defense Supply Agency. The items are only standard components, including such things as electrodes, cables, insulators, lugs and wire assemblies. No items which are peculiar to any of the specialized equipment of any of the services are included.

WORKERS ASK IMPORT CURB—Acting under the new Trade Act, workers at the Sandusky, Ohio, Philco Corp. plant producing transistor radios, have asked the U. S. Tariff Commission to protect their jobs from foreign imports. The Commission scheduled a hearing in Washington on whether radios are being imported "in such increased quantities" as to threaten these workers' jobs. The new trade law provides that the Government can raise tariff or impose quotas on foreign goods which are putting any large group in the U. S. plant out of work, or threatening to do so.

EXPAND TECHNICAL INFORMATION

—NASA's Industrial Applications Div., which spots space research with possible commercial uses, has become part of a stepped-up program to increase uses of NASA's scientific and technological advances. The Industrial Applications Office becomes the Office of Technology Utilization under the new program. NASA will coordinate the work of OTU with its Office of Scientific and Technical Information so industrial applications can be identified and passed on to private companies.

BACK COMPUTER PURCHASES—Congress is being asked to force government agencies to adopt a report of government auditors that more computers be purchased, rather than leased. Rep. Jack Brooks (D., Texas), has introduced a bill which would give the General Services Administration power to decide whether computers and related equipment should be purchased or leased. At present, each agency makes its own decisions. The bill is an outgrowth of a recent report by the General Accounting Office which found that of 1,006 computers being used by the government, 86% (867) were leased. Rental payments totaled \$145 million a year. The government auditors claim that savings by buying about 500 of the computers would total about \$148 million over five years, and would exceed \$100 million per year after that. The auditors also suggest a new central management office be set up to make sure ADP equipment is fully utilized.

SEEK TIGHTER INDUSTRIAL SECURITY

—Fresh demand is being made for stricter industrial security law to protect classified information released to defense contractors. Several attempts to adopt tighter industrial security act have been made in recent years, but all have fallen short, usually after House passage. Renewed bid is being made by the House Un-American Activities Committee, headed by Rep. Francis Walter (D., Pa.). Move is aimed at reestablishing industrial security program in force prior to a U. S. Supreme Court decision of 1959, which struck down the basis on which security classification could be denied a defense plant worker. Decision was based on a lack of specific Congressional or Presidential authorization for program. Since then, a Presidential order has been issued, but the Committee believes Congressional approval still is needed to sanction a tough program.

U. S.-RUSSIAN WEATHER TELETYPE SET

—Weather, a factor in military planning, could pave the way for easing of cold war tensions. Recent announcement of a direct weather teletype link between Russian and U. S. Weather Bureaus may get the ball rolling. NASA's Hugh Dryden agrees new weather communications tieup could lead to bigger things. For the time being, however, circuit will be used to compare notes of U. S. and Russian weather satellite experiments.

From this new pulse generator...





with these features:

Length, delay continuously adjustable!
Constant 50 ohm output impedance!
Rise, decay time less than 1 nsec!

New  215A Pulse Generator is the ideal instrument for measuring switching, recovery and storage time of diodes, transistors and thin film memory units. The 215A is useful for locating reflection sources in transmission and delay lines, measuring electrical length of cables, determining step response of circuits.

The 215A gives you clean pulses with 1 nanosecond rise and decay time. Constant 50 ohm output impedance, during all portions of pulse, allows operation into any load with freedom from multiple reflections. Calibrated front panel controls adjust pulse length from 2 to 100 nanosec-

onds, attenuation from 1 to 12 db, and delay, —10 to 140 nanoseconds after trigger output pulse. Positive and negative pulses are selectable from front panel.

Trains of pulses, either internally or externally triggered, can be generated by gating the pulser with a +1 volt signal. Internal repetition rate is 100 cps to 1 mc or pushbutton for single pulses. Pulses can be triggered by an external 10 cps to 1 mc source. Count down circuitry permits synchronization on external signals up to 100 mc. Solid state design makes the  215A compact, rugged and reliable.

Write or call your hp rep or Hewlett-Packard direct for a demonstration on your bench.

SPECIFICATIONS

Rise time:	Less than 1 nsec	External trigger:	Input voltage 1 v peak-to-peak; pulses 0 cps to 1 mc, 30 nsec min. duration; sine waves 10 cps to 1 mc; synchronizes to 100 mc. 1 μ sec min. pulse spacing for random repetition rate
Decay time:	Less than 1 nsec	Output impedance:	50 ohms
Output:	At least 10 v peak into 50 ohms 20 v peak open circuit	Gate input:	+1 v to turn on
Polarity:	Positive or negative, selectable	Trigger output:	Amplitude, at least 1 v peak into 50 ohms, either polarity; rise time, better than 5 ns; duration, approximately 50 nsec
Attenuator:	1 to 12 db, calibrated	Dimensions:	5 $\frac{1}{2}$ " high, 16 $\frac{3}{4}$ " wide, 18 $\frac{3}{8}$ " deep. Converts to rack mount with furnished brackets. 33 lbs.
Pulse length:	Continuously adjustable, 2 to 100 nsec, calibrated dial	Price:	\$1,875.00
Pulse delay:	Continuously adjustable, —10 to 140 nsec after trigger output pulse, calibrated dial		
Internal repetition rate:	100 cps to 1 mc or pushbutton for single pulses		

Data subject to change without notice. Price f.o.b. factory.

HEWLETT-PACKARD COMPANY

1501 Page Mill Road, Palo Alto, California, Area Code 415, DA 6-7000
Sales and service representatives in all principal areas
Europe, Hewlett-Packard S.A., 54-54bis Route des Acacias, Geneva
Canada, Hewlett-Packard (Canada) Ltd., 8270 Mayrand St., Montreal



An Announcement of Major Importance Concerning a NEW Capacitor

Never before, such a combination of performance characteristics in a tantalum capacitor—solid or wet.
Never before, such a combination of performance characteristics in ANY capacitor—of this size and weight.

Hi-VolTan

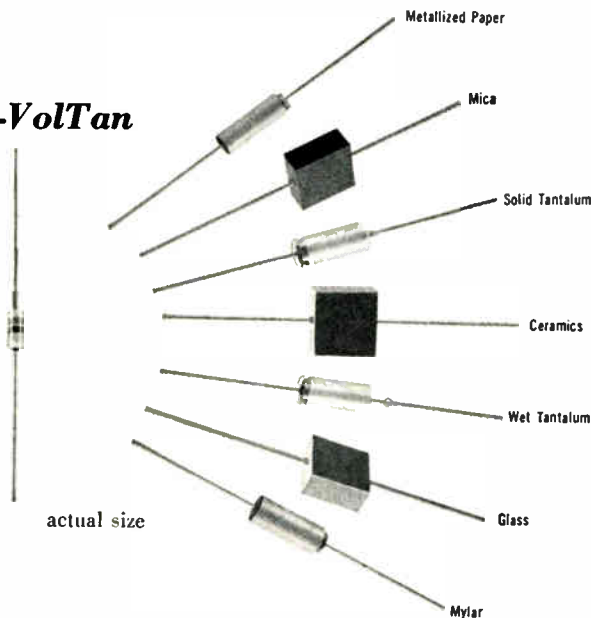

GENERAL INSTRUMENT has developed and is now offering for sale an entirely new kind of capacitor—the “Hi-VolTan”®.

Hi-VolTan is not a wet electrolyte tantalum unit. It is not a “solid” electrolyte tantalum device. Uniquely, it is a tantalum capacitor with NO ELECTROLYTE AT ALL. The cathode connection to the oxide dielectric is metallic—not electrolytic nor semiconductive. Since there is no electrolyte, there is no electrolytic ionization—and, therefore, no built-in potential for instability.

Probably the best way to describe this breakthrough in capacitor technology is by comparing Hi-VolTan with other types of capacitors:

Hi-VolTan vs. Solid Tantalum

No solid tantalum capacitor can withstand 200 V test (breakdown) voltage, and 125 V working voltage—Hi-VolTan does. Moreover, Hi-VolTan is smaller and lighter, with far higher Q (greater than 150 @ 1000 cycles), lower leakage (higher dielectric resistance—more than 100,000 megohms @ 100V) . . . and with substantially greater stability of parameters with variations in temperature, frequency and voltage, plus greater reverse voltage capability.

Hi-VolTan vs. Wet Tantalum

Compared with wet tantalums, all of Hi-VolTan’s advantages over solid tantalums apply in even greater degree, except the voltage capability which wet tantalums do match.

Hi-VolTan vs. Mylar

Hi-VolTan, with only one-tenth the volume and one-sixth the weight, offers operating characteristics equal to those of Mylar . . . plus significantly higher storage temperatures.

Hi-VolTan vs. Metallized Paper

Again, with only one-seventh the volume and one-seventh the weight, Hi-VolTan offers equal operating characteristics . . . plus higher Q (better Dissipation Factor) . . . plus higher storage temperatures . . . plus lower temperature coefficient.

Hi-VolTan vs. Ceramics

Hi-VolTan, in addition to its substantial size and weight advantages over ceramics, has higher stability which is especially impressive in terms of three parameters: capacitance, dissipation factor, and leakage, under widely varying conditions of temperature, frequency and/or voltage. Parameter changes in the Hi-VolTan are, in fact, the smallest of any comparable capacitor; moreover (unlike ceramics) these extremely small variations are uniform, smooth and predictable.

Hi-VolTan vs. Mica and Glass

If size and weight in your circuit are of little consequence, mica and glass need not be replaced by Hi-VolTan. But, certainly, in any case, Hi-VolTan’s characteristics should be carefully evaluated.

Hi-VolTan — Range and Characteristics

Type	Case Size	Weight ozs.	Capacitance Range-mmf	Volts D.C. Operating 85°C	D.F. @ 1000-25°C	% Cap. Change		Insulation Resistance Megohms @ 25°C
						-55°C to 25°C	25°C to 85°C	
HVT-A*	.065”D x .183”	.004	400-3000	125	.005	2	2	150,000 @ 100V
HVT-B	.065”D x .183”	.004	400-3000	100	.005	2	2	100,000 @ 100V
HVT-C	.065”D x .183”	.004	3100-5000	50	.007	3.5	3.5	100,000 @ 50V
HVT-D	.065”D x .183”	.004	5100-10000	25	.009	4.5	4.5	100,000 @ 25V

*For 125°C operation, derate operating voltage by 30%.
*All HVT-A capacitors factory tested for breakdown @ 200V.

Operating Temperature Range:
-100°C to 125°C

For complete data, and a free sample that can be evaluated in your own laboratory, please write us on your company letterhead, stating capacitance range in which you are most interested.

GENERAL INSTRUMENT
CAPACITOR DIVISION
CAPACITORS

GENERAL INSTRUMENT CORPORATION

65 Gouverneur St., Newark 4, New Jersey

MARKETING

Facts and Figures Round-Up

HOME ENTERTAINMENT PRODUCTS TAKE SEASONAL SALES DIVE

Monthly sales of home entertainment electronic products took a typical after-Christmas dip in January, according to Electronic Industries Association statistics.

Radio sales by distributors fell off abruptly, moving from 1,587,590 in December—peak month in 1962—to 453,348 in January. Radio sales during January 1962 hit 562,869.

Distributor television sales stood at 503,821, against 635,973 sold during the previous month and 465,836 during January of last year.

Television receiver production of all types declined in January, though the output of sets capable of receiving both UHF and VHF showed a strong increase, rising from 49,341 in December to 58,032. Production of all-channel sets during January a year ago totaled 39,609. Total output of TV receivers in January was set at 484, compared with 519,799 in December and 488,869 in January 1962.

Phonograph sales at both distributor and factory outlets in January fell far under those during the previous month, but remained substantially ahead of sales during January of last year.

Distributors sold 81,046 monaural and 235,479 stereo sets in January, compared with 232,373 monaural and 632 stereo sets in December.

TV SET MAKERS GIRD FOR UHF CROSSOVER

As big television set producers turn mostly to color-TV as the newest full-scale market, they and smaller companies are also turning to developing UHF broadcasting and receiver capabilities.

Congress has passed legislation requiring future TV sets to be capable of receiving all VHF and UHF frequencies allocated by the FCC. After April 30, 1964, only VHF-UHF receivers will be permitted in interstate commerce. Thus, as TV set makers phase over into making all-channel receivers, sales are slowly building up.

Meanwhile, FCC has designated a 20-man executive team to help expedite the broadcasting, production, sales and public crossover into UHF.

The team will act as an executive committee for the Committee for the Full Development of UHF Broadcasting.

Broadcasters, legal representatives and electronics hardware makers are included in the executive committee.

SURVEY SEES \$500 MILLION INFRARED MARKET BY 1965

A \$500 million market for infrared products by 1965—a three-year rise of more than 100% in sales—is predicted from a recent survey of IR manufacturers by Robert Manley and Associates, Inc., New York management consultants.

The firm acknowledged that a large IR manufacturer and an R&D institute have predicted a billion-dollar market.

"Factors influencing the expansion" will be increased reliability, major breakthroughs in government research and greater use of IR in space programs.

Infrared devices will have greater use in space than in the atmosphere where their use is limited by inaccuracies not found in space. Present IR market is largely military, partially because firms are loath to back new ventures. Many risked a lot of money in the '50's with little return.

The survey foresees danger for firms that plan commercial business in IR

without scrutinizing military R&D breakthrough. Small companies that dominate commercial IR must keep on their toes to hold their position. Military producers have an inside track on research from which will come other commercial IR applications.

"Most pressing" infrared development problems are detectors for sophisticated uses, measurement and testing devices, modulation and demodulation methods, improved IR vidicons and miniature closed-cycle detector coolers, and/or detectors to operate at higher temperatures.

Factors that will slow IR market expansion are prejudices from past experiences and difficulties in promoting enough sales coverage in a broad market.

The survey also uncovered "tremendous enthusiasms" for laser and maser devices that indicate future markets matching or bettering in size those forecast for infrared.

ABOUT ELECTRONIC DISTRIBUTORS AND "JOBBER"

One of the later developments in the electronics industries is the "parts jobber"—or "distributor."

Originally, parts jobbers sold only replacement parts for radios, then for public address and audio systems, and then for television. Now they are selling components for expanding defense electronics and R&D laboratories.

Distributors still draw most of their business from radio-TV, Hi-Fi and P.A. repairmen. The broadening of R&D, however, has forced electronic component manufacturers to depend more upon regional distributors.

Such distributors if fully stocked in an item can empty the shelf for a rush order. Some manufacturers thus are relieved of late deliveries and the relatively high cost of handling small

and piece-meal orders.

Not all distributors understand their own business. Nor do they fully understand the electronics defense business which they still characterize as "industrial electronics." A big education job is needed.

At last year's spring conference the EIA board approved a proposal for a Distributor Products Division for manufacturers of components sold mainly through distributors.

The next step is to propose such a division for distributors themselves.

MICROWAVE FIRM SALES HIT \$75 MILLION IN '62

Factory sales of microwave components during 1962 reached \$75 million, according to the Electronic Industries Association.

Based on reports from 84 manufacturers comprising nearly 90% of industry volume, with estimates for the remaining 10%, the sales figure gives the first reasonably accurate estimate of the size of the microwave industry.

Included in the overall sales figure are individual sales on ferrite components; semi-conductor parametric amplifiers, harmonic generators and mixers; solid state duplexers; and non-ferrite, non-semiconductor couplers, loads and terminations, attenuators, switches, cavities, couplers, joints and duplexers.

SOUND CREDIT POLICIES URGED FOR EXPORTERS

Electronics exporters' problems today are in making sales against vigorous international competition. James B. Greene, Jr., assistant vice president of Chase Manhattan Bank, said that currency controls, import regulations and restrictive exchange rules have been lessened. U.S. exporters need not worry about loss risk and about being paid for overseas sales if they follow sound credit policies. There is no substitute for accurate and up-to-date credit reports.

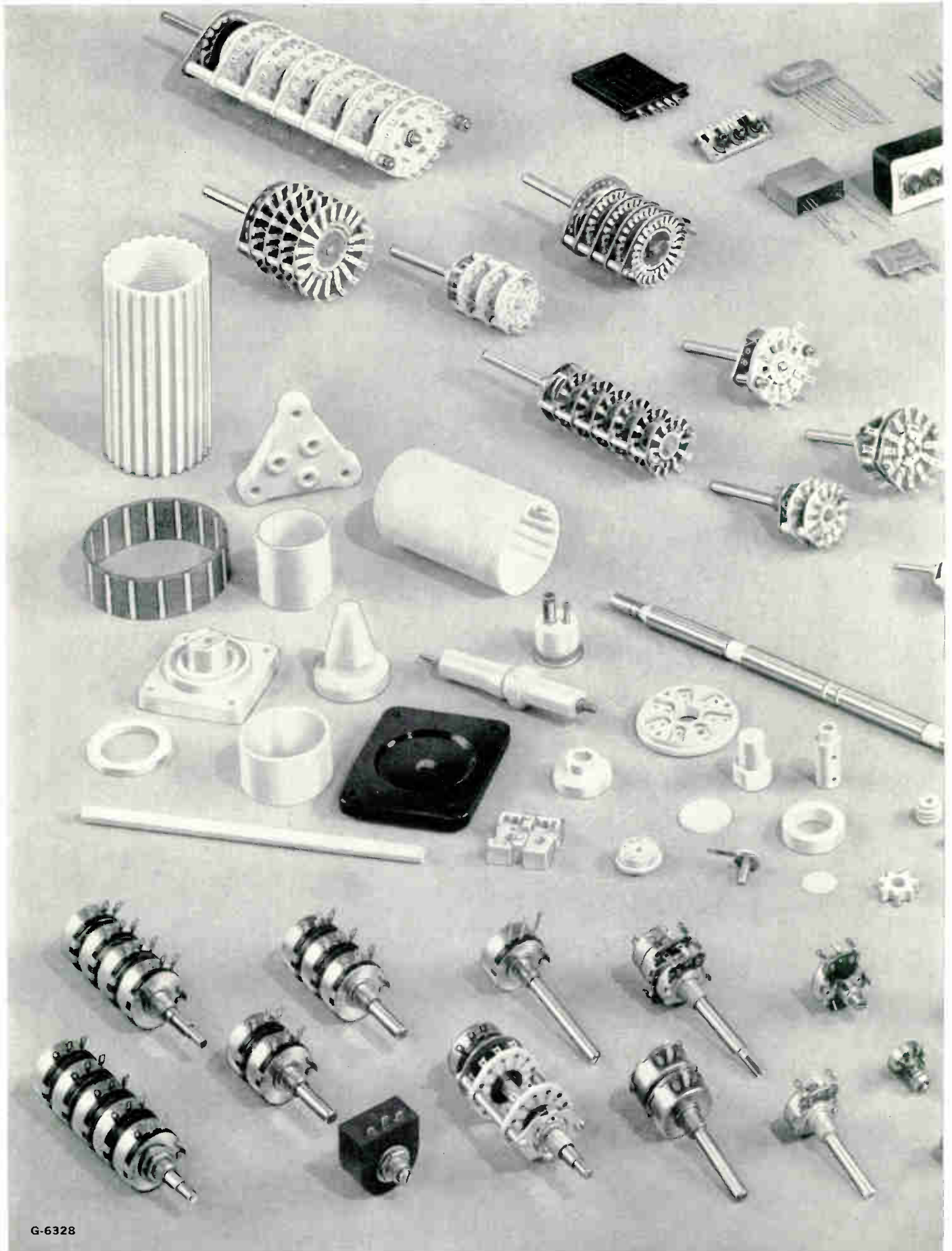

G-6328



PEC CIRCUITS

Military and commercial types in production quantities to your size and circuit requirements.

For information, circle Reader Service Card 106

CAPACITORS

Ceramic, ultraminiature, high capacity, high voltage, high accuracy, trimmer, feed-thru and polystyrene.

For information, circle Reader Service Card 104

SWITCHES

Rotary, Spring Return, Lever, Slide, MIL-S-3786A, Custom design.

For information, circle Reader Service Card 105

CERAMICS

Piezoelectric Transducers, Precision, Metalized Seals, Ceramic Assemblies.

For information, circle Reader Service Card 107

POTENTIOMETERS

Hot molded carbon, wirewound, composition linear motion, miniature, MIL-R-94.

For information, circle Reader Service Card 103

THIS IS



SUPERIOR PRODUCTS FOR ELECTRONICS

THE ELECTRONICS DIVISION OF GLOBE-UNION INC.
 938E. East Keefe Avenue • Milwaukee 1, Wisconsin
 In Canada: Centralab Canada Ltd., Box 400, Ajax, Ontario

See us at Booth 3306—Electronic Packaging Show—June 4-6—New York Coliseum
 ELECTRONIC INDUSTRIES • May 1963

Circle 103 on Inquiry Card

600 mc f_T Switches...

120v V_{CB} Core Drivers...

100 mc Amplifier...

All Available Now with...

PHILCO SILICON PLANAR RELIABILITY

Philco's versatile line of Epitaxial Silicon Planar NPN Transistors enables you to upgrade reliability in every transistor application.

ULTRA HIGH SPEED SWITCHES

TYPE*	Maximum Ratings			Characteristics							
	T_S °C.	V_{CB} volts	P_T @ 25° C.	I_{CBO} max. μ A	h_{FE} min.	$V_{CE(SAT)}$ max. volts	f_T min.	C_{ob} max. pf	t_s max. nsec	t_{on} max. nsec	t_{off} max. nsec
2N709	300	15	300	0.05	20	0.30	600	3	6	15	15
T-2877	300	15	300	0.05	20	0.30	500	3	8	15	15

*T0-18 case—collector internally connected to case.

CORE DRIVERS/PULSE AMPLIFIERS

TYPE*	V_{CB} max. volts	f_T @ 50 ma mc	h_{FE} @ 150 ma
2N1893	120	50	40
2N1613	75	60	40

*T0-5 case—collector internally connected to case.

100 mc LOW-NOISE AMPLIFIER

Industry's Newest Silicon Amplifier Standard

TYPE	Power Gain	Maximum Noise Figure	Minimum BV_{CEO}
T-2857*	15-22db @ 100 mc	5db @ 100 mc	20 volts

The new Philco T-2857 is industry's first silicon amplifier transistor to be functionally tested at 100 mc for fixed-matched, fixed neutralized, and fixed-bias performance. This insures interchangeability in practical communications circuits.

*T0-18 case with 4 leads—collector isolated from case.



Whatever your silicon transistor application, evaluate Philco Planar Transistors.

For complete data, and new Reliability report, write Dept. EI563.

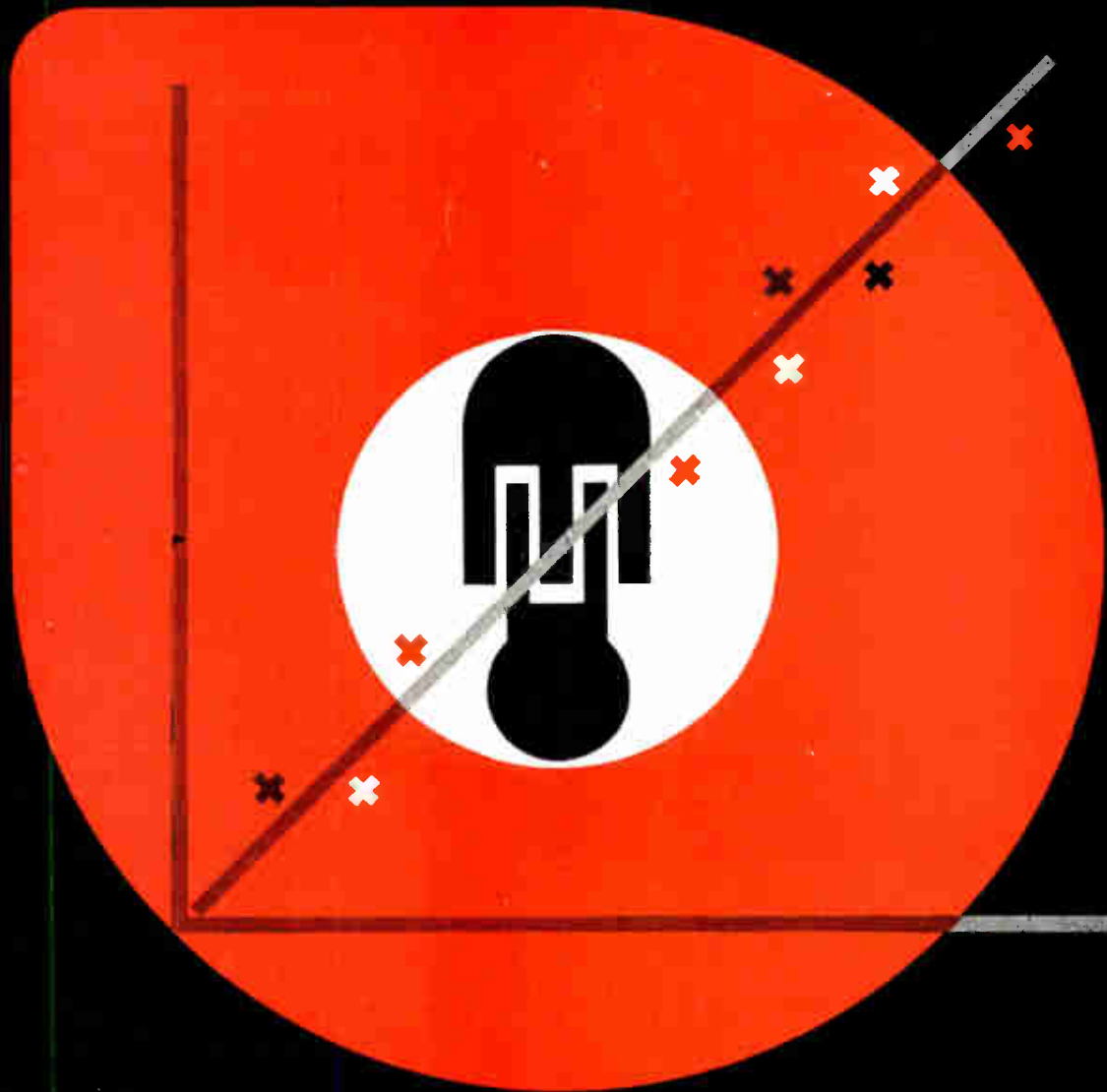

VERY HIGH SPEED SWITCHES

These Philco Types Feature Industry's Best Combination of Voltage, Switching Speed, and Beta.

TYPE†	Maximum Ratings					Characteristics								
	T _s °C.	V _{CB0} volts	V _{CE0} volts	P _T @ 25° C. mw	I _C ma	I _{CB0} max. ma	h _{FE} min.	V _{CE} (SAT) max. volts	f _T min. mc	C _{ob} max. pf	t _s max. nsec	t _{on} max. nsec	t _{off} max. nsec	
2N2710	300	40	20	360	500	0.03	40	0.25	500	4	15	20	35	
2N2651	300	40	20	360	500	0.03	25	0.25	350	4	25	35	75	
2N914	300	40	15	360	500	0.025	30	0.25	300	6	20	40 @ 200 ma	40 @ 200 ma	
2N834	175	40	30**	300	200	0.50	25	0.25	350	4	25	35	75	
2N784A	300	40	15	350	200	0.025	25	0.19	300	3.5	15	20	40	
2N708	300	40	15	360		0.025	30	0.40	300	6	25			
2N706	175	25	20*	300	50	0.5	20	0.60	200	6	60			

*V_{CEP}

**V_{CEs}

† TO-18 case collector internally connected to case.

PHILCO®

A SUBSIDIARY OF *Ford Motor Company*

LANSDALE DIVISION, LANSDALE, PA.



Circle 22 an Inquiry Card



SNAPSHOTS... OF THE ELECTRONIC INDUSTRIES

"HAIR-THIN"

Thin-film electronic circuit (in tweezers at right) under development at Hughes Aircraft Co., Newport Beach, Calif., is only 1/10 the thickness of a human hair (stretched lengthwise across picture). Technician examines fully integrated circuit which performs thin-film active and passive component functions.

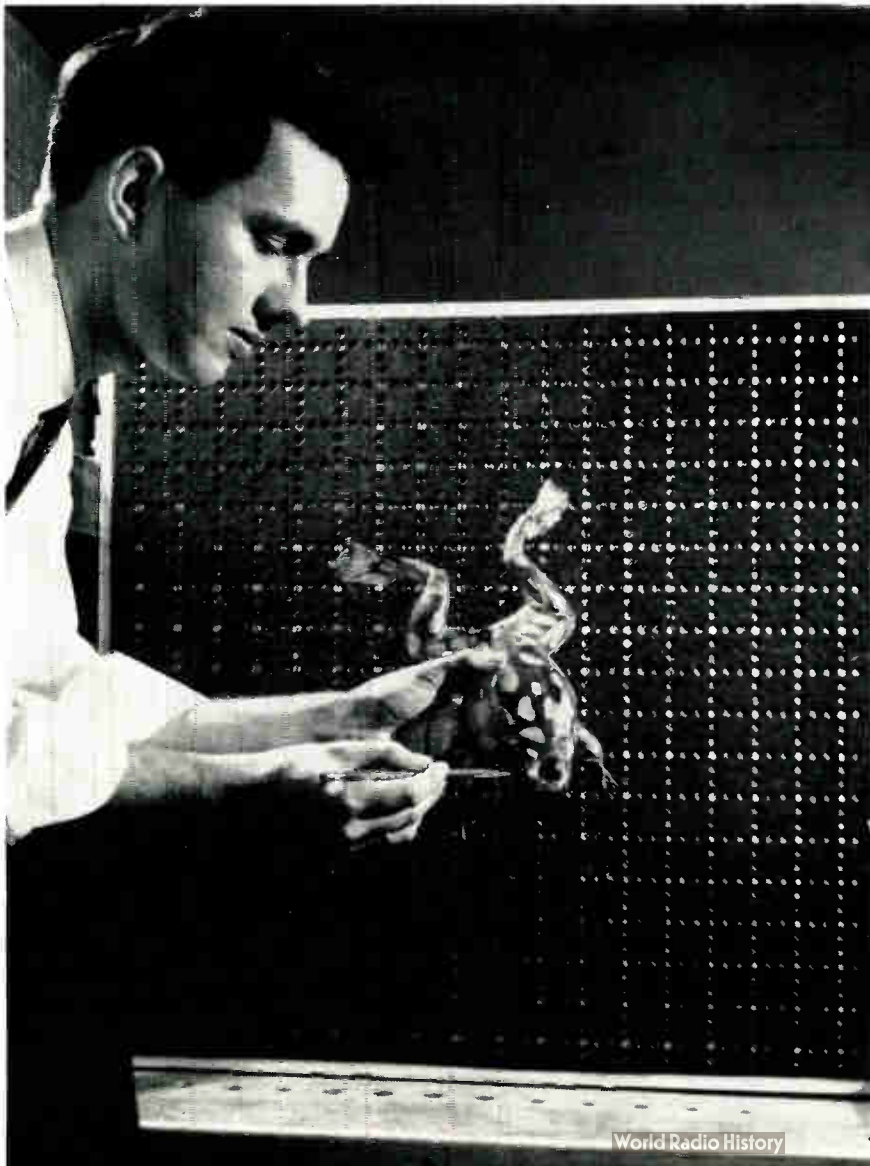

FROG'S EYE

Thomas Kelley, RCA engineer (l.), points out that the 40-inch square, six-foot long machine in the background doesn't compare in compactness with a frog's eye, but it performs the same functions. Built by RCA's Applied Research Activity, Camden, N. J., for the Air Force, the computer has all the feature-abstracting abilities of the real thing.

DIODE TESTER

Zener diode tester automatically checks seven key parameters and sorts diodes into voltage categories. Nicknamed "APT" for Automatic Parameter Tester, the tester was designed and built by Motorola engineers in Phoenix, Ariz. It can test over 40,000 diodes/day.



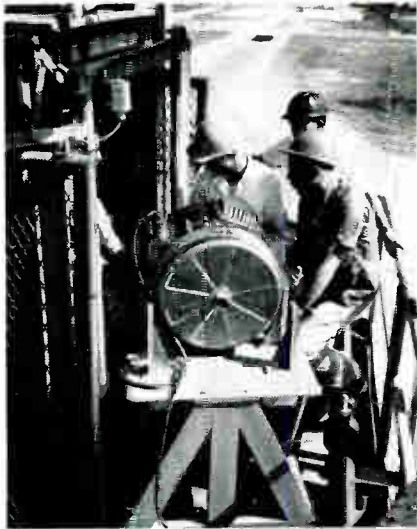

GUIDANCE SYSTEM

ACHiever inertial guidance system is placed in a Titan II missile at Cape Canaveral, Fla. The ACHiever inertial guidance system, manufactured at the Milwaukee plants of AC Spark Plug Division of General Motors Corporation, has directed the Titan II missile on a number of successful flights for U. S. A. F.

TRANSPORTABLE ANTENNA

Transportable h-f antenna (r) covers the entire band from 4 to 32 MC with a maximum VSWR of 2:1. Made by Granger Associates, Palo Alto, Calif., it emits desired high-angle radiation at low freq. and low-angle radiation at high freq., without lobe splitting.

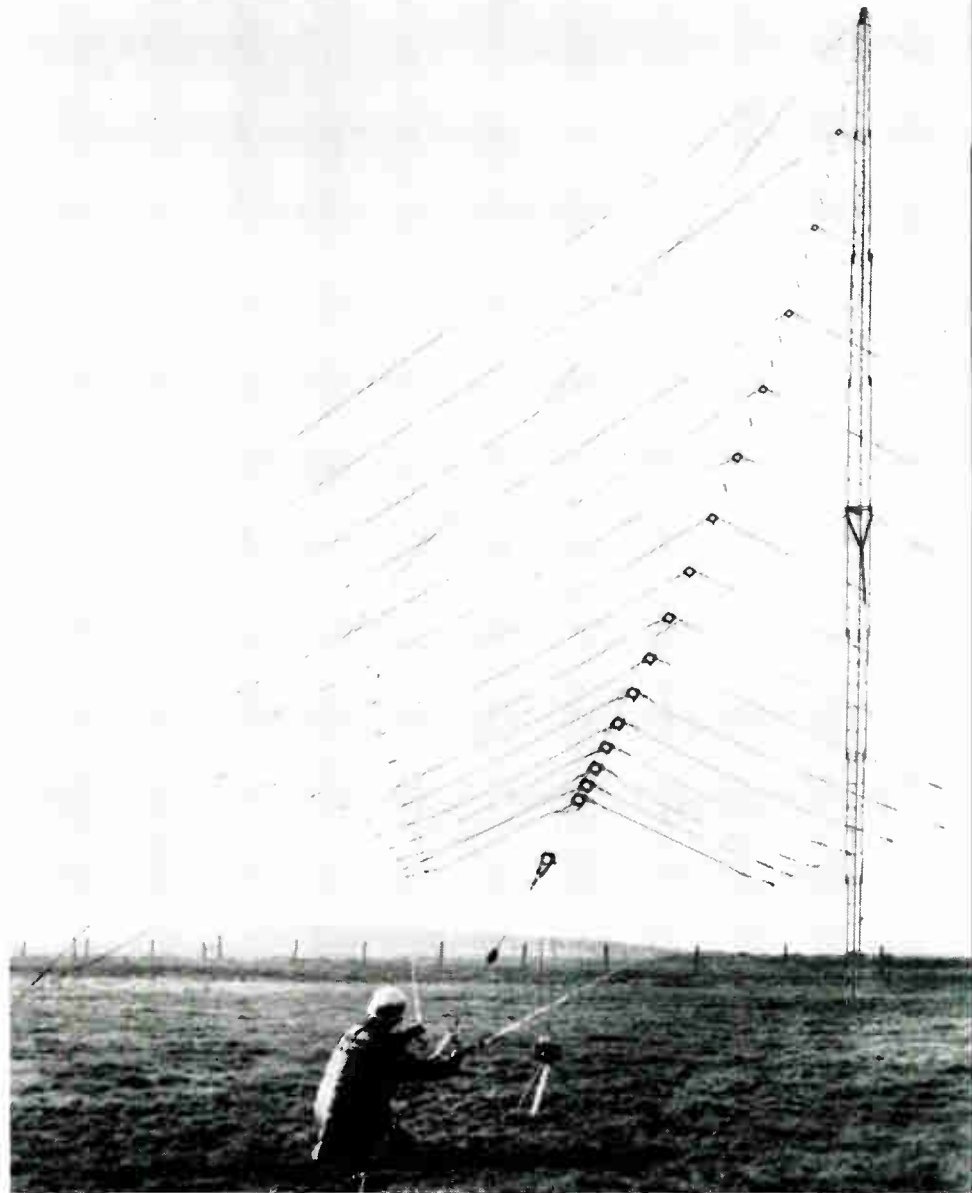

R-F CHOKE

Chokes made by Cambridge Thermionic Corporation, Cambridge, Mass., are shown being color-coded to indicate inductance value. These chokes are made with ranges from 1.0 uh to 100 mh. Minimum Q's are guaranteed, as are inductance tolerances of $\pm 10\%$.



LOCATING DEFECTS

By coordinating directional focus of probe with the volume control on the Ultrasonic Translator, Project Mercury suit technicians, such as Joe Schmitt, can pinpoint leaks as small as 0.0025. The Ultrasonic Translator is made by Delcon Corp., Palo Alto, Calif.

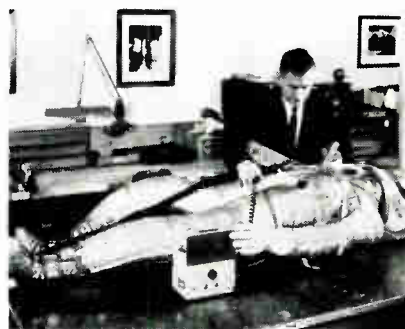

"CLEAN ROOM"

Dust-free enclosure at Transducer Div. of Consolidated Electroynamics Corp., Monrovia, Calif., is used for critical assembly of transducers. The "Clean Room" is necessary as these tiny sensing devices will be used in missile, satellite and jet aircraft programs.





SNAPSHOTS... OF THE ELECTRONIC INDUSTRIES

FINE CONTROL

Pin-point control of microminiature ruby laser welding is shown in connections of lead wires to a transistor header. The laser beam accomplishes welds, without physical contact, in less than 1 msec. Welds were done at Hughes Aircraft Co., Fullerton, California.

SPACE LASER

Laser light beam is directed into optical receiver (rear rt.) where it strikes a photo cell, is converted into original TV signals and relayed to the picture tube. Hand-size "Optical modulator" (1), is the key to applying the laser to space communications. It is made by North American Aviation, Downey, Cal.

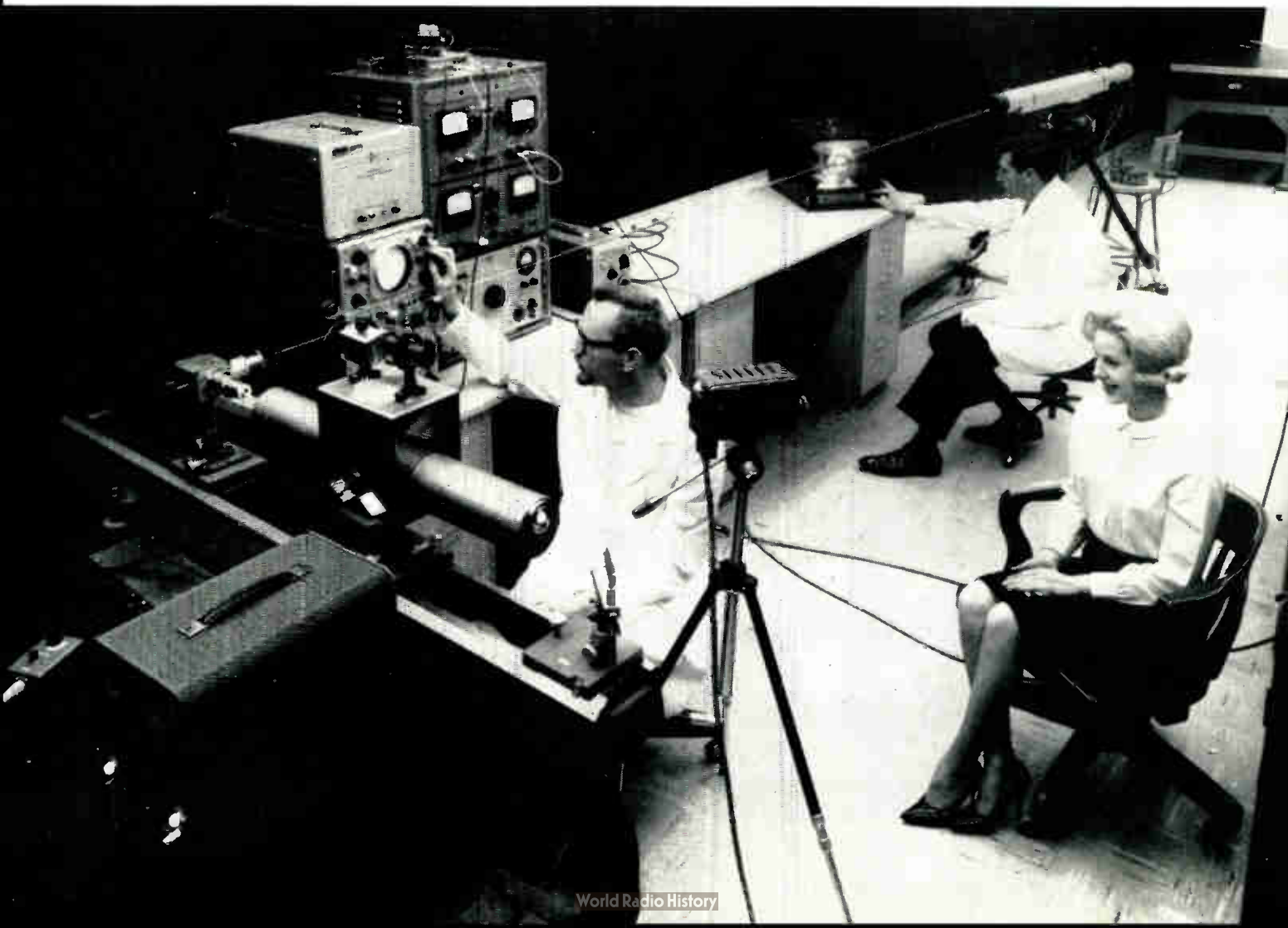

NUMBER ONE IN ELECTRICAL CONNECTORS...

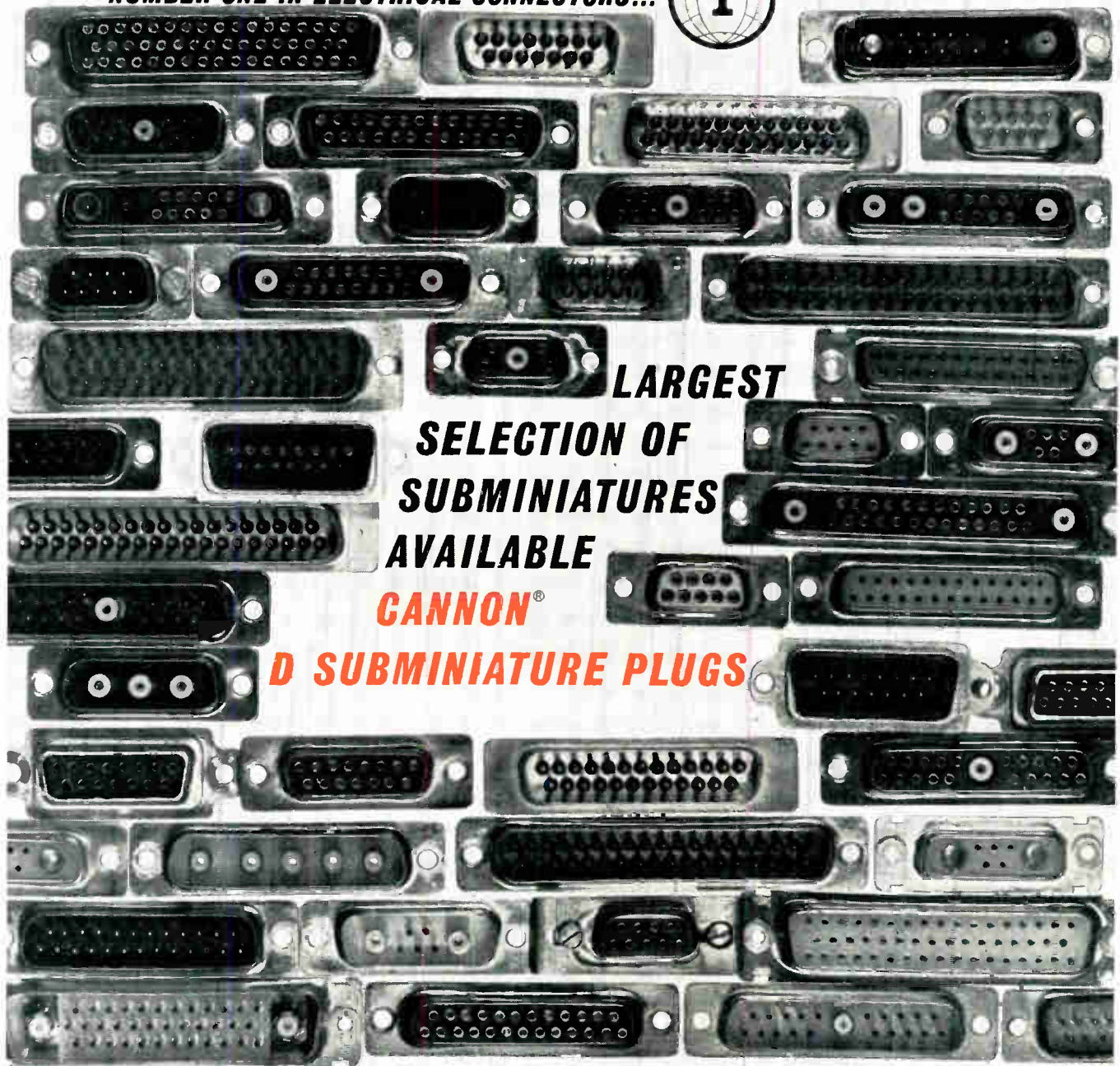

**LARGEST
SELECTION OF
SUBMINIATURES
AVAILABLE**

**CANNON®
D SUBMINIATURE PLUGS**

SIZES FROM 9 TO 50 CONTACTS

- SOLDER POT CONTACTS
- CRIMP REMOVABLE SNAP IN CONTACTS
- CRIMP REAR-RELEASE CONTACTS
- HERMETICS
- COAXIAL INSERTS
- HIGH VOLTAGE INSERTS
- COMBINATION LAYOUTS
- MOISTURE RESISTANT
- VIBRATION RESISTANT
- HIGH ALTITUDE
- LOW MAGNETIC PROPERTIES
- CORROSION RESISTANT
- PRINTED CIRCUIT APPLICATIONS
- CUSTOM APPLICATIONS

Contact your Cannon Authorized Distributor or write to:

® "CANNON" IS A TRADEMARK REGISTERED IN U. S. PAT. OFF. AND FOREIGN COUNTRIES BY CANNON ELECTRIC COMPANY

CANNON ELECTRIC COMPANY

3208 Humboldt Street, Los Angeles 31, California

ADDITIONAL PLANTS IN: SANTA ANA & ANAHEIM, CALIF. • PHOENIX, ARIZ. • SALEM, MASS. • TORONTO • LONDON • PARIS • BORNEM, BELGIUM • TOKYO • MELBOURNE

Sales offices and representatives in principal cities of the world



© 1963 CANNON ELECTRIC COMPANY

SNAPSHOTS... OF THE ELECTRONIC INDUSTRIES

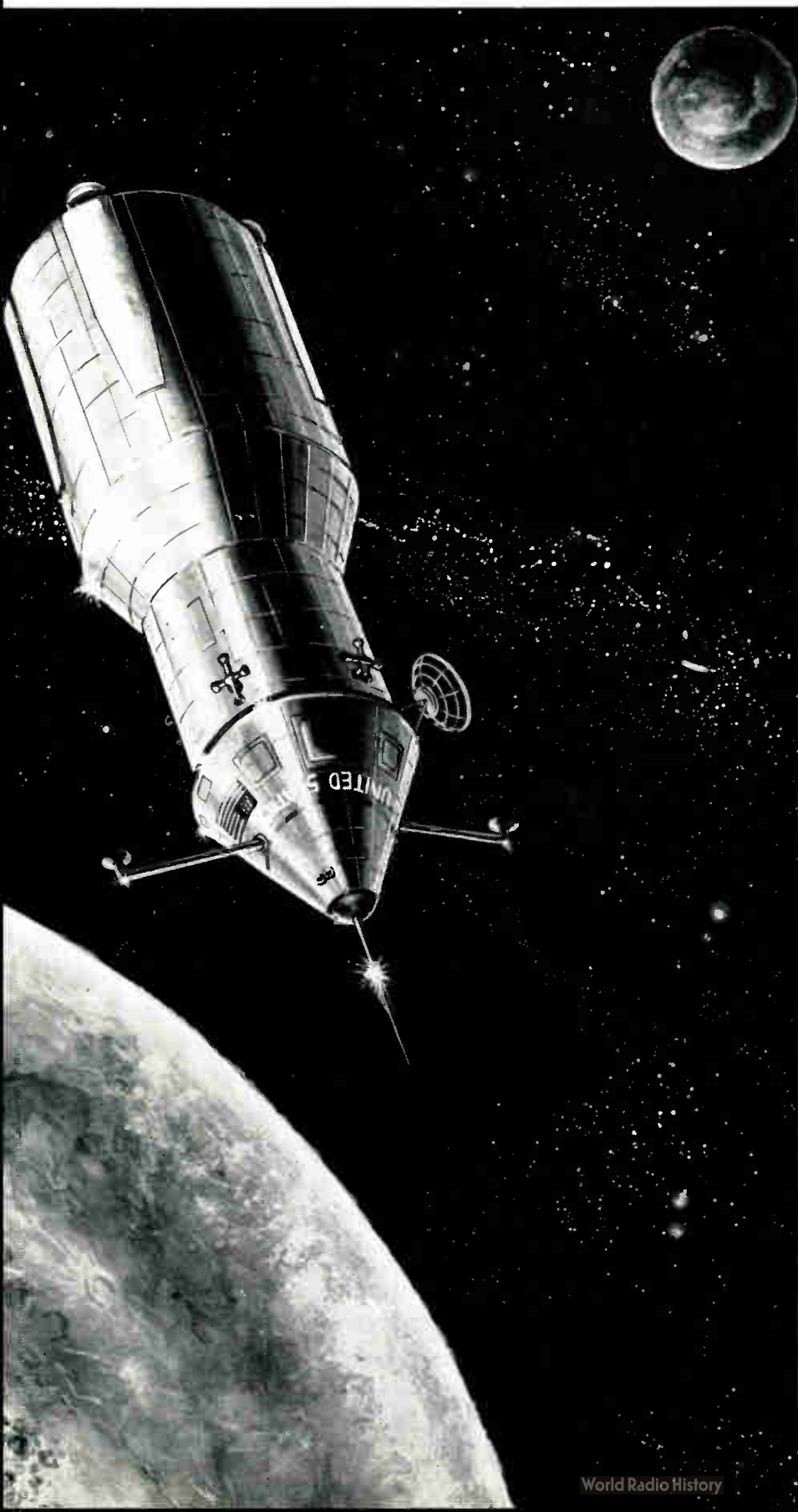

"BEANSTALK"

Antenna mast called "Beanstalk" can be erected in less than 2 hrs. to a height of 100 ft. Developed by Sealing Corp. of America (Santa Monica, Cal.), it is raised by less than 25 lbs. of air pressure under normal loads.

APOLLO SPACECRAFT

Artist's conception of the Apollo spacecraft (1) that will carry three astronauts to the moon. General Motors' AC Spark Plug Div., Milwaukee, Wis., is helping M.I.T. to design and build its guidance and control system.

MICROWAVE PHOTOTUBE

Lasecon microwave phototube is examined by Georgine Comerford. Designed by RCA Electron Tube Div., for use as a laser signal detector and converter, the tube combines high sensitivity and the wide bandwidth properties of a TWT. Device is 18 inches in length.



Smaller diameter for complex hook-ups with **Beldfoil*** shielded cables

Beldfoil*
Shielding



Conventional
Shielding



Where shielding is required you can reduce the size and weight of your cable with Beldfoil shielding. This new development can greatly reduce the diameter of multi-conductor cables.

Multi-cable hook-ups can also be confined to less area. In many applications Beldfoil shielded cables can replace combined and complex hook-ups of twisted pairs and individual conductors laced together.

Beldfoil is a lamination of aluminum foil with Mylar† which provides a high dielectric strength insulation that is small in diameter, light in weight and low in cost. Its superior characteristics give 100% isolation between shields and adjacent pairs.

For audio and radio frequency applications, it eliminates cross-talk and is ideal for stationary or limited flexing.

The cable cross sections shown below (outer jacket not shown) are just a few of the many intricate and diverse ways Beldfoil has been used to solve a specific shielding problem for a customer.

If you have a space or design problem on shielded cables Belden engineering can help you.

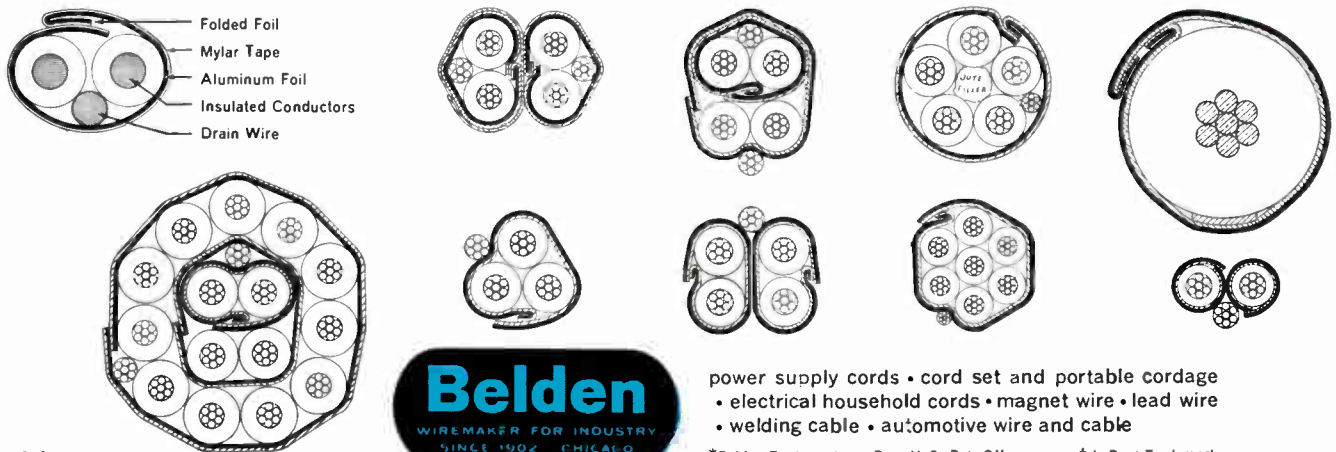

power supply cords • cord set and portable cordage
• electrical household cords • magnet wire • lead wire
• welding cable • automotive wire and cable

*Belden Trademark Reg. U. S. Pat. Off.

†du Pont Trademark

read this

see this

use this

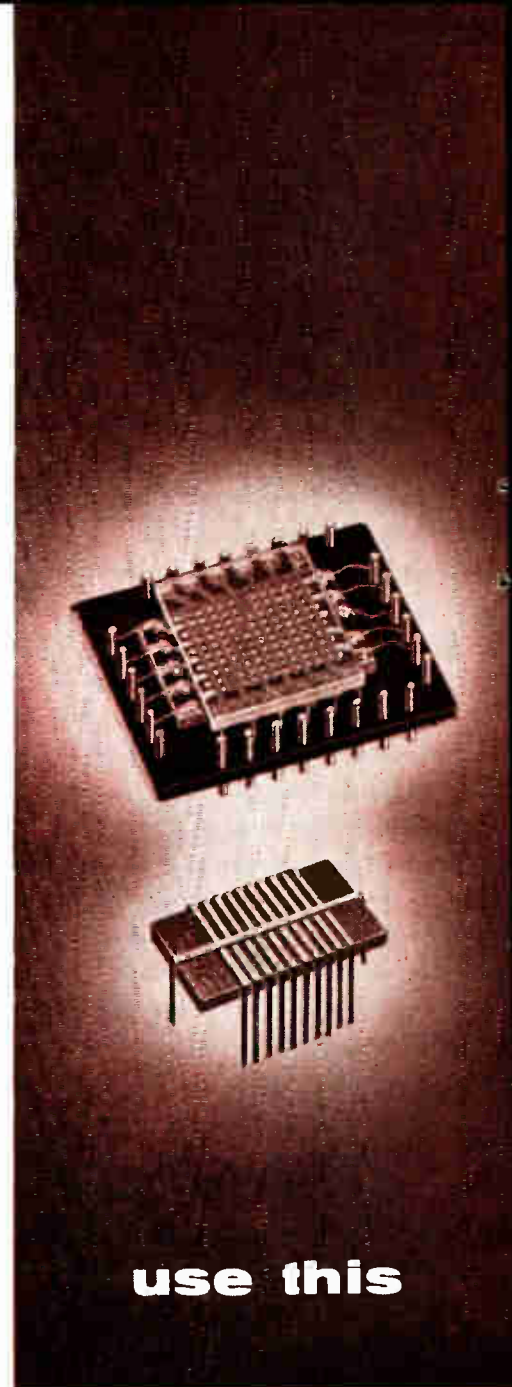
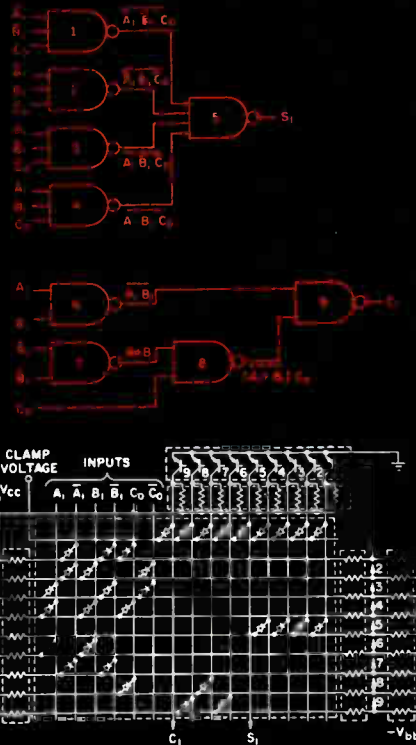

Now there is a new approach to micro-circuit packaging . . . BIPCO® Diode Matrices and Transistor Strips. They provide the only approach combining:

- Total function logic
- Connection oriented packaging
- Connection oriented batch manufacturing

See how these unique features will benefit you.

Above is the logic diagram for a full adder and its equivalent BIPCO circuit. Note how "total function" logic is performed with matrices of diodes and strips of transistors and resistors. Since the interconnections are always the same, other functions (counting, decoding, accumulating, etc.) can be performed by simply changing the arrangement of the diodes within the matrix. You can specify parameters, logic levels.

BIPCO devices containing up to 100 silicon diodes and 10 silicon transistors are available as individual packages or as printed circuit assemblies for counting, decoding and code-converting applications. Because the diodes and transistors are manufactured and connected in batches, the cost of these units is competitive with that of conventional components and less than that of other micro-circuit devices.

Write today for our newest brochure . . . "BIPCO Logic | the Total Function Approach".

Circle 24 on Inquiry Card

WorldRadioHistory

ELECTRONIC CONTRIBUTIONS BY
Burroughs Corporation
ELECTRONIC COMPONENTS DIVISION
PLAINFIELD, NEW JERSEY



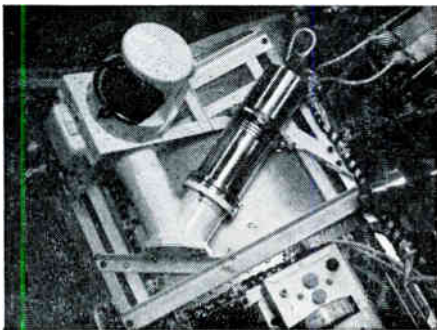

Here, in Lockheed Missiles & Space Company's Physical Sciences Laboratories, scientists are engaged in a comprehensive space physics research program embracing experimental and theoretical work in space radiation, aurora, atmospheric structure, geomagnetic micropulsations, x-ray astronomy, and the propagation of electromagnetic waves in space. Experimental programs include the measurements of geophysical and space properties, both in space and in the laboratory.

Currently, measurements of variations on the earth's magnetic field are being made at remote islands in the Pacific Ocean, providing clues to the effect of solar activity on its shape and stability. The influence of solar wind on the geo-

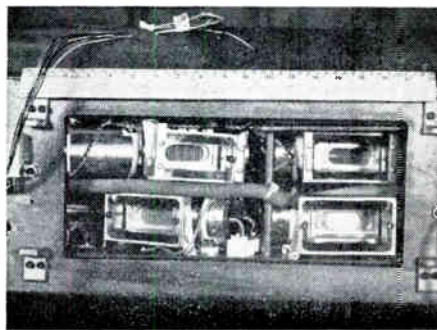

magnetic field is also being investigated in laboratory experiments, by bombarding magnetic fields with clouds of highly ionized gases.

Scientists at Lockheed are engaged in a continuing program of designing and placing density gages, mass spectrometers, ion traps, and similar instruments on space vehicles to measure the density, composition, and temperature of matter in space. These experiments lead to a better understanding of the chemical reactions occurring in the atmosphere high above the earth.

Important investigations of the low energy x-rays emitted by stars are being carried out and interpreted to give information on the structure of stellar coronas.

LOOK AT LOCKHEED...AS A CAREER

Consider Lockheed's leadership in space technology. Evaluate its accomplishments —such as the Polaris missile, the Agena vehicle's superb record of space missions. Examine its outstanding advantages —location, advancement policies, creative climate, opportunity for recognition.

Then write for a brochure that gives you a more complete Look at Lockheed. Address: Research & Development Staff, Dept. M-44E, P.O. Box 504, Sunnyvale, California. Lockheed is an equal opportunity employer.

SCIENTISTS & ENGINEERS: In addition to positions in the physical sciences, other important openings exist for specialists in: Trajectory analysis • Gas dynamics • Orbit thermodynamics • Electromagnetics • Chemical & nuclear propulsion • Systems engineering • Electronic engineering • Communications & optics research

LOCKHEED

MISSILES & SPACE COMPANY

A GROUP DIVISION OF LOCKHEED AIRCRAFT CORPORATION

Sunnyvale, Palo Alto, Van Nuys, Santa Cruz, Santa Maria, California • Cape Canaveral, Florida • Huntsville, Alabama • Hawaii

LOOK AT LOCKHEED IN SPACE PHYSICS:

Continuing investigation of matter and forces in space



Help yourself

You have probably become conditioned to sacrificing one feature to gain another in your selection of micro-miniature connectors. The part that's small enough may be relatively unreliable or nearly impossible to work with. Often you must choose between size, electrical characteristics, or performance reliability.

Not so with the Amphenol Wire-Form Group.

NO COMPROMISE

The Wire-Form Contact is an interconnection device that combines small size with easy handling in assembly . . . high reliability with low cost. Most important of all, though, is the application versatility of the Wire-Form.

The Wire-Form Group conforms effortlessly to your packaging requirements, whatever they may be. From single contacts on component leads through Strip Connectors or Tiny Tim® Connectors on modules to Micro-Rac® or Mighty-Mite® Connectors for system input-output lines . . . the Wire-Form family can provide the best answer to your design needs. No more "round hole-square peg" problems!

FOR EXAMPLE

The Wire-Form Contact is extremely small, permitting high-density packaging. Depending on the connector insert used, you can have contact centers on 0.100", 0.085", or even down to 0.075". Yet connectors are easy to assemble . . . because you terminate *before* contacts are inserted, while there's still room to maneuver. Later, if you want to change circuitry or replace a component, contacts can be removed, repositioned, or replaced without discarding the connector.

Wire-Form Contacts can be termi-

nated by crimping, soldering, welding, or wire-wrapping. For single-contact terminations we have eyelet type female contacts that can be potted in modules or soldered into circuit boards.

PRICED RIGHT

The Wire-Form family will help keep costs down. High volume manufacturing methods let Amphenol market Wire-Forms at unusually low purchase prices. For example, our circular Wire-Form Connector (the Mighty-Mite) meets or exceeds the performance characteristics of other micro-miniature connectors selling for ten times its price. But initial cost is only half the battle . . . What about installed cost? Well, it's rock-bottom too. The Poke-Home feature means that most all of the assembly can be done out in the open, with plenty of room, and no fiddling with tweezers or magnifying glass. In short, it can be done quickly. And quickly means inexpensively, as labor costs go.

Wire-Forms give top reliability. Equalized, multi-point contact pressure results in exceptionally stable and low contact resistance. Contact resistance

varies less than half a milliohm through a thousand cycles of engagement-disengagement. (See chart below.)

FAMILY PLAN

One of the more important things to remember about the Wire-Form Group is the way it works as a team. No matter what kind of challenge comes up, at least one member of the Wire-Form team can handle it. This means you only need to stock one basic component, the Wire-Form Contact, to meet virtually all your micro-miniature connection needs. The savings in inventory investment, in stock control, and in uniform manufacturing methods can be substantial.

FACTS AND FIGURES

The new 24-page catalog on Amphenol Micro-Miniature Connectors (Catalog MM-1) has the facts, figures, drawings, and detailed performance characteristics you'll need to "help yourself." You can get a copy by contacting your local Amphenol Sales Engineer or by writing to Dick Hall, Vice President, Marketing, Amphenol Connector Division, 1830 S. 54th Avenue, Chicago 50, Illinois.

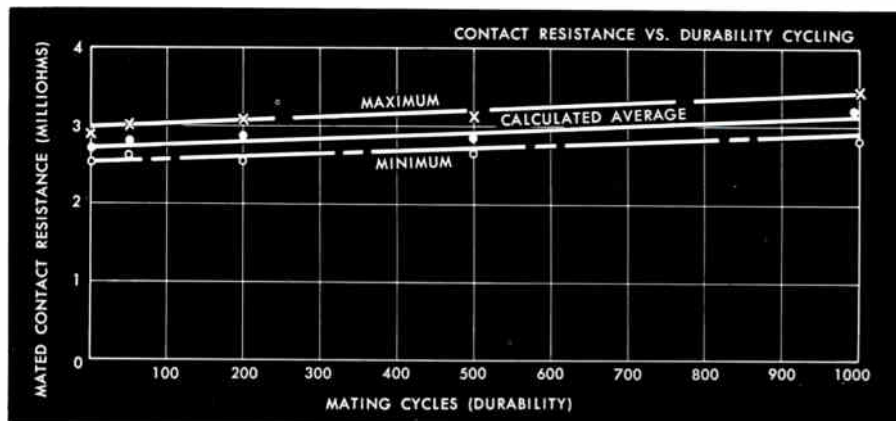

Tested male contacts were Amphenol cat. number 22-692, formed from gold-clad, nickel-interlined beryllium copper wire. The females (cat. number 220-502 short) are copper bodies with electroless gold over nickel plating. Each pair was subjected to 1000 mating cycles.



Connector Division / Amphenol-Borg Electronics Corporation



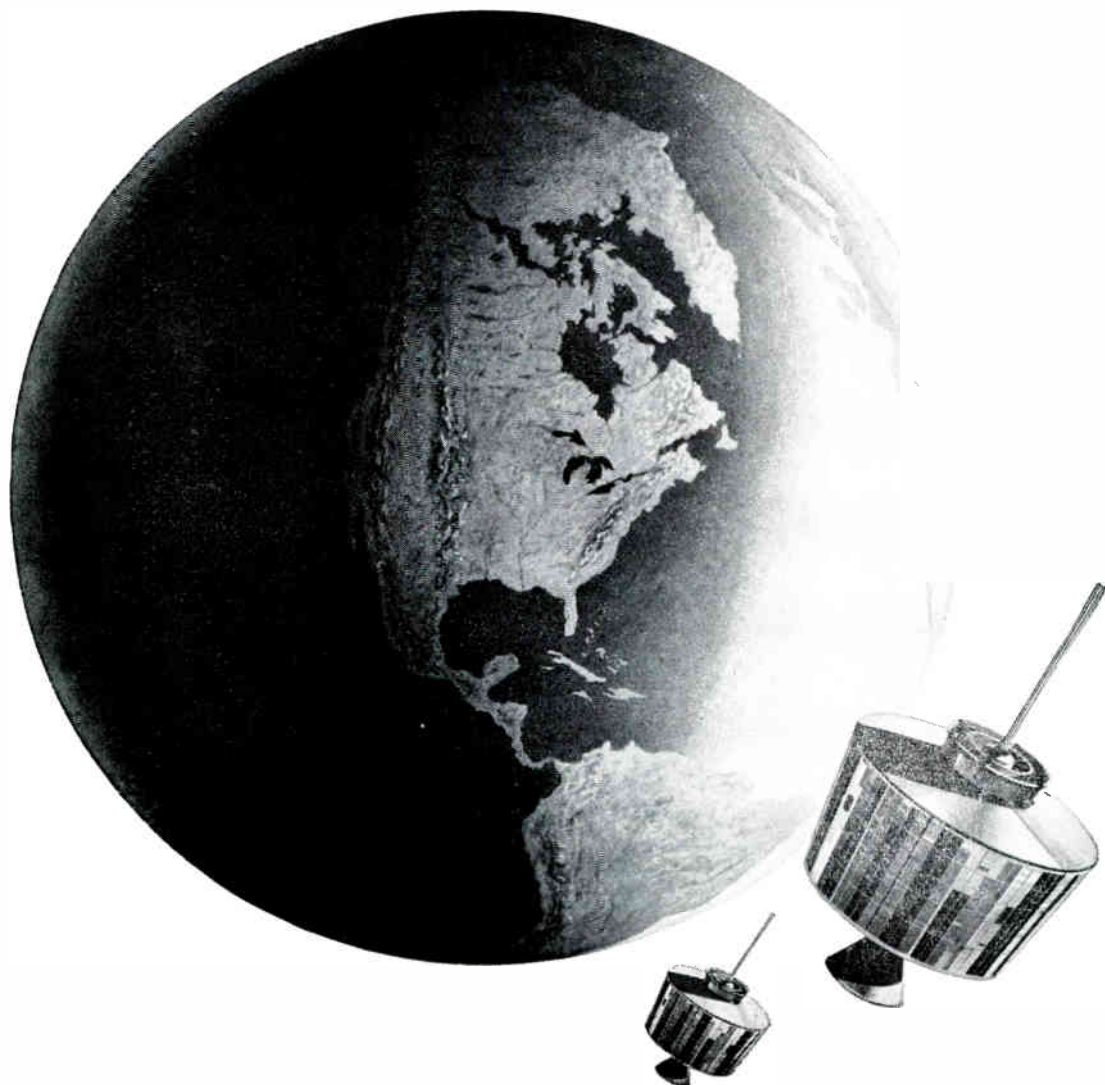

circuit designers...is your appointment in space with Hughes?

Today, Hughes is one of the nation's most active space/electronics firms. Projects include: MMRBM Integration, Assembly & Checkout, TFX(N) Guided Missile System, VATE, TOW Anti-Tank Missile, SURVEYOR, SYNCOM, ARPAT, POLARIS and others.

This vigor promises the qualified engineer or scientist more and bigger opportunities for both professional and personal growth.

Many immediate openings exist. The engineers selected for these positions will be assigned to the following design tasks: the development of high power airborne radar transmitters, the design of which involves use

of the most advanced components; the design of low noise radar receivers using parametric amplifiers; solid state masers and other advanced microwave components; radar data processing circuit design, including range and speed trackers, crystal filter circuitry and a variety of display circuits; high efficiency power supplies for airborne and space electronic systems; telemetering and command circuits for space vehicles, timing, control and display circuits for the Hughes COLIDAR* (Coherent Light Detection and Ranging).

If you are interested and believe that you can contribute, make your appointment today.

Please airmail your resume to:
Mr. Robert A. Martin
Head of Employment
Hughes Aerospace Divisions
11940 W. Jefferson Blvd.
Culver City 6, California

We promise you a reply within one week.

Creating a new world with electronics

HUGHES

HUGHES AIRCRAFT COMPANY
AEROSPACE DIVISIONS
An equal opportunity employer.



**1 MC to 300 MC
WIDE-SWEEPING
SWEEPING OSCILLATOR**

KAY
Multi-Sweep
**MODEL VIDEO 300
159-A**

ALL SOLID STATE

- **300 mc to less than 1.0 mc in single sweep**

The Multi-Sweep Model Video 300 is a wide range video-vhf sweeping oscillator which provides a full 300 mc of swept-frequency output by all-electronic frequency modulating techniques. It provides a linear swept frequency output, AGC'd for constant output over the frequency band. The Multi-Sweep Model Video 300 includes provision for the insertion of external oscillators to generate variable birdie-bypass type markers on all frequencies. A calibrated frequency dial permits the use of the unit as an IF-VHF oscillator with continuously variable center frequency and sweep width.

- **All electronic**

Sweep Frequency Range

The Model 300 is a wide-sweeping swept frequency oscillator with high and undistorted output, essentially free of spurious signals. Over the entire sweeping range, it generates a 0.5 volt (rms into load) output which is held constant to within ± 0.25 db by a fast-acting automatic gain control circuit. The RF output is monitored by a calibrated panel meter.

- **All solid state**

Sweep Rate

The repetition rate of the sweep may be locked to the nominal line frequency or varied around this frequency for hum checks. A manually-controlled swept output provides a means of varying c-w signal in sync with the oscilloscope display. The manual control covers the same frequency range to which the Model 300 is set for electronic sweeping.

- **0.5 volt rms into load AGC'd to ± 0.25 db**

Advanced Design

The Multi-Sweep Model 300 employs recently developed techniques in providing a compact and versatile instrument. All elements, including the frequency modulated source and its means of modulation use recently developed solid state circuits. Careful isolation and buffered outputs provide for excellent waveshapes and clean, reliable outputs.

- **Built-in detector**

SPECIFICATIONS

Frequency Range: Continuously variable 1 mc to 300 mc.

Markers: Provision for birdie-bypass markers derived from external oscillators. Separate level control and output.

Sweep Width: Linear, continuously variable 200 kc to 300 mc. CW operation.

Attenuators: Switched 20,20,20,10,6,3 db plus variable 6 db.

Sweep Rate: Variable around line frequency, locks to line. Manual control.

Power Supply: Input approx. 20 watts, 117 volts ($\pm 10\%$), 50-60 cps ac, regulated.

- **Stable narrow sweeps**

RF Output: 0.5 volt rms into nominal 50 ohms (70 ohms on request); flat to within ± 0.25 db over widest sweep — metered.

Dimensions: 6 $\frac{3}{4}$ " x 15 $\frac{1}{2}$ " x 13 $\frac{1}{2}$ ".

Weight: 24 lbs.

Price: \$795.00 f.o.b. factory. \$875.00 f.a.s. N. Y.

KAY ELECTRIC COMPANY

Dept. EI-5 Maple Avenue, Pine Brook, Morris County, New Jersey • Capital 6-4000

In 1962 electronic stocks danced a light fantastic up the price curve. Securities analysts, otherwise experienced, unwittingly undermined the electronic securities market by offering advice not based on sound analysis of the electronic sales market and technology. They advised managements to sell stock rather than products. Then the ground opened up. Here is a brief history, and some amends being made in 1963.

THE WALL STREET WALTZ IS OVER for many electronic companies.

Electronics stocks that orbited almost overnight are down to earth again, after their heydays in 1959, 1960, 1961, and early 1962. Among the first prices to break were semiconductor shares. By May and June of 1962, when the entire market nosed down, electronics stocks were among the leaders.

On the day after last Christmas, Standard & Poor's did some comparing. Comparisons for 1961 to 1962 showed aerospace stocks down 2.6%, radio-TV manufacturers stocks down 18%, and electronics stocks down 25.7%.

May Make Same Mistakes Again

A paradox of the 1963 International Convention of the Institute of Electrical and Electronic Engineers was a panel on engineering management. Four security "analysts" were invited to advise engineers on "Outlooks on Electronics for Engineers and Management."

One analyst candidly admitted, "It takes a lot of courage for us to face each other now, after what happened last year. We do have much better tools and we would have made fewer errors if we had stuck to them."

They confessed: "We were too lazy to analyze; we repeated glowing reports from electronics managers and engineers without analyzing what they told us. We were too afraid to admit we were wrong, or that we did not understand whatever companies told us about electronics. We lacked courage to stop promoting electronics stocks because investors insisted

NOW THAT THE WALL STREET WALTZ IS OVER— WHAT?

on giving us money, which we in turn insisted on passing along to companies."

Actually, from a management standpoint, the sharp increase of electronics activity in defense and space technology set the pace for the rapid growth of electronics stocks. But the growth, so quick and broad, caused a sharp imbalance of low supply and high demand that shot prices skyward.

They Flocked to Wall Street

The situation was serious, but it might have been funny. Many a president of a small- or medium-size electronics company, who would have been shown to the door of his local bank, was given the red carpet on Wall Street.

Electronics companies learned they could make more money by selling a part of their equity, while keeping the controlling interest. Electronics executives were torn between selling stock on Wall Street, or selling hardware at the Pentagon. The stocks usually won out.

Now, penitent and somewhat wiser, security analysts openly admit they were the unwitting tools of their own "unprofessionalism."

One analyst, who helped influence hundreds of millions of investor-speculator dollars, still has his job and his interest in the electronics industries. He offers three reasons: (1) Electronics is still a growing industry, having expanded from \$2.7 billion in 1950 to an anticipated \$15 billion in 1963. (Electronics business should continue growing at the rate of about 8% compounded annually to 1970.) (2) Many electronics companies generally are immune to the business cycle, since Congress underwrites the DOI budget. (3) Electronics is a technically-oriented business with an insatiable demand that keeps rising as it feeds upon itself.

Other Analysts Disagree

Despite this optimism, other analysts disagree. One cites several counter-reasons: (1) Some 80%

By **SIDNEY FELDMAN**

Contributing Editor
ELECTRONIC INDUSTRIES



Scenes of May 28, 1962 performance where dancing electronics stocks tripped over well-meaning analysts and fell flat on their

faces . . . trading floor of the American Stock Exchange, left, and exterior of the New York Stock Exchange building.

THE WALL STREET WALTZ (Continued)

to 90% of the electronics companies do not constitute a "growth" industry. Electronics companies are in a cyclical business, dependent on a DOD budget, dependent on Russian moves and our counter-moves, dependent on shrewd managing in the face of DOD cancellations or stretchouts. (2) Many electronics companies have a number of divisions which analysts have been unable to analyze. In the past they have equated all divisions without understanding that some divisions make money while others lose. (3) Electronics Companies still lack an important component of success—good management—difficult to achieve in any industry.

Electronics analysts already have confessed, not to misrepresentation, but to how poorly they analyzed or how little they understood electronics business and technology.

Security analysts often did misrepresent but not wilfully. Several analysts, of prominent brokerage houses, formed a group of "electronics specialists" who "exchanged ignorances." Nevertheless, they thrived because high demand and speculator greed kept the fool's paradise going.

Could Not Reprove Industries

Electronics corporate representatives could not be criticized severely for misleading security analysts. They often were invited to electronics companies as the chosen few to see the company "books," or the inside track on unusual developments and hardware. The trouble was that these analysts often did not

Trading floor activity was often feverish as electronic stocks changed hands and their prices went into orbit before crashing.
(Courtesy of the American Stock Exchange)



analyze, and they did not know the difference.

Time and again, in overflowing sessions of the New York Security Analysts, presidents and finance officers of electronics companies bared the hard, educational facts about the electronics business. But analysts did not understand. After such crowded presentations, a few analysts would raise hands to ask the usual trio of questions: (1) What electronic doohickey do you make? (2) Who are your competitors? (3) What will be your earnings, if any?

Some analysts criticized electronics firms that even remotely thought of profits or dividends: the big idea was to sell, sell, sell stock.

Current Electronics Stocks Appraisal

Here is how another analyst now appraises electronic stocks: (1) How profitable is the company's produce line? (2) Which of the company's divisions are making or losing money? (Note: Many firms claim such information is competitive. Analysts have learned to dig by asking such figures of a company's competitor—and find that the information is not as competitive as claimed.) (3) What is the company's trade and market position, and its share of the market? (4) Does the company have an R&D program that could lead to practical products and profits? (5) How good is the management (though measuring this quality is as elusive as it is subjective). (Note: Like horserace handicappers, security analysts are given to studying past sales performance and profits to forecast or guess at future possibilities.) (6) Has the market price of the stock already over-discounted its future growth? (7) What is a good price/earnings ratio for the stock?

Analysts confess they neglected to apply one yardstick—the price/earning ratio—to electronics stocks. They do now. During the Wall Street-electronics heyday some stocks rose to outlandish multiples of 30, 40, 50, 60 times earnings.

Originally, aircraft stocks had low multiples of price averaging about ten times earnings. When the Government ordered airplanes, aircraft stocks went up. As airplane orders nose-dived, so did stocks.

Since 1957, when aircraft manufacturers began to diversify into electronics, the marriage of the two has evolved into aerospace stocks.

Stocks Tend to be Depressed

Today, both electronics and aerospace stocks tend to be depressed. Some analysts believe that the aerospace industry "is getting to look more like the old aircraft industry." They attribute this to the political aspects of aircraft-aerospace defense contracts, such as the controversial TFX contract. *(Continued)*

Proven Dependability At No Extra Cost



SILICON AVALANCHE DIODES

3 Amperes To 250 Amperes 50-1000 PIV

A new and distinct generation of semiconductors—a major breakthrough in manufacturing techniques produce the newest development in silicon power rectifiers.

All Syntron Silicon Avalanche Diodes have these outstanding characteristics

- Inherent protection against voltage transients
- New standards of reliability
- Simplified series operation—eliminates shunting resistors
- Protects other components against overvoltage.

BUY THIS!

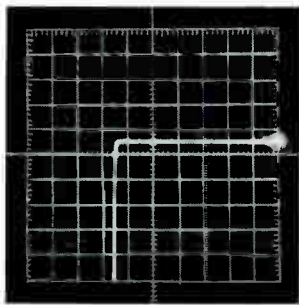

SYNTRON

NOT THIS

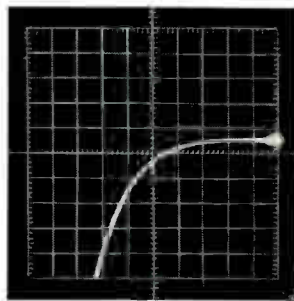

CONVENTIONAL

IT COSTS NO MORE

Syntron Silicon Avalanche Diodes are available in production quantities (New JEDEC Registrations) at the price of conventional units.

Call your Syntron Representative or write direct for additional data.

63R108

See Our Cataloging In  **THOMAS**
MICRO-CATALOGS



SYNTRON

SYNTRON COMPANY
SEMICONDUCTOR DEPT. 63R104

263 Lexington Avenue • Homer City, Pa.

THE WALL STREET WALTZ (Continued)

Stock of some companies, such as Lockheed, have been downgraded to a p/e ratio of about ten to one. Chastened analysts now subject electronics stocks to the scrutiny of historically lower aircraft p/e ratios.

There are changes. Many security analysts, who once watched the electronics business from the outside, have joined the Electronics Industries Association (EIA) as associate members. Banks and bankers now belong to EIA and other trade associations, and participate in their activities.

When the bottom began to fall out of the semiconductor business, other electronics companies started to feel investor-speculator shyness. By the May-June 1962 break, prices were further depressed. Then, virtually no electronics companies dared issue stocks or debentures.

Some electronics company managements took to their financial storm cellars, withdrawing issues of new or secondary stock (large blocks of stocks resold by original owners). Still others began patronizing banks for loans.

Began Feeding Out Stock

As the storm settled, electronics company managements began placing blocks of stock to private investors through investment bankers and brokerage houses. No stocks were offered "red-hot," but sedate little announcements told of such private placements. Smaller companies by-passed brokers and floated their own stock issues.

Daring electronics executives took to buying company stock to help keep the price from being too depressed. Other companies lacked either capital or such daring. Some executives lacked both. Others laid low, holding on to their companies.

Some executives have sold off some stock for capital gains, while retaining company control. However, some company managers have resisted stockholder pressure to bring new management blood into their companies.

Can Have Cake and Eat It Too!

A growing number of electronics managements realize they can have their cake and eat it, too, by having their smaller, under-capitalized divisions taken over by bigger electronics firms. This merger trend started gathering pace as the Wall Street "money well" began drying up.

The speed-up of electronics firm mergers has been documented by the Federal Trade Commission. Statistics show (under the awkward category of "Electrical Machinery") that this group led all the others in the past three years: 92 mergers and acquisitions in 1960, 88 in 1961, and 85 in 1962.

Parallel mergers and acquisitions in the "professional and scientific instruments" category ran second to electrical machinery: 17 in 1960, 26 in 1961, and 27 in 1962.

Non-Electronics Firms Diversify

Some new blood and new money have come into the electronics industries. Companies, such as the former Singer Sewing Machine Co., now the Singer Manufacturing Co., have acquired small electronics companies.

(Continued on page 64)

Just before the last waltz, electronics stocks rose to outlandish multiples of 30, 40, 50 and even 60 times their earnings.

(Courtesy of the New York Stock Exchange)



Progress Report on ALSIMAG[®] BERYLLIA Ceramics

OF ESPECIAL INTEREST TO
THE ELECTRONIC INDUSTRY

PROPERTIES OF ALSIMAG BERYLLIAS

PROPERTY	ALSIMAG 735*	ALSIMAG 754*
	A dense 98% BeO	A dense 99.5% BeO
Water Absorption	0 Impervious	0 Impervious
Specific Gravity	2.90	2.88
Density	.105	.104
Color	Near White	White
Safe Temp at Continuous Heat	°C 1 600 °F 2 912	1 600 2 912
Hard- ness	Mohs' Scale 9 Rockwell 45 N 65	9 65
Thermal Exp. Linear Coef. Per °C	25-300 6.1 x 10 ⁻⁶ 25-700 7.8 x 10 ⁻⁶ 25-900 8.5 x 10 ⁻⁶	6.0 x 10 ⁻⁶ 7.8 x 10 ⁻⁶ 8.5 x 10 ⁻⁶
Compressive Strength	> 175 000	> 185 000
Flexural Strength	30 000	35 000
Thermal Conductivity	25°C .50 300°C .25 500°C .15 800°C .07	.55 .28 .17 .08
Dielectric Strength 60 Cycle AC Test Discs 1/4" thick	255	260
Volume Resistivity	25°C > 10 ¹⁴ 100°C > 10 ¹⁴ 300°C 6.0 x 10 ¹³ 500°C 1.5 x 10 ¹² 700°C 3.5 x 10 ¹⁰ 900°C 1.0 x 10 ⁹	> 10 ¹⁴ > 10 ¹³ > 10 ¹⁴ 1.0 x 10 ¹³ 1.0 x 10 ¹¹ 3.0 x 10 ⁹
To Value	C 1 350 F 2 462	1 400 2 552
Dielectric Constant	25°C 300°C 500°C 800°C	25°C 300°C 500°C 800°C
	1 MC 6.3 6.4 6.6 7.3	6.4 6.6 6.9 7.9
	10,000 MC 6.1 6.1 6.2 6.5	6.1 6.1 6.3 6.5
Dissipation Factor	25°C 300°C 500°C 800°C	25°C 300°C 500°C 800°C
	1 MC .0001 .0002 .0006 .0025	.0001 .0001 .0004 .0025
	10,000 MC .0001 .0001 .0001 .0007	.0001 .0001 .0001 .0005
Loss Factor	25°C 300°C 500°C 800°C	25°C 300°C 500°C 800°C
	1 MC .0006 .0012 .0040 .0183	.0006 .0007 .0028 .0200
	10,000 MC .0006 .0006 .0006 .0046	.0006 .0006 .0006 .0033
	25,000 MC .0300 .0300 .0341 .0469	.0240 .0244 .0284 .0422

***WARNING:** in working with beryllia ceramics personnel should avoid exposure to dust or fume producing operations, such as sawing, grinding, drilling, or processing in moist atmospheres at high temperatures. Specialized equipment is necessary to prevent the dispersal of the dust and fumes into the air.

Sizes, configurations and dimensional tolerances in ALSiMag Beryllia Ceramics of the types shown above now approach those of ALSiMag Alumina Ceramics. Metallization techniques on ALSiMag Beryllias also have shown substantial progress. These advances permit increased latitude in the use of beryllia ceramics.

ALSiMag Beryllia has a dielectric constant about three quarters that of dense alumina. The Te value is almost twice that of alumina. In the range of 100°C., ALSiMag Beryllia has thermal conductivity about 10 times that of a dense alumina. The favorable heat transfer properties, coupled with excellent electrical insulation characteristics at elevated temperatures, enable beryllia to serve better than any other commercially practical material in certain critical applications. It promises to be especially valuable in micro-miniaturization.

Strict controls are exercised by American Lava Corporation in processing ALSiMag Beryllias. All parts are ultrasonically cleaned and carefully packaged to safeguard each part and permit appropriate handling on arrival. No-charge samples are generally NOT available in ALSiMag Beryllia Ceramics. Prototype orders are supplied to your specifications at a definite quoted price. Technical data will be sent on request. Please use your business letterhead.

Illustrations at upper left:

Beryllia ceramics, in circle, shown approximately twice size; others shown about one-half size.



AMERICAN LAVA CORPORATION

TELEPHONE 265-3411 • AREA CODE 615 • CHATTANOOGA 5, TENNESSEE

For service, contact American Lava representatives in Offices of Minnesota Mining and Manufacturing Co. in these cities (see your local telephone directory): Boston: Needham Heights, Mass. • Chicago: Bedford Park, Illinois • Cleveland, Ohio
Birmingham, Mich. • Laurens, S. C. • Los Angeles, Cal. • Minneapolis, Minn. • Metropolitan New York: Ridgefield, N. J.
Up-State New York: Newark, N. Y. • Philadelphia, Pennsylvania • Richardson, Texas • South San Francisco California
All export except Canada: Minnesota Mining and Manufacturing Co., International Division, 99 Park Ave., New York, N. Y.

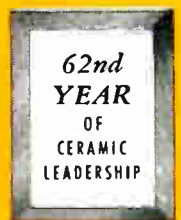

REWARD!

For Information On Switch Problems

Users of switches, confronted with problems in new products under development, are receiving rewarding solutions in the form of Grayhill engineered push-button switches.

Many Grayhill developed switches are further rewarding in minimum lead-time, being variations or combinations of standard switches in the broad Grayhill line, which also includes: push-pull; rotary tap; concentric shaft; spring return; illuminated; and other miniature and sub-miniature switches. Send your specs, quantity, and delivery requirements for quotation.



GRAYHILL Silent-Action Push-Button Switches

Ultra-Miniature to Standard GENERAL SPECIFICATIONS

Miniaturization—

Ideal for high density packaging.

Low Level Performance—

under .010 ohms contact resistance. Typical, depending on model.

High Dielectric Strength—

withstand 2000 VAC typical.

High Insulation Resistance—

20,000 megohms to 900,000 megohms depending on model.

Life Expectancy—

1/2 million to 1 million operations at rated load depending on model.

Standard Types—

SPST, SPDT & DPST

Delivery—

Stock to 6 weeks—depending on quantity.

Immediate Delivery of Samples for Prototypes

SEE OUR SPECIFICATIONS IN
VSMF
THE MICROFILM CATALOG FILE

Catalog
on Request

Switch
with
GRAYHILL



"N. Gineer"

Area Code 312, Phone 354-1040
543 Hillgrove Avenue
La Grange, Illinois

Grayhill INC.



"PIONEERS IN MINIATURIZATION"

Circle 57 on Inquiry Card

THE WALL STREET WALTZ (Concluded)

At the annual shareholder meeting of Television-Electronics Fund, Inc., January 17, 1963, more than 95% of voting shareholders approved continuance of management and underwriting contracts of the Fund with Television Shares Management Corporation.

Kansas City Southern Industries, Inc., organized by Kansas City Southern Railway management to permit diversification outside the railroad industry, now owns 40% of the 1,018,500 shares of Television Shares Management Corporation. Railroad money has rolled into the electronics business.

Looking to Long-Term Trend

The prudent heads in electronics are looking beyond past valleys and peaks to the long-term trend. Television-Electronics Fund, Inc., believes that aerospace and electronics industries have more favorable prospects for accelerating growth than any other segment of our economy.

Open-end investment funds stress disinterest in short-term swings. These funds regularly put money to work in electronics companies regardless of a roller-coaster market. Many spokesmen feel that issues of well-established electronics firms belong in portfolios of common stocks.

Wall Street electronics security analysts have been gaining confidence as the shadowy loss of May and June 1962 fade. They appreciate that by helping to float, or to send certain electronics stock issues sky-high, they have tampered with normal economics.

* * *

SYSTEMS CHECK

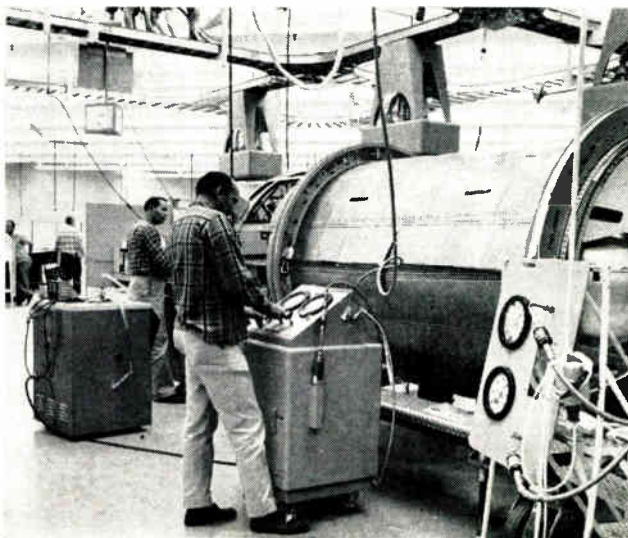

AF Agena D vehicle, wrapped in special blanket to protect thermal surface, goes through one of thousands of systems checks in assembly area of Lockheed Missiles & Space Co.

Quite a package!

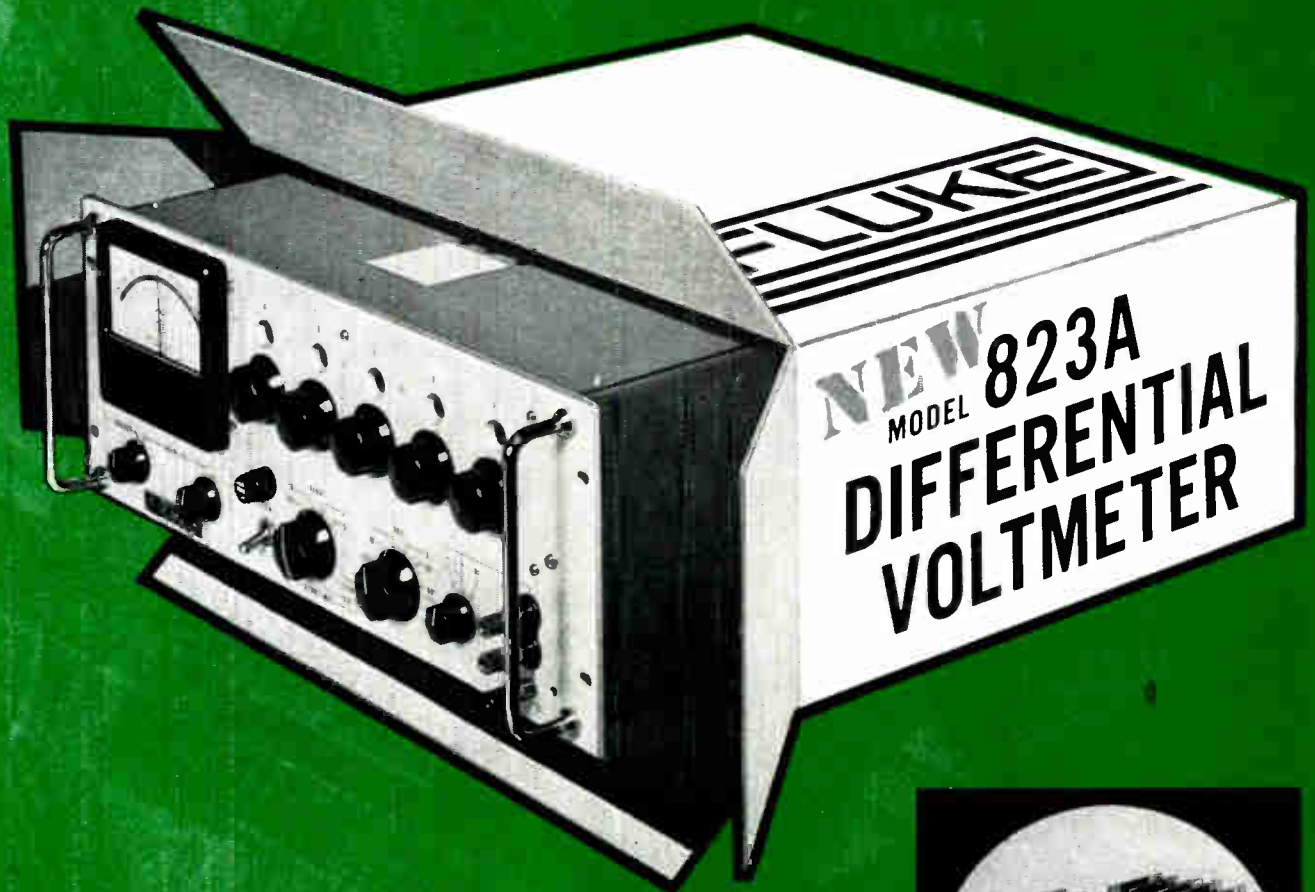

Fluke-manufactured, precision wirewound resistors, aged and matched both for resistance and temperature coefficient, guarantee the long term DC accuracy of the voltmeter to be better than 0.01%. Resistors used in critical portions of the Kelvin-Volley divider have temperature coefficients of less than one part per million per degree Centigrade.

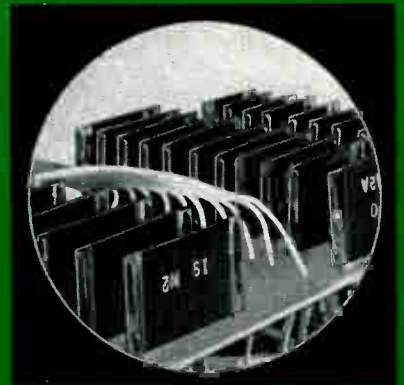

Accuracy of 0.01% DC, 0.1% AC *a uniquely useful measuring instrument*

The new Fluke Model 823A differential voltmeter provides the highest accuracy obtainable in a portable instrument. In addition, it provides infinite DC input resistance at null (0-500V), divider terminal linearity of 2-20 ppm, DC polarity switch, recorder output, and no zero controls.

Model 823A is designed to perform under severe environmental conditions. It is guaranteed to withstand the shock and vibration requirements of Mil-T-945A. It is guaranteed to perform within specifications from 0-80% humidity and from 55° to 95°F. It's quite a package.

Ask your Fluke representative for a demonstration, or request complete data from John Fluke Mfg. Company, Inc., P.O. Box 7428, Seattle 33, Wash. Tel. PR 6-1171; TWX 206-879-1864, TLX 852.



Circle 34 on Inquiry Card
WorldRadioHistory

Brief Specifications:

MODEL 823A

DC ACCURACY

± 0.01% from 0.5V to 500V
± (0.01% + 10 uv) below 0.5V

AC ACCURACY

± 0.1% from 30 cps to 5 KC
± 0.15% from 20 cps to 10 KC
overall frequency range 5 cps - 100 KC

CALIBRATION

500V internal reference supply calibrated to better than 20 ppm against built-in standard cell

INPUT POWER

115/230V AC ± 10%, 50-400 cps, 80 watts

CABINET

RACK

SIZE: 13" high x 9 1/4" wide x 16" deep 7" high x 19" wide x 15 1/2" deep

WT.: 28 pounds 26 pounds

PRICE: \$1300.00 \$1320.00

MODEL 803D

New Model 803D, available in either rack or cabinet configuration, offers many of the features of Model 823A. Accuracy—AC, 0.1%; DC, 0.02%. Price—cabinet, \$1100.00; rack, \$1120.00.

NEW MEASUREMENT CAPABILITIES AND CONVENIENCE

*with the new Tektronix Type 82 Plug-In
Unit in a Type 581 or 585 Oscilloscope*

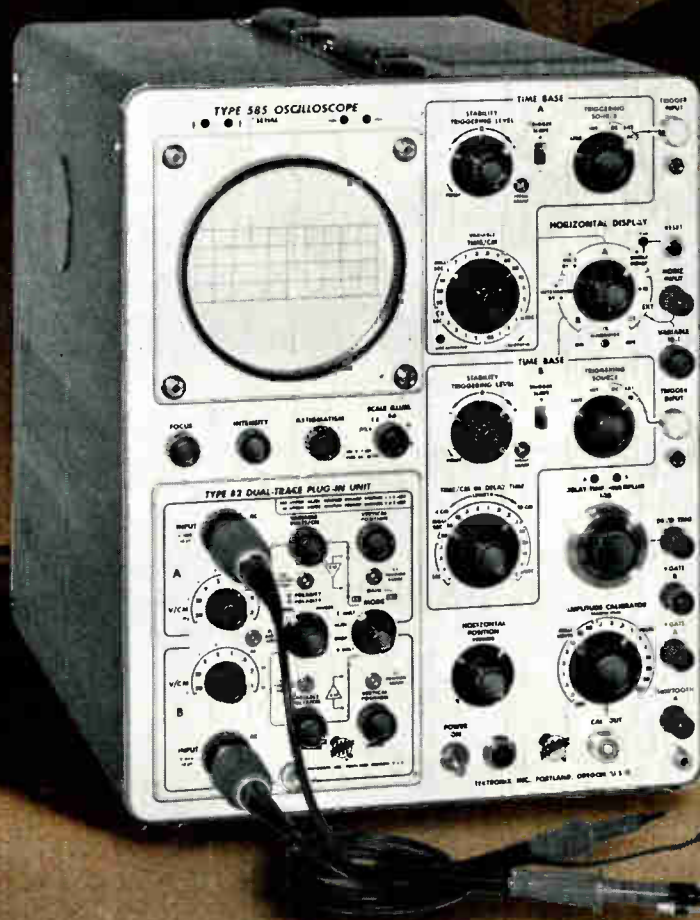



DUAL-TRACE

DC-TO-80 MC at 10 mv/cm

CALIBRATED STEP ATTENUATION

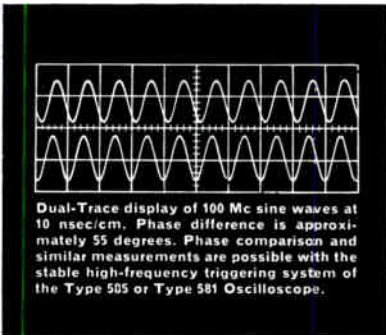

CHARACTERISTICS of the plug-in and oscilloscope

Dual-trace operation with 4 operating modes and independent controls for each channel — for individual attenuation, positioning, inversion, and ac or dc coupling.

Risetime nominally 4.3 nsec (80 Mc at 3-db down) at 10 mv/cm and 4.0 nsec (85 Mc at 3-db down) at 100 mv/cm.

Calibrated Sensitivity in 8 steps from 100 mv/cm to 20 v/cm and, in 10X Amplifier Mode, from 10 mv/cm to 2 v/cm, variable between steps.

Internal and External Triggering to beyond 100 Mc.

Sweep Range from 10 nsec/cm to 2 sec/cm.

Single-Sweep Photography at 10 nsec/cm for recording fast transients.

Bright, High Resolution Display with small spot size.

Compatibility with 17 Letter-Series Plug-Ins to permit differential, multi-trace, sampling, other laboratory applications—when used with Type 81 Adapter.

Conventional Passive Probes for measurement convenience.

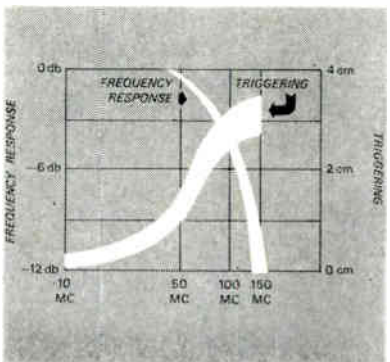

Supplied small size passive probes provide high input impedance characteristics. Probes increase input R to 10 megohms and decrease input C to approximately 7 pf.

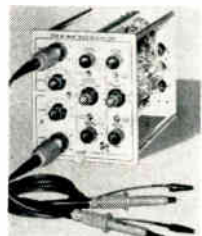

Risetime (of supplied probe, plug-in unit, oscilloscope) at overall sensitivity of 0.1 v/cm is approximately 5 1/4 nsec.

- Type 82 Dual-Trace Unit \$ 650 (includes 2 passive probes)
- Type 86 Single-Trace Unit \$ 350 (includes 1 passive probe has single channel operation, with other features similar to Type 82 Unit.)
- Type 585 Oscilloscope \$1725
- Type 585 has 2 modes of calibrated sweep delay—either triggered or conventional—ranging from 1 μsec to 10 seconds.
- Type 581 Oscilloscope \$1425

ADAPTER enhances versatility

The Type 81 Adapter allows insertion of 17 Tektronix letter-series plug-ins. Bandwidth (up to 30 Mc) and Sensitivity depend upon plug-in used.

- Type 81 Plug-In Adapter \$ 135

U. S. Sales Prices f.o.b. Beaverton, Oregon
Oscilloscope prices without plug-in units.

Call your Tektronix Field Engineer for a demonstration.

Tektronix, Inc. / P. O. BOX 500 • BEAVERTON, OREGON / (Area Code 503) Mitchell 4-0161 • TWX: 503-291-6805 •
Telex: 036-691 • Cable: TEKTRONIX • OVERSEAS DISTRIBUTORS IN 27 COUNTRIES
Tektronix Field Offices are located in principal cities throughout the United States. Please consult your Telephone Directory.
Tektronix Canada Ltd: Montreal, Quebec • Toronto (Willowdale) Ontario • Tektronix Ltd., Guernsey, Channel Islands

Circle 35 on Inquiry Card



TIPS (Technical Information and Product Service)

4 MORE VALUE-ACCENTED

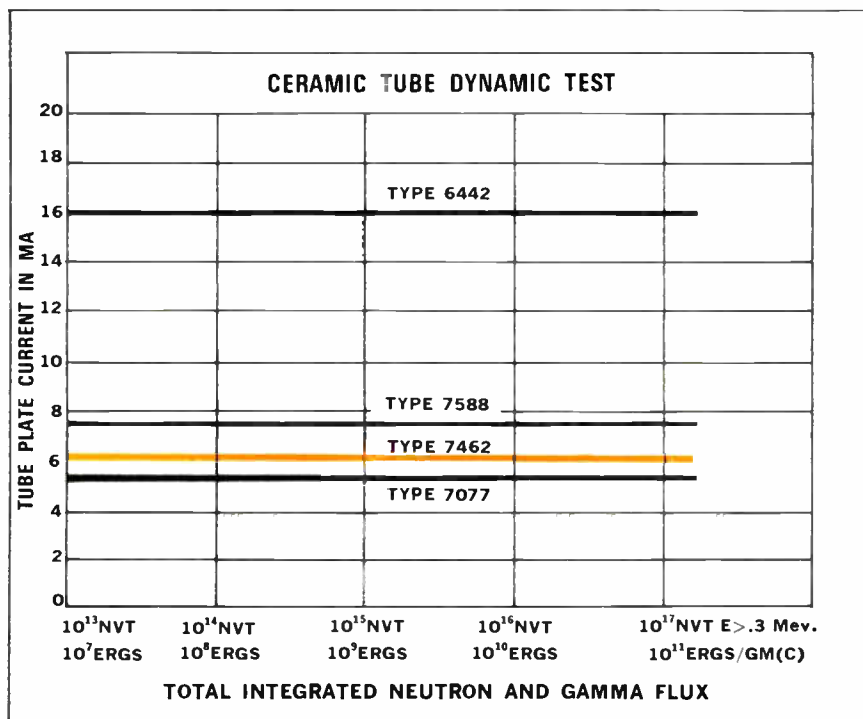

New tests confirm G-E ceramic tubes survive high nuclear radiation levels



Recent tests confirm that G-E ceramic tubes show no measurable changes in operation or characteristics during and after receiving total integrated flux of 5.6×10^{16} N_TVT ($E_n > 0.3$ Mev) and 7×10^{10} ergs/gm (c).

This exposure is in excess of all estimated requirements for presently conceived weapons systems. Tests were conducted by the radiation effects group of a leading airframe manufacturer and proved: *G-E ceramic tubes will meet all currently anticipated requirements for steady-state radiation tolerance in weapons systems, communications and other military electronic equipment.*

Three types of G-E tubes (five samples of each)—6442, 7077 and 7588—were irradiated under D-C operating conditions. Also, 18 samples of type 7462 were irradiated while operating in three 6-stage, 60-megacycle IF amplifiers. No significant changes were noted in tube currents, gain, bandwidth, or noise. Final complete and detailed information on these most recent tests will be available after June 1963.



New flexible-lead photoconductive cell for street-lighting applications



The B-1035 is G.E.'s newest photoconductive cell, and the first of its type to offer these important *value-analyzed* features:

1. Flexible Leads—The B-1035 allows fast, easy, direct-soldering installation. No sockets or clamp-on clips are required, resulting in definite savings of time and materials.
2. Low Moisture Level—Like all G-E photoconductive cells, the new B-1035 is hermetically sealed after reducing the moisture level within the envelope to an extremely low level. This assures longer life and increases over-all performance. As an added benefit in designing, the B-1035 has a $\frac{1}{2}$ " lower seated height than G-E type B-935 which it replaces.

MAXIMUM RATINGS AND CHARACTERISTICS—Photoconductive material: Cadmium sulfide. Spectral response: S-15. Voltage between terminals, DC or peak AC: 350 volts. Power dissipation: 0.35 watts. Photo current: 50 ma. Ambient temperature range: -75 to +60°C. Diameter: 1.26 in.

CHARACTERISTICS AT 25°C.—Voltage between terminals, 50 VAC. Illum. sens., 2000 ua/fc. Max. dark current, 40 ua.

DEVELOPMENTS FROM G-E RESEARCH

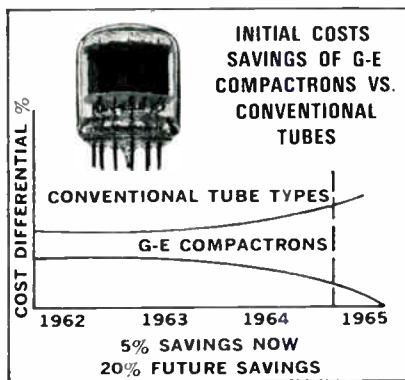

More G-E compactrons in tomorrow's radio, TV, hi-fi and industrial equipment

 Two major reasons account for the mushrooming growth of G-E compactrons in new, critical circuit design: (1) performance; (2) lower costs. Compactrons overcome the limitations of tubes and transistors and deliver more watts per cubic inch than any other component. They have a lower initial cost per function and offer savings in labor and materials.

By combining several functions into one low-profile envelope requiring fewer pins, stems, sockets, welds and handling, compactrons provide increased reliability and more compact circuitry, when compared to present-day components.

SPECIFIC VALUE-ANALYZED BENEFITS OF G-E COMPACTRONS

- They use up to 35% less power to perform the same function.
- Cost less than tubes or transistors to perform any given function. Lower initial costs, plus fewer compactrons needed in a given circuit, reduce hardware, wiring and soldering connections, and assembly time.
- Wide range of 52 production types to meet all requirements.
- Dissipate heat up to 35% better than conventional tubes, increasing life and reliability.
- Provide more compact circuits, allowing use of a smaller chassis and cabinet with resultant savings in materials.

Circle 38 on Inquiry Card

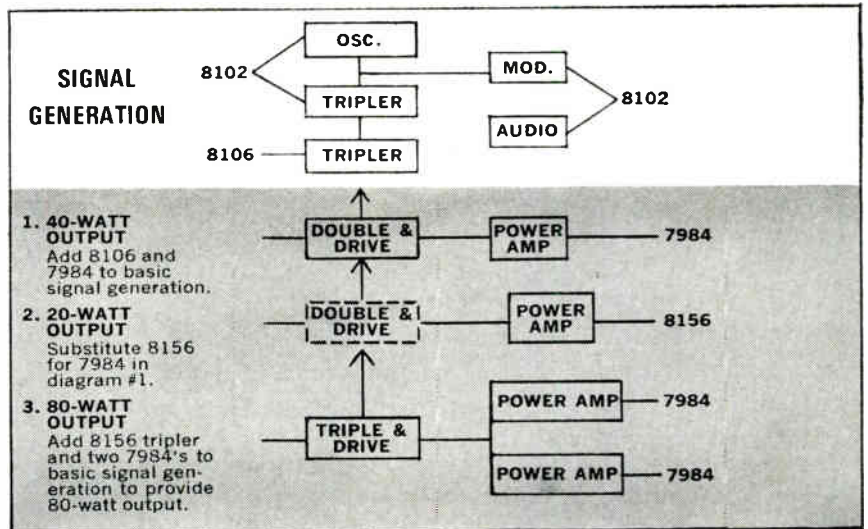

20-80 watt power output range possible from four new communication tubes

 A 20, 40 or 80-watt transmitter, working from the same basic signal-generation unit, can be built with the use of these two new compactrons and two new 9-pin miniatures. Specifically designed for use in mobile communications equipment, they help reduce circuit design and assembly costs without any loss in quality or transmitter performance. The above diagram shows the three different transmitter outputs which are possible using only these four basic new tubes:

7984 high-power transmitting tube. Power output: 46 watts at 175 MC. Single-ended construction, low seated height, multiple cathode and screen connections, low output capacitance and low driving-power requirements. Compactron T-12 tube.

8156 medium-power transmitting tube. Power output: 21 watts at 175 MC. Low output capacitance: 4.8 pf. Compactron T-12 tube. 1¹⁵/₁₆ inches seated height.

8106 175-MC. driver and multiplier. Miniature beam pentode. Low cathode-and-screen inductance, multiple leads, T-6¹/₂ bulb. 1¹⁵/₁₆ inches seated height.

8102 FM modulator and frequency tripler. Miniature triode-pentode.

Progress Is Our Most Important Product

GENERAL  ELECTRIC

For more information: Write G-E Receiving Tube Dept., Technical Information and Product Service (TIPS), Room 7003C, Owensboro, Ky. Please specify product(s).

Circle 39 on Inquiry Card

LOOK BEFORE YOU LEAP— WITH R&D BY-PRODUCTS

In the wide range of technologies covered by electronics and aerospace industries, more useful by-products are being generated from industrial research. Developing them is much easier than marketing them successfully. Many firms could have cut their marketing losses substantially — as others might do in the future — if they had followed certain basic rules for by-product evaluation.

“SEAT-OF-THE-PANTS” STRATEGY is still being used by a surprising number of managers as they go after new markets. This sort of strategy is especially prevalent among firms looking to capitalize on by-products developed in the course of major R&D programs.

In the long run, managers who use this approach

“For most by-products . . . a break-even point beyond two years is cause for serious concern; competition and rapidly changing technology don't leave much time for accruing profits. Products might also be obsolete before the break-even point is reached.”



either fail on legitimate profit-making opportunities, or they invest in products pre-ordained to failure. Nowhere is this pattern more evident than in the electronic computer industry.

Many companies in military computer systems or related areas have tried to extract the computer as a by-product, and exploit it in the commercial market. Inadequate analysis of investment requirements, inexperience in specialized marketing problems, and other predictable shortcomings, have cost hundreds of millions of dollars in the past decade.

Similar shortcomings have led to dramatic deficits in the areas of instrumentation (by-products of flight test and wind tunnel work), industrial controls (by-products of flight controls), and closed circuit television equipment (by-products of military communications and telemetry).

Could Have Been Saved

Much of the lost money could have been saved had managements asked fundamental questions about corporate objectives, corporate product area competence, organization planning, legal influences, and charity, patriotism and prestige.

Those fundamental questions were considered by corporations that have demonstrated successful by-product exploitation of inertial navigation devices (by-products of a cancelled missile program), missile

By **JOSEPH K. SLAPP**

Manager, Subcontractor and Arsenal Integration
Shillelagh Program
Aeronutronic Div. of Ford
Newport Beach, Calif.

checkout equipment (by-product of extensive missile flight test experience), and high-speed electronic printers (by-products of special-purpose cathode ray tube development).

With clearly stated corporate objectives, any firm can set the method and extent of evaluation warranted for each proposed by-product. Defined objectives don't guarantee that every proposed by-product will be analyzed automatically and correctly. However, they do mean that there exist basic criteria against which the by-product can be compared before the company spends a lot of money.

Analyze the Organization

Poor organization planning contributes to failure; a group originating a by-product is much less interested in helping it get started as a separate project than in performing creditably in its own work area, particularly when the organization operates on the profit center concept.

This can be avoided by feeding back some of the by-product's profit or loss into the basic program group's balance sheet. This encourages the program manager to help, and also helps him and the company.

The other main organizational problem, besides lack of incentive, is the difficulty in transferring information from project to by-product. It can be eliminated by transferring key personnel, but this penalizes the program manager and discourages him from supporting future by-product analysis.

A preferable solution is to expand the program manager's responsibilities to include the by-product project. This injects the important incentive factor.

The legal aspects of by-product development involve two patent questions: Is the company's invention protected? Is the company infringing on someone else's invention? For purely military programs, the value of a patent is somewhat diminished by the grant to royalty-free license. For products having commercial implications, a patent has real long-term significance.

Tech Review and Market Survey

Once administration has been satisfied, the by-product must undergo a thorough technical review covering product utility, soundness, competitive status, and product life.

"What is the product good for, and who wants it?" This can only be answered by a market evaluation, made either by a consultant or by the company. Typical depth surveys by consultants may cost from \$10,000 to \$100,000. This limits the consultant-survey usefulness to those products having high sales promise.

By careful selection of contacts, a knowledgeable company team can make a quick trip to potential users, universities and manufacturers of related equipment thus measuring the market, the product's usefulness and design features. Historical data charts for the market area can provide back-up material.

Competitive Products Best Source

The competitors' products are the best source of information on competitive status. Purchase competitive units and analyze them thoroughly. This provides not only technical and performance data, but also a good "fix" on the cost of the item.

The difference between cost and price is chiefly in overhead, profit and R&D amortization. Profit and overhead rates can be estimated fairly well. This yields the unit R&D writeoff, an important figure to know because it tells how much the competitor can lower his price, after amortization, without hurting his profit.

Thus it provides a guide to pricing strategy for your prospective product, and lets you estimate whether the features of your product will warrant the price you will charge, relative to the competition. Of course, this technique is useful only for analyzing products already on the market. Decisions on prospective competing products must be made from an extrapolation based on present status, capability, and published papers.

The final major technical consideration—production life—depends on such factors as competition, stability of the market, the product's performance growth potential (can the product be steadily improved without significant change to the basic design or tooling?), and customer satisfaction.

Market Timing Important

One frequent mistake in new product programs is to delay marketing until the unit is perfected. This gives the competition the jump, and shortens the product's life by minimizing the amount of low improvement following its introduction. More than one company has swallowed defeat after having victory in its jaws, just by holding back too long.

Just as important as the administrative and technical factors is the strategy of finances: investment, break-even point, return, alternative uses of assets, and resource availability.

If a company analyzes its prospective products on an incremental investment basis (each product analyzed as though it were a separate business), then the total expected cost of the by-product program will be calculated. This cost or investment must be programmed to show the chronological requirements

LOOK BEFORE YOU LEAP (Concluded)

through phases from R&D to post-warranty service.

All applicable cost categories must be included: labor, materials, facilities, publicity, taxes, and cost of capital.

When compared to the anticipated income, the cost figures provide management with a measure of the risk to be undertaken, by answering the question, "If the program has to be cancelled at any point, what is the potential loss?" When the potential loss is zero, the break-even point has been reached.

Two-Year Break-Even Point

For most by-product evaluations in the aerospace industries, a predicted break-even point in excess of two years is cause for serious concern. Because of the great competition and the rapidly changing technology, not much more time is left for accruing profits. Also, if the two-year estimate proves wrong, the product might become obsolete before the break-even point is reached.

It helps to know how many units must be sold to reach the break-even point. This can be compared to the market estimate to determine the probability of reaching required sales volume. The break-even quantity, Q , can be calculated from:

$$Q = \frac{F}{S - V}$$

where: F = Fixed expenses,

S = Unit selling price,

V = Unit variable expenses.

This assumes that the unit price is constant and that the variable expenses are proportional to volume. Usually the break-even analysis is done graphically. Costs and income are plotted on the ordinate against volume (dollars or unit quantities) as the abscissa.

This lets you include variable prices, shifts in fixed expense levels (rents, property taxes, insurance, etc.), costs of inventory due to variations between sales and production volume, and other true-to-life conditions. The point at which the total cost line crosses the total income line is the break-even point. To the right lies the profit area, to the left the loss area.

Besides defining the risk, the break-even chart has peripheral advantages such as helping to formulate the pricing strategy. A simplified chart is shown in Fig. 1.

Estimating the Profits

The aim of a by-product program, however, is not to break-even, but profit. This profit is normally considered in relation to capital employed, or to sales. The Small Business Administration uses the diagram shown in Fig. 2 to illustrate this.

The turnover measures the business-getting efficiency of the investment, while the earning ratio tells the profit level of that business. Both are important to determine the reasons for the return on investment, and to choose corrective actions when that figure is too low.

The percentage objective for return on investment depends on the company and on the market area.

It is good to know the investment requirements for a prospective program, but this is no help without an assurance that the resources will be made available. The people, facilities and funds must be ready for assignments—as scheduled—or the product will not reach the market on time, with proper specifications, in correct quantities.

After reviewing all the factors, it becomes clear that the "look" which must be taken "before you leap" should be more than a casual glance—if the leap is to be a successful one.

Fig. 1: A simple break-even chart.

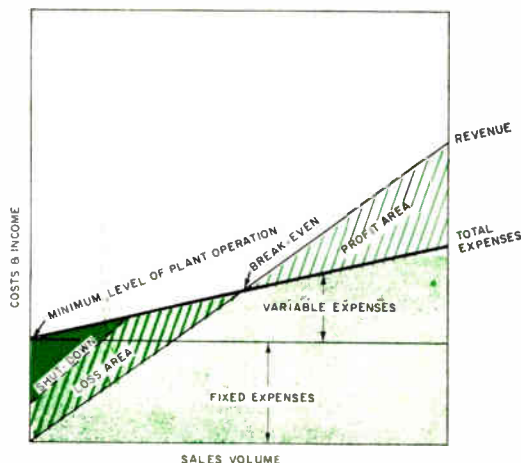
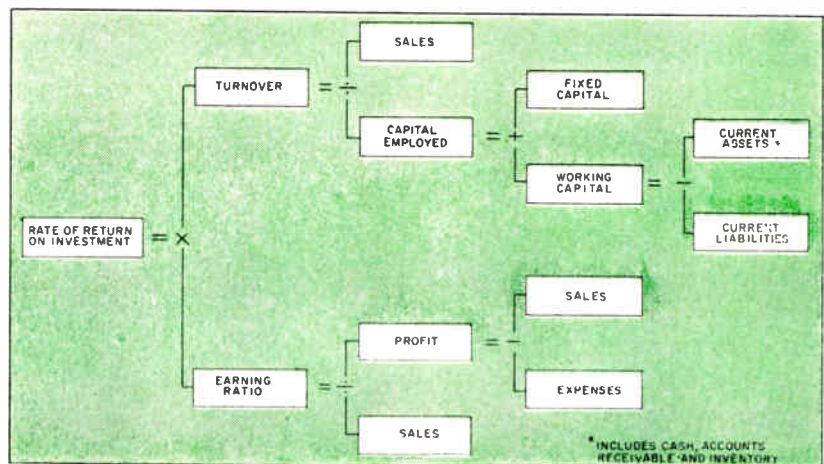
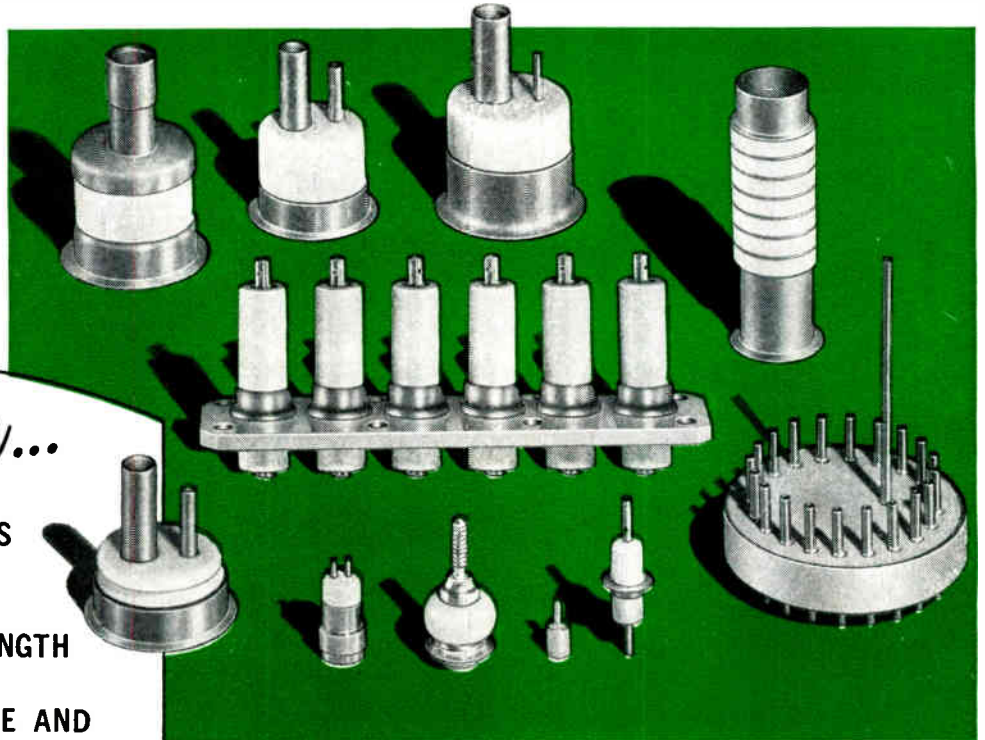

Fig. 2: Capital-sales-profit chart used by Small Business Administration.



ALITE[®] HIGH ALUMINA CERAMIC-TO-METAL SEAL ASSEMBLIES



Combine...

- VACUUM-TIGHTNESS
- SUPERIOR MECHANICAL STRENGTH
- HIGH TEMPERATURE AND HEAT-SHOCK RESISTANCE
- RELIABLE ELECTRICAL CHARACTERISTICS
- HIGH RESISTANCE TO NUCLEAR RADIATION
- PRECISION TOLERANCES

Looking for ways to improve reliability, reduce maintenance problems? The unique advantages of high alumina ceramic-to-metal seals produced by Alite's exclusive process may be just what you need!

From design to finished part, every manufacturing step is handled within our own plant and carefully supervised by our strict Quality Control methods to assure absolute adherence to specifications, utmost uniformity and reliability.

Alite's production experience with braze materials such as silver and copper, and its continuous research and development work with high temperature/low vapor pressure braze alloys, assure you of the most reliable assemblies the industry can provide. Vacuum-tight, these seals can be made to withstand the most rigorous environmental conditions, including vacuum, pressure, high or low temperatures, mechanical shock, and the like.

Let us review your specific requirements and help you take advantage of Alite's superior properties.

Write For These Helpful Brochures

Bulletin A-8 provides detailed descriptions and specifications of Alite formulations. Bulletin A-40R gives complete data on Alite standard bushings, which are available for off-the-shelf delivery.



331-H

**ALITE
DIVISION**





An hour ago, we got an emergency call for electronic chemicals

When you need chemicals in a hurry to stave off production shut-downs, you can count on Baker & Adamson. We'll ship at once! We ship orders the same day we hear from you. This is our standard practice.

We stock B&A® "Electronic Grade" Chemicals in 21 cities coast-to-coast. Even if you're in hard-to-reach areas, we can give you fast shipment from our nearest warehouse.

Our B&A product line is the widest anywhere. It includes acetone, methyl alcohol, isopropyl alcohol, carbon tetrachloride, anhydrous ether, hydrogen peroxide (30%, and 30% stabilized), trichloroethylene and sodium carbonate (monohydrate).

For more information, write or phone your nearest B&A supply point. All inquiries receive prompt attention.

B&A Supply Points

Albany, N.Y.	E. St. Louis, Ill.
Baton Rouge, La.	Houston, Tex.
Birmingham, Ala.	Los Angeles, Calif.
Boston, Mass.	*Montreal, Quebec
Bridgeport, Conn.	Passaic, N.J.
Buffalo, N.Y.	Philadelphia, Pa.
Charlotte, N.C.	Pittsburgh, Pa.
Chicago, Ill.	San Francisco, Calif.
Cleveland, Ohio	*Toronto, Ontario
Detroit, Mich.	*Vancouver, B.C.

*In Canada: Allied Chemical Canada, Ltd.

BAKER & ADAMSON®
"Electronic Grade"
Chemicals



GENERAL CHEMICAL DIVISION
P. O. Box 353, Morristown, N. J.

Please send export inquiries to: Allied Chemical International
 40 Rector Street, New York 6, N. Y.

Long term, drift-free performance! Unlimited shelf life! Minimum derating requirements! Highest immunity to mechanical wear! Negligible change under widely varying atmospheric conditions! Widest resistance range—100 Ω to 100 megohms! Wobble-free shaft operation! Velvet touch and zero backlash, optional! Selection from complete line, including switches! **LOW COST!**

*If you're not getting all these advantages now... switch to Stackpole **STABILITE**TM Controls*

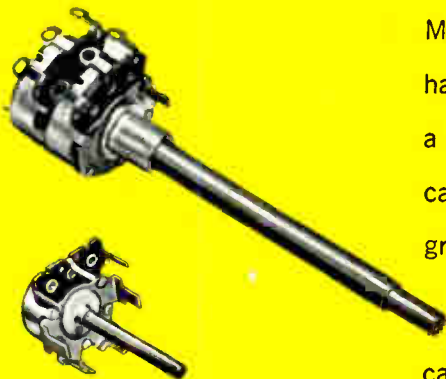

Many variable resistors have some of these features, but no other has all these features. Reason: Stackpole STABILITE Controls use a unique new resistance element—the first inherently stable carbon composition element ever developed for commercial grade controls.

Want top quality and economy too? Then write or call today!

STACKPOLE

CARBON COMPANY, *Electro-Mechanical Products Division*
Johnsonburg, Pennsylvania



**We produced the world's thinnest (.005 diam.) flux-core solder
... then somebody dropped it!**

Less than twice the size of a human hair, this new Kester wire solder they're looking for is just .005" in overall diameter. Try to find that on a tweed carpet!

This new Kester solder has a hollow core filled with flux. To produce this takes ingenuity. It requires the most precise manufacturing standards to conform to the rigid specifications of the electronics industry. Can you

visualize using this .005" diam. Kester Solder in your manufacturing operation? Perhaps this is just what you need to solve your most difficult precision soldering problem. Kester will offer engineering assistance if you will state briefly your application situation. Write today.

KESTER SOLDER
KESTER SOLDER COMPANY

4210 Wrightwood Avenue, Chicago 39, Illinois • Newark 5, New Jersey • Anaheim, Calif. • Brantford, Ontario, Canada
Over 64 years manufacturing quality solders and fluxes



A LOW-COST STANDARD

for Time/Frequency Measurements and Calibrations

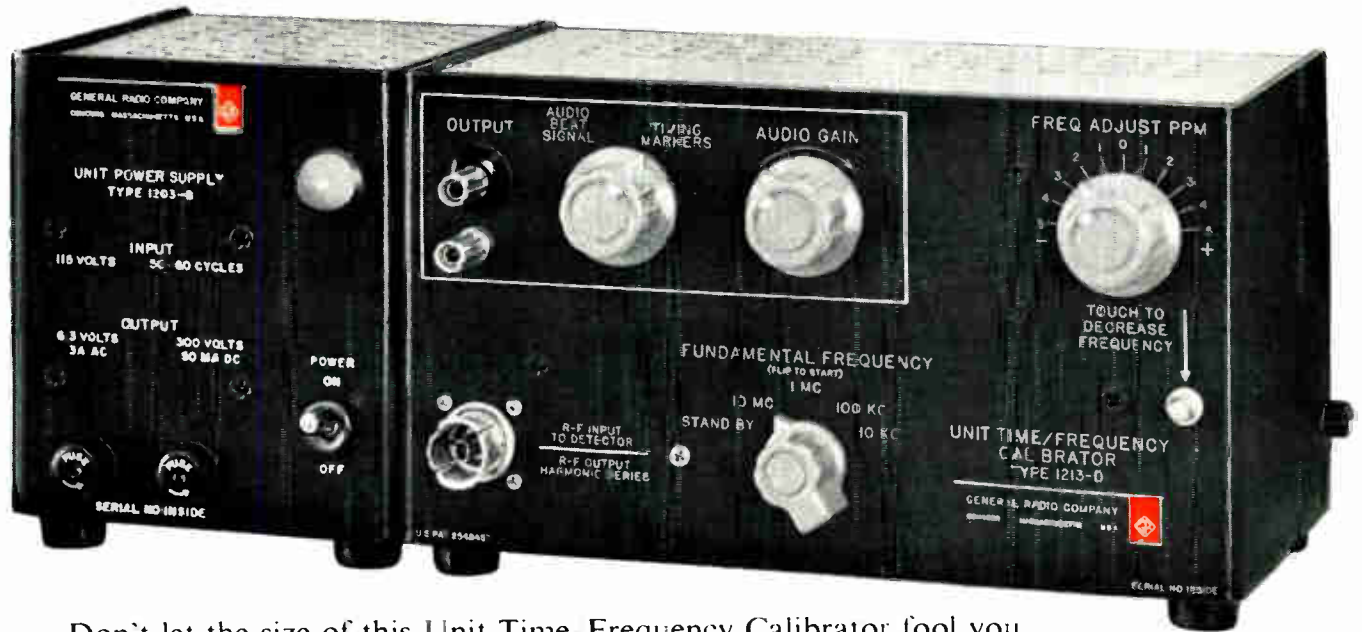

Don't let the size of this Unit Time/Frequency Calibrator fool you. Its volume is less than $\frac{1}{3}$ cu. ft. and it requires less than $\frac{1}{4}$ sq. ft. of bench space, but its performance is superior to that of many multi-instrument systems.

★ Accurate crystal-controlled 10-kc, 100-kc, 1-Mc, and 10-Mc fixed marker frequencies; harmonics usable to 10 Mc, 100 Mc, 500 Mc, and 1000 Mc respectively. Output amplitude is 5 v peak-to-peak on 10 Mc output; 30v peak-to-peak at lower frequencies.

★ *Excellent* Frequency Stability — frequency can be easily standardized with WWV to obtain short-term measurement accuracy to 2 parts in 10,000,000. Momentary line voltage fluctuations of $\pm 10\%$ affect frequency by less than 5×10^{-8} . Combined effects of switching and loading due to external connections are less than 1×10^{-7} .

★ The ideal instrument for producing timing markers at intervals from 0.1 μ sec to 100 μ sec for calibrating oscilloscope sweeps, receivers, transmitters, and other test equipment.

★ Usable beat notes to 1000 Mc can be produced with 50-mv input signal.

★ Touch-button frequency deviator can be used to introduce a momentary frequency decrease for establishing "sense" in indications near zero beat.

Write for Complete Information

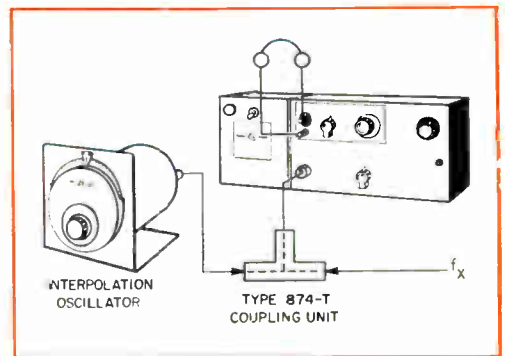

Measurements at any frequency

By simply feeding an interpolation frequency into the Calibrator's mixer along with the unknown signal, you do not restrict yourself to measurements at harmonics of the calibrator's fundamentals. Measurement or standardization at any frequency from 10 kc to above 1000 Mc then becomes possible.

Type 1213-D Unit: Time/Frequency Calibrator,
supplied with Type 1213-P1 Differentiator for
producing oscilloscope timing markers **\$310**

Type 1203-B Unit Power Supply (recommended) **\$55**

Type 480-P4U3 Relay Rack Panel for mounting
Calibrator and Power Supply **\$12**

GENERAL RADIO COMPANY

WEST CONCORD, MASSACHUSETTS

In EUROPE
General Radio
Overseas
Zurich, Switzerland

NEW YORK, N. Y., 964-2722
Ridgefield, N. J., 943-3140

CHICAGO
Oak Park 848-9400

PHILADELPHIA, 424-7419
Abington, 887-8486

WASHINGTON, D. C.
(Rockville, Md.) 946-1600

SYRACUSE
454-9323

DALLAS
FL 7-4031

SAN FRANCISCO
(Los Altos) 948-8233

LOS ANGELES
469-6201

ORLANDO, FLA.
425-4671

In CANADA
(Toronto) 247-2171

TRANSITRON'S EXCLUSIVE GERMANIUM PLANAR MICRO DIODES

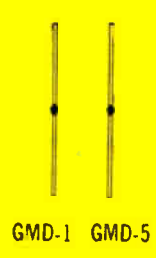

GMD-1 GMD-5

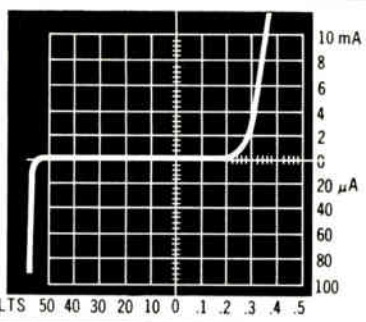

Trace of new GPD-1 shows its extremely low leakage current, sharp breakdown voltage, and low forward voltage drop. GMD-1 planar micro-diode produces identical trace.
(Trace shown taken from Tektronix Type 575 Curve Tracer.)

IMPROVED SPECIFICATIONS	
SPECIFICATIONS @ 25° C	GPD-1 GMD-1
Maximum Forward Voltage @ 10 mA	0.45V
Maximum Inverse Current @ -10V	1.0 μ A
Minimum Inverse Voltage @ 5 μ A	40V
Maximum Capacitance @ -3V	2pf
Maximum Recovery Time (5mA to -20V, Recovery to -25Kt)	0.3 μ sec

...AND ALL OFFER SPECIFICATIONS SUPERIOR TO ANY GERMANIUM DIODE NOW IN USE

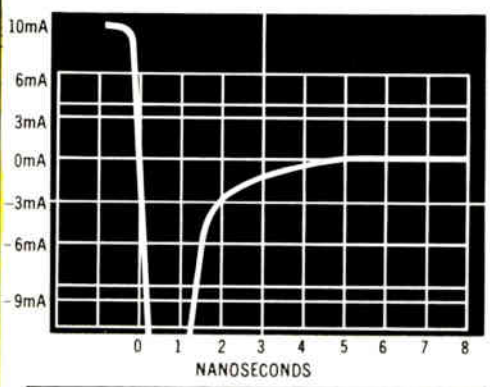

Trace of new high speed GPD-5 shows its very fast recovery. GMD-5 planar micro-diode produces identical trace.
(Trace shown taken from Lumatron Model 12-AB Oscilloscope.)

SPECIFICATIONS @ 25° C	GPD-5 GMD-5
Maximum Forward Voltage @ 10mA	0.45V
Maximum Inverse Current @ -20V	10 μ A
Minimum Inverse Voltage @ 100 μ A	30V
Maximum Capacitance @ -3V	2pf
Maximum Recovery Time (10mA to -6V, Recovery to -3mA)	4nsec

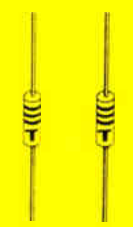

GPD-1 GPD-5

NOW AVAILABLE IN THE POPULAR SUBMINIATURE GLASS PACKAGE

TRANSITRON — industry's sole source of germanium planar micro-diodes — now adds two new subminiature glass planar equivalents to its highly regarded family of germanium diodes: GPD-1 offers superior DC characteristics and very low leakage . . . GPD-5 offers exceptionally fast switching and inverse recovery. Hermetically sealed in a DO-7 glass package and capable of handling greater power than their micro-equivalents, the GPD-1 and the GPD-5 replace a wide range of germanium and silicon diodes presently used in computer applications — adding planar construction for increased reliability. The new diodes are regarded as a technical achievement, serving to narrow significantly the performance gap between silicon and germanium. The GPD and GMD units offer all the advantages of germanium forward conductance, while closely approaching the inverse characteristic of silicon.

Both of these diodes are now available for your own immediate evaluation. **Transitron's recently introduced GMD-1 and GMD-5 microminiature germanium planar diodes have also been upgraded to achieve the same high specifications.**

Produced by advanced "batch" and automated production techniques, these dependable planar diodes offer substantial savings to volume OEM users. Both are now available in quantity — from Transitron's Wakefield facility, or through your Transitron Distributor. All units are also available in multiple semiconductor assemblies and multiple chip arrays. Special types may be readily designed for your own individual requirements.

Write Transitron, Wakefield, Massachusetts, for more complete information.

Transitron 
electronic corporation
wakefield, melrose, boston, mass.
SALES OFFICES IN PRINCIPAL CITIES THROUGHOUT THE U.S.A. AND EUROPE • CABLE ADDRESS "RELCO"

How much time and thought does the average electronic engineer give to his profession in extra activities such as in boning up with technical literature on the job, joining and taking part in professional and technical societies, and attending their local meetings and major conferences and conventions? A recent E.I. survey offers some eye-raisers.

HOW DO ENGINEERS KEEP UP-TO-DATE?

WHAT DOES THE AVERAGE ELECTRONIC ENGINEER DO besides earn money, raise a family, mow the lawn and go to Bermuda?

You will recall that in March, 1962, *ELECTRONIC INDUSTRIES* presented its "Profile of Today's Electronic Engineer—1962," which painted our engineer as a somewhat steady salary earner, insurance buyer, family raiser, community man and an asset collector.

We couldn't provide a study on "how much time, effort and thought do you put into your job?" Results of such a study are obvious, even if conducted off-the-record.

Although this study is rather limited in scope, it did cover several hundred engineers in U. S. industrial-scientific regions in metropolitan areas around New York, Philadelphia, Boston, Cleveland, Chicago, Los Angeles and San Francisco.

What Else Does He Do?

Our aim was to find out what the average electronic engineer puts into his profession beyond his daily eight-hours-plus in the areas of:

1. Membership in technical or professional societies
2. Attendance at national and major regional conferences
3. Reasons for attending
4. Opinions on value of conferences

We make no attempt to show how much an electronic engineer does in his job for the Zotz Corporation. We do feel, however, that the survey hints that our average engineer is not doing as much as he might to help him keep up with the state of his art.

While it is true that there are many and varied reasons why an engineer may not go into extra innings as much as he could, our study could not go into all ramifications.

We discovered, first of all, that our average engineer puts in less than three hours—more than likely less than two—a week at work delving into technical

literature. He seems to favor such likely sources of technical data as text books, catalogs, professional journals, and trade magazines. These sources range narrowly from "important" to "very important."

Taking engineers as a group, only 60% of the engineers polled are members of one or more professional societies and associations. (About 76% of society members are listed with the IEEE, while 55% are members of other organizations.)

Some Non-Members Do Attend

We noticed the interesting tendency of non-member engineers to attend local society meetings and some major regional and national conventions. Yet only 66% of non-member engineers reported that they have averaged several meetings each during the past year.

A little more than 50% of member engineers indicated they joined societies as sources of technical developments, trends, information and innovations. About 15% mentioned social contacts.

HERE IS A BRIEF RUN-DOWN ON OUR AVERAGE ELECTRONIC ENGINEER . . .

1. More than $\frac{1}{2}$ of him spends less than 3 hours a week reading technical literature in his field at work.
2. Less than $\frac{2}{3}$ of him belongs to any technical or professional society.
3. Only about $\frac{2}{3}$ of him attends, or has ever attended local meetings and major conferences of such societies.
4. When he does attend, half of him is interested only in his specialty field.
5. Less than $\frac{1}{4}$ of him ever tries to cover a major part of the conference program.
6. "Extensive travel and high cost" may keep as much as $\frac{4}{5}$ of him away from major conferences.
7. Only $\frac{1}{5}$ of him thinks that conferences are of any great value.

TIME SPENT BY ENGINEERS READING TECHNICAL PUBLICATIONS AT WORK DURING THE AVERAGE WEEK

QUESTION 1: On the average how much time do you spend during a week, at work, reading technical publications important to your job? I'm speaking of reading in your office or on your job.

No hours	%
1 hour or less	3.8
1 to 2 hours	6.5
2 to 3 hours	22.0
3 to 4 hours	22.6
4 to 7 hours	12.3
7 to 12 hours	13.3
Over 12 hours	8.1
	11.6

SOURCES OF INFORMATION ENGINEERS USE TO GATHER HELPFUL INFORMATION

QUESTION 2: I'm going to read some possible sources of information persons like yourself would likely use to gather information helpful to their job. As I read each source, will you tell me, please, if it is a very important source of information to you; of average importance; or of little or no importance?

	Average Ratings
A. Direct Mail Advertising	1.8
B. Directories and Catalogs	2.3
C. Other Persons in Company	2.5
D. Salesmen-Sales Engineers	2.0
E. Text Books	2.4
F. Professional Journals such as Proceedings, or Transactions of IRE, AIEE, AICHE, ASME, etc.	2.3
G. Trade Magazines such as Electronics, Electronic Industries, Electronic Design, etc.	2.5
H. Local Meetings of Professional Societies and Associations	1.6
I. National & Regional Meetings of Professional Societies and Associations	1.7
J. Trade Shows and Exhibits	2.0

NOTE: The above averages were calculated by assigning very important a value of 3; average importance a value of 2; and little or no importance a value of 1. Therefore, the higher the average rating, the more important is the source; the lower the average rating, the lesser important is the source.

ENGINEERS' MEMBERSHIP IN PROFESSIONAL TECHNICAL SOCIETIES OR ASSOCIATIONS

QUESTION 3: Do you belong to any professional technical societies or associations?

	%
Yes, do belong	61.0
No, do not belong	39.0

AMONG ENGINEERS NOT BELONGING TO SOCIETIES: ENGINEERS WHO HAVE EVER ATTENDED A SOCIETY MEETING

QUESTION 4: Have you ever attended a local meeting of any professional technical society or association?

	%
Yes, have attended	72.4
No, have never attended	27.6

AMONG ENGINEERS NOT BELONGING TO SOCIETIES: MEETINGS ATTENDED IN PAST YEAR

QUESTION 5: How many of these regular local meetings would you say you attended during the past year—from July 1961 to the present.

ENGINEERS UP TO DATE (Continued)

A little more than 58% of our engineers said they attended from one to nine local society meetings during the past year, and only 63% reported ever having attended major conventions. This last figure is fairly close to that reported in a survey taken for the Western Electronic Show and Convention at San Francisco last year. Of the engineer-attendees polled some 59% had attended previous Wescon conferences. Oddly enough, in the EI survey, about 2% confessed they didn't remember how many meetings they had attended.

As reasons for attending conventions, more than 95% of the more active engineers in the EI poll said that they attended to keep up with developments in their fields and to get information that might help them in their jobs. Some 52% said they also attended to represent their firms. "To see old friends" and "seek job opportunities" both averaged about 40%.

The Wescon study revealed that 89% of last year's attendees came for their companies, while some 76% reported they came "to keep up with the electronics industry." Only 34% gave personal reasons. In the *(Continued on page 82)*

	%
None during past year	34.0
One	10.5
Two	27.0
Three	15.2
Four	5.8
Five or more	7.5

SOCIETIES TO WHICH ENGINEERS BELONG

QUESTION 6: Would you tell me please, the names of the societies or associations to which you belong? Just initials would be sufficient.

	%
IEEE	76.2
All others	55.5

REASONS FOR JOINING SOCIETIES

QUESTION 7: Tell me please, your reasons for joining (this society) (these societies)?

	%
Source of technical developments; trends; information; innovations	56.0
Professional contacts; social contacts	15.4
Important for my work; beneficial	8.6
Benefits derived from membership	19.3
Source to disseminate technical information; exchange ideas	10.6
To be active in my field	32.0
To maintain prestige; status; public relations	5.4
All other reasons	1.7
Don't know	2.1

NOTE: This totals to more than 100% because of multiple mentions.

ENGINEERS HOLDING OFFICE OR TITLE

QUESTION 8: At present, do you hold any offices or title in (this society) (these societies)?

	%
Hold office or title	11.3
Do not hold office or title	88.7

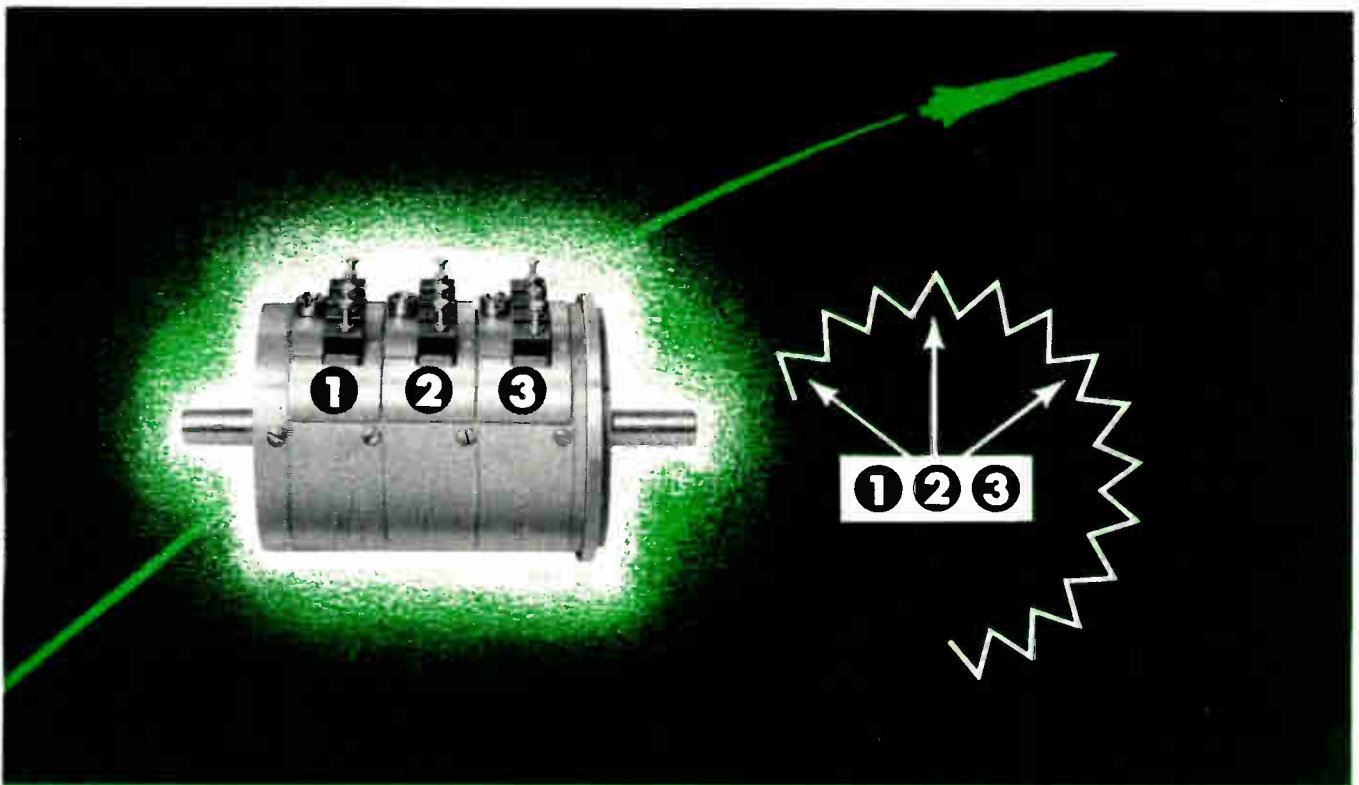

SINGLE-TURN VARI-PHASE™

PRECISION POTENTIOMETERS

FEATURES

- True individual cup adjustment
- No clamping rings—more compact design
- Anodized aluminum cases
- Available with complex electrical outputs
- 2, 2.5, 4.5, 5.5, 6.1 watt sizes
- Resistance tolerance: Standard $\pm 5\%$;
Special $\pm 1\%$
- Wide selection of standard mounts,
also specials
- Manufactured in accordance with
applicable sections of MIL-R-19,
MIL-R-12934

Variable phasing that permits individual cup adjustment without effecting "to the rear" units. Simply loosen set-screw, shift terminal block in desired direction, tighten set-screw, and it's done. Far superior to usual clamping ring technique. Designed for use in military and non-military applications in aircraft and electronic equipment. Write for complete technical data on all Clarostat fixed and variable resistance components today . . .

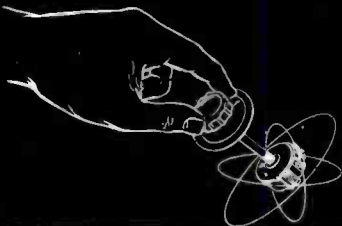

PRECISION POTENTIOMETER DIVISION

CLAROSTAT

CLAROSTAT MFG. CO., INC. DOVER, NEW HAMPSHIRE

MEETINGS ATTENDED IN PAST YEAR

QUESTION 9: During the past year from July 1961 to the present date—how many of the regular Local meetings sponsored by (this society) (these societies) have you attended?

None during past year	39.1
One	6.6
Two	10.1
Three	11.7
Four	11.5
Five to eight	5.2
Nine or more	13.4
Don't know	2.2

ATTENDANCE AT NATIONAL OR REGIONAL CONFERENCES

QUESTION 10: Have you ever attended a national or major regional conference of a professional society or association?

Yes	63.1
No	36.9

CONFERENCES ATTENDED DURING THE PAST YEAR

QUESTION 11: How many of these conferences or meetings have you attended in the past year—that is from July 1961 to the present date?

None during past year	28.6
One	36.2
Two	18.5
Three	9.1
Four or more	7.6

WHY ENGINEERS ATTEND CONFERENCES

QUESTION 12: Now I'm going to read you some statements which could explain why you ever attended national or regional conferences. As I read each statement, will you tell me if the statement does apply to your attending conferences or does not apply.

PERCENT SAYING STATEMENT APPLIES:	%
A. To represent my company	52.8
B. To participate as speaker, moderator or conference committee member	21.0
C. To keep informed of current developments in my field	96.4
D. To increase my job opportunities	40.8
E. To renew old acquaintances	39.8
F. To obtain information that can help me in my job	97.9
G. Current information in my field can be obtained much quicker in national conferences than from any other source	46.8

HOW ENGINEERS ATTEND CONFERENCES

QUESTION 13: I'm going to read you a few more general statements. As I read each statement, would you tell me, please, if it applies or does not apply as a description of your national or regional conference attendance? You can answer each statement with a yes or no.

PERCENT SAYING STATEMENT APPLIES:	%
A. I usually attend all conferences of professional societies, to which I belong	7.9
B. I usually attend conferences only if papers in my specialty are presented	57.3
C. I usually attend conferences from beginning to end	22.9

(Questions continued on page 84)

ENGINEERS UP TO DATE (Continued)

case of both Wescon and the EI study, about 60% of polled engineers said they had to make a report on the convention to their firms.

Attracted Only By Specialties

Of the engineers who attend major conferences, about 57% go only when papers in their specialties are listed, while 50% of those who actually do go, attend only the individual sessions in their specialties. Only 23% said they really try to cover most of the conference program.

The Wescon study revealed that about 56% of the total respondents actually attended the technical sessions, attending an average of 2.6 sessions each.

Some 50% in the EI study agree that there are sufficient conventions, while 28% think there are too many. Only a short 10% want more. Nearly 75% consider conferences only fairly useful, while a hopeful 17% think highly of such activity. Fortunately, only a small 5% remain unimpressed.

The Wescon report disclosed that, of all the listed sessions, least interest was shown in a special session for generating ideas to improve the technical conference programs.

Reasons for Not Attending

Most EI respondents reported that "distant locations involving extensive and costly travel" usually was a prime factor in keeping them away from major conferences. About 50% said they could get the information in the conference proceedings anyway, and that too few papers in their specialties are presented. The Wescon study, conducted only among actual attendees, indicated that more than 70% could not attend the technical sessions owing to various weak time problems, such as "too busy," "couldn't get off," "couldn't get here in time," "only had a few hours," etc.

The EI study indicated that 35% are in research and development, 28% are designers and 25% are in technical and engineering management. The remaining 12% are corporate officers of one sort or another.

Putting it another way, the study showed that 12% are corporate officials, firm owners and partners. Some 38% are chief engineers, department heads, managers, supervisors and section leaders. A little less than 50% are graduate engineers and technicians engaged mostly in bench activity.

This means that about 50% of our engineers polled are on some sort of executive level, where the greater responsibility lies for extracurricular activity to keep abreast of the state of the art.

Clare now offers...

the Type BA Relay

with Vibration Resistance:

100g through 4000 cps!

Shock Resistance:

125g for 11 milliseconds!

and remarkable reliability!



FROM LEFT:

- BA6A Six-pole round relay can
- BA1B Single-pole round relay can
- BA1C Single-pole printed circuit board module



Meeting or exceeding any known specifications for shock and vibration resistance, and offering reliability of a very high order, Clare Type BA Relays can meet your most exacting design requirements.

Precise balancing of the armature in each BA Switch Capsule makes possible vibration and shock resistance characteristics greater than 100g through 4000cps, and greater than 125g for 11ms, when hard mounted.

The remarkable reliability of the Type BA Relay is directly attributable to the fact that each switch is assembled in a super-clean atmosphere and sealed in glass under pressure to guarantee a true hermetic seal, thus eliminating the possibility of contact contamination.

Circle 47 on Inquiry Card

Three packages (6-pole round enclosure, single-pole round enclosure, and single-pole module for printed circuit board application) are available.

For detailed problem analysis and engineering assistance, write Group 5D7, Application Engineering, C. P. Clare & Co., 3101 Pratt Blvd., Chicago 45, Ill.

For comprehensive design data sheet on Clare Type BA Relays, write for Data Sheet 753, or use Reader Service Card.



Relays and related control components

\$545

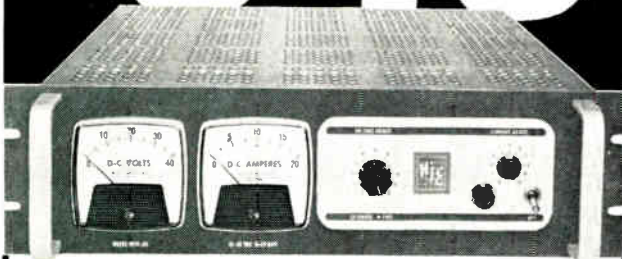

SY-36-20

Output Voltage: 10-36 Volts DC

Output Current: 0-20 Amps

Load Regulation: $\pm 0.01\%$

Ripple: 1MV RMS Max.

Size: 5 $\frac{1}{4}$ " x 19" x 16 $\frac{5}{8}$ "

NJE now offers the finite regulation and ripple previously found only in high cost laboratory equipment in their new low cost "SY" system power supplies. The key is improved SCR circuitry, unique production methods... and pioneering engineering brains. NJE puts them together to put together more power supply for the money than anything available today! It is the wedding of the low cost reliable fixed output power supply and the precision laboratory power supply.

The new "SY" line offers transient response at 50 microseconds, remote sensing, remote programming, coarse and fine voltage control, and are short circuit proof by means of an electronic current limiting circuit controlled from the front panel.

The new "SY" line offers unique circuitry that allows for the parallel operation of any units having the same voltage range capabilities. Loads will be distributed proportionally to the normal rated output.

**IMMEDIATE DELIVERY
5 YEAR WARRANTY**

Contact factory for information on other available models or see catalog in Electronic Engineers Master, Sec. 4000.



20 Bright Avenue • Kenilworth, N. J.

(Area Code 201) 272-6000 • TWX: 201-276-7630

"POWER SUPPLIES UNLIMITED"

D. I usually attend only on days during which papers in my specialty are presented	49.9
E. I usually attend conferences regardless of their location	18.3
F. I usually attend conferences regardless of how long they last	27.4
G. During the conference I usually attend only sessions in my specialty	43.0
H. I usually submit a report to my company on the sessions I attended	63.4

OPINION OF THE NUMBER OF CONFERENCES HELD EACH YEAR

QUESTION 14: Do you think there are too many national conferences held each year; too few held; or just enough?

	%
Too many	28.7
Too few	10.3
Just enough	49.9
Don't know	11.1

OPINION ON THE VALUE OF CONFERENCE

QUESTION 15: Do you think the information usually presented is very useful; fairly useful; or not useful?

	%
Very useful	17.0
Fairly useful	74.2
Not useful	5.3
Don't know	3.5

REASONS FOR NOT ATTENDING

QUESTION 16: Following are a few reasons persons might have for not attending some national or regional conference. As I read each statement, would you tell me if it would apply to you as a reason or would not apply?

PERCENT SAYING STATEMENT APPLIES:	%
A. Because the information is available to me when the proceedings are published	54.6
B. Because the same information is available to me through other sources	53.5
C. Because their location involved extensive or costly travel	80.0
D. Because too few papers in my specialty are presented	48.3
E. No time to attend	12.4
F. All other reasons	6.8

JOB TITLE

QUESTION 17: First, what is your present job title?

	%
Corporate Officials; Owners, Partners	12.1
Chief Engineers; Dept. Heads; Managers	5.9
Supervisors; Section Heads; Group Leaders	29.2
Engineers	49.5
All other titles	3.3

JOB FUNCTION

QUESTION 18: Now, I'd like to read you a list of job functions. Which one of these functions would you consider to be your primary function?

	%
A. Corporate Management	3.0
B. Operating or Production Management	1.8
C. Technical or Engineering Management	25.4
D. Design Engineering	28.1
E. Research and Development Engineering	34.5
F. All other functions	7.2

This is not a microwave sweep oscillator

This is the first microwave sweep signal generator

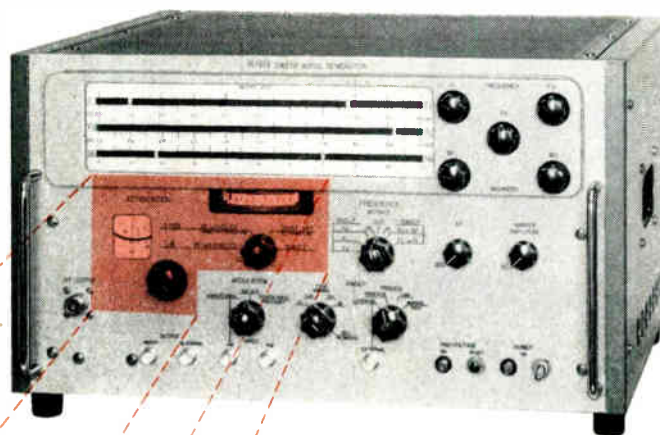

HERE, IN ONE COMPACT PACKAGE, is the microwave industry's first electronically swept signal generator. Alfred's new 630 Series now provides precise frequency tuning PLUS known absolute power output over a 60 db range, calibrated in dbm, all during swept or CW operation. Note these special features:

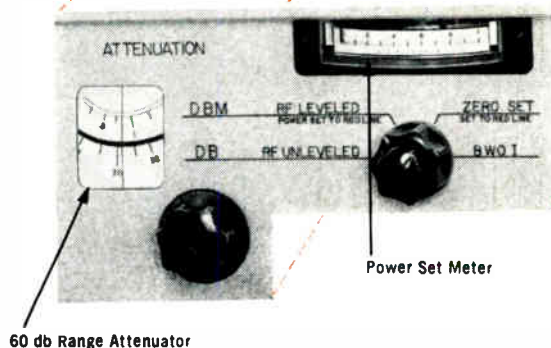

FLAT OUTPUT—Feedback leveler holds power variation to less than ± 0.5 db at rated output over each range. Variation in any 100 Mc range is less than ± 0.1 db. Accuracy ± 1 db at rated power output.

TRANSISTORIZED— $10\frac{1}{2}$ " panel height—lightweight—low power consumption—only five vacuum tubes used.

STABILIZED POWER OUTPUT—Balanced bolometer assures constant power output over wide temperature range.

AVAILABLE IN THREE RANGES—1 to 2, 2 to 4 and 4 to 8 Gc. Frequency is continuously adjustable over entire range with direct calibrated dial (1% accuracy).

ADJUSTABLE FREQUENCY MARKERS—Each unit has two time-saving indicators of band limits and two additional frequency markers.

KEY SPECIFICATIONS FREQUENCY RANGE: Model 631, 1 to 2 Gc; Model 632, 2 to 4 Gc; Model 633, 4 to 8 Gc. RF POWER: At least 1.0 mw. Continuously variable over 60 db range. Greater power output available unleveled. RESIDUAL FM: Less than 0.003% peak of highest frequency. DRIFT: ± 0.01 % per hour. SWEEP WIDTH: Continuously adjustable from 0 to any part of the entire frequency range. Symmetrical Sweep: 0 to ± 5 % of range about any center frequency. SWEEP TIME: CW operation, 100 to 0.01 second. Square Wave Operation, 100 to 0.5 second. AMPLITUDE MODULATION: CW, square wave or external.

COMPLETE DATA AVAILABLE—Alfred's policy is to publish complete specifications and guarantee them as stated. For detailed information on Series 630 Sweep Signal Generators, contact your Alfred engineering representative or write to:

ALFRED ELECTRONICS

Stanford Industrial Park • 3176 Porter Drive • Palo Alto, California
Phone: (415) 326-6496

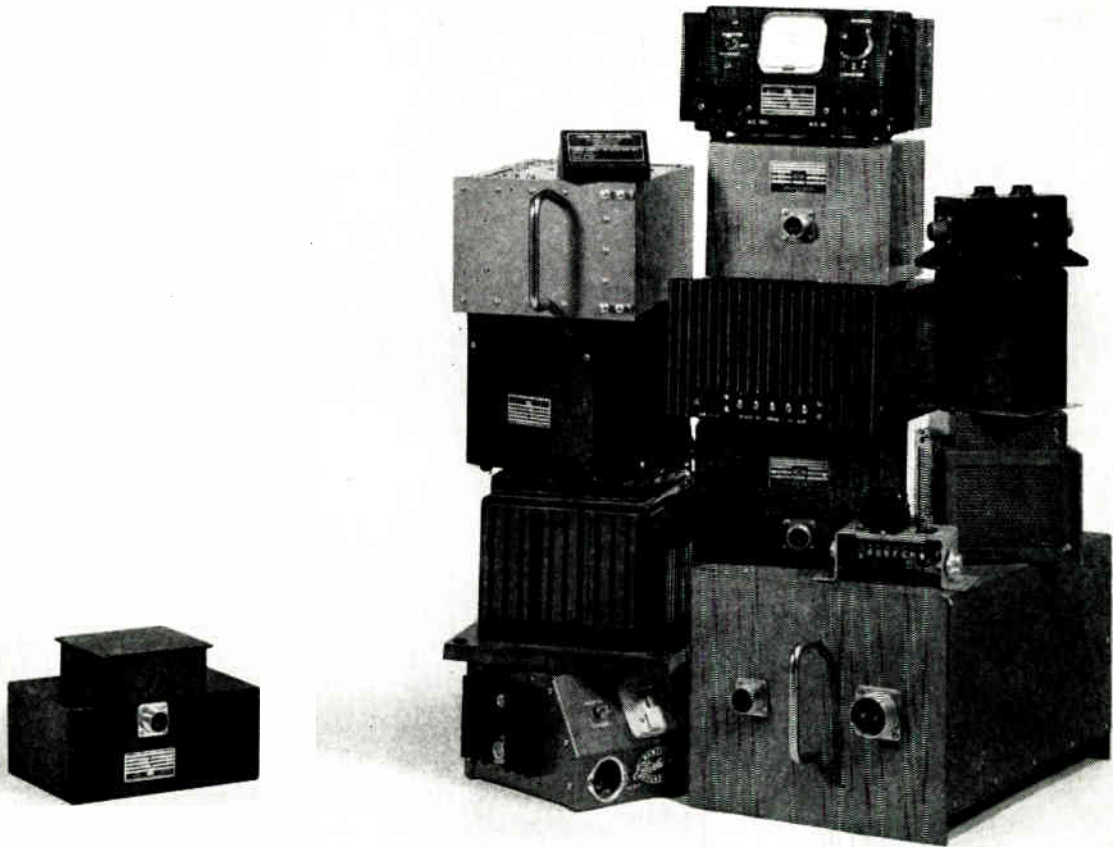

When you make a good inverter . . .

it's hard to stop.

If you're looking for one of the most complete lines of static inverters for military and industrial applications, you'll find it at Hamilton Standard.

From models in production, you can mix a limitless combination of characteristics to match your application—perfectly.

The variables: output rating (from 25 va to 10 Kva), number of phases, wave form, conversion

efficiency, operating temperature range (-55°C to $+125^{\circ}\text{C}$), size, weight, design life, vibration (10 to 5,000 cps at 30 Gs), overload protection, operating shock performance (10 to 400 Gs).

We'd be glad to send a representative list (complete with specifications) of our static power conversion equipment. Write: Electronics Department, Hamilton Standard, Broad Brook, Connecticut.

Hamilton Standard

ELECTRONICS DEPARTMENT
BROAD BROOK, CONNECTICUT

DIVISION OF UNITED AIRCRAFT CORPORATION

**U
A**

You're Going to Hear a Lot About



— a New Yardstick in Evaluation of Rectifier QUALITY

Why this hitherto-missing “fourth parameter” in controlled avalanche rectifiers is sure to become an important requirement in ALL quality rectifiers — and how GI's new VIP Series rate on this basis today.

As every up-to-date electronic engineer undoubtedly knows, the big news in power rectifiers is the “controlled avalanche” device . . .

GENERAL INSTRUMENT'S new “VIP” (Voltage Impulse Protection) is such a device — the industry's first series of axial-lead rectifiers capable of dissipating reverse transients up to 1 KW — repeatedly, and *without damage* . . . and meeting four requirements *now*, that will shortly become standard for *all* quality rectifiers.

FOUR Requirements of Quality Rectifiers

CONTROLLED AVALANCHE, if it is to have real meaning, must meet *four* essential, precise and predictable criteria . . . criteria that are also highly demanding indicators of true *quality control* and *advanced technology* in rectifier manufacture.

THREE OF these criteria have received some publicity and attention: (1) accurately specified maximum and minimum “avalanche voltage” values among different units of the same nominal rating; (2) ability to operate in the avalanche region indefinitely; (3) specific and predictable absorption of momentary power surges, accurately defined.

THE FOURTH — and hitherto largely neglected — parameter is what is termed — ΔBV — or *dynamic impedance*. — ΔBV — is actually the slope of the characteristic curve in the avalanche region . . . the abrupt, steep region just beyond the avalanche “knee”. It is specifically defined as the change in voltages accompanying a “change of reverse current” from 5 to 50 microamperes.

THIS SLOPE is a dynamic picture of exactly what occurs in *the one area of importance* that gives the controlled avalanche device its very desirable and distinctive attributes. The clean, sharp — *low* dynamic impedance beyond

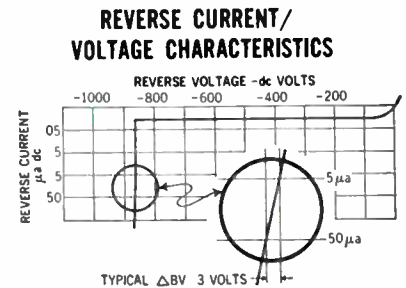
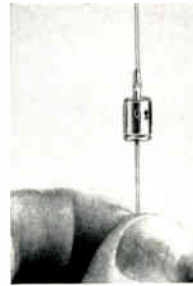

the knee—is the real “picture” of the *predictable performance* of such a rectifier. Quality-wise, it is the evidence of extreme *surface stability and junction uniformity*. It means that “avalanche” has been controlled wholly in the bulk and not wholly or even partially at the surface of the device. It means a stable device, one that avalanches the breakover current uniformly over the junction, rather than across junction edges through “pinpoint” areas that eventually short and cause catastrophic failure.

IN SHORT — ΔBV is not merely a measure of the inherently predictable and precise performance of an avalanche rectifier per se . . . it is also a measure of the inherent quality of the rectifier and its performance in *all* ways. Which is why, in the months and years ahead, you're going to hear a lot about — ΔBV — dynamic impedance — as the most significant yardstick in quality rectifier evaluation . . . and why you'll also hear a lot about VIPs, which not only do everything required of conventional rectifiers, but also measure up to that new yardstick of quality . . . today.

VIP UNITS are *now* on distributors' shelves in a fair range of ratings . . . and more are on the way. Ask your General Instrument Distributor about them — or, if more convenient, drop us a line for further data.

GENERAL INSTRUMENT CORPORATION

65 Gouverneur St., Newark 4, New Jersey



RECTIFIER DIVISION

RECTIFIERS

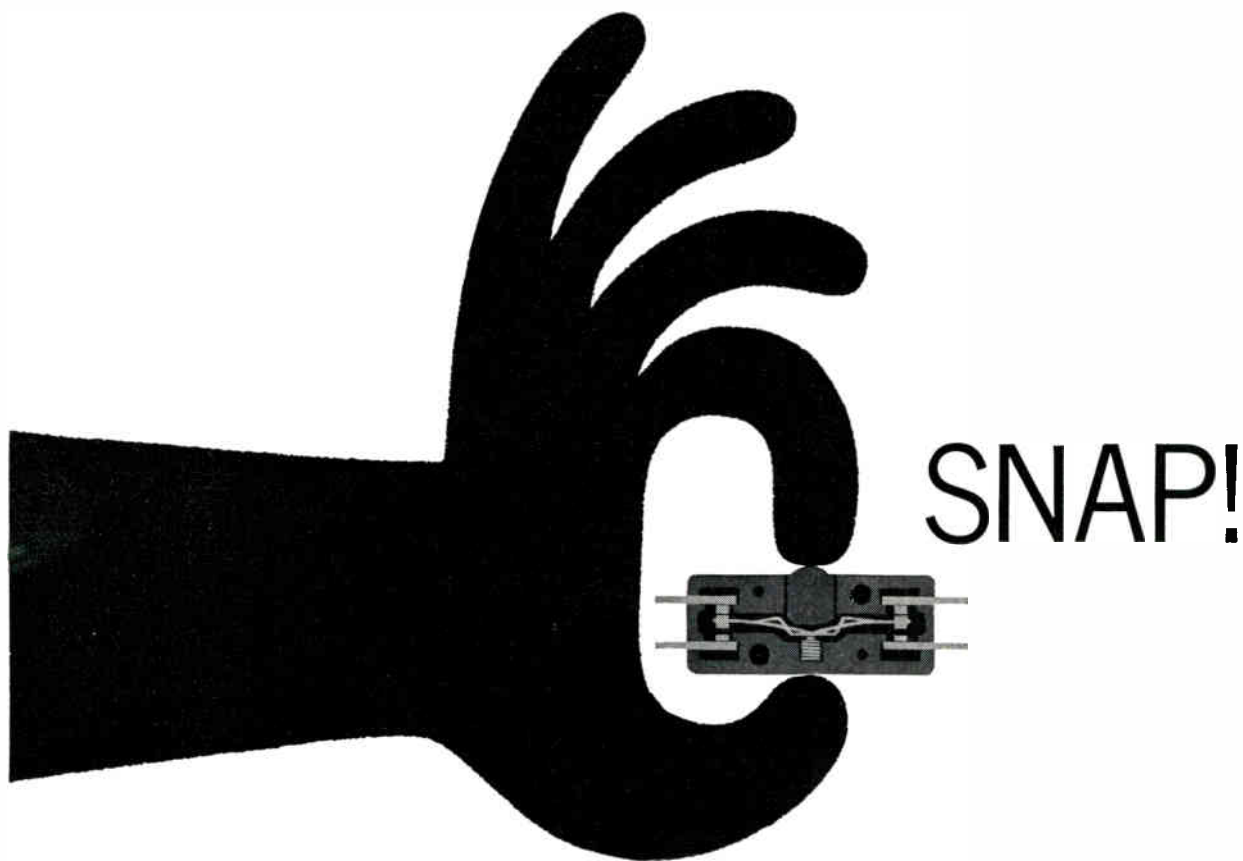

FAST-ACTING BASIC SWITCHES—Our unique snap-action makes the vital difference in performance and reliability. It gives you the most abrupt make or break, with maximum contact pressure. The result is increased capacity, lowered contact resistance, ability to withstand vibration and impact. To solve your switching problems, see our complete line of basic switches and actuators: sub-subminiature, subminiature, miniature, SPDT, SPDT double break, DPDT 4-circuit, TPDT 6-circuit, ½ to 40 amps, high inrush, and Mil Spec models. Write for free *Basic Snap-Action Switch Catalog*. #110.



CONTROLS COMPANY OF AMERICA
 CONTROL SWITCH DIVISION
 1420 Delmar Drive, Folcroft, Pennsylvania



Siemens Components Center, Munich—Main Offices, Research, Manufacturing and Sales

This is Siemens

Siemens is one of the world's largest business enterprises. The photo shows about one third of the Munich complex devoted exclusively to Siemens electronic components. Other Siemens components plants are located in Heidenheim and Regensburg. New buildings are also under construction at all three locations.

A large proportion of the total production of Siemens components is used in Siemens telecommunication equipment and other Siemens electronic products... world known for their high standards of quality. As a result, unusually complete and exact data is available on Siemens components' performance under actual operating conditions.

For general information on Siemens, circle 92 on Reader Service Card.

SIEMENS & HALSKE AG · GERMANY

Subsidiary in the U.S.A.:

SIEMENS AMERICA INCORPORATED

350 Fifth Avenue, New York 1, N.Y.

In Canada:

SIEMENS HALSKE SIEMENS SCHUCKERT (CANADA) LTD.

407 McGill Street, Montreal 1, P.Q.

MKH and MKL...

the smallest metallized film capacitors



Siemens MKH and MKL capacitors set new standards for both **small size and high reliability**. Twenty years' experience in making metallized capacitors has resulted in advanced manufacturing techniques which closely control every capacitor property. And these capacitors are almost completely foolproof in service; their "self-healing" ability eliminates the possibility of any voltage breakdown.

TWO SELF-HEALING PROCESSES

1. There is very little probability of an internal voltage breakdown. Whenever it happens, however, the thin metal coatings at the breakthrough point act as a fuse element and vaporize. The resulting gas pressure blows the vaporized metal away from the breakthrough point—interrupting the breakthrough within a few microseconds and eliminating any possibility of its recurrence.

Tests at nominal voltage show that **the average probability is less than one self-healing breakdown per year and per mF**. This value is for the first year. It is even less for following years. (The average total is 15 self-healing breakdowns in 20 years.) At lower than nominal voltages, the probability is far less.

Overload tests (at 2.2 times nominal voltage and at 85°C) show that decrease of capacitance as a result of self-healing is negligible, even after several years.

2. The second process, "electrochemical self healing," starts whenever and wherever insulation resistance decreases in the dielectric material. This process works at any voltage, even at 10 mV. It may continue for several hours or days. Its effect is to change the metal coating at the point of lowest insulation resistance to a non-conductive oxide...thus eliminating the point electrically.

There is practically no change in insulation resistance during or after an electrochemical self heal...or after a self-healing breakdown.

MKH metallized polyester capacitors—small size at low cost.

MKH capacitors are available, with axial or radial leads, in a flat shape. See photo below. A round type will be available soon. Leads are soldered to metallized ends to ensure reliable contact. The dielectric is polyester film widely used for capacitors.

Operating temperatures: -40° to +125°C.

Insulation resistance: At least 20,000 megohms for nominal capacitance up to .022 mF at +20°C. For higher capacitance values: 10,000 megohms × mF (typical values).

Temperature coefficient: Approx. .04%/°C between 0° and 70°C.

Dissipation factor: 0.5% at 1 kc; 1.5% at 10 kc (typical values).

Dimensions (in inches):

Capacitance Values (mF) ⁽¹⁾	Nominal Voltage	
	250 VDC	400 VDC ⁽²⁾
.01		.21 × .36 × .56
.015	Rated for up to 630V	.25 × .40 × .56
.022		.30 × .46 × .56
.033		.25 × .40 × .56
.047		.21 × .36 × .80
.068	.23 × .38 × .56	.25 × .40 × .80
.10	.26 × .42 × .56	.28 × .44 × .80
.15	.25 × .38 × .80	.25 × .50 × 1.09
.22	.25 × .48 × .80	.30 × .54 × 1.09
.33	.23 × .48 × 1.09	.32 × .70 × 1.09
.47	.25 × .62 × 1.09	.32 × .82 × 1.19
.68	.26 × .76 × 1.09	.40 × .89 × 1.19
1.0	.36 × .74 × 1.09	.52 × 1.01 × 1.19
2.0	.48 × .99 × 1.19	

(1) Usual tolerance: ±20%. Closer tolerances and intermediate values on request. (2) All values from .033 to .22 mF also available at 630V ratings.

MKH capacitors (±20% tolerance and axial leads) are in limited stock in White Plains, N. Y.

MKL miniature metallized lacquer capacitors—smallest film capacitor in mass production.

The dielectric is a 1/10 mil film of lacquer. A recent invention has substantially improved insulation resistance and allowed higher voltage ratings.

MKL standard type B 32110 capacitors are cased in an aluminum tube sealed with epoxy resin. MKL Type B 32120 capacitors are enclosed in a non-magnetic metal can hermetically sealed with glass. For both types, a plastic sleeve provides external insulation.

MKL capacitors are used for all types of circuits requiring high components density.

Operating temperatures: -40 to +85°C.

Insulation resistance: 5000 megohms × mF (typical value). 1000 megohms × mF (minimum value).

Temperature coefficient: Approx. .08%/°C for temperature above 0°C.

Dissipation factor: 1% at 100 cps; 1.5% at 1 kc; 2% at 10 kc. (All at 20°C.)

Dimensions (Type B 32110) in inches⁽¹⁾:

Capacitance Values (mF) ⁽²⁾	Nominal Voltage	
	50 VDC	100 VDC ⁽³⁾
0.1		.21 × .73"
0.22	.21 × .73"	.25 × .73
0.47	.29 × .73	.29 × .83
1.0	.29 × .83	.37 × .83
2.2	.42 × .83	.42 × .98
4.7	.42 × .98	.46 × 1.34
10.0	.50 × 1.34	.66 × 1.34

(1) Dimensions for Type B 32120 are slightly larger. (2) Usual tolerance: ±20%. Closer tolerances and intermediate values on request.

(3) All values are also available in 160V rating.

MKH and MKL capacitors are distributed by William Brand Electronic Components Inc. Services are available through sales representatives throughout the U. S.

CIRCLE 93 ON READER SERVICE CARD.

Siemens components available: Ferrite pot cores and transfluxors; capacitors (electrolytic, polystyrene, metallized plastic, metallized paper); deposited-film resistors; semiconductors. R. I. meters and screened diodes.

Distributor for these electronic components:

WILLIAM BRAND
Electronic Components, Inc.
220 Ferris Ave., White Plains, N.Y.
Telephone. 914 WH 8 3434

In Canada:
SIEMENS HALSKE SIEMENS SCHUCKERT
(CANADA) LTD.
407 McGill Street, Montreal 1, P.Q.

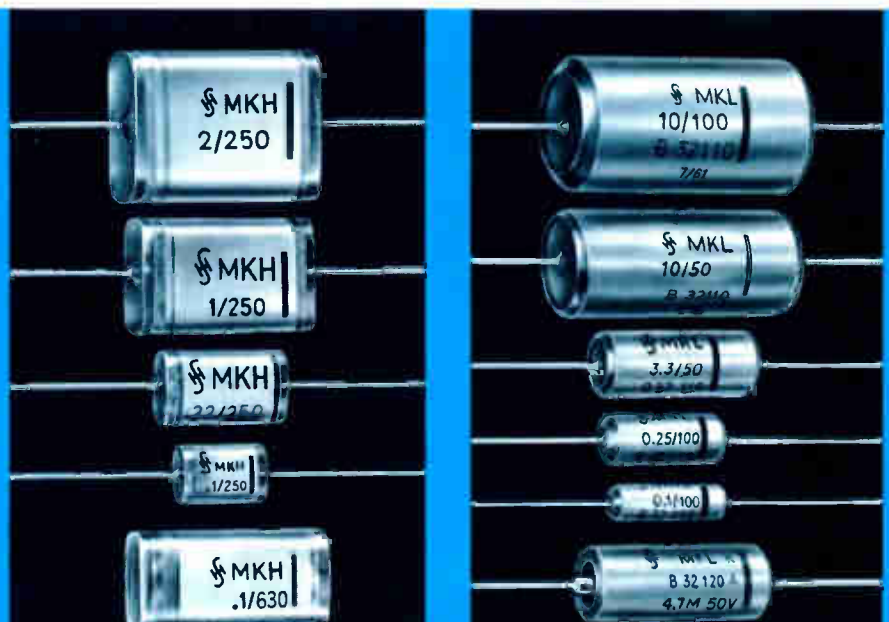

APPROX. ACTUAL SIZE

APPROX. ACTUAL SIZE

LIONEL CONNECTORS

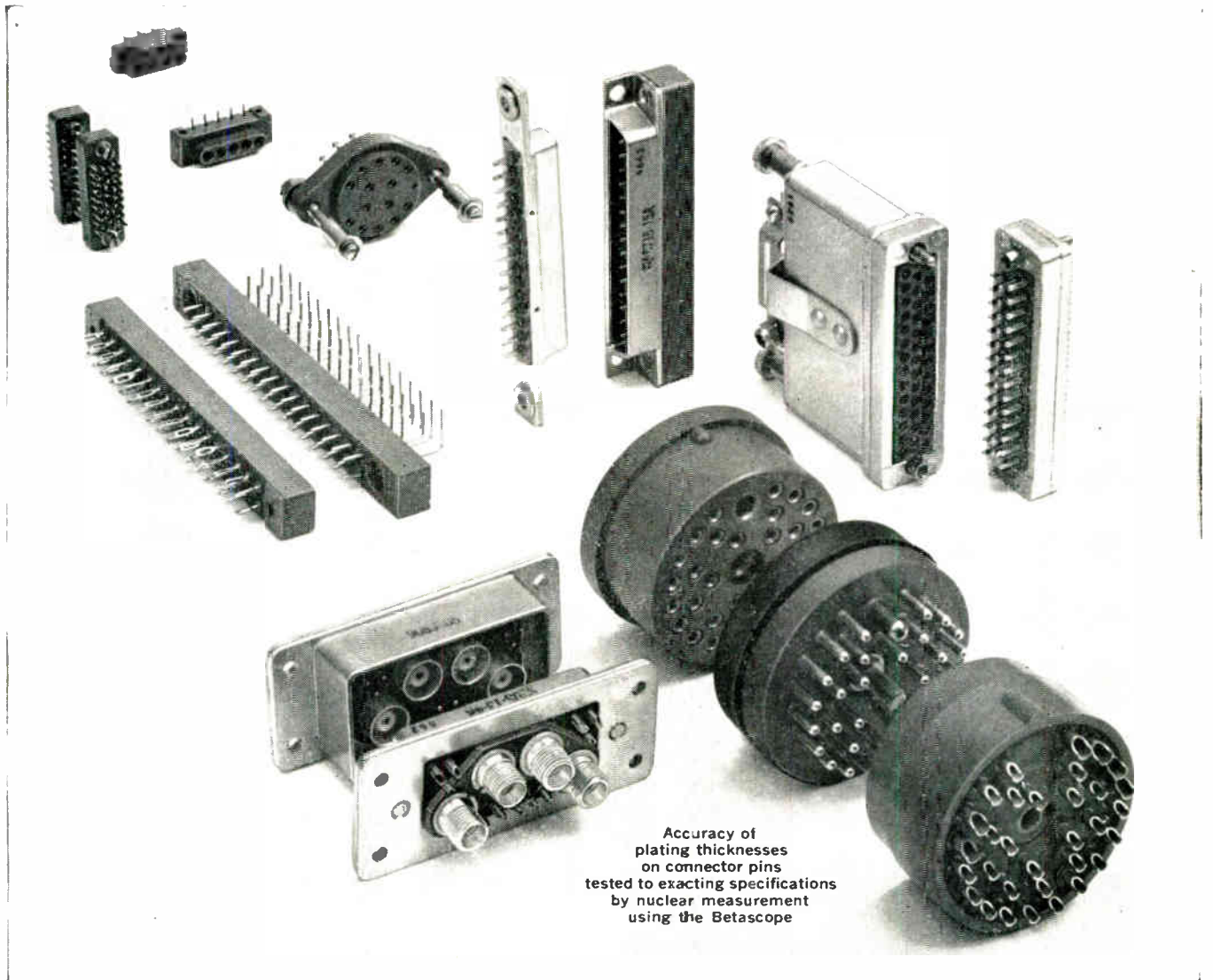

Accuracy of plating thicknesses on connector pins tested to exacting specifications by nuclear measurement using the Betascope

SPECIFIED TODAY — DELIVERED TOMORROW

Project Engineers are specifying LIONEL Connectors for applications ranging from their most demanding aircraft and missile requirements to their simpler needs, where pennies count—and find them delivered fastest. ■ LIONEL's extensive connector inventory covers a wide range of types, sizes and configurations, meeting applicable MIL specs or designed for optimum efficiency in commercial uses. ■ Whether your connector need is simple or complex — or compounded by environmental problems of temperature extremes, vibration, moisture or the atmosphere — call LIONEL. ■ For your most exotic or sophisticated connector applications, rely on the years of LIONEL-ANTON connector know-how and ingenuity. Our custom design service always available to meet new challenges.

SEND FOR OUR NEW COMPREHENSIVE CATALOG

LIONEL ELECTRONIC LABORATORIES, INC., Dept. RR-1
 1226 Flushing Avenue, Brooklyn 37, New York
 Please send me your NEW Lionel Catalog.
 Have your Applications Engineer call on me.

Name _____

Title _____

Company _____

Address _____

City _____ Zone _____ State _____

5E1



LIONEL ELECTRONIC LABORATORIES, INC.

1226 FLUSHING AVENUE, BROOKLYN 37, NEW YORK ■ A SUBSIDIARY OF THE LIONEL CORPORATION

LATE DEVELOPMENTS IN INTEGRATED CIRCUITS

SERVO AMPLIFIER

THIS 1.5 WATT CRYSTAL FEEDBACK AMPLIFIER CONTAINS 10 transistors, 5 diodes, and 27 resistors. It is diffused into a 4-mil thick wafer that is 170 x 170 mil square.

The device is a class A, dc coupled, ac differential amplifier. The transistors are capable of sustaining 75 volts during the swing of a 400 cycle signal, and they can deliver a maximum of 200ma into size 8 and size 11 servo motors.

The circuits are available on two types of material. The first is a 20-ohm-cm P-type crystal upon which a 1 mil, 2.5 ohm-cm N-type epitaxial layer is grown. The other is a bulk 2.5 ohm-cm N-type wafer. This wafer is lapped and polished to a 4.5 mil thickness. Holes are etched into the oxide where crystal contact is desired. Aluminum is evaporated over the entire wafer and subsequently etched off the crystal. Regrowth of P-type material in collector regions is prevented by N⁺ diffusion. Interconnection of elements is accomplished by a similar procedure of deposition and removal. The aluminum leads are vacuum baked at 500°C to alloy the aluminum to the oxide surface layers. This amplifier was developed by Norden Division, United Aircraft Corporation, Norwalk, Conn.

Microphotograph showing full interconnections

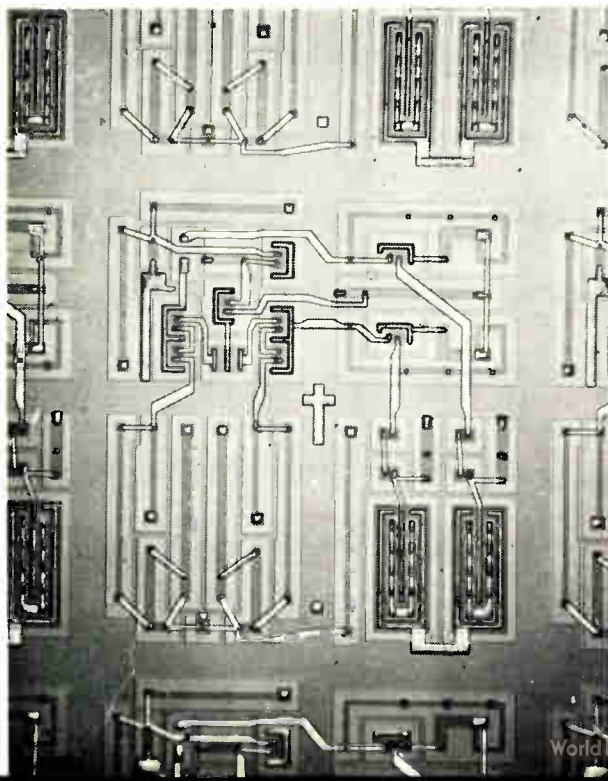

Neuron may be used to perform nine different logic functions. Switching times in the range of 1 MC or higher are typical.



MULTI-FUNCTION LOGIC ELEMENT

NEURON™ IS A SINGLE-CRYSTAL LOGIC ELEMENT which closely parallels the functions of the Neuron brain cell.

The transistor-sized device uses advanced field-effect semiconductor techniques to govern the output signal. The basic logic functions obtainable include: AND, OR, NOR, NAND, exclusive OR, bi-stable and mono-stable FFs, multivibrator, and inverter.

The manner in which the inputs are used will determine the function Neuron will perform.

The operation of this diffused silicon semiconductor depends on both bi-polar and uni-polar transistor action. Surface passivation assures reliability, long life and drift-free operation. The present configuration has four high-impedance inputs (gates), which when coupled with extremely low input capacitance, causes minimal source loading at high repetition rates. Switching times of 1MC or higher are typical with fan outs considerably greater than encountered with conventional logic approaches.

In many logic functions, some Neuron inputs are not used. If the functions associated with the unused inputs are compatible with the logic function being performed, the unused inputs can be paralleled with used inputs for circuit redundancy and greater reliability. Crystalonics Inc., 147 Sherman St., Cambridge 40, Mass.

SINGLE CHIP, R-F AMPLIFIER

THE WESTINGHOUSE TYPE WM-1101 functional electronic block is a planar silicon integrated circuit. It functions as an r-f amplifier and provides a power gain of 30db at frequencies up to 6mc. Bandpass tuning is provided by conventional external components.

Employing planar fabrication techniques, the WM-1101 is fabricated on a single silicon chip. The equivalent r-f circuit consists of two stages of direct-coupled amplification with a degenerative feedback loop. The feedback allows stable operation over the normal operating temperature range. The output is taken from the emitter of the second stage. For a higher impedance load, the output can be taken from the collector of the second stage. Conventional L-C tuning can be used to cover the desired r-f range.

Electrical characteristics include a nominal block-supply voltage of 12v, total block current of 4ma, operating temperature range from -55° to $+125^{\circ}\text{C}$ and a maximum storage temperature of $+200^{\circ}\text{C}$.

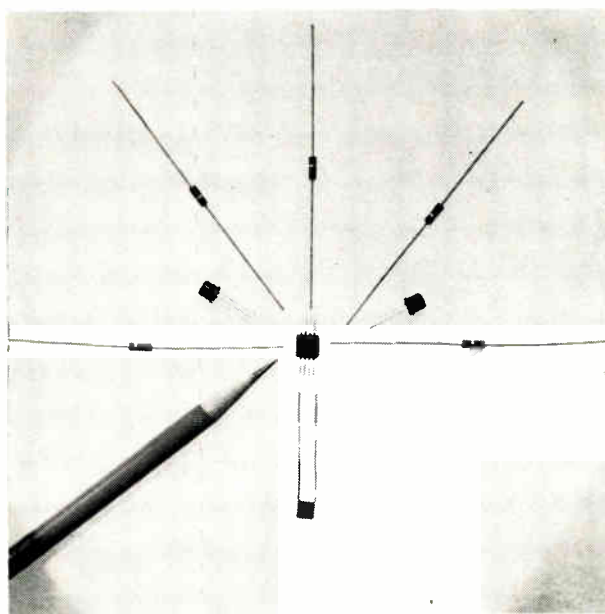

The r-f circuit which encompasses these components are combined into a single silicon chip.

Westinghouse Electric Corp., Molecular Electronics Div., P.O. Box 1836, Baltimore, Md.

HIGH FAN OUT GATE

MOTOROLA'S MECL[®] LOGIC CIRCUITS offer delays as short as 3.5 nsec. with a power dissipation of 35mw, or as long as 100nsec. with a dissipation less than 1mw.

The basic Mecl logic gate with a fan in of 5 consists of eight npn transistors. Six transistors form a current-mode switch and two are arranged as emitter followers. The first five are input transistors and are biased to cutoff; the sixth is a controlling transistor with a fixed bias. The controlling element for the first five is the base. The emitter followers serve as dc

translators to make the output compatible with the dc requirements of the following stage.

For any signal condition, two outputs are available—one from the controlling transistor and the other from the common collector junction of the five transistors. These signals constitute the desired and the complement. Therefore, the function of OR and NOR or AND and NAND can be accomplished by merely designating which signal polarity will be a logical 1.

The Mecl circuits offer input resistances in thousands of ohms and output impedances in ohms. Thus very high dc fan outs are possible. Motorola Semiconductor Products, Inc., 5005 E. McDowell Rd., Phoenix 8, Ariz.

High dc fan outs and power dissipations between 1mw and 35mw are featured.

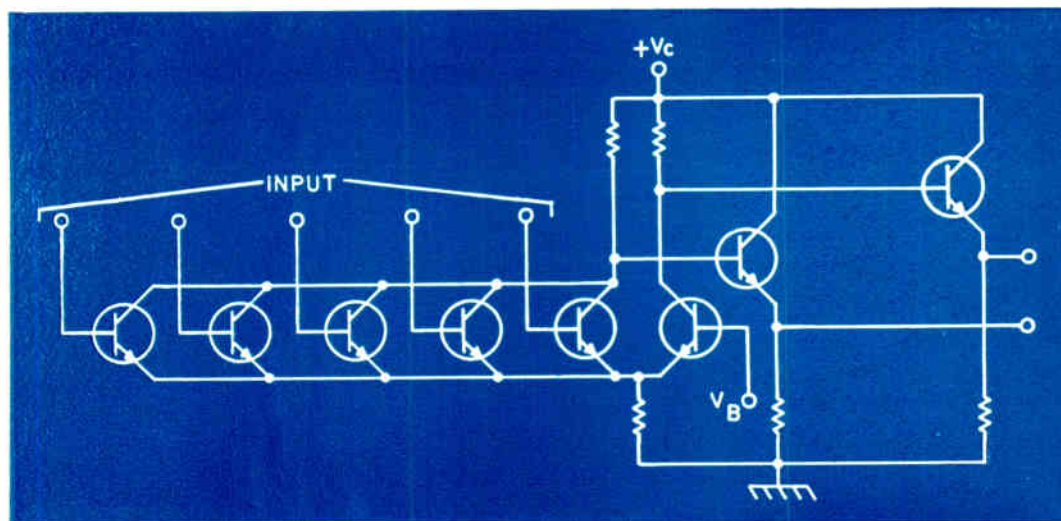

INTEGRATED CIRCUITS

BUILDING-BLOCK ELEMENTS

THE INSULATED-GATE FIELD-EFFECT TRANSISTOR is a solid-state element which combines the best properties of transistors and vacuum tubes. Both P and N type devices are available.

Circuits using these elements are made by producing conducting paths in a slice of high-resistance silicon. Gaps are provided for any desired active element, and insulators are produced by oxidizing the silicon over the gap. A metal electrode is deposited on the insulator and connected into the circuit. When power is supplied, the gap conducts and the circuit is completed.

Operating characteristics include: Temperature range from -80° to 190°C , and switching speed from 10-20nsec. RCA Laboratories, Princeton, N. J.

A logic circuit containing 16 insulated-gate, field-effect transistors is shown with a mockup as a backdrop.

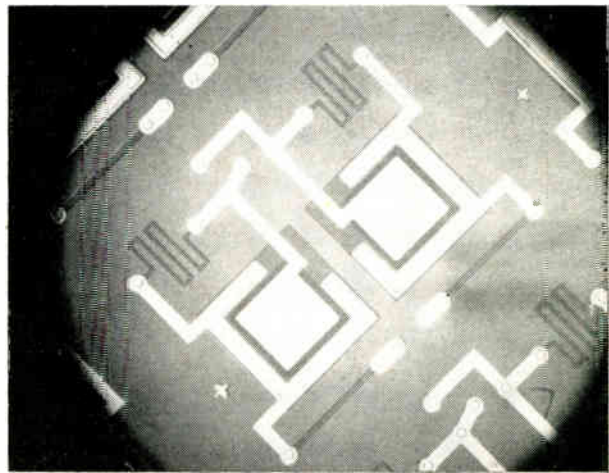
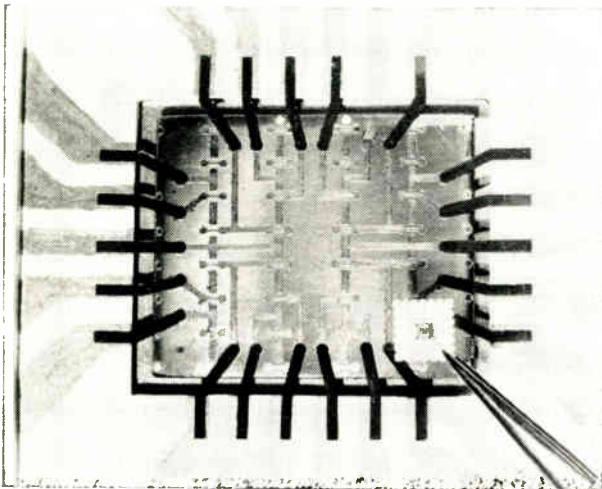

This circuit presents 5 volt logic levels, operates at rates up to 20 MC, and 5.5ma at 5 volts.

DIGITAL MICROCIRCUIT

THE NC-8 IS A BI-STABLE FLIP-FLOP which operates from a 12v. supply and presents 5v. logic levels.

The circuit, which is fabricated inside a TO-5 header, uses npn silicon epitaxial transistors, silicon epitaxial diodes, and a passive network of resistors and capacitors. The components are deposited on a silicon wafer by diffusion and a controlled oxide growth. The transistors, diodes, and R-C wafer are bonded to gold-plated ceramics on the header, and interconnected by a thermo-compression bonding of gold wire. The unit is surface-passivated, hermetically sealed, and meets military reliability specifications.

The NC-8 operates at rates up to 20MC and delivers 5.5ma at 5 volts. Maximum power dissipation is 200mw, and maximum input fall-time is 30 nano-seconds. It operates between -55°C to $+125^{\circ}\text{C}$. General Instrument Semiconductor, Div. of General Instrument Corp., 600 W. John St., Hicksville, L. I.

INTEGRATED ONE-SHOT

SE160 IS AN INTEGRATED, buffered one-shot multivibrator which operates in the 5 megacycle range. The circuit features include complementary outputs, OR gate trigger input, and a short recovery time. It is designed for pulse-shaping and delay applications, and exhibits good temperature stability over the range of -55°C to $+125^{\circ}\text{C}$. The fanout is 5 over the full temperature range, and rise and fall times are less than 25 nanoseconds. The circuit utilizes a diffusion process to reduce isolation capacitance. Signetics Corporation, 680 West Maude Ave., Sunnyvale, Calif.

SE160 operates at 5 MC and has a fanout of 5 or above at rated temperatures. Fall times are less than 25 nsecs.

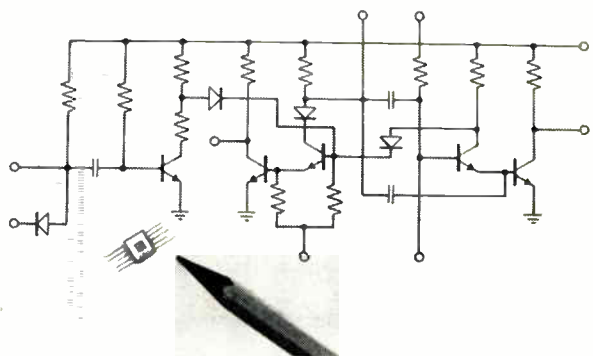

LIGHT DEPENDENT RESISTOR

THE LDR-25 IS A LIGHT DEPENDENT RESISTOR with high power-handling capabilities. When used in circuits which supply currents of approximately 0.5a to solenoids, it eliminates the need for high-current carrying relays. Because of its high-voltage rating and slow switching speed, it is particularly suited for controlling inductive loads where voltage surges encountered with breaker points or junction devices are a problem.

The LDR-25 is constructed of a thin layer of sintered semiconductor applied to an aluminum oxide substrate. Hermetic sealing is accomplished by film adhesives and a glass cap.

LDR-25 operates directly from 110vac, is rated at 200vdc or peak ac, and has a power dissipation rating of 25w. When used with captive-light sources, it provides power gain as well as complete isolation between control and load circuits. When used with standard miniature incandescent lamps, it can continuously supply 50w into the load from inputs of 1w or less. When miniature neon lamps are used, 40w are provided from an input of less than 500mw. Delco Radio, Div. of General Motors Corp., Kokomo, Ind.

LDR-25 provides power gain and complete isolation between control and load circuits.

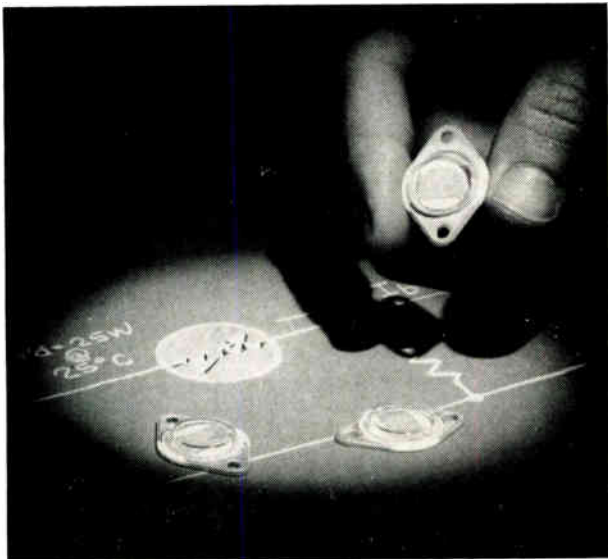

OPERATIONAL AMPLIFIERS

THE SERIES 52 CATALOG LINE SEMICONDUCTOR NETWORK includes two operational amplifiers, each fabricated within a single block of ultra-pure silicon. Included in the Series 52 "Master Slice" are 13 component paths (5 npn transistors, 2 pnp transistors and 6 resistors with values from 5000 to 50,000 ohms) used to perform the amplifier functions.

(Continued on page 207)

NOW ANYONE CAN STRIP WIRE ALL DAY WITHOUT NICKING!

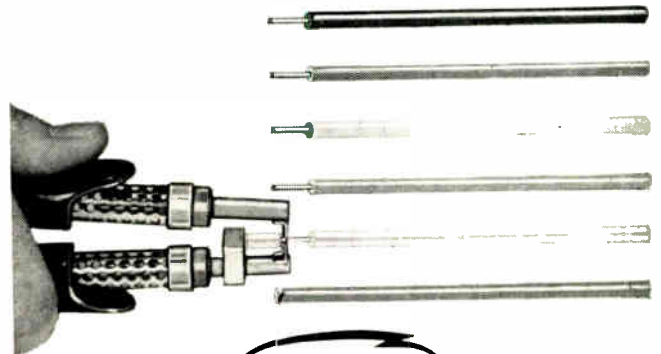

New **IDEAL**

THERMO-STRIP™

WIRE STRIPPER
FOR PLASTIC INSULATION

The Precision Stripper That Can't Harm Wire

Make precision stripping routine — for missile components, aircraft, computers, instruments — any equipment where wire damage can't be tolerated. New Ideal Thermo-Strip melts through insulation — no cutting, no tearing — prevents all nicking and breaking. Won't disturb strands of even finest wire. Works on all thermo-plastic insulation, including Teflon. Infinitely variable heat control prolongs element life, cuts fumes, lets you pick the exact temperature for the job. Can operate continuously — with no warm-up wait. Safe, fast, easy to use — Thermo-Strip is a precision wire stripper, not a converted soldering gun.

JUST PLUG IT IN . . .
Comes complete with 50-watt transformer and your choice of tools:

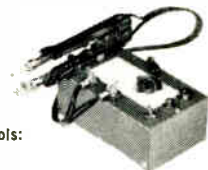

Pincer — for high-speed production stripping. Just grip wire, and pull off insulation slug with heating elements.



Single Element — for probing into miniature or crowded assemblies. Just put wire end in electrode V-notch.

Selection of elements.

TRY IT IN YOUR SHOP! / IDEAL INDUSTRIES, Inc.
5127-E Becker Place, Sycamore, Illinois

Please arrange a trial for me Send data only

Name _____

Company _____

Address _____

City _____ Zone _____ State _____

Sold Through America's Leading Distributors. IN CANADA: IRVING SMITH, Ltd., Montreal

WHAT'S NEW

INTEGRATED CIRCUITS

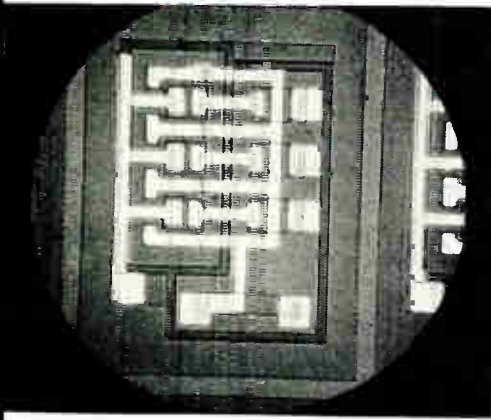

This three input, DCTL NOR gate is constructed of a silicon monolithic chip and has silicon resistors.

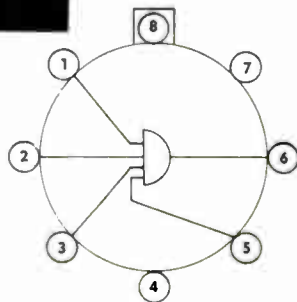

**SCHEMATIC DIAGRAM
(TOP VIEW)**

The terminal locations shown on the schematic are to be used with the following reference chart.

FOUR INPUT DCTL NOR GATE

TRANSITRON'S INTEGRATED three and four input direct coupled transistor logic consists of two matched transistors and three silicon resistors, which are constructed on a silicon monolithic chip.

This NOR gate operates between -55°C and $+125^{\circ}\text{C}$, has a supply voltage of 3 volts ($\pm 10\%$), and the maximum average propagation delay time at 25°C is 50 nanoseconds.

In addition to the electrical characteristics at 25°C shown, data sheet TE-1346-1002 presents electrical characteristics at -55°C and $+125^{\circ}\text{C}$, graphs for collector current vs. collector-emitter voltage; collector current vs. base-emitter voltage; collector saturation voltage vs. case temperature; collector current vs. collector-emitter voltage; base-emitter voltage vs. case temperature; collector saturation voltage vs. case temperature; dc current gain vs. case temperature; propagation delay time vs. case temperature; and propagation delay time vs. fanout. Transitron Electric Corp., Wakefield, Mass.

During all measurements +3 volts at terminal (8) and terminal (4) grounded

Test Voltages: 550 \pm 2 mV, 760 \pm 2 mV, 790 \pm 2 mV, 1200 \pm 10 mV, 3000 \pm 10 mV.

	Terminal 1		Terminal 2		Terminal 3		Terminal 5		Terminal 6		Terminal 7	
	V mV	I mA	V mV	I mA	V mV	I mA	V mV	I mA	V mV	I mA	V mV	I mA
1	760	.45		0		0		0		0		
2			760	.45		0		0		0		
3					760	.45		0		0		
4							760	.45		0		
5	760	.75	790		790		790			0		
6	790		760	.75	790		790			0		
7	790		790		760	.75	790			0		
8	790		790		790		760	.75		0		
9	760			0		0		0		400		
10		0	760			0		0		400		
11		0		0	760			0		400		
12		0		0		0	760			400		
13	1200			0		0		0		400		
14		0	1200			0		0		400		
15		0		0	1200			0		400		
16		0		0		0	1200			400		
17	550		550		550		550			760	3.30	
18	-4V	5 μ A	-4V	5 μ A	-4V	5 μ A	-4V	5 μ A		0		

- NOTES:**
- Each double column represents voltage and current at a terminal.
 - Each row represents a test.
 - The unenclosed figures define the test condition, the enclosed figures an extreme value of the parameter under consideration. $\overline{123}$ = 123 maximum $\underline{123}$ = 123 minimum

Now available!

THREE NEW FILTER FAMILIES

designed to improve future systems!

If you are concerned with new systems development, and would like to take advantage of advanced technology and the kind of sophistication that will improve transient response and eliminate obsolete circuitry . . . then here are three new filter families, that have advanced the state of the art, which you can immediately incorporate in your network designs — exclusive from Burnell. Call or write today for literature and technical assistance.

Burnell offers the most complete line of communications network components available to the electronics industry, with a versatility of experience unmatched in the production of filters, delay lines and toroids for interpretation of *complex signals*. Burnell will custom design filter networks to your specifications which may include special delay, attenuation, and transient response, involving precisely specified rise time, overshoot and ringing.

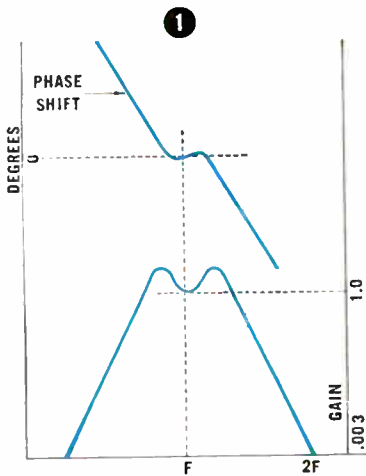

ZERO PHASE FILTERS

Impedance	1000 ohms/Grid	400 cps Center
ATTENUATION & PHASE CHARACTERISTICS		
OP SERIES	OP400 L	OP400 M
Pass Band (3 DB)	± 20 cps	± 20 cps
Harmonic attenuation 2nd harmonic and all higher frequencies	50 DB	
Harmonic attenuation (2nd)	> 15 DB	> 25 DB
Harmonic attenuation (3rd)	> 40 DB	> 60 DB
Max. phase ± 20 cps	$\pm 1^\circ$	$\pm 1^\circ$
Max. phase ± 30 cps		$\pm 5^\circ$
Phase shift at Center Frequency	$0^\circ \pm 1/2^\circ$	$0^\circ \pm 1/2^\circ$
Gain =	UNITY	UNITY
60 cps equivalent filters are also available having a pass band of $\pm 5\%$ with phase of $\pm 1^\circ$.		

For the Servo Engineer . . . By specifying Burnell's new line of Zero Phase Shift networks, it is possible to recover, without phase shift, the fundamental frequency from any periodic wave form without using complex squaring circuitry. This advancement in the state of the art is accomplished by combining zero phase shift in the vicinity of the center frequency — with high attenuation in the stop bands.

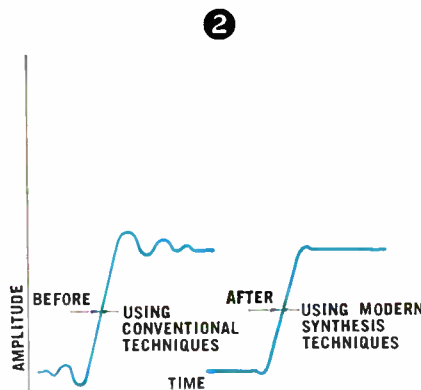

LOW PASS FILTERS WITHOUT DISTORTION
This family of filters is designed with modern synthesis techniques to have specified transient characteristics such as fast rise time, low overshoot and ringing.

60/3 DB Shape Factor	Ringing (over/undershoot)
2:1	$< 5\%$
3:1	$< 2\%$
4:1	$< 1\%$

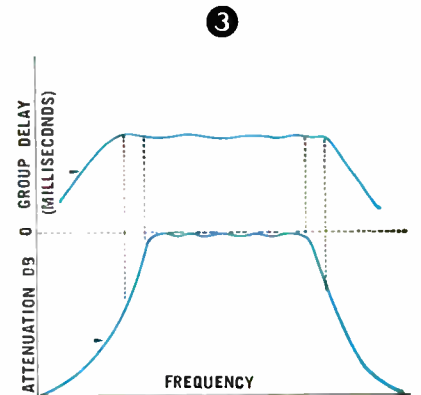

CONSTANT DELAY BAND PASS FILTERS

This is part of a family of constant delay band pass filters of unusual characteristics, for example:

- 1—Group delay is constant well into the stop band!
- 2—Matched delay—as an example of delay matched band pass filters, we have produced a set of four filters having the same band widths of 500 cycles at $1\frac{1}{2}$ DB with center frequencies ranging from 680 cycles to 2720 cycles; having a 20 DB band width of 710 cycles with group delay constancy of $\pm 3\frac{1}{2}\%$ over the pass band and between channels.
- 3—Constant delay band pass filter.

Frequency	Attenuation
5210 cps to 8336 cps	$< .5$ DB
1,000 cycles & below	> 20 DB
10,000 cycles & higher	> 20 DB
Delay: Group delay constant $\pm 1\%$ from 3,500 cps to 9,900 cps.	

Copyright 1963

Burnell & Co., Inc.

PIONEERS IN microminiaturization OF TOROIDS, FILTERS AND RELATED NETWORKS

SUBSIDIARIES: G-K Electronics, Inc., Pelham, N.Y. • GLP Electronics, Inc., Bristol, Conn.

EXECUTIVE OFFICE AND PLANT
DEPT. EI-35
PELHAM, NEW YORK
PELHAM 8-5000
TELETYPE PELHAM 3633



MFD. IN CANADA
BY EDO (CANADA) LTD.
CORNWALL, ONT.
WELLINGTON 2-6774
ALSO MFD. AT
PACIFIC DIV.

100 KC to 5.0 MC HIGH STABILITY OSCILLATOR

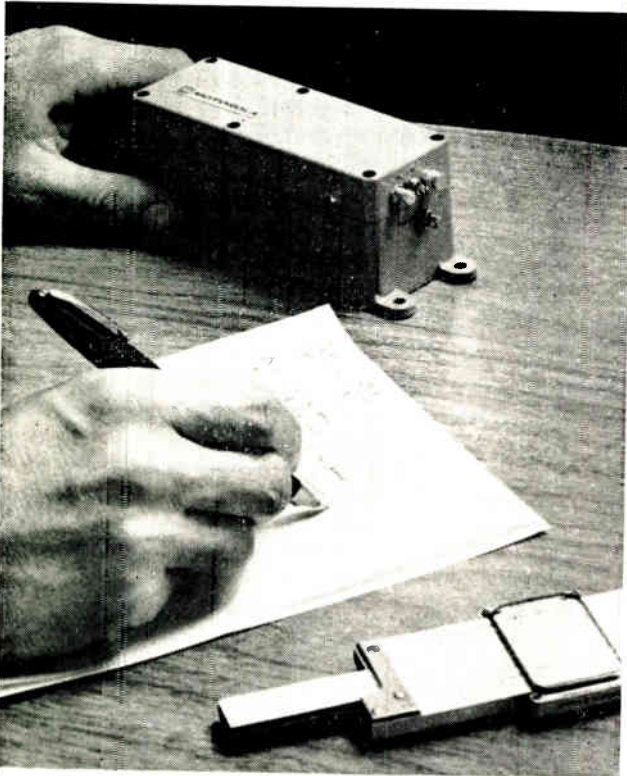

a versatile, precision "workhorse"
with an order of magnitude
BETTER STABILITY
of 1×10^{-9} per day

FASTEST WARM-UP

Temperature	Within 1×10^{-8}
-55°C	16 minutes
-25°C	11 minutes
• -55°C to +77°C operating temperature range	

This precision oscillator is on the job in hundreds of applications . . . and stands ready for action wherever your projects call for a precision frequency source to serve under rugged operating conditions. Proven under rigid military environments, backed by over 2 decades of Motorola volume crystal production experience, you can count on this oscillator for unexcelled stability . . . fastest warm-up . . . lowest power needs in • Single Side-Band • Missile Systems • Navigation • Telemetry • Instrumentation • Model SLN6039A Prices on request.

For complete operational facts kit call your Motorola Instrument representative or write Dept. ACI318.



Motorola Communications & Electronics, Inc.
4501 Augusta Blvd., Chicago 51, Ill. A Subsidiary of Motorola Inc.

Circle 31 on Inquiry Card

WHAT'S NEW

RESISTANCE MEASUREMENT SYSTEM

THE COMBINED USE OF MODEL 6105 Resistivity Adapter, Model 240 High-Voltage DC Supply, and the 610A Multi-Range Electrometer comprise a system for measuring flexible insulation samples. Accuracies are 4% and 5% and test potentials range from 1 to 1000v.

The test sample is placed between the two electrodes and the desired test potential is selected from the voltage supply. The electrometer measures the current passing through the test sample. Using the voltage supply and the electrometer readings, resistances can be computed by using a simple equation.

The 6105 Resistivity Adapter minimizes measurement error. The electrode configurations conform to the American Society for Testing Materials recommendations (D-257-52T) for measuring insulating-material resistance. The test sample is shielded to prevent stray pickup, and guard-ring circuit configuration eliminates leakage currents from the measuring circuit. Samples to be tested may be between $2\frac{1}{2}$ and $3\frac{1}{2}$ in. diameter or square, and $\frac{1}{16}$ and $\frac{1}{4}$ in. thick.

The 240 High Voltage Supply provides excitation voltages up to 1000v in discrete 1v steps, accurate within 1%. The circuit employs cascaded regulators and a premium, doubly-regulated voltage reference. Inherent overload protection is provided. Input power requirements are 100-130v (or 200-260v), 50-60cps, 70w.

The 610A Multi-Range Electrometer allows direct-reading current ranges to 10^{-13} amps full scale (3% to 10^{-10} amps and 4% beyond.) Input resistance may be varied from one to over 10^{14} ohms for optimum balance of low-circuit loading vs. minimum pickup. Keithley Instruments, Inc., 12415 Euclid Ave., Cleveland 6, Ohio.

The combined units allow volume resistivity tests from 10^3 to 10^{13} ohm-cm., and surface resistivity tests from 10^3 to over 10^{15} ohms.

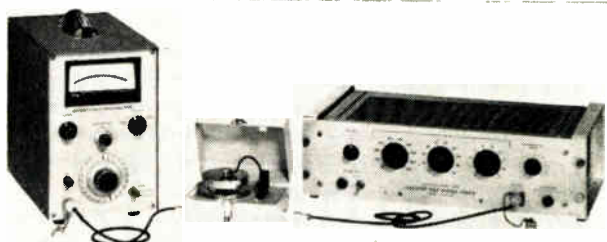

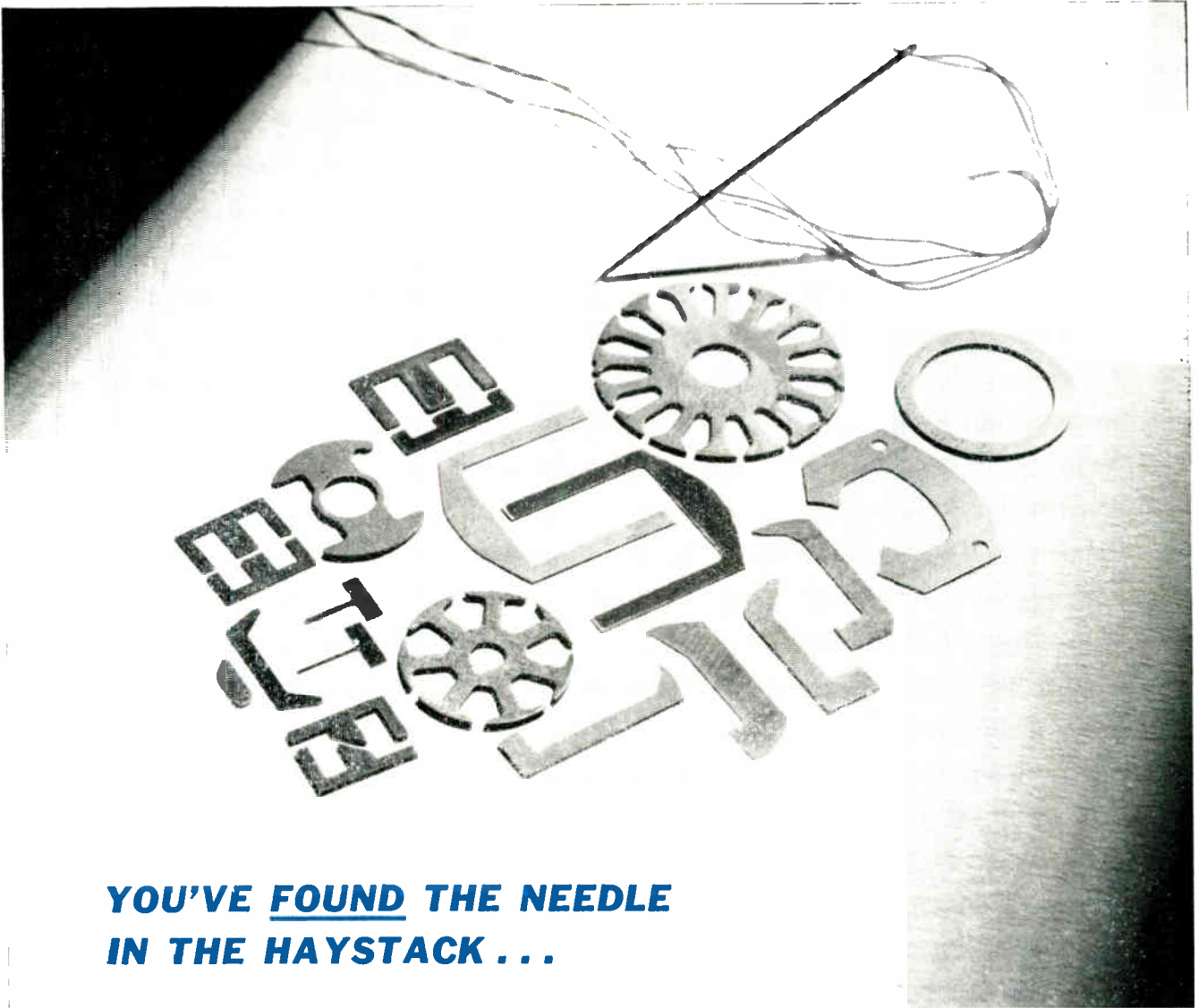

**YOU'VE FOUND THE NEEDLE
IN THE HAYSTACK...**

TOP QUALITY THIN-GAUGE NICKEL IRON LAMINATIONS FOR YOUR MINIATURIZATIONS

Special die-making processes and press equipment are available at Arnold's Pacific Division in Fullerton, California, to produce the tiniest of parts in production quantities for your designs. Material thicknesses of .001", .002", .003" and .004", etc. are available in 4-79 Permalloy, Mumetal, 4750 and other high permeability nickel-iron alloys—as well as a range of silicon steels—from which these parts may be produced to meet your magnetic requirements.

Special hydrogen-annealing furnaces are also available for optimum heat treatment after anneal.

The complete Arnold processing techniques used are capable of producing thin-gauge laminations to exacting dimensional tolerances. Their perfection of size and surface finish can be strong factors in protecting the uniformity and quality of your equipment.

Specify Arnold thin-gauge miniature parts for your requirements in magnetic recording and pick-up heads, etc.; and for tiny motor and transformer laminations. We invite your inquiries for the tooling and production of special shapes. *Technical data on request.*

PACIFIC DIVISION

ARNOLD
 SPECIALISTS in MAGNETIC MATERIALS

11-4673

THE ARNOLD ENGINEERING COMPANY, Main Office: MARENGO, ILL.
 PACIFIC DIVISION: 1551 E. Orangethorpe Ave., Fullerton, Calif. • TRojan 1-1560



Tough customer for tough customers with tough customers.

If your electrical equipment has to meet rugged environmental conditions where failures are too costly to be allowed, and this makes you a tough guy to please, you'll be interested in our QWLD connector.

It's tough enough to take the brunt of heavy-duty applications such as in missile launching equipment, ground radar, or power and control circuits, as well as in mining or oil field applications.

Five integral keys and keyways provide for positive polarization and positive mating even in blind locations.

Other features include improved waterproofing, closed entry socket contacts, self-ejecting coupling action. The connector is designed to meet military specification MIL-C-22992 (ships). For more information, write us in Sidney, New York.

Scintilla Division



Circle 54 on Inquiry Card

World Radio History

ELECTRONIC INDUSTRIES

Coming Next Month

"THE STATE-OF-THE-ART in the ELECTRONIC INDUSTRIES"

Articles by leading authorities comment on the progress and future in the various segments of the industry. Among the contributors will be:

Gen. Bernard A. Schriever, on "Technological Requirements of National Security"

Adm. Charles F. Horne, on "Predictions for the Future of the Electronic Industry"

Mr. Robert C. Sprague, on "Microelectronics: In Search of the Ideal Circuit"

Dr. John S. Bardeen, on "Trends in Semiconductor Research"

Dr. Daniel E. Noble, on "Looking Ahead With Integrated Circuits"

Prof. Charles E. Cameron, on "The State-of-the-Art of Relays"

Mr. Robert E. Moe, on "Vacuum Tubes—Today and Tomorrow"

Dr. Dean A. Watkins, on "State-of-the-Art—Microwave Tubes"

Mr. Ivan G. Easton, on "Electronic Measurement Standards"

—Space does not permit us to list all the prominent scientists and engineers contributing to this issue.

Manuscripts submitted by these authors will be the feature articles contained in 10 major sections of this Special All-Reference Issue. These are:

THE ELECTRONIC INDUSTRY (OVERALL REVIEW)	ELECTRONIC COMPONENTS
TUBES AND SEMICONDUCTOR DEVICES	MATERIALS AND HARDWARE
DATA PROCESSING AND AUTOMATION	MILITARY ELECTRONICS
MEASUREMENT AND TEST EQUIPMENT	SPACE ELECTRONICS
ELECTROMECHANICAL COMPONENTS	MICROWAVE

DIRECTORY SECTION

This issue also contains our annual directory of electronic products manufacture. Names and addresses of over 6000 electronic companies are listed along with information on more than 3100 products currently being produced. Product-headings guide the reader to specific interest items.

WATCH FOR THESE COMING ISSUES:

AUGUST
12th Annual
WESCON Issue

NOVEMBER
12th Annual
Microwave Issue

JANUARY
Statistical and
Annual Industry Review

DESIGNING WITH... OPTOELECTRONIC COMPONENTS

A wide range of new optoelectronic products offers combinations of electrical characteristics unavailable in conventional all-mechanical or solid-state designs.

This article describes a variety of these units—many of which are still in the developmental stage.

PHOTOELECTRIC DEVICES are well known in their role of sensing ambient illumination or as transducers, such as shaft position encoders. Recently electro-optical elements have been used less directly as circuit components. With these, a feature is the replacement of electrical connections by light paths. Thus, the new products can offer combinations of electrical characteristics unavailable in normal all-mechanical or solid-state designs. Many of these units are still in the developmental stage, but promise to fill a demand in instrumentation usage.

* * *

The broad category of photo-electrical interactions has been termed "optoelectronics." It implies the coupling of a light-responsive and a light-producing element. Of main interest are those combinations which are commercially available for use in circuits. Included are relays, pots and choppers. Other more complex functions have often been proposed for computers as memories, analog data processors and logic networks.

A variety of physical phenomena can be exploited. While the detector is usually a cadmium sulfide photoconductor, the advent of new silicon photo diodes will also permit either much power amplification (for example, Raytheon's RM-3002) or rectification (GE's ZJ235) within the photoelement itself. Light sources are now chosen from neon lamps, tungsten bulbs, or electroluminescent (EL) wafers. An advantage of these products is, the wide range of permissible input voltages, ac or dc, for the lamps.

Potentiometers

Noise, linearity and life are performance limitations of conventional, wire-wound, precision pots. The photoconductive pot, by eliminating moving contacts, provides one answer. Other features are negligible

torque, stepless output, and essentially infinite resolution. At present, though, the promising new photo pots have not realized their full potential where high accuracy and linearity are expected.

Two companies, Giannini Controls Corp. and Duncan Electronics, are developing similar devices. Each unit uses a self-contained light spot. This spot moves about a circular photoconductive surface deposited between an inner circular, conductive track and an outer resistive strip of tin oxide. Presence of the light flux causes a connection to be formed across the photoconductor at that point; however, contact resistance is high with present configurations, so that high impedance loads are a necessity.

Usually the photoconductor is cadmium sulfide (CdS) or cadmium selenide (CdSe) with a range of light to dark conductance ratios of 10^6 to 10^8 . Rotational rate and frequency response of the light spot is limited by the material's time constant. Neither manufacturer has yet recommended the pots for other than dc use. Conceivably, future models made of other materials, such as lead sulfide, could accommodate 1,000 cps. Present pots have been operated at shaft rotational rates of several thousand RPM, although their modulation efficiency drops accordingly.

Units are now available on a prototype basis with resistances from 100 Ω to 100 k Ω at 1w. Judging by the specs available, the products are still undergoing development. They are not intended to replace inex-

By RICHARD K. McDONALD

Research Specialist
The Boeing Co. (M.S. 41-08)
P.O. Box 3707
Seattle 24, Wash.



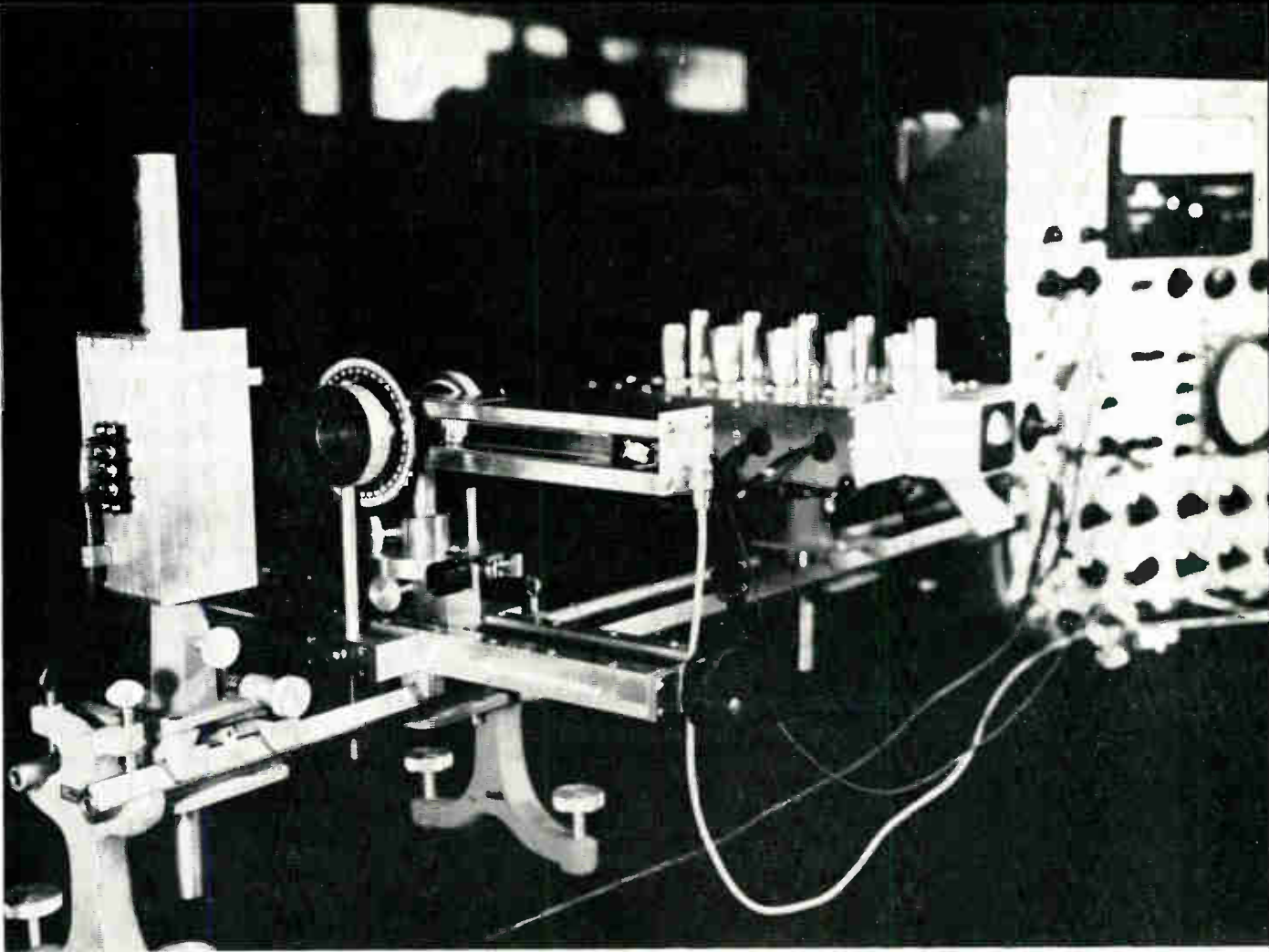

This operating model of a photoelastic ultrasonic delay line was made by Corning Glass Works. It uses a polarized light source, a collimator, a bar of fused silica as a delay medium, a scanner,

six optical fiber bundles tapping the delay medium at $0.1 \mu\text{sec}$ intervals, and six photo detectors. Units of the system were mounted on an optical bench for maximum experimental flexibility.

pensive carbon resistors, but will serve best in military and instrumental uses where low noise and limitless life (except for lamp bulb) are most valued. Normal vibration and environment specs can be met, but the temperature range will be a limitation of the photoconductor. A precision wire-wound pot can reach 175° before being derated to zero power as compared to 125°C for the comparable photoconductive unit.

Choppers & Switches

More progress has been made with electro-optical choppers and switches. Simplest development is an off-on push-switch which eliminates all contact noise and bounces. It also has long life (50,000 hr./bulb). In a commercial unit made by Invac Corp., mechanical switches are replaced by a shutter that blocks off the path between a source and a photoconductive cell. Change in switch resistance is from $750\text{k}\Omega$ open to $1\text{k}\Omega$ closed. Rise time is 3 ms.

While solid-state switches have become common in the past decade, none except the light-operated relay can offer such complete isolation between input and output circuits. In both this sense and its dynamic characteristics, the photo-switch is like a high-resist-

ance electromechanical relay. Rise times are on the order of milliseconds and more than one circuit at a time can be controlled. However, their limited power rating prevents their use for machinery control. Neither conventional mechanical or solid-state can match their characteristics. This is particularly true for low-noise, microvolt signal levels where long-life, reliability, and small size are important.

Switches designed specifically as choppers or modulators are made by Transformer Engineers (The Autoverter) and James Electronics, Inc. (The Photocom). Both contain a pair of modulated light sources, each mated with its own photoconductive cell. Thus the equivalent switching circuit is that of a SPDT switch. Since the switches are 180° out of phase, these devices can serve as a full-wave modulator—a feature useful with high-gain feedback systems or dc amplifiers having differential inputs.

Actually a photoconductor is an imperfect switch and a high impedance path remains even with the circuit "open." In theory the ratio of open resistance (the dark condition) to closed (illuminated) is above 10^6 under ideal conditions. Unfortunately, time con-

OPTOELECTRONIC COMPONENTS (Continued)

stant limitations and use of realistic light sources drop this on-off ratio to about 50 to 60 cps.

Transformer Engineers place the drive circuits within the chopper package itself. Either ac or dc power input (100-200 mw) can be specified, and the output frequency may be selected from 50 to 1,000 cps. At 400 cps the modulation efficiency is 50%. One advantage over transistor modulators is its low offset voltage of $2\mu\text{v}$, which is nearly temperature invariant.

The "Photocom" differs mainly in that the user is expected to furnish his own modulation input. Drive signals from dc (as a common relay) to 2,000 cps are acceptable. Modulation efficiency can be as high as 86% at 60 cps and 25°C . "Off" resistance is $10^9 \Omega$ as compared to $10^3 \Omega$ "on" for their high impedance model.

Both of these products have low noise levels ($0.2 \mu\text{v}$), lifetimes measured in years, no microphonics, no mechanical vibration, high stability and versatility. As an example, the switching circuits can take signals from dc to low frequency r-f (2 mc) or voltages to 300 v.

Another experimental chopper assembly was shown last fall by Hewlett Packard Associates. It consists of two silicon phototransistors and two EL gallium arsenide diodes mounted together on a seven-pin TO-5 transistor header.

Raytheon also makes a line of photoswitches under their tradename "Raysistor." Here the aim has been to supply the user with maximum flexibility. Each

Raysistor consists of a single switch in a variety of sizes and either incandescent or gas light sources. One model is designed as a high voltage isolator, handling voltage differences up to 25 kv. A typical unit with a gas lamp for higher frequency operation has less than $2 \mu\text{v}$ noise, nominal "on" resistance of 600Ω , "open" resistance of $5 \times 10^7 \Omega$, and a response time of 1 msec. on and 60 msec. off.

Compared to dry reed switches, the photoswitch is at a disadvantage with respect to not having infinite resistance (i.e., $10^{15} \Omega$) while open and of not being able to handle as much power, 50-75 mw. typical. (Some reed switches can carry 15-20 w.) Both types switch at comparable frequencies and are long lived, 10^8 cycles for dry reed and 10^4 hr. for the electro-optical family. Where the latter type excels most is in low noise applications, or where vibration, stray magnetic or electrostatic fields could cause microphonics.

Any of the photoconductive switches are limited in temperature range by the negative resistance coefficient of the CdSe or CdS photoconductor. Most units can operate in the standard limits of -55° to $+65^\circ\text{C}$. While the rise time lengthens with temperature increases, the longer decay constant remains about the same.

By combining an EL wafer vis-a-vis with thin CdS cells, Ericsson Telephones, Ltd. (England) have made a series of switches with different dynamic properties than the American counterparts. By using an extended source, the device is able to simultaneously activate five independent, external circuits. Its trade name is "Photoactor" and its optimum use may

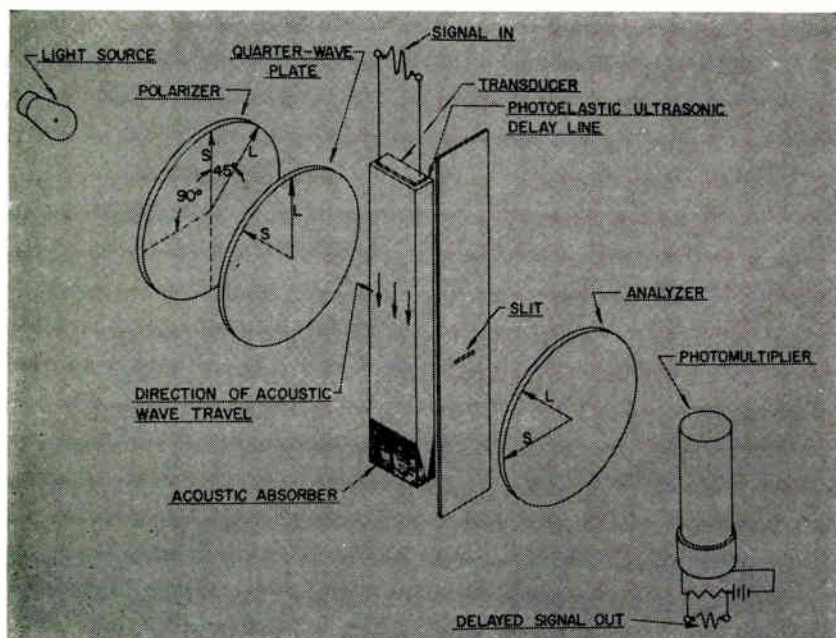

Corning delay line system includes fused silica delay line plus an allied optical system for detecting acoustical signal. Lines L & S represent main axes in longitudinal or shear models of wave propagation.

Seven pin miniature Photocom chopper.



be for controlling EL panels serving for data storage and display. There is no relay noise, fragile construction, or critical adjustment. Resistance changes from 200 M Ω "off" to 20 k Ω "on" with rise times of 20-50 msec. With mass production methods, this relay type may someday be the least expensive on the market.

Many uses are suggested for the photo choppers and switches. As an overload preventor, a combination of a neon light and a CdS cell is an ideal limiter because the cell has no circuit influence other than a conventional resistor, until overvoltage conditions fire the lamp. Another use is as a chopper stabilized dc power supply where the goal is a minimum of long-term drift. One such instrument on the market using this concept has a pair of photo choppers in the modulator and demodulator circuit (Dymec Div. of Hewlett-Packard).

The same company offers a wide band (dc to 50,000 cps.), high gain amplifier featuring a photo-chopper. Having a photochopper helps achieve drift levels of <1 μ v/week, and any perturbations due to mounting position or vibration are eliminated.

Aside from their role as special switches, electro-optical components are used as variable resistors or as voltage isolation devices. In comparing photo choppers to other types, it is well to remember that while modulation efficiency may be lower, the S/N ratio is usually higher. Maintenance problems are reduced and contact bounce is eliminated. Below 60 cps, voltage output is nearly a square wave; at higher frequencies, the output becomes more sinusoidal.

Single switches composed of an EL cell with a photo-conductor are not on the market, although arrays have appeared in many prototype computers. So many interactions are possible. For example, one configuration switches on with short pulses and off with long, or switches on with blue light from one EL source and off with red light from another separate EL source. Examination of EL-PC switches is beyond this article's scope, but undoubtedly many analog functions such as pattern recognition, will be satisfied in this manner in the future. Digital uses are less certain, because minimum switching times are about 50 msec.

Relays & Oscillators

Making its debut last year was a new contactless oscillator based on the interruption of a light path.

The usual mechanical resonant reed relay or tuning fork oscillator depends upon a make and break electrical connection on each cycle. While non-mechanical filters, such as piezoelectric, are available, they either

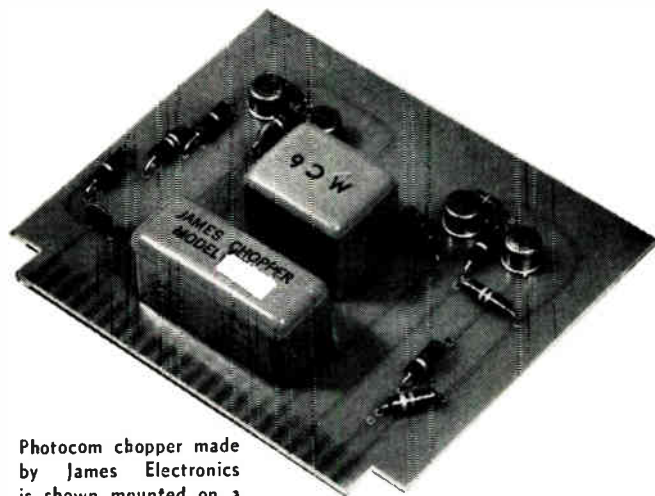

Photocom chopper made by James Electronics is shown mounted on a printed circuit board.

lack high sensitivity, are too susceptible to environment, or will not handle audio frequencies.

J-B-T Instruments, Inc. avoids these problems with their "Photoreed" resonator. Instead of having its magnetic-coil driven reed physically open the circuit, the Photoreed merely uses the reed as a shutter between a lamp and a photocell. Such devices can be built with a much sharper frequency response (0.1% bandwidths) and longer dwell times. Unlike all-mechanical assemblies, effective bandwidth and tuning frequency can be changed electrically instead of being physically adjusted. Use of photoconductors limits the frequency range to 1200 cps; but a silicon photodiode, at higher cost, could increase the range to the mechanical limits of the tuning fork.

Little power (200 mw) is needed to activate the Photoreed for direct relay operation. This is an improvement of ten over relays with contacts. Besides their use as frequency-sensitive control relays, filters, or as oscillators, the photo sensitive reeds could be used in logic networks, or could be modified to give either a voltage or a power gain. Two frequency inputs could produce a beat frequency from the photocell output. OAO star trackers built by Kollsman Instrument Corp. use this concept. A pair of vibrating reeds chop the bundle of light rays collected from a star. One frequency corresponds to pitch; the other to roll. Servo error signals are extracted by demodulation of the two frequencies in the photomultiplier output.

So far all of the devices mentioned are of recent origin, somewhat in the proving stages. A number

A REPRINT OF THIS ARTICLE CAN BE OBTAINED
by writing on company letterhead to
The Editor
ELECTRONIC INDUSTRIES
Chestnut & 56th Sts., Phila. 39, Pa.

OPTOELECTRONIC COMPONENTS (Concluded)

of other potential uses on an electro-optical basis can be visualized. A function generator has been described wherein a transparent disk rotates between a source and phototransistor. By simply printing opaque patterns onto the disk, an endless variety of complex waveforms are available. Rapid interchanges at low cost are possible by replacement of the printed disk.

Glass Delay Line

Corning Glass Co. has reported a photoelastic glass delay line. Its input electrical signal is first transposed into an acoustical wave. Transmission of this acoustical signal will introduce stresses in the silica dielectric, causing a change in its optical birefringence. Key to use of the glass delay line is the availability of a polarized light method for detecting stresses. Depend-

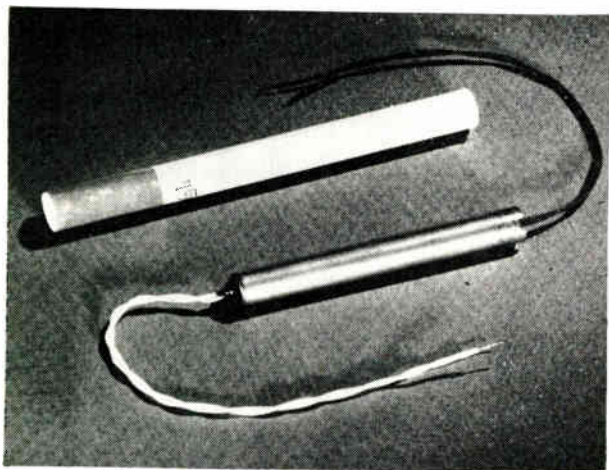

Raytheon electro-optical relay (Raysistor) is smaller than a cigarette. It is free of contact noise when replacing relays or pots.

High-voltage Raysistor Isolator controls circuits at 25 kv from ground level circuits. This model uses 120 v. for the control.



ing on where the optical detector is situated along the length of the glass bar, the original signal can be recovered with any delay time up to 100 μ sec.

Tuned Circuit

A tuned circuit has been patented (U. S. 3,029,346) purporting to change its resonant frequency with a photocapacitor in series with an inductance, an EL cell and a power source. As interesting as this is, a detailed description of a capacitor capable of directly varying its capacitance with light illumination has not been found. If one is known, then the invention offers an all-solid-state, variable-tuned circuit, controlled by the current to a small internal light source.

Computer Uses

Going further into electro-optical methods of value to computers, the scope of uses covers memories, logic networks, switches, and various analog functions such as time compression. High-density, three-dimensional micro-circuits have been proposed wherein the links between the layers of deposited circuits are accomplished with light-emitting diodes and phototransistors. Transistors on more than one layer could intercept signals from a single junction diode source. With transparent base materials, there could be many connections between layers without the mechanical interference problems of wires or deposited leads.

Typical of the design tricks possible with miniature silicon PN/PN rectifier photo switches (such as the ZJ-235) is a three-position switch for ac operation. Two ZJ-235's are installed in parallel, back-to-back. With one switch illuminated by a small lamp in the load line, half the power is transmitted. A second lamp for the other switch, also in the load line, is equipped with a thermistor. After a chosen interval the second bulb glows and full power is allowed to pass. Other combinations of the miniature lights and switches can produce optical flip-flops or alarm relays.

The photo-energized rectifier just mentioned illustrates some functions that the new detectors can handle within themselves. For photo-electric card readers, even the amplifier may be eliminated as with the 1N2175, photo-duodiode. Undoubtedly more electro-optical devices will be appearing. A challenging prospect for components good to 2Gc. is raised by the recent appearance of gallium arsenide diode light sources (such as the SNX-100 by Texas Instruments Inc.) and the silicon planar epitaxial photo diode detectors. Even lasers have been suggested for optical computers, mainly because the photon transit times, being shorter than electron transit times, could lead to faster switching. A laser source could be combined with fiber optics for multiple path operations.

SIMPLE, ECONOMICAL LASER DEMODULATION

A low-priced phototube can do the laser demodulation job in many cases. The tube is an off-the-shelf item and can be placed in a waveguide in much the same manner as a crystal detector is placed in a normal microwave system.

THE LASER HOLDS GREAT PROMISE for communication systems of the future. One laser system, for instance, could carry more than 25,000 TV channels. This would overcome today's problem of an over-crowded frequency spectrum.

In the last year there has been much talk about the laser and its modulation problems for communications. However, in relation to the amount of information available about lasers, there has been a shortage of information describing light demodulation. Laser modulation without a means of demodulation would of course, be pointless.

The authors describe a low-priced, simple method of doing the job. The method is so simple that you will wonder why it wasn't done sooner.

* * *

Fig. 1: Photo shows a coaxial photo-tube detector. Opening for permitting light to enter the tube is on the left end.



The full potential of the laser in communications requires efficient methods of modulating and demodulating. Raytheon's Research Division has found a simple and very practical scheme for the microwave demodulation of an optical amplitude-modulated signal.

To be useful, a photo-demodulator must have a very broadband response, extending into the millimeter wave range if possible, to derive maximum benefit from the laser high carrier frequency (5×10^{14} cps). Other needed features include high sensitivity, ruggedness, simplicity and ease of construction.

The devices that are possible photo-demodulators operating in the microwave region are the photo-TWT,¹ the PIN photo-diode,^{2, 3, 4} the photomultiplier,⁵ and the simple phototube.^{6, 7} The photo-TWT and PIN photo-diode have been the subjects of a concentrated R&D effort, while, in spite of its pioneering status, the ordinary phototube (and its simple variations) has been largely neglected.

Through the use of high bias voltages and special cathode-anode geometries, the usefulness of the simple vacuum photocell in the lower GC range may not be as limited as thought. In fact, much interesting work remains in this field. Further development should be stimulated by the constructional simplicity of a vacuum phototube (compared with traveling-wave structures and semiconductor junction devices),

By **H. G. MCGLEES**
and **G. W. SAEGER**

Spencer Laboratory
Research Division
Raytheon Company
Burlington, Mass.

LASER DEMODULATION (Concluded)

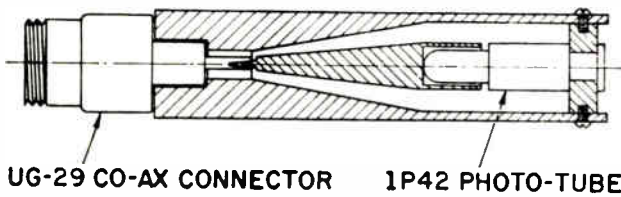

UG-29 CO-AX CONNECTOR IP42 PHOTO-TUBE
Fig. 2: The structure of a coaxial photo-tube holder.

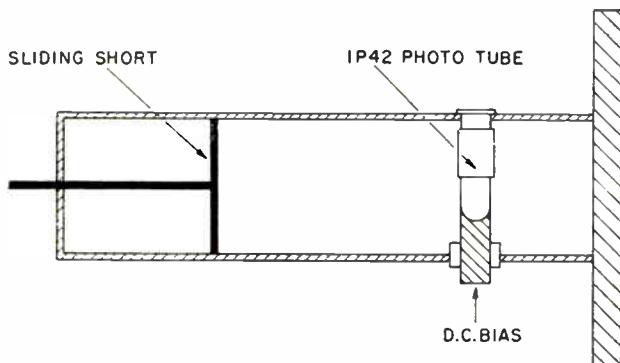

Fig. 3: A Waveguide photo-tube holder is shown here.

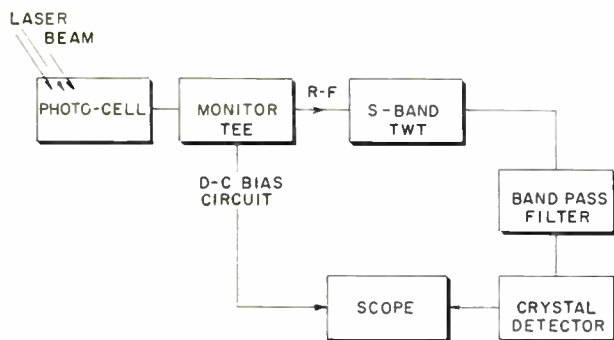
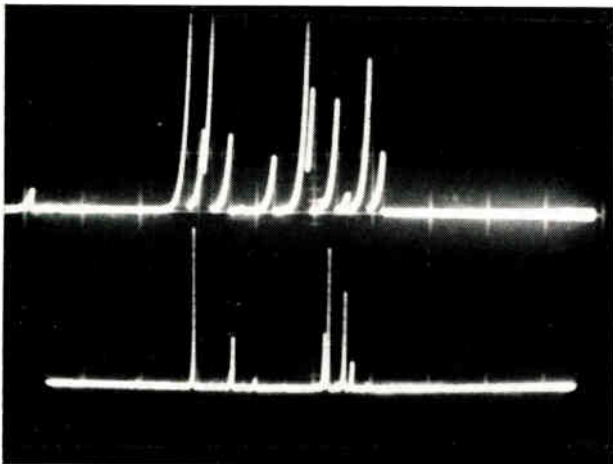

Fig. 4: Block diagram of an experimental test setup.

Fig. 5: Detected microwave components shown on a scope.



and its resultant low product cost. Of course, the high frequency response of phototubes cannot be expected to equal the theoretical limits of the photo-TWT, but it can be extended to the point (10 gc) where it would be economically competitive. Recent work at the Research Division of Raytheon has shown this.

In our initial experiment, a photo-TWT (Sylvania SY 4302) was used to analyze the output of a laser using a 2½ in. ruby in an elliptical cavity. For a ruby of this length, the axial mode frequencies are integral multiples of 1.3 gc. The second and third mode difference frequencies appear in S-band at 2.6 and 3.9 gc. These were detected by the photo-TWT. Using a pump power of about 450 joules, the observed microwave output was about -30 dbm.

In spite of the results achieved with the photo-TWT setup, its high cost (over \$1000) and need of associated power supplies led us to wonder whether these results might be matched by a less cumbersome device. Since the photo-TWT is basically a photo-detector followed by an amplifying microwave structure, it seemed feasible to use, instead, a simple phototube followed by a separate microwave amplifier. The transit time of some miniature phototubes places their cut-off frequencies well into S-band or even X-band, if the bias voltage is suitably increased.

An ordinary, commercially available, miniature phototube, the 1P42 (cost \$13) was placed in a specially constructed coaxial holder (cost less than \$100 to design and build) and biased by two 90 volt batteries. The results were gratifying. The microwave output of the 2.6 gc signal component was equal to that of the photo-TWT setup. Sensitivity to the 3.9 gc component was about 10 db less, indicating the effect of transit time frequency cutoff for that particular bias voltage.

The coaxial holder is shown in Fig. 1 and Fig. 2. The waveguide version of the same device is shown

Fig. 6: Test setup with a laser head and the demodulator.

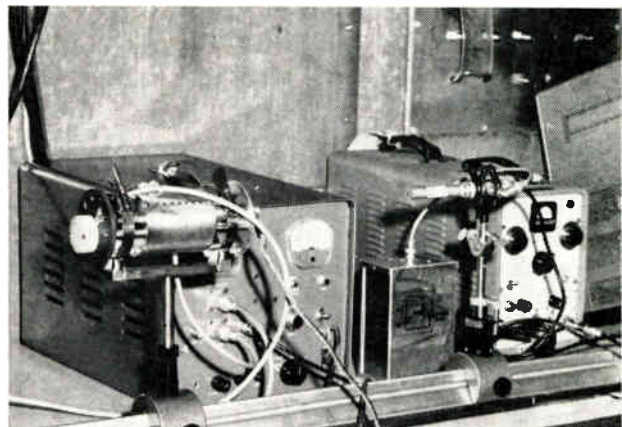

in Fig. 3. Fig. 4 shows the experimental setup and Fig. 5 is an oscillogram of the detected outputs at S-band and X-band.

The success of our initial experiments with miniature phototubes has encouraged further and more detailed examination of the precise limitations of this device, and its commercial use as a microwave optical demodulator.

Although the transit time of a phototube imposes an upper frequency constraint, this can be extended by raising the bias voltage or by decreasing the cathode-anode separation distance. It seems quite feasible to extend the phototube optical demodulator's useful range to 10 gc through the use of special cathode-anode geometries and high bias voltages.

In our experiment a phototube was used whose cathode had an S-9 spectral response, which is only slightly sensitive to the red light of a ruby laser. The use of a cathode with an S-1 response would materially improve the phototube's performance.⁸

In summary, the phototube contrasts favorably with other demodulators. It is simple and compact, eliminates the problems of microwave tube construc-

tion, and is easily replaceable like a crystal detector. Through the use of a coaxial holder design, it is hoped that one tube and holder could be used to cover the entire 1 to 10 gc range. Finally, it is sensitive enough to compete economically with the photo-TWT and photo-diode, even when no external amplification is provided.

The work described in this article was initiated by Dr. P. A. Lindsay, manager of Raytheon's Electron Physics Laboratory, and was carried out under his technical supervision.

REFERENCES

1. Siegman, A. E. and B. J. McMurtry, "Photo-mixing Experiments with a Ruby Optical Maser and a Traveling-Wave Microwave Phototube," *Appl. Opt.*, 1:51-3, January 1952.
2. Inaba, H. and A. E. Siegman, "Microwave Photo-mixing of Optical Maser Outputs with a PIN-junction Photo-Diode," *Proc. IRE (Corr.)* 50:1813-4, August 1962.
3. Kibler, L. U., "A High-speed Point Contact Photo-Diode," *Proc. IRE (Corr.)* 50:1834-5, August 1962.
4. Herzog, B., A. P. Rodgers, J. E. Peterson, M. E. Lasser, G. Lucousky and R. B. Emmons, "Detection of Ruby Laser Axial Mode Differences with Photo-Diode," *Opt. Soc. Am. Spring Meet.*, Washington, D. C., March 1962.
5. Gaddy, O. L. and D. F. Holshouser, "Photomultiplier Detection of Microwave Modulated Light," *Proc. IRE (Corr.)* 50:1515, June 1962.
6. Forrester, A. T., R. A. Gudmundsen and P. O. Johnson, "Photoelectric Mixing of Incoherent Light," *Phys. Rev.* 99:1691-1700, September 15, 1955.
7. Lindsay, P. A., S. F. Paik, K. D. Gilbert, S. A. Rooney, "Optical Mixing in Phototubes," *Proc. IRE (Corr.)* 50:2380-1, November 1962.
8. Feist, W. M., "New Applications of Photocathodes and Associated Problems," AIEE Winter Meet., N. Y. C., January 1962.

CIRCUIT-WISE

IMPROVED NEON TRIGGER CIRCUIT

THE USE OF A NEON LAMP as a trigger is not a new one. The circuit of Fig. 1 suffers however from such poor rise time and jitter behavior that it is seldom used. Typical rise time is about 5 μ sec. and jitter exceeds 55 μ sec. with an NE-2.

Most of the difficulty stems from the long time needed by the neon gas before it absorbs enough energy to ionize. This situation can be improved in many ways; one of the simplest is to pump the neon gas optically with another neon lamp operating on dc. The degree of improvement becomes startling when the trigger is pumped by a type 1133 incandescent bulb placed within 2 to 3 inches of its envelope. A 40-volt pulse with a 1 μ sec. rise time may be obtained in this manner from a 117 volt, 60 cps source. The peak-to-peak jitter is less than 1 μ sec.

Admittedly, a type 1133 bulb with its 32 candle-power rating and relatively large envelope pose quite a pill for the designer to swallow. A simple reflector was therefore formed of aluminum foil. The original intent was to shape the reflector as an elliptical tube with the trigger tube at one focus and the pump at the other (a la laser). Aluminum foil being somewhat

difficult to fashion accurately with the fingers and a pencil, the whole thing degenerated into a type 47 pilot lamp and an NE-2 placed together and wrapped closely (but crudely) with well-wrinkled foil. It worked fine.

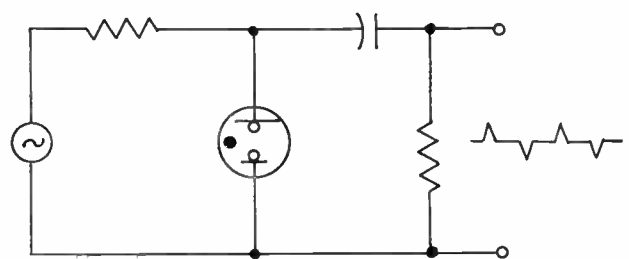

Fig. 1: A conventional neon trigger circuit is instable.

Several immediate uses for this trigger come to mind. In low-cost, closed circuit TV cameras the vertical deflection system is usually synced at the line frequency to reduce the effects of hum in the raster. This trigger could easily provide the drive for the vertical deflection amplifier.

Many low-cost frequency counters use the line frequency as a time base. This trigger could replace the Schmitt trigger usually employed.

Submitted by Thomas P. Prouty, Senior Electronics Engineer, MHD Research, Inc., P. O. Box 1815, Newport Beach, Calif.

A LOGICAL APPROACH TO LOGIC CIRCUITS

When most engineers think of logic they usually think of computers. This article will point the way for the use of logic in many other applications. The logic is isolated from the logic system. Then low-cost production methods are applied to both the logic and the system.

A NEW IDEA IN CIRCUIT PACKAGING will be shown by presenting a useful logical subsystem which is applicable to machine control, computers, positioning devices and many more. An interesting point to note is that both the logical subsystem and the packaging methods are based on simplicity.

Whenever a logic presentation is made, the full-adder is mostly used as an example of a logical system. But interest should also be stimulated in areas not directly related to the data processing and computer field.

* * *

By and large, the simplest and most popular logical device is the NAND element. This device differs in

View of logic boards used in the accumulator. Each is about 2½ x 2½ in. and contains 10 standard NAND gates (see Fig. 1).

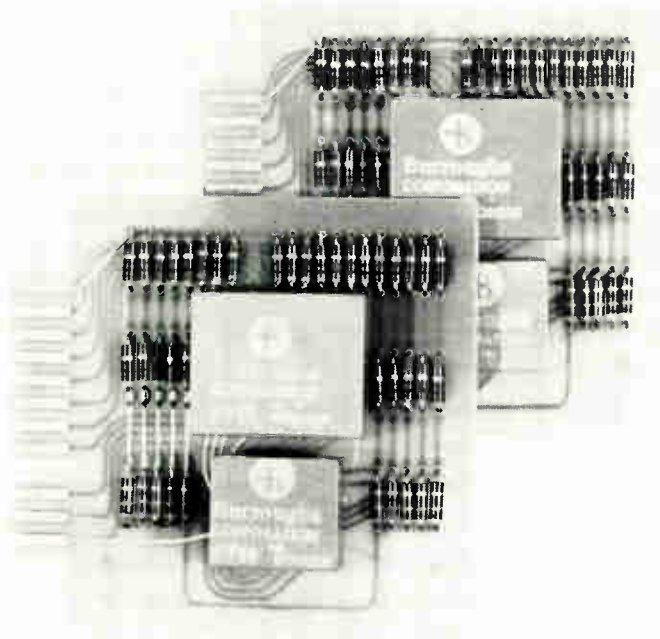

name only from the NOR element. This simple device will be used exclusively here. For this reason, NAND logic will be explained.

Logic Elements

Shown in Fig. 1 is the schematic of the NAND circuit. If we state that logic One is equal to +12 v., logic Zero is equal to zero v., we have defined our logic levels. There are only two.

The following statements will complete the description:

1. Placing Ones on all the input lines will produce a Zero on the output line.
2. Placing a Zero on any input line will produce a One on the output line. It now becomes apparent why this circuit was so named; it "nands" Ones and "nors" Zeros. The "n", of course, means that the outputs exist in their inverted forms. The above simple facts will be used in the discussion which follows.

The device presented here is a bi-directional decade counter, but with the associated logical subsystem, it becomes a decimal accumulator.

Decimal Accumulator

An accumulator, basically, can store a number and accept inputs which can increase or decrease the magnitude of the number stored. Also, the accumulator recognizes algebraic signs.

Many methods have been used to construct practical accumulators, both binary and decimal. Some are parallel input devices and some are serial input.

By **JAMES J. KLINIKOWSKI**

Electronic Components Div.
Burroughs Corp.
Plainfield, N.J.

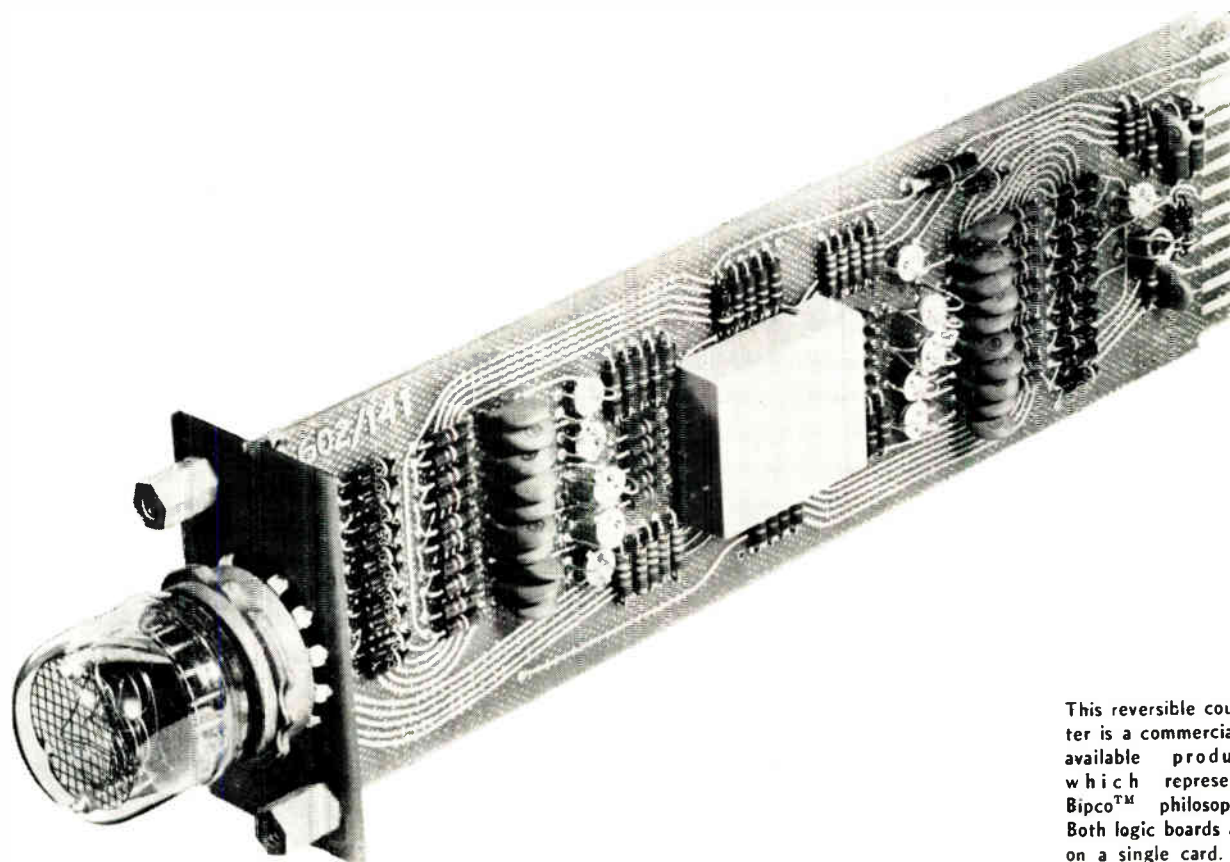

This reversible counter is a commercially available product which represents BIPCO™ philosophy. Both logic boards are on a single card.

With all of them, however, the problems of (1) representing zero practically, and (2) handling negative numbers, must be solved—or effectively bypassed—so that all other needs of the system are satisfied. Zero is sometimes positive, sometimes negative. In some cases both a positive Zero and a negative Zero are necessary. Negative numbers are usually interpretative and exist in complementary form.

The reversible decade counter, which will be described, is the heart of the accumulator. It is a decade counter with integral visual display having forward and reverse trigger lines, and capable of counting in either direction.

System Operation

This device has one Zero which is represented with both plus and minus signs. Negative numbers are represented in their true form.

This accumulator uses serial inputs and will count pulses appearing on the forward (add) and reverse (subtract) input lines over a range from +999,999 to -999,999. Forward pulses will be added to the previous count and reverse pulses will be subtracted. Addition and subtraction is automatically performed with this device.

Refer to Fig. 2. The basic unit is a multi-decade reversible counter with plus and minus indication. The logic system built around the counter-storage consists of two BIPCO™ general-purpose logic

boards, each about $2\frac{1}{2} \times 2\frac{1}{2}$ in. Each logic board contains ten standard NAND gates. Gates numbered with subscript "a" are on logic board A and gates numbered with subscript "b" are on board B. Board A determines when Zero is present in the accumulator and board B switches inputs and provides the polarity indication.

The operation of the device is based on 3 conditions:

1. When Zero is present in the accumulator, the next input pulse must cause the counter to count forward.
2. When a positive number is present in the ac-

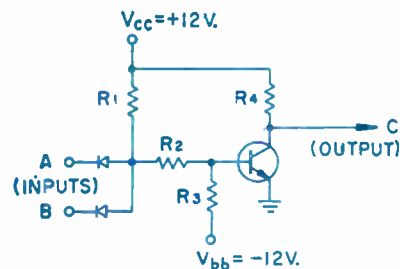

INPUTS		OUTPUT
A	B	C
0	0	1
0	1	1
1	0	1
1	1	0

LOGICAL "0" = 0 VOLTS
LOGICAL "1" = +12 V

$$C = \bar{A}\bar{B} + \bar{A}B + A\bar{B} = \bar{A} + \bar{B} = \overline{AB}$$

Fig. 1: The NAND circuit: its schematic, logic diagram and a truth table. Device is utilized throughout in the decimal accumulator.

LOGIC CIRCUITS (Continued)

cumulator, forward (add) pulses will increase the magnitude of the number stored and reverse (subtract) pulses will decrease the magnitude of the number stored.

3. When a negative number is present in the accumulator, forward pulses will decrease the magnitude of the number stored, and reverse pulses will increase the magnitude of the number stored.

The function of the logic circuitry is to satisfy the above three conditions. Functions of specific gates are as follows.

Gates 1a to 7a sense the presence of a Zero. Gates 1a to 6a are connected to the Zero outputs of each

counter. When the counter is at Zero, these outputs will be a logic Zero. At all other numbers, these outputs will be effectively a logic One. If less than six decades are used, the remainder of these six inputs should be grounded. When Zero is present, the output of gate 10a is logical Zero. This output is connected to board B. Two other outputs provide an indication of Zero and its complement.

Gates 1b and 2b make up the control flip-flop for board B. The outputs of this flip-flop are connected to a TRIXIE® module which contains the plus-minus-NIXIE® indicator tube. When Zero is present in the accumulator, the Zero input from board A will cause the outputs of both 1b and 2b to be logic One, which in turn will cause both plus and minus indicators to be on simultaneously.

This Zero input from board A will also inhibit signal transfer through gates 4b and 6b. Then forward (add) pulses will be transferred to gate 7b through gate 3b and reverse (subtract) pulses will be transferred also to gate 7b, but through gate 5b. Gates 3b and 5b furnish the "set" and "reset" inputs to the flip-flop. If the next input pulse is forward (add) the flip-flop will be "set" through gate 3b, and the plus sign will remain on as the counter is advanced one count. If the next pulse had been reverse (subtract) the flip-flop would have been "reset," through gate 5b, and the minus sign would have remained on as the counter was advanced one count.

Once the flip-flop is set or reset, as the case may be, a Zero signal from gate 1b will inhibit transfer of pulses through gates 3b and 6b or a Zero signal from gate 2b will inhibit transfer of pulses through gates 4b and 5b.

Pulses transferred through gates 7b and 9b will always increase the absolute magnitude of the number stored, and pulses transferred through gates 8b and 10b will always decrease the absolute magnitude of the number stored. Gates 9b and 10b perform simple inversion.

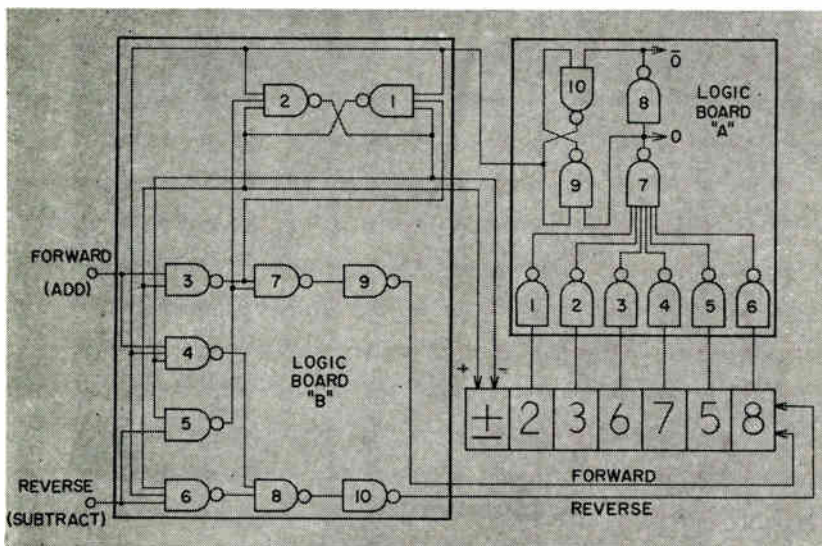
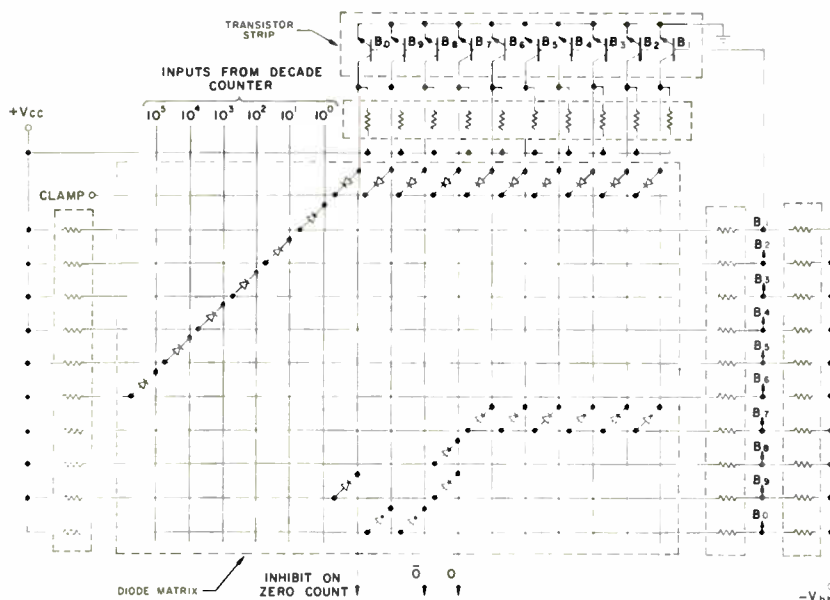

Fig. 2 (above): The reversible counter is the basic unit in the accumulator.

Fig. 3 (below): Logic board A. Resistor and transistor strips are indicated.



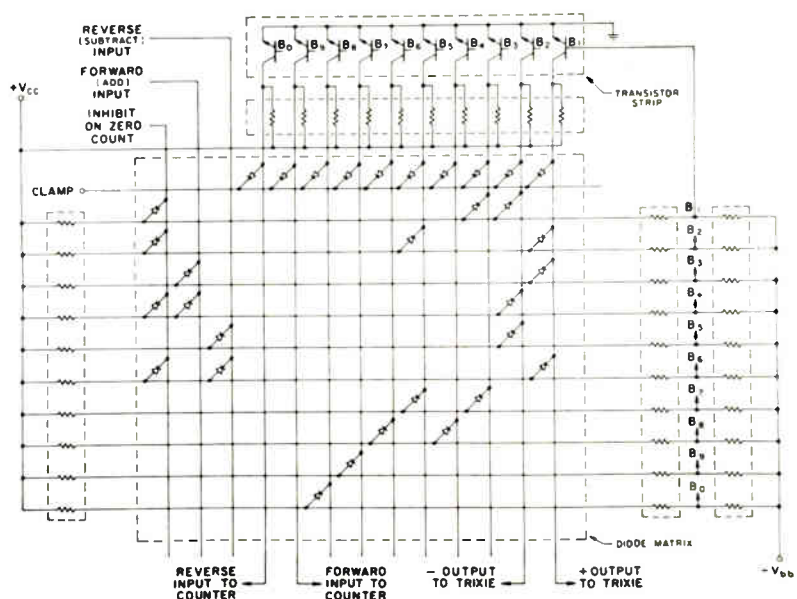
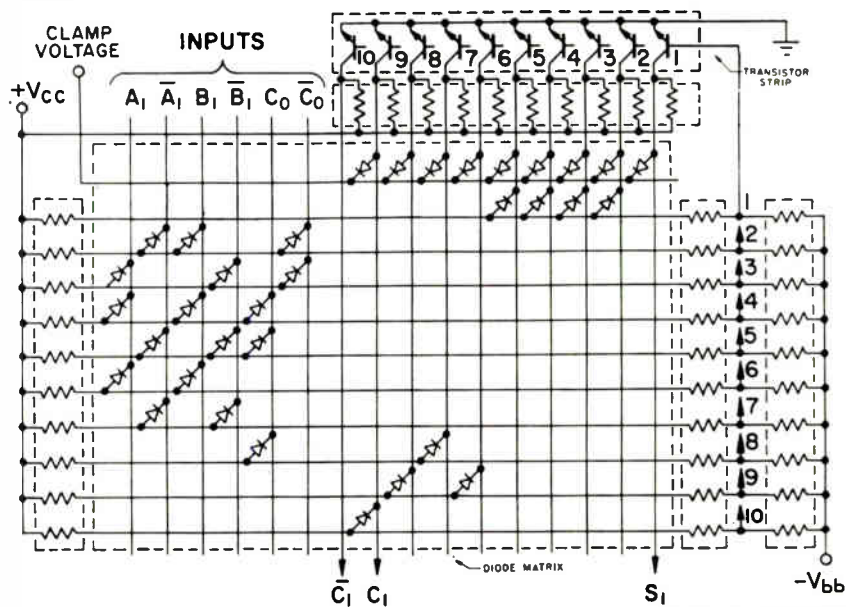

Fig. 4 (above): Schematic of logic board B. Its diode matrix, shown in dotted lines, is the only difference from board A. Board B is used to indicate polarity.

Fig. 5 (below): Full adder, schematic diagram. This demonstrates another of a variety of functions which one basic board can do simply by replacing its matrix.



The accumulator can be extended beyond six decades if one more NAND gate is added for each decade added. This is necessary for Zero recognition.

Applications

Due to its simplicity and the fact that the majority of interconnections are already made in the diode matrices, this is a very compact device. It can be contained in a space 10 x 10 x 2½ in. or about 0.15 cu. ft.

This device should find use in plotting tables, posi-

tioning devices, digital voltmeters, computers, data processing systems, machine control, monitoring systems, difference indicators, and many more.

The reversible counter and the logic boards are seen in the photograph. Schematics of logic boards A and B are shown as Figs. 3 and 4 respectively.

This system is further reduced in size by combining the logic of both logic boards on a single board the size of the reversible counter. The plus-minus NIXIE® indicator tube can be mounted on one end of the board. This allows the entire accumulator to be

(Continued on following page)

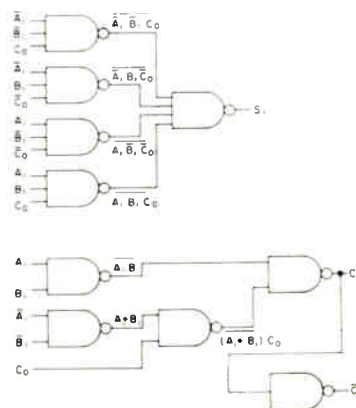

Fig. 6 (above): Logic diagram of full adder to verify how function performs.

Fig. 7 (below): Ten-stable-state ring counter. Matrix has diagonal removed.

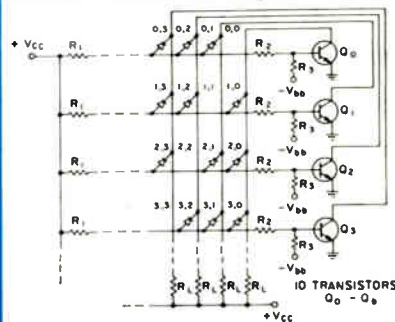
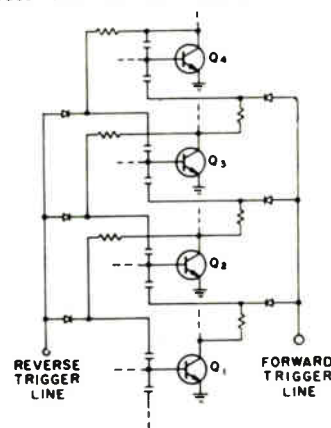

Fig. 8 (below): Bi-directional counting uses only one matrix. R-C coupling and diodes turn on the desired transistor.



LOGIC CIRCUITS (Concluded)

mounted behind an extruded bezel, using printed circuit boards of one standard size.

There are many advantages to using the matrix technique to handle the logic circuitry. Many interconnected logic circuits can be mounted on a printed circuit card (in this case, 20).

The components can be adapted to batch manufacture, a low cost process.

From the schematics of logic boards A and B (Figs. 3 and 4) we see that strips of identical components surround the matrix. This shows why batch manufacture applies so well. Thin film resistors are deposited many at a time and transistors are made in strips. Assembly of the finished boards is thereby also simplified.

Space is conserved due to the small size of the matrix and the batch components. This technique can also be used when conventional, rather than deposited film resistors are used for increased power dissipation. The systems engineer is, therefore, not confined to the logic levels set by the manufacturer. He is free to choose the components and voltages which best suit his need.

Reliability

One of the major problems is the interconnection reliability problem. Computer engineers will attest to the fact that many hours can be spent locating a vibration sensitive mechanical contact. With this technique, these problems are minimized.

A good compromise is effected between component size and contact reliability. Film resistors are small, yet large enough for a tension-free solder connection, weld, or a good thermo-compression bond.

Interconnection conservation is seen by looking at the diode matrix in Figs. 3 and 4. Since each diode represents a connection, conservation is proportional to the number of diodes.

Total Function Packaging

In the decimal accumulator, note that it needs only one printed circuit design. The only difference between logic board A and logic board B is the diode setup in the matrix. In all other respects, the two boards are the same. The row of clamping diodes may, or may not, be used depending on speed considerations.

One basic board can perform a variety of functions. By replacing any of the above matrices with the matrix shown in Fig. 5, the board then becomes a full adder as is shown by the accompanying circuitry. The logic diagram of Fig. 6 simplifies tracing through

the matrix to verify the performance of this function. Other logic functions similar to the full adder can be done by the same board, simply by changing matrices. Circuits possible include storage registers, binary accumulators, decade counters, or any special purpose a logic designer might envision. The logic is always contained within the diode matrix and total functions are isolated from the remaining circuitry in this manner. Separating the logic from the logic system represents a large step in low cost packaging.

Reversible Counter

The reversible counter is basically the same ten matrix-connected NAND gate previously used. However, since its operation as a counter depends upon directional coupling (to be described), and due to the higher voltages needed for the display, the board is larger. In addition, the description should relate to the principle of "logic separation" as previously discussed.

Shown in Fig. 7 is a ten-stable-state device. By inspection of the matrix, it can be seen that each NAND gate, when it is turned on and saturated, will produce a Zero on the inputs of the remaining nine gates. Therefore, the remaining gates will have a One on their output lines. In this case, logic One is equal to +55 v. and logic Zero is equal to about 0 v. In short, any transistor when turned on and saturated will "bias off" the other nine.

The change from one stable state to another is caused by the input pulse, which turns on the only transistor allowed to be turned on by the directional coupling, (Fig. 8). Direction of this progression is determined by the two trigger lines shown. A trigger amplifier is inserted in each trigger line. This enables the counter to operate on negative pulses of less than 1 v. The output of each collector is a -55 v. pulse which is connected to a NIXIE® indicator tube. Though the 55 v. signal level is in sharp contrast to the +12 v. level used in the accumulator logic, it does show the design flexibility possible in spite of the small size of the NAND gate packages.

Though +55 v. is logic One in the counter, and logic One is +12 v. in the logic circuitry, any voltage above +12 v. can be considered to be logical One so far as the logic boards are concerned. This assumes, of course, that breakdown voltage of the coupling diodes is above +55 v. in gates 2 to 7 of logic board A.

The author wishes to thank Mr. A. Somlyody of Burroughs Corp. for the reversible counter use, and the many people at the Burroughs Paoli Research Center and the Electronic Components Division for their work on diode matrices and strip components, which led to these packaging concepts.

There are certain advantages in placing circuits right at the antenna. This integration improves the electrical performance and reliability, reduces the number of components used and gives a more compact package. Here is a description of how far this work has gone.

ANTENNAS HAVE BUILT-IN CIRCUITS

INCORPORATION OF CIRCUIT FUNCTIONS such as mixing, amplifying, etc., into an antenna structure is an evolutionary development. It is in line with current trends to package things more compactly, to reduce unnecessary redundancy, to increase reliability, and to improve electrical performance. These are precisely the objectives of integrating circuit functions into the antenna structure.

This integration process is more than just setting a conventional amplifier or mixer close to the antenna terminals. It involves the use of conventional circuitry and antennas as well as the development of new circuitry and new antennas with the aim as part of the circuitry, and vice versa.

* * *

It appears that the earliest work along these lines was that of E. M. Turner of the Aeronautical Systems Division, Wright-Patterson Air Force Base. About 1958 Turner obtained experimental evidence of conversion in the structure illustrated in Fig. 1. A detailed study of this device was begun at The

Ohio State University Antenna Laboratory in 1959, and work on integrated antenna-circuits has continued to the present time. Other laboratories also have become interested in this concept, with the development of the Parant, a unified dipole and parametric amplifier by A. D. Frost of the University of New Hampshire, and the negative conductance slot-amplifier by M. E. Pedinoff of Hughes Aircraft, Culver City, California, to mention only two.^{1, 2} This paper is intended to present some of the developments in the field and to indicate briefly a few applications for integrated systems.

Antennaversers

Antennaverter is the name given to a system in which the mixer is placed in the antenna structure. Fig. 1 shows such a system. The conical spiral antennaverter in Fig. 1 uses a broad-band antenna and an untuned mixer. Use of the untuned mixer overcomes the narrow bandwidth of the usual tuned mixer circuit. Since there is no transmission line between mixer and antenna, possible mismatch at certain frequencies is eliminated and r-f loss is reduced. The spiral elements of the antenna are coaxial lines which serve as transmission lines for local oscillator and i-f signals. Although the system studied here used the conical spiral antenna, the results are directly applicable to other broad-band structures.

The actual and equivalent circuits of the structure in Fig. 1 are shown in Fig. 2. Since there are no tuned circuits, ideal band-pass filters are used to represent the input and output sections. For a tunnel-diode converter where the bias is adjusted so that the I-V characteristic can be approximated by

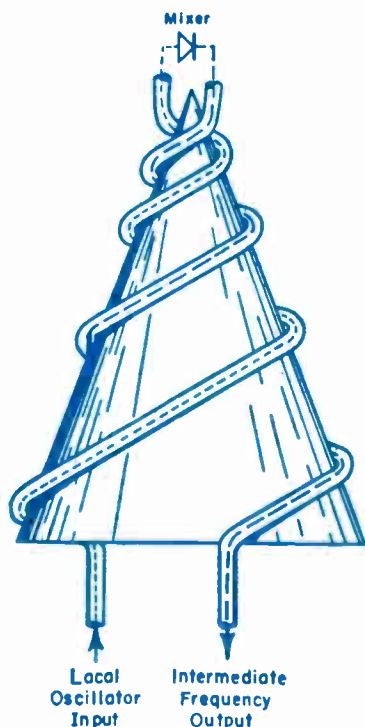

Fig. 1: Conical spiral antennaverter has a mixer placed in the antenna.

J. R. Copeland

W. J. Robertson

By JOHN R. COPELAND
and WILLIAM J. ROBERTSON

Research Associate
Antenna Laboratory
Dept. of Electrical Eng.
The Ohio State Univ.
Columbus 10, Ohio



ANTENNAS & CIRCUITS (Continued)

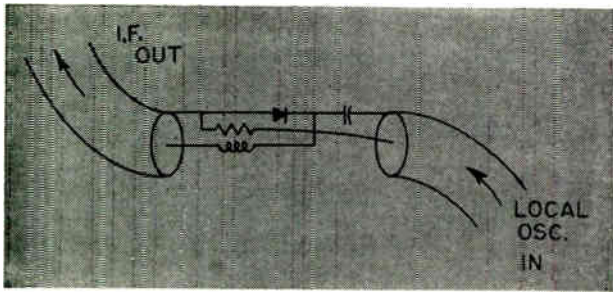

Fig. 2: The equivalent circuit for Fig. 1 is shown above.

Fig. 3: A measurement system for the antennaverter.

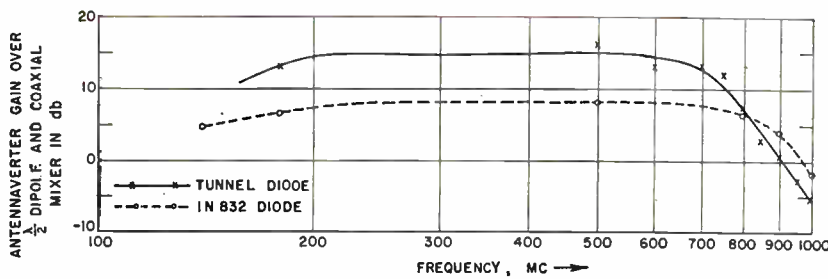
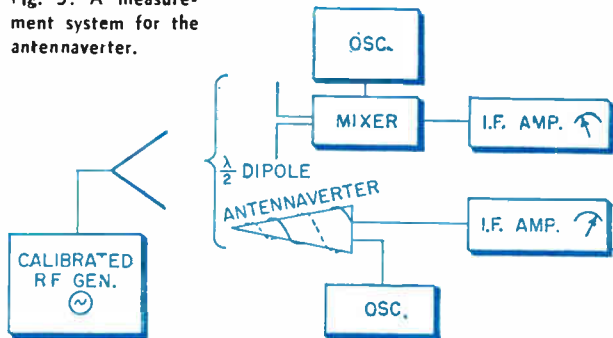

Fig. 4: Measured performance on the conical spiral antennaverter.

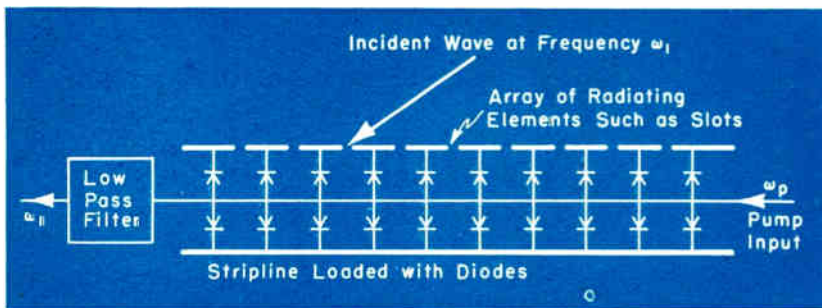
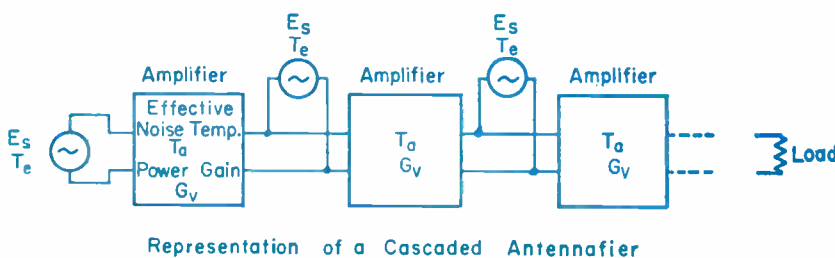

Fig. 5a: A traveling wave parametric antennafier is shown above.

Fig. 5b: An antennafier can be illustrated by a cascaded system.



Representation of a Cascaded Antennafier

$$I = G_o V - p V^2, \quad (1)$$

the conversion gain of the converter is given by

$$g_c = \frac{4 p^2 V_o^2 G_L G_o}{(Y_2 G_{T_1} - p^2 V_o^2)^2} \quad (2)$$

where

$$G_{T_1} = G_o + G_o + G_1.$$

$$Y_2 = G_o + G_2 + G_L.$$

The various quantities are defined as follows:

G_1 = loss conductance of filter No. 1.

G_2 = loss conductance of filter No. 2.

G_3 = loss conductance of filter No. 3.

G_L = load conductance.

G_o = generator conductance.

V_o = local-oscillator signal (peak value).

The local-oscillator frequency ω_o is equal to the sum of the signal frequency ω_s and the intermediate frequency ω_i . The detailed analysis of the tunnel-diode antennaverter is given in Ref. 3.

Both a tunnel diode and a conventional diode have been measured in the antennaverter of Fig. 1. The most interesting results are obtained with the tunnel diode which can be adjusted (biased) to give conversion gain. Using the measurement apparatus in Fig. 3, the tunnel-diode antennaverter and an antennaverter with conventional diode were compared with a dipole and conventional mixer. The measured results are given in Fig. 4. A General Electric ZJ56 tunnel diode and a 1N832 diode were used in the antennaverter, and the conventional mixer used with the dipole was a General Radio 874-MR with 1N21B diode.

The tunnel-diode antennaverter gives conversion gain as contrasted to conversion loss with the usual mixer diodes such as 1N21B and 1N832. According to Eq. 2 the gain can be made arbitrarily large as $Y_2 G_T - p^2 V_o^2$ approaches zero. From the standpoint of stability, practical values of gain are limited to 20-30 db.

Fig. 7: Log-periodic array is loaded with tunnel diodes to increase power gain.

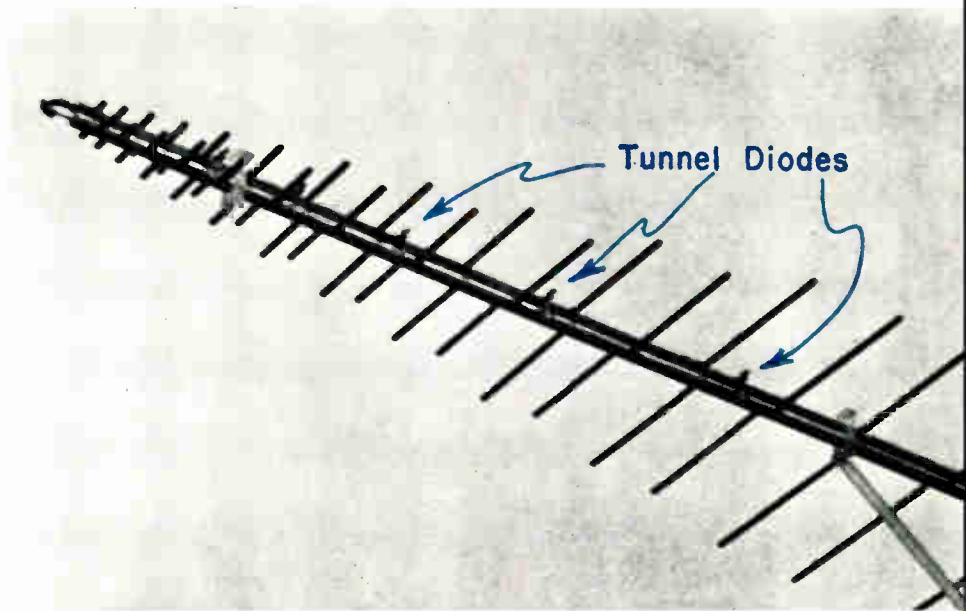

Antennafiers

An antennafier is an integrated antenna and amplifier. A number of integrated designs has been studied, and these are illustrated in Fig. 5 through 10. Figs. 5, 6, and 7 show array-type structures in which radiating elements are coupled to a transmission line which is loaded with amplifying diodes. Such structures can be represented by a cascaded system as shown in Fig. 5.

Noise temperature and power gain can be obtained by use of the cascade representation in Fig. 5. The signal delivered to each amplifier from each antenna is E_s . For simplicity it will be assumed that the antenna elements are connected to the system by unilateral devices so that no power is delivered to the antenna by its amplifier. It is also assumed that the system is adjusted so that the signals are in phase at the input terminals of the amplifiers. This satisfies the condition that the signal source lies in the direction of the beam maximum.

If there are N amplifier stages, the total power

$$P_{out} = E_s^2 \left[\sum_{i=1}^N G_i^2 \right] \quad (3)$$

output is where G_i is the voltage gain of each stage.

The total power input is simply

$$P_{in} = N E_s^2 / Z_0 \quad (4)$$

Thus the power gain P_{out}/P_{in} can be written as

Fig. 6: An antennafier array which uses tunnel diodes.

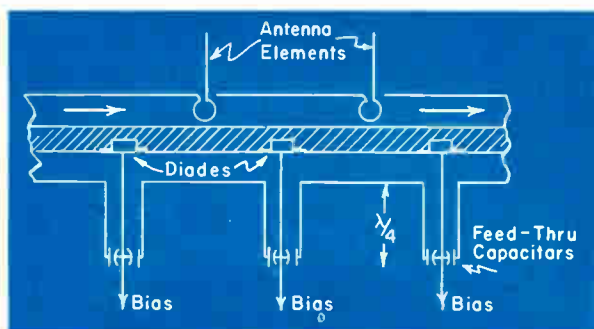

$$G = \frac{P_{out}}{P_{in}} = \frac{E_s^2}{N} \left[\sum_{i=1}^N G_i^2 \right] \quad (5)$$

If T_e is the effective noise temperature as seen at the terminals of each antenna element and T_a is the effective noise temperature of each amplifier (referred to the input), the overall system noise temperature (referred to a set of "equivalent" input "terminals") is

$$T_a = \frac{N T_e \sum_{i=1}^N (G_i^2)}{\left[\sum_{i=1}^N G_i^2 \right]^2} + N T_e \quad (6)$$

For more details of this subject see Ref. 4.

The cascaded antennafier can be compared to a conventional system in which the amplifiers of Fig. 5 are replaced by sections of transmission line at temperature T_0 with power-transmission coefficient α . If a single amplifier with gain G and temperature T_a is placed at the output of the antenna array, the noise temperature of the system (referred to the input of the amplifier) is

$$T_a = T_e \left[\sum_{i=1}^N \sqrt{\alpha} \right]^2 + (1 - \alpha) T_0 \sum_{i=1}^N \alpha^i + T_a \quad (7)$$

where T_0 would normally be 290°K.

If α is significantly less than unity, the antennafier

ANTENNAS & CIRCUITS (Continued)

temperature can be considerably lower than that of the conventional system.

Actual measured gains of the antennafiers in Figs. 5, 6, and 7 gave about 3 db or more per stage with up to 30 db total gain. In general, instability was encountered with gains greater than about 15 db. This is not an inherent limitation, however, because careful design from the standpoint of properly matching the individual negative-resistance elements to the line can improve stability substantially.

The antennafier illustrated in Fig. 8 is patterned after the antennaverter in Fig. 1. In this case a varactor diode is used and a pump signal is substituted for the local oscillator signal. The output is an amplification of the incident signal. The usual signal and idler circuitry of a parametric amplifier are supplied to the diode by the broad-band antenna itself. By using a pump frequency above the high-frequency cutoff of the antenna, the lower idler can be made to fall within the pass band of the antenna while the upper idler will be well outside the pass band. This satisfies the conditions for negative-resistance operation of the parametric amplifier. Furthermore, since the effective noise temperature of the idler circuit is that of the antenna at the idler frequency, the noise contributed from that source can be quite small, depending on the efficiency of the antenna, the direction in space in which it is pointing, and the choice of frequencies.

A model was tested in which the operating range of the conical spiral was approximately 150-900 mc.

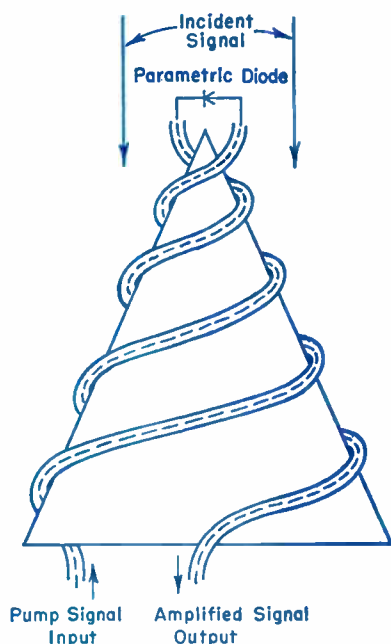

Fig. 8: The antennafier shown is patterned after the antennaverter in Fig. 1.

The varactor diode was placed across the feed terminals of the antenna. Output signal was taken from one of the two coaxial cables which made up the spiral arms of the antenna. The pump signal was brought in through the other cable and capacitively coupled to the diode.

With the pump frequency about 1500 mc and a signal frequency of about 700 mc the device operated with small gain, on the order of 3 to 6 db compared to the unloaded conical spiral. Some tendency toward unstable operation was noted, so it appears that the gain could be improved considerably with careful design, especially by further suppressing the upper idler frequency.

This type of antennafier is extremely simple and can be tuned over a wide band by varying the pump frequency. It should give very low-noise amplification, and ought to be considered as a low-noise feed for reflector antennas as well as an element in large arrays. To date this item has received only brief attention and more work is planned.

Considerable effort has been devoted to the resonant half-wave dipole tunnel-diode antennafiers illustrated in Fig. 9. A detailed analysis has been made to determine impedance, gain, and noise figure of these devices. A thorough understanding of such antennafiers will not only assist in properly designing individual antennafiers, but also will help in designing arrays of such elements. A detailed analysis of the four cases illustrated in Fig. 9 has appeared in report form.⁵ Circuit gains of 10 db with noise temperatures of 800°K are typical. The pattern, of course, is that of the half wave-length dipole.

The last antennafier to be studied under this program is illustrated in Fig. 10. This is a gamma-matched dipole with an integrated transistor amplifier. True integration is achieved since the dipole is used as the input tank circuit of the amplifier. A thorough study and analysis has been made of the antennafier and was published in report form.⁶ Test results show a gain of about 12 db over the unloaded dipole and a noise temperature of 350°K. The gain is comparable to that of the same transistor used in a conventional amplifier circuit, but the noise temperature is about 20% better than was obtained from the conventional amplifier. This is attributed to lower losses in the antenna than in the input tuned-circuit of the conventional amplifier. Thus the antennafier is decidedly superior to a combination of passive antenna and conventional amplifier. This element is readily used in receiving arrays where beam shaping can be accomplished electronically by adjusting the gains of the individual elements.

Antennamitters

A unified design incorporating transmitting circuitry in the antenna may be termed an antennamitter. Fig. 11 illustrates one such design using a free-running 1N2939 tunnel-diode oscillator as a very low-powered transmitter. The operating frequency of about 145 mc was determined by the resonant frequency of the half-wave dipole and gamma-match combination.

The operating frequency could be adjusted over a range in excess of 20% by alteration of the gamma match, but in any case the frequency stability of the device was rather poor, because of the low Q of the frequency-determining circuits.

The total dc input power to the tunnel-diode used in this antennamitter was approximately 50 μ w, and no attempt was made to measure efficiency or output power. Other tunnel-diodes could be used to obtain somewhat greater output, but frequency limitations currently prevent use of high-power tunnel-diodes in this application.

Modulation was applied to the dc bias as shown in Fig. 11. Both amplitude and frequency modulation occurred, but so long as the modulating signal remained small, the distortion was not excessive in an AM receiver, and voice signals could be recovered without loss of intelligibility.

Measurements of Integrated Systems

Gain and noise figure of an integrated system are not so easily measured as in the case of a conventional amplifier or mixer. In the latter case, input and output terminals are well defined: but in the former case, an amplifier may be distributed throughout an antenna structure with no accessible terminals for measurements.

Gain of an antennafer can be measured by the usual comparison method where the standard would usually be taken to be the unloaded antenna. For noise-figure measurements, since conventional input terminals are not available, one can use field-strength sensitivity measurements. Field-strength sensitivity is defined as the field strength of the electromagnetic wave in which the antenna must be immersed to provide signal output equal to noise output. Strictly speaking, this implies an electric field strength, but for this work it is far more convenient to work in terms of power density.

The noise temperature of an antennafer or antennaverter can be determined from the ratio of the field-strength sensitivity with amplifier (or mixer) circuit operating, to the field-strength sensitivity with

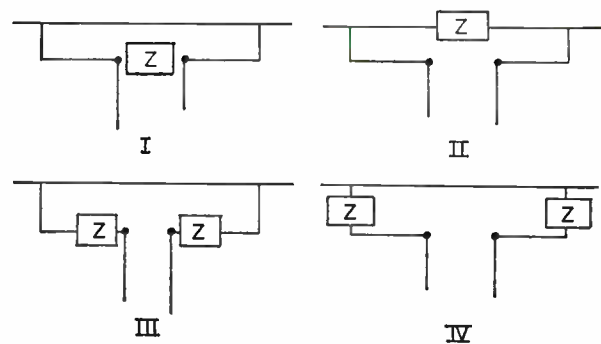

Fig. 9: Dipoles are loaded with tunnel diodes for gain.

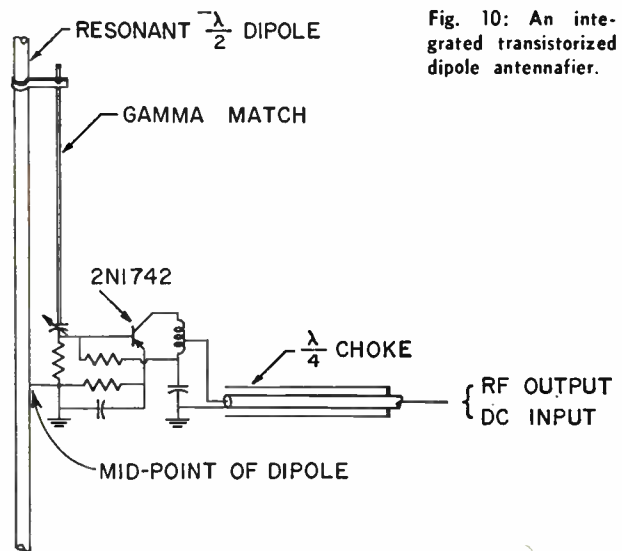

Fig. 10: An integrated transistorized dipole antennafer.

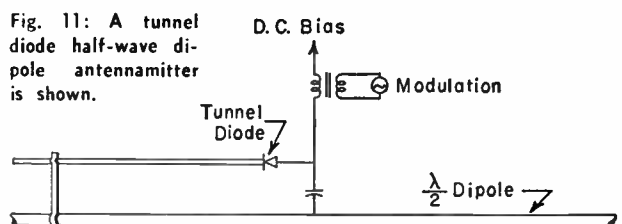

Fig. 11: A tunnel diode half-wave dipole antennafer is shown.

A REPRINT OF THIS ARTICLE CAN BE OBTAINED
by writing on company letterhead to
The Editor
ELECTRONIC INDUSTRIES
Chestnut & 56th Sts., Phila. 39, Pa.

amplifier (or mixer) disabled or removed from the antenna. The noise figure T_a for an antennafer can be found from the field-strength sensitivity ratio (FSSR), which is given as:

$$\text{FSSR} = \frac{T_e + T_a + T_r/G}{T_e + T_r}, \quad (8)$$

where

ANTENNAS & CIRCUITS (Concluded)

T_a = temperature of antenna due to sky temperature, ground temperature, and antenna losses.

T_a = temperature contribution of the amplifier circuitry.

T_r = temperature of the receiving system following the antenna.

G = gain of antenna.

The above method was developed for use with antennafiers, but has been extended for use with antennaversers in which the output frequency is different from the input frequency. Then it is no longer possible to disable the active portion of the antenna-verter for the one field-strength sensitivity measurement. Instead, it is necessary to use an identical antenna (or the same antenna with down-converter removed) and a separate mixer circuit whose characteristics are known. Since it is necessary for the effective bandwidth to be the same for both measurements (usually the effective bandwidth of the i-f amplifier), the bandwidth of the separate mixer circuit must not be smaller than for the remainder of the system. Also the conversion gain, or loss of the separate mixer must be known accurately.

For more details of gain and noise-figure measurements see Refs. 7 and 8.

Conclusions

The concept of integrated antenna-circuitry design is that of combining certain antenna functions with certain circuit functions in a single structure. The integrated devices discussed in this report fall into three categories: antennaversers, antennafiers, and antennamitters. They are named according to the chief circuit function performed, and are comprised of an antenna combined, respectively, with a down-converter, with an r-f amplifier and with transmitting

circuitry. The active elements which have been utilized are the tunnel diode, the transistor, and the varactor diode.

All of the experimental designs reported here have been tested in the VHF-UHF spectrum, but the techniques are readily applicable to other frequency ranges.

Some of the potential advantages offered by integrated design techniques over conventional design are improved electrical performance, increased reliability, reduced number of components, and more compact packaging.

Acknowledgments

Most of the work reported here was performed by the Antenna Laboratory, The Ohio State University Research Foundation, under Contract AF 33(616)-6211, Aeronautical Systems Division, Air Force Systems Command, United States Air Force, Wright-Patterson Air Force Base, Ohio. The authors wish to thank both Dr. C. H. Walter of the Antenna Laboratory and Mr. E. M. Turner of ASD for their many valuable suggestions. Mr. K. Fujimoto performed much of the work on the dipole-tunnel diode antenna-fier combinations.

References

1. Frost, A. D., "Parametric Amplifier Antenna," *Proc. IRE*, Vol. 48, p. 1163, June 1960.
2. Pedinoff, M. E., "The Negative Conductance Slot Amplifier," *IRE Transactions of PGMTT*, Vol. 9, p. 557, November 1961.
3. Interim Engineering Report 903-11, 1 July 1960, (AD 242 911), The Ohio State University Antenna Laboratory.
4. Interim Engineering Report 903-22, 1 September 1961, (AD 265 963), The Ohio State University Antenna Laboratory.
5. Fujimoto, K., "The Analysis and Design of Tunnel Diode Dipole Antennafiers," Report 1566-1, March 1963, The Ohio State University Antenna Laboratory.
6. Copeland, J. R., and Robertson, W. J., "The Transistorized Dipole Antennafier," Report 1566-2, March 1963, The Ohio State University Antenna Laboratory.
7. Copeland, J. R., Robertson, W. J., and Walter, C. H., Final Engineering Report, Vol. II, Part I, 1 December 1960 Report 903-16, The Ohio State University Antenna Laboratory.
8. Copeland, J. R., and Robertson, W. J., "Antennaversers and Antennafiers," *Electronics*, October 6, 1961.

CIRCUIT-WISE

DTL POWER CONVERTER

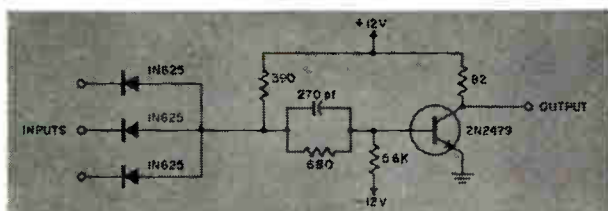

Circuit courtesy of the Lansdale Division of Philco.

THE CIRCUIT SHOWN is a circuit for high current logic and memory driving. It uses high speed epitaxial silicon mesa transistors.

In a Diode-Transistor-Logic (DTL) power inverter the 2N2479 delivers high speed at high switched collector current, and affords a per stage propagation delay time of less than 50 nano seconds. For higher supply voltages the 2N2087 transistor could be used.

TRANSISTOR AC REGULATOR FOR X-RAY TUBE CURRENT

In many industrial control circuits, silicon power transistors can do the job of a SCR with far less wave distortion, faster response, somewhat simpler circuitry and competitive overall cost levels.

This article describes a novel technique for using a power transistor, primarily a dc device, in an ac circuit.

The method is general and of basic interest for other applications.

X-RAY DIFFRACTION PHENOMENA are the chief investigative tool for crystallographic studies of molecular structure. When an x-ray beam is directed against the material to be studied, the rays are diffracted by the material and emerge at an angle different from the angle of the incident beam.

By measuring the intensity of radiation at various emergent angles, the crystalline structure of the material can be deduced. These energies are measured either directly with counters or indirectly by densitometer measurements of exposed photographic film. With either measurement technique, the anode current of the x-ray tube must be stabilized over rela-

tively long periods of time to permit accurate comparison of energy levels at various angles.

In the demountable x-ray tubes commonly used for these studies, anode current drift can result from filament poisoning, tube leakage, out-gassing of internal components, line transients and other effects. Anode voltage control cannot be used since anode voltage must be held relatively constant to insure a consistent spectral distribution of the beam. By suitable adjustment of the filament emission, however, the anode current may be set to any desired value.

* * *

The obvious solution to this control problem was a closed loop regulating system which would adjust the filament current so as to maintain anode current constant at a preset value. The system requirements were straightforward except for waveform considerations. Since steeply rising wave fronts in the filament current could cause trouble with high voltage insulation in the filament transformer, silicon controlled rectifiers and magnetic amplifiers were ruled out as control elements. The problem then was to design a simple, reliable regulator which would be responsive to dc anode current and could control the ac filament current with a minimum of waveform distortion. Solid-state devices were preferred in order to minimize space requirements and insure long term reliability.

Dr. Taylor (left) points to an item for Mr. Sueker, as these authors discuss this experimental model of the regulator chassis.

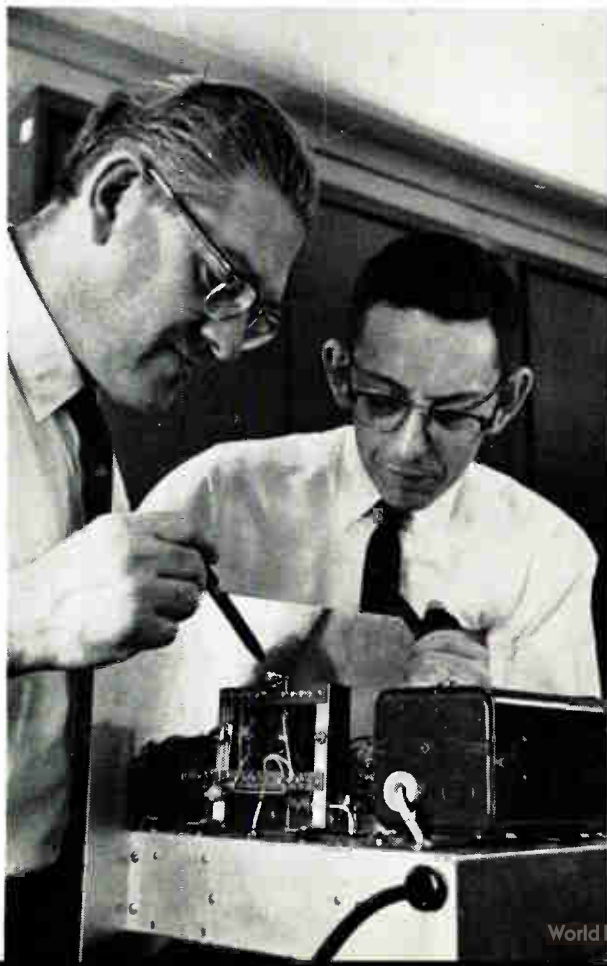

By Dr. ABRAHAM TAYLOR

Advisory Physicist
Westinghouse Research Laboratories
Pittsburgh 38, Pa.

and KEITH H. SUEKER

Mgr. of Commercial Eng. Dept.
Westinghouse Semiconductor Div.
Youngwood, Pa.

X-RAY TUBE REGULATOR (Concluded)

The familiar series regulator circuit shown in Fig. 1a was adapted to meet these requirements. Fig. 1b shows the same circuit with the addition of a bridge rectifier in series with the load. Since the transistor can now conduct with either polarity of supply voltage, the circuit will operate with ac input and deliver ac output to the load. Except for the slight rectifier drop, the characteristics are identical to the circuit of Fig. 1a. With the addition of the transformer shown in Fig. 1c, the circuit may be adapted to operation on any desired source voltage. The characteristics are identical to the circuit of Fig. 1b except for the voltage and current transformations introduced by the transformer.

Performance Characteristics

With a given set of circuit components, the operating characteristics may be determined from the output curves of the transistor. These curves are shown in Fig. 2 for the 2N2227. Fig. 3a illustrates the circuit performance with a 240/24 v. transformer and a 7K ohm resistive load. This resistance represents approx. the steady-state filament load referred to a 240 v. circuit. A constant 2 v. secondary drop is included for rectifier losses. The waveforms of load voltages are shown in Fig. 3b. While the response would scarcely qualify the regulator for "high fidelity" use, the distortion is acceptably low for the intended use. The output is entirely free of any steeply rising voltage transients.

In a full range series regulator supplying a resistive load, the maximum control element dissipation is one-fourth of the maximum load demand. In this case, the x-ray tube filament rating is a nominal 5 a. at 15 v. or 3.1 a. referred to 24 v. Thus, the transistor

Fig. 1: Steps taken to provide the regulator circuit with ac output to the load from any selected source voltage.

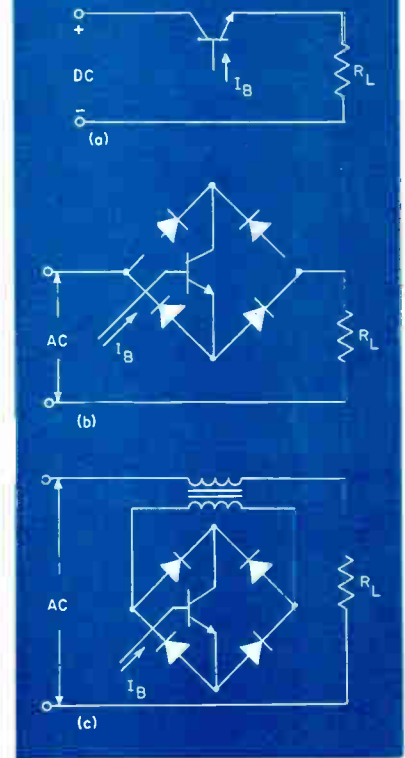

Fig. 2 (below): Output curves of 2N2227, high gain power transistor, directly controlled by amplified dc error signal.

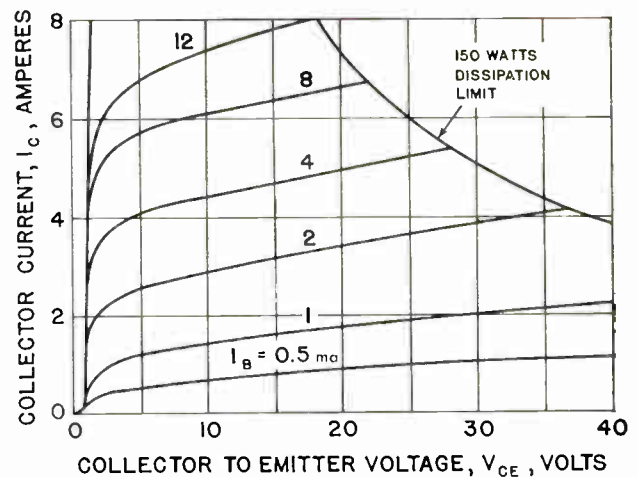
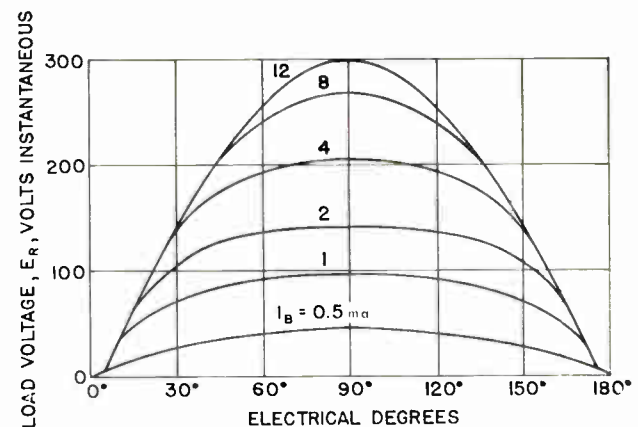
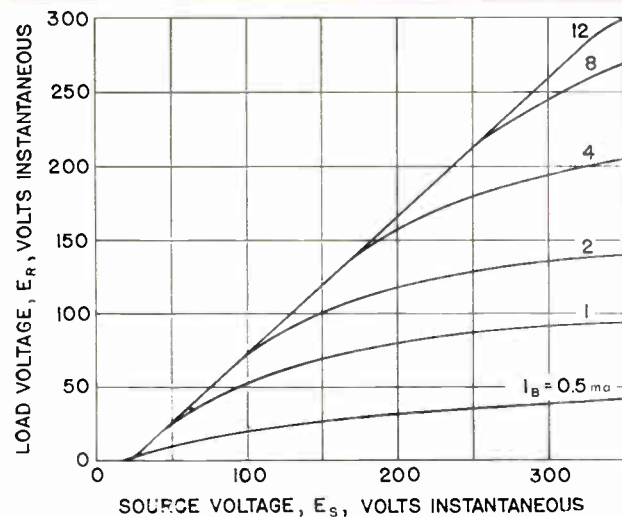

Fig. 3 (a, left): Steady-state circuit operation with simulated filament load. (b, below) Waveforms of output voltages with the same load clearly indicate a freedom from any steep transients.



dissipation reaches a maximum of about 20 w. Considerable additional capacity is needed, however, since the transistor must supply transformer losses and be able to start a cold (low resistance) filament at reduced voltage. The 2N2227, rated at 10 a. collector current and 150 w. dissipation, provides ample reserve power handling capacity.

Regulator Operation

The complete regulator schematic is shown in Fig. 4. The circuit consists of a voltage reference, a sensing circuit for the x-ray tube anode current and the series control circuit previously described. The voltage reference is simply a dc supply stabilized at 30 v. nominal with Zener diode D_2 .

The anode current is sensed through the series dropping resistors R_2 and R_3 in the ground return of the anode supply. The value of resistor R_2 is adjustable so as to provide a 30 v. output for any desired beam current from 10 to 150 ma.

Resistor R_4 provides a forward bias on Q_2 which saturates Q_1 for all anode currents below the set value. Transistor Q_2 provides sufficient gain to saturate Q_1 with a 200 μ a. error signal and reduce sensing circuit loading to a negligible level.

Diode D_5 isolates the monitoring voltmeter from the reference circuit. Diodes D_3 and D_4 protect Q_2 from excessive error voltages. Zener diode D_6 pro-

ects transistor Q_1 from line transients which may result from flashover, cable arcing or other severe system disturbances.

If an increase in x-ray tube anode current causes the sensing circuit voltage to exceed the 30 v. level, base current in Q_2 is reduced, the drive to Q_1 is reduced, Q_1 absorbs more voltage and filament voltage is consequently reduced. As the filament voltage drops, emission drops and a compensating drop in anode current occurs. Between the extremes of saturation and cutoff, the circuit has the proportional response and relatively low waveform distortion characteristic of the basic circuit.

This transistor regulator has proved to be highly successful in operation. Regulation is well within 1% for normal line variations and changes in the x-ray tube operating conditions. The 2N2227 silicon power transistor was an ideal control element for this application because it has exceptionally high gain, high dissipation capabilities and can be controlled directly from the amplified dc error signal. The cost and response lag of a magnetic amplifier or SCR gate control is thereby eliminated. Although normally regarded as a dc device, a silicon power transistor has also proven suitable for ac regulation with the novel circuitry employed. The basic concept should have applications in other fields.

- C_1 100 μ f, 50 V
- C_2 4000 μ f, 50 V
- D_1 1N1219
- D_2 1N1609
- D_3, D_4 1N1217
- D_5 1N536
- D_6 10M39Z5
- D_7 1N1342
- Q_1 2N2227
- Q_2 2N652

- R_1 300 Ω , 5W
- R_2 2500 Ω , 50W
- R_3 200 Ω , 10W
- R_4 100K, 1W
- T_1 240/24V, 100VA
- T_2 115 / 25.2V @ 1A
- T_3 212 / 15V @ 5A

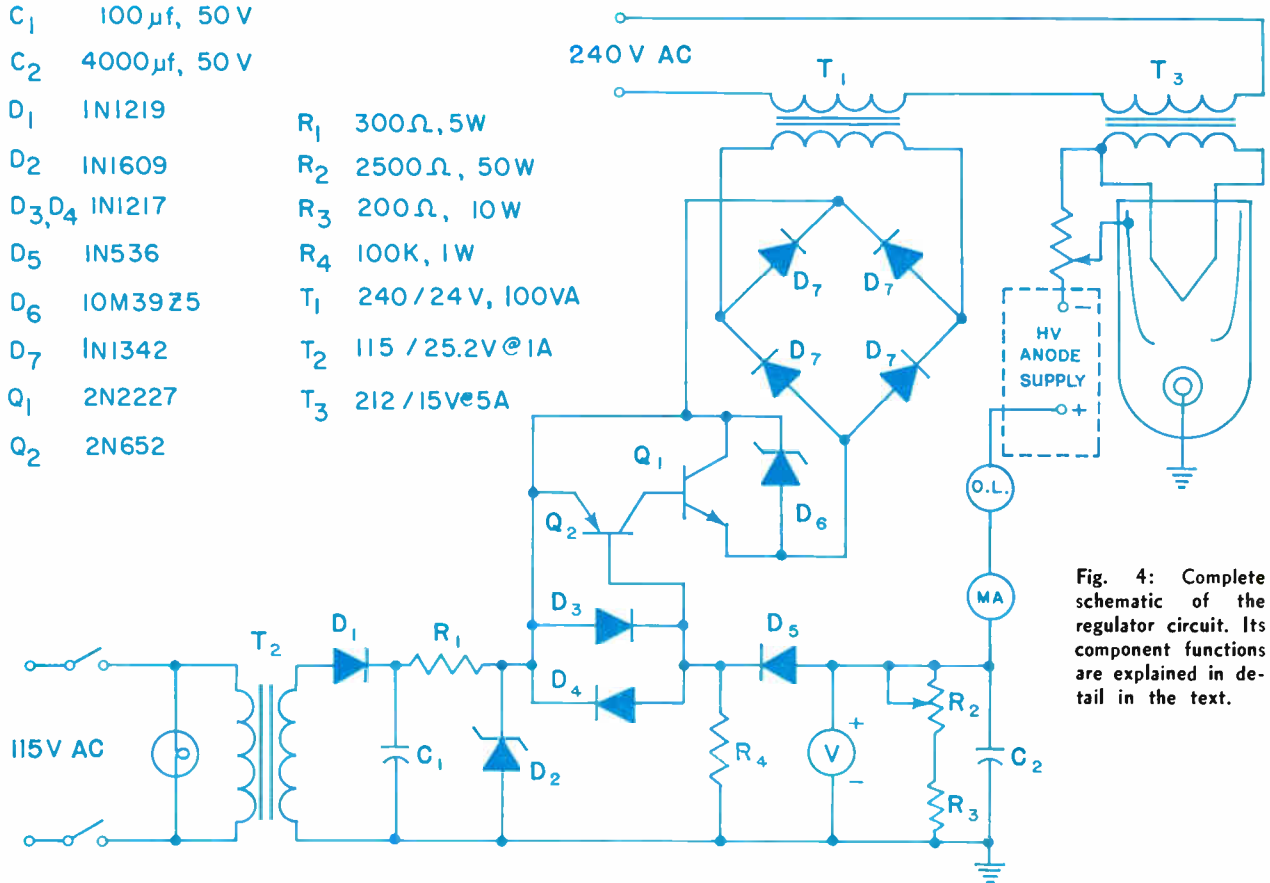

Fig. 4: Complete schematic of the regulator circuit. Its component functions are explained in detail in the text.



ELECTRONIC INDUSTRIES

**THE STATE OF THE ART REFERENCE ISSUE
JUNE 1963**

The State of the Art Reference Issue.

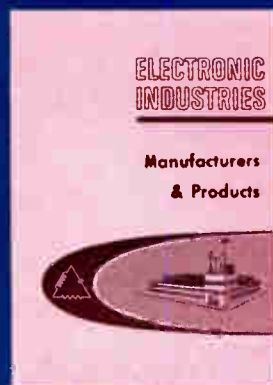
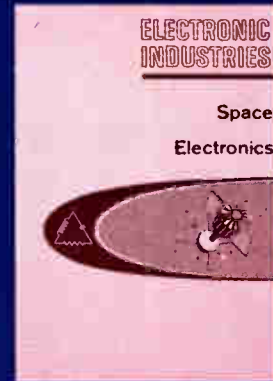
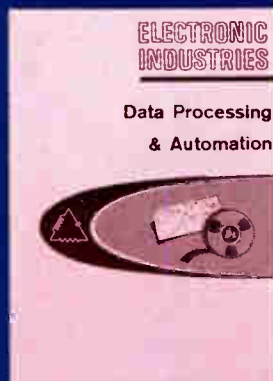
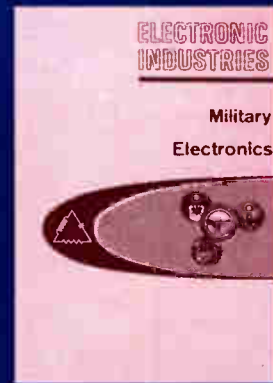
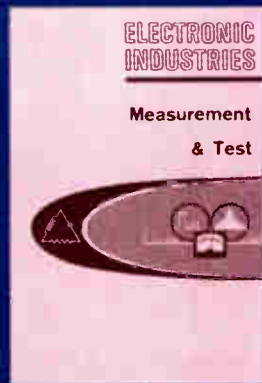
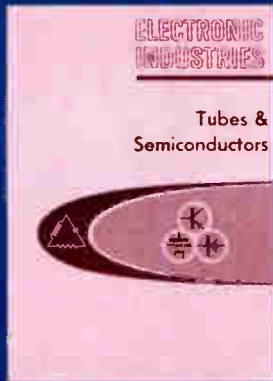

COMING NEXT MONTH
The most complete, most useful
source of reference data
and manufactured products
available anywhere!
WATCH FOR YOUR COPY.

A SIMPLE VACUUM TUBE MINI-OHMMETER

Complete details are given for building an inexpensive, low resistance ohmmeter that features burnout protection.

RESISTANCE MEASUREMENTS OF LOW OHMIC VALUES have traditionally been made using the ammeter-voltmeter or Wheatstone bridge methods, together with calculations. The conventional ohmmeter marked a step forward because it gave direct readings and was easy to use. But, expensive meter burnout sometimes resulted when power was carelessly left on.

The low ohm, direct reading meter described here will eliminate accidental burnout of the meter movement. A tube filament behaves as a fuse to save the meter from overloading.

* * *

The inconvenience found in reading low values of electrical resistance with conventional ohmmeters is overcome by using the Edison Effect in the Vacuum Tube Mini-Ohmmeter (Fig. 1). A 1.5 v dry cell furnishes the filament power to a diode-connected pentode tube, whose plate-current readings in microamperes depend upon the temperature of the filament (Fig. 2).

In operation, the unknown resistor (R_x) completes the series connection of the tube's filament

Fig. 1: The mini-ohmmeter is shown with the unknown resistor, R_x , connected. Meter indicates the resistor's value.

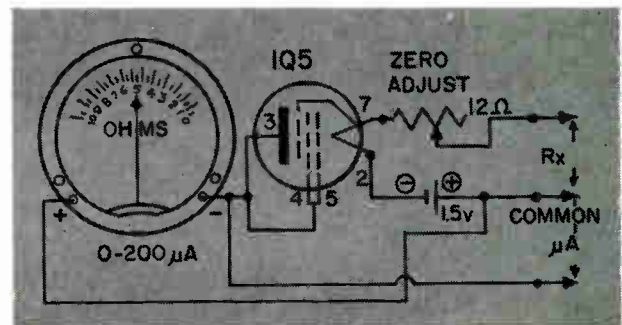
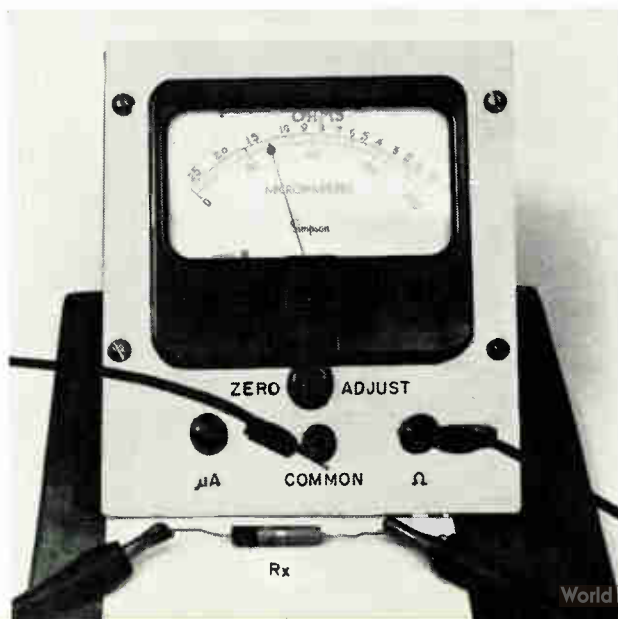

Fig. 2: Circuitry for the low-ohm meter is shown above.

circuit. Thermionic emission causes plate-current to flow when the tube plate is connected through the 0-200 microammeter coil to the positive side of the filament dry cell.

The deflection of the meter's pointer depends upon the temperature of the filament, and hence, corresponding values of unknown resistances. Larger deflections are displayed for low-resistance values and smaller deflections for high-resistance values within the range of 0-10 ohms. Extended ranges may also be incorporated into the instrument by switching appropriate shunts directly in parallel with the meter coil.

The scale is calibrated by substitution of known precision values of low resistance. The meter is zero-adjusted to indicate full-scale reading when the test prods are short-circuited; and indicates a minimum reading when a maximum value of 10 ohms is being measured. Intermediate values of unknown resistance display corresponding values. A 12-ohm rheostat is connected in series with the filament and the unknown. This is used for a zero-adjustment of the Vacuum Tube Mini-Ohmmeter to compensate for ageing of the dry cell.

By **SIEGFRIED S. MEYERS, Ph.D**

Dept. of Applied Electricity
Brooklyn Technical H. S.
29 Fort Greene Place
Brooklyn 17, New York



Cinch
ELECTRONIC
COMPONENTS

COMPONENTS ENGINEERED FOR SPECIFIC RELIABILITY REQUIREMENTS

*The reliability of permanently assembled bifurcated contacts . . .
The convenience of crimp-on snap in terminals . . .*

For outstanding reliability, convenience, and versatility in printed circuit board applications, TWIN-CON Edge Connectors are your wisest choice. Cinch's TWIN-CON meets MIL-C-21097 (latest revision). It can be used with double sided .062" printed circuit boards, and it is available in 15, 22, and 43-position sizes. Detailed specifications are available by writing Cinch or calling your local Cinch sales office for Product Bulletin PBM-4.

For extremely high production needs, also inquire about Cinch's completely automatic TWIN-CON Crimp Machine. Contacts can be *bulk fed* into the machine. Provides unmatched savings in installation time and cost.

WITH CINCH'S TWIN-CON EDGE CONNECTORS*

*Patent Pending.

Probe-proof closed entry back plates protect wire leads and pin receptacles.

Wire pins "snap" into contact receptacles, are held securely by detent action.

Permanently assembled, twin-barrel contact receptacles permit 2 wires per contact, 4 wires per position.

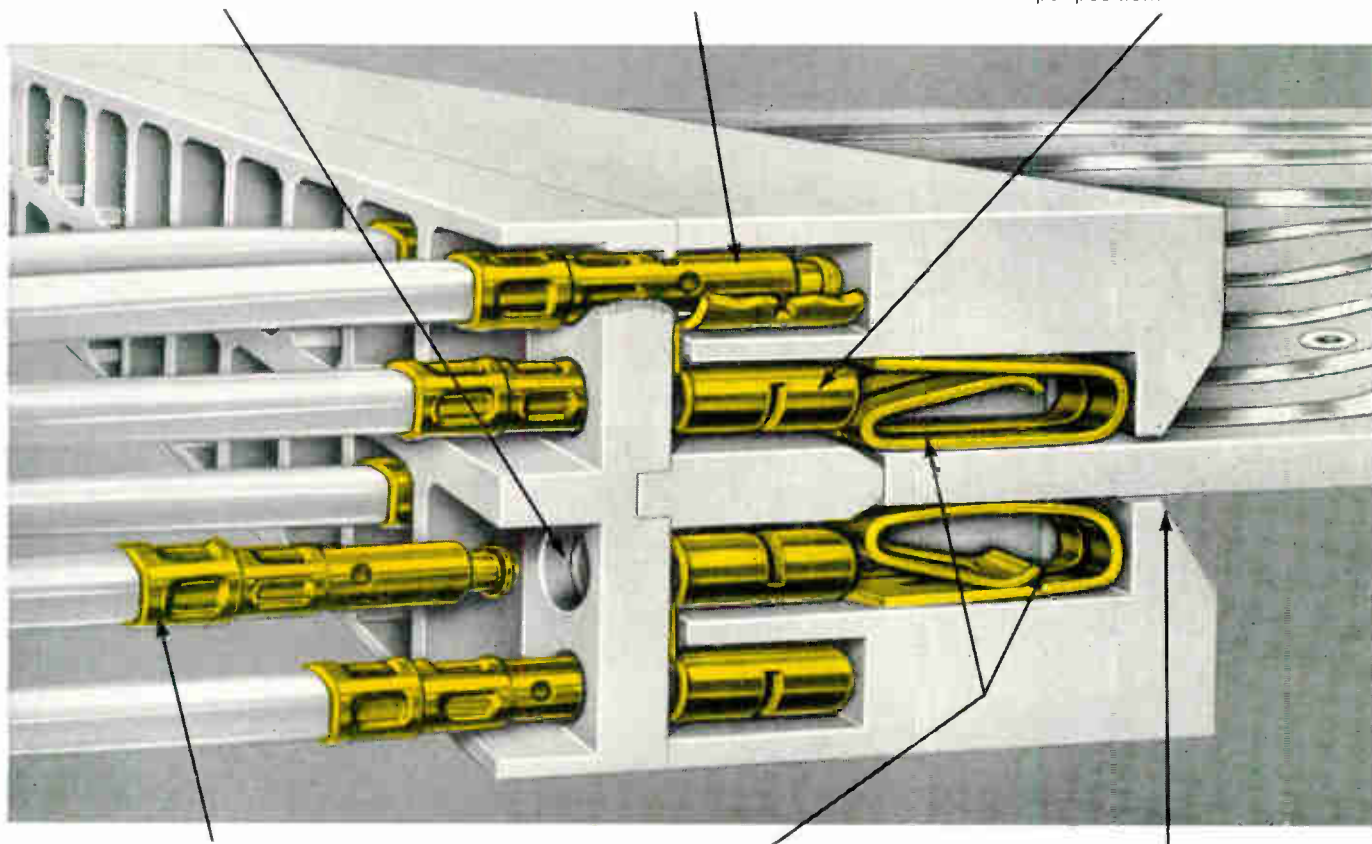

Multiple-contact, crimp-on, snap-in removable wire pins provide widest range of wiring flexibility.

Bifurcated "flexing action" contacts provide twin wiping contact surfaces instead of one, assure positive contact.

Closed entry card slot on 15 and 22-position sizes protects contacts from oversize probe or PC board.

CM-6310

CINCH MANUFACTURING COMPANY

1026 South Homan Avenue, Chicago 24, Illinois
Plants located in Chicago, Illinois, Shelbyville, Indiana,
City of Industry, California, and St. Louis, Missouri.



A DIVISION OF UNITED-CARR FASTENER CORPORATION, BOSTON, MASSACHUSETTS

Circle 58 on Inquiry [World Radio History](#)

NEW TECH DATA

for Engineers.

Wire Terminator

Bulletin D-1 describes function and operation of Xtract-O-Matic, which terminates shielding, produces a pigtail and extracts inner conductor at any desired point in braided metal shielding. Pigtail is produced intact ready for soldering, grounding, or insertion into a ferrule. LaBert, Inc., 13273 Ventura Blvd., Studio City, Calif.

Circle 250 on Inquiry Card

Connector Design

Bulletin WH3 describes a new biconical tapered conductor design for the improvement of PDE coaxial connector vswr performance. Improvements include reduced electrical and an uninterrupted wave-surface path. Phelps Dodge Electronic Products Corp., 60 Dodge Ave., North Haven, Conn.

Circle 251 on Inquiry Card

Signal Generator

A new series of transistorized pulse and square-wave generators are available from Intercontinental Instruments Inc., 123 Gazza Blvd., Farmingdale, N. Y. Included are operating freq. pulse widths and rise times.

Circle 252 on Inquiry Card

Transistor Chopper

Model 70 is a new silicon-transistor chopper that alternately connects and disconnects a load from signal source. It operates at temp. of -55°C to $+135^{\circ}\text{C}$, and chopping freq. are from dc to above 100kc. Solid State Electronics Corp., 15321 Rayen St., Sepulveda, Calif.

Circle 253 on Inquiry Card

UHF Tube

Tech. Bulletin RCA-8184 describes UHF beam-power tube 8184. Used for pulsed r-f amplifiers, it is rated for a max. peak input of 2 megawatts. Commercial Engineering, RCA Electron Tube Div., Harrison, N. J.

Circle 254 on Inquiry Card

Hall Effect Packages

Data Sheet 63300 provides data on transducers using the Hall effect. Information on these thin-film devices include illustrations, drawings, and specs. Data Sheet 63301 describes Halleflex multiplier packages. Helipot Technical Information Service, 2500 Harbor Blvd., Fullerton, Calif.

Circle 255 on Inquiry Card

Cermet Resistor Catalog

A comprehensive 12-page, 2-color catalog features complete line of CTS cermet high-temp. variable and micro-miniature fixed resistors. Included are electrical and mechanical specs., environmental performance specs., dimensional drawings, and illustrations. CTS of Berne, Inc., Berne, Ind.

Circle 256 on Inquiry Card

TWT Amplifiers

Bulletin 62-49 provides information on 5 types of TWT amplifiers: 4 octave band and 1 very broadband unit. Specs. include dimensions, band operation, saturated power output, and other characteristics. American Electronic Laboratories, Inc., 301 Richardson Rd., Colmar, Pa.

Circle 257 on Inquiry Card

Potentiometer Brochure

It lists specs. and prices on precision potentiometers. Information includes resistances, terminal types, power ratings, operating temps., and dimensions. A cut-away drawing illustrates internal construction and design. Bourns, Inc., Trimpot® Div., 1200 Columbia Ave., Riverside, Calif.

Circle 258 on Inquiry Card

Solid-State Power Supplies

Catalog A-631, 32 pages, describes advanced designs and developments in solid-state power supplies. Information includes specs., operating characteristics, graphs, and photos. Deltron Inc., 4th & Cambria Sts., Philadelphia 33, Pa.

Circle 259 on Inquiry Card

Microwave Catalog

Microwave Catalog 100, 20 pages, 2 colors, covers antennas operating from 806mc to 12gc; microwave antennas for special applications; and a complete line of feeds, mounts, radomes, control and thermostat kits. Technical Appliance Corp., Defense and Industrial Div., Sherburne, N. Y.

Circle 260 on Inquiry Card

Transistor Chart

A transistor reference chart, which gives various transistors for medium, low, and high-speed switching uses, (below and above 5mc) and high current, video amplifier, chopper and control uses, is available from Semiconductor Specialists Inc., 5700 W. North Ave., Chicago 39, Ill.

Circle 261 on Inquiry Card

Electromanometers

Bulletin 1547C describes the capabilities of CEC's rack-mounted electromanometers available from Consolidated Electrodynamics Corp., sub. of Bell & Howell, 360 Sierra Madre Villa, Pasadena, Calif. Precision pressure balances differential, gage, and absolute pressures to 500 psi at an accuracy of $\pm 0.05\%$

Circle 262 on Inquiry Card

Film Resistors

Two catalogs outlining their complete lines of precision carbon-film and metal-film resistors are available from Electra Mfg. Co., Independence, Kans. Included are physical and electrical data and a cross-reference guide outlining all important features of Mil-R-10509D.

Circle 263 on Inquiry Card

Subminiature Potentiometers

Technical data sheet on Daystrom 312 Series Squaretrim® subminiature trimming potentiometers provides complete specs. covering these $\frac{1}{2}$ in. sq. adjustable potentiometers. Operating ranges are 10 Ω to 100K Ω , -55° to $+150^{\circ}\text{C}$, and a power rating of 1w. Information includes photos, and electrical, mechanical, and environmental specs. Weston-Instruments & Electronics Div., 614 Frelinghuysen Ave., Newark 14, N. J.

Circle 264 on Inquiry Card

Circuit-Breaker Guide

Bulletin 202, 32 pages, will assist engineers in selecting hydraulic-magnetic breakers. Listed are single and multipole models with ratings up to 225a. Design information is included. Heinemann Electric, 250 Magnetic Dr., Trenton 2, N. J.

Circle 265 on Inquiry Card

Capacitors

Line of 100v solid-tantalum capacitors, rated between 0.1 to 2.7 μf , is available from Linde Co., Kemet Dept., 11901 Madison Ave., Cleveland 1, Ohio. The capacitors, which meet the requirements of Mil-C-26655A, operate between 85° to 125°C .

Circle 266 on Inquiry Card

Tape Components

A 24-page illustrated catalog describing perforated tape components and systems is available from Tally Register Corp., 1310 Mercer St., Seattle 9, Wash. Information includes specs., photos, and applications.

Circle 267 on Inquiry Card

Servo Motor Catalog

Catalog B1262 provides detailed specs., drawings, and photos for 34 servo motors and motor-gearhead combinations available from Bowmar Instrument Corp., 8000 Bluffton Rd., Ft. Wayne, Ind. Information includes dimensions, ratio ranges, load and starting torques, formulas for linear motors, and merit calculations.

Circle 268 on Inquiry Card

Transistor Testers

Two transistor test sets are available from Baird-Atomic, Inc., 33 University Rd., Cambridge 38, Mass. Model OT-1 measures gain (h_{re}) at 20, 100, and 200mc by means of individual plug-in units. Model PB-1 measures breakdown voltages and leakage currents up to 300v, and gain and saturation up to 30v and 50ma.

Circle 269 on Inquiry Card

Miniature R-F Inductor

The "Super Wee-Ductor" has inductances of 0.1-100,000 μH and low dc resistance. Measuring 0.410 x 0.157 in., it is epoxy molded and has shielding for noncoupling. Nytronics, Inc., 550 Springfield Ave., Berkeley Heights, N. J.

Circle 270 on Inquiry Card

Thermocouple Amplifier

Tech. Data 19A describes the Model 190 magnetic thermocouple amplifier. Typical gain is 4000 and drift stability is $\pm 5\mu v$. This solid-state amplifier contains no choppers, tubes, or transistors. Application information and circuit diagrams are given. Acromag, Inc., 15360 Telegraph Rd., Detroit 39, Mich.

Circle 271 on Inquiry Card

Generators

An engineering report on "NoBrush" generators and freq. converters is available from the Georator Corp., 315 Tudor Lane, Manassas, Va. Background, design information, characteristics, operational data, applications, and other pertinent information are included.

Circle 272 on Inquiry Card

Designer's Handbook

A 32-page catalog performs a dual function of listing steppers and sequence relays, and provides operating, dimensional and mounting data. Typical stepper circuits and wiring methods are shown. Guardian Electric Mfg. Co., 1550 W. Carroll Ave., Chicago 7, Ill. Request should be made on company letterhead.

High Purity Materials

This booklet describes high-purity elements available for semiconductor, missile, and space applications. Uses include solid-state, lasers, thermoelectricity, and thin films. United Mineral & Chemical Corp., 16 Hudson St., New York 13, N. Y.

Circle 273 on Inquiry Card

Power Supply Catalog

Complete power supply specs., including ac Invertrons® and plug-in oscillators plus solid-state dc supplies and modules, are available in a catalog from Behlman-Invar Corp., 1723 Cloverfield Blvd., Santa Monica, Calif.

Circle 274 on Inquiry Card

Flowmeter

The first device to linearly measure the mass flow of gas, Model MFM-150-1 Mass Flowmeter, is described in a bulletin available from Technology Inc., 3090 Richfield Ctr., Dayton 30, Ohio. Specs., and drawings are included.

Circle 275 on Inquiry Card

Light Beam Oscillographs

An illustrated, 3-color brochure, Catalog Sheet 2300, describes the Brush Series 2300 eight or 16 channel light-beam oscillographs. It uses an incandescent light source for simple, safe and economical operation. Illustrations indicate simplicity of operation and accessibility for changing chart records. Brush Instruments, div. of Clevite Corp., 37th & Perkins, Cleveland 14, Ohio.

Circle 276 on Inquiry Card

Design for MINIATURIZATION



Thin Wall VARGLAS Silicone Rubber SLEEVING



Varglas Silicone Rubber Sleeving with its space-saving thin wall construction and precision ID, is the answer for insulation in the trend toward miniaturization.

The ultimate in flexibility and dielectric strength, Varglas retains its protective properties over a wide temperature range, from minus 70° to plus 400°F. Tough and abrasion-resistant, this supported silicone rubber sleeving resists deterioration and "cut through"; will not crack or craze. Dielectric protection provided up to 8,000 volts and certified to meet government specification MIL-I-18057A.

Available in brilliant, non-fading colors for instant, easy color-coding in a complete range of sizes from .010" to 3" ID, and obtainable in coils or on spools as well as in individual 36" lengths. Deliveries made promptly off-the-shelf or produced on order within one week.

Let Varflex engineers work with you in developing special types of sleeving and tubing to meet your particular specifications. No obligation.

• WRITE FOR FREE FOLDER Containing Test Samples

Makers of Electrical Insulating Tubing and Sleeving

Varflex

Never Satisfied Until You Are

VARFLEX SALES CO., Inc. • 308 N. Jay St., Rome, N. Y.



NEW TECH DATA

for Engineers.

Instruments and Systems Catalog

A new catalog from C.T.I. lists their line of test instruments. Featured are cable harness analyzers, including a tape-programmed model and a tape-programmed functional analyzer. Also included are radome testing and flight simulation instruments. California Technical Industries, div. of Textron, Inc., 1421 Old County Rd., Belmont, Calif.

Circle 309 on Inquiry Card

Copper-Clad Laminates

Data Sheet No. 8-1B describes 7 grades of copper-clad laminates for printed-circuit production. Tables list the overload currents and resistances for printed circuits of different line widths. Taylor Corp., Valley Forge, Pa.

Circle 310 on Inquiry Card

Environmental Equipment

A 16-page guide to multi-chamber environmental equipment for simultaneous comparative testing of electronic and electro-mechanical devices is offered by Cincinnati Sub-Zero Products, Inc., 3930 Reading Rd., Cincinnati 29, Ohio.

Circle 311 on Inquiry Card

Subminiature Power Supplies

Catalog Bulletin No. 209PS illustrates and describes low-power output subminiature solid-state dc to dc power converters. Typical ratings are 24v to 30v inputs and outputs from 30v to 180v. Advanced Electronics Corp., 2 Commercial St., Hicksville, L. I., N. Y.

Circle 312 on Inquiry Card

Video Amplifier Tube

Triode-pentode 6/10LB8 offers improved performance and, if desired, permits the removal of one i-f stage. The structure features the strap-frame grid construction and provides 20% increase in useful linear video output for 42% reduction in video amplifying drive. Sylvania Electric Products Inc., 1100 Main St., Buffalo 9, N. Y.

Circle 313 on Inquiry Card

Switching Controls

Bulletin 1010 describes transistorized static switching controls. It describes a building-block static switching control system and illustrations show logic units. The Clark Controller Co., 1146 E. 152 St., Cleveland 10, Ohio.

Circle 314 on Inquiry Card

Control Modules Handbook

A 24-page booklet entitled, "Handbook of Output Driver Applications," covers the design, functions, and use of output drivers and electronic modules in control systems. Information concerning electronics in detection, actuation, and control are included. Solutions to switching, logic, and transducer detection problems are fully explained and graphically portrayed. Sectron Inc., 1 Pingree St., Salem, Mass.

Circle 315 on Inquiry Card

NPN Transistors

The Semiconductor Div. of Sylvania is offering a brochure on TO-5 and TO-46 npn large-signal silicon epitaxial mesa transistors. Listed are performance characteristics, graphs, and tests. Sylvania Electric Products Inc., 1100 Main St., Buffalo 9, N. Y.

Circle 316 on Inquiry Card

Aerofilm Capacitors

Bulletin NPJ-121 describes Aerovox Type V146XR Aerofilm® "Wrap & Fill" capacitors. Complete specs., including operating temps., insulation resistance, and capacity ratings for these Mylar® units are listed. Aerovox, New Bedford, Mass.

Circle 317 on Inquiry Card

NEW

USE LIKE A BELT . . . LOCK HOLDS TIGHT

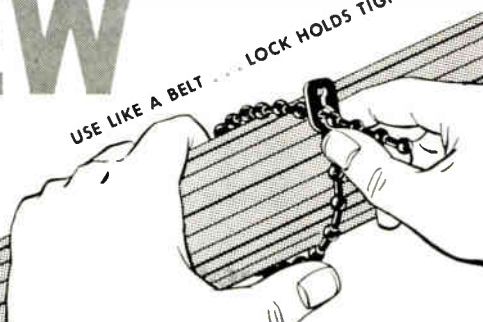

PLASTIC AND NYLON

HI WIRE-TIES

FAST, LOW COST WAY TO TIE, MOUNT, IDENTIFY WIRE BUNDLES

- Look . . . no tools! Easy hand-installation.
- Strong — Safe — Reusable.
- Standard types: Plastic — red, yellow, blue. Nylon — natural color.
- Snap-in-plug type: Plastic — red, yellow, blue. Fits 1/4" hole.

4 1/4" LENGTH ONLY

PLASTIC & NYLON 4 1/4" & 10" LENGTHS

Hi

WRITE FOR FREE SAMPLES

HOLUB INDUSTRIES, Inc.

448 ELM STREET • SYCAMORE, ILLINOIS

Circle 59 on Inquiry Card

HOW PRECISION CAN LOWER YOUR BOBBIN COSTS!

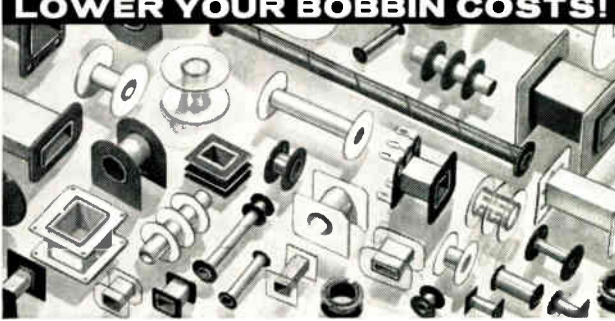

From Prototype Through Production

For engineering and prototype quantities: Our fabrication facilities enable us to supply virtually any type bobbin desired. Over 4,000 tools accumulated over 25 years permit the production of small quantities at no tooling cost or, in some cases, a small revision charge. Materials can be furnished to meet practically any electrical and temperature requirement.

For production quantities when mold costs can be absorbed: The transition can be made economically to molded parts. Our fully automatic single cavity system provides parts at low mold cost and piece prices comparable to multi-cavity operation. Bobbins can be furnished in all thermo-plastics, including glass filled and asbestos filled materials for elevated temperatures.

Request bulletins. Send or phone specifications for quote.

BUCKEYE BOBBIN DIVISION
PRECISION PAPER TUBE COMPANY

12200 SPRECHER AVE., CLEVELAND 35, OHIO
TELEPHONE: ORchard 1-5200

Circle 60 on Inquiry Card

NEW TECH DATA

for Engineers.

Digital Incremental Recorder

Bulletin 73 describes a tape recorder which acquires irregularly-occurring digital data, records it incrementally, and produces a magnetic tape in format for computer use. Incremental recording, typical applications, modes of operation, design and specs. are included. Precision Instrument, Stanford Industrial Park, Palo Alto, Calif.

Circle 318 on Inquiry Card

High-Voltage Capacitors

Tech. Bulletin 405 lists capacitors with voltage ratings from 10kv to 60kv with capacitance ranges from 0.05 μ fd to 10 μ fd. They operate at 85°C with a life expectancy of 10,000 hrs. Information includes specs. and graphs. Captronics, Inc., 9 Cricket Terrace, Ardmore, Pa.

Circle 319 on Inquiry Card

Resistor Catalog

Catalog 98-44, 92 pages, gives information on wire-wound, film, and variable wire-wound resistors, and power rheostats. It contains photos, drawings, and tech. data. Mallory Controls Co., div. of P. R. Mallory & Co., Indianapolis 6, Ind.

Circle 320 on Inquiry Card

Switches

Bulletin GEA-7318.1 describes GE's CR115, Type D, proximity limit switches that detect ferrous and non-ferrous metals without physical contact. Offered are 3 types of sensing heads, 2 amplifiers, and open or closed power supplies. General Electric Co., Schenectady 5, N. Y.

Circle 321 on Inquiry Card

Pulse Generator

Model 220 is a 5mc transistorized pulse generator which produces droopless pulses with 10ns rise time or better, and 25v into 50 Ω . The low-source impedance of 5 Ω or less assures min. interaction between equipment and component. Velonex, div. of Pulse Engineering, 558 Robert Ave., Santa Clara, Calif.

Circle 322 on Inquiry Card

Zener Diodes

A new series of ultra-stable compensated zener diodes, designed for precision instruments, are available from Pacific Semiconductors, Inc., 14520 Aviation Blvd., Lawndale, Calif. Min. zener voltage is 8.0v; max. 8.8v.

Circle 323 on Inquiry Card

Special Coax

A brochure illustrating Microdot's capabilities in custom assemblies and harnesses for miniaturized coaxial circuitry is available from Microdot Inc., 220 Pasadena Ave., So. Pasadena, Calif. Illustrated are combinations of single-pin r-f connectors, multi-pin connectors, and "Mini-Noise" low-noise cable. Special configurations, such as hermetically sealed connectors and custom-made plates and mountings, are shown.

Circle 324 on Inquiry Card

Photomultiplier Tubes

Catalog PM-1 lists over 35 photomultiplier tubes. Contained are performance data and condensed uses, electrical and physical specs., and photos. Electron Tube Div. of Electra Megadyne Inc., 1750 N. Vine St., Los Angeles 28, Calif.

Circle 325 on Inquiry Card

Chopper-Noise Limits

First in a series of articles on chopper characteristics, limitations, and applications. This monograph describes circuit-noise sources and methods of elimination. Airpax Electronics Inc., Cambridge Div., Cambridge, Md.

Circle 326 on Inquiry Card

Features the latest technical advances of clamp design and manufacture. Includes prints, tables, illustrations, specs, application and installation tips for ANY clamp problem... be it military or commercial. Sizes 1/8" to 6" dia. in aluminum, steel or stainless in complete selection of high and low temperature insulation materials. Shows all sizes and styles of loop clamps, bonding clamps, multiple clamps, center clamps, wire harness clamps, wave-guide clamps... plus blocks, brackets, busbars, line supports and related items.

CATALOG-AVAILABILITY OF OVER 40,000 DIFFERENT CLAMPS!

Before you design or buy, check with TA FIRST!

Send for your free copy of TA'S New Clamp Catalog 212G



TA Mfg. Co., 4607 Alger St., Los Angeles 39, Calif.
TWX 9863 Glendale, Calif. • WUX CAT L.A., Calif. phone CH 5-3748

Circle 61 on Inquiry Card

ELECTRONIC INDUSTRIES • May 1963

It's the 'Who's Who' in Electronic Threads

The most complete catalog in the industry... LTC's illustrated brochure covering electronic lacing cords and tapes. LTC's line includes nylon, linen, teflon, cotton and dacron... a variety of constructions, put-ups and special finishes.

For catalog, write:

THE LINEN THREAD CO.

Blue Mountain, Alabama

A DIVISION OF INDIAN HEAD MILLS, INC.

Circle 62 on Inquiry Card

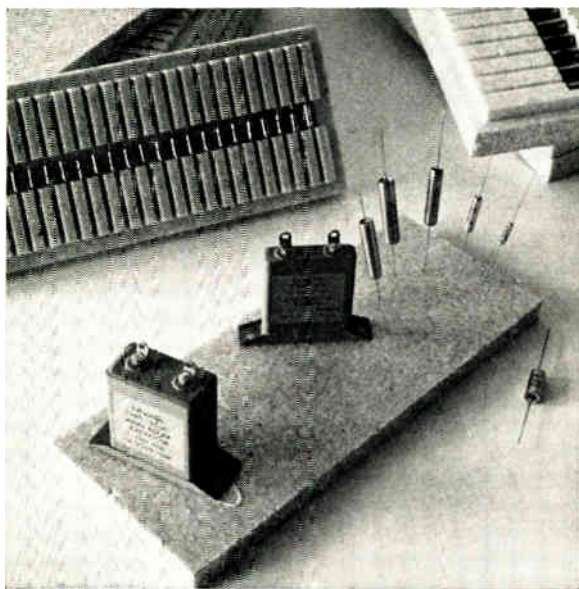

The Fansteel family of solid tantalum capacitors

Fansteel offers a complete line of solid tantalum capacitors—regular, high capacitance and non-polar. All types feature high reliability, low leakage current, excellent temperature and frequency stability.

Fansteel solid tantalum capacitors perform dependably at operating temperatures ranging from -55° to $+125^{\circ}\text{C}$. Ratings range from 0.016 uf in the STAN non-polar to 4000 uf in the STA High Capacitance unit.

These types of solid tantalum capacitors are available from Fansteel:

1. Type STA Regular—Ratings: 0.033 uf to 330 uf.
2. Type STA High-Capacitance—Ratings: 300 uf to 4000 uf.
3. Type STAN Non-Polar—Ratings: 0.016 uf to 165 uf.
4. Type STAN High-Capacitance—Ratings: 150 uf to 2000 uf.
5. Type CS*—Rating: 0.033 uf to 330 uf.
*Conform to Mil-C-26655A.

At Fansteel's plant, stricter controls, new automated equipment and additional test facilities are continually improving capacitor reliability. Each capacitor is subjected to a number of strict quality assurance checks and final inspection for individual characteristics.

For complete information on the Fansteel solid tantalum capacitor line, see your Fansteel representative or write Fansteel direct.

FANSTEEL

METALLURGICAL CORPORATION

RECTIFIER-CAPACITOR DIVISION

North Chicago, Illinois.

Circle 63 on Inquiry Card

NEW TECH DATA

Flux Responsive Heads

A new series of flux-responsive magnetic heads use the Hall effect to produce an output that is directly proportional to the recorded signal level. The heads are available with from 1 to 7 in-line tracks or in 7 track and 14 track IRIG interlaced assemblies. Applied Magnetics Corp., 749 So. Kellogg Ave., Goleta, Calif.

Circle 277 on Inquiry Card

Ultra-Precision Crystals

Tech. bulletin gives detailed specs. on 3 ultra-precision crystals at freqs. of 1000kc, 2500kc and 5mc. Freq., holder types, temp. range, electrical equivalent parameters, etc. are given. Reeves-Hoffman, div. of Dynamics Corp. of America, Cherry & North Sts., Carlisle, Pa.

Circle 278 on Inquiry Card

Silicon Power Module

Bulletin 41-263-6 describes all-silicon, high-stability, high-temp. modular power packs. Information on uses, circuit description, operation, specs., and special features are included. Electronic Research Assoc., Inc., 67 Factory Place, Cedar Grove, N. J.

Circle 279 on Inquiry Card

Plastic Laminates

Catalog L-CDL-569 describes Textolite®, a copper-clad plastic laminate. Includes information on epoxy glass, phenolic paper, and epoxy paper. Application data, material characteristics, mechanical, electrical, physical and thermal properties are included. General Electric Co., Coshocton, Ohio.

Circle 280 on Inquiry Card

Capacitor Wall Charts

Two 17 x 22 in. wall charts, compiled to aid in selection of electrolytic capacitors, are available from Cornell-Dubilier Electronics, div. of Federal Pacific Electric Co., 50 Paris St., Newark 1, N. J. One chart pertains to aluminum electrolytics, the other relates to niobium and tantalum electrolytics.

Circle 281 on Inquiry Card

A-F Amplifier

The GB "A" series of transistorized voice-frequency amplifiers provide 39db of gain. It is designed for systems where medium gain and low operating power are essential. Lynch Communication Systems Inc., 695 Bryant St., San Francisco 7, Calif.

Circle 282 on Inquiry Card

IR Detector

This 26-page manual describes an infrared detector measurement console which measures and analyzes important infrared parameters. Included are circuit specs. and applications. Instrumentation Div. of Infrared Industries, Inc., Box 989, Santa Barbara, Calif.

Circle 283 on Inquiry Card

Are you our kind of engineer?



1



2



3

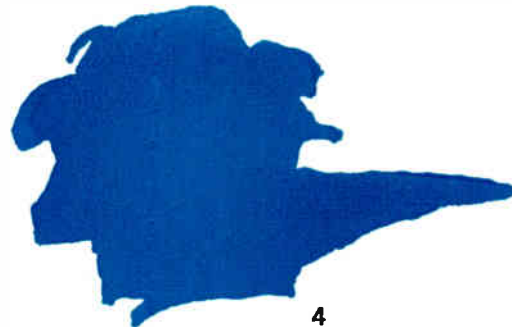

4

Pick your favorite ink-blot

We've been selling Fansteel capacitors and rectifiers long enough to know that all engineers are different.

For example, if you picked ink-blot 1 you may be a neat, orderly fellow who likes things to be well-organized and planned. You probably appreciate the way Fansteel keeps its promises and documents its claims.

If you're a 2-man, you're more likely to be an innovator, scoring breakthroughs where others have failed. You probably appreciate Fansteel for providing you with the kinds of capacitors and rectifiers that make breakthroughs both possible and practical.

Ink-blot 3 seems to appeal to the security-minded . . . engineers who demand reliability in all that they de-

sign and specify. They want proof. Perhaps that's why so many in this group always take their capacitor and rectifier problems to Fansteel first.

If you picked blot 4, you're a renegade. Nonconformists like you help keep Fansteel on its toes; for quality, integrity, and reliability aren't always enough to solve a problem. Fansteel salesmen find genuine delight and satisfaction in helping you not to conform because they

know that the future is neither conventional nor predictable.

If our little Engineering Personality Test missed you altogether, kindly accept our sincere apologies. Please rest assured that you're still our kind of engineer, nevertheless.

FANSTEEL

METALLURGICAL CORPORATION

RECTIFIER-CAPACITOR DIVISION
North Chicago, Illinois.

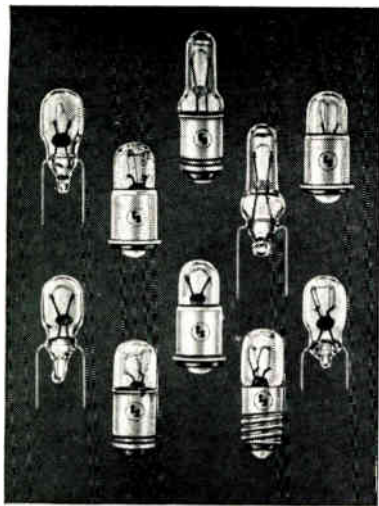

BUILT TO BACK-UP YOUR EQUIPMENT RELIABILITY

TUNG-SOL SUBMINIATURE READ-OUT AND INDICATOR LAMPS

Designers have a wide range of selection in Tung-Sol subminiature lamps. Configurations, filament construction and light output fully meet all current instrument design requirements up to 28 volts. Life ratings range up to indeterminate. Supplied in clear glass bulbs or in colors.

Special design requests are evaluated with all the experience Tung-Sol has amassed during nearly sixty years of making low voltage lamps. If anyone can meet your subminiature lamp requirements, Tung-Sol can. Write for data folder A-14. Tung-Sol Electric Inc., Newark 4, N. J. TWX: 201-621-7977.

CENTER LINE



TUNG-SOL

QUALITY

Circle 65 on Inquiry Card

NEW TECH DATA

Millimeter BWO

A 2-color bulletin describes the SBM-421 and SBE-402 permanent-magnet focused BWO spanning 40,000mc and delivering 2 to 40mw. Described are several outstanding features including performance, electrical, and mechanical data. Sperry Electronic Tube Div., Gainesville, Fla.

Circle 284 on Inquiry Card

Subminiature Electrometer

Low noise amplification in the order of 5×10^{-14} amps is possible with Raytheon subminiature electrometer tube, CK587. The pentode has a low input power requirement and draws 0.0075w. Specs. are available from Industrial Components Div., Raytheon Co., 55 Chapel St., Newton 58, Mass.

Circle 285 on Inquiry Card

Component Ovens

Complete mechanical, electrical and performance data on the Series PC proportional control component oven is available from Control Indicating Corp., Div. of Hi-G, Inc., Spring St. & Route 75, Windsor Locks, Conn. It features a stability of $\pm 0.01^\circ\text{C}$ by using a true proportional control bridge circuit.

Circle 286 on Inquiry Card

R-F Shielding

"ECCOSHIELD® Enclosures Using Eccoshield WP" describes a method using metal foils and precision caulking and sealing techniques in constructing high-performance r-f shielded chamber. Data sheets, drawings, and applications are available. Emerson & Cuming, Inc., Microwave Products Div., Canton, Mass.

Circle 287 on Inquiry Card

Electric Lacquer

I.C-705 is a waterproof, clear electric lacquer which protects coils from moisture. It meets the requirements of MIL-I-17384, Type G, and air-dries quickly. John C. Dolph Co., Dept. SG-10, Monmouth Junction, N. J.

Circle 288 on Inquiry Card

CW Gas Lasers

A brochure, which features the new mirror-mounted laser with a base usable as a perot interferometer, is available from Sylvania Electric Products Inc., 1100 Main St., Buffalo 9, N. Y. Included are component lists and photos of mode patterns. Image converters and power supplies are described.

Circle 289 on Inquiry Card

HV Selenium Rectifiers

Bulletin 103 provides details on high-voltage selenium rectifiers. Performance curves and tables give engineering data. Edal Industries, Inc., 4 Short Beach Rd., E. Haven, Conn.

Circle 290 on Inquiry Card

BOURNS PRECISION POTENTIOMETERS

with smaller cases,
higher resistances, better
linearity, and higher
operating temperatures than
any other line



Model 3500— $\frac{7}{8}$ " 10-turn:
500 Ω to 125K, 2.0W at
70°C, $\pm 0.2\%$ std. linearity,
0.01 to 0.03% resolution,
125°C.



Model 3520— $\frac{7}{8}$ " 5-turn:
200 Ω to 75K, 1.5W at 70°C,
 $\pm 0.3\%$ std. linearity, 0.015
to 0.070% resolution, 125°C.



Model 3510— $\frac{7}{8}$ " 3-turn:
200 Ω to 50K, 1.0W at 70°C,
 $\pm 0.3\%$ std. linearity, 0.028
to 0.100% resolution, 125°C.



Model 3700— $\frac{1}{2}$ " 10-turn:
500 Ω to 100K, 1.0W at
70°C, $\pm 0.25\%$ std. linearity,
0.020 to 0.060% resolu-
tion, 125°C.



Model 3600 KNOBPOT® Po-
tentiometer— $\frac{3}{4}$ " 10-turn
(potentiometer, dial, and
knob, all in one): 1K to
100K, 1.5W, std. linearity
(dial accuracy) $\pm 0.5\%$, .011
to .035% resolution, 125°C.
(Also available without dial.)

KNOBPOT POTENTIOMETER ACCESSORIES

Color accessories meet requirements of MS-91528B and MIL-STD-242 (ships)

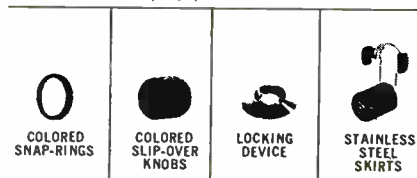

TURNS-COUNTING DIALS



Available for all Bourns precision potentiometers except KNOBPOT units, which incorporate their own dials.

All Bourns precision potentiometers meet MIL-STD-202B, Method 103 (steady state humidity). All units except Model 3600 may also be specified to meet MIL-STD-202B, Method 106 (cycling humidity).

Available off the shelf at factory prices from distributors across the nation. Write for complete technical data.



BOURNS

BOURNS, INC., TRIMPOT DIVISION
1200 COLUMBIA AVE., RIVERSIDE, CALIF.
PHONE 664-1700 TWX 714-882 9582
CABLE: BOURNSINC.

Circle 50 on Inquiry Card

Get This Tiny TRIMPOT® Potentiometer in Wirewound and RESISTON® Carbon Versions

Take your choice—wirewound or carbon. Either way, you're getting the only potentiometer with all these features:

- (1) Smaller-than-transistor size—just $\frac{3}{16}$ " dia. x $\frac{3}{16}$ " high.
- (2) Resistance from 50Ω to 20K (wirewound), 10K to 1 Meg (RESISTON carbon).
- (3) Full compliance to all applicable MIL test procedures (wirewound MIL-R-27208A and non-wirewound MIL-R-22097B).
- (4) Positive end stops.
- (5) Precious-metal contacts.
- (6) Sealed lightweight plastic case (no shorts to the board).

- (7) Industry-standard pin arrangement.
- (8) Indestructible SILVERWELD® termination.

	Model 3300 (wirewound)	Model 3301 (RESISTON carbon)
Resistances	50Ω to 20K	10K to 1 Meg
Max. Oper. Temp.	175°C	150°C
Power Rating	0.5W	0.25W

Production quantities available immediately with either printed circuit pins or solder lugs and bushing mount. Write for complete data.

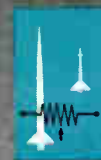
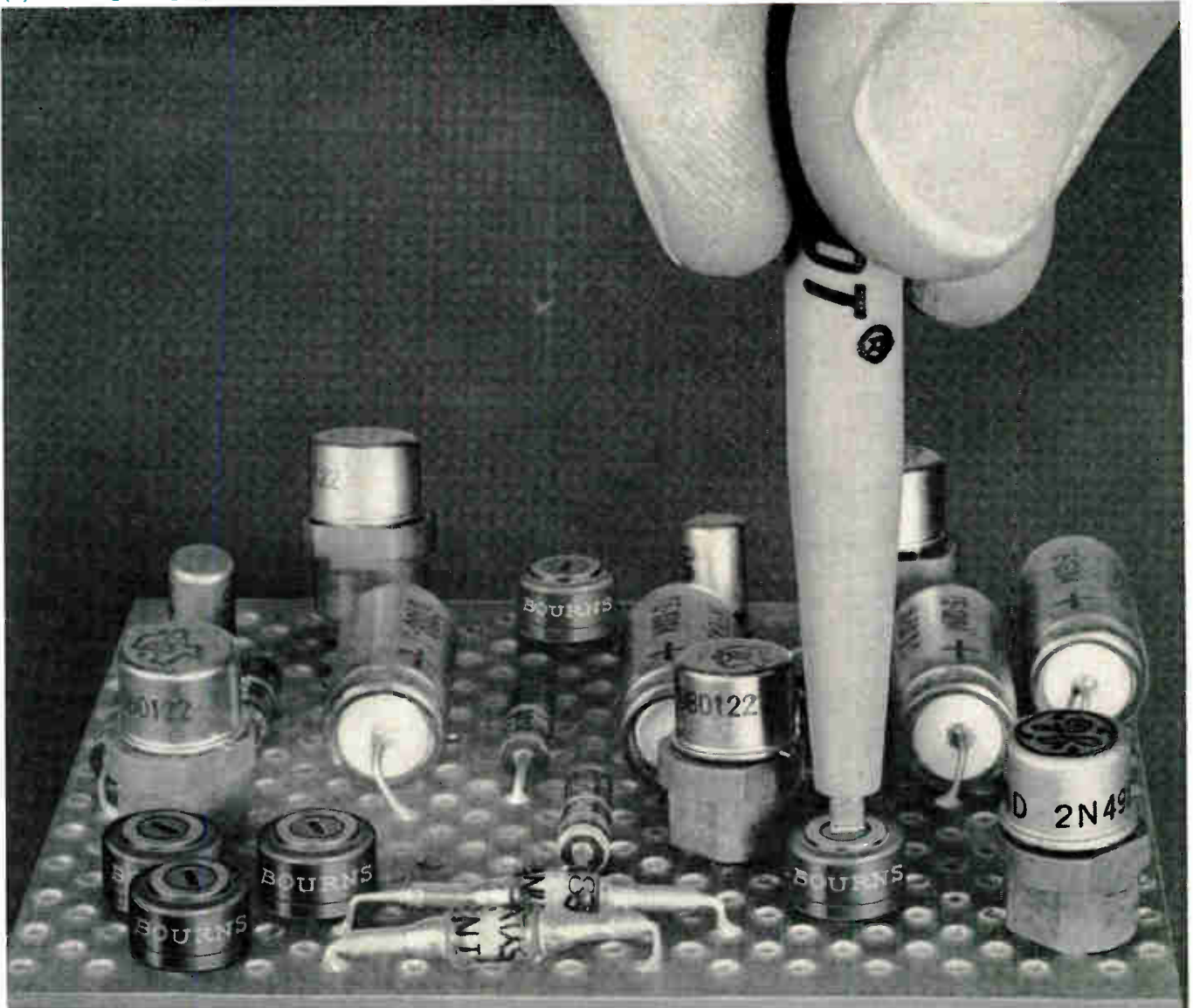

BOURNS

BOURNS, INC., TRIMPOT DIVISION
1200 COLUMBIA AVE., RIVERSIDE, CALIF.
PHONE 684-1700 · TWX 714-682 9582
CABLE: BOURNSINC

MANUFACTURER: TRIMPOT® SINGLE- AND MULTI-TURN POTENTIOMETERS, TRIMPOT RELAYS, PRECISION POTENTIOMETERS. PLANTS: RIVERSIDE, CALIF.; AMES, IOWA; TORONTO, CANADA

kearfott technical information report

ANALOG COMPUTERS,



Having produced more than 17,000 analog navigation computers, we've come to the conclusion that analog computers have considerable merit. In fact, we're planning to build quite a few more.

We're not saying that digital machines are passé. There's as much need for computation in pure digital form as there is for analog. However, analog computers do have certain major advantages... lower cost, real time computation and elimination of elaborate converters.

When examining the requirements for navigational computers you needn't be concerned with complex programming and storage, since these considerations are inherent to analog computers.

For a further exposition on analogy, we'd be delighted to give you the booklet pictured above. Please send for it.



MINAC-5 NAV COMPUTER. We'll spell the name again—MINAC.

These initials stand for Miniature Airborne Navigation Computer—the best available.

For the Doppler people, there is the MINAC 5. For those who prefer Inertial, we have MINAC 8.

The computer is small—occupying only ½ cubic foot. Weight is 30 pounds, including the control/indicator.

It's versatile, providing present position, wind speed and direction, distance to destination, bearing and ground track relative to true heading, true heading, ground track and ground speed. It can store two target destinations and accept alternate destinations without loss of primary data. Naturally it's accurate... $\pm 0.25\%$ of total path travelled or 1 NM/HR, whichever is greater.



A well engineered control/indicator goes with this flight-tested computer.

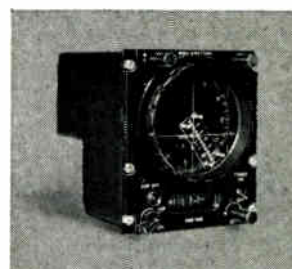

ASW COMPUTER. The AN/AYK-2 Computer with moving base capabilities further demonstrates Kearfott versatility. This computer is designed for Airborne ASW in fixed or rotary winged aircraft. The unit consists of computer and control/indicator, receiving data from any Doppler Radar set, Magnetic Compass and Air Speed Transducers. It computes N-S and E-W components of aircraft ground track and wind velocity, and of distance travelled.

The AN/AYK-2 can also incorporate a supplementary function. It receives inputs of a moving base velocity and heading, then computes and displays the bearing plus N-S, E-W data needed for the aircraft's return to its repositioned base.

Further capabilities include continuous display of present position, heading relative to take-off point and distance, and bearing to any selected one of four stored destinations.

CONVERTERS AND DISPLAYS



COMPUTER/INDICATOR. Ground speed and drift angle are computed and displayed with Kearfott's T8605-22N—specifically designed for rotary wing aircraft. Input signals to the 5.5 lb., internally lighted computer/indicator are from Doppler radar, representing heading axis and lateral axis speed. We then solve for hypotenuse and cosine functions of the input voltages by a buffered resolver servo and a ground speed follow-up servo. Accuracy and sensitivity are assured from 2 to 180 knots. Doppler radar noise is damped above 10 cps. The T8605-22N is complete with two transistorized servo amplifiers, two transistorized buffer amplifiers and their individual power supplies, packaged in little more than 1/20 of a cubic ft. Environmental performance of our compact computer package meets all applicable requirements for MIL-E-5400, MIL-E-5272, MIL-E-5422 and MIL-I-6181.

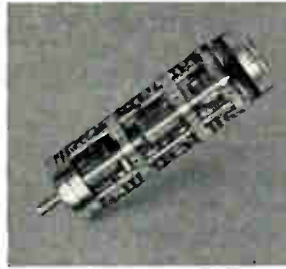

A/D CONVERTERS. Proving we're not really anti-digital—and because we know there's a good market for better products—we've developed the finest Shaft-to-Digital encoders available—all in the standard size 11 diameter. These encoders are complete with external logic, and provide BCD (8-4-2-1) shaft position output with overall accuracy of $\pm 1/4$ bit.

They're available in ranges from 0-999, 0-9999, 0-99999, 0-3599, 2^8 , 2^{13} , and ± 89.9 .

The converters can be read on the run, or on demand, at speeds up to 500 RPM, and sampling rates of 50,000 counts per minute without ambiguity. With proper maintenance, exceptionally long life is standard— 5×10^6 cycles at 500 RPM with an increase of 3×10^6 cycles possible.

Other characteristics include: low torque—0.3 oz. in.; low inertia—25 gm-cm²; power ± 6 VDC, 2 Ma per bit.

Each encoder contains "OR" gating, and is designed for serial interrogation to allow time sharing of selection logic and encoders.

Gold alloy tracks and brushes make for low noise and minimum wear.



DELSIN. Another display problem is solved with Delsin, Kearfott's solid state indicator, accepting BCD input—displaying alpha-numeric values on a seven-segment electroluminescent panel.

The standard 3" indicator above contains a binary-to-decimal converter, driver, lamp encoding matrix, solid state switching matrix, lamp and associated electronics.



Delsin is also packaged in stick form, incorporating all necessary logic and switching circuitry and lamp, for individual alpha/numeric digits in a self-contained unit. Delsin sticks can be stacked side by side, developing a display of any word length. A typical 3-digit stick form display is about the size of a cigarette pack, and provides 7 ft. lamberts light output. It operates over a temperature range of -55° C to $+71^\circ$ C, and meets all applicable requirements for MIL-E-5400.

GP GENERAL PRECISION AEROSPACE KEARFOTT DIVISION
LITTLE FALLS, NEW JERSEY
GENERAL PRECISION, INC.

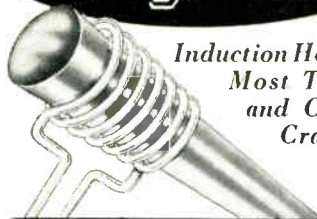

*Induction Heating's
Most Trusted
and Creative
Craftsmen
Since
1926*

HIGH FREQUENCY INDUCTION HEATING UNITS

- for
- BRAZING ● SOLDERING
 - HEAT TREATING
 - ZONE REFINING
 - CRYSTAL GROWING
 - PLASMA TORCH

Typical Applications WAVEGUIDE ASSEMBLIES INDUCTION BRAZED

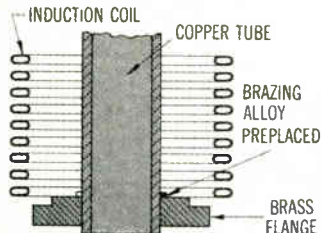

Induction brazing has proved to be an excellent method for production assembly of wave guides. In the diagram, a rectangular copper tube is joined to a brass flange using a pre-placed ring of brazing alloy. Uniform localized heating minimizes distortion. Induction brazing produces consistently sound joints with smooth fillets.

Free Application Engineering Service

GLASS - TO - GLASS SEALS

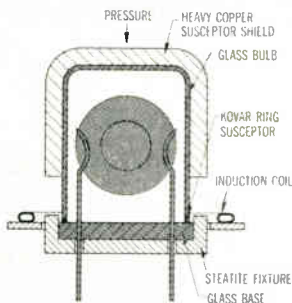

Holders for quartz crystals are sealed by induction heating in an evacuated bell-jar. A glass-coated kovar metal ring is used as a susceptor between bulb and base. Steatite nest, held in plate-type induction coil positions glass base, while spring-loaded copper block locates glass bulb and also provides pressure to cause plastic flow of glass after localized heating. In production, several crystals are sealed at one time.

WRITE FOR LEPEL CATALOG

Lepel HIGH FREQUENCY
LABORATORIES, INC.

55th ST. & 37th AVE., WOODSIDE 77, N. Y. C.
CHICAGO OFFICE: 6246 WEST NORTH AVENUE

Circle 68 on Inquiry Card

NEW TECH DATA

Prism Laser Q Spoiler

A 1500 rps rotating prism laser Q spoiler that can produce pulse durations as short as 50nsec., with peak output power in the mw range, is available from Beckman & Whitley, Inc., San Carlos, Calif. Model 402 is designed to Q spoil laser beams up to $\frac{5}{8}$ in. in dia.

Circle 327 on Inquiry Card

Epoxy Mixing

Bulletin R-962 describes Hull Corp.'s Blendmaster, proportioning, mixing and dispensing equipment. Models 26 PDL and 26 PD25-2 are described with sketches and diagrams showing principles of operation, full specs. and dimensions. Hull Corp., Hathboro, Pa.

Circle 328 on Inquiry Card

Accelerometers

This illustrated 32-page brochure contains complete information on a broad line of self-generating piezoelectric accelerometers. Various GLENNITE accelerometers are listed in the brochure and are supplied in dynamic ranges from 0.005 to 50,000g. In addition to the complete specs., the booklet includes associated data such as related equipment selector charts, useful environmental formulae, elements of accelerometer operation and design, and typical calibration procedures. Bulletin AA-1000 available from Gulston Industries, Inc., 212 Durham Ave, Metuchen, N. J.

Circle 329 on Inquiry Card

Wire Wound Resistors

High temp. power wire wound resistors, featuring fireproof inorganic construction, are described in a 4-page color catalog available from International Resistance Co.'s Boone (N. C.) Div. Units are available in ratings of 2, 3, 5, 7, 10, 15 and 20w. Bulletin P-7 is available from International Resistance Co., 401 N. Broad St., Philadelphia, Pa.

Circle 330 on Inquiry Card

Clean Room Filters

The MICRETAIN® Series of ABSOLUTE® filters is described in a bulletin available from Cambridge Filter Corp., 738 E. Erie Blvd., Syracuse 1, N. Y. Typical installations and applications, materials of construction, and physical properties are featured in this 4-page bulletin, #142-A.

Circle 331 on Inquiry Card

Module Test Connector

The Series RD test connectors provide for the connection of miniature and micro-miniature circuit modules to chassis mounted test circuitry. The connector accepts lead wires with dia. of 0.015—0.032 in. Specs., photo, and characteristics are included in Bulletin RD1, Barnes Development Co., 213 W. Baltimore Pike, Lansdowne, Penna.

Circle 332 on Inquiry Card



AVAILABLE NOW! THERMALLOY HEAT SINKS With Teflon Inserts

2207 / PR10, / PR10A, / PR11 and / PR11A

■ Licensed under Pacific Semiconductor Patent 3,033,537, these units are available with teflon inserts for lead insulation. Screwdriver slot enables fast, positive tightening. Tapped holes in base provide direct mounting for minimum lead lengths and maximum retention under shock and vibration. ■ Check these advantages, provided in ALL Thermalloy convection-cooled heat sinks for TO-5/9, TO-8, TO-16, TO-18 and TO-46 transistors.

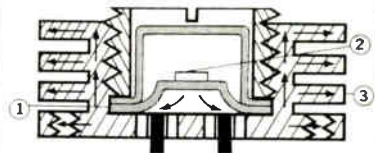

Thermalloy heat sinks attach to the transistor at point of maximum case temperature — the weld flange. In cutaway view, note the 2 piece threaded construction. Tightening the insert firmly clamps both sides of the transistor weld flange (1). This weld flange is the nearest thermal contact to the source of heat — the transistor junction (2). Arrows show thermal path from junction to heat sink fins (3), where heat is removed by natural convection or forced air. Less efficient designs attach only to the transistor body and must be matched to the body diameter. Thermalloy weld flange contact eliminates this requirement — each model fits all cases within its JEDEC designation.

■ These same design principles are offered in other Thermalloy finned heat sinks — including a single thru-hole in place of individual lead holes... and finger-tightened tops in place of slotted inserts.



**Thermalloy
Company**

P. O. Box 26036 / 414 Exposition
Dallas 26, Texas / TA 7-3333

For catalog describing these heat sinks plus 60 other convection- and conduction-cooled types, contact Thermalloy now.

Circle 69 on Inquiry Card

Compact View of Hart Relays



SERIES R&S Miniature, Hermetically Sealed.

4PDT. Contact ratings from micro-amperes to 10 amps. Meet or exceed MIL-R-5757D. A-c coil version available.



SERIES P High Speed Polarized.

SPDT. Operating response to 200 microseconds. No contact bounce.



SERIES W General Purpose.

DPDT, double break, a-c, d-c relays. Plug-in type or quick-disconnect terminals. Rated up to 25 amps, yet more compact than most 10 amp relays. Holding contact available.

For complete information write to:



HART
MANUFACTURING CO.
306 BARTHOLOMEW AVENUE
HARTFORD 1, CONNECTICUT
Telephone: Area Code 203 525-3491
A SUBSIDIARY OF OAK MANUFACTURING CO.

Circle 70 on Inquiry Card

ELECTRONIC INDUSTRIES • May 1963

NEW TECH DATA

Instrument Catalog

Catalog 100C, 24 pages, includes specs. and applications for electro-mechanical transducers and associated read-out instruments. Featured are load-cell type force transducers and transistorized read-out instruments. Dayton Corp., 2875 Culver Ave., Dayton 29, Ohio.

Circle 333 on Inquiry Card

Dielectric Testing Parameters

Suprenant Mfg. Co., sub. of IT&T Corp., Clinton, Mass., has initiated a series of "Service to Industry" bulletins. The first, "Dielectric Testing Parameters," will assist quality-control engineers and inspectors in the use of dielectric high-voltage testing equipment.

Circle 334 on Inquiry Card

Right Angle Tube Sockets

Information is available giving detailed materials and installation data on 4 types of right angle tube sockets. These sockets have been designed to save space, increase shock resistance and permit the placement of tubes closer to heat sinks in electronic packages. Spec. Sheet 265B1 is available from Aerovox Corp., New Bedford Div., New Bedford, Mass.

Circle 335 on Inquiry Card

New Welder Catalog

A 6-page brochure describes stored-energy welding power supplies. Includes specs. on stored-energy power supplies with capacities of 15 to 1000w-sec., which are suitable for welding metals from 0.0001 to 0.060 in. Hughes Welders, 2020 Short St., Oceanside, Calif.

Circle 336 on Inquiry Card

Voltage Sensor

Information is available on a Over-voltage/Undervoltage Sensor in 3 types for use with dc power supplies. Information includes specs., terminal connection tables and dimensional drawings. Perkin Electronic Corp., 345 Kansas St., El Segundo, Calif.

Circle 337 on Inquiry Card

O-Ring Catalog

This 25-page catalog entitled, "Viton O-Rings," describes the complete physical properties and characteristics of Viton O-Ring which are said to be able to seal hydrogen peroxide, red fuming nitric acid, high temp. fuels and petroleum oils, and hard vacuums. Test results are reported for over 300 different fluids in which the O-Rings have been immersed and dimensions and tolerances for the 257 available standard sizes which are included. Parker Seal Co., 105 67 Jefferson Blvd., Culver City, Calif. Catalog #5711.

Circle 338 on Inquiry Card

ULTRA-MINIATURE TRANSISTOR TRANSFORMERS and REACTORS



DO-T DI-T SERIES

Hermetically Sealed to MIL-T-27A

IMMEDIATE DELIVERY From Stock

There is no transformer even twice the size of the DO-T and DI-T series which has as much as 1/10th the power handling ability... which can equal the efficiency... or equal the response range. And none to approach the reliability of the DO-T and DI-T units (proved to, but exceeding MIL-T-27A grade 4).

Rugged COMPLETELY METAL CASED
High Power Rating up to 10 times greater
Excellent Response twice as good at low end
Low Distortion reduced 80%
High Efficiency up to 30% better, compare DCR
Moisture Proof hermetically sealed to MIL-T-27A
Anchored Leads will withstand 10 pound pull test
Printed Circuit Use nylon insulated leads
Suited to Clip Mounting use Augat #6009-8A clip

UNITED TRANSFORMER CORPORATION

150 Varick Street, New York 13, N.Y.
PACIFIC MFG. DIVISION
3630 Eastham Drive, Culver City, Calif.
EXPORT DIVISION
13 East 40th Street, New York 16, N. Y.

WRITE FOR LATEST CATALOG

Circle 71 on Inquiry Card

THERMISTORS — and how they behave

The increasing use of thermistors in a wide variety of measurement and control applications may be attributed in part to their unusual electrical versatility. They exhibit three basic dynamic properties, each of which leads to a broad and distinct group of applications.

Resistance-Temperature Characteristics

Probably the most familiar property of the thermistor is the fact that, within certain limits, its electrical resistance is almost entirely a function of its temperature. More important, this temperature dependence is so great that, over the range of -100°C to 400°C , there may be a change of as much as 10 million to one in its resistance.

The result is an extremely high sensitivity (many times greater than that of thermocouples and resistance bulbs, for example). This makes the thermistor an unusually effective transducer for temperature measurement, control, and compensation, particularly where accuracy and high resolution are important.

The temperature coefficient of resistance of a thermistor (which, unlike that of most materials, is negative) may be expressed as:

$$\alpha = \frac{1}{R_0} \frac{\Delta R_0}{\Delta T} \text{ ohms/ohm/}^{\circ}\text{C, or } \%/^{\circ}\text{C}$$

The resistance-temperature behavior of individual thermistor types is usually specified by the ratio of the resistance at 0°C to the resistance at 50°C .

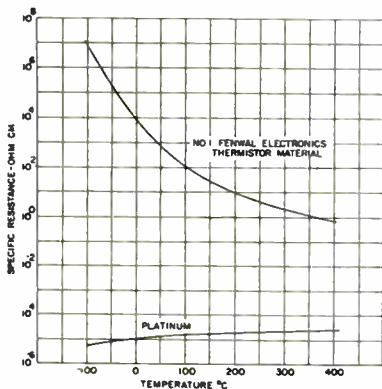

Fig. 1. Resistance-temperature response of typical thermistor material, compared with platinum.

Voltage-Current Characteristics

If the voltage-current curve of a typical bead thermistor is plotted (fig. 2) it is found that, at low values, current is proportional to applied voltage. As the voltage is increased however, the increased current which results begins to raise the temperature of the thermistor detectably above that of its surroundings. As the temperature increases, resistance drops and the current continues to increase rapidly. At some maximum value this self-heating effect will reach a steady-state condition, limited by the amount of power available in the circuit, or more commonly, by the voltage drop across a fixed resistor usually placed in series with the thermistor. In this (self-heating) portion of the I-R curve, the thermistor is exhibiting a negative resistance characteristic.

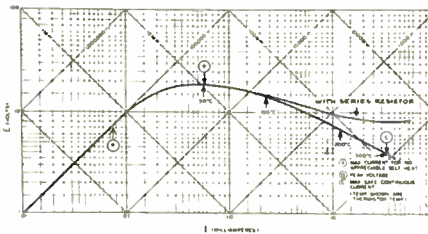

Fig. 2. Typical thermistor E-I curve (in still air, 25°C).

It is this characteristic which provides a whole new field of uses for the thermistor. In essence, while in the self-heated state, it is sensitive to anything that changes the rate at which heat is conducted away from it. It is so used to measure flow, pressure, liquid level, composition of gases, etc. If the rate of heat removal is fixed, then the thermistor is sensitive to power input, and can be used for voltage or power level control.

Current-Time Characteristics

When the self-heating effect described above occurs in a thermistor network, a certain finite time is required for the thermistor to heat and the current to build to a maximum steady-state value. This time, while fixed for a given set of circuit parameters, may be easily varied by changing the applied voltage or the series resistance of the circuit.

This time-current effect provides a simple and accurate means of achieving time delays from milliseconds to many minutes.

Carbon Element Pot

A bound, 15-page catalog EEM4700, 11-60 Section 4, gives complete specs. on molded carbon-element potentiometers. Contains electrical and mechanical parameters of various carbon and composition element units. Clarostat Mfg. Co., Inc., Dover, N. H.

Circle 339 on Inquiry Card

Electrical Tapes

A 6-page brochure entitled, "An Engineer's Discussion of the Functional Temperature Limits of Scotch[®] Brand Electrical Tapes," describes 40 different tapes in 9 classifications. Minnesota Mining & Mfg. Co., 2501 Hudson Rd., St. Paul 19, Minn.

Circle 340 on Inquiry Card

Clutches/Brakes

This 8-page brochure gives data on small (servo size 11, 15, 16) magnetic dry particle clutches and brakes for precision instruments and servo systems. Vibrac Corp., Alpha Industrial Park, Route 129, Chelmsford, Mass.

Circle 341 on Inquiry Card

DC Power Supplies Handbook

A 32-page catalog and handbook is available from Dressen-Barnes Electronics Corp., 250 N. Vinedo Ave., Pasadena, Calif. Dimensional and spec. data, plus engineering standards for specifying multiple dc outputs, modified power supplies, and rack panel-mounted modules are detailed.

Circle 342 on Inquiry Card

Thin-Film Bridge

A thin-film integrated magneto-resistive Wheatstone bridge circuit, composed of 4 MistoR[™] magnetic flux-sensitive resistors, is available from American Aerospace Controls, Inc., 123 Milbar Blvd., Farmingdale, L. I., N. Y. Magnetic field density range is 0 to 50,000 gauss.

Circle 343 on Inquiry Card

Low-Leakage Diode

The CD 13333 is a glass silicon diode featuring low-leakage, high-reliability, high-temp. characteristics. Low leakage currents make it useful in magnetic amps., speed gates and matched quads or other multiples. A leakage current curve is included. Continental Device Corp., 12515 Chadron Ave., Hawthorne 2, Calif.

Circle 344 on Inquiry Card

Memory Test Systems

A 20-page brochure describes memory-core testers, memory testers, and memory exercisers for testing complete memory systems. Technical Publications Dept., Digital Equipment Corp., 146 Main St., Maynard, Mass.

Circle 345 on Inquiry Card

The only manufacturer of Iso-curve[®] thermistors — interchangeable units with identical resistance/temperature curves.

* PAT. APPLIED FOR

63 Fountain Street Framingham, Massachusetts

Circle 72 on Inquiry Card

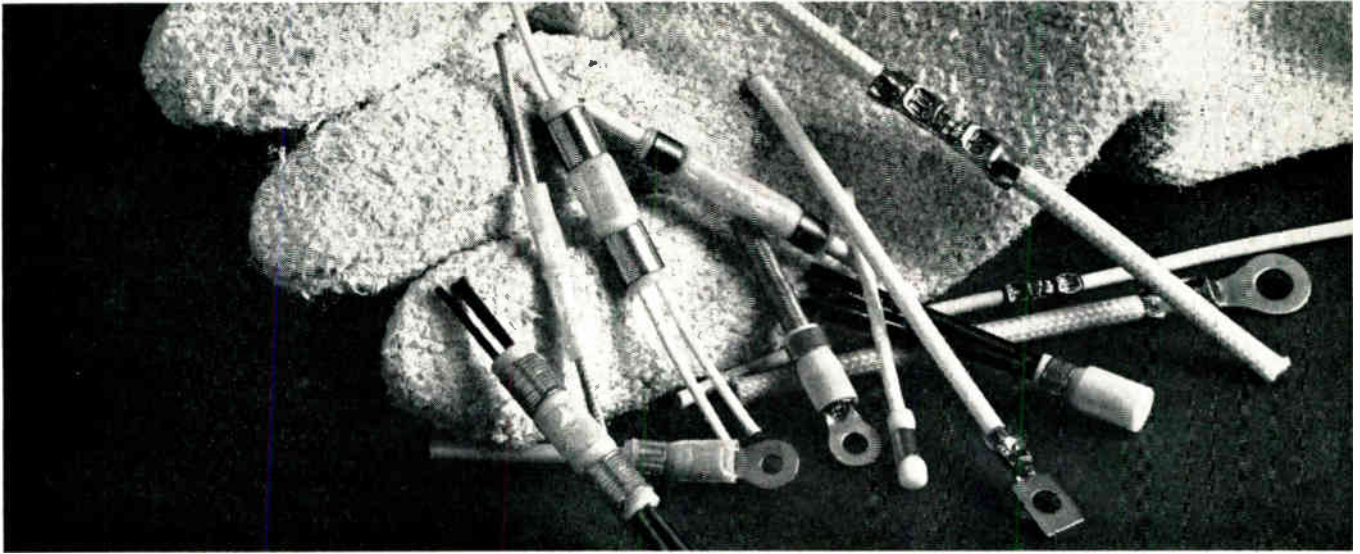

Some . . .



like it hot!

Go as high as you want and as hot as 1200° F. and our STRATOTHERM* terminals and splices perform with utmost reliability . . . all the way! In a vapor-trailed jet at 35,000 feet or a cherry-nosed missile braked by earth's atmosphere, STRATOTHERM brand products easily ride out vibration, corrosion, heat, cold and other extremes that go with pushing beyond sound or into space.

You can choose from three basic, temperature-oriented types: uninsulated (650° F. or 1200° F.), pre-insulated (550°F.) and post-insulated (500° F.). Splices (sealed or unsealed) for single or multiple wire applications. Caps for pigtail splices and spare wire caps . . . all part of the largest line of high-temperature, high-altitude connection devices available anywhere.

Quite by design, our STRATOTHERM terminal and splice line offers many other advantages including:

- choice of plating predicated on temperature requirements
- color coding of sleeve or crimping rings
- precision controlled crimping with matching A-MP* tools—hand or automatic
- wire size range—AWG 26-2/0
- TEFLON® insulation used throughout

There's more to tell; all of it convincing, if your needs are in high-temperature, high-altitude connections. So, send now for complete information on AMP STRATOTHERM terminals and splices.

*Trademark of AMP INCORPORATED.

TEFLON® Trademark of E. I. Du Pont



AMP products and engineering assistance are available through subsidiary companies in: Australia • Canada • England • France • Holland • Italy • Japan • Mexico • West Germany

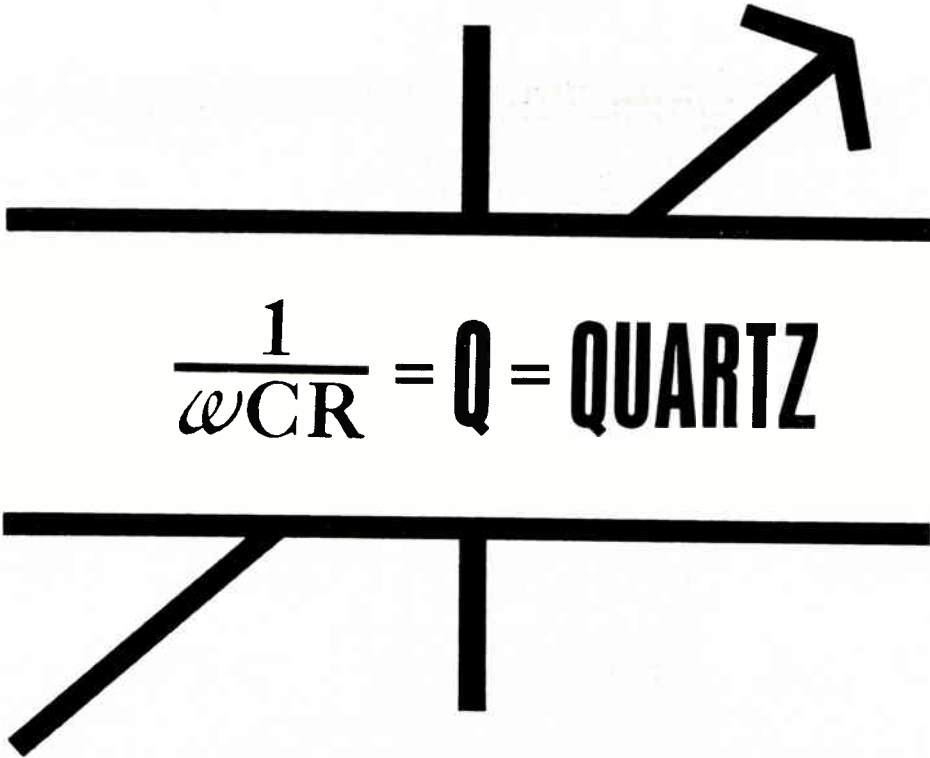

$$\frac{1}{\omega CR} = Q = \text{QUARTZ}$$

QUARTZ MEANS Q IN JFD PRECISION QUARTZ TRIMMER CAPACITORS

ENGINEERS EXPECT MORE FROM JFD QUARTZ TRIMMERS AND THEY GET IT:

1. High Q and low inductance coaxial construction for high frequency operation. (Custom-made units are even used as tuning cavities.)
2. High Stability across a wide range of temperature extremes because of approximately zero temperature coefficient. (± 25 PPM/ $^{\circ}$ C manufacturing tolerances.)
3. High altitude performance—in the Sealcap series. (Closed dielectric end and sealed adjustment end) eliminates corona, arcing or voltage discharge. Outgoing inspection under 40 pounds PSI in water-filled tank assures water-tight construction. Sealcaps will more than withstand humidity and salt-spray cycling as per Mil-C-14409A.
4. High temperature operation. no derating up to +150 degrees, or low temperature operation (cryogenics anyone?) down to -55° C. (Specials with no derating from -65° to $+200^{\circ}$ C upon request.)
5. High resistance to shock and vibration. All JFD units will exceed low frequency (60 cycles) and high frequency (2000 cycles) cycling requirements of Mil-C-14409A (as well as other performance requirements of said spec. QS171, for example, was selected for 3000 G crash-landing on the moon in the Ranger Satellite.)

Select from over 174 different standard panel and printed circuit JFD Quartz Trimmers in ranges varying from 0.6-1.8 pf. to 0.8-16. pf. Our engineers will be glad to discuss the application of these extra-ordinary capacitors to your extra-ordinary projects. (We make ordinary capacitors, too. Call us and see.)

Special models with virtually limitless modifications can be designed to meet your particular needs by our local field engineers. For more information, write for Catalog C-63.

U. S. Pat. No. 2,922,093 Canadian Pat. No. 604,810

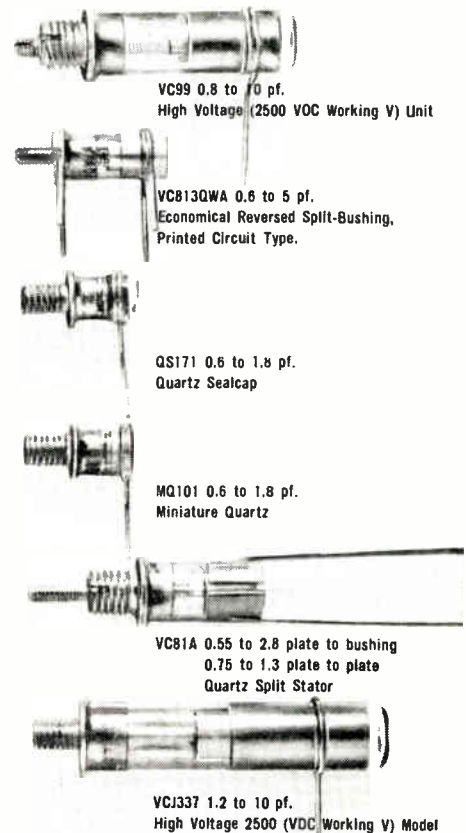

JFD ELECTRONICS CORPORATION
THE  AMERICA KNOWS BEST!

Components Division

15th Avenue at 62nd Street, Brooklyn 19, N. Y. • Phone 212 DE 1-1000 • TWX212-833-7001 Cable-JEFDEE N. Y.
 JFD WESTERN • 9 Morlan Place • Arcadia, Calif. • Phone: Hillcrest 6-0312
 JFD MIDWESTERN • 6330 Hermione St. • Chicago 46, Ill. • Phone: 775-5424
 JFD MIDWESTERN-OHIO • P. O. Box 36090 • Cincinnati 36, Ohio • Phone: 421-1166
 JFD NORTHEASTERN • Ruth Drive, P. O. Box 228 • Marlboro, Mass. • Phone: HUNtley 5-7311
 JFD CANADA • 51 McCormack Street • Toronto, Ontario, Canada • Phone ROger 2-7571
 JFD ELECTRONICS (ISRAEL) LTD. • Industrial Area B, Building 23 • Azur, Israel • Cable Address: JFD AZUR, ISRAEL
 LCC STEAFIX • 128 Rue de Paris • Montreuil, Seine, France
 STANDARD TELEPHONE & CABLES LTD. • Footscray, Sidcup, Kent, U. K.
 DUCON CONDENSER PTY. LTD. • Villawood, N. S. W., Australia

Variable Trimmer Piston Capacitors ■ Metalized Inductors ■ LC Tuners ■ Filters ■ Diplexers ■ Fixed and Variable Distributed and Lumped Constant Delay Lines ■ Pulse Forming Networks

VISIT JFD BOOTH #3208 AT THE 1963 ELECTRONIC PARTS SHOW

FREE! Use These Cards for:

- Catalogs, Bulletins, Literature • Design features of advertised products
- Information about new Products • New Tech Data for Engineers

YOUR NAME **TITLE**

FIRM **Mail Stop or Div./Dept.**

FIRM ADDRESS

CITY OR TOWN **ZONE** **STATE**

1	2	3	4	5	6	7	8	9	10	11	12	13	14	15	16	17	18	19	20
21	22	23	24	25	26	27	28	29	30	31	32	33	34	35	36	37	38	39	40
41	42	43	44	45	46	47	48	49	50	51	52	53	54	55	56	57	58	59	60
61	62	63	64	65	66	67	68	69	70	71	72	73	74	75	76	77	78	79	80
81	82	83	84	85	86	87	88	89	90	91	92	93	94	95	96	97	98	99	100
101	102	103	104	105	106	107	108	109	110	111	112	113	114	115	116	117	118	119	120
121	122	123	124	125	126	127	128	129	130	131	132	133	134	135	136	137	138	139	140
141	142	143	144	145	146	147	148	149	150	151	152	153	154	155	156	157	158	159	160
161	162	163	164	165	166	167	168	169	170	171	172	173	174	175	176	177	178	179	180
181	182	183	184	185	186	187	188	189	190	191	192	193	194	195	196	197	198	199	200
201	202	203	204	205	206	207	208	209	210	211	212	213	214	215	216	217	218	219	220
221	222	223	224	225	226	227	228	229	230	231	232	233	234	235	236	237	238	239	240
241	242	243	244	245	246	247	248	249	250	251	252	253	254	255	256	257	258	259	260
261	262	263	264	265	266	267	268	269	270	271	272	273	274	275	276	277	278	279	280
281	282	283	284	285	286	287	288	289	290	291	292	293	294	295	296	297	298	299	300
301	302	303	304	305	306	307	308	309	310	311	312	313	314	315	316	317	318	319	320
321	322	323	324	325	326	327	328	329	330	331	332	333	334	335	336	337	338	339	340
341	342	343	344	345	346	347	348	349	350	351	352	353	354	355	356	357	358	359	360
361	362	363	364	365	366	367	368	369	370	371	372	373	374	375	376	377	378	379	380
381	382	383	384	385	386	387	388	389	390	391	392	393	394	395	396	397	398	399	400

Postcard valid 8 weeks only. After that use own letterhead describing item wanted.
Please send me further information on the items I have circled above.

EI-109

MAY, 1963

FIRST CLASS
PERMIT NO. 2333
CAMDEN, N. J.

BUSINESS REPLY MAIL

No Postage Stamp Necessary if Mailed in U.S.A.

POSTAGE WILL BE PAID BY

ELECTRONIC INDUSTRIES

The Computer Center

P. O. Box 1970

Camden 1, New Jersey



FREE! Use These Cards for:

- Catalogs, Bulletins, Literature • Design features of advertised products
- Information about new Products • New Tech Data for Engineers

FIRST CLASS
PERMIT NO. 2333
CAMDEN, N. J.

BUSINESS REPLY MAIL
 No Postage Stamp Necessary if Mailed in U.S.A.



POSTAGE WILL BE PAID BY
ELECTRONIC INDUSTRIES
 The Computer Center
 P. O. Box 1970
 Camden 1, New Jersey

YOUR NAME **TITLE**

FIRM **Mail Stop or Div./Dept.**

FIRM ADDRESS

CITY OR TOWN **ZONE** **STATE**

1	2	3	4	5	6	7	8	9	10	11	12	13	14	15	16	17	18	19	20
21	22	23	24	25	26	27	28	29	30	31	32	33	34	35	36	37	38	39	40
41	42	43	44	45	46	47	48	49	50	51	52	53	54	55	56	57	58	59	60
61	62	63	64	65	66	67	68	69	70	71	72	73	74	75	76	77	78	79	80
81	82	83	84	85	86	87	88	89	90	91	92	93	94	95	96	97	98	99	100
101	102	103	104	105	106	107	108	109	110	111	112	113	114	115	116	117	118	119	120
121	122	123	124	125	126	127	128	129	130	131	132	133	134	135	136	137	138	139	140
141	142	143	144	145	146	147	148	149	150	151	152	153	154	155	156	157	158	159	160
161	162	163	164	165	166	167	168	169	170	171	172	173	174	175	176	177	178	179	180
181	182	183	184	185	186	187	188	189	190	191	192	193	194	195	196	197	198	199	200
201	202	203	204	205	206	207	208	209	210	211	212	213	214	215	216	217	218	219	220
221	222	223	224	225	226	227	228	229	230	231	232	233	234	235	236	237	238	239	240
241	242	243	244	245	246	247	248	249	250	251	252	253	254	255	256	257	258	259	260
261	262	263	264	265	266	267	268	269	270	271	272	273	274	275	276	277	278	279	280
281	282	283	284	285	286	287	288	289	290	291	292	293	294	295	296	297	298	299	300
301	302	303	304	305	306	307	308	309	310	311	312	313	314	315	316	317	318	319	320
321	322	323	324	325	326	327	328	329	330	331	332	333	334	335	336	337	338	339	340
341	342	343	344	345	346	347	348	349	350	351	352	353	354	355	356	357	358	359	360
361	362	363	364	365	366	367	368	369	370	371	372	373	374	375	376	377	378	379	380
381	382	383	384	385	386	387	388	389	390	391	392	393	394	395	396	397	398	399	400

Postcard valid 8 weeks only. After that use own letterhead describing item wanted. Please send me further information on the items I have circled above.

FREE! Use These Cards for:

- Catalogs, Bulletins, Literature • Design features of advertised products
- Information about new Products • New Tech Data for Engineers

YOUR NAME TITLE

FIRM Mail Stop or Div./Dept.

FIRM ADDRESS

CITY OR TOWN ZONE STATE

1	2	3	4	5	6	7	8	9	10	11	12	13	14	15	16	17	18	19	20
21	22	23	24	25	26	27	28	29	30	31	32	33	34	35	36	37	38	39	40
41	42	43	44	45	46	47	48	49	50	51	52	53	54	55	56	57	58	59	60
61	62	63	64	65	66	67	68	69	70	71	72	73	74	75	76	77	78	79	80
81	82	83	84	85	86	87	88	89	90	91	92	93	94	95	96	97	98	99	100
101	102	103	104	105	106	107	108	109	110	111	112	113	114	115	116	117	118	119	120
121	122	123	124	125	126	127	128	129	130	131	132	133	134	135	136	137	138	139	140
141	142	143	144	145	146	147	148	149	150	151	152	153	154	155	156	157	158	159	160
161	162	163	164	165	166	167	168	169	170	171	172	173	174	175	176	177	178	179	180
181	182	183	184	185	186	187	188	189	190	191	192	193	194	195	196	197	198	199	200
201	202	203	204	205	206	207	208	209	210	211	212	213	214	215	216	217	218	219	220
221	222	223	224	225	226	227	228	229	230	231	232	233	234	235	236	237	238	239	240
241	242	243	244	245	246	247	248	249	250	251	252	253	254	255	256	257	258	259	260
261	262	263	264	265	266	267	268	269	270	271	272	273	274	275	276	277	278	279	280
281	282	283	284	285	286	287	288	289	290	291	292	293	294	295	296	297	298	299	300
301	302	303	304	305	306	307	308	309	310	311	312	313	314	315	316	317	318	319	320
321	322	323	324	325	326	327	328	329	330	331	332	333	334	335	336	337	338	339	340
341	342	343	344	345	346	347	348	349	350	351	352	353	354	355	356	357	358	359	360
361	362	363	364	365	366	367	368	369	370	371	372	373	374	375	376	377	378	379	380
381	382	383	384	385	386	387	388	389	390	391	392	393	394	395	396	397	398	399	400

Postcard valid 8 weeks only. After that use own letterhead describing item wanted.
Please send me further information on the items I have circled above.

EI-109

MAY, 1963

FIRST CLASS
PERMIT NO. 2333
CAMDEN, N. J.

BUSINESS REPLY MAIL

No Postage Stamp Necessary If Mailed in U.S.A.

POSTAGE WILL BE PAID BY

ELECTRONIC INDUSTRIES

The Computer Center

P. O. Box 1970

Camden 1, New Jersey



FREE! Use These Cards for:

- Catalogs, Bulletins, Literature • Design features of advertised products
- Information about new Products • New Tech Data for Engineers

FIRST CLASS
PERMIT NO. 2333
CAMDEN, N. J.

BUSINESS REPLY MAIL
 No Postage Stamp Necessary If Mailed in U.S.A.



POSTAGE WILL BE PAID BY
ELECTRONIC INDUSTRIES
 The Computer Center
 P. O. Box 1970
 Camden 1, New Jersey

YOUR NAME **TITLE**

FIRM **Mail Stop or Div./Dept.**

FIRM ADDRESS

CITY OR TOWN **ZONE** **STATE**

1	2	3	4	5	6	7	8	9	10	11	12	13	14	15	16	17	18	19	20
21	22	23	24	25	26	27	28	29	30	31	32	33	34	35	36	37	38	39	40
41	42	43	44	45	46	47	48	49	50	51	52	53	54	55	56	57	58	59	60
61	62	63	64	65	66	67	68	69	70	71	72	73	74	75	76	77	78	79	80
81	82	83	84	85	86	87	88	89	90	91	92	93	94	95	96	97	98	99	100
101	102	103	104	105	106	107	108	109	110	111	112	113	114	115	116	117	118	119	120
121	122	123	124	125	126	127	128	129	130	131	132	133	134	135	136	137	138	139	140
141	142	143	144	145	146	147	148	149	150	151	152	153	154	155	156	157	158	159	160
161	162	163	164	165	166	167	168	169	170	171	172	173	174	175	176	177	178	179	180
181	182	183	184	185	186	187	188	189	190	191	192	193	194	195	196	197	198	199	200
201	202	203	204	205	206	207	208	209	210	211	212	213	214	215	216	217	218	219	220
221	222	223	224	225	226	227	228	229	230	231	232	233	234	235	236	237	238	239	240
241	242	243	244	245	246	247	248	249	250	251	252	253	254	255	256	257	258	259	260
261	262	263	264	265	266	267	268	269	270	271	272	273	274	275	276	277	278	279	280
281	282	283	284	285	286	287	288	289	290	291	292	293	294	295	296	297	298	299	300
301	302	303	304	305	306	307	308	309	310	311	312	313	314	315	316	317	318	319	320
321	322	323	324	325	326	327	328	329	330	331	332	333	334	335	336	337	338	339	340
341	342	343	344	345	346	347	348	349	350	351	352	353	354	355	356	357	358	359	360
361	362	363	364	365	366	367	368	369	370	371	372	373	374	375	376	377	378	379	380
381	382	383	384	385	386	387	388	389	390	391	392	393	394	395	396	397	398	399	400

Semiconductor Versatility

■ Ever-increasing knowledge in the state of the art of producing semiconductors has resulted in development of a great variety of products. This, coupled with decreasing prices, has allowed the use of solid state and metallic devices in applications never before possible. The three circuits illustrated below are just a suggestion of the wide scope of application. If you use or control dc power it will pay you to investigate Tarzian semiconductors.

Semiconductor Ignition System uses a silicon rectifier and a Zener diode.

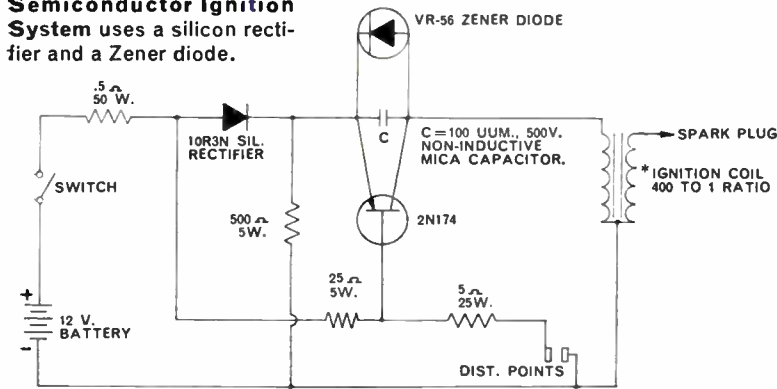

Send for Bulletins 62CC4 and 61VR11.

*AVAILABLE FROM PALMER ELECTRONICS LABORATORIES, INC., CARLISLE 20, MASS. OR AUTOMOTIVE ELECTRONICS CO., 387 PARK AVENUE SOUTH, NEW YORK 16, N.Y.

Wide choice of semiconductor components at low cost has made a "solid-state" ignition system not only practical but popular. Type 10R3N is a low cost 20 ampere rectifier; VR56 a one watt zener, both available from Sarkes Tarzian.

A Sarkes Tarzian Type S-5745-5 assembly provides the polarizing element in the reversing dc control for motors. An S-493C "Klipvolt" suppressor dampens any transients generated by the dc field.

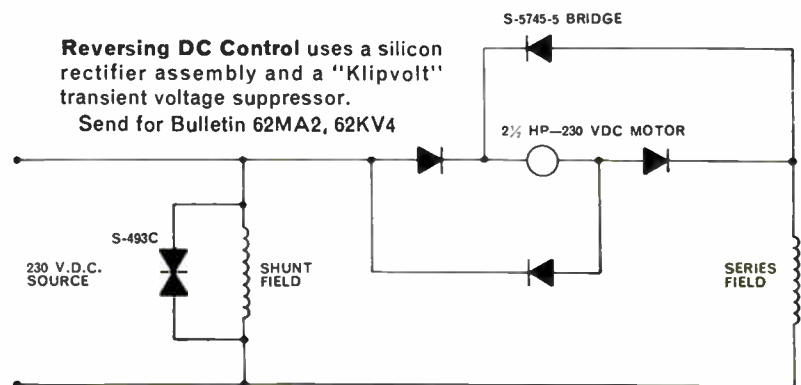

Reversing DC Control uses a silicon rectifier assembly and a "Klipvolt" transient voltage suppressor. Send for Bulletin 62MA2, 62KV4

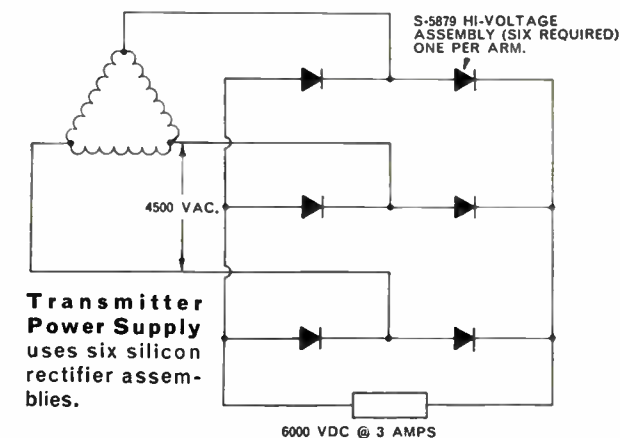

Transmitter Power Supply uses six silicon rectifier assemblies.

Six Sarkes Tarzian S-5879 assemblies, one in each arm of a three phase bridge connection, provide the compact, reliable, cool operating rectifier elements needed in a power supply that will deliver to 6000 volts dc at 3 amperes. Each arm has a peak inverse voltage rating of 12,000 volts for optimum safety factor.

The Tarzian lineup of semiconductors includes:

- | | |
|-------------------------------------|-----------------------------------|
| Silicon Rectifiers | High Voltage Cartridge Rectifiers |
| Silicon Voltage Regulators | Silicon Controlled Rectifiers |
| Klipvolt Suppressors | Selenium Rectifiers |
| Tube Replacement Silicon Rectifiers | Special Devices |



SARKES TARZIAN, Inc.

World's Leading Manufacturers of TV and FM Tuners • Closed Circuit TV Systems • Broadcast Equipment • Air Trimmers • FM Radios • Magnetic Recording Tape • Semiconductor Devices

SEMICONDUCTOR DIVISION • BLOOMINGTON, INDIANA

Canadian Licensee: Marland Engineering Limited • 350 Weber Street North, Waterloo, Ontario

Send for data sheets, or an outline of your high voltage power requirements. Custom designing costs you no more.



OUR NEW MODEL 335 HALLEFEX GENERATOR

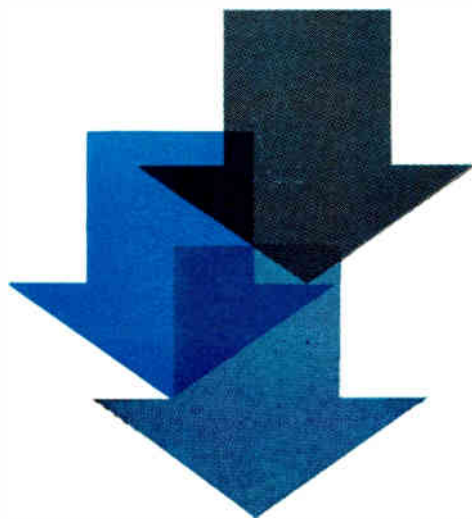

AND ITS AIR GAP



NOW...
0.001" AIR GAP GIVES
YOU UNHEARD-OF
MAGNETIC
SENSITIVITY!

We've taken the breathing space out of air gaps. Want proof? Take a look at the high-permeability Hallefex Model 335. Its magnetic gap is squeezed to less than 0.001" — up to 15 times smaller than in other Hall generators.

You'll find no trick to this disappearing act. Just a patented manufacturing technique that deposits a microns-thin film of indium antimonide on a ferrite substrate, then covers both with a second ferrite slab which acts as a flux concentrator. But wonders don't cease with the introduction of efficiency to magnetic circuits. The same process also sends input impedance up to a practical range of 100 to 600 ohms and voltage output sensitivity up to an equally impressive 2.0 volts/amp.-Kilogauss, minimum. Other wonders, too — and to learn about them, contact your nearest Helipot rep or Sales Office.

Our Hall Effect Applications Group will provide you with an idea-provoking data file, and stands ready to lend you assistance in every Hallefex application. Write, wire or phone Sales Manager for Special Products, Helipot Division. Telephone: TROJAN 1-4848. Teletype: FULLERTON CAL 5210. Model 335 evaluation units are yours by return Air Mail for \$35 each.

ALSO... PRECISION POTENTIOMETERS, HIGH-PERFORMANCE SERVOMOTORS, CLEAN-DESIGN METERS.

Beckman INSTRUMENTS, INC.
HELIPOT DIVISION
Fullerton, California

INTERNATIONAL SUBSIDIARIES: GENEVA, SWITZERLAND;
MUNICH, GERMANY; GLENROTHES, SCOTLAND.

*TRADEMARK B. I. I.

NEW PRODUCTS

5-DIGIT VOLTMETER

100 μ v sensitivity and accuracy of $\pm 0.01\%$.



The V-85 is a 5-digit voltmeter which uses reed delays, thus allowing 3 readings/sec. Features include 100 μ v sensitivity, plug-in circuit cards, accuracy of 0.01% ± 1 digit, and reference stability of 0.005% per month. Range and polarity are automatic. Cubic Corp., San Diego 11, Calif.

Circle 170 on Inquiry Card

TRANSFORMER

Output $\pm 1\%$ line regulation.

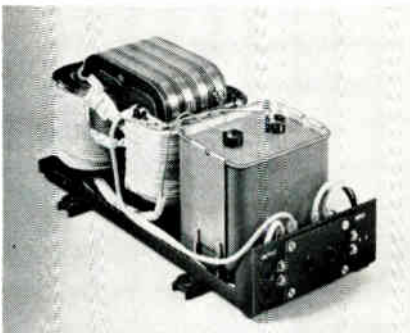

Constant output is suitable for computers, communications equipment, inverters, missile test and operating equipment, and ground-support equipment. Solid-state components provide 13 $\frac{1}{8}$ x 5 $\frac{1}{8}$ x 6 in. package weighing 45 lbs. A $\pm 1\%$ line regulation is assured without sensing devices or a dc power supply. Input voltage, 95-135vac at 60cps; output power 1450va; output voltage 120vac; output current 12a; load regulation $\pm 2\%$ current limited to 20a under short-circuit conditions. Amp Inc., CAPITRONTM Div., 155 Park St., Elizabethtown, Pa.

Circle 171 on Inquiry Card



WHY DOES BECKMAN OFFER 2 HALL EFFECT SUBSTRATES?

We've complicated matters by giving our new-generation Hall Effect voltage generators two different substrates. For the best of reasons. There are two different areas of application - depending on the nature of the flux field being monitored. And there's a Beckman Hallefex* Generator for each. It makes sense.

Here are the hows and wheres.

FERRITE SUBSTRATE

Using a special manufacturing process, we vacuum-deposit a microns-thin semiconductor film on the ferrite base. Then, to protect the film and improve flux density, we add a ferrite concentrator.

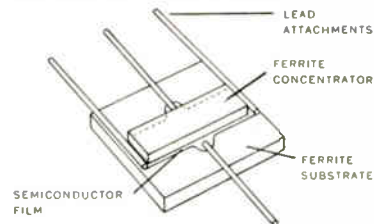

The ferrite unit is essential...

1 - where it's desirable to have low reluctance in the magnetic circuit. This is possible because we've reduced the effective air gap to 0.001". That's up to 15 times smaller than in other Hall generators.

2 - where it's permissible to distort the magnetic field if the flux density can be increased. Because flux takes the path of least reluctance, this can improve field strength by several hundred times or more.

Check the Hallefex Model 335. It has an indium antimonide film that delivers input resistances of 100 to 600 ohms and output sensitivity of 2.0 volts/amp.-Kilogauss, minimum. Or the Model 336 with an indium arsenide film for optimum tempo.

NON-MAGNETIC SUBSTRATE

Employing the same basic manufacturing process, we here deposit the film on a non-magnetic

base. And encapsulate the whole works for protection.

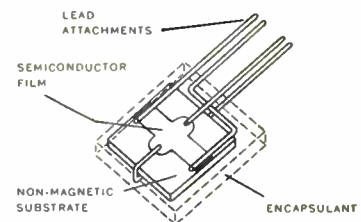

A non-magnetic unit is essential...

1 - where there must be a minimum of disturbance to the mechanics of the system.

2 - where there must be a minimum of disturbance to the spatial flux distribution of magnetic paths. Distortion would be introduced by the presence of stray or induced poles in ferritic material.

3 - where a large dynamic range of flux densities is to be measured. Because they're subject to saturation, ferrite models have a built-in upper limit.

4 - where the coercive forces must be small compared to the applied MMF, or where the retentivity of the substrate must be small compared to the allowable error.

5 - where high frequencies are involved. Because hysteresis loss varies directly with frequency, a non-ferrite unit would be preferred.

Check two Hallefex models with non-magnetic substrates. The 350 has an indium antimonide film for maximum sensitivity. And the 351 has an indium arsenide film for optimum tempo.

HALL EFFECT APPLICATIONS GROUP AT YOUR SERVICE

Just say the word to Sales Manager for Special Products, Helipot Division. Telephone: TRoJan 1-4848. Teletype: FULLERTON CAL 5210. Evaluation units by return Air Mail. Prices: Model 350 - \$25; Model 351 - \$35; Model 335 - \$35; Model 336 - \$45.

*TRADEMARK B.I.I.

Also... precision potentiometers and high-performance servomotors.

International Subsidiaries:
Geneva, Switzerland; Munich, Germany; Glenrothes, Scotland.

Beckman INSTRUMENTS, INC.

HELIPOT DIVISION
Fullerton, California

For the calibration of ac voltmeters, signal generator outputs, or the frequency re- sponse of 'scopes

*... Ballantine Laboratory Standards
for AC Voltage Measurements*

MODEL 440 MICROPOTENTIOMETER

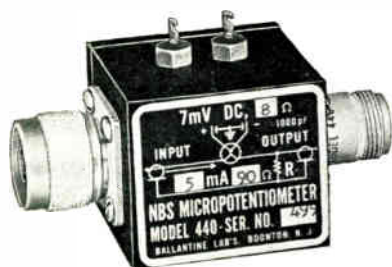

Price: \$175 per resistor, plus
\$75 per thermocouple
housing assembly.

Acts as a low impedance source of accurately known voltage at frequencies from 0 to 900 Mc. It consists essentially of a UHF thermocouple whose heater is in series with a special radial resistor. When connected to an external signal source, the voltage drop across the resistor can be held to a known value over a range of frequencies from 0 to 900 Mc by monitoring the dc output of the thermocouple. Each thermocouple-resistor combination can be operated over a voltage range of 4 to 1 selected between the limits of 15 microvolts and 1 volt. The device is ideal for calibration of ac voltmeters, 'scopes, or signal generators. There is probably no device better adapted to these tasks, principally because it is so simple to use over such a wide range of frequencies. It is based on designs by Mr. Myron C. Selby of the National Bureau of Standards.

MODEL 393 HF (HIGH FREQUENCY) TRANSFER VOLTMETER



Price: \$950 with 5 probes, 1 to 50 volts

A device for the precision measurement of ac voltages of 1 to 50 volts at frequencies from 25 cps to 30 Mc. Measurements are made by equating an unknown ac voltage to an accurately measurable dc voltage using a resistor-thermocouple probe. Accuracy is better than 0.1% up to 10 Mc, and better than 0.5% to 30 Mc even without application of calibration data. It is based on designs by Mr. F. L. Hermach of N. B. S.

MODEL 390 A-T (ATTENUATOR-THERMOELEMENT) VOLTMETER



Price: \$2,250

A laboratory standard device for measurement of voltages from 1 volt to 300 volts (depending on frequency) from 10 Mc to 1000 Mc. NBS calibration is available to 400 Mc at the present time, but facilities are planned to 1000 Mc. The Model 390 is based on a design by Messrs. Selby and Behrent of N. B. S.

*Ask for 4-page brochure on
any of these instruments.*



— Since 1932 —

BALLANTINE LABORATORIES INC.
Boonton, New Jersey

CHECK WITH BALLANTINE FIRST FOR LABORATORY AC VACUUM TUBE VOLTMETERS, REGARDLESS OF YOUR REQUIREMENTS FOR AMPLITUDE, FREQUENCY, OR WAVEFORM. WE HAVE A LARGE LINE, WITH ADDITIONS EACH YEAR. ALSO AC/DC AND DC/AC INVERTERS, CALIBRATORS, CALIBRATED WIDE BAND AF AMPLIFIER, DIRECT-READING CAPACITANCE METER, OTHER ACCESSORIES.

NEW PRODUCTS

20 MEGACYCLE GATE

Saturation voltage below 0.3v.

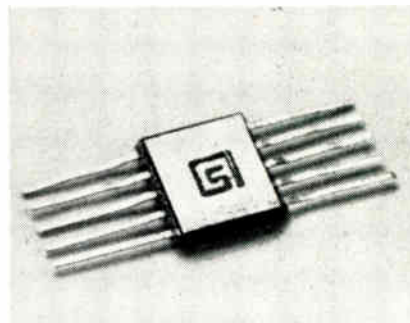

Model SE 201 uses a transistor-coupled circuit (TTL) to gain high speed. Special fabrication reduces isolation capacitance and saturation voltage. At full load, transistor saturation voltage at 125°C is held below 0.3v. Signetics Corp., 680 W. Maude Ave., Sunnyvale, Calif.

Circle 172 on Inquiry Card

SUPERCONDUCTING COILS

Average ratings of 15, 30, and 50K Gauss.



These niobium-zirconium wire-wound coils have a total mass weight of 200 lbs. With a negligible power input, they can produce a magnetic field equal to a conventional coil requiring a 5 to 50kw input and weighing over 6 tons. All coils produce rated field strength at 4.2°K. The 30,000 gauss units have working volumes of 1/2 in. inside dia. by 1 1/2 in. long, and 2 in. inside dia. by 2 1/2 in. long. Field uniformities are within 6%. Westinghouse Cryogenic Systems Dept., P. O. Box 868, Pittsburgh 30, Pa.

Circle 173 on Inquiry Card

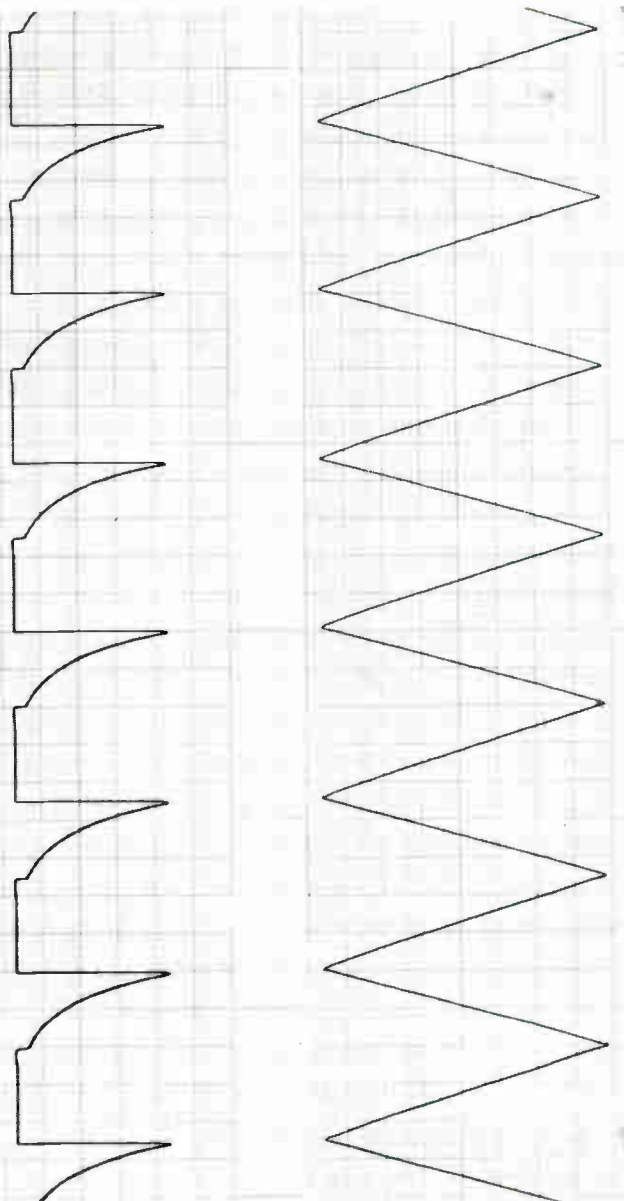
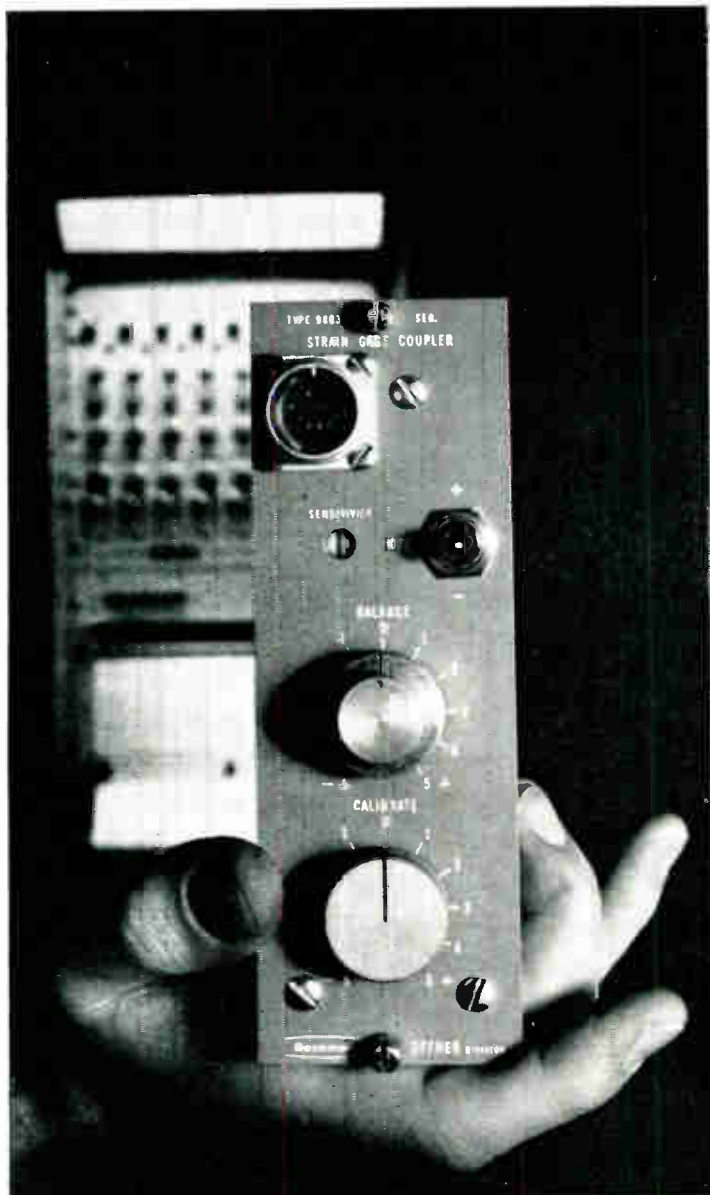

LOW-COST PLUG-IN INPUT COUPLERS ALLOW THE TYPE S RECORDER TO ACCOMMODATE A WIDE RANGE OF INPUT SIGNALS. 23 STANDARD COUPLERS ARE AVAILABLE.

OFFNER TYPE S DYNOGRAPH IS SERVO CONTROLLED AT THE PEN POINT TO ASSURE LOCKED-IN ACCURACY.

Offner adaptability in ink rectilinear recordings

Only OFFNER offers the advantages of ink rectilinear recording with the flexibility of fast input coupler exchange. Servo loop at the stylus point forces locked-in accuracy. The OFFNER input couplers change the function of the amplifier system and provide all necessary bridge balancing, calibration and "computing" facilities...thus obviating the need for expensive special-purpose amplifiers.

Specifications:

Number of Channels	1-8 standard; to 24 special
Sensitivity	With preamp $1\mu\text{v}/\text{mm}$ to $5\text{v}/\text{mm}$ Without preamp $1\text{mv}/\text{mm}$ to $5\text{v}/\text{mm}$
Frequency Response	DC to 150 cps
Phase Error	0-120 cps, 0.05 msec max. delay error
Linearity	0.15% (full scale) for DC: or AC within maximum amplitude envelope
Drift	(shorted input) With preamp $1\mu\text{v}/\text{hr}$ at max. gain Without preamp $<0.05\text{mm}/\text{hr}$
Recording Amplitude	Full chart channel width from DC-30 cps with progressive reduction to 5mm at 150 cps

• Input Impedance	With preamp 2 megohms without preamp 1 megohm
• Warm-up Time	Instantaneous
• Nominal Cost/Channel	With preamp \$1,250 Without preamp \$850

Beckman®

INSTRUMENTS, INC.

OFFNER DIVISION
Schiller Park, Illinois

International Subsidiaries: Geneva, Switzerland; Munich, Germany; Glenrothes, Scotland

063-650

a MIL-TYPE first from DICKSON

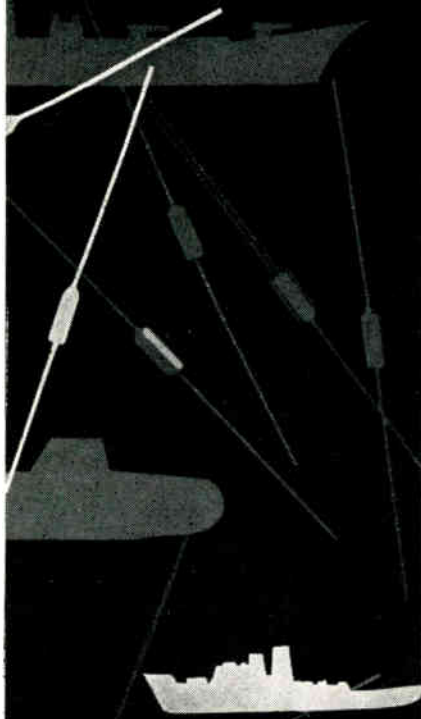

9 VOLT TC ZENERS to MIL-S-19500 / 156A (Navy)

Dickson is the first to offer 9 volt, 500 mw, silicon diffused-junction temperature compensated zener reference diodes to meet the requirements of MIL-S-19500/156A (Navy), USN Types 1N935B, 1N937B, 1N938B, and 1N939B offer temperature coefficients of .01, .002, .001, and .0005%°C. Modest quantities are immediately available for your critical military applications.

Dickson also offers the industry's broadest line of standard temperature compensated zener reference diodes. The following types are presently available from stock, to JEDEC specifications:

1N429	1N1530-30A	1N2765-70A
1N821-27A	1N1735-42A	1N3154-57A
1N935-39B	1N2163-71A	1N3580-84B
1N941-45B	1N2620-24B	1N4057-85A

For complete information contact your authorized Dickson Representative, or write, wire or phone Mr. Jack Nancarrow, Dickson Electronics, P. O. Box 1387, Scottsdale, Arizona. Phone code 602, 946-5357.



DICKSON
ELECTRONICS CORPORATION

248 Wells Fargo Avenue, Scottsdale, Ariz.

Circle 82 an Inquiry Card

NEW PRODUCTS

S-BAND PARAMETRIC AMPLIFIER

1.7 db noise figure at room temperature.

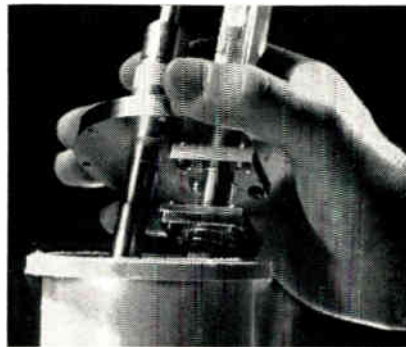

Freq. range of 2.7—3.0gc and a bandwidth of 30mc at 3db points are featured in this nondegenerate, S-band parametric amplifier. Typical noise figures are 1.7db at room temperature and 0.7db at liquid nitrogen temperature. Special cooling allows operation at liquid nitrogen or room temperature. Gain is 15db (± 1 db) over 24 hrs. operation; phase stability is 5° for 24 hrs. Microwave Physics Corp., a sub. of Melpar, Inc., 420 Kirby St., Garland, Tex.

Circle 174 an Inquiry Card

MATCHED TRANSISTORS

Noise figure of 2db.

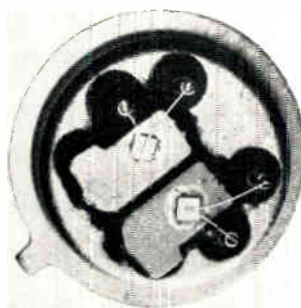

Types 2N2720-22 and 2N2639-44 are closely matched, low-level npn silicon planar transistors which are electrically isolated in a single 6-lead TO-5 package. This allows the use of balanced inputs to minimize input drift and eliminates common-mode signals. Units feature close matching of characteristics: noise figure—typically 2db; and low leakage—1na maximum at 30v. Sperry Semiconductor, div. of Sperry Rand Corp., Norwalk, Conn.

Circle 175 an Inquiry Card

VACUUM PUMP

Attains a pressure of 0.1 micron.

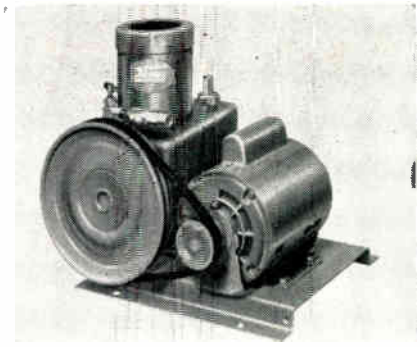

The KCV vane-type high-vacuum pump is a 2-stage compound pump having 2 pumping cylinders separated by a center wall. Each cylinder houses a rotor with 2 spring-loaded vanes connected in series to attain 0.1 micron. A feather-type discharge valve prevents air from bleeding back into the pump. A filter in the separator tank eliminates the discharge of smoke with the exhaust. Kinney Vacuum Div., The New York Air Brake Co., 3529 Washington St., Boston 30, Mass.

Circle 176 an Inquiry Card

POWER TAP SWITCH

Contact resistance approx. 0.010Ω.

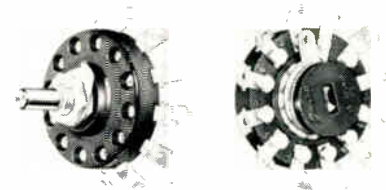

The #19 Series has a 15a, 125vac rating. Dependable life exceeds 50 kc; U.L. listing; contact resistance approx. 0.010Ω for a new switch and 0.020Ω after life at rated load. Construction is single-pole, single-deck, with 2 to 11 taps, plus the common; 30° indexing; available with non-shorting contacts only. Insulating material is arc-resistant mineral-filled phenolic per Mil-M-14A, Type MFH. Grayhill, Inc., 561 Hillgrove Ave., La Grange, Ill.

Circle 177 an Inquiry Card

SMALL WONDER

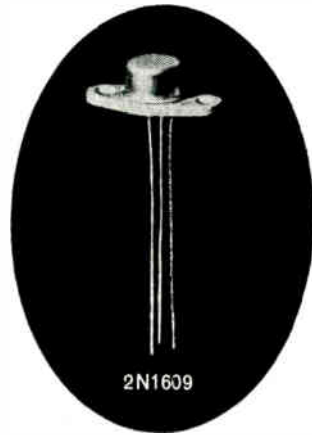

2N1609

your circuitry problems are getting smaller.
Our family of miniature germanium transistors
is getting bigger! Now there are . . .

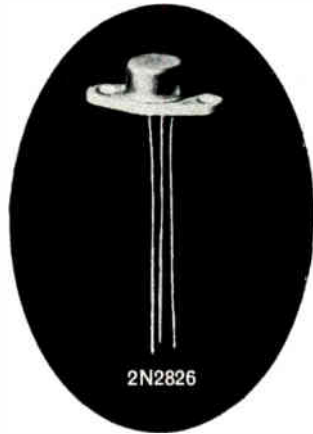

2N2826



2N2827

TWO MORE

extremely low leakage . . . high heat dissipation . . . high frequency response

NUMBER	Ic Max	Vceo (α) Ic = 50ma	f _{ae} typ.	hFE Ic = 100ma	Vce (Sat) (α) Ic = 1/2 A	Vebo (α) Ic = 100ma	V _{ibo} (α) Icb*
2N2826	1.5A	15V	17kc	75-200	1.0V	15V	25V(α) 200 μA
2N2827	1.5A	30V	17kc	75-200	1.0V	20V	40V(α) 200 μA
2N1609	1.5A	60V	17kc	30-75	1.0V	40V	80V(α) 100 μA
2N1610	1.5A	60V	17kc	50-125	0.6V	40V	80V(α) 100 μA
2N1611	1.5A	40V	15kc	30-75	1.0V	20V	60V(α) 100 μA
2N1612	1.5A	40V	17kc	50-125	0.6V	20V	60V(α) 100 μA
2N1172	1.5A	30V	17kc	30-90	0.5V	20V	40V(α) 200 μA

Applications include DC to DC converters, voltage regulators, power stage drivers, servo amplifiers and many others. Applications assistance and complete engineering data? Call or write our sales office. Or see your Delco Radio Distributor.

DELCO
DEPENDABILITY
RADIO
RELIABILITY

Division of General Motors,
Kokomo, Indiana

Union, New Jersey
324 Chestnut Street
MURdock 7-3770
AREA CODE 201

Detroit, Michigan
57 Harper Avenue
TRinity 3-6560
AREA CODE 313

Santa Monica, California
726 Santa Monica Blvd.
UPTon 0-8807
AREA CODE 213

Syracuse, New York
1054 James Street
GRanite 2-2668
AREA CODE 315

Chicago, Illinois
5151 N. Harlem Ave.
775-5411
AREA CODE 312

General Sales Office: 700 E. Firmin, Kokomo, Ind., Gladstone 2-8211—Ext. 500 • Area Code 317

R_x for ca·tas·tro·pho·bia*

Even though you have designed your circuit carefully, so as not to over-voltage or over-wattage resistors, you may still experience resistor failure. This catastrophic failure can be due to effects of the lateral electrostatic field when this field exceeds 10kV. So stop and ponder these facts: Victoreen RX3HV encapsulated resistors meet requirements of operation at more than 10kV above ground, such as use as a series filter or a bleeder string in HV power supplies. Stable and long lasting even in hostile environments, RX3HV resistors are available in values to 200 Meg with power rating to 2 watts. Specify Victoreen RX3HV resistors for circuits involving 10kV or more. Check our Applications Engineering Department for details.

*Fear of Catastrophic Failure

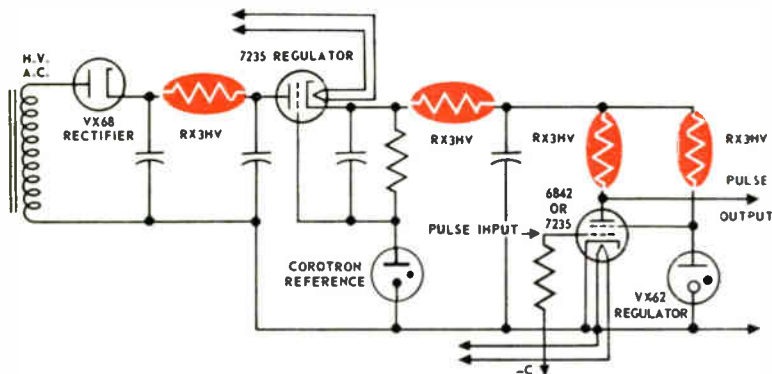

THE VICTOREEN INSTRUMENT COMPANY
5806 HOUGH AVE. • CLEVELAND 3, OHIO

A-8316A

NEW PRODUCTS

GERMANIUM TUNNEL DIODES

Cutoff freq. from 3gc to 32gc.

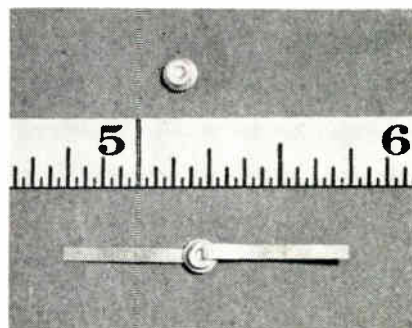

Series D4961 and D4971 have a high-peak current-to-capacitance ratio, cutoff frequencies from 3gc to 32gc, and peak currents from 2.0ma to 100ma. Storage temperature is -40°C to 100°C . Series D4961 is available in a low-inductance "pill" package for use in strip line; D4971 features the pill package with ribbon leads for welded or dip-soldered mounting. Sylvania Electric Products Inc., 1100 Main St., Buffalo 9, N. Y.

Circle 178 on Inquiry Card

ADJUSTABLE CABINETS

Struts may be repositioned to accommodate any chassis.

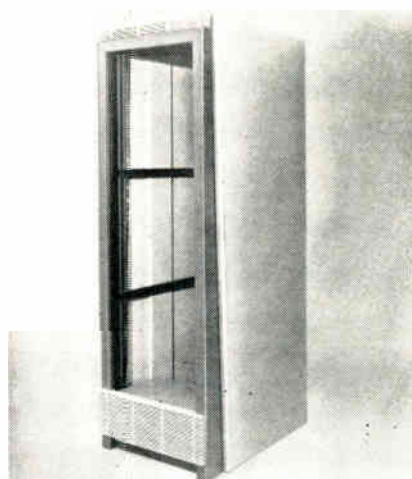

STAC single-bay cabinets offer external and internal flexibility. Spring-loaded nuts, contained in horizontal and vertical rolled channel members, allow the struts to be positioned to meet the required sizes. The nature of the channel to spring-loaded nuts arrangement allows any fine adjustments to be made in the field. Different side panels and ventilating grills allow external modifications. Columbia-Hallowell Div., Standard Pressed Steel Co., Jenkintown, Pa.

Circle 179 on Inquiry Card

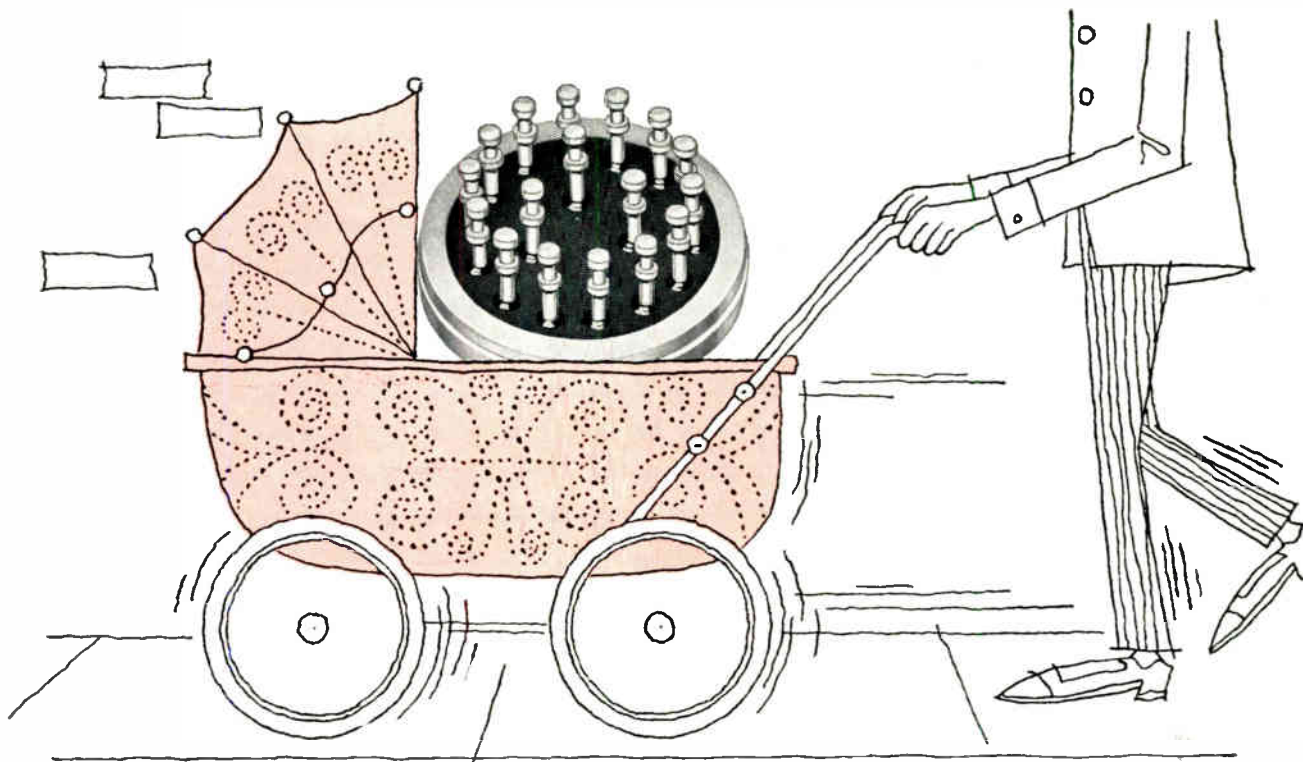

Please don't "BABY" Fusite Terminals

In our standard quality control testing procedures we twist, bend, pull and vibrate the electrodes in their glass base. We put them from dry ice to boiling water and we subject them to tremendous pressures. After a trip through this torture chamber, Fusite Terminals still check leak-proof to 1×10^{-10} std. cc/sec on a Veeco Leak Detector.

Two Reasons this is Important to You

1. Whatever your manufacturing or assembly operation, be it welding, soldering or mechanical, you need not make special concessions to Fusite Glass-to-Steel Terminals.
2. Even more importantly—no matter the conditions under which your products operate, your field failures caused by any rupture of seal between glass and metal of your hermetic terminal will be close to nil.

Why not test Fusite Terminals for yourself? Write for a sample and catalog. Dept. G-1.



THE FUSITE CORPORATION
6000 FERNVIEW AVENUE • CINCINNATI 12, OHIO

Fusite Corporation, Cincinnati, O.

Woodford Mfg. Co., Versailles, Ky.

Fusite N. V., Konigweg 16, Almelo, Holland

Fusite GmbH, Dieselstrasse 5 Karlsruhe, W. Germany

Fusite-Japan, Gotemba, Japan

SYSTEMS & CIRCUITS

A SYSTEM FOR MEASURING LIGHT INTENSITY output from a laser, by attenuating a laser output through filters and measuring the output intensity by photocells, was disclosed by the Advanced Development Lab., SURANO, Raytheon Co.

By splitting the beam into two parts with a half silvered mirror and using a filter and photocell for each beam, intensity ratios of the two

parts with and without filters may be obtained. This is sufficient information for the calibration of the filters. The filters are in turn used to calibrate the light intensity of the laser beam.

AN ELECTRONIC TRAFFIC CONTROL SYSTEM able to automatically detect, analyze and regulate all vehicles moving through a grid of 25 downtown intersections will soon

be installed in Boise, Idaho. Called the PR (Pro Rata) Traffic System, it has been purchased from Laboratory For Electronics, Inc.

In operation, overhead radar detectors will continuously transmit traffic volume and density information to the PR System Master Computer located in the City Hall. Following analysis of how many vehicles are passing through the entire area, the computer will transmit commands to local intersection controllers indicating which streets should be given the most green lights to speed up traffic flow.

Fire headquarters has Pre-emptors to clear right-of-way through the PR system areas for emergency vehicles.

SATELLITE COMMUNICATIONS radio system that eliminates eavesdropping was developed by The Bendix Corp. The space system, called CAPRI for Coded Address Private Radio Intercom, will enable the user to dial and hold a private conversation with any one of the many other users—without going through a switchboard. Many private conversations, transmitted on the same frequency, can be on the air at one time without interfering with one another.

A COMMUNICATIONS TERMINAL which provides flexible data communication and recording capability has been announced by IBM, White Plains, N.Y.

The IBM 1050 data communications system can transmit information recorded in punched cards, paper tape or edge-punched documents, as well as through a keyboard. It can receive information in the form of printed copy or punched into cards, paper tape or edge-punched documents.

These functions are performed by six separate units, any or all of which can be combined to form a single, compact system. This flexibility enables the businessman to easily vary system components as job needs change. Thus they can serve as the "nerve-endings" of a data transmission network linking a company's offices, plants and warehouses with a computer center.

The systems can communicate directly with each other, and also can be used as independent units to punch data into cards or paper tape, print documents, prepare data for transmission and convert data from one form to another. These off-line operations can be performed simultaneously with on-line data communication.



They Wanted High Reliability

To successfully build missiles and space ships all components must be constructed with the highest reliability. To illustrate the magnitude of the values involved, diametral clearances as small as 50 millionths of an inch must be maintained between some parts. Specs of dust, metal, oxides, lint, only 1/40 the diameter of a human hair can cause malfunction. As a consequence, final cleaning is of major importance.

With this knowledge, National has designed a new concept of ultrasonic "white room" cleaning that will provide predictable results of the highest reliability. This system encompasses the following: 1. Achieves the desired degree of cleanliness; 2. Recoverability of solvent; 3. Reduces rejection rates; 4. Minimum safety investment; 5. Employee acceptance; 6. High reliability; 7. Low operating cost.

For further information on this new concept of ultrasonic "white room" cleaning systems, write or call us now.



NATIONAL ULTRASONIC CORPORATION

James St., Somerville, New Jersey

Area Code 201 722-5200

ULTRASONIC CLEANING AND PROCESSING EQUIPMENT

A PROGRAMMING AID for the simulation of inventory systems has been developed by GE's Computer Dept. in Phoenix, Ariz.

Called TRIM, the new software package is an analytical tool used in the design and implementation of improved control systems. It uses a GE-225 general purpose computer, causing it to behave like a complete, single stage inventory system.

The new aid differs from the real thing in at least three ways. It is faster than an operating system on the factory floor; it can simulate 50 time periods of inventory systems activity in less than five minutes; it can explore inventory situations without a dollar being risked. Finally, it can select the best method of operation.

TRIM routines process customer demands, estimate future needs, place and receive replenishment orders, purge over-age inventory, and cancel over-extended back orders.

AN ELECTRONIC "FROG'S EYE," unveiled by the USAF's Aeronautical Systems Division, has been called the Forerunner of a new generation of information processing devices based on an animal nervous system.

The device was built by RCA, Camden, N. J., for research by ASD's Electronic Technology Lab. It performs many of the same functions as the real thing.

By duplicating the computer-like optical system of the frog, the Air Force hopes the device will lead to ways of providing data interpretation—even decisions—in fields such as air traffic control, missile detection and photo reconnaissance. It also may supply the link needed to build weapon systems that could detect targets, make decisions about what action to take against them, intercept them and order their destruction—all automatically.

RCA's version of the frog's retina is three and a half feet square, six feet long, and weighs hundreds of pounds. Functions of the frog's microscopic nerve cells have been duplicated by printed circuits, photoelectric cells, neon bulbs and relays. The model is made up of 33,000 electronic components. A photograph of the model can be found on this month's "Snapshots" page.

RADIO - FREQUENCY intensity measurements of the Milky Way galaxy have been stepped up by 1,000-mi. high rocket experiments. One result is that the number of electrons in space has now been fixed—at 15 electrons per 100 cc's.

Announcing...

COLD HEADED ROLLED THREAD

subminiatures

... now available in specials and standards, made from most cold heading wires—brass, steel, copper, 18-8 stainless steel, Monel, 18% nickel-silver.



mass produced at substantial savings in time and labor . . . with vast improvements in quality over similar parts and fasteners made on a screw machine.



Smallest diameter—approx. .020

Maximum length— $\frac{1}{8}$ "

Slots (minimum)—.010 wide, .010 deep

Threads—00.90

(other sizes will be considered.)

Knurling—dependent on wire diameter

Collar studs can be made and knurled depending on location of collar to length of stud.

Parts may be supplied with die chamfer point or straight cut off.

Hubbell cold headed, rolled thread subminiatures set a new standard for quality and economy. Heads are unusually well formed with deep, clean slots. Threads are exceptionally clean and sharp and lead threads are tapered for easier, faster starting.

Compared to screw machine operations, Hubbell cold headed, rolled thread parts and fasteners are more uniform and can be produced at faster speeds, resulting in lower costs. Product uniformity also contributes to lower costs through faster, trouble-free assembly operations, fewer rejects and more reliable end products.

HARVEY

HUBBELL

INCORPORATED

Machine Screw Department, Bridgeport 2, Connecticut

Write, or call
EDison 3-1181

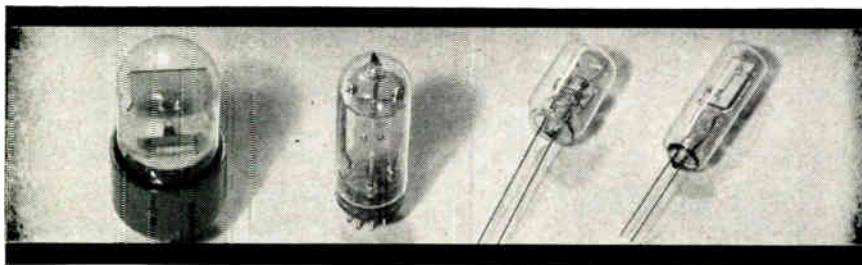

LOW FREQUENCY CRYSTALS

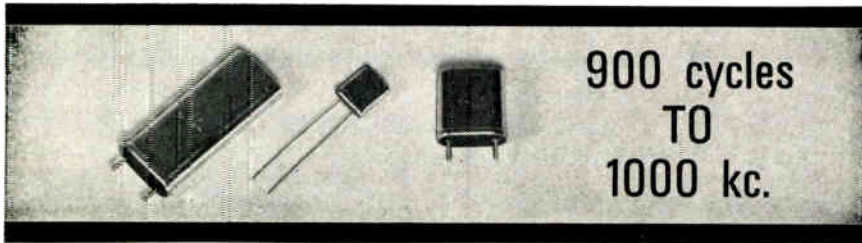

900 cycles
TO
1000 kc.

for **OSCILLATOR, FILTER** and **SPECIAL APPLICATIONS**



If a special low-frequency crystal is your current problem, tell it to Knights. The James Knights Company builds all low-frequency types to commercial or military standards, to specific requirements, in metal or glass, in all holder configurations. For a wide choice of "regular types", or for more information on special applications, write or wire:

THE JAMES KNIGHTS COMPANY • Sandwich, Ill.

Circle 88 on Inquiry Card

BIG SAVINGS

ON TINY TUBULAR PARTS

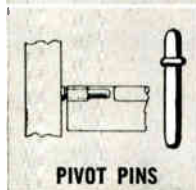
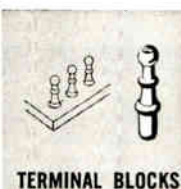
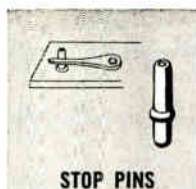
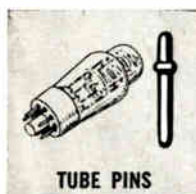

**BEAD CHAIN
MULTI-SWAGE
PARTS**

**For
Economical,
Dependable,
High-Volume
Production!**

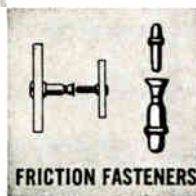

The advanced manufacturing method, developed and used exclusively by Bead Chain, swages practically any type of small tubular part from flat stock into precision forms with positive, tight seams. Diameters up to 1/4", lengths to 1 1/2".

If you can use high-volume production, we can deliver it at a much faster rate and at far less cost!

Send us a blueprint or sample and quantity requirements. We will quickly show you the big economies we can deliver.



THE BEAD CHAIN MANUFACTURING COMPANY
201 Mountain Grove St., Bridgeport 5, Conn.

Circle 89 on Inquiry Card

NEW PRODUCTS

WIRE STRIPPER

For wire sizes from #10 to 26.

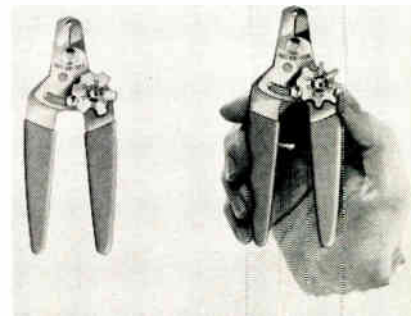

"Dial-it" is used for stripping, cutting and looping free-stripping wire. Over-all length is 5 1/2 in. The dial eliminates the possibility of error on overhead work. Available in 2 sizes: No. 227 for 10 to 20 wires and No. 228 for 12 to 26 wires. Holub Industries, Inc., Sycamore, Ill.

Circle 180 on Inquiry Card

PHASED ARRAY TWT

Beam voltage of 10kv and gain of 50db.



QKW1013 features consistent tube-to-tube performance, less than $\pm 10^\circ$ variation in phase-vs-freq. characteristic, and good power linearity across its freq. range of 1200 to 1400 mc. Employing a hybrid slow-wave structure and a modulating anode, the water-cooled tube's other specs. include a min. power rating of 5kw; duty cycle, 0.08; pulse width, 1 to 750 μ s; gain, 50db; beam voltage, 10kv; and nominal peak beam current, 2.5a. It is designed for external focusing and all connections, except r-f output, are at the gun end. Raytheon Co., Lexington, Mass.

Circle 181 on Inquiry Card

LOWER YOUR READOUT COSTS MORE THAN 40%

WITH

BINA-VIEW BINARY INPUT SELF DECODING READOUTS

ACTUAL SIZE DISPLAY

The Bina-View one plane readout combines a built-in decoder with a light-interference type display to give you the industry's most economical long life readout package... *as low as \$65.25 in 1-9 quantities!*

Decoding is accomplished electromechanically from binary input to display without relay contacts or electronic circuitry. Floating decimal point now available by lighting separate lamp.

CHECK THESE OUTSTANDING ADVANTAGES

■ **Translates Binary Codes Direct to Decimal or Alpha-Numeric Display.** Any 6-bit binary code can be used for full alpha-numeric presentation. Pure binary numeric display can be accomplished up to 38 characters using 6 bits; beyond 38 characters, BCD and multiple units must be used.

■ **Reduces Number of Conductors in Cables.** As few as 7 wires are required to operate the first of a series of Bina-View readouts. Only 1 wire for each additional unit is necessary.

■ **Low Power Requirement.** Transistor circuitry can drive Bina-View readouts directly; only 100 mw signal input per bit and 4 watts for set-up are required.

■ **Human Factors Consideration.** All characters displayed on one plane... bright distinct characters visible over 170° viewing angle... de-energized characters completely invisible.

■ **Automatic Memory.** In case of power interruption, the last character shown re-appears when operation resumes, and remains until the next character is set-up.

■ **Optional Check Back.** Binary electrical outputs corresponding to characters being displayed can be used to verify input signals or to operate remote readouts. Signals can be stored until the unit resets providing electrical data storage.

BINA-VIEW READOUT SPECIFICATIONS

Maximum Character Size: 1 3/8"

Operating Voltage: 6, 12, 24, or 48 vdc

Dimensions: 3 3/32" H x 1 7/32" W x 6 27/32" L

Number of Characters Available per Unit: Up to 38

Codes: Standard 4, 5, or 6-bit codes available

Lamp Voltage: 6 or 28v, both ac or dc

ONLY IEE ONE-PLANE READOUTS GIVE YOU SUCH VERSATILE DISPLAYS!



Up to 38 characters available for true alpha-numeric display.



Word messages can be used singly or in combination on the same character plate.



Virtually any symbol can be displayed.



Red and green color emphasis can be added; other colors available.

Write for complete Bina-View specifications. For your copy of the new IEE Readout-Message Designer's Kit, write on your company letterhead.



INDUSTRIAL ELECTRONIC ENGINEERS, INC.

5528 Vineland Avenue • North Hollywood, California • Phone: (213) 877-1144 TWX: (213) 769-1636

Circle 90 on Inquiry Card

75% smaller
than the smallest
(by volume)

new size Y Ohmite
tantalum slug capacitor



Size Y
Actual Size



Size U
MIL Size T1



Size F
MIL Size T2



Size G
MIL Size T3

ACTUAL
SIZES

NOW **7** CHOICES IN OHMITE
TANTALUM SLUG CAPACITORS



■ Size Y is the tiniest hat-shaped capacitor ever developed. Its case measures only $\frac{19}{64}$ " long with a flange diameter of $\frac{13}{64}$ " and body diameter of $\frac{1}{8}$ ". Yet this miniature unit offers characteristics equal to any of the larger sizes. Size Y meets all requirements of MIL-C-3965B.

Eleven stock values from 0.91 to 15 mfd (125 volts DC max.) are available for fast delivery. Tolerances of $\pm 10\%$ (K) and $\pm 20\%$ (M) are offered in all values. Operating temperature range is -55° to $+85^{\circ}\text{C}$.

WRITE FOR BULLETIN 159

RHEOSTATS • POWER RESISTORS • PRECISION RESISTORS • VARIABLE TRANSFORMERS
TANTALUM CAPACITORS • TAP SWITCHES • RELAYS • R.F. CHOKES • SEMICONDUCTOR DIODES



OHMITE
MANUFACTURING COMPANY
3662 Howard Street, Skokie, Illinois

OHMITE DIODES

Germanium, Gold Bonded



Standard Glass Envelope (Enlarged)

Quad in 1/2" submin. case

Quad in 3/4" submin. case

In 6H6 tube shell and base

One of industry's largest off-the-shelf selections; 90% of orders shipped same day.

IS YOUR DIODE DATA UP-TO-DATE?

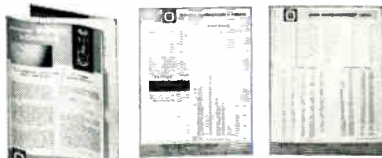

Catalog 801 Stock Price List, SR819 Interchangeability Tables, 803

OHMITE
 MANUFACTURING COMPANY
 3662 Howard Street, Skokie, Illinois
 Circle 154 on Inquiry Card
 ELECTRONIC INDUSTRIES • May 1963

NEW PRODUCTS

TEST-POINT JACK

0.504 in. high and 0.218 in. dia.

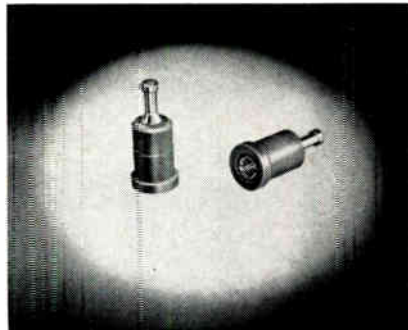

Test-point jack SKT-0806 features a beryllium-copper lug of extra length for accommodating heavy-gage wire or extra lead connections. This "Press-Fit" jack accepts an 0.080 in. diameter probe 0.187 in. long. Sealectro Corp., 139 Hoyt St., Mamaroneck, N. Y.

Circle 182 on Inquiry Card

X-RAY SPECTROMETER

Analyzes elements in different atmospheres.



The SPG-3 spectrometer can alternately analyze, without modification, elements in the periodic table from magnesium and above in air, helium, vacuum, or other atmospheres. Unit includes high-voltage power supply, x-ray tube, and detection apparatus. Independent or simultaneous photon measurement is performed by 2 counter tubes located within the vacuum chamber. Electronically controlled selection of 2 analyzing crystals—and up to 4 samples—is made from a panel outside the vacuum. General Electric Co., X-Ray Dept., 4855 W. Electric Ave., Milwaukee 1, Wisc.

Circle 183 on Inquiry Card

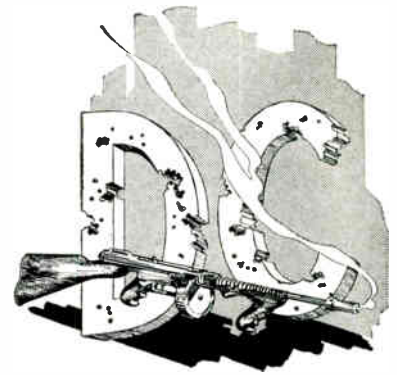

ACTUAL SIZE (Model 50A)

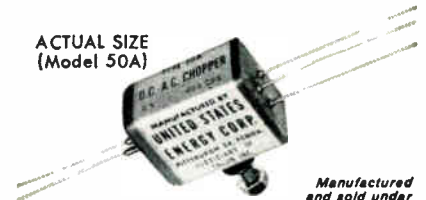

Manufactured and sold under Patent # 2,959,648 and pats. pend.

WHICH CHOPPER WOULD YOU DESIGN INTO YOUR SYSTEM?

Under certain extreme environmental circumstances, the larger chopper, pictured above, has been used with dramatic results.

Electronically, we feel that equally dramatic results may be achieved by the use of USEC's new line of Talon DC-AC choppers. Due to extremely low noise levels (in the sub-microvolt region), the new line of Talon DC-AC choppers insures vastly improved signal-to-noise ratios so necessary in small signal applications. They will withstand extremes of shock and vibration and they offer extremely high reliability and life. Operation is from a DC-450 cps 6V source and they are hermetically sealed.

Write today for complete operating specifications. Manufacturer's representatives territories are open.

usec/UNITED STATES ENERGY CORP.
 (A Subsidiary of Talon Inc.)
 300 MT. LEBANON BLVD., PITTSBURGH 34, PA.
 Telephone (412) 561-3440

Circle 94 on Inquiry Card

Get ~~QUICK~~ Cooperation from SPRAGUE on your PULSE NETWORK PROBLEMS

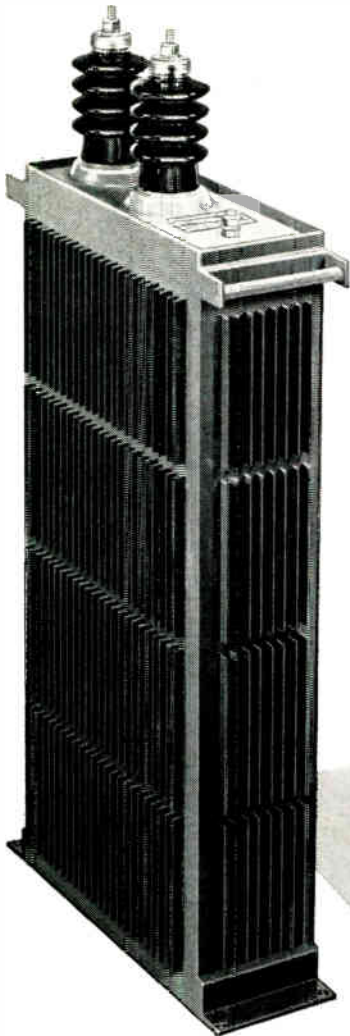

**Experienced
Systems
Engineers
At Your Service!**

Sprague has much to offer to designers of radar systems, laser systems, tube testing systems, and other specialized systems. A highly-technical special engineering section devoted exclusively to pulse capacitors and networks includes *systems* as well as pulse network engineers. We can help you with your problems because we fully understand your problems!

But Sprague service does not end here. Following up the design aspect, we can quickly and efficiently estimate pulse network sizes and prices for bidding pur-

poses. We're also equipped to give quick reaction capabilities for your breadboard and prototype units.

A pioneer in pulse networks, Sprague is a major supplier of custom units from less than 1 KV up to 500 KV over a broad range of power levels.

For application engineering assistance, or additional information, write to Pulse Network Section, Sprague Electric Company, 233 Marshall Street, North Adams, Massachusetts.

SPRAGUE COMPONENTS

PULSE-FORMING NETWORKS
CAPACITORS
RESISTORS
TRANSISTORS
INTERFERENCE FILTERS
PIEZOELECTRIC CERAMICS

PACKAGED COMPONENT ASSEMBLIES
FUNCTIONAL DIGITAL CIRCUITS
MAGNETIC COMPONENTS
PULSE TRANSFORMERS
CERAMIC-BASE PRINTED NETWORKS
HIGH TEMPERATURE MAGNET WIRE

SPRAGUE
THE MARK OF RELIABILITY

NEW PRODUCTS

SOLID-STATE TELEGRAPH RELAY

.AC isolation, 70db.

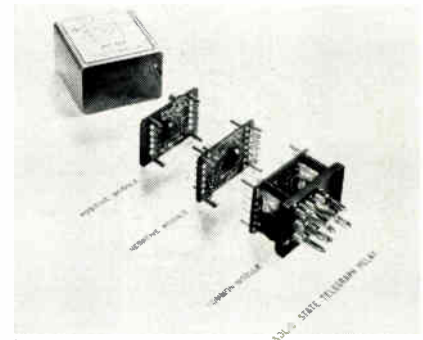

This relay provides break-before-make switching for every mode of telegraph operation ranging from 60 to 260v output with current from 15 to 200ma. It operates adjustment-free with minimum electrical radiation, and plugs-in to directly replace mechanical relays. Philco Corp., Lansdale, Pa.

Circle 184 on Inquiry Card

MOTOR GENERATOR

Weights 7 oz; overall length is 2.775 in.

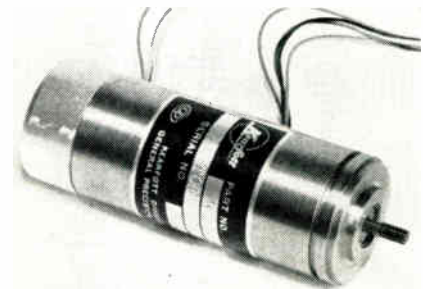

CRO 0875 670 is a size 11 temperature-compensated integrating motor generator for accurate advanced systems. A 115v, 400-cycle unit, its output characteristics are: in-phase position error, 0.0025v; quadrature position error, 0.005v; in-phase axis error, 0.0035v; quadrature axis error, 0.007v; volts/1000rpm, 2.75v; and phase shift, 0°. Mechanical characteristics: no load speed, 6400; rotor inertia, 5.5gm cm²; stall torque, 0.75 in. oz.; theoretical acceleration 9600 rad/sec². General Precision Aerospace, Kearfott Div., 1150 McBride Ave., Little Falls, N. J.

Circle 185 on Inquiry Card



ANTENNA PERFORMANCE

IN A CLASS BY ITSELF

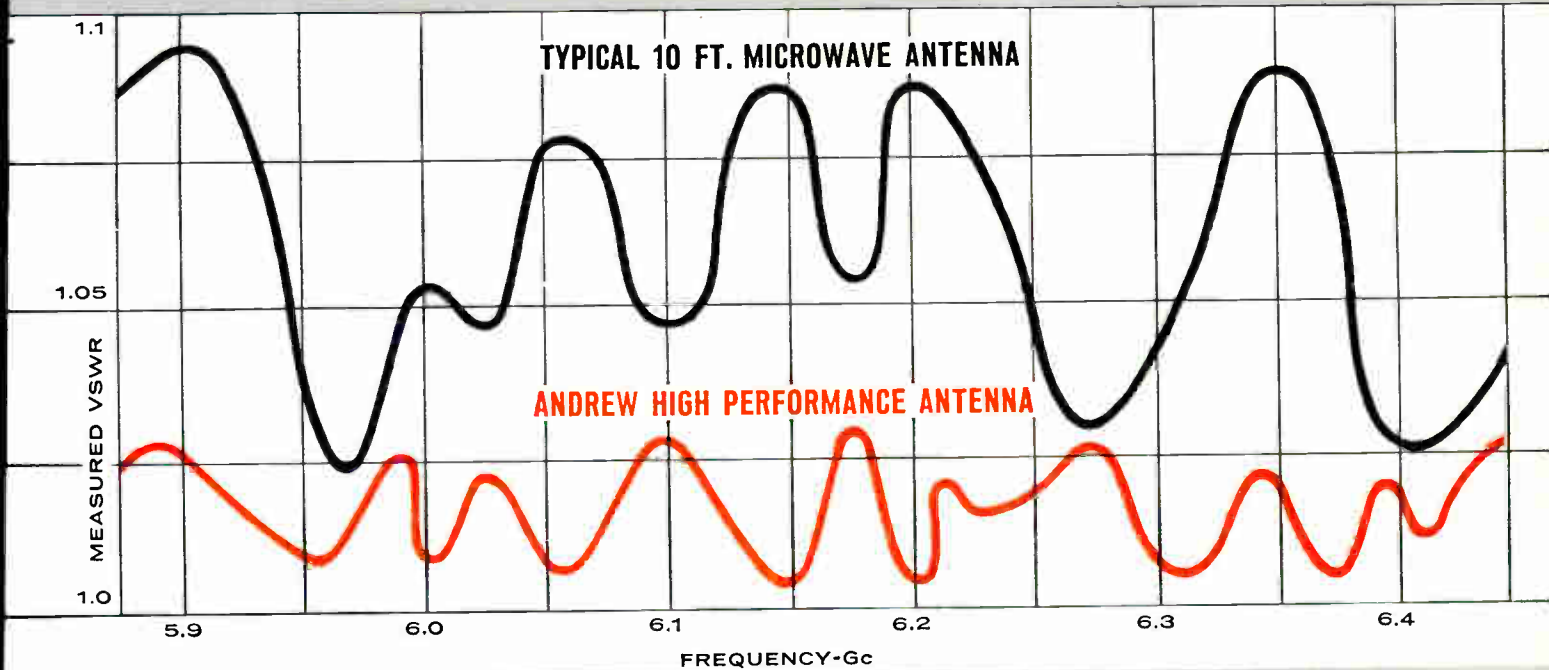

COMPOSITE E & H PLANE PATTERN



The certification of each individual antenna in this line is your assurance of high performance with low VSWR. Specially designed for signal congested areas, the Andrew High Performance Microwave Antenna is shielded to reduce the wide angle lobes and to increase the front to back ratio. A reinforced back frame provides an extremely stable system and keeps the antenna pointed on the path after installation. New radomes, engineered specifically for high performance characteristics, maintain gain efficiency of basic antenna. Write or call your Andrew sales engineer for complete information.

NEW
high performance
Microwave
Antenna

5925-8250 Mc



Andrew

P. O. BOX 807, CHICAGO 42, ILLINOIS

BOSTON
NEW YORK
WASHINGTON, D. C.
LOS ANGELES
TORONTO

Circle 100 on Inquiry Card
World Radio History

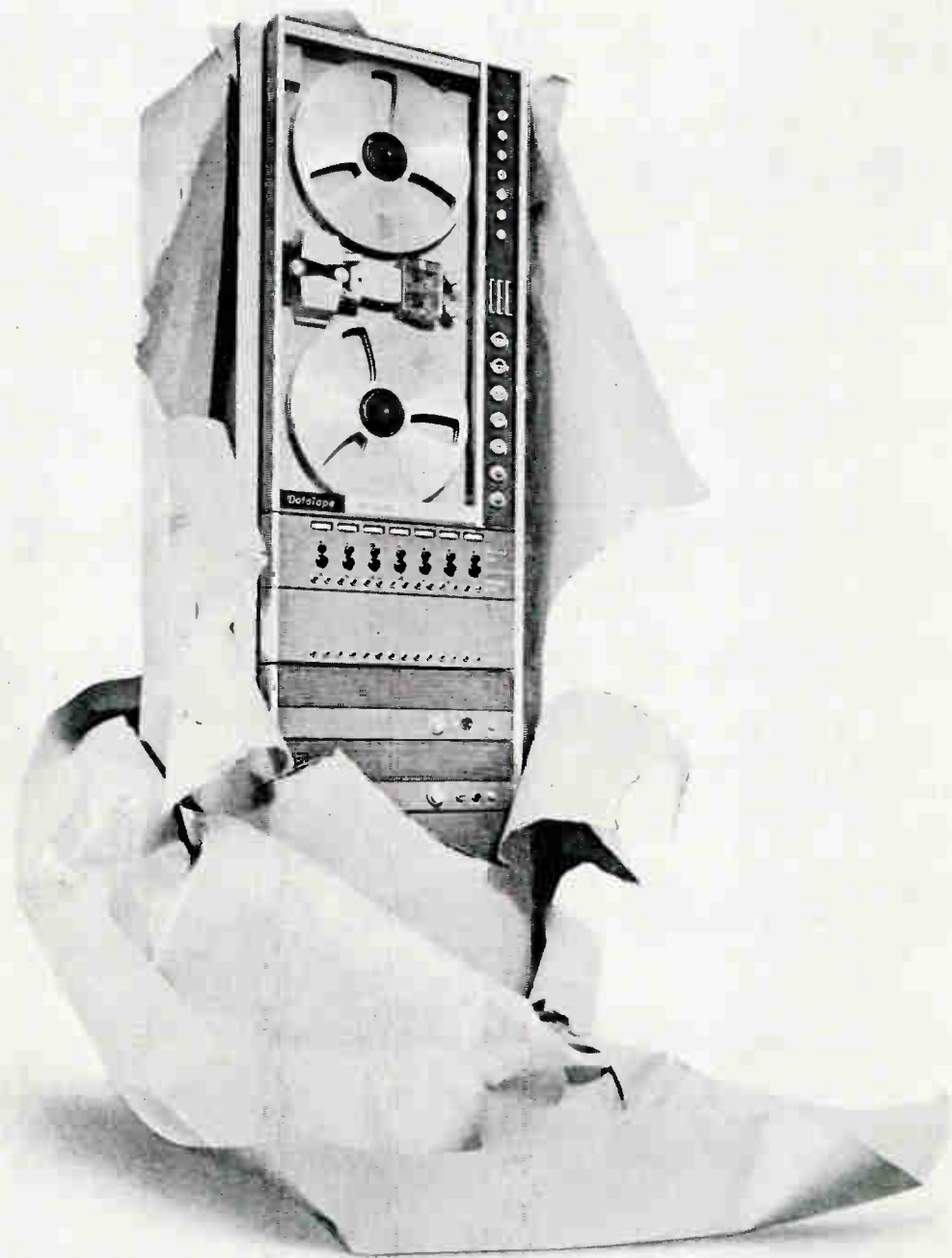

Who's delivering 1.5 mc recorders to working specs? (CEC. That's who)

Here's the *first* 1.5 mc recorder sold to working specifications — CEC's VR-3600. This means specs that are practical from the users viewpoint—all met with one set-up of the tape system, not with separate adjustments before each test.

It's been proven with units built and delivered in quantity.

And the VR-3600's outstanding specifications make it a "state-of-the-art" system, with performance superior to any comparable instrumentation in the extremely wide bandwidth, multi-channel field. Each of the unit's 7 or 14 record/reproduce channels can be used for data storage in the

100 kc to 1.5 mc frequency range... with high signal-to-noise and low distortion characteristics.

The direct system has a full 1.4 mc bandwidth, fully amplitude and phase equalized, with less than 2% harmonic distortion. No intermodulation product exceeds 0.75%, and phase response is held to within 0.2 usec.

In the tape transport, skew is under $-.30$ usec., flutter is less than 0.30% p-p at 120 ips, tape is constantly cleaned by a vacuum/ionization device and tension is held smoothly constant by a closed-loop servo.

Contact your local CEC sales representative, or write for Bulletin 3600-X12.



CEC
Data Recorders Division

CONSOLIDATED ELECTRODYNAMICS

A Subsidiary of Bell & Howell • Pasadena, California

2 more ways to measure with CEC

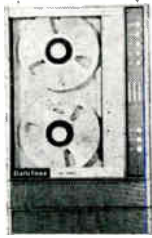

You get twice the bandwidth capability of conventional machines at equivalent speeds with two other CEC wide band tape systems, the VR-3300 portable and the VR-2800. Bandwidth of direct recording/reproducing is 100 cps to 200 kc; 0 to 20 kc with wide band FM techniques. They're designed to fill gaps between the workhorse 100 kc models and more sophisticated machines. Solid state for greater inherent reliability, CEC's VR-2800 and VR-3300 feature standard EMA rack mounting and can be used in the lab, van, ship or block-house. Both systems are available for 7 channel (1/2" tape) or 14 channel (1" tape) operation. Interchangeable electronics means economy in support spares. Further data? Call CEC or write for CEC Bulletins 2800V-X25 and 3300V-X18.

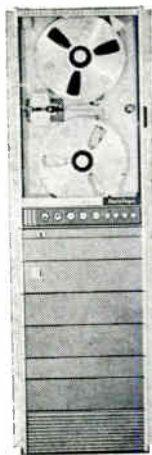

CEC
Data Recorders Division

CONSOLIDATED ELECTRODYNAMICS
A Subsidiary of Bell & Howell • Pasadena, California
Circle 96 on Inquiry Card

NEW PRODUCTS

LV ZENER DIODE

Includes voltages of 3.9 to 7.5v.

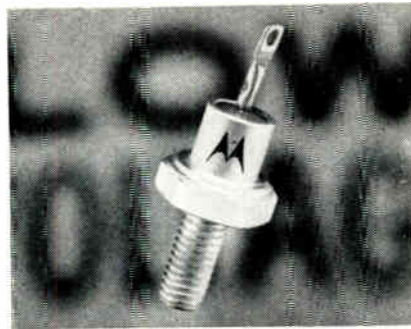

Types 1N3993—4000 extend Motorola's 10w zener diodes to include 3.9 to 7.5v. These alloy-junction transistors have junction and storage temperatures from -55 to $+175^{\circ}\text{C}$, and tolerances of ± 5 and 10%. Motorola Semiconductor Products Inc., Box 955, Phoenix 1, Ariz.

Circle 186 on Inquiry Card

BEAM-TYPE PENTODE

Plate voltage of 5kv.



The VX-76 beam-type pentode can be used as an amplifier, or as a regulating tube in series or shunt-regulator circuits. Transconductance is 4000 micromhos. Normal life exceeds 1000 hrs.; withstands shock to 500G, and vibration to 10G. Weight is 3 oz. Electrical characteristics: 100ma maximum peak and 10ma average plate current, 10w plate dissipation, heater cathode voltage (Ehk) $\pm 300\text{v}$, heater voltage (Ef) 6.9 max., and 5.7 min. vac/vdc, envelope temperature 200°C max. The Victreen Instrument Co., 5806 Hough Ave., Cleveland 3, Ohio.

Circle 187 on Inquiry Card

LET ZERO SOLVE
YOUR PACKAGING PROBLEMS

deep drawn
aluminum and
magnesium boxes
and covers
18,000 standard
sizes and shapes —
no tooling cost!

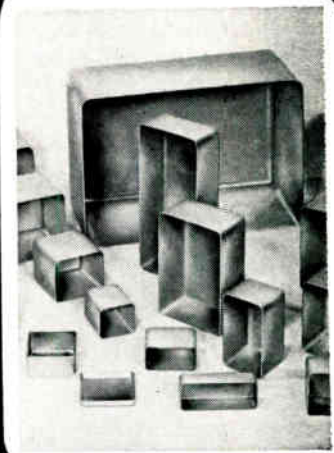

Choose from more than 18,000 standard sizes and shapes... large and small... rectangular, square and round... pay no tooling charge! Fast delivery—usually from stock. All can be trimmed, modified and customized to your specifications at lowest cost... accessories, handles, brackets, latches, etc., added... holes and louvers punched. Complete paint facilities, too. Send print or contact your Zero sales engineer for quotes on custom drawn parts using exclusive "Zero-Method."

write today for new
32-page zero
stock box catalog

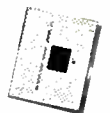

ZERO MANUFACTURING CO.
1121 Chestnut Street, Burbank, California
Telephone Victoria 9-5521 area code 213
TWX 213-846-8094
Factories in Burbank, Calif. & Monson, Mass.

Circle 97 on Inquiry Card



**KEEP
PURE WATER
PURE TO
POINT OF USE**



**WITH
BARNSTEAD
TIN LINED PIPING**

With Barnstead Tin Lined Piping you can distribute distilled or demineralized water to any point in your plant or laboratory without fear of contamination. Combining the desirable characteristics of pure tin plus the strength and durability of metal pipe, tin lined piping, fittings and valves can be enclosed in floors or walls permanently. Gooseneck faucet with self-closing handle may be either wall or bench mounted.

Faucets come complete with accessories for through-wall mounting.

Tin lined pipe is standard weight brass pipe lined with pure block tin 1/16" in thickness. Tin threads on pipe are screwed into tin threads within the fitting to insure tin-to-tin contact. No special tools or skills are needed. No plumbing problems.

NEW BULLETIN #180 describes the complete line of Barnstead tin lined pipe, fittings, faucets and valves. Write for your copy today. Consult Barnstead, Pure Water Specialists since 1878.

Barnstead
STILL AND STERILIZER CO.

51 Lanesville Terrace, Boston 31, Mass.
Circle 99 on Inquiry Card

NEW PRODUCTS

GAS LASER

Capable of transmitting speech signals.



The r-f generator which excites this laser is equipped with amplitude modulation facilities. A microphone input modulates the laser beam which, when detected, can be used to transmit speech or music. Special confocal mirrors have a max. reflectivity at 6328 Å, providing its highest magnification factor (Q) at this wavelength. It produces 1mw (cw) continuous wave at 6328 Å. Excitation is at 50mc, about 30w r-f. Maser Optics, Inc., 89 Brighton Ave., Boston, Mass.

Circle 188 on Inquiry Card

RECEIVER/DECODER

Provides an on-off channel for auxiliary control.

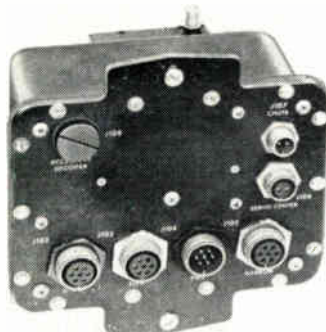

AN/ARW-79 is a receiver with proportional control decoder for controlling pilotless aircraft and missiles. It operates in conjunction with an airborne gyro to provide automatic flight stabilization. Attitude commands are transmitted by a dual-channel pulse-modulated control system. An accessory decoder, designated KY-489/ARW-79, provides 6 additional on-off command channels. RS Electronic Corp., 795 Kifer Rd., Sunnyvale, Calif.

Circle 189 on Inquiry Card

CERMET TRIMMER

Resistive range of 100Ω to 500Ω.

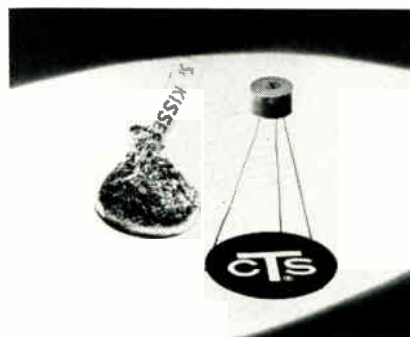

CeraTrols[®] Series 385 has infinite resolution, good high-freq. characteristics, 1/2 to 5 oz. in. turning torque, 1 lb. in stop torque and -65°C to +175°C operating temperature range. Rating is 1/8w at 125°C derated to zero load at 175°C with a maximum of 200 vdc across resistance element. Diameter is 11/32 in. Trimmer exceeds performance specs. of Mil-R-94B. Ceramic substrate allows high overload capacity. CTS of Berne, Inc., a sub. of CTS Corp., Berne, Ind.

Circle 190 on Inquiry Card

DC POWER SUPPLY

0.001% regulation over a line change of 105 to 125v.

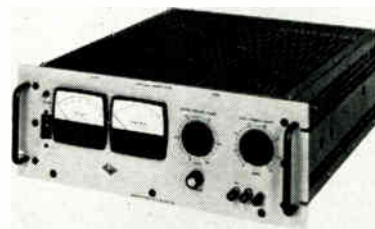

Model TCR-30-100 delivers 0 to 100v at up to 30a. It features constant voltage or constant current operation with automatic mode transfer. Maintains 0.01% (10mv max.) regulation for full load charge. In the constant current mode, line regulation is 0.02% (6ma max.) and over full voltage compliance it is 0.05% (15ma max.). Behlman-Invar Electronics Corp., 1723 Cloverfield Blvd., Santa Monica, Calif.

Circle 191 on Inquiry Card

DALE

RELIABILITY...

build it into your circuit with
RS and HS Miniature Power Resistors

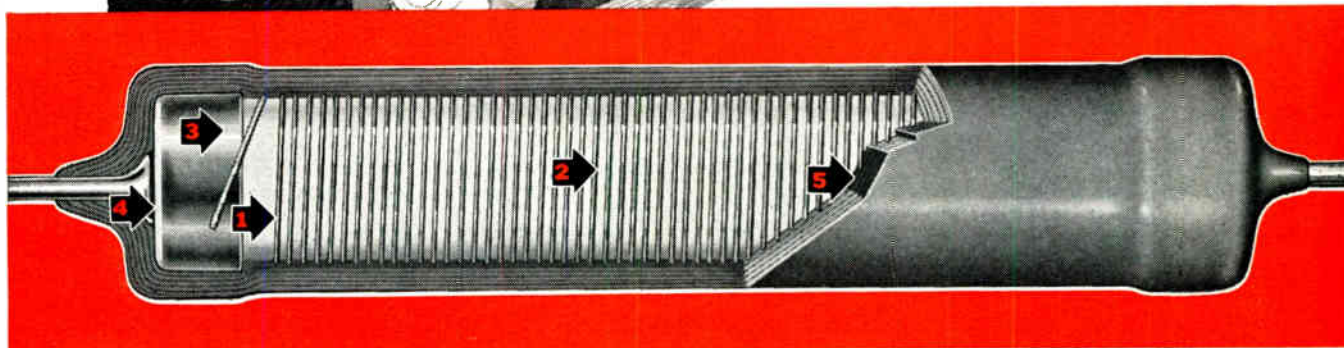

DALE pioneered the silicone coating which gives these precision power resistors outstanding environmental protection. An additional benefit is the assurance of **INHERENT STABILITY** which has resulted from Dale's vast experience in the technology of winding fine resistance wire. Operating temperatures range from -55° to 350° C. RS (up to 275°) and HS (up to 350°) resistors feature low temperature coefficient and long life stability in a broad range of sizes from $\frac{1}{4}$ to 13 watts. Dale's participation in the **MINUTEMAN** High Reliability Component Development Program has provided new levels of achievement in design and processing of resistors. Add reliability to your circuit by specifying Dale RS and HS Resistors. Available with weldable leads.

SPECIFICATIONS

• RS available in nine sizes ($\frac{1}{4}$, $\frac{1}{2}$, 1, 2, 2.5, 3, 5, 7, 10 watts)
HS available in eight sizes (1.25, 3, 3.25, 3.75, 4.25, 6.5, 9, 13 watts) • Continuous operating temperatures: -55° to 275° C. for RS; -55° to 350° C. for HS • Meet functional requirements of MIL-R-26C. (RS meets characteristic G) (HS meets characteristic V) • Resistance range from 0.05 ohm to 175K ohms, depending on type and tolerance • Tolerances: 0.05%, 0.1%, 0.25%, 0.5%, 1%, 3% • Temperature coefficient: 0.00002/degree C.

HERE'S HOW DALE "BUILDS IN" RELIABILITY

- ➡ **CENTERLESS GROUND** cores of high purity ceramic untouched by hand or foreign material assure that wire lays firmly and uniformly, eliminating local hot spots.
- ➡ **RIGID SPECIFICATIONS** must be met by all resistance wire (analysis of each melt required). Tension accurately controlled, pitch limited to 200% minimum. Untouched by hand or foreign materials.
- ➡ **NON-CORROSIVE** stainless steel used for end caps assures good weldability and ideal mechanical properties.
- ➡ **COMPLETE WELDED CONSTRUCTION** from terminal to terminal. Welds tested on sample basis to destruction.
- ➡ **OUTSTANDING PROTECTION** against thermal shock, moisture and mechanical damage is provided by a laminated coating made up of many thin coats of silicone. Each coat is cured at a temperature higher than the maximum operating temperature of the resistor, thus providing an automatic normalizing process and a coating free of pinholes, cracks or blisters.

COMPLETE TESTING PROGRAM: 100% final resistance check; Hipot test in excess of requirement on sampling basis; complete military specification environmental test on sampling basis.

Write for Dale Resistor Catalog A

DALE ELECTRONICS, INC.

1304 28th Avenue, Columbus, Nebraska

A subsidiary of THE LIONEL CORPORATION

Also Made and Sold by Dale Electronics Canada, Ltd., Toronto, Ontario, Canada

SEE OUR SPECIFICATIONS IN
VSMF
THE MICROFILM CATALOG FILE

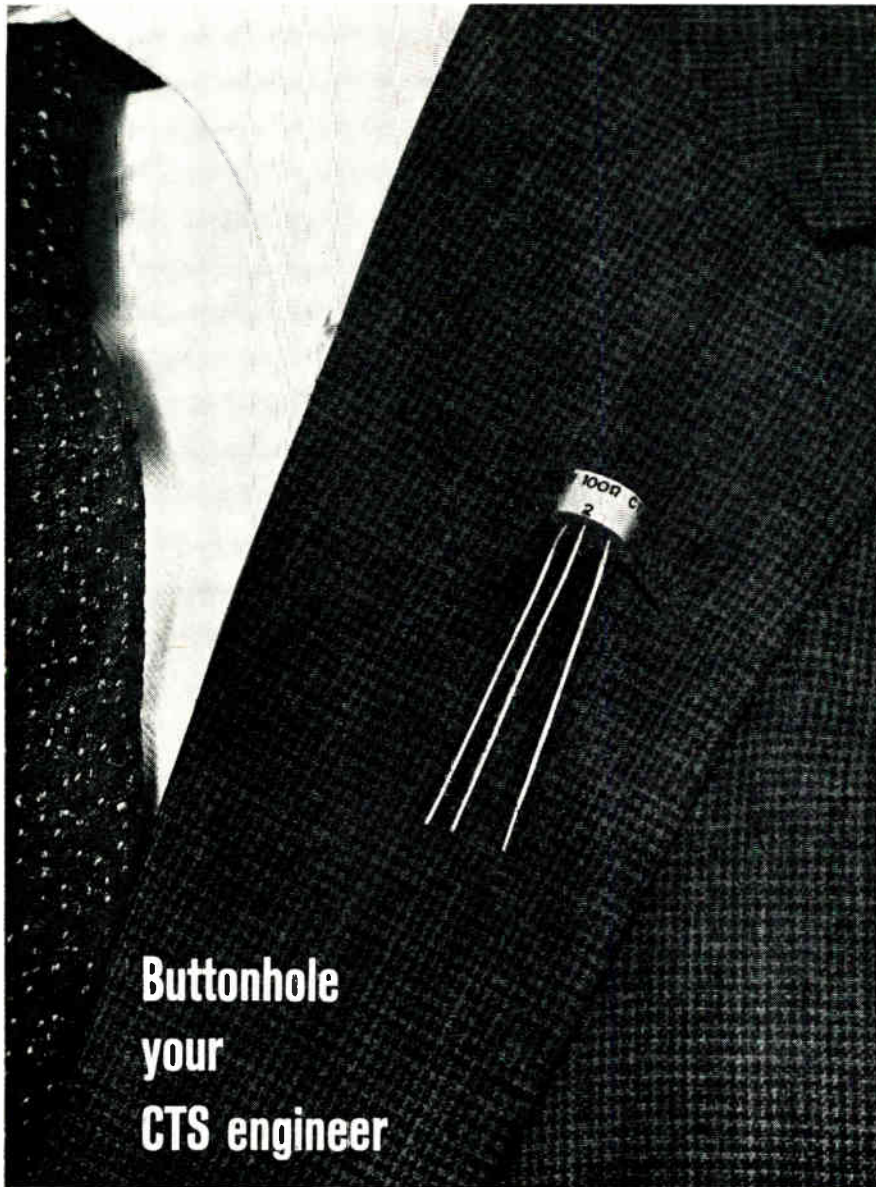

Buttonhole
your
CTS engineer

ask him about the new 11/32" dia.

CERMET TRIMMER POTENTIOMETER

The new 11/32-inch diameter TO-5 transistor size Cermet Trimmer Potentiometer, Series 385, has an exceptionally wide resistance range of 100 ohms to 500K ohms, high stability and reliability under extreme temperatures and severe environmental conditions. Its ceramic substrate offers superior heat sink capabilities, permitting even heat dissipation and preventing hot spot temperatures. Rating is 1/4 watt at 125°C derated to zero load at 175°C with a maximum of 200 VDC across resistance element. Exceeds performance specifications of MIL-R-94B. Ask your CTS engineer for more information.



CTS OF BERNE, INC.
BERNE, INDIANA

SUBSIDIARY OF **CTS CORPORATION** • ELKHART, INDIANA

NEW PRODUCTS

FREQUENCY CONVERTER

Model PS-62-66 is rated at 3500va.

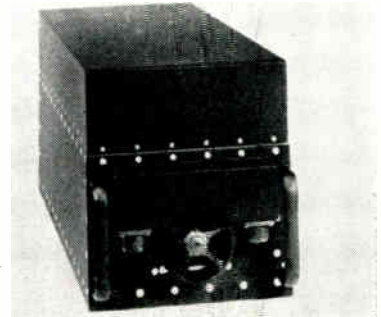

This all silicon, solid-state unit converts 400 cps to 60 cps without the use of a 60-cycle power transformer. Efficiency rating exceeds 90%. The sinewave output contains less than 5% harmonic distortion. It meets the requirements of Mil-E-5400, Class I, Mil-1-26600, and other applicable military specifications. Unitron Inc., Box 1331, Garland, Tex.

Circle 192 on Inquiry Card

WAVEFORM ANALYZER

Contains a digital computer.

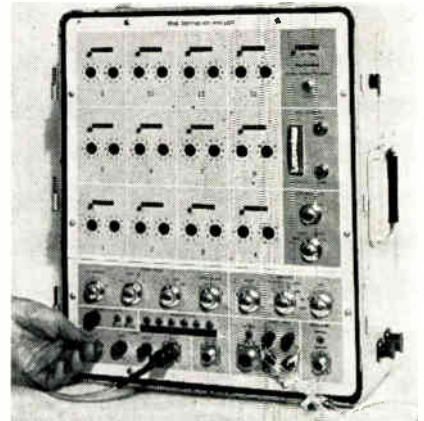

Instantaneous and cumulative direct read-out data, useable for field-load data acquisition, vibration analysis, load monitoring, life evaluation, damage analysis, and fatigue studies, are displayed on the Hughes Peak Distribution Analyzer. Designed for field or lab use, it is equipped with a built-in digital computer. The instrument weighs approx. 55 lbs, measures 10 3/4 x 16 1/2 x 20 in., and operates on 12 vdc. The direct readout eliminates the need for oscillograph tape to record test results. Hughes Aircraft Co., P. O. B. 90515, Los Angeles 9, Calif.

Circle 193 on Inquiry Card

NEW PRODUCTS

TEMPERATURE TELEMETERS

Measure from -200°F to $+4000^{\circ}\text{F}$.

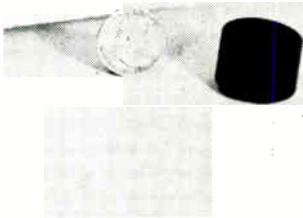

Four miniature (volume of $\frac{1}{2}$ to 2 cu. in.) temperature telemeters measure from -200°F to $+4000^{\circ}\text{F}$. Encapsulated in epoxy, these elements are almost environment proof. They have withstood over 10,000Gs and can be immersed in oils or water. Industrial Electronics Corp., P. O. Box 862, Melbourne, Fla.

Circle 194 on Inquiry Card

A/D CONVERTERS

Zero drift held to 0.005%.

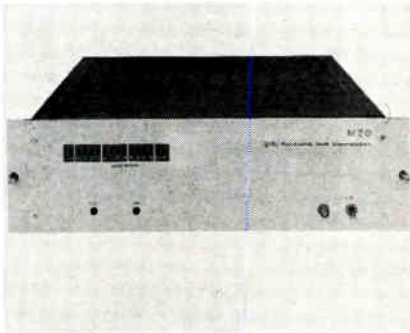

M20 and M21 are high-speed analog-to-digital converters. The M20 is a 30kc converter, producing 30,000 15-bit conversions/sec. ($2\mu\text{sec/bit}$); the M21 is a 70kc converter, handling 70,000 12-bit conversions/sec. ($1.2\mu\text{sec/bit}$). Converters offer: elimination of multiple converters; accurate and practical digitizing of shock, vibration, electrical network and acoustical data; reduction or elimination of dispersion or skew error; on-line digitizing of telemetry data; choice of serial or parallel binary or decimal digit output. Packard Bell Computer, 1905 Armacost Ave., Los Angeles 25, Calif.

Circle 195 on Inquiry Card

CHOOSE YOUR 1 MC TIME BASE



1 PPM PER DAY OR 0.1 PPM PER DAY OR 0.01 PPM PER DAY

Bulletin 533 Available

- PRECISION GLASS MOUNTED QUARTZ CRYSTALS . . .
- TRANSISTORIZED CIRCUITRY . . . PLUG-IN CRYSTAL OSCILLATORS

Bliley ...if you buy quality

BLILEY ELECTRIC COMPANY • ERIE, PENNSYLVANIA
Circle 102 on Inquiry Card

MAKING ROOM AT THE TOP

EICO creates a new, professional lab quality test instrument series at moderate prices.



EICO®

AC VTVM & AMPLIFIER
#250

Kit \$49.95, Wired \$79.95

VTVM: 12 ranges from 1mv to 300v rms; response absolutely flat from 10 cps to 600 kc; input impedance 10M Ω shunted by 15 μf ; accuracy $\pm 3\%$ of full scale.

Note: Average responding meter calibrated in rms. Linear 0-1, 0-3 scales. Decibel scales based on 0db=1mw in 600 Ω with 10db interval between ranges.

AMPLIFIER: 60db gain on 1mv range; response +0, -3db from 8cps to 800kc; output to 5v rms undistorted, variable down to zero by attenuator control at output; input impedance 10M Ω , output impedance 5K Ω ; hum & noise -40db for signal inputs above 2mv.

DESIGN QUALITY: All frame-grid tubes; 60db frequency-compensated input attenuator ahead of cathode follower with 10db/step attenuator following; two-stage R-C coupled amplifier and full-bridge meter circuit in one overall feedback loop; no response adjustment required in amplifier circuit; single sensitivity adjustment; voltage-regulated power supply. 50/60 cycle operation.

EICO MODEL 255 AC VTVM
Identical to Model 250 described above, but less amplifier facility. 50/60 cycle operation.
Kit \$44.95 Wired \$72.95

See the 41 additional EICO instruments helpful for your lab and line work. Write for free catalog and name of neighborhood distributor.

EICO® Dept. EIN-5
3300 N. Blvd., L.I.C. 1, N. Y.
Export Dept.: Roburn Agencies, Inc.
431 Greenwich St., N. Y. 13, N. Y.

Add 5% in the West.

23 FEATURES

TO SPEED AND SIMPLIFY

Precision Impedance Measurements

AC DETECTOR OUTPUT—Ac detector signal may be applied to oscilloscope or external meter when desired.

SYNC—Sync signal for use with oscilloscope presentation.

DC GENERATOR VOLTAGE—High and low voltage supplies to cover a wide range of resistors. Power limited for bridge and component protection.

POLARITY SWITCH—Polarity reversal for eliminating errors caused by thermal voltages and for changing meter deflection direction.

LID INFORMATION—Abbreviated operating instructions speed measurements for occasional users. Control names, bridge functions and circuit diagramming always in sight to aid in unusual applications.

LIGHT BEAM GALVANOMETER—High sensitivity oil damped torsion suspension no-stick galvanometer for accurate dc measurements even at range extremes.

SENSITIVITY—Wide range of meter sensitivity for rapid nulling. Switches have both momentary and fixed positions.

METER ZERO—Electrical meter zero to set galvanometer and balance out thermal voltages.

DAMPING—Galvanometer can be operated near critical damping with any applied resistance.

METER—Sensitive meter gives easy-to-read ac null indication. Can be easily calibrated by detector sensitivity controls for deviation or difference readings.

DUAL ELECTRON RAY INDICATOR—High and low sensitivity electron ray sections with logarithmic response provide rapid initial null indication.

DETECTOR—Sensitivity can be set to give best performance or to calibrate detectors for deviation measurements.

GENERATOR—Applied voltage can be changed to give optimum measurement conditions.

FREQUENCY—Plug-in unit changes tuning of oscillator and both stages of sensitive detector.

DEKASTAT ADJUST—External resistance can be added to extend the range of the value dials or to cancel the effect of lead resistance.

VALUE—Three decade step switches and a 100 position rheostat combine to give 120,005 division resolution.

RANGE—Seven ranges of values can be chosen and indicated in the reading line.

IN-LINE READING—The measured value is read in one straight line across controls.

UNKNOWN TERMINALS—The same terminals are used for all unknown components. The adjacent ground post is used for three-terminal measurements.

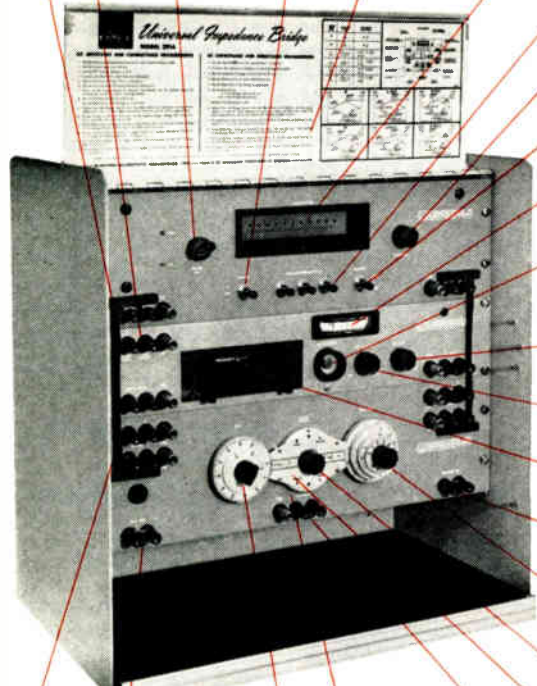

GENERATOR - DETECTOR CONNECTIONS—Connections can be quickly and easily changed for ac resistance measurements and for adding dc bias for capacitance and inductance measurements.

D-Q ADJUST—External controls can be added to give greater range or resolution to readings of D or Q.

CIRCUIT—Six bridge circuits can be chosen for: Resistance, Conductance, Series Capacitance and D, Parallel Capacitance and Q, Series Inductance and Q, Parallel Inductance and D.

D-Q DIALS—Three ranges of D and Q are provided to give accurate measurements over the widest practical range.

MODEL 291B UNIVERSAL IMPEDANCE MEASURING SYSTEM

Seven ranges of inductance, capacitance, resistance and conductance. Three decades of D and Q. Five place readings. Resistance and conductance accuracy to $\pm 0.05\%$ Inductance and capacitance accuracy to $\pm 0.1\%$. Ac and dc generators and detectors specifically designed for use with the bridge assure ample sensitivity for attaining any specified accuracy throughout the measurement range. Complete system in metal cabinet, \$1125.00, f.o.b. Portland, Oregon. For detailed information, send for Catalog Sheet C-13.

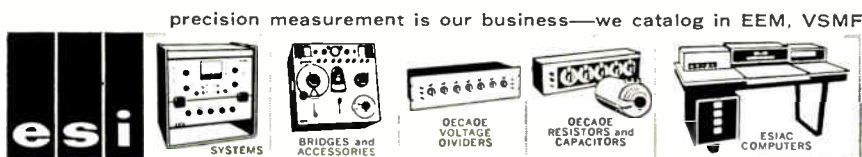

Electro Scientific Industries
7524 S.W. Macadam Avenue • Portland 19, Oregon • Area Code 503, 246-3331

NEW PRODUCTS

CAPACITOR MICROELEMENTS

Ceramic wafer is 0.310 in. sq. and 0.10 in. thick.

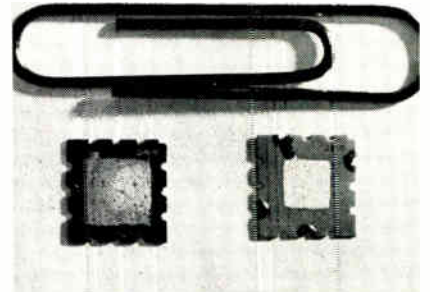

Two types of single-layer ceramic-capacitor microelements for micromodule circuitry are available. These temp. compensating capacitors, types MMC and MMG, are rated at 100 VDCW and have a capacitance range of 4.7 to 400mmf. Operating temperature range is -55°C to $+125^{\circ}\text{C}$, and a minimum insulation resistance is 10,000 megohms. Cornell-Dubilier Electronics Div., Federal Pacific Electric Co., 1605 Rodney French Blvd., New Bedford, Mass.

Circle 196 on Inquiry Card

TRANSFORMER

Frequency of 200cps—15kc.

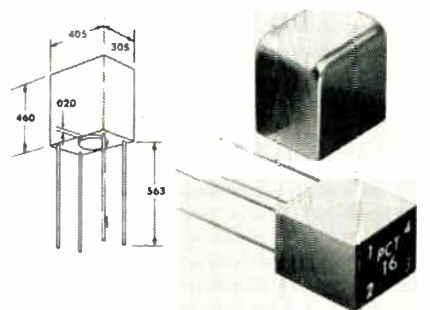

Type PCT-16 is a ultraminiature transformer for transistor servo amplifiers and demodulator circuits. It is a low-level, high-impedance, hermetically-sealed, input transformer that meets the specifications of Mil-T-27A. Primary and secondary impedances are each 250K Ω , zero unbalanced dc in primary. DC resistances are 3500 Ω for primary, 4500 Ω for secondary. RMS test voltage is 500v, power level is $\frac{1}{2}$ mw. Insertion loss is approx. 1.75db at 1000 cycles. Freq. range is 200cps—15kc. Stancor Electronics, Inc., 3501 Addison St., Chicago 18, Ill.

Circle 197 on Inquiry Card

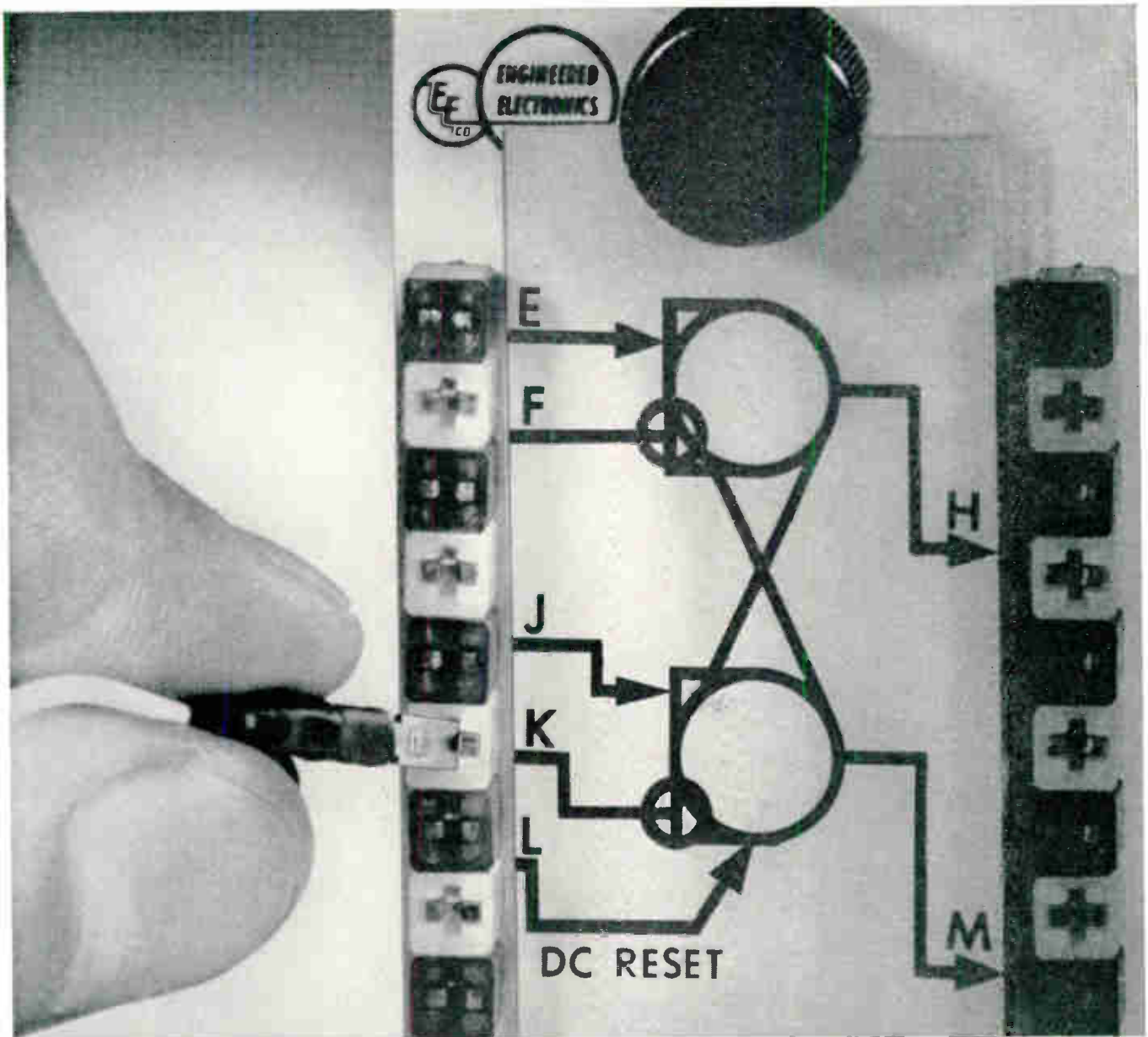

HOW TO BREADBOARD A 10 MC DIGITAL SYSTEM—FAST

Your fastest, surest means is EECo's new high-speed system breadboard. This transistor unit lets you: (1) patch up trial circuit combinations with the same catalog modules that go into the final system, (2) perform tests at operating frequencies by pushbutton and (3) get a "stop-action" look at the over-all logic flow.

Using patchcords, you can hook up, take down or change circuitry at will to study the effects of wiring, propagation delay, clock duty cycle and alternative design approaches. And, because you use field-proven modules in the breadboard, you know that the final system will work.

EECo equipment has no equal for practicality or versatility. It is com-

pletely self-contained, but has provision for external test equipment. The built-in clock source lets you apply pulses singly or in pairs. You may operate the system slowly to watch individual operations or at high speeds to simulate end-system performance. To help you patch your circuits together, EECo provides handy symbol cards — cards that indicate module circuitry, part numbers and input-output pin connections to give you a road map of the system as you assemble it.

The more you value your time and ability, the more you can benefit by using EECo breadboard equipment. Write today for the full story.

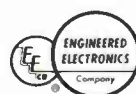

ENGINEERED ELECTRONICS Company
1441 East Chestnut Avenue, Santa Ana, California
Telephone 547-5651 • Cable Address: Engelex

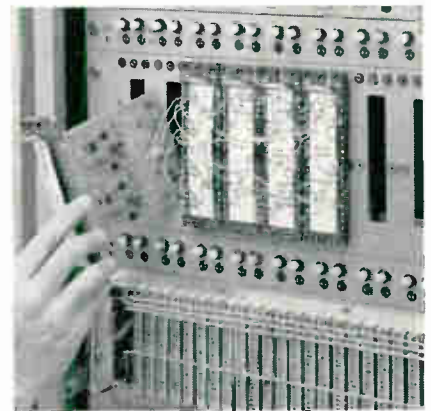

Breadboard (first stage shown) uses standard EECo catalog modules, permits pushbutton tests at operating frequencies.

See EECo products in Booths 122 and 124 at the Spring Computer Conference.

INSTANT COLOR!

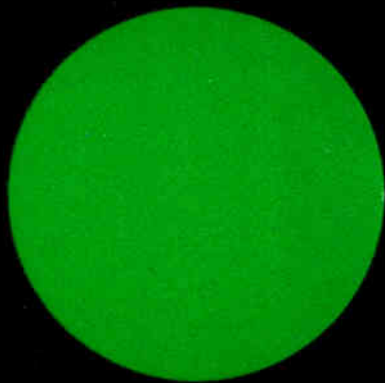

**CHANGE COLORS OF
CLEAR INCANDESCENT
MINIATURE LAMPS
INSTANTLY with**

**SILIKROME™
COLORED FILTERS**



Easily slips over lamp

● Elastomeric, unbreakable, reuseable

Send for **FREE SAMPLES** and literature

APM-HEXSEAL CORP.

**SILIKROME™
DIVISION**

41K Honeck St., Englewood, N. J.
Tel.: (201) LO 9-5700

SEAL WITHOUT REDESIGN WITH HEXSEALS*
SEELSKREWS* SEELBOLTS* SEELRIVITS*
RUBRGLAS-SEELS* SILICORINGS* *Trade Mark

Circle 107 on Inquiry Card

NEW PRODUCTS

SUBMINIATURE CONNECTORS

Meet requirements of MIL-STD-202A.

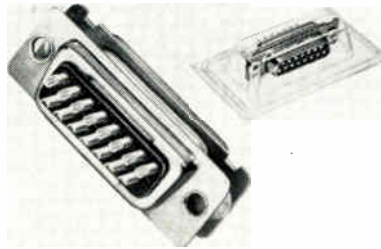

Type "D" subminiature, high-contact density connectors are suited for aircraft, missile, and ground support installation. Junction shells with integral clamp make them adaptable for cable attachment. Shells are cadmium-plated steel with a yellow chromate supplementary coating, and exceed the moisture resistance, vibration, and shock test requirements of Mil-STD-202A. Cinch Mfg. Co., 1026 So. Honan Ave., Chicago 24, Ill.

Circle 198 on Inquiry Card

FERRITE-SWITCH ATTENUATOR

Max. insertion loss of 1.3db.

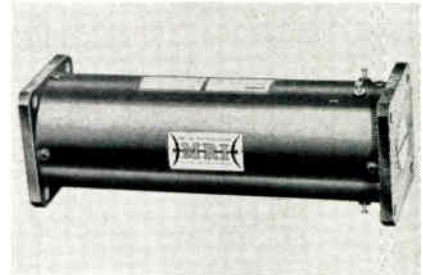

Model C-999-156-002 is an X-band waveguide ferrite-switch attenuator that has a maximum insertion loss of 1.3db and a minimum attenuation of 20db over the X-band. The VSWR in the on or off position is 1.50 maximum. Switching time is less than 150 μ sec. The control winding draws between 45 and 65ma dc; bias winding draws less than 37ma. Micro-Radionics, Inc., 14844 Oxnard St., Van Nuys, Calif.

Circle 200 on Inquiry Card

MICROWAVE SIGNAL SOURCES

Different power levels for L, S, C, and X-bands.

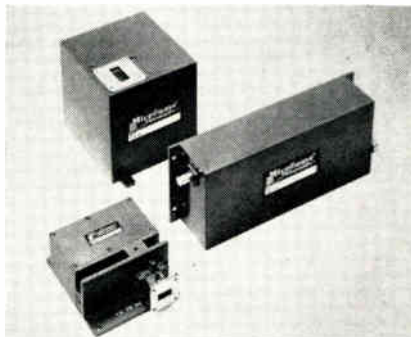

This solid-state, crystal-controlled r-f power source produces microwave power by using stable transistor oscillators and amplifiers to drive harmonic multipliers. For stability, crystal-controlled transistor oscillators are used with transistor power amplification in the vhf range. Freq. stability of the microwave output equals that of the primary crystal-controlled oscillator. Freq. and output levels are: 3-5w in L-band; 1-2w in S-band; 300-500mw in C-band; and 100-200mw in X-band. Microwave Assoc., Inc., Burlington, Mass.

Circle 199 on Inquiry Card

CLEAR GLASS WINDOWS

For visual observance of internal conditions.



Clear glass, hermetically-sealed windows feature American taper (NPT) pipe threads for easy and rapid installation. Designated HTW series, their uses include air conditioning equipment, refrigeration systems, heating units, electronic and nucleonic apparatus. Specific applications: Indicator light and meter reading, photo-sensitive elements, flow, fluid level and pressure indicators, gas-moisture control valves, transistor photo caps, and other photo-sensitive devices. Electrical Industries, 691 Central Ave., Murray Hill, N. J.

Circle 201 on Inquiry Card

SOLAtion LINE VOLTAGE REGULATOR corrects

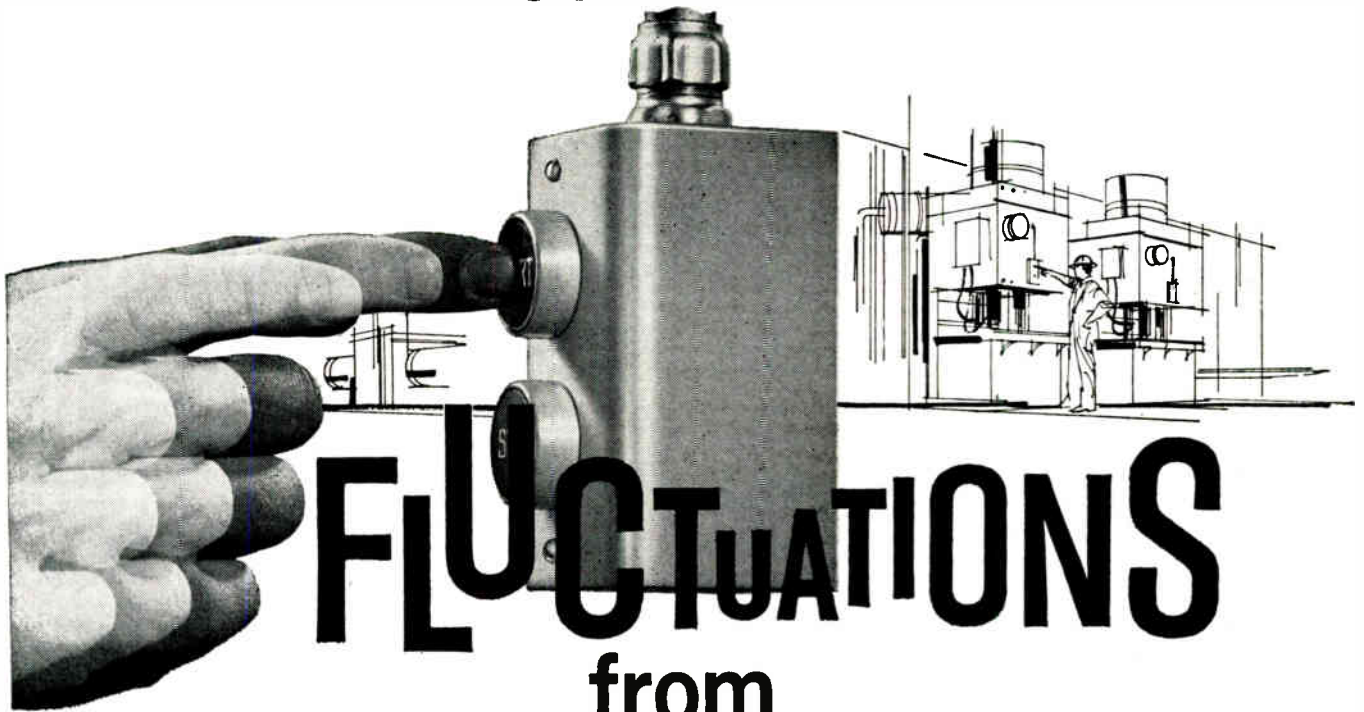

FLUCTUATIONS

from
the very
first
cycle

Responds up to 10 times faster than electromechanical devices . . . irons out fluctuations due to both line and load changes! Voltage correction is practically concurrent with every disturbance; starts long before output voltage nears the boundaries of the regulation envelope. Even under extreme conditions, correction never takes more than one-sixth second. And *talk about reliability!* Solatron line voltage regulators eliminate moving parts; rule out mechanical wear and tear. Complete maintenance-free operation. Solid-state sensor monitors actual output . . . then regulates the transformer *flux* to automatically maintain correct nominal voltage.

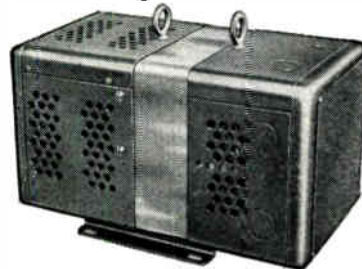

S-7-63

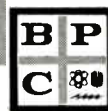

Division of Basic Products Corporation
SOLA ELECTRIC CO., 1711 Busse Road,
Eik Grove Village, Illinois, HEMpstead 9-2800

IN CANADA, SOLA BASIC PRODUCTS, LTD.,
377 Evans Avenue, Toronto 18, Ontario

Compare the advantages:

Superior performance — regulation $\pm 1\%$ for line and load variations, zero to full load.

High efficiency — 95% or better at full load.

"Lifeguard circuitry" — withstands momentary overloads many times rated current.

Input PF — 90% minimum on unity PF loads.

Smaller, lighter—considerably more compact than other standard regulators.

Solatron line voltage regulators are offered in ratings from 3 to 100 kva, for 120 and 240 vac, 60 and 400 cycles. For more information contact your local Sola distributor or call us direct.

See Sola Electronic Parts Distributor Show, May 20-22, Conrad Hilton Hotel, Booth 3303

NEW PRODUCTS

CRYSTAL CAN RELAY

Contact rating of 2a at 32vdc.

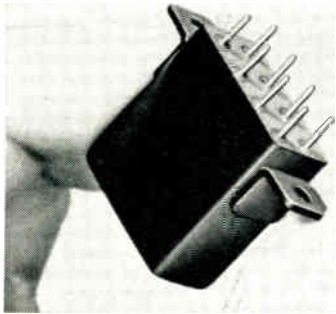

Type BA Series crystal can relay offers increased sensitivity and longer life. It is two-pole, double-throw relay and has a contact rating of 2a @ 32vdc. DC sensitivity for 20.5 coil voltage is 10mw. Coil resistance is 2250Ω. Vibration resistance is 15G to 2000 cps, and shock resistance of 30G for 11ms. It meets the requirements of Mil-R-5757D. Hi-G Inc., Bradley Field, Windsor Locks, Conn.

Circle 202 on Inquiry Card

PLASTIC TRANSISTORS

Cut-off frequency is above 100mc.

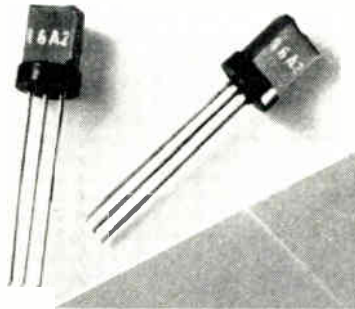

Types 2N2711—2N2716 contain a silicon pellet imbedded in an epoxy of plastic. Collector to emitter voltage is 18v; emitter to base is 5v. Operating temp. 100°C; storage temp. is -30°C to +125°C. Base spreading resistance is below 40Ω. Types 2713 and 2714 have a storage time of 85nsec., and beta holdup above 150ma. General Electric Co., Syracuse, N. Y.

Circle 203 on Inquiry Card

THERMISTOR

Designed for clip-mounting.



F.E.I. type G-474 is an indirectly-heated thermistor designed for clip-mounting. The clip does not affect either the dissipation or the time constant of the thermistor. It is used for remote control of amplifier input voltage and permits the use of long lines on the input without pick-up or capacitive effects. Fenwal Electronics, Inc., 63 Fountain St., Framingham, Mass.

Circle 204 on Inquiry Card

How Taylor copper-clad quality control

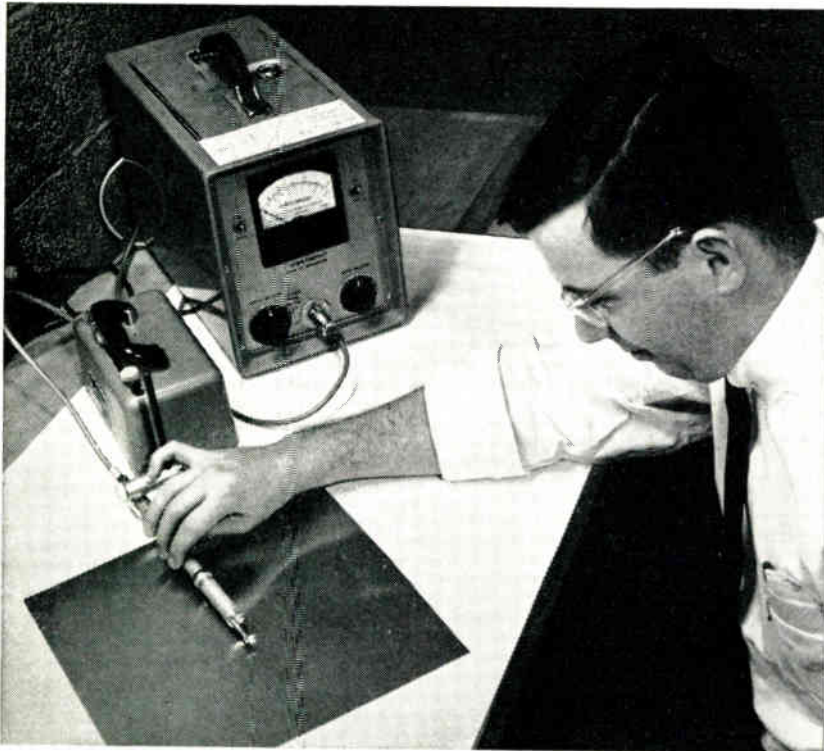

One of the many instruments used by Taylor to check product quality is the Profilmeter. Here a quality-control specialist is inspecting surface finish on a composite sheet.

You get clean copper-clad material. The copper-clad laminated plastic, used in making etched printed circuits, is prepared for pressing in Taylor's dustfree "white rooms."

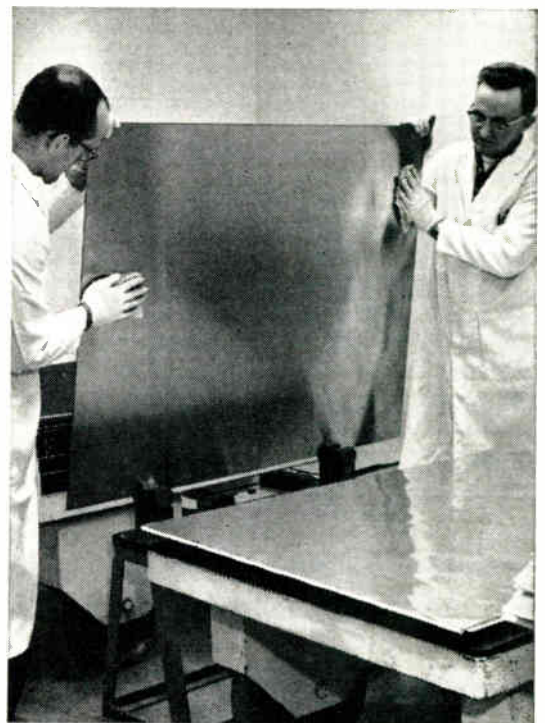

NEW PRODUCTS

HIGH ALUMINA CERAMIC

Dielectric Constant of 9.73.



Ceramic CRL-995 is a high alumina of 99.50% primary crystalline Al_2O_3 . This material provides a dielectric constant of 9.73 and low loss at high frequency. Maximum temperature for constant use is 2800°F, and the loss factor is 0.002 at 10gc. Sheet EP-1434R contains details and specifications. Centralab, The Electronics Div. of Globe-Union, Inc., 900 E. Keefe Ave., Milwaukee 1, Wisc.

Circle 205 on Inquiry Card

3-PHASE INVERTER

Response time is less than 50msec.

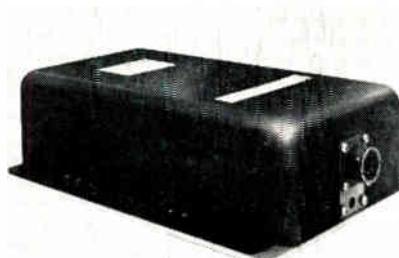

A solid-state, 3 ϕ , 1 kVA inverter is available. The all silicon inverter is rated at 1000va and uses inputs of 25 to 36vdc. Output frequency and tolerance is 400cps, $\pm 0.02\%$; voltage regulation is 115vac $\pm 1\%$; efficiency is 80% at rated load. Harmonic distortion is less than 2.5%; phase displacement, 120°. Kinetics Corp., 410 So. Cedros Ave., P. O. B. 427, Solana Beach, Calif.

Circle 206 on Inquiry Card

SYNCHRO/RESOLVER BRIDGES

Accuracy to 2 sec-of-arc.

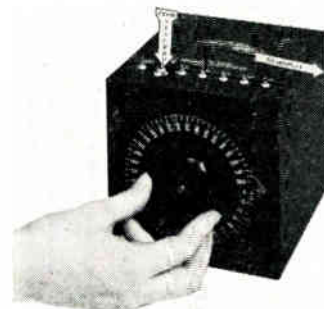

Series 11C is a panel-mounted synchro and resolver bridge which generates an output voltage linearly proportional to the electrical error. A single detented control operates the bridge, or a rotary solenoid automatically advances the bridge position. Specs.: interval, 5°; line-to-line impedance, standard 10K; size 5½ x 5½ x 7 in. Theta Instrument Corp., Saddle Brook, N. J.

Circle 207 on Inquiry Card

provides high reliability in etched circuits



Every precaution is taken to protect the surface. Before leaving the "white rooms" for the laminating presses, copper-clad loads are covered with plastic film to prevent dust or other foreign matter from contaminating the surfaces of the material.

Taylor copper-clad laminates are custom-engineered to provide assured performance by combining thermosetting resins, reinforcing materials, and copper foil in carefully formulated combinations.

Composite sheets are made in atmosphere-controlled layup rooms under strict quality control (MIL-Q-9858 qualified). All have low moisture absorption, excellent chemical re-

sistance, and high mechanical strength, combined with good dielectric strength, high surface resistivity and insulation resistance.

The standard glass epoxy grades shown in the table meet most of the critical requirements of today. If you are working on requirements for tomorrow, let Taylor assist you by developing a copper-clad material engineered to your planned application. Bulletin 8-1B gives technical information about our standard grades. Write for your copy today.

TAYLOR COPPER-CLAD GLASS EPOXY LAMINATES

TAYLOR GRADE	NEMA GRADE	MILITARY SPECIFICATIONS	PRINCIPAL CHARACTERISTICS
Fireban 1011-E	G-10, G-11, FR-4, FR-5	MIL-P-13949 Types GE, GB, GF, GH	Combines all desirable properties of G-10 (GEE) and G-11 (GEB), plus flame retardance in one grade.
Fireban 600-E	G-10, FR-4	MIL-P-13949 Types GE, GF	Self-extinguishing. Excellent electrical properties under high humidity conditions. Extremely high flexural, impact and bond strength.
GEC-500-E	G-10	MIL-P-13949 Type GE	Extremely high flexural, impact and bond strength. Low moisture absorption. High insulation resistance.

Taylor corporation
ENGINEERED PLASTICS

FORMERLY TAYLOR FIBRE CO.
VALLEY FORGE 53, PA.
WEST COAST PLANT: LA VERNE, CALIF.

Why depend on 'selected' transistors for your communications applications?

See how Amperex production-run P.A.D.T.'s

**you need
LOW NOISE AT HIGH FREQUENCY**

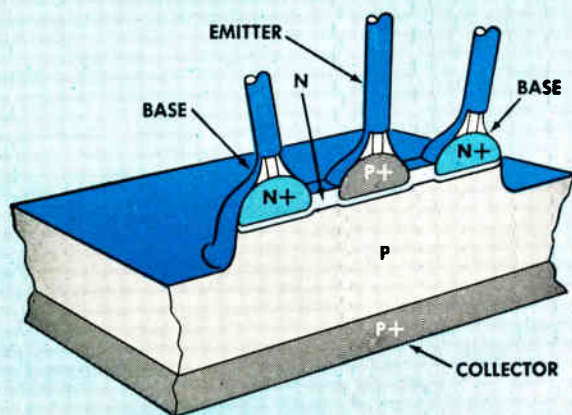

**3-DOT SMALL GEOMETRY
gives you**

Low $r_{bb'}$ · High f_T

as in the P.A.D.T. 2N2495

**you need
STABLE HIGH GAIN**

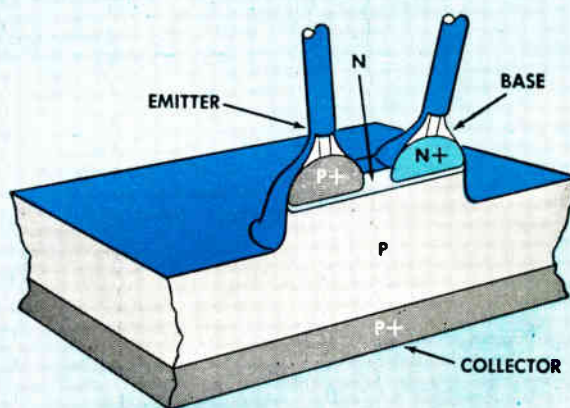

**2-DOT SMALL GEOMETRY
gives you**

**Stable High Gain
Low, low Capacity · High f_T**

as in the P.A.D.T. 2N2654

AMPEREX production-run P.A.D.T. transistors are immediately available from these and other authorized Industrial Electronic Distributors and in volume quantities from our semiconductor plant at Slatersville, Rhode Island

CALIFORNIA
R. V. WEATHERFORD COMPANY
Glendale 1, Calif.

KIERULFF ELECTRONICS
Los Angeles 15, Calif.

BRILL SEMICONDUCTOR CORP.
Oakland 6, Calif.

COLORADO
INTERSTATE RADIO & SUPPLY
Denver 4, Colorado

CONNECTICUT
CRAMER ELECTRONICS, INC.
Hamden, Conn.

DISTRICT OF COLUMBIA
ELECTRONIC WHOLESALERS, INC.
Washington 1, D. C.

FLORIDA
THURLOW ELECTRONICS, INC.
Cocoa, Fla. • Jacksonville, Fla. • Miami, Fla.
Orlando, Fla. • Pensacola, Fla. • Tampa, Fla.

ILLINOIS
NEWARK ELECTRONICS CORP.
Chicago, Ill.

INDIANA
RADIO DISTRIBUTING COMPANY
Indianapolis 6, Indiana

MASSACHUSETTS
RADIO SHACK CORP.
Boston, Mass.

MICHIGAN
RADIO SPECIALTIES COMPANY
Detroit, Michigan

MINNESOTA
ADMIRAL DISTRIBUTORS, INC.
St. Louis Park 16, Minn.

MISSOURI
BURSTEIN-APPLEBEE COMPANY
Kansas City, Missouri
INTERSTATE INDUSTRIAL ELECTRONICS
St. Louis 32, Missouri

NEW YORK
MILO ELECTRONICS
New York, N. Y.

ROME ELECTRONICS
Rome, N. Y.

OHIO
UNITED RADIO, INC.
Cincinnati, Ohio

OKLAHOMA
OIL CAPITAL INDUSTRIAL ELECTRONIC
DISTRIBUTORS
Tulsa, Oklahoma

OREGON
UNITED RADIO SUPPLY, INC.
Portland 9, Oregon

PENNSYLVANIA
RADIO ELECTRIC SERVICE CO.
Philadelphia, Pa.
CAMERADIO COMPANY
Pittsburgh, Pa.

TEXAS
BUSACKER ELECTRONIC EQUIPMENT CO., INC.
Houston 19, Texas

WASHINGTON
ROBERT E. PRIEBE COMPANY
Seattle 1, Washington

designs for specific requirements!

**you need
POWER AT HIGH FREQUENCY**

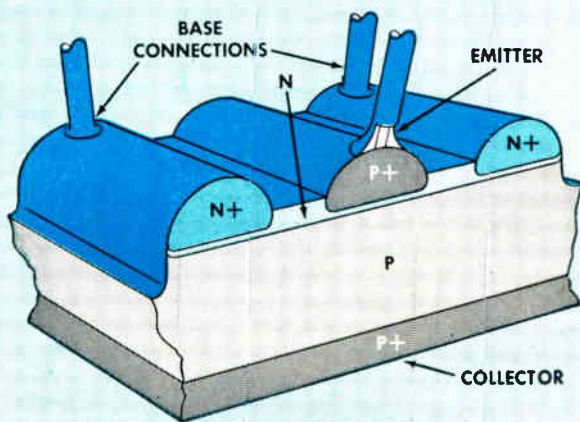

**P.A.D.T. STRIPE GEOMETRY
gives you**

**Lower $r_{bb'}$ · High Dissipation
High f_T · High Beta
as in the P.A.D.T. 2N2786**

**you need
HIGH GAIN, LOW NOISE, LOW COST**

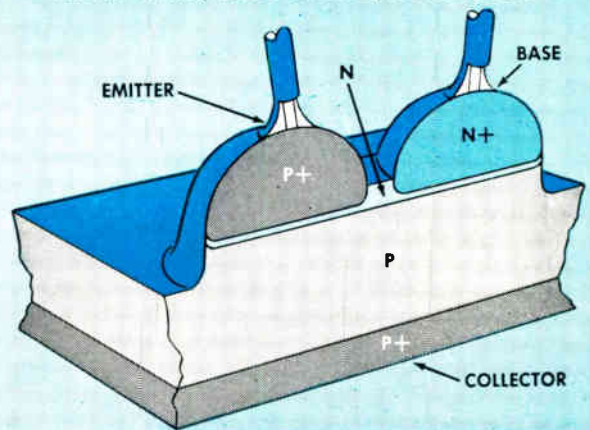

**2-DOT LARGE GEOMETRY
gives you**

a universal, high performance transistor for a wide range of frequencies for entertainment, industrial and military applications.

as in the P.A.D.T. 2N2084 (MIL-S-19500/213A NAVY)
P.A.D.T. 2N2089 } for P.A.D.T. 2N2092 } for
P.A.D.T. 2N2671 } VHF P.A.D.T. 2N2672 } RF

AMPEREX semiconductor specialists have been engaged in a continuing technological program that brings the superior performance and high-level production-benefits of PADT to ever expanding applications in the areas of communications, radar, instrumentation and AM-FM-TV receivers. From this program there have emerged the four distinctive P.A.D.T. transistor geometries illustrated above...each with "DESIGNED-IN" parameters and performance characteristics of significance to specific end-equipment needs — and reproducible, IN MASS PRODUCTION, without selection... at P.A.D.T. production-run prices! As you are undoubtedly aware, P.A.D.T. is the unique AMPEREX Post Alloy Diffusion Technique by which simultaneous diffusion and alloying take place under specified and controlled conditions. This exclusive process makes it possible to mass-produce superior communications type transistors with a base layer of only a few ten thousands of an inch and with extremely high cut-off frequencies... and P.A.D.T. does this with consistently high yields and with unequalled uniformity, stability and reliability. For detailed data and/or applications engineering assistance, write to: AMPEREX Electronic Corporation, Semiconductor and Receiving Tube Division, Hicksville, Long Island, New York.

IN CANADA: PHILIPS ELECTRON DEVICES, LTD., TORONTO 17, ONTARIO.



World Radio History

Circle 110 on Inquiry Card



**Another FIRST
from Hoskins!**

Tungsten/26 Rhenium Seamless Tubing for nuclear and thermionic applications

First to offer Tungsten/Rhenium alloys as calibrated thermocouple wire for accurate measurement of ultra high temperatures. □ First to supply these refractory metal alloys in strip form for structural applications. □ Now first again to produce Tungsten/26 Rhenium seamless tubing to meet the critical requirements of advanced nuclear reactors and thermionic devices.

Properties of interest to interested persons include: Very high melting point, approximately 5800°F. Good room temperature ductility. Good weldability. Excellent hot strength. Stability in vacuum, hydrogen and inert atmospheres. Good emission characteristics. Compatibility with nuclear fuels. □ Detailed technical data plus price and delivery information available upon request.

HOSKINS

MANUFACTURING COMPANY • 4445 LAWTON, DETROIT 8, MICH.

Exclusive Producers of Chromel/Alumel® Thermocouple Alloys in Wire and Seamless Tubing Form

NEW PRODUCTS

HF HYBRID

Solves broadband power splitting and balun problems.

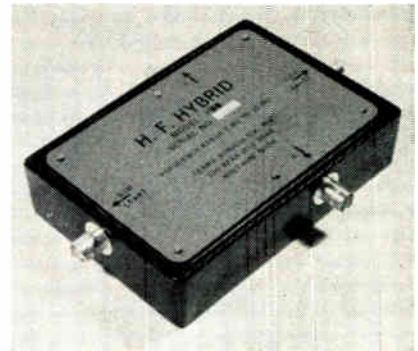

This balanced-to-unbalanced transformer features a broadband performance of 5mc to 32mc, high isolation, low insertion loss, and excellent phase balance. The VSWR is less than 1.5 when all ports are terminated in 75Ω. Dimensions are 5 x 4 x 1 in. Adams-Russell Co., Inc., 280 Bear Hill Rd., Waltham 54, Mass.

Circle 208 on Inquiry Card

METAL-CERAMIC TRIODE

Peak power of 2kw.

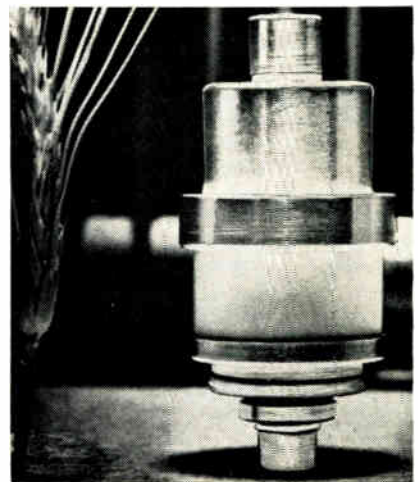

ZP-1026 is a compact, metal-ceramic triode amplifier with high power handling capability through 1600mc. Peak power output of 2kw under a 0.02 duty cycle, and 750w at 0.03 duty cycle. It is designed for grid-pulsed amplifiers operating in L-band. It weighs 3¼ oz. and is 2¾ in. long and 1.2 in. in diameter. General Electric, Power Tube Div., Schenectady, N. Y.

Circle 209 on Inquiry Card

NEW Subscription Order

I wish a new complimentary Subscription to

ELECTRONIC INDUSTRIES

Company Name _____ Mail Stop _____
 or
 Div./Dept. _____

Name _____ Position/Title _____

Company Address _____

City _____ Zone _____ State _____

IMPORTANT

FOR OUR STATISTICAL RECORDS PLEASE CHECK THE ONE APPROPRIATE CATEGORY THAT BEST DESCRIBES YOUR COMPANY OR DEPARTMENT. Failure to do so will delay your subscription.

- Mfr. of non-military electronic receiving and transmitting equipment.
- Mfr. of non-military electronic instruments, measuring, control and test equipment.
- Mfr. of non-military electronic computers, data processing, analysers, business machine.
- Mfr. of Guided Missiles and Accessories; Aircraft and Accessories, All Type of Military Products and Equipment.
- Mfr. of electronic components, parts, tubes and like products.
- Mfg. Co. (non electronic) using any of the above equip. in mfr., research or development work.
- Broadcasting or telecasting station.
- Commercial communication user (Tel & Tel, Police, Airports, Recording Studio, Etc.).
- Independent research, test, design laboratories and independent consultants—not part of a mfg. Co.
- Gov't Bureaus, Gov't laboratories, Gov't research center, military installation.
- Wholesaler, mfg. representative, service firm.
- University (educational) Public Library.
- Other (Please explain)

CHANGE OF ADDRESS

I wish to continue receiving **ELECTRONIC INDUSTRIES**
Change my address as indicated.

<u>OLD</u>	<u>NEW</u>
<p style="font-size: small; text-align: center;">Paste wrapper imprint here, or . . . Write in complete old address</p>	Company _____ Mail Stop or Div./Dept. _____ Title/Position _____ Company Address _____ City _____ Zone _____ State _____ Signature _____

IMPORTANT

FOR OUR STATISTICAL RECORDS PLEASE CHECK THE ONE APPROPRIATE CATEGORY THAT BEST DESCRIBES YOUR COMPANY OR DEPARTMENT. Failure to do so will delay your address change.

- Mfr. of non-military electronic receiving and transmitting equipment.
- Mfr. of non-military electronic instruments, measuring, control and test equipment.
- Mfr. of non-military electronic computers, data processing, analysers, business machine.
- Mfr. of Guided Missiles and Accessories; Aircraft and Accessories, All Type of Military Products and Equipment.
- Mfr. of electronic components, parts, tubes and like products.
- Mfg. Co. (non electronic) using any of the above equip. in mfr., research or development work.
- Broadcasting or telecasting station.
- Commercial communication user (Tel & Tel, Police, Airports, Recording Studio, Etc.).
- Independent research, test, design laboratories and independent consultants—not part of a mfg. Co.
- Gov't Bureaus, Gov't laboratories, Gov't research center, military installation.
- Wholesaler, mfg. representative, service firm.
- University (educational) Public Library.
- Other (Please explain)

FIRST CLASS
PERMIT NO. 36
PHILA., PA.

BUSINESS REPLY MAIL

No Postage Stamp Necessary if Mailed in U. S. A.

POSTAGE WILL BE PAID BY

ELECTRONIC INDUSTRIES

Chilton Company

Chestnut & 56th Sts

Philadelphia 39, Pa.

Att: Circulation Dept.



FIRST CLASS
PERMIT NO. 36
PHILA., PA.

BUSINESS REPLY MAIL

No Postage Stamp Necessary if Mailed in U. S. A.

POSTAGE WILL BE PAID BY

ELECTRONIC INDUSTRIES

Chilton Company

Chestnut & 56th Sts.

Philadelphia 39, Pa.

Att: Circulation Dept.



NEW PRODUCTS

TIME-INTERVAL METER

Accurate to ± 1 nsec.

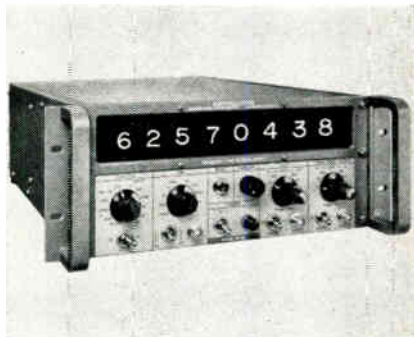

Model 14-34 is a 1 nsec. time-interval meter which performs digital measurement as short as 10^{-9} sec., as long as 1 μ sec., and in conjunction with a counter, for many seconds. The measured interval can be the leading and trailing edges of a single pulse, leading edges of 2 pulses, or the period of repeating waveforms. Trigger level adjustments over a range of 0.1 to 10v. Three display tubes give readings up to 999 nsec. Northeastern Engineering Corp., 25 S. Bedford St., Manchester, N. H.

Circle 210 on Inquiry Card

HEATING EQUIPMENT

Converts KC to MC.

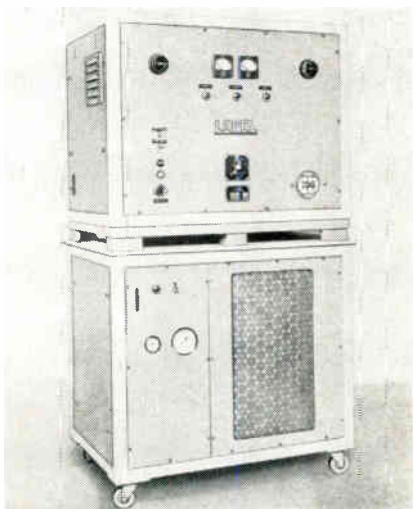

Model T 5-3-B is a tube generator with a power output of 5kw. Two separate inter-changeable tank circuits convert 250—600kc to 2—10mc. Oscillator power supply can be solid-state rectifiers, thyratrons, or rectifier tubes. An automatic timer is incorporated for pre-determined heating cycles. Lepel High-Frequency Laboratories, Inc., Woodside, N. Y.

Circle 211 on Inquiry Card

New G-E tungsten-rhenium wire increases the life and reliability of electronic receiver tubes and compactron devices

General Electric has produced a wire superior to any high-quality lamp and electronic wire available at this time. It's an alloy of tungsten and rhenium—a rare metal that weighs twice as much as lead and is more expensive than gold.

Increased pliability

Perhaps the most important characteristic of G-E tungsten-rhenium wire is its increased pliability after heat treatment or after recrystallization. And the higher recrystallization temperature of tungsten-rhenium wire gives it greater heat tolerance.

Greater strength

less electrical current.

Tungsten-rhenium wire has up to 40 per cent greater high-temperature tensile strength. And it also has greater electrical resistivity which permits it to get hot faster and with

Complete range of sizes

General Electric tungsten-rhenium wire will be made in all wire sizes from .4 mil to 60 mils diameter. In every size and use it will provide better oxidation resistance. Besides being used in electronic tubes and Compactron devices, other uses for G-E tungsten-rhenium wire include flash bulbs, lamps and power electronic tubes, and uncalibrated wires for thermocouples.

Costs more but worth it

Because it contains rhenium, new General Electric tungsten-rhenium wire costs more than conventional tungsten wire. We know you'll think it's worth the extra cost when you get the full story. Just ask General Electric Co., Lamp Metals and Components Dept. ED-22, 21800 Tungsten Road, Cleveland 17, Ohio.

Progress Is Our Most Important Product



GENERAL ELECTRIC

NEW 10 INCH RECORDER WRITES WITH 4 MC RESPONSE

**COMBINES Z-AXIS MODULATED SCOPE
WITH 8 GALVANOMETERS FOR TRUE
3-DIMENSIONAL SIGNAL ANALYSIS**

Now you can get permanent film or paper records of high speed analog phenomena beyond the linear reach of galvanometers, and still correlate 8 channels of galvanometer information on the same record. The new Model OR-280 CRT Recorder by Interstate provides a 10" linear record that is: (1) flat to 20 kc in the swept axis, (2) intensity modulated via a 4 mc video amplifier, and (3) useful to 30 ips paper speed.

This precision solid state instrument features a recording spot size of less than 0.004 inch for utmost versatility — has high input impedance.



WRITE TO:  **Interstate ELECTRONICS CORPORATION**

707 East Vermont Avenue • Anaheim, California • Telephone 714-772-2222
(A subsidiary of Interstate Engineering Corporation)

NATIONWIDE REPRESENTATIVES

ANOTHER  **Interstate SOLID-state INSTRUMENT**

NEW PRODUCTS

NON-INVERTING AMPLIFIER

10Mc module which operates between -55°C to $+125^{\circ}\text{C}$.

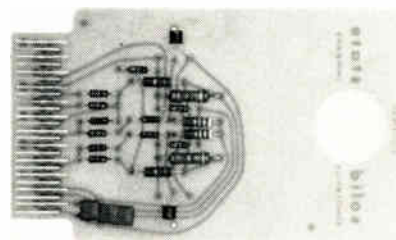

Model DCNA1132 contains a 2-stage non-inverting amplifier and provides normal non-inverted and inverted outputs. A direct-coupled gate minimizes driving-circuit loading. This silicon digital card, designated DIGICARDS, uses 3.28 x 5.50 in. glass epoxy boards, printed circuitry, and 24 terminal Series 7009 Elco Varicon® connectors. Applications include amplification, isolation, and level standardization. Solid State Electronics Corp., 15321 Rayen St., Sepulveda, Calif.

Circle 212 on Inquiry Card

VOLT-OHM MICROAMMETER

200K Ω/v V-O-M.



Model 630-NS has dc voltage ranges at 200K Ω/v for greater accuracy. A 5 μa current-measuring circuit is adaptable for semiconductor leakage-current measurements from 0.1 μa to 12a. Meter movement has no pivots, bearings, or hair-springs—thus no rolling friction. Meter has 63 ranges that are usable with frequencies through 100kc. The Triplet Electrical Instrument Co., Bluffton, Ohio.

Circle 213 on Inquiry Card

At Bendix when we say "silicon in '63,"

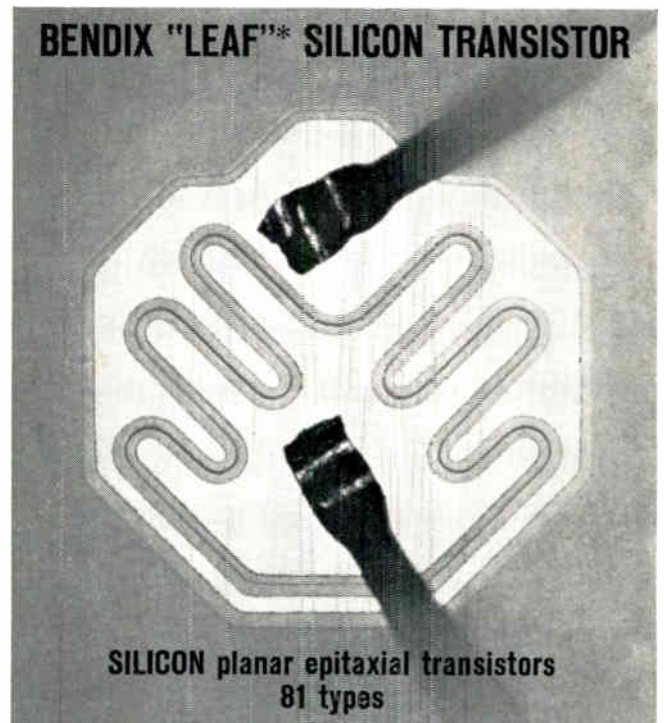
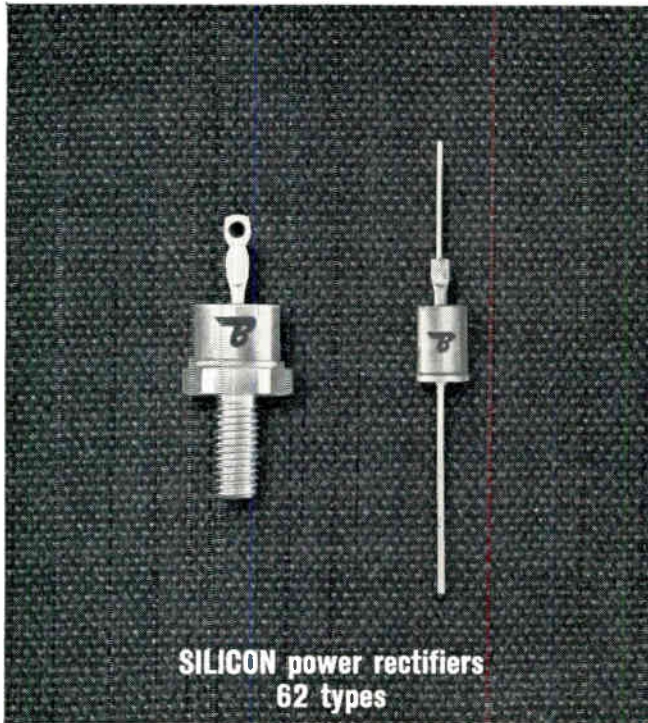

*Patent applied for. (Magnified 105 times, actual size .025")

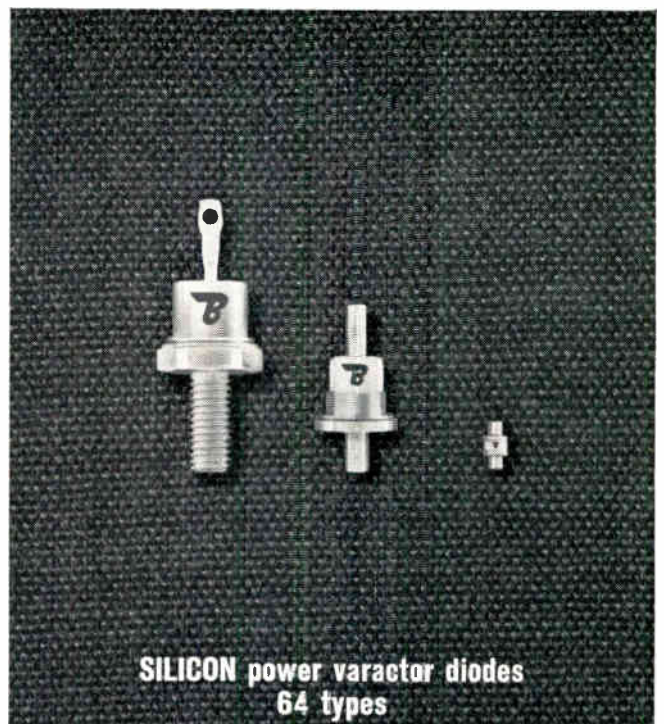

we mean it.

Write us in Holmdel, New Jersey, soon.

Bendix Semiconductor Division





modular

strap-down gyro packages

FOR GUIDANCE . . . STABILIZATION . . . CONTROL

Operational . . . producible . . . with reliabilities and performance fully demonstrated in current satellite and aircraft programs. The following four representative types indicate the scope and experience of design, engineering, and production capabilities immediately available to aid in your advanced projects. Write for Data File 305.

THREE AXIS SATELLITE INERTIAL REFERENCE PACKAGE:

Three single-axis floated gyros and two accelerometers, with loops employing seven voltage and five power amplifiers. Current regulator and heater relay amplifiers. Amplifiers fully transistorized, individually encapsulated.

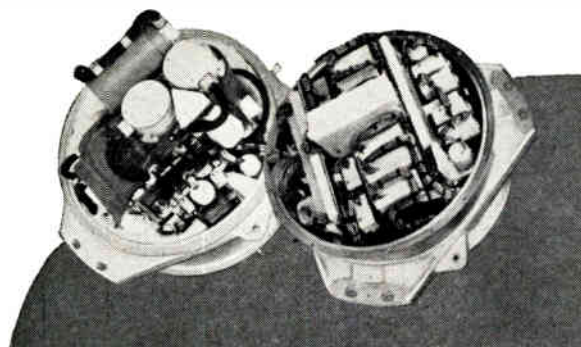

SINGLE CHANNEL SATELLITE STABILIZATION SYSTEM:

Utilizes Reeves D30S gyro, with trimmed drift rate of 0.1°/hr. Gyro loop incorporates voltage amplifier, demodulator, and d.c. power amplifier for gyro d.c. torque motor. Proportional temperature control amplifier regulates temperature.

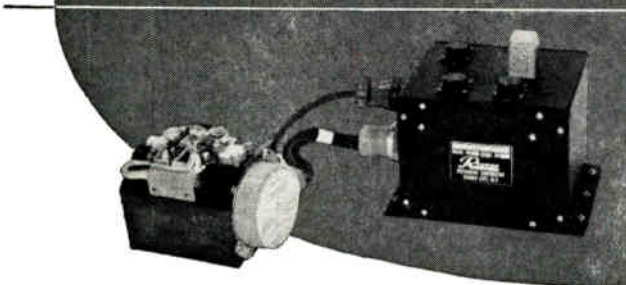

TWO CHANNEL ANTENNA STABILIZATION SYSTEM:

Each loop comprises a Reeves HIG-4 gyro and a voltage amplifier and power amplifier. Proportional temperature control amplifiers regulate temperature to ± 0.5 degrees for each gyro.

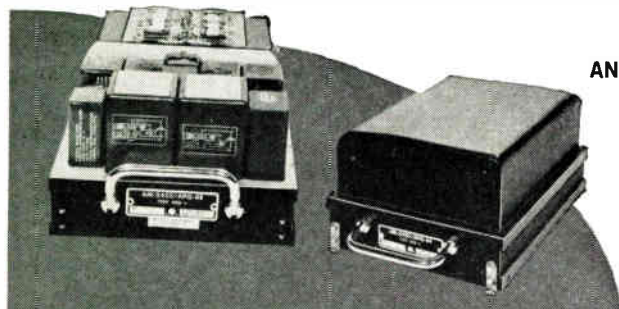

MODULAR AMPLIFIER COMPONENTS:

Transistorized, encapsulated units, readily incorporated into any system for voltage and power amplification; demodulation, and high precision temperature control.

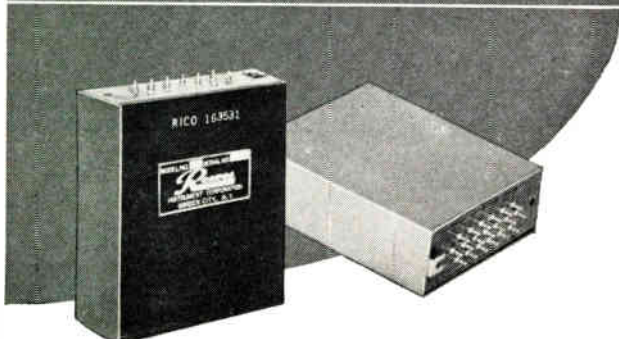

REEVES INSTRUMENT CORPORATION

A Subsidiary of Dynamics Corporation of America, Roosevelt Field, Garden City, N.Y.

NEW PRODUCTS

CAPACITORS

Operates at 200vdc from -55° to $+150^{\circ}$ C.

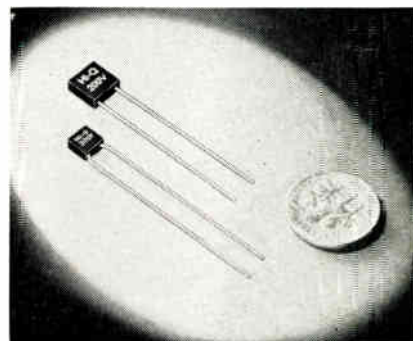

CK-05 and CK-06 capacitors operate without derating at 200vdc from -55° to $+150^{\circ}$ C. They are life tested at 400vdc, and meet Mil-C-11015/18/19. Type CK-05 (MC52) is available in capacities from 10pf to 2500 pf and measures 0.1 in. thick x 0.2 in. sq. Type CK-06 is available in capacities from 1001pf to 12,000pf and measures 0.1 in. thick x 0.3 in. sq. Both units are molded. Aerovox Corp., New Bedford, Mass.

Circle 214 on Inquiry Card

PC CONNECTORS

Feature bellows-type contacts.

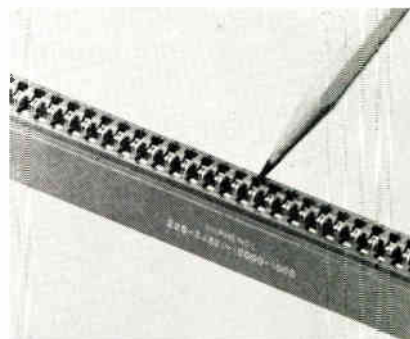

Blue Ribbon Series 225 features bellows-type contacts which are said to be more flexible than tuning-fork or ribbon contacts. The connector contacts can be flexed up to 0.040 in. without permanent deformation, and have internal double-rack construction to inhibit movement when wires are removed from terminations. They meet the requirements of Mil-C-21907B. Amphenol Connector Div., Amphenol-Borg Electronics Corp., 1830 S. 54th Ave., Chicago 50, Ill.

Circle 215 on Inquiry Card



HIGH ISOLATION
LOW INSERTION LOSS
LOW VSWR



You bought our
3 port circulator
for these reasons.

These circulators formerly produced by Red Bank Division are now being manufactured and marketed by Microwave Devices, Inc. They provide an isolation of more than 20 db and an insertion loss of less than .4 db over a bandwidth in excess of 20%. VSWR is 1.20 maximum. They will withstand severe shock and vibration, and temperatures from -55° to 85°C . At room temperature, the isolation is at least 20 db over a 40% bandwidth and the insertion loss is less than 0.15 db over a 30% bandwidth.

For more information about our "ideal" circulators and other microwave ferrite devices, write or call us, detailing your specifications.

Regional offices—*Northeast Area* (Connecticut Plant), Farmington Industrial Park, Farmington, Conn., Area 203-677-9771; *Middle Atlantic Area* (Headquarters), 1445 Research Blvd, Rockville, Md., Area 301-762-1234; *West Coast Area* (Regional Office), 117 E. Providencia Ave., Burbank, Calif., Area 213-849-3961.

Microwave Devices, Inc.



NEW PRODUCTS

TIMER

Available in 4 timing ranges

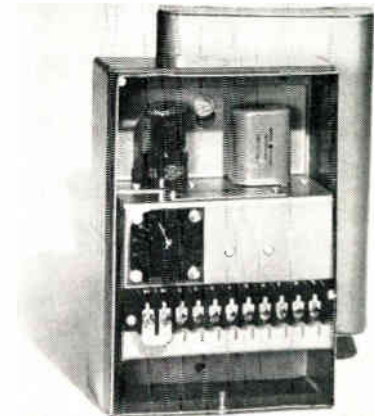

This lightweight timer operates for either timed interval or timed delay and is available in 4 timing ranges: 0.08 to 1.0 sec.; 0.06 to 10.0 sec.; 2.0 to 60.0 sec.; and 4.0 to 120.0 sec. The single-pole, double-throw, hermetically-sealed output relay is rated at 5a resistive load, and has an expected life of 100,000 operations at full rated load or 4 million operations at 1a. General Electric Co., Schenectady 5, N. Y.

Circle 218 on Inquiry Card

LOW-NOISE PREAMPS

Model 132 spans the L and S-bands; 133 the C and X.

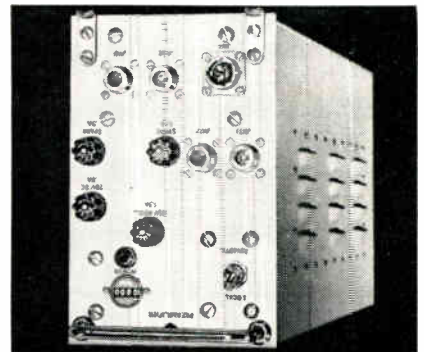

Model 132 exhibits 25db min. small-signal gain, 13.5db max. noise figure, and a dynamic input of 48db over 1.0 to 2.6gc. Across the 2.3 to 4.45gc it provides 30db min. small-signal gain, 11.5db max. noise figure and a dynamic input of 42db. The 133 has 30db min. small-signal gain and 11.5db max. noise figure over 4.3 to 7.35gc and 7.05 to 10.75gc ranges. Typical dynamic input of 42 and 40db are achieved across the 4.3 to 7.35 and 7.05 to 10.75gc bands. Instruments / Subsystems Div., Huggins Laboratories, Inc., 999 E. Arques Ave., Sunnyvale, Calif.

Circle 219 on Inquiry Card

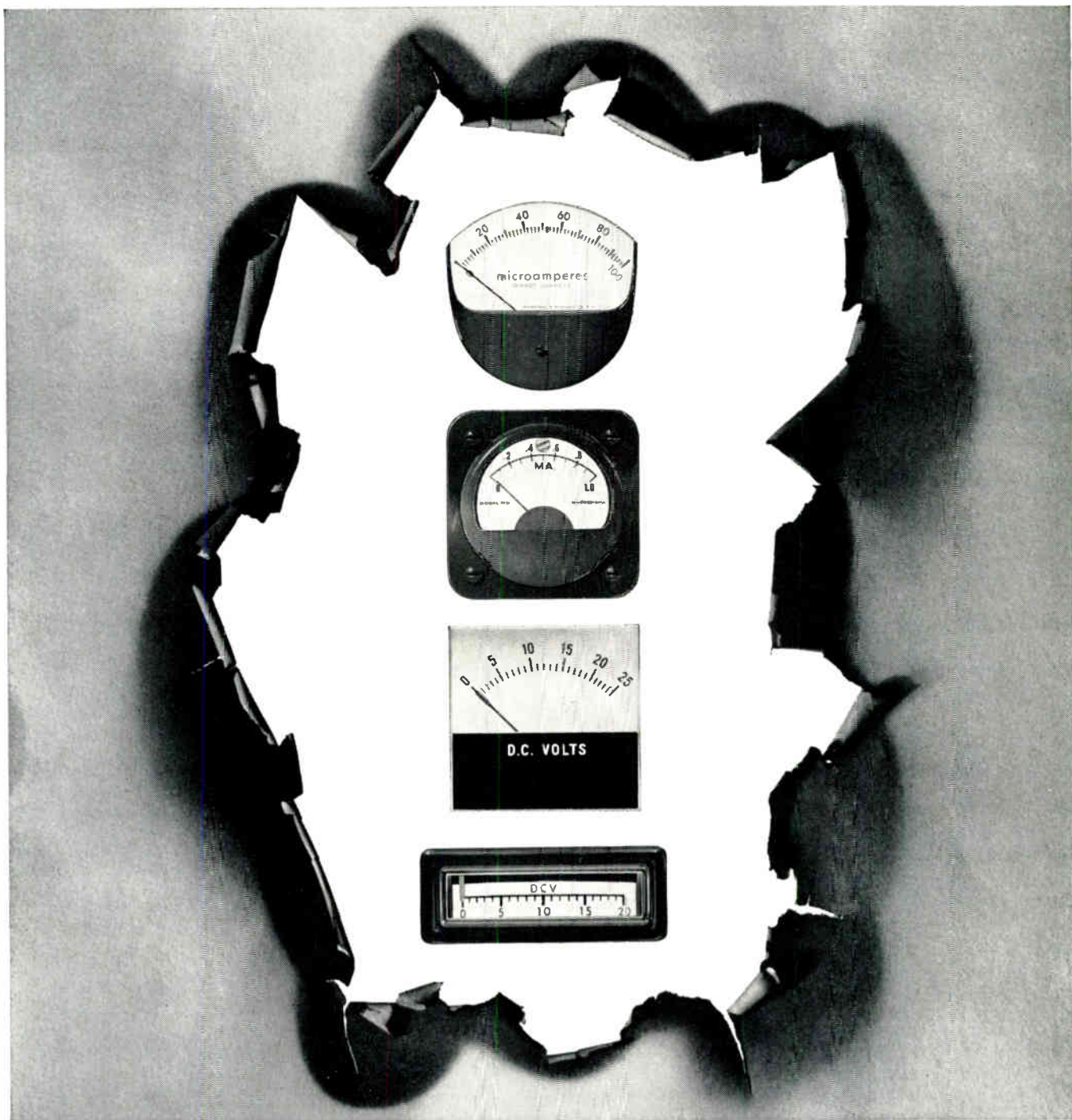

Hottest miniatures around

Hottest trend today in the meter field is miniaturization. And miniature meters are a Honeywell specialty. We offer the broadest line on the market. Under one quality name, you can now find a miniature that will answer your design problems exactly. For a small meter that offers unusual panel beauty there's the MM-1 Medalist®. For a meter that shrugs off vibration and physical shocks, pick the HS-1 Ruggedized Meter. For tight stacking, either vertically or horizontally, choose Honeywell's new, modern-

styled, MS-1 Square Meter. And there's the MCE-1 Edgewise Meter that fits into a space only ½ inch high. All give optimum readout, maximum scale length for the space, and are 1½ inches or less. And they're all backed by Honeywell — a leader in the meter field. For more information, write Honeywell, Precision Meter Division, Manchester, New Hampshire. In Canada, Honeywell Controls, Ltd., Toronto 17, Ont. Honeywell

Honeywell

International: with sales and service offices in principal cities of the world.

MAXIMUM SEMICONDUCTOR THERMAL CONTROL IN A SHAPE ALL ITS OWN...



* Patented

IERC DIVISION

IERC's new approach to heat dissipator design has produced semiconductor thermal control devices that even look different.* These new designs are smaller, lighter, more efficient, and provide greater systems compatibility. These and many other IERC types comprise the most complete line of heat dissipators available.



Series F-400 and F-600 modular forced convection assemblies employing new design concepts provide greater efficiency with up to 50% less weight.

Write for latest IERC Semiconductor Thermal Control technical data today.

INTERNATIONAL ELECTRONIC RESEARCH CORPORATION
135 West Magnolia Boulevard, Burbank, California • Victoria 9-2481
Foreign Manufacturers: Europelec, Paris, France. Garrard Mfg. & Eng. Co., Ltd., Swindon, England

NEW PRODUCTS

FIBER OPTIC CRT

Produces ultra-violet output.

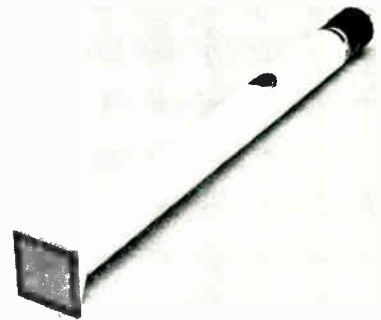

The E2A16B PIPIN fiber optic tube uses MICROPIN high-resolution electron gun and phosphor screen. It is designed primarily for direct exposure applications on a 35 mm film size, and is suited for use with a new, fast, dry process films. Other applications include information storage and retrieval as well as high-efficiency image conversion. Litton Industries, Electron Tube Div., 960 Industrial Rd., San Carlos, Calif.

Circle 220 on Inquiry Card

VARIABLE PF CAPACITOR

It has a capacitance as high as 500 picofarads.

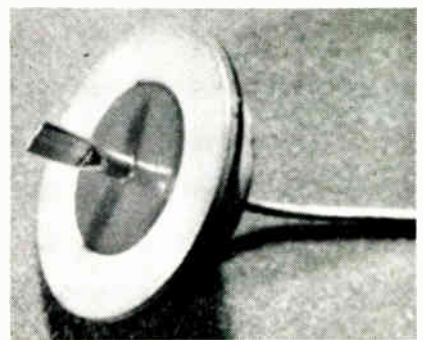

Voltcap, a voltage-variable capacitor, has a capacitance as high as 500pf (8v), high Q, and reverse breakdown voltage greater than 100v. Produced by silicon-planar epitaxial techniques, it operates on a few microwatts and varies capacitance by changing dc bias voltage. It is designed for receiver or multisection filter tuning, and other uses requiring high Q values, large capacitance-change ratios, and extremely close tracking. Philco Corp., Dept. PR-315, Lansdale, Pa.

Circle 221 on Inquiry Card

VOLTAGE DIVIDER

1 ppm absolute linearity.

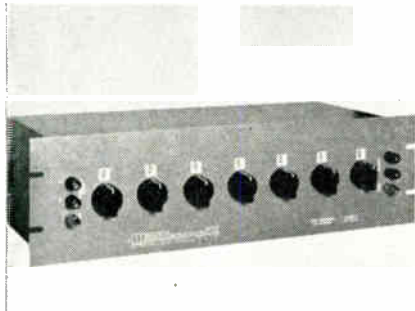

ESI RV 722 Dekavider is a Kelvin Varley voltage divider featuring 7-dial, in-line presentation and 1 ppm terminal linearity. Rear calibration terminals allow calibration to 0.1 ppm absolute linearity. Temperature coefficient is ± 0.5 ppm/ $^{\circ}\text{C}$; input resistance, 1000 Ω ; maximum power, 5w. A calibration certificate gives check-out readings accurate to 0.2 ppm. ESI-Electro Scientific Industries, 7524 S.W. Macadam Ave., Portland 19, Ore.

Circle 222 on Inquiry Card

ZENER REFERENCE DIODES

Temperature stability better than ± 0.5 or $\pm 1.0\%$.

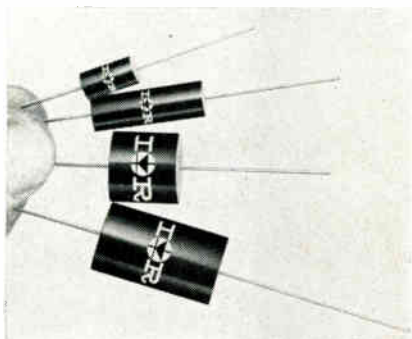

Bulletin SR-256-B describes zener reference elements covering the voltage range from 6.2 to 49.6v. Designed for critical temperature stability, they have a -55 to 100°C temp. range. Designated 1N1735-1742 and 1N1736A-1742A, they provide superior stability due to cancellation of temperature coefficients. Power dissipation at 25°C ranges from 200mw for the 6.2v unit to 1600 mw for the 49.6v unit. International Rectifier Corp., 233 Kansas St., El Segundo, Calif.

Circle 223 on Inquiry Card

WRAP-AROUND MAGNETIC SHIELDS

APPLIED IN SECONDS

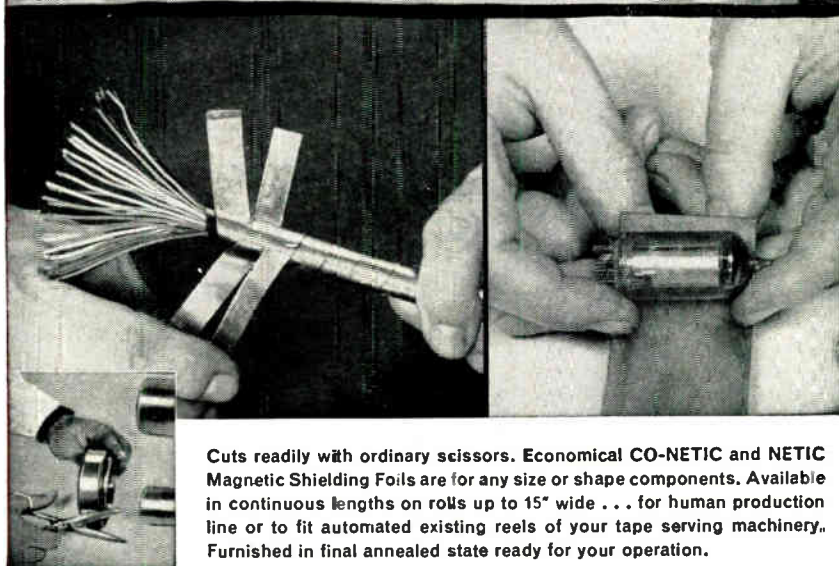

Cuts readily with ordinary scissors. Economical CO-NETIC and NETIC Magnetic Shielding Foils are for any size or shape components. Available in continuous lengths on rolls up to 15" wide . . . for human production line or to fit automated existing reels of your tape serving machinery. Furnished in final annealed state ready for your operation.

HOW YOU SAVE SPACE, WEIGHT, TIME, MONEY

Minimum weight and displacement shielding designs are possible due to the magnetic shielding effectiveness of Co-Netic and Netic foils . . . foils can be supplied FROM .002", even thinner if you desire. Ordinary scissors cut foil easily to exact contour and size required. Foil can be wrapped quickly around hard-to-get-at components, saving valuable time, minimizing tooling costs.

HOW TO INCREASE RELIABILITY

Guard against performance degradation from unpredictable magnetic field conditions to which your equipment may be exposed. Eliminate such failure or erratic performance possibilities with dependable Co-Netic and Netic protection . . . assuring performance repeatability for your device over a wider range of magnetic field conditions.

Co-Netic and Netic alloys are not affected significantly by dropping, vibration or shock. They are characterized by low magnetic retention and do not require periodic annealing. When grounded, they effectively shield electrostatic as well as magnetic fields over a wide range of intensities.

Every satellite and virtually all guidance devices increase reliability with Netic and Co-Netic magnetic shielding alloys. Use these highly adaptable foils for saving valuable space, weight, time and money . . . in solving your magnetic shielding problems for military, commercial and laboratory applications.

PHONE YOUR NEAREST SALES OFFICE TODAY:

MERIDEN, CONNECTICUT, BEverly 7-9232
UNION CITY, NEW JERSEY, UNion 4-9577
BALTIMORE, MARYLAND, HOpmans 7-3766
DECATUR, GEORGIA, 378-7516
CORAL GABLES, FLORIDA, Highlans 3-7439
MAITLAND, FLORIDA, Midway 7-7830
ST. PETERSBURG, FLORIDA, WAverly 1-9735
DALLAS, TEXAS, FLeetwood 1-1615

HOUSTON, TEXAS, HOmestead 5-7780
ALBUQUERQUE, NEW MEXICO, AMherst 8-6797
PHOENIX, ARIZONA, AMhurst 4-4934
SAN DIEGO, CALIFORNIA, BRowning 8-6230
LOS ANGELES, CALIFORNIA, WEbster 1-1041
PALO ALTO, CALIFORNIA, DAvenport 1-5064
SEATTLE, WASHINGTON, EA 3-8545
MONTREAL, QUEBEC, WEllington 7-1167

MAGNETIC SHIELD DIVISION

Perfection Mica Company / EVERglade 4-2122

1322 N. ELSTON AVENUE, CHICAGO 22, ILLINOIS

ORIGINATORS OF PERMANENTLY EFFECTIVE NETIC CO-NETIC MAGNETIC SHIELDING



cable on a diet

Weight and attenuation are reduced through the new, more efficient outer conductor design applied to this type of Times special coaxial cable. Attenuation is reduced at least 20% at all frequencies from 40mc to 10gc (see graph). With 100 feet of cable at 3gc, this reduction in attenuation will provide better than 3 times the power output of its RG counterpart. Shielding effectiveness is slightly improved. Weight averages 20% less than comparable cable with conventional braid. And these improvements are achieved at no significant increase in cost. These techniques are applicable to most RG cable. Prove it to yourself! Write or wire for a "Cable on a Diet Kit." These weight and attenuation reductions are typical examples of Times ability to design and produce cable and cable assemblies for critical applications. For assistance with your transmission systems problems, and for your free "Cable on a Diet Kit," wire or write today Times Sales Manager, Dept. EI-65.

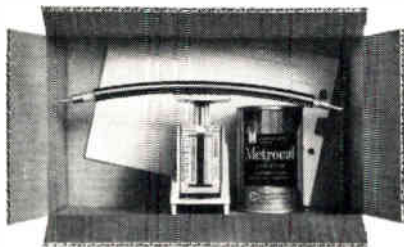
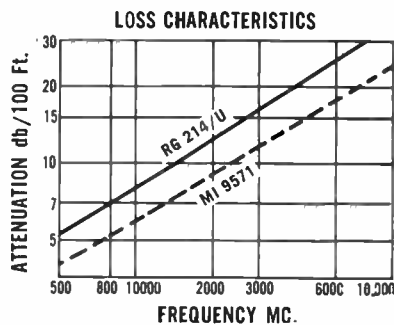

CABLE ON A DIET KIT



TIMES WIRE AND CABLE

Division of The International Silver Company
Wallingford, Connecticut

TRANSMISSION SYSTEM DESIGN AND ENGINEERING • STANDARD & SPECIAL PURPOSE COAXIAL CABLE • MULTICONDUCTOR CABLE • COMPLETE CABLE ASSEMBLIES • TEFLON® HOOP-UP WIRE

* A DuPont Trademark

NEW PRODUCTS

COAX-WAVEGUIDE ADAPTERS

Designed for minimum physical size.

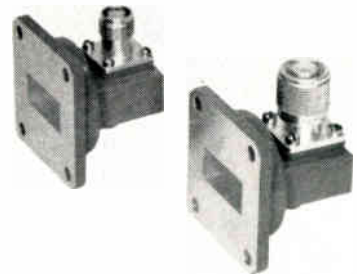

Type TNC coaxial-to-waveguide adapters are used at frequencies between 8.2 to 12.4gc, and perform transitions from standard X-band waveguide to coax through either male or female type TNC connector. They provide VSWR of 1.15 over the waveguide operating frequency. Waveline Inc., Caldwell, N. J.

Circle 224 on Inquiry Card

REGULATED DC-DC INVERTER

Converts 28vdc to double output between 275 and 475vdc.



Miniature dc-dc transistorized static inverter designed for missile and airborne systems. Model A6A2 converts a 28vdc source to any two desired output voltages between 275 and 475 vdc. Measures $2\frac{3}{4} \times 2\frac{3}{4} \times 3\frac{1}{4}$ in. Meets environmental requirements of Mil-E-5272C, including Procedure I for vibration. Standard regulation is $\pm\frac{1}{2}\%$ for changes of output voltage for input line variations from 24 to 30vdc. Load regulation is 1% change of output voltage from $\frac{1}{2}$ to full load. Protected against short circuit of output, input transient spikes and reverse polarity damage. Abbott Transistor Laboratories, Inc., 3055 Buckingham Rd., Los Angeles 16, Calif.

Circle 225 on Inquiry Card

New compact storage tube for airborne applications

Hughes has developed a 5" diameter direct view storage tube with an overall length of 8" (tube envelope length — 4"). The Hughes H-1076AP20 TONOTRON* tube overcomes the severe size limitations inherent in airborne equipment. Designed with weather radar and terrain avoidance radar in mind, the H-1076AP20 has both original design and retrofit applications. It is now feasible to realize the advantages of high light output direct view halftone storage tubes where before only standard cathode ray tubes could be used. While much smaller in size, the average performance characteristics of the Hughes compact TONOTRON* tube are equal to or better than many larger 5" diameter storage tubes: H-1076AP20 5" TONOTRON* direct view halftone storage tube with electrostatic focus and magnetic deflection. 4" minimum useful screen diameter. On-axis construction.

STORED RESOLUTION 50 lines/in (shrinking raster) for 5 μ a beam current and 80% of equilibrium brightness.

BRIGHTNESS 2000 ft. L equilibrium brightness at 10,000 volts. **WRITING SPEED** 60,000 in/sec for 5 μ a beam currents, from 0% to 80% of equilibrium brightness.

ERASE TIME 200 milliseconds (length of single pulse to reduce brightness from 100% to 20%).

VIEWING TIME** 30secs.—0% to 20% of equilibrium brightness.

For additional information and answers for your specific display problems, call, wire or write today: Hughes Storage Tubes, 2020 Short Street, Oceanside, California—Area Code 714, 722-2101, Ext. 273 or 280. Hughes Storage Tubes, 1 Bala Ave., Bala Cynwyd, Pennsylvania, Area Code 215, MO. 4-3950. For export, write Hughes International, Culver City, California.

Creating a new world with electronics
HUGHES
 HUGHES AIRCRAFT COMPANY
 VACUUM TUBE PRODUCTS DIV.

*Trademark Hughes Aircraft Company **By means of pulsing techniques, unneeded light output can be traded for extended viewing time.

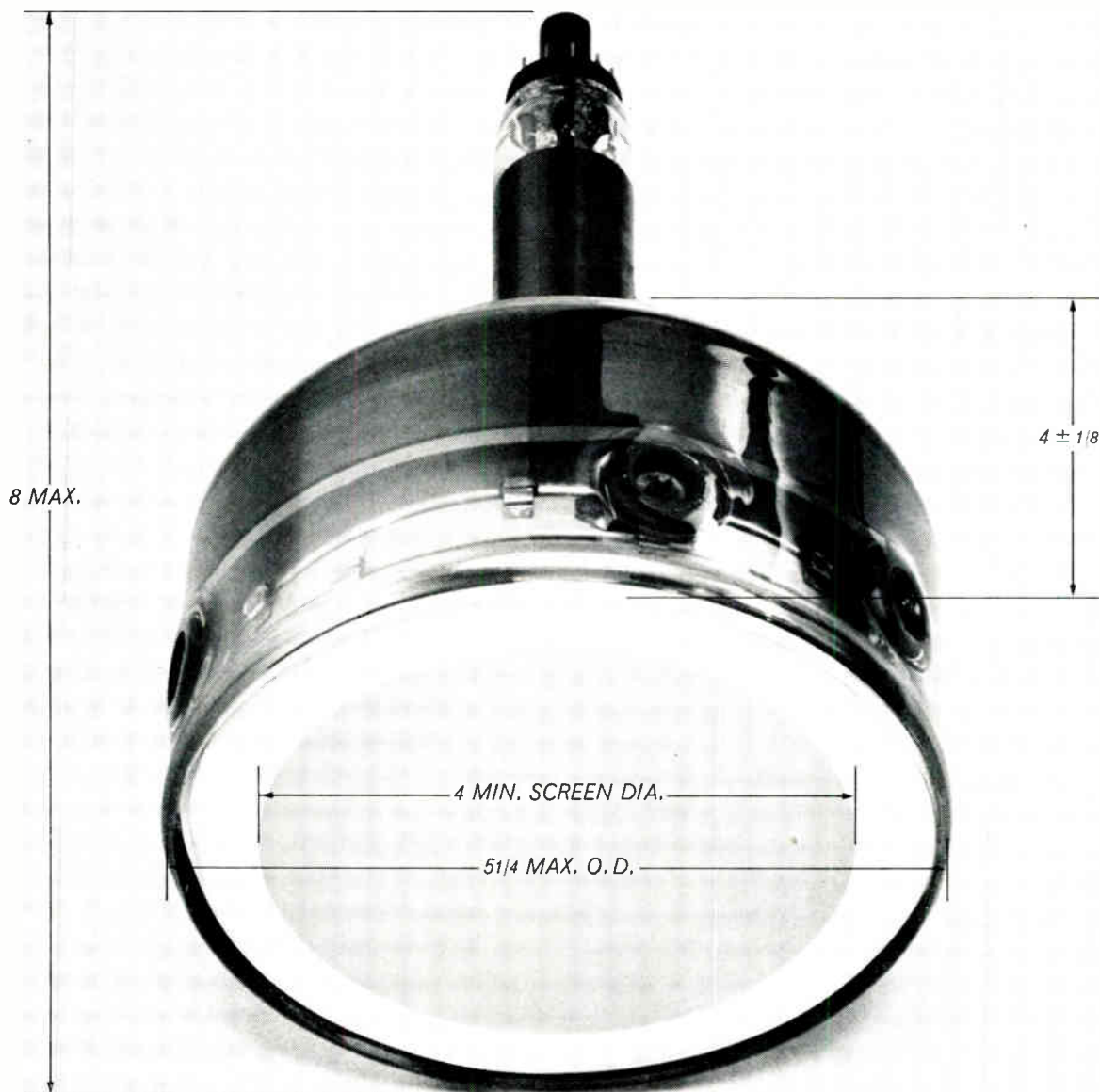

NOW
FROM WESTON



**Stability, flexibility and
50 mv sensitivity!**

Weston's 20Mc, solid-state Universal Counter-Timer provides outstanding stability and flexibility through a combination of unique features:

- 50 mv sensitivity
- Time base frequency available on front panel
- Powered from 110 or 220 v; 50, 60, or 400 cps
- Standard crystal stability of ± 1 part 10^8 /day
Optional extra ± 1 part in 10^9 /day
- Convenience of plug-in circuit cards
- Bright in-line Nixie readout
- Automatic unit and decimal display
- Panel arrangement for ease of operation
- Standard BCD output: 1-2-4-8 code
- Light weight: 30 pounds
- Rack or bench mounting
- Outstanding flexibility through these exclusive accessories:
 - Optional battery operation for field or flight use
 - Direct reading 500 Mc converter
 - Adjustable time base which permits direct readout in transducer input units
 - Decimal divider for longer time base and period measurements

The Universal Counter-Timer offers reliability and dependability typical of fine Weston products. Write for detailed information on this and other Weston electronic test equipment. Our field representatives will be glad to supply a unit for evaluation.

WESTON
Instruments & Electronics
614 FRELINGHUYSEN AVENUE, NEWARK 14, NEW JERSEY



Division of
Daystrom,
Incorporated

NEW PRODUCTS

MICRO DOUBLE NOR GATE

Fan-in of 3 and fan-out of 6.

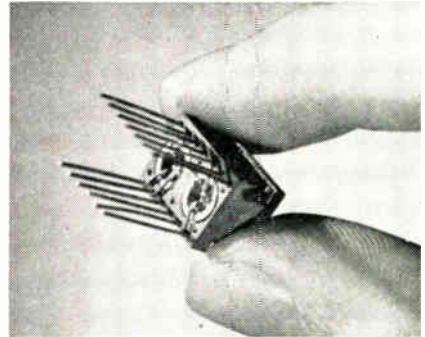

Types GG700 and GG1050 microcircuit double NOR gates have a fan-in of 3 and a fan-out of 6. Propagation delay/stage is 70nsec.; pulse repetition rate is 1mc between -55° to $+125^{\circ}\text{C}$. Operating supply is 6 to 12v. Construction uses thin-film techniques and semiconductors. Size $\frac{3}{8} \times \frac{1}{2}$ in. Intellux Inc., 30 S. Salsipuedes, Santa Barbara, Calif.

Circle 226 on Inquiry Card

PHOTO DIODE

SD-100 for visible and near infrared range of 0.45 to 0.85 microns.

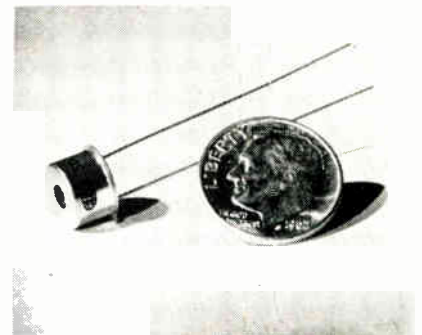

This silicon diode has a rise time of less than 3nsec. and a fall time of less than 20nsec. Response of the SD-100 in the above range is flat within 10%. Linearity of the output current is achieved over 5 decades of light input with appropriate bias. Noise current is in order of 10^{-12}a . Sensitivity measured at 0.8 microns is approx. $0.5\mu\text{a}/\mu\text{w}$. Diode can have current outputs in order of 1a. It is a p-n junction device of the surface barrier type in TO-5 package with a window. Operates at a bias voltage from 5 to 100v. Edgerton, Germeshausen & Grier, Inc., 170 Brookline Ave., Boston 15, Mass.

Circle 227 on Inquiry Card



MOST COMPLETE LINE OF ELECTRONIC HARDWARE

- Low Cost
- Fast Delivery
- Uniform Quality

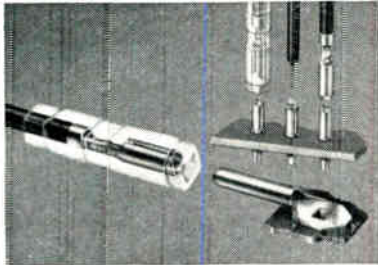

PIN TERMINALS RECEPTACLES • DISCONNECTS

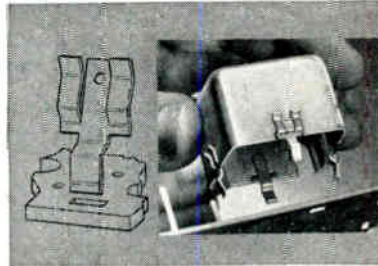

SPRING CLIPS

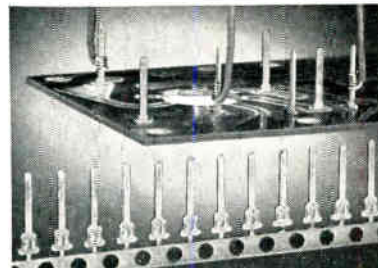

WRAP-A-WIRE TERMINALS

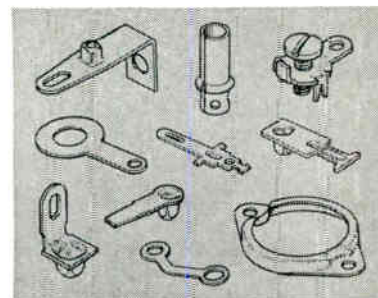

LUGS AND TERMINALS

REQUEST BULLETIN NO. 612. SEND B/P OR SPECS. FOR QUOTATION.

Malco MANUFACTURING COMPANY

4037 W. LAKE ST., CHICAGO 24, ILL.

Circle 124 on Inquiry Card

NEW PRODUCTS

HIGH VOLTAGE SUPPLIES

Ranges to 5Kv and 150ma.

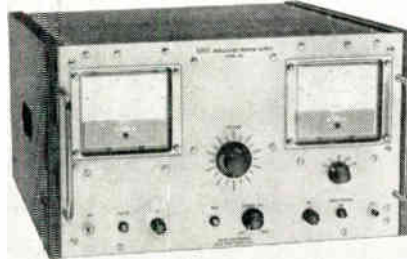

Five models provide voltage ranges of 0 to 5kv at currents up to 150ma. Floating output permits operation with either positive or negative grounding, or full floating to 7.5 kv relative to ground. Adjustable overcurrent tripout protects devices under test. Units feature low peak-to-peak ripple and drift of less than 0.5v/day. Alfred Electronics, 3176 Porter Dr., Palo Alto, Calif.

Circle 228 on Inquiry Card

PCM SIGNAL CONDITIONER

Complete ground station for PCM telemetry data.

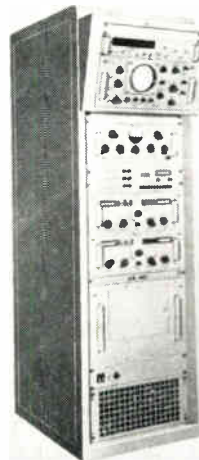

The Model 5228 system accepts serial PCM inputs in NRZ, RZ, or split-phase form from a tape playback driver, receiver, integral signal simulator, or other external source. Output is regenerated noise-free parallel and serial PCM data, and 4 phases of sequential timing pulses phase-locked to the incoming bit-rate freq. Solid-state system provides bit synchronization at extremely low S/N ratios and over wide bit-rate ranges (10-640,000 bits/sec.). Dynatronics, Inc., Box 2566, Orlando, Fla.

Circle 229 on Inquiry Card

HOW DOES YOUR CIRCUIT SEE A RESISTOR AT 100Mc?

like this



... or this

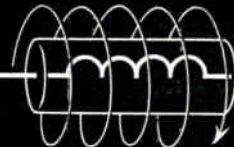

WESTON[®] VAMISTORS

PRECISION METAL FILM RESISTORS

offer superior HF response

Inductance has an important place in high frequency design—but *not* where your circuit calls for resistance! Weston Vamistors are *engineered* for critical HF applications. From dc to 100 Mc, inductance remains *virtually unchanged* at 0.007 μ h, and d-c resistance shifts less than 10% in units up to 50K! Distributed capacitance is less than 0.6 pf.

Vamistors offer many other features of importance to design engineers. They're the *most reliable* precision metal film resistors available. Average noise level is -33db (0.023 μ v/v), using NBS measurement techniques. And the current established failure rate is .015% per 1000 hrs @ 60% confidence level (full load @ 125C) based on over 6 million unit hours of testing.

The Vamistor's superior HF response is a result of advanced Weston design and special production techniques:



Alloy is thermally-bonded into internal glaze with patented Weston process.

Weston developed and produced resistance alloy offers uniformity and ideal metallurgical properties for vacuum deposition.

Length of resistance spiral is automatically controlled to minimize heat spots.

Incoming materials inspection, in-process control, testing and quality assurance programs guarantee specifications!

Weston Vamistors are available with highest ratings from 1/8 to 2 watts. Tolerance: to 0.05%. Temperature coefficient: 0 \pm 25 or 50ppm/ $^{\circ}$ C. Stability: exceed all MIL R-10509D specs.

Write for details. We'll include Weston Spec 9800 covering High Reliability Vamistors.

WESTON Instruments & Electronics

Division of Daystrom, Incorporated, Newark 14, N. J.

Circle 125 on Inquiry Card

DC to AC

or



- Frequencies from 400 cps to 5 KC
- Output voltages from 5-500 VAC
- 50, 100, 200 VA Standard

Designed to change low voltage DC power to sine or square wave power, these small-size, transistorized inverters can be supplied in a wide range of output voltages and frequencies. Units feature regulation to 1/2% for input 24 to 30 VDC, short circuit protection, and meet the environmental requirements of MIL-E-5272C. Prices range from \$185. to \$595. Delivery of most units from stock.

Send for complete 20-page catalog.

abbott transistor
LABORATORIES, INCORPORATED
3055 Buckingham Rd. • Los Angeles 16
Direct Dial 213 • REpublic 1-9331

Circle 126 on Inquiry Card

WEPCO THERMAL WIRE-STRIPPER

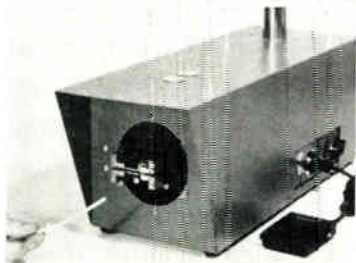

Model AT-1

"... SAVED \$25,000
IN ONE YEAR!"

The new AUTO-THERM WIRE STRIPPER is a semi-automatic stripper designed to strip by heated elements without nicks, cuts and tension adjustment prevents crushing of the wire. Rotating-head action strips hard-to-remove insulation. Strips Teflon, Vinyl, Cotton, Nylon, Fiberglass, etc. Adjusts from #30 AWG to 3/4" wire, including coax, shielded and irregular shapes. Solenoid-actuated operation with a built-in ventilation system... and the production capacity is in excess of 1000 ends per hour!

One of six models, from \$22.95 to \$395.00 • Send wire sample for recommendations.

Price \$395.00 FOB San Clemente, Calif.

Western Electronic Products Co.
107 Los Molinos, San Clemente, Calif.
Tel: (714) 492-4677

Circle 127 on Inquiry Card

NEW PRODUCTS

VHF-UHF DIODES

Voltages from -6 to -120v.

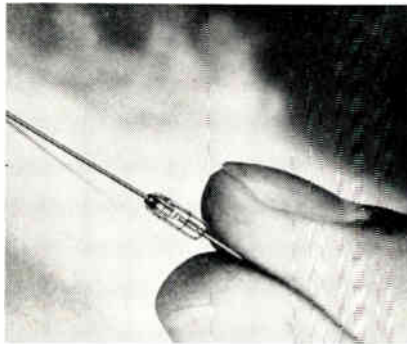

D4500 series silicon-epitaxial varactors feature 3 quality levels based on maximum series resistance, and are designed for AFC, r-f tuning, low-frequency harmonic multiplication, limiting, switching and phase shifting. They have 8 voltage breakdowns (-6v to -120v) and capacities ranging from 0.5 to 30.0pf. All are hermetically sealed and operate at temperatures from -65°C to 175°C. Sylvania Electric Products Inc., 100 Sylvan Rd., Woburn, Mass.

Circle 230 on Inquiry Card

MODULAR PUSHBUTTON

Performs functions of 10 switches.



Series PBS is a one pushbutton digital or binary switch. Each printed-circuit, 10-position module is manually operated. Positions advance on the return stroke, thus eliminating jamming. Internal colored lighting is available for both digital and binary types. Two widths: 1 in. panel space for digital or alpha readouts, and 1 3/4 in. panel space for function readout. Chicago Dynamic Industries, Inc., Precision Products Div., 1725 Diversey Blvd., Chicago 14, Ill.

Circle 232 on Inquiry Card

MINIATURE CIRCUIT BREAKER

Snap-action is rated at 5a.

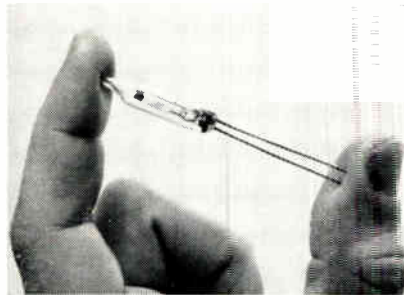

The Thermo-Snap regulates temperature and current flow. The glass-encapsulated, hermetically-sealed breaker contains an inert gas that provides fast heat conduction and prolongs contact life. It is rated at 5a, 115/240v continuous duty. The breakers, series type SB-600, includes temp. range from 80° to 180°C. and can be specified in tolerances of ±5, 7, or 10°C. Sylvania Electric Products, Inc., sub. of General Telephone & Electronic Corp., Lighting Products Div., Salem, Mass.

Circle 231 on Inquiry Card

TRANSISTORIZED DC PREAMPS

Deliver 10ma output.

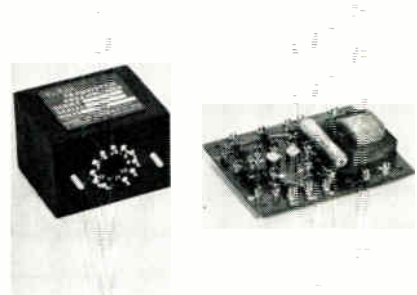

Models VTA-5 and VTA-6 are pre-amplifier packages which improve the sensitivity and response time of typical SCR gate drives. From input signals up to 80mv and 160µa, they deliver an output of up to 10ma into a load impedance up to 450Ω. They are substantially drift free over the temperature range between 0° and 65°C. They may be used as general-purpose dc amplifiers or for amplifying inputs to thyatron control circuits. Vec-Trol Engineering Div., Sprague Electric Co., Magee Ave., Stamford, Conn.

Circle 233 on Inquiry Card



PDE DESIGN DIGEST

NEWS FOR SYSTEMS COMMUNICATIONS ENGINEERS

FOAMFLEX AIR DIELECTRIC, SEMI-FLEXIBLE COAXIAL CABLE NOW AVAILABLE IN 125 OHM IMPEDANCE

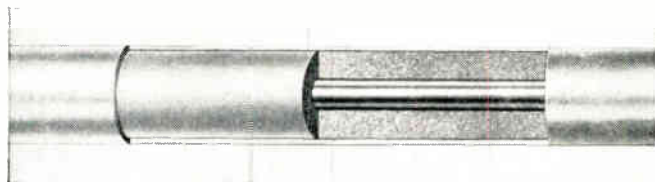

Now there is a broader selection of lightweight, low-loss Foamflex for many proven microwave and RF applications. Available in 50, 70, 75, 100, 125 ohms in seven diameters: 0.18", 1/4", 3/8", 1/2", 3/4", 7/8", 1-5/8". Telemetry feed networks, closed circuit TV, Minitrack installations are a sampling of advanced Foamflex systems now in operation. The all new catalog is loaded with reference data. Use the coupon to request a copy.

EIA COAXIAL CONNECTORS REDESIGNED

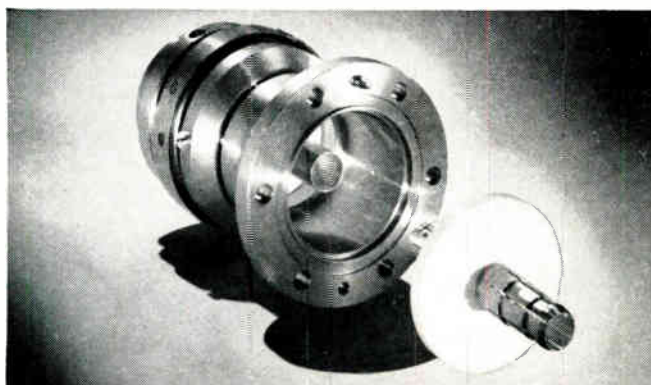

Two new design features are now incorporated in all EIA connectors. A Teflon* gas barrier permits electrical disconnection of the PDE cable without loss of pressure. To allow sex change, a standard double-ended EIA male inner connector is inserted by hand. If female characteristics are desired, the device need not be used. Ask for the new PDE Connector Bulletin for helpful engineering material.

* E. I. du Pont De Nemours registered trade name

X-RAY REVEALS ABILITY TO BEND CABLE WITHOUT ELECTRICAL OR MECHANICAL DISTORTION

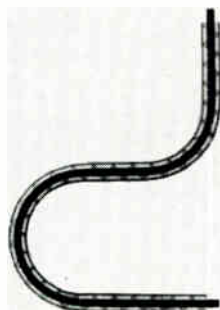

This formed bend, 3 times the diameter of the Helical Membrane cable, indicates the ability of PDE semi-flexible coaxial cable to be shaped into sophisticated configurations without mechanical or electrical distortion. Multiple bends with minimum straight length between curves allow terminal-to-terminal installation of all PDE cables without interruption for transitions.

PHELPS DODGE ELECTRONIC PRODUCTS CORPORATION • NORTH HAVEN, CONNECTICUT

HIGH PERFORMANCE WAVEGUIDES AVAILABLE IN BOTH STRAIGHT LENGTHS AND CUSTOM SHAPES

Rectangular and circular waveguides possess precise tolerance for top performance at high frequencies. Certified oxygen-free copper and commercial bronze, 90%, with a mirror-smooth finish, assure maximum signal fidelity. Available in 12-foot lengths in 16 JAN and EIA sizes. Custom shapes including twists, bends, coils, offsets, transitions, fabrications and complete assemblies can be engineered to meet your selected frequencies. Bulletin WG 1 offers full details.



STYROFLEX® COAXIAL CABLE EXHIBITS GREATER UNIFORMITY IN OSCILLOGRAM TESTS

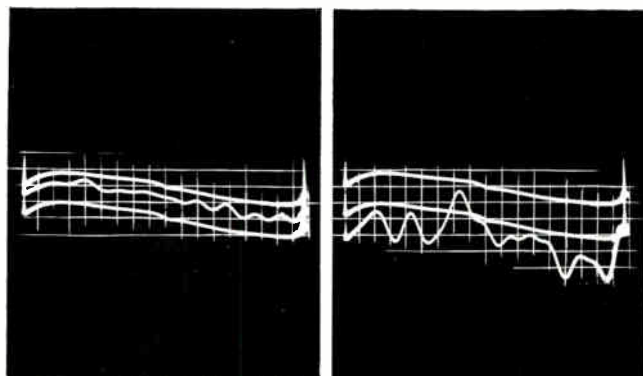

The oscillogram to the left is of 1/2", 50 ohm Styroflex cable. It reveals a VSWR of 1.01. To the right is type RG-8/U coaxial cable with VSWR of 1.05. In this test with a frequency band of 70-90 mc, the greater uniformity of Styroflex coaxial cable is apparent. If you are involved with critical performance standards in feed networks, you will want a copy of the new Styroflex cable catalog. Request Bulletin PS 4.

Send me the information requested below: ^{4E}

- | | |
|---|--|
| <input type="checkbox"/> Foamflex coaxial cable catalog | <input type="checkbox"/> Waveguide brochure |
| <input type="checkbox"/> PDE Connector catalog | <input type="checkbox"/> Styroflex® coaxial cable catalog |
| <input type="checkbox"/> Systems Communications Capability brochure | <input type="checkbox"/> Please have your representative contact me. |

NAME _____

TITLE _____

COMPANY _____

ADDRESS _____

CITY _____ ZONE _____ STATE _____

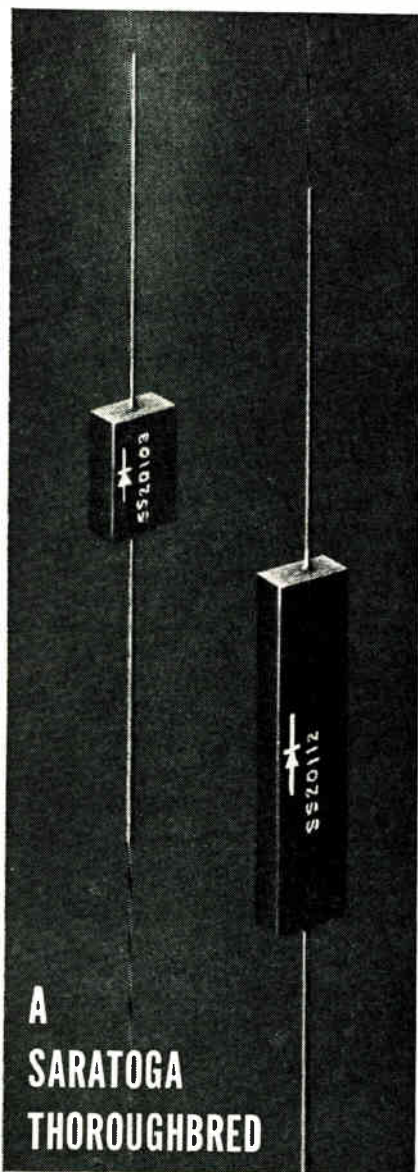

A SARATOGA THOROUGHbred

HIGH VOLTAGE HALF-WAVE RECTIFIER

Epoxy encapsulated solid state assembly.
Range — 1500 to 10,000 PIV, 250 MA
(full cycle average).

Operating and storage temperature:
—65° C to +150° C.

Designed to meet requirements of
MIL-S-19500C.

For use in package modulators, pulse
packages, radar power supplies and other
high voltage, low current applications.

For additional information
on Saratoga's complete
line of semiconductor de-
vices, write:



Saratoga Semiconductor

A Division of Espey Mfg. & Electronics Corp.
Saratoga Springs, N. Y. • Telephone 4100

Circle 129 on Inquiry Card

NEW PRODUCTS

DROPOUT COMPENSATOR

Restores signal dropouts.

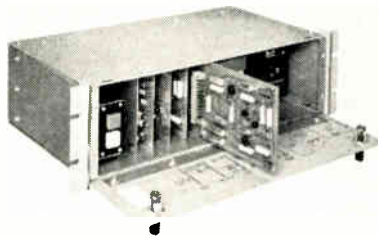

Signal dropouts in video-tape playback are restored by a new VTR accessory. Designated Dropout Compensator, the new unit compensates for dropouts caused by dirt or balling effect on the tape's oxide coating. The unit replaces the information by substituting the same portion of the previous line, which has been stored in a 63.5 μ sec. delay channel. Mincom Div., 3 M Co., 2049 So. Barrington Ave., Los Angeles 25, Calif.

Circle 234 on Inquiry Card

LASER RADIOMETER

Sensitivity of 625 μ v/joule



The RN-1 radiometer measures laser outputs, and is relatively insensitive to wavelength of the incident radiation. It overcomes the problem of heat loss by reradiation. Sensitivity at 6943 \AA is 625 μ v/joule. Thermal relaxation is 20 sec. to $\frac{1}{2}$ value. Useful range is 0.01 to 5 joules/sq. cent.; higher energy densities are measured using beam diverging or splitting techniques. Westinghouse Electronic Tube Div., Elmira, N. Y.

Circle 236 on Inquiry Card

HI-TORQUE DC MOTOR

Chronometrically governed for power drive applications.



K5801
HI TORQUE
CHRONOMETRICALLY
GOVERNED D.C.
MOTOR

Model K5801 is capable of delivering $\frac{3}{4}$ oz. in. torque at 3600RPM with an accuracy better than 0.05%. Available as direct drive or with integral gear head for almost any output speed requirement. Normally furnished for 24-30vdc operation, but windings for other voltages are available. Heavy duty construction assures reliable operation for over 2000 hrs. without overhaul. Motor output is only 130ma at 27.5vdc. Measures 2 x 2 x 2 3/16. Weight is 9 oz. max. A. W. Haydon Co., 232 N. Elm St., Waterbury 20, Conn.

Circle 235 on Inquiry Card

CERAMIC CAPACITORS

Designed to meet Mil-C-11015B series CK60, CK61, CK62, CK63.

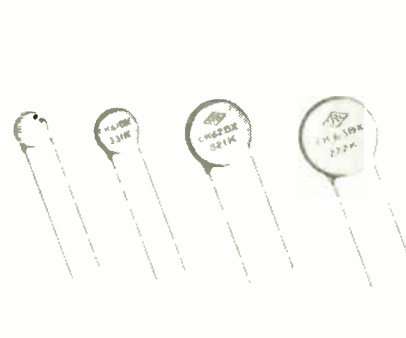

Rated at 500wvdc, 1800vdct, these disk capacitors come in Mil standard values from 2.2pf to 3300pf, in $\pm 10\%$ and $\pm 20\%$ tolerances. Two operating temp. ranges available: —55° to +85°C and —55° to +125°C. Life tested for 1000 hrs. at 1000v at max. operating temp. Power factor 1.5% max. and leakage resistance 20,000 megohms min. initial, 5000 megohms min. after life test. Size 0.280 to 0.660 in. dia. 0.120 in. thick. Centralab, The Electronics Div. of Globe-Union Inc., 900 E. Keefe Ave., Milwaukee 1, Wisc.

Circle 237 on Inquiry Card

NEW PRODUCTS

VARACTOR MULTIPLIERS

Output to 2300mc.



These varactors are used where precise, low-level signals are needed at freqs. above the range of quartz-crystal oscillators and other freq. standards. They cover a range of 30mc to 2300mc. Output frequency is 500mc, minimum power output of 300mw and a bandwidth of 1.0%. Efficiency is 60%; bandwidths of 5% have been obtained. Frequency Engineering Laboratories, Asbury Park, N. J.

Circle 238 on Inquiry Card

LOW WATT RESISTORS

Ranges from 10Ω to 1 meg.

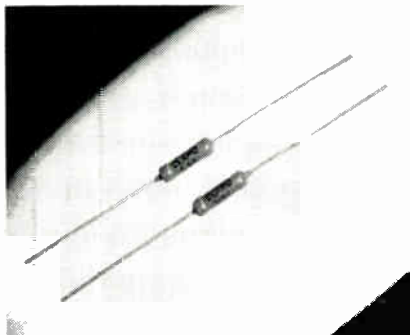

"CEP" is an epoxy-coated, deposited carbon 1% resistor rated at 1/2w @ 70°C. It has a 10% resistance change under load life conditions, 20% humidity change, and a temperature coefficient of 1/3 that of the carbon composition resistor. The resistance range is from 10Ω to 1 meg (±1%). Temperature coefficient is a mean 300 ppm and voltage rating is 350v. Clarostat Mfg. Co., Inc., Dover, N. H.

Circle 239 on Inquiry Card

TANTALUM CAPACITORS

Hermetic seal eliminates electrolyte loss.

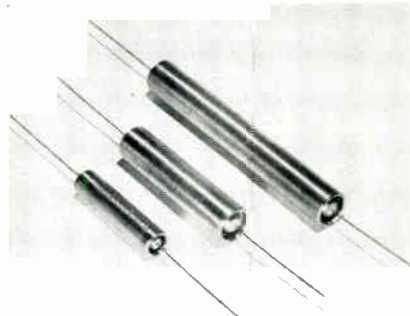

This foil-tantalum capacitor's hermetic seal virtually eliminates electrolyte loss. They are available in 3 Minuteman-size cases at 15 to 150v, 1.5 to 610μf and 85°C and 125°C. They are polar or non-polar, plain or etched foil construction. They can withstand pressures of 5,000 lbs./sq. in. and high temperature and voltage surges. General Electric, Electronic Specialty Capacitor Operation, Irmo, S. C.

Circle 240 on Inquiry Card

WITH VIDEOSONIC* SYSTEMS YOU CAN TRAIN YOUR EMPLOYEES IN A FRACTION OF THE USUAL TIME

The Videosonic System, developed and thoroughly proven by Hughes over the past several years, is an advanced method of audio-visual instruction which has enabled major electronics manufacturers to cut the training time of their employees by 50 per cent or more. One firm reported that their trainees, using the Videosonic System, reached a capability level in 43 hours which formerly took three months to attain.

Utilizing colored slides and tape-recorded instructions, this system communicates with your trainees individually with complete uniformity of instruction. Exclusive Videosonic programming techniques assure far better retention of instructions than is possible with conventional training methods.

For full information on how to: substantially reduce training time, make your trainees productive more quickly, dramatically decrease training costs, quickly train unskilled employees, realize immediate training results — write to VIDEOSONIC SYSTEMS, P. O. Box 3310, Fullerton, California.

Videosonic Systems offers you complete equipment and programming which includes problem analysis, script writing, photography, recording, system implementation, and programming training. Discover how Videosonic Systems can also increase the efficiency of your skilled assemblers.

*Trademark, Hughes Aircraft Company

HUGHES

HUGHES AIRCRAFT COMPANY
VIDEOSONIC SYSTEMS DIVISION



measure dc



100mv to 500v



within 0.02%

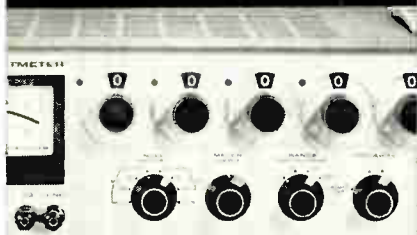

New Differential Voltmeter

Keithley 660 measures dc voltages with the accuracy and stability of a laboratory standard and the ease and low cost of an ordinary VTVM.

Features include:

- 0.02% limit of error
- reference supply stable to 0.005% indefinitely, without periodic re-standardization
- 100 μ v f.s. null range
- 2 μ v resolution
- infinite resistance at null, to 500v
- 0.005% repeatability
- 25 mv recorder output
- fully guarded input
- positive, negative or floating

Model 660 Differential Voltmeter . \$575
Model 6601A Voltage Divider . . . \$175

Send for four page Engineering Note on the Model 660

latest catalog available upon request



KEITHLEY INSTRUMENTS

12415 Euclid Avenue • Cleveland 6, Ohio

Circle 131 on Inquiry Card

34.5% of Electronic Exports Went To Euromart

Common Market (or Euromart) nations have become the largest single market for exports of U. S. electronic products. They accounted for 34.5% of all U. S. electronic exports for the first nine months of 1962.

Canada, meanwhile, continues as our biggest single nation customer, taking 19.4% of electronic exports for the same period.

Exports total for U. S. electronic products for the first nine months of 1962 was \$556.1 million, a 27% rise over the \$437.5 million for 1961 (same period).

Up to Oct., 1962, 74% of all U. S. electronic exports went to 10 nations, which imported \$342.1 million in electronic hardware, excluding special category items often military in nature.

The upshot is that uncommon opportunities seem to be luring U. S. firms into doing more business with Common Market nations and a few others.

EUROPE

Paris—NASA and the French Nat'l Center for Space Studies will cooperate in investigating propagation of VLF electromagnetic waves at altitudes between 46 and 62 miles. NASA sounding rockets carrying French instruments will be launched from Wallops Island, Va., this year.

London—The British Meteorological Office will build a system of automatic weather stations to fill gaps in the observing network throughout the British Isles. Initially, the MO has contracted with EMI Electronics, Ltd., to supply an experimental telemetry system.

Rome—AMF Atomics Div., American Machine & Foundry Co., will design a \$1 million nuclear research reactor for Italy's Atomic Energy Commission. It will be for the reactor test installation at the Casaccia Ctr. for Nuclear Studies, near here.

London—Avco Corp., Cincinnati, Ohio, has signed an agreement with Ultra Electronics, Ltd., allowing the British firm to use certain of the U. S. firm's communications manufacturing patents, developments and techniques.

AUTOMATED TRAINING

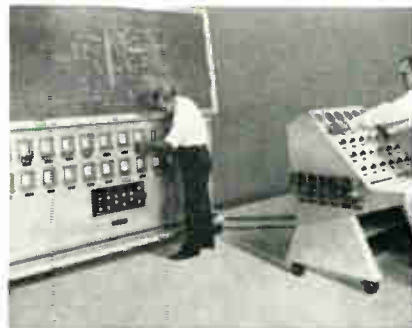

Operators of a Spanish ammonia plant at Abonos Sevilla S. A. learn to control the process on this Honeywell-built trainer. Miniature pneumatic instruments simulate process when controlled manually from the instructor's console (r). Analog control devices simulate students' control operations.

The British firm will make military ground communications equipment, including a miniature, transistorized transceiver, a more powerful portable transceiver and a small radio receiver.

Bonn—The West German Defense Ministry has awarded a \$16.8 million contract for radio communication equipment to Standard Telephones & Cables, Ltd., British ITT affiliate.

Bonn—The West German Government has purchased the first UNIVAC 1107 Thin-Film Memory Computer to be sold abroad. The \$2½ million system will be used for a classified application.

London—A new Bell & Howell international product marketing subsidiary has been formed here. The Photo Products Div. and the Consolidated Electrodynamics Div., Woking, Surrey, an instrumentation unit, comprise the subsidiary.

Budapest—Magyar Televizio, the Hungarian broadcasting authority, has ordered a second outdoor broadcast unit from EMI Electronics, Ltd. (The first was supplied in 1960.) Equipped with 4 EMI 4.5 in. image orthicon cameras and a zoom lens, the vehicle will have 4 video and 4 sound outputs.

London—Pye, Ltd., of Cambridge, will design and build a 100 KW nuclear research and training reactor for the Universities of Manchester and Liverpool. The reactor will be made by Pye under a licensing agreement with American Machine & Foundry Co., New York, N. Y.

U. S. Comprises Own "Common Market"

The United States, as a "common market" of interdependent states, is the world's largest market for all products, including electronics.

Jose de Cubas, President of Westinghouse International, suggested that the mass U. S. domestic market is a strong bargaining point for getting tariff concessions abroad for needed increases in our exports.

In view of the Commerce Department drive to step up U. S. exports, Mr. de Cubas urged pressure from Washington to reduce Common Market tariffs, and asked that the Government work more closely with U. S. private industry in this regard.

NORTH AMERICA

Kingston—A \$25,000,000, 1,450-mile deep-sea telephone cable system from Florida to the Panama Canal Zone via Jamaica has been completed. American Telephone & Telegraph Co. and International Telephone & Telegraph Co. cooperated in the project, which will improve communications and will lower rates among these points.

New York—The British Information Services Office in New York has moved to 845 3rd Ave. It formerly was at 45 Rockefeller Plaza.

Kingston — Jamaican Broadcasting Co. has ordered over \$1 million in TV studio equipment from EMI Electronics, Ltd., of England. It is for the new Jamaican TV service that will be inaugurated Aug. 1.

New York—Transpose, Inc., international translation service, has been established here. It is to provide an international communications link for matters concerning industry, trade, scientific and technical data.

Ottawa—Sperry Gyroscope Co. of Canada, Ltd., has licensed Nuova San Giorgio, S.P.A., Genova-Sestri, Italy, to make its Canadian-designed numerical control equipment for sale in Europe. These units are used largely by machine tool manufacturers.

Ottawa—Page-Hershey Tubes, Ltd., Toronto, has bought an h-f resistance welder which operates at 560 KW from Thermatool Corp., an AMF subsidiary. It will be used to produce

½ in. wall pipe, 16 in. in dia., at 100 ft./min. Purchase of a second unit is being negotiated. The cost of both will total over \$1 million.

ASIA

Tokyo—Anelex Corp., Boston, Mass., and Hitachi, Ltd., here have signed an agreement under which Hitachi will market, install and service Anelex products in Japan and Asia. Anelex makes high-speed printers, including bi-lingual ones.

Tokyo—Pioneer Electronic Corp. here has developed an underwater speaker providing a frequency response of 20 to 20,000 cps at depths up to 100 ft. Power-rated at 30 w., the U.L-2 has a cone resonance of 150 cps and a voice coil impedance of 16 ohms.

Bahrain—Twenty transmitters have been installed on this British protectorate as part of the world-wide communications station net of Cable & Wireless, Ltd. The transmitters, mostly of Marconi make, include 9 of 3.5 KW, 1 of 10 KW, and 1 of 30 KW.

Hong Kong—AT&E (Bridgenorth), Ltd., recently supplied complete VHF radio-telephone equipment for the harbor phone system of Cable & Wireless, Ltd., here. The system provides harbor communications for ships, boats and offshore islands.

BEAT THE MACHINE

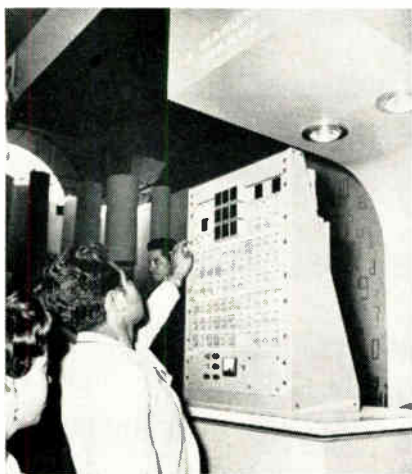

Eager fair goer at U. S. Exhibition in Mexico City tries to beat the electronic tic-tac-toe machine exhibited by Harman-Kardon, Inc., Plainview, L. I., N. Y. The machine is used by U. S. Commerce Dept. to demonstrate automation in the United States. Recent exhibition was largest U. S. trade fair ever held in Latin America. Three-week show at Chapultepec, Mexico City, drew 1 million.

measure
true
rms
to
50
mc



NEW
Wideband
Voltmeter

- 20 cps to 10 megacycles ±1%
- 18 cps to 20 megacycles ±3%
- 15 cps to 50 megacycles ±5%
- 100 microvolt to 300 volt range
- crest factor, 6 at full scale
- crest factor, 60 at tenth scale
- 1 megohm, 20 pf input impedance
- ac amplifier output—100 mv, rms
- ac amplifier response—6 nsec
- dc output—100 millivolts

Model 121 True rms Wideband Voltmeter \$870
Model 1201 Cathode Follower Probe \$120

Send for Engineering Note describing the Model 121

ALSO AVAILABLE

Model 120 Peak Reading Voltmeter-Amplifier \$775



KEITHLEY
INSTRUMENTS

12415 Euclid Avenue • Cleveland 6, Ohio

Circle 132 an Inquiry Card

Precision POWER SOURCE

MODEL 605

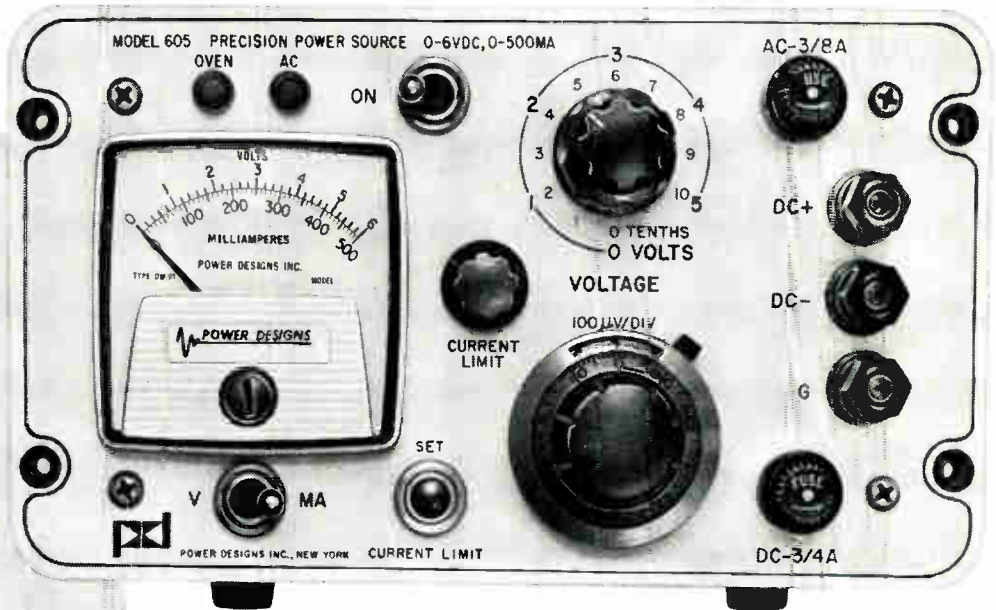

APPLICATIONS

TUNNEL DIODE, MICRO CIRCUITS,
METER CALIBRATION,
STANDARD CELL SUBSTITUTION,
D.C. MICRO-LOGIC CIRCUITRY



\$285⁰⁰

FOB WESTBURY, N. Y.

100 μ V Stability Per 8 Hours
100 μ V Resolution
100 μ V Peak to Peak Ripple and Noise
0-6 VDC 0-500 MA

FEATURES

- Low noise twin transistor differential amplifier and silicon voltage diode in temperature stabilized oven.
- Remote sensing for negligible interconnecting lead error.
- Continuously adjustable current limiting.
- Accurate remote voltage programming @ 1000 Ohm/Volt (within 0.1%).
- Direct read out dual concentric switch and 10 turn precision potentiometer with accuracy of 0.1%.
- Front and rear access terminals.
- All silicon transistor circuitry.

Write for complete specifications

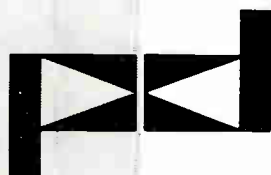

POWER DESIGNS INC.

1700 SHAMES DR., WESTBURY, L. I., N. Y.
516 EDgewood 3-6200 • TWX: 516 333-5698

ON THE WEST COAST: POWER DESIGNS PACIFIC INC., STANFORD INDUSTRIAL PARK, PALO ALTO, CALIF. • 415 321-6111

TRANSISTORIZED TELEVISION CAMERA

General Electric's new transistorized camera can handle up to 80% of today's local and network TV studio at about one-tenth the operating cost of larger camera (left). The small camera costs about half as much as the larger, and with transistorization it uses a vidicon instead of the more costly orthicon the larger camera uses.



National Association of Broadcasters has filed opposition to FCC proposal which would fix FM station assignments to a prescribed number within given areas. The Association took its stand for an FM assignment plan based solely on mileage separations and run on a "go-no-go" basis. In this approach, distance between stations on close frequencies is the chief criterion governing assignments, rather than fixing a set number of stations for a certain area.

A 2-way data communications system, "biomedical belt pack", that lets doctors on earth check a moon astronaut's physical condition was shown by The Bendix Corp., Bendix-Pacific Div., at the ARS Annual Meeting and Space Flight Symposium. Fitting around the upper portion of the man, it transmits telemetered data to a central control system aboard the space vehicle. This will relay the data back to earth via the vehicle telemetry system. The equipment can also serve as a 2-way voice system.

Rules for discounting "simplexing" by FM stations have been proposed by FCC. Simplexing, use of FM channel for storecasting background music with spoken material "beeped" out, was originally permitted to bolster station earnings and promote FM. FCC had made it clear in 1955 that when suitable multiplex transmitting equipment became generally available, "simplexing" was to stop, since FCC held it predominantly non-broadcast. In its proposal, the FCC tentatively concludes that subscriber-oriented stations cannot be as responsive to changing community needs as are stations using channels for regular broadcasting.

ELECTRONIC OPERATIONS

SYSTEMS WISE

The National Industry Advisory Committee (NIAC) has been asked to study how AM, FM and TV stations can alert the public in emergencies. The DOD Emergency Communications Committee and the FCC want the information as part of their review of defense requirements for non-Government emergency communications facilities.

The first six-patient wireless intensive-care monitor on the market enables the cardiac function of ambulatory as well as confined patients to be monitored around-the-clock. The Guardian 6000 broadcasts the electro-cardiogram and heart rate from miniaturized radio transmitters carried by, or alongside of, each patient. The data is beamed to a central display console. The monitor also allows the doctor to observe the effects of drugs on the patient's heart. Telemedics, Inc., subsidiary of Vector Manufacturing Co., Inc., Southampton, developed the unit.

Two University of Michigan researchers report initial success with a machine to help adult aphasics. Research findings suggest the device can one day serve, in ways the live examiner and therapist cannot, in helping many of the estimated 1,500,000 Americans affected by language impairment from brain injury. The machine helps the patient in sentence patterns, acts as object of patient's aggression and hostility, from which the patient can walk away without feeling guilty.

AROUND THE WORLD IN 4.8 MILLION WATTS

One of two transmitter control rooms of the U. S. Information Agency's new \$23 million Voice of America short wave complex near Greenville, N. C. The system uses 22 transmitters, total at 4800 kw, a receiving center and two transmitting stations. Each station has three 500 kw, three 250 kw, three 50 kw and 5 kw transmitters.



This digital telephone dial test set has a built-in automatic self-check which is capable of detecting any possible malfunction in the operating circuits or in the self-check circuits. Testing time for the seven dial parameters is only 2.266 seconds.

COMPLEX ELECTRONIC EQUIPMENT MUST BE CHECKED quickly, thoroughly, and automatically. A digital system was designed with a built-in self-check which, with a light-check, can detect 100% of all possible troubles; and it also allows a person with no technical knowledge to isolate single malfunctions to one or more plug-in cards. This checkout feature is provided by about 18% of the transistor circuits which make up the system.

Dial Tester Description

The system with this self-checking capability is a telephone dial test set, Fig. 1. During one single dialing of the digit "0," the dial tester automatically checks seven parameters of the dial and displays the results as HIGH, LOW, or OK on "IN-LINE" displays. Three of the measurements are also shown as binary numbers for accurate reading and adjustment. Also, any of four abnormal conditions would activate alarm indications. The test is made through the line cord of the telephone. All results are displayed simultaneously after the dial returns to rest.

A number of requirements, such as high accuracy, easy maintainability, and compatibility with other equipment, dictated the use of digital circuitry. The test set, therefore, employs NOR logic circuits packaged on plug-in cards which hold from one to six transistors each. Before the self-checking feature was added, the logic circuitry required 309 transistors. Another 145 transistors served as light drivers for the light bulbs which provide the various displays.

A self-checking feature was considered desirable for two main reasons. First, the test set is operated in a location where there are no technicians experienced in checking and trouble-shooting a complex digital system. Even a minor malfunction would, without the self-check, put the test set out of service for a long time. Secondly, many malfunctions could remain undetected for long periods of time. These might cause great numbers of good dials to be maladjusted or rejected or bad dials to be accepted.

Because of the many dials which the tester must

For Systems . . .

TEST SET DETECTS ALL DIALING TROUBLES

handle each day, a premium was placed on speed and operating ease. These requirements led to the design of a self-check which requires only the activation of a single push button and which takes only a little more than two seconds to complete.

Checkout Capability Design

All indicator lights and their transistor drivers are completely checked by one revolution of the light-check switch. It remains for the self-check to test the logic circuitry. The substance of this self-check is what will be called the "self-check sequence."¹

This sequence is a prescribed series of actions performed by the logic circuits on command of the self-check start button. Most of these actions are the same operations which are carried on by the circuits in the performance of their normal tasks.

Some circuits perform actions which are not similar to those they would ordinarily perform. Instead, they serve to control and perpetuate the progress of the self-check sequence. The fact that the circuits can perform their self-check function proves, however, that they would work properly during normal operation.

Only where no existing circuits could perpetuate the sequence, were new circuits added. Whenever such a self-check circuit was added, it was considered an integral part of the system and itself became subject to testing by the self-check.

One essential feature of the sequence is that all circuits participate in it at some time during the

1. Lee, F., "An Automatic Self-Checking and Fault-Locating Method," *Trans. IRE*, vol. EC-11, no. 3, October, 1962.

By FRED LEE

Development Engineer
Sylvania Electronic Systems
P. O. Box 188
Mountain View, Calif.



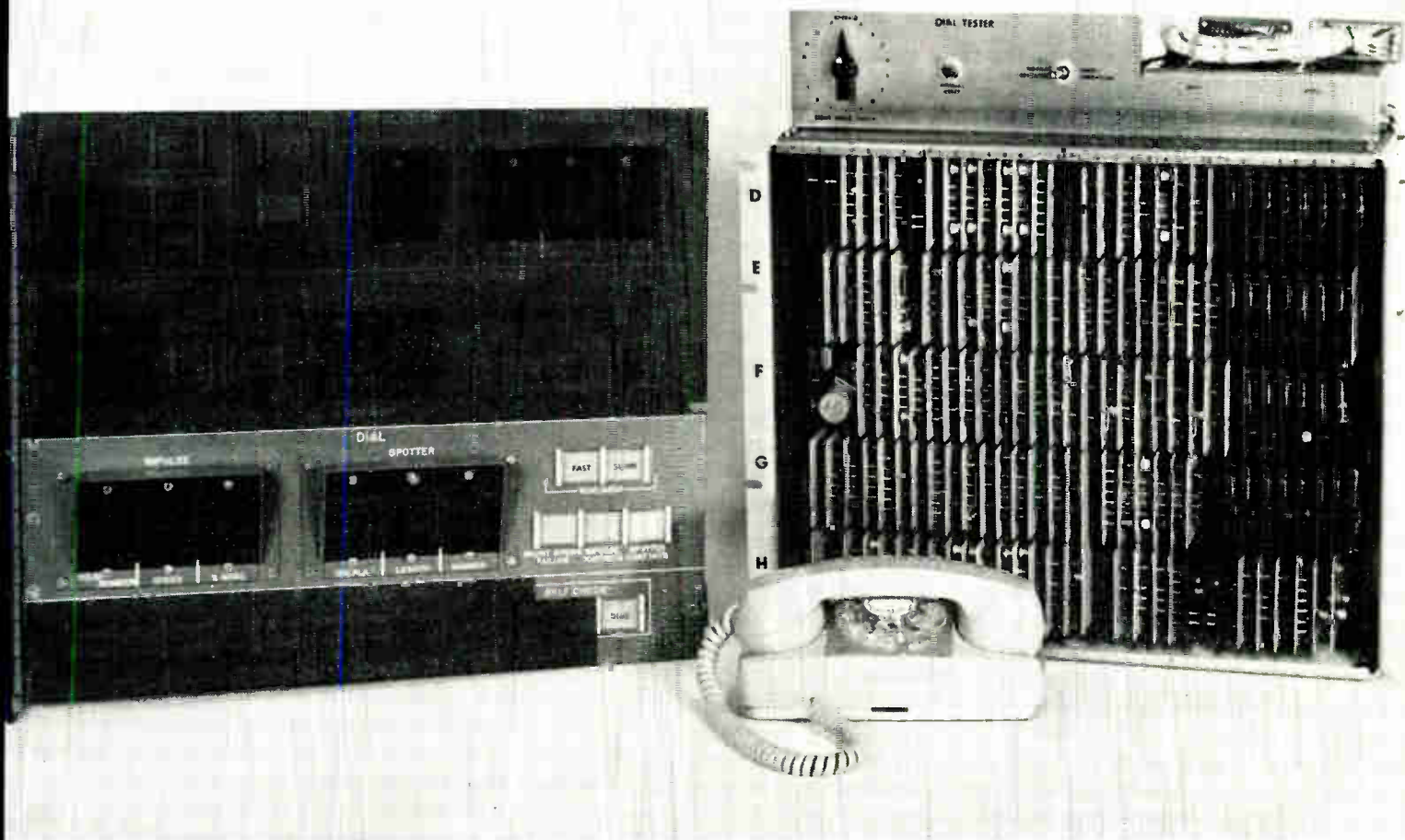

Fig. 1. Telephone dial test set display panel (left) and logic circuitry.

self-check. That is, every signal which could be generated in the dial tester is generated at least once.

Secondly, the signals appear in a prescribed sequence. Failure of any of these signals to appear, or to cease, on schedule interferes with the proper completion of the sequence. Thus, successful completion proves that no trouble exists in the system.

Many signals which occur in the dial tester are so necessary to the operation of the circuits, that their absence, or failure to cease, would interfere with the self-check sequence with no further effort required of the designer. Of the other signals, as many as possible were purposely woven into the sequence so that their correct occurrence is necessary to the perpetuation of the sequence.

The absence, or continual presence, of signals of a third kind—mostly output signals which operate various display lights—would not interfere with the sequence. These are called “key” signals. The self-check sequence was designed so that these key signals—or at least their leading edges—occur sequentially throughout the self-check. A simple out-of-sequence detector was added to stop the sequence, should any key signal fail to appear in its proper place in the series. The detector consists of two flip-

flops and a comparator which generates an alarm if the flip-flops are not in similar states. One of the flip-flops is triggered by each of the key signals; the other is set and reset by alternate key signals. Any change in the sequence of these signals results in an alarm.

A fourth group of signals is involved in the generation of the various key signals. A trouble in any of the signals of this group manifests itself in the failure of a key signal to appear in its proper place which, in turn, causes the out-of-sequence detector to stop the sequence before its normal end.

Many troubles remain which are not detected by this scheme. Some of these effect signals at least one of which is present at any time throughout the self-check. If these are combined by an OR circuit, they form a continuous signal. Furthermore, if any signal is missing, the OR circuit output is interrupted. Such a circuit was added. Any interruption of the output signal is allowed to stop the self-check.

The remaining troubles could be detected by testing for the presence of certain signals at the end of the self-check. An AND circuit performs these tests and checks for those other conditions which indicate that a self-check has been successfully completed.

A REPRINT OF THIS ARTICLE
CAN BE OBTAINED BY WRITING
on company letterhead to
The Editor
ELECTRONIC INDUSTRIES
Chestnut & 56th Sts., Phila. 39, Pa.

TEST SET (Continued)

Fig. 2. Each indicator lamp on the main panel is paralleled by a low current bulb on the maintenance panel shown above.

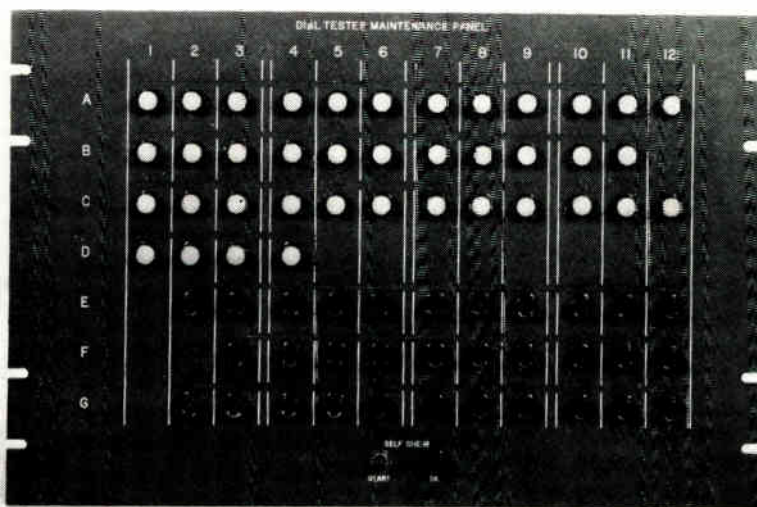

This circuit's output activates the green light which gives the operator complete assurance that there is no malfunction in the dial tester.

Circuit state at the time of a self-check stop is often peculiar to a trouble. Knowing this, the designer can provide fault-isolation. Isolation to a few circuits could be obtained by using the existing indicators augmented by only four new ones. To simplify fault-locating and light tabulating, each indicator lamp on the main display panel is paralleled by a low current bulb on the maintenance panel. Fig. 2.

Fig. 3 is a sample page from the trouble chart where these lights are tabulated. The symbol O means that the light is off after a self-check. Other round symbols, such as G, C, Q and θ also show that the light is off after the self-check, but in addition, give a clue to the behavior of the light during the self-check or a dial test. The symbol I stands for a light which is on after a self-check as do symbols like L, T, and X which also describe the behavior of the light during a self-check or dial test.

Four criteria were selected for evaluating check-out methods. They are the fault-detection, the fault-isolation capability, the cost in additional parts and circuitry, and the time consumed by the checks.

Fault-Detection

To perfect and evaluate the system fault-detection capability, an attempt had to be made to actually insert all possible troubles. The most frequently encountered trouble in the NOR circuitry is a shorted, or an open, transistor. Such trouble causes failure of some signal to appear, or the continual presence of a signal, plus any effects caused, in turn, by that anomaly. Any other conceivable trouble in the logic circuitry would manifest itself in the failure of some transistor to turn on or off; and, therefore, also

result in the continual absence or presence of some signal. In the dial tester circuits, the transistor collectors are brought directly to an output pin of the plug-in card; and, the load resistors are located at the input terminals of the following circuits. An open transistor could, therefore, be simulated by simply disconnecting an output pin. Clipping the output pin to ground simulates a shorted transistor. A simple test jig was built with which simulated opens and shorts could be inserted easily by means of switches.

It was possible to refine the self-check to the extent that not a single simulated trouble would allow the green light to appear at the end of a self-check. The self-check then is capable of detecting 100% of all possible troubles in the logic circuitry. Since all display lights and their drivers are tested by the light-check switch, a successful light-check and a green light at the end of a self-check impart complete confidence in the system.

Fault-Isolation

The trouble charts used for fault-isolation were prepared by tabulating the light indications on the maintenance panel after each trouble in the logic circuitry had been inserted and a self-check performed. The entries were rearranged in numerical order (considering the line of light indications as a number with an on light a 1 and an off light a 0). It was found that 40.1% of the 759 possible troubles yield unique self-check results. Another 19.5% of the troubles give results which are also obtained from one other trouble, and so on.

However, the smallest replaceable component is the plug-in card. Many of the troubles which yield identical results start from the same card or even the same circuit. A more meaningful evaluation,



Printed Circuit Connectors with operating voltages to 1500 V RMS... up to 5 amps current carrying capacity!

Ideally suited for limited space applications! Extremely compact —highly resistant to extremes of shock, vibration, temperature and moisture. Body, tough low-loss polyamide per MIL-P-17091 (Du Pont Zytel 101 nylon). Available in 13 colors, including basic colors for MS16108C coding applications. Contact resistance: less than 2 milliohms. Capacitance between two adjacent jacks: less than one mmf.

TIP JACKS—Formed silver-plated beryllium contact. Horizontal Jack accepts .080" dia. tip plug in either end, top or bottom. Vertical Jack mounts through single .052" hole requiring minimum mounting area.

SUB-MINIATURE TIP PLUGS—One-piece, nickel-plated, machined brass tip. Solder type lead connection. Available in standard length or with 4" body for access to "hard to reach" test points.

STANDARD NYLON CONNECTORS—Complete line of Tip Plugs; Standard, Metal-Clad, and Rapid-Mount Tip Jacks; Banana Plugs and Jacks; Binding Posts. Tough, low-loss, shock-proof nylon will not chip or crack. Voltage breakdowns to 12,500 VDC. Catalog lists available types.

OTHER CONNECTORS—In addition to nylon types, Johnson also manufactures standard connectors. Catalog lists available types.



E. F. JOHNSON COMPANY

3002 TENTH AVENUE S.W. • WASECA, MINNESOTA

NEW CERAMIC-TYPE MOLDING MATERIAL FOR *Micro Miniaturization* MODULAR PACKAGES

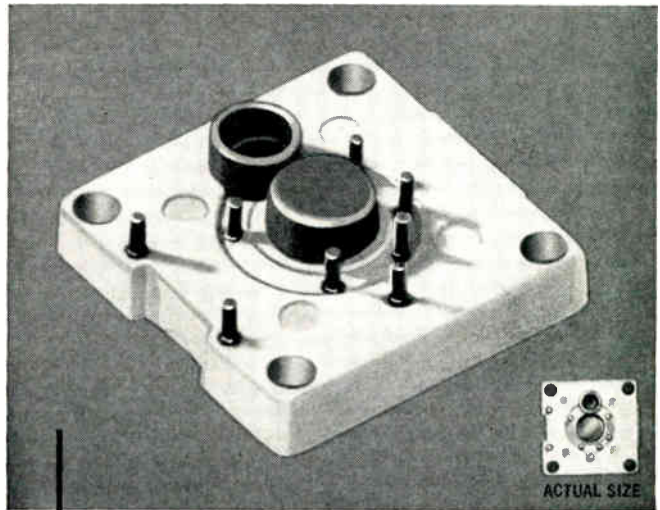

HAVEG develops
new method for manufacturing
HERMETIC SEALS
of complicated design with
ceramic type materials

- 10 inserts hermetically sealed in the molding process. Inserts shown are .020 dia. —(.006 flat or round are possible).
- precision tolerances $\pm .001$ on center distance.
- insert material molded to exact specifications and inserts sealed — no metallizing required.
- dimensional stability and excellent electrical and arc properties between 600°F and 1000°F fill that important "temperature gap" in molded materials.

Learn more about HAVELEX and how it can help you solve some of your problems. For latest technical data, write to HAVELEX Sales Mgr., Dept. EI-35.

HAVELEX®

HAVEG.

HAVEG INDUSTRIES, Inc. • 336 Weir Street • TAUNTON, MASS.

Circle 135 on Inquiry Card

MINIATURE Nylon Plugs and Jacks

DESIGNED FOR
PRINTED CIRCUIT USE:

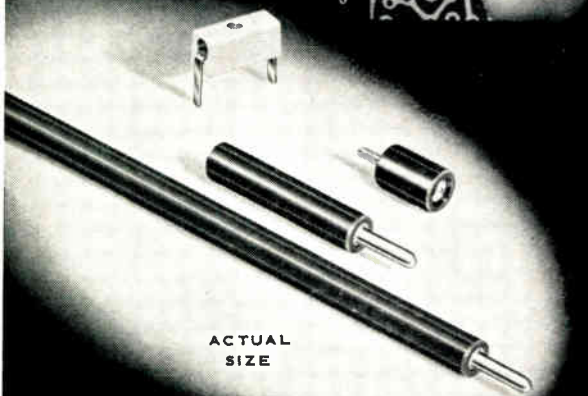
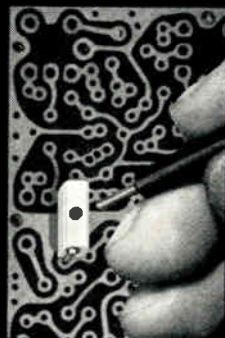

ACTUAL
SIZE

DETAILED COMPONENTS CATALOG AVAILABLE
—Write today on company letterhead!

• CAPACITORS • TUBE SOCKETS • CONNECTORS • PILOT LIGHTS
• INSULATORS • KNOBS AND DIALS • INDUCTORS • HARDWARE

Circle 134 on Inquiry Card

OPERATIONAL AMPLIFIERS

(Continued from page 95)

Fabricated using the planar configuration for transistors, diodes and resistors, these operational amplifiers offer high reliability, small size and low weight. Packaged in the hermetically sealed enclosure, these amplifiers, which meet the standards of Mil-5-19500, are designed to operate over -20°C to $+85^{\circ}\text{C}$.

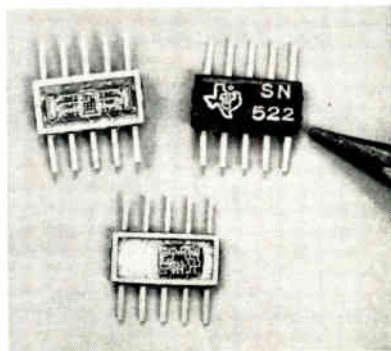

The 52 Series networks are mounted in a glass-to-metal hermetically sealed package. Leads are gold-plated Kovar. Weight is 0.1 gm.

General operating characteristics are: open-loop voltage gain, 62db; common mode rejection, 60db; dynamic output voltage range, $\pm 2.5\text{v}$; frequency response, dc to 50kc. Texas Instruments Incorporated, Semiconductor-Components Div., P.O. Box 5012, Dallas 22, Tex.

METAL-FILM TRIMMING POT

WESTON'S VAMITRIM[®] rectangular metal-film trimming potentiometer can be used in UHF circuits. Heretofore, trimmers were eliminated because of high-reactive factors. Vamitrim's infinite-resolution, low-noise characteristics make it a vital component for use in the precision balancing circuits of analog computers, missile guidance, and command systems.

Vamitrim, which exceeds the requirements of MIL-R-22097B, has a minimum contact path of seven inches in length; its overall length is $1\frac{1}{8}$ inches. The metal-film resistive path of the inner diameter of the tubular ceramic core is a low-temperature coefficient alloy, spiralled to achieve resistance value. Tracking of this 15-inch long spiral path by a precision-metal contactor makes possible adjustment of units with 10 turns over the range 5K to 50K ohms, and 25 turns over the range 50K to 200K ohms. Operating temperature range is -55° to $+150^{\circ}\text{C}$. Wattage rating is 0.5 at 85°C with derating to 0 at 150°C . Resistance tolerance is $\pm 5\%$; end resistance is less than 1%. Insulation resistance is 10,000 megohms. Maximum working voltage is 400 volts. Additional information may be obtained from Weston Instruments and Electronics Div., Daystrom, Inc., 614 Frelinghuysen Ave., Newark, N. J.



**SHORT WEIGHT
OR
SHORT WAIT?**



FULL VALUE TRIAD TRANSFORMERS FOR EVERY JOB

Quality-wise, Triad transformers are never short-weighted. You get full value every time. Quality, however, generates demand. And because it takes just so much time to build a truly fine transformer, the demand does sometimes exceed productive capacity. To avoid even a short wait, however, contact Triad at a reasonably early phase of your project. Commercial grades for manufacturers of communications, television, high-fidelity, public address, and instrumentation equipment. Mil-spec grades for producers of advanced military electronic systems. Specifications and prices for over 1,000 standard models are contained in our Industrial Transformer Catalog. See your distributor or write Triad Distributor Division, 305 N. Briant St., Huntington, Ind.

T TRIAD DISTRIBUTOR DIVISION
A DIVISION OF LITTON INDUSTRIES 

LETTERS

to the Editor

"Designing Adaptive Digital Networks"

Editor, ELECTRONIC INDUSTRIES:

In reference to the article by G. S. Glinski, "Designing Adaptive Digital Networks," February 1963, please note the following discrepancy in Figure 3. The inverter transistor is shown as an emitter follower, where in actuality, it is being operated as a common emitter switch with collector and emitter reversed. If this is not an error in the schematic, why not reverse all the inverter stages? Also, since the inverter is capable of driving the networks, why not do away with the emitter follower output stage and connect R9 directly to R7 yielding two switches in the output and one less transistor?

David W. Friedman
Engineer
Philco Corporation

1102 Stotesbury Ave.
Wyndmoor, Pa.

The author replies:

Editor, ELECTRONIC INDUSTRIES:

The circuit diagram of Fig. 3 of my article is in error. The transistor T5 has its collector and emitter reversed.

The circuit suggested by Mr. Friedman would work satisfactorily provided not more than 4 or 5 other neurons were to be driven from one unit (otherwise the loading effect would become unacceptable).

It should be pointed out that our main interest was in the experimentation with the neuron networks and not the development of the most efficient neuron unit. This is why the existing design of Dr. Harman of the Bell Telephone Laboratories has been employed.

Incidentally, Dr. Harman has now a better neuron design. Also, it is possible now to buy the neuron units commercially. For example, from the Perceptive Research Products (P. O. Box 94, East Station, Yonkers, N. Y.).

Mr. Friedman's pointing out of an error is sincerely appreciated.

G. S. Glinski

Chairman

Electrical Engineering Dept.

University of Ottawa

Ottawa 2, Canada

"Save Your Old Parts"

Editor, ELECTRONIC INDUSTRIES:

The readers of your Letters section might be interested in this idea—"Electronic Antiquarianism."

The development of Radio is in a good part the development of materials and components. As one reads through books and articles on wireless in the post World War I era one can't help but be impressed by the knowledge of radio theory which was known at the time and is still very good today. The radio designers made the best possible with their materials and the components available to them, and the changes in these components recall a fascinating history. The Princeton Tube Collection is an excellent demonstration of electronic progress over the years.

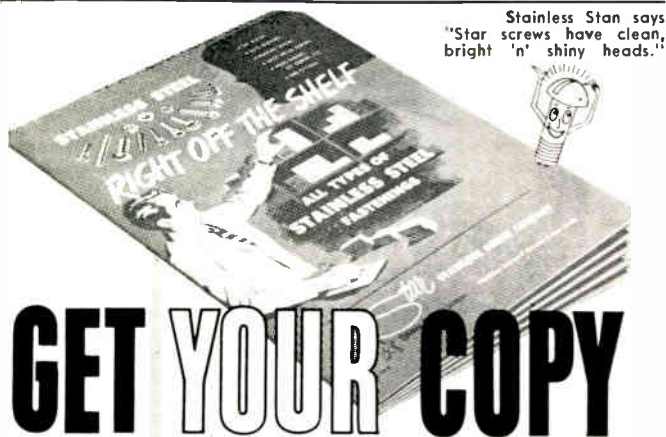

Stainless Stan says
"Star screws have clean,
bright 'n' shiny heads."

STAINLESS STEEL
300 & 400 Series

- AN Drilled Fillisters
- Bolts
- Cap Screws
- Cap, Socket Head
- Cotter Pins
- Dowel Pins
- Hinges
- Machine Screws
- Nuts
- Set Socket
- Sheet Metal Screws
- Stud Bolts
- Taper Pins
- Washers
- Wood Screws

STAR'S CATALOG OF *Right-off-the-Shelf*® STAINLESS STEEL FASTENERS

Save time . . . save money. This book lists over 8,000 stainless steel fastenings available for immediate delivery RIGHT OFF THE SHELF®!

Write for your new catalog TODAY.



STAR STAINLESS SCREW CO.

165 E. Railway Ave., Paterson 3, N. J.
Phone: LAmbert 5-5500
Direct New York Telephone: Wiscansin 7-6310
Direct Philadelphia Telephone: WALnut 5-3660

Circle 137 on Inquiry Card

SAFE, RELIABLE SOLDERING . . . with water – soluble flux!

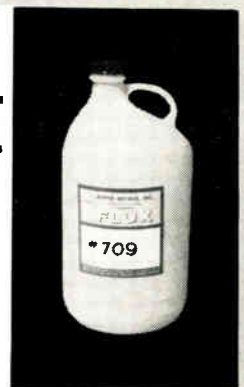

Alpha #709 non-aqueous, water-soluble flux is ideal for spatter-free soldering of printed circuit boards and other critical electronic assemblies containing hermetically sealed components. Its rapidly evaporating vehicle leaves a smooth, dry film ready for safe, reliable soldering. Alpha #709 residue is completely soluble in water, freon or alcohol.

Alpha #709 is ideal for low temperature soldering applications. It may be applied, dried and dipped in solder with assured safety.

alpha® **alpha metals, inc.**
56 Water St., Jersey City, N. J. Henderson 4-6778
Los Angeles, Calif. • Alphasoy Corp. (Div.) Chicago, Ill.
• Alpha Metals, Inc. (U.K.) Ltd., London, England

Circle 138 on Inquiry Card

Collections are something you always should have started years ago! When I was a boy we used UV 201-A's for BB-gun practice or, if you were a better marksman, 199's. Today those once common tubes are rare antiques and even a Type 80 is hard to find.

We are now a dozen years into the semi-conductor era of Radio, and new transistor and diode types are appearing by the thousands and disappearing almost as rapidly to be replaced by newer 2N-numbers. A IN34 may still be found in a bottom drawer somewhere but a point-contact transistor may be regarded as a true antique these days.

My point is this, gentlemen, if you wish to be an antiquarian of Radio development, NOW is the time to collect these fast changing components! The contents of your laboratory bench drawer, if properly saved today, may be your claim to a valuable electronic antique collection 20 years from now.

John D. Fogarty
Engineering Manager
Data Communications Section
Remington Rand Univac
Blue Bell, Pa.

"Self-Verification"

Editor, ELECTRONIC INDUSTRIES:

As an enthusiastic proponent of Self-Verification I was pleased to see the paper by Messrs. Cohen, Kishi and Rosenthal in your February issue. It is in the hope of stimulating discussion on this important topic that I respectfully submit my somewhat contradictory opinions and some evidence to support them.

My main concern is with the attitude expressed by the statements that very few systems can, or will, be 100% self-verified, that the cost of approaching complete self-verification is extremely high, and that automatic self-verification (by periodically exercising every function through its normal states) is generally not possible. These pessimistic impressions expressed by the authors seem to be shared by most engineers. My own experiences have taught me to believe the opposite—that most digital systems (including communication systems) seem to lend themselves very well to some complete, or nearly complete, self-verification scheme and that the implementation of such a scheme can be surprisingly inexpensive.

I have in recent years applied my own technique¹ (which might involve any of the four types of SV described by the authors) to a number of completely different digital systems. The results (with no system left unreported) can be summarized as follows:

1. System: Telephone Dial Test Set²
Size: 555 transistors
Verification: 100%—tested by simulation of all possible troubles
Fault Location: 74% of indications isolate single plug-in
Cost: 18.2% increase in transistors
2. System: Communication system involving automatic sequential interrogation by central station of substations and appropriate replies
Size: 4000 transistors
Verification: Believed 100%—breadboard tested but no attempt to simulate all troubles
Fault Location: Not attempted
Cost: 4.7% increase in circuitry
3. System: (cannot be described)
Size: 350 transistors, 75 stepping switches
Verification: Near 100%—only paper design complete
Fault Location: Isolation to plug-in looks good—not tested
Cost: Less than 10% increase in circuitry
4. System: Airborne Data Processing System (including computer with 7 subroutines)
Size: 10,000 transistors
Verification: 90 to 100%—only preliminary design completed

(Continued on page 210)

TYMETER®

**DIGITAL
READOUT
CLOCKS &
COMPUTERS
FOR
NEW
IMPROVED
APPEARANCE
OPPORTUNITIES
at LOW COST**

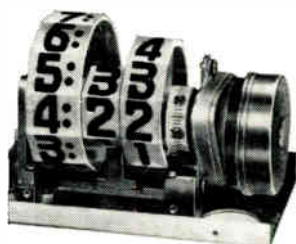

#130 Digital Readout Clock Movement with large 5/8" easy-to-read digits.

Tymeter Digital Readout Clocks and Computers are engineered for installation in any equipment or product, rack, clock case, console, cabinet or panel. Designed for front or back convenient, economical mounting . . . TYMETERS are compact and dependable.

TYMETER experience and design ingenuity in DIGITAL READOUT CLOCKS and COMPUTING Equipment takes in many forms . . . 12 and 24 Hour Clocks, 12 and 24 Hour Time Computers, Elapsed and Interval Timers, Second-by-Second Gradinetic Readout Clocks and Time Computers. TYMETERS feature 5/8" digits.

Catalog, Specifications
Quotations and Samples
on Request

**TYMETER ELECTRONICS
PENNWOOD NUMECHRON CO.
7249 FRANKSTOWN AVE. PITTSBURGH 8, PA.**

Circle 139 on Inquiry Card

CONNECTOR DESIGN CRITERIA

by *V/B*



VIBRATION DAMPENERS

(our connectors have vibration dampeners too!)

DEUTSCH

Circle 140 on Inquiry Card

LETTERS

to the Editor

(Continued from page 209)

Fault Location: Not wanted, but can easily be added
 Cost: Less than 4% increase in circuitry

The convictions I have gained from these experiments prompt me to advocate a different method from that outlined by the authors of attacking the SV problem. Instead of first computing such things as MTBF and cost trade-offs and then fitting an SV method to these, I propose that the designer (not a second stringer or someone from another department) first consider whether the operational sequences of his system cannot be made to yield some excellent self-checking mode. I strongly believe that he would usually be pleasantly surprised. Then—if there is any doubt—he could make certain that his SV scheme would provide sufficiently high system availability for sufficiently low cost.

1. "An Automatic Self-Checking & Fault-Locating Method," *Trans. IRE*, Vol. EC-11, pp. 649-654, October 1962.
2. "A 100 Percent Self-Check with Fault-Isolation," *Electronic Industries*, soon.

Fred Lee
 Engineer
 Signal Processing Systems
 Department

Sylvania Electric Products Inc.
 Electronic Systems
 Mountain View Operations
 P. O. Box 188
 Mountain View, Calif.

"Guide to Lamps"

Editor, ELECTRONIC INDUSTRIES:

Due, perhaps, to my failure to get in touch with your publication, it was nevertheless a bit of a shock to find no mention of the Grimes Manufacturing Company in your January issue—Designers' Guide to Lamps, Indicator Lights and Illuminated Switches.

As the company which designs and builds the lights, indicators, warning systems and other related gear for the Mercury, Gemini and DynaSoar space vehicles, and whose lights and indicators are found on and in every military and civilian jet—including the Boeing

707 cockpit pictured in your articles—it was damaging to our ego, to say the least, to find ourselves ignored entirely.

We have always prided ourselves in being the world's leader in the field of aircraft lighting, and even maintain a separate research and development facility at Delray Beach, Fla., to help us preserve that peerless reputation. For some three decades we have lighted the world's aircraft and are now lighting its space vehicles—and have earned the industry's complete respect in doing so.

We're proud—justly, we believe—in the work we are doing in the fields of exterior and interior aircraft lighting and related electronics, including indicators, warning systems, control boxes, missile controls, signal lights, and so on.

May we invite a member of your staff to visit us and see for himself? And may we also ask that we be considered in any future issues related to our field?

Robert Vincent

Director of Public Relations
 Grimes Mfg. Co.
 Urbana, Ohio

William J. Kennedy
 Sales Manager
 shown 1/25 actual size
 Model 9200
 Coaxial Termination
 shown actual size.



50-OHM COAXIAL TERMINATIONS

■ "Model 9200 50-Ohm Coaxial Termination is one of eight models in our SAGE-LINE of terminations. It provides a maximum VSWR of 1.15 over the entire range from DC-5000 MC. Its peak power capability is 1 KW; average power, 1 watt. ■ The 9200 connector is type N male. The dimensions are $2\frac{7}{32}$ " in diameter and $1\frac{13}{32}$ " in length. Weight is 2 ounces. All materials and finishes are to government specifications. ■ The price of the 9200 is \$12.50, FOB Natick. Quantity discounts are available. Delivery is from stock for quantities up to 100. ■ If you have a question or would like to place an order, I hope you will call the number shown below. We'll look forward to talking with you." ■

William J. Kennedy / Sales Manager



SAGE LABORATORIES, INC.
 3 HURON DRIVE • NATICK, MASS. • Tel: 617-653-0844
 TWX: 617-653-6193 • Cable: SAGELABS-NATICK

Circle 141 on Inquiry Card

Even CONTAINER-KRAFT can't SKIN or BLISTER PACKAGE an ELEPHANT . . .

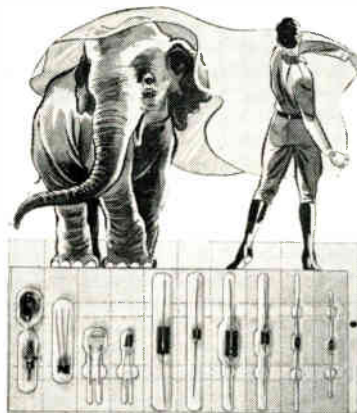

- We CAN skin or blister package your PRODUCT . . .
- Offer YOU the finest heat-sealing equipment FREE . . .
- Supply ALL ESSENTIALS for skin or blister packaging in YOUR OWN PLANT . . .
- CUSTOM DESIGN a blister pack to meet YOUR REQUIREMENTS

We are licensed for "Skin Pack" process by UNION CARBIDE and by LOCKHEED for the P-75 "Vendor Pac" — and we do have 17 years experience in industrial and consumer packaging.

Let us show you — ABSOLUTELY WITHOUT CHARGE — how SKIN or BLISTER PACKAGING by Container-Kraft can give your product . . . greater market and consumer appeal . . . quick identification . . . easy in-package testing . . . complete inventory control. Send us a sample of your product and we will package it for you FREE Container Kraft packaging fulfills all essentials in handling and using electronic component parts.

Write for details and send YOUR product to:

Container-Kraft

721 East 61st Street, Los Angeles 1, California — Phone 232-3281

Circle 142 on Inquiry Card

IEC MEETING ON MICROELECTRONICS

Members of the Advisory Committee on Electronics and Telecommunications (ACET) of the International Electrochemical Commission (IEC) met last month in New York to set up an ACET Working Group to plan handling of committee problems in microelectronics. Delegates, left to right, are: J. A. Caffiaux, EIA host; A. B. Credle, IEC TC 53; P. E. Corcoran, Sec.; J. F. Gaschi, Sec., IEC TC 47 (France); R. L. Pritchard, Representing Ch., IEC TC 47; E. B. Redington, Representing Sec., IEC TC 53; L. van Rooij, Ch., IEC TC 52 (The Netherlands); S. D. Hoffman, Sec., U. S. Nat'l. Committee; V. M. Graham, V. P., U. S. Nat'l. Committee; F. R. Lack, Dir. of Eng., EIA; R. E. Gay, Mng. Dir.,

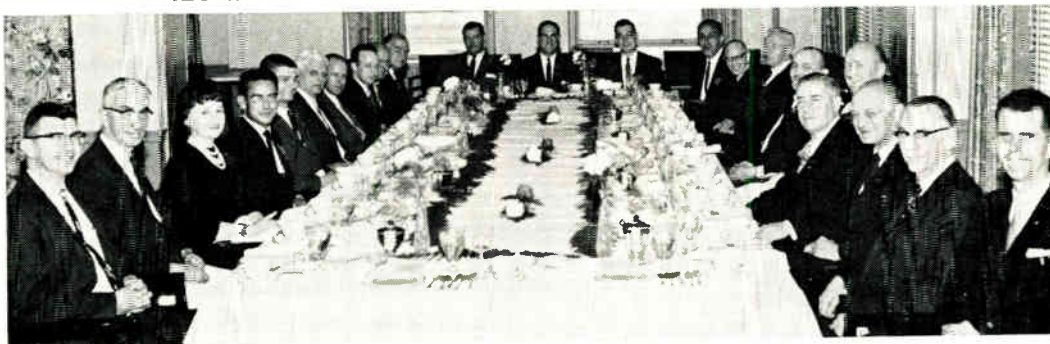

ASA; Leon Podolsky, Ch.; W. A. McAdams, V. P., U. S. Nat'l. Committee; E. Keonjian, observer; H. W. Stawski, Sec., IEC TC 52 (Italy); J. White, Representing Ch., IEC TC 40 (United Kingdom); P. A. Fleming, Representing Ch., IEC TC 39 (United Kingdom); G. F. Hohn, EIA host; P. Besson, Ch., IEC TC 12 (France); E. F. Seaman, Ch., IEC TC 50; J. W. McNair, Tech. Dir., ASA; J. H. Schumacher, EIA host.

ASTIA NAME CHANGED, ASSUMES NEW FUNCTIONS

A Defense Dept. order has converted the former Armed Services Technical Information Agency (ASTIA) into the Defense Documentation Center for Scientific and Technical Information and given the DOD component some new objectives and functions.

New objectives include: removal of some restrictions on what it may handle; speeding up the flow of needed classified documents to eligible contractors; more stringent enforcement of contractors' obligations to forward their technical reports to DOD, and establishing quality standards for technical reports.

DDC will have these functions, some of them new: Restricted data on nuclear weapons, heretofore not handled by ASTIA, may now be accepted by DDC. Now-scattered DOD document centers will be transferred to DDC control. DDC will provide a clearing house on current R&D efforts within DOD and act as a referral center on available DOD information.

Like ASTIA, DDC will be under operational control of the Air Force, but under management control of the Director of Defense Research & Engineering.

TWO NEW TEST RECORDS

CBS Laboratories, Stamford, Conn. has developed two new testing records. The STR 130 is a frequency response test record for testing electrical systems of phonographs and recording equipment. The other, STR 140, with "pink" noise in one-third octave intervals, is for acoustical tests measuring overall response of a system in an average room.

AFSC TO LAUNCH 6 RE-ENTRY TEST VEHICLES

The first of six recoverable, non-orbiting unmanned vehicles to test space flight and re-entry problems will be launched from Cape Canaveral in mid-1963 by the Air Force Systems Command.

Called ASSET (Aerothermodynamic/elastic Structural Systems Environmental Tests), the entire program will last 13 months.

ASSET will verify aerodynamic

theories, vibration conditions, materials design and structural approaches used in hypersonic aircraft and advanced re-entry vehicles being developed by AFSC.

Primary purpose is to correlate flight test data with theoretical and ground test data. Configuration, materials, component systems and recovery systems for ASSET already have been studied and evaluated.

ONE PIECE — no splice

UNIFORM — no splice humps

ECONOMICAL — no splicing cost

Mono Cord

NO SPLICE RINGS

Mono Cord one piece, no splice round section rings are used as reciprocating or static seals in pressurized systems by the automotive, plumbing and many other industries.

These seals, built to critical standards, must be leakproof against liquids or gases, unaffected by chemical or temperature changes and remain physically constant throughout use.

Mono Cord no splice rings are molded from natural and synthetic rubbers in a wide variety of sizes to fit your specifications. For precision rings at economy prices, specify Mono Cord rings by Western.

Write or phone for information, literature or a visit by our sales engineer in your area

WESTERN RUBBER CO.
GOSHEN 10, INDIANA

Molded and Lathe-Cut Rubber Parts for All Industries

Analyze high voltage spikes easily

Now you can quickly analyze the amplitude and duration of random high voltage spikes, without going blind over a scope. Leland's Voltage Spike Analyzer is a versatile piece of test equipment that lets you explore spikes from 10 to 990 volts with durations from 1 to 10 microseconds. Heart of the analyzer is a set of four adjustable solid-state gate circuits which may be digital dial-set for four different voltages in increments as narrow as ten volts. The time matrix is built-in, with indicators for 1, 3, 6, and 10 microseconds. An incoming spike is thus "trapped" and its profile is retained in lighted indicators as long as desired, then instantly erased at the touch of a button.

Uses are in optimizing circuit design and filtering and thereby increasing reliability, determining actual filtering requirements, locating sources of spikes, and in field-checking to isolate spike-producing elements. Unit operates from 110 volts, 60 or 400 cycle line, or has provision for self-contained batteries for remote use. Request Bulletin SA-100 from Leland Airborne Products Division of American Machine & Foundry Co., Vandalia, Ohio.

LELAND



Circle 144 on Inquiry Card

MIS-MATCHES

SUPER VACUUM BOTTLES have been designed at Aerojet-General for cooling miniature parts of satellites and other space systems. Inside special vacuum bottles they place liquefied nitrogen or hydrogen and other gases capable of being turned liquid, then freeze them solid. The vacuum of space keeps the gas frozen—at temperatures from -320°F . down to even -440° . Advantage is that it requires no power supply for its operation.

AVERAGE HI-FI FAN plays his set 547½ hrs. a year, reports Jensen Industries. That boils down to 10½ hrs. a week, an hour and a half a day. In the process he wears out one diamond needle, or 12 sapphire needles.

"FLAT-TIRE DETECTOR" called the "Magna-Miler" has been designed by Magnavox for heavy duty trucks, buses and construction equipment. Tiny transmitters are mounted on each wheel, activated by a pressure switch on the tire valve stem. A receiving antenna is mounted on the vehicle axle that relays warnings signals to the driver. Cost, for a six-tire vehicle, about \$150.

CLOSED CIRCUIT TV and tape recorders are being used at National Institute of Mental Health to check the exploratory behavior of 3-6 month old infants. Reactions are observed and recorded when certain objects are observed and recorded when certain objects are given to them to handle.

A RARE 1926 TV SET owned by J. R. Poppele, president of Tele-Measurements Inc., was displayed last month at the "Electronics for the Television Industry" Show in New York. The vintage video set, a "Jenkins Radiovisor," has a 2-square inch screen and a tuning range of 100 to 150 meters. Images were reproduced by means of a light source shining through apertures on a revolving drum.

ELECTRONIC ANESTHESIA will be the next big step in medical electronics. Experimental equipment is already being marketed by Southern Solid State Electronics Inc. Their "Anesthetronic" consists of a pair of headphone-like electrodes, which are placed just above the ears. Twenty-five volts is applied at 700 cps. The patient is anesthetized in two seconds, and awakens within 10 seconds after the current is turned off.

ELECTRONIC SLEEP-INDUCING equipment has been developed by the Russians which makes spectacular claims for treating insomniacs, mental and emotional illnesses, and a wide variety of physical ailments. Low electric currents are passed through the head, through electrodes over the eyes, to the back of the head. Among the more radical claims is that the induced sleep is so deep that a full night's rest can be achieved in just two hours.

TELEVISION "WALL" is being constructed by the East German government. Sets sold behind the Wall shall be capable only of receiving the East Berlin TV channel—not that of West Berlin.

SCIENTISTS are congregated in just three locations along both coasts. The West Coast has most, with 1,240 scientists per million population. The Middle Atlantic is next, with 1,040 per million and New England is third, with 1,030 per million. The South and Midwest are behind, with 810 and 750 respectively.

TRANSISTOR ... small signal "h" parameters



Model 1803A

Write for information about industry's most complete line of standard and custom designed instruments for semiconductor testing.

DYNATRAN

electronics corporation

178 HERRICKS ROAD
MINEOLA, NEW YORK

Pioneer 1-4141

Circle 145 on Inquiry Card

Specifically
Engineered
for RF
Components!



A-27 Superfine
Q-max
EXTREMELY LOW-LOSS
RF LACQUER

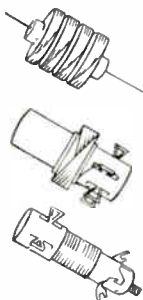

Q-MAX impregnating and coating composition penetrates deeply, seals out moisture, provides a surface finish. Q-MAX imparts rigidity and promotes stability of the electrical constants of high frequency circuits. Effect on the "Q" of RF windings is negligible.

Write for catalog today.

Q-max Corporation
MARLBORO, NEW JERSEY
Telephone: 462-3636 (Area Code 201)
Circle 146 on Inquiry Card

- **SCAN CONVERSION**
- **FLICKERLESS DISPLAY STORE**
- **VIDEO STORAGE**

RECORDING STORAGE TUBE SYSTEMS

Single-gun, dual-gun, multi-tube systems to convert scan for radar, sonar, television, and to perform analog processing, data analysis, contract or expand time scale, auto correlation.

- **SLOWED TELEVISION TRANSMISSION**

by telephone line or other narrow-band systems.

- **IMAGE ENGINEERING**

OPTICAL CHART READERS, FLYING SPOT SCANNERS, LOW-LIGHT-LEVEL CAMERAS, and IMAGE RECTIFICATION. Automatic inspection and recognition of size, shape, color, and texture.



Write or call for complete information:

IMAGE INSTRUMENTS, Inc.
2300 Washington Street
Newton 62, Massachusetts
617 WOODWARD 9-8440
Circle 147 on Inquiry Card

MIS-MATCHES

X-RAY ANALYSIS has discovered diamonds in the Dyalpur meteorite that fell in India in 1872. Diamond crystallites were found in two size ranges—a few large crystals and a large number of small ones. Dr. M. E. Lipschutz of NASA, who made the discovery, concluded that the diamonds in the Dyalpur were probably formed by shock when the meteorite's parent body collided with another object in space.

THERMAL DIFFUSION process of converting sea water into drinking water is being investigated by Ford Motor Co. scientists. In the separation techniques a salt solution is placed in a container which has one wall colder or warmer than the others. A temperature "gradient" is formed through the liquid. This gradient causes the salt to concentrate along one wall, which makes its removal a simple mechanical matter.

A MOON BASE large enough to accommodate 50 persons will be established by the early 1970's, predicts Armour Research Foundation's Dr. Leonard Rieffel.

A FLIGHT ACCELERATION FACILITY is to be designed by Ford, Bacon & Davis, Inc., New York, N. Y., and erected at NASA's Manned Spacecraft Center at Houston, Tex. The facility is to include a centrifuge capable of whirling a simulated Project Apollo command module and its crew with forces many times the normal pull of gravity. With its rotunda and supporting structures and equipment, it is estimated to cost \$10,500,000.

Its primary function will be to train and test. The entire simulated mission will be programmed and controlled by computer. Safety factors will be paramount. The computer will automatically reject a decision on the part of the crewman if there is a possibility of dangerous results. However, if the decision is a correct one, it will incorporate the decision into the flight pattern.

\$\$\$ for Circuit Designs

Have you come up with any simple or unique circuit designs lately? Do you think that they would be useful to fellow engineers? If so, why not send them to us for possible publication? We pay our usual space rates for those accepted. Please keep them as concise as possible and send to: **Circuit Design Editor, ELECTRONIC INDUSTRIES, 56th & Chestnut Sts., Philadelphia 39, Pa.**

FREE 26-PAGE CATALOG



All New SHAFT ENCODER

For INDICATION and
DATA LOGGING

DECIMAL OUTPUT Generates 10 wire/digit code directly. No expensive translation from binary, BCD or Gray.

LOWER COST Less than half the price of conventional encoders.

ON-THE-FLY OUTPUT Instantaneous, continuous output to lampbanks or printers.

5 TIMES LONGER LIFE Absence of brush logic ensures 5-10 times longer life.

DIRECT LAMPBANK OR PRINTER ACTUATION Simply connect. Converters not required.

Theta

INSTRUMENT CORPORATION

Saddle Brook, N. J.
(201) HUBBARD 7-3508

Circle 148 on Inquiry Card

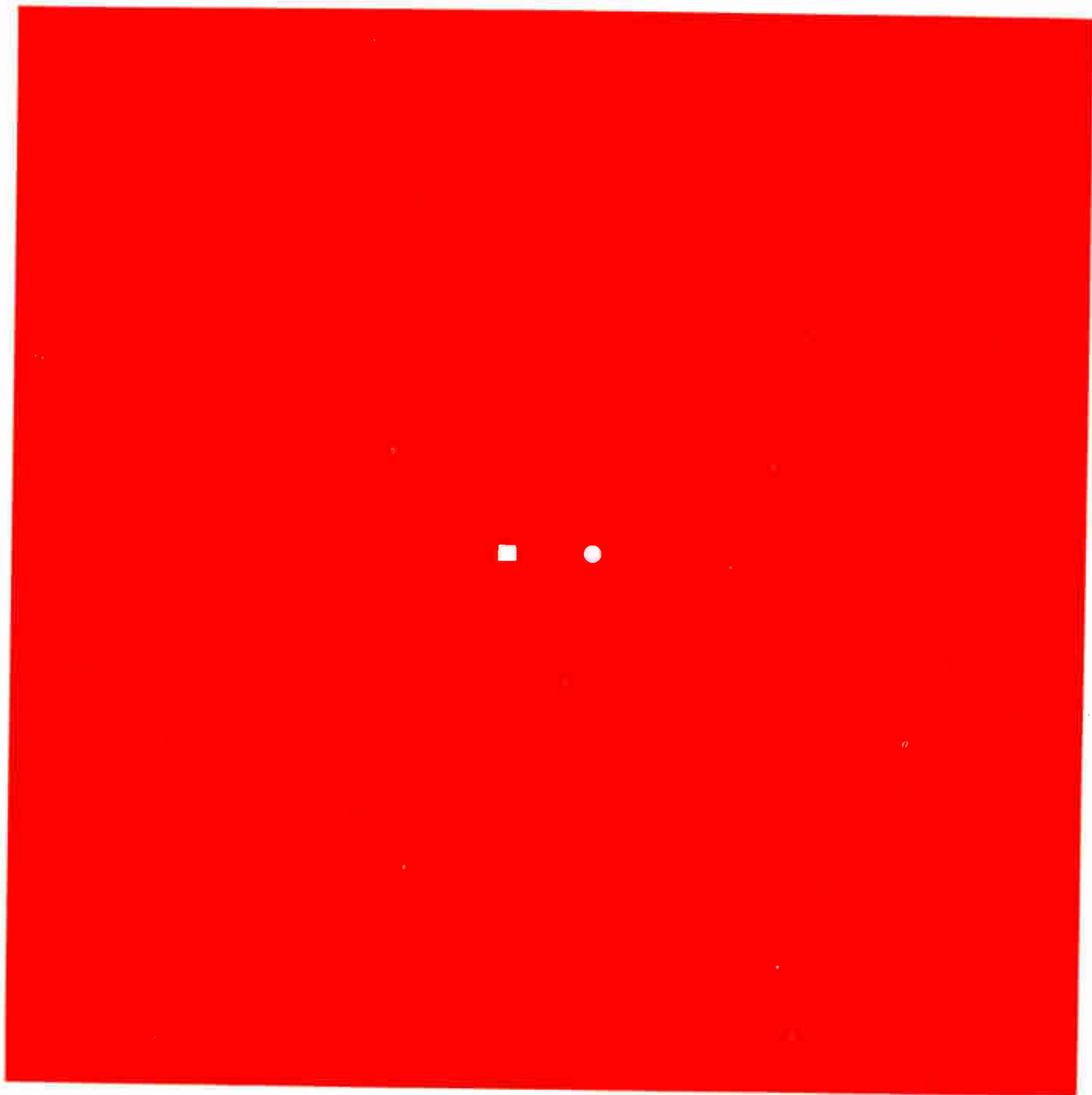

The small white rectangle above represents the approximate size of space required to contain one page of newspaper size document reduced for storage through NCR's **PHOTOCHROMIC MICRO-IMAGE** process. The small white dot on the right represents the area that would hold thousands of micro-capsules (cell-like structures containing useful materials) produced through NCR's amazing chemical process of **MICRO-ENCAPSULATION**.

One apparent application of the NCR Photochromic Micro-Image process is that it permits easy and efficient storage, access and reproduction of voluminous data. The process of Micro-encapsulation has applications cutting across many fields of interest including paper coatings (such as on our No Carbon Required paper), food, pharmaceuticals, adhesives, etc.

These are but some of the outstanding achievements of NCR scientists and research and development personnel. Through the years our devotion to the concept of improvement, growth, and service to business and industry has led to many other changes which have benefited the world. Government and military agencies

also have an active interest in the advanced work being done by NCR scientists and engineers.

Our Research and Development programs are not limited to the fields of Photochromics and Micro-encapsulation. Rather, the programs extend into many disciplines including physical and chemical research in the areas of semiconductor materials and devices that will have practical application in computer development and add to the total effort of the company. The NCR effort is concentrated on the total systems concept.

To determine whether your career plans fit in with our research and development plans, merely drop us a note with a brief description of your interests and scientific background. Applications at all professional levels will be considered.

Write to:

T. F. Wade, Technical Placement

The National Cash Register Company

Main & K Streets, Dayton 9, Ohio

An Equal Opportunity Employer



PROFESSIONAL OPPORTUNITIES

Reporting late developments affecting the employment picture in the Electronic Industries

Design Engineers
Development Engineers
Administrative Engineers
Engineering Writers
Physicists
Mathematicians
Electronic Instructors
Field Engineers
Production Engineers

LURE OF GOVT. WORK LOW AMONG ENGINEERS

The appeal of government employment is low among engineers and scientists working in private industry, as revealed in a survey by the Research Division of Careers Incorporated.

Careers, sampling some 350 engineers and scientists, found that government rated ahead of industry in only three of eleven categories. They were of the non-intellectual or passive variety such as fringe benefits, job security and vacation leave.

In such areas as encouragement of initiative, challenging work, achievement of recognition—the goals of any first-rate professional man—the government placed far below private industry.

The survey sample consisted of degree-holding engineers and scientists, median age 31, an experience median of ten years, and a median annual salary of \$10,150—the “prime-of-life” technical professional man.

The dim view they take of government service would appear to be a warning not to be ignored by our national policymakers.

17 NSF GRANTS AID GRADUATE RESEARCH

Graduate research laboratories at 17 U. S. universities will be constructed or renovated using \$5,118,200 in National Science Foundation grants.

The following universities are participating: Duke Univ.; Mich. St. Univ.; Stanford Univ.; Univ. of Tenn.; Cornell Univ.; Purdue Univ.; Rice Univ.; Oregon St. Univ.; Iowa St. Univ.; Univ. of Wash.; Pittsburgh Univ.; Okla. Univ.; Johns Hopkins Univ.; Okla. St. Univ.; Univ. of Missouri; Ill. Inst. of Technology, and Indiana Univ.

Largest amount, \$1,213,000, will go for constructing a biochemistry building at Mich. St. Univ. Smallest will be \$10,400 for renovating chemistry facilities at Ill. Inst. of Technology.

TEACHER TIME-SAVER



New GE advanced electronic laboratory console uses omni-dial for teachers to supervise all students from a single control. The omni-dial conforms to classroom seating patterns and performs functions that need four controls in other learning labs. Included is remote control of students' tape recorders to save 50% of grading time.

REASONS FOR ENGINEER ENROLLMENT DROP REVEALED

A preliminary survey sponsored by two national engineering groups has revealed some reasons for declining freshman engineering enrollments.

The study was made by Opinion Research Corp., Princeton, N. J., for the Professional Engineers Conference Board for Industry and National Society of Professional Engineers.

Interviewers found that unhappy experiences with high school math often dissuaded bright students from thinking about engineering careers.

Another factor was failure of parents and guidance counselors to inform students properly about engineering careers.

A third reason was a negative image of engineering that students acquire. Engineers are not regarded as creative, imaginative or intellectually curious by some teenagers.

Also, students do not think of engineering as a respected career. The students collectively ranked engineering at the bottom of a list including medicine, law, business, teaching and physical science.

UNIVERSITIES PROMOTE BIO-MED ENGINEERING

Two universities and a technical institute disclosed entry into biological and medical engineering technology.

A cooperative program in bio-medical engineering will be sponsored by Worcester Polytechnic Institute and Clark University. The program provides for sharing of W.P.I.'s electrical engineering and Clark's biology departments.

Biomedical engineering, the application of engineering and electronics principles to medical and biological problems, is the basis of similar programs in 38 U. S. universities but they are usually interdepartmental programs within a single university.

Students who concentrate on engineering will receive MS degrees from W.P.I. Those who emphasize biology will receive MA degrees from Clark.

Northwestern University stresses bio-technology as the next great electronics growth market and educational field. The university announced formation of the nation's first Bio-Medical Engineering Center in January, and pointed out the opportunities that lay ahead in this field for engineers and doctors in developing a new and revolutionary breed of electronic medical instruments.

ARA APPROVES LOAN FOR NEW TEXAS PLANT

The Area Redevelopment Admin., U. S. Commerce Dept., has approved a \$382,649 industrial loan to help start an electronics plant employing 180 skilled workers in Crockett, Tex.

The money will go to Audio Electronics, Inc., for a plant to make educational tape recording and audio-visual projection units.

FOR MORE INFORMATION . . . on opportunities described in this section fill out the convenient resume form, page 216.

ELECTRONIC INDUSTRIES Professional Profile

The ELECTRONIC INDUSTRIES Job Resume Form for Electronic Engineers

Name _____ Tel. No. _____
 Street _____
 Address _____ Zone _____
 City _____ State _____

Single Married Citizen Non-Citizen Date of Birth _____
 Will Relocate Yes No. If Yes Another City Another State
 Salary Desired to Change Jobs in present area _____
 Salary Desired to Change Jobs and relocate in another area _____
 Professional Memberships _____

College or University	Major	Degree	Dates

RECENT WORK EXPERIENCE

Company	Div. or Dept.	Title	Dates

SIGNIFICANT EXPERIENCE AND OBJECTIVES

STATE ANY FACTS ABOUT YOURSELF THAT WILL HELP A PROSPECTIVE EMPLOYER EVALUATE YOUR EXPERIENCE AND JOB INTERESTS. INCLUDE SIGNIFICANT ACHIEVEMENTS, PUBLISHED PAPERS, AND CAREER GOALS.

Mail to: ELECTRONIC INDUSTRIES—Professional Profile—56th & Chestnut Sts.—Philadelphia 39, Pa
 This resume is confidential. A copy will be sent only to those Companies whose number you circle below.

800 801 802 803 804 805 806 807 808 809 810

A fairly new aid to R&D planning and control, called "statistical network theory", is moving rapidly into a stronger position in government and industry. A new breed of design engineer is budding, who, once left to his own methods and ideas, now reluctantly finds himself working up networks along with programmers, consultants, reliability experts and other specialists. Industry and design engineers are finding out that network theory works, and is probably here to stay.

THE ERA OF THE DESIGN ENGINEER concerned only with technical problems and left alone to develop his own designs is over. Today he is involved with specialists in the human factor, reliability, value engineering, industrial design, computer programming and even program management techniques.

Many engineers are reluctant to accept new techniques or services which may appear to reflect on their approaches to design, planning and schedules, and the use of available manpower. This may stem in part from a fear of performance criticism by management.

Within the past two years still another specialist has come into prominence with a new technique for program planning and control based on statistical network theory. It may be called PERT (Performance Evaluation Review Technique) or CPM (Critical Path Method).

About two years ago the theory and application of network control was introduced to engineering and management personnel at General Electric's Missile and Armament Department. Explanation covered several meetings and seminars, initial reactions were varied. Casual and caustic comments were:

"I've been doing this in my head right along."

"I have ten people looking over my shoulder now, don't add any more."

"Let the other group try it, I've got a crash program going and have no time for that stuff."

"The customer's not asking for it, why bother?"

"I've been in this business for ten years, I know how to schedule a program without all that hanky-panky."

"This technique may be OK for that \$10,000,000 program but not for my \$250,000 R&D contract."

Worth Looking Into

The more open-minded engineer, particularly with

WHAT THE ENGINEER SHOULD KNOW ABOUT PERT

background in statistics and linear programming, candidly agreed that this new technique was worth looking into. Furthermore, most engineers will admit that initial program schedules usually appear extremely difficult to meet. Schedule commitments, in fact, are often practically "impossible."

A statistical, scientific, detailed program analysis affords the responsible engineer an opportunity to convince not only company management but also the more important customer that he knows what he's doing, and what logical steps are needed to complete a realistic program on schedule.

Let's consider a first application of network theory to a small Government-sponsored R&D program. This was done on a casual basis primarily for familiarization and indoctrination of the new technique. The PERT (Performance Evaluation Review Technique) method was employed, not because it was preferred to the Critical Path Method or other approaches, but its approach appeared to be oriented more toward defense work.

Steps in Network Application

The first step is to prepare a brief network model based on the key events of the overall program. Give careful consideration to inter-relation of events and analyze all activities that must be accomplished before the program can be completed. Interdependence of events can be a revelation not apparent in a conventional bar graph.

As a second logical step, work out a somewhat more detailed network. The big question is: "How

By **HARRY G. BENIS**

Project Engineer
Helicopter Armament Section
General Electric Co.
Burlington, Vt.

AN ENGINEER'S EXPOSURE (Continued)

detailed should the network be?" An excessively detailed breakdown will result in multiplicity of activities and events too cumbersome for either manual or computer calculations. The network should be broken down in detail to include all major activities needed to determine critical paths in overall schedule. See Fig. 1:

The third step is a problem. The first network should be based on the use of fixed resources—that is, normal cycle times, available manpower and no overtime. The optimistic time estimate for an activity hinges on everything proceeding smoothly with no delays, no problems—a most unusual but welcome circumstance.

For the most likely time estimate, give some thought to "in house" labor load, program priority, "state of the art" development and procurement problems, and manpower availability. The pessimistic time estimate is undoubtedly the most misunderstood.

This applies to any unfortunate circumstance short of "an act of God"—for example, unacceptable design approach, failure to produce acceptable samples of a complex casting after the seventh pouring, catastrophic test failure, incompatibility or delinquent delivery of GFE. A realistic appraisal of the three time estimates will often indicate a skewed distribution toward the optimistic estimate. See Fig. 2:

Who Does All the Work?

We didn't mention who must do the work. Let's get this straight right now. A responsible design engi-

neer is the only one (plural for a larger program) competent to work up the network. If it's done by a person or group not familiar with overall program details, it will usually fail. Furthermore, in working on the initial network model, close coordination with qualified technical programmers and consultants is a must. These specialists offer the technical and systems management thinking required to the design engineer.

For a short period after the network, with activity time estimates, is finished, the engineer has a welcome breathing spell while network experts reduce the data. At General Electric's Missile and Armament Department, network programming was set up with excellent results on a small digital computer which processes networks with 500 events and 750 activities. Further developments include a calendar-oriented, priority operations schedule.

Review of the first computer tab run is generally dismal and unhappy. For example, in our specific program the results indicated a four month slippage on a program with a one-year contractual commitment. This separates the men from the boys. The open minded, aggressive engineer responds to the challenge and is ready and willing to take a second detailed look at the network.

A study of the critical paths indicates where corrective action must be taken, particularly when analyzing the overall program phase by phase. This will give a clear-cut picture of where the schedule problems occur, either in preliminary design, detail design, fabrication, vendor procurement, preliminary test and assembly, final test or very probably a combination of two or more major program phases.

Fig. 1: Network should include all major activities in detail to define schedule's critical paths.

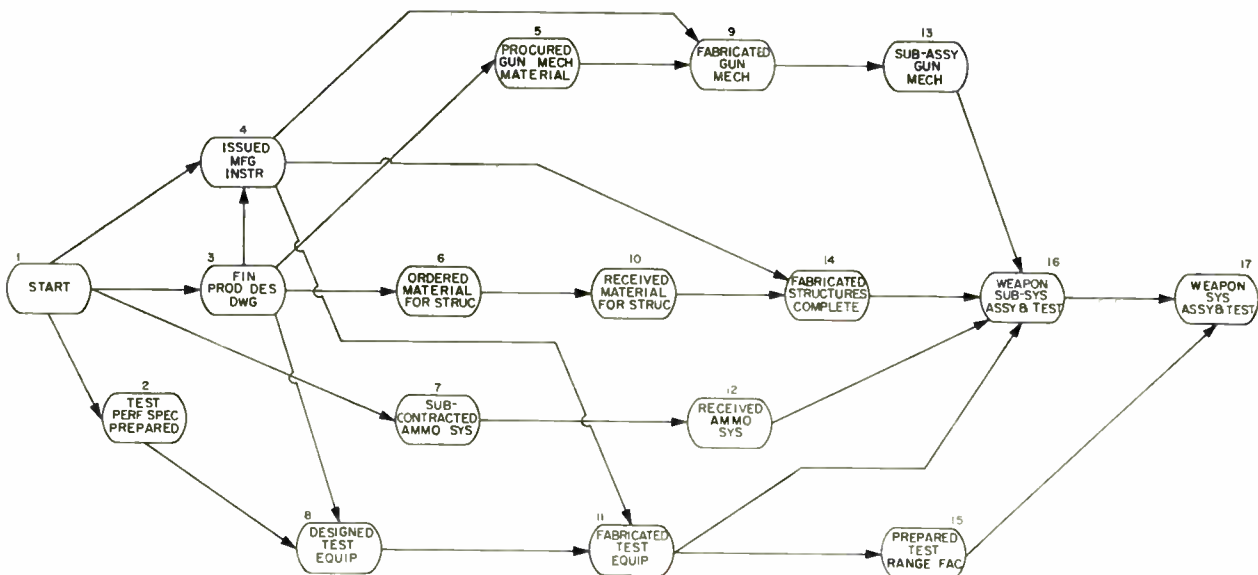

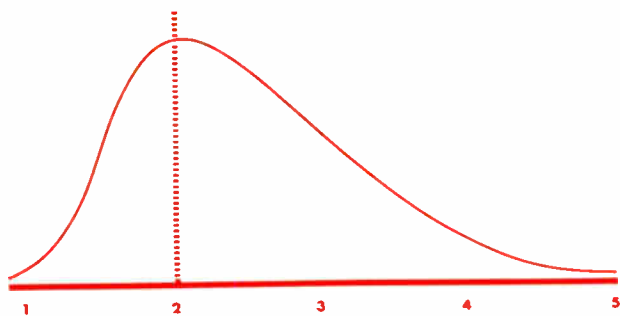

Fig. 2: Appraisal curve of the three time estimates is often distorted and one-sided toward the optimistic estimate.

Something to Sink Teeth Into

Now the engineer has something to sink his teeth into—a detailed schedule problem in black and white. The job ahead is to shorten the first, second . . . critical paths. This can't be accomplished blithely by shortening the original time estimates for each activity and hoping for the best. In fact, original time estimates should not be changed unaccountably.

The problem must be approached by considering parallel approaches, advance material release on long lead items, manpower shifts, overtime and other generally accepted techniques for "crashing" the troublesome phases of the overall program. Following these reallocations of resources and changes in plans along critical paths, a second analysis should reveal improvements in the overall plan.

The computer tab run is somewhat more encouraging this time, giving an indication of eight weeks' slippage in the design and fabrication phases. The test phase looks good. This represents a major schedule

achievement—lopping nine weeks' slippage from the original tab run.

Tough One to Answer

Now the question arises as to how far to carry the detailed network analysis and revision. Frankly, this is a tough one to answer. Even the most patient engineer may be wearing thin by this time. Careful consideration must be given to probability of program completion on schedule, customer interest and priority and many other relevant factors. In the particular example under consideration, it was felt that the anticipated eight-week slippage was still excessive—representing over 10% extension of contract requirements. Therefore, a third review and revision of the network critical paths were made.

At this stage, all the stops were pulled out and a revised analysis on a much more stringent basis was made including evaluation of design and fabrication on a very high priority and advance ordering of long lead items on a calculated risk basis. The final network revision is illustrated in Fig. 3.

The computer tab results were much more encouraging this time. The data indicated a four-week slippage up to the test phase and actually a fighting chance of meeting schedule. However, this wasn't the end by a long shot. Continuing network analysis and revisions, as required on a monthly or bimonthly basis, are necessary to keep abreast of actual performance-to-schedule requirements.

The Heart of the Problem

Now we've come to the heart and meat of the over-
(Continued on page 225)

Fig. 3: A third and final network revision dated for high priority and advanced ordering at calculated risk.

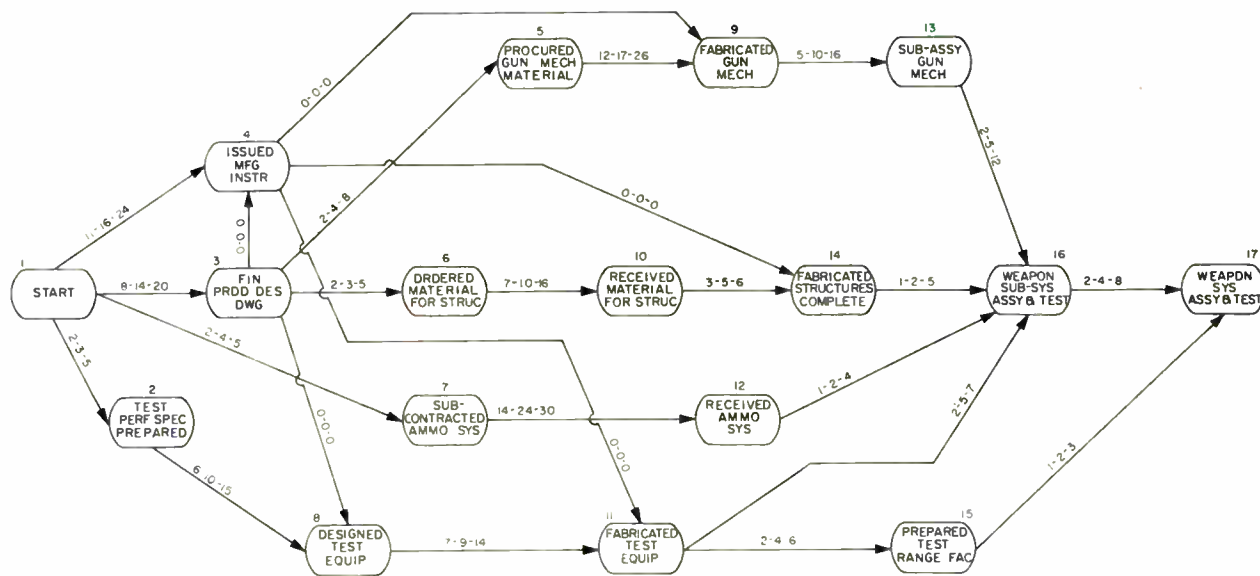

NASA APOLLO SPACECRAFT



AC SPARK PLUG, THE ELECTRONICS
DIVISION OF GENERAL MOTORS,
OFFERS ENGINEERS AND SCIENTISTS . . .

OPPORTUNITY FOR GROWTH IN THE INERTIAL GUIDANCE AND NAVIGATION FIELD

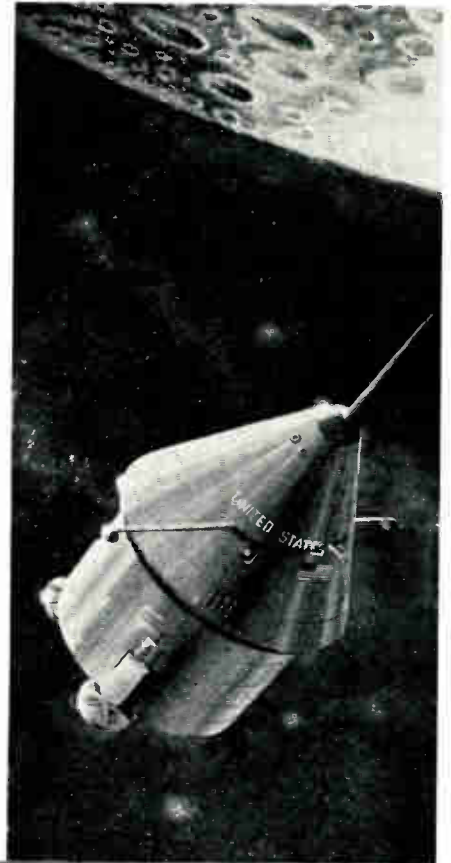

AC has assembled one of the finest technical teams in the country. They have provided intellectual stimulus for such outstanding projects as APOLLO (Navigational-Guidance), TITAN II, TITAN III (Inertial Guidance), B-52 C&D (Bombing Navigational System) and Advanced Guidance and Navigational Systems. They will also provide intellectual and professional stimulus for you. You enjoy the satisfaction of accomplishment at AC . . . not only in the job you do, but the advancement that comes from achievement. As a member of a division of General Motors, you will share the outstanding benefits offered by this corporation.

Review the opportunities listed on the opposite page. Then contact us for an immediate evaluation of your qualifications.

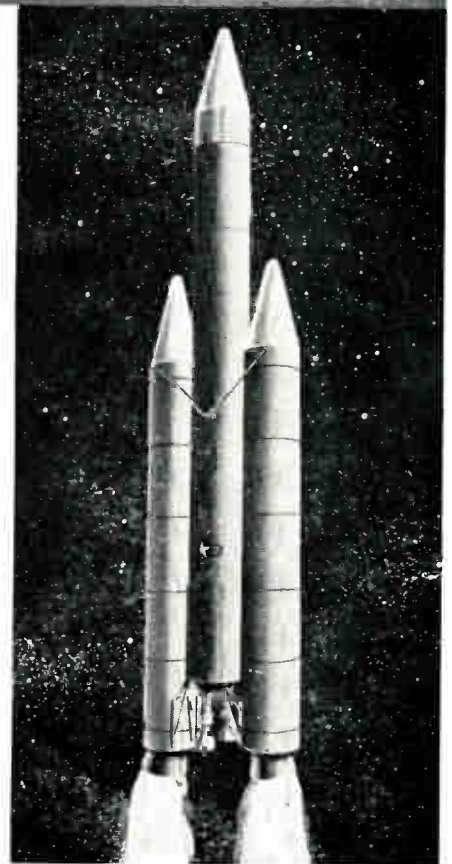

USAF TITAN III SPACE BOOSTER

MIDDLE WEST

MILWAUKEE

(Systems Design,
Development, Manufacturing)

SYSTEMS ANALYTICAL ENGINEERS

To perform analytical trajectory studies for missile applications. Strong math background with experience in analog and digital computer simulations is essential. Will interpret customer requirements, analyze system model specifications, error allocations, accuracy estimates and guidance equations.

SYSTEMS MECHANIZATION ENGINEERS

To design and mechanize inertial guidance systems or subsystems. BS, MS or PhD in EE, Math or Physics with minimum of two years aircraft or fire control experience employing closed loop systems, switching circuits and digital techniques.

DATA ANALYSTS

To perform data analysis studies to evaluate inertial guidance system performance based on in-house or field test programs. BS, MS or PhD in Math with knowledge of telemetry instrumentation and digital techniques.

SENIOR SCIENTIFIC PROGRAMMERS

Concerned with simulation of guidance and control systems, electronic system design and logic designs. Will perform satellite and trajectory studies, numerical and statistical analysis and systems calibration. BS or MS in Engineering, Physics or Math with a minimum of two years experience.

CIRCUIT DESIGN AND ANALYSIS ENGINEERS

To design and/or analyze servo amplifiers, DC operation amplifiers, power converters, feedback amplifiers and pulse circuits. Will work in the area of IMU electronics. BSEE, plus three to five years experience in above field required.

MECHANICAL DESIGN AND DEVELOPMENT ENGINEERS

To assist in the design and development of the Apollo ground handling equipment. BSME, plus two to three years related experience required.

SYSTEMS ENGINEERS

To assist in interface of Apollo airborne and ground support equipment and including the development of test circuits to ensure proper GSE checkout before interface. BSEE, plus two to three years related experience required.

WEST COAST

LOS ANGELES

(Advanced Concepts Laboratory—
Research & Development)

COMPUTER RELIABILITY ENGINEER

Senior opening for position in the area of advanced digital computer reliability techniques toward the design of space guidance computers. Investigations include self-adaptive techniques, allocation of redundancy and reliability performance evaluation. At least three to five years of directly applicable experience and advanced degree in engineering, mathematics or related sciences is preferred.

TRANSISTOR CIRCUIT DESIGN ENGINEERS

To interpret basic sub-system requirements and to design and develop efficient and reliable solid state circuit design and the design of feed-back circuits. MSEE with one year experience or BSEE with two years experience.

ADVANCED GUIDANCE SYSTEMS ANALYSIS

Experience in systems analysis, advanced guidance analysis and trajectory analysis relating to space vehicles and ballistic missiles.

MISSILE AND SPACE SYSTEMS ANALYSTS

To perform analysis of advanced missile and space guidance systems involving design of trajectories; statistical approach to mid-course and terminal guidance problems, optimization of guidance systems. BS, MS or PhD in EE, ME or Aeronautical Engineering with strong background in one or more of the following areas: astrodynamics, guidance and control theory and/or statistics.

MECHANICAL SPECIALISTS

Specific requirement is for Inertial Measurement Unit Mechanical Design Specialists. Must have eight to ten years experience as designer in fields relating to stable platforms, gyro packaging and associated areas. BSME required; advanced degree is preferred.

SENIOR MECHANICAL ENGINEER

To design hardware relating to inertial guidance components. BSME required, plus minimum of five years experience in inertial guidance hardware design.

EAST COAST

BOSTON

(Advanced Concepts Laboratory—
Research & Development)

SENIOR PHYSICISTS AND ENGINEERS

Preferably having advanced degrees and experience in theoretical and experimental development of precision devices. The particular area of investigation relates the application of mechanics, electricity, nucleonics and physical phenomena to inertial measurement components, such as gyros and accelerometers.

INERTIAL SYSTEMS ENGINEERS

To engage in the analysis, synthesis and mechanization of advanced inertial navigation systems. Will perform optimization studies, error analysis and system configuration studies in the fields of space navigation and avionics. Advanced degree or BS with analytical systems background required. Two or more years experience in inertial systems preferred.

ELECTRONICS ENGINEER

To design and develop semiconductor pulse circuits, logic circuits, digital analog circuits and precision DC amplifiers. BS or MS, plus three to five years experience in above field. Experience in the area of precision electrical measurement desirable.

ELECTRONICS ENGINEER

To design transistor feedback, servo amplifier and low level switching circuits. BS or MS with three or more years experience in the above fields desirable.

SENIOR MATHEMATICAL ANALYST

To engage in mathematical and computer studies relating to the evaluation and optimization of new and improved inertial instruments, components and systems. BS or MS in applied mathematics or physics, plus three to five years experience in mathematical and/or computer analysis.

MECHANICAL ENGINEER

To design miniature inertial platforms and gimbal systems. BSME required, plus three to five years experience in the inertial platform-gimbal systems field.

MATHEMATICAL ANALYSTS

To perform analysis, as required, in the development of inertial components and systems. BS or MS in applied mathematics, plus one to three years experience in the field of mathematical analysis.

For further information, write or send résumé to Mr. A. J. Raasch, Director of Scientific and Professional Employment, Dept. 5753, AC Spark Plug Division, Milwaukee 1, Wisconsin.

AC SPARK PLUG  THE ELECTRONICS DIVISION OF GENERAL MOTORS • AN EQUAL OPPORTUNITY EMPLOYER

RELIABILITY ENGINEERS

Specific opportunities for R & D Reliability Engineers and Managers with the Quality Assurance Section at Norden. Applicants should have a degree or its equivalent and 3-10 years' experience applicable to the areas indicated below. Current expanding programs at Norden encompass computer techniques, display integration, radar and communications systems, special-purpose TV, IR, microelectronics, inertial systems for stabilization and navigation of aircraft and space vehicles, missiles, and marine vessels.

SYSTEM RELIABILITY

Reliability design review, analysis and test of systems and subsystems for approval of designs. Prediction and determination of MTBF and failure effects, including recommendation of design modifications. BS or MS in EE desirable.

COMPONENT RELIABILITY

Application, evaluation, test and selection of components for use on all systems. Authority to approve choice and applications of components on all systems. BS or MS in EE desirable.

ENVIRONMENTAL

Dynamicists, Climatic and Interference Specialists required for R & D reliability reviews, environmental evaluation and test, and qualification tests of systems, subsystems and components. BS or MS in EE or ME desirable.

*Please forward your resume to:
Mr. James E. Fitzgerald, Employment Department, Norden, Helen Street, Norwalk, Connecticut.*

Norden

U
A
DIVISION OF UNITED AIRCRAFT CORPORATION

An Equal Opportunity Employer

Robert W. Kellhofer — named by Autonetics Div., North American Aviation, Inc., Anaheim, Calif., as Western Region Vice President.

Norman J. Regnier—named Marketing Manager, RS Electronics Corp., Sunnyvale, Calif., a division of Pacific Industries, Inc.

Francis J. Bigda—named Vice President and General Manager, Sales Div., Renwell Industries, Inc., S. Hadley Falls, Mass.

Robert C. Nixon—appointed Manager, Industrial Sales Dept., Scientific Instrument Group, Bausch & Lomb, Inc., Rochester, N. Y.

Bruce Birchard—appointed Vice President in charge of the newly created Industrial Products Div., Sony Corp. of America, New York, N. Y.

Warren B. Hayes—named President and Chief Executive, Pansteel Metallurgical Corp., N. Chicago, Ill.



W. B. Hayes



J. W. Barron

Dr. Donald W. Gade—elected Senior Vice President, California Computer Products, Inc., Anaheim, Calif.

Carl Deutsch—named Executive Vice President, Deutsch Co. Electronic Components Div., Banning, Calif.

Roland Haskins—named Manager, Product Sales, Space & Systems Div., Packard Bell Electronics Corp., Los Angeles, Calif.

Dwain B. Bowen — appointed Manager, Laser Applications, Quantum Physics Div., Electro-Optical Systems, Inc., Pasadena, Calif.; **Abraham Jacoby** — appointed a Senior Engineer, Quantum Physics Div.

Robert F. Tresnak—appointed Assistant Sales Manager for Analab Instrument Corp., Cedar Grove, N. J., a subsidiary of the Jerrold Corp.

T. R. (Bob) Colville—appointed Manager, Marketing and Sales, Videosonic Systems Div., Ground Systems Group, Hughes Aircraft Co., Fullerton, Calif.



T. R. Colville



S. D. Haffey

Joseph W. Barron—elected Vice President—Administration and Marketing, Link Div., General Precision, Inc., Binghamton, N. Y.

Richard D. Geckler—named Vice President, Future Operations, Aerojet-General Corp., Azusa, Calif.; **Robert B. Young**—appointed Vice President, Sacramento Plants, and **E. S. Reichard, Jr.**—named Vice President, Contracts.

Herbert A. Finke—named President and Chief Executive, National Co., Inc., Malden, Mass.

John C. Ho—elected Vice President for R&D, Frequency Electronics, Inc., Astoria, N. Y.

Frank G. Meyer—appointed Director of Marketing, Omni Spectra, Inc., Detroit, Mich.

Theodore W. Helweg — appointed Manager, Industry Marketing Operations, RCA Electronic Data Processing, and **Charles T. Harbin**—appointed Sales Manager of RCA's Electronic Data Processing Service Center, Washington, D. C.

Stanley D. Haffey—appointed General Manager — Operations, Electronics Div., Avco Corp., Cincinnati, Ohio.

Herbert B. Roberts—named Special Marketing Assistant to the President, Mallory Battery Co., N. Tarrytown, N. Y.

Otto A. Schulze—appointed Vice President, American Machine & Foundry Co.'s Advanced Products Group, Greenwich, Conn.

Charles W. Johnson—named Vice President—Operations, Lawson Products, Inc., Chicago, Ill.

Leonard J. Battaglia—elected President, Distributor Products Div., International Telephone & Telegraph Corp., Lodi, N. J.; **Dr. William M. Duke**, President of ITT Federal Laboratories, Nutley, N. J.—elected ITT General Manager—Defense Operations; **George A. Banino**, President of ITT Kellogg Communications System Div.—appointed Executive Vice President, ITT Federal Laboratories.

(Continued on page 224)

NOW AVAILABLE! ALL NEW 1963 EDITION

ELECTRONIC INDUSTRIES

marketing map

a distribution of electronic plants in the United States on a county basis

EXCLUSIVE

Marketing Map of the United States

showing

- Distribution of electronic plants in the United States on a county basis
- Detailed breakdown of 8 major metropolitan areas
- Distribution of plant locations & electronic engineers in major states
- 4 color codes indicating number of plants by county
- Suitable for framing and wall mount
- 52 x 33 inches in size
- Orders filled and mailed same day

QUANTITY IS LIMITED — ORDER YOURS TODAY

Prices:

- Individual copies mailed in tubes \$3.50 each
- 2 to 25 copies 3.50 each
- 26 to 100 copies 3.00 each
- More than 100 copies 2.50 each

Please make checks payable to **ELECTRONIC INDUSTRIES** and mail to Market Research Department,

**ELECTRONIC INDUSTRIES, 56th and Chestnut Streets
Philadelphia 39, Pennsylvania**

ELECTRONIC INDUSTRIES

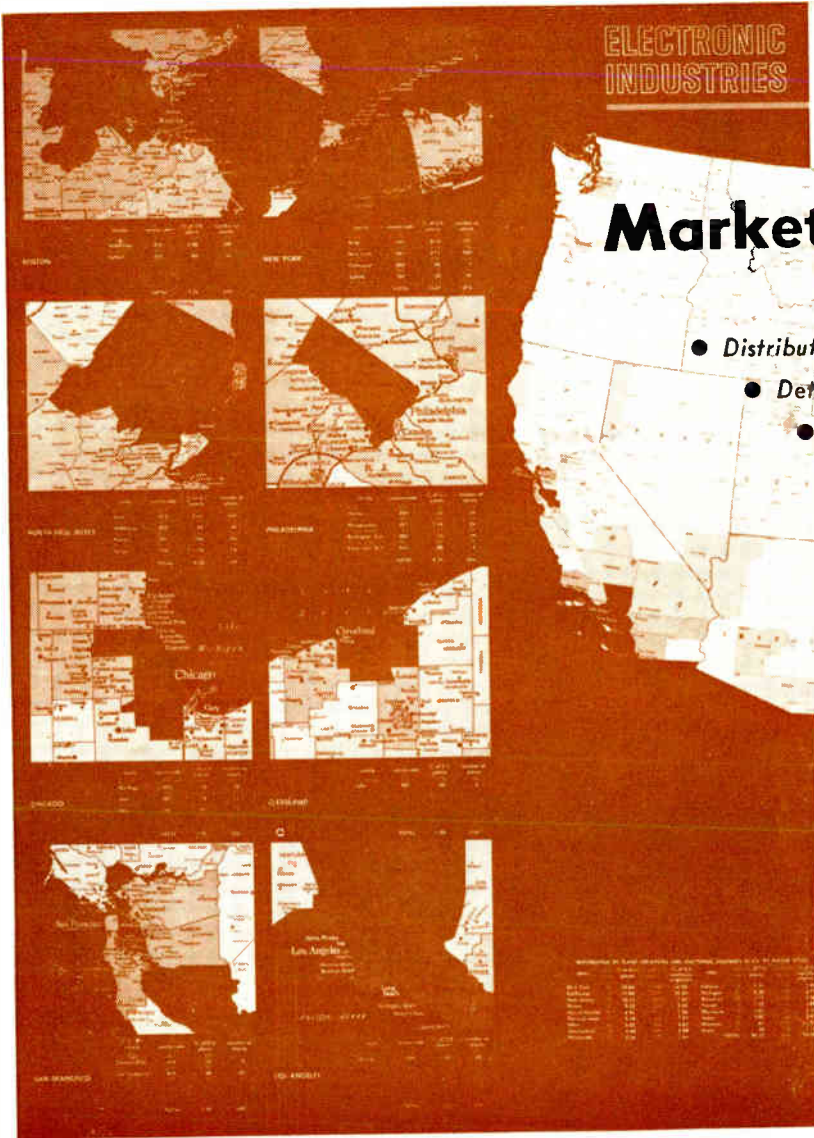

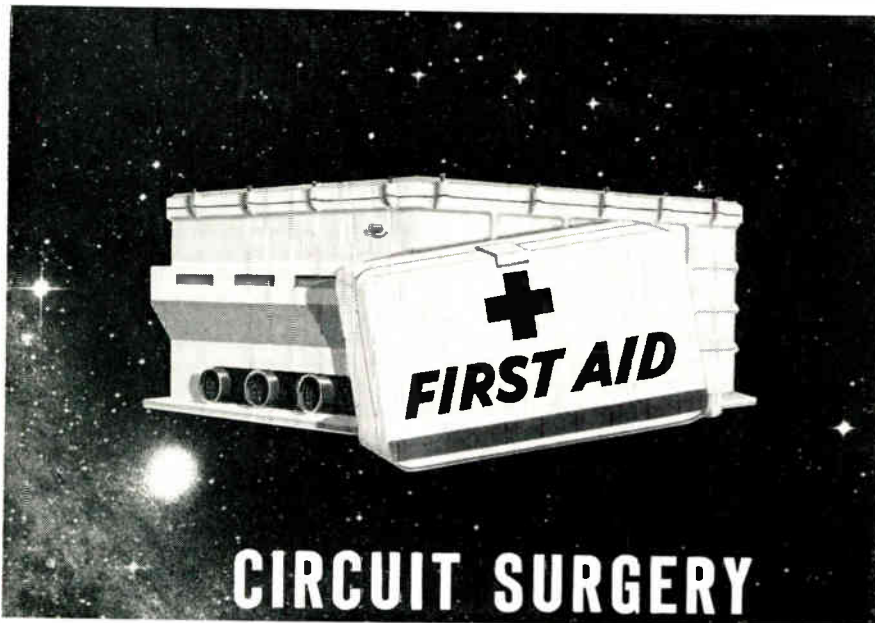

CIRCUIT SURGERY IN SPACE!

The problems associated with translating the self-healing concept into practical, space-applicable devices provide technical challenges of the highest order to Engineers and Scientists at Honeywell in Florida.

Advanced development work on ULTRA-RELIABLE aero space guidance systems include our investigations in the following areas: Multi-Redundancy techniques, Self-Adaptive techniques, including Self-Diagnosis, Self-Repair and modular number systems. These studies provide FRESH OPPORTUNITY FOR TALENTED ENGINEERS AND SCIENTISTS AT EVERY LEVEL OF EXPERIENCE.

Other studies which may open up new avenues of career advancement for you are:

- Development of fluid components for Computer and Navigation systems.
- Advanced inertial systems design and development, including electrostatic gyros, strapped down systems and fluid inertial components.
- Optical Navigation systems and devices, (Astral Inertial Systems, Star Trackers, etc.)
- Metrology. Continuing development of precise angle measurement devices beyond the capability of our "Dyngon," which accurately measures less than 1 arc second.
- Optical Coordinate Transfer Devices.

Interested in contributing your talents in any of the above areas? Just send a brief note describing your education, experience and specific area of interest to V. L. Ericson, Honeywell, 13350 U. S. Highway 19, St. Petersburg, Florida. We promise a prompt, confidential reply, and, perhaps, an invitation to visit with us, to see our facilities, meet our people and discover for yourself the added attraction of living here on Florida's Suncoast.



Honeywell

An Equal Opportunity Employer

"A GOOD PLACE TO WORK . . . A GOOD PLACE TO LIVE"

To investigate professional openings in other Honeywell facilities, send your resume to H. F. Eckstrom, Honeywell, Minneapolis 8, Minnesota.

HONEYWELL ENGINEERS ARE DOING THINGS IN FLORIDA

Marvin I. Steinberg—appointed Sales Manager, Sensitive Research Instruments, Singer Metrics Div., Singer Mfg. Co., Bridgeport, Conn.

Walter A. Clements, Vice President for Distributor Sales and Advertising of Littlefuse, Inc.—elected President of the Association of Electronic Parts & Equipment Manufacturers, Inc.

Robert T. Reid—appointed General Sales Manager, TRW Electronics/Pacific Semiconductors, Inc., Lawndale, Calif.

Wallace W. Orr—appointed Director of Marketing and Contract Administration, United ElectroDynamics, Inc., Pasadena, Calif.

Charles F. Adams, President of Raytheon Co., Lexington, Mass.—elected a Fellow of Brandeis University, Waltham, Mass.

Palmer Derby—named Assistant General Manager, Microwave and Power Tube Div., Raytheon Co., Waltham, Mass.



P. Derby



W. B. Armstrong

William B. Armstrong—appointed Assistant General Sales Manager, Syntron Co., Homer City, Pa.

William H. Manning—appointed Manager, Marketing Services, Marshall Industries, Inc., San Marino, Calif.

Charles W. George—named General Manager of the newly formed Radio Guidance Operation, Defense Electronics Div., General Electric Co., Utica, N. Y.; **Maj. Gen. Harold E. Watson (USAF, Ret.)**—named a Consultant on Aerospace & Defense Technology for GE's Defense Programs Operation; **Harrison Van Aken**—named General Manager, Computer Dept., Phoenix, Ariz.; **Clair C. Lasher**—appointed to manage GE's newly established Computer Offshore Operation and **John S. Chamberlin**—named Marketing Manager of GE's Radio Receiver Dept., Utica, N. Y.

David Hart—named Assistant Sales Manager, Semiconductor Div., Sarkes Tarzian, Inc., Bloomington, Ind.

AN ENGINEER'S EXPOSURE (Concluded)

all problem. The network has been developed, analyzed and reanalyzed—but this is only a means to the end. The real work sheet, the information the engineer really needs, is the previous computer analysis arranged in such a way as to indicate a Calendar Oriented Priority Operations Schedule. The temptation for current acronyms calls for abbreviated terminology—let's call it COPOS.

The writer is convinced that network theory has made its entry and is here to stay. Most recently, the combination of schedules and costs appear to be a tremendous program and evaluation technique, although there may be more work required in this area.

However, everything new and of value has growing pains. There's the problem of education, indoctrination and application. It's gratifying to note that the U. S. Government, Department of the Navy in particular, has spearheaded this effort.

Of particular interest is the requirement by Government agencies for network analysis on proposal efforts. Conceivably, this can result in contract awards to a bidder with a longer program schedule and higher cost because he has analyzed the problem.

The era of "buying in" and worrying about the consequences later may be near an end.



Measures resistance to 10,000,000 megohms

versatile • accurate • reliable

dual test voltage... 500 vdc and 50 vdc
24" total scale length... 1 to 10,000,000 megohms in 6 decades

measures resistance on printed circuits, transistor and miniaturized circuit components, cables, motors, etc.

measures leakage resistance of capacitors

measures grounded and ungrounded sections of three-terminal resistors

2-35.7

advanced features

- constant test voltage over full range
- no overload damage
- positive line voltage control
- maximum guarding flexibility
- latest tube-miniaturization techniques

Get all facts...
write for Bulletin 2-1.4

Associated Research, Inc.
Manufacturers of Electrical Testing Instruments since 1936
3787 W. Belmont Avenue, Chicago 18, Illinois

Circle 149 on Inquiry Card

ELECTRONIC INDUSTRIES • May 1963

KINNEY . . . EVERYTHING IN VACUUM

High Vacuum to 5×10^{-7} Torr with KINNEY Portable High Vacuum System

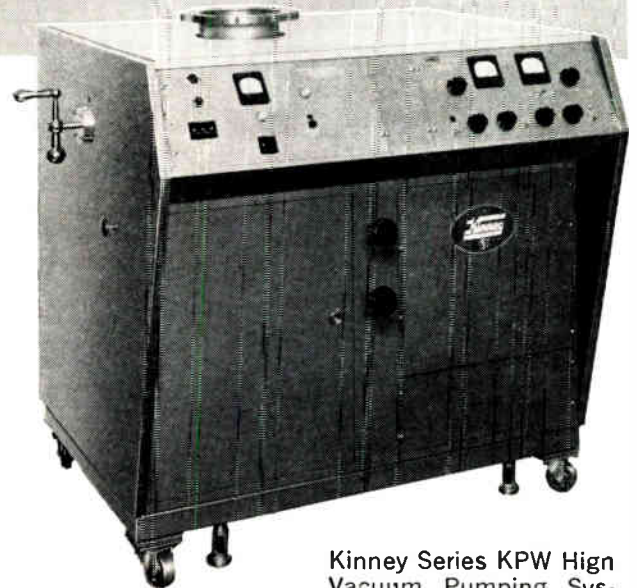

Kinney Series KPW High Vacuum Pumping Systems, in 2", 4", and 6" sizes, are compact, dependable units engineered to fill a wide range of applications. They can be easily moved and connected to evacuate a wide variety of systems.

Each unit consists of a mechanical pump, a diffusion pump, roughing and backing valves, liquid nitrogen or water cooled baffle, high vacuum valve, and ionization-thermocouple gauge enclosed in a hammertone grey enamel cabinet topped with a formica work surface.

FEATURES

- Rapid Evacuation to 1×10^{-6} torr
- 5×10^{-7} torr ultimate pressure
- Straight through pumping
- Ultra-high vacuum baffling
- Designed around dependable Kinney components



KINNEY VACUUM DIVISION

The New York Air Brake Company
3529 Washington Street
Boston, Massachusetts

Circle 150 on Inquiry Card

**FOR SERVO TESTS RESULTS YOU CAN ACCURATELY REPEAT
AND REPEAT AND REPEAT AND REPEAT AND REPEAT AND REPEAT AND**

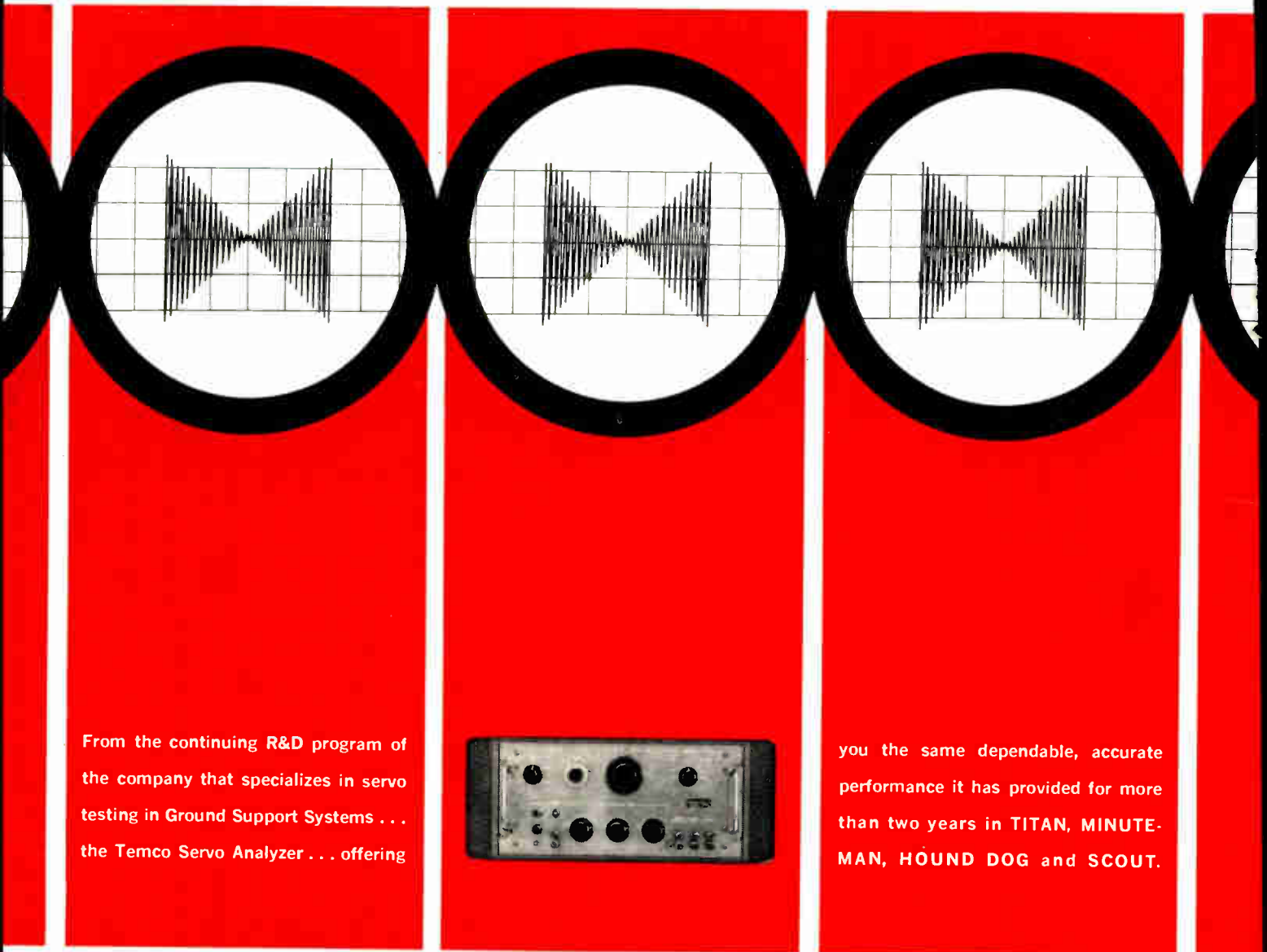

From the continuing R&D program of the company that specializes in servo testing in Ground Support Systems . . . the Temco Servo Analyzer . . . offering

you the same dependable, accurate performance it has provided for more than two years in TITAN, MINUTE-MAN, HOUND DOG and SCOUT.

THE TEMCO / SERIES 100/200 / SERVO ANALYZER

The Temco Servo Analyzer accurately measures servo functions in the most complex electronic, electro-hydraulic, electromechanical and electro-pneumatic systems. Its unique all-electronic circuitry provides a constancy of calibration and repeatable accuracy unmatched in the field — performance you can have confidence in.

This precision analyzer is designed to meet the stringent ground support requirements of space and launch vehicles, weapons systems and automatic controls. Design engineers, production technicians and field personnel find it simple to operate in achieving accurate, repeatable results.

Two models are offered in either rack or cabinet mounts. Model 101 provides an unmodulated phase-reference, and Model 201 provides either modulated or unmodulated phase-reference outputs for optimum oscilloscope presentation.

Features: All-electronic operation • 2% frequency accuracy • 50 to 10,000 cps carrier range • 0.005 to 1000 cps frequency range • phase measurement accuracy — 2 degrees • attenuation read directly in db.

Free Booklet: "Testing and Evaluation of Servo-mechanisms." Ask for this valuable summary of servo testing techniques when you write.

LTV TEMCO ELECTRONICS

A DIVISION OF LING-TEMCO-VOUGHT, INC. / P. O. BOX 6118 / DALLAS 22, TEXAS / BR 6 - 7111

Circle 151 on Inquiry Card

World Radio History

ELECTRONIC INDUSTRIES Advertisers - May 1963

This index is published as a convenience. No liability is assumed for errors or omissions.

Abbott Transistor Laboratories, Inc.	194	General Radio Company	77	Saratoga Semiconductor	
AC Spark Plug		Grayhill Incorporated	64	A Division of Espey Mfg. & Electronics	196
The Electronics Division of General Motors 220, 221				Sarkes Tarzian, Inc.	147
Alfred Electronics	85	Hamilton Standard		Siemens America Incorporated Insert following p. 88	
Alite Division		Division of United Aircraft Corp.	86	Siliconix Incorporated	14
U. S. Stoneware	73	Hart Manufacturing Co.	139	Sola Electric Company	173
Allen-Bradley Company	31	Havag Industries, Inc.	206	Sprague Electric Company	7, 9, 162
Allied Chemical		Hewlett-Packard Company	38, 39	Stackpole Carbon Company	75
General Chemical Division	74	Holub Industries, Inc.	130	Star Stainless Screw Company	208
Alpha Metals, Inc.	208	Honeywell		Stevens Manufacturing Company, Inc.	10
American Electrical Heater Company	30	Precision Meter Division	187, 224	Sylvania Electric Products, Inc.	22, 23
American Electronic Laboratories, Inc.	12	Hubbell, Harvey, Incorporated	157	Syntron Company	61
American Lava Corporation		Hoskins Manufacturing Company	178		
Subsidiary of 3M Company	63	Hughes Aircraft Company		TA Manufacturing Company	131
AMP Incorporated	Insert following p. 16, 141	Aerospace Divisions	56	Taylor Corporation	174, 175
Amperex Electronic Corporation	176, 177	Vacuum Tube Products Div.	191	Tektronix, Incorporated	66, 67
Amphenol-Borg Electronics Corporation		Videonic Systems Division	197	Thermalloy Company	138
Connector Division	Insert following p. 53			Theta Instrument Corporation	213
Andrew Corporation	163	Ideal Industries, Inc.	95	Times Wire and Cable	190
APM-Hexseal Corporation	172	Image Instruments, Inc.	213	Transitron Electronic Corporation	78
Armco Division		Industrial Electronic Engineers, Inc.	159	Tung-Sol Electric Incorporated	134
Armco Steel Corporation	26	International Electronic Research Corporation ..	188		
Arnold Engineering Company	99	Interstate Electronics Corporation	182	United States Energy Corporation	161
Associated Research, Inc.	225			United Transformer Corporation	139
Automatic Electric	34				
		Jerrold Electronics	24	Varflex Sales Co., Inc.	129
Ballantine Laboratories Inc.	150	JFD Electronics Corporation	142	Victoreen Instrument Company	154
Barnstead Still and Sterilizer Company	166	Johnson, E. F., Company	206	Vitramon Incorporated	29
Bead Chain Manufacturing Company	158			Western Electronic Products Co.	194
Beckman Instruments, Inc.		Kay Electric Company	57	Western Rubber Co.	211
Helipot Division	148, 149	Keithley Instruments	198, 199	Weston Instruments & Electronics	192, 193
Offner Division	151	Kester Solder Company	76		
Belden	51	Kinney Vacuum Division		Zero Manufacturing Company	165
Bendix Corporation		The New York Air Brake Co.	225		
Microwave Devices, Inc.	186	Knights, James, Company	158		
Pioneer-Central Division	228				
Scintilla Division	100	Leland Airborne Products			
Semiconductor Division	183	Division of American Machine & Foundry Co.	212		
Binswanger Corporation	228	Lepel High Frequency Laboratories, Inc.	138		
Bliley Electric Company	169	Linen Thread Company	131		
Bourns Incorporated	134, 135	Lionel Electronic Laboratories, Inc.	91		
Burnell & Company, Inc.	97	Litton Industries			
Burroughs Corporation	52	Triad Distributor Division	207		
Bussmann Mfg. Division		Lockheed Missiles & Space Company	53		
McGraw-Edison Co.	16	LTV Temco Electronics			
		A Division of Ling-Temco-Vought, Inc.	226		
Cannon Electric Company	49	Magnetic Shield Division			
Centralab		Perfection Mica Company	189		
The Electronics Division of Globe Union Inc.	42, 43	Magnetics, Inc.	32		
Cinch Manufacturing Company	127	Malco Manufacturing Company	193		
Clare, C. P., & Company	83	Motorola Communications & Electronics, Inc.			
ClaroStat Mfg. Co., Inc.	81	Precision Measuring Instruments	98		
Consolidated Electrodynamics	164, 165	Semiconductor Products Inc.	27		
Container-Kraft	210				
Controls Company of America	88	NJE Corporation	84		
CTS of Berne, Inc.	168	National Cash Register Company	214		
		National Ultrasonic Corporation	156		
		Norden			
		Division of United Aircraft Corp.	222		
Dale Electronics, Inc.	167	Ohmite Manufacturing Company	160, 161		
Deutsch	209				
Dickson Electronics Corporation	152	Pennwood Numechron Company			
Dynatron Electronics Corporation	212	Tymeter Electronics	209		
		Phelps Dodge Electronic Products Corp.	195		
		Philco			
		Lansdale Division	44, 45		
		Sierra Electronic Instruments	13		
		Polarad Electronic Instruments	Inside Back Cover		
		Power Designs Incorporated	200		
		Precision Paper Tube Company			
		Buckeye Bobbin Division	130		
		Pyle-National Company	35		
		Q-Max Corporation	213		
		Radio Corporation of America	Back Cover		
		Radio Materials Company	Inside Front Cover		
		Rayclad Tubes Incorporated	33		
		Raytheon Company	36		
		Reeves Instrument Corporation	184		
		Sage Laboratories, Inc.	210		

ELECTRONIC INDUSTRIES REGIONAL SALES MANAGERS

Philadelphia (39)—56th & Chestnut Sts.
(Area Code 215) SHERWOOD 8-2000
JOSEPH DRUCKER
HERMANN W. BOZARTH
(Classified Advertising)

New York 17—100 East 42nd St.
(Area Code 212) OXFORD 7-3400
GERRY PELISSIER
HUGH ROBINSON

W. Hartford, Conn.—62 LaSalle Rd.
(Area Code 203) 236-4237
AL KAISER

Boston (10), Mass.—10 High St.
(Area Code 617) LIBERTY 2-4460
JOHN PICKERING, Jr.

Chicago (1)—540 N. Michigan Ave.
(Area Code 312) 467-9660
JOHN W. BERNHARDT
PHILIP T. CLARK

Cleveland (15)—930 Keith Bldg.
(Area Code 216) SUPERIOR 1-2860
ROBERT COBURN

Los Angeles (57)—198 S. Alvarado St.
(Area Code 213) DUNKIRK 7-1271
GEORGE F. KELLEY
BURT UNDERWOOD

San Francisco (3)—1355 Market St.
(Area Code 415) 861-7107
DON MAY

Atlanta (9)—1776 Peachtree St., N.W.
(Area Code 404) 875-1255
JOHN W. SANGSTON

Dallas (6)—Meadows Bldg.
Expressway at Milton
(Area Code 214) EMERSON 3-6426
HAROLD E. MOTT

EUROPEAN SALES OFFICES

London, S. W. (1)—67/68 Jermyn St.
St. James
MAX F. HOLSINGER

Dusseldorf—Huttenstrasse 17
Am Ernst-Reuter-Platz
MAX F. HOLSINGER

FAR EAST SALES OFFICE

Tokio Marunouchi, Japan
C. P. O. Box #1572, Room 814
Tel: 211-3506-3509
Togin Bldg.
CLARENCE T. SAKAGUCHI

How Important is Experience?

When you select a microwave spectrum analyzer, remember that Polarad is the pioneer. In fact, we have had more experience in designing, building, and helping engineers apply microwave spectrum analyzers than all of our competitors combined . . . several times more. We wrote the only textbook in the field — in its fifth printing now. (Write for one — it's free.)

So What? Why should it matter to you that we have the most experience? Does experience really count? We think it does. In fact, we believe it is the **most important factor in your final decision.** Let us tell you why.

Every circuit in a Polarad spectrum analyzer is a second- or third-generation design. That means:

- **refinements** that make it more precise and stable.
- **sophistications** that make it more versatile and useful.
- **revisions** that make it more reliable and economical.
- **updating** that assures state-of-the-art capability.

On the other side of the coin is what experience **spares** you. You know the kind of thing we mean:

- subtle surprises . . . the mixer, or other circuit that isn't there, just when you need it. (All Polarad Spectrum Analyzers are furnished **complete**.)
- inconveniences . . . like the hard-to-read

scale, the oversensitive control, or the awkward panel arrangement.

- weak links . . . the causes of sudden failure right in the middle of an important test.

Everyone is plagued by these things . . . and only experience — **properly applied to the evolution and elaboration of a design** — ever eliminates all of them.

To sum up, when you buy a Polarad spectrum analyzer, you benefit in two ways: you get the **most** instrument for your money; **and** you get the accumulated experience of thousands of engineers, in many hundreds of installations all over the world. No one else can offer you that much.

Call your Polarad Field Engineer for positive proof.



Newest in a Distinguished Family — the Model SA-84 WA Extended-Range Spectrum Analyzer

Extended Frequency Range: 10 MC-63,680 MC in a single self-contained instrument! Extended Dispersion Range: 25 KC to well over 80 MC (to 100 MC on special order!) Highest Sensitivity ever offered in this class of spectrum analyzer!

Wide-Range Variable Resolution: 1 KC-80 KC! Many other features: 0.01% Crystal-controlled markers over entire frequency range . . . log-linear display . . . (up to 36 db calibrated log display) accurate IF attenuator . . . full 5" usable display.

POLARAD

**HAVE YOU MADE
RESERVATIONS YET?**



Polarad's new "Project Mohammed" is now bringing the "Mountain" (our new Mobile Microwave Calibration Laboratory) to "Mohammed" (your microwave instruments). Be sure to take advantage of this opportunity to have your gear checked — at your doorstep. Save weeks of delay and needless expense. Call your Polarad field engineer for details and schedules!

Polarad Electronic Instruments

A Division of Polarad Electronics Corporation
World Leader in Microwave Instrumentation
34-04G Queens Blvd., Long Island City 1, New York

Circle 73 on Inquiry Card

World Radio History



Complete RCA MEMORY SYSTEMS

with specified extra wide safety margins

Standard or custom systems, incorporating RCA ferrite and semiconductor devices, are designed, built, and tested by memory-circuit specialists—at RCA's newly expanded memory products operation in Needham Heights, Mass.

Here is the new answer to memory-system design and production, offering new latitude to the computer engineer, new solutions to your system production problems—complete RCA Memory Systems. Designed and produced by RCA from ferrite cores to entire packaged systems, these precision units are pre-tested to broad operating limits and are delivered ready for immediate use in computer designs.

Here are some of the outstanding features of complete RCA Memory Systems:

- **Specified Wider Margins of Operations...** Up to 8 percent... to cope with broad variations in power levels.
- **Custom Design Service...** RCA's engineering staff will custom-design a memory system to your specifications.
- **Superior Reliability...** Components and circuits proved by the long, dependable service of over 150 systems now in use.
- **Complete Information Retention...** even in case of full power loss.
- **Wide Temperature Range...** 0°C to 50°C.

For Systems Engineering Service—Call your RCA Office. For further technical information on RCA Memory Systems, write Dept. FJ5, RCA Memory Products Dept., 64 "A" St., Needham Heights 94, Massachusetts.

STANDARD RCA MEMORY SYSTEMS

Capacity	128 to 32,768 words, 4 to 64 bits per word.
Speed	Complete Read-Write cycle times: 0.375 to 12usec.
Modes of Operation	Read-Regenerate/Read-Modify/Write Only/Read Only/Master Clear.
Reliability	Acceptance tests made with all power supply voltages varied both plus and minus 8 percent from their nominal values while the system is being temperature cycled.

ADDITIONAL OPTIONAL FEATURES

- **Self Checking**—with simulated worst-case conditions.
- **Information Retention**—prevents loss of stored and in-process information in the event of primary power failure.
- **Indicator Lights**—for memory address register and memory information register.
- **Interlace Register**—permitting simultaneous read and write operations.



**The Most Trusted Name
in Electronics**

RCA SEMICONDUCTOR AND MATERIALS DIVISION FIELD OFFICES... EAST: 32 Green St., Newark 2, N. J., HU 5-3900 • 731 James St., Room 402, Syracuse 3, N. Y., GR 4-5591 • 605 Marlton Pike, Erlton, N. J., HA 8-4802 • Greater Baltimore Area, 1725 "K" Street, N.W., Washington 6, D. C., FE 7-8500 • NORTHEAST: 64 "A" St., Needham Heights 94, Mass., HI 4-7200 • SOUTHEAST: 1520 Edgewater Dr., Suite No. 1, Orlando, Fla., GA 4-4768 • CENTRAL: Suite 1154, Merchandise Mart Plaza, Chicago 54, Ill., 527-2700 • 2132 East 52nd St., Indianapolis 5, Ind., CL 1-1-405 • 5805 Excelsior Blvd., Minneapolis 15, Minn., WE 9-0676 • 714 New Center Bldg., Detroit 2, Mich., TR 5-5600 • 7905 Carpenter Freeway, Dallas 7, Texas, ME 1-9720 • Continental Terrace Bldg., 2785 North Speer Blvd., Room 346, Denver 11, Colo., 477-1688 • WEST: 6801 E. Washington Blvd., Los Angeles 22, Calif., RA 3-8361 • 1838 El Camino Real, Burlingame, Calif., OX 7-1620 • 2250 First Avenue, So., Seattle 4, Wash., MA 2-8816 • GOVERNMENT: 224 N. Wilkinson St., Dayton 2, Ohio, BA 6-2366 • 1725 "K" Street, N.W., Washington 6, D. C., FE 7-8500.

Circle 74 on Inquiry Card

World Radio History