

# ELECTRONIC INDUSTRIES

---



**APRIL 1963**

**Connectors and terminations**

**Transistors—thermistor controlled**

**Circuit realizability criteria**

# DALE SURGE ARRESTERS

...better protection against  
micro-fast transient overvoltage

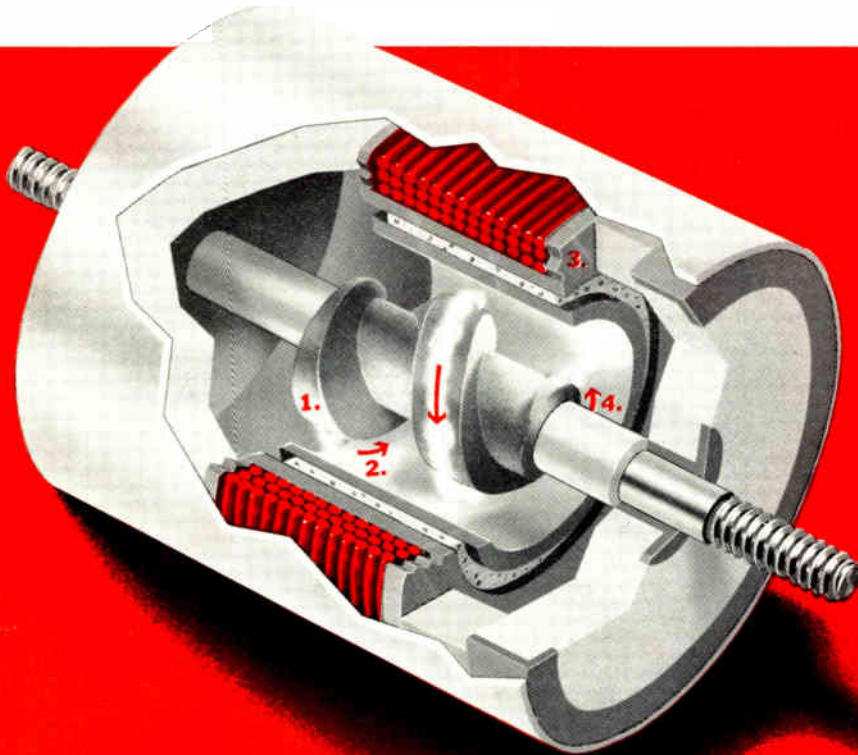

## HERE'S HOW DALE SURGE ARRESTERS WORK:

Arc is initiated between top of spiral electrode (1) and cylindrical electrode (2); Coil (3) is energized. Magnetic force of coil causes spark to rotate down tapered spiral electrode, lengthening it to breaking point (4) before excess current is drawn. Presence of radioactive isotope pre-ionizes air to assure unchanging breakdown voltage.

**THE** exclusive design\* of Dale Surge Arresters provides voltage surge by-pass capabilities both more efficient and more reliable than conventional spark gap arresters. Developed as part of an extensive transient voltage research program, the new Dale Surge Arresters have significant applications in power supplies to protect silicon rectifiers and to protect underground cables and other devices where transient voltages may be of damaging magnitude. Key to the effectiveness of the Dale Surge Arrester is a tapered spiral electrode (see drawing) which lengthens the spark gap—breaking it before excessive current is drawn. Since the air within the arrester is pre-ionized by the presence of a radioactive isotope, the level of breakdown voltage has only minor variance—providing a device which is continually capable of dissipating micro-fast transient overvoltages. When considering methods of transient voltage protection—both from the standpoint of protective ability and cost—Dale Surge Arresters are your most practical choice.

\*Patent Pending

## TWO TYPES AVAILABLE

**LA-8** Enclosed in dust-proof case. Will by-pass 10 current surges rising to 15,000 amps peak in 5 micro-seconds and containing total charge of 21 coulombs without damage to arrester or equipment attached and with less than 20% change in original DC breakdown voltage. May be mounted in any position. Spark gap arc-over voltage factory adjustable from 1500 to 4000 VDC ± 20%.

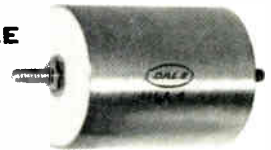

**LA-9** Hermetically sealed with soft solder (Melting point above 220° C). Will by-pass up to 100 current surges of 300 amps peak with 2x4 millisecond wave shape with no damage to arrester and equipment attached and less than 20% change in original DC breakdown voltage. May be mounted in any position. Factory adjustable from 500 to 5000 VDC ± 20%. (10% tolerance available).



Both LA-8 and LA-9 have insulation resistance in excess of 1000 megohms and will not drop below 10 megohms during or after rated number of current surges.



**DALE ELECTRONICS, INC.**

1304 28th Avenue, Columbus, Nebraska

A subsidiary of THE LIONEL CORPORATION

Also Made and Sold by Dale Electronics Canada, Ltd., Toronto, Ontario, Canada



Circle 98 on Inquiry Card

SHELBY A. McMILLION,  
Publisher  
BERNARD F. OSBAHR,  
Editor

# ELECTRONIC INDUSTRIES

## UNIONISM OR PROFESSIONALISM?

ENGINEERS have been rather cool toward union organization, but this attitude could change.

While engineering is rightfully called a profession, little is being done to maintain its public image. As a group, engineers have been markedly lax in promoting their professional stature in the market place. Perhaps they need a counterpart of the American Medical Association if engineering is to become a really recognized profession.

The development of true professionalism among electronic engineers could be the most effective answer to the threat of unionization.

Many technical societies now serve the electronic industry but so far they have not sponsored any national programs to develop engineering professionalism. Their major activity has been the dissemination of technical information. As established groups, these organizations are in the best position to raise the stature of engineering as a profession. Such programs need imaginative leadership and enthusiastic support from the engineering membership.

Automation and improved techniques have reduced union membership in the unskilled and semi-skilled trades. Union leaders are concerned. They must organize new groups if they are to retain their power and influence. White collar groups in general and, more recently, electronic engineers in particular, have become interesting targets.

We have 854,000 engineers now working in the

U. S., of which 650,000 are college graduates. Unions currently represent only 40,000 of these engineers. The electronic industry has approximately 200,000 engineers—an interesting potential for organization.

What are the chances of union success?

Our industry has changed in the last decade from consumer orientation to domination by government procurement. About 52% of the electronic industry output is supported by government money. Drastic changes in engineering employment and job tenure were inevitable.

Engineers used to look forward to a career with a single company. Job-hopping was infrequent. Now many engineering jobs depend on a single government contract which can change drastically or be cancelled on short notice. Many an electronic engineer finds himself suddenly in the job market with a good chance that the next assignment may demand a move of home and family to another part of the country. Insecurity is a real concern to many engineers—and insecurity makes fertile ground for union activity.

We believe in the vigorous development of engineering professionalism. It preserves the dignity of the individual and his profession; encourages greater creativity; builds recognition and stature for the individual. Finally, high professional standards would attract the kind of new young talent vitally needed by our expanding industry.

• • •



# ELECTRONIC INDUSTRIES

Vol. 22, No. 4

April 1963



## MONTHLY NEWS ROUND-UP

Radarscope: What's ahead for the Electronic Industries	4
As We Go To Press	6
Electronic Shorts	9
Coming Events	13
Electronic Industries News Briefs	24
MARKETING: Facts and Figures Round-Up	27
Snapshots . . . of the Electronic Industries	32
Washington Trends	38
Next Month in Electronic Industries	93
International News	210

## EDITORIAL FEATURES

EDITORIAL: UNIONIZATION OR PROFESSIONALISM	1
DISARMAMENT: WHAT WOULD IT MEAN TO THE ELECTRONIC INDUSTRY?	S. Feldman 42
CONNECTORS—AND TERMINATIONS	S. Ruth 55
WHAT'S NEW	76
MANAGEMENT OVERHAUL KEY TO AMPEX RECOVERY	J. P. Geddes 86
A LOOK AT MODERN DIPLEXERS	T. J. Vaughan 94
SILICONE DIELECTRICS IMPROVE CONNECTORS	R. Lawrence 99
FUNCTION GENERATION WITH ACTIVE NONLINEAR ELEMENTS	N. D. Diamantides 102
CIRCUIT REALIZABILITY CRITERIA	J. W. LaPatra 104
THERMISTORS FOR TEMPERATURE STABILIZATION OF TRANSISTOR CIRCUITS	M. L. Chater 109
INTEGRATED CIRCUIT DESIGN TECHNIQUES	J. R. Hulme 112
ENGINEER'S NOTEBOOK #67—DECIBEL NOMOGRAPH	H. Y. Wong 116
ELECTRONIC OPERATIONS	215
FOR SYSTEMS . . . A TESTER FOR WIRING SHORTS	W. E. Dobbins 216
PROFESSIONAL OPPORTUNITIES	231
LOW VOLUME MANUFACTURING IN UNDERDEVELOPED COUNTRIES	G. C. Jones & Associates 232

## DEPARTMENTS

New Products	122
New Tech Data for Engineers	184
Letters	202
Industry News	206
Systems-Wise	215
Systems & Circuits	228

SHELBY A. McMILLION,  
Publisher

BERNARD F. OSBAHR,  
Editor

CREIGHTON M. MARCOTT  
Executive Editor

JOHN E. HICKEY, Jr.  
Managing Editor

SMEDLEY B. RUTH  
ANDREW MITCHELL  
Associate Editors

CHARLES WEBB  
Assistant Editor

SIDNEY FELDMAN  
Contributing Editor

DR. ALBERT F. MURRAY  
Consulting Editor

ELMER KETTERER  
Art Director

IDA M. GOOD  
Editorial Secretary

ANNE N. AXE  
Editorial Asst.

MAE E. MOYER  
Readers' Service

SOL MEDNICK  
Cover Design

## EDITORIAL NEWS BUREAUS

Los Angeles—198 S. Alvarado St.  
(Area Code 213) Dunkirk 7-1271  
J. PHILIP GEDDES, Mgr.

Washington—1093 National Press Bldg.  
(Area Code 202) 393-3474  
TWX—202 965-0675

GEORGE BAKER, Mgr.  
NEIL R. REGEIMBAL  
DAVID R. HEINLY

## BUSINESS DEPARTMENT

ELMER DALTON  
Advertising Promotion  
& Circulation Manager

DONALD J. MORAN  
Marketing Manager

GORDON HERNDON  
Production Manager

See Advertisers Index for Regional Sales Managers.

Chilton Company—G. C. BUZBY, President  
Executive Vice Presidents: R. E. McKenna,  
G. T. Hook. Vice Presidents: P. M. Fahren-  
dorf, L. V. Rowlands, M. E. Cox, E. B.  
Terhune, Jr., R. W. Case, Jr., J. H. Kofron.  
Treasurer: Stanley Appleby. Secretary: J. A.  
Montgomery. Other Directors: F. P. Tighe,  
C. A. S. Heinle, G. E. Cameron, T. C.  
Campbell. Assistant Secretary: I. C. Holloway.

ELECTRONIC INDUSTRIES, April, 1963.  
Vol. 22, No. 4. A monthly publication  
of Chilton Company. Executive Editorial &  
Advertising offices at Chestnut & 56th Sts.,  
Phila. 39, Pa. (Area Code 215) SHERWOOD  
8-2000. Controlled circulation postage paid  
at Philadelphia, Pa. \$1 a copy; Direc-  
tory issue (June), \$5.00 a copy. Sub-  
scription rates U. S. and U. S. Posses-  
sions: 1 yr. \$10.00; 2 yrs. \$18.00. Canada  
1 year, \$12.00; 2 yrs. \$20.00. All other  
countries 1 yr., \$18; 2 yrs. \$30.00.  
Copyright 1963 by Chilton Company. Title  
Reg. U. S. Pat. Off. Reproduction or re-  
printing prohibited except by written author-  
ization.





# HIGHLIGHTS

of this issue

## Disarmament: What Would it Mean to the Electronic Industry? page 42

Strenuous efforts are being made to minimize the threat of thermonuclear war. What course would our industry take in the event that world-wide agreements wipe out the vast defense and aerospace markets? Should the industry—as some firms have done—begin planning now for diversification? Here are some current observations and comments by outstanding figures in government and science.



Connectors and Terminations

## Connectors—and Terminations page 55

Connectors are taking on added importance. From what was once a seldom needed or used piece of hardware, they have grown to a \$250 million a year business. The problems associated with them, the termination methods and trends are discussed in this article.

## Management Overhaul Key to Ampex Recovery page 86

Top management at Ampex was lulled by success into a sense of false security. Then, two things cost the company a year's progress and \$3 million. The firm divided into five little companies just before sales dipped and it reacted slowly to economic trends. Outside consultants started a management overhaul and recommended a new president. He put the company in the black in less than a year.

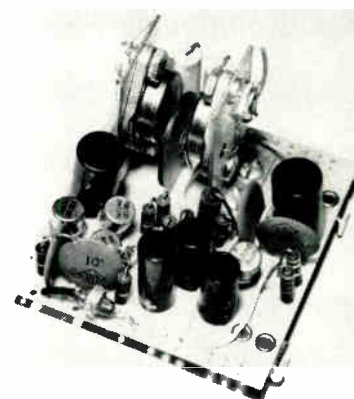

Thermistors

## A Look at Modern Diplexers page 94

Present day requirements demand that diplexers have high isolation and low insertion loss and be capable of handling very high average powers. The various configurations of diplexers are discussed here, together with comments on their abilities to meet these requirements.

## Silicone Dielectrics Improve Connectors page 99

For years neoprene was the commonly used elastomer for wire sealing grommets and resilient insert bodies in connectors. Silicones were tricky to handle, and hence were avoided by connector manufacturers. This problem has been solved, and their use improves connectors as revealed here.

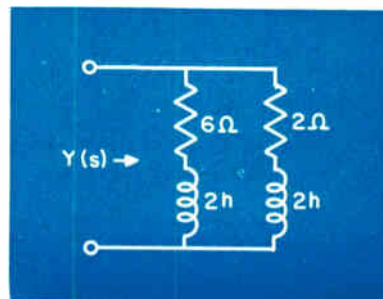

Circuit Realizability

## Function Generation with Active Nonlinear Elements page 102

Mathematical operations on signals are dictated by advanced requirements of modern electronic applications. These may be easily implemented by means of simple components. Circuits for a complete operation are presented.

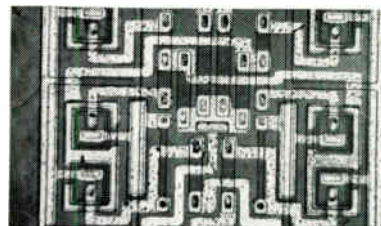

Integrated Circuit Design

## Thermistors for Temperature Stabilization of Transistor Circuits page 109

The thermistor can offset temperature effects of all components in a circuit. Increased gain may result in the modified circuit for the same temperature variations. At times, germanium transistors can replace silicon types. The method for stabilizing circuits within specified temperature limits is given.

## Integrated Circuit Design Techniques page 112

Certain rules have been developed which aid in designing custom integrated circuits. This article shows how to apply them to simulate a model having discrete components. A method to reduce circuit complexity is also presented.

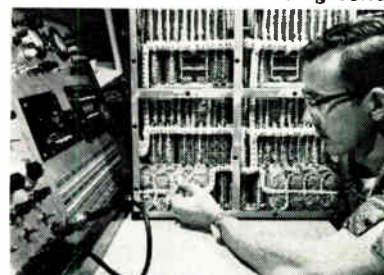

Wiring Tester

## Low Volume Manufacturing in Underdeveloped Countries page 232

The methods of manufacturing and of personnel supervision that work best in the U. S. are not necessarily the best for other forms of society, particularly in primitive areas. The level of education, religious practices and capacity for supervision are just a few of the items to be considered.

# RADARSCOPE

Analyzing current developments and trends throughout the electronic industries that will shape tomorrow's research, manufacturing and operation

**NEW FAMILY OF THIN-FILM CIRCUITS** is under development at RCA Laboratories, funded by the U. S. Navy Bureau of Weapons. The circuits consist of both active and passive elements evaporated as film on glass, permitting single process fabrication of an entire circuit. Initial use of the circuits will be in aircraft cockpit displays. A program objective is to develop film circuits using light signals directly for power without conversion to electric signals.

**BRUSHLESS MOTORS** up to 1 hp in size and using transistorized switching instead of the ordinary brushes and commutators are now being produced by Astro-Dynamics, Burlington, Mass. The small electronic commutation motors will be used for space applications, liquid-submersion applications, for driving tools in cramped quarters and where sparking of ordinary motors may be dangerous.

## TELEVISION BY LASER

General Telephone & Electronic Corp. engineer demonstrates laboratory model of laser system that transmits and receives television pictures. Believed to be first transmission by laser light beam of microwave signal carrying television information, the system includes improved gas laser and special optical modulator, developed by GTEC.

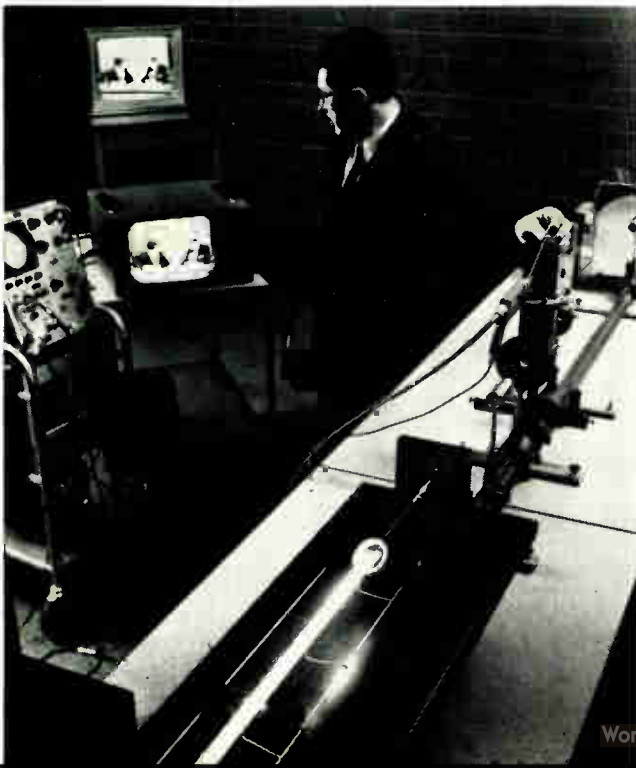

**LASER DEMODULATOR TUBE** capable of detecting modulations at microwave frequencies in visible light was announced jointly by Douglas Aircraft Company, Inc., and the National Engineering Science Company. The new demodulator, assembled at NESCO, has a photo emissive surface on which modulated laser light waves are received. Signal amplitude variations cause electron stream variations when laser beam hits photo surface. The stream is focused and passed through a microwave waveguide where stream fluctuations result in generation of a microwave signal.

**RE-TRAINING ENGINEERS** whose skills have become "obsolete" in the space age, could help overcome the shortage of scientists and engineers, reports Sen. Howard W. Cannon (D.-Nev.), a member of the Space and Armed Services Committee. He urged an engineer-scientist retraining program similar to one for blue-collar workers, and more on-the-job educational opportunities for technicians, citing Federal Space Agency success. He observed that President Kennedy's 1962 request for special studies for technical manpower utilization has brought no results, and that the siphoning of technical manpower away from civilian industry into Federal R&D will present a grim outlook for our world market position.

**METRIC TERMS** should become part of standard industrial specs in view of the stiffening competition for foreign markets, observes the American Society for Testing Materials, major source for U. S. industrial standards. The ASTM, requiring metric equivalents throughout its publications, recommends quantities and tolerances easily convertible to metric values, but does not suggest any change in current values. It merely advocates specifying both English units and their precise metric equivalents.

**JAPANESE ELECTRONICS OUTPUT** totaled \$797 million in the first half of 1962, a 20% increase over the \$660 million of the first half of 1961, reports the Electronics Division, Business and Defense Services Administration, Department of Commerce. The continued growth rate sharply contrasts with the slackening pace predicted by the Japanese Government and Japanese industry early last year. Consumer electronic products accounted for more than one-half the output during the first six months of 1962.



**ELECTRONICS DEVELOPMENT** is now more a matter of refinement than of revolutionary discovery, says G.E. Vice President L. Berkley Davis, general manager of the firm's electronic components division. According to Davis: those who remain in the electronics industry, whether to sell, design or make, will have to broaden and increase their technical knowledge and technological value. Military and space electronics will grow while consumer markets, though increasing, will become an even smaller share of the total; and successful electronics firms will have engineering, sales, service and management personnel with broader and increasingly technical-business backgrounds.

**OBSOLESCENCE OF ENGINEERING SKILLS**

was underlined by Dr. T. Paul Torda, professor of mechanical engineering at Illinois Institute of Technology. He said, "we're running out of competent engineers in this (Chicago) area, not simply because they move to other parts of the country, or because our universities aren't producing enough graduates, but because technology is advancing so rapidly." He observed that when scientists and engineers stop formal study and work for firms, they often lose contact with important studies and research. Books alone can't help the engineer. There is a time lag of at least five years before new knowledge is available in print.

**UMBRELLA FOR ELECTRONIC EYE**

Aluminum "umbrella" keeps the 250,000 volts in check that powers an electron diffraction camera at Westinghouse. The camera looks at atomic structure of matter. It generates and accelerates electrons to 90% of the speed of light, beams them onto the study sample and photographs its atomic arrangement.

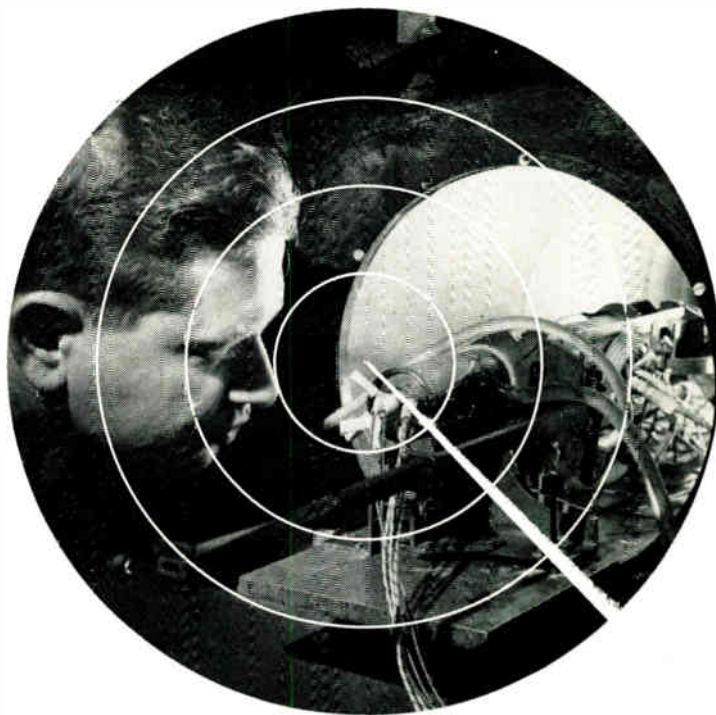
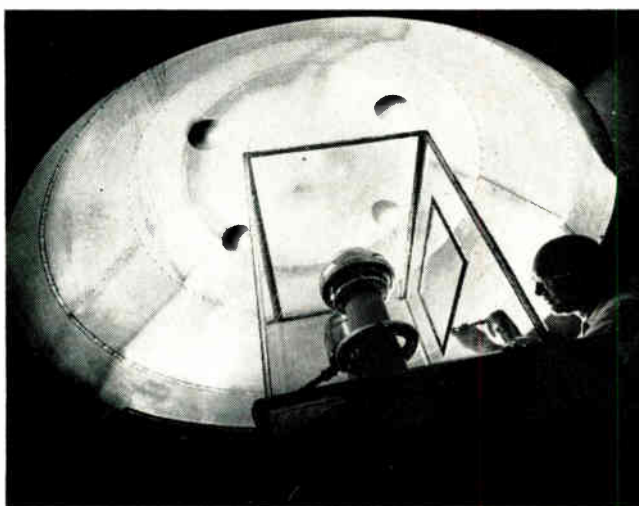

**BEAM-PLASMA TUBE**

Experimental tube developed by RCA, under Air Force Systems Command, using interacting pulsating electron beam and ionized cesium gas to amplify signals up to 23 GC, may open new communications channels near infrared frequencies. It will permit very high definition radar plus undetectable and jam-proof communications systems.

**RESEARCH AND DEVELOPMENT** costs for the U. S. Government in 1964 fiscal are estimated at \$14.9 billion out of a total national budget of \$98.8 billion, according to a memo from the Aerospace Industries Association of America, Inc. R&D cost the U. S. \$12.2 billion in 1963 fiscal, in great contrast to the 1954 figure of \$3.1 billion. The memo, based on congressional budget message excerpts, provides for an R&D obligational authority of \$7.3 billion for the Department of Defense, compared to \$7.0 billion in 1963. Included in the overall expenditures are R&D projects for aircraft, missiles and military astronautics.

**MORE AID FOR ENGINEERING STUDENTS**

is being urged by the National Society of Professional Engineers (NSPE). Exec. Dir. P. H. Robbins said that if Congress wants to expand space, defense and R&D efforts, then it must help to provide engineering and scientific manpower. He asked the House Education and Labor Committee to endorse expanded student loans and graduate fellowships. He urged Congress to enact aid for college-level, two-year technical institutes to produce more semi-professional engineering and scientific technicians. He suggested that direct Federal aid be given to public colleges and universities as well as to private institutions. (More RADARSCOPE on Page 242)



# AS WE GO TO PRESS

## AUTOMATIC LANDING GUIDANCE ANTENNA

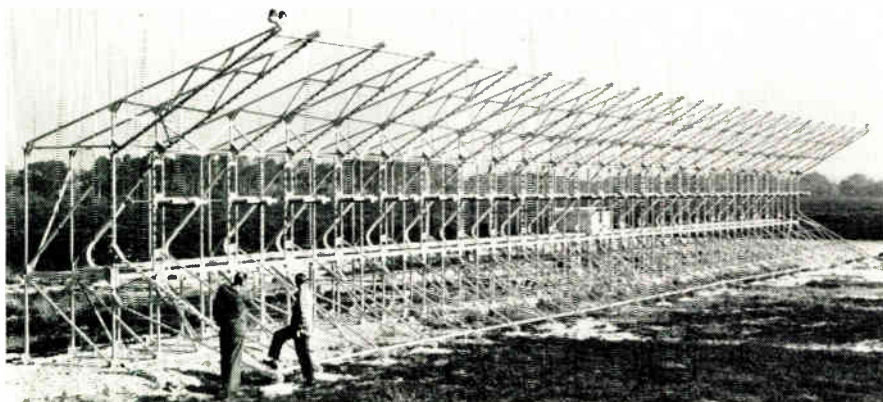

Instrument Low-Approach System localizer antenna, 160-ft. long, 18-ft. high, installed at Bournemouth, England, Airport by ITT affiliate Standard Telephones & Cables, Ltd., is part of new radio-guidance system for fully automatic landing. Antenna radiates a  $4^\circ$  wide beam to keep A/C centered toward runway. Radio altimeters feed guidance data to autopilot through ILA System receiver in A/C. Antenna is 1,000 ft. beyond runway end.

## LASER SYSTEM CARRIES TV SIGNALS VIA MICROWAVE

The prototype of a laser communications system that may increase more than 16-fold the number of TV or telephone channels carried by microwaves and which may be used for space communications has been developed by General Telephone & Electronics Laboratories, Bayside, N. Y.

Such a system could theoretically handle more than 160 TV or 100,000 telephone channels at once. Present broadband point-to-point microwave links handle only 6,000 telephone or 10 TV channels.

Between five and 10 years of research remain between the present experimental system and practical application of it, GT&E officials stress. They say the first applications will probably come in space-to-space and earth-space communications, followed by point-to-point earth transmission.

Key element in the experimental system, which transmits a single TV picture by means of an SSB optical modulation technique, is a TWT photodetector. It separates laser light signals from microwaves which have been superimposed on them. These microwaves are then amplified, demodulated, and displayed on a TV picture tube.

(Earlier National Engineering Science Co. and Douglas Aircraft announced development of a laser demodulator employing the photodetec-

tion principle. They used it to receive and detect modulation on laser beams at the NESCO labs in Pasadena, Calif.)

A TV broadcast signal and a continuous microwave signal are first applied to a TWT. The resultant video-modulated microwave signal is fed into an electro-optic light modulator through which a laser beam is projected. When the beam emerges, it carries video and sound data superimposed on the microwave signal.

The transmitter beam is relayed to an experimental optical receiver in the same way microwave information is beamed from one station to the next.

## THIN FILM MONITOR

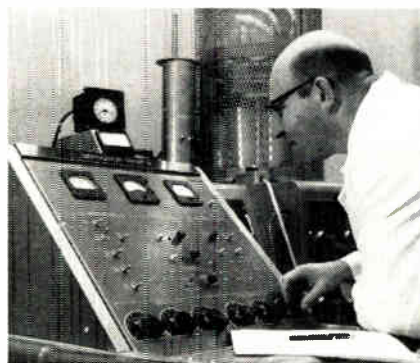

Operator monitors resistor and capacitor values during thin-film deposition at GE's new Microelectronics Laboratory, Utica, N. Y. Machine registers ohms/unit area for resistors, automatically stops deposition at proper value. The monitor controls dielectric thickness by measuring frequency of oscillating quartz crystal in silicon monoxide vapor.

## THIN-FILM, INTEGRATED CIRCUIT METHODS COMBINED

Scientists at the Micro-electronics Technology Laboratory of Philco's Lansdale Div. have made thin-film passive components on the silicon dioxide surface of passivated silicon chips. This work, still in early development, promises to greatly expand the use and applications of integrated micro-circuits.

Combining tantalum thin-film passive element production with integrated circuit planar fabrication of active elements unites the best features of what have been competing micro-circuit technologies.

Using tantalum thin films formed by a photolithographic technique to make resistors and capacitors permits attainment of component tolerances impossible with conventional solid-silicon methods. Also, greatly improved drift characteristics and freedom from parasites can be obtained.

Use of a silicon block for integrated fabrication of all active elements removes the necessity for separate production and attachment of active elements, now needed with existing thin-film methods.

Integrated circuits made by this new technique will have the size, weight and reliability of conventional integrated silicon circuits, plus much improvement in component tolerance. This will make possible the design of high-performance analog circuits and very low-power or high-speed digital circuits.

Integrated silicon circuits are now mainly restricted to medium power, medium speed, digital uses and to a few simple analog functions.

## DATA TAPE HANDLER RESISTS HEAT AND SHOCK

Sylvania Electric Products, Inc., Needham, Mass., has developed a small, automatic system to handle magnetic tape for data processing. It can withstand violent shock, vibration and extreme temperature.

Each tape handling system unit is 19 x 23 x 24 in. It is reliable at temperatures from  $-25^\circ$  to  $+125^\circ$  F. and shock levels equal to several hundred G's.

(More News on Page 9)

# THIN-FILM MICROCIRCUITS NOW AVAILABLE FROM SPRAGUE!

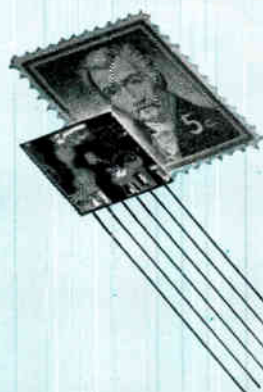

Smaller than a postage stamp, this typical CERACIRCUIT is a two-stage oscillator and gated amplifier, used as a clock-pulse source in digital systems.

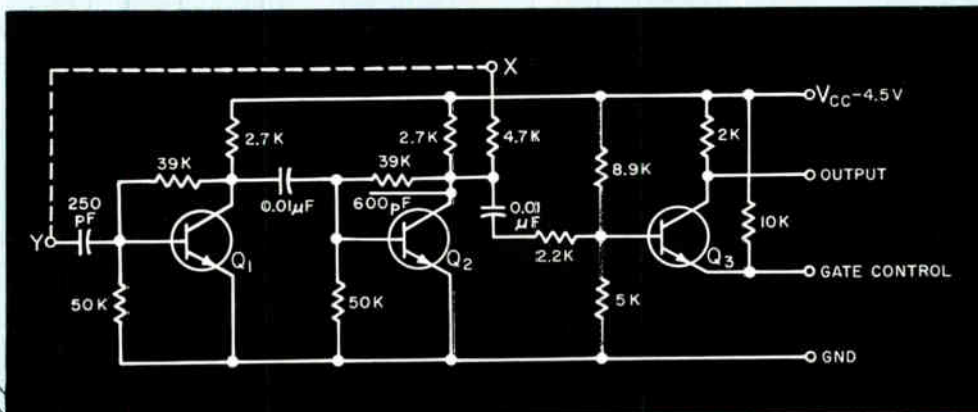

## LINEAR and DIGITAL

# CERACIRCUITS<sup>★</sup>

FOR GREATER DESIGN FLEXIBILITY... INCREASED RELIABILITY... CIRCUIT ECONOMY!

Thin-film CERACIRCUITS allow great flexibility in the choice of components and types of circuits. Chopping size, weight, and cost, while boosting reliability and power utilization, these revolutionary microcircuits are being used by alert design engineers in ever-increasing numbers. Their ease of usability is remarkable. Containing familiar circuit elements such as capacitors, inductors, resistors, diodes, and transistors, CERACIRCUITS offer precision components with a wider choice of tighter parameters, assuring greater design freedom.

\*Trademark

Custom thin-film CERACIRCUITS are here . . . Now! A Sprague microcircuit specialist will be glad to discuss the transition of *your* circuits to thin-film. He can also supply CERACIRCUITS such as linear amplifiers, oscillators, NOR gates and drivers, indicators, binary counters, and clocks for evaluation of Ceramic-base CERACIRCUITS in *your* equipment. For complete information, write to Technical Literature Service, Sprague Electric Company, 233 Marshall Street, North Adams, Massachusetts.

### SPRAGUE COMPONENTS

MICROCIRCUITS  
CAPACITORS  
TRANSISTORS  
MAGNETIC COMPONENTS  
RESISTORS

INTERFERENCE FILTERS  
PULSE TRANSFORMERS  
PIEZOELECTRIC CERAMICS  
PULSE-FORMING NETWORKS  
TOROIDAL INDUCTORS

HIGH TEMPERATURE MAGNET WIRE  
CERAMIC-BASE PRINTED NETWORKS  
PACKAGED COMPONENT ASSSEMBLIES  
FUNCTIONAL DIGITAL CIRCUITS  
ELECTRIC WAVE FILTERS

**SPRAGUE**<sup>®</sup>  
THE MARK OF RELIABILITY

<sup>®</sup>'Sprague' and <sup>®</sup>'' are registered trademarks of the Sprague Electric Co.



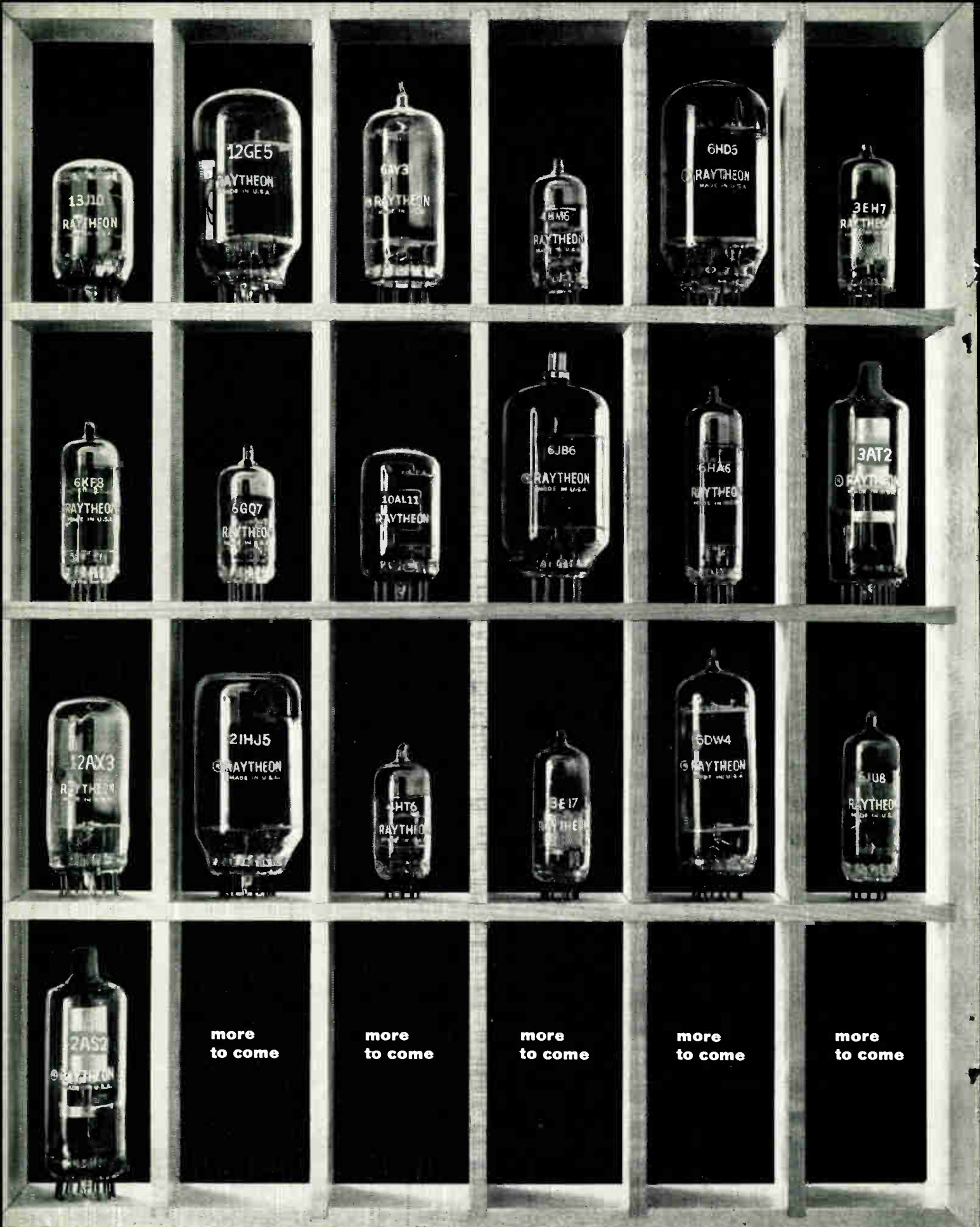

For recent data on Raytheon's growing lines of entertainment receiving tubes, write:  
Raytheon Company, Industrial Components Division, 55 Chapel St., Newton 58, Mass.

Circle 2 on Inquiry Card





## 'SUPER' MAGNETS



Superconducting magnets receive final tests at Westinghouse Cryogenic Systems Dept., Pittsburgh, Pa. Magnets range in strength from 15,000 to 50,000 gauss and from .5 to 2 in. in core diam. Frosted magnet (ctr.) has just received final check in bath of liquid helium at  $-452^{\circ}$  F. Magnets are for university and industrial laboratories to study superconductivity, related subjects.

## IBM PROGRAM TO REWARD TOP SCIENTISTS, ENGINEERS

A program to recognize and reward its highly creative scientists, engineers and other professionals has been announced by International Business Machines Corp.

IBM has established the rank of "IBM Fellow" to give special recognition to members of its technical staff having outstanding records of sustained innovation and achievement. They will have freedom to choose and carry out research projects in their field of specialty, and will be consultants to other IBM scientists and executives.

## SPONSORS ULTRASONIC ARTICLES WRITING CONTEST

The Ultrasonic Mfrs. Assoc., New Rochelle, N. Y., is sponsoring its First Annual Award Contest for the best articles concerning the ultrasonics field.

Two cash prizes will be awarded—one for \$100 and another for \$50. The contest opened Mar. 1 and will close Dec. 31, 1963. It is open to any person engaged or interested in ultrasonics, including university students.

## MEDICAL ELECTRONICS

A medical Electronics Committee to help speed development of life-saving devices has been proposed by Lester Avnet, Pres. of Avnet Electronics Corp., New York, N. Y.

Mr. Avnet said the Committee could be composed of electronics industry leaders and faculty members of the Albert Einstein College of Medicine of Yeshiva Univ.

(More News On Page 11)

# ELECTRONIC SHORTS

Stanford physicists and engineers will use a satellite to test the Theory of Relativity. Experiment uses a frictionless, free-fall gyro suspended in a vacuum inside a satellite. Barely perceptible precession caused by the earth's gravitational field will be measured. The gyro's axis arc movement should normally be only about  $1^{\circ}$  in 500 years. This will be speeded up since the satellite orbits 15 or 16 times daily.

Basic circuits for a micro-miniaturized monopulse radar receiver have been developed by Autonetics Div., North American Aviation, Inc., Anaheim, Calif. Thin-film hybrid circuits are used in the system, which employs attenuators for gain control. A thin-film deposition technique is used to produce circuit passive elements. The receiver's wide-band video amplifier has a gain of 20 db from 10-150 MC. Thin-film band-pass filters are used.

Eastern Air Lines Boeing 727 jets will be equipped with 180-mile weather radar developed by Bendix Radio Div., Baltimore, Md. New radar gives pilots 3 more decision-making minutes for in-flight weather evaluation. Designated RDR-1E, it is basically a solid-state unit, employing only 4 tubes. Gain controls are eliminated, enhancing target definition.

A minute thermoelectric converter which absorbs solar energy and changes it to electrical energy has passed orbit test flights. Developed by General Atomic Div., General Dynamics Corp., it is comprised of 36 thermoelectric elements sandwiched between 2 metal sheets. One collects solar energy and the other acts as a waste heat radiator.

Study contract which calls for research into advanced and very efficient bandwidth compression systems to transmit TV data from deep space to earth has been awarded to Electro-Mechanical Research, Inc., Sarasota, Fla., by NASA Manned Spacecraft Ctr. Digital TV study will concentrate on eliminating redundancy between elements, lines and frames in TV information.

Two Navy contracts have been awarded to Sylvania Electric Products, Inc., for silent-tuning radio calibration sets. The sets, already developed, operate on a self-generating noise principle and do not emit detectible r-f energy that might disclose ship or antenna location.

Eclipse-Pioneer Div., Bendix Corp., Teterboro, N. J., has developed a precise aerospace device to permit the sun's center to be used as a reference for controlling satellite attitude. Called Fine Sun Sensor, it allows space-borne detecting and sensing equipment to be accurately aimed at selected areas of the universe. It pinpoints sun's center to 1 arc-sec.

Union Switch & Signal Div., Westinghouse Air Brake Co., has delivered apparatus to remotely control unmanned 32-ton switcher locomotive to grain handling facility at Port Allen, La. From 5 lb. portable control unit, operator controls normal functions of locomotive, which hauls loaded grain cars from storage yard to rocker-type grain car dumper, returns empties to storage tracks.

Nuclear instrumentation system to operate 2 reactors has been delivered to GE Atomic Power Eqpt. Dept., San Jose, Calif. System is only known one which provides for operation of 2 reactors from a console. GE's Experimental Reactor Physics Unit and Nuclear Electronic Products Sec. built it. Simultaneous operation is prevented by special coax switches and enabling circuits. Reactor safety system is solid-state dual logic system.

CBS Laboratories, Stamford, Conn., has made "microLap," high-quality ruby recording stylus originally developed to cut Columbia master records, available to record makers. New stylus is especially designed to improve record quality by meeting  $15^{\circ}$  modulation standard developed by CBS Labs and recommended by Record Industries Ass'n.

Martin Co. Space Systems Div. engineers, Baltimore, Md., have developed 2-man improved mooncraft model to simulate critical rendezvous and docking steps of lunar landing mission. Equipment includes full-scale lunar mission flight simulator connected to analog computer through which motion equations are reflected on realistic panel for crew.

# Did you know Sprague makes...?

## MAGNETIC LOGIC DEVICES



Core-diode and core transistor magnetic shift registers and magnetic counters for switching and storage applications in computer and logic circuitry.

CIRCLE 131 ON READER SERVICE CARD

## MOLDED PULSE TRANSFORMERS

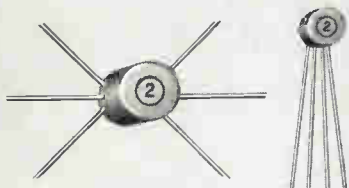

Miniature Pulse Transformers with tough molded cases for increased protection against physical damage and severe atmospheric conditions.

CIRCLE 132 ON READER SERVICE CARD

## NANOSECOND PULSE TRANSFORMERS IN TO-5 TRANSISTOR CASES

Special design offers distinct advantages: (1) Mini-fied size. (2) Welded hermetic seal. (3) Increased reliability. (4) Compatibility with transistor mounting techniques.



CIRCLE 133 ON READER SERVICE CARD

## SOMETHING NEW IN COUNTING TECHNIQUES

Simple yet versatile, low-cost yet reliable counters available for predetermined (2 to 11) or selectable (5 through 10) counting cycles.



CIRCLE 134 ON READER SERVICE CARD

## DYNACOR® BOBBIN CORES



Series "300" Cores with logical flux values in popular physical sizes are stocked in production quantities for fast delivery. They're value engineered for quality with economy!

CIRCLE 136 ON READER SERVICE CARD

## HERMETICALLY-SEALED TO-5 ENCASED SWITCH CORES

Designed especially for high-speed, low-power switching up to 100 kc, adaptability with conventional transistor packaging techniques, and performance under MIL-S-21038 environmental conditions.



CIRCLE 135 ON READER SERVICE CARD

## ELECTRONIC MODULES TO CUSTOMER REQUIREMENTS



Custom packaging is no novelty at Sprague's Special Products Division, where "specials" are continually being developed and produced with countless variations in electrical characteristics and mechanical configurations.

CIRCLE 137 ON READER SERVICE CARD

For application engineering assistance (without obligation, of course) on any of the above products, write or call the Special Products Division, Sprague Electric Company, 233 Union Street, North Adams, Massachusetts.

45SP-111-63

**SPRAGUE®**  
THE MARK OF RELIABILITY

\*Sprague and  are registered trademarks of the Sprague Electric Co.

## New Pulse Transformer Assortment Facilitates "Bread-Board" Designs



The 100Z41 Pulse Transformer Assortment offers the circuit designer a versatile selection of miniature pre-molded pulse transformers. Developed by the Sprague Electric Company, this experimental assortment is suitable for a wide range of requirements and designs in either electron-tube or transistorized circuitry.

### Provides 58 Combinations

This assortment contains 12 specially-selected type 32Z miniature pulse transformers which permit 58 turns-ratio and primary inductance combinations. With proper choice of terminal windings and connections, these transformers provide primary inductances ranging from 160 microhenries to 43 millihenries, and turns-ratios from 1:5 step-up to 6:1 step-down.

### Permits Frequent Re-Use

The potted, pre-molded case construction of these pulse transformers facilitates bread-board wiring and permits frequent re-use.

The assortment is packaged in a clear, hinged-lid plastic case, complete with simple instructions. A printed table inside the lid indicates all turns-ratios, inductances, windings, and connections.

### Specific Designs Available

When the required transformer characteristics are determined, production quantities to exact requirements can be easily obtained from Sprague's broad line of hermetically sealed or encapsulated pulse transformers.

For fast delivery or additional information on the 100Z41 Pulse Transformer Assortment, contact the nearest Sprague Products Co. Industrial Distributor, or write Sprague Electric Company, 233 Marshall Street, North Adams, Massachusetts.

45-470

Circle 138 on Inquiry Card



# AS WE GO TO PRESS

## TV CAMERA TUBE BOOSTS TELESCOPE POWER 100 TIMES

Northwestern University scientists have found a new way to record the minute amounts of light reaching earth from planets and distant stars.

By attaching an image orthicon tube to an 18½ in. refracting telescope they increased the telescope's light-gathering power 100 times.

Reporting in *Applied Optics*, they said such a device could see a strong flare sent up by astronauts on the moon, or track satellites and space vehicles going to the moon and planets.

## LOW-POWER RECEIVER USES PHASE-LOCKED DEMODULATION

A space tracking communications receiver, which uses a phase-locked demodulation system to save power, has been developed by Autonetics Div., North American Aviation, Anaheim, Calif.

The demodulation system decreases the threshold signal-to-noise ratio. It has a 10 MC tracking frequency range with a -30 dbm input signal.

The receiver's high operating frequency, 16,000 GC, allows an incoming signal to be directed in a reduced beam. This permits smaller broadcasting and receiving antennas.

Telemetered data, voice or TV can be received using about one-half to one-fourth normal power.

## COLOR TELEVISION ON BLACK AND WHITE SETS

The General Television Corp., Ferndale, Mich., disclosed a new process that shows color on black and white TV sets.

The process—patent pending—depends on alternating fields of black and white that cause mild color tints to show up on monochromatic CRTs.

John Maher, general manager, reports that the vague but noticeable hues can be produced only through a special video tape. No regular equipment, from the TV transmitter to the viewer's set, is altered in any way.

Called "Telehue," the process produces 15% low-saturation tints of red, blue, green and yellow around perimeters of outline letters and line drawings. The viewer cannot turn the colors off without blacking out the whole screen.

Mr. Maher says he does not expect the process to invade or interfere with the color TV market. It is "only a secondary process and good for simple advertising and promotion."

## GSA OPENS NATIONAL GOVT. COMMUNICATIONS NET

A unified nationwide communications network to serve civilian agencies of the Federal Government has been put into action by the General Services Admin.

Called the Federal Telecommunications System, the leased network connects activities in 43 cities. It is composed of telephone, high-speed data and facsimile transmission equipment.

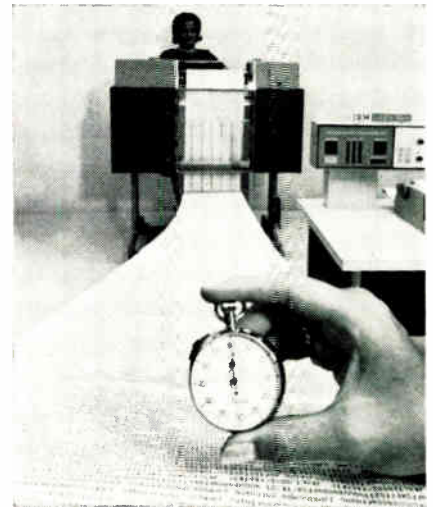

Photo shows 1460's 1,100 line/min. output.

## 1,100 LINE/MIN. PRINTER FEATURE OF NEW COMPUTER

International Business Machines Corp. has introduced a new computer, the 1460, with a 1,100 line per min. printer—nearly twice as fast as any printer previously produced by the company.

The 1460's printer is an advanced model of the 1403 Mod. II printer, previously the fastest, which prints alphameric data at 600 lines per min. The 1460 printer can also be used with the IBM 1410 and 7010 systems.

The computer costs more than IBM's standard 1401 and less than the 1410, largest computer in the 1400 series. The 1460 processes information internally almost twice as fast as the 1401 and can use the same programming systems.

## RECENT ASTIA CONFERENCE HIGHLIGHTS



Wiring a mechanized sorter to retrieve scientific data is shown to radiobiology experts at conference at Armed Forces Technical Information Agency, Arlington, Va. Conference was to inform experts about

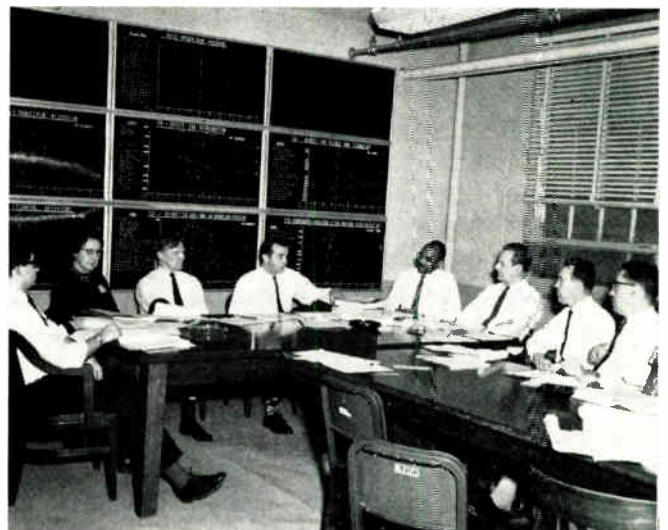

1-hour information retrieval program DOD has started in their field. At right, ASTIA holds symposium on developing specialized vocabulary for similar program that DOD has initiated in semiconductor field.



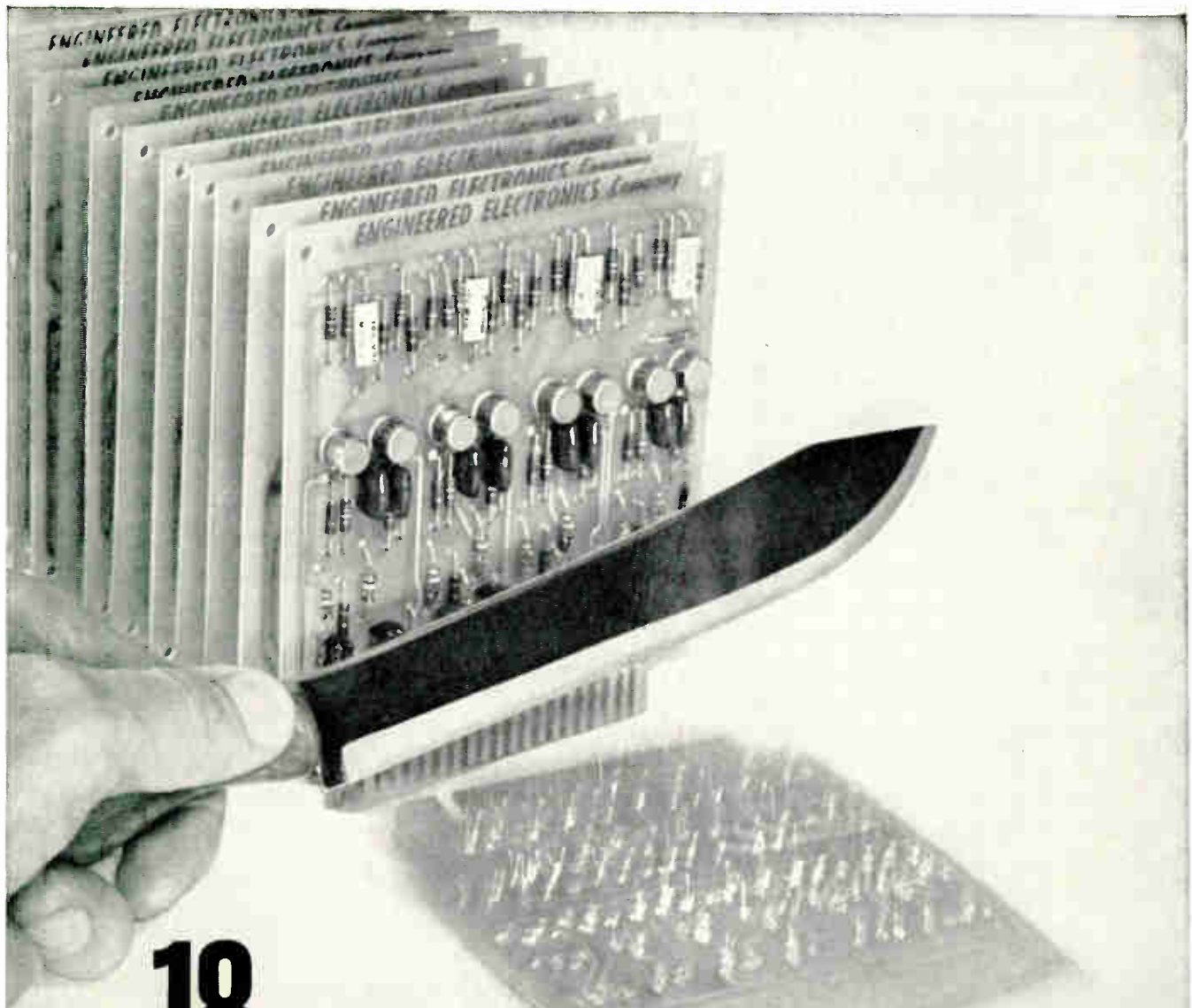

# 18 NEW SILICON MODULES FROM EECO

125°C circuits in 1 Mc and 10 Mc versions

1 Mc Series	10 Mc Series	Circuits Available
U-501	U-701	Triple 4-input NOR circuit
U-502	U-702	Eight driver circuits
U-503	U-703	Dual flip-flops
U-504	U-704	Multivibrator and three drivers
U-505	U-705	Three one-shots
U-506	U-706	Two exclusive-OR (NAND) circuits
U-507	U-707	Two exclusive-OR (NOR) circuits
U-508	U-708	Full adder
U-509	U-709	Three 4-input-OR circuits

The ability of all 18 modules in this new silicon family to exceed the searing demands of MIL-E-5400F, Class II, for temperature typifies their excellent performance in general.

Superior materials and special packaging techniques make these circuit cards your logical answer to *any* problem in high temperatures or reliability. Designs are based on derated specifications for the components used, and the resulting specifications are then further derated to give you reliability in reserve. Should any module ever fail to perform according to specs under the terms of the company's warranty, it will be repaired or replaced free.

Standard, conservative loading specifications and the availability of compatible hardware make it easy for you to determine your design requirements. Write, wire or phone today for free technical literature or a call from one of our applications engineers.

Power required: +12VDC, -12VDC.

Logic levels: 0 and +6VDC, nominal.

Card dimensions: 4½" x 5" x ¼".

Contacts: Two sides rhodium-plated with beveled edges for insertion into standard 22-pin etched circuit board connectors. (Special contacts also available.)

Construction: Glass-epoxy etched circuit card with funnel eyelets.



**ENGINEERED ELECTRONICS Company**

1441 East Chestnut Avenue, Santa Ana, California  
Telephone 547-5651 • Cable Address: ENGELEX

# COMING EVENTS

...in the electronic industry

## APRIL

- April 14-19: Spring Mtg., Electrochemical Soc.; Penn-Sheraton Hotel, Pittsburgh, Pa.
- Apr. 16-17: 1963 Ohio Valley Instrument-Automation-Electronics Exh. & Symp., ISA, SESA; Cincinnati Gardens, Cincinnati, Ohio
- Apr. 16-18: 10th Cleveland Electronics Conf., IEEE, ISA, Cleveland Physics Soc., Case Inst. Tech., Western Reserve Univ.; Sheraton - Cleveland Hotel, Cleveland, Ohio
- Apr. 16-18: "Optical Masers," 13th Annual Int'l. Symp. of Brooklyn Polytechnic Inst., Microwave Res. Inst., Brooklyn Polytechnic Inst., IEEE, OSA, U. S. Defense Research Agencies; United Eng. Ctr., New York, N. Y.
- Apr. 17-19: Mtg., Philco 2,000 Users Grp.; Antlers Hotel, Colo. Springs, Colo.
- Apr. 17-19: 15th Annual Southwestern IEEE Conf. & Electronics Show; Dallas Mem. Audit., Dallas, Tex.
- Apr. 17-19: 1963 Tech. Mtg. & Eqpt. Exp., Inst. Env. Sci.; Statler-Hilton Hotel, Los Angeles, Calif.
- Apr. 17-19: 1st Int'l. Conf. on Non-linear Magnetics, IEEE (PGEC, PGIE); Shoreham Hotel, Washington, D. C.
- Apr. 18: "Plastics for Electronics," Tech. Conf., SPE; Syracuse Univ., Syracuse, N. Y.
- Apr. 19-20: AMS Mtg., Chicago, Ill.
- Apr. 20: Mtg., Missouri, Arkansas Sec., ASEE; Washington Univ., St. Louis, Mo.
- Apr. 21-24: 2nd Annual 3-Day Seminar, Ass'n. of Electronic Parts & Eqpt. Mfrs., Univ. of Ill.; Monticello, Ill.
- Apr. 21-26: 93rd SMPTE Conv. & Eqpt. Exh.; Traymore Hotel, Atlantic City, N. J.
- Apr. 22-23: Maintenance & Plant Eng. Conf., ASME; Indianapolis, Ind.
- Apr. 22-23: Mtg., APS; Sheraton-Park Hotel, Washington, D. C.
- Apr. 22-24: 2nd AIAA/NASA Manned Space Flight Mtg.; Marriott Motor Hotel, Dallas, Tex.
- Apr. 22-24: 3rd Annual San Diego Symp. for Biomedical Eng., IEEE; Del Webb's Oceanhouse, San Diego, Calif.
- Apr. 22-25: Nat'l. Packaging Exp., AMA; McCormick Place, Chicago, Ill.
- Apr. 22-26: 44th Annual Tech. Mtg. & Welding Exp., AWS; Sheraton Hotel, Trade & Conv. Ctr., Philadelphia, Penna.
- Apr. 23-25: 11th Nat'l. Conf. on Electromagnetic Relays, NARM, Okla. St. Univ.; Student Union Bldg., Okla. St. Univ., Stillwater, Okla.
- Apr. 23-25: Hypersonic Ramjet Conf., IEEE, ASME; Naval Ordnance Laboratory, White Oak, Md.

- Apr. 24-26: Power Ind. Computer Application Conf., IEEE; Westward-Ho Hotel, Phoenix, Ariz.
- Apr. 24-26: IEEE 6th Reg. Tech. Conf.; San Diego, Calif.
- Apr. 24-26: Cellular Plastics Tech. Conf. & Div. Mtg., SPI; New York Hilton Hotel, New York, N. Y.
- Apr. 24-26: IEEE Southeast-South Central Dist. Mtg.; John Marshall Hotel, Richmond, Va.
- Apr. 25: "New Trends in Vinyl Plastics in Def. & Ind.," SPE; Cherry Hill Inn, Haddonfield, N. J.
- Apr. 25-26: Railroad Conf., ASME, IEEE; Biltmore Hotel, Atlanta, Ga.
- Apr. 25-26: Nat'l. Conv., Soc. Amer. Value Engrs.; Americana Hotel, New York, N. Y.
- Apr. 25-26: Mtg., Southeastern Sec., ASEE; Ga. Inst. Tech., Atlanta, Ga.
- Apr. 26-27: AMS Mtg.; New Mexico St. Univ., Univ. Park, N. Mex.
- Apr. 26-27: Mtg., Pacific Northwest Sec., ASEE; Oregon St. Univ., Corvallis, Ore.

## '63 Highlights

- ICEAS, Int'l. Conf. & Exh. on Aerospace Support, Aug. 4-9, IEEE, ASME; Sheraton - Park Hotel, Washington, D. C.
- WESCON, Western Electronic Show and Conf., Aug. 20-23, IEEE, WEMA; Cow Palace, San Francisco, Calif.
- NEC, National Electronics Conf., Oct. 28-30, IEEE, McCormick Place, Chicago, Ill.
- NEREM, Northeast Research and Eng. Mtg., Nov. 4-6, IEEE; Boston, Mass.
- Apr. 26-27 Mtg. Allegheny Sec., ASEE; Univ. of W. Va., Morgantown, W. Va.
- Apr. 26-28: New England Div. Conv., ARRL; Swampscott, Mass.
- Apr. 27: Mtg., Rocky Mountain Sec., ASEE; Univ. of Utah, Salt Lake City, Utah
- Apr. 28-May 2: 65th Annual Mtg., ACS; Penn-Sheraton Hotel, Pittsburgh, Pa.
- Apr. 29-30: Electro-Nuclear Conf., IEEE; Richland, Wash.
- Apr. 29-May 1: 9th Nat'l. Analysis Instrumentation Symp. & Exh., ISA; Rice Hotel, Houston, Tex.
- Apr. 29-May 2: 1963 Spring URSI-IEEE Mtg.; Nat'l. Academy of Sciences, Washington, D. C.
- Apr. 29-May 3: Annual Conf., SPSE, Army Res. Ofc.; Ambassador Hotel, Atlantic City, N. J.
- Apr. 29-May 3: AMS Mtg.; New York, N. Y.

## MAY

- May 1-3: IEEE Great Lakes Dist. Mtg.; Blackhawk Hotel, Davenport, Ia.
- May 1-3: Nat'l. Mtg., Amer. Assoc. for

- Contamination Control; Statler-Hilton Hotel, Boston, Mass.
- May 1-9: 3rd Nat'l. Conf. on the Peaceful Uses of Space, Armour Res. Found.; Ill. Tech. Inst., Chicago, Ill.
- May 2-3: 4th Nat'l. Symp. on Human Factors in Electronics, IEEE (PGHFE); Marriott-Twin Bridges Motel, Washington, D. C.
- May 6: Mtg., Mid-Atlantic Sec., ASEE; Lafayette Col., Easton, Pa.
- May 6-7: 1963 Packaging Tech. Conf., IEEE Packaging Ind. Subcommittee; Kellogg Ctr., Mich. St. Univ., E. Lansing, Mich.
- May 6-8: Aerospace Reliability & Maintainability Conf., AIAA, SAE, ASME; Marriott Motor Hotel, Washington, D. C.
- May 6-9: 9th Nat'l. Aerospace Instrumentation Symp., ISA; Jack Tar Hotel, San Francisco, Calif.
- May 7-9: Production Eng. Conf., ASME; Netherland-Hilton Hotel, Cincinnati, Ohio

## "CALL FOR PAPERS"

10th Nat'l. Symp. on Reliability and Quality Control, Jan. 7-9, 1964, Statler-Hilton Hotel, Washington, D. C. The title of the paper, an 800-word abstract and a brief biographical sketch of the author(s) must be submitted by May 15, 1963. Send ten copies of each to: Dr. L. S. Gephart, Lockheed Missiles & Space Co., Dept. 64-01, Building 104, Sunnyvale, Calif.

1963 Fall Joint Computer Conf., Nov. 12-14, 1963, Las Vegas Convention Ctr., Las Vegas, Nev. Papers are encouraged in the areas of system organization, computer hardware, applications, and programming. Promising new developments should be emphasized. A complete manuscript, plus 300-word abstract, should be submitted by June 3, 1963. Send three copies to: Mr. Paul M. Davies, Technical Program Chairman, Abacus, Inc., 1718 21st St., Santa Monica, Calif.

## ENGINEERING EDUCATION

Short courses of interest to engineers.  
Computer Research

The 10th Annual Symp. on Computers and Data Processing held by Denver Research Inst., Univ. of Denver (Colo.) will be June 26-27, 1963, at (continued on page 15)

# Bendix "Leaf"\* Silicon Transistor

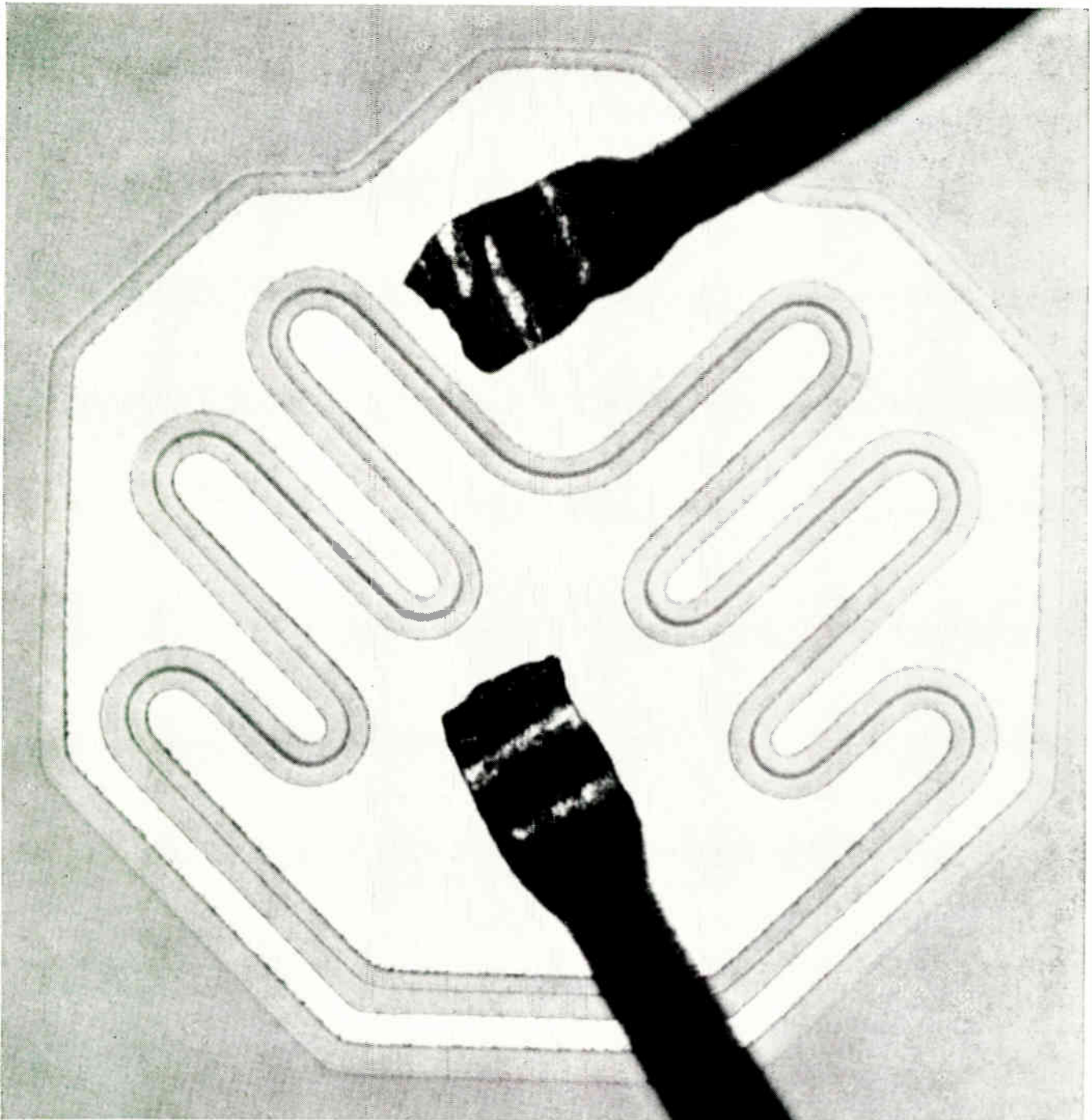

\*Patent applied for.

Magnified 265 times—actual size .025".

## BENDIX SILICON PLANAR EPITAXIAL TRANSISTORS OFFER THESE ADVANTAGES:

MECHANICAL	ELECTRICAL
"Leaf" Configuration Larger Emitter Area Larger Emitter Periphery Larger Bonding Area TO-5 and TO-18 Packages	Lower Saturation Voltage Higher Gain Improved Beta Linearity Higher Reliability 81 Types

Write us in Holmdel, New Jersey

## Bendix Semiconductor Division

HOLMDEL, NEW JERSEY





## COMING EVENTS

(continued from page 13)

Elkhorn Lodge, Estes Park, Colo. Sessions to cover components, logic design, computer design philosophy, and artificial intelligence. For more information, contact: W. H. Eichelberger, Denver Research Institute, Univ. of Denver, Denver 10, Colo.

### Electronic Welding

Courses in electronic welding are being offered by *Vacuum Tube Products Div., Hughes Aircraft Co.*, at its Oceanside, Calif., plant. Week-long courses for management, engineering and technical personnel are taught at various times during the year. One course, "Electronic Welding Engineering," for production managers and engineers, will be held *April 29-May 3, 1963*. A more advanced course for engineers, "Welded Electronic Packaging," is set for *May 6-10, 1963*. For details, write: Hughes Welders, 2020 Short St., Oceanside, Calif.

### HOLMES, GARDNER TO SPEAK AT COMPONENTS CONFERENCE

Addresses by D. Brainerd Holmes, NASA's Director of Manned Space Flights, and Dr. James H. Gardner, Deputy Director of Defense Research & Engineering, will highlight the 1963 Electrical Components Conference, to be held May 7-9 at the International Inn, Washington, D. C.

The Components Conference is sponsored by the IEEE and EIA, with the ASQC participating.

### OVER 100 PAPERS SCHEDULED FOR 1963 SJCC

Papers by over 100 U. S. and overseas engineers will be presented at 10 day-through-evening sessions, plus three panel-discussion forums, at the 3-day Spring Joint Computer Conference, which begins May 21 in Detroit's Cobo Hall.

Broad advances in computer technology will be covered in 38 of the papers. The conference will be accompanied by an exhibit of computer components, accessories, complete units and systems valued at over \$12.5 million.

The SJCC is sponsored by the American Federation of Information Processing Societies—a group composed of the IEEE, ACM and Simulation Councils, Inc.



The 164

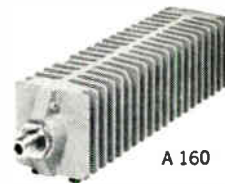

A 160



"made-to-measure precision"

**How to  
twist the power  
in a 50Ω line  
around your finger  
(and live!)**

Wrap your fingers around the selector knob on a Sierra 164 Bi-Directional Power Monitor, and you're ready to measure power flowing either way in the line. Twist the knob, and you see reflected; twist again, and you're reading incident. The knob, in your gentle fingertip grasp, takes the sweat and swearing out of switching. To us, that's really living.

A 164 has other qualities that help add sparkle to life afield, or in the lab. With just 9 easy-to-calibrate plug-in elements, it covers one of the widest dynamic ranges around: 1 to 1,000 watts and 2 to 1,000 MC. At 7½ lbs., the case with handy carrying strap practically floats off the end of your arm. And when you mate it to a Sierra Series 160 Coaxial Load, you've got a termination wattmeter that's the living end.

The 164 Power Monitor costs \$110, complete with Type N connector and a sunny smile from your Sierra sales representative. The smile is optional. So are matching Type UHF, C, LC, HN, BNC, or TNC connectors. Even before you buy, you're entitled to a bulletin that gives full information in a spirit of sobriety. Write us for it, or contact your nearest Sierra representative.

SIERRA ELECTRONIC DIV.

OF  
**PHILCO**

A SUBSIDIARY OF *Ford Motor Company*

Sierra Electronic Division/3885 Bohannon Drive/Menlo Park 2, California

NEWS FROM  
BELL TELEPHONE LABORATORIES

## New high-purity alloys make better electron tubes



Ingot of high-purity nickel alloy is removed from controlled atmosphere melting furnace. Alloy is virtually free of impurities which inhibit electron emission. The new alloying technique and the methods for making cathodes and evaluating their electron-emitting properties were developed by K. M. Olsen and H. E. Kern.

Scientists at Bell Telephone Laboratories have developed new high-purity nickel alloys which are proving highly effective in lengthening the life of advanced-design electron tubes used in the Bell System. This development meets the demand of new electronic technology for long life and high reliability in electron tubes.

One of the new alloys is now providing the outstanding performance required in the electron-emitting cathode of the traveling wave tube in the Telstar satellite.

The first step was to devise new means for the fabrication of ultra-pure nickel to eliminate those impurities harmful to cathode performance. It was then possible to add to the ultra-pure nickel the alloy constituents and activating agents desired for optimum cathode performance, and at the same time to hold the undesirable impurities at levels below 50 parts per million. These techniques involved purifying the nickel raw materials and melting, alloying and casting in controlled atmospheres of hydrogen and helium.

This development is an example of how metallurgical scientists work to improve communications. The new nickel alloys are now being produced by the Western Electric Company, manufacturing unit of the Bell System.



## Bell Telephone Laboratories

World center of communications research and development



**NOW**  
**from AE**  
**Class E quality**  
**with plug-in**  
**convenience**  
**and economy**

Take one Class E relay with taper tabs... add a mating socket and a clear plastic cover. The result... a telephone quality relay with all the convenience of octal-type plug mounting... that saves you \$1.93 or more per relay! And, the EIN's modern, low silhouette design improves the appearance of your manufactured equipment and cuts space requirements up to 20%. Simplified fabrication is possible, too, through the use of standard taper tab receptacles for socket terminations. (Terminals may be soldered in the usual way if desired.)

Consider another outstanding EIN benefit... because sockets, relays and covers are sold as separate items, you may buy only the sockets and mount and wire them into your chassis. Then, order the relays and covers and insert them to complete the assembly. There is no need to maintain large inventories of parts until you need them.

And, EIN relays with many of the most-used spring combinations are available "off-the-shelf" for immediate delivery.

In two money saving areas... initial cost and versatility... the EIN provides an excellent solution to your problems of purchasing, delivery, mounting, assembly, maintenance and environmental protection.

For additional information, address your request to: Director, Control Equipment Sales, Automatic Electric, Northlake, Ill.

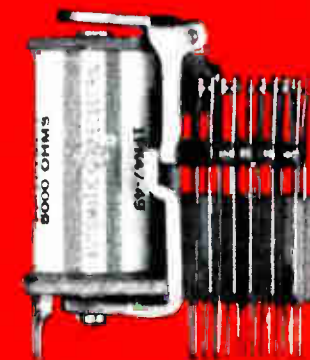

### TECHNICAL SUMMARY

- OPERATING VOLTAGE**—Up to 220 volts, d.c. or a.c.
- RELAY LIFE**—100- to 200-million operations, depending on application.
- OPERATE TIME**—Range, 0.005 to 0.050 sec. max.
- RELEASE TIME**—Range, 0.005 to 0.150 sec. max.
- CONTACTS**—Twin, Code 0-18 ga. (palladium-silver) make or break 135 watts (max. 3 amps., non-inductive load). Large, single contacts available for heavy duty application.
- CONTACT SPRING CAPACITY**—Maximum of 12 springs per pile-up.
- COILS**—Single-wound, available with resistance up to 10,000 ohms. Double-wound coils can be furnished on special orders.
- SOCKET TERMINALS**—Accommodate AMP Series 78 taper tab receptacle, or may be soldered.
- DIMENSIONS**—(Including cover): Up to 4 Form C contact springs, 1<sup>2</sup>/<sub>4</sub>" x 1<sup>4</sup>/<sub>64</sub>" x 2<sup>5</sup>/<sub>8</sub>"; up to 8 Form C contact springs, 1<sup>2</sup>/<sub>4</sub>" x 2<sup>1</sup>/<sub>64</sub>" x 2<sup>5</sup>/<sub>8</sub>". (Socket terminals extend 3<sup>8</sup>" below mounting surface.)
- SPECIAL MOUNTING**—If additional protection against "shake-out" is necessary, any of four methods employing hold-down screws (supplied) or optional banana plugs\* may be used. Ask for AE's Product News on EIN relay for mounting details.
- SPECIAL FEATURES**—Available as magnetically latched relay.

\*Optional at slight additional cost; banana plugs secure relays against reasonable shock and vibration while retaining quick plug-in and removal feature.

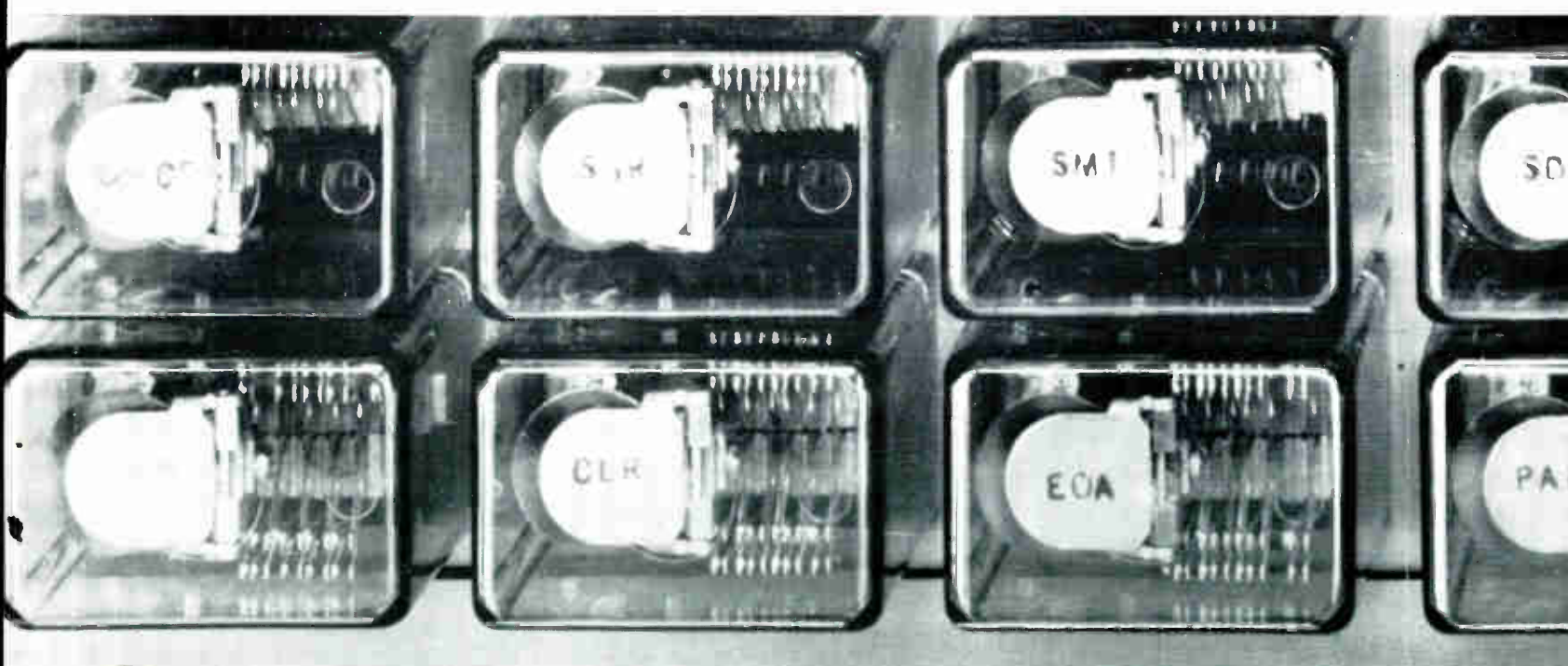





**NEW**  
**SERIES EIN**  
**RELAY**

(you'll be seeing lots of them)

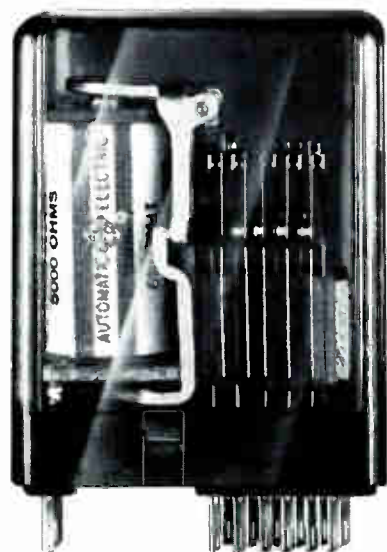

**PLASTIC COVER**  
**INTEGRAL SOCKET**  
**ECONOMY**  
**OFF-THE-SHELF DELIVERY**  
**AND IT'S FROM**  
**AUTOMATIC ELECTRIC**

**HOW TO ORDER**

The Class E taper tab relay, socket and cover which make up a Series EIN relay must be ordered as three separate items. Sockets RS-18 and RS-19 and plastic cover RV-49 fit Class E taper tab relays with up to 4C spring combinations, while sockets RS-20 and RS-21 and plastic cover RV-50 fit relays with up to 8C spring combina-

tions. For example, an order for an RS-30 taper tab relay should be accompanied by an order for either an RS-18 or RS-19 socket and an RV-49 plastic cover. Optional banana plug mounting (mentioned elsewhere) available @ 25¢ per relay. Specify catalog number TT-36.



TT-36  
(two supplied)

**TAPER TAB CLASS E RELAYS, D.C. TO MAKE SERIES EIN RELAY**

Cat. No.	Spring Comb	Coil Ohms	Min Volt	Max Volt	Min Amps.	NET PRICE (EACH)		
						1 9	10-19	20 +
RS-22	2C	1300	17	75	.013	\$ 7.98	\$5.70	\$4.56
RS-23	4C	60	4.5	15	.075	9.56	6.83	5.46
RS-24	4C	150	8	26	.054	9.56	6.83	5.46
RS-25	4C	300	11	36	.037	9.81	7.01	5.61
RS-26	4C	500	15	45	.030	9.81	7.01	5.61
RS-27	4C	1300	26	62	.020	10.26	7.33	5.86
RS-28	4C	4000	64	140	.016	10.26	7.33	5.86
RS-29	4C	8000	57	160	.0070	10.78	7.70	6.16
RS-30	4C	10000	68	200	.0068	10.78	7.70	6.16
RS-31	8C	20	4	9	.020	12.84	9.17	7.34
RS-32	8C	90	8.4	18	.093	12.95	9.25	7.40
RS-33	8C	200	14	31	.070	13.20	9.43	7.54
RS-34	8C	300	17	34	.056	13.20	9.43	7.54
RS-35	8C	1000	30	62	.030	13.65	9.75	7.80
RS-36	8C	4000	57.2	130	.014	13.65	9.75	7.80
RS-37	8C	5000	64	140	.014	14.17	10.12	8.10
RS-38	8C	8000	80	180	.010	14.17	10.12	8.10

**TAPER TAB CLASS E RELAYS, A.C. TO MAKE SERIES EIN RELAY**

Cat. No.	Spring Combination	Coil Ohms	Nominal Voltage	NET PRICE (EACH)		
				1-9	10-19	20 +
RS-39	2C	550	110 v. a.c.	\$ 8.20	\$5.86	\$4.69
RS-40	4C	550	110 v. a.c.	10.49	7.49	5.99

**SOCKETS**

**COVERS**

Cat. No.	Plating Material	NET PRICE (EACH)			Dimensions	FOR RELAYS WITH:	Cat. No.	NET PRICE (EACH)		
		1 9	10 19	20 +				1 9	10-19	20 +
RS-18	Cadmium	\$1.19	\$ .85	\$ .68	1 5/16" x 1 1/16" x 1/2"	◀ 2C and 4C Comb. ▶	RV-49	\$ .42	\$ .30	\$ .24
RS-19	Gold	1.40	1.00	.80						
RS-20	Cadmium	1.47	1.05	.84	1 1/16" x 2" x 1/2"	◀ 8C Comb. ▶	RV-50	.49	.35	.28
RS-21	Gold	1.89	1.35	1.08						

All items available from stock. Prices are subject to change without notice.

Custom Assemblies engineered to your specifications are also available.

Home Office—Northlake, Ill., 345-7111  
Salesmen in principal cities. See the yellow pages, under "Relays".

**AUTOMATIC ELECTRIC**  
Subsidiary of  
**GENERAL TELEPHONE & ELECTRONICS**



# VOA

***smashing the truth through the iron curtain***



■ In the continuing cold war between West and East, one of the more powerful weapons the United States has is the around-the-clock broadcasts of news and commentary by the U. S. Information Agency. Heard in 36 languages, this broadcast operation known as the Voice of America is virtually the only means of getting the truth to millions behind the Iron and Bamboo Curtains. Attesting to the success of the USIA program is the fact that the Communists use some 2,000 transmitters in an effort to block out free world broadcasts.

■ To maintain and strengthen the Voice of America, the world's largest transmitting facility is now beaming programs overseas from Greenville, North Carolina. Building this facility

was a joint effort by Continental Electronics Systems, Inc., and Alpha of Texas Inc., subsidiary of Collins Radio Co., with Continental responsible for the electronic aspects of the project. ■ The Consolidated East Coast Facilities are at three sites totalling 6,000 acres of cleared timber land. Two transmitter sites and the receiving sites are 18 miles apart. Each of the transmitting sites has three 500,000 watt short wave transmitters supplied by Continental Electronics Manufacturing Company. Other transmitters include: Three 250,000 watt transmitters, three 50,000 watt and two 5,000 watt transmitters, for a combined total transmitting power of 4.82 million watts.

## *Continental Electronics*

SYSTEMS, INC. MAILING ADDRESS: BOX 17040 • DALLAS 17, TEXAS • EV 1-7161  
4212 SOUTH BUCKNER BLVD. *LTV* SUBSIDIARY OF LING-TEMCO-VOUGHT, INC.  
*Designers and Builders of the World's Most Powerful Radio Transmitters*



Circle 7 on Inquiry Card  
World Radio History



This is the micropower transistor—a new silicon epitaxial planar device that offers higher efficiency at microwatts or milliwatts. As a switch, or as an amplifier, the type 2N2784 offers capabilities beyond any now available! Typical: 1 KMC bandwidth—higher beta level at

microamperes, with reduced falloff beyond 10 milliamperes.

This performance stems from advanced device design and refined photolithographic techniques plus Sylvania's exclusive skills in epitaxial technology. Unusually small

## Fastest silicon switch available: new

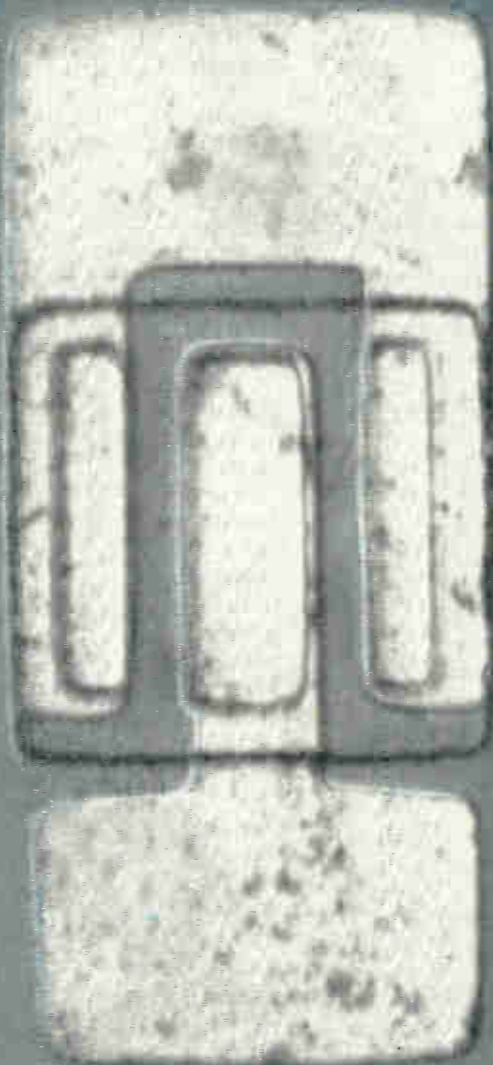

Epitaxial construction, new 3-stripe configuration, and small size, produce new high switching speed ( $T_{on} + T_{off} = 12$  nanoseconds) with low saturation voltages (typically 0.2 volts).



junction sizes and spacings, low capacitances, result in improved frequency response for both switching and amplifier applications.

The Sylvania 2N2784 and the 2N709 and 2N709A, which are members of the 2N2784 family, are all avail-

able in the TO-18 package. The 2N709 and 2N709A will also be made available in TO-51 co-planar and TO-46 packages.

For more information, write to Semiconductor Division, Sylvania Electric Products Inc., Box 87, Buffalo, N. Y.

# 1 KMC Sylvania epitaxial planar transistor

SYMBOL	CHARACTERISTICS	2N2784		2N709		2N709A		TEST CONDITIONS	
		Min	Max	Min	Max	Min	Max		
$h_{FE}$	DC Current Gain	40	120	20	120	30	90	$I_C=10mA$	$V_{CE}=0.5V$
$h_{FE}$	DC Current Gain	15		15		15		$I_C=30mA$	$V_{CE}=1.0V$
$h_{FE} (-55^\circ C)$	DC Current Gain	10		10		10		$I_C=10mA$	$V_{CE}=0.5V$
$V_{BE} (sat)$	Base Saturation Voltage	.70	.85 V	.70	.85 V	.70	.85 V	$I_C=3.0mA$	$I_B=0.15mA$
$V_{CE} (sat)$	Collector Saturation Voltage		.26 V		.30 V		.30 V	$I_C=3.0mA$	$I_B=0.15mA$
$C_{ob}$	Output Capacitance		3.0 pf		3.0 pf		3.0 pf	$I_E=0$	$V_{CB}=5.0V$
$C_{TE}$	Emitter Transition Capacitance		2.0 pf		2.0 pf		2.0 pf	$I_C=0$	$V_{EB}=0.5V$
$I_{cbo}$	Collector Cutoff Current		5 $\mu A$		50 $\mu A$		5 $\mu A$	$I_E=0$	$V_{CB}=5.0V$
$I_{cbo} (150^\circ C)$	Collector Cutoff Current		5.0 $\mu A$		5.0 $\mu A$		5.0 $\mu A$	$I_E=0$	$V_{CB}=5.0V$
$BV_{cbo}$	Collector to Base Break-down Voltage	15	V	15	V	15	V	$I_C=10\mu A$	$I_E=0$
$V_{CE0} (sust)$	Collector to Emitter Sustaining Voltage	6.0	V	6.0	V	6.0	V	$I_C=10mA$	$I_B=0$
								(pulsed)	
$BV_{EBO}$	Emitter to Base Break-down Voltage	4.0	V	4.0	V	4.0	V	$I_C=0$	$I_E=10\mu A$
$T_s$	Charge Storage Time Constant		5.0 ns		6.0 ns		6.0 ns	$I_C=I_{B1}=I_{B2}=5.0mA$	
$t_d + t_r$	Turn-on Time							$I_C=10mA$	$I_{B1}=2mA$
	( $V_{BE(0)}=-1.0V$ )		9 ns		15 ns		15 ns	$I_C=10mA$	$I_{B1}=I_{B2}=1.0mA$
$t_s + t_f$	Turn-off Time		9 ns		15 ns		15 ns	$I_C=10mA$	$V_{CE}=4.0V$
$f_T$	Gain-Bandwidth Product	1000	mc	600	mc	800	mc	$I_C=5.0mA$	

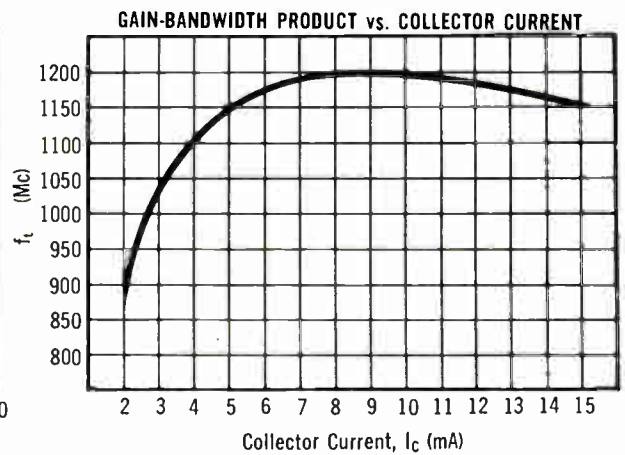
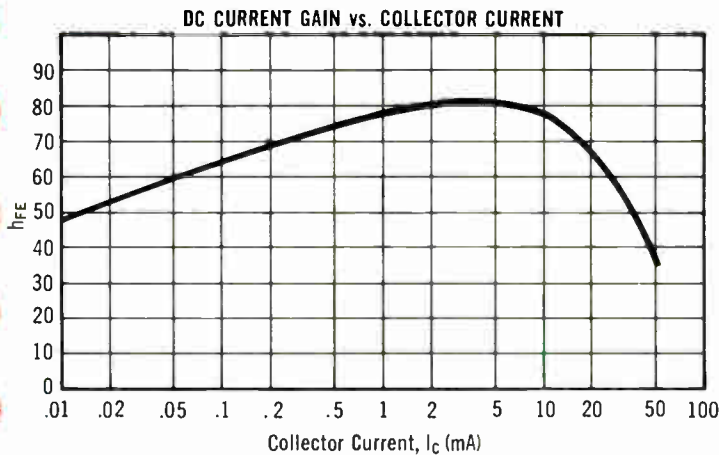

# SYLVANIA

SUBSIDIARY OF  
**GENERAL TELEPHONE & ELECTRONICS**



NEW CAPABILITIES IN: ELECTRONIC TUBES • SEMICONDUCTORS  
MICROWAVE DEVICES • SPECIAL COMPONENTS • DISPLAY DEVICES

Circle 12 on Inquiry Card

# NEWS BRIEFS

Capsule summaries of important happenings in affairs of equipment and component manufacturers

## EAST

**ELECTRONICS, INC.**, Warren, Pa., has formed an **INT'L DIV.** to promote and service foreign sales. The division will be based in New York.

**AVNET ELECTRONICS CORP.**, New York, N. Y. will acquire the **FAIRMONT MOTOR PRODUCTS CO., INC.**, Philadelphia, Pa., and its two affiliated enterprises for \$4 million in cash.

**INTERNATIONAL TELEPHONE & TELEGRAPH CORP.** has formed the **ITT ELECTRON TUBE DIV.** A unit of the division will be in a new \$3.5 million plant planned near Easton, Pa. The 25,000 sq. ft. facility will be for making special purpose tubes and will also contain research facilities.

**SBD SYSTEMS, INC.**, has moved power supply engineering and production operations into new and larger plant facilities in Farmingdale, L. I., N. Y.

**BIDDLE-GRAY CORP.**, Plymouth Meeting, Pa., has acquired the **GRAY INSTRUMENT CO.**, Philadelphia, Pa. Both firms stem from the Queen Co., a Phila. instrument manufacturer from 1853 until the turn of the century.

**RCA SERVICE CO.**, Cherry Hill, N. J. has received a \$3.7 million contract from NASA's Manned Spacecraft Ctr., Houston, Tex. to design, make, install and test a solar simulation system to test the Apollo spacecraft.

**GENERAL RADIO CO.**, W. Concord, Mass., will construct a 75,000 sq. ft. plant in Bolton, Mass., this year. It will be used to design and make signal generators and microwave equipment.

**U. S. SONICS, INC.**, acoustic materials R&D company, has acquired a mile square lake with 40 ft. depth near Bolton, Mass. The firm is now building a floating laboratory to develop ASW devices for the Navy and commercial underwater sensing devices.

**PHILCO CORP.'S COMPUTER DIV.**, Philadelphia, Pa., has delivered a large-scale 211 computer system to the EDP Ctr. of **AERONUTRONIC DIV.**, **FORD MOTOR CO.**, Newport Beach, Calif. Philco, a Ford subsidiary, installed a similar system for the parent company in Dearborn, Mich., last month.

**DYNAMICS CORP. OF AMERICA**, New York, N. Y., aerospace and communications systems and equipment firm, will acquire **INT'L ELECTRONIC RESEARCH CORP.**, Burbank, Calif., instrument and component manufacturer, in an exchange-of-stock transaction.

**SANDERS ASSOC., INC.**, Nashua, N. H., is building a 50,000 sq. ft., 2-story plant in Bedford, Mass., to accommodate R&D and manufacturing operations for its missile-electronics weapons systems.

## MID-WEST

**DALE ELECTRONICS, INC.**, Columbus, Neb., has opened its third production facility there. The new 41,120 sq. ft. building will be used to produce both precision and trimmer potentiometers.

**LOCKHEED MISSILES & SPACE CO.**, Sunnyvale, Calif., has begun building an R&D Ctr. in the Industrial Res. Park in Huntsville, Ala. **NORTHROP CORP.**, **IBM** and **THOMPSON-RAMOWOOLDRIDGE** either plan or are constructing R&D facilities in this location.

**MONSANTO CHEMICAL CO.** is expanding its electronic chemicals plant at St. Charles, Mo. The multi-million dollar expansion will include enlarging present float-zone, polycrystalline and Czochralski silicon production facilities and associated evaluation laboratories.

**STANDARD KOLLSMAN INDUSTRIES, INC.**, Melrose Park, Ill., has acquired the **GRIGSBY CO., INC.**, Arlington Hts., Ill., electronic switch manufacturer. The firm will be operated as a division of SKI.

**MINN. MINING & MFG. CO.**, St. Paul, Minn., has formed an **INSTRUMENT DEPT.** The department, located in Hawthorne, Calif., near Los Angeles, will produce digital instruments for measurement and control of electronic processes.

**CONTROL DATA CORP.**, Minneapolis, Minn., computer manufacturer, has formed a new subsidiary, **MEISCON CORP.**, in Chicago, Ill. The new firm is built around a nucleus of engineers and mathematicians formerly employed by a now bankrupt firm, **MEISSNER ENGINEERS, INC.**

Two former Midwestern divisions of **PACIFIC INDUSTRIES, INC.**, San Francisco, Calif., both of which produced quartz crystals and crystal filters, have been merged. They are **MIDLAND MFG. CO.**, Kansas City, Kans., and **WRIGHT ELECTRONICS CO.**, Kansas City, Mo.

**CENTRALAB ELECTRONICS DIV.**, **GLOBE UNION, INC.**, Milwaukee, Wis., will build a 40,000 sq. ft. plant at Lafayette, Ind., to make electronic components. The facility, to be located in McClure Industrial Park, will cost \$500,000.

**TRION INSTRUMENTS, INC.**, Ann Arbor, Mich., subsidiary of **LEAR SIEGLER, INC.**, Santa Monica, Calif., has been renamed the **LASER SYSTEMS CTR.** of LSI, in accordance with a Lear-Siegler policy of identifying company operations with their products and programs.

**SCIENTIFIC COMPUTERS, INC.**, Minneapolis, Minn., has acquired **COMPUTER LABORATORIES, INC.**, Houston, Tex., computer service firm, in an exchange-of-stock transaction. Computer Laboratories will continue operating in Houston as an SCI subsidiary. SCI's existing Houston computer center will be integrated into Computer Laboratories Center there.

**VALLEY MFG. CO.**, Valley, Neb., has completed a 25,000 sq. ft. addition to its tapered steel pole manufacturing facilities there.

## WEST

**PHILCO CORP.'S WESTERN DEVELOPMENT LABORATORIES**, Palo Alto, Calif., will be expanded in a \$14.7 million development program over the next two years. Most of the expenditures will be to equip a new environmental center. This will include a thermal vacuum chamber, electrodynamic vibrator system, high vacuum space chamber, sphere shock machine and data center.

**WESTERN OPERATION, SYLVANIA ELECTRONIC SYSTEMS, INC.**, will nearly triple its manufacturing space in Santa Cruz, Calif. The expansion will include a 48,000 sq. ft. systems manufacturing building, office building and additions to the present 32,000 sq. ft. structure.

**THE DEUTSCH CO.**, Los Angeles, Calif., is building a \$400,000 corporate headquarters on a 2½ acre site at the Los Angeles Int'l. Airport. The headquarters, to be occupied in June, will also be occupied by the Los Angeles Sales Office of **DEUTSCH ELECTRONIC COMPONENTS DIV.**, Banning, Calif.

**VARIAN ASSOC.**, Palo Alto, Calif., is building a \$1 million, 43,000 sq. ft. new structure in Palo Alto to house its central research facility. Equipment will include chemistry, electronic and physics laboratories, special equipment for radioactive trace studies, a large scientific computer, conference rooms and a library.

**TAMAR ELECTRONICS, INC.**, Los Angeles, Calif., has purchased **STODDART AIRCRAFT RADIO**,

also of Los Angeles for an undisclosed sum. The Stoddart firm had sales of about \$3.5 million in 1962.

**CONSOLIDATED AMERICAN SERVICES, INC.**, Hawthorne, Calif., supplier of nondestructive testing and nuclear decontamination services, has formed a new subsidiary, **CONSOLIDATED X-RAY, INC.**, in Tulsa, Okla. The subsidiary will supply radiographic inspection services for petroleum pipelines, gas transmission and gas utilities, and to petrochemical and chemical process plants.

**REMANCO, INC.**, Santa Monica, Calif., will merge with another microwave firm, **MICRO-RADIONICS, INC.**, Van Nuys, Calif. **ELECTRONICS CAPITAL CORP.**, San Diego, Calif., has invested \$1,750,000 to acquire a two-thirds interest in the combined firm, which will operate at the Micro-Radionics facilities.

**ULTRA-SONIC SYSTEMS, INC.**, Palo Alto, Calif., has been renamed the **DURASONICS DIV.** of **DURA-BOND BEARING CO.** Ultrasonic Systems was acquired by Durabond as a wholly owned subsidiary early in 1962.

**WATKINS-JOHNSON CO.**, Palo Alto, Calif., electronics firm, has acquired **STEWART ENGINEERING CO.**, Santa Cruz, Calif., in an exchange-of-stock transaction. The Santa Cruz firm makes backward-wave oscillators and controlled atmosphere furnaces used in making electron tubes.

**SCIENTIFIC DATA SYSTEMS** has awarded **ELECTRONIC MEMORIES, INC.**, Los Angeles, Calif. a contract for over \$250,000 worth of ferrite core memory stacks to be used in computers.

**HUGHES AIRCRAFT CO.'S ELECTRONICS DIV.** has reorganized its **PACKAGED ASSEMBLIES DEPT.** and changed its name to the **MODULAR CIRCUITS DEPT.** Other special semiconductor work besides that on modular circuits has been transferred to the **SEMICONDUCTOR DIV.**, **HUGHES COMPONENTS GRP.**

**X-ONICS CORP.**, San Diego, Calif., ultrasonic products manufacturer, has merged with **TRI-LAB ELECTRONICS**, a components firm. X-onics is also negotiating to acquire **LA JOLLA ELECTRONICS CORP.**

**VARO, INC.**, Garland, Tex., electronic concern, has acquired some of the assets of **U. S. INDUSTRIES ENGINEERED PRODUCTS DIV.**, Goleta, Calif. This division sold electromechanical products to the aerospace industry. Acquired assets, contracts, patents, copyrights and equipment, etc., will be taken over by Varo's **ELECTRO-KINETICS DIV.**, Santa Barbara, Calif.

**COMPUTER CONTROL CO.**, Los Angeles, Calif., has received a \$150,000 NASA contract for Ranger follow-on experiments. The contract is for design and construction of digital Data Conditioning Systems. These will sample instrument data and prepare it to send back to earth. Sampling rate, experiment timing and readout word lengths can be varied with the DCS stored program.

**UNIVAC DIV., SPERRY RAND CORP.**, has formed a Western Regional Defense Marketing Organization in Los Angeles, Calif. It will be at 5316 W. Imperial Highway.

**AMERICAN MICRO DEVICES, INC.**, has moved its **STANDARD RECTIFIER DIV.** from Santa Ana, Calif., to Phoenix, Ariz. An expansion of the firm's Phoenix facility has just been completed.

**BURR-BROWN RESEARCH CORP.**, Tucson, Ariz., transistorized instrument manufacturer, has moved into a new 10,000 sq. ft. facility there which doubles the capacity of its former plant.



## PVC-R

**UNIVERSAL DATA PROCESSING CORP.**, Los Angeles, Calif., has acquired **INTEGRATED BUSINESS PROCEDURES, INC.**, N. Hollywood, Calif.

**CONTINENTAL ELECTRONICS MFG. CO.**, sub of **LING-TEMCO-VOUGHT, INC.**, Dallas, Tex., has received contracts totaling \$872,000 from the U.S. Navy for the manufacture of 3 high power, low frequency fleet communications radio transmitters. Two of the 100k, PEP, CW, FSK, SSB AN/FRT-61 transmitter will be installed at the Navy Radio Center, Dixon, Calif. The third will be installed in Scotland.

**NORTHROP CORP., NORTHROP NORAIR**, Hawthorne, Calif., has received a \$434,000 U.S. Air Force contract to explore the use of exotic columbium and molybdenum metals for aerospace vehicles. Under contract to the Manufacturing Technology Laboratory of the USAF Aeronautical Systems Div., Norair will develop manufacturing methods and processes for joining columbium and molybdenum alloys into large, high-strength honeycomb sandwich panels.

**BENDIX CORP., BENDIX-PACIFIC DIV.**, N. Hollywood, Calif., has been awarded a contract in excess of \$1 million by the USAF for a sonar system to help missile tracking ships pinpoint the location of nose cones or instrument packages upon sea landings.

**TELECOMPUTING SERVICES, INC.**, subs. of **TELECOMPUTING CORP.**, has consolidated its data processing operation, in a building providing twice the floor space previously available to its California Div. and Los Angeles Data Center, at 8155 Van Nuys Blvd., Panorama City, Calif.

**AUTOMATIC SIGNAL DIV. OF LABORATORY FOR ELECTRONICS, INC.**, Norwalk, Conn., has received a contract from New York City, calling for delivery of radar surveillance equipment, to study traffic conditions on the Long Island Expressway.

**SPIROTECH CORP.**, has been recently formed and is now in production of precision wire-wound potentiometers. The main offices and plant for the new corporation are in Farmingdale, L. I., N. Y.

**KOLLSMAN INSTRUMENT CORP.**, Elmhurst, N. Y., has been selected by the U.S.A.F. as prime contractor for the AN/USQ-28 geodetic survey and photo mapping system for RC-135A jet aircraft. \$3,364,493 have been obligated of the total amount of the contract which has not been disclosed. The contract is expected to have a potential of about \$50 million.

**JANCO CORP.**, Burbank, Calif., maker of rotary and solenoid-operated switches, has completed a plant expansion. The expanded facilities at 3111 Winona Ave., Burbank, contain 30,000 sq. ft. and house executive offices, sales display room, engineering and drafting departments and production facilities.

**CENTURY GEOPHYSICAL CORP.**, Tulsa, Okla., has acquired **HULL INSTRUMENTS, INC.**, Pasadena, Calif., in an exchange-of-stock transaction. The acquired firm, including executive and technical personnel, will be absorbed by **CENTURY ELECTRONICS & INSTRUMENTS**, Tulsa subsidiary of GGC.

**RHO ENGINEERING**, component and power supply manufacturer, has relocated to more spacious headquarters at 2234 Calby Ave. in W. Los Angeles. The \$250,000 plant occupies 25,000 sq. ft. of floor space. New facilities have glassed-in areas for winding, calibrating, encapsulating (all temp. and humidity controlled), cycling and quality control. An R&D lab and maintenance machine shop are included.

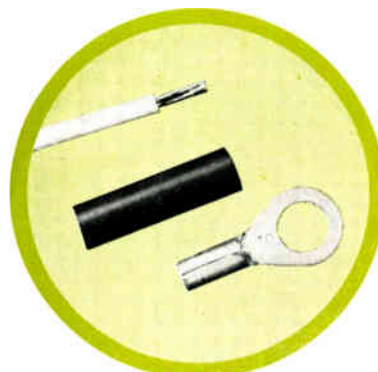

A SLIP ON SLEEVE

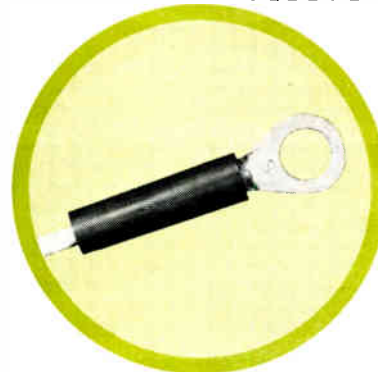

THAT CAN BE CRIMPED



THEN SHRUNK TO FIT

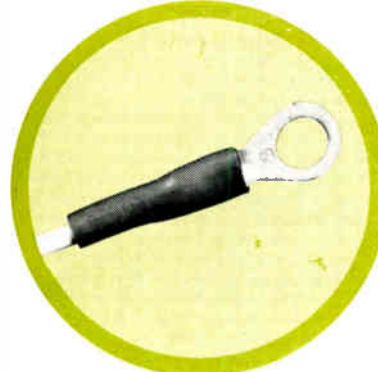

A SUBSIDIARY OF  
RAYCHEM  
CORPORATION

**RAYCLAD TUBES**  
INCORPORATED  
HIDALGO CITY, CALIFORNIA

**THERMOFIT**  
**PVC-R**  
SEMI-RIGID RADIATION  
CROSS LINKED HEAT SHRINKABLE  
POLYVINYLCHLORIDE TUBING

# PHILCO T2351 UHF/L-BAND TRANSISTOR

## IT'S AN AMPLIFIER . . .

8 db minimum power gain at 1 Gc  
12 db typical power gain at 1 Gc  
8 db typical noise figure at 1 Gc

Philco coaxial package, with electrically shielded base design, reduces feedback capacitance an order of magnitude compared with TO-18 versions.

## IT'S AN OSCILLATOR . . .

10 mw typical power output at 1 Gc.

## IT'S AN MADT\* . . .

Proven Philco MADT design in a new coaxial double-ended package. The new Philco package provides virtually complete isolation between input and output.



Actual Size

## IT'S AVAILABLE TODAY IN QUANTITY!

For immediate delivery, call your Philco Industrial Semiconductor Distributor, or your nearest COMPAR office. For complete data, write Dept. EI463S.

SPECIAL PRODUCTS OPERATION

# PHILCO®

A SUBSIDIARY OF *Ford Motor Company*

\*Micro Alloy Diffused-base Transistor

Circle 9 on Inquiry Card

LANSDALE DIVISION, LANSDALE, PA.  
IN EUROPE: Avenue de Beauregard 3, Fribourg, Switzerland

World Radio History





# MARKETING

## Facts and Figures Round-Up

### NUCLEAR POWER AND MARKET GROWTH

Atomic energy "industry," long considered a powerful mirage, has been critical of the AEC. Practically all peaceful and military uses and financing of atomic energy have been under the strong hand of the AEC. Now the mirage seems to be taking more definite form.

Dr. Glenn T. Seaborg, AEC chairman, told a Congressional committee that 1962-1963 will be a milestone in civilian nuclear power. Private utilities and manufacturers are considering five large nuclear projects to cost about \$500 million. They will generate a total output of 2,400 nuclear megawatts.

"Implications are clear," said Seaborg, "when those figures are held up to the estimated \$970 million for the 22 plants now under construction, with a collective output of 1,270 megawatts.

"In effect, the civilian nuclear program seems to have gone critical."

Many companies making electronic instruments for the industry also may be "going critical." This latest move in nuclear power offers potential growth and markets for electronic instrumentation. Items such as dosimeters and other detection devices would help that growth. Nuclear reactor controls and instrumentation directed at safety in handling materials would open another part of the market.

AEC's strong control over nuclear power can be laid to a creditable desire for employee safety on one hand, and a somewhat fearful desire for fool-proof controls on the other.

### MORE FIRMS USING EDP TO FORECAST SALES

A study by the National Industrial Conference Board of more than 200 firms shows that more companies, in increasing though still small numbers, are using computers to "crystal ball" sales trends. As the sales forecast is a key management tool, so the computer is a tool of sales forecasters. Ultimately, EDP planners foresee a rising tide of management and marketing uses of computers, far beyond the current and relatively limited uses of the instruments for clerical and accounting jobs.

### EDP MARKET WILL TOTAL OVER \$4 BILLION IN 1963

Total 1963 national expenditures for computer hardware and "software" are estimated at approximately \$4 billion. This figure was forecast by Harold A. Strickland, Jr., vice president and general manager of GE Industrial Electronics Division.

Computers are leading double lives in the industry. They represent a growing market for relatively high-priced and complex electronic circuitry. That same circuitry is now processing a small, but growing amount of managerial and marketing information, and some computers are processing such marketing data for the electronics companies that make computers.

According to Strickland, some 6,275 digital computers will be delivered in the U. S. in 1963 for data processing applications. Of these, 200 will go to the Federal Government, and about 6,075 to institutions, industry, banking and commerce. Their total value, including standard peripheral equipment, will approximate \$2.6 billion, and their

use, including "software," will involve an additional \$1.4 billion.

Looking ahead, John E. Johnson, vice president, RCA Automatic Data Processing, said that even if computer equipment is used for clerical automation alone, the total computers delivered would probably hit 40,000 by 1970. He noted that the EDP industry has already delivered some 10,000 systems in this country. He predicts that the computer population by 1970 could easily reach 75,000 for all applications.

Johnson's prediction is based on the "three-step evolution" of automation of specific clerical jobs, integrated data processing and use of computers for profit-making management.

By computer, RCA Electronic Tube Division has developed both long-range and short-range strategies for market planning, and has pinpointed certain sales in radio and black & white TV sets by EDP programming.

### MARKETING ACCENT SWITCHES TO SAVING

Although the DOD is the biggest buyer in electronics, the defense and aerospace marketing accent appears to have switched from selling to saving.

Budgets for the DOD have gone from \$51 billion for fiscal 1962 to \$53 billion for fiscal 1963. An estimated DOD budget of \$55.4 billion is forecast for fiscal 1964. And yet the industry question seems to be "what's being economized?"

General Dynamics Astronautics claims "savings on top of savings" in the move of the Azusa Mark I missile tracking system from Cape Canaveral to Grand Bahama Island. The move cost the Air Force \$887,820, more than 10% less than the contract price.

Martin Marietta, Orlando (Fla.) Division, accents results of its "Zero Defects Program."

It cites no defects in hardware or documentation for Pershing ground support sets and a 25% drop in overall plant rejects compared with 1961. It cites a 30% reduction in scrap costs, also compared to 1961.

Federal Aviation Agency, a government-civilian operation with defense interests, notes that Consolidated Air

Route Traffic Control Centers will fetch potential savings of "more than \$116 million in the next 16 years." Cooperative programs with the DOD, such as joint use of long-range radar, saved about \$9.5 million in capital improvement funds.

### NEW ELECTRONIC MARKETS

GE has an electronic timer with hermetically sealed relay. The unit can be operated for time interval or time delay, in four timing ranges.

Electronic goggles, part of an Air Force experiment, are designed to protect the wearer from the blinding flash of a nuclear blast. The principle includes automatic detection of light flashes to produce an output current pulse that will plate a lens. Researchers are working on other optical protective aids.

Electronic air cleaner, "aggressively marketed" by Minneapolis-Honeywell, "traps 70% to 95% of dirt and dust in homes." The firm withdrew from making and selling such cleaners for office and factory buildings. It is still making and selling its "new and improved residential model," which is installed in ductwork of a home heating and cooling system.

# Don't Confuse These Two

You Need HIGH STABILITY PORCELAIN CAPACITORS  
... for tuned circuits and r.f. applications

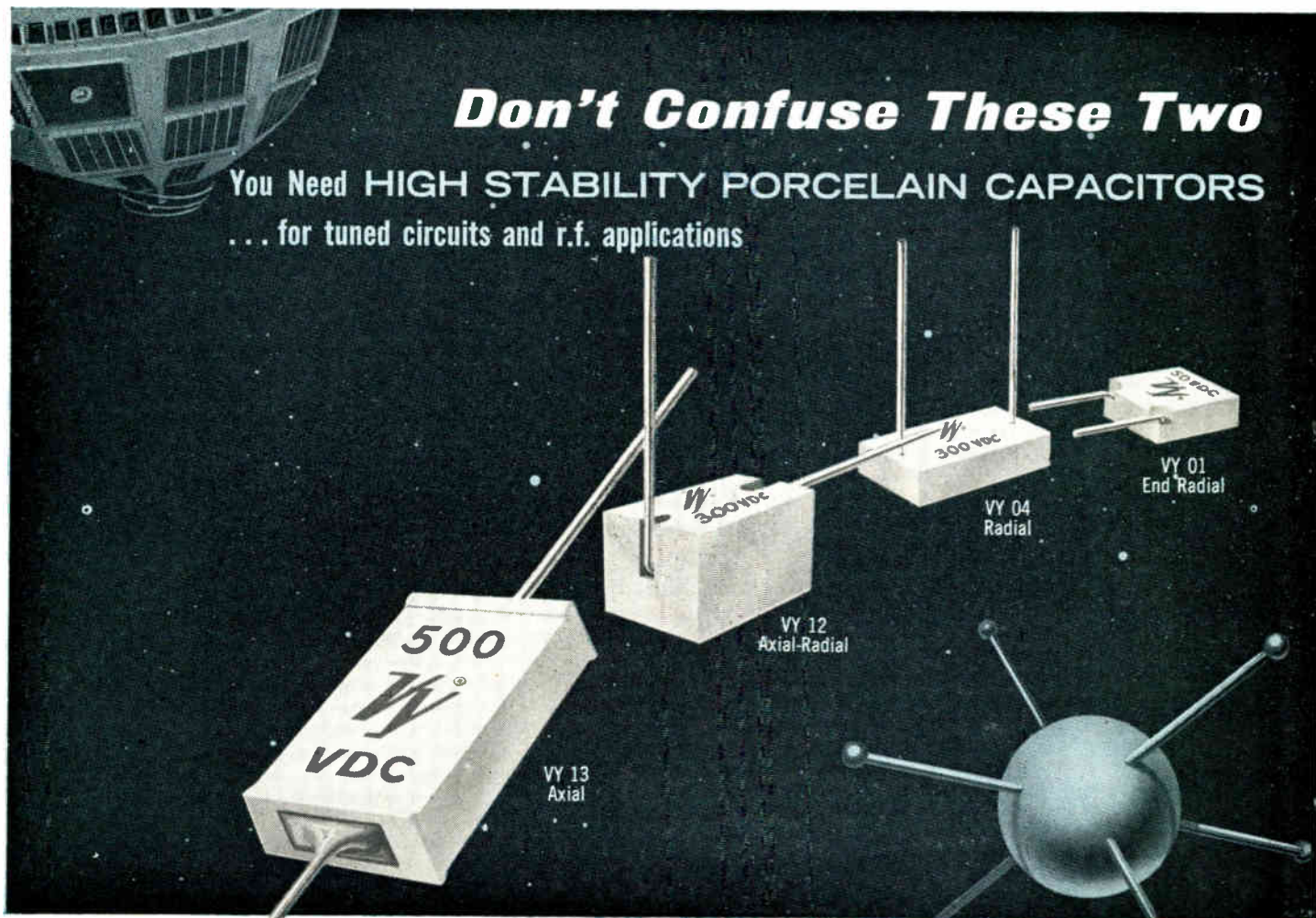

**solid state  
PORCELAIN  
CAPACITORS**

- \* low loss
- \* low noise
- \* greater stability
- \* wide temperature range
- \* impervious to humidity

- -55°C to 125°C operation
- 0.5 mmf to 6800 mmf
- 50 to 500 vdc

Conforms to  
MIL-C-11272B

The molecular fusing of an exclusive, dense dielectric material with fine silver electrodes gives "VY" Capacitors exceptional stability, long life, and unexcelled performance. Manufactured from high quality glass "frit", developed in the "Vitramon" research laboratories, "VY" Capacitors exhibit the following typical performance characteristics after an accelerated test of 10,000 hours at 125°C with 150% of rated voltage: Dissipation Factor .00203, Insulation Resistance  $10^{14}$ , Capacitance Drift 0.1 mmf. After 30,000 hours at 25°C and rated voltage, Dissipation Factor was .00072 and Insulation Resistance 100 ohm farads.

For High Reliability Application  
write for S-1002B.

**HIGH RELIABILITY ELECTRONIC COMPONENTS DESIGNED TO MEET THE**



# Quality Capacitors...

You Need these tiny GENERAL PURPOSE CERAMIC CAPACITORS  
... for coupling and by-pass applications

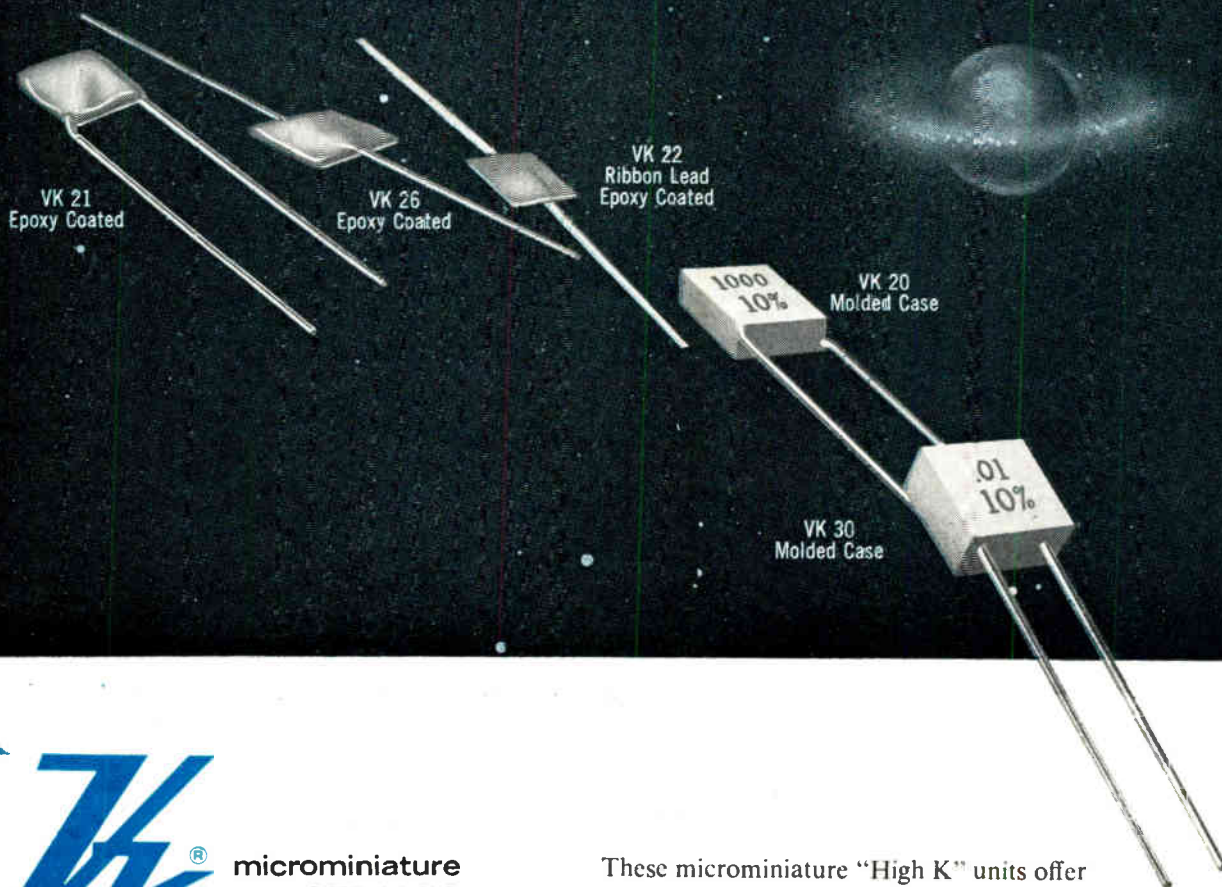

microminiature  
CERAMIC  
CAPACITORS

- -55°C to 150°C
- 10-10,000 mmf
- 200 vdc rating

Conforms to  
MIL-C-11015C 18A 19A  
CK05 and CK06

These microminiature "High K" units offer outstanding performance characteristics and a wide capacitance range. Dissipation Factor is 1.5% for values through 680 mmf and less than 2.5% for values from 820 mmf through 10,000 mmf. Temperature Coefficient is  $\pm 10\%$  for values through 680 mmf and  $\pm 15\%$  for values from 820 mmf to 10,000 mmf. Available with molded case and radial leads; epoxy coated with radial or axial leads; and epoxy coated with axial ribbon leads. MIL parts stocked in depth to meet your CK requirements.

**VITRAMON**  
INCORPORATED

Box 544 • Bridgeport 1, Conn.

For High Reliability Application  
write for S-1003.

**MOST RIGID REQUIREMENTS OF THE INDUSTRY**



# How Armco Thin Electrical Steels Help You Design Low-Cost, Efficient Apparatus for 400 Cps and Higher Frequencies

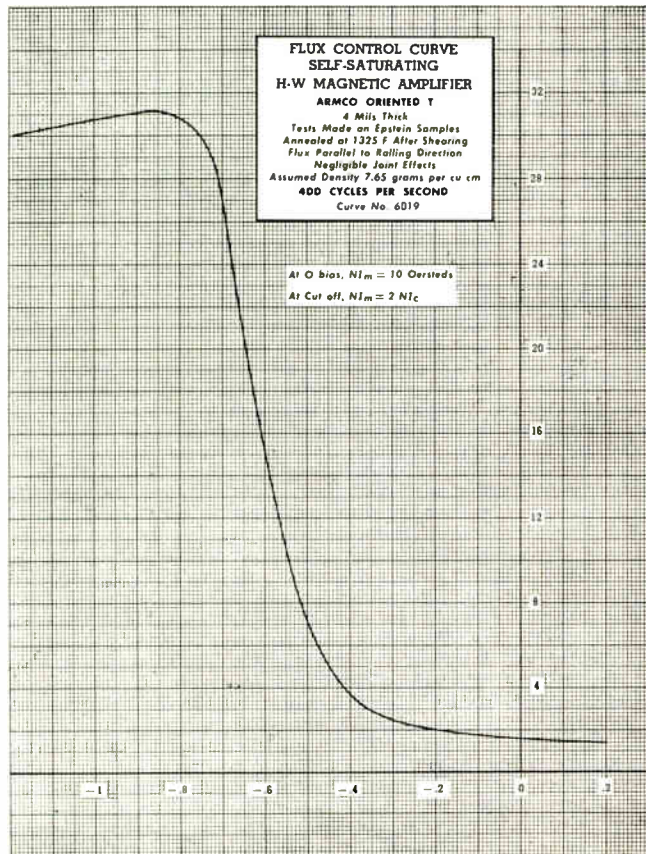

D-C Control Bias—Oersteds

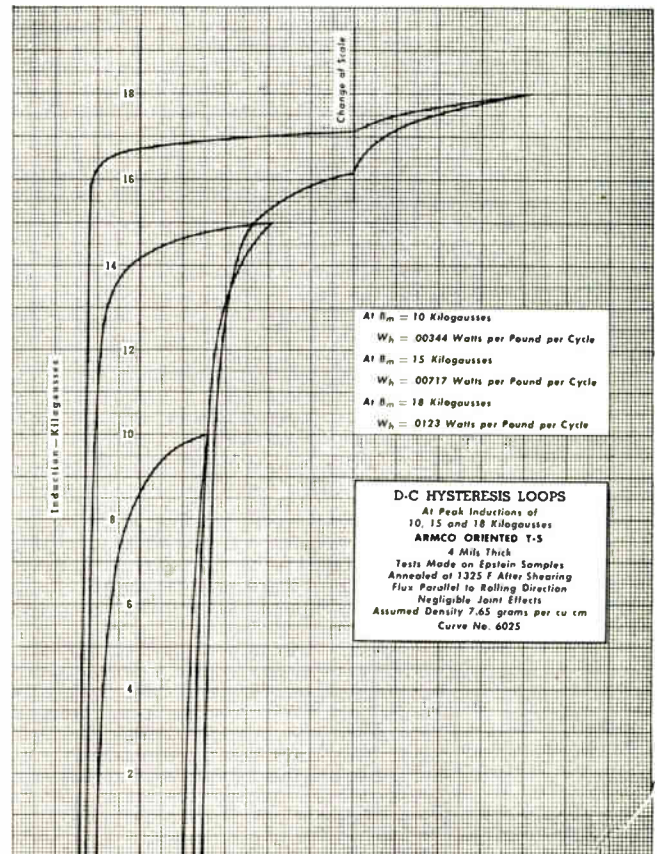

Magnetizing Force—Oersteds

Armco TRAN-COR T, Oriented T, and Oriented TS provide all the advantages of high quality, low-loss electrical steels plus a wide range of magnetic properties and thicknesses. You can design more precisely and produce reliable components at least cost.

Thin Armco Electrical Steels offer all these advantages:

- Exceptionally high permeability
- Low hysteresis loss
- Minimum interlaminar loss
- High lamination factors
- Properties fully developed at the mill
- Unexcelled uniformly high quality

Armco TRAN-COR T, a nonoriented grade, is produced in 7 and 5 mil thicknesses; Armco Oriented T in 6 to 1 mils; and Armco Oriented TS, a super-oriented grade, 4 mils thick.

Use the multiple advantages of Armco Thin Electrical Steels for radio and television transformers as well as magnetic amplifiers, reactors, pulse generators and other components that operate at 400 and higher cps. Write us for complete information, including design curves. **Armco Division, Armco Steel Corporation, Dept. A-383, P. O. Box 600, Middletown, Ohio.**



**Armco Division**

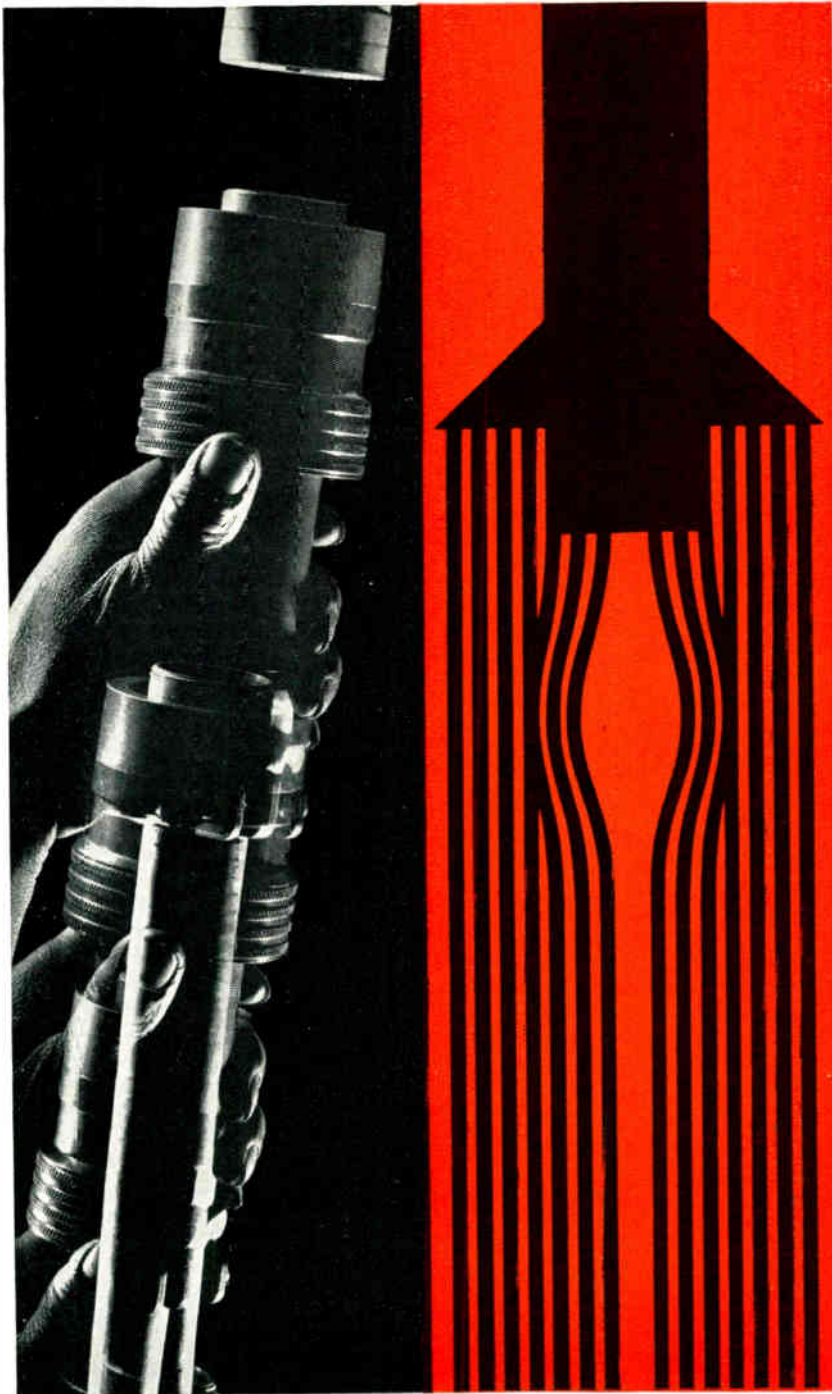

**"Q" IS FOR QUICK CONNECT AND QUICK DISCONNECT.** New Class "Q" field-indexable plugs and receptacles now extend the capabilities of Pyle-Star-Line®, Neptune Series, connectors. They have significantly facilitated coupling and uncoupling of cable networks for power, control, and communication circuits.

An axial "push" visibly and audibly engages, locks, and environmentally seals the connector. Conversely, an "axial" pull on the plug instantly disengages it from the receptacle.

Field indexing of Class "Q" connectors permits a single cable assembly, using either MOD I (captive contact) or MOD II (crimp removable contact) inserts, to dependably service as many as 16 key positions without mismatching. Spare cable assembly inventory is simplified since it can now be based solely on contact configuration and cable length requirements. The Class "Q" connectors are also available without the indexing feature.

These "push-pull" connectors have a commendable record for durability and reliability under the severe operating conditions of GSE equipment. Investigate how they can meet your performance requirements. Ask for the additional technical information contained in Bulletin No. 662.



CONNECTOR DIVISION, THE PYLE-NATIONAL COMPANY, 1334 NORTH KOSTNER AVENUE, CHICAGO 51, ILLINOIS  
ALSO MFG. IN CANADA BY: PYLE-NATIONAL (CANADA) LTD., CLARKSON, ONTARIO

# Pyle-National



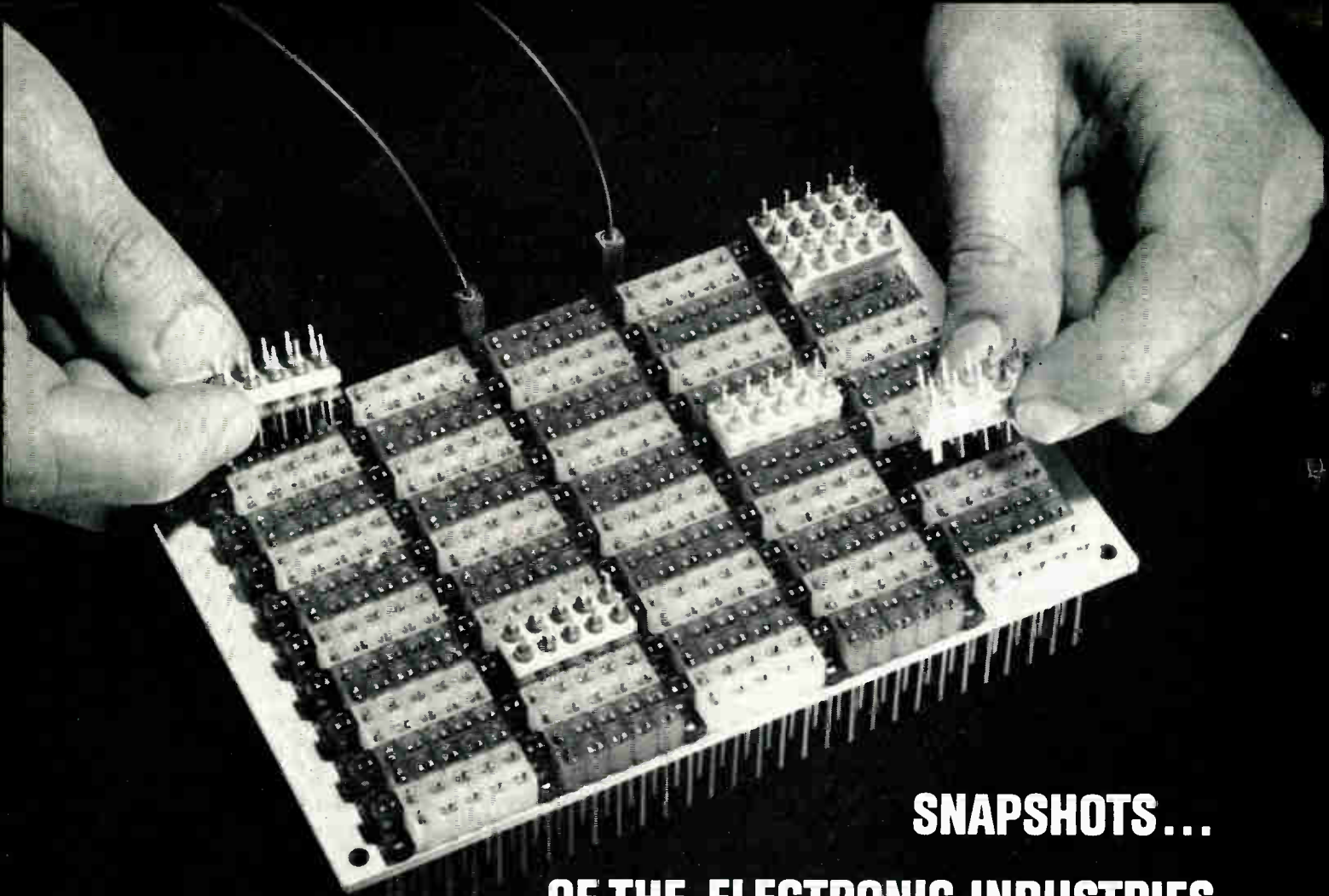

## SNAPSHOTS... OF THE ELECTRONIC INDUSTRIES

### U. S.—BRITISH PROJECT

Engineers (right) check solar paddles and antennas of a test model of the S-52 satellite which is being built in Baltimore, Md., by Westinghouse for NASA. Joint U. S.—British project will measure galactic "noise," the distribution of ozone in the atmosphere and the quantity and size of micrometeoroids in space.

### SUBMINIATURE

Ordinary book match gives an idea of the size of 50-position subminiature pin and socket connector made by AMP, Inc., Harrisburg, Pa. Match covers contact area which is 50% of the total.

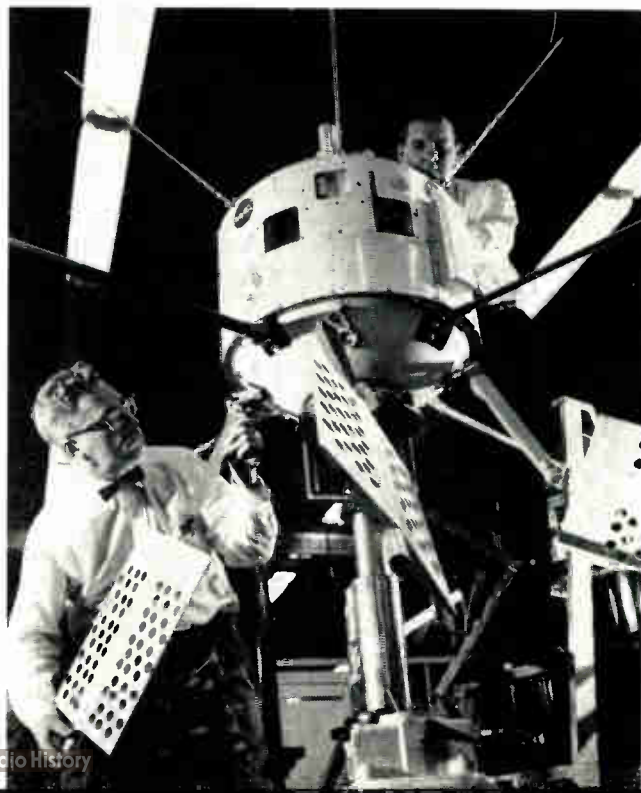



### "WASP" CONNECTORS

Wasp (for Wrapost Aluminum Systems Panel) diode board with module bases is made by Malco Manufacturing Co. of Chicago, Ill. The boards are made on an aluminum matrix and can be mounted to cabinet side rails to become a structural part of the whole package.

### HIGH-GAIN

Antenna for USAF being assembled (rt) at Radiation, Inc., Palm Bay, Fla., is part of a high-gain, wideband telemetry system of the elevation over azimuth type. It is designed with solid-state control systems for automatic acquisition and tracking, and position recording of targets providing electromagnetic waves.



### DELICATE OPERATION

Rotor balancing of Minuteman gyros is performed by technician at Honeywell's Aeronautical Div. in Minneapolis (below). It is one of the first production Minuteman gyros built by Honeywell under contract to the Autonetics Division of North American Aviation, Inc.

### SYNCOM TRACKER

USNS Kingsport (rt) is a seagoing satellite terminal for tracking and communications for NASA's Project Syncom. Ship's 30 ft. parabolic "dish" antenna is gyrostabilized on three axes, enabling it to keep accurately on target



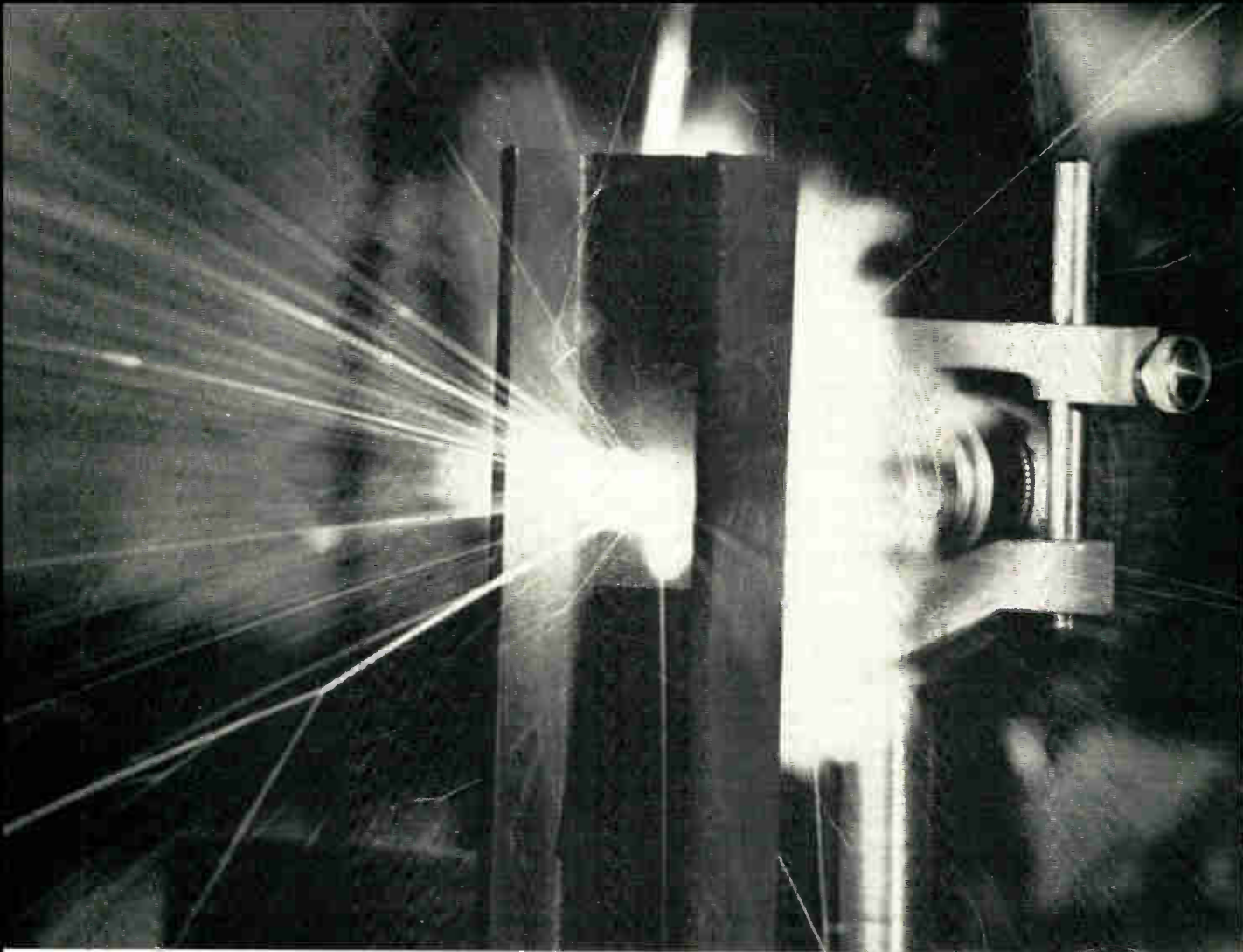

#### POWER TO BURN

Photograph shows powerful laser blasting through one quarter inch thick steel girder. The laser, known as the LHM-4 delivers 350

joules of energy. According to its developers, Raytheon Company, Lexington, Mass., it is the most powerful laser known to date.

### SNAPSHOTS . . . OF THE ELECTRONIC INDUSTRIES

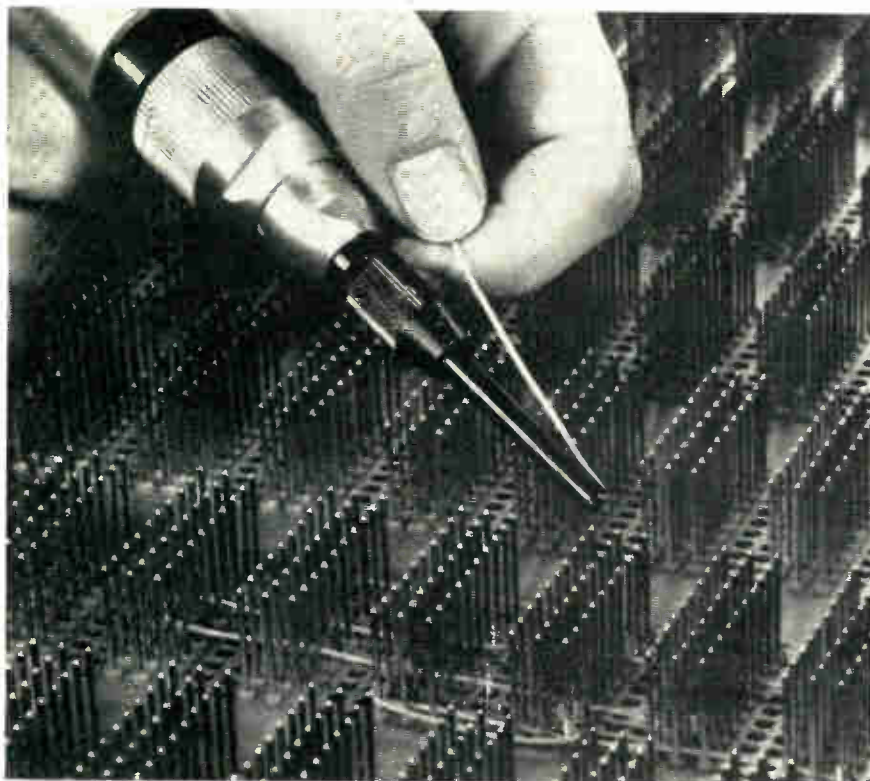

#### "WIRE-WRAP"

A solderless connection is about to be made to one of many terminals by a hand-held Wire-Wrap tool. These tools are made by Gardner-Denver Co., Quincy, Ill. More information about this method can be found in connector staff report in this month's issue.

#### MAMMOTH "MELONS"

Inflatable radomes seen here were designed for quick erection (30 min.) and used by troops in combat zones. They were developed by Goodyear Tire & Rubber Co., Akron, Ohio.







#### THIN-FILM CIRCUIT

Circuit is microscopically inspected for possible flaws in connection of leads which are thermo-compression bonded to the circuit. New General Electric facility at the company's Light Military Electronics Dept., Utica, N. Y., can turn out 1,000 such circuits per month.

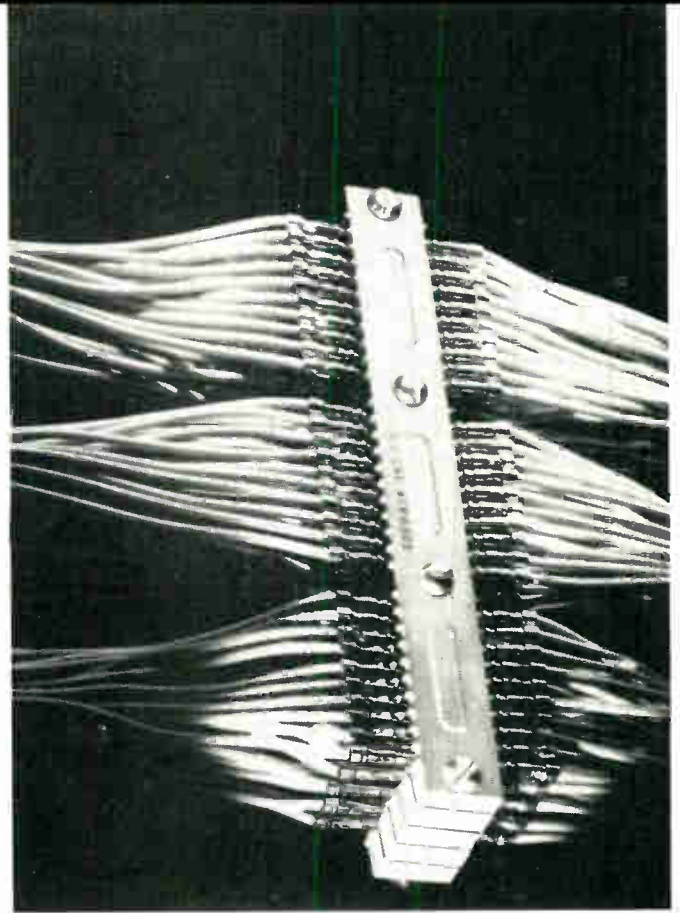

#### HIGH-DENSITY

High terminal density is provided by this taper pin connection system. The Thomas & Betts Co. (Elizabeth, N. J.), taper blocks are molded of diallyl phthalate. This molding material is used to avoid any possibility of block warping which might cause shorting of the pins.

#### CORONA

Photo shows Corona effect on a connector undergoing tests in the Test Laboratory of the Scintilla Division/The Bendix Corp., Sidney, N. Y. Engineers at Bendix have done extensive work on the problem of Corona (the visible deionization release of energy associated with electrical wiring. Corona is undesirable because it causes power loss and insulation damage, and is a source of high frequency radio interference. It can be avoided by increasing spacing of the wires, junctions or contacts or by decreasing the voltage as critical altitudes are approached. Air gaps may also be pressurized or eliminated entirely.

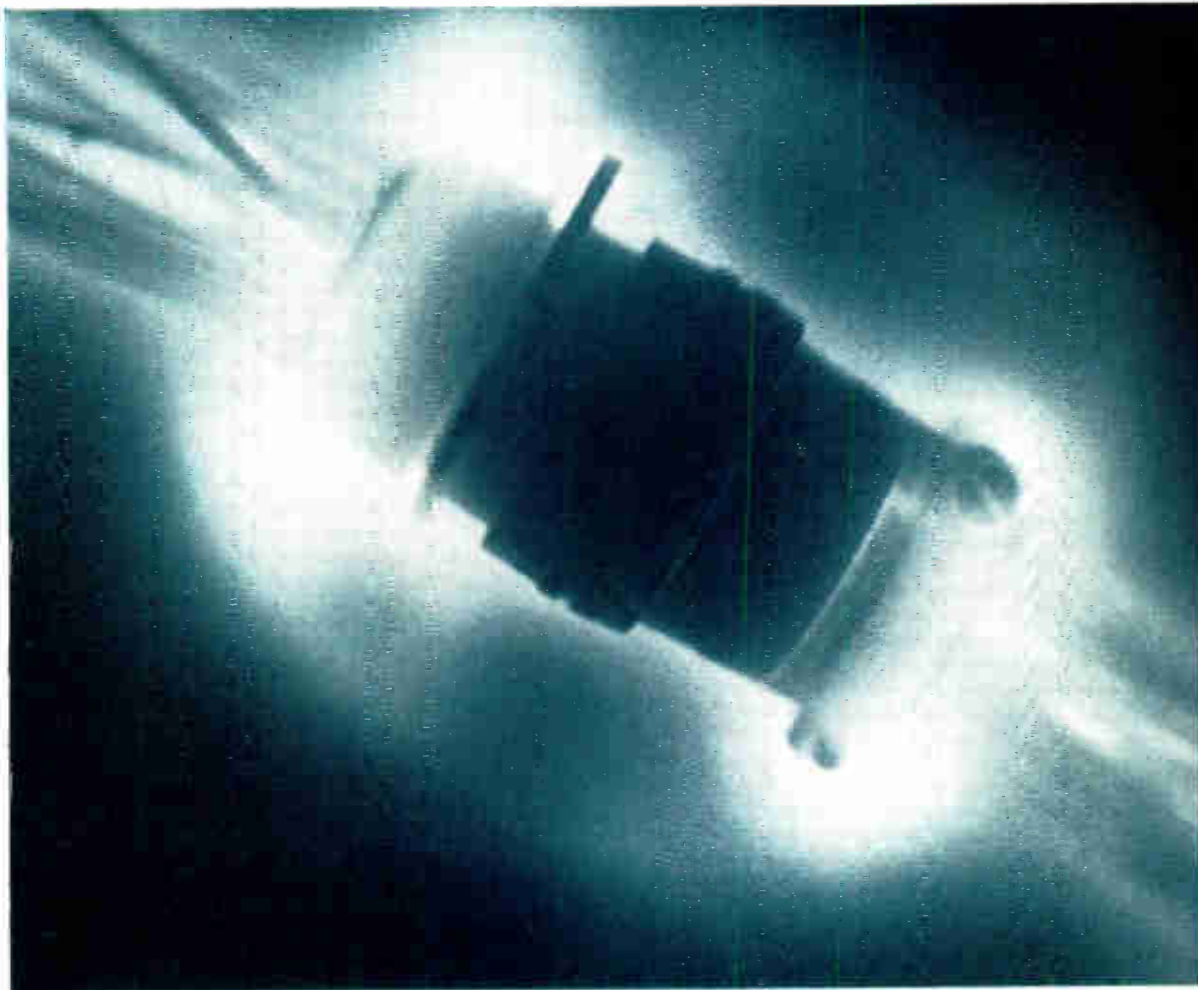





**all it takes  
is 5¢ width  
of panel space**



**to mount National's  
new miniature 5:1  
ball reduction drive**

If panel space is at a premium National's new line of 5:1 and 10:1 ball reduction drives will help solve your problem. There are 16 different styles, each with a variety of input and output shaft dimensions, all available "from stock" for immediate shipment. Taking as little as 5¢ width of panel space, these versatile new drives are designed to mount from either the front or rear of the panel. Minimum available output torque varies from 12 to 60 in. oz., depending on the type selected.

National has been manufacturing dials, drives and reduction mechanisms for nearly half a century. National carries in stock for immediate delivery the largest variety of standard and ball reduction drives, vernier and planetary dials, uncalibrated dials, precision drives, right angle drives and accessories available from any single source. Custom modification of standard components can be achieved quickly at low cost.

*Write today for complete specification sheets on dials, drives and mechanisms and on National's new miniature ball reduction drives.*



**NATIONAL RADIO COMPANY, INC.**

A Wholly Owned Subsidiary of National Company, Inc.

37 Washington Street, Melrose 76, Mass. Phone NORmandy 5-4800 TWX 617-665-5032.

Export: Ad Auriema Inc., 85 Broad St., N.Y.C. Canada: Len Finkler Ltd., 2 Tycos Drive, Toronto 19.

# when great names get together...

... something good is bound to happen... like this Roanwell headset-microphone created for ICBM missile launching complexes.

The specifications were tight... they had to be. At countdown, communications for up to 50 technicians must be loud and clear. Units must offer individual operation; be explosion-proof, compact, light and RELIABLE.

Difficult? Yes. Insoluble? No! Roanwell de-

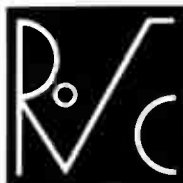

signed the system and called for Clarostat to provide the unit's volume control.

CLAROSTAT Series 48 POTPOT® encapsulated potentiometers are the singular solution. Extremely reliable, POTPOTS are sealed to eliminate explosion hazards and maintain operational characteristics when subjected to such corrosives as liquid oxygen. All have "O" ring shaft and mounting seals. All are available in a variety of resistance, tolerance and function configurations. All are designed to do the job... and then some. POTPOTS are the obvious choice of a great name manufacturer who can't compromise with quality.

Roanwell Corporation wanted—and got—the finest... Clarostat. If you're a great name (or would like to be one) contact Clarostat... today.

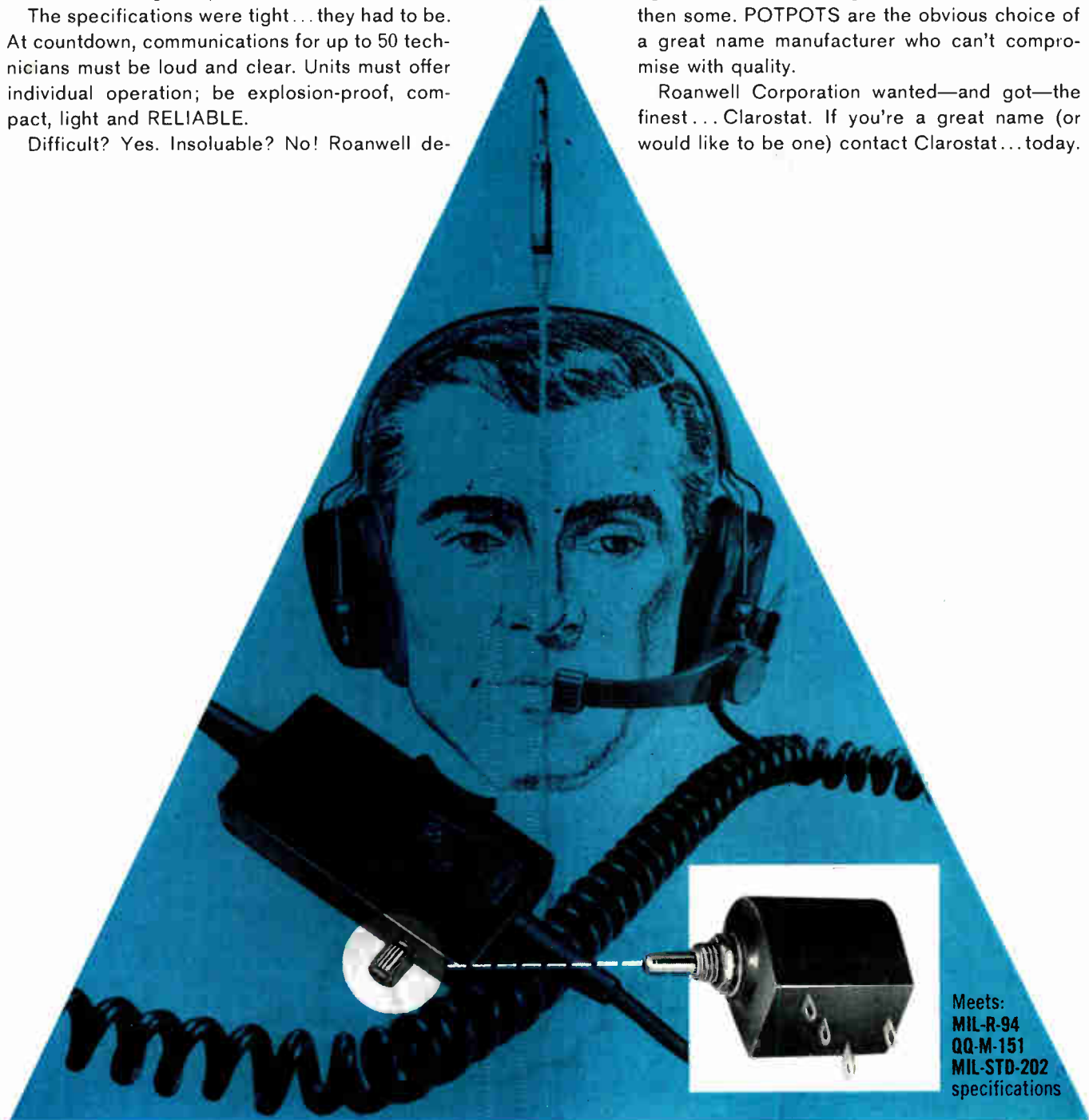

Meets:  
MIL-R-94  
QQ-M-151  
MIL-STD-202  
specifications

# CLAROSTAT

MFG. CO. INC., DOVER, NEW HAMPSHIRE



# WASHINGTON TRENDS

**COUNCIL PUSHES DEFENSE BUYING CHANGES**—Pressure for sweeping defense buying changes is building under the growing influence of Defense-Industry Advisory Council. Council, composed of 20 industrial and business leaders, is now strong partner in the contracting policy area. Formed only last May, it is now attacking keystone areas of defense procurement—leading to some re-shaping of Pentagon policies.

It wants the "Bell Report" implemented. (This would tighten up government contracting for R&D and technical services.) It is pushing for a code of conduct for defense contractors. It also wants uniformity of criteria to set negotiated contract fees. It is also investigating such questions as whether systems such as "PERT" should be handled by the Government or through private contractors.

**DYNA-SOAR NEXT ON SCRAP HEAP?**—The Air Force is squaring for a fight to keep its Dyna-Soar space project. Reports say project may soon get economy axe. Dyna-Soar would develop winged, manned orbital space craft equipped with highly sophisticated electronic gear to detect and intercept hostile satellites over the U.S. Ultimate goal: "Space Patrol" under AF control. Some \$300 million has been budgeted for project in 1963-64. AF spokesmen say they will "stand up and fight"—but Dyna-Soar may well follow Skybolt to trash pile.

**BIGGEST SPACE CONTRACT**—NASA's signing of the biggest space contract in history—\$419 million with the Boeing Co.—puts Project Apollo on a full development basis. The contract is for development of boosters to be first stage of the three-stage Apollo spacecraft. Second stage is being developed by North American Aviation, the third by Douglas Aircraft. Apollo will be able to launch 120 tons into orbit—45 tons to the vicinity of the moon.

**SATELLITE CORP. STARTS COUNTDOWN**—The Communications Satellite Corp. is ready to start work which will lead to its global space communications network. With the naming of its two top operating and administrative officers and first financing underway, corporation has begun its long countdown. Leo D. Welch, former Chairman of Standard Oil of New Jersey, is the new Chairman and Chief Executive Officer. Mr. Welch had a long career in international financing before taking over Standard Oil in 1960. President of the Satellite Corp.

is Joseph V. Charyk, 42, scientist and former Under Secretary of the Air Force. Corporation is also arranging to borrow \$5 million to finance its operations next year, when it should be ready to sell stock to the public.

**SMALL FIRMS LOSE GROUND**—Subcontracting appears to be the only way small firms can reverse continuing drop in their share of defense procurement dollars. Small firms, Pentagon reveals, are now getting only 15.5% of the defense dollar, compared to 17.2% last year. Small Business Admin. procurement experts, going to bat for small firms, are trying to get the Pentagon to pay more attention to getting prime contractors to subcontract to small firms. SBA is also pushing the "value engineering" concept, under which prime and sub contractors share in savings resulting from efficiency and lower costs. This is area where the small subcontractor has a definite advantage by having closer cost and quality controls, SBA points out.

**UPDATE AIR TRAFFIC CONTROL EQUIPMENT**—Federal Aviation Agency will buy \$113.1 million worth of electronic gear and related equipment to expand and modernize the nation's air traffic control and navigation facilities. The improvements will be "balanced" between airlines, general and private aviation, and the military. Expenditures will include \$12 million for modernizing radio navigation facilities and \$9.5 million for building new towers and services at airports without them.

**NASA TOUGHENS BUYING POLICIES**—NASA is joining DOD in toughening up reliability and quality controls. Space Agency spokesmen told a recent Industry Program Plans Conference in Washington that it is effecting a tight joint NASA-contractor program to police its projects to help insure reliable hardware. Reason for this approach, NASA says, is that the complexity of procurement systems prevents a single contractor from having true systems management responsibility.

**PUSH EQUAL PAY**—Legislation calling for equal pay for equal work for women employees is getting attention in Congress. Some action may come this year on this perennial move as the Kennedy Administration joins fight. Hearings on the bills to prohibit discrimination in wages because of sex are due soon in both Senate and the House.



**NEW**

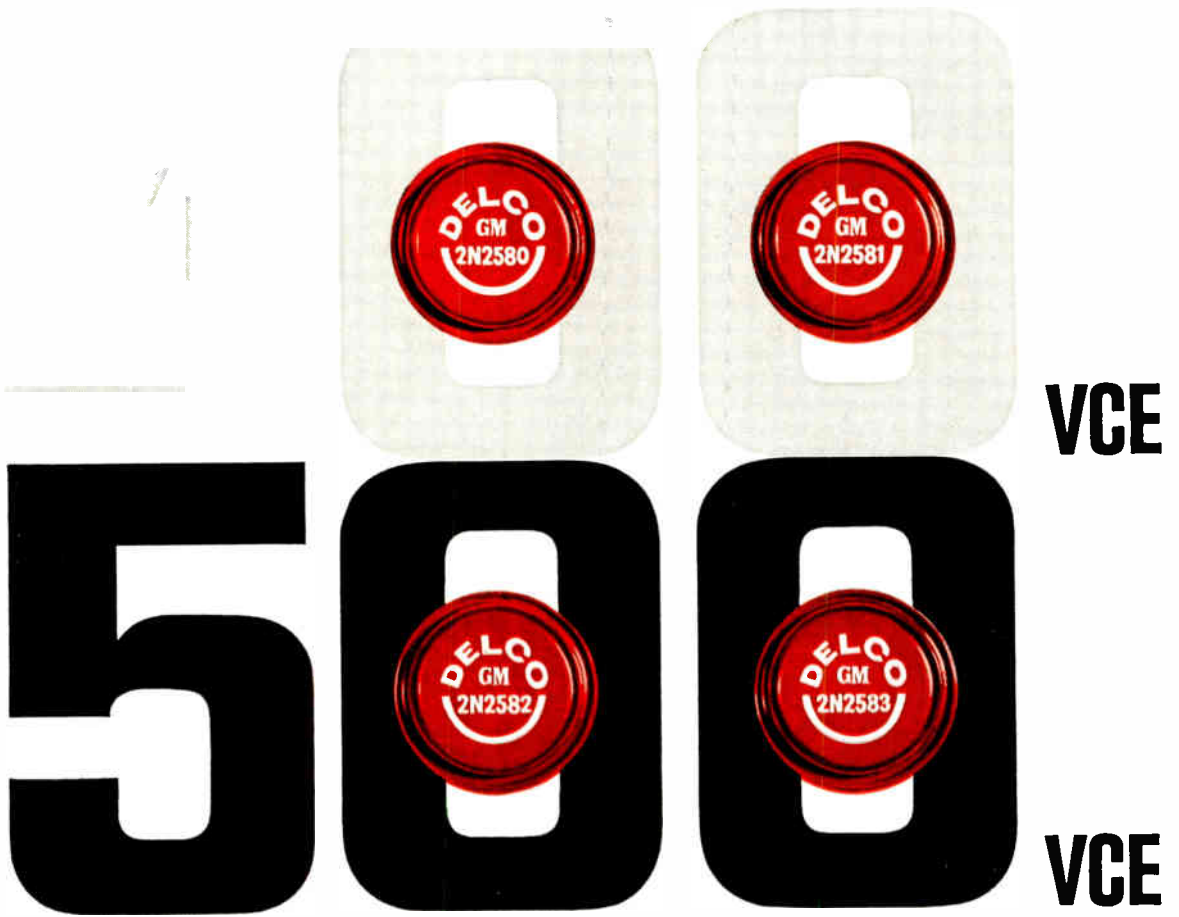

No.	V <sub>ce</sub> I <sub>c</sub> =5ma	V <sub>ce</sub> Sustaining	h <sub>FE</sub>		V <sub>ce</sub> Sat.		V <sub>be</sub> Sat.	
			I <sub>c</sub> =5A	I <sub>c</sub> =10A	I <sub>c</sub> =5A	I <sub>c</sub> =10A	I <sub>c</sub> =5A	I <sub>c</sub> =10A
2N2580	400	325v	10 min. 40 max.		0.7v		1.5v	
2N2581	400	325v	25 min. 65 max.	10 min.		1.0v		1.7v
2N2582	500	325v	10 min. 40 max.		0.7v		1.5v	
2N2583	500	325v	25 min. 65 max.	10 min.		1.0v		1.7v

New from Delco Radio! Silicon power transistors with V<sub>ceo</sub>, V<sub>cb0</sub> and V<sub>ces</sub> of 400 and 500 volts in two gain ranges. This new line of high power transistors permits never-before-possible simplification of design in a wide area of applications. Available at all Delco Radio distributors or through our sales offices. Right now.



Union, New Jersey  
324 Chestnut Street  
MURdock 7-3770  
AREA CODE 201

Detroit, Michigan  
57 Harper Avenue  
TRinity 3-6560  
AREA CODE 313

Santa Monica, California  
726 Santa Monica Blvd.  
UPTon 0-8807  
AREA CODE 213

Syracuse, New York  
1054 James Street  
GRanite 2-2668  
AREA CODE 315

Chicago, Illinois  
5151 N. Harlem Ave.  
775-5411  
AREA CODE 312

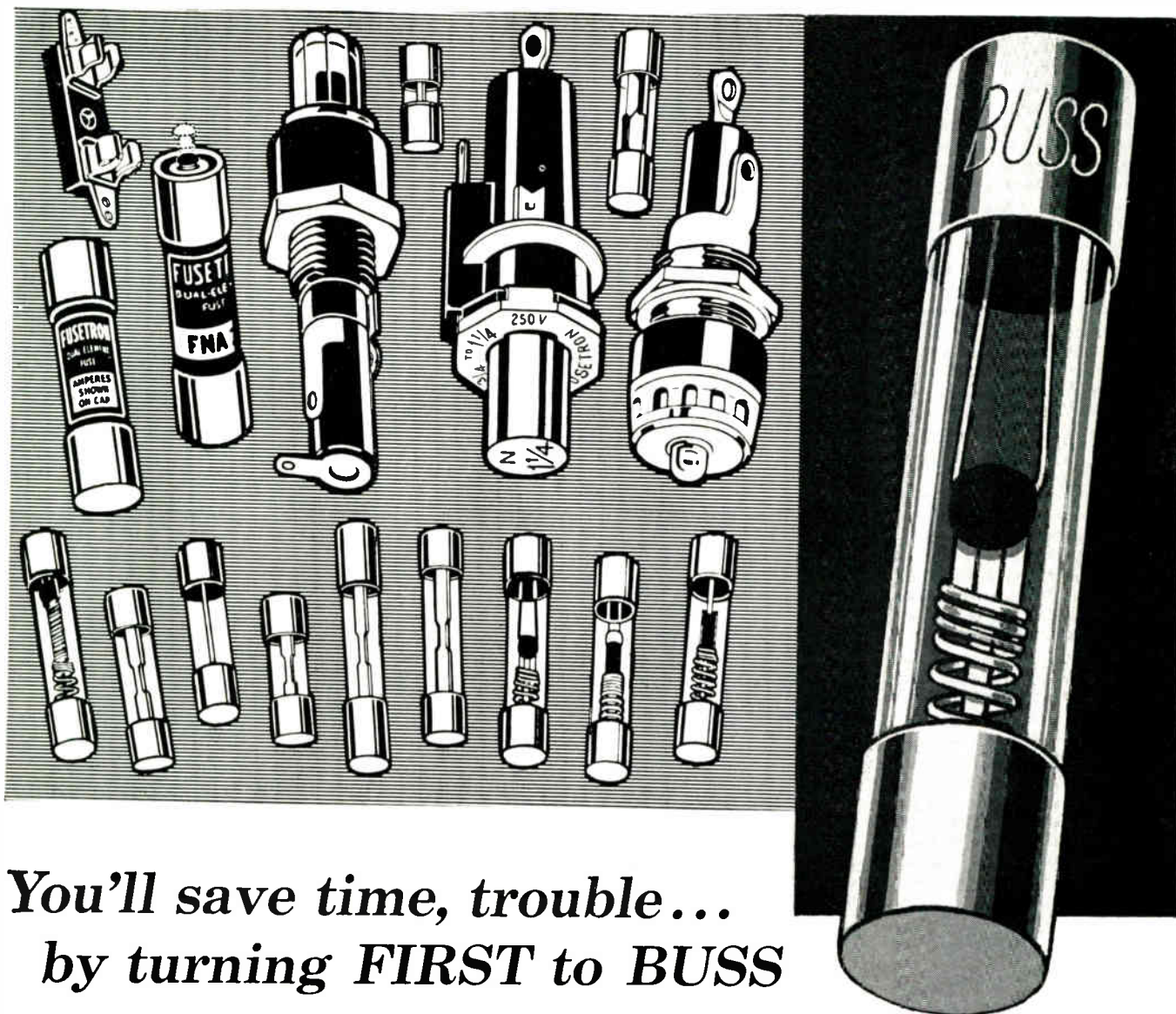

**You'll save time, trouble...  
by turning *FIRST* to *BUSS*  
for fuses of unquestioned high quality**

By relying on BUSS as your source for fuses, you can quickly and easily find the type and size fuse you need. The complete BUSS line of fuses includes: dual-element "slow-blowing", single-element "quick-acting" and signal or visual indicating types... in sizes from 1/500 amp. up—plus a companion line of fuse clips, blocks and holders.

**BUSS fuses are made to protect—  
not to blow needlessly**

When you specify BUSS fuses—users of your equipment receive maximum protection against damage due to electrical faults. And just as important, users are safeguarded against irritating, useless shutdowns caused by faulty fuses blowing needlessly.

A component part that operates as intended helps to maintain the reputation of your equipment for quality and service. That's why it pays to rely on dependable BUSS fuses.

If you should have a special problem in electrical protection... the world's largest fuse research laboratory and its staff of engineers are at your service—backed by over half a century of experience. Whenever possible, the fuse selected will be available in local wholesalers' stocks, so that your device can be easily serviced.

For more information on BUSS and FUSETRON Small Dimension Fuses and Fuseholders... Write for bulletin SFB.

**BUSS: The complete line of fuses and  
fuse mountings of unquestioned high quality.**



**BUSSMANN MFG. DIVISION**  
McGraw-Edison Co.  
St. Louis 7, Mo.



# Read to 1/1000 Turn Accuracy

With New Spectrol Dials for  
Potentiometers and Other Rotating Devices



**Model 11** \* diameter 1"  
\* number of turns 11  
\* protrusion from panel  $\frac{7}{8}$ "  
\* numbers snap into the window as each turn is completed \* base price in 1-9 quantities, \$7.75.



**Model 30** \* diameter  $1\frac{1}{16}$ "  
\* number of turns 10  
\* protrusion from panel 1"  
\* numbers snap into the window as each turn is completed \* base price in 1-9 quantities, \$5.75.

**Model 25** A new turns-counting dial with DIGITAL readout for multi-turn applications \* 3-digit dial reads to 1099 (11 turns) \* 4-digit dial reads to 9999 (100 turns) \* fine calibrations allow setting to 1/1000 of a shaft turn \* 2 to 1 gear ratio between setting knob and device shaft allows extremely fine settings \* diameter  $1\frac{3}{16}$ " \* standard 11-turn, 3-digit dial price, 1-9 quantities, \$14.25 \* standard 100-turn, 4-digit dial price, 1-9 quantities, \$19.75.



Spectrol Multidial® turns-counting dials offer these unique features: **Finely marked scale graduations** enable the operator to read settings with high accuracy. **Easy installation.** No disassembly, extra panel drilling or mounting hardware required. **Easy locking** with a finger touch that grips or releases without disturbing the setting. Settings are unaffected by vibration or shock. **Universal application** to any type of multi-turn potentiometer or other device. **Attractive satin chrome finish** with black plastic turning knob. Available for  $\frac{1}{4}$ ",  $\frac{3}{16}$ " and  $\frac{1}{8}$ " diameter shafts.

Call your nearest Spectrol distributor for immediate off-the-shelf delivery at factory prices, or write for complete specifications.

**SPECTROL** ELECTRONICS CORPORATION

1704 South Del Mar Avenue  
San Gabriel,  
California

Adams Court  
Plainview, L. I.  
New York

P.O. Box 130  
Brampton  
Ontario

Circle 21 on Inquiry Card

World Radio History

Strenuous efforts are being made to minimize the threat of thermonuclear war. What course would our industry take in the event that world-wide agreements wipe out the vast defense and aerospace markets? Should the industry—as some firms have done—begin planning now for diversification? Here are some current observations and comments by outstanding figures in government and science.

# DISARMAMENT: WHAT WOULD IT MEAN TO THE ELECTRONIC INDUSTRY?

TODAY'S ELECTRONIC TECHNOLOGY is directly inter-related with defense marketing and international power politics in the diplomatic see-saw of the arms race versus disarmament.

In the event of possible world-wide accord on arms control and disarmament, the question naturally arises as to what course the electronics industry is likely to take. It may mean de-mobilizing and re-tooling for industrial and business control systems and more consumer production for "peace gaming." Production of weapons systems for "war gaming" will diminish.

It should be obvious that in recent months many scientists, engineers and industrialists, who have been schooled or oriented for defense research and for production of offensive and defensive war systems, have felt internal conflict. They are divided within as to what will happen to their electronic worlds when our national economy switches from "hot war" preparations to "cool peace." They have been accused at times of being the "armorers of modern war."

## Most Engineers in Defense

A recent survey shows that roughly 75% of U.S. electronics and electrical engineers are currently engaged in some form of Government defense work,

directly or indirectly. This means that, according to the latest figures from several sources, there are probably about 125,000 electronic and electrical engineers in defense research and production.

The Department of Defense (DOD) currently wields a 50-billion-dollar-plus budget for the 1964 fiscal, of which some 10 billions will sustain more than 60% of billings by our vast electronics industries. This powerful budget figure towers above the mere \$6.5 million budget allocated for the 1963 fiscal to the United States Arms Control and Disarmament Agency (ACDA), chartered in 1961. Of that budget, \$4 million has been channelled into research and development for arms control.

Congress has yet to decide (as of March 1, 1963) whether to lift the \$10 million budget ceiling imposed on ACDA. It has yet to consider voting the \$15 million budget for the 1964 fiscal, of which some \$11 million is earmarked for research.

## ACDA Market is Small

It now becomes apparent that if every cent of the ACDA budgets goes to the electronics industry, this market still remains infinitesimal when compared to our tremendous defense and aerospace markets. One may find comfort in considering the ACDA budgets

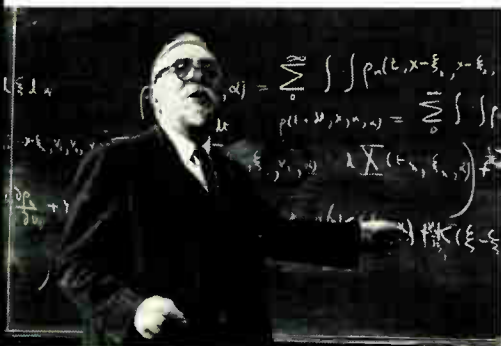

Dr. Norbert Wiener, far left, Mathematics Professor Emeritus, communications sciences theorist, MIT, says scientists should reject further "death-dealing" research. William C. Foster, left, directs U. S. Arms Control and Disarmament Agency (ACDA).

By **SIDNEY FELDMAN**

Contributing Editor  
ELECTRONIC INDUSTRIES



as possible "seed money" in study contracts, which could mushroom into greater industrial contracts ranging into hundreds of millions and even the billions of dollars worth of future research and production for the "peace age."

Technologically speaking, U.S. scientific knowledge and production potential can be cast in the direction of either total war or all-out peace, though, at this juncture the U.S. appears to be pursuing both military and peace preparations concurrently.

In addition to diverting into peaceful industrial and consumer production, defense contractors and engineers could participate in the infinitely small market for arms control and disarmament technology. Some defense firms, in fact, are going a step further by conscientiously preparing to diversify by commercializing some of the research and production systems of defense and military aerospace technology for non-military markets.

### Arms Control Talks

One of the earliest suggestions for waging peace with the tools of modern technology was the Eisenhower "Open Skies" plan to monitor earthbound armament and disarmament activities from aircraft, which was met with wrangling and final refusal by the Russians.

In 1958, the Soviet Union surprised the Eisenhower Administration by accepting a U.S. invitation to a Surprise Attack Conference in Geneva, which left the U.S. surprised and confused at our Government's lack of preparation for its own conference. By the time the meeting dragged to its frustrating close, however, the U.S. had managed to derive a fairly good approach to technical disarmament from among its representatives. These included technical advisers to the President, to the Department of Defense and to the Atomic Energy Commission.

The outgrowth of these unrewarding debates with the Soviet Union caused the Department of Defense to shell out \$100 million (so far) on Project Vela, which include: Vela Uniform, ground based detectors to monitor underground detonations; Vela Sierra, aerospace detectors to observe surface explosions, and Vela Hotel, a satellite-based detection system.

### ACDA Enacted

It was not until September, 1961 that a somewhat shaky Congress responded to President Kennedy's campaign "peace" promise, by enacting a modified version of ACDA. Its director, William C. Foster, led the U.S. team to the Geneva meeting with the Soviet in 1958, and also took part in beating some of the World War II swords into peacetime plough-



Decisions affecting, directly or indirectly, the electronics industry and how electronic production potential is used, are and will be made at the UN, New York, and the Kremlin, Moscow.



## DISARMAMENT (Continued)

shares during the partial dismantling of our military might.

So far as we know, the founding of ACDA is the first sound move in the general direction of permanent arms control and disarmament. Most previous disarmament activities had been conducted, pigeon-holed or even lost somewhere in the maze of lesser Government offices in Washington.

Although ACDA funding is modest, its "mission" is extensive and complex, being "the identification, verification, inspection, limitation, control, reduction, or elimination of armed forces and armaments of all kinds under international agreement, including the necessary steps taken under such an agreement to establish an effective system of international control, or to create and strengthen international organizations for the maintenance of peace."

### Offices of ACDA

Three ACDA offices are of vital import to electronic engineers, defense contractors, and the industry as a whole:

1. Science and Technology Office—researches and coordinates systems of arms control and disarmament.
2. Weapons Evaluation and Controls Office—monitors military aspects of arms control and disarmament.
3. Economic Office—concerns itself with economic impacts and consequences of disarmament, and the necessary adjustments to be made.

Will electronics production lines now turning out components and circuits for weapons systems one day be re-tooled for consumer production and industrial and business controls?



Some defense contractors already have begun to diversify by taking on small study contracts with ACDA. The largest single contract — \$354,000 — awarded recently to Sylvania Electronic System's Electronic Defense Laboratories, at Mountain View, California, is for a design and evaluation study of an inspection system for a ban on weapons of mass destruction in space, and for restrictions on missile flight tests.

Another contract, for \$215,000, was awarded in February 1963, to Aerospace Corporation, El Segundo, California, to study ballistic missile and military space systems development in relation to arms control and disarmament measures.

### Independent Study

Aerospace Corporation, organized in 1960 to handle U.S. scientific-engineering planning and technical direction of space and advanced ballistic missile programs, performed an independently-financed study program in 1962 on special problems of arms control and disarmament. Study results have been made available to ACDA under an arms control agreement.

Bendix Systems Division has a \$150,000 contract with ACDA to study techniques to monitor production of strategic delivery vehicles, and a \$95,000 contract concerned with verification requirements for a disarmament inspection system, while Raytheon Corporation's special Strategic Study Department, in its Missile and Space Division, is working on a \$125,000 contract to study progressive zonal inspection methods to verify any disarmament agreement.

Most of the electronic systems used in military operations could be used, or modified for re-use, in monitoring, surveillance and verification of arms control and disarmament activities, as well as for diversion to peacetime industrial systems control.

As war armaments have become more sophisticated, depending heavily on electronic technology, so have the makers of such hardware depended more and more on scientists, engineers and technicians.

### Scientists Debate

In the May, 1947 issue of "The Atlantic Monthly" Dr. Norbert Wiener, eminent M.I.T. mathematician, and important theorist on communication and control during World War II, debated with Louis N. Ridenour, scientist, educator, writer and defense industry official.

Wiener declared that he would not yield any information about a paper he wrote on controlled missiles, that such weapons could kill innocent foreign civilians while not protecting our own. He held that "scientists should have nothing further to do with "death-dealing research."



Ridenour, on the other hand, pointed out then what is still true today. The scientist's social responsibility is nothing unique. All citizens have equal responsibility to work for peace (if that is indeed what we want). He said that the scientist has the same choice in working for war or for peace, as Western Electric Company, for example, has in making telephones either for domestic circuits or for battlefield communications. In short, the scientist works at science, and Western Electric makes telephones; society decides how our science and technology are to be used.

### **World Police Force**

Cyrus Eaton, multi-millionaire "humanist," has held conferences at Pugwash, Nova Scotia, where American, Russian and other world scientists have discussed peace. A consulting management engineer, Howard G. Kurtz, has through the years managed to convert some members of the press to his own way of thought on his concept of War Safety Control, a world-wide electronic detection and data transmission system to warn all nations of any sub rosa mobilizing war production. His concept also envisions a strong "world police force" for the enforcement of peace, including extensive electronic instrumentation.

The U.S. has been moving toward a similar concept of a total inspection and verification system to police-the-peace, involving world-wide communications and data analyses systems, and an International Disarmament Organization to inspect and provide planning, legal and diplomatic services.

Dr. Leo Szilard, who with Enrico Fermi, did the theoretical work on atomic fission that launched large-scale nuclear research, has been devoting much of his time in "peace mongering" to help lessen the danger of thermonuclear war. He suggests a lobby of scientists to petition for peace, short of conditional surrender. His group is called the "Council for a Livable World."

Many other groups, too numerous to mention, are active throughout the U.S. and the world in general in the pursuit of peace and disarmament. These groups include colleges, civic organizations, business clubs, foundations, quasi-government organizations and many more.

### **Disarmament in Industry**

Such groups for the study of arms control and disarmament are also prevalent among defense contractors. Some are General Electric, Boeing, Douglas, General Dynamics, Lockheed and North American Aviation, in addition to ACDA contractors Sylvania, Aerospace, Raytheon and Bendix. The RAND Corp., U.S. Air Force "think agency," has been studying arms control and disarmament, and the



An Air Force B-58 supersonic bomber and a Polaris missile in flight. Can materials, systems and manpower for these war artifacts be diverted for peacetime non-military use?

## DISARMAMENT (Continued)

DOD itself participates in various arms control and disarmament conferences, partly for "self defense," it is said.

Understandably, there is fear and uncertainty among defense contractors and their technical staffs and other employees should arms control and disarmament agreement become reality. These fears suggest that disarmament would pull out the kingpins that hold the wheels of our national economy. Naturally, this possibility has not escaped the notice of the Economic Office of the ACDA.

### Economic Adjustment Study

Studies are now being made by economists conducting a research program on economic adjustments to disarmament under the aegis of the Center for Research in Conflict Resolution. Briefly, the studies include models for observing the economic effects of phasing-out certain defense armaments while phasing-in peacetime industrial programs and an international disarmament organization. Phase-in aspects include Government subsidies and higher compensating levels of activity in peaceful uses of electronic production, the atom, outer space and weather control. There is also strong support for a domestic civil defense program, which is not regarded as being contradictory to arms control and disarmament.

With the creation of ACDA, engineers, scientists and industrialists, and many others, now have the opportunity to take part officially in working toward arms control. Curiously enough, ACDA and a peace-oriented industry may begin competing for scientists

Could weapons control and monitoring systems like this one be used, or modified for use, in peacetime industrial and business controls for consumer research and production?



and engineers against the DOD, AEC, NASA and other government agencies, as well as against defense contractors. One thing remains quite sure, however. ACDA's budget is small, and its task is great.

### End Result Unknown

What will be the end result of current peace talks and the many collateral moves toward arms control and disarmament, no one can say. One school of thought in the U.S. says that we cannot do business on any level with the Soviet Union. Another says we can. It is barely possible that the Russians say virtually the same things about us.

Dr. Albert R. Hibbs, speaking as chief of the Arms Control and Disarmament Group at the Jet Propulsion Laboratory, California Institute of Technology in 1962, was quoted as saying that chances appear good for an international treaty with the Soviet Union demilitarizing space within two to three years.

The late Robert E. Gross, reflecting what may be thought of as typical defense contractor thinking, said in 1957, when he was head of the Lockheed Aircraft Corporation, "if disarmament comes at all it is not likely to be sudden, or large scale. Our experience with the Russians has been too discouraging for us to accept soon and with eagerness what have proved in the past to be empty gestures toward friendliness."

### Any Progress Helps

While speaking before an assembly of engineers last summer, Trevor Gardner, a member of President Kennedy's Disarmament Advisory Board, and president of Hycon Manufacturing Company, Monrovia, California, concluded that "it has taken civilization 100 centuries to develop the tools with which it can destroy itself. It seems unlikely that the sensitivity and peril of the present international situation can be quickly removed.

"However, even interim incremental progress in disarmament would tend to provide us with some added security from nuclear devastation. . . . It is possible and believable that during this decade your art can construct the necessary technological 'bridge of trust' to permit a downturn in the present accelerating spiral of the arms race."

In recent years, engineers and scientists have had a broader opportunity to re-direct their technology from war purposes into more peaceful areas. In effect, as guns may be used either offensively or defensively, so infrared instruments may either pinpoint enemy targets, or scout non-conformity with disarmament agreements.

Putting it in its very basic terms, it's either swords or ploughshares. Which will it be?





**A NEW PAIR OF BEAM POWER VHF PENTODE TRANSMITTING TUBES, IN THE T-12 COMPACTRON DESIGN, FOR USE AS RF POWER AMPLIFIERS AND OSCILLATORS AT FREQUENCIES TO 175MC.**

**Cooler, smaller, more powerful than conventional designs.** Tung-Sol's 8149 and 8150 are ideal for service in mobile and portable communications transmitters and receivers. Improved design and compactron packaging offer significant advantages over other tubes used in the same class of service.

**Cooler running.** Internal heat dissipation is approximately 20% better than similar tubes with molded bases.

**Take less space.** Seated height is only 2½ inches for the 8149 and only 2¾ inches for the 8150.

**More powerful.** Compactron design provides higher plate dissipation—35 watts under ICAS conditions, which is 15 watts more than earlier types of conventional design.

**Reduced pin failures.** Pins are an integral part of the tube structure. Unlike pins in molded bases, they cannot become unsoldered.

Both the 8149 and 8150 feature a center-tapped heater, so they can be operated

from either a 3-cell or a 6-cell storage battery system.

For complete data sheets and other information, write Tung-Sol Electric Inc., Newark 4, New Jersey. TWX: 201-621-7977.

**TUNG-SOL  
8149  
8150**

**Typical Operation**

(Class C Amplifier at 175 Mc/s)

**Voltage**

Plate .....	380	volts
Grid 2 supply .....	380	volts
Grid 1 .....	-78	volts
Peak RF grid 1 .....	120	volts

**Current**

Plate .....	180	mA
Grid 2 .....	12	mA
Grid 1 .....	2.0	mA
Driving power—		
approx. ....	2	watts

**Power Output** ..... 40 watts

Technical assistance is available through: Atlanta, Ga.; Columbus, Ohio; Culver City, Calif.; Dallas, Tex.; Denver, Colo.; Detroit, Mich.; Melrose Park, Ill.; Newark, N. J.; Seattle, Wash. In Canada: Abbey Electronics, Toronto, Ontario.



# now...one new **EH** swept signal oscillator gives you continuous coverage in octave or greater bandwidths from 1 to 40 KMC

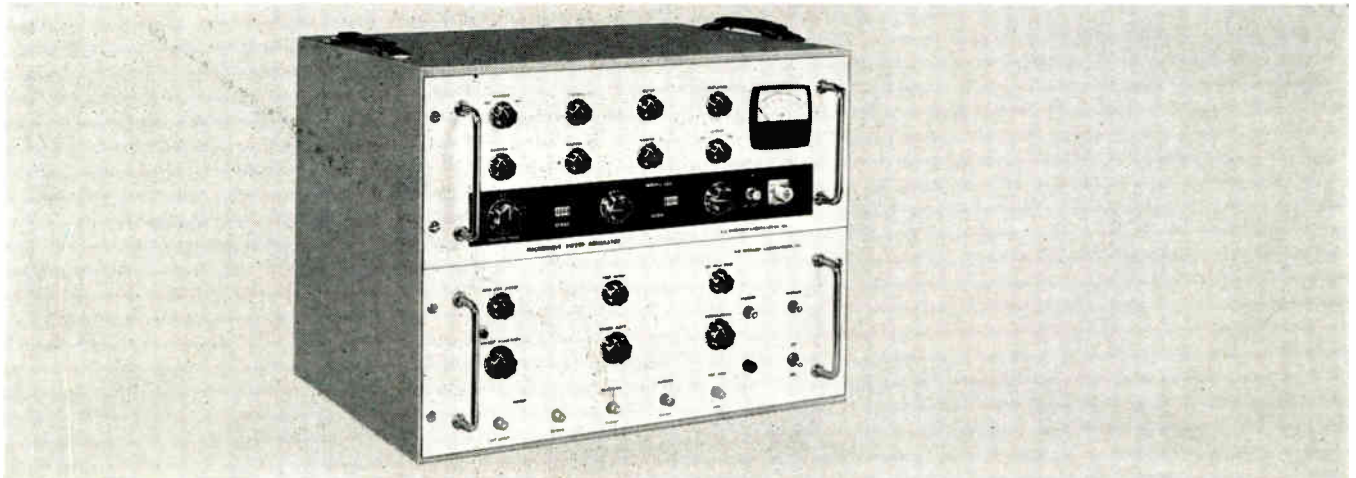

**MODEL 563** CHANGE THE RF HEAD AND CHANGE THE RF OPERATING FREQUENCY

- ULTRA-STABLE LOW RIPPLE POWER SUPPLY ASSURES EXCELLENT FREQUENCY STABILITY
- DIGITAL IN-LINE READOUT ■ FASTEST SWEEP RATE IN THE INDUSTRY AT 1 KC ■ THREE MARKERS ADJUSTABLE IN WIDTH FOR USE WITH ANY SWEEP WIDTH ■ 2-STEP INTERNAL LEVELER INTRODUCES LESS VSWR ■ PM FOCUSED TUBES REDUCE INSTRUMENT WEIGHT AND BULK, INCREASE RELIABILITY

This new E-H Series—utilizing shielded PM focused tubes driven by stable transistor-tube circuitry—sets new high standards for reliable, cool operation over octave or greater bandwidths. The Series sets a new mark for *flexibility*, too—since frequencies may be changed simply by replacing plug-in heads (complete with dial, tube and levelling components). Check the specifications now. Then call an E-H rep for a demonstration.

## specifications

FREQUENCY CONTROL ..... Continuously adjustable with direct calibrated dial, accurate to  $\pm 1\%$

SWEEP SELECTOR ..... Internal (recurrent), Single, CW, External, and Symmetrical

SYMMETRICAL SWEEP ..... Zero to 1% around any center frequency

SINGLE SWEEP TRIGGERING ... Front panel push-button triggers sweep

SWEEP WIDTH ..... Continuously adjustable from 0 to any part of the entire frequency band

TIME (FREQUENCY) ..... 0.001 to 100 seconds

MONITOR OUTPUT ..... 20V linear triangle

FREQUENCY MARKERS ..... Three internal markers, 25 volts in amplitude, continuously adjustable in width from 0.1 to 1%, accurate to 1%

AMPLITUDE MODULATION ..... 800-1200 CPS square wave; other frequencies available

EXTERNAL SWEEP ..... 20 volts gives full sweep. Negative voltage frequency

**PRICE \$3575** for standard units. Custom frequencies available to 40KMC.

MODEL .....	561	562	563	564
FREQUENCY .....	1-2 Gc	2-4 Gc	4-8 Gc	8 -12.4 Gc



**E-H RESEARCH LABORATORIES, INC.**  
163 ADELIN STREET • TEMPLEBAR 4-3030 • OAKLAND 20, CALIFORNIA



# MAGNEREED RELAYS

*dry reed relays by MAGNECRAFT*

Featuring—

- Pre-adjusted gold contacts sealed in an atmosphere of inert gas inside a glass capsule
- Actuation by a coil around the sealed switch capsule
- Permanent protection of contacts from dust, contamination and tampering
- Contact resistance stabilized over tremendous life
- High speed switching
- Sensitive operation
- Simple construction
- Adaptability to widely varied mounting configurations



Class 101 SPST-NO miniature MAGNEREED



Class 102 SPST-NO standard MAGNEREED



Class 103 SPDT standard MAGNEREED

102PC Printed Circuit Relay showing rugged terminal pins in Epoxy Resin Board. Pins are spaced on 0.1 grid centers with 0.2 minimum space between terminals.

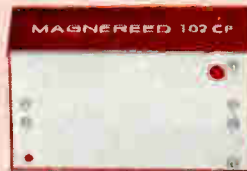

102PC assembly before encapsulation. The rugged terminal posts extend through the Epoxy board to provide the terminal pins shown above.



The unique MAGNEREED construction shown above maintains stability of adjustment. The reed leads are not bent but soldered to the rigid terminal posts with capsule and coil in position. The leads are not subjected to stresses that transmit to the reeds inside the capsule and disrupt adjustment stability.

Encapsulation of the assembly in Epoxy resin eliminates breakage, also protects the coil, leads and terminals against mechanical injury and atmospheric change.

## Encapsulated MAGNEREED RELAY Assemblies for Printed Circuits

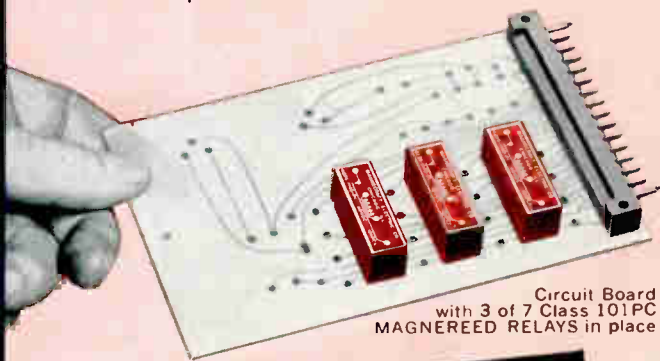

Circuit Board with 3 of 7 Class 101PC MAGNEREED RELAYS in place



101PC. SPST-NO



102PC. SPST-NO



103PC. SPDT



101PC. DPST-NO

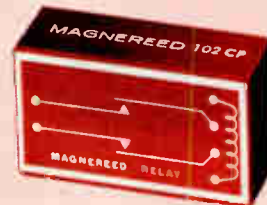

102PC. DPST-NO

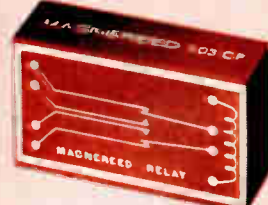

103PC. DPDT

## Other available types of MAGNEREED RELAYS

- High Current Switching Relays
- Low capacitance for RF switching
- High voltage switching to 5000 V
- High insulation resistance to  $10^8$  megohms
- Polarized Reed Relays

Plug-in MAGNEREED RELAY Assembly with Plastic Cover

Available with two or three Class 103 SPDT Relays with common operating coil and 8- or 11-pin standard octal plug.

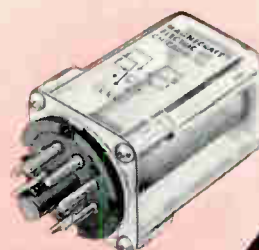

Inherent reliability and tremendous life combined with exceptionally fast low level and low load switching make MAGNEREED RELAYS the logical choice for a tremendous range of application.

For example, in many applications they replace complex and costly solid state switching devices with simple circuitry and marvelous economies.

New developments and innovations are constantly extending the application of MAGNEREED RELAYS into new fields.

Whatever your relay requirements phone our Sales Representative in your area or send for literature.



103PC DPDT Relay with 3-inch leads instead of the terminal pins provided for printed circuit use. All the encapsulated assemblies illustrated can be furnished with the 3-inch leads on special order (not stock).

## Stocked by Leading Distributors

Call Sales Representative near you for information about MAGNEREED RELAYS or names of distributors in your area.

### Phone numbers of Sales Representatives.

CALIF	Los Angeles, NO 3-8236	N H	Manchester, 472-4091
COLO	Littleton, 798-0422	N J	Livingston, IN 3-5000 Orange, OR 4-4100
CONN	Farmington, 677-9025 Trumbull, AM 8-9631	N Y	Buffalo, TF 9-0200 Fairport, BR 1-4370 Fayetteville, NE 7-3851
FLA	North Miami, WI 7-5080	ORE	Portland, CA 6-3903
ILL	Chicago, JU 8-3738	PENN	Philadelphia, PI 2-5476
IND	Fort Wayne, ANTHONY 2083	TEXAS	Dallas, FL 7-5713 Houston, MO 7-1256
IOWA	Burlington, PL 2-3186	VA	Arlington, JA 5-5898
KANS	Kansas City, JO 2-4108	WASH	Seattle, AT 2-7200
MASS	Boston, FA 3-1008	WISC	Milwaukee, UP 1-2933
MICH	Belmont, GL 1-1449		
MINN	Minneapolis, 866-3639		
MO	St. Louis, WO 2-5627		

In CANADA—Scarborough, Ontario, PL 7-3253



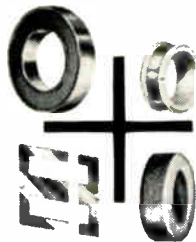
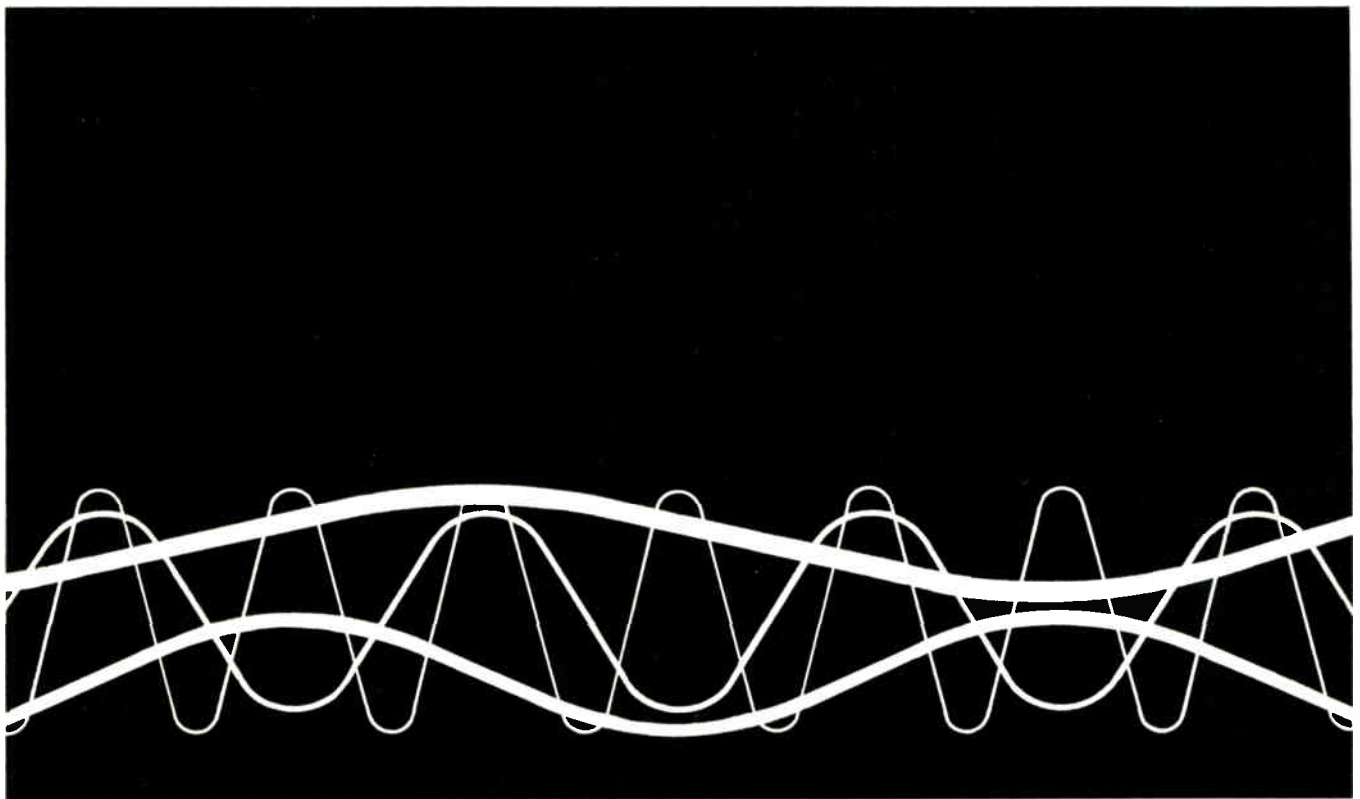

## ***Optimizing circuit components to frequency? Get more from magnetics***

**THE CORE:** What's the best core for operating at low frequencies? What powder core or flake core is best for a higher frequency? That depends on what you're looking for. Frequency alone does not determine where one type of core should be used in favor of another. There's an overlap of usefulness and many core possibilities within a frequency range. Core choice for optimum performance at a given frequency must be related to core cost, and operating temperature, to name a few. Optimizing comes from a careful analysis of the many variables. The *man from Magnetics Inc.* will re-acquaint you with them and will assist you with your selection.

**THE MORE:** The 550 mu Permalloy cores permit greater circuit miniaturization, bridging the design selection gap between laminations and powder cores. Or, choosing a laminated core where you may have thought to use a powder core might be just the thing to effect lower costs, size reduction, operating stability, and high efficiency. Because we produce and stock a wide range of sizes and types of high permeability components, we can assist you a little more than most. Just how much more? Ask the *man from Magnetics Inc.* next time he calls . . . or write us on your letterhead giving the details of your problem. Magnetics Inc., Dept. EI-6 Butler, Pa.

TOTAL ASSISTANCE, SERVICE, SELECTION/GET THE MORE FROM MAGNETICS

***MAGNETICS inc.***  
®



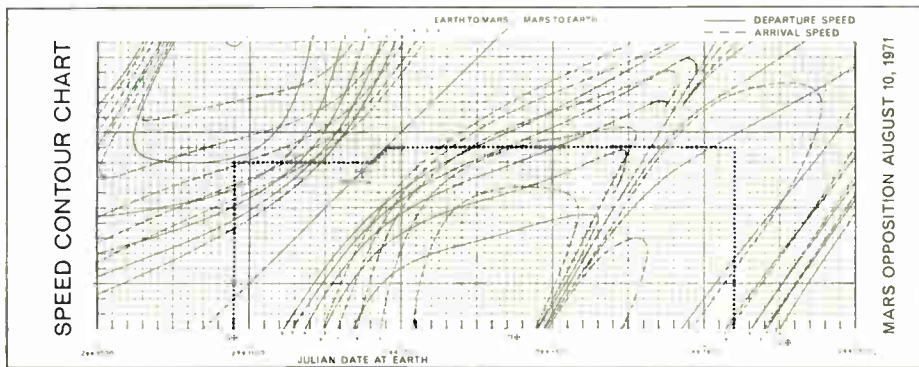

**LOOK AT LOCKHEED...AS A CAREER**

Consider Lockheed's leadership in space technology. Evaluate its accomplishments — such as the Polaris missile, the Agena vehicle's superb record of space missions. Examine its outstanding advantages — location, advancement policies, creative climate, opportunity for recognition.

Then write for a brochure that gives you a more complete Look at Lockheed. Address: Research & Development Staff, Dept. M-47 C, P.O. Box 504, Sunnyvale, California. Lockheed is an equal opportunity employer.

**SCIENTISTS & ENGINEERS:** In addition to positions relating to flight mechanics, such as mission & trajectory analysis, guidance & controls analysis, other important openings exist for specialists in: Orbit thermodynamics • Electromagnetics • Gas dynamics • Chemical & nuclear propulsion • Systems engineering • Computer research • Electronic engineering • Communications & optics research

**LOCKHEED**  
**MISSILES & SPACE COMPANY**  
A GROUP DIVISION OF LOCKHEED AIRCRAFT CORPORATION

Sunnyvale, Palo Alto, Van Nuys, Santa Cruz, Santa Maria, California • Cape Canaveral, Florida • Huntsville, Alabama • Hawaii

At Lockheed Missiles & Space Company, a dedicated team of scientists devotes its entire attention to problems in interplanetary navigation. Of particular interest are problems attendant to the guidance of a manned vehicle to another planet. With many successful accomplishments to their credit (such as the Polaris and various Agena missions), this group faces every new challenge with confidence.

A promising means for manned spacecraft guidance includes taking celestial and planetary optical sightings, feeding that information into an onboard computer, and computing the spacecraft's position and velocity to predict its future course. The computer will then calculate the predicted destination planet error, decide if a correction is necessary, and

compute its value. These procedures would be repeated continually until the planet is reached. The optimum timing and magnitude of correction, in view of the information obtained from the observations, is the subject of continuing study.

Even before work on hardware for an interplanetary mission is begun, orbit characteristics must be determined to set the requirements to be built into the spacecraft. An optimum trajectory must be shaped for the specific mission, in order to realize ultimate effectiveness. An outstanding accomplishment by Lockheed scientists is the computation of some 250,000 different orbits to Mars and a similar number to Venus. Each orbit varies as to speed, fuel, departure, arrival, and elapsed time.

**LOOK AT LOCKHEED IN FLIGHT MECHANICS:**  
*Further advances in space flight leadership*

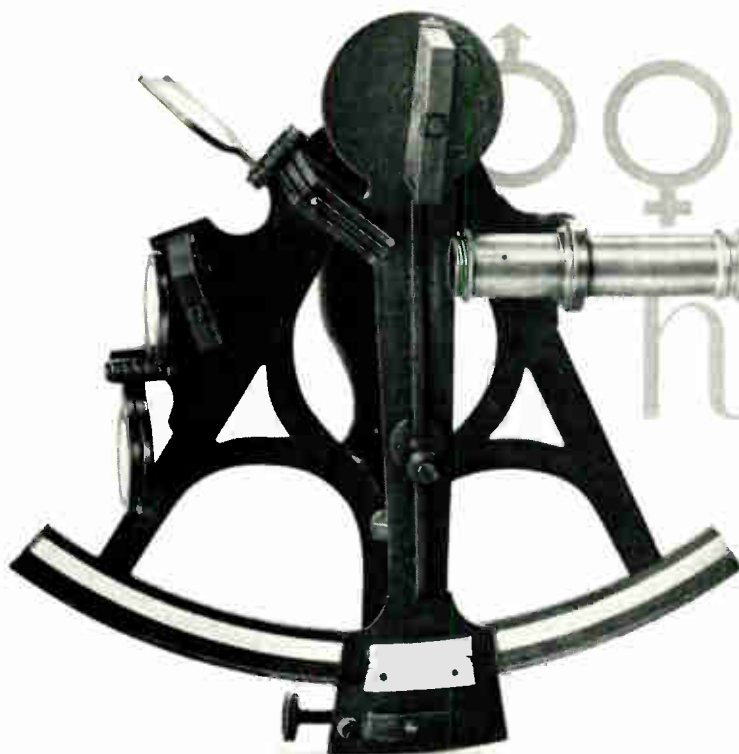

# Choose from **360** Sarkes Tarzian *klipvolt* transient voltage suppressors

Type No.	DIMENSIONS (in inches)					Max. DC Blocking Volts
	"A"	"B"	"C"	"D"	"M"	
S-530	1 1/2	1/2	1	1	1 1/2	27
S-530A	1 1/2	1/2	1 1/4	1 1/4	1 1/2	27
S-530B	1 1/2	1/2	1 1/2	1 1/2	1 1/2	27
S-530C	1 1/2	1/2	2	2	2 1/2	27
S-530D	1 1/2	1/2	2 1/2	2 1/2	3	27
S-530E	2 1/4	1 1/4	3	3	3 1/2	27
S-530F	2 1/4	1 1/4	4	4	4 1/2	27
S-530G	2 1/4	1 1/4	5	5	5 1/2	27
S-530H	2 1/4	1 1/4	6	6	6 1/2	27
S-530J	2 1/4	1 1/4	5	6	5 1/2	27
S-530K	2 1/4	1 1/4	6 1/4	7 1/4	6 1/2	27
S-530L	2 1/4	1 1/4	12	4 1/4	5 1/2	27
S-531	1 1/2	1/2	1	1	1 1/2	54
S-531A	1 1/2	1/2	1 1/4	1 1/4	1 1/2	54
S-531B	1 1/2	1/2	1 1/2	1 1/2	1 1/2	54
S-531C	1 1/2	1/2	2	2	2 1/2	54
S-531D	1 1/2	1/2	2 1/2	2 1/2	3	54
S-531E	2 1/4	1 1/4	3	3	3 1/2	54
S-531F	2 1/4	1 1/4	4	4	4 1/2	54
S-531G	2 1/4	1 1/4	5	5	5 1/2	54
S-531H	2 1/4	1 1/4	6	6	6 1/2	54
S-531I	2 1/4	1 1/4	4 1/4	6	5 1/2	54
S-531J	2 1/4	1 1/4	5	6	5 1/2	54
S-531K	2 1/4	1 1/4	6 1/4	7 1/4	6 1/2	54
S-531L	2 1/4	1 1/4	12	4 1/4	5 1/2	54
S-532	1 1/2	1/2	1	1	1 1/2	81
S-532A	1 1/2	1/2	1 1/4	1 1/4	1 1/2	81
S-532B	1 1/2	1/2	1 1/2	1 1/2	1 1/2	81
S-532C	1 1/2	1/2	2	2	2 1/2	81
S-532D	1 1/2	1/2	2 1/2	2 1/2	3	81
S-532E	2 1/4	1 1/4	3	3	3 1/2	81
S-532F	2 1/4	1 1/4	4	4	4 1/2	81
S-532G	2 1/4	1 1/4	5	5	5 1/2	81
S-532H	2 1/4	1 1/4	6	6	6 1/2	81
S-532I	2 1/4	1 1/4	4 1/4	6	5 1/2	81
S-532J	2 1/4	1 1/4	5	6	5 1/2	81
S-532K	2 1/4	1 1/4	6 1/4	7 1/4	6 1/2	81
S-532L	2 1/4	1 1/4	12	4 1/4	5 1/2	81
S-533	1 1/2	1/2	1	1	1 1/2	108
S-533A	1 1/2	1/2	1 1/4	1 1/4	1 1/2	108
S-533B	1 1/2	1/2	1 1/2	1 1/2	1 1/2	108
S-533C	1 1/2	1/2	2	2	2 1/2	108
S-533D	1 1/2	1/2	2 1/2	2 1/2	3	108
S-533E	2 1/4	1 1/4	3	3	3 1/2	108
S-533F	2 1/4	1 1/4	4	4	4 1/2	108
S-533G	2 1/4	1 1/4	5	5	5 1/2	108
S-533H	2 1/4	1 1/4	6	6	6 1/2	108
S-533I	2 1/4	1 1/4	4 1/4	6	5 1/2	108
S-533J	2 1/4	1 1/4	5	6	5 1/2	108
S-533K	2 1/4	1 1/4	6 1/4	7 1/4	6 1/2	108
S-533L	2 1/4	1 1/4	12	4 1/4	5 1/2	108
S-534	1 1/2	1/2	1	1	1 1/2	135
S-534A	1 1/2	1/2	1 1/4	1 1/4	1 1/2	135
S-534B	1 1/2	1/2	1 1/2	1 1/2	1 1/2	135
S-534C	1 1/2	1/2	2	2	2 1/2	135
S-534D	1 1/2	1/2	2 1/2	2 1/2	3	135
S-534E	2 1/4	1 1/4	3	3	3 1/2	135
S-534F	2 1/4	1 1/4	4	4	4 1/2	135
S-534G	2 1/4	1 1/4	5	5	5 1/2	135
S-534H	2 1/4	1 1/4	6	6	6 1/2	135
S-534I	2 1/4	1 1/4	4 1/4	6	5 1/2	135
S-534J	2 1/4	1 1/4	5	6	5 1/2	135
S-534K	2 1/4	1 1/4	6 1/4	7 1/4	6 1/2	135
S-534L	2 1/4	1 1/4	12	4 1/4	5 1/2	135
S-535	1 1/2	1/2	1	1	1 1/2	162
S-535A	1 1/2	1/2	1 1/4	1 1/4	1 1/2	162
S-535B	1 1/2	1/2	1 1/2	1 1/2	1 1/2	162
S-535C	1 1/2	1/2	2	2	2 1/2	162
S-535D	1 1/2	1/2	2 1/2	2 1/2	3	162
S-535E	2 1/4	1 1/4	3	3	3 1/2	162
S-535F	2 1/4	1 1/4	4	4	4 1/2	162
S-535G	2 1/4	1 1/4	5	5	5 1/2	162
S-535H	2 1/4	1 1/4	6	6	6 1/2	162
S-535I	2 1/4	1 1/4	4 1/4	6	5 1/2	162
S-535J	2 1/4	1 1/4	5	6	5 1/2	162
S-535K	2 1/4	1 1/4	6 1/4	7 1/4	6 1/2	162
S-535L	2 1/4	1 1/4	12	4 1/4	5 1/2	162
S-536	1 1/2	1/2	1	1	1 1/2	270
S-536A	1 1/2	1/2	1 1/4	1 1/4	1 1/2	270
S-536B	1 1/2	1/2	1 1/2	1 1/2	1 1/2	270
S-536C	1 1/2	1/2	2	2	2 1/2	270
S-536D	1 1/2	1/2	2 1/2	2 1/2	3	270
S-536E	2 1/4	1 1/4	3	3	3 1/2	270
S-536F	2 1/4	1 1/4	4	4	4 1/2	270
S-536G	2 1/4	1 1/4	5	5	5 1/2	270
S-536H	2 1/4	1 1/4	6	6	6 1/2	270
S-536I	2 1/4	1 1/4	4 1/4	6	5 1/2	270
S-536J	2 1/4	1 1/4	5	6	5 1/2	270
S-536K	2 1/4	1 1/4	6 1/4	7 1/4	6 1/2	270
S-536L	2 1/4	1 1/4	12	4 1/4	5 1/2	270
S-537	1 1/2	1/2	1	1	1 1/2	450
S-537A	1 1/2	1/2	1 1/4	1 1/4	1 1/2	450
S-537B	1 1/2	1/2	1 1/2	1 1/2	1 1/2	450
S-537C	1 1/2	1/2	2	2	2 1/2	450
S-537D	1 1/2	1/2	2 1/2	2 1/2	3	450
S-537E	2 1/4	1 1/4	3	3	3 1/2	450
S-537F	2 1/4	1 1/4	4	4	4 1/2	450
S-537G	2 1/4	1 1/4	5	5	5 1/2	450
S-537H	2 1/4	1 1/4	6	6	6 1/2	450
S-537I	2 1/4	1 1/4	4 1/4	6	5 1/2	450
S-537J	2 1/4	1 1/4	5	6	5 1/2	450
S-537K	2 1/4	1 1/4	6 1/4	7 1/4	6 1/2	450
S-537L	2 1/4	1 1/4	12	4 1/4	5 1/2	450

The Tarzian "klipvolt" line includes:

- A** Polarized suppressors
  1. Cartridges
    - a. Standard construction
    - b. Sealed construction
  2. Stacks
- B** Single-phase non-polarized suppressors
  1. Cartridges
    - a. Standard construction
    - b. Sealed construction
  2. Stacks
- C** Three phase non-polarized suppressors
  1. Stacks

■ The background of this advertisement shows a partial listing of the "klipvolt" line. For the full listing, send for free 8-page catalog and application manual—Bulletin 62-KV-11.

Max. RMS Volts	Peak Discharge Current (Amperes)	Fig.
35	2.5	6
35	4.5	6
35	8	6
35	13.5	6
35	20	6
35	30	6
35	55	6
35	85	6
35	105	6
35	165	6
35	180	9
70	2.5	6
70	4.5	6
70	8	6
70	13.5	6
70	20	6
70	30	6
70	55	6
70	85	6
70	105	6
70	165	6
70	180	9
105	2.5	6
105	4.5	6
105	8	6
105	13.5	6
105	20	6
105	30	6
105	55	6
105	85	6
105	105	6
105	165	6
105	180	9
140	2.5	6
140	4.5	6
140	8	6
140	13.5	6
140	20	6
140	30	6
140	55	6
140	85	6
140	105	6
140	165	6
140	180	9
175	2.5	6
175	4.5	6
175	8	6
175	13.5	6
175	20	6
175	30	6
175	55	6
175	85	6
175	105	6
175	165	6
175	180	9
210	2.5	6
210	4.5	6
210	8	6
210	13.5	6
210	20	6
210	30	6
210	55	6
210	85	6
210	105	6
210	165	6
210	180	9
270	2.5	6
270	4.5	6
270	8	6
270	13.5	6
270	20	6
270	30	6
270	55	6
270	85	6
270	105	6
270	165	6
270	180	9
450	2.5	6
450	4.5	6
450	8	6
450	13.5	6
450	20	6
450	30	6
450	55	6
450	85	6
450	105	6
450	165	6
450	180	9

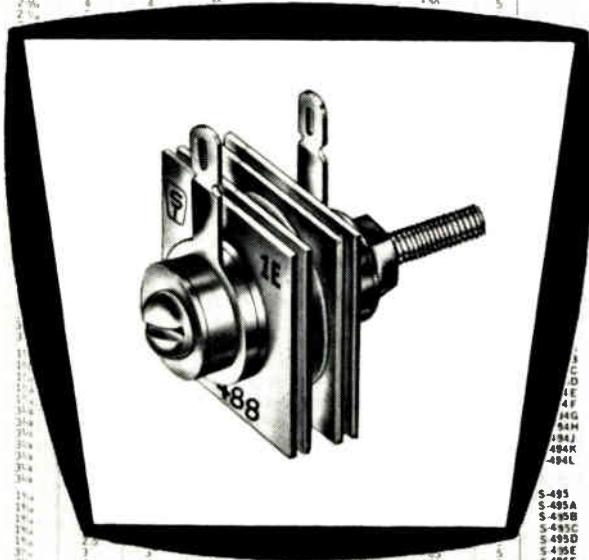

**SARKES TARZIAN, Inc.**  
 World's Leading Manufacturers of TV and FM Tuners • Closed Circuit TV Systems • Broadcast Equipment • Air Trimmers • FM Radios • Magnetic Recording Tape • Semiconductor Devices  
**SEMICONDUCTOR DIVISION • BLOOMINGTON, INDIANA**  
 Canadian Licensee: Marsland Engineering Limited • 350 Weber Street North, Waterloo, Ontario



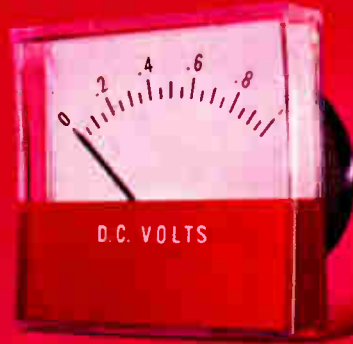
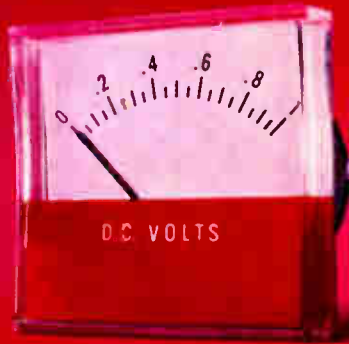
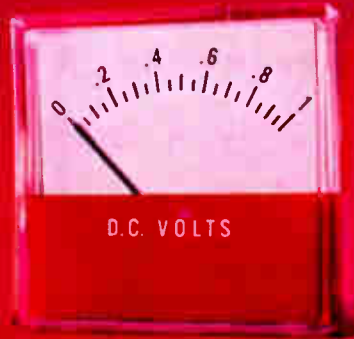

Look what Honeywell has done to modernize meters

# The New Honeywell MS Line—3 sizes, all colors

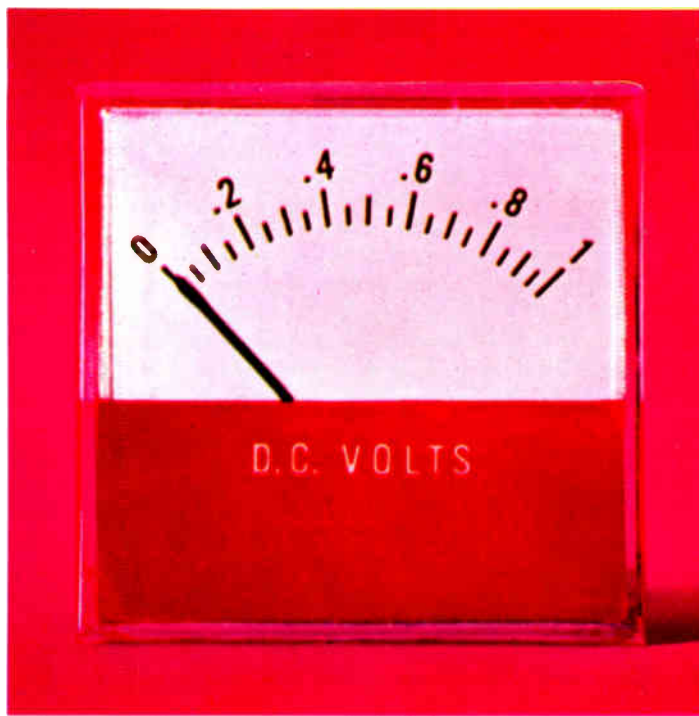

## Contemporary design

Straight sides and square corners, plus color styling of the cover, give the "MS" Series a distinctive appearance. The clean, functional design blends with the square and rectangular shapes of modern electronic and process equipment.

## Clear, uncluttered dial

All extraneous data has been removed from the dial face — the unit of measurement is hot-stamped on the inner surface of the cover.

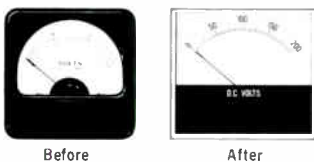

The scale numerals are above the scale to avoid covering by the pointer. This new "clean face" is a Honeywell exclusive.

## Minimum glare and shadow

Concave face improves readout by minimizing shadows and glare. Whereas light is reflected over the entire area of a flat surface, a concave surface reduces the effect and localizes it to a much smaller area.

Full light reaches the dial through the sides and top as well as the front of the crystal-clear Plexiglas cover.

## Longer scale length

Scale is as much as 50% longer than conventional meters of same size. For instance, the MS1 meter has greater scale length than some 2½-inch meters — a real saving in valuable panel space without sacrificing reading accuracy.

For complete information, write Honeywell, Precision Meter Division, Manchester, N. H. In Canada, Toronto 17, Ontario.

## SPECIFICATIONS

**Sizes and Types** — MS1 (1½-inch), MS2 (2½-inch) and MS3 (3½-inch). DC meters in all sizes to measure volts, millivolts, milliamperes, amperes and microamperes. AC rectifier-type voltmeters in all sizes; AC iron-vane types in 2½-inch and 3½-inch sizes to measure milliamperes, amperes and volts. VU meters with buff dial, "A" or "B" scales in all sizes. Null indicator types available in 1½-inch and 2½-inch sizes.

**Ranges** — All standard ranges. Special ranges and customized dials also available on request.

**Accuracy** — ±2% of full scale for all DC ranges. For AC ranges, ±3% of full scale.

**Mechanism** — Model MS1 has self-shielded, core-magnet mechanism. MS2 and MS3 models require special calibration for use on steel panels.

**Mounting** — MS1—single-hole mounting. Gasket and mounting ring provided. MS2, MS3 — to ASA mounting dimensions.

**Cover Dimensions** — MS1 — 1.750" square; MS2 — 2.178" high x 3.140" wide; MS3 — 3.500" high x 4.100" wide.

**Cover Colors** — Normally furnished in onyx black. Available in 15 other standard colors. Any custom color to order.

"WHERE ELECTRONICS MEETS THE EYE"

Honeywell International: Sales and service offices in all principal cities of the world. Manufacturing in United States, United Kingdom, Canada, Netherlands, Germany, France and Japan.

# Honeywell



# ELECTRONIC INDUSTRIES

## CONNECTORS AND TERMINATIONS

APRIL 1963

# CONNECTORS— AND TERMINATIONS

Connectors are taking on added importance. From what was once a seldom needed or used piece of hardware, they have grown to a \$250 million a year business. The problems associated with them, the termination methods and trends are discussed in this article.

WHEN WE THINK OF COMPLEX ELECTRONIC EQUIPMENT sooner or later we must think of miniaturization and the reliability problems which arise as a result of it. This line of thought leads in turn to electrical connectors and/or connections and the problems which their design, selection and use bring about.

Years ago the electrical connector was seldom needed or used. The power plug was one of the few easily removable connectors used. Solder connections, or soldered or screw-type terminal boards were used to interconnect sub-assemblies. As equipment became more complex, more and more connectors were needed. The modular concept came into being as equipment was required to be more versatile (and thus

more costly). So, progressing from equipment with possibly one connector we have come to modern times and to equipment which uses thousands of these devices. The connector problem has grown from a minor to a major problem.

\* \* \*

## Misunderstanding

There are two groups with related connector problems—the users and the manufacturers. Many of these problems come as a result of misunderstanding and/or lack of knowledge.

Some users feel that the manufacturer doesn't understand their problems, and more that he doesn't try to understand them. They feel that he is only interested in selling them standard or off-the-shelf items. This feeling is understandable and not entirely without basis; but, in most cases it is not true.

Manufacturers try to understand their customers problems. They couldn't hope to stay in business if they didn't. They wouldn't expend the time or money to put consultants in the field if they weren't making an effort. They would put people in the field whose only function would be to sell. Granted, the end objective of consultants might be to sell, but much time is often spent by them without selling a single connector—time for which the company is never paid.

Generally manufacturers would like to sell standard or off-the-shelf items, but not always for the reasons you might think. As a rule the customers best interest is at the root of the recommendation.

Crimp, manual snap-in contacts used in this AMP printed circuit connector can be terminated at rates up to 3,000/hr. These contacts are available strip-mounted for fast automated assembly.

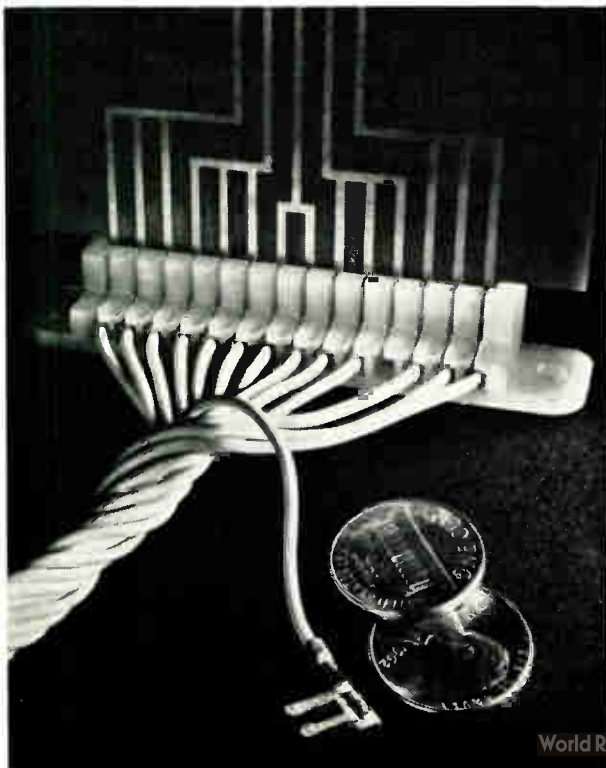

---

By **SMEDLEY B. RUTH**

Assistant Editor  
ELECTRONIC INDUSTRIES



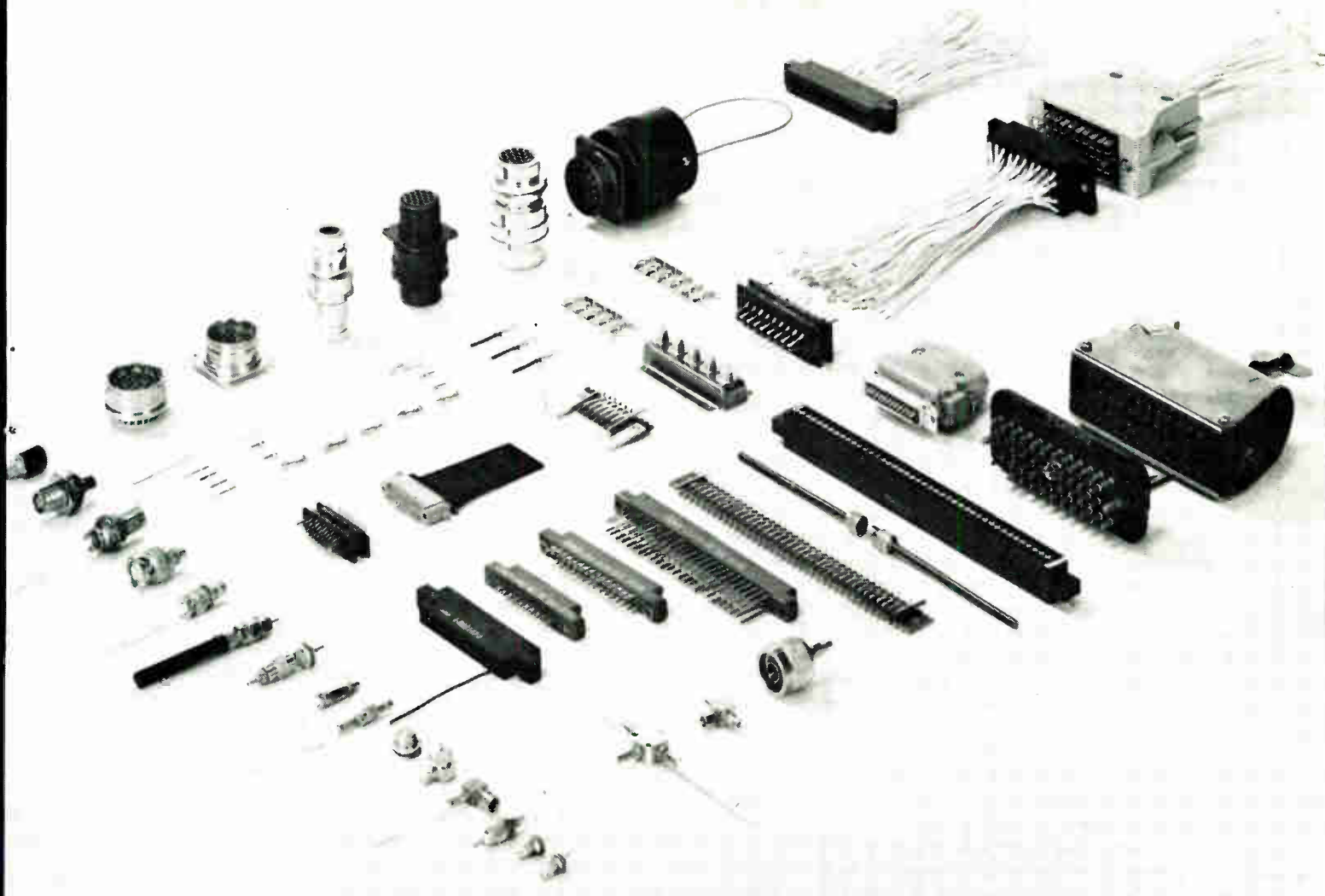

Some of the various connector types, contacts and termination methods which are in use today are shown in the photograph.

Time and space are often determining factors. Few users realize that it takes weeks (probably anywhere from 8 to 12) from the time a manufacturer receives final specifications for a connector for him to make molds and have a finished connector available. This is assuming that his plant has the equipment and personnel available at the time the new order is received. Users cannot expect even the largest vendors to have workers and machinery on standby for special orders that may be received. Tooling is expensive and time-consuming.

If the customer is lucky, tooling for a standard connector may be modified to conform to the new specs. Still to be considered is the time that it would take for a quantity of these connectors to be produced. Also, it must be noted that some manufacturers, while selling standard connectors, welcome opportunities to develop connectors of special size, shape, configurations, and environments.

A point was made concerning the amount of time it takes to make a connector after receipt of the final specs. This brings to light another important point—

when to choose the connector? More often than not the connector is the last item considered when designing equipment. Considering the number of connectors used in some equipment this could be disastrous, particularly if completion time is a factor.

It is understandable why the connector is the last item to be considered. Until recently, the connector did not perform any circuit function. It merely connected subassemblies or equipment for test purposes. Many designers feel that it is only a piece of hardware. This may have been true years ago, but not today. As a connector serves the function of forming or helping make up a system, it fits the dictionary definition of a component. Aside from this, it should be considered a component if for no other reason than that it (along with connections) accounts for such a large percentage of the cost of most electronic equipment. Cost estimates of connectors and connections, and their installation in a large digital computer range as high as 80% of the total cost.

The importance of selecting the proper connector cannot be emphasized too strongly. Consider for a



## CONNECTORS (Continued)

moment what would happen if a component (such as a transistor) were selected for a printed circuit card in a computer and it was later found that the component had been improperly selected. It could normally be replaced in a matter of minutes at a nominal cost. Now suppose that an improper connector had been selected. The labor costs could be much higher; and, depending upon the method of termination of the connector, the time involved for replacement could run into hours. Multiply this one card by the thousands contained in the machine and you can see the importance of proper connector selection.

Most component engineers in industry (and also the manufacturers) agree that the vendor should be consulted as early in the design stage as possible. The vendor will probably be able to make helpful suggestions or at least make the design engineer aware of what is available. This could save the user money, and what is generally more valuable to him—time. Often, a thought given to packaging methods and the connector early in the design stage can result in a more economical and efficient piece of equipment. Consult the connector manufacturer. They have an abundance of experience, skills, and research in the design, development and manufacture of connectors. Or if your company employs a components engineer consult him early in the design stage.

### Study Group

These components engineers are usually in contact with the manufacturers representative. These men are genuinely interested in keeping up with the latest connector developments. A group in operation in the Phila. area known as Electronic Connector Study Group, was formed in 1958 by several components engineers from RCA, Remington Rand, Tele-Dynamics, Philco and Burroughs. The group meets periodically to discuss common technical problems. They also meet with manufacturers to interchange ideas and common problems, with the aim of self-improvement and contributing to the state-of-the-art in general.

The group is unsponsored, has no dues (expenses are taken care of by members as the need arises), and has no formal organization except for a Steering or Planning Committee. This Committee holds meetings as needed to plan future programs. All of the men who attend the meetings do so because of their interest in the subject, and at their own expense. They are not company delegates in the usual sense.

About once every six weeks a different manufac-

turer is invited to the meeting. The majority of meetings are held with a connector manufacturer, and representatives of other manufacturers are excluded. Some meetings are held on a subject of interest to both users and manufacturers with the presentation being given by invited speakers. At this type of meeting all users and manufacturers are invited. Education of the user is probably the most important factor in connector selection.

### Reliability

Some users feel that manufacturers' claims for their connectors are greatly exaggerated. They say that pages and pages of specs are quoted to emphasize just how reliable a particular connector is, and then when they use it, it fails. The first question which must be asked here is—why did the connector fail? Was it used in the environment for which it was designed? Did human influence affect its failure?

Manufacturers feel that their products are frequently misused by the equipment manufacturer or the ultimate user. This gives the connector an unfair reputation for poor reliability. Surveys in the past have shown that about 50% of all connector failures were caused by loose, broken and bent pins; and broken wires. This type of failure can generally be traced to careless handling. When connectors are properly protected and applied, they can be very reliable. Actual failure rate of connectors is probably about 1%.

Feedback of failure information to the manufacturer would help him to improve reliability. Also, when ordering connectors, a clear and complete statement of connector requirements would be helpful. Another point—be sure to order from a reliable manufacturer. Make certain that he will stand behind his product.

The trend to miniaturization has caused equipment and connector reliability to be sacrificed, or at least endangered. The connector industry is constantly at work on this problem. Manufacturers such as AMP, Inc., Bendix Scintilla, and Amphenol-Borg, have extensive R&D facilities which are concerned with, among other things, reliability. Other manufacturers are also working on the problem. Time and money is being spent and it is paying off. One last important point to remember—you must expect to pay for reliability. The more stringent and numerous the connector requirements, the greater the cost.

### Termination Methods

Contact termination is the permanent joint made between a connector contact and the conductor. There are four major methods of contact termination in use

today. They are the solder, crimp, solderless wrap and weld methods.

#### *Solder Method*

There are three common methods of making a solder connection to a connector contact. They are: solder cup, solder eye and solder dip. The solder cup contact is usually screw machined, while the solder eye is a sheet metal contact. When using the solder cup, the wire is inserted into the contact cavity which is filled with molten solder. With the solder eye method, the wire is pushed through the eye in the contact. It is then wrapped around the contact and soldered. With these types, the contacts are pre-assembled in the connector during manufacture.

A flat tab or a round pin is used when making solder dip connections. Pin to board terminations use these contacts. Multiple connections to a printed circuit board can be made fast and economically with this method.

Until a few years ago solder was the normally accepted method of fastening a wire to a connector con-

system cooling. This is apt to happen to solder because of its use of materials having a low melting point.

It is difficult to properly inspect a solder junction. This makes quality control a difficult task. Human variables involved (pre-cleaning, fluxing, soldering and post-cleaning) in the operation add to this difficulty.

Wire is made brittle by the solder process. There is a sharp transition from the wire which is flexible, to the junction which is rigid.

With solder, the entire connector must be replaced if a contact is permanently damaged.

It is difficult to solder a miniature connector because of the close spacing of contacts. At the other extreme, it is also difficult to replace or repair the wires in the center of a large connector having many connections.

It should be mentioned that it is best to use soldering or solderless wrap if the contacts must be environmentally sealed or bonded to the insert.

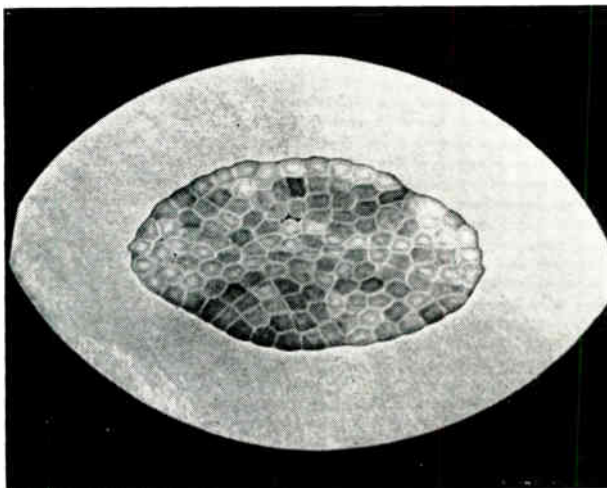

AMP photograph illustrates a confined "C" type crimp termination. It is used with closed barrel screw-machined contacts.

tact. This method is still widely used, but it is losing ground to some of the newer methods.

The soldering iron, a generally available tool is used with this method. Unfortunately, it is often improperly used. Factory and service personnel sometimes are not skilled enough, or are careless in its use. This results in cold or high resistance solder joints, burned wires and heat damage to parts which are close to the area being soldered. Also, through carelessness, solder may be allowed to drop into the equipment and endanger other components.

A solder junction is free of exposure type contamination, but it is also susceptible to corrosion due to the use of fluxing and pre-cleaning solutions. In high heat environments it can soften due to insufficient

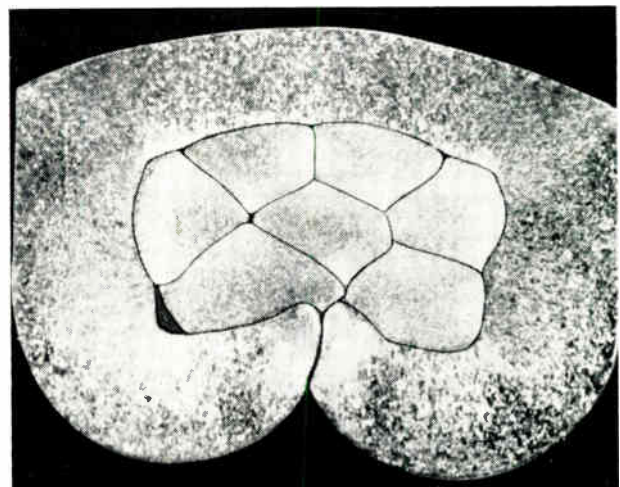

AMP photograph illustrates an "F" type of crimp termination. It is used with U shaped contacts for high speed production.

Another attractive feature of the solder type connector is its generally low cost.

#### *Crimp Method*

The crimp method of making terminations has made steady gains in popularity since its inception. There are good reasons for this.

Crimp type connections allow the user to make the installation at any point in his production cycle. This simplifies the operation and at the same time lowers the cost. In addition to the time saved during initial wiring and assembly of the connector, individual contact replacement can be done without removing the connector from its mounting. Snap-in contacts can be crimped and placed in the insulator at any time. Thus, with the use of a simple extraction tool,

## CONNECTORS (Continued)

a contact can be removed for circuit changes or checks and be reinserted at any time.

Stranded and insulated wire can be crimped more readily than soldered. A crimped termination can withstand temperature, shock and vibration better than a soldered termination.

The human factor is limited with this method, making possible the use of unskilled personnel. Quality control inspection may be easily made as the crimp may be physically measured.

Connection is made through direct contact with the metal. The heat problem is eliminated. Even coaxial cable connectors may be crimped.

Crimping can be done with simple hand tools, or automatic machinery. This machinery is generally leased or rented from the manufacturer.

There are certain disadvantages associated with the crimp method. Reuse of crimp junctions is almost impossible.

Special tools are needed in order to make a proper crimp joint. Also, there must be enough clearance in the area of the connection to allow for the swing of the crimp tool.

### *Solderless Wrap Method*

This method of making terminations, as with the crimp method, is gaining in popularity. It is also commonly known as the Gardner-Denver Wire-Wrap.

With this method the wire is, as the name implies, wrapped around a long terminal. A hand tool is used to achieve the wrap. A wire with a skinned end is inserted into the tool wrapping bit. The bit is placed over the terminal to be wrapped and in about 1/10 of a second the wire is wound around the terminal.

This produces a permanent gastight connection. Automated machines may also be used for the wire wrapping of terminals. Automatic machine operation is controlled by program information from punched cards or tape. These machines can also be operated semi-automatically by an operator.

In automatic operation the machine wraps inter-connecting wires in an electronic assembly which has terminals located on a grid pattern in one plane. It wraps both ends of each wire simultaneously and in opposite directions. The wire is automatically cut and stripped.

The connection achieved is gastight. It has mechanical stability and no stress concentrations. It produces large contact areas and high pressure contact.

Here, as in the crimp method, the human factor is at a minimum. The finished junction may be soldered if needed. Also, the contacts are capable of being rewrapped.

A wire wrap terminal may accommodate three or more connections without crowding. The process is cheap and fast, but still reliable. There is a clean metal-to-metal contact between wire and terminal.

All processes have their limitations and wire wrap is no exception. Solid wire must be used which, in itself, has environmental limitations. Tools must be constantly monitored to insure production reliability. A wire wrap joint can only be tested by the unwrap and pull test. This establishes the minimum and maximum for a good connection. Naturally, these tests can only be performed on a test connection basis.

A major complaint against the wire wrap method is that it requires the use of fairly sophisticated tooling.

### *Weld Method*

There are people in industry who feel the welding method will begin to replace the other methods in usage within the next three years. This may be true, but a number of problems must be solved before this prediction comes to pass.

Pneumatically - operated semi-automatic tool (l) made by Buchanan will crimp over 100 contacts with one loading.

Taper pins are easily inserted into connector with hand insertion tool made by Thomas & Betts (r).





At the present time inspections of the welded joint must be visual. Performance data obtained by sampling methods is sometimes used as a guide. No satisfactory method exists for non-destructively testing a welded wire joint.

Testing methods using calibrated fixtures or hand assemblies that exert a constant minor load on the welded joint have been tried by various organizations. More precise evaluation of this method is necessary before its use is recommended, as even minor stressing of the welds can initiate damage at the weld interface or in adjacent welds. Later handling or testing can aggravate these areas to failure. More research effort is needed in this area.

It is believed that the most effective available inspection method is the close control of equipment, process, and material variables. This requires the use of welding equipment that provides variable control of pressure and energy settings.

Welded joints, if properly made, are strong, but in the event of failure, special tooling is needed for repair.

With the normal weld joint, diameter of the material is increased slightly. Cannon Electric Co. has developed an arc-percussion welding method which makes a butt weld with no increase in diameter.

The three year figure mentioned should not be scoffed at. If the research work of firms such as Unitek Corp., Weldmatic Div., progresses as expected the welding method could well become useful for many connector applications.

A welding process lends itself to automation and thus a cost saving which is always attractive. Also, there is no "soft" metal to melt as in a solder connection.

### Contacts

There are many types of contacts available. Some of them are familiar to most engineers, but others are either new or so rarely used that they are unfamiliar. Let's examine some of the various types.

Pin and socket types are easily recognized. These use a round pin as the male member and a cylindrical socket as the female member. The female portion may be a stamped metal part, formed round, and possibly with an indented portion or neck which makes the contact with the pin. It may also be of tubular design with saw slots on the mating end. This allows that portion to be pinched in to reduce the diameter for making contact with the male pin. There is a snap-in variety available. This type may be terminated to the wire and then, using a special tool, pushed (snapped-in) into the connector body. An advantage of this type is that contacts may be placed only where needed

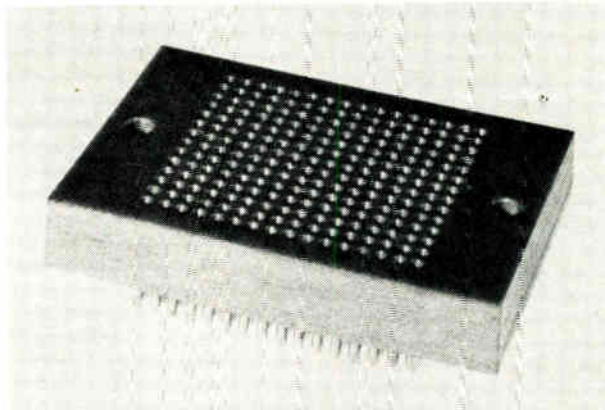

Package damage due to soldering or clip leads is eliminated through use of this test connector. Made by Barnes Development Co., it allows a fast connection to be made between chassis mounted test circuitry and microminiature circuit modules.

in the body. Thus the user does not have to pay for contacts which he doesn't need. Also, in the event of damage, individual contacts may be replaced rather than complete connectors. Other advantages of this type were discussed in the section on crimp terminations.

The "butt" type contact achieves its mating action merely by the touching of two surfaces. In order to establish enough pressure to insure a good contact, parts used in this type of connector must be spring loaded.

The tuning fork contact is generally stamped of heavy sheet metal and has relatively short, rigid spring members. This type exerts a great deal of pressure on the printed circuit board with which it is used. Due to its high pressure, it can damage the plating surface and expose the basic metal after a few mates if improperly used. These are best when used in a semi-permanent connection. A variation of this type is Elco Corporation's Varicon contact. On these, mating takes place on four bevelled surfaces at the interior corners of a slot. These surfaces provide a smooth and relatively large area on a true 45° angle. Grain of the material runs perpendicular to the direction of mating, eliminating the tendency toward relaxation. The two tines on each mating member are always under pressure when mated. This reduces the possibility of oxidation of the mating surfaces. This type can be mounted to the printed circuit board making both the male and female members exactly alike. The sliding or wiping action of the contacts breaks any film that may exist. This action actually burnishes the plating material into the base metal. This eliminates microscopic peaks and valleys and provides an even greater mating area than the original. Contact resistance in this type is less than 0.002 ohm.

The cantilever type spring contact is generally

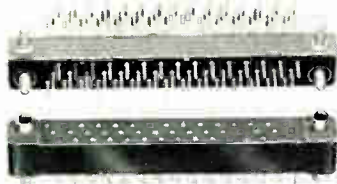

Sub-Miniature Printed Circuit connectors made by Continental Connector Corp., use both dip solder and solder eye methods of termination. Right angle pins dip solder directly to PC board. Three-row, staggered contact placement has 0.050 in. center to center spacing between contacts.

These Deutsch Snap-In Coaxial Contacts feature crimp terminated outer conductors and inner contacts. The inner-socket contact is also the closed entry type. This design resists damage to the pin or socket during mating or from using a test probe.

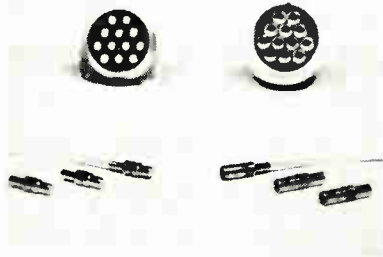

Hand-insertable, snap-in, snap-out, crimp-type contacts of this connector fit into sleeves instead of riding on bare plastic of the connector body. Male and female contacts in U.S. Components Corp. REMI connector are interchangeable as to position.

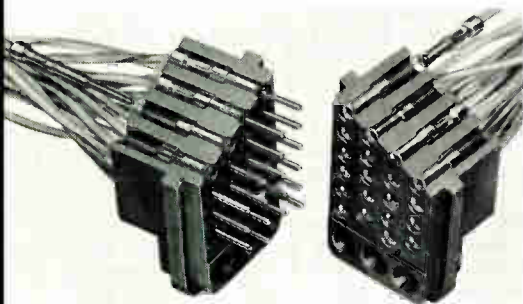

Flat flexible cable connector developed by Burndy Corp., involves no preparation or stripping of cable before using. Contact in the connectors is accomplished quickly and easily through insulation "milling." Connector allows 19 connections to be made in 19 seconds.



Series 7021 and 7022 Varicon contacts are bonded within a dialyl phthalate insulator block which remains as a part of the connector. This series replaces and is interchangeable with an earlier Elco Corp. series in which contacts were supplied on removable strips.

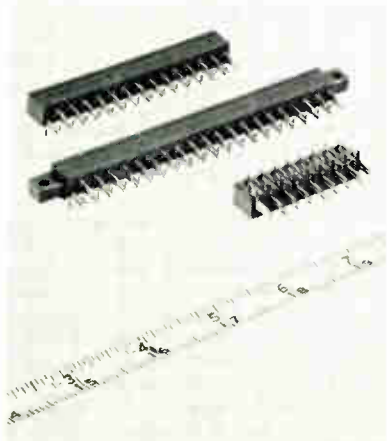

## CONNECTORS (Continued)

formed from sheet metal. It has only one short spring member which provides only one or two points of contact. This type is sometimes bifurcated, giving additional points of contact.

The accordion-type spring contact is formed from strip metal. It has long spring members and thus is able to accept boards of various thicknesses with only a small change in contact force. This type has four or more points of contact. As with the cantilever type it is sometimes bifurcated, giving it additional points of contact with the board.

The hyperboloid or wire cage contact uses a geometrical socket. This socket consists of metallic wires forming a resilient cage. When a solid pin is inserted into the cage, it makes even contact along the wires which form the cage. Wires of the cage are under tension and the arrangement assures a low spring rate with good wear allowance. It is a feature of Electronic Fittings Corp.'s CURTAC connectors.

The Cannon Micropin or twisted-wire pin consists of seven strands of 0.005 dia. bronze wire wound helically around a core of three strands of 0.0035 dia. soft copper wire. This special "cable" is 4-way crimped into a pin sleeve at one end, and terminated in a hemispherically shaped weld at the other end. Between these ends, the strands have been shaped into a bulge. Diameter of the bulge is slightly larger than the inside diameter of the socket. Contact action of the pin is to elongate and twist during entrance into the socket. Contact is maintained along seven spiral lines. The socket itself is simply a tube of the proper (0.0225) inside diameter. It has a chamfered entry and is simple and inexpensive.

A contact similar to the Micropin is Amphenol's Poke-Home contact. This type has a four-member spring design. The members exert self-equalizing force on four separate contact areas on the female wall. Female contacts are cylindrical in form.

A connector developed for the Goddard Space Flight Center by Components Corp., is primarily a contact. Called DIGI-KLIPS, it is composed of small heat-treated wire forms made of beryllium-copper. Designed for use with printed circuit boards, they are small and inexpensive. In actual tests they have performed at temperatures of more than 200°C without fatigue or failure. Since there are no enclosures or cavities, they can be sterilized completely for either space or medical use. They can also be formed into various shapes for special uses.

Connectors available from U.S. Components, Inc., feature hand-insertable snap-in, snap-out contacts.

The male and female spring phosphor bronze contacts snap into specially heat-treated beryllium copper sleeves instead of riding on the bare plastic of the connector body. Contacts are easily removable with a simple hand tool. The male and female contacts are interchangeable as to position. This feature provides many extra keying possibilities in addition to standard polarization.

A coaxial connector offered by AMP, Inc., features a simultaneous one-crimp termination of center conductor and outer shield, plus cable support.

Closed entry contacts are a feature of Continental Connector Corp.'s miniature rectangular connectors. The female member of these connectors is tapered at the end, spring loaded, and split into four sections and held together by a ring. When the male member is inserted, the four leaf spring pieces spread apart. The spring action causes them to grasp the male member making a reliable contact.

Some of the contacts which have been mentioned are unique at this time but they no doubt will find increased usage as engineers become aware of their existence. Other types are illustrated in the accompanying photographs.

### Plating Materials

Selection of plating materials should be done on an individual basis to suit customer needs. It is doubtful if one type of finish will ever satisfy every need. Main consideration should be the use conditions of the connector. Of course, cost is often a determining factor. Gold plating, for example, can be seventy times the cost of an equal plating of silver. Customers should take all factors into consideration when specifying connector plating. Plating material, thickness, and the surface area of the connector are the controlling factors.

The Connector Committee of the EIA has established a subcommittee to investigate various types of contact plating. They are trying to gather enough data for submission of real and final recommendations. It is probable that these will include specific finishes for 4 or 5 different classes of environmental severity. The user will then have to determine which category his requirement falls under, and pick the appropriate finish.

Other factors which determine the effectiveness of the plated surfaces include: cleanliness, composition, surface condition of the metal, rate of application and purity of the plate, and control of the process. The manufacturer should be consulted when specifying the plating material. He has the experience and technical know-how needed to select the proper plating for any particular use.

### Insert Materials

The space age has brought about the need for lighter connectors. These must also be able to withstand extreme environments. A by-product of this requirement is the need for better and more economical materials. Choice of these materials must be carefully made. The particular thermoplastic or thermosetting plastic to be used is governed not only by the use, but also by the related size and design of the part. This includes wall thicknesses, section thickness variations, types of inserts needed, etc.

The plastic chosen should offer the lowest material cost/in.<sup>3</sup> of component part and the shortest mold cycle time while still satisfying the electrical, mechanical, thermal, and chemical resistance needs of the application. A plastic's characteristics when bonded and riveted, when encapsulated, and its chemical compatibility with other parts are other factors which must be considered.

Thermoplastic and thermosetting are the two main groups under which plastics can be classified. Thermoplastics soften when heated and solidify upon cooling. They can be reshaped over and over by alternate

Cannon Micropin is 4-way crimped into a pin sleeve at one end, and terminated in a hemispherically shaped weld at the other end. Seven spiral lines of contact are achieved with this method.



heating and cooling. Thermoplastics include: vinyls; polyamides (Nylon); polycarbonates (Lexan); acetates; styrene polymers and copolymers; acrylics; and polyolefins and polypropylenes.

Thermosetting plastics harden under heat into a permanent shape. The finished piece is really one large three dimensional molecule. Heating may soften the structure to a degree, but the flowability of the original uncured resin cannot be restored. Thermosets include: alkyds, epoxies, allyls (Diallyl Phthalate), phenolics, and melamine formaldehydes.

*Diallyl Phthalates* are used where high arc resistance, low dielectric loss, high dielectric strength, and good mechanical properties must be maintained under conditions of high humidity and elevated temperatures.

They have negligible post-mold shrinkage making them ideal for close-tolerance uses. Glass fiber reinforced diallyl phthalates are military approved molding materials for connector use.

*Phenolics* offer strong, rigid, dimensionally stable parts, resistance to heat and a wide variety of solv-



## CONNECTORS (Continued)

ents, and have good electrical characteristics and machinability.

They are easy to handle and are available in a range of colors.

*Melamine Formaldehyde*—No other thermosetting materials have such a variety of uses in so many fields.

Properties of melamine molding compounds will vary widely according to the kind of filler used. For example, glass fiber material has good electrical properties, high heat resistance and good impact strength. Asbestos filler is used for molding components needing maximum arc and heat resistance and dielectric strength with retention of these properties at elevated temperatures.

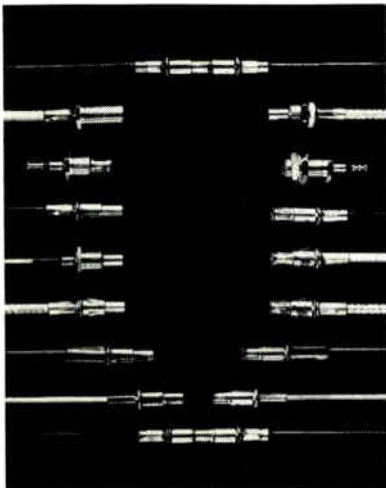

Variety of Microdot, Inc., Microcrimp coaxial connectors were specifically designed for application to digital computer circuitry. These miniature solderless connectors can be assembled with a single crimping tool. Inspection holes are provided in both the center contact and the shield crimping sleeves.

*Polycarbonates* are available in a number of injection molding, extrusion and casting grades. Polycarbonate resin is well-suited, from a properties standpoint, to the demanding needs of critical electrical and electronic products. It is self-extinguishable, has good heat stability, high impact strength, good dimensional stability over a wide range of temperature and humidity environments, and stable electrical properties. Transparency, creep resistance, a high gloss surface finish, and low predictable mold shrinkage are also important attributes of polycarbonate resin.

*Alkyds*—Alkyd resins contain no highly volatile monomer and do not degass during cure. They have good arc and heat resistance; resistance to moisture, acids, and solvents; dielectric qualities; and dimensional stability at high temperatures.

Alkyds may be processed economically because of their low pressure molding characteristics and high speed cure which allow high production rates.

## Standardization

There has been a great deal of talk about standardizing connectors. Needless to say, the military is, and will continue to be, interested in standardization. It would solve many problems. Costs could be kept to a minimum. Connector inventories could be cut as a lower variety would be needed for stock. Delivery time for connectors would be less as they would be standard items and there would be no wait for "tooling up."

The general feeling is that connectors cannot, and should not, be standardized. To do so would limit new equipment design concepts and stop any advancement of the connector art—connectors would never be improved. It could be argued that new connector designs could be considered and possibly be made standard items. This might be true, but it would take time—time which the industry cannot afford to waste.

There are several areas in which standardization might be realized. Crimp-type snap-in contacts and wire-wrap terminals are two parts which could possibly be standardized. Even today the ends of contacts which fit on external connectors must be standard. Those on connectors which are used internally (on equipment) need not be. The section of the contact which makes actual physical contact with another must be standard. This is to prevent a mismatch of connectors in equipment made by different manufacturers.

There have been recent designs offered which, although not standard items, should serve the same purpose. They should help cut inventories and thus cut costs and delivery time. In fact, any design which has flexibility helps to cut inventories and thus serves the same purpose as standardization.

The hermaphroditic connector is a partial answer to the inventory problem. This connector has no male or female members; it is sexless; both mating members are alike at their mating faces. This obviously cuts inventory needs in half.

Another is the modular packaging idea. Elco Corporation's Modu-Con is an example of this concept. The Modu-Con is both a module and a connector. The connector is an integral part of the module—a connection point or contact is treated as a component.

Several companies offer connectors designed for stack or modular use. With these types, the designer may use only as many contact positions as he needs. This is also possible with strip connectors such as those offered by Amphenol-Borg and Cannon. These connectors have their contacts in a single row in strips. These strips can be cut to length to provide a

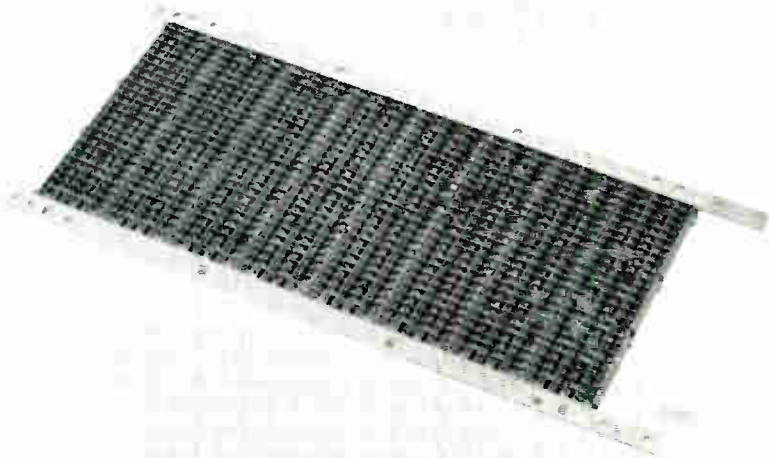

Patch panel is composed of many interlocking connectors. Plug-in units can be used for programming as needed by the user. Connections to these units are made by means of contacts within the connectors and each contact is connected to the others by a metal bus strip. Contacts are retained in this Elco connector by means of a spring lance.

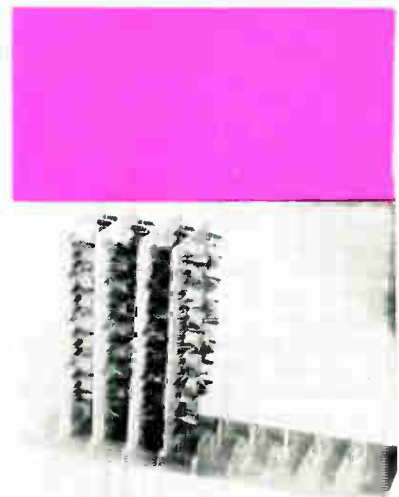

DIGI-KLIP connector made by Components Corp., is composed of heat treated beryllium-copper wire forms mounted in a printed circuit board. The keying is done with blank KLIPS ("bar-keys") or pins.

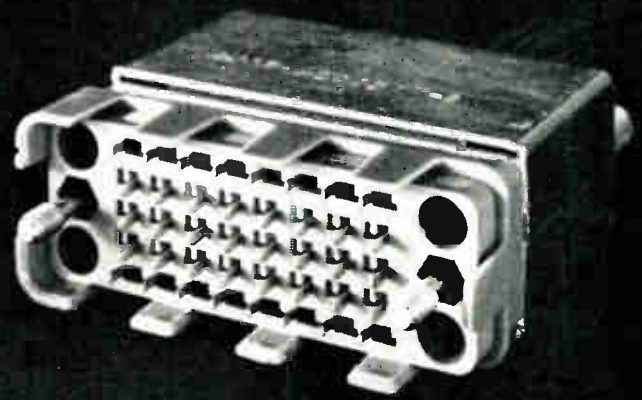
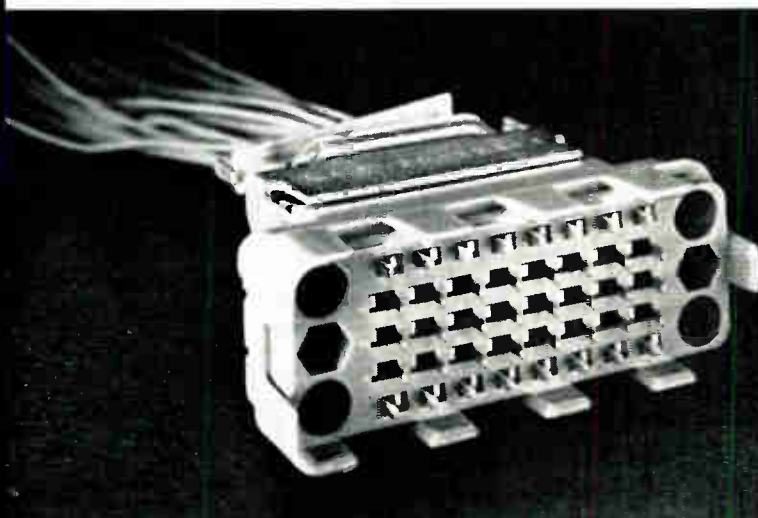

Identical crimped contacts can be snapped into either half of this miniature AMP DUALATCH Connector. Controlled crimping is done on A-MP Automachines at rates up to 1500 terminations/hr.

Burndy connector, along with six plug-in printed circuit boards, is used for programming of an ITT Corp. electronic system. Programming is done by changing the base wiring of the connector.

Pancake or Tri-Lock connector (below rt.) recently announced by Bendix Scintilla Div., is about half the size and weight of the company's standard Pygmy connector shown on the left.

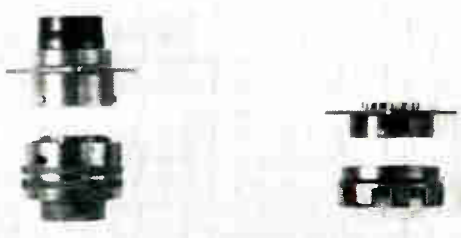

## CONNECTORS (Continued)

number of contacts in a row. Strips can be mounted to circuit boards with adhesive compounds or screws.

Another development which could aid in cutting inventories is Amphenol's Intercon—a three-dimensional, weldable miniaturized circuitry for providing interconnections. Intercon has projecting tabs that are integral parts of the interconnecting wire pattern. The tabs are projected into the third dimension beside each component lead. This permits quick reliable welding or soldering by an automated process. These tabs may be lifted where desired by any simple tool. A hand punch can be used to interrupt conductors.

Brown Engineering Co.'s "Becon" is adaptable to various uses. This connector is but a block of diallyl phthalate into which have been molded grooves to carry the contact springs of gold plated beryllium copper. The plastic contains tapped bushings for hold-



Miniature connector made by Continental accepts either pc boards or tape cable. It uses "Bellow-form" contacts which provide coil spring action grip that clasps the pc board over the entire contact area.

down screws. This connector can be screwed down anywhere on a printed circuit board. When attached to the board, protruding contacts are compressed against mating conductors on the boards. These connectors are being used in the Saturn rocket.

The connectors mentioned all have the same virtue—flexibility. As long as connectors have flexibility there will never be any serious effort to force standardization. In fact, some companies have such stringent or unusual connector needs, or feel so strongly about anyone outside the company knowing their plans, that they design their own connectors. These companies generally obtain a patent on the connector and then contract a connector manufacturer to make the connector for them. Obviously, only a company with a need for a large number of connectors could do this. As a rule, at least 2000 to 5000 connectors would have to be made before the tooling would pay for itself. Also, it must be remembered that the designer bears the responsibility for design inadequacies.

### New Designs & Trends

Connector manufacturers have been making remarkable strides in connector design. As long as we have changing needs the electronic industry will grow

and with it the connector industry. Engineers will continue to attempt to design connectors out of equipment; and connectors will continue to be needed for reasons of convenience, maintenance, testing and cost. A word about that last item—cost. As long as we have the throw-away trend, the connector is needed. This trend cuts costs. Instead of replacing an entire package, a plug-in portion of it may be replaced.

A project on which the Burndy Corp. is now working illustrates this last point. A micro-modular package which costs about \$10,000 is being used by a Burndy customer. This package contains many modules which dip solder into the main board which in turn contains one connector. As it now stands, if one of these modules fails, the entire package is inoperative, and it is a major task to replace the defective module. Because of one small unit, the entire package must be replaced.

Burndy has proposed a micromodule package with module plug-in units. This would require many more connectors, but it would allow the individual modules to be serviced in the field. Result—many more connectors, but a more serviceable unit. Also, a \$10,000 package is not needed as a spare.

Another Burndy project is concerned with a unique use of connectors. The company, working with ITT on one of their systems, has developed a connector, which, along with six plug-in printed circuit boards, is used for programming purposes. The printed circuit boards are plugged into a base connected to the equipment (see illustration). The other end is plugged into another receptacle which contains wiring. Programming is done by changing the printed circuit board cards and/or the base wiring.

Probably the most important trend in the connector industry today is the one which the entire industry is following. It is the trend to miniaturization. Connectors with 0.050 centers are being made today. Actually, we are told that the only ones now used are in prototype machines. So, it appears that the connector manufacturers are ahead of the industry in this respect. Lighter and smaller ones appear every day. Bendix Scintilla recently announced a new line of connectors called Pancake. They have the same mounting dimensions as their Pygmy line but are only about half the size and weight.

ELECTRONIC INDUSTRIES has just been notified of a development which could well become a trend in the connector industry. Amphenol has an-

---

A REPRINT OF THIS ARTICLE CAN BE OBTAINED  
by writing on company letterhead to  
The Editor  
ELECTRONIC INDUSTRIES  
Chestnut & 56th Sts., Phila. 39, Pa.

---



nounced that they are now in the interconnecting business—not just in the business of making connectors. They are offering to their customers the technical know-how to design and produce interconnecting systems for complex electronic installations.

They say that if consulted they can determine which type of interconnecting method can be used. It might be a conventional connector, Intercon, or a combination of these. If this combination is the answer, it probably will involve packaging modules to perform this interconnecting service. They are prepared to do this packaging. In fact, they are setting up a national program to do this. Look for other companies to follow suit. We should see an increasing number of connectors being built into modules.

Advances have been made in materials, both for insulating and plating, but not so many that there is not room for many more.

Flexible tape cables are finding increasing usage. This is, and will continue to be, reflected in new connector designs. Unfortunately, most of these designs have required that the tape cable be stripped or otherwise prepared before using with the connector. A new connector developed by Burndy needs no stripping. Called Tapecon, it uses an insulation milling design.

Elco's series 1422 panel is composed of many interlocking connectors placed together to form a patch panel. Patch cords, diode plugs and other devices can be plugged in for programming as needed by the user. Connections to the plug-in units are made by means of contacts within the connectors. Each contact is connected to the other contacts within the row by means of a metal bus strip. This strip has contacts at fixed intervals. It is supplied either cut to length or in reels.

It is expected that coaxial cable will go more to solid and multiple-layered outer conductors in order to cut down on radiation. This will mean new coaxial connectors will have to be made. Also, there will be an increasing need for connectors for the higher frequencies. For example, Gremar (and surely others) is developing connectors for use in X-Ray tube circuitry, Laser and Maser power supplies and chemical fuel cells.

More work will be done to update current military specs. The feeling at this time seems to be that most current specifications are at least five years behind the industry needs. A few might be ahead of the industry but these are rare.

Finally, with increased cooperation between the user and the manufacturer, it is difficult to say just how far the connector and electronic industries can go. At this point it would seem to be very far indeed.

The author would like to thank the following for their contributions to this article:

AMP, Inc., Harrisburg, Pa.  
 Amphenol Connector Div., Amphenol-Borg Electronics Corp., Chicago, Ill.  
 Andrew Corp., Chicago, Ill.  
 Barnes Development Co., Lansdowne, Pa.  
 Berg Mfg. Corp., New Cumberland, Pa.  
 Brown Eng. Co., Inc., Huntsville, Ala.  
 Buchanan Electrical Prod. Corp., Hillside, N. J.  
 Burndy Corp., Norwalk, Conn.  
 Burroughs Corp., Paoli, Pa.  
 Camblock Corp., Waltham, Mass.  
 Cannon Electric Co., Los Angeles, Calif.  
 Cinch Mfg. Corp., Chicago, Ill.  
 Circon Components Corp., Santa Barbara, Calif.  
 Clevite Ordnance Div. Clevite Corp., Cleveland, Ohio.  
 Components Corp., Denville, N. J.  
 Continental Connector Corp., Woodside, N. Y.  
 Deutch Co., Electronic Components Div., Banning, Calif.  
 Donmar Products Inc., Denver, Colo.  
 Elco Corp., Willow Grove, Pa.  
 Gardner-Denver Co., Quincy, Ill.  
 General Radio Co., West Concord, Mass.  
 Gremar Mfg. Co., Wakefield, Mass.  
 Gulston Industries, Inc., Metuchen, N. J.  
 Hermetic Pacific Corp., Rosemead, Calif.  
 Malco Mfg. Co., Chicago, Ill.  
 McCormick Selph Assoc., Hollister, Calif.  
 Micon Electronics Inc., Garden City, N. Y.  
 Microdot Inc., Los Angeles, Calif.  
 Molded Insulation Co., Philadelphia, Pa.  
 National Connector Corp., Minneapolis, Minn.  
 National Tel Tronics Corp., Yonkers, N. Y.  
 Norman Jones, Inc., So. Merrimac, N. H.  
 Physical Sciences Corp., Los Angeles, Calif.  
 Prodelin, Inc., Hightstown, N. J.  
 Pyle-National Co., Chicago, Ill.  
 RCA, Camden, N. J.  
 Remington Rand Univac, Blue Bell, Pa.  
 Sealectro Corp., Mamaroneck, N. Y.  
 Sintilla Div., Bendix Corp., Sidney, N. Y.  
 Star-tronics, Inc., Georgetown, Mass.  
 Stoddart Aircraft Radio Co., Inc., Hollywood, Calif.  
 Switchcraft, Inc., Chicago, Ill.  
 Thomas & Betts Co., Inc., Elizabeth, N. J.  
 Titeflex, Inc., Springfield, Mass.  
 Trompeter Electronics Inc., Canoga Park, Calif.  
 U. S. Components, New York, N. Y.  
 Viking Industries, Inc., Canoga Park, Calif.  
 Weldmatic Div., Unitek Corp., Monrovia, Calif.

(See Connector Glossary on following pages)

Brown Engineering Co. connector can be attached anywhere on a printed circuit board. When attached to the board, protruding contacts are compressed against mating conductors on the board.

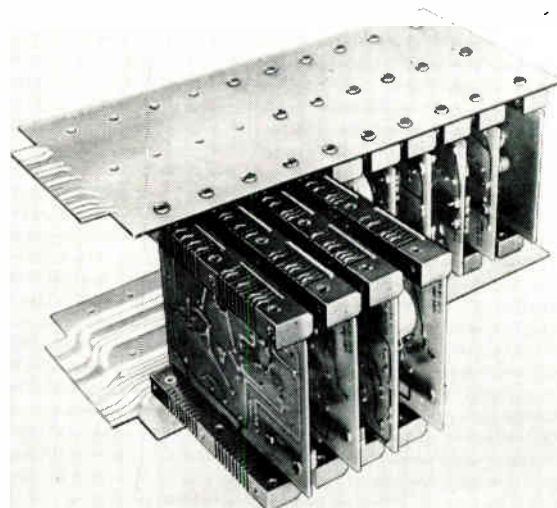

## GLOSSARY OF CONNECTOR TERMS

**ACCORDION**—A type of printed circuit connector contact where the spring is given a "Z" shape to permit high deflection without overstress.

**BACK-MOUNTED**—When a connector is mounted from the inside of a panel or box with its mounting flanges inside the equipment.

**BAIL**—Loop of wire used to prevent permanent separation of two or more parts assembled together. Example: the bail holding dustcaps on round connectors.

**BARREL**—Cylindrical portion or portions of a terminal, splice or contact accommodating the conductor or conductors.

**BASE METAL**—Metal from which the connector is made and on which one or more metals or coatings may be deposited.

**BAYONET COUPLING**—A quick coupling device for plug and receptacle connectors, accomplished by rotation under pressure of the two parts.

**BELLED MOUTH**—Flared or widened entrance to a connector barrel, permitting easier insertion of the conductor.

**BIFURCATE**—Describes lengthwise slotting of a flat spring contact, as used in a printed circuit connector, to increase the flexibility of the spring and provide additional points of contact. Example: Bifurcated contact.

**BODY**—Main, or largest, portion of a connector to which other portions are attached.

**BOOT**—A form placed around wire termination of a multiple-contact connector to contain the liquid potting compound before it hardens. Also a protective housing usually made from a resilient material to prevent entry of moisture into a connector.

**BUTT**—When two conductors come together end-to-end, but do not overlap, with their axis in line.

**CAMFER**—Angle on the inside edge of the barrel entrance of a connector which permits easier insertion of the cable into the barrel.

**CLOSED ENTRY**—Any design which limits the size of the mating part to a certain dimension.

**CONFIGURATION**—Number, spacing and arrangement of contacts in a multiple-contact connector.

**CONNECTOR**—Used generally to describe all devices used to terminate or connect electrical conductors. In the electronics industry it is used more specifically to describe a multicontact connector as opposed to single conductor terminals or splices.

**CONNECTOR ASSEMBLY**—Consists of a mated plug and receptacle.

**CONTACT**—A name given to the element in a connector which makes the actual electrical contact between two halves. Also, the point of joining in an electrical connection.

**CONTACT ALIGNMENT**—Defines the overall side play which contacts shall have within the insert cavity so as to permit self-alignment of mated contacts. Sometimes referred to as amount of contact float.

**CONTACT AREA**—Area in contact between two conductors or a conductor and a connector permitting flow of electricity.

**CONTACT ENGAGING AND SEPARATING FORCE**—Force needed to either engage or separate random-picked pins and sockets when they are both in and out of connector inserts. Values are generally established for maximum, average, and minimum forces. Performance acceptance levels vary by specification and/or customer requirements. Sometimes contact engaging and separating force is not only measured initially but also after a specified number of engagements and separations.

**CONTACT LENGTH**—Length of travel made by one contact in contact with another during assembly or disassembly of a connector. Also see **WIPING ACTION**.

**CONTACT RESISTANCE**—Maximum permitted electrical resistance of pin and socket contacts when assembled in a connector under typical service use. Electrical resistance of each pair of mated pin and socket contacts in the connector assembly is determined by measuring the voltage drop from the extreme terminal end of the pin to the extreme terminal end of the socket (excluding both crimps) when carrying a specified test current. Overall contact resistance includes measurement from wire to wire.

**CONTACT RETENTION**—Defines minimum axial load in either direction which a contact must withstand while remaining firmly fixed in its normal position within an insert. Generally the test load is increased uniformly at a rate of 1 lb./sec. until the minimum requirement is reached.

**CONTACT SIZE**—Defines the largest size wire which can be used with the specific contact. By specification dimensioning it also defines the diameter of the engagement end of the pin.

**CRIMP**—Act of compressing (deforming) a connector barrel around a cable in order to make an electrical connection.

**DEAD-FRONT**—Mating surface of a connector designed so that the contacts are recessed below the surface of the connector insulator body to prevent accidental short-circuiting of the contacts.

**DEPTH OF CRIMP**—Thickness of the crimped portion of a connector measured between two opposite points on the crimped surface. Also see "**T**" DIMENSION.

**DETENT**—A bump, or raised section projecting from the surface of a spring or other part.

**DIP SOLDERED**—Process of making electrical connections, usually to a printed circuit board, by the use of dipping one side of the board in molten solder, thus soldering the projecting component leads to the circuitry printed on the board.

**ENVIRONMENTALLY SEALED**—Connector is provided with gaskets, seals, potting or other devices to keep out moisture, dirt, air or dust which might reduce its performance.

**EXTRACTION TOOL**—A tool used for removing a contact from a connector.

**FACE SEAL**—That design feature which fills the voids between the faces of Plug and Receptacle when they are fully engaged. This provides an environmental seal between the faces of the Plug and Receptacle and also increases the dielectric between contacts which can increase the service rating of the connector.

**FEED-THRU**—A connector or terminal block, usually having double-ended terminals which permit simple distribution and bussing of electrical circuits. Also used to describe a bushing in a wall or bulkhead separating compartments at different pressure levels, with terminations on both sides.

**FERRULE**—A short tube. Used to make solderless connections to shielded or coaxial cable. Also molded into the plastic inserts of multiple contact connectors to provide strong, wear-resistant shoulders on which contact retaining-springs can bear.

**FLAG TERMINAL**—A type of terminal where the tongue projects out from the side of the terminal barrel rather than the end of the barrel.

**FLANGE**—A projection extending from, or around the periphery of, a connector and provided with holes to permit mounting the connector to a panel, or to another mating connector half.

**FLASH**—A thin film of metal formed at the sides of a forging or casting where some of the metal is forced between the faces of the forging dies or the mold halves. Also the excess metal extruded between both halves of crimping dies when making certain circumferential or symmetrical crimps. Also a thin deposit of plastic material usually at the base of molded-in pins.

**FLOATING BUSHING**—A design feature which aids in the alignment of Plug and Receptacle shells during engagement. The Floating Bushing generally is an eyelet type bushing which is fitted into the Plug mounting holes so that there is freedom of motion in all directions between the plug and receptacle.

**FRAME**—In the case of a multiple contact connector having a removable body or insert, the frame is the surrounding portion (usually metal) which supports the insert and permits a method for mounting the connector to a panel, or a mating connector half.

**FRONT-MOUNTED**—A connector is front-mounted when it is attached to the outside or mating side of a panel. A front-mounted connector can only be installed or removed from the outside of the equipment.

**GRID-SPACED**—When contacts in a multiple-contact connector or on the edge of a printed circuit board are spaced equally in a geometric pattern.

**GROMMET**—A rubber seal used on the cable side of a multiple-contact connector to seal the connector against moisture, dirt or air.



**GROOVE**—Slot or cavity in a connector which bears directly on the cable. Also the depression in a crimping die which holds the connector during crimping.

**GUIDE PIN**—A pin or rod extending beyond the mating face of a two-piece connector and designed to guide the closing or assembly of the connector to assure proper mating of contacts, and to prevent damage to these contacts caused by mismating of the connector halves.

**HARDWARE**—Hardware usually means shells, guide pins, polarizing pins, strain relief clamps, mounting screws, etc.

**HERMAPHRODITIC CONNECTOR**—A connector in which both mating members are exactly alike at their mating face. There are no male or female members, but provisions have been made to maintain correct polarity, hot lead protection, sealing and coupling.

**HERMETIC SEAL**—Hermetically sealed connectors are usually multiple contact connectors where the contacts are bonded to the connector by glass or other materials and permit a maximum leakage rate of gas through the connector of 0.1 micron ft.<sup>3</sup>/hr. at one atmosphere pressure.

**HIGH POTENTIAL**—Minimum test voltage which an electrical connector shall withstand for one minute without showing evidence of electrical breakdown when the voltage is applied between the two closest contacts and between the shell and the contacts closest to the shell.

**HOLDING STRENGTH**—Ability of a connector to remain assembled to a cable when under tension.

**INHIBITOR**—A corrosion inhibitor is a material which prevents or delays oxidation and galvanic action on a connector surface, or the interface of different conductors.

**INSERT**—That part which holds the contacts in their proper arrangement and electrically insulates them from each other and from the shell. Also referred to as a **BODY** or **PANEL**.

**INSERT CAVITY**—A defined hole in the connector insert into which the contacts must fit.

**INSERT RETENTION**—Axial load in either direction which an insert must withstand without being dislocated from its normal position in the connector shell. Generally the load is accomplished by applying air pressure to either face of the insert and is increased uniformly at a rate of about 10 lb./sec. until the specified pressure is reached. The insert must retain its normal location in the connector shell for a minimum time at the specified pressure.

**INSULATION RESISTANCE**—Minimum megohm resistance permitted when insulation resistance is measured between any pair of contacts and between any contact and the shell.

**INSERTION TOOL**—A small, hand-held tool used to insert contacts into a connector.

**INTERCHANGABLE CONNECTOR**—A connector which can mate with another made by a different manufacturer. Also describes a type of connector where inserts having various contact configurations can be interchanged in the standard shell.

**INTERFACE**—The two surfaces on the contact side of both halves of a multiple-contact connector which face each other when the connector is assembled.

**INTERFACIAL SEAL**—Sealing of a two-piece, multiple-contact connector over the whole area of the interface to provide sealing around each contact. This is usually done by providing a soft insert material on one or both halves of the connector which are in compression when mated.

**JACKSCREW**—A screw attached to one-half of a two-piece, multiple-contact connector and used to draw both halves together and to separate them.

**KEY**—A short pin or other projection which slides in a mating slot or groove to guide two parts being assembled. Generally used in round, shell-enclosed connectors to obtain polarization.

**KEYWAY**—The slot or groove in which a key slides.

**LONGITUDINAL INDENT**—An indent shape where the longest dimension is in line with the connector barrel.

**MATE**—Joining of two connector halves; or of a cable to a connector.

**MIGRATION**—In the case of some plated metals, such as gold plated over silver, the silver ions can migrate or move through the gold plating to the surface of the

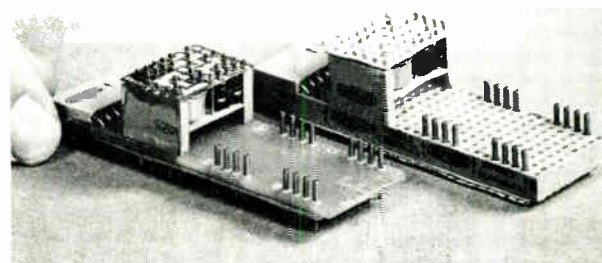
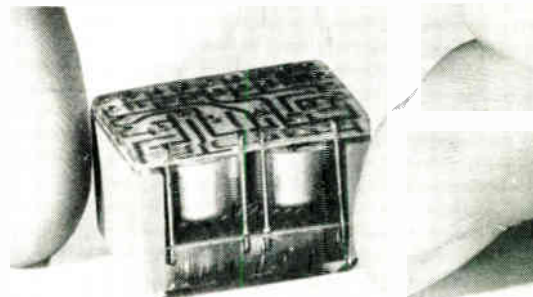
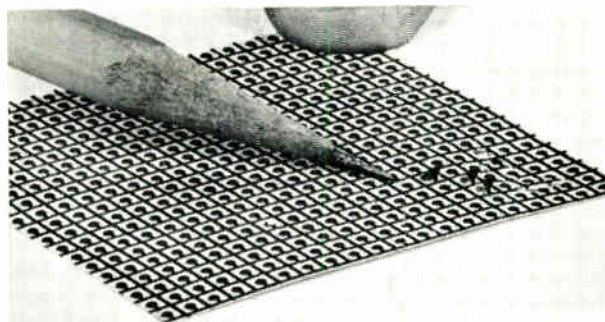

Intercon connector (top) has projecting tabs that can be welded or soldered by an automated process. Prototype module (center) is made of Intercon and strip connectors. These are plain, flat connectors that can be cut to fit any application. Bottom photo shows a production unit (left) and a prototype unit (right) of an Amphenol interconnecting system which the company is now offering to industry. Prototype unit makes use of a combination of strip connectors attached to one another plus Intercon mounted on the module.

Connector designed by Remington Rand Univac has a contact density of 22 contacts/in.<sup>2</sup> Two different types of polarizing pins are also used as through contacts. Female contacts are removable. Two levels of female contacts reduce insertion force. A later design has four more contacts in the same spacing.

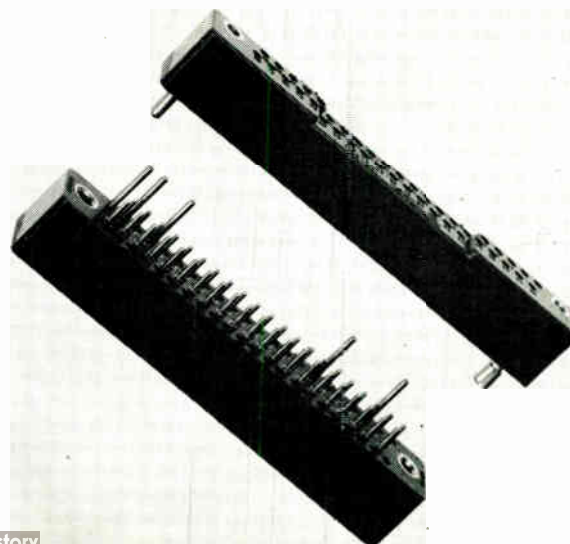



## GLOSSARY OF CONNECTOR TERMS

(Continued)

gold and oxidize. This can be a problem when silver is used as an underplate for gold plating.

**MODULAR**—A modular connector is one in which similar or identical sections can be assembled together to provide the best connector type or size for the application.

**MOUTH**—Cable entrance of a connector barrel. See **BELLED MOUTH**.

**PERIPHERAL SEAL**—A design feature which provides an environmental seal between the forward end of plug and the forward end of the receptacle even though they are not fully engaged. It generally consists of a piece of rubber fastened around the inner sidewall of the receptacle front opening skirt or around the outer sidewall of the plug engagement section.

**PIN CONTACT**—A male-type contact, usually designed to mate with a socket or female contact. It is normally connected to the "dead" side of a circuit.

**PLUG**—The part of a connector which is normally "removeable" from the other, permanently mounted, part. Usually that half of a two-piece connector which contains the pin contacts.

**POLARIZE**—To design the two mating halves of a two-piece connector such that only a particular combination of halves can be assembled, thus preventing accidental assembly of unrelated circuits.

**POLARIZING PIN**—A pin located on one half of a two-piece connector in such a position that by mating with an appropriate hole on the other half during assembly of the connector it will assure that only related connector halves can be assembled. Also known as polarizing keys when applied to Edge-on printed circuit connectors.

**POSITIVE LOCK**—A type of latch or locking mechanism used to hold a die set in an installation tool, or an insert in a connector shell, in such a way that the parts cannot be unlocked accidentally. Also describes retention of certain wire terminating contacts (tabs) used with Edge-on printed circuit connectors.

**POTTING**—Sealing of the cable end of a multiple-contact connector with a plastic compound or material to exclude moisture, prevent short circuits, provide strain relief, etc.

**PROGRAMMING**—Ability to select various circuit patterns by interconnecting or "jumping" appropriate contacts on one side of a connector plug or panel.

**PULL-OUT**—Force needed to separate a cable from a connector by pulling them apart.

**QUAD-INDENT**—An indenter shape producing four closely-grouped indents on the connector barrel.

**QUICK DISCONNECT**—A type of connector shell which permits rapid locking and unlocking of two connector halves.

**RACK**—A drawer-type cabinet used to house components which permits convenient removal of portions of the equipment for repair or examination. A rack and panel connector is one which connects the inside back end of the cabinet (rack) with the drawer containing the equipment when it is fully inserted.

**RANGE**—Number of sizes of connectors or cables of a particular type.

**READ-OUT**—A term used with printed circuit boards and printed circuit connectors, meaning the ability to make contact with certain circuits. Example: a double read-out printed circuit connector will permit two wires to be connected to any one circuit on the printed circuit board.

**REAR SEAL**—That design feature which provides an environmental seal at the rear of Plug or Receptacle. It generally consists of rubber grommets which fit between the wire and sidewall of the insert cavities or consists of a flat sheet of rubber which fits between the back-up plate and insert of Plug and Receptacle. This flat sheet of rubber is sometimes called Family or Group Seal since it contains the same number of holes as the insert has cavities. It is through these holes that wires are threaded to the Connector Contacts.

**RECEPTACLE**—Usually the fixed or stationary half of a two-piece, multiple-contact connector. Also the connector half usually mounted on a panel and containing socket contacts.

**RIGHT ANGLE EDGE CONNECTOR**—One wherein the plug is mounted to a chassis or back panel and the receptacle is mounted along an edge of and soldered to the circuits of a printed circuit board. Pins of the receptacle generally are simple rod stock bent at right angles and molded into the receptacle insert. Board and receptacle assembly is inserted into the plug to complete circuit wiring.

**SAFETYING**—That feature of connector design which permits safety wiring of plug and/or receptacle to prevent the loosening or vibrating free of plug from receptacle.

**SELF-ALIGN**—Design of two mating parts so that they will engage in the proper relative position.

**SHANK**—Cylindrical or rod-like portion of a connector or contact.

**SHELL**—Outside case into which the insert and contacts are assembled. Shells of mating connectors usually also provide proper alignment and protection of projecting contacts.

**SMOOTH CONTACT**—A pin or socket contact having a relatively smooth profile or surface. Unlike standard contacts, the smooth contact does not have a locking spring projecting from its side, but is locked in the connector body by another method.

**SNAP-ON**—Used to describe the easy removal or assembly of one part to another. Example: Certain connectors are provided with snap-on plastic covers to permit quick and convenient installation.

**SOCKET CONNECTOR**—A connector containing socket contacts into which a plug connector having male contacts is inserted.

**SOCKET CONTACT**—A female contact designed to mate with a male contact. It is normally connected to the "live" side of a circuit.

**SOLDER-CUP**—A tubular end of a terminal in which a cable is inserted prior to being soldered.

**SOLDER-EYE**—A solder-type terminal provided with a hole at its end through which a wire can be inserted prior to being soldered. A ring-shaped contact termination of a printed circuit connector for the same purpose.

**SOLDERLESS WRAP**—Method of connecting a solid wire to a square, rectangular, or V-shaped terminal by tightly wrapping or winding it around with a special tool. Also **WIRE WRAP**.

**SPACER**—A metal piece placed between two conductors in a connector. Example: most aluminum to copper connectors use a spacer located between the dissimilar cables to reduce galvanic corrosion.

**SPRING-FINGER ACTION**—Design of a contact, as used in a printed circuit connector or a socket contact, permitting easy, stress-free spring action to provide contact pressure and/or retention.

**STREAMLINED**—Design of high-voltage connectors to eliminate sharp points or corners and to recess all hardware to reduce corona discharge.

**STRIP**—To remove insulation from a cable. Also "strip contacts," a continuous length of formed contacts for use in an automatic installation machine.

**STUFF**—Portion of a terminal connector located between the tongue and the barrel. Also called **RAMP**.

**"T" DIMENSION**—Dimension of the crimped portion of a connector measured between two opposite points on the crimped surface. Also called **"G" DIMENSION**.

**TAPE CABLE**—A form of multiple conductor consisting of parallel metal strips imbedded in insulating material. Also called **FLAT FLEXIBLE CABLE**.

**TAPER PIN**—A pin-type contact having a tapered end designed to be impacted into a tapered hole.

**THERMOPLASTIC**—A type of plastic which can be remelted a number of times without any important change in properties. Example: Nylon, Lexan and PVC are thermoplastic plastics. Such plastics are resilient after molding.

**THERMOSETTING PLASTIC**—A type of plastic in which a chemical reaction takes place while it is being molded under heat and pressure, making it rigid. This type of plastic cannot be reheated or softened. Example: Melamine, Diallyl-Pthalate are thermosetting plastics.

**UMBILICAL CONNECTOR**—A connector used to connect cables to a rocket or missile prior to launching, and which is removed from the missile at the time of launching.

**WIPING ACTION**—Action of two electrical contacts which come in contact by sliding against each other.

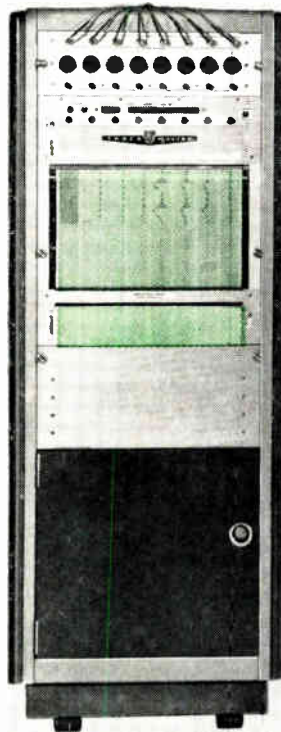
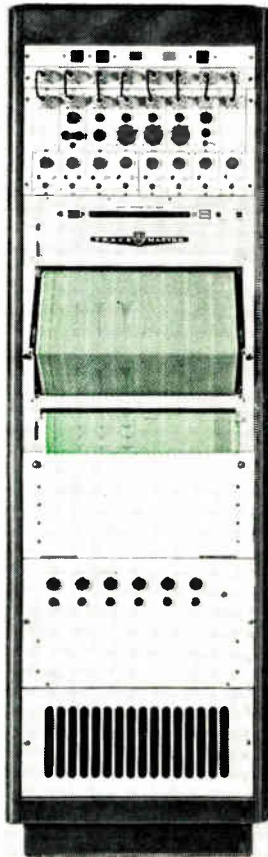

	<b>SERIES 250 TRACEMASTER</b> 8-channel, Rack Cabinet on casters	<b>SERIES 260 TRACEMASTER</b> 8-channel, Rack Cabinet on casters	<b>SERIES 290 TRACEMASTER</b> Model 291 Single-channel; Portable	<b>SERIES 290 TRACEMASTER</b> Models 292 & 293 2 and 3 channel; Portable
<b>FREQUENCY RESPONSE</b>	DC to 110 cps. flat at 40 mm. peak to peak. Down 3 db at 140 cps.	DC to 100 cps. flat at 40 mm. peak to peak. Down 3 db at 125 cps.	DC to 90 cps. flat at 30 mm. peak to peak. Down 3 db at 125 cps.	DC to 90 cps. flat at 30 mm. peak to peak. Down 3 db at 125 cps.
<b>TRACE DEFINITION</b>	5.5 lines/mm	5.5 lines/mm	5.5 lines/mm	5.5 lines/mm
<b>SENSITIVITY RANGE</b>	2 Microvolts to 10 v/chart div.	3 mv to 2 v/chart div.	5 mv to 5 v/chart div.	5 mv to 5 v/chart div.
<b>CHART SPEEDS</b>	0.2 to 500 mm/sec.	1 to 250 mm/sec.	1 to 100 mm/sec.	1 to 100 mm/sec.
<b>CHART PAPER/CARBON COST (MIN. ORDER)</b>	4¢ per foot	4¢ per foot	2.36¢ per foot	3.1¢ per foot
<b>CHART CAPACITY</b>	1000 ft. roll	1000 ft. roll	200 ft. roll	200 ft. roll
<b>DIMENSIONS</b>	70" H x 22" W x 22" D	60" H x 23½" W x 23" D	12½" H x 14½" W x 7" D	13½" H x 17½" W x 8" D
<b>WEIGHT</b>	500 lbs., approx.	360 lbs., approx.	20 lbs.	40 lbs.

## NOW... a Tracemaster System to meet your recording problem!

AO Tracemaster presents three outstanding direct-writing recorder systems to help you acquire more meaningful low-frequency data.

**Series "250"**— For test installations requiring a multi-channel record of diverse signal inputs. Full line of pre-amplifiers and signal conditioners available.

**Series "260"**— For economical recording of multiple medium sensitivity inputs such as telemetry and analogue computer read-out.

**Series "290"**— Single, 2-or 3-channel portables for on-the-spot recordings in the lab, field or plant.

All systems provide a far higher frequency response at full stylus deflection than any other direct-writing recorder. This is accomplished by AO's unique pen motor design and fine electronics. Also featured is the exclusive direct-carbon-transfer

writing method which offers a far more uniform and finer line trace...two to three times finer than any other direct-writing technique, allowing twice as many lines/mm and twice the definition.

The specifications above give reasons why each Tracemaster system has established new standards of performance for direct-writing recorders in its class and price range. Write for free catalog.

**American  Optical**  
COMPANY

INSTRUMENT DIVISION, BUFFALO 15, NEW YORK

INDUSTRIAL ELECTRONICS • Phone: 716-895-4000, TWX 716-858-1380

Sylvania PANELESCENT® EL readout displays now have 3 times the light output of earlier versions—thanks to development of a new, more efficient electroluminescent phosphor. Ideal for computers, counters and other equipment, this readout is a soft green that stands out clearly against an improved neutral gray background. Readability is excellent, even without the customary bezel or other light shield. And you save the cost of a polarized filter, which some readouts require for sufficient contrast.

## **Now 3 times brighter, Sylvania can brighten sales prospects for**

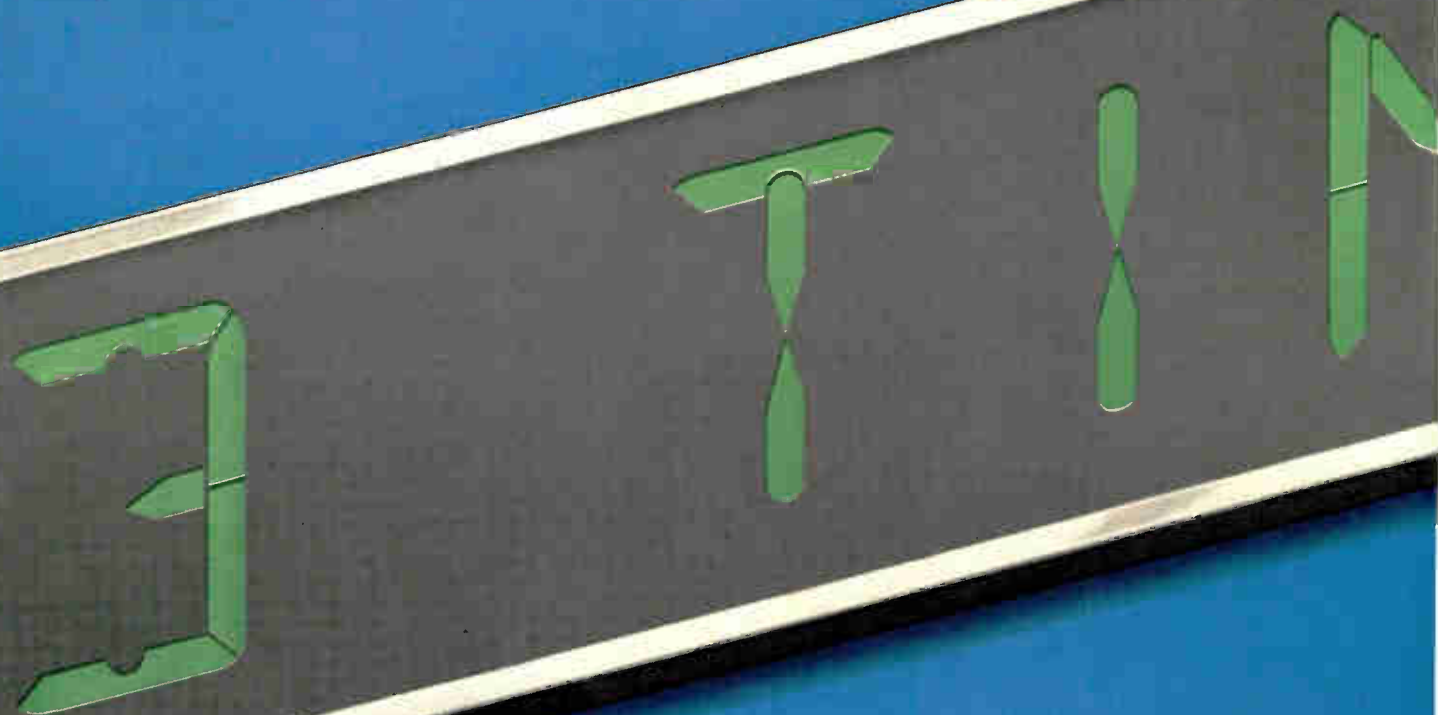



Compare these other EL advantages against any other method of lighted alphanumeric display:

- Extremely long life
- Highest reliability of any readout device
- Full 170-degree viewing angle—easy, accurate reading without parallax
- Low power—15 times less than for neon tubes; 120 times less than for incandescent lamps
- Fast switching—20 times faster than neon tubes; 200 times faster than incandescent

## EL readout your equipment

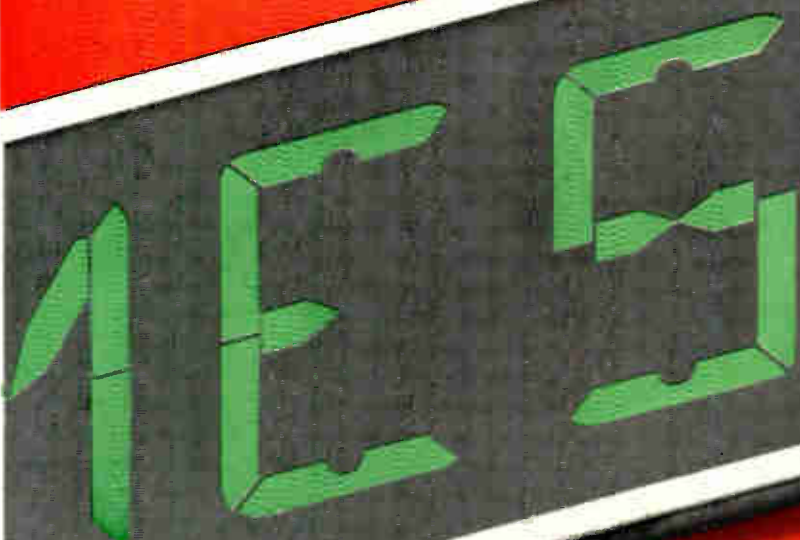

## Low-cost



Key to EL economy is this Sylvania binary-to-display switching matrix. Without additional amplification, it can drive Sylvania numerics using logic from a 1-2-4-8 decimal coded binary counter. Compact (only 4" long), with a simple, inherently reliable design, these matrices can mean considerable savings over other binary-to-display systems.

- SM118—for tube-type counters
- SM124—with memory capability, for rapidly changing inputs
- SM123—for solid-state counters

Sylvania offers a wide variety of EL devices: numerics and alphanumerics from ½" to 5" high—packaged in several different mountings—in a variety of display patterns. For position-plotting, Sylvania offers X-Y grid panels with resolution of 16 lines/inch. Other devices, such as binary dot and "bit 'n bar" matrices for use in coding film, can be custom-designed for your application.



Get the full EL story from this new booklet, available from your Sylvania Sales Engineer. Or write Electronic Tubes Division, Sylvania Electric Products Inc., P.O. Box 87, Buffalo, N. Y.

# SYLVANIA

SUBSIDIARY OF

**GENERAL TELEPHONE & ELECTRONICS**



NEW CAPABILITIES IN: ELECTRONIC TUBES • SEMICONDUCTORS  
MICROWAVE DEVICES • SPECIAL COMPONENTS • DISPLAY DEVICES

Circle 13 on Inquiry Card



# New Value Package

You can use the Type 561A Oscilloscope—with Type 3A1 Dual-Trace Amplifier Unit and Type 3B3 Time-Base Unit—for a wide range of DC-to-10 MC laboratory applications.

You can observe no-parallax displays and sharp trace photography. For the new rectangular ceramic crt has an internal graticule with controllable edge lighting.

You can display single or dual-trace presentations or algebraic addition.

You have 10 mv/cm sensitivity with .035  $\mu$ sec risetime.

You have highly adaptable time-base features including:

1. Calibrated sweep range—from 0.1  $\mu$ sec/cm to 1 sec/cm for normal and delayed-sweep presentations.
2. Calibrated sweep delay—for setting and measuring precise delay intervals from 0.5 microsecond to 10 seconds.
3. Single-sweep control—for simplifying waveform photography of normal-sweep presentations.
4. Flexible triggering facilities—with triggered operation extending to beyond 10 megacycles.

Also, you can use any of 10 other amplifier and time-base units for differential, multi-trace, sampling, other applications, including matched X-Y displays using the same type amplifier units in both channels.

TYPE 561A OSCILLOSCOPE (without plug-ins)	\$470
TYPE 3A1 DUAL-TRACE AMPLIFIER UNIT (6 cm linear scan • no signal delay)	\$410
TYPE 3B3 TIME BASE UNIT	\$525

U. S. Sales Prices f.o.b. Beaverton, Or. 97001

**For a demonstration, please call  
your Tektronix Field Engineer**

# Sweep Delay and Dual-Trace Plug-in Units

with the Tektronix Type 561A Oscilloscope

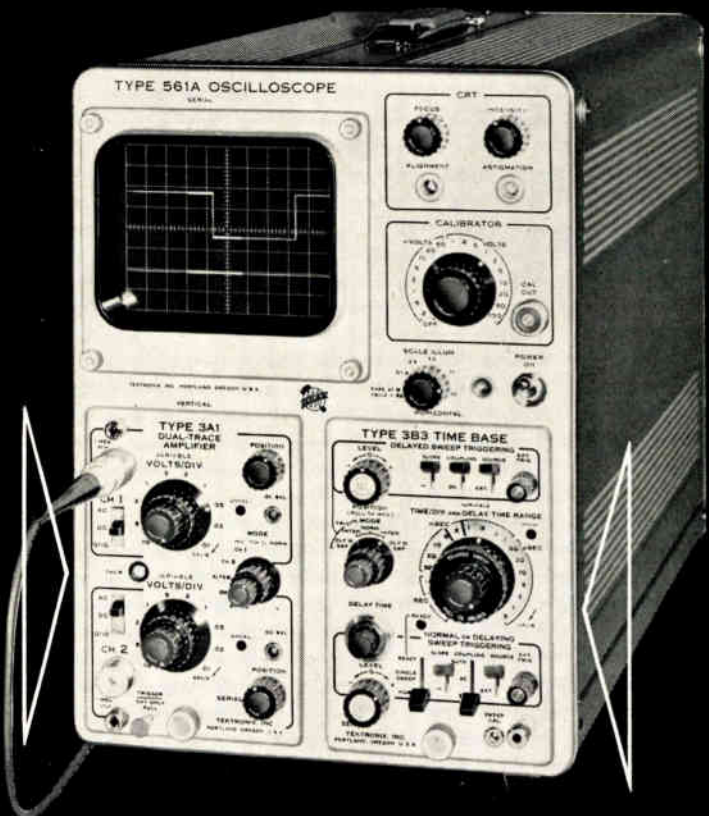

- illuminated internal graticule
- rectangular ceramic crt

**Tektronix, Inc.** / P. O. BOX 500 • BEAVERTON, OREGON / Mitchell 4-0161 • TWX-503-291-6805 • Cable: TEKTRONIX.  
OVERSEAS DISTRIBUTORS IN 27 COUNTRIES AND HONOLULU, HAWAII.

Tektronix Field Offices are located in principal cities throughout the United States. Please consult your Telephone Directory.  
Tektronix Canada Ltd: Montreal, Quebec • Toronto (Willowdale) Ontario • Tektronix International A. G., Terrassenweg 1A, Zug, Switzerland.





(Photo 2½ times actual size)

## Got a match?

Any ordinary book match will do.

Placed over our AMPin-cert\* 50-position Sub-miniature Pin and Socket Connector, the match completely covers the contact area which is a full 50% of the total! Compare this with other connectors of only 20% area-use efficiency and obviously this gives you the density you need. But we didn't stop there.

This is the only connector of its type which gives you crimped, snap-in type contacts. Here is an important plus feature when you're working in close quarters. It does away with cold solder joints, burned insulation, fine wire breakage and permanently fixed connections. Add to all this our controlled crimping process which delivers terminated contacts all perfectly identical in appearance and performance and you've got something that's difficult to match—density, versatility and reliability, at the lowest applied cost in the industry.

\*Trademark of AMP INCORPORATED

That's it, except for—

- wire range—stranded or solid—26-36 AWG
- working voltage of 300 volts AC RMS or better
- .060 center to center spacing in single line ( .050 in clusters)
- polarized for error free assembly
- self extinguishing housing

If you're looking for a sub-miniature connector that really packs in working features, send for complete information on our AMPin-cert Sub-miniature Pin and Socket Connector today!



AMP products and engineering assistance are available through subsidiary companies in: Australia • Canada • England • France • Holland • Italy • Japan • Mexico • West Germany



## OPTICAL TRANSISTOR

A NEW TYPE OF TRANSISTOR, in which signals are carried by light rather than by electric current, has been reported by IBM Corp.

The experimental device, called an optical transistor, has been operated at high frequencies and is easy to make.

Although it performs as a transistor, the optical transistor—which is made of gallium arsenide—operates on a completely different principle. In the optical transistor, some of the energy of the incoming electric current is converted into light. After passing partly through the device, the light is absorbed and frees electrons on the output side. Electrons then pass into the external circuit as output current. Effect is as if current were passing through the device, but the energy is actually carried by light.

Advantage of the optical transistor principle is that light moves much faster than electric charges through the "base," or middle portion, of the device. To obtain high frequency operation in a conventional transistor, the base must be made very thin to shorten the time needed for electric charges to move across it. Such very thin base regions, which are hard to make, are not needed with the optical transistor.

Ultimate speed of the device will be limited by the speed of emission and absorption of light in the de-

Richard F. Rutz (standing) and Ralph C. McGibbon, of IBM's Thomas J. Watson Research Center, examine photomicrograph which shows three-layer structure of new optical transistor.

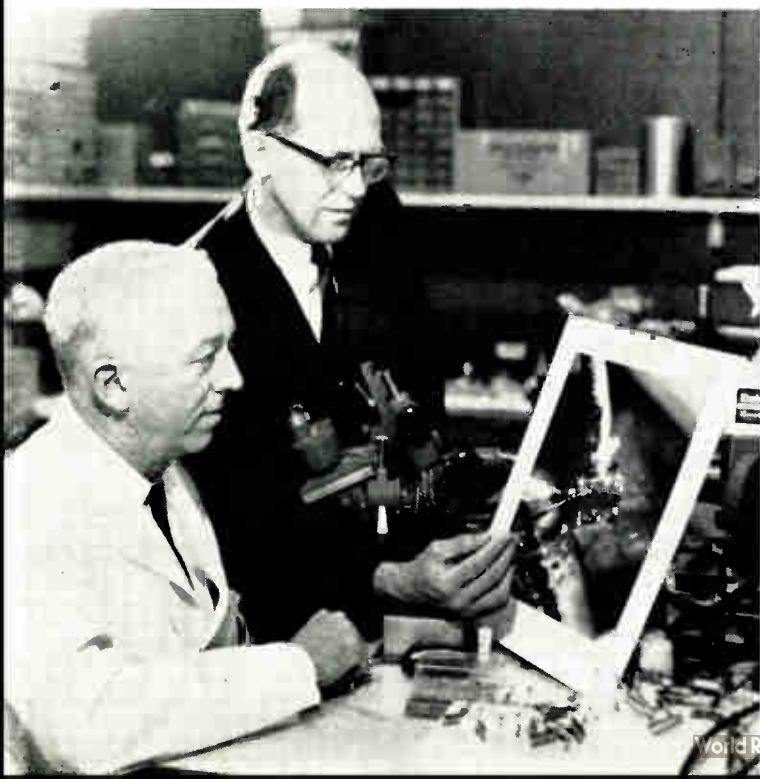

vice, which is not yet known accurately. The optical transistor has already been operated as an oscillator at a frequency of 1 mc. It is believed that its ultimate speed may approach the gc range. Early experimental devices have switched signals in ten nsecs., although with some power loss, in an inverting circuit.

Efficiency of GaAs in converting electricity to light has recently aroused much scientific interest. However, until the first GaAs optical transistors were made, it was not realized that gallium arsenide p-n junctions could efficiently absorb, as well as emit, light.

Although the devices made so far have a very low current gain, they show a power gain of as much as 50 at liquid nitrogen temperatures (77°K.). Current gains at room temperature have been as high as 0.1. IBM scientists believe it will be possible to raise the current gain to high enough levels so that the device might be usable for practically the whole range of high-frequency transistor uses.

## NEW PROGRAMMING CONCEPT

A NEW PROGRAMMING CONCEPT using A-MP Matrix Pinboards has been introduced by AMP INC. The Pinboards are matrix switching devices that manually program hundreds or thousands of individual circuits. Pinboards perform switching operations with convenience and simplicity in a wide range of uses from digital computers to vending machines. Analog Function Generators, Sequencing Devices, In Put-Out Put Switching, Communication Systems, Instrumentation, Data Process Systems, Automated Process Control and Test Equipment Programming are just a few of these uses.

The basic matrix pinboard is a series of bussed SPST switches arranged on X-Y coordinates where the switching is done by inserting a shorting pin to connect two circuit busses. Compared to the manipulation of conventional switches, pinboards yield greater density, improve reliability and are a more convenient programming method at a lower cost.

They are available in 10 standard sizes from 10 x 10, which provides 100 holes, to 20 x 20 which provides 400 holes. Combinations of pinboards can be ganged to get more switching combinations. Con-

*(Continued on page 200)*

## PLASTIC LASER

RCA HAS ANNOUNCED THE DEVELOPMENT and operation of a plastic laser.

The experimental device, developed at the company's laboratories in Princeton, N. J., is made with a fiber of transparent material of the same type used in making many familiar clear plastics.

Using a newly discovered physical effect, it produces coherent pulses of intense crimson light at the highest visible frequency yet known to have been attained by a laser.

The laser is a clear plastic fiber 15 in. long, containing traces of europium, a rare earth, in which the laser action is achieved.

The plastic polymethyl methacrylate acts as a holder for molecules known as "chelates" or "molecular claws" which enclose each atom of europium.

To make the fibers work as lasers, they are placed in a liquid nitrogen filled dewar—resembling a thermos bottle—and exposed to intense flashes of ultraviolet light. Energy from this light is transmitted by the fibers to the chelates, which absorb the energy and transfer it to the europium atoms, causing them to emit bright flashes of red light.

The fibers, each only about 20 times the diameter of a human hair, trap most of the light and force it to travel along their length. Each time such a flash occurs, it sweeps along the fiber and stimulates other flashes. These combine to create a single pulse of coherent light which bursts from the ends of the fibers with enormous power.

The achievement of laser action with europium in an organic polymer follows previous unsuccessful attempts in which europium has been incorporated in inorganic crystals.

This suggests that the way may now be opened to a new family of lasers. These might use still other materials that resist laser action when they are contained in inorganic crystals. Some of these materials may be capable of producing coherent light at yellow, green, blue, and other frequencies if they are incorporated in chelate structures distributed through a plastic in the manner of this new experimental device.



Dr. Nikolaus Wolff holds a spray of plastic fibers similar to those which have produced laser action. In the foreground are other shapes that future plastic lasers might take.

Atoms of the rare earth, europium, are locked into molecular structures called "chelates" by chemical means and then distributed in controlled ratios through a transparent optical fiber. Ultraviolet light shown on the fiber is transmitted to the chelates which absorb its energy and then transfer it to the europium atoms. When one atom is excited enough to fluoresce, the resulting light travels along the fiber causing other atoms to follow suit. As they do, they add their energies together to form a single pulse of crimson light which bursts from the ends of the fiber with great intensity.

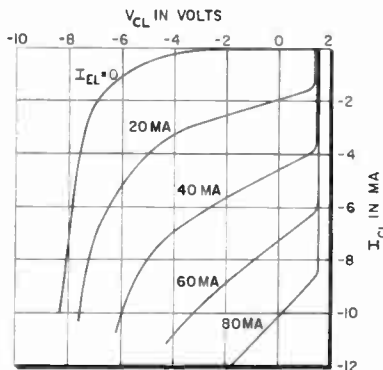
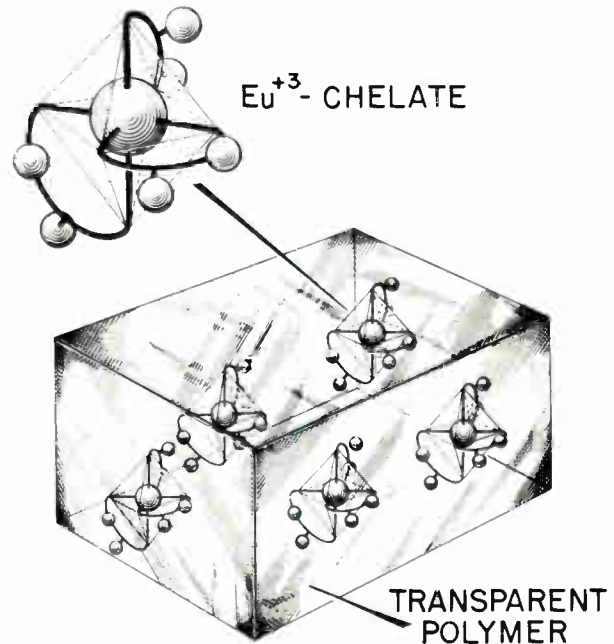

Measured current-voltage characteristics of the optical transistor.  $V_{CL}$  is the voltage between collector and base, and  $I_{CL}$  is the current into the collector.  $I_{EL}$  is the current into the emitter, which is constant for each trace.



“OUR **Panoramic**\* ANALYZERS  
ARE AN ABSOLUTE NECESSITY...”

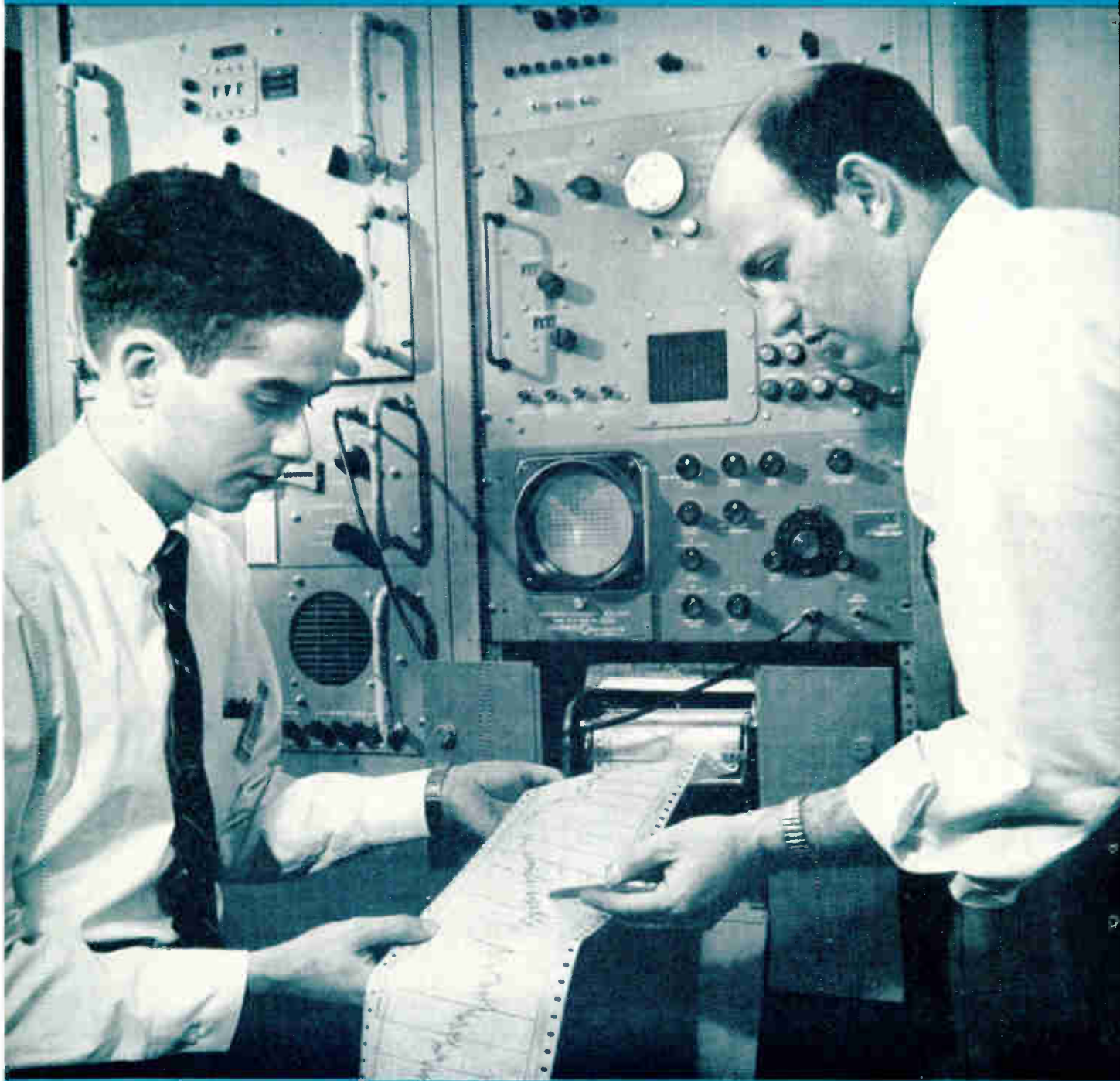

GPL Division engineers study recording of spectrum distribution of test signals from Doppler Radar Signal Simulator. The instrument is a PANORAMIC Ultrasonic Spectrum Analyzer Model SB-15 with optional PANORAMIC Recorder Model RC-3a/15.  
\*A Trademark of THE SINGER MANUFACTURING COMPANY



INTERVIEW WITH GPL DIVISION,  
GENERAL PRECISION AEROSPACE, ON TESTING  
OF AN/ASQ-28 DOPPLER RADAR EQUIPMENT

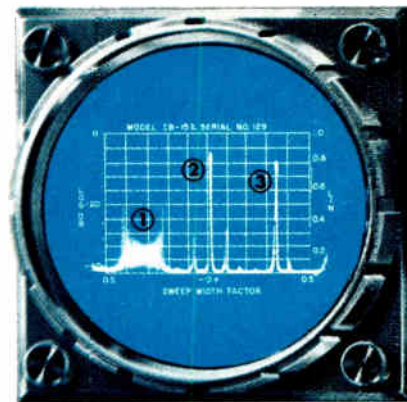

Screen photo shows versatility of the SB-15a: (1) FM display measures dynamic deviation; (2) and (3) are AM and SSB signals, respectively, with sine wave modulation.

"We have one chronic complaint about spectrum analyzers," said the project engineer. "There aren't enough of them."

We were standing in a busy corner of GPI's test section in Pleasantville, N. Y., where this Division of General Precision Aerospace produces, among other electronic gear, advanced Doppler Radar Systems under Navy and Air Force contracts.

"Take this set-up," he continued, indicating a test in which one of the Model SB-15 PANORAMIC Ultrasonic Spectrum Analyzers was connected to a GPL-designed Doppler Radar Signal Simulator. "There's really no other way to do it. It's interesting that the accuracy of the simulator signal we're testing here must be at least an order of magnitude greater than the airborne system we will test with it."

He switched out the sweep rate derived from the RC-3a Recorder and selected the more rapid sweep rate of the SB-15 for a "quick-look" analysis.

"That's a complicated audio signal," said our host, pointing to the screen trace. "It's generated and then shaped to simulate the signal received by our airborne navigation system. Right now we're measuring signal-to-noise ratio. However, at any time we may want to run a whole program of qualitative tests on the same signal. PANORAMIC analyzers give us the needed flexibility and resolution."

He demonstrated this point with a series of quick manipulations of the continuously variable center frequency and scan-width controls.

"We use the analyzer for trouble shooting, too," he continued. "If a Simulator signal looks wrong, we work back through its audio circuitry with the SB-15 and find the cause."

We asked about reliability.

"Very rugged," was the answer. "This particular PANORAMIC unit was here four years ago when I joined the section. We have several. Some are the newer Model SB-15a. This one is a special 400-cycle power line job that's been pulled out of the lab and used in a number of actual flight tests. Aside from our own checks and routine trips to our calibration lab, it's almost constantly in use."

We commented on what seemed a large amount of gear for an air navigation project.

"Oh, this is all test equipment," our guide explained. "For instance, our AN/APN-153 Doppler Navigation unit itself is only one cubic foot in size and weighs under 50 pounds. We're very proud of that."

Had he any general comments about the equipment?

"Well..." He thought a moment. "In my judgment, for anyone requiring rapid analysis of sonic or ultrasonic signals, the spectrum analyzer is an absolute necessity."

#### DESCRIPTION

Model SB-15a PANORAMIC Ultrasonic Spectrum Analyzer automatically and repetitively scans spectrum segments from 1 kc to 200 kc wide through the entire range (100 cps to 600 kc) with a 60 db dynamic range. It plots frequency and amplitude along the calibrated X and Y axes of a long-persistence 5" CRT or also on a 12" x 4 1/2" chart with optional RC-3b. Sweep rates are adjustable from 1 to 60 cps. Adjustable resolution permits selection and detailed examination of signals as little as 100 cps apart. Self-checking internal frequency markers are provided at every 10 kc. The unit has an internal amplitude reference at 100 kc. The compact SB-15a, only 8 3/4" high, needs no external power supply or regulator. The optional recorder RC-3b permits very slow scans for high resolution at broad sweep widths and statistical analysis of complex signals. The recorder is compatible with a wide variety of PANORAMIC instruments.

#### APPLICATIONS

- Ultrasonic noise and vibration analysis
- Communications system analysis
- VLF radio and carrier channel analysis
- General Fourier analysis
- FM Telemetry subcarrier channel analysis

#### SPECIFICATION HIGHLIGHTS

- Frequency Range: 100 cps to 600 kc
- Sweep Width: Adjustable, calibrated from 1 kc to 200 kc
- Center Frequency: Adjustable, calibrated from 0 to 500 kc
- Markers: Crystal controlled, 10 kc and 100 kc plus harmonics, usable throughout band; also provides amplitude reference
- IF Bandwidth: Adjustable, 100 cps to 4 kc
- Sweep Rate: Continuously adjustable, 1 cps to 60 cps (30 seconds to 16 hours in steps with the RC-3b PANORAMIC Recorder)
- Amplitude Scales: Linear, 40 db log (extendable to 60 db) and 2.5 db expanded
- Sensitivity: 200  $\mu$ v to 200 v full scale deflection
- Accuracy:  $\pm 0.5$  db
- Input Impedance: 50,000 ohms

*GPL Division of General Precision Aerospace is just one of hundreds of users who find PANORAMIC Spectrum Analyzers indispensable for monitoring, testing, and trouble-shooting in the audio, ultrasonic, and low rf frequency bands. Our applications engineers will be glad to discuss your requirements at your convenience and without obligation. Write today, outlining your application, for literature and prompt recommendations.*



MANUFACTURED BY



*The measure of progress...*



**SINGER METRICS DIVISION**  
THE SINGER MANUFACTURING COMPANY  
915 PEMBROKE STREET • BRIDGEPORT 8, CONNECTICUT • (203) FOREST 6-3201

# WHAT'S NEW

## MAGNETIC BEARING

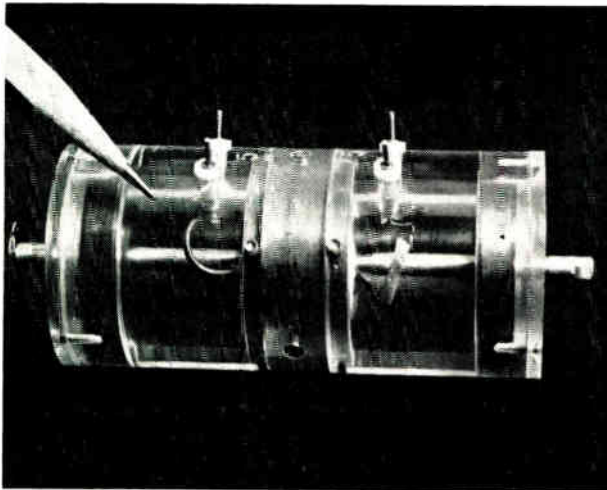

Shown is a Magcentric bearing enclosed in lucite. The four terminals are for power input to two electromagnets. The bearing shaft ends are suspended in a group of magnetic fields.

Armature showing location of permanent magnets and ferrite disc. The magnetic lines of flux are showing surrounding each magnet.

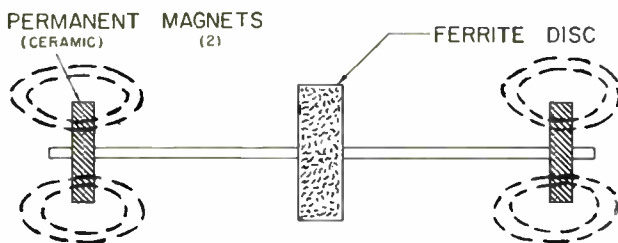

A MAGNETIC BEARING which overcomes the problems inherent in lubricated or pivot bearings has been developed by the Cambridge Thermionic Corp., Cambridge, Mass.

The bearing eliminates physical contact between shaft and housing by suspending the bearing in a magnetic field. Equilibrium is maintained by an electromagnet located on each end of the armature shaft. Designated Magcentric, it should receive prime use under aerospace zero-gravity and vacuum conditions. The bearing will be made commercially available.

The stationary part of the device consists of an armature on which permanent ceramic magnets and electromagnets are located on each end. A ferrite disc is mounted in the center. Theoretically, this configuration would allow the armature to be centered and suspended in the assembly without external excitations. But because of mechanical and magnetic unbalance, this state cannot be achieved practically and the armature will tend to be laterally expelled from the assembly. The self-correction needed is supplied by external excitation of the electromagnets.

Two similar coils are chosen for these electromagnets. Inductive parameters are maintained by placing the ferrite disc an equal distance between the coils. In order that these coils may act as a balancing device, they are paralleled with a capacitor and tuned to resonance at a specific frequency.

## CIRCUIT TESTING CONNECTORS

TWO NEW TYPES OF CONNECTORS for testing voltages or signals in circuits have been announced by Pyle-National Co., Chicago, Ill. These indexable test connectors help prevent physical and electrical damage to connector contacts being monitored.

A Test Probe Connector is coupled to the plug or receptacle to be tested. It enables a Banana-type testing probe to be inserted at the exposed end of the insert. A Test Cable Connector is crimped and molded or potted to a cable which may be terminated to a regular line connector or to a test set. It meets application needs for testing ground support equipment.

Both Pyle-Star-Line Test Connectors have a multiple-position indexing feature. This feature permits either plugs or receptacles to mate with matched insert key positions of connectors installed on equipment or cables. By rotating a threaded insert retain-

ing ring, key positions of the contact inserts are readily indexed.

The hardcoated aluminum alloy connector shells are available in sizes 12 through 28. Push-in removable crimp type contacts range in sizes from 18 through 1/0, with 36 insert configuration variations.

**Pyle-Star-Line Test Connectors feature a multiple-position indexing feature which allows key position adjustments to be made without tools. The shells are available in sizes 12 through 28.**



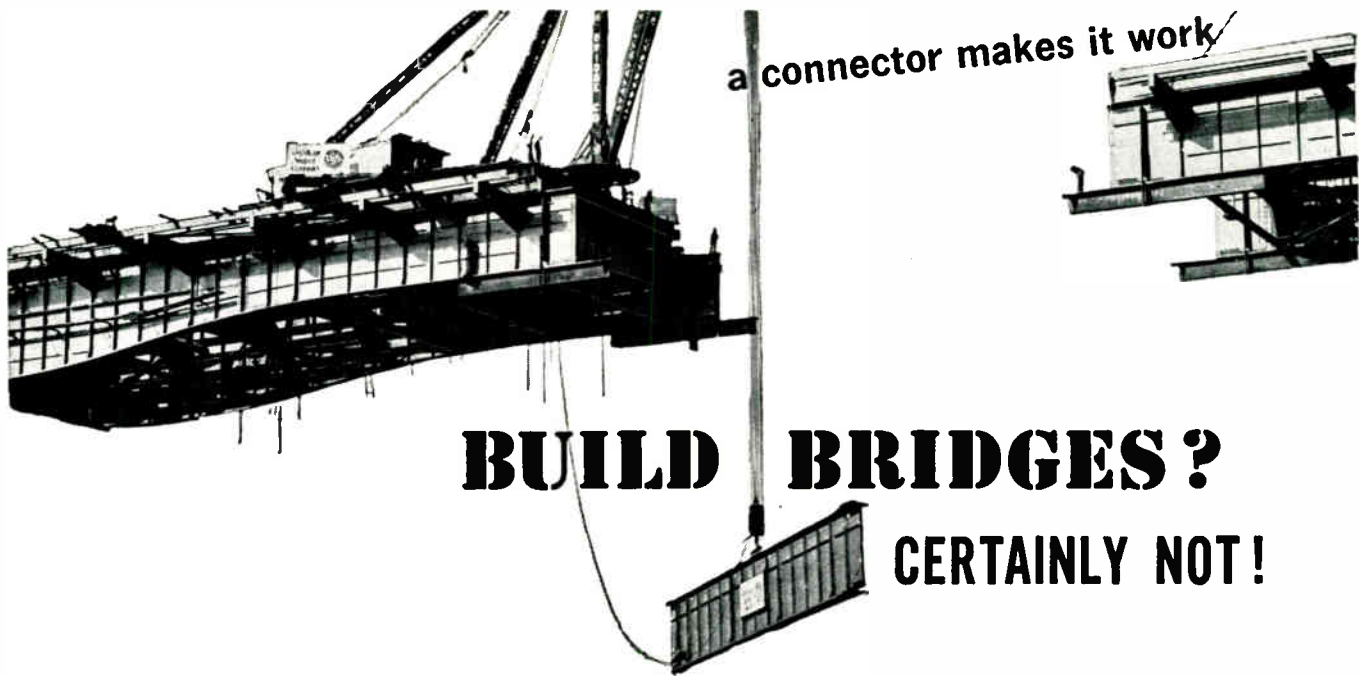

# BUILD BRIDGES? CERTAINLY NOT!

**Our Business is Precision-Engineered Electronic Connectors...  
IN PRINTED CIRCUIT RECEPTACLES**  
improved patented\* designs  
provide outstanding performance

(Comply with MIL-C-21097 Applicable Provisions, Latest Revision.)

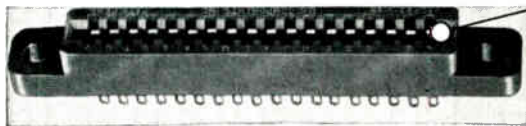

## BUILT-IN 4-WAY CONTROLS FEATURE:

**SMOOTHNESS:** Exclusive 'spherical radius' cantilever-type design (without tortuous bends), with free-float, maximizes smoothness of action on board.

**FLEXIBILITY & STRENGTH:** Controlled terminal hardness of top quality, heat-treated beryllium copper results in flexibility plus strength in critical areas, without creep.

**LOW CONTACT RESISTANCE:** Special gold over silver contact plating maintains low contact resistance after repeated insertions and withdrawals.

**WIDE BOARD TOLERANCES:** Contact retention forces maintained over wide range of board tolerances and after repeated insertions and withdrawals, because of contact and connector design.

### FOR VERSATILITY

- **DOUBLE ROW TYPES:** Wire solder, taper tab, wire wrap terminals
- **SINGLE ROW TYPES:** Wire solder terminals
- **OPTIONAL MOUNTINGS**
- **POLARIZING STUDS** (No lost contact positions)
- **PRINTED CARD ACCOMMODATION:**  $\frac{1}{16}$ " or  $\frac{3}{32}$ "
- **MANY SPECIAL TYPES:**

Write for Catalog UPCR for complete details, all types.

\*U.S. Pat. Nos. 2,853,689; 2,909,755

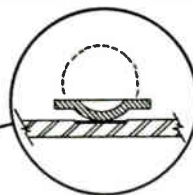

SPHERICAL RADIUS

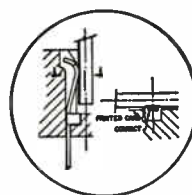

**2. CONTROLLED TERMINAL HARDNESS,** heat-treated beryllium copper permits flexibility in crucial areas maintaining maximum strength and no-creep.

**1. NEW CONTACT DESIGN,** scientifically curved for maximum smoothness during repeated card insertion.

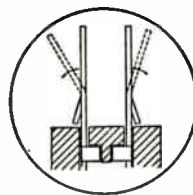

**3. WIDE BOARD TOLERANCE RANGE,** controlled insertion and retention forces are assured over card range thickness of .062 or .093  $\pm$  .010.

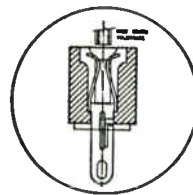

**4. NEW SINGLE ROW CONTACT DESIGN** — controlled insertion and retention force over wide board range thickness of .062  $\pm$  .010.

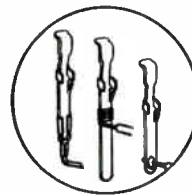

**5. PRECISION CONTACTS,** wire-solder taper tab (series 78), and wire-wrap versions. Government approved processing — silver and gold plated.

## U. S. COMPONENTS, INC.



1320 Zerega Avenue • Bronx 62, New York or use TWX: 212-824-6990: TEL: 212-TA 4-1600: TELEX: 01-2411: or Cable: COMPONENTS NYK.



### "M" AND "S" MINIATURES

Slightly larger than the "U" and "UB" Types, still excellent for use in compact equipment. Soldered plate construction, heavily anchored stator supports. DC-200 treated steatite insulators. Plates are nickel-plated brass. Available in Single Section, Butterfly and Differential types with straight, locking and screwdriver shafts. "S" also available in Dual type.

**TYPE "M"**—Requires only  $\frac{1}{8}$ " x  $\frac{1}{4}$ " panel area. Peak voltage rating: 1250 volts on .017" spaced units; 850 volts on 160-130, spaced .013"; mounting bushing,  $\frac{1}{4}$ "-32.

**TYPE "S"**—Slightly larger than Type "M". Peak voltage rating: 850 volts—plate spacing .013", other spacings available on special order. Mounting studs tapped 4-40 on  $\frac{17}{32}$ " centers.

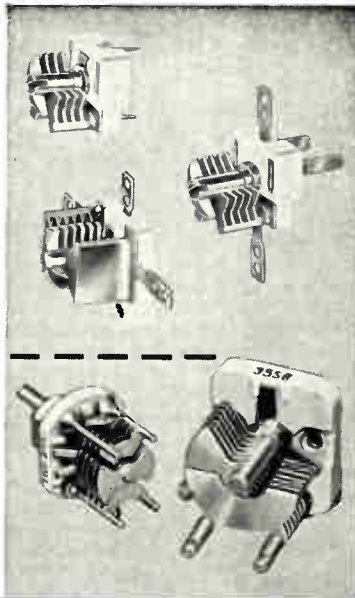

### SUB MINIATURE "U" AND "UB" TYPES

These tiny, sub-miniatures require less than 0.2 or 0.3 square inch mounting area, depending on type. Unique, precision machined design from one piece of solid brass delivers outstanding reliability, with exceptionally uniform delta C and voltage characteristics.

All metal parts silver-plated—ceramic is steatite Grade L-4 or better. Virtually impervious to shock and vibration damage—provides freedom from moisture entrapment found in trimmer capacitors of enclosed or solid dielectric type. Voltage breakdown ratings to 1,300 volts DC. Extra heavy rotor end plate is slotted for screwdriver adjustment. Choice of 3 fast, easy mounting types: "LocTab", Printed Circuit or 2-Hole.



**E. F. JOHNSON COMPANY**

3002 TENTH AVENUE S.W. • WASECA, MINNESOTA

- Outstanding reliability—exceptional mechanical stability!
- High "Q"—greater than 1500 at 1 mc!
- High torque-to-mass ratio—2 to 7 inch ounces!
- Low temperature coefficient—approx. 35 PPM/°C positive!

# "U," "UB" AIR VARIABLES

*Available in Butterfly, Differential,  
Dual and Single Section Types*

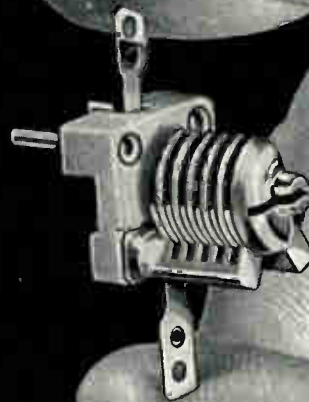

**DETAILED COMPONENTS CATALOG AVAILABLE—Write today on company letterhead**

● CAPACITORS • TUBE SOCKETS • CONNECTORS • PILOT LIGHTS • INSULATORS • KNOBS AND DIALS • INDUCTORS • HARDWARE

# BURNDY

MAKES ALL TYPES OF ELECTRICAL  
CONNECTORS

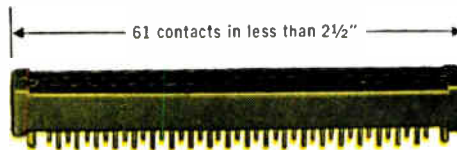
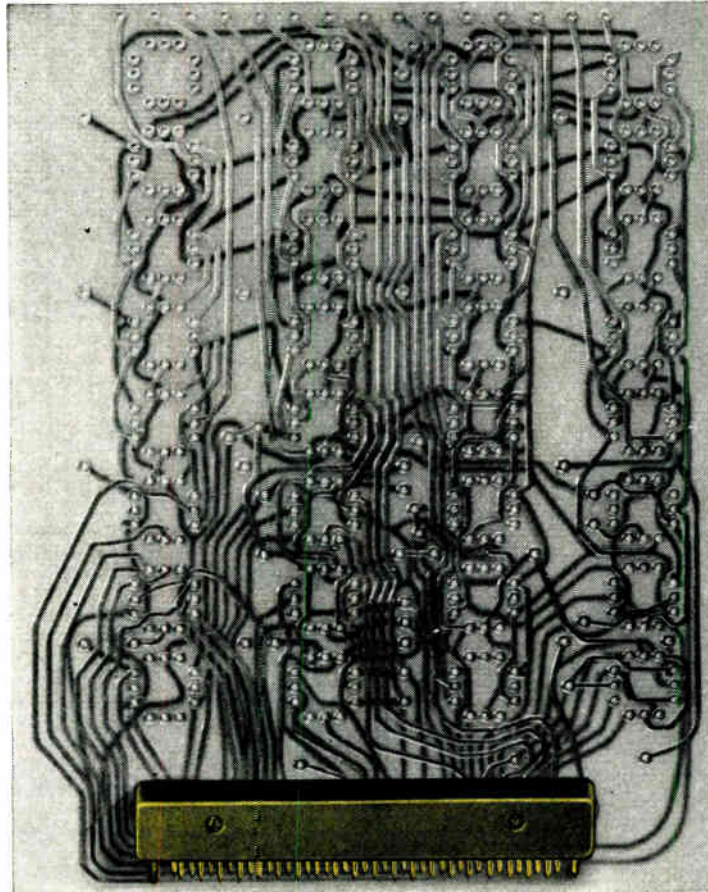

## ***Ultra-miniature PC connector*** *(for small size problems)*

**UPC.** Burndy's new ultra-miniature printed circuit connector for inter-connecting layered printed wiring or PC boards on micro-module systems.

**Its advantages:** smaller than any PC connector available; very high contact density; low engagement force. On hand in 13, 49, 61 and 92 contact sizes —3 rows of .050 staggered spacing.









**Termination techniques:** solder pin, solder cup or solder dip. Minimum axial stress protects solder dip connections. Conforms to Signal Corp Technical Requirement SCL-6250B. For full technical data write OMATON.

**BURNDY**  
Norwalk, Connect.

**DESIGN  
ENGINEERS**

**TAKE  
YOUR  
CHOICE** **44**

**new miniaturized  
batteries available now  
from BURGESS!**

							
<b>3.0 VOLTS</b> .439 cu. in. to .884 cu. in.	<b>4.5 VOLTS</b> .338 cu. in. to 1.202 cu. in.	<b>6.0 VOLTS</b> .432 cu. in. to 1.745 cu. in.	<b>7.5 VOLTS</b> .525 cu. in. to 2.051 cu. in.	<b>9.0 VOLTS</b> .684 cu. in. to 2.370 cu. in.	<b>10.5 VOLTS</b> .774 cu. in. to 1.711 cu. in.	<b>12.0 VOLTS</b> .864 cu. in. to 1.908 cu. in.	<b>13.5 VOLTS</b> .954 cu. in. to 2.112 cu. in.

**Choose BURGESS BATTERIES in the Right Size, Shape & Voltage!**

BURGESS has the battery you need for miniaturized power supply! 44 new battery types — full range of voltages, sizes, shapes! Check the table above for the battery you need!

Send for BURGESS' new illustrated miniaturized battery brochure. Tells you why BURGESS BATTERIES are your best choice for miniaturized products — presents dramatic proof of BURGESS' superiority in performance!

BURGESS — the complete line of new miniature batteries, will solve the power supply design problems common to transistorized circuitry!

**Burgess also manufactures a full line of:**



**ZINC-CARBON**



**MERCURY**



**NICKEL-CADMIUM**



**ALKALINE**

Excel in adaptability, availability and economy. Complete line of cylindrical cells, and flat cells featuring exclusive "wafer-cell" construction.

Uniform operation over wide temperature range, high ampere-hour output, flat discharge curve.

High energy output from a small package! Hermetically sealed-in-steel.

Longer life in use and on the shelf! Widest range of applications!

**EXCLUSIVE WAFER CELL!**



Increases capacity as much as 30% — improves shelf characteristics significantly — gives practical impetus to miniaturization! A BURGESS EXCLUSIVE — and another reason 2 out of 3 electronic design engineers prefer BURGESS!

**FREE DESIGN SERVICE!**

Special design problems? Let BURGESS Engineering help you find the answer! BURGESS will design and manufacture a battery to your specifications! Write for complete details.

**NEW ENGINEERING MANUAL!**

A valuable 100 page encyclopedia of engineering data. Design engineers are invited to write on their company letterhead for a copy of this engineering manual. Free to those engaged in design work — \$1.00 to others.



**BURGESS BATTERY COMPANY**

DIVISION OF SERVEL, INC.

**Freeport, Illinois**



# DOUBLE-BARREL NEWSBREAK IN INFINITE-RESOLUTION POTENTIOMETERS

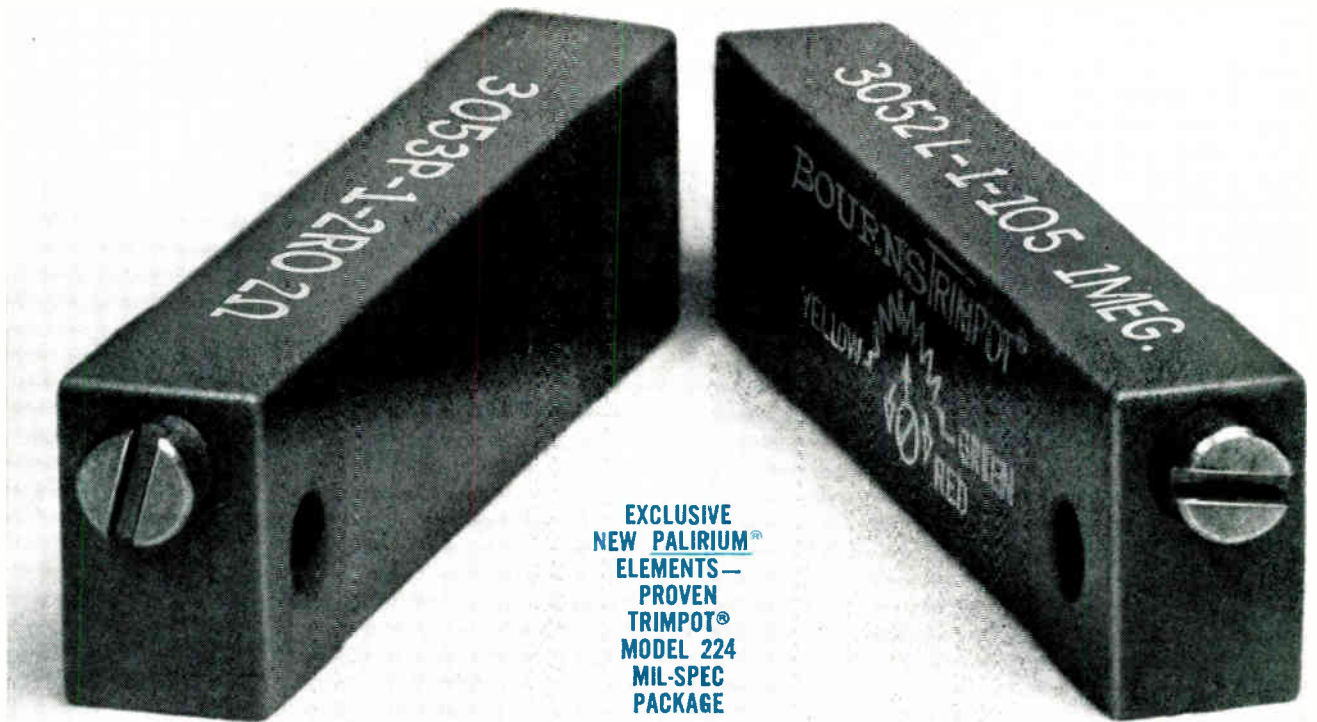

EXCLUSIVE  
NEW PALIRIUM®  
ELEMENTS—  
PROVEN  
TRIMPOT®  
MODEL 224  
MIL-SPEC  
PACKAGE

## NOW — INFINITE ADJUSTABILITY IN A 2-OHM POTENTIOMETER!

Now you can bring the convenience of infinite adjustability to applications that have always required an arduous fixed-resistance approach. The new TRIMPOT Model 3053, with its exclusive PALIRIUM film element, overcomes the problems in resolution and contact resistance that heretofore have made a low-resistance unit of this kind impossible. Stability of the infinite-resolution Model 3053 is outstanding, enhanced by an unusually low temperature coefficient and the time-proven Mil-Spec configuration of Bourns' famous TRIMPOT Model 224. This potentiometer should help you develop new circuit-design approaches.

Total resistance range:	2 Ω to 100 Ω
Resolution:	Infinite
Power rating:	½ W @ 70°C
Contact resistance variation:	2% max.
Temperature coefficient (2,5 Ω):	+ 400 PPM/°C max.
Temp. coefficient (10 to 100 Ω):	+ 300 PPM/°C max.
Humidity:	Exceeds MIL-R-22097B
Max. operating temperature:	175°C
Environmental stability:	1% or less
Load life stability:	2% or less

AVAILABLE IMMEDIATELY FROM FACTORY STOCK AT COMPETITIVE PRICES.

Write for latest Trimpot potentiometer summary brochure.



ACTUAL SIZE

## NOW — TWICE THE STABILITY IN RESISTANCES UP TO 1 MEGOHM!

At the other end of the scale, TRIMPOT Model 3052 offers you two to four times the stability of competitive high-performance potentiometers over the resistance range of 100K to 1 megohm. Like the companion low-resistance unit, Model 3052 features the approved Mil-Spec configuration of Bourns' high-temperature, humidity-proof Model 224. Its spec of 500 maximum applied volts is approximately 60 per cent better than that of other available units, and its total resistance tolerance of ±10% cuts the usual competitive figure in half. The new high-resistance, infinite-resolution element is also available in Model 3012 with the popular 1¼" x ½" x ¼" package. The prices? Less than you've been paying!

Total resistance range:	100K to 1 Meg.
Resolution:	Infinite
Power rating:	1 W @ 70°C
Contact resistance variation:	2.5% max.
Temperature coefficient:	Less than 300 PPM/°C
Humidity:	Exceeds MIL-R-22097B
Max. operating temperature:	175°C
Environmental stability:	2% or less
Load life stability:	2% or less

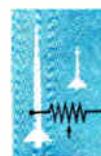

# BOURNS

BOURNS, INC., TRIMPOT DIVISION  
1200 COLUMBIA AVE., RIVERSIDE, CALIF.  
PHONE 684-1700 · TWX: 714-682 9582  
CABLE: BOURNSINC.

Manufacturer: TRIMPOT® potentiometers; transducers for position, pressure, acceleration. Plants: Riverside, Calif.; Ames, Iowa; and Toronto, Canada

Top management at Ampex was lulled by success into a sense of false security. Then, two things cost the company a year's progress and \$3,000,000. The firm divided into five little companies just before sales dipped and it reacted slowly to economic trends. Outside consultants started a management overhaul and recommended a new president. He put the company in the black in less than a year.

# MANAGEMENT OVERHAUL KEY TO AMPEX RECOVERY

**SUCCESS SPOILED AMPEX CORP.** Success was so sweet, and so long-lasting that it was beginning to seem too easy. The company had grown at a phenomenal rate over a long period. Between 1950 and 1960 sales soared from less than \$1 million to more than \$73 million. Earnings matched the growth rate. But, in 1961, the company was jolted out of its complacency by the shock of a \$3 million dip in annual sales accompanied by a net loss of \$3.9 million. The board of directors concluded that management control was weak, and they turned outside for help. Help started with the services of a consulting company, Cresap, McCormick and Paget, and ended with a new president, William E. Roberts.

Mr. Roberts is a capable executive, with strong views on corporate management responsibilities. They go far beyond the solution of Ampex's troubles. Examples:

"Many U. S. corporations are broke and don't know it. Just making a profit is relatively simple in any established company. Fulfilling growth potential, on the other hand, is something that many managements choose to ignore. Many company directors are rubber stamps and don't exercise adequate control of the companies on whose boards they sit. Shareholders suffer and cannot understand why."

Ampex straddles the military and commercial markets with a wide range of electronic products, approximately 45% of total sales going directly to the government.

## Profit and Loss

Bill Roberts is reluctant to place previous Ampex management in a bad light.

"The company had a very dynamic growth rate, both in sales and in earnings, for almost its total 14-year history (Fig. 1). The company management, I think, assumed that even though there were negative

signs being displayed for 1961, they could hold approximately the same rate of growth for the year. Unfortunately, there was a bit of a recession experienced by most companies at the tail end of 1960. The incoming rate of military orders slowed down. There was also a bit of a drop in the commercial market.

"With this drop in incoming orders, management again determined that they would manufacture to their forecast of incoming orders. The result was indigestion from the mass of products released to the shop. A massive inventory accumulated. I think that they didn't catch the trend to a dip in incoming orders, and the probability of lack of shipments, quickly enough. Their expense/budget plan was not reversed in time, so this compounded the situation. On top of this, about one year previously, the company determined that it would decentralize in the truest, purest sense of the word, to provide for further growth. They broke down into the five little Ampexes.

"The decision to do this and the method of approach I don't disagree with one bit. But I do question the manner in which the decision was carried out. They made exactly the same errors that General Electric, IBM, General Motors, or Bell and Howell or any other company you want to pick that has gone from centralized to decentralized control, makes at first change in direction. They gave too much autonomy to the individual division. They would have caught it and cured it, just as every other company has, and were on the verge of doing so, but it happened at a time when by having fractionated the company into the five smaller companies, they had lost control. They had over de-centralized.

By **PHILIP GEDDES**

West Coast Bureau Manager  
ELECTRONIC INDUSTRIES



"Many U.S. corporations are broke and don't know it. . . . Fulfilling growth potential . . . is something that many managements choose to ignore."



"For a company our size, you can support one research foundation well. You can by no means support five different independent activities."



"It's amazing what comes out of the woodwork when you have the top 25 people define their jobs. . . . Managers must absolutely, clearly, understand their jobs."



"If we can identify a piece of bad inventory, no matter how large or small, it's written off the books in the month in which it's uncovered. We don't wait for year-end write-offs."

"On the positive side of the ledger, management had great courage in preserving the two very real values that existed in the company for future growth. Number one factor was that the company did not cut back the expenditures planned in the area of research and development. There was a slight lowering of R&D expenditure, about \$200,000 or thereabouts, but it was still well in excess of \$6 million. Management could also have reduced engineering by several million dollars. They would have shown a better profit and loss statement but they chose not to do so. By preserving the health of the major body of top technical and scientific personnel, and keeping R&D spending up, they provided the keystones on which we have made the turn around."

### The Turnaround

Bill Roberts brought Ampex out of the sharp decline in one year. He is no miracle maker. And, he is too modest a person to ascribe the recovery to just his own efforts. But, modesty aside, the fact remains that Ampex under Roberts has shown a \$3.2 million profit for 1962, despite dollars invested in R&D climbing higher than ever before.

What exactly did Roberts do?

"The first thing that had to be done was a matter of re-determining proper organization, staffing that organization with proper manpower, then getting a proper balance between decentralized operations. There are certain things that are better operated on a centralized basis but let me be specific. In a company our size, it is, in my judgement, foolish to have five different advertising agencies, each representing five different divisions of the company. I think that it is foolish to have different sales promotion groups, each of whom is doing its own booking of industry shows in which those divisions will be represented. We found ourselves at each convention with an Ampex exhibit right across the aisle that we didn't know was to be there. We found ourselves with three and four independently operated sales offices in a city.



## MANAGEMENT OVERHAUL (Continued)

These were extravagances that this company could not afford. They are better handled on a centralized control basis.

"We were attempting to build independent research departments within the fractionated company. We have recentralized all research. We also centralized certain types of advanced development, but not all. Certain development projects emanate upwards out of engineering. Those that belong with the engineering group remain with the product division. On the other hand, there are certain advanced development areas that emanate downwards from research activities and so these rightfully belong in the centralized activity within the research function. For a company our size, you can support one research function well. You can by no means support five different independent activities."

### Planning Products & Marketing

In the area of corporate planning, Roberts indicates that planning was in existence before he came on the scene but "more or less on an uncoordinated basis." He is currently concentrating planning into two major areas: broad corporate planning and product planning. His corporate planning leans very heavily on "great strength" in product planning, centralized as a staff function. The four prime movers in total corporate planning are John P. Buchan, V.P., Finance and Treasurer; Arthur H. Haus, V.P., Research and Advanced Development; Robert Sackman, V.P., Product Planning; and Roberts. The quartet is supplemented by the divisional V.P.s.

The present mix, in the five broad product lines that Ampex is marketing, is roughly 50/50 government and commercial. Roberts considers this "very healthy" adding, "there is nothing scientific about what the "right" figure is." He expects government/military work to increase in future years. This is because of the major gains occurring in their commercial and industrial markets.

"Profit on government orders," he says, "is less than in the civilian market, but, there are real values in government R&D funding on the pioneering front." He expresses great satisfaction at the help Ampex' technology has had in expanding. In his words, "... though there is a slightly lower level of return on each dollar of turnover, it has been a very important total dollar to the corporation."

Currently Ampex Corp. is spending better than \$9 million from profits in research and development (Fig. 11). On top of this, Roberts estimates that government funded research probably is within the three to four million dollar bracket this year. The total percentage allocated to research is therefore very impressive.

Marketing efforts at Ampex he describes as "relatively small" on an internal basis, supplemented by external market data studies. Roberts believes that the company has probably under-used rather than over-used market research data in making decisions. Better balance in this area is in sight. He sees a definite need for professional marketing personnel to support what he calls, "our own seat of the pants feeling on a product."

It seems natural to assume that every executive in  
(Continued on page 236)

Fig. 1. Graph shows dynamic growth rate of Ampex in sales and earnings within 14 years. Fig. 2. Ampex is now spending \$9 million on R&D.

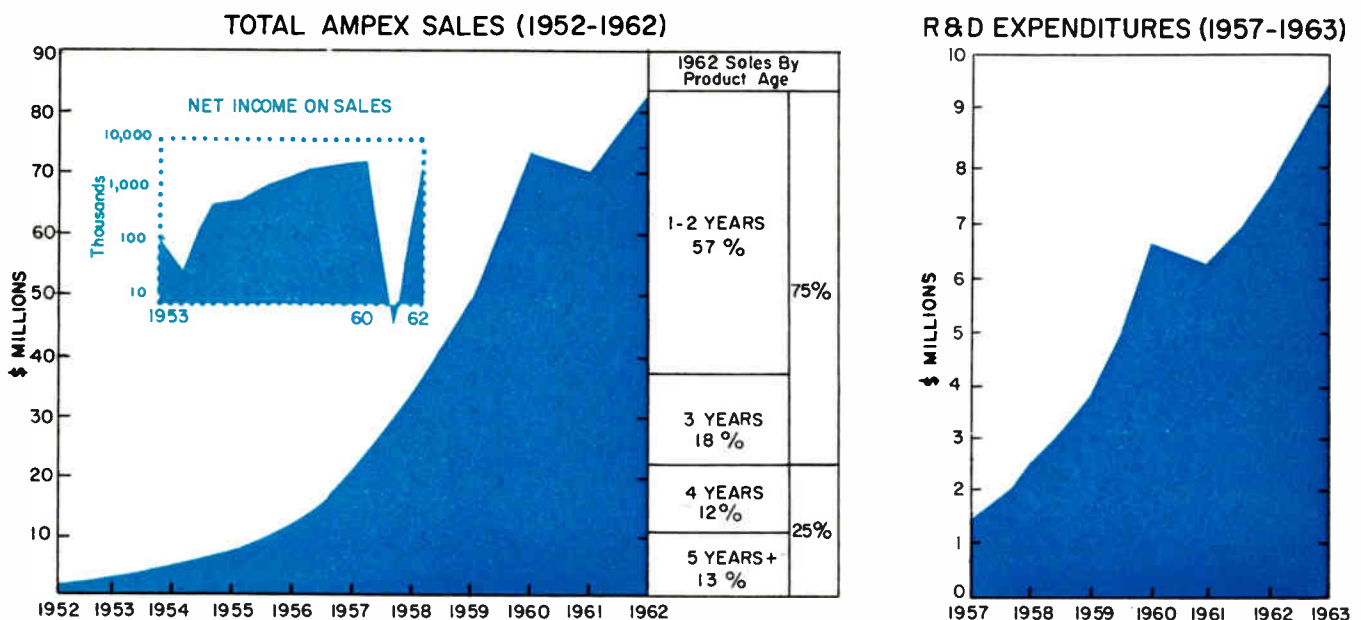

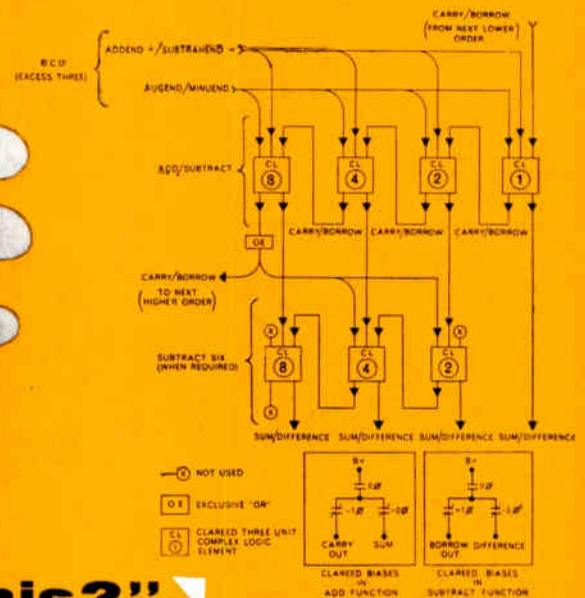
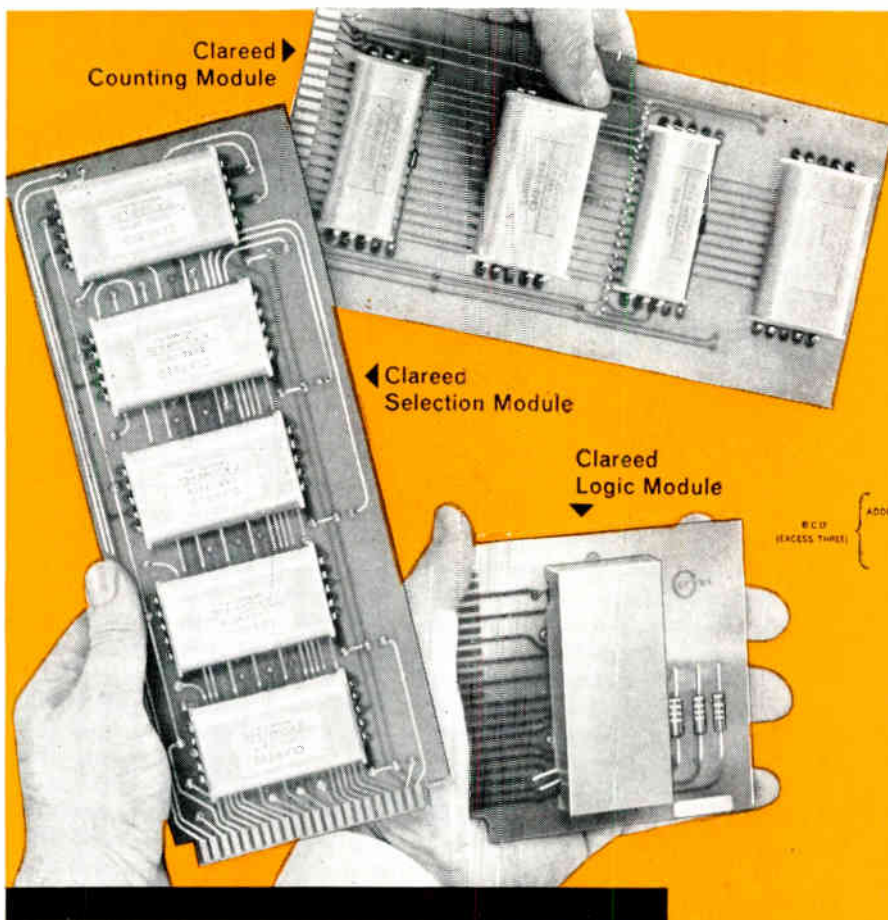

**We're still asking...  
"Which one does this?"**

If you work with control systems which involve counting, selection, or logic functions, take a look at Clareed Control Modules.

You'll see a system approach providing simpler (and often more economical) solutions than those offered by solid-state or other techniques. You'll find plenty of speed for most applications, and reliability of a very high order.

Clareed Control Modules use magnetic flux to make decisions. Combinations of flux levels and flux polarities, generated by multiple-wound coils, operate glass-encapsulated Clareed switches. Among the advantages of Clareed Control Modules are:

- Multiple-input and multiple-output capabilities; making possible logic at both input and output.
- Complete isolation between input and output. The output is the contact closure. This contact can handle low-level analog signals, other digital signals, and AC or DC power up to 15 va.

- Clareed systems are not affected by transient line noise.

Only one Clareed EXCLUSIVE OR element and seven Clareed Three-Input Complex Logic elements are needed to accomplish the Binary Coded Decimal Full Adder/Subtractor shown above, with weighted binary output and decimal CARRY-BORROW. (Which Clareed Control Module is used? "Logic.")

Standard Clareed Control Modules offer useful, uncomplicated ways of performing these functions:

- In logic: AND, INCLUSIVE OR, EXCLUSIVE OR, NAND, NOR, EXCLUSIVE NOR, as well as more complex logic in a single module.
- In counting: Three basic flip-flops which can be made into ring counters, bi-directional counters and shift registers for binary-coded decimal, decimal, and radix<sup>(N)</sup> counters.
- In selection: A variety of selection systems, using a single-mode matrix, a single-mode memory matrix, or a two-mode matrix (Mode 1: all crosspoints normally open; Mode 2: all crosspoints normally closed).

Systems using Clareed Control Modules can easily be serviced with a simple multimeter.

For detailed problem analysis and engineering recommendations, write Group 4D4, Application Engineering, C. P. Clare & Co., 3101 Pratt Boulevard, Chicago 45, Illinois. For useful manuals, see offers below.

**Take your choice!**

**Concise:** For a terse, time-saving explanation of Clareed Control Modules in counting, selection, and logic, get 8-page Manual 400 by circling number 152 on Reader Service Card.

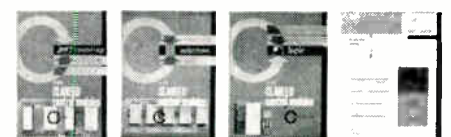

**Complete:** For detailed information on Clareed Control Modules in counting, selection, and logic, get Manual 400 plus Application Manuals and data sheets on all Clareed Control Modules. Circle number 153 on Reader Service Card.



# DESIGNED TO MEET MIL-C-21097

*Series 600-11 with "Bellowform" Contacts and Polarizing Slots*

Polarizing slots in molding permit any required polarization. Plastic Polarizing Key is easily inserted in slots, eliminating the removal of a contact position.

Available in a variety of mounting types: Through Hole; Threaded Insert; Floating Bushing and Threaded Floating Bushing.

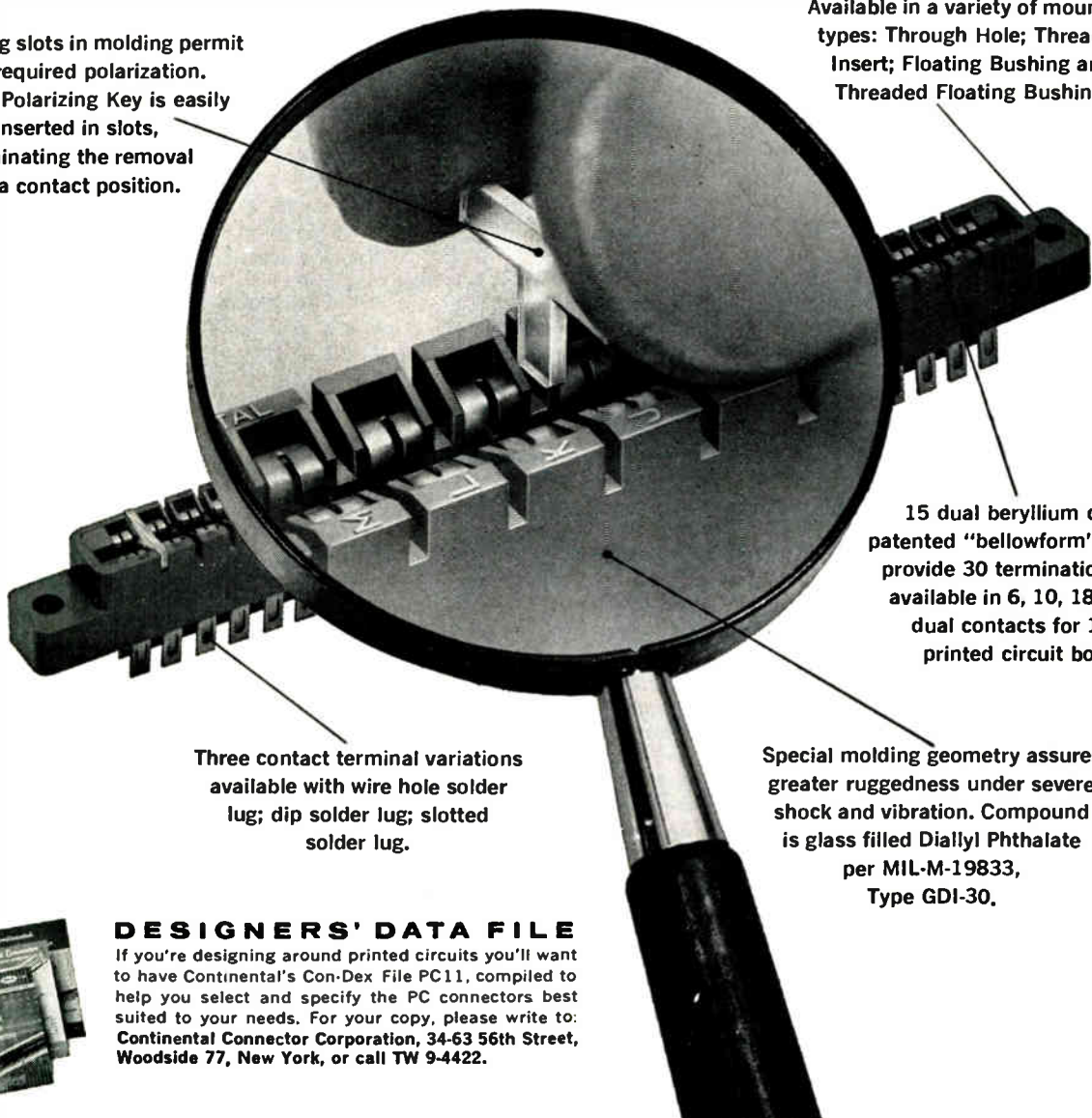

15 dual beryllium copper patented "bellowform" contacts provide 30 terminations. Also available in 6, 10, 18 and 22 dual contacts for 1/16" printed circuit board.

Three contact terminal variations available with wire hole solder lug; dip solder lug; slotted solder lug.

Special molding geometry assures greater ruggedness under severe shock and vibration. Compound is glass filled Diallyl Phthalate per MIL-M-19833, Type GDI-30.



## DESIGNERS' DATA FILE

If you're designing around printed circuits you'll want to have Continental's Con-Dex File PC11, compiled to help you select and specify the PC connectors best suited to your needs. For your copy, please write to: Continental Connector Corporation, 34-63 56th Street, Woodside 77, New York, or call TW 9-4422.

MICRO-MINIATURE • SUB-MINIATURE • MINIATURE • PRINTED CIRCUIT • RIGHT ANGLE PIN & SOCKET • CENTER SCREWLOCK

# CONTINENTAL CONNECTORS

CONTINENTAL CONNECTOR CORPORATION • WOODSIDE 77, NEW YORK



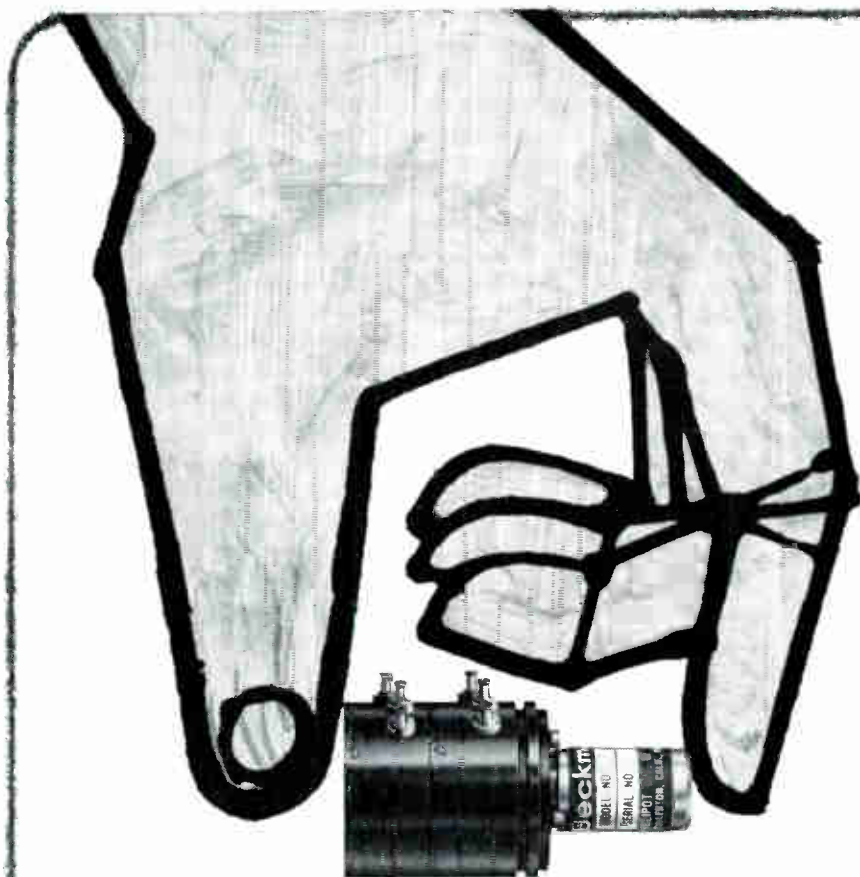

***both the same size...performance-wise***

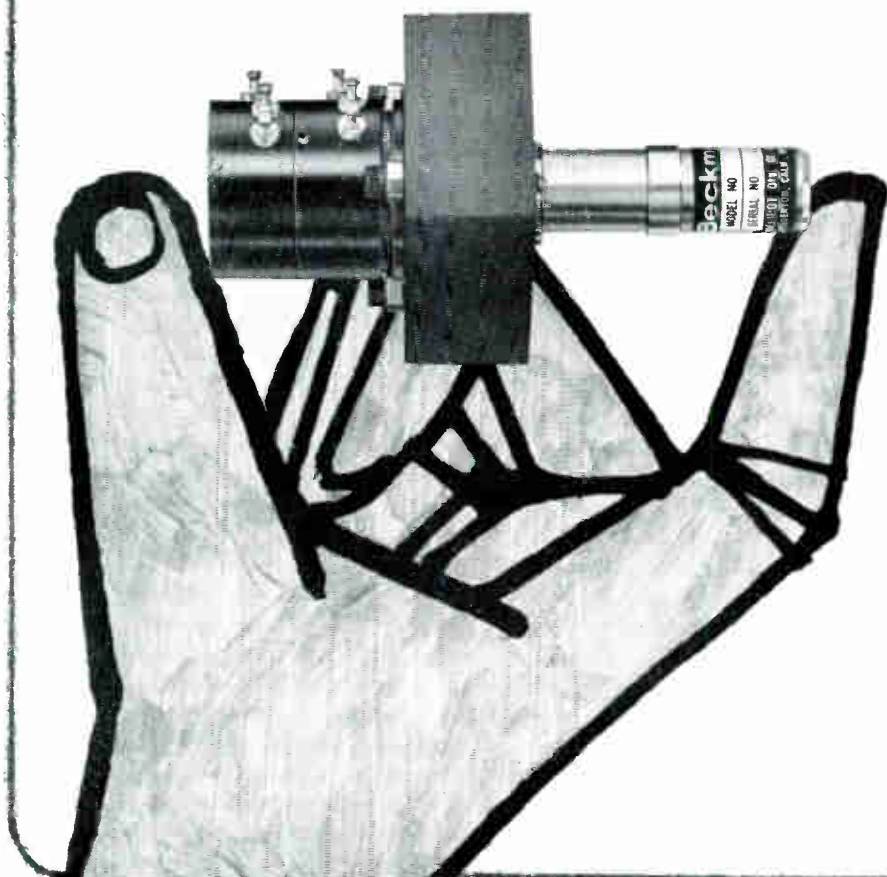

NEW...  
FIRST READY-BUILT  
SERVOPACKAGE  
SAVES YOU 30% ON  
SIZE AND WEIGHT

Introducing the Motor-Pot—the year's best example of pint-sizing. In a single package, you get high-performance servomotor, precision potentiometer and gearhead at a 30% saving in size and weight over typical in-line subassemblies. We've done it by cleverly placing the gearhead and part of the motor right inside the pot.

There are two standard models. The Model 45 Motor-Pot with its 1-1/16" diameter single-turn pot and size 5 servomotor. And the Model 46 with a 2" diameter ten-turn pot and size 8 motor. Also any number of custom variations.

The ready-made 45 and 46 give a clue to our in-line capability. And our experience furnishes the proof. We'll meet your most demanding spec with component matching you can count on. One-stop shopping also saves you time and money. There's no testing, positioning and aligning of components purchased from different suppliers. No more do-it-yourself assembly at all!

Your nearest Helipot rep has our full servopackage story. For more information, contact him or write us direct.

ALSO... NEW-GENERATION HALL EFFECT DEVICES,  
CLEAN-DESIGN METERS.

**Beckman** INSTRUMENTS, INC.  
**HELIPOT DIVISION**  
Fullerton, California

INTERNATIONAL SUBSIDIARIES: GENEVA, SWITZERLAND;  
MUNICH, GERMANY; GLENROTHES, SCOTLAND.

Actual width of record is 6 inches

# At Brush it's a matter of record

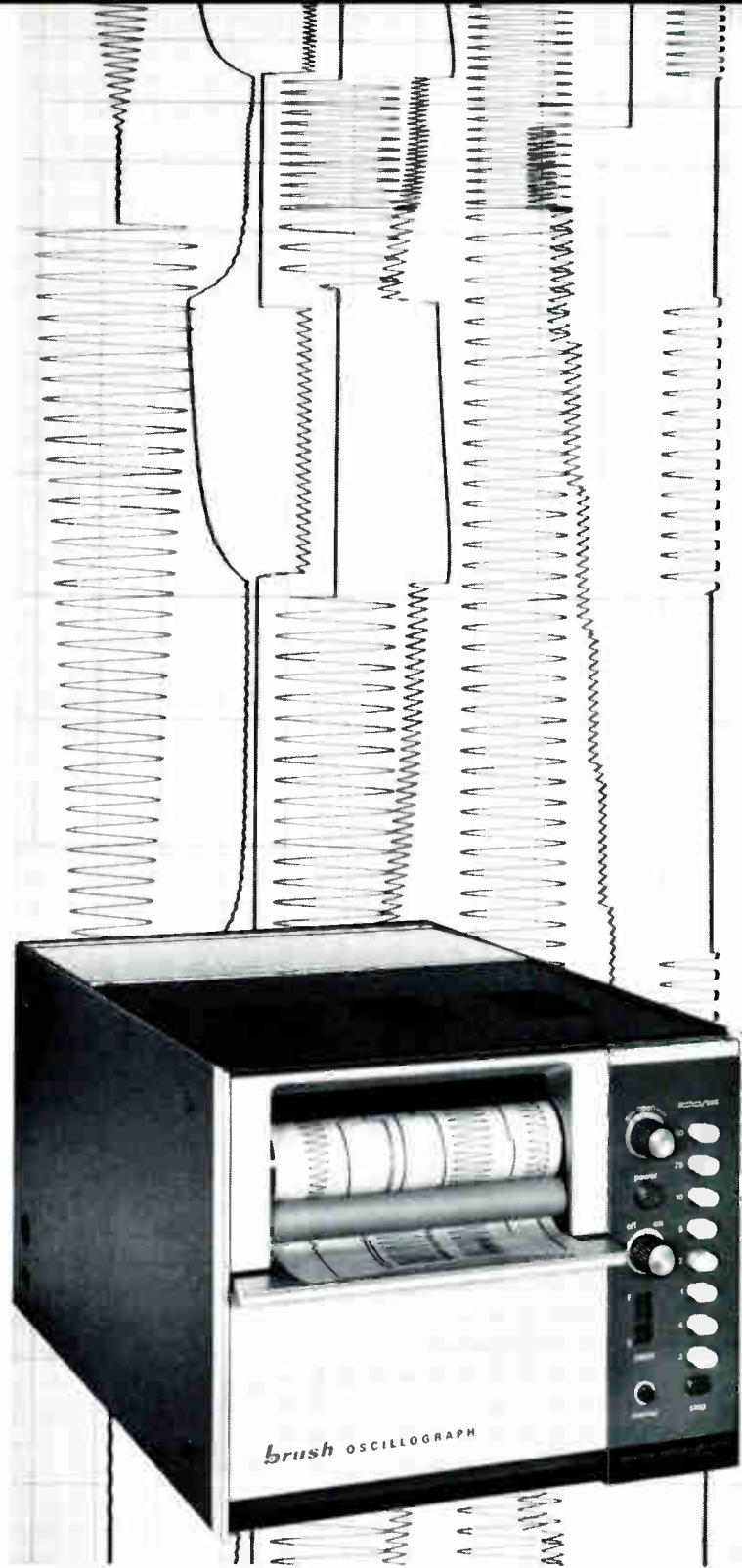

... and *this* record speaks for itself. It was made by the new oscillograph Series 2300 . . . a product of Brush's advanced recording system design. Its unique optical system produces these high contrast traces . . . at all writing speeds. An extremely stable tungsten light source eliminates cluttered records caused by ultra-violet "jitter" or RF interference. The start-up of this low-cost lamp is virtually instantaneous. Overall system linearity is better than 2%. Eight record speeds are controlled by pushbuttons. Paper take-up is built-in. A complete line of accessories accommodates special requirements. So now, you can record over the whole range of most-used frequencies with Brush systems incorporating all the known refinements in oscillography. Write for full details.

**brush** INSTRUMENTS

DIVISION OF CLEVITE 37TH AND PERKINS, CLEVELAND 14, OHIO

World Radio History

# ELECTRONIC INDUSTRIES

Coming Next Month

## MATHEMATICS FOR DESIGN

The science of mathematics has many branches: algebra, geometry, differential and integral calculus, determinants, hyperbolic functions, Boolean algebra. Of these many approaches, which one is the most appropriate for a given design problem. This problem is one that has intrigued the editors of ELECTRONIC INDUSTRIES for some time. In the May 1963 issue, through a special

arrangement, EI will publish the opinions of a well-known mathematician. Dr. E. A. Knoblauch, of Burroughs Corp., is one of the very few mathematicians in the country with sufficient grounding in engineering to make recommendations for the most effective mathematical approach to engineering problems. This article will be "must" reading for all engineers in design work.

## WHAT ENGINEERS THINK OF PROFESSIONAL SOCIETIES, SHOWS AND CONVENTIONS

In March 1959 and March 1962 ELECTRONIC INDUSTRIES published "Today's Electronic Engineer," studies of the personal characteristics of engineers. In this study, EI goes further, probing into the engineer's opinions on his professional societies, and on shows and conventions. Hundreds of personal interviews were conducted among engineers at the WESCON show. The

questions included: Do you belong to any professional technical societies or associations? How many regular local meetings would you say you attended during the past year? What were your reasons for joining these societies? Do you think there are too many national conferences each year? Too few? Just enough? Engineers' views on these subjects will be described.

## OPTOELECTRONIC COMPONENTS IN CIRCUIT DESIGN

The term opto-electronic has been coined to describe the coupling of a light-responsive and a light-producing element. The wide range of new opto-electronic products offers combinations of electrical characteristics un-

available in conventional all-mechanical or solid-state designs. Many of these units are still in the developmental stage, but promise to fill a demand in specialized instrumentation usage.

## SIMPLE, ECONOMICAL LASER DEMODULATION

If the full potential of the laser in communication is to be realized, efficient methods of modulating and demodulating must be devised. This article describes a simple and very practical scheme for the microwave demodulation of an optical amplitude-modulated signal.

The photo-demodulator has a very broad-band response, extending into the millimeter wave range, to derive maximum benefit from the laser high carrier frequency ( $5 \times 10^{10}$  CPS). Other desirable features include high sensitivity, ruggedness, and simplicity.

## PLUS ALL OTHER REGULAR DEPARTMENTS

Our regular editorial departments are designed to provide readers with an up-to-the-minute summary of world wide important electronic events. Don't miss Radarscope, As We Go To Press, Electronic Shorts, Coming Events,

late Marketing Statistics, Snapshots of the Electronic Industries, International News, News Briefs, New Products, Industry News, Systems and Circuits, Washington Trends, Professional Opportunities, etc.

---

## WATCH FOR THESE COMING ISSUES:

**\*JUNE**

**Annual All-Reference Issue**

**\*AUGUST**

**WESCON Show Issue**

**\*NOVEMBER**

**Annual MICROWAVE Issue**



# A LOOK AT MODERN DIPLEXERS

Present day requirements demand that diplexers have high isolation and low insertion loss and be capable of handling very high average powers. The various configurations of diplexers are discussed here, together with comments on their abilities to meet these requirements.

THE DIPLEXER IS A DEVICE used in a communication system to separate the transmitter and receiver when used on a common antenna. The words diplexer and duplexer are sometimes used synonymously. However, the generally accepted definition is that if the device that switches between the transmitter and the receiver is accomplished on a power basis (e.g., a gas tube,) it is called the duplexer. If the switching is accomplished on a frequency basis (e.g., filters), it is called the diplexer. Present-day requirements demand that diplexers have high isolation and low insertion loss and be capable of handling very high average powers.

## Diplexer Requirements

*Isolation:* The basic requirement is that there must be high isolation between transmitter and receiver. There must be enough isolation to prevent the transmitter energy from getting into the receiver and also to protect the receiver from any receive frequency generated by the transmitter. The usual requirement is 45, 60 or 110 db of rejection over the bandwidth

of interest. The rejection bandwidth is always the same as the pass band.

*Diplexing:* The unit must perform a diplexing action. To connect a transmitter and receiver to a common antenna the transmitter frequency ( $f_t$ ) and the receiving frequency ( $f_r$ ) must be capable of selecting its own terminal.

The receive terminal must look like a short circuit to the transmitter frequency and the transmitter terminal must look like a short circuit to the receive frequency. To perform the above action it is only necessary for the effective short circuits to have about 20 db front-to-back isolation. Although to satisfy the isolation requirements this is usually made 45, 60, 110 db as required.

## Pass Band VSWR

A pass band VSWR must be less than 1.25:1, 1.10:1. The VSWR should be low to insure:

- Maximum transmission of energy from transmitter to antenna.
- The power handling capabilities are not reduced by high standing waves.
- The load as seen by the transmitter is constant to minimize power variation and frequency pulling as the diplexer impedance changes with environmental condition.

Folded "T" type—band 755—985, with stub and matching xfmr

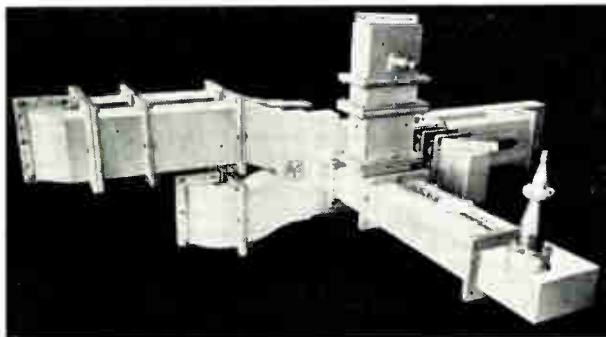

By **THOMAS J. VAUGHAN**

Manager of Engineering  
Antenna Systems Inc.  
Hingham, Mass.

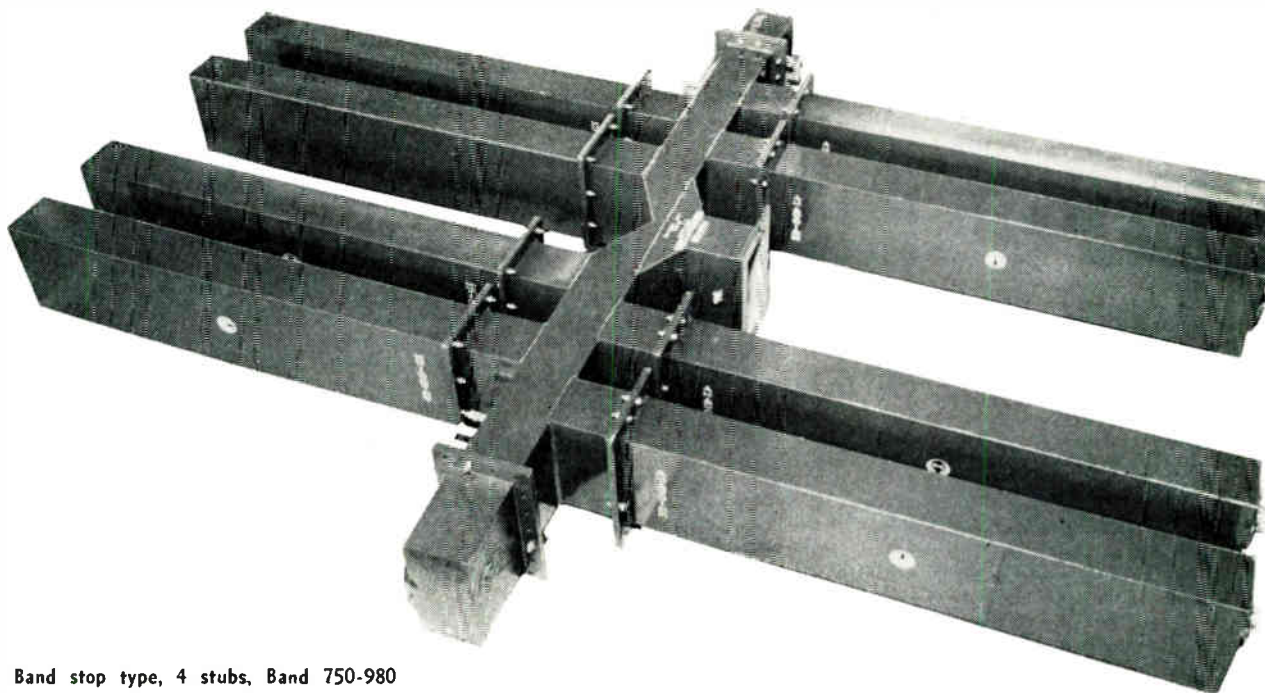

Band stop type, 4 stubs, Band 750-980

d. Intermodulation is kept to a minimum.

These units are used in communication systems carrying anywhere from 60 to 600 voice channels. The noise level in the unused channels will increase if high standing waves are present on the line.

#### Low Insertion Loss

The pass band insertion loss should be kept to a minimum. If .4 db is lost in the diplexer, this means about 10% of the transmitter power is wasted. At \$2.00 per watt in a 20 kilowatt system, this represents a loss of \$4,000.

Another, just as serious problem, is the 2 kilowatts dissipated in the diplexer when converted to heat can result in a temperature rise which could seriously damage or detune the unit since the diplexer is usually made up of frequency sensitive devices.

#### Wide Bandwidth

The bandwidth should be wide enough to handle the minimum number of voice channels to be carried. The bandwidth should be equal to approximately 2 times (peak deviation plus twice the maximum channel frequency) the megacycles. This means that the bandwidths depending upon the number of channels may be between 3 and 12 mc.

#### Tuneability

In most communication systems the transmit and receive separation may vary between 8% and 20% occurring anywhere in the assigned operating bands.

The more common assigned bands are as follows:

350- 490 MC	4400-5000 MC
790- 950 MC	7125-8500 MC
1725-2100 MC	

Because of interference and to provide some anti-jamming capabilities, it is necessary to periodically change both the transmit and receive frequencies. It is usually required that this be done in a 30-minute period and be accomplished without adding new equipment.

#### Harmonic Rejection

Most communication systems have a harmonic filter at the output of the transmitter. Harmonic rejection is necessary to minimize the amount of harmonic power radiated which may interfere with other systems. Harmonic power may also act as a pump frequency in the par-amp and effect receiver performance. This can be an absorption (it absorbs the unwanted harmonics) or reactive type (reflects the unwanted harmonics back into the transmitter). Even so, it is desirable that the diplexer provide as much harmonic rejection as possible, usually 20 db for the 2nd harmonic and 30 db rejection for the 3rd.

#### High Power Handling Capabilities

In tropo-scatter systems it is required that the diplexer handle larger and larger powers to overcome the large path attenuations. Most systems require the unit to handle 1, 10, 20, 50 or 100 kilowatts.

(Continued on page 97)

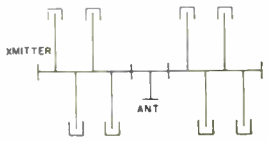
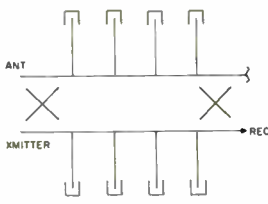
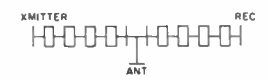
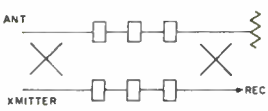
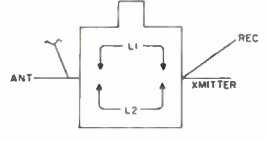
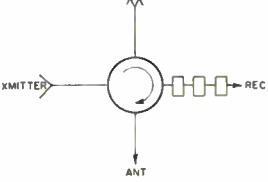
	TYPE DESCRIPTION	SKETCH	TYPE OF LINE	TUNEABILITY	ENVIRONMENTAL	SIZE	POWER	PASS BAND VSWR	PASS BAND LOSS	STOP BAND ATTENUATION	HARMONIC REJECTION
BAND STOP	STUBBS on a "T"		Coax or Waveguide	Very good field tuneable over full band Any freq. separation	Rugged Not sensitive to environment	Large tuning shorts must be accessible	Will stand very high average and peak power. Needs no cooling	Depending on No. of stubs typical-4 stubs 1.2 over .05% band	Good Determined entirely by total length of guide or Coax used	Any isolation level can be obtained. Depends on No. of stubs. Units can be cascaded. Band width limited. Typical-4 stubs 85 db @ .05% 150 db @ f <sub>o</sub>	Good
	HYBRID & STUBBS		Coax or Waveguide	Very good field tuneable. Limited by bandwidth of hybrid	Rugged Not sensitive to environment	Coax is used at low freq. Stubs may be 20 ft. long depending on freq. separator	Can be used up to the full rating of the hybrid	Depending on No. of stubs & hybrids typical-2 stubs 1.2 over .05% band	Good Depends on No. of stubs & hybrid	Any isolation level can be obtained depending on No. of stubs addition isolation obtained from hybrid ≈ 30db-waveguide ≈ 40db-Coax	Good
BAND PASS	BAND PASS FILTER on "T"		Waveguide Coax @ very low freq.	Waveguide not field tuneable. Filters have to be inter-changed.	Sensitive to temperature	More compact	At high average powers radiating fins or water cooling must be used	Very good 1.2 up to 20% band Band width establishes No. of cavities	Medium Depends on No. of cavities and quantity of transmission line	No band width problem. Level set by No. of cavities	Medium
	BAND PASS FILTER & HYBRID		Coax or Waveguide	Waveguide not tuneable. Filter & hybrids have to be inter-changed.	Sensitive to temperature	Can be made very compact	Filters are limiting factor. Not hybrid	Very good Limited by band width of hybrid	Medium Depends on No. of cavities & hybrid	No band width problem. Addition isolation obtained by hybrid	Medium
FOLDED "T"	FOLDED "T"		Waveguide	Field tuneable by replacing line length	Rugged Not sensitive to environment Nothing to deteriorate with time	Size in between band pass & stubs type	Highest power rating Will handle full power of folded "T"	Depends on length of L1 & L2 Typical 1.2 over .03% band	Very good Depends only on amount of transmission line involved	Medium Maximum isolation obtainable is isolation of hybrid	Very good
CIRCULATOR	CIRCULATOR & BAND PASS FILTER		Waveguide with Coax Preselector	Broad band has bandwidth of circulator. Must use Coax pre-selector type	Limited by behavior of ferrite	Compact	Low to medium power At high average power circulator performance deteriorates	Depends on circulator & preselector filters	Medium Loss in circulator increases with higher average powers	Medium Isolation of circulator may be as low as 10 - 20 db Relatively little protection from rec. noise generated by transmitter	Medium



## DIPLEXERS (Continued)

### Small Sizes

Space is always at a premium and the diplexer is usually mounted in or on the roof of the transmitting van. It is, therefore, desirable that it be as small and compact as possible.

### Capable of Handling the Environmental Condition

Since some units are mounted outside, the diplexer must be capable of performing all the environmental conditions.

### The General Solution

The general solution to the diplexer is to use a 3-port device made up of band pass or band reject filter.

The band stop type is designed to reject only the undesired band (hence band stop) while the band pass is designed to pass the desired band and reject everything else (hence band pass). The band stop diplexer is usually made up of long stubs shunted across the transmission line.

The stubs are tuned to approximately  $\lambda/4$  of the difference frequency ( $f_T - f_R$ ) and spaced at  $\lambda/4$  intervals along the transmission line. The stub throws a low reactance in shunt with the line at the reject frequency forcing the energy to be reflected. At the pass frequency a low reactance is inserted in series with the line allowing the energy to pass with little reflection. Some of the more novel designs can be completely decoupled from one another allowing one to add as many stubs as is necessary to obtain rejection over the desired band width. Over 100 db rejection can easily be obtained with 4 stubs. An advantage of the stubs is that in either coax or wave guide they can be made tuneable over the full operat-

Fig. 1: Behavior of diplexer

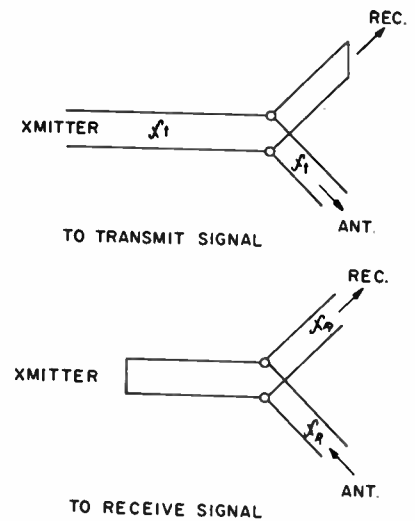

ing band. Another advantage is that they usually handle the full power rating of the coax or wave guide. A disadvantage is that the stubs are sometimes large and bulky and have limited pass band VSWR (i.e., a 10 mc band can be obtained at 5 kmc but a 3 mc band at 400 mc with the same number of stubs and approximately the same rejection). Good pass band attenuation can easily be obtained in the stub type. The band pass type is made of either  $\lambda/4$  or direct coupled filters. A Tchebyscheff or maximum flat response can be used to obtain any pass band desired. For example, at 800 mc a VSWR 1.1:1 can be obtained over a 10 mc pass band with 6 direct coupled cavities, while still providing 110 db rejection at 8% frequency separation. Another advantage is that they can be made smaller and more compact. The major disadvantage with the band pass is that they cannot be made field tuneable when required to carry high average powers. Also at high average powers even a small amount of insertion loss will result in temperature rise and detuning of the cavities.

(Continued on following page)

Fig. 2: Action of band stop and bandpass

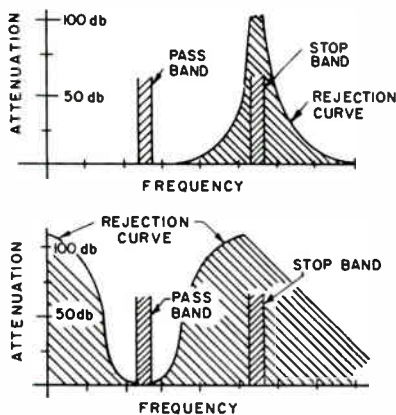
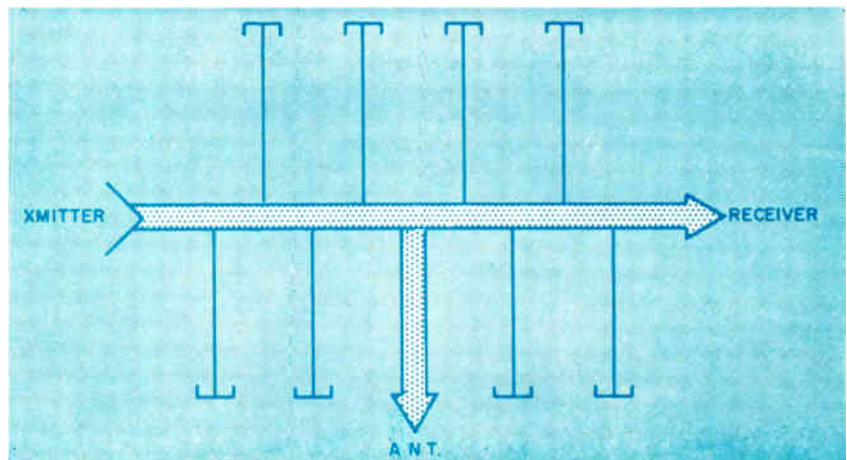

Fig. 3: In the diplexer, switching is on a frequency basis



## DIPLEXERS (Concluded)

There are two additional types that are often used. The first is the circulator with band pass filters and the other is two folded "T's" with differential line length in between.

### The Circulator Type

Here the transmitter is coupled directly to the antenna via the circulator. Transmitting power which gets past the circulator is reflected by the filter into the load. Since the power level at the filter is very low, tuneable preselector units can be used. A disadvantage is that as the power level at the circulator is increased the isolation decreases (for example, at 5 KMC and 1 Kilowatt of power the circulator isolation is only 15 to 20 db). Another more serious disadvantage is that the circulator being a ferrite device cannot handle the highest average powers required.

### The Folded "T"

The folded "T" type consists of two folded "T's" coupled together with two transmission lines at different lengths. The transmit signal is coupled in one arm of the folded "T". The energy is split equally and in phase between the two collinear arms of the "T". The energy is then coupled through lines  $L_1$  and  $L_2$  to the second "T". If there is no phase difference between the two signals, they will recombine in the second "T" and go out the antenna terminal. The amount of unwanted energy coupled to the receiver is a function of the directivity of the "T" which is about 40 db. The receive frequency goes through the reverse process except that in this case line length  $L_1$  and  $L_2$  are such that the signals when they recombine in the "T" are out of phase and will come out the fourth terminal. Line lengths  $L_1$  and  $L_2$  are specially chosen so we will get the right phase relationship for the transmit and receive frequency. This design does have the advantage that the pass band insertion loss will be very low for both transmit and receive; if the line lengths are chosen

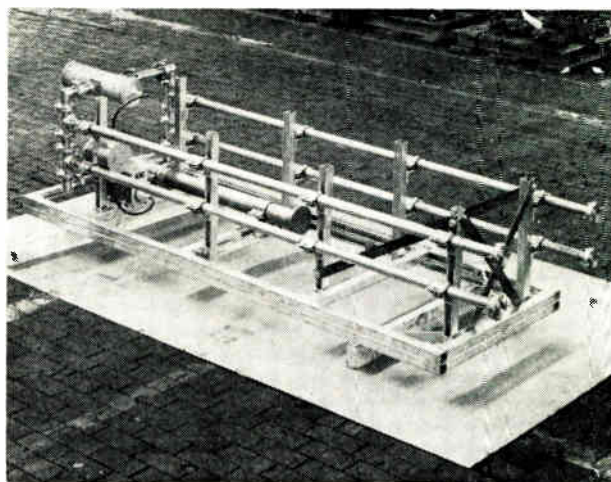
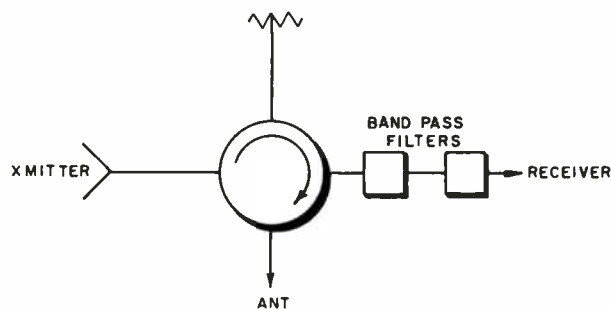

Band stop type diplexer, coax 2 stubs—band 350—470

properly and it will handle very high powers since there are no resonant structures involved.

This unit can be made field tuneable by changing the length of Line  $L_2$ . To do this it is necessary to have an adjustable phase shifter or length of transmission line available at the site pre-cut to the new frequencies.

There are no presently available units that will meet all of the requirements. It is necessary to weigh one's own requirements and emphasize those features important to him.

### Presently Available Units

Some of the units presently available are shown in the accompanying tables, and photographs. For comparative purposes values for the pass and stop band properties should be considered typical and not specific since a trade off must be made between power, frequency, band width, insertion loss, VSWR, harmonic rejection, tuneability and size.

For example, in the band stop type high rejection can be obtained at the expense of increase size whereas wide band width can be obtained in the band pass at the expense of more cavities. However, this results in higher insertion loss which will generate power handling problems.

Fig. 4 (left): Configuration of the circulator type diplexer

Fig. 5 (below): Configuration of the folded "T" diplexer

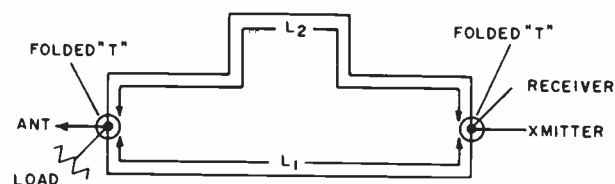

For years neoprene was the commonly used elastomer for wire sealing grommets and resilient insert bodies in connectors. Silicones were tricky to handle, and hence were avoided by connector manufacturers. This problem has been solved, and their use improves connectors as revealed here.

# SILICONE DIELECTRICS IMPROVE CONNECTORS

A VERY IMPORTANT FUNCTION OF THE CONNECTOR is to provide good dielectric separation between conductors (wire and contacts). Therefore, in evaluating an elastomer for use as an insert (dielectric core) material for connectors, electrical characteristics are of prime importance. Another important function of the environmental connector is to isolate the incorporated terminations and contact junctions from adverse environments.

Any elastomer, besides being a good dielectric, must possess good sealing characteristics. It must be able to retain them during, and after, subjection to adverse conditions. Also, the material must have adequate physical strength, and must not degrade when exposed to heat and various solvents.

Experience in evaluating and testing many elastomer materials shows that silicone compounds have high values for all needs. A methyl vinyl silicone is best for non-oil-resistant (MIL-H-5605) uses, and a fluoro-silicone performs best in most oil-resistant classed uses.

\* \* \*

Resilient inserts for connectors are generally molded from either one of two materials—neoprene or silicone. Neoprene is an organic material which, historically, has good moldability. Silicone, because it is harder to handle in connector production, has only been made broadly available as an insert material in recent months. In view of the margins of safety needed in all components of today's systems, a comparison of these two materials, of which the "hearts" of high performance connectors are made, is in order.

## Electrical Properties

One way to evaluate the relative electrical properties of materials is to compare volume resistivity. Silicone has a resistivity of  $2 \times 10^{16}$  ohm-cm., while that of neoprene is only  $10^{12}$  ohm-cm. Silicone retains its higher resistivity over a wide temperature range, and neoprene has a relatively large decrease in resistivity over a shorter temperature range.

The dielectric strength of silicone is roughly 900 volts per mil; neoprene's is about 450 volts per mil. This shows a much better margin of safety from the use of silicone, and with no increase in component size.

Arc resistance—the ability to withstand high potential across surface without breaking down—is in excess of 200 seconds with silicone, compared to neoprene's 120. And, the arc track left on the surface of neoprene is a conducting carbon deposit, while that

In outward appearances this connector is no different than connectors made several years ago. However, the insert is silicone instead of neoprene, which gives higher reliability.

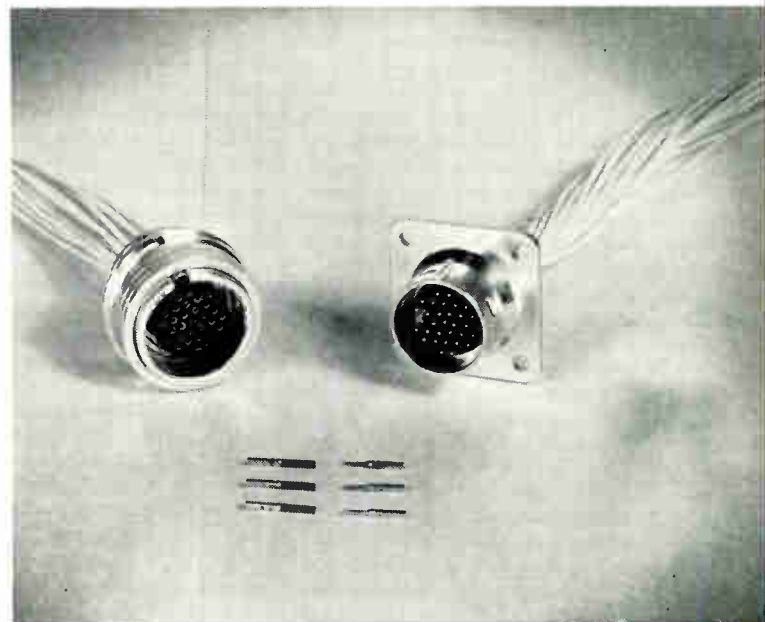

## By ROLAND LAWRENCE

Vice President  
Electronic Components Div.  
The Deutsch Company  
Banning, Calif.



## SILICONE DIELECTRICS (Continued)

left on silicone is non-conducting. In addition, the fillers used to make neoprene compounds are resistant (to make the 120 second duration) have the effect of lowering its physical strength and sealing characteristics.

### Sealing Values

The sealing value of an elastomer depends on its hardness (actually, its softness on a relative hardness scale) and its modulus. Silicone can be compounded with excellent Shore (a relative hardness scale) and modulus characteristics, but the fillers used to give adequate arc resistance to neoprene compounds make their sealing value much lower.

Soft neoprenes have a greater tendency to set under compression, and this degrades sealing value. Silicone has much lower compression set tendencies, making its long term sealing values much better.

Exposure to 257°F\* will stiffen neoprene, further degrading its sealing capability. This temperature has no effect on the relative Shore of silicones.

### Physical Properties

Compression set resistance is one property of elastomers that is important in environmental connectors. If the material used has poor compression set resistance, it will tend to lose interfacial seal (the seal established between mated faces of two halves of a connector, which isolates conductors from outside and from each other). Compression set is also critical at the wire entry end of each connector half, for each wire seal, if degraded, can allow contaminants to enter.

Compression set resistance of silicones is excellent in the temperature range from -67°F to 257°F. Neoprene, with fillers added for arc resistance, has

\*It should be noted that where connector materials are concerned the temperature rating is based upon the ambient temperature plus the rise due to passage of current through the incorporated conducting elements. Hence, 257°F might be based on an ambient of 177° plus 80° internal rise. The degradation of insert materials due to temperature is therefore a critical consideration, especially where design stress levels are approached.

**Table 1**  
Comparative Properties of Neoprene vs. Silicones

Properties	Neoprene	Silicone	Fluorosilicone
<b>ELECTRICAL PROPERTIES:</b>			
Insulation Resistance	Good	Excellent	Excellent
78°F	Fair	Excellent	Excellent
257°F	(I. R. is much more temperature dependant than silicones)		
Dielectric Strength	Fair	Excellent	Excellent
Arc Resistance	Fair (Requires special compounding—at the sacrifice of other properties)	Excellent (Ash is non-conductive)	Excellent (Ash is non-conductive)
<b>WIRE SEALING PROPERTIES:</b>			
Sealing Properties after exposure to 257°F	Poor (High Shore) Fair-Good (Low Shore) (Low shore can be achieved only by sacrificing electrical properties)	Excellent	Excellent
	Degraded (Depends on specific compound)	Excellent	Excellent
<b>PHYSICAL PROPERTIES:</b>			
Compression set	Poor (40-50%)	Good less than 5%	Good less than 5%
Low temperature properties (-67°F)	Fair-Poor (Depends on plasticizer used. Brittle point -30°F — -50°F)	Excellent	Excellent
Tensile strength	Excellent	Good	Good
Tear strength	Excellent	Good	Good
Retention of properties after exposure to 257°F	Fair (Tends to become brittle)	Excellent	Excellent
Oil resistance	Good (Fair retention of physicals)	Fair	Excellent

Fig. 1: Testing large numbers of units shows the best "average performance." The design stress level here is about 2500 DWV.

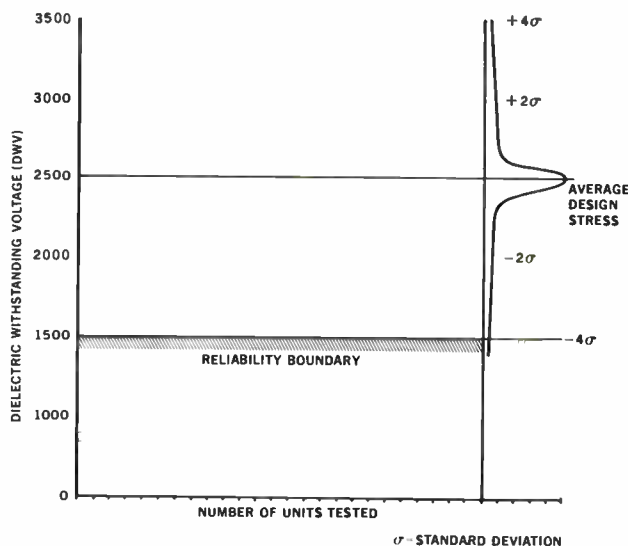

fair resistance to compression set at room temperature—with about 20% to 30% set effect. At 257°F set effect will go as high as 40% to 50%. The softer neoprenes, the ones that offer initially good sealing values, can have set effects as high as 70%.

Resistance to extremes of temperature, and not just ambient, is high on the list of insert elastomers.

Silicones remain flexible down to  $-100^{\circ}\text{F}$ , and therefore have good sealing values at this level. Neoprenes, on the other hand, tend to become brittle at about  $-25^{\circ}\text{F}$ . This low temperature brittle point can be lowered through the addition of various plasticizers—lowered to about  $-30^{\circ}$  or even  $-50^{\circ}\text{F}$ . But these low temperature plasticizers will boil off at the higher temperatures, leaving the neoprene again unable to sustain good low temperature characteristics.

The initial physical strength of neoprene (tensile and tear) has been acknowledged as being greater than silicone's, but neoprene is degraded very rapidly by increased temperature, while silicone compounds are highly temperature resistant. Also, silicone compounds now available have tensile ratings to 1700 psi, and tear strengths to over 225 lb/inch. These ratings are in excess of connector needs.

Oil-resistance is an important factor in many uses, especially in any system that is in close proximity to hydraulic components. Fluoro-silicone elastomers are more oil-resistant than methyl vinyl silicones, and far superior to neoprenes in this regard. As do neoprenes, the fluoro-silicones will swell when exposed

to some fluids, but to a smaller degree. Those fluids that cause swelling in the neoprenes also cause them to lose strength. Phosphate ester type hydraulic fluids (Skydrol) virtually destroys the physical properties of neoprene, while the silicones are resistant to them.

Outgassing from elastomer inserts in connectors can cause damage to wires and contacts, and also to other structural and circuit components within the system. Neoprene inserts have a high outgassing rate at  $275^{\circ}\text{F}$ , and the high acid content of the gases has a corrosive effect. Silicone compounds have a much smaller outgassing rate at  $257^{\circ}\text{F}$ , and the gases are non-acidic.

Neoprene was the original, commonly-used elastomer for wire sealing grommets and resilient insert bodies. While the silicones offered promise of many advantages over the neoprenes, the compounds were so tricky to process and mold that for many years they were avoided by many connector manufacturers, and were more expensive. The newer silicone compounds are not as difficult to mold, though, and more connectors with inserts made of these higher performance materials are available, and at better prices.

## CIRCUIT-WISE

### PULSE EMITTER FOLLOWER

THIS IS A TWO-STAGE CASCADED EMITTER FOLLOWER intended primarily as a video line driver for positive pulses. It has a nominal input impedance of about  $80\text{k}\Omega$  in parallel with 25 pf and will drive loads with impedances as low as 50 ohms. It may be modified for negative inputs by replacing Q1 and Q2 with their complementary pnp types and reversing the polarity of the collector supply. Cascading two emitter followers provides the advantages of a very high input impedance and a constant output impedance which is practically independent of the source impedance and about equal to the internal emitter resistance.

#### NOTES:

1. These are the maximum powers dissipated in the resistors. In determining these values, allowance has been made for variations in component values, power supply voltages, and transistor characteristics.
2. The performance specifications are based on component values which do not deviate from nominal by more than the limits specified. Thus the term "limits" includes initial tolerance plus drifts caused by environmental changes or aging.
3. The operating characteristics are based on operation at  $25^{\circ}\text{C}$  with a  $100\Omega$  load and on transistors with betas of 75.
4. The 17-volt absolute maximum input voltage is limited by the collector-to-emitter voltage of the transistor. For a particular load and duty factor it may be necessary to reduce the input voltage.
5. The droop may be improved by increasing coupling capacitor C2. The droop in percent for any pulse width,  $\tau$ ,

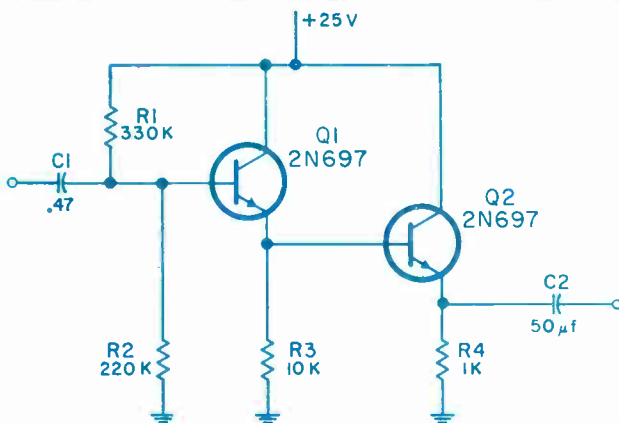

Unless otherwise stated: R in ohms; C > 1 in pf; C < 1 in  $\mu\text{f}$ ; L in  $\mu\text{h}$

is approximately  $100\tau/R_L C2$ , where  $R_L$  is the load resistance. Components:

Max. power dissipation (note 1): R1: 1 mw; R2: < 1 mw; R3: 7 mw; R4: 60 mw.

Max. capacitor voltage: C2: 8 volts; C1: select voltage rating for particular coupling application.

Limits (these are not tolerances; see note 2): All R:  $\pm 10\%$ . All C:  $\pm 20\%$ .

Operating characteristics (note 3):

Temp.:  $-55^{\circ}\text{C}$  to  $+125^{\circ}\text{C}$ .

Load resistance: 100 ohms.

Input:

Resistance:  $80\text{k}\Omega$ .

Capacitance: 25 pf.

Signal polarity: Positive.

Maximum signal amplitude: 17 volts peak (note 4).

Voltage amplification: 0.975.

Power gain: 30 db.

Droop for 100  $\mu\text{sec}$  pulse (note 5): 2%.

Output impedance (independent of load): 2 ohms.

Maximum power needs: 25 dc  $\pm 10\%$  at 8 ma.

Abstracted from "Handbook Preferred Circuits Navy Aeronautical Electronic Equipment" (NAVWEPS 16-1-519-2). Volume II.

# FUNCTION GENERATION WITH ACTIVE NONLINEAR ELEMENTS

Mathematical operations on signals are dictated by advance requirements of modern electronic applications. These may be easily implemented by means of simple components. Circuits for a complete operation are presented.

SOLUTIONS TO COMMUNICATION AND CONTROL PROBLEMS at most times require at least one unit to perform an algebraic or a transcendental operation. Depending on the nature of the problem, one or more of these units may be used at some point of the system. Needs of this kind are to be expected in contemporary technology.

Successful circumvention of difficulties in application is directly dependent upon correct expression of the physics of the problem into concise mathematical formulations. Raising a quantity,  $x$ , to a power or producing some function of it, such as the sine or the logarithm of  $x$ , by means of an electronic computing circuit are operations as common today as finding their values in tables was two decades ago. Toward this end an amplifier of average performance characteristic, or, better yet, a high-gain computer type amplifier provides a potent tool, depending on the accuracy required.

\* \* \*

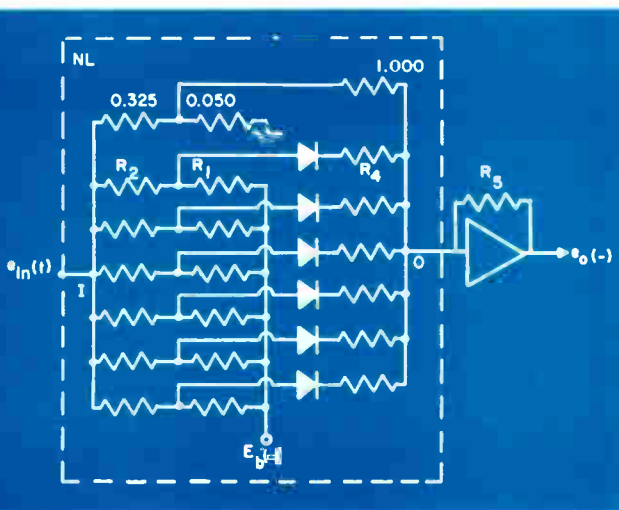

Computational tasks of the above nature become relatively easy to cope with if straight-line segment approximations of the desired function are acceptable. Of course, the greater the number of segments the closer the approximation.

The nonlinear circuit presented here was built to enable the addition of the two time-varying orthogonal components of a vector. This requires squaring the magnitudes of the components and extracting the square root of the sum of the squares. Seven segments were found to be adequate for the accuracy sought.

## Operation Device

The nonlinear circuit arrangement that makes such a computation possible is a tandem connection of six properly biased diodes. This in effect represents a nonlinear input resistance unit to an operational amplifier. The unit is shown within the block NL in Fig. 1. Each diode will begin to conduct only when the positive input voltage,  $e_{in}$ , becomes high enough to make point  $J$  positive as opposed to the negative bias  $E_b$ .

The input-output characteristics of each branch is shown in Fig. 2 in terms of the various resistors involved. Obviously, appropriate selection of the

Fig. 1 (left): Nonlinear circuit having six diodes in tandem connection. This NL unit enables the mathematical operation.

By **NICK D. DIAMANTIDES**

Engineering Scientist  
Goodyear Aircraft Corp.  
Akron 15, Ohio





ratios  $R_2/R_1$  will cause the cutoff points of the successive branches to be spaced farther and farther away from the level  $e_{in} = 0$ .

### Squaring Circuit

The particular power function implemented for the present vector addition was

$$e_o = -0.02 e_{in}^2 \quad (1)$$

where

$$0 \text{ v.} \leq e_{in} \leq 50 \text{ v.}$$

and the bias selected  $E_b = -50 \text{ v.}$  With a further assumption that  $R_5 = 0.75 \text{ meg}\Omega$ , the following resistor values (See Table 1) were computed, yielding satisfactory performance. The diodes used were 1N645 or equivalent.

Table 1

$R_2/R_1$	0.10	0.20	0.30	0.40	0.60	0.80
$R_4 \text{ meg}\Omega$	3.401	3.125	2.885	1.442	1.172	1.042

The degree of accuracy in generating the function of Eq. (1) is shown by the lower characteristic curve of Fig. 3. One circuit unit as in Fig. 1 is necessary for each of the two orthogonal vector components. After addition of their outputs, the computation of the absolute value of the resultant vector necessitates the extraction of a square root.

### Square Root Circuit

It is very convenient that an exact duplicate of the resistance unit NL may be employed to perform the operation

$$e_o = \sqrt{0.02 e_{in}} \quad (2)$$

which is the inverse of that in Eq. (1). For purposes of present discussion, the following function generation was performed

$$e_o = -\sqrt{\frac{1}{0.02} e_{in}} \quad (3)$$

where

$$-50 \text{ v.} \leq e_{in} \leq 0 \text{ v.}$$

The results are presented in the upper curve of Fig. 3.

The circuit used is shown in Fig. 4 where it is seen that the NL unit is now connected in the feedback branch of the operational amplifier.

In both configurations, the circuit exhibits satisfactory performance for input frequencies up to about 20 cps. Beyond that the diode characteristics introduce detrimental effects.

The discussion makes apparent the fact that a variety of computational functions may be implemented in this manner with a minimum of equipment.

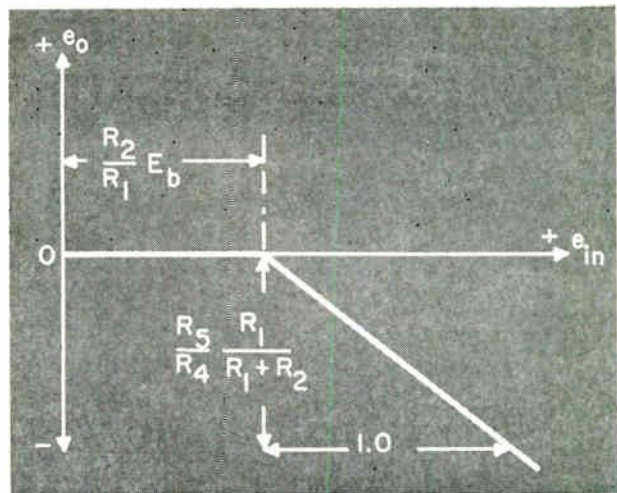

Fig. 2: Each branch of Fig. 1 can have its characteristic different from the others depending on the values of resistors used.

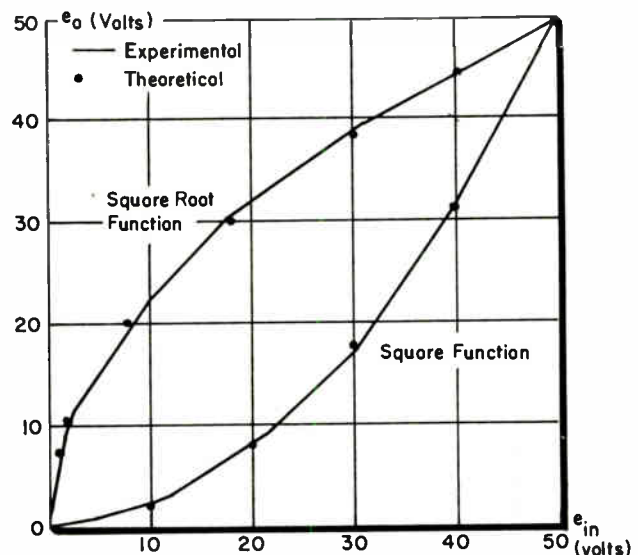
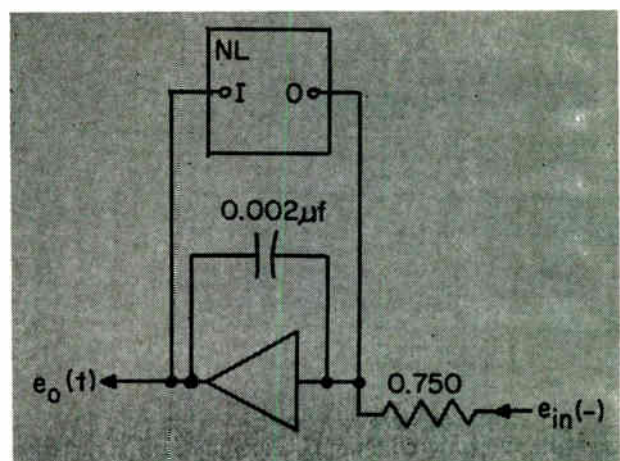

Fig. 3: Segmented curve for a square function. Square root extraction provides the absolute value of resultant vectors.

Fig. 4: The resistance NL unit of Fig. 1 is shown in the feedback of an operational amplifier for the square root function.



Modern circuit synthesis provides the circuit when the input and the output are specified. A breach between theory and practice exists due to the difficult mathematics. Here is an approach to make techniques clear and useful for the electronics engineer.

# CIRCUIT REALIZABILITY CRITERIA

SOME FORM OF SYNTHESIS EFFORT is constantly being applied by circuit designers. Even circuits which can be designed by recognition and experience are simple results of a powerful synthesizing tool. The class of synthesis usually employed obtains passive networks from specifications given in the frequency domain. Also, there are methods available to make use of time domain specifications.<sup>1</sup>

These two alternatives are part of so-called "modern network synthesis," or "exact network design,"<sup>2</sup> based on insertion-loss theory. This approach, which is gaining more acceptance by engineers, replaces earlier design techniques based on image-parameter theory.

\* \* \*

Fundamental questions in a synthesis procedure are:

1. Is the network specification given as a physically realizable rational function?
2. If the answer to (1) is no, is an approximation available which will permit development of a usable physical network?

When the answer to (1) is yes, an infinite number of satisfactory circuits may exist. The number of realizable networks actually satisfying the specifications depends on the extent of the circuit restrictions given. Restrictions which will narrow the choice are:

- a. Number of elements in circuit.
- b. Type of elements in circuit.
- c. Number of external terminals available.
- d. Method of terminating circuit.
- e. Form of the circuit (e.g., is a common ground required?).
- f. Number and nature of describing system functions.
- g. Magnitude of element values.
- h. Size or weight of the circuit.
- i. General economic factors.
- j. Degree of reliability required.

Many more restrictions exist. Before all of these may be considered, the basic question must be

answered: Does the mathematical description given in the specification have any physically realizable network?

The synthesist must first test his system function for realizability. Then his subsequent procedure may be crude, complex, empirical, sophisticated, or merely done by inspection. The realizability criterion employed has a format based on a minimum set of restrictions and is built from this foundation. Naturally, this must be our path in presenting the material.

## System Functions

A circuit is normally specified as a function  $F(s)$  which is the ratio of two system variables. The first test of realizability is to check the stability of the network. Certainly a passive network cannot be unstable. However, if the form of the system function is such that the time response resulting from a forcing function input has terms whose exponents are positive functions of time, then the response must go to infinity as time increases.

When the nature of the Laplace transform of a response not having these terms is considered, then a stable system function may have no poles in the right-half plane. Since the system function contains a polynomial in both the numerator and denominator, stability requires that the roots of the denominator be negative. A polynomial with this characteristic is called Hurwitz.

A polynomial  $P(s)$  is said to be Hurwitz on the following conditions<sup>3</sup>:

1.  $P(s)$  is real when  $s$  is real.



By JOHN W. LAPATRA

Assistant Professor  
Dept. of Elec. Eng.  
Univ. of the Pacific  
Stockton, Calif.

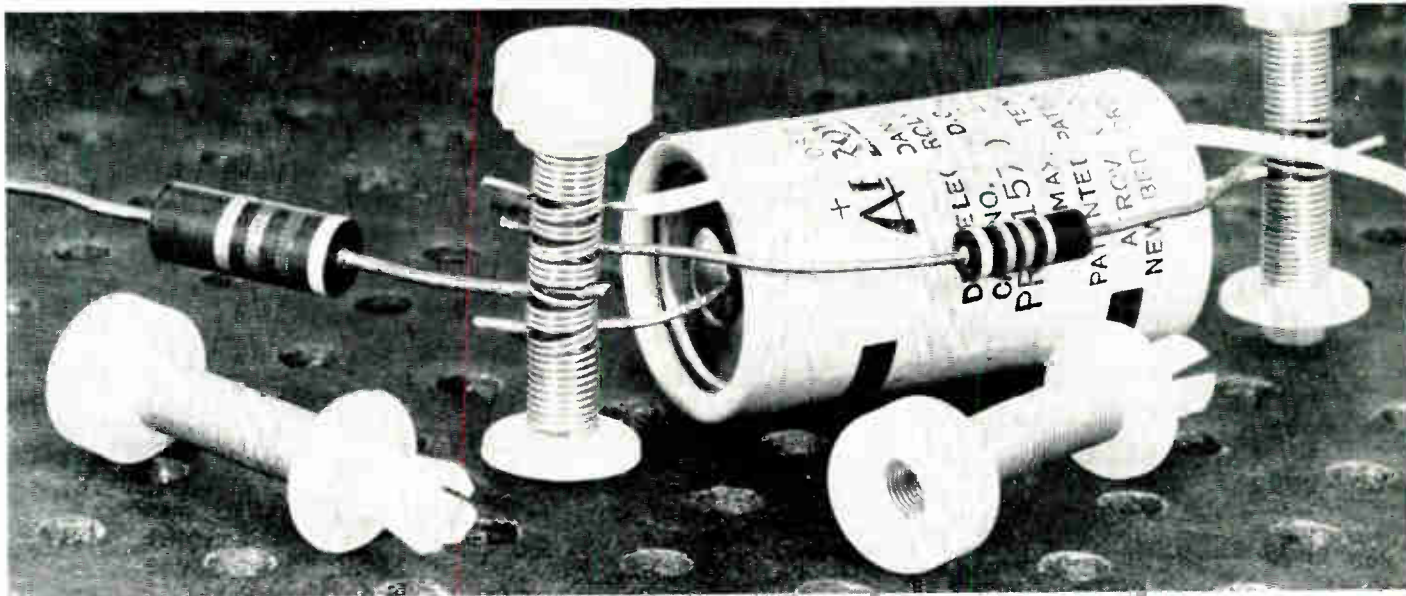

A synthesized circuit is shown being made up of elements determined by the mathematical procedure which is described in the

text. In this check on the specific results of calculations, components are being assembled on a breadboard made by Elec-Traid.

2. The roots of  $P(s)$  have real parts which are zero or negative.

To avoid the necessity of attempting to factor a high degree polynomial a quick test for the Hurwitz character is available. The continued fraction expansion of the ratio of the odd to even or even to odd parts of the polynomial must have positive quotients to be Hurwitz.

Example 1: Is the polynomial,  $s^4 + s^3 + 5s^2 + 3s + 2$ , Hurwitz?

$$\begin{aligned} \frac{s^4 + 5s^2 + 2}{s^3 + 3s} &= s + \frac{2s^2 + 2}{s^3 + 3s} \\ &= s + \frac{1}{\frac{s^3 + 3s}{2s^2 + 2}} = s + \frac{1}{\frac{s}{2} + \frac{s}{2s^2 + 2}} \\ &= s + \frac{1}{\frac{s}{2} + \frac{1}{2s^2 + 2}} = s + \frac{1}{\frac{s}{2} + \frac{1}{2s + \frac{2}{s}}} \\ &= s + \frac{1}{\frac{s}{2} + \frac{1}{2s + \frac{1}{\frac{s}{2}}}} \end{aligned}$$

All the  $s$  terms are positive, therefore, the polynomial is Hurwitz.

A REPRINT OF THIS ARTICLE CAN BE OBTAINED  
by writing on company letterhead to  
The Editor  
ELECTRONIC INDUSTRIES  
Chestnut & 56th Sts., Phila. 39, Pa.

Example 2: Test  $s^4 + s^3 + 2s^2 + 3s + 1$ .

$$\frac{s^4 + 2s^2 + 1}{s^3 + 3s} = s + \frac{1}{-s + \frac{1}{-\frac{s}{4} + \frac{1}{\frac{4s}{1}}}}$$

Polynomial is not Hurwitz.

### Driving Point Immittances

The system function,  $F(s)$ , represented as a ratio of two variables  $A(s)$  and  $B(s)$  is:  $F(s) = A(s)/B(s)$ . If this ratio employs variables from the same terminal-pair the system function is termed "driving-point". If the variables are taken from different terminal-pairs  $F(s)$  is called "transfer". The driving-point function for an electric circuit with one terminal-pair must necessarily be either an impedance or an admittance. The literature refers to this entire function class as driving-point immittances. This function represents, of course, the first stipulation of restrictions and should now be considered in terms of necessary and sufficient conditions for realizability. Stated more simply, can the function be realized in terms of positive resistances, inductances, and capacitances? If so, this driving-point immittance is said to belong to a class of functions known as "positive-real" (or p.r.). Knowledge of the properties of p.r. functions will permit testing the circuit specification for physical realizability.

Necessary and sufficient conditions for a rational function  $F(s)$  with real coefficients to be p.r. are:



## CIRCUIT REALIZABILITY (Continued)

(a) The poles of  $F(s)$  may be only in the left-half plane or on the  $j\omega$  axis.

(b) The poles of  $F(s)$  on the  $j\omega$  axis must be simple (no repeated imaginary roots) with real and positive residues.

(c)  $\text{Re } F(j\omega) \geq 0$  for all  $\omega$ .

Condition (a) is satisfied if the denominator of the immittance function is a Hurwitz polynomial. Condition (b) is most easily tested by making a partial fraction expansion of the terms involving poles on the imaginary axis to verify that the residues are real and positive. Ingenuity must be exercised to avoid complete factoring of a complex polynomial. However, if one of the many methods available to factor high degree polynomials is utilized, the Hurwitz character would be checked at the same, thus excluding a separate test.

Condition (c) is met by finding the even part of  $F(s)$ , letting  $s = j\omega$ , and then examining this func-

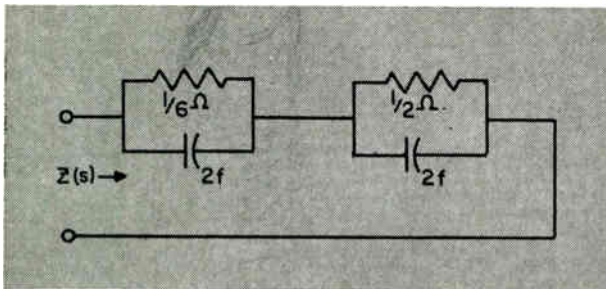

tion, which is the real part of  $F(j\omega)$ . The even part of  $F(s)$  is:

$$\text{Ev } [F(s)] = \frac{N_E D_E - N_O D_O}{(D_E)^2 - (D_O)^2}$$

where:  $N_E$  = even part of numerator,  $N_O$  = odd part of numerator,  $D_E$  = even part of denominator, and  $D_O$  = odd part of denominator.

Example 3: Is  $F(s) = (s + 1)/(s^2 + 4)$  p.r.?

$$\frac{s + 1}{s^2 + 4} = \frac{s + 1}{(s + j2)(s - j2)}$$

The denominator has no repeated imaginary roots, no roots in the right-half plane, and the residue of the imaginary axis poles is positive. Therefore conditions (a) and (b) are satisfied.

$$N_E = 1, N_O = s, D_E = s^2 + 4, D_O = 0.$$

$$\text{Ev } [F(s)] = \frac{s^2 + 4}{(s^2 + 4)^2} = \frac{1}{s^2 + 4}.$$

$$\text{Re } [F(j\omega)] = \frac{1}{-\omega^2 + 4}.$$

When  $\omega^2 > 4$  the real part of  $F(j\omega)$  is less than zero, therefore,  $F(s)$  is not p.r.

Example 4: Test  $(s + 5)/(s^2 + 2s + 1)$  for positive realness.

$$\frac{s + 5}{s^2 + 2s + 1} = \frac{s + 5}{(s + 1)(s + 1)}$$

Condition (a) is satisfied and (b) is not applicable.

$$N_E = 5, N_O = s, D_E = s^2 + 1, D_O = 2s.$$

$$\begin{aligned} \text{Ev } [F(s)] &= \frac{5(s^2 + 1) - s(2s)}{(s^2 + 1)^2 - (2s)^2} \\ &= \frac{3s^2 + 5}{s^4 - 2s^2 + 1}. \end{aligned}$$

$$\text{Re } [F(j\omega)] = \frac{-3\omega^2 + 5}{\omega^4 + 2\omega^2 + 1}.$$

When  $3\omega^2 > 5$ , the real part of  $F(j\omega) < 0$ , so the function is not p.r.

Example 5: Test

$$F(s) = \frac{s + 2}{s^2 + 4s + 3} = \frac{s + 2}{(s + 1)(s + 3)}.$$

By inspection, condition (a) is satisfied and (b) is not applicable.

Fig. 1 (left): A parallel R-C combination for the circuit resolved.

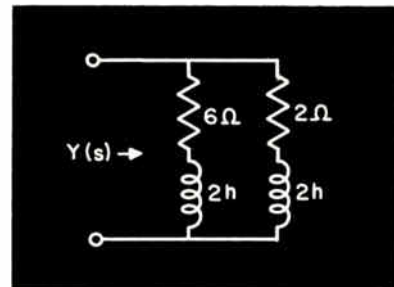

Fig. 2 (right): A circuit formed with  $F(s)$  taken as an admittance function.

$$N_E = 2, N_O = s, D_E = s^2 + 3, D_O = 4s.$$

$$\text{Ev } [F(s)] = \frac{2(s^2 + 3) - s(4s)}{(s^2 + 3)^2 - (4s)^2}.$$

$$\text{Ev } [F(s)] = \frac{-2s^2 + 6}{s^4 - 10s^2 + 9}.$$

$$\text{Re } [F(j\omega)] = \frac{2\omega^2 + 6}{\omega^4 + 10\omega^2 + 9}.$$

Thus, the function,  $F(s)$ , is p.r.

A partial fraction expansion of  $F(s)$  is

$$\frac{s + 2}{(s + 1)(s + 3)} = \frac{1}{s + 3} + \frac{1}{s + 1}$$

Synthesis by recognition could be accomplished if it were noted that the expression  $a/(s + b)$  is the form of the impedance of a parallel R-C combination.

$$Z_{RC}(s) = \frac{\frac{1}{C}}{s + \frac{1}{RC}}$$

For this assumption the circuit is shown in Fig. 1.

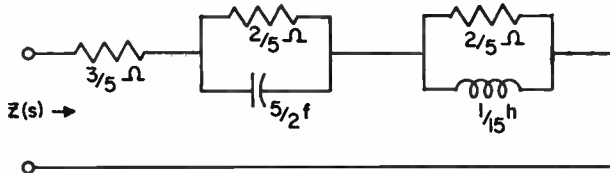

Fig. 3: Circuit now includes R, L and C elements. The values are solved from a p.r. function by partial fraction expansion.

If  $F(s)$  were assumed an admittance function, the admittance of a series R-L combination satisfies the basic form

$$Y_{RL}(s) = \frac{1}{s + \frac{R}{L}}$$

The circuit is seen in Fig. 2.

Circuits at this stage are permitted to include resistance, inductance and capacitance. However, Ex. 5 was limited to two elements. This allowed a "synthesis by recognition" type of procedure. If a function is p.r. there may be a realization technique available such as by Brune or Bott-Duffin; nevertheless, their complexity places them beyond the scope of this article. Ref. 4 may be checked for details on these methods. The following example demonstrates how partial fraction expansion can sometimes produce a 3-element kind realization.

Example 6: A p.r. function which is solved.

$$Z(s) = \frac{(s+2)(s+3)}{(s+1)(s+6)}$$

$$\frac{Z(s)}{s} = \frac{(s+2)(s+3)}{s(s+1)(s+6)} = \frac{A}{s} + \frac{B}{s+1} + \frac{C}{s+6}$$

$$\frac{Z(s)}{s} = \frac{1}{s} + \frac{-\frac{2}{5}}{s+1} + \frac{\frac{2}{5}}{s+6}$$

$$Z(s) = 1 - \frac{\frac{2}{5}s}{s+1} + \frac{\frac{2}{5}s}{s+6}$$

$$Z(s) = 1 - \left[ \frac{2}{5} - \frac{\frac{2}{5}}{s+1} \right] + \frac{\frac{2}{5}s}{s+6}$$

$$Z(s) = \frac{3}{5} + \frac{\frac{2}{5}}{s+1} + \frac{\frac{2}{5}s}{s+6}$$

By inspection, the circuit is as in Fig. 3.

### Properties of L-C Immittance Functions

Continue to narrow the restrictions on the one terminal-pair circuit. Then the types of elements in the driving-point system function will be permitted to include only inductance and capacitance. This theoretically lossless circuits will provide a useful

stepping stone. The properties of this function are the following<sup>5</sup>:

1. The immittance function must be a ratio of odd to even or even to odd polynomials.
2. Poles and zeros cannot be multiple (repeated) and must lie on the  $j\omega$  axis of the  $s$  plane.
3. Either a zero or a pole is present at the origin and infinity.
4. Poles and zeros alternate along the  $j\omega$  axis.
5. The highest power of the numerator and denominator polynomial differs by one, and the lowest power of each differs by one.

Example 7: Examine the driving-point impedance,

$$Z(s) = \frac{(s^2 + 1)(s^2 + 9)}{s(s^2 + 4)} = \frac{s^4 + 10s^2 + 9}{s^3 + 4s}$$

for realizability and possible synthesis configurations.

Checking first for p.r. condition:

- (a) Hurwitz by inspection.
- (b) Poles on  $j\omega$  axis are simple and a partial fraction expansion will check the residues.

$$\frac{s^4 + 10s^2 + 9}{s^3 + 4s} = s + \frac{9}{s} + \frac{15s}{s^2 + 4}$$

so condition (b) is satisfied.

- (c)  $N_E = s^4 + 10s^2 + 9, N_O = 0,$   
 $D_E = 0, D_O = s^3 + 4s.$   
 $\text{Ev } [F(s)] = 0; \text{Re } [F(j\omega)] = 0$

Therefore the  $Z(s)$  is p.r. Verifying now the characteristics of the L-C configuration:

1.  $Z(s)$  is a ratio of even to odd polynomials.
- 2, 3, and 4 are checked by inspection of the  $s$  plane pole-zero plot in Fig. 4.
5. Verified by inspection.

Fig. 4: Initially, the immittance function must be positive-real. The pole-zero plot checks for an L-C configuration.

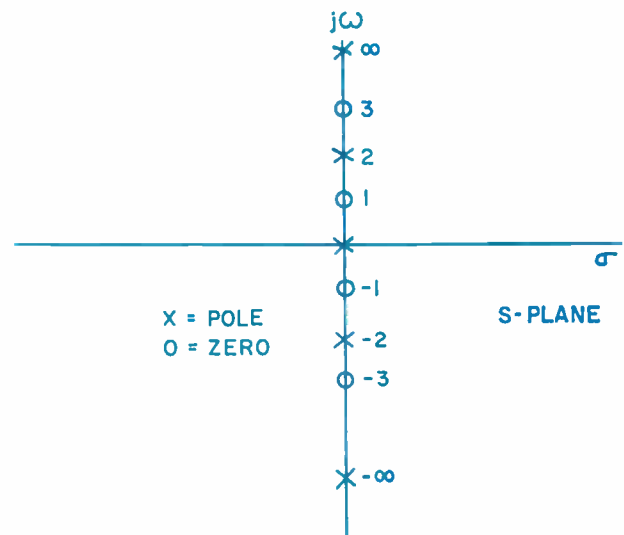

## CIRCUIT REALIZABILITY (Concluded)

The partial fraction expansion,

$$s + \frac{9}{4} + \frac{15}{4} \frac{s}{s^2 + 4},$$

has terms which are recognizable as three impedances in series. Term 1 is an inductance, term 2 a capacitor, and 3 a parallel L-C combination where

$$Z_{LC}(s) = \frac{\frac{S}{C}}{s^2 + \frac{1}{LC}}$$

This impedance representation is shown in Fig. 5.

### Properties of Other Driving Point Impedances

A few remaining system functions of this type should be described.

A. Impedance limited to R-C elements.

(a) Poles and zeros appear alternately on the negative real axis of the  $s$  plane.

(b) A pole must be nearest the origin and a zero is at infinity.

(c) The residues of the poles must be real and positive.

Example 8: Given a p.r.

$$Z(s) = \frac{s+1}{s(s+2)}$$

Test this function for R-C realizability.

(a) Poles and zeros are interlaced on the negative real axis.

(b) A pole is nearest the origin. The zero at infinity may be determined by examining the circuit realized from partial fraction expansion.

$$\frac{s+1}{s(s+2)} = \frac{1}{2} \frac{1}{s} + \frac{1}{2} \frac{1}{s+2}$$

Fig. 5: A theoretically lossless circuit with L-C combinations. Its driving-point impedance was verified on the plot in Fig. 4.

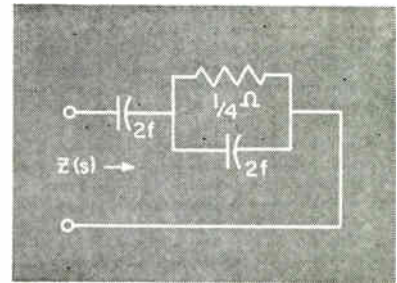
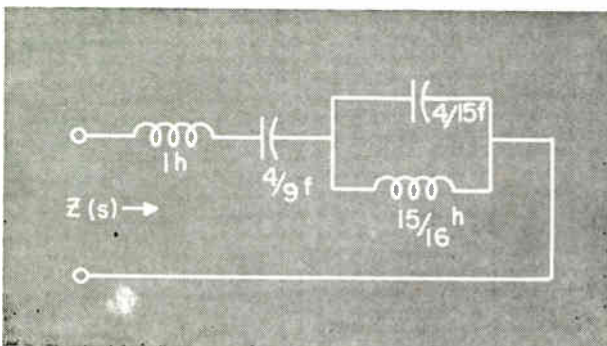

Fig. 6: Circuit realized when the impedance is limited to R-C parts.

Note that the residues are real and positive as required. Circuit is given in Fig. 6.

The impedance of this circuit approaches zero as the frequency approaches infinity, therefore the required zero at infinity is present.

B. R-L Impedance and R-C admittances.

(a) Poles and zeros appear alternately on the negative real axis of the  $s$  plane.

(b) A zero must be nearest the origin and a pole is at infinity.

(c) The residues of the poles must be real and negative.

### Discussion

Much has been written about realizability criteria for one terminal pair circuits with varying degrees of restrictions. The logical procedure would be to continue with two terminal-pairs and follow the pattern to higher order systems.

Unfortunately, however, the complexity and lack of completeness increases much more rapidly than the number of terminal pairs. For some cases much more work needs to be done. For the circuit designer who would like to know more about this fascinating and valuable subject an extensive list of references has been included.<sup>6-14</sup> Exact circuit design utilizing modern network synthesis should be a part of every designer's bag of tools.

### References

1. LaPatra, J. W., "Time Domain Synthesis of One-Port Networks," *Electronic Design*, April, 1962.
2. Weinberg, L., *Network Analysis and Synthesis*, McGraw-Hill Book Co., New York, 1962.
3. Kuo, F. K., *Network Analysis and Synthesis*, John Wiley and Sons, Inc., New York, 1962.
4. Van Valkenburg, M. E., *Introduction to Modern Network Synthesis*, John Wiley and Sons, Inc., New York, 1960.
5. Van Valkenburg, M. E., *Network Analysis*, John Wiley and Sons, Inc., New York, 1955.
6. Guillemin, E. A., *Synthesis of Passive Networks*, John Wiley and Sons, Inc., New York, 1957.
7. Tuttle, D. F., Jr., *Network Synthesis*, John Wiley and Sons, Inc., New York, 1958.
8. Kuh, E. S., and Pederson, D. O., *Principles of Circuit Synthesis*, McGraw-Hill Book Co., 1958.
9. Balabanian, N., *Network Synthesis*, Prentice-Hall Inc., New Jersey, 1958.
10. Storer, J. E., *Passive Network Synthesis*, McGraw-Hill Book Co., New York, 1957.
11. Truxal, J. G., *Control System Synthesis*, McGraw-Hill Book Co., New York, 1955.
12. Cauer, Wilhelm, *Synthesis of Linear Communication Networks*, McGraw-Hill Book Co., 1958.
13. Reed, M. B., *Electric Network Synthesis*, Prentice-Hall, Inc., Englewood Cliffs, N. J., 1955.
14. Stewart, J. L., *Circuit Theory and Design*, John Wiley and Sons, Inc., New York, 1956.



The thermistor can offset temperature effects of all components in a circuit. Increased gain may result in the modified circuit for the same temperature variations. At times, germanium transistors can replace silicon types. The method for stabilizing circuits within specified temperature limits is given.

## THERMISTORS FOR TEMPERATURE STABILIZATION OF TRANSISTOR CIRCUITS

THERMISTORS ARE PARTICULARLY SUITED for temperature stabilization of transistor circuits. They show a substantial decrease in resistance for a slight increase in temperature. Often a single thermistor compensates for the temperature effect in a transistor circuit. At times it is required to shape the thermistor characteristic with a fixed shunt and/or series resistor. The degree of temperature stability achieved depends on the transistor and other circuit components used, temperature range involved and variation in output level.

Side economies can sometimes be realized with thermistor stabilization. For instance: in some cases germanium transistors can be used instead of silicon transistors; greater gain may be realized in a circuit for given temperature variations; or capacitors and resistors with higher coefficients of temperature may be used. The thermistor can compensate for temperature effects of all components in a circuit.

\* \* \*

Many sizes, styles, sensitivities and resistance values of available thermistors exist, see Table 1. This wide variety can help solve almost any temperature stabilization problem.

### Effect of Temperature on Transistors

The main effect of temperature on germanium transistors is a considerable increase in collector current,  $I_{CO}$ . At low temperatures the collector current increases gradually. At high temperatures collector

current increases rapidly until at 85°C most circuits become unusable. The effect of a decrease in base-emitter voltage is relatively unimportant since  $V_{BE}$  is small.

The main effect of temperature on silicon transistors is to cause a considerable variation of base-emitter voltage,  $V_{BE}$ . At low temperatures, the base-emitter voltage is relatively constant. At high temperatures,  $V_{BE}$  decreases until at 150°C most circuits become unusable. The increase in collector current,  $I_{CO}$ , is relatively unimportant since  $I_{CO}$  is small.

The approach in achieving temperature stabilization is the same whether germanium or silicon transistors are used. (Continued on following page)

A breadboarded circuit stabilized for temperature variations. A disk thermistor appears between transistors on heat sinks.

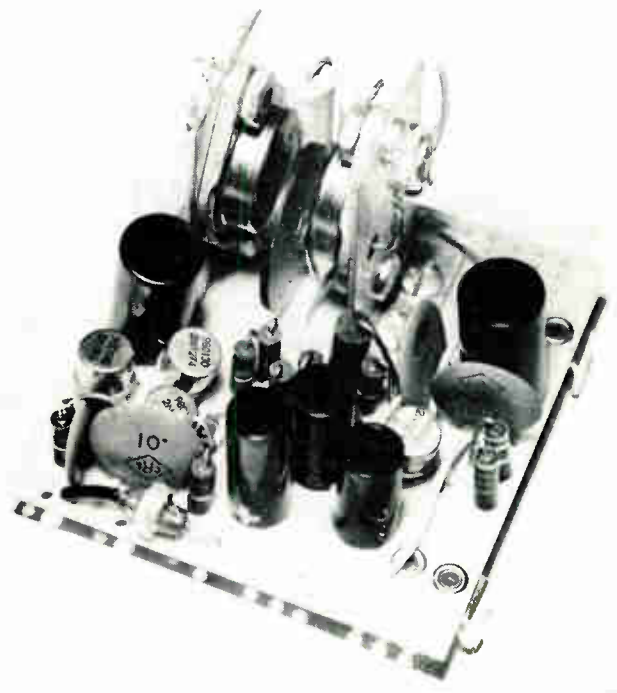

By MICHAEL L. CHATER

CRT Dept.  
General Electric Co.  
Los Angeles, Calif.

## THERMISTORS (Continued)

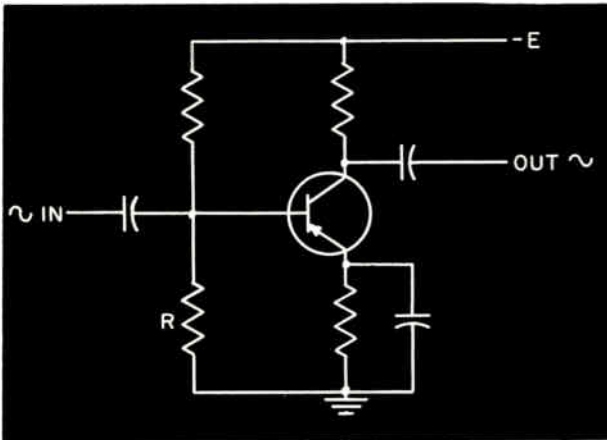

Fig. 1: Usual biasing scheme needs temperature compensation. Thermistors do the job with least change to the circuit design.

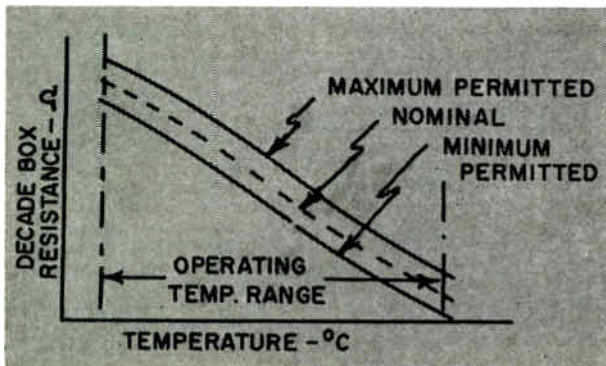
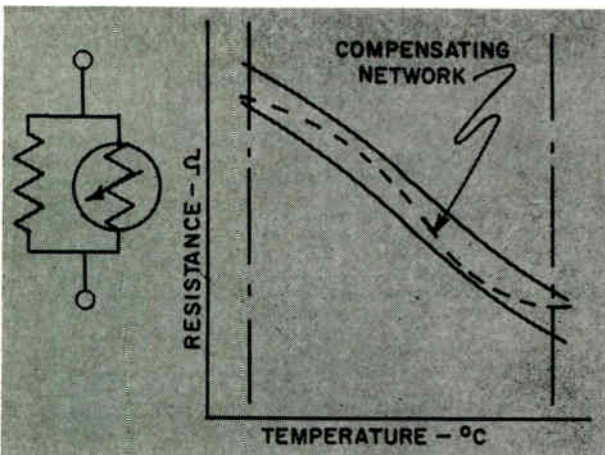

Fig. 2: R-T curve of changes in resistance made to compensate for temperature variations of the other components in a circuit.

Fig. 3: An optimum network to stabilize a circuit. Its R-T curve is shown within limits in the operating temperature range.



A REPRINT OF THIS ARTICLE CAN BE OBTAINED  
by writing on company letterhead to  
The Editor  
ELECTRONIC INDUSTRIES  
Chestnut & 56th Sts., Phila. 39, Pa.

## Practical Temperature Stabilization

In whatever circuit employed, it is necessary to find a resistor whose value should decrease with rise in temperature in order to achieve a stable output level. Most circuits follow the general configuration shown in Fig. 1. There are some circuits where a negative temperature-sensitive component like a thermistor cannot be employed. In this example, resistor,  $R$ , must be substituted by a thermistor or thermistor network.

Determine  $R$ - $T$  curve of the transistor circuit. It is possible to calculate the desired "resistance-temperature characteristic" for resistor  $R$ , but this method is laborious and results are only approximate. It does not account for either the difference between transistor junction and ambient temperatures, or the temperature variations of other circuit components. Therefore, we suggest that a decade box be substituted for  $R$  and the rest of the circuit be placed in a temperature chamber. Then run tests to determine the desired resistance-temperature values for  $R$  to maintain a constant output level. At each temperature, record the maximum and minimum permissible values of the decade box in addition to the nominal values. Then obtain a graph as shown in Fig. 2. If the design of a thermistor or thermistor network that will lie within the limits shown can be realized, complete stability will result.

For determining the compensated circuit, there is no easy way to design a suitable thermistor network. There are many tools available. With experience we can select suitable component values. There are graphs for selecting thermistor values available from most manufacturers.

The best approach is to consider the overall desired resistance change and the actual resistances involved. A large change and/or large resistance values indicate grade 1 material; a small change and/or small resistance values indicate grade 2 material. A typical good stabilizing network is shown with the  $R$ - $T$  characteristics in Fig. 3. Wherever necessary, there may be other suitable networks.

## Specific Considerations

Tolerances of thermistors are specified by the manufacturer both on resistance at a given temperature, and on sensitivity over a given range. Spot calculation checks on these tolerances will show if the thermistor network exceeds the limits shown in Fig. 3.

In any batch of transistors the production spread of  $I_{CO}$  or  $V_{BE}$  may be very large. For good stabilization it may be necessary to select or restrict the pur-

chase of transistors to a narrow band within this spread. It is very important that the transistor used to obtain the desired  $R-T$  characteristics (such as shown in Fig. 2) is representative (preferably, the geometric mean) of this narrow band.

As in the case of the transistor, it is necessary to ensure that all pieces of any one circuit component have the same temperature characteristics.

In any circuit where large changes of temperature can occur rapidly, say in 60 sec. or less, it is necessary to select a thermistor whose time constant is similar to that of the transistor. In order to minimize temperature differences between power transistors and their associated thermistors, thermistor washer assemblies are available. These can be bolted to the heat sink, chassis, or transistor mounting stud.

In some circuits, the current requires using a large thermistor in order to minimize self-heating. It is practical to operate with a considerable degree of self-heating, provided its effect is taken into account. This involves knowledge of the thermistor's dissipation constant ( $\text{mw}/^\circ\text{C}$ ) in that particular environment.

Most thermistors are only rated  $150^\circ\text{C}$ . If the operating range of the circuit exceeds this, or if self-heating is considerable, then  $250^\circ\text{C}$  high-temperature solder should be specified.

This disk type thermistor (seen right) has one of several configurations in use

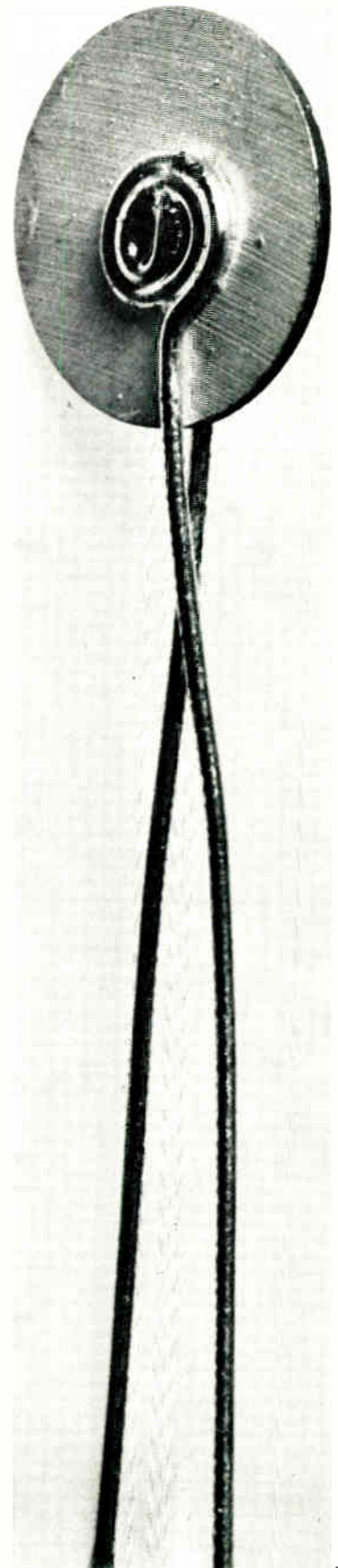

**Table 1**

**Condensed Data to Exemplify the Range of Sizes, Styles, and Sensitivities of Thermistors\***

Resistance (ohms @ $25^\circ\text{C}$ )	See Note	Nominal Diameter (in.)	Nominal Length or Thickness (in.)	Dissipation Constant <sup>1</sup> ( $\text{mw}/^\circ\text{C}$ )	Thermal Time Constant <sup>2</sup> (seconds)
<b>Disk Type:</b>					
200,000	4	0.050	0.048	2	4.5
100,000	4	0.100	0.095	4	12
1,000	4	0.750	0.053	22	80
1,000	4	1.000	0.095	32	155
100	3	0.050	0.017	2	3
100	3	0.100	0.070	4	10
1.0	3	0.750	0.039	20	50
1.0	3	1.000	0.070	30	120
<b>Rod Type:</b>					
1,000,000	4	0.050	0.500	3	12
1,000,000	4	0.112	1.600	10	70
1,000	3	0.050	0.500	3	12
1,000	3	0.112	1.600	8	60
200	3	0.173	1.100	11	80

**Notes:**

1. Slope of the linear portion of the dissipation characteristic which is the thermistor temperature rise above ambient versus the electrical power input.

2. Time required for a thermistor to change 63.2% of the temperature difference between its initial temperature and the temperature of its surroundings. No power applied during the change.

3 and 4. Specific resistivity at  $25^\circ\text{C}$  ( $\text{ohm-cm}$ ) for (3) is  $30 \pm 10\%$ , and for (4) is  $21000 \pm 10\%$ . The beta between  $25^\circ\text{C}$  and  $75^\circ\text{C}$  (in Kelvin) for (3) is  $3000 \pm 150$ , and for (4) is  $4500 \pm 100$ .

\* The information presented is found in a complete data sheet provided by the Magnetic Materials Section, General Electric Co., Erdmore, Mich.



Certain rules have been developed which aid in designing custom integrated circuits. This article shows how to apply them to simulate a model having discrete components. A method to reduce circuit complexity is also presented.

# INTEGRATED CIRCUIT DESIGN TECHNIQUES

Fig. 1: Functional plan of the sequence followed in the development of a custom integrated circuit. The product is based upon the design and performance specification requirements of the user. The circuits are then produced by the Micrologic process.

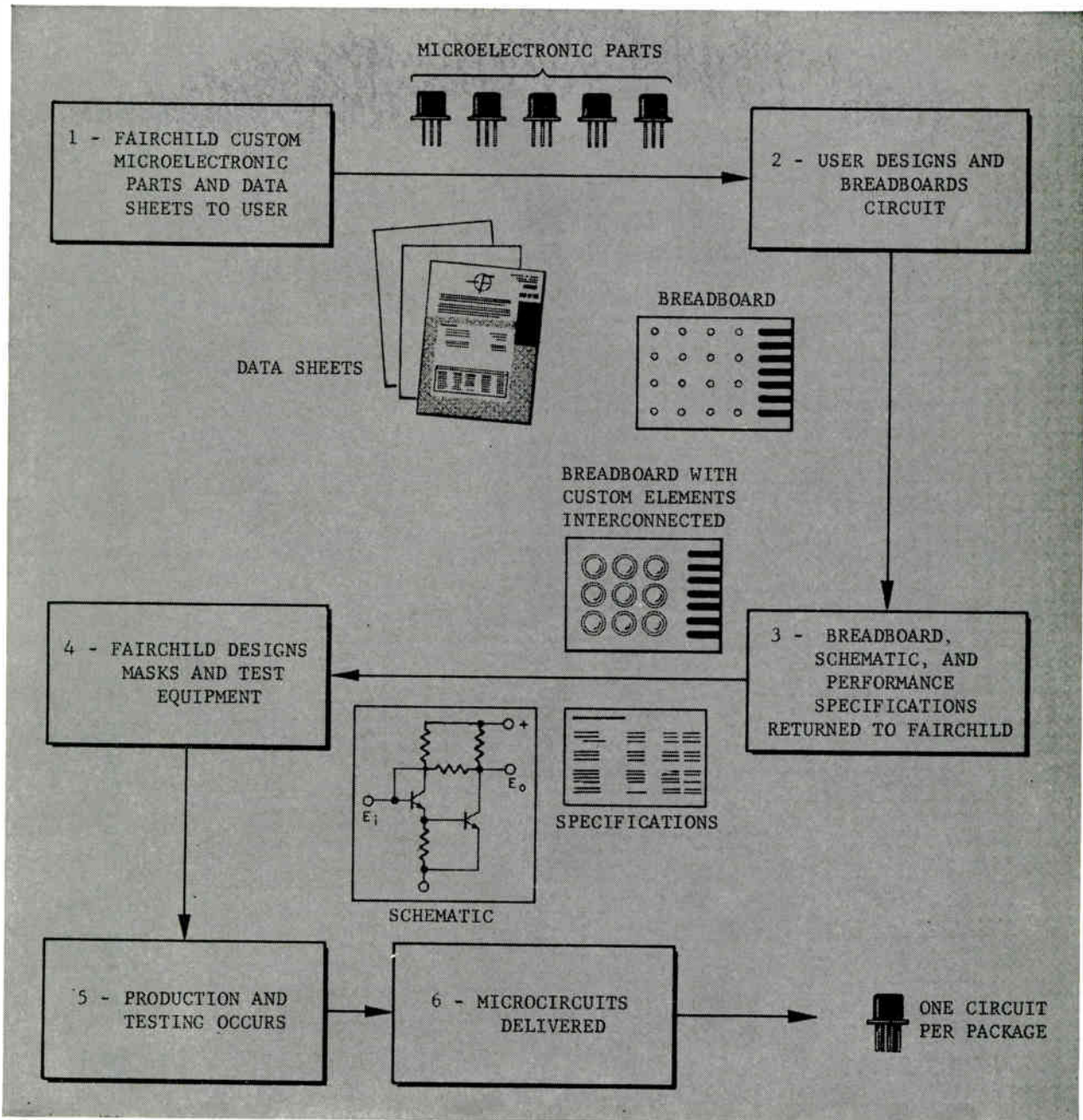

THE CIRCUIT ENGINEER can now design custom integrated circuitry, and predict performance and production spread in final circuits, without incurring developmental tooling costs.

Integrated circuit design does not follow the rules for circuits using discrete components. This is a result of more complex equivalent circuits for the basic elements and wider spread of characteristics. Also, limitations and behavior of circuit elements often make an optimum integrated circuit differ appreciably from the functional equivalent devised with conventional parts.

\*\*\*

Integrated circuits by their very nature must be produced as complete units. Development by a process, whereby successive versions of a circuit are built and tested before arriving at a final acceptable design, requires partly repeating the prior processing in each advanced step. Design errors or even minor circuit changes are, therefore, expensive because of high tooling cost.

Fairchild Semiconductor has been producing a set of digital integrated circuits known as "Micrologic" since early 1961. Their process specifications and design rules have been verified by more than five-million circuit hours of operating life test. A family of integrated circuit or microelectronic parts manufactured by the same process is now available with descriptive data and electrical characteristics. The parts include transistors, diffused resistors, and arrays of diodes. Capacitors will soon be added. They accurately simulate performance of corresponding elements in any integrated circuit manufactured by the Micrologic process.

By using these parts to construct a working model or breadboard, data for any custom microelectronic circuit can be obtained prior to incurring production development costs. The final circuit will essentially comprise these same elements in integrated circuit form. All parts are diffused into a single chip and interconnected with evaporated aluminum.

### Custom Circuit Development

The sequence followed in developing a custom integrated circuit is shown in Fig. 1. Initially, micro-

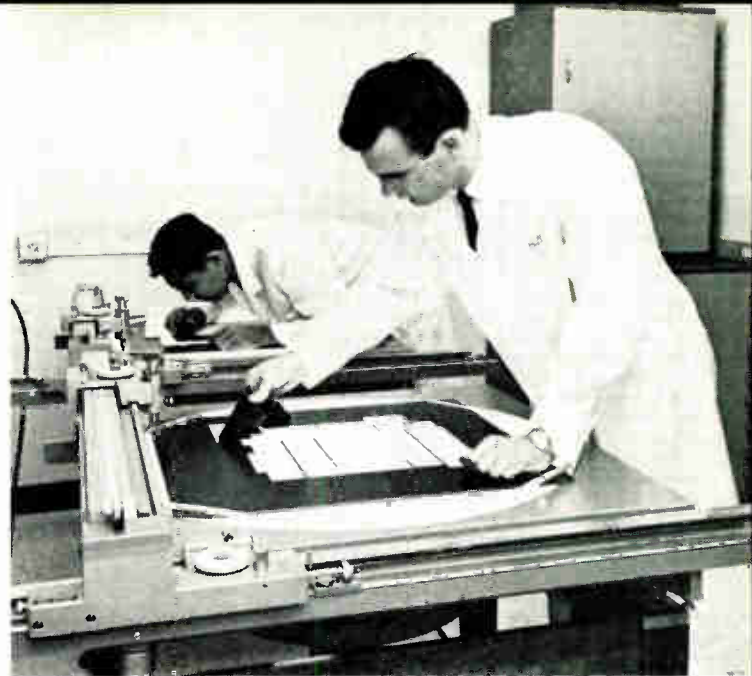

Masks are being prepared for photo-etching by multi-diffusion. The result is precisely indexed patterns of the microcircuit.

electronic parts and data sheets are used for circuit design and breadboarding. Development of diffusion and metal interconnecting masks and associated test equipment depends upon the design and performance specifications supplied by the user. Circuits are then produced by the micrologic process, and chips are mounted in the desired package, tested and delivered. The procedure, from circuit design to delivery, can normally be completed in two to four months.

### Diffused Component Characteristics

Conventional npn planar transistors are made by diffusing controlled amounts of impurities into n-type starting material, as shown in the cross-section view of Fig. 2. Several hundred individual transistors having a common collector can be formed in a wafer of silicon. Transistors are separated into individual units by mechanical scribing. The separated dice are mounted on individual headers.

The natural high density prior to scribing suggests use of multiple transistors in a single circuit. A separate p-type diffusion, known as the "isolation diffusion," electrically separates the transistors embodied in an integrated circuit. This results in an "isolation diode," tied to the collector of each transistor, as shown in Fig. 3.

The isolation diode has some undesirable effects on transistor parameters. It adds a leakage current path to the collector node and creates a parasitic junction capacitance in the equivalent circuit. Necessity for a top collector contact makes it difficult to obtain the low collector-to-emitter saturation voltages possible with an individual device, whose wafer backside may be used for collector contact.

### By JOHN R. HULME

Applications Engineer  
Fairchild Semiconductor  
545 Whisman Rd.  
Mountain View, Calif.





## INTEGRATED CIRCUIT (Continued)

### Diffused Resistors

A cross-section view of a diffused resistor is shown in Fig. 4a. The resistor comprises a long, narrow, and sometimes convoluted, region of p-type base diffusion in n-type starting material. As with the transistor, a p-type isolation region separates the resistor from other components. When a positive voltage is applied to one end of the resistor, the p-n junction at that end becomes forward-biased and allows sufficient current to supply reverse leakage to the isolation diode. The remainder of the distributed resistor junctions are reverse-biased, since all the n-type material is at the same potential.

Two voltage ratings are important in diffused resistors. When the isolation breakdown voltage is exceeded, current  $I_2$  in Fig. 4b becomes excessive. Also, breakdown voltage of the resistor junction must be considered. Current  $I_1$  flows through the forward biased end of the resistor, and back through that part of the resistor diode being operated in avalanche, when this rating is exceeded. This shunt current can cause the voltage-current characteristic of the resistor to appear non-ohmic, which results in excessive heating and reduced effective resistance.

The diffused resistor has distributed shunt capacitance which must be taken into consideration for

Integrated differential amplifier is seen in the foreground. Note the contrast in size with its breadboard counterpart.

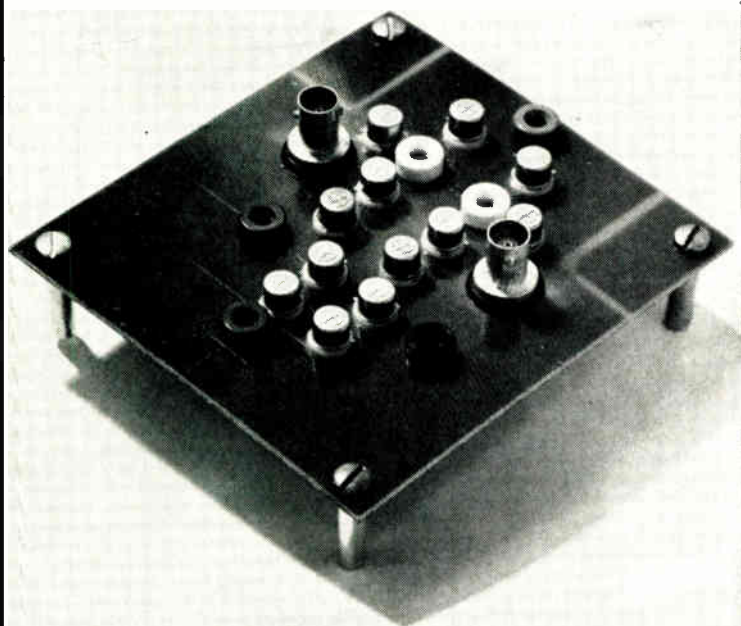

high frequency applications. This characteristic is normally undesirable, but can be used to advantage in frequency selective circuits.<sup>1</sup>

Diffused integrated resistors have rather broad tolerances. When several resistors are produced in the same silicon crystal, however, their values tend to correlate. As a result of geometric pattern matching, much closer tolerances on resistive ratios can be obtained than the tolerance of resistance values. Circuit design should, therefore, take advantage of resistance or voltage ratios, rather than be subject to absolute values and temperature coefficients.

### Diffused Diodes

Integrated circuit diodes are generally produced by collector-base diffusion. Since this consists of a p-type diffusion into n-type material, it is possible to make common-cathode diodes in a single isolation region, as shown in Fig. 5. Common-cathode diode arrays have a single isolation junction tied to the cathodes. The junction size is proportional to the number of diodes in the array.

The diodes of the common-anode array using collector-base diffusion cannot share an isolation region, since their cathodes would also be common. Thus each diode of the array must have its own isolation region. This is shown in Fig. 6, for a two-diode array. Each diode has an isolation junction tied to its cathode. The anodes are connected by means of external metallizing.

Common anode diodes can be formed in a single isolation region if lower reverse breakdown voltages comparable to  $BV_{EBO}$  can be tolerated. Such a circuit is analogous to a transistor with multiple emitters. The number of emitters will depend upon the desired number of diodes.

### Circuit Complexity

There is a practical limit to the number of components in an integrated circuit. When this limit is exceeded, the circuit becomes so difficult to produce that the process becomes uneconomical.

The area of an integrated circuit chip is a major factor in determining final processing yield. Obviously, chip area limits the number of circuits which can be produced on a single wafer. Also, the probability of imperfections due to dislocation in the crystalline structure, surface irregularity, physical damage; or likelihood of having elements with sub-standard parameters is proportional to area. Since chip size is subject to cumulative areas of individual elements, it is possible to assign weights to integrated circuit parts corresponding primarily to their area contribution.



The relative weight assigned to each integrated circuit part according to its area contribution in the composite circuit is shown in Table 1. Cumulative point count for a circuit indicates level of complexity. Up to 150 total points in a circuit is generally reasonable for production and yield. Beyond this level the circuit should be carefully considered. It may be advisable to attempt to simplify, or separate, the circuit into more than one package.

### Design Rules

Table 1 shows that for optimum integrated circuit design certain elements are preferred. For example, a resistor of large value, due to its area, contributes more to point count than a transistor with small geometry. Common-collector transistors or common-cathode diodes have relatively low weights because they share a common isolation region. External connections, such as power supply or input and output terminals, are weighted relatively high. The circuit itself is so small that a comparatively large area must be allocated to bonding pads.

The integrated circuit breadboard is intended to duplicate final integrated circuit performance. If the breadboard is to realistically portray the leakage currents, distributed capacitances and resistor dividers, certain precautions must be taken.

When an integrated circuit is produced, the whole back of the wafer is a p-type diffusion. This is the anode of all isolation diodes in the circuit. To simulate this condition in a breadboard, the isolation diode terminals of all parts must be tied together. This point, in turn, is generally tied to the most negative supply voltage to assure that the isolation diodes are reverse-biased.

### Present Circuit Capability

Using integrated circuit parts whose characteristics are fixed by extensive experience with successful production devices, a designer may develop virtually any type of integrated circuit. The basic design technique is similar to that of conventional circuits, even to the point of testing a typical breadboard before incurring processing costs.

An integrated differential amplifier and several forms of integrated logic circuits have already been developed at Fairchild Semiconductor using the procedure described. Close correlation of the performance of the initial breadboard with the final circuit has conclusively established the validity of this approach to custom integrated circuits.

### Reference

1. Kaufman, W. M., "Theory of a Monolithic Null Device and Some Novel Circuits," *Proc. IRE*, pp. 1540-1545, Sept., 1960.

**Table 1**  
**AREA CONTRIBUTION OF PARTS IN A COMPOSITE CIRCUIT**

Add 1 point for each volt of supply voltage above 5 volts.

COMPONENT	POINTS (Note 1)
<b>Transistors:</b>	
Single Small-Geometry	5
Multiple Small-Geometry, Common Collector	$2(n - 1) + 5$ (Note 2)
Single Large-Geometry	9
Multiple Large-Geometry, Common Collector	$5(n - 1) + 9$ (Note 2)
<b>Diodes</b>	4
Multiple Common-Cathode Diodes	$(n - 1) + 4$ (Note 2)
Resistors $R \geq 300$ Ohms	$K + 4$ (Note 3)
Resistors $R \leq 300$ Ohms	$65/R + 4$ (Note 4)
External Connections	4

#### NOTES

1. All point assignments assume circuit design does not exceed specifications of individual microelectronic components
2.  $n$  = number of transistors or diodes. Formula is applicable for  $n \leq 5$ .
3.  $K$  = number of kilohms.
4.  $R$  = number of ohms.

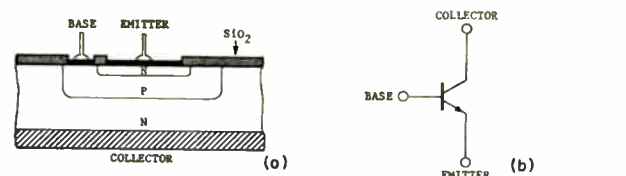

Fig. 2: Customary npn planar transistors made by controlled diffusion.

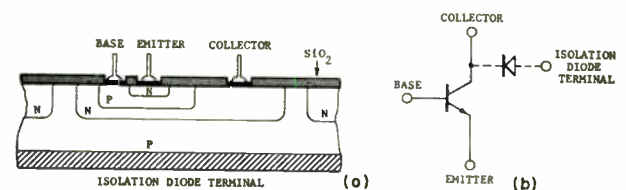

Fig. 3: Multiple transistors separated by "isolation diffusion."

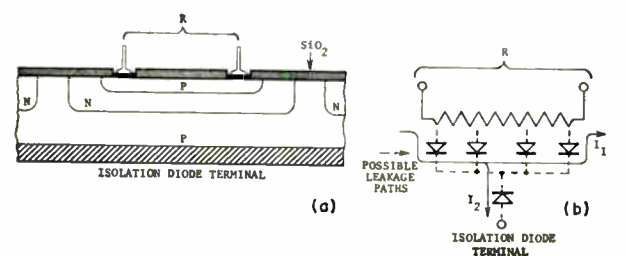

Fig. 4: Cross-section (a) and schematic (b) of diffused resistor.

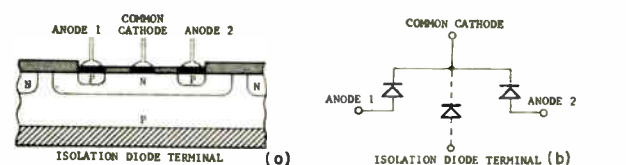
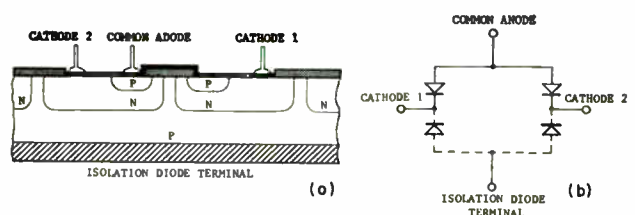

Fig. 5: Diffused common-cathode diodes can have isolation region.

Fig. 6: External metallizing is needed for common-anode diodes.



# ENGINEER'S NOTEBOOK

## #67 DECIBEL NOMOGRAPH

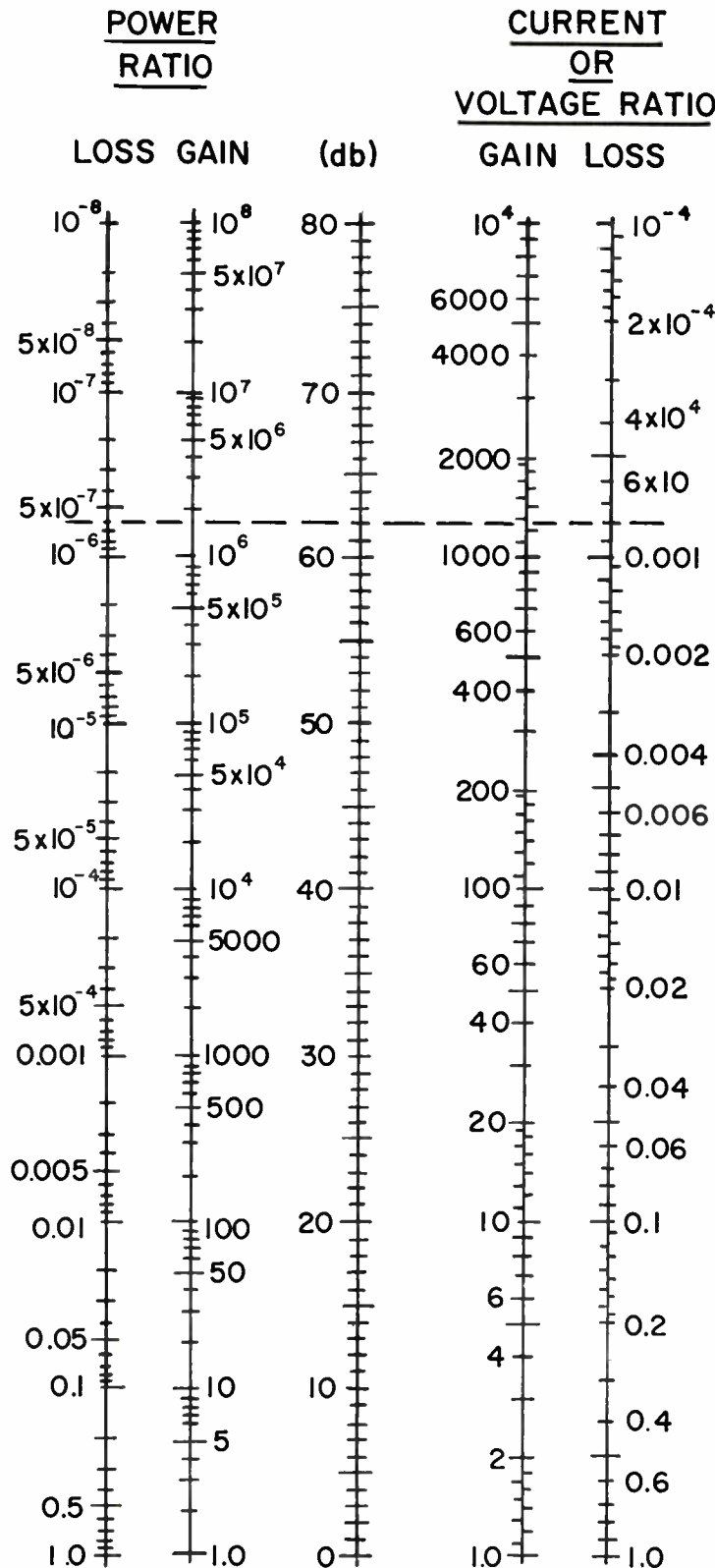

THIS STRAIGHT-LINE NOMOGRAPH provides a direct and simple means of converting current, voltage, or power ratio to decibel (db) and vice-versa. An accuracy compatible with the slide rule can be achieved with careful reading of this nomograph.

Unknown ratios or db value can be determined from this nomograph as follows:

1. Construct a line perpendicular to the vertical scales through a known ratio or db value.
2. Read the unknown value directly on the constructed line that intersects the proper scales.

### EXAMPLE:

Determine a db value with a given voltage ratio of 1260. From the straight-line nomograph, the corresponding db value for 1260 is 62 db.

A REPRINT OF THIS ARTICLE  
CAN BE OBTAINED BY WRITING  
on company letterhead to  
The Editor  
ELECTRONIC INDUSTRIES  
Chestnut & 56th Sts., Phila. 39, Pa.

By **HAROLD Y. WONG**

Research Engineer  
Lockheed Missile & Space Co.  
Sunnyvale, Calif.





COMPONENTS ENGINEERED FOR SPECIFIC RELIABILITY REQUIREMENTS

# now available from Cinch

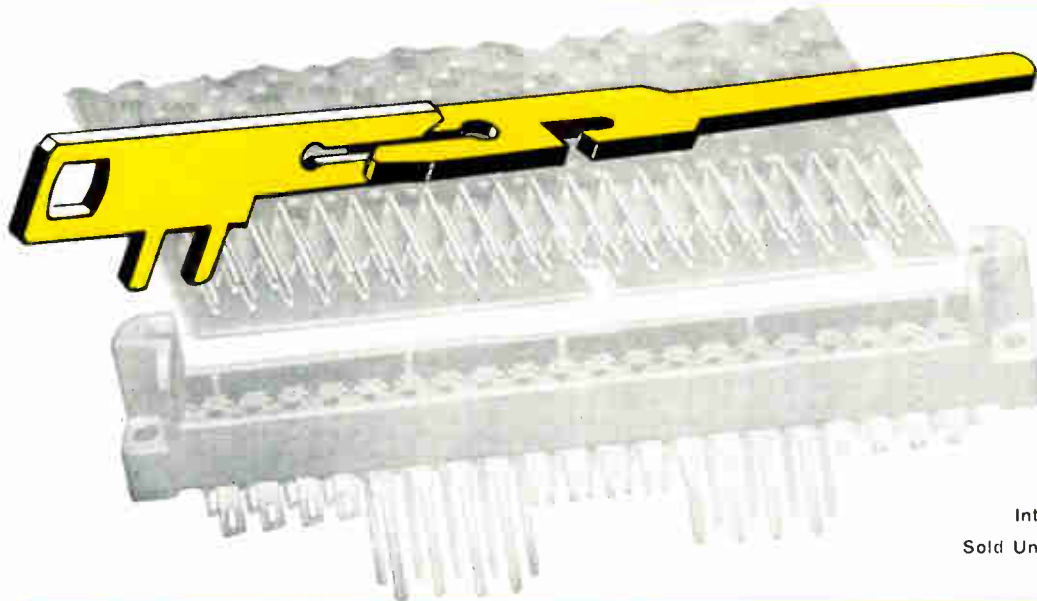

## SERIES 7008 PRINTED CIRCUIT CONNECTORS

Interchangeable with Elco's Products  
Sold Under Elco's Trademark "VARICON"

Unique **7008**  
Contact Design Provides  
FOUR Wiping Surfaces  
To Assure Positive Contact!

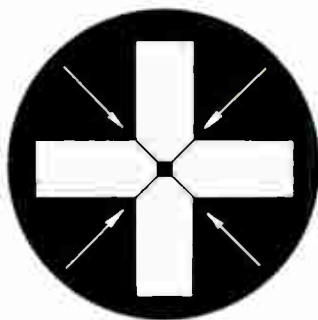

An entirely different concept in contact design is utilized in the 7008 Series. All contacts feature a fork-like nose engaging section. The contacting surfaces have a 45° precision-coined bevel edge which extends the entire length of each fork of the contact. When the mating members are engaged, *four* self-wiping contacting areas are formed, each at 90° to the other. This large contacting area, when coupled with the four separate contacting surfaces, mechanically produces positive contact between the mating members at all times.

Cinch now offers you a complete line of connectors especially designed for the exacting requirements of sophisticated equipment incorporating printed circuitry.

The basic construction of this 7008 Series involves the use of a unique, fork-like hermaphroditic contact assembled in a simple reliable monoblock insulator. A wide number of possible variations assures the availability of a unit suited to your specific requirements.

These variations—in number of positions, tail styles, contact arrangements, mounting provisions, and the like—are fully outlined in Cinch Product Bulletin PBM-3, available from your local Cinch representative or by writing us directly.

CM-6306

## CINCH MANUFACTURING COMPANY

1026 South Homan Avenue, Chicago 24, Illinois  
Plants located in Chicago, Illinois, Shelbyville, Indiana,  
City of Industry, California, and St. Louis, Missouri.

Manufactured under License Agreement with Elco Corporation

Circle 54 on Inquiry Card  
World Radio History



A DIVISION OF UNITED-CARR FASTENER  
CORPORATION, BOSTON, MASSACHUSETTS



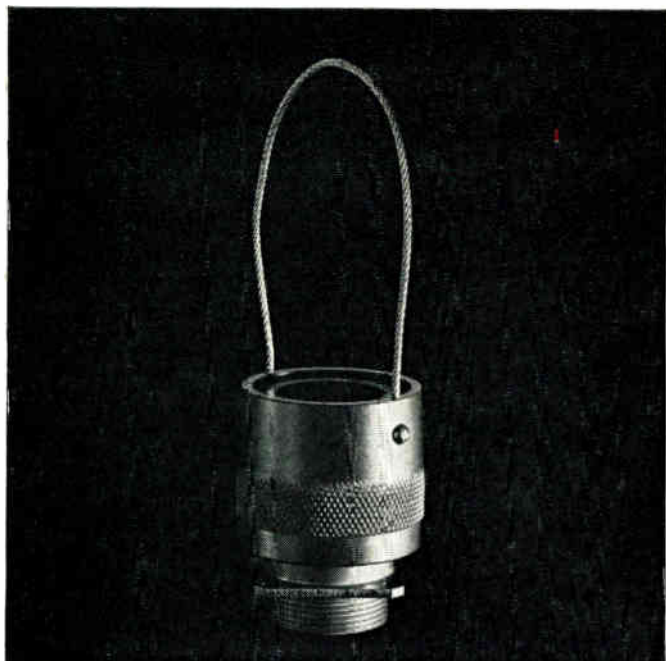

**This connector**

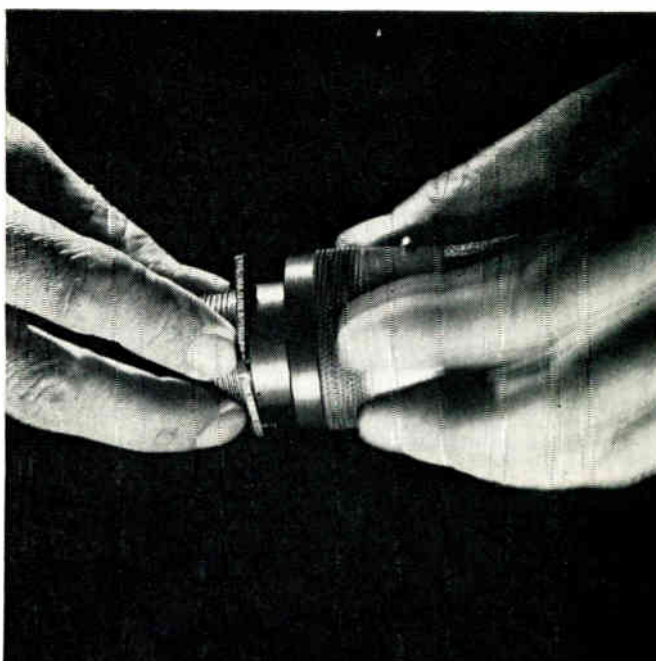

**twists together**

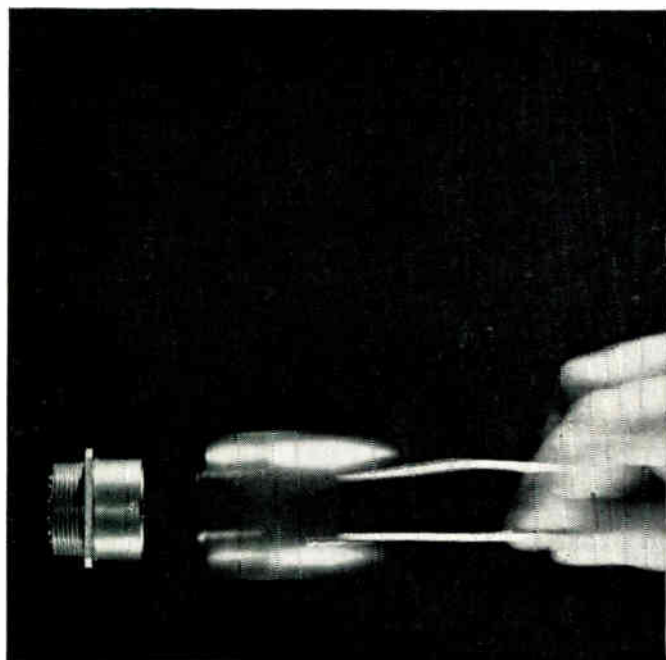

**and pulls**

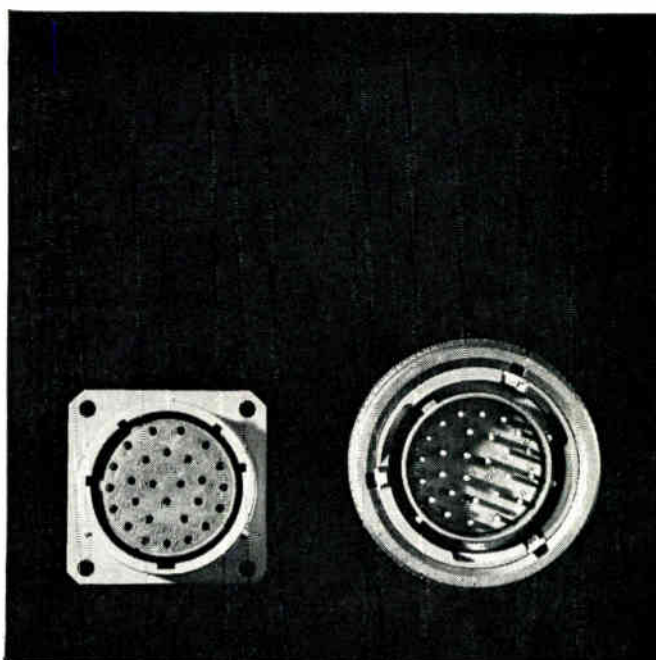

**apart.**

This Bendix® Pygmy® Electrical Connector uniquely combines positive coupling and pull-to-disconnect features. It is connected by a twist; disconnected either by hand or remotely by lanyard.

Complete intermateability with PT receptacles is achieved through use of standard Pygmy PT plug shells, five-key polarization, and three-point bayonet lock coupling. The "twist/pull" design assures interfacial sealing and meets applicable requirements of the current issue of MIL-C-26482.

Resilient inserts assure extreme vibration resistance and provide support for size 20 or 16 gold-plated Pygmy contacts of either the solder or removable crimp type. Plating options for the aluminum shell components are: cadmium with an olive drab chromate after treatment, or alumilite hard anodic coating.

Write us today in Sidney, N. Y., for your copy of our informative technical bulletin SL-102, giving complete information on shell sizes and arrangements, as well as helpful design and dimensional data.

**Scintilla Division**





Thin coat tapes...*like having  
a quarter reel bonus in recording time!*

25% more tape to the reel! That explains how "SCOTCH" BRAND Thin Coat Heavy Duty Instrumentation Tapes extend recording time, conserve data storage space, permit more compact equipment for high frequency recording.

An .18-mil oxide coating (60% thinner than standard) reduces tape thickness, while polyester backings of normal thickness assure no loss in strength or change in physical properties. And the thinner coating of high potency oxides provides closer head-to-tape conformity and improved high frequency resolution in the bargain.

Heavy duty oxide-binder formulation shrugs off heat as high as 225°F, minimizes rub-off to assure 15 times the life of ordinary tapes. Conductivity is 1000 times that of



ordinary coatings, drains off dust-attracting static. Silicone lubrication protects against head wear, extends tape life. Choice of 7 thin coat heavy duty tapes meets all high frequency and short wavelength requirements.

*TECHNICAL TALK Bulletin No. 1* provides helpful information on handling and storing instrumentation tapes. It discusses splicing, ways of minimizing dropout errors, precautions in handling and storing, and how to avoid tape distortion, accidental erasure, etc. Free. Write 3M Magnetic Products Division, Dept. MBR-43, St. Paul 19, Minn.

"SCOTCH" AND THE PLAID DESIGN ARE REGISTERED TRADEMARKS OF MINNESOTA MINING & MANUFACTURING CO., ST. PAUL 19, MINNESOTA. EXPORT: 99 PARK AVENUE, NEW YORK. CANADA: LONDON, ONTARIO ©1963, 3M CO.

Magnetic Products Division **3M** COMPANY



Complete . . .  
from **BEZEL** to **B.C.D.\***

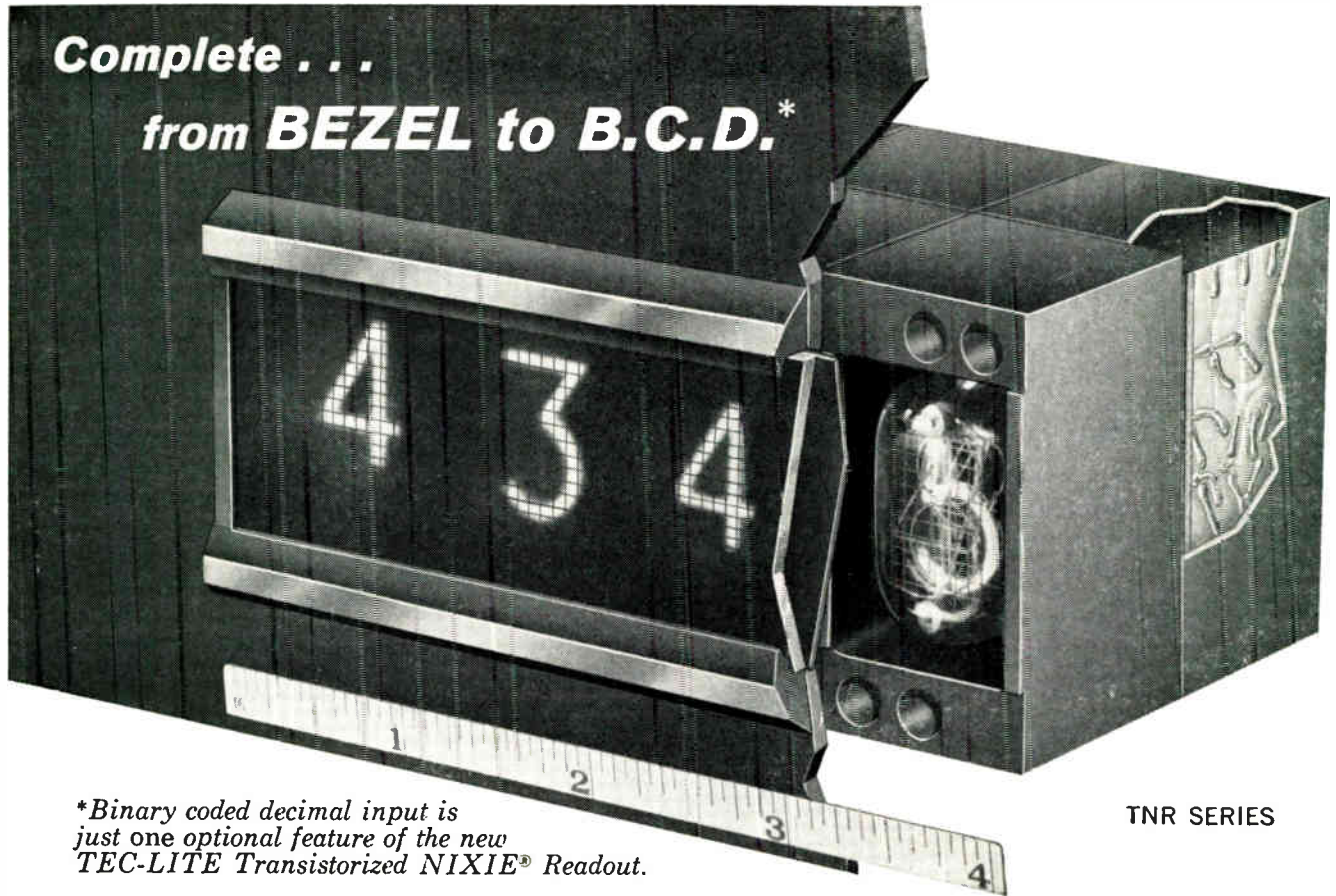

*\*Binary coded decimal input is just one optional feature of the new TEC-LITE Transistorized NIXIE® Readout.*

TNR SERIES

Simplify digital display design problems with compact TEC-LITE Transistorized NIXIE Readouts. Complete readouts, bezel to BCD, use conservatively rated components and ultra long-life NIXIE tube to give reliable performance for hundreds of thousands of hours.

Decimal input — decimal readout is provided by the TNR-10 Series; binary input decimal readout by the TNR-20 Series. Typical signal ranges are: ON +4 to +15, OFF +5 to -2v; ON -5 to +15v, OFF -4 to -6v. Less than 1 ma signal current required. Many other signals standard or easily provided. Supply, +180VDC at 2 to 6 ma.

Options include octal readout, counters and memory. Decimal point, colon or degree symbol also available. Converter power supplies allow operation from 24 or 28VDC. Complete electrical-mechanical data is available from TEC-REPS listed below.

- Signals as low as 2 volts control numeral display
- Supply, +180VDC at 2 to 6 ma
- Compact, mounts on 1-inch centers
- Size: 1"W x 1¾"H x 2½"L\*  
\*TNR-10 Series
- Decimal to decimal as low as \$61.90\*
- Binary to decimal as low as \$80.20\*

\* With bezel, Polaroid filter, glass and NIXIE tube in 10-29 quantities. Delivery, 2 to 4 weeks ARO.

**Transistor  
Electronics  
Corporation**

Box 6191 • Minneapolis 24, Minnesota  
Phone (612) 935-7701



ORIGINATOR OF  
TRANSISTORIZED INDICATING DEVICES

See these and other TEC-LITE Transistorized Indicators—standard and custom designed for solid state systems.

**MTL SERIES**



**"Transistorized" MINI-LITE  
INDICATOR**

U.S. Patent No. 2,985,874

**TBL SERIES**



**BUTTON LITE  
(Transistorized)**

U.S. Patent No. 2,985,874

**LVN SERIES**



**"Transistorized" LOW VOLTAGE  
NEON INDICATOR LITE**

U.S. Patent No. 3,041,499

**TIL SERIES**



**TRANSISTOR CONTROLLED  
INCANDESCENT LITE**

U.S. Patent No. 2,985,874

NIXIE (R) Burroughs Corp.



# Will the real Stackpole resistor stand up?

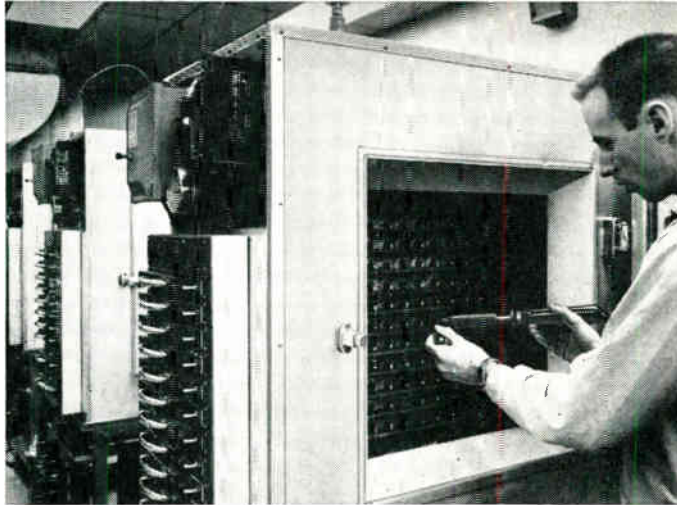

70°C load life test. Stackpole COLDITE 70+ Resistors are soldered into ovens and temperature is raised to 70°C. Resistance is read after 0, 50, 100, 250, 500, 750 and 1000 hours under full load. MIL-R-11 allowable change:  $\pm 10\%$  maximum,  $\pm 6\%$  average. Stackpole maximum expected changes: +2.5% to -5.0% for all types!



Production line sorting. The next to the last quality control check made before shipment. All COLDITE 70+ Resistors coming down production lines pass this machine which automatically measures resistance values. Machine unerringly classifies resistors according to specified tolerances.

Will it meet, or exceed, your MIL-R-11 requirements? Will it stand up to the load life . . . have the humidity and temperature characteristics and the solderability . . . you require?

You bet! And at left are some of the reasons you can be so sure. They are just two of the many ways in which every Stackpole COLDITE 70+® Fixed Composition Resistor is checked and double-checked in one of the toughest quality control programs in the industry.

When a Stackpole resistor leaves our plant, you are getting the real thing! Even the color coding bands are critically inspected to make certain that a Stackpole resistor looks like the quality component it is.

Stackpole COLDITE 70+ Fixed Composition Resistors are available in all popular resistance values and sizes. And they are competitively priced! There is no extra charge for the extra measure of quality you are getting!

You can get immediate delivery of Stackpole COLDITE 70+ Fixed Composition Resistors from leading electronic parts distributors across the country. For information on large runs, write: Electronic Components Division, Stackpole Carbon Company, St. Marys, Pennsylvania.

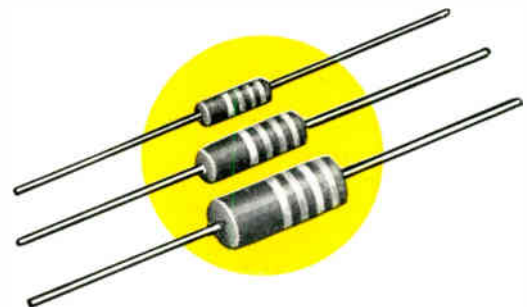

# STACKPOLE

CARBON COMPANY, *Electronic Components Division*  
St. Marys, Pennsylvania

# NEW PRODUCTS

...for the Electronic Industries

## POTENTIOMETER

Resistance range 10 $\Omega$  to 100K $\Omega$ ; operating temp. -65° to +175°C.

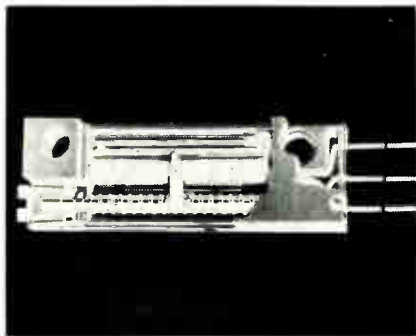

High-temp., humidity-proof, wirewound trimmer, the 2750 Series Micropot meets military specs. for environment, including Mil-STD-202, method 106 for humidity, and Mil-R-27208A for life. Overall size is 1.25 x 0.19 in. Leadscrew actuation provides complete range of adjustment in 22 turns. Three standard terminal configurations available: stranded copper wire leads, gold plated solder lugs, and gold plated printed circuit pins. Borg Equipment Div. Amphenol-Borg Electronics Corp., 120 So. Main, Janesville, Wisc.

Circle 200 on Inquiry Card

## NUVISTOR AMPLIFIERS

SV Series of amplifiers with center freqs. of 30mc and 60mc.

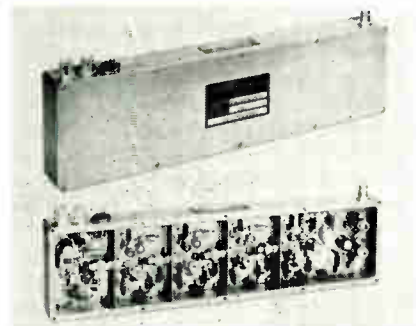

Series of nuvistor i-f preamplifiers, post amplifiers, low-noise and lin-log amplifiers covers many radar, missile and laboratory uses. These amplifiers provide conventional tube-type device performance and reliability and approach the transistor-type in size and power consumption. Designed to Mil-T-21200, SV series nuvistor amplifiers meet external environmental conditions with no change in electrical characteristics. A casting type of construction provides rugged unit easy to mount. Remanco, Inc., 1805 Colorado Ave., Santa Monica, Calif.

Circle 201 on Inquiry Card

## COAXIAL SWITCH

1P6T has uniform electrical characteristics at all outputs.



Coaxial switch has identical  $\pm 2\%$  electrical characteristics through each of six 51 $\Omega$  resistor terminated type N coaxial outputs. Unit developed for noise and interference testing of r-f systems under Mil-I-6181B, 6181D, 26600 and 19610, or other circuit monitoring. Switch is remotely operated with a power rating of 100w CW through connectors and  $\frac{1}{2}$ w through resistor terminations. VSWR ranges from 1.02 at 50mc to 1.3 at 1200mc. Output coils are 26vdc, 280 $\Omega$ . FXR, Danbury, Conn.

Circle 202 on Inquiry Card

## MODULAR POWER SUPPLIES

6340 Series Modular Power Supply is designed for rack panel grouping.



The 6340 Series units are provided with a constant current overload protection circuit. Both the load and line regulation are less than 3mv or 0.02%, whichever is greater. Ripple and noise is less than 1mv RMS for any combination of line voltage, output voltage and load current. Operating temp. range is 0° to 50°C and temp. coefficient is less than 0.033% plus 2mv/°C. Convection cooling is employed and complete 6340 Series has no moving parts. Net weight ranges from 5 to 25 lbs. Harrison Labs., 45 Industrial Rd., Berkeley Heights, N. J.

Circle 203 on Inquiry Card

## ANGLE POSITION INDICATOR

API-8025 Angle Position Indicator is fully transistorized.

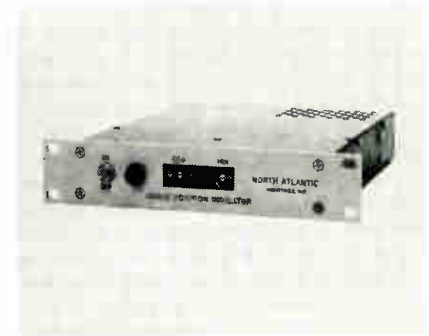

Instrument servo precisely measures synchro or resolver shaft position. Used in production and field checkout systems. Has standard accuracy of 6 minutes of arc, a 30 sec. repeatability and has a 10 sec. response for a 180° step input. Provides digital readout in degrees and minutes from 0° to 360°, with continuous rotation in either direction. Unit operates on 115v, 400cps input. It measures  $9\frac{1}{2}$  x  $1\frac{3}{4}$  x 9 in. for half-rack mounting. North Atlantic Industries, Inc., Terminal Dr., Plainview, N. Y.

Circle 204 on Inquiry Card

## PLUNGER-ACTUATED SWITCH

Switches transfer and maintain chatter-free contact under vibrations and shock.



Compact design ranges from SPST to 5PDT at current ratings to 25a. Weighs less than 8 oz. Min. service is 25,000 cycles. The switches used on missiles, can sustain random vibrations up to 200G RMS (on 30 sec. per axis), 5 to 2000cps and shocks to 100G. Specs. are: 100mv max. at full rated load; dielectric strength, 1250vac at sea level, circuit to circuit or to case; IR, 100meg $\Omega$  min. at 500vdc between any insulated elements; and operating and storage temp. -65° to +165°F. Kinetics Corp., 410 So. Cedros Ave., Solana Beach, Calif.

Circle 205 on Inquiry Card

# MR. RELAY

by Allied Control

1. I'D LIKE YOU TO MEET S, THE ONLY RELAY FOR SANDWICH CIRCUIT BOARDS. HE'S WELDED ALL THE WAY AND CONTAMINATION-FREE.



2. HIS CONTACTS ARE BIFURCATED TO INSURE DRY CIRCUIT RELIABILITY AND LESS BOUNCE TOO.

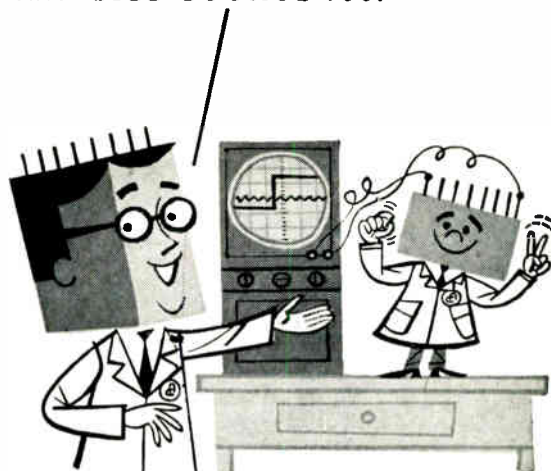

3. SEE, S IS ONLY HALF THE SIZE OF A CRYSTAL CAN RELAY AND INTERCHANGEABLE ... IN EVERY WAY

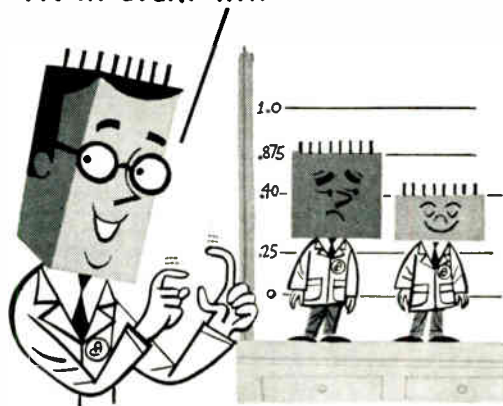

4. AND S IS REALLY A CHAMP WITH HIS PERMANENT MAGNET DESIGN.

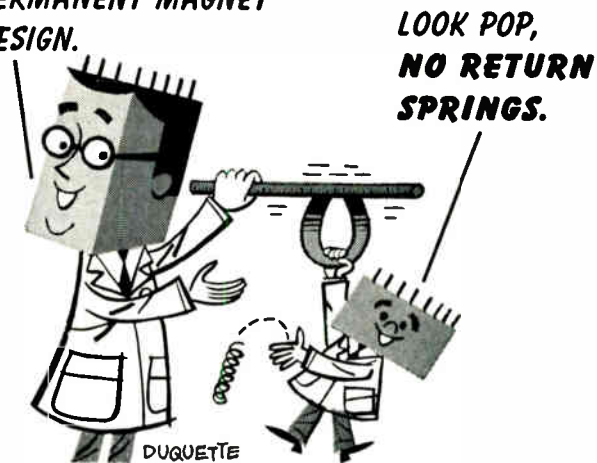

There's more news worth noting about Allied's new S relay. Flux contamination, for example, is a thing of the past. We use the latest heliarc welding techniques to seal the S relay within an inert atmosphere. Since there's no bobbin (the coil is wound *directly* on the magnetic core), Allied eliminates possible contamination here, too. And talk about immunity to shock and vibration! S is really rugged with its balanced rotary action armature. All S relays are calibrated for contact over-travel of the energized contacts *during* production, so they *stay* and *stay* on the job. Want complete application data? Write for Catalog Sheet S or call your nearest Allied representative.

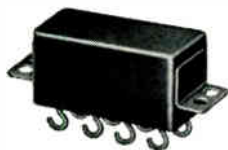

©1962 BY ALLIED CONTROL COMPANY, INC

**ALLIED CONTROL COMPANY, INC.**

2 EAST END AVENUE, NEW YORK 21, N. Y.

OPERATING CONDITIONS	
Contact Rating: (at nominal coil voltage)	2 amperes resistive at 29 volts d-c Low level contacts available
Contact Arrangement:	Two pole double throw
Shock:	50g operational
Vibration:	5 to 55 cps at 0.125 inch D. A. 55 to 2000 cps at a constant 20g
Operate & Release Time: (at +25°C)	4 milliseconds maximum at nominal coil voltage
Terminals:	Plug-in, printed circuit, hook type solder terminals and 3 inch leads
Weight:	0.3 ounce maximum

AL-239-B



# NEW PRODUCTS

...for the Electronic Industries

## INDICATOR-TESTER SWITCH

*Transistor driven neon switch controlled by a solid-state gating circuit.*



Included in Type 01 lighted pushbutton line. Miniature in size, back of panel is 2.625 in. deep, 0.850 x 0.725 in. rectangular, this series was designed to solve space problems in computers, data processing, and industrial control systems by furnishing a neon indicator and transistorized test circuitry in one package. High voltages in logic circuits now can be externally confined to the indicator-test unit. Over one million proven test cycles of life. Licon Div., Illinois Tool Works Inc., 6615 W. Irving Park Rd., Chicago 34, Ill.

Circle 206 on Inquiry Card

## WIRING TOOL

*For miniaturized components; use wire as fine as 30 or 32 gauge.*



With the attachment of an accessory to the "Wire-Wrap"® tool it is practical to wire miniaturized components. The designed bit and nose piece fit on present battery-powered or other Wire-Wrap tools. Picture illustrates size of connections on a component. Connections made by using the tool with 32-gauge wire are possible on 0.1 inch modular spacings, permitting at least 100 terminals per square inch. Permanent connections are made in only 3 seconds. Gardner-Denver Co., Gardner Expressway, Quincy, Ill.

Circle 207 on Inquiry Card

## DECIMAL SHAFT-ENCODER

*Model DE drives printers directly for data-logging applications.*



Mechanical motion is converted into a digital format by the Decitrak. Commercial printers and card punches are directly actuated by its high electrical output level. Decitrak's direct-decimal output needs no code conversion. Random shaft motions in both clockwise and counter-clockwise directions produce non-ambiguous printouts. Scales of 359.9°, ±179.9° or 9999 are available. Accuracy is within ±1 digit. Electrical output is 10 wire/digit decimal code, parallel form. Theta Instrument Corp., Saddle Brook, N. J.

Circle 208 on Inquiry Card

## AMPLIFIER TRANSISTORS

*Darlington amplifier shows a 2000 minimum current gain at 1µa.*

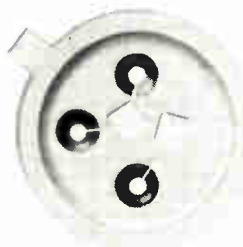

The Darlington amplifier transistor types 2N2723, 2N2724, and 2N2725 are 2 npn silicon planar devices in a single 4 lead TO-18 package interconnected to provide very high current gain, as high as 2000 min. at 100µa. These transistors all feature leakages as low as 1na max. at 30v and noise figure typical at 2db. These devices are particularly useful for high impedance inputs, low noise amplifiers, and high gain stages. Sperry Semiconductor, Div. of Sperry Rand Corp., Norwalk, Conn.

Circle 209 on Inquiry Card

## SUBMIN. SNAP SWITCH

*MAC series features low force and wide movement characteristics.*

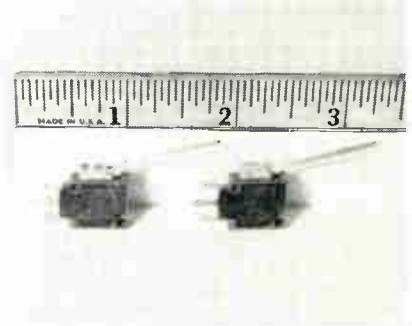

Force is 2 grams max. at the end of the actuator when measured about 1/4 in. from the actuator pivot point. Total movement is approx. 40° from at rest position to full travel. The wire actuator may be bent into any configuration thus giving complete versatility as to the form used. The flat blade actuator may be used as a good surface for cam or roller actuators. The entire assembly is 0.175 in. wide. The switch is rated at 5a, 250vac resistive U. L. and C. S. A. approved. Columbus Electric Mfg. Co., 621 N Hamilton Rd., Columbus 19, Ohio.

Circle 210 on Inquiry Card

## VOLTAGE REFERENCES

*Low cost, encapsulated unit for battery and standard cell replacement.*



The Series 300 is stabilized (0.005%) for line voltage changes. The standard model has a temperature coefficient of 0.005%/°F, other models are available with coefficients of 0.002%/°F and 0.001%/°F. Voltage and current ratings are available in any values up to 5vdc and 10 milliamperes. Special packaging is available to meet all applicable military specs. For use in systems, computers, test equipment, power supplies and other fixed load applications. Electronic Control Systems, Inc., Fairmont, W. Va.

Circle 211 on Inquiry Card



DIGITRONICS DIAL-O-VERTER D520  
MAGNETIC TAPE TERMINAL WITH  
DOOR OPEN SHOWING CIRCUIT CARDS

**Digitronics assures  
the reliability of  
their high-speed  
Dial-o-verter system  
with ALLEN-BRADLEY quality  
electronic components**

**HIGH-SPEED HANDLING OF DATA DEMANDS  
UTMOST RELIABILITY!**

■ You don't need a Ph.D. to understand that the higher the data handling speed, the greater is the necessity for uninterrupted operation—even short delays lose volumes of information. Therefore, Digitronics Corporation uses Allen-Bradley fixed and adjustable hot molded resistors in their Dial-o-verter system.

A-B fixed resistors are so thoroughly reliable that even with the billions of Allen-Bradley fixed resistors in use, there's never been a *single* record of catastrophic failure! The key to such a phenomenal performance is to be found in A-B's hot molding technique—a process developed and used *only* by Allen-Bradley. It results in such uniform properties that long term resistor performance can be accurately predicted.

Allen-Bradley's Type R adjustable fixed resistors are also hot molded so that the solid resistance element, terminals, and insulating body are produced in a rugged unit structure. The molded case is both dust-tight and watertight—it is completely satisfactory for use where entire circuits are encapsulated. With almost infinite resolution, abrupt changes in resistance cannot occur during adjustment, and the moving element is self-locking in its "set" position.

Be sure your equipment has the reliability *only* Allen-Bradley hot molded resistors can give. For full details on all A-B quality electronic components, please write for Publication 6024. Allen-Bradley Co., 222 W. Greenfield Ave., Milwaukee 4, Wis. In Canada: Allen-Bradley Canada Ltd., Galt, Ont.

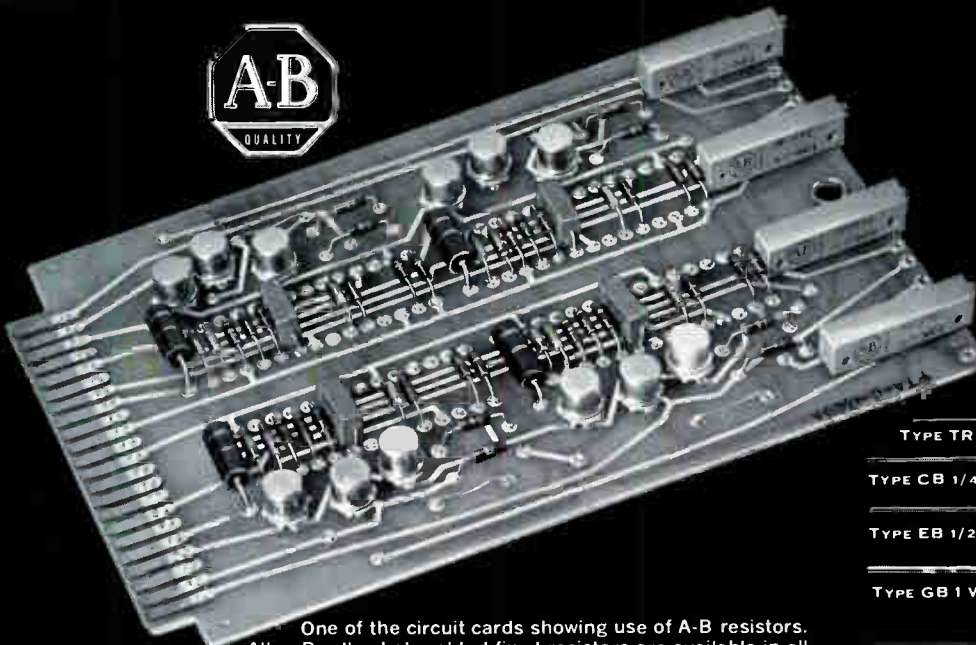

One of the circuit cards showing use of A-B resistors. Allen-Bradley hot molded fixed resistors are available in all EIA and MIL-R-11 standard resistance values and tolerances.



A-B Type R adjustable fixed resistors, rated 1/4 watt at 70°C, available in total resistance values from 100 ohms to 2.5 meg.



- |                   |                |
|-------------------|----------------|
| TYPE TR 1/10 WATT | MIL TYPE RC 06 |
| TYPE CB 1/4 WATT  | MIL TYPE RC 07 |
| TYPE EB 1/2 WATT  | MIL TYPE RC 20 |
| TYPE GB 1 WATT    | MIL TYPE RC 32 |
| TYPE HB 2 WATTS   | MIL TYPE RC 42 |

**ALLEN-BRADLEY**  
QUALITY ELECTRONIC COMPONENTS





# Allen-Bradley's "time-proven" components bring the ultimate in reliability to your circuit design

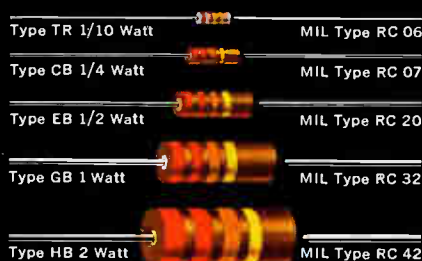
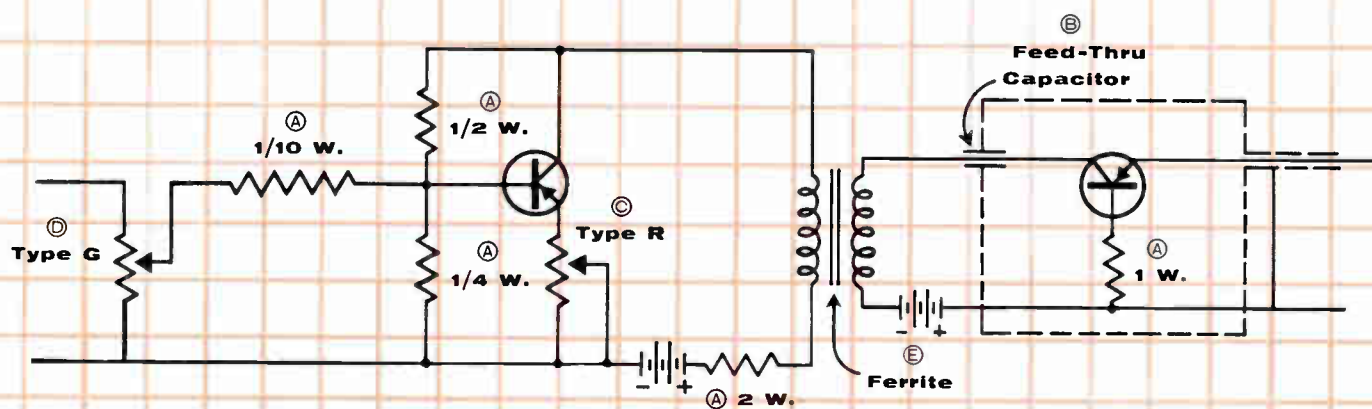

**(A) HOT MOLDED FIXED RESISTORS** are available in all standard EIA and MIL-R-11 resistance values and tolerances.



**(B) FEED-THRU CAPACITORS**—Available in standard values of 470 mmf  $\pm 20\%$  and 1000 mmf G.M.V. Special values from 6.8 to 1000 mmf. Rated to 500 v DC max.



**(C) HOT MOLDED ADJUSTABLE FIXED RESISTORS**—Rated 1/4 watt at 70°C. Values to 2.5 meg. Tol:  $\pm 10$  and 20%.



**(D) TYPE G HOT MOLDED POTENTIOMETERS**—Only 1/2" diam. Rated 1/2 watt at 70°C. Resistance values to 5 meg. Tol:  $\pm 10$  and 20%.



**(E) FERRITES** in a wide range of "items," such as flared rings, quarter rounds, U cores, E cores, cup cores, etc., can be supplied.

With the quality of the components which you select, you automatically establish the "quality" of your product. Consequently, there's no surer way of making certain of optimum performance than by using Allen-Bradley electronic components. Such stable characteristics insure against catastrophic failure, and conservative ratings are way beyond the "promise" of any similar products. Hundreds of customers of many years standing have learned from their experience with Allen-Bradley hot molded resistors, that today's shipments are as uniform in quality as they were ten or twenty years ago—and such uniform quality can always be expected.

Remember also that with billions of A-B resistors in use, there is *not one instance* of catastrophic failure on record! Allen-Bradley's *exclusive* hot molding process results in such uniformity that long term resistor performance can be accurately predicted.

Then there's the compact Type G potentiometer. The solid, hot molded resistance element assures exceptionally smooth control throughout its long life—there are never any abrupt resistance changes during adjustment. The

noise factor is remarkably low initially, and it actually decreases with use.

Allen-Bradley's Type R adjustable fixed resistors are also made by this same hot molding process—resistance element, terminals, and insulating base are all molded into a solid unit. Stepless adjustment is provided, and the moving element is self-locking at its "setting."

In the higher frequencies—up to 1,000 mcps—A-B ceramic feed-thru and stand-off capacitors' unique discoidal design eliminates all parallel resonance effects.

Entirely new answers to design problems are possible with A-B's broad line of ferrites . . . reducing product size, weight, or cost, and improving performance. They can be supplied in a wide range of shapes and sizes—while maintaining extremely uniform electrical and mechanical characteristics.

For more details on all A-B quality electronic components—types, ratings, dimensions—please send for Publication 6024: Allen-Bradley Co., 222 West Greenfield Avenue, Milwaukee 4, Wisconsin. In Canada: Allen-Bradley Canada Ltd., Galt, Ontario.



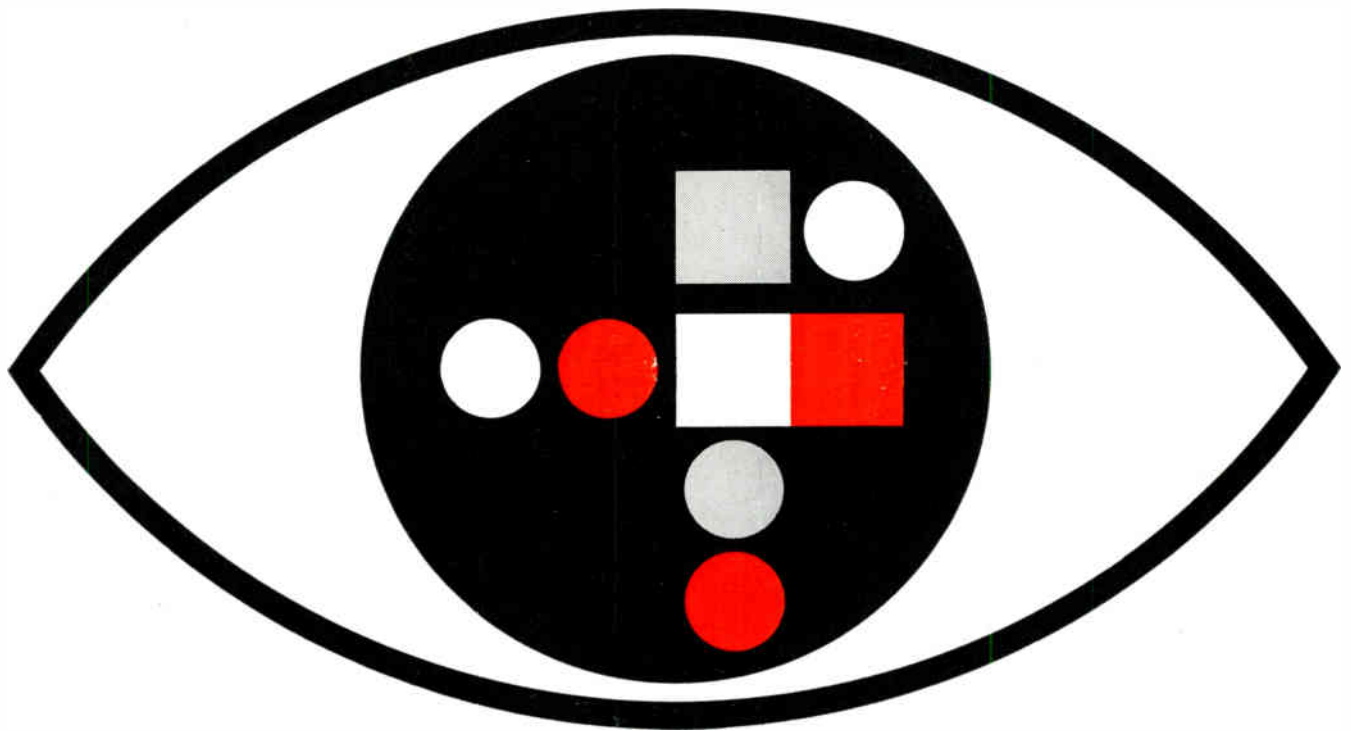

**EYE-CATCHING INDICATOR LIGHTS**—designed to meet both military and industrial-commercial design requirements. Select incandescent or neon, 1, 2, 3 or 4 lamps, and round, square, or rectangular faces in many sizes. We offer models to mount in single round or rectangular holes, or to matrix-mount. All colors in indicators, press-to-test, digital readout, billboard message, and read-when-lit styles. Even 60,000-hour subminiatures and edge-lit panel lamps. All indicator lamps and matching lighted pushbutton switches easily relamp from front of panel. Write for new free *Indicator Light Catalog #120*.

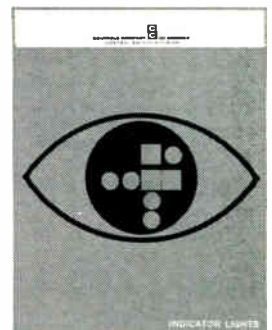

  
**CONTROLS COMPANY OF AMERICA**  
 CONTROL SWITCH DIVISION  
 1420 Delmar Drive, Folcroft, Pennsylvania

# NEW PRODUCTS

...for the Electronic Industries

## DELAY LINES

Magnetostrictive delay lines for telemetry and digital applications.



Model 170 for telemetry uses provides a delay length of 50 to 150,  $\pm 5\mu\text{sec}$ . fixed with an input impedance of 100 $\Omega$  for operation in the subcarrier frequency range from 100kc to 1mc. Model 213 delay line designed for digital applications provides a delay length of 100 to 2000 $\mu\text{sec}$ . and a pulse repetition rate of up to 2mc NRZ. Units have stainless steel cases with a solder seal for humidity protection. Del-time Inc., 608 Fayette Ave., Mamaroneck, N. Y.

Circle 212 on Inquiry Card

## SELF-POTTING SPLICE CAPS

Device for sealing and capping crimped or soldered wire splices.



Thermofit SCL Caps are heat-shrinkable, sealed-end sleeves which "pot," moisture-proof and insulate in one quick operation. Caps may be used on vinyl, nylon, polyethylene, or other low temp. wire insulations. SCL caps prevent water from entering most types of splices when temp. cycled in salt water, (Mil-202B Method 104, Test Condition C). Caps withstand up to 300°C for short periods of time and from -65° to 125°C continuously. Dielectric strength is 800v/mil. 4 sizes of caps cover splices to 0.425 in. in dia. Standard color is black. Rayclad Tubes Inc., Redwood City, Calif.

Circle 213 on Inquiry Card

## SILICONE COOLANT

Silicone dielectric fluid with operating temp. range -130°F to 400°F.



For aerospace electronic coolant applications. Dow Corning 331 Fluid developed to meet requirements of proposed USAF Mil-S-27875 has a low viscosity, 10 centistokes, for higher pumping rates and rapid heat transfer. The viscosity remains more uniform with temp. changes than any organic fluid. Also has low volatility—only 4% weight loss after 4 hrs. at 392°F. Maintains low dielectric losses over a wide temp. range. Dow Corning Corp., Midland, Mich.

Circle 214 on Inquiry Card

## VOLTAGE STABILIZER

Only 25msec. required to bring voltage to rated output.

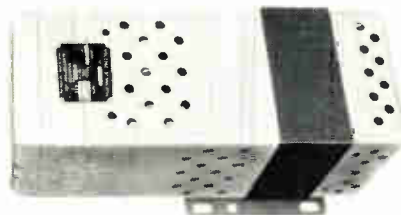

"Powerguard" automatic voltage stabilizers in 30, 60, 250, 500, 1000 and 3000va units. These powerguard stabilizers correct line voltage variations of  $\pm 15\%$  to within  $\pm 1\%$ . The units contain no moving parts, provide maintenance free operation, and have high resistance to physical and mechanical shock. The electrical design includes built-in safety factors. Current limiting protects load equipment from excess fault current. High reactance limits current inrush. Short-circuiting of output will not damage the stabilizer. Stancor Electronics, Inc., 3501 Addison St., Chicago 18, Ill.

Circle 215 on Inquiry Card

## MEMORY PLANE

Device is stable over a wide operational temp. range.

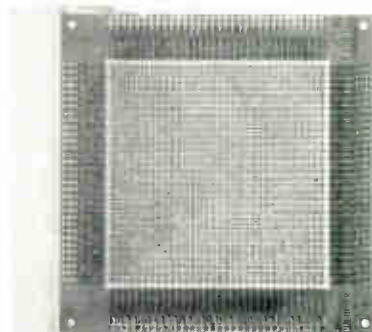

Coincident-Current Wide Temperature Range Ferramic Core Memory Plane is a 64 x 64 printed circuit plane. It employs the IGC MC-180, 0.050 in. core. Stability of performance characteristics extends over a temperature range of -50°C to +100°C. When memory tested the plane is exercised through patterns of all Ones, all Zeros, and double checkerboard (worst case) and its complement. Indiana General Corp., Electronics Div., Keasbey, N. J.

Circle 216 on Inquiry Card

## ALL CRIMP CONNECTOR

Smooth Bantam line conforms to Mil-C-26482C (Navy) requirements.



Connector offers the following advantages. Insert supports contacts of the connector for pin alignment and proper mating of plug and receptacle. Closed entry socket with internal spring to prevent damaging resilient insert or grommet. Removable crimped smooth contacts meet or exceed Mil-C-26636 and Mil-C-23216 requirements and conform to dimensions of specifications in MS 3192 and 3193. The connector shown has 48 pins. Contact design for constant insertion and withdrawal forces and low and consistent contact resistance. Bundy Corp., Norwalk, Conn.

Circle 217 on Inquiry Card

# SILICON PLANAR EPITAXIAL DIODES

TRANSITRON'S NEW SG5000-5400 SERIES — OUTSTANDING SUCCESSORS TO THE POPULAR SG5000 — PROVIDES THE MOST EFFECTIVE COMBINATION OF HIGH FORWARD CONDUCTANCE, LOW CAPACITANCE AND FAST SWITCHING EVER OFFERED TO THE INDUSTRY.

# DEMANDED

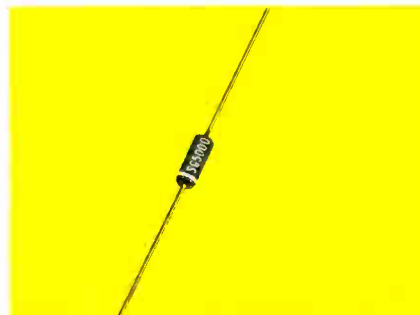

Introduced a short time ago, the SG5000 offered a new high in reliability, performance and versatility that quickly made it a popular component for computer circuit design. Fully aware of the need for a complete range of similar devices, Transitron has now developed a series of premium subminiature glass silicon planar epitaxial diodes.



# EXPANDED

Transitron's new SG5000-5400 series offers a combination of 3 major characteristics that is superior to any now available: higher forward conductance . . . 200 to 400 mA @ 1 Volt; lower capacitance . . . 2 to 4 pf @ 0 Volts; faster switching . . . down to 2 nsec. All types will fully meet the rigid requirements of military and space exploration high reliability systems.

SPECIFICATIONS AT 25°C				
Type	Minimum Forward Current @ 1 Volt (mA)	Minimum Breakdown Voltage @ 5µA (Volts)	Maximum Capacitance @ 0 Volts (pf)	Maximum Inverse Recovery Time (nsec)
SG5000	200	100	2	2
SG5100	400	50	4	2
SG5200	400	75	4	2
SG5300	300	100	2	2
SG5400	200	150	2	2

A balanced combination of very low capacitance and exceptional high current switching makes the diodes of the new SG5000 series ideal for memory core driving applications. And since all types can be custom-encapsulated as multiple-chip assemblies, they are

highly compatible with the critical space limitations of computer memory core systems.

Another important application is logic systems. The SG5000 series provides tightly controlled lower forward voltages at specified low current levels, and more units can be paralleled and still deliver fast switching.

Because these units fulfill maximum diode specifications, it is no longer necessary to use 2 or 3 diode types in a system. Now, only one diode need be evaluated for component procurement.

All SG5000-5400 silicon planar epitaxial diodes are digitally marked for quick diode type identification. And all types are also available through your Transitron Distributor... For further information, write for Transitron's "Silicon Planar Epitaxial Diode" bulletins.

## Transitron

electronic corporation  
wakefield, melrose, boston, mass.

SALES OFFICES IN PRINCIPAL CITIES THROUGHOUT  
THE U.S.A. AND EUROPE • CABLE ADDRESS: TRELCO

Circle 63 on Inquiry Card



# NEW PRODUCTS

...for the Electronic Industries

## MICRO DIODES

Body size is smaller than conventional 250mw glass diode package.

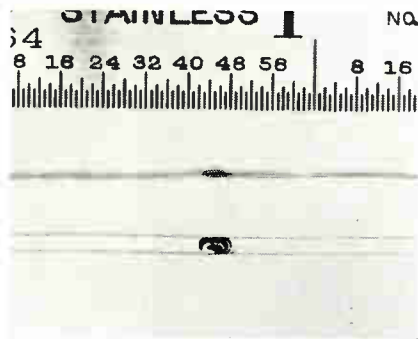

In this series of 750mw micro devices are rectifiers with average current ratings of 1/2a and PIV up to 1000v. As part of this 750mw micro diode line there are available high conductance computer diodes capable of pulse currents in excess of 1a. Microwave switches capable of handling peak power in excess of 1kw at S-band freqs. are also available in this new series of 750mw micro devices. MicroSemiconductor Corp., 11250 Playa Court, Culver City, Calif.

Circle 218 on Inquiry Card

## CIRCULAR CONNECTORS

Microminiature type for cable-to-cable or cable-to-chassis use.



Mighty Mite® circular connectors are the 222 series. Environmental versions meet or exceed performance per Mil-C-26482: 375v RMS up to 70,000 ft. and 1500v at sea level; also withstand 5 continuous temp. cycles between -55° to +125°C. Mighty Mite connectors are available with 7, 19, 31 and 61 contacts per assembly. Wire-Form, Poke-Home® contacts with inherent retention are used. Cutouts required range from 0.496 to 0.996 in. dia. Amphenol Connector Div., Amphenol-Borg Electronics Corp., 1830 S. 54th Ave., Chicago 50, Ill.

Circle 219 on Inquiry Card

## SIGNAL COMPRESSOR

Model TM6629 accepts 1RIG tones in freq. from 1 to 100kc.



Unit has constant low distortion output for varying peaks of multiple modulating signals. Used in driving telemetering command signal generators. Fed with voltage levels from 0.5v to max. peak of 8.5v, unit will deliver a constant 5.6v pk-pk within ±10% with distortion less than 2%. No level compensation is needed when switching-in additional channels to freq. modulate an r-f carrier. Marconi Instruments, 111 Cedar Lane, Englewood, N. J.

Circle 220 on Inquiry Card

## ONE-BRUSH SHAFT ENCODER

Very low torque, low moment of inertia and no contact noise.



Model SD3 is a one-brush absolute position shaft encoder. Heart of the device is a single, lightweight wiper which results in very low torque and low moment of inertia. Extended life capability allows encoder's wiper to be repositioned to a new wiping track at least 4 times during the life of the encoder. Life of the shaft encoder is over 6 million shaft turns. Resolution is 1000 counts (binary coded decimal) in 360° of rotation with an accuracy of ±1 count. Unit is 4 in. in dia. Perkin-Elmer Corp., Vernistat Div., Norwalk, Conn.

Circle 221 on Inquiry Card

## THERMOELECTRIC COOLER

For operation with temp. sensitive components in space-limited environs.

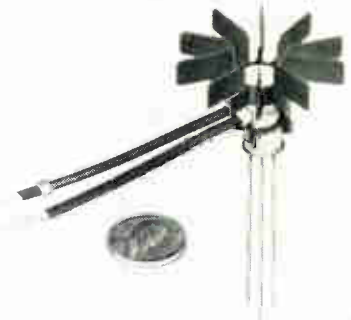

This unit has a temp. operating range of -100° to +125°C with a max. heat pumping capacity of 350mw. Able to be integrated into a circuit, this thermoelectric cooler eliminates need for refrigeration of an entire package. No moving parts. Model XT-10 pictured is for the TO-5 and TO-9 case size. Unit is adaptable to most TO case sizes. Power supplies to handle up to 8 model XT-10 units in series are available. Atlee Corp., 2 Lowell Ave., Winchester, Mass.

Circle 222 on Inquiry Card

## SILICON PNP SWITCH

Subminiature light actuated switch rated to 250mw.



Types QLS2-QLS25 for light-controlled power use. These 250mw rated silicon pnp switches are triggered from 100 to 900 foot candles of light. The 4-layer devices have complete electrical isolation of input from output, possess blocking voltages from 25 to 250v, and currents up to 100ma (rated on degree of light sensitivity required). Operating temp. from -20° to 150°C. On-off control is limited to junction temp. below 75°C. Unit body measures 0.265 x 0.107 in. dia. International Rectifier Corp., 233 Kansas St., El Segundo, Calif.

Circle 223 on Inquiry Card

# The Complete Line of 1 to 10 Watt

## AMPLIFIERS BY ALFRED

### 500 Mc to 18 Gc

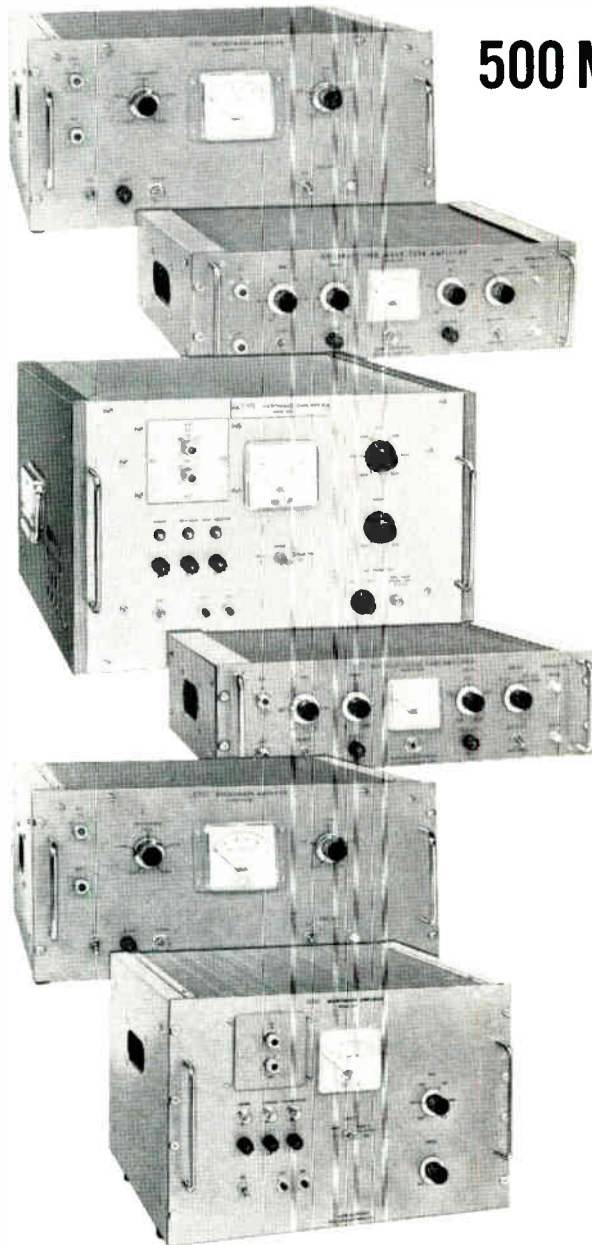

#### FEATURES

- Rated gain and power output over each range at one setting of controls
- Can provide greater than rated power over limited frequency ranges
- Flat response
- Easy to operate — just connect and turn on
- Alfred ruggedness and reliability
- Rack or bench mounting
- RF connectors on front or rear

#### APPLICATIONS

- Broadband power amplifiers
- Buffer amplifier or load isolator
- Driver amplifier for high power pulse and CW tubes
- Stable power oscillators using external resonant feedback networks
- Frequency multiplication

For complete information, please call your Alfred engineering representative or write us. All specs guaranteed as stated. Stock delivery in most cases.

Each Alfred Broadband Amplifier consists of a TWT, its focusing magnet, and a completely regulated supply for obtaining optimum performance from the TWT.

## ALFRED ELECTRONICS

Stanford Industrial Park • 3176 Porter Drive • Palo Alto, California  
Phone: (415) 326-6496

Basic Specifications	508†	5-6752	502A	5-6868†	5-542†	529†	529-S1†	528*	528A*	527*	527-S1*	526*
Freq. Range (Gc)	.5 to 1	1 to 2	2 to 4	2 to 4	4 to 8	4 to 8	4.8 to 6.5	7 to 11	7 to 11	8 to 12.4	8 to 11	12.4 to 18
Power Output (watts-min.)	1	1	1	10	1	10	10	5	10	2	10	1
Gain (db small signal)	30	33	30	33	30	30	30	30	30	30	33	30
Gain (db saturation)	30	30	30	20	30	27	27	30	25	27	30	30
Price	\$3290.	\$1950.	\$1590.	\$2550.	\$2790.	\$3650.	\$3250.	\$3150.	\$3600.	\$3150.	\$3450.	\$3950.

\*Can be pulse modulated only.

†Can be pulse and amplitude modulated.

17

# SOLID STATE POWER CONVERSION

for a broad range of power requirements

Unitron can meet exacting requirements with custom-engineered Inverters, Frequency Converters, DC/DC Converters, and Power Supplies, with the reliability of semiconductor circuitry and *no moving parts*. Units can be designed for a broad range of power requirements in airborne and ground support systems.

Unitron has compiled a valuable background of design and production experience by specializing in solid state power conversion equipment. This background provides Unitron with a unique ability to furnish custom-designed equipment with almost off-the-shelf timing and economy.

Unitron's capability is reflected by *delivered units*, such as the three examples of custom-designed Frequency Converters shown below.



3.5 KVA  
Freq. Converter

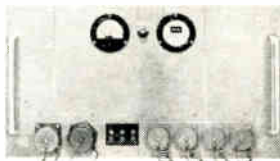

1.5 KVA  
Freq. Converter



8.0 KVA  
Freq. Converter

These 400/60 cps Converters share exceptional performance characteristics, such as better than 90% efficiency ... regulation to  $\pm 1.0\%$  ... less than 5.0% distortion ... frequency stability from 0.001%. Their environmental and RFI characteristics are compatible with applicable military specifications.

## UNITRON INCORPORATED

1624 N. First • Box 1331 • Garland, Texas

## NEW PRODUCTS

### TERMINAL BLOCK

For connecting flat conductor cable to station wire or line cord.

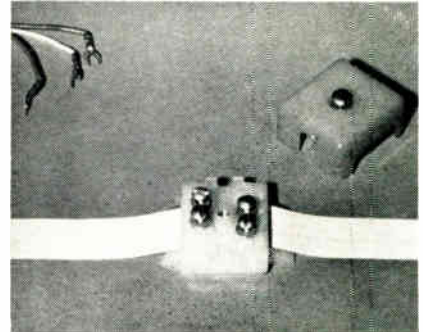

Among the commercial applications of the flat conductor cable is that found in the installation of telephone circuits. This nylon telephone station block was developed to speed installation with the new adhesive backed inside station wire. The station block is available in five decorator colors to match interior decoration and the flat conductor cable colors. The Thomas and Betts Co., Elizabeth, New Jersey.

Circle 224 on Inquiry Card

### ACCELEROMETERS

High performance piezoelectric units measure shock vibration.



Statham AK series use a sensitive piezoelectric element for measurements in missiles, aircraft, and ballistic impact. Features are: Model AK116—self-capacity of 8000pf for direct feed into VTVM. Model AK119—sensitivity of 60mv peak/peak g; Model AK120—weight 0.3 oz.; Model AK117—natural freq. of 100kc; Model AK118—temp. range of  $-320^{\circ}$  to  $+500^{\circ}$ F; Model AK121—tri-axial instrument; Model AK115—general purpose unit; and Model AK122—hermetically sealed, general purpose unit. Statham Instrument, Inc., 12401 W. Olympic Blvd., Los Angeles 64, Calif.

Circle 225 on Inquiry Card



# LOWER YOUR READOUT COSTS MORE THAN 40%

WITH

## BINA-VIEW BINARY INPUT SELF DECODING READOUTS



ACTUAL SIZE DISPLAY

The Bina-View one plane readout combines a built-in decoder with a light-interference type display to give you the industry's most economical long life readout package... *as low as \$65.25 in 1-9 quantities!*

Decoding is accomplished electromechanically from binary input to display without relay contacts or electronic circuitry. Floating decimal point now available by lighting separate lamp.

### CHECK THESE OUTSTANDING ADVANTAGES

- **Translates Binary Codes Direct to Decimal or Alpha-Numeric Display.** Any 6-bit binary code can be used for full alpha-numeric presentation. Pure binary numeric display can be accomplished up to 38 characters using 6 bits; beyond 38 characters, BCD and multiple units must be used.
- **Reduces Number of Conductors in Cables.** As few as 7 wires are required to operate the first of a series of Bina-View readouts. Only 1 wire for each additional unit is necessary.
- **Low Power Requirement.** Transistor circuitry can drive Bina-View readouts directly; only 100 mw signal input per bit and 4 watts for set-up are required.
- **Human Factors Consideration.** All characters displayed on one plane... bright distinct characters visible over 170° viewing angle... de-energized characters completely invisible.
- **Automatic Memory.** In case of power interruption, the last character shown re-appears when operation resumes, and remains until the next character is set-up.
- **Optional Check Back.** Binary electrical outputs corresponding to characters being displayed can be used to verify input signals or to operate remote readouts. Signals can be stored until the unit resets providing electrical data storage.

### BINA-VIEW READOUT SPECIFICATIONS

Maximum Character Size: 1 3/4"  
 Operating Voltage: 6, 12, 24, or 48 vdc  
 Dimensions: 3 1/2" H x 1 7/8" W x 6 7/8" L  
 Number of Characters Available per Unit: Up to 38  
 Codes: Standard 4, 5, or 6-bit codes available  
 Lamp Voltage: 6 or 28v, both ac or dc

**ONLY IEE ONE-PLANE READOUTS GIVE YOU SUCH VERSATILE DISPLAYS!**



Up to 38 characters available for true alpha-numeric display.



Word messages can be used singly or in combination on the same character plate.



Virtually any symbol can be displayed.



Red and green color emphasis can be added; other colors available.

Write for complete Bina-View specifications. For your copy of the new IEE Readout-Message Designer's Kit, write on your company letterhead.



## INDUSTRIAL ELECTRONIC ENGINEERS, INC.

5528 Vineland Avenue • North Hollywood, California • Phone: (213) 877-1144 TWX: (213) 769-1636

Circle 66 on Inquiry Card

## FOR HIGH CAPACITY CURRENT INTERRUPTION . . . SPECIFY GIBSON SILVER-TUNGSTEN REFRACTORY CONTACTS



Gibson silver-tungsten refractory contacts successfully resist the severe arc erosion and sticking caused when interrupting high power circuits . . . even when the interruption ratings are 100,000 amperes or higher. The high conductivity, corrosion resistance and low contact resistance of silver is combined, through Gibson's power metal process, with the non-welding and arc-resistant properties of tungsten for these heavy-duty applications. Gibson silver-tungsten refractory contacts last longer, perform better under the most extreme conditions.

### METAL COMPOUNDING

Gibson powder metal techniques provide nearly all required proportioning of refractory metals to meet the most exacting specifications. Gibson's sophisticated metallurgical processes assure the proper characteristics of the combined materials through precise control of such factors as particle size and distribution, compacting pressure, sintering and impregnating times, temperatures and atmospheres. Gibson refractory compounds cover a wide range of standard applications, or they can be custom-engineered to suit your needs.

### FORMS AVAILABLE

Refractory Gibsilloys are supplied in all normal contact forms. In addition, where the efficient designs of interrupting devices call for contacts of unusual shapes, Gibson techniques have been developed to produce such shapes

economically. In so far as possible, the powder metal tools are specially designed to produce the shapes, and machining operations are used to complete the shapes only when absolutely necessary.

### ATTACHMENT TO SUPPORT

The successful attachment of these contacts to their supports depends on proper preparation of the brazing surface so that the material is not weakened by oxidation during brazing. Gibson applies special soldering agents to the brazing surfaces under controlled atmospheres, protecting the contact material and assuring subsequent proper attachment.

### CONTACT ASSEMBLIES

Gibson facilities also permit supplying complete contact assemblies, ready for installation in the customer's devices.

For complete information write for Technical Bulletin 506, Refractory Gibsilloys.

**GIBSON ELECTRIC COMPANY**  
A subsidiary of TALON, INC.

BOX 598, DELMONT (PITTSBURGH DISTRICT), PA.

Representatives in Principal Cities of the United States and Canada

**Gibsiloy**  
ELECTRICAL CONTACTS  
Since 1933

## NEW PRODUCTS

### MICROWAVE REFLECTORS

Made of aluminum interlocking extrusions.

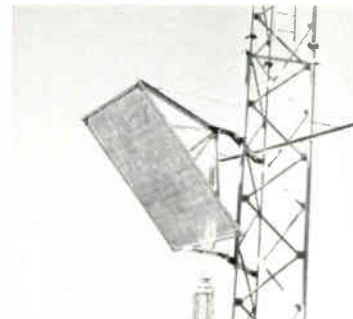

Three standard sizes, 6 x 8, 8 x 12 and 10 x 15 feet. All Reynolds aluminum, the reflectors in these sizes weigh approximately 140, 280 and 438 pounds respectively. Features include simplicity of design and ease of handling. The extrusions can be shipped, knocked-down, to the erection site, are easily snapped-together for assembly in the field. Rohn Mfg. Co., Box 2000, Peoria, Ill.

Circle 226 on Inquiry Card

### MULTIPLE RESISTORS

Up to 30 variable resistors (1/2w. 15/16 in. dia.) on a single shaft.

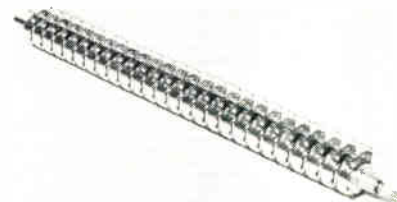

The units have any combination of resistances, from 200Ω to 10megΩ, in wide range of tapers and terminal types. Using a composition resistance element, the units have a min. rotational life of 25,000 cycles tested at 600 cycles/hr. Standard units have less than 10% change in resistance after 1000 hrs. at 40°C and de-rate to 0 load at 105°C. Unit seen has 26 of 30K linear taper resistors on a single shaft, with less than 3% backlash over the entire length. Centralab, The Electronics Div. of Globe-Union Inc., 900 E. Keefe Ave., Milwaukee 1, Wisc.

Circle 227 on Inquiry Card

# 0.2% Accuracy



## in an Instrument with a Meter?

Sounds impossible but it's true. Of course there's a little trickery involved . . . but it's honest. We've moved the first one or two digits off the meter and put them on a switch, and thereby let the meter do the fine work — the interpolating. The switch (marked Interpolation Offset Frequency) controls a precise 0.05% voltage divider connected across a highly linear frequency dis-

criminator. The meter (accuracy, 1% of reading) simply reads what's left over. This technique lets you read up to three significant figures without eye strain. Pencil and paper will soon show you that this procedure gives you an accuracy of better than 0.2% of full scale.

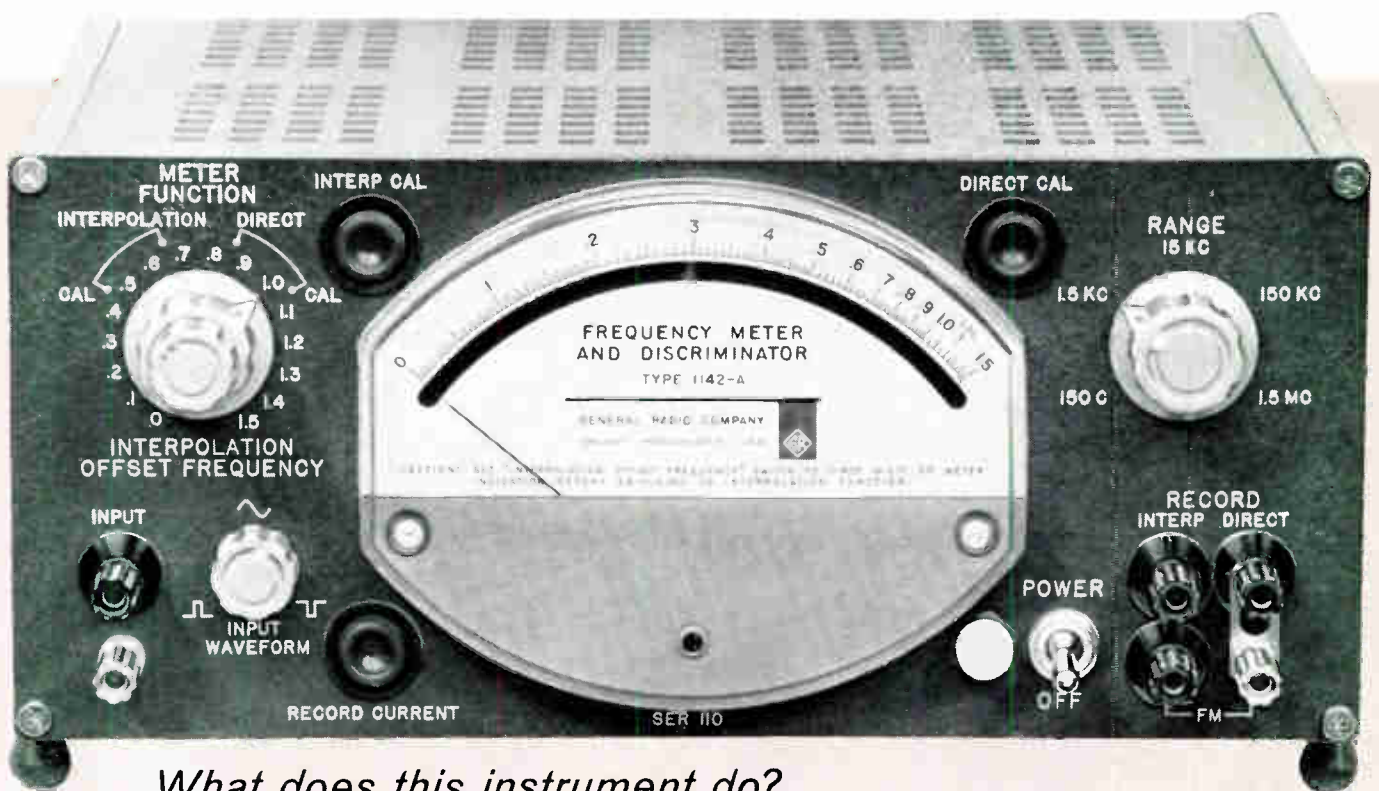

### *What does this instrument do?*

The 1142-A Frequency Meter and Discriminator measures frequencies from 3 cycles to 1.5 megacycles. If you choose, you can also measure a 100-Mc signal to 1 part in  $10^9$  by using heterodyne techniques. This instrument also gives you an analog output proportional to frequency for direct use with graphic recorders (no digital-to-analog converters necessary). As a discriminator, the 1142-A has a linearity that is typically 0.1%. Residual noise level is down more than 100 db. Sensitivity is 20 mv between 20c and 150 kc, rising to 200 mv at 3c and 1.5 Mc.

The Price is \$525 (in U.S.A.), several hundred dollars less than the lowest price 1-Mc digital frequency counter.

**GENERAL RADIO COMPANY**  
WEST CONCORD, MASSACHUSETTS

In EUROPE  
General Radio  
Overseas  
Zurich, Switzerland

NEW YORK, N. Y., 964-2722  
Ridgefield, N. J., 943-3140

CHICAGO  
(Oak Park) 848-9400

PHILADELPHIA, 424-7419  
Abington, 887-8486

WASHINGTON, D. C.  
(Rockville, Md.) 946-1600

SYRACUSE  
454-9323

DALLAS  
FL 7-4031

SAN FRANCISCO  
(Los Altos) 948-8233

LOS ANGELES  
469-6201

ORLANDO, FLA.  
425-4671

IN CANADA  
(Toronto) 217-2171



# new P.A.D.T. transistor

## has both!

### high $f_T$ (250 mc)

and

### low feedback capacitance (0.50 pf.)

giving you higher stable gain

### at the usual P.A.D.T. production-run prices



## Amperex 2N2654

The 2N2654 has been specifically designed by Amperex semiconductor engineers to provide the high stable gain characteristics so desirable for efficient RF and IF amplification in typical Communications Receiver circuits, FM, TV and battery portables from 450kc through 100 Mc.

This PNP germanium, PADT transistor, offers unusual and exceptionally stable performance even at low battery and varying supply voltages, particularly significant in battery portables and mobile operation.

These unparalleled features of the 2N2654 permit optimum receiver design with consequent elimination of

costly compensation circuitry and resultant simplification of alignment procedures. Here is another production-run Amperex PADT Transistor that will save you time and money.

Like all Amperex PADT's, the new 2N2654 is available for immediate delivery, in quantity, and at the usual PADT production-run prices. For complete technical data on the 2N2654 and for applications engineering assistance, write: Amperex Electronic Corporation, Semiconductor and Receiving Tube Division, Hicksville, Long Island, New York.

IN CANADA: PHILIPS ELECTRON DEVICES, LTD., TORONTO 17, ONTARIO

### 2N2654 IMPORTANT PARAMETERS

The Amperex 2N2654 is especially recommended for high gain, high stability RF-IF service, at all popular battery and supply voltages.

### TYPICAL CHARACTERISTICS

$Y_{re}$ = 65 millimhos	10 v., 2 ma, 10.7 mc
$f_T$ = 250 mc	10 v., 2 ma
$h_{FE}$ = 65	6 v., 1 ma
$C_{re}$ = 0.50 pf	10 v., 1 ma
$C_{ce}$ = 1.6 pf	10 v., 1 ma
Power Gain = 18.8 db	100 mc, 6 v., 1 ma
$BV_{cbo}$ = 35 volts minimum	
Envelope = T0-12	



Circle 69 on Inquiry Card

World Radio History

# Amperex P.A.D.T. transistors are available from these and other authorized Industrial Electronic Distributors

## CALIFORNIA

R. V. WEATHERFORD COMPANY  
Glendale 1, Calif.

KIERULFF ELECTRONICS  
Los Angeles 15, Calif.

BRILL SEMICONDUCTOR CORP.  
Oakland 6, Calif.

ELMAR ELECTRONICS INC.  
Oakland 7, Calif.

## COLORADO

INTERSTATE RADIO & SUPPLY  
Denver 4, Colorado

## CONNECTICUT

CRAMER ELECTRONICS, INC., Hamden, Conn.

## DISTRICT OF COLUMBIA

ELECTRONIC WHOLESALERS, INC.  
Washington 1, D. C.

## FLORIDA

THUROW ELECTRONICS, INC.  
Cocoa, Fla. • Jacksonville, Fla. • Miami, Fla.  
Orlando, Fla. • Pensacola, Fla. • Tampa, Fla.

## ILLINOIS

NEWARK ELECTRONICS CORP.  
Chicago, Ill.

## INDIANA

RADIO DISTRIBUTING COMPANY  
Indianapolis 6, Indiana

## MASSACHUSETTS

RADIO SHACK CORP., Boston, Mass.

## MICHIGAN

RADIO SPECIALTIES COMPANY  
Detroit, Michigan

## MINNESOTA

ADMIRAL DISTRIBUTORS, INC.  
St. Louis Park 16, Minn.

## MISSOURI

BURSTEIN-APPLEBEE COMPANY  
Kansas City, Missouri  
INTERSTATE INDUSTRIAL ELECTRONICS  
St. Louis 32, Missouri

## NEW YORK

MILO ELECTRONICS, New York, N. Y.  
ROME ELECTRONICS, Rome, N. Y.

## OHIO

UNITED RADIO, INC., Cincinnati, Ohio

## OKLAHOMA

OIL CAPITOL INDUSTRIAL ELECTRONIC  
DISTRIBUTORS, Tulsa, Oklahoma

## OREGON

UNITED RADIO SUPPLY, INC.  
Portland 9, Oregon

## PENNSYLVANIA

RADIO ELECTRIC SERVICE CO.  
Philadelphia, Pa.

## TEXAS

BUSACKER ELECTRONIC EQUIPMENT CO., INC.  
Houston 19, Texas

## WASHINGTON

ROBERT E. PRIEBE COMPANY  
Seattle 1, Washington

Ask Amperex

## NEW PRODUCTS

### MINIATURE CONNECTORS

Connector series meet environmental requirements of Mil-C-26482.



Series RM-RS available in 8, 10, 12, 14, 16, 18, 20, 22, shell sizes. All have Grommet seal contacts. The nine shell sizes accommodate all insert arrangements specified by Mil-C-26482. Pin and socket inserts are interchangeable with plug and receptacle shells. Series RM has crimp type contacts; Series RS has solder type. Polarization achieved by shells, with keys and keyways. Contacts furnished in two sizes—#20 AWG, 7.5a; and #16 AWG, 13a. Mounting: wall, box, or jam nut. Winchester Electronics, Inc., 19 Willard Rd., Norwalk, Conn.

Circle 228 on Inquiry Card

### HIGH-VOLTAGE SUPPLY

Power source which supplies voltages from 0 to 2500v at up to 2ma.

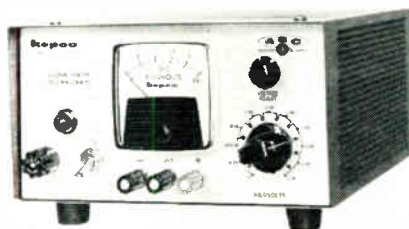

Model ABC 2500M is a dc regulated power supply and is continuously adjustable over its full range. It has better than 0.05% regulation and stability. A 10-position step range selector and a 10-turn fine control voltage adjustment permit uncommon resolution of not more than 25mv. Ripple is less than 0.5mv RMS. Recovery time for abrupt line and load variations is less than 50µsec. Supplies have short circuit protection and no transient voltage overshoot for input power turn-on or turn-off. Kepco, Inc., 131-38 Sanford Ave., Flushing 52, N. Y.

Circle 229 on Inquiry Card

## NARROW - CAPS

### Subminiature CERAMIC CAPACITORS

For 1/10" modular spacing. Intermediate values obtainable. W.E.P.A. Spec. nickel leads available for welding.

#### 35 STOCK VALUES

Part No.	Capac. mmf.	Tol.	W.V. D.C.	Max. Body Lgth.
NC-5	5	±15%	50	1/4"
NC-7.5	7.5	±15%	50	1/4"
NC-10	10	±15%	50	1/4"
NC-15	15	±15%	50	1/4"
NC-22	22	±15%	50	1/4"
NC-33	33	±15%	50	1/4"
NC-47	47	±15%	50	1/4"
NC-68	68	±15%	50	1/4"
NC-82	82	±15%	50	1/4"
NC-100	100	±20%	50	1/4"
NC-150	150	±20%	50	1/4"
NC-220	220	±20%	50	1/4"
NC-250	250	±20%	50	1/4"
NC-330	330	±20%	50	1/4"
NC-470	470	±20%	50	1/4"
NC-500	500	±20%	50	1/4"
NC-680	680	±20%	50	1/4"
NC-750	750	±20%	50	1/4"
NC-1000	1000	±20%	50	5/16"
NC-1500	1500	±25%	25	5/16"
NC-1500B	1500	±20%	25	5/16"
NC-2000	2000	±25%	25	5/16"
NC-2000B	2000	±20%	25	5/16"
NC-3000	3000	±30%	25	5/16"
NC-3000B	3000	±20%	25	5/16"
NC-3000C	3000	±25%	25	5/16"
NC-4000	4000	±30%	25	5/16"
NC-4000B	4000	±20%	25	5/16"
NC-4000C	4000	±25%	25	5/16"
NC-5000B	5000	±20%	25	5/16"
NC-6500	6500	±20%	25	5/16"
NC-6500B	6500	±20%	25	5/16"
NC-7500B	7500	±20%	25	5/16"
NC-01	10000	±30%	10	5/16"
NC-01B	10000	±20%	25	5/16"

## SLIM - CAPS

.060" wide max. x .060" thick max. Working voltage 25 VDC. W.E.P.A. Spec. nickel leads available for welding.

#### 23 STOCK VALUES

Part No.	Capac. mmf.	Tol.	Max. Body Length
SC-1	1.0	±25%	.100"
SC-2.5	2.5	±25%	.100"
SC-5	5.0	±25%	.100"
SC-7.5	7.5	±25%	.100"
SC-10	10	±25%	.100"
SC-15	15	±25%	.100"
SC-22	22	±25%	.100"
SC-33	33	±25%	.100"
SC-47	47	±25%	.100"
SC-68	68	±25%	.100"
SC-82	82	±25%	.100"
SC-100	100	±25%	.100"
SC-150	150	±25%	.100"
SC-220	220	±25%	.200"
SC-330	330	±25%	.200"
SC-470	470	±25%	.200"
SC-680	680	±25%	.200"
SC-820	820	±25%	.200"
SC-1000	1000	±25%	.200"
SC-1500	1500	±25%	.200"
SC-2500	2500	±25%	.250"
SC-3300	3300	±25%	.250"
SC-4000	4000	±25%	.250"

# MUCON CORPORATION

9 ST. FRANCIS ST., NEWARK 5, N. J.  
201 Mitchell 2-1476-7-8  
Circle 70 on Inquiry Card

# R<sub>x</sub> for ERGOPHOBIA \*

Save yourself time, trouble and unnecessary work by designing right from the start for Victoreen high voltage regulator tubes. Take the new VX-68, for example. A half-wave HV rectifier, it is ideal for half- or full-wave rectifier, voltage doubler or tripler, or HV clipper circuits. Circuit complexity, assembly costs and weight plummet while reliability zooms. Let Victoreen's Applications Engineering Department give you a practical, workable solution to your high voltage regulation problems.

\*Fear (or hatred) of work

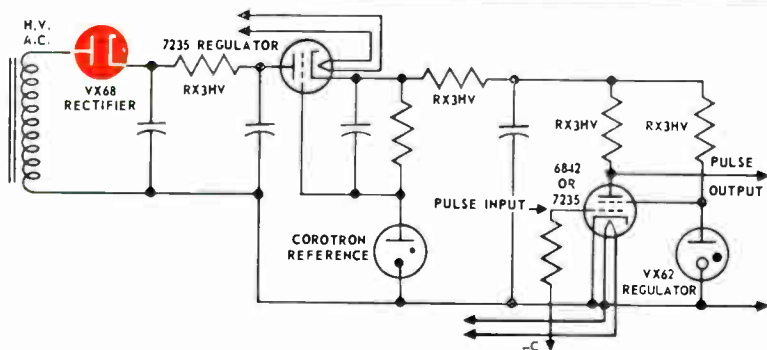
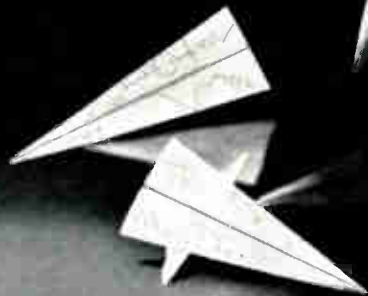

THE VICTOREEN INSTRUMENT COMPANY  
5806 HOUGH AVE. • CLEVELAND 3, OHIO

A-8239A

## NEW PRODUCTS

### MINIATURE CABLES

Instrument cables, rated 105°C have sub-miniature shielded pairs.

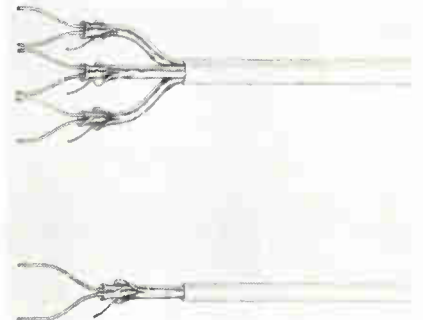

Design is useful for very low level circuits. Features include color coded conductors insulated by polyurethane with nylon overcoat. The shield of each pair is isolated and is terminated by a separate drain wire. Available in a 3-pair cable at 0.135 in. diameter, (8642), and a single pair cable of 0.100 in. diameter, (8640). Belden Manufacturing Co., 415 S. Kilpatrick, Chicago 44, Ill.

Circle 230 on Inquiry Card

### BATTERY DEVICE

Pressure-sensitive device for safe and automatic end of charging cycle.



Miniaturized to the size of a quarter, the device is temp. compensated, shock and vibration resistant unit that can be designed and built into each battery. It limits the pressure range to as little as 2psig before cutoff, and responds to voltage variations as low as 0.14v. It prevents overcharge and thus prolongs battery life. It can be incorporated into batteries like the power pack shown on the left; chargers, such as the prototype model of a silicad multiple charger, center; or combination battery and charger packs. The compact TV battery, right, is part of such a package. Yardney Electric Corp., 40-52 Leonard St., New York 13, N. Y.

Circle 231 on Inquiry Card



TARGET TODAY AT PDE...



# TOMORROW'S GUIDANCE SYSTEMS

Challenging new guidance and navigational problems posed by the demands of tomorrow's weapons systems and spacecraft are under active research at PDE. A history of feed network systems and subsystem installations for advanced pre-programmed and command guidance systems plus existing off-the-shelf components are providing the nuclei for successful solutions.

PDE is an established source for five basic air dielectric, semi-flexible coaxial cables available in bulk, custom-cut lengths or shaped to specified requirements. A full range of connectors, cable delay lines and specially configured waveguides complete the hardware picture. Proven capability extends the promise of quick answers in guidance design areas without costly time consuming delays.

Should you be involved with the responsibility of guiding a bird to target, look to the problem solving abilities of Phelps Dodge Electronics.

*When system communications is the key to your project . . . see PDE.*

**PHELPS DODGE ELECTRONIC PRODUCTS CORPORATION** • NORTH HAVEN, CONNECTICUT

Regional Sales Offices in New York, Washington, Dallas, Chicago, Los Angeles.  
Technical Representatives in all areas.



Circle 72 on Inquiry Card



# NOW AVAILABLE

## 100, 75, and 50 Ohm Spir-O-foam



SPIR-O-LOK  
U.S. PAT. 3,010,747

# Aluminum Sheathed, Semi-Flexible Coaxial Cable

■ Here is an economical, low-loss, broadband coaxial cable which is ideal for CATV, closed-circuit TV, and many other UHF and VHF applications. Due to its aluminum-sheathed, foamed polyethylene dielectric construction, this semi-flexible cable provides perfect RF shielding, needs no pressurization.

Spir-O-foam is manufactured in continuous lengths to 1000 feet. It is shipped on non-returnable, no-deposit reels to eliminate two-way freight charges and laborious record-keeping.

Electrically matched to all Spir-O-foam cables, Prodelin Spir-O-lok connectors are quickest and easiest to install in the field. No soldering operations, special flaring tools or special skills required. These connectors are available in several types of terminations and, if desired, may be factory installed free-of-charge.

### FEATURES

- Low Loss
- Perfect RF Shielding
- Eliminates Pressurization
- Marked for Easy Identification and Length Measurements
- Unlimited Operating Life
- Four Sizes: 3/4", 1/2", 3/8", and 1 1/4" O.D.
- Polyethylene Jacketed (Optional)
- Matched Spir-O-lok Connectors

Write Dept. V for Catalog 591



PRODELIN, INC. Main Office: Hightstown, N. J. • 448-2800 • Area Code 609  
Pacific Div.: 901 American St., San Carlos, Calif. • 593-8277 • Area Code 415

## NEW PRODUCTS

### POWER DIVIDER

Microwave component is the DSB-1-5402 binary power divider.



A strip transmission line, the low freq. unit operates in the freq. range of 500 to 4000MC and features low insertion loss and phase coherence error of less than 1°. These units are available with 2, 4 and 8 outputs, each covering 3 octaves, and can be optimized to any particular freq. or designed to special requirements. L.E.L., Inc., 75 Akron St., Copiague, N. Y.

Circle 232 on Inquiry Card

### LIGHTWEIGHT FAN

Weights 1.5 lbs. and delivers 270 cu. ft. of air/min. at free delivery.

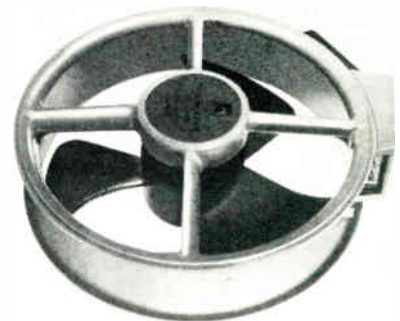

"Feather Fan" is used for cooling electronic packages in computer consoles, relay racks, power supplies, and instruments. The fan has precision miniature SS ball-bearings, prelubricated for maintenance-free operation. Its compact size (7 in. dia. x 2 7/16 in. thick), permits easy mounting to any equipment panel. Airflow is reversible simply by turning fan end-for-end. Fan can be run continuously at any temp. from -55° to 65°C; draws only 22w, 3380RPM; 115vac, 50-60cps, 1 φ operation. A 2μf capacitor can be mounted on the fan. Designed filter assembly can be supplied. Rotron Mfg. Co., Inc., Woodstock, N. Y.

Circle 233 on Inquiry Card

# OHMITE TECHNOLOGICAL BREAKTHROUGH!

## MOLDED VITREOUS ENAMELED WIRE-WOUND RESISTORS

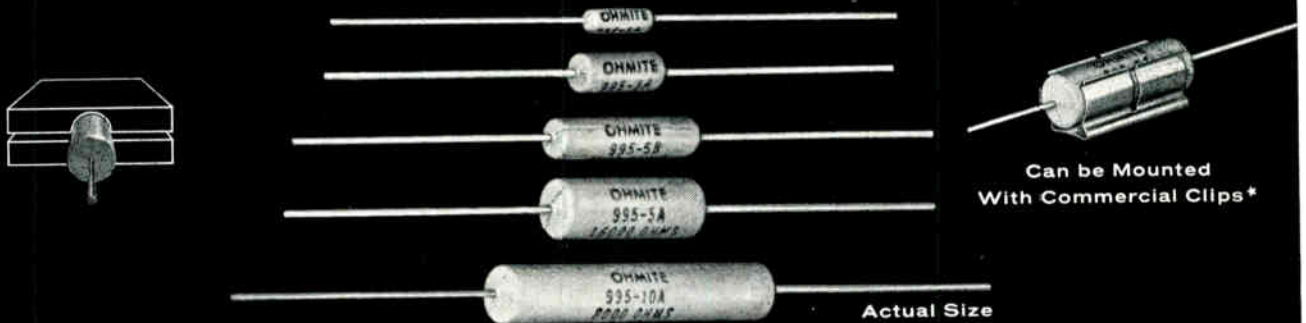

Can be Mounted  
With Commercial Clips\*

**A NEW PRODUCT . . . A NEW METHOD**

Patent Applied For

Patent Applied For

### ADVANTAGES

- ★ Insulated for 1000 V to Ground
- ★ Uniform Shape
- ★ Uniform Sizes
- ★ Permanent "Fired-on" Vitreous Markings, Completely Cleaning-Solvent Resistant
- ★ Plus All The Advantages of Ohmite Time-Proven Vitreous Enamel

The NEW Series 99 Resistors are the result of an outstanding technological development—an exclusive new molding process for applying vitreous enamel to resistors. This "Patent Applied For" molding process is the first radical manufacturing change in the history of vitreous enameled resistors—replacing the traditional "wet dipping" process. The dense uniform vitreous enamel jacket created by molding—fired at high temperature—produces the hard, glossy, moisture-resistant covering proved in years of service, as well as the extra advantages featured above.

Series 99 Resistors meet all requirements of MIL-R-26C, including pertinent V-block insulation tests<sup>Δ</sup>. Construction is all ceramic and metal. Ratings are based on a maximum hot spot temperature of 350°C with a 25°C ambient. Standard tolerance is ±5%, other tolerances available.

Standard leads are grade A nickel, tinned for soldering. Also supplied untinned for welding. Other types of lead material are available.

<sup>Δ</sup>For 1-watt size only, V-block not to exceed length of resistor body.

RHEOSTATS • RESISTORS • RELAYS • TAP SWITCHES • R.F. CHOKES  
VARIABLE TRANSFORMERS • TANTALUM CAPACITORS • SEMICONDUCTOR DIODES

**MILLIONS OF UNIT-HOURS OF TESTING**—This new molded vitreous enamel construction has been test-proven in pilot production. Load-life tests are being conducted at full-rated wattage on all sizes and resistance values which represent the approximate minimum and maximum for each size. The total number of resistors in this test group is 1,966, and 2,000 hours of cyclic "on-time" have been exceeded, thereby producing an equivalent total to date (January, 1963) of 5,242,666 unit test hours (cyclic, 1½ hours on, ½ hour off) of successful operation. Testing on all units continues.

OHMITE STYLE	RATE WATTS AT 25° C	DIMENSIONS (INCHES)		OHMS RANGE (COMM'L.)
		DIAM. +.031-.000	LENGTH =.015	
995-1A	1	0.125†	0.422‡	1 TO 3,000
995-3A*	3	0.203	0.547	1 TO 8,000
995-5A§	5	0.313	0.922	1 TO 30,000
995-5B	5	0.203	0.938	1 TO 18,000
995-10A†	10	0.313	1.781	1 TO 51,000

NOTE: Standard lead length is 1½" \*Also in MIL style RW69V §Also in MIL style RW67V †Also in MIL style RW68V ‡Tolerance, +.015-.005

Write for Bulletin 103



**OHMITE**  
MANUFACTURING COMPANY  
3662 Howard Street, Skokie, Illinois  
Phone: (312) ORchard 5-2600



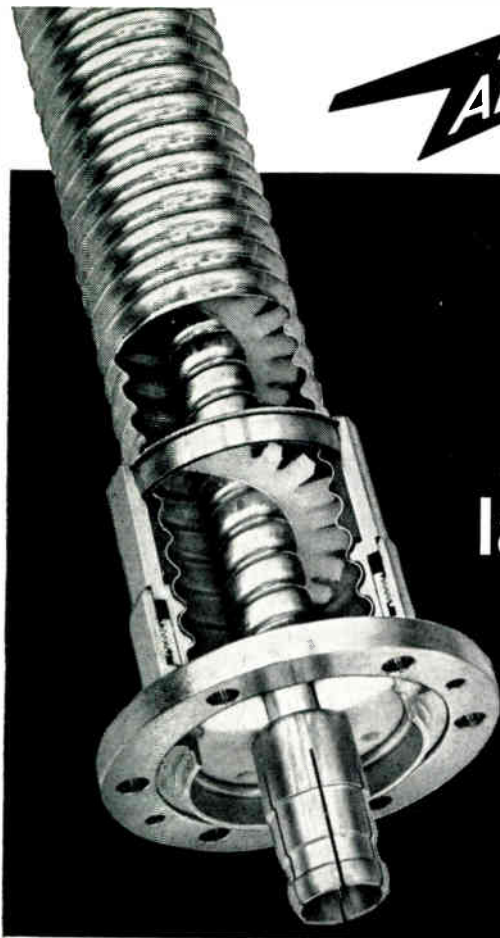

# H8

new  
large size  
HELIAx

## Flexible Coaxial Cable

**3 inch**  
Nominal Size

---

30 inch  
Bending Radius

---

**315 kw**

---

In Excess of  
**2500 ft.**  
Continuous  
Lengths

H8, HELIAx is available, both jacketed and unjacketed in standard and high average power designs. High power designs use high temperature polyethylene insulation.

H8, HELIAx features corrugated copper inner and outer conductor construction. The corrugations impart unusual strength and flexibility, while maintaining excellent electrical characteristics.

H8, HELIAx peak power rating is 315 kw. Average power ratings at 100 mc are:

H8-50	Unjacketed, 50 ohm	23 kw
H8-50	Jacketed, 50 ohm	26.5 kw
H8-50A	Unjacketed high power, 50 ohm	34.5 kw
H8-50A	Jacketed high power, 50 ohm	40 kw

Attenuation is 0.14 db/100 feet at 100 mc

H8, HELIAx is available in continuous specific lengths as limited only by receiving and handling facilities.

WRITE FOR BULLETIN 8486

HELIAx is available in sizes 3/8 to 3 inches.

*Andrew*  
P.O. Box 807, Chicago 42, Illinois

BOSTON  
NEW YORK

LOS ANGELES  
TORONTO  
WASHINGTON, D.C.

## NEW PRODUCTS

### SILICONE DIP COATING

Pours easily in uncured form and resists air pockets.



RTV-30 is a low viscosity (300 centipoises) high strength room temperature vulcanizing liquid silicone rubber. When cured to a solid rubber it has physical profile similar to higher viscosity materials. Its resistance to the formation of air pockets and ability to permeate small crevices makes it useful as a potting and encapsulating compound for electrical and electronic components and assemblies. General Electric, Silicone Products Dept., Waterford, N. Y.

Circle 234 on Inquiry Card

### MIN. AND SUBMIN. CONNECTOR

Connection approaches reliability of an uninterrupted conductor.

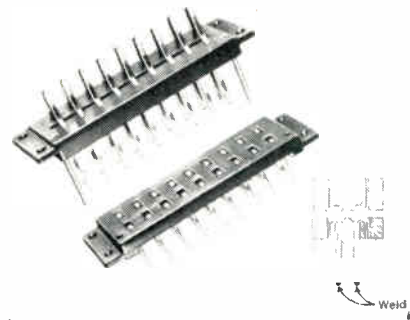

Ultrakon contacts may be bonded for permanent connection in circuit. Insertion force is 10 lbs. max. Withstands vibrations of 5/2000cps at 30G. Withstands 48 hr. salt spray test, 50G physical shock test and -65° to +125°C thermal shock test per Mil-STD-202. Pins and contacts are gold-plated phosphor bronze; insulators are diallyl phthalate SDG-F per Mil-M-14F. Available with contacts spaced 0.50 & 0.100 in. for welding and 0.100 & 0.200 in. for wire-wrapping. In 18 and 34 double-row contact and 9 and 17 single-row versions. Cinch Mfg. Co., 1026 S. Homan Ave., Chicago 24, Ill.

Circle 235 on Inquiry Card

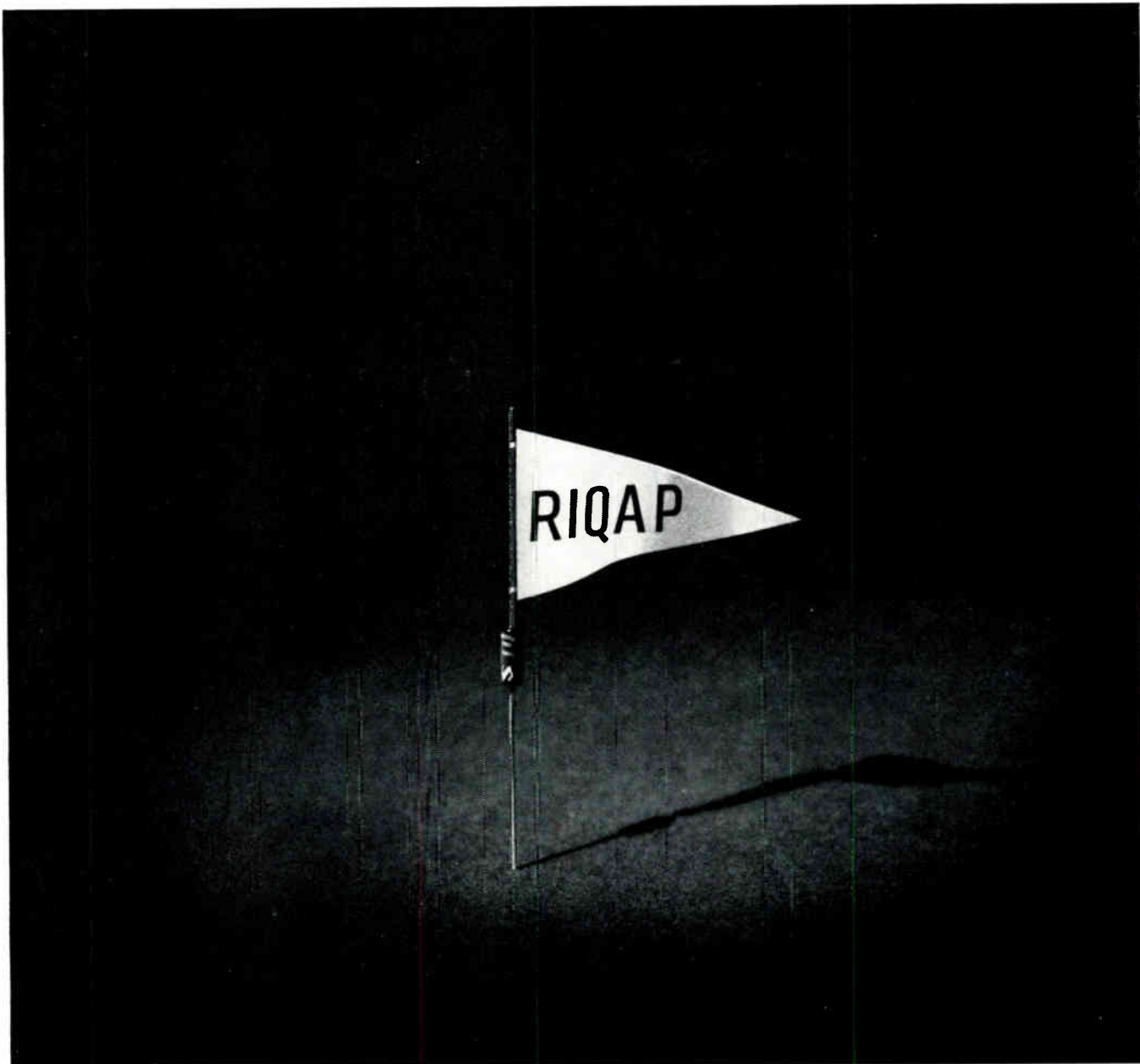

## Something new on Sylvania silicon diodes

If we may be pardoned a little sub-miniature flag-waving—Sylvania, alone among diode makers, has just won approval in the Army's Reduced Inspection Quality Assurance Plan. This means that some 30 silicon diodes (silicon is our major area of emphasis for the future), and twice that many germanium types, now receive less inspection by the Federal Government because of increased reliance on Sylvania's control

policies and practices.

Besides being a source of pride for us, this recognition has special meaning for you. The factors which made the RIQAP award possible—advanced manufacturing and quality control, and quality end-product—are benefits you get in Sylvania diodes.

Quality is planned in. For each type, a discrete manufacturing start is made and strict controls are applied, verified

by frequent in-process inspection and testing. Consequently, limits are tight for the desired parameter and marginal units are few. This, plus mass-production efficiency, means greater value, greater assurance of performance and reliability—merits which are fast making Sylvania a leader in silicon.

Semiconductor Division, Sylvania Electric Products Inc., Box 87, Buffalo, New York.

# SYLVANIA

SUBSIDIARY OF

**GENERAL TELEPHONE & ELECTRONICS**



NEW CAPABILITIES IN: ELECTRONIC TUBES • SEMICONDUCTORS • MICROWAVE DEVICES • SPECIAL COMPONENTS • DISPLAY DEVICES

ELECTRONIC INDUSTRIES • April 1963

Circle 14 on Inquiry Card

143

*in this neat  
package...*



**a complete  
dc laboratory**

The Keithley 610A Electrometer has 64 dc ranges . . . all you need to investigate in-circuit measurements with no loading, semi-conductor parameters, capacitor characteristics, photo-electric devices, piezo-electrics, properties of insulators and outputs of ion chambers. The 610A is line-operated and comes in bench or rack models. Brief specifications:

- 9 voltage ranges from 0.01 to 100 volts fs with 2% accuracy on all ranges
- input impedance selectable in decade steps from 1 ohm to  $10^{14}$  ohms
- 28 current ranges from 3 amperes to  $10^{-12}$  ampere fs
- 27 resistance ranges from 10 to  $10^{14}$  ohms fs with provision for guarding
- constant current source from 1 milliampere to  $10^{-12}$  ampere in decade steps
- gains to 1000 as a preamplifier, dc to 500 cps bandwidth, 10 volt and 1 milliamperere outputs
- price \$565

**Other ELECTROMETERS**

- |             |                            |       |
|-------------|----------------------------|-------|
| Model 620,  | 31 ranges, bat.-operated,  | \$280 |
| Model 621,  | 37 ranges, line-operated,  | \$390 |
| Model 600A, | 54 ranges, bat.-operated,  | \$395 |
| Model 603,  | 50 kc bandwidth amplifier, | \$750 |

Send for latest catalog



**KEITHLEY  
INSTRUMENTS**

12415 Euclid Avenue • Cleveland 6, Ohio

Circle 75 on Inquiry Card

## NEW PRODUCTS

### HEAT SHRINK WIRE MARKER

*Identifies, protects, strengthens and insulates wire and cable.*

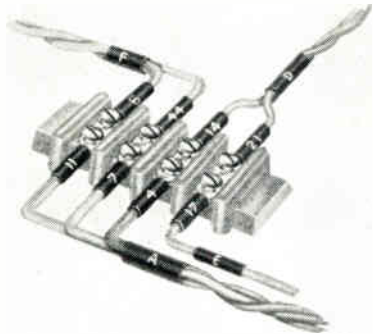

Made of irradiated polyolefin, FIT markers are supplied in an expanded form and may be easily applied to a wire or cable, even over connectors of irregular shapes. When a temp. of approx. 275° F (135°C) is applied, the markers return to predetermined size, 50% smaller. The shrinkage process guarantees a slip-proof, tight bond that acts as a strain relief at stress points and insulates and protects the wire connector covered. Alpha Wire Corp., 200 Varick St., New York 14, N. Y.

Circle 236 on Inquiry Card

### MICROWAVE ABSORBER

*Weather-proof material for use on outdoor test ranges.*

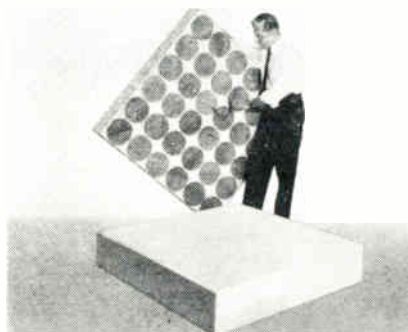

Type OD-10-WA is designed for improved performance at wide angles of incidence over a broad freq. range. The 4 x 4 ft. x 10 in. rigid slabs housing the absorbing elements are completely walk-proof. Use as walkways and work areas. With only a moderate sacrifice near normal, OD-10-WA performance at 60° to 70° from normal incidence is between 20 and 30 db down from L through K-band, for parallel polarization, and L through X-band for perpendicular polarization. B. F. Goodrich Co., Sponge Products Div., Shelton, Conn.

Circle 237 on Inquiry Card

### VACUUM PENETRATION

*For pin-to-pin receptacle mating with push-pull plugs.*

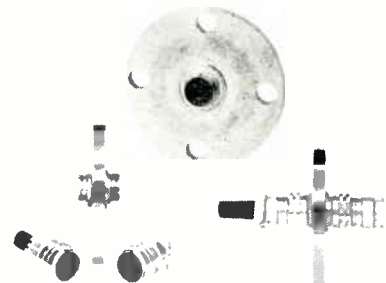

For vacuum chamber applications, DM-5623 penetration is provided in size 37 shell with a wide range of number 20 contact configurations as well as coaxial and thermocouple conductors in various layouts. Leakage rate has been tested to  $1 \times 10^{-6}$  cm<sup>3</sup>/sec. Shell design allows for max. panel thickness of 5/8 in. and can be solder, braze, weld, or jam-nut mounted. Design also features materials and finishes developed to minimize outgassing problems. Electronic Components Div., The Deutsch Co., Banning, Calif.

Circle 238 on Inquiry Card

### MINIATURE RELAY

*Version of "Shake-Out-Proof" Series E1N is proven Class E relay.*

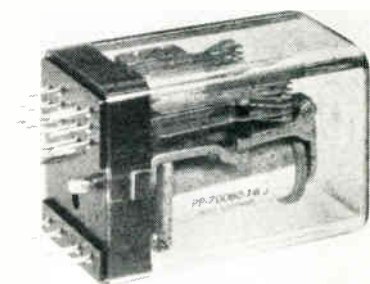

This relay resists normal shock and vibration, yet permits instant removal to inspect/replace. Use in business machines, instruments, elevator controls, aircraft and missile controls, and machine tools. Operating voltages up to 220v dc or ac. May have a max. 12 springs per pileup, in twin pileups. Variety of contacts and operate/release delays also available. Life of 100 to 200 million operations. E1N relays available as 16-contact and 28-contact types. Automatic Electric Co., subs. of General Telephone & Electronics, Northlake, Ill.

Circle 239 on Inquiry Card



# WHO NEEDS PANELS AND CONNECTORS?



Type 1040-M normally open time delay preset range 0.5 seconds to 20 minutes.

## APPLY THESE RELAYS DIRECT

Adlake molded (epoxy) head relays fasten directly to the point of application. You save on materials. Because they install faster, production costs are lower. Other advantages: excellent insulating ability, dimensional stability, flame proof and additional Adlake reliability. Available as time delay and quick-acting relays. Remember: *Adlake makes more kinds of mercury relays than anybody.* Ask for a catalog.



Type 1155 normally open



Type 1101-M normally open



The Adams & Westlake Company  
Dept. N8804 Phone Area 219  
CONgress 4-1141

Visit Booth 1417 at the Design Show  
Circle 76 on Inquiry Card

## NEW PRODUCTS

### SHIELDING MATERIAL

*RFI strip yields 135db overall system attenuation.*

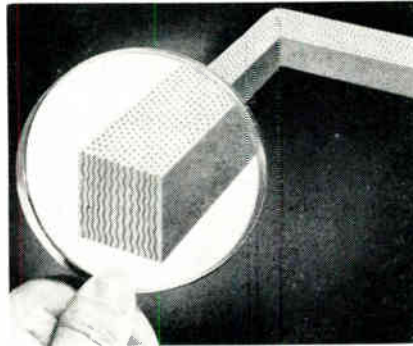

"Polarstrip," an oriented-wire shielding material makes packaging enclosures RFI tight and provides an integral pressure seal. The strip yields overall system attenuation of 125-135db and insertion loss measurements as much as 100 db. Available in 80 standard sizes in both aluminum and monel. Metex Electronics Corp., Walnut Ave., Clark, N. J.

Circle 240 on Inquiry Card

### STRAIN-GAGE RELAY

*Solid-state temperature & strain-gage relay.*

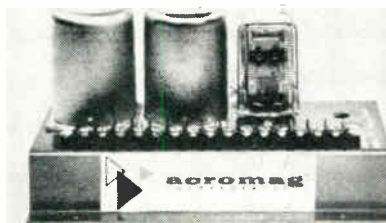

Sensitivity is  $\pm 0.2^\circ$  with a resistance thermometer, and better than 2% with a strain-gage. Model ST-301 can be used with strain gage D/P (differential pressure) cells to form a reliable solid state flow alarm and monitor. Model ST-301 features a built-in dc bridge excitation supply, and a magnetic-transistor amplifier driving a DPDT output relay. A 2-sec. low-pass filter is built-in to prevent false response from noise. Power supply requirements, 115vac, 60cps, 3w. Acromag, Inc., 15,360 Telegraph Rd., Detroit 39, Mich.

Circle 241 on Inquiry Card

measure dc



100mv to 500v

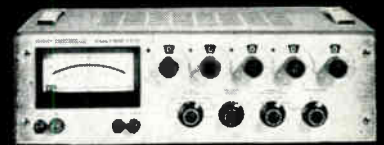

within 0.02%

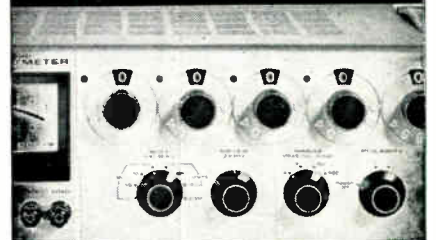

## New Differential Voltmeter

Keithley 660 measures dc voltages with the accuracy and stability of a laboratory standard and the ease and low cost of an ordinary VTVM.

#### Features include:

- 0.02% limit of error
- reference supply stable to 0.005% indefinitely, without periodic re-standardization
- 100 $\mu$ v f.s. null range
- 2 $\mu$ v resolution
- infinite resistance at null, to 500v
- 0.005% repeatability
- 10mv recorder output
- fully guarded input
- positive, negative or floating

Model 660 Differential Voltmeter . \$575  
Model 6601 10:1 Divider Probe . \$175

Send for four page Engineering Note on the Model 660

latest catalog available upon request



KEITHLEY INSTRUMENTS

12415 Euclid Avenue • Cleveland 6, Ohio

Circle 77 on Inquiry Card

# MANDEX OFFERS YOU THE MOST COMPLETE LINE OF TERMINAL STRIPS

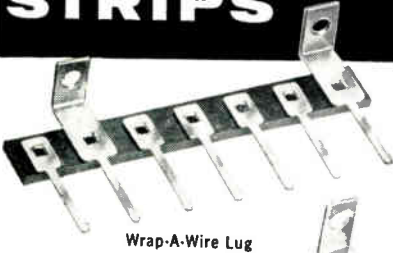

Wrap-A-Wire Lug



Tear-Drop Lug



External "T" Lug



Subminiatures  
(1/4" Spacing)

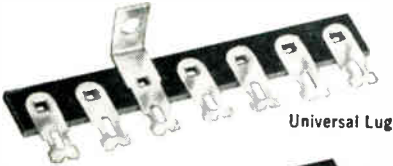

Universal Lug



Wire-Grip Lug

## High Speed Automated Assemblies Bring You:

- Consistent Quality
- Quick Delivery
- Low Cost

Send prints-specs for prompt quotation... For complete information request

## NEW MANDEX GUIDE BOOK TO TERMINAL STRIPS



**M X**  
MANDEX  
MANUFACTURING  
COMPANY, INC.  
Specialists In Electronic Parts

2618 West 48th St., Chicago 32, Illinois  
Circle 78 on Inquiry Card

## NEW PRODUCTS

### MODULAR CONNECTOR

Current capacity is 15; the 105°C. nylon housing is color coded.

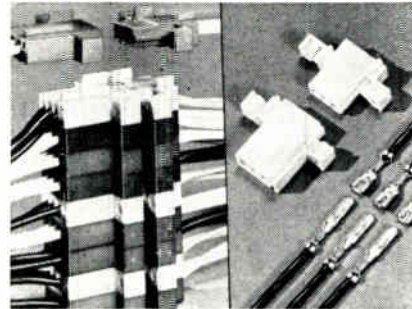

The 0.187 Fastin-Faston™ modular connector can be used with standard tabs and takes a wire size 20-16 AWG. A self interlocking housing device permits the addition of modules without use of locking hardware. Construction creates positive polarization. Egg crate construction completely shields contacts and meets UL requirements in construction and material. Snap-in, shielding contacts are easily removable for interchange of circuits. AMP Inc., Harrisburg, Pa.

Circle 242 on Inquiry Card

### 1MC OSCILLATOR

Stability guaranteed at  $\pm 1 \times 10^{-6}$  per 24 hrs.

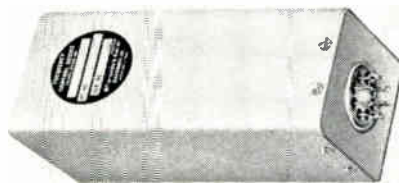

Entire absence of thermostat-generated noise, low power demand and compactness are features. Model FS-1017 is a 1μsec. freq. and time control device. Stability is maintained over a combined 0° to 60°C temp. range and load variation of  $\pm 10\%$ . Power input for oscillator and oven is nominal 4w from a 28v  $\pm 5\%$  supply. Output voltage is 1.0v RMS, output impedance 500Ω, and distortion 5% max. Package size is 2 x 2 x 4 1/2 in.; weight is 12 oz. Plug-in octal base is standard. Frontier Electronics Div., International Resistance Co., 4600 Memphis Ave., Cleveland 9, Ohio.

Circle 243 on Inquiry Card



in quantities up to  
**500 Per Item**

### CONTACT THESE AUTHORIZED ELMENCO INDUSTRIAL DISTRIBUTORS

ALABAMA, Huntsville: Electronic Wholesalers, Inc.  
ARIZONA, Phoenix: Kierulff Electronics, Inc., Midland Specialty Co.

CALIFORNIA, Glendale: R. V. Weatherford Co., Inglewood: Newark Electronics Co. Inc., Los Angeles: Federated Purchaser, Inc., Hollywood Radio & Electronics Inc., Kierulff Electronics, Inc., Shelley Radio Co., Inc., Mountain View: Kierulff Electronics, Inc., Oakland: Brill Electronics, Palo Alto: R. V. Weatherford Co., Zack Electronics, Riverside: Electronic Supply of Riverside, San Diego: Shanks & Wright, San Francisco: Pacific Wholesale Co., San Jose: Peninsula Electronic Supply Inc.

COLORADO, Denver: Denver Electronic Supply Co.  
DISTRICT OF COLUMBIA, Capitol Radio Wholesalers, Inc., Electronic Wholesalers, Inc.

FLORIDA, Melbourne: Electronic Wholesalers Inc., Miami: Electronic Wholesalers Co. Orlando: Hammond Electronics Inc.

ILLINOIS, Chicago: Allied Electronics Corp., Newark Electronics Corp.

MARYLAND, Baltimore: D & M Distributing Co., Electronic Enterprises, Inc., Kann-Ellert Electronics Inc., Wholesale Radio Parts Co., Inc.

MASSACHUSETTS, Newton: Cramer Electronics, Inc. Cambridge: Electrical Supply Corp.

NEW JERSEY, Camden: General Radio Supply Co., Radio Electric Service Co. of N. J. Inc., Mountinside: Federated Purchaser, Inc.

NEW MEXICO, Alamogordo: Radio Specialties Co., Inc., Albuquerque: Electronic Parts Co., Inc.

NEW YORK, Binghamton: Stack Industrial Electronics Inc., Mineola: Arrow Electronics Inc., N. Y. C.: Electronics Center, Inc., Harvey Radio Co., Inc., Lafayette Radio Electronics Corp., Milo Electronics Corp., Terminal-Hudson Electronics Co., Inc., Woodside: Boro Electronics, Inc.

NORTH CAROLINA, Winston-Salem: Electronic Wholesalers Inc.

PENNSYLVANIA, Harrisburg: D & M Distributing Co., Inc., Philadelphia: Almo Radio Co., Phila. Electronics Inc., Radio Electric Service Co. of Penna., Inc., Reading: George D. Barbey Co., Inc., York: Wholesale Radio Parts Co., Inc.

TENNESSEE, Nashville: Electra Distributing Co. Inc.

TEXAS, Dallas: All-State Electronics Inc., Engineering Supply Co., El Paso: Midland Specialty Co., Houston: Busacker Electronic Equipment Co., Inc.

UTAH, Salt Lake City: Standard Supply Co.

WASHINGTON, Seattle: C & G Electronics Co.

CANADA, Montreal, Quebec: Atlas Wholesale Radio, Inc., Toronto, Ontario: Electro Sonic Supply Co. Ltd.

# ARCO

electronics inc.

Community Drive, Great Neck, New York  
NEW YORK • DALLAS • LOS ANGELES  
Exclusive Supplier of ELMENCO Capacitors to  
Distributors and Jobbers in U.S.A. and Canada

Circle 79 on Inquiry Card



# Here is MEASURED RELIABILITY!

## DUR-MICA CAPACITORS TYPE M2DM

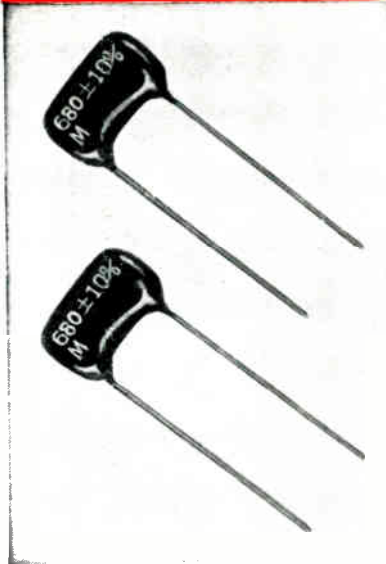

**Ten thousand EL-MENCO high reliability dipped mica capacitors were put on life test at 85°C with 225% of the rated DC voltage applied - After 26,500,000 actual test unit-hours no failures of any type occurred.**

The accumulated  $26.5 \times 10^6$  test unit-hours without any failures can be used to calculate many different failure rates depending upon the confidence level desired. However, we shall explore the meaning of the results at a 90% confidence level.

Assuming no acceleration factor for either temperature or voltage, we have verified a failure rate of less than 0.01% per 1000 hours. (Actually, there is a temperature effect and it has been found that, with the DC voltage stress remaining constant, the life decreases approximately 50% for every 10°C rise in temperature. There is also a voltage effect such that, with the temperature stress remaining constant, the life is inversely proportional to the 8th power of the applied DC voltage.)

Assuming no temperature acceleration factor and assuming the voltage acceleration exponent is such as to yield an acceleration factor as low as 100, we have nevertheless verified a failure rate of less than 0.0001% per 1000 hours.

Assuming no temperature acceleration factor and assuming the voltage acceleration factor is on the order of 250 (test results are available to confirm this) we have accumulated sufficient unit-hours to verify a failure rate of less than 0.00004% per 1000 hours!

*Note that all the above failure rates are calculated at a 90% confidence level!*

## Only 1 Failure in 14,336,000 Unit-Hours for 0.1 MFD Capacitors

Life tests have proved that El-Menco Mylar-Paper Dipped Capacitors — tested at 105°C with rated voltage applied — have yielded a failure rate of only 1 per 14,336,000 unit-hours for 1.0 MFD. Since the number of unit-hours of these capacitors is inversely proportional to the capacitance, 0.1 MFD El-Menco Mylar-Paper Dipped Capacitors will yield ONLY 1 FAILURE IN 14,336,000 UNIT-HOURS.

## MYLAR-PAPER DIPPED CAPACITORS TYPE MPD

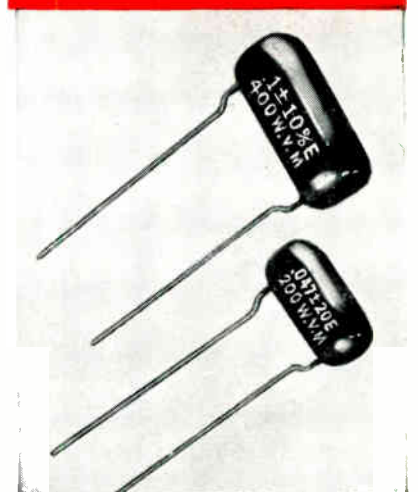

**MINIMUM LIFE EXPECTANCY FOR 1.0 MFD \*\* MYLAR-PAPER DIPPED CAPACITORS AS A FUNCTION OF VOLTAGE & TEMPERATURE**

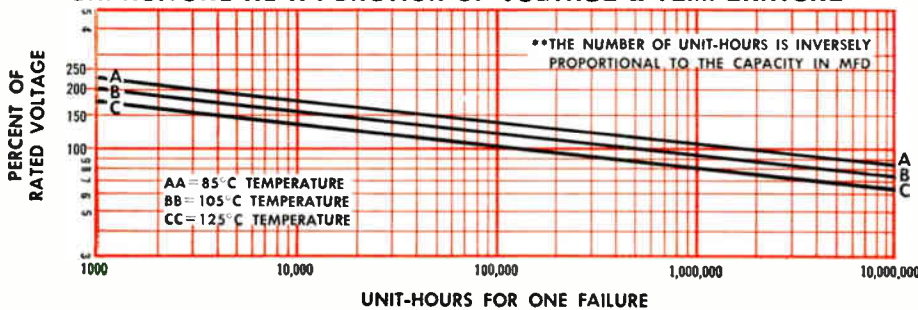

\* Registered Trade Mark of DuPont Co.

*Write for Reliability Study and technical brochures.*

# THE ELECTRO MOTIVE MFG. CO., INC.

WILLIMANTIC, CONNECTICUT



*Dipped Mica • Molded Mica • Silvered Mica Films • Mica Trimmers & Padders  
Mylar-Paper Dipped • Paper Dipped • Mylar Dipped • Tubular Paper*

ARCO ELECTRONICS, INC., Community Drive,  
Great Neck, L. I., New York  
Exclusive Supplier to Jobbers and Distributors  
in the U. S. and Canada

West Coast Manufacturers Contact:  
COLLINS & HYDE CO., 535 Middlefield Road  
Palo Alto, California  
5380 Whittier Blvd., Los Angeles, Cal.



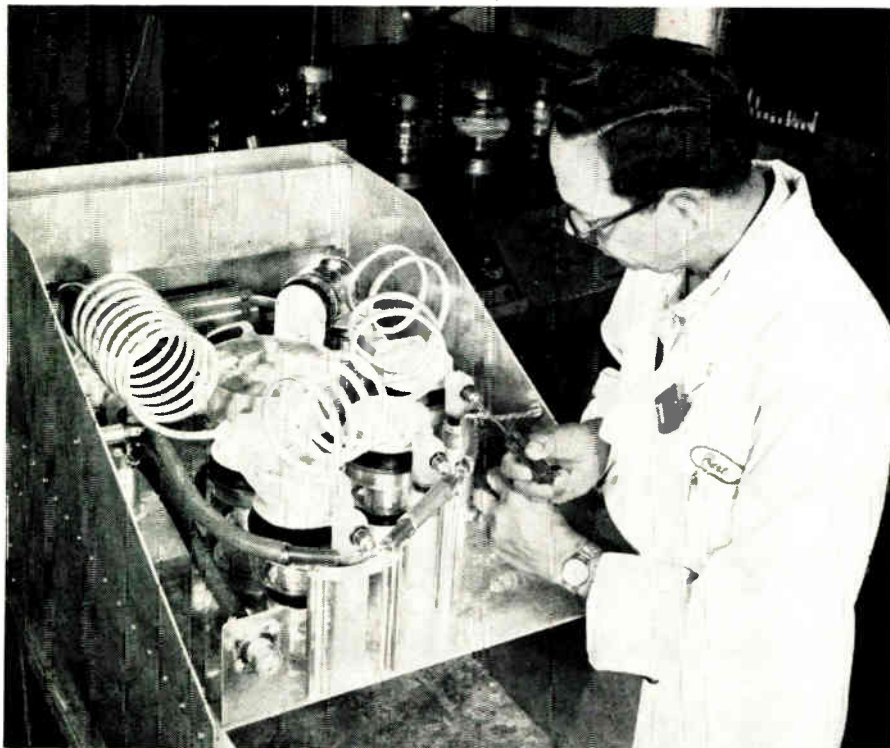

## EXCEPTIONAL\* DESIGNS START WITH JENNINGS VACUUM CAPACITORS

This electronics engineer is just completing a 17.5 kw, all band, continuous tuning power amplifier to be used for test purposes. It has a range of 2 megacycles through 34 megacycles yet only occupies 2' x 2' x 3' of space!

Can you imagine this amplifier being designed or even dreamed of with anything but vacuum capacitors? Every circuit design presents different problems but this application illustrates the range of design possibilities available with Jennings vacuum capacitors. Here are some of the exclusive advantages of these capacitors that make it possible to extend your range of design ideas:

**WIDE FREQUENCY RANGE** . . . Jennings vacuum capacitors offer the widest capacity change ratio available anywhere. Some capacitors have ratios as high as 150 to 1.

**RELIABILITY** . . . Sealed plates never become contaminated.

**EFFICIENCY** . . . Vacuum dielectric results in very low dielectric losses.

**COMPACTNESS** . . . High strength vacuum dielectric results in much smaller capacitor with the additional advantage of lower inductive losses.

**WIDE SELECTION** . . . Jennings offers over 400 types of fixed and variable vacuum capacitors to meet your circuit requirements.

Write today for more detailed information about Jennings complete line of vacuum fixed and variable capacitors.

RELIABILITY MEANS VACUUM / VACUUM MEANS *Jennings*

JENNINGS RADIO MFG. CORP., 970 McLAUGHLIN AVE., SAN JOSE 8, CALIF., PHONE Cypress 2-4025

## NEW PRODUCTS

### MESSAGE DATE-TIME MONITOR

*Provides accurate time record of message transmission.*

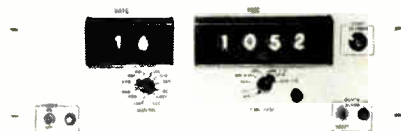

Automatic Message Date-Time Monitor for use in communications (Telegraph) and control systems. Unit reads out dates in month and day and 2400 hr. "real time" with high reliability. Transmits time data in parallel form, providing visual reading by the sender, as well as electrical output recording. Power: 105 to 125vac @ 50-60cps, 15w; mounting: Panel mounted in standard 19 in. rack, 7 in. high; operating temp. range: 0° to +50°C. Communications Div., Elgin National Watch Co., 366 Bluff City Blvd., Elgin, Ill.

Circle 244 on Inquiry Card

### HALL EFFECT KIT

*For demonstrating and exploring the Hall effect.*

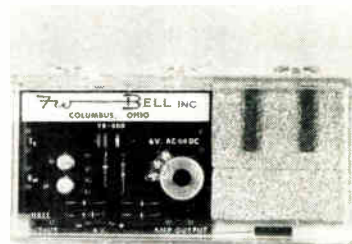

Compact kit contains the necessary components. Designed for R&D men, professors, hobbyists and inventors. In the kit are: One Model BH206 "Hall-Pak" Hall effect device; a small circuit board, containing a balancing network and a dc transistorized amplifier with a voltage gain of about 50; two bar magnets for a stable dc field; and instructions for testing and demonstration. The BH206 is a transverse probe 0.030 in. thick for general use. Also available are other models of "Hall-Pak." F. W. Bell, Inc., Columbus, Ohio.

Circle 245 on Inquiry Card

**WILL ANY OF THESE**

**Acme Electric**

**STANDARD STOCK**

**POWER SUPPLIES  
Meet Your Needs?**

Why pay the extra cost of custom built power supplies if your needs can be accommodated by one of these Acme Electric stock model designs? These units have all the "most wanted" features of circuitry and performance; continuous duty, negligible thermal drift, constant output voltage, fast recovery on line voltage variations and load changes, current limiting and ever so many other advantages. Check the specs and write for catalog 174.



Input: 100-130 volts, 60 cycles  
Output: Regulated  $\pm 1\%$  for line voltage variation  
Ripple: Less than 1% RMS

Catalog Number	Watts	Amps	D.C. Volts	Efficiency Approx. %	Approx. Ship. Weight Lbs.
PS-41422	50	2.08	24	72	14
PS-41423	150	6.25	24	76	23
PS-41424	200	4.15	48	81	25
PS-41425	250	2.0	125	86	26
PS-41426	300	2.0	150	86	30
PS-41427	200	1.0	200	80	25
PS-41428	250	1.0	250	85	26

**Dependable Construction Features**

Continuous duty, constant voltage transformer; computer grade electrolytic filter capacitors; silicon rectifiers; input and output connections on terminal board; heavy gauge, structurally braced relay rack panel.

**SIGNAL DEVELOPER  
POWER  
SUPPLY**



A reliable, solid state rectifier, supplying 5 ma, 0-25 volts direct current for manual control of a magnetic amplifier or other application requiring low current values. Manual regulator gives stepless control of dc output from 0 to 25 volts. Compact, lightweight. Our stock model PS-39787, full details in catalog 174. Write for your copy.

**ACME ELECTRIC CORPORATION**

849 WATER ST. SAA 3645/2080 CUBA, N.Y.  
In Canada: Acme Electric Corp. Ltd., 50 Northline Rd., Toronto, Ont.

**Acme Electric**

Circle 82 on Inquiry Card

ELECTRONIC INDUSTRIES • April 1963

**NEW PRODUCTS**

**MODULAR CABLE CONNECTOR**

Made of durable machined parts and designed for modular systems.

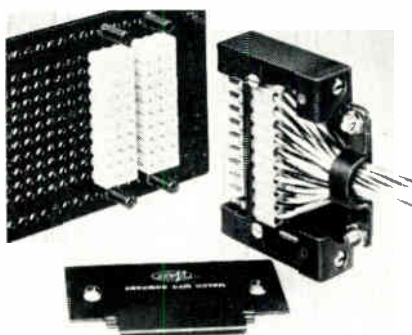

This cable connector allows foolproof programming through the use of keying washers and slotted stand-off keys. Precision made hold-down screws secure the connector housing to the receptacle plate. Sizes of the modular cable connector range from 20 points upward. Malco Manufacturing Co., Dept. ES-2, 5025 West Lake St., Chicago 24, Ill.

Circle 246 on Inquiry Card

**DIGITAL BLOCK**

JK (Logic) Flip Flop is a 10Mc module for  $-155^{\circ}$  to  $125^{\circ}$ C.



The Model DBFF1006 is a high speed flip flop suited to the JK logic operation which permits the 0-0, 0-1, 1-0, and 1-1 states at its inputs. This module uses saturated switching and trailing edge turn-off logic to provide operation over wide temp. range. The modules are solid epoxy encapsulated and are capable of withstanding severe environments. These units use Mil approved components and can be plugged into a standard connector, soldered into a printed circuit board, welded or soldered point-to-point. Dimensions of the block are 0.75 x 1.0 x 2.0 in. Solid State Electronics Corp., 15321 Rayen St., Sepulveda, Calif.

Circle 247 on Inquiry Card

new  
spacesaving 1,000-15,000 PIV  
**SILICON RECTIFIERS**  
from **DICKSON**

Conservatively rated, these new devices are capable of handling large surge currents and have extremely low reverse leakages. The DURAPAK<sup>®</sup> high-temperature vacuum-molded package provides a hermetic seal with excellent dielectric qualities. Reliability and stability have been proved in life-tests involving more than 1,000,000 device hours.

- 15 types 1,000 through 15,000 PIV
- Up to 1.0 Amp average rectified current (I<sub>o</sub>)
- Reverse current (I<sub>r</sub>) less than 2  $\mu$ A at 25°C and at rated PIV
- Units meet or exceed environmental requirements of MIL-S-19500

FOR COMPLETE INFORMATION, contact your nearby Dickson distributor or write: Mr. Russ Grabb, Dickson Electronics, P. O. Box 1387, Scottsdale, Arizona.

\*Trademark of Dickson Electronics Corp.



**DICKSON**  
ELECTRONICS CORPORATION

248 Wells Fargo Avenue, Scottsdale, Ariz.

Circle 83 on Inquiry Card



# WHAT GASEOUS DIELECTRIC HAS...

- high heat transfer
- high dielectric strength, power to microwave frequencies
- no dipole moment
- unusual sonic properties
- remarkable inertness
- high molecular weight
- low condensation temperature
- high compressibility
- virtually unlimited life
- colorlessness
- odorlessness
- non-toxicity
- detectability
- ready availability from two producing locations

**SF<sub>6</sub>** offers all of the above. This dielectric gas has found successful application in heavy electrical units, miniaturized electronic devices and X-ray equipment. If the unusual properties of sulfur hexafluoride suggest other potential applications to you, mail the coupon for our 22-page technical bulletin.

E1-43

Baker & Adamson® Fine Chemicals  
GENERAL CHEMICAL DIVISION  
P. O. Box 353, Morristown, N. J.



Please send your technical bulletin on SF<sub>6</sub>.

Name \_\_\_\_\_

Title \_\_\_\_\_

Firm \_\_\_\_\_

Address \_\_\_\_\_

City \_\_\_\_\_ Zone \_\_\_\_\_ State \_\_\_\_\_

Circle 84 on Inquiry Card

## NEW PRODUCTS

### CERAMIC BOBBIN RESISTOR

Unencapsulated ceramic bobbin resistors in 7 sizes from 0.15 to 1.0w.

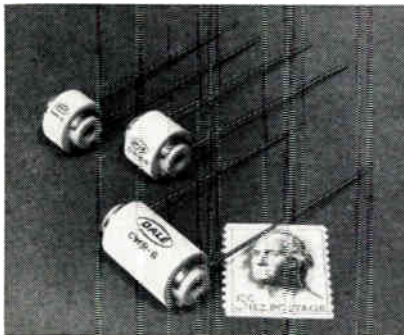

Resistance range of the CWR line is from 1Ω to 150KΩ for the 0.15w CWR-1 to 1Ω to 12megΩ for the 1w CWR-7. Tolerances are 0.5% and 1%. Radial leads of tinned copperweld are standard. Models CWR-1 to CWR-3 are inductively wound; Models CWR-4 to CWR-7 have non-inductive windings. Operating temp from -55° to 145°C. Dale Electronics, Inc., P.O. Box 488, Columbus, Nebr.

Circle 248 on Inquiry Card

### WIRE BONDER

For bonding wire during semiconductor manufacture.

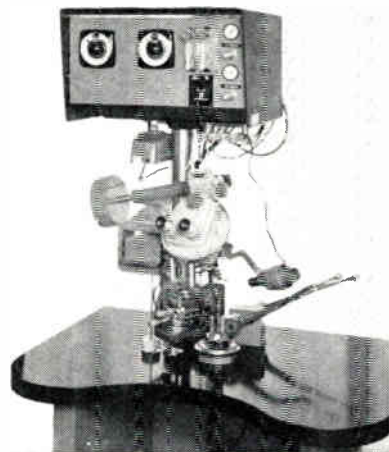

The "Bird Beak" Thermocompression Wire Bonder is designed to place as many as possible of the critical processing steps under the control of the machine. Time, temp., and tool pressure during bonding can be preset and are rigidly controlled by the machine. Any number of bonds may be made in a series. By a proper choice, bond widths of approx. 0.0007 in. and up can be made consistently and repeatedly. Kulicke and Soffa Mfg. Co., 135 Commerce Dr. Industrial Pk., Ft. Washington, Pa.

Circle 249 on Inquiry Card

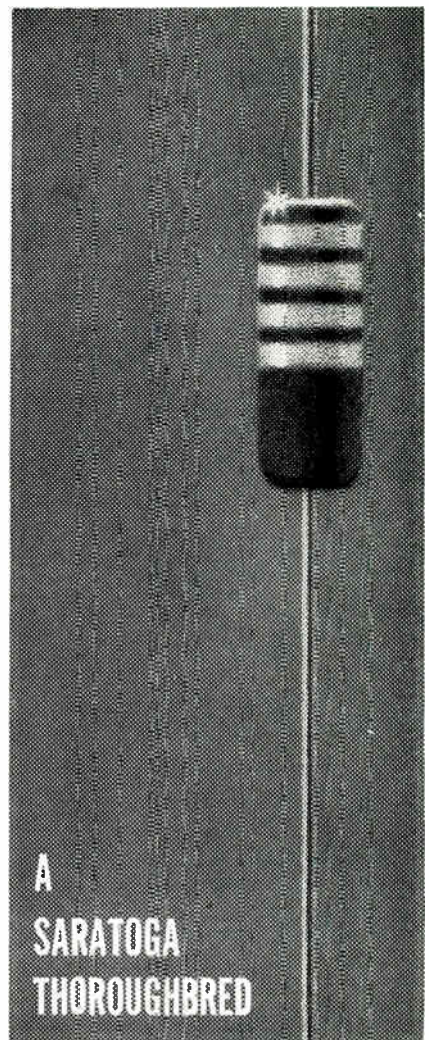

A  
SARATOGA  
THOROUGHbred

### 250MW and 400MW SILICON ZENER DIODES

**Reliability** — assured by 100% load testing and burn-in. All units meet the requirements of MIL-E-1 and MIL-S-19500C.

**Availability** — from stock in the 250MW 1N713-1N745 series and the 400MW 1N960-1N992 series.

**Zener Voltages** — from 9.1 to 200 Volts (5%, 10%, 20% tolerances).

#### Military Types:

1N716, 1N718, 1N720, and 1N722 — per MIL-E-1/1238 (Sig C.)

Also 400MW units—USN 1N962B through USN 1N973B — per MIL-S-19500/117 (Navy).

For additional information on Saratoga's complete line (standard and special) of silicon diodes, write:



### Saratoga Semiconductor

A Division of Espy Mfg. & Electronics Corp.  
Saratoga Springs, N. Y. • Telephone 4100

Circle 85 on Inquiry Card



# NEW PRODUCTS

## TORSION TRANSDUCER

*Eliminates the use of slip rings or other methods of making contact.*

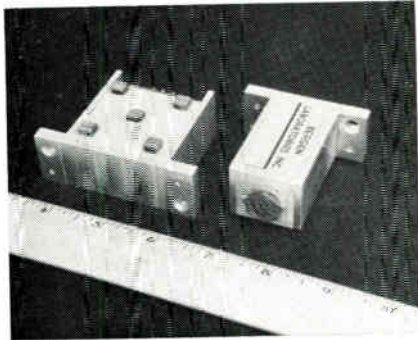

The Fluxducer is a modular torsion transducer which converts the changes in the magnetic properties of a stationary or rotating shaft into an electrical signal. Magnetic changes can be measured at a small distance from the shaft. The Fluxducer module can be calibrated using a known load with the shaft stationary. Contactless torque measurements can be made from 0 to 30,000RPM. Shaft dia. from 3/4 to 15 in. can be covered by 5 different modules., e.g.. Model LEC 291 is used with shafts 3/4 to 1 1/4 in. in dia. Bergen Laboratories Inc., 60 Spruce St., Paterson 1, N. J.

Circle 250 on Inquiry Card

## COAXIAL "Y" CIRCULATORS

*Low loss units give continuous coverage from 1.7 to 8.0gc.*



Performance characteristics for a typical ferrite unit Model XH-410 (2.0 to 3.0gc) are: isolation, 20db min.; insertion loss, 0.3db max.; and vswr, 1.25 max. Sizes are comparable to narrowband circulators and range from 3 3/4 in. for the XH-409, 1.7-2.3gc model to 2 in. for the XH-422, 6.0-8.0gc unit. Melabs, 3300 Hill-view Ave., Stanford Industrial Pk., Palo Alto, Calif.

Circle 251 on Inquiry Card



...DESIGNED FOR STATE-OF-THE-ART

# Voltage Divider Certification

7 dial in-line presentation providing 0.1 ppm resolution. Large numerals for rapid, error-free reading.

Calibration terminals in rear for each decade can be used for short-term calibration to 0.1 ppm absolute linearity.

Maximum safe voltage of 700 volts dc indicated for instrument protection.

Lucite windows keep dials and divider parts clean.

Commas and "powers of ten" simplify setting interpretation.

Compensated common circuit provides high ratio accuracy at low settings.

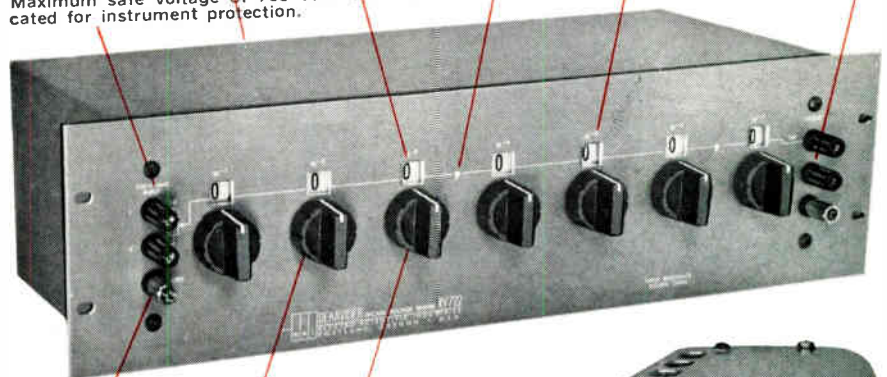

Gold-plated binding posts provide reliable corrosion-free contact surfaces.

Continuous rotation on all except the first knob for maximum speed of setting. No open circuit transient.

Knobs set to clock positions for rapid adjustment with minimum visual attention.

Calibration terminals in rear for each decade

Bracket supports back of switch structures.

Wafers support back of resistors.

Internal metal shielding provides strength and additional protection for resistors when dust cover is removed for calibration.

Precision-adjusted and stabilized, specially selected low temperature coefficient resistors matched for value and temperature coefficient insure a minimum of environmental influence.

Redundant switches for extreme reliability. 8 solid silver contacts in parallel for each switch connection.

Silicone treated switch decks to minimize humidity effects.

Lexan insulation through front panel, air insulation through sub panel minimize leakage.

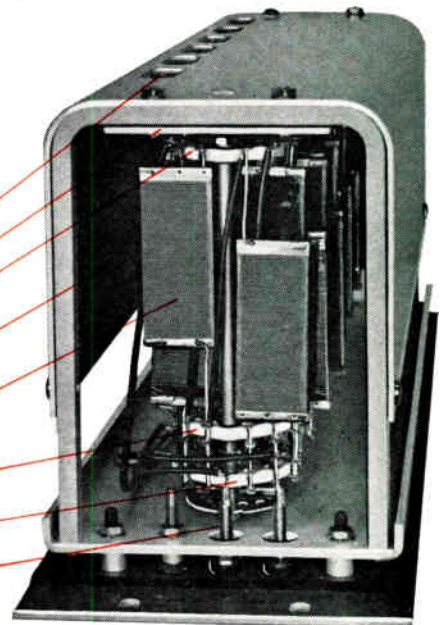

## MODEL RV722 DEKAVIDER® DECADE VOLTAGE DIVIDER

A state-of-the-art Kelvin Varley voltage divider providing  $\pm 1$  ppm terminal linearity,  $\pm 0.1$  ppm resolution. Special circuitry and paralleled silver alloy switch contacts provide improved accuracy at all settings. Temperature coefficient,  $\pm 0.5$  ppm/ $^{\circ}$ C. 100 kilohms input resistance, 5 watts maximum power. Supplied with calibration certificate giving check-out readings accurate to 0.2 ppm. Terminals at each decade for calibration. Price: \$950.00, f.o.b. Portland, Oregon. For additional information, send for Catalog Sheet C-14, ESI Engineering Bulletin No. 24, "Calibration of a Kelvin Varley Standard Divider."

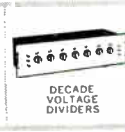

## Electro Scientific Industries

7524 S.W. Macadam Avenue • Portland 19, Oregon • Area Code 503. 246-3331

Electronic Components  
from Westinghouse

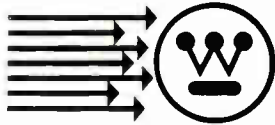

For your needs . . . one source

**NO SWISS  
CHEESE  
JOINTS**

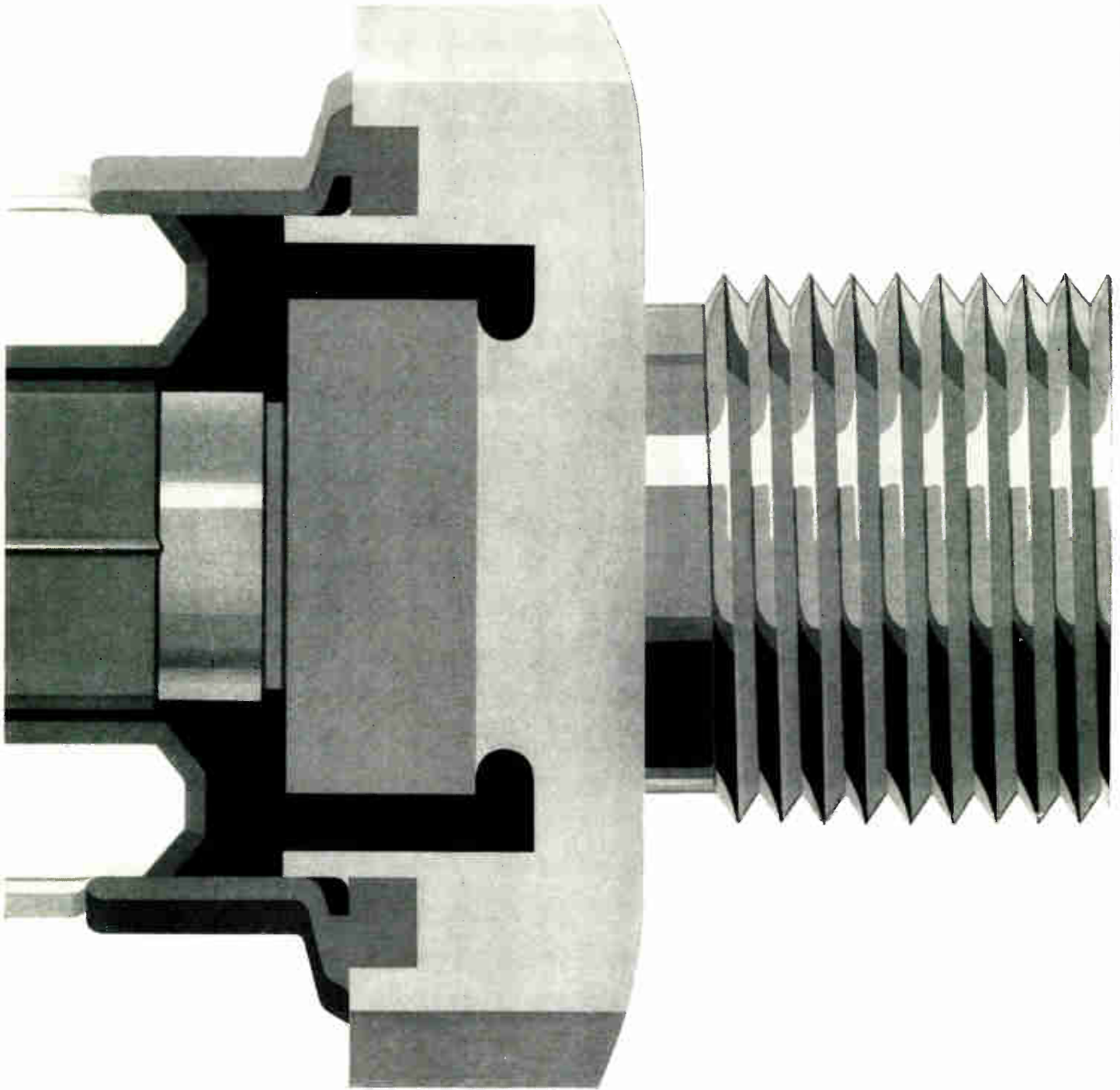



## Minuteman experience leads to a new technology

We call it the Void Free (VF) Process. It's concerned with junction mounting, one of the most critical operations in semiconductor manufacturing. If the solder is pocked with holes, like swiss cheese, trouble can develop. Current bunches up. Hot spots occur. The junction may fail.

Now Westinghouse has solved this problem. The new VF Process creates a hard solder bond that is free of voids. The junction can handle higher currents. Reliability is greatly enhanced.

Where did VF come from? It all began with Minuteman. Westinghouse makes the highest power semiconductors for the missile. It led to this breakthrough in semiconductor technology.

## Here's the first result



### New 275 amp silicon rectifier!

VF Process gives this silicon rectifier a 275 ampere continuous rating and a 5000 ampere surge capacity. The new type 770 is designed for the toughest military and industrial applications. Use it in electrochemical refining, plating, elevators, cranes, ground power supplies... any high power equipment.

## Same capability applied to low power rectifiers

The same men who came up with the VF idea also work on the smaller rectifiers. A few of their contributions: rock top construction, hard soldering, 100% power testing. This is why these rectifiers have an unmatched reliability.

## Send for data sheet

It's a data sheet that does more than gloss over the surface. It gives complete electrical and mechanical specifications such as extended forward characteristics, surge and rating curves, and transient thermal impedance. Write: Westinghouse Semiconductor Division, Youngwood, Pa. You can be sure... if it's Westinghouse. SC-1092

## We never forget how much you rely on Westinghouse

Circle 87 on Inquiry Card

## NEW PRODUCTS

### HELIUM DEWAR ASSEMBLY

Supplies cryogenic environment to operate superconducting magnets.



Standard Dewar assembly is a liquid-nitrogen-shielded, stainless steel vessel. Helium capacity is 7½ liters. Losses as low as 0.1 to 0.25 liter/hr. are achieved through precise Dewar design, and careful operation. A transfer tube is provided to carry the helium efficiently to the Dewar. Nitrogen capacity is approx. 12 liters. Working dimensions of the magnet chamber are 4.45 in. ID x 30 in. long. Outside dimensions are 8½ in. dia. x 47½ in. long. Special sizes and shapes of Dewar assemblies also can be furnished. Access to the coil may be either vertical or horizontal, and optical access can be provided. Westinghouse Research Laboratory, Cryogenic Systems Dept., Pittsburgh 35, Pa.

Circle 252 on Inquiry Card

### FIXED DELAY LINES

"Spiradel" is available in 9 standard case sizes.



These small diameter, distributed constant delay lines have a range of time delays from 20nsec. to 300nsec. Case dimensions are diameters from 0.6 in. to 1.50 in. by 0.375 in. height. Helipot Div., Beckman Instrument, Inc., 2500 Harbor Blvd., Fullerton, Calif.

Circle 253 on Inquiry Card

EXTREMELY BROADBAND

2-16 Gc

MODEL T-601

OCTAVE BANDWIDTH

1-12 Gc

RANGE COVERED BY 4 MODELS

AEL

## TWT POWER AMPLIFIERS

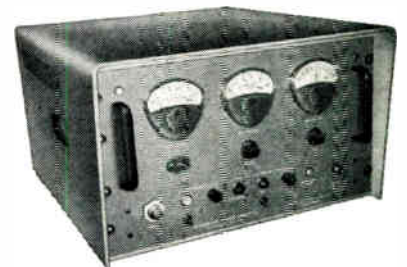

with 1 watt output guaranteed over octave bandwidths

### FEATURES

- Periodic permanent magnet focusing on all tubes
- Ruggedly built for long service
- Continuously variable gain controls
- CW, pulsed or AM modulated operation

### CHARACTERISTICS and PRICES

Model	T601	T607	T608	T609	T610
Frequency, Gc	2-16	1-2	2-4	4-8	8-12
Min. Pwr. Output, Watts	1*	1	1	1	1
Min. Small Sig. Gain, db	50.0*	36.0	30.0	30.0	36.0
Price	\$3990	\$2150	\$2150	\$2750	\$2750

\*Over center octave band.

Prices subject to change without notice.

Write for more information.

AEL

American Electronic Laboratories, Inc.

1313 RICHARDSON ROAD, COLMAR, PENNA.  
Just north of Philadelphia

Circle 88 on Inquiry Card



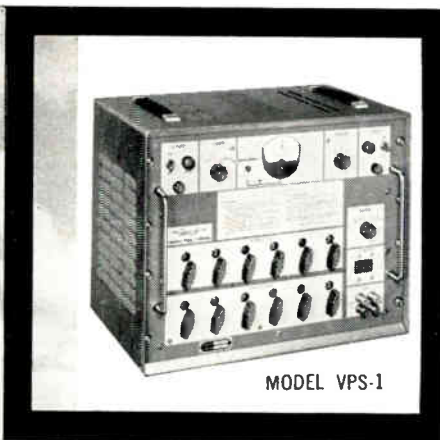
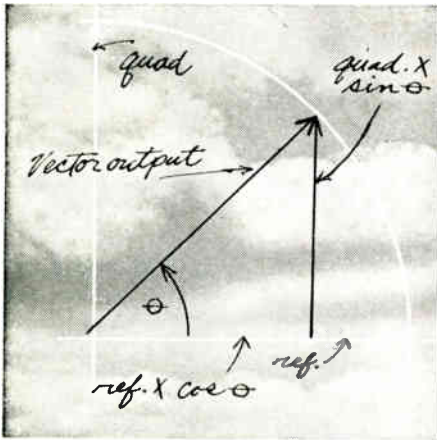

## GERTSCH VARIABLE PHASE STANDARD

-- permits shifting of phase between  
2 self-generated voltages to any desired  
angle, with accuracy better than  $\pm .05^\circ$

**Precise generation of voltage vectors.** The Gertsch VPS-1 generates 2 signals differing in phase by any angle from  $0^\circ$  to  $360^\circ$ , as determined by front-panel controls. The reference signal has a fixed amplitude of 50V rms. The vector output, which may be displaced in phase, has a maximum amplitude of 50V rms, and can be attenuated in steps of 50 mv within a range of 0-50V rms.

**Operation at any 3 frequencies** within a range of 150-3000 cps is provided by a front panel selector switch. Fine adjust control permits varying the frequencies  $\pm 5\%$  max.

**Completely self-contained-unit** requires no accessories for operation. Case or rack mounted. Send for literature VPS-1.

# **Gertsch**

**GERTSCH PRODUCTS, Inc.,**

3211 South La Cienega Boulevard, Los Angeles 16, California / UPTon 0-2761 - VERmont 9-2201

## NEW PRODUCTS

### POWER SUPPLY

Model 413A has a 0-3111 voltage range; 0.25% accuracy.

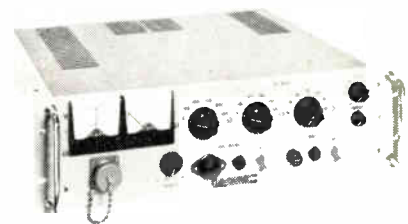

Fluke Model 413A, features 0.25% accuracy over a broad, 0-3111 output voltage range. Current output range is 0-20ma. Stability equals 0.005% per hour after warm-up. Model 413A also offers high resolution, front panel polarity reversal, and front panel meters to indicate approximate output voltage and current. John Fluke Mfg. Co., P.O. Box 7428, Seattle 33, Wash.

Circle 254 on Inquiry Card

### POWER TRANSISTOR

High Current Silicon Transistor: 50a, 300v, 150v, 0.04 ohm.



This silicon power transistor is now in production. The unit, a npn silicon power transistor, can be used in high current switching uses, as a power regulator and for de-dc converters. Forward current gain: min. 10 @ 50a; max. collector voltages to 150v; saturation resistance is 0.04Ω max. @ 50a. It is housed in a 1 1/16 in. double-ended stud mounted package with flag-type collector terminals. Silicon Transistor Corp., 150 Glen Cove Rd., Carle Place, L. I., N. Y.

Circle 255 on Inquiry Card

**Simplifies circuitry,  
lowers equipment costs  
...in both carrier and  
pulse-type applications**

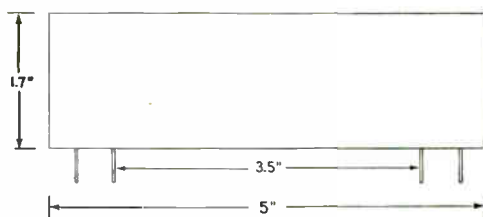

(TYPICAL DIMENSIONS)

SPECIALTY DEVICES OPERATION  
**GENERAL  ELECTRIC**  
DEFENSE ELECTRONICS DIVISION



## **ELECTRICALLY VARIABLE DELAY LINE**

In computers, radar and communications, and many other electronic applications, G-E Electrically Variable Delay Lines lower equipment costs by simplifying circuitry. In addition, this simplified circuitry requires less space and increases equipment reliability. To provide these important design advantages, G-E devices control delays electrically and eliminate the complex circuitry required with mechanical methods.

G-E Electrically Variable Delay Lines are available for either carrier or pulse-type applications, with continuous electrical adjustment in both. These devices can perform transmission time control, pulse control and shaping, high-frequency phase control, pulse time modulation, and phase frequency modulation. (Delay variation to 20 microseconds; Delay-bandwidth products to 10 megacycle microseconds.)

**LOWER COSTS . . . SMALLER SIZE  
. . . INCREASED RELIABILITY.** At Specialty Devices Operation, these important features are custom-designed into delay lines to meet the specific requirements of each customer application.

For more information, write Section 179-11, General Electric Company, Schenectady, New York.

# NEW ... for designers of microminiature circuits that require MICROMINIATURE COMPONENTS

The mighty  
**MINIKIN**  
does a big job  
wherever  
**RG 196-U CABLE**  
is used. It is  
the only connector  
of its size that is  
weatherproof ...  
with bayonet lock.  
Excellent VSWR!

Call your DAGE Representative or  
Write or call direct to the Factory



**DAGE ELECTRIC CO., INC.** FRANKLIN, INDIANA  
INDIANAPOLIS TELEPHONE  
Area Code 317 787-5305

Circle 91 on Inquiry Card

## NEW PRODUCTS

### DC POWER SUPPLY

*Semi-regulated unit for logic circuit applications.*



This semi-regulated, high current family of dc power supplies furnishes 0.3% regulation, less than 100mv RMS ripple and a 10msec. recovery time. Four models are available: SR40-25, 2-40vdc @ 0-25a; SR40-40, 2-40vdc @ 0-40a; SR20-40, 2-20vdc @ 0-40a; and the SR20-70, 2-20vdc @ 0-70a. Housed in a standard 19 in. wide rack package with a 7 in. and 8¼ in. panel height. The weight of the units is 100 and 120 lbs. respectively. Trygon Electronics, 111 Pleasant Ave Roosevelt, L. I., N. Y.

Circle 256 on Inquiry Card

## THE PERFECT PACKAGE

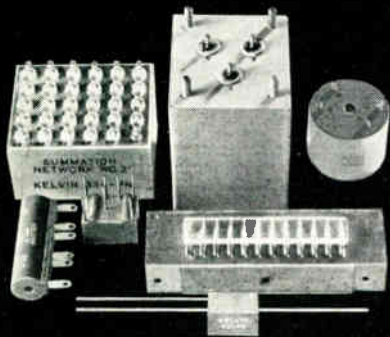

FOR HIGH PERFORMANCE APPLICATIONS

## KELVIN CUSTOM DESIGNED RESISTANCE NETWORKS

Our experienced engineers will answer your application inquiries accurately and promptly. Send specifications or requirements to:

### PRESENT APPLICATIONS:

VOLTAGE DIVIDERS	REFERENCE OR RATIO STANDARDS
COMPUTER APPLICATIONS	LADDER TYPE CONVERTERS
SUMMING NETWORKS	MISSILE CHECKOUT SYSTEMS
DIGITAL TO ANALOG CONVERSION	

Kelvin has specialized for years in the custom design and production of resistance networks to suit individual customer requirements.

Recognized, high quality Kelvin precision wire-wound resistors are used to obtain the ultimate in high accuracy and stability. Units perform in airborne and missile environments involving altitude, shock, vibration, humidity and wide temperature ranges. Networks are packaged in hermetically sealed cases or encapsulated in epoxy resin to meet exact mechanical specifications.

### Electrical Characteristics Available:

- Nominal resistance tolerances to  $\pm .005\%$ .
- Resistance ratio tolerances as close as  $.002\%$ .
- Long term resistance stability of  $\pm .002\%$  per year.
- Low reactances to provide rise times as low as 50 nanoseconds.
- Temperature coefficients of resistors track as close as 1PPM/°C from  $-55^{\circ}\text{C}$  to  $+125^{\circ}\text{C}$ .

Representatives in principal cities



**KELVIN ELECTRIC COMPANY**

5907 Noble Ave., Van Nuys, Calif., TRiangle 3-3430  
New York: Yonkers, 916 McLean Ave., BEverly 7-2500

### CRYSTAL BANDPASS FILTER

*A wide range of filter impedances is available.*

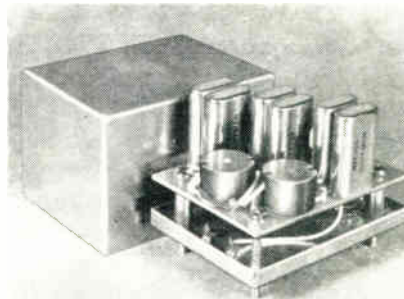

Model F2187 bandpass filter has center freq. of 250,000kc over bandwidths of 100cps at 3db and 300cps at 60db. The shape factor from 60 to 3db is a maximum 3:1 ratio, and ripple is a maximum 0.25db. Standard dimensions are 3 x 2¼ x 2 in. Case may be adapted to meet practical requirements of a layout. Filters with similar characteristics can be produced over a wide range of center frequencies with specified bandwidths. Reeves-Hoffman Div. of Dynamics Corp. of America, Cherry and North Sts., Carlisle, Pa.

Circle 257 on Inquiry Card



## NEW PRODUCTS

### C-BAND OSCILLATOR

Manual tuning range for the oscillator is from 5.4 to 5.9gc.

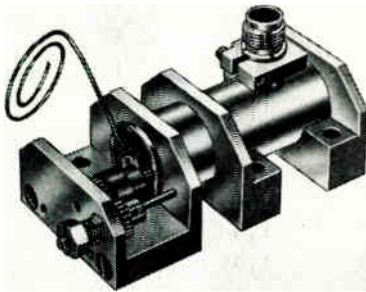

Listed as 9127-1059 the oscillator has a manual tuning range of 5.4 to 5.9gc; power output of 3mw min.; plate voltage 170v through suitable dropping resistor at 13ma; heater voltage 6.3v at 240ma; vibration 20 G up to 2000cps significantly less than 1mc FM; shock 100 G less than 1mc shift. Frequency stability is better than  $\pm 2$ mc from  $-55^{\circ}$  to  $+105^{\circ}$ C. Trak Microwave Corp., Tampa, Fla.

Circle 258 on Inquiry Card

### RECORDER/REPRODUCER

Smooth tape handling, flexibility, and speed accuracy in 4700 Series.

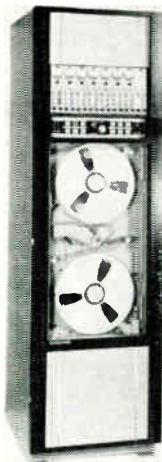

Unique drive motor and capstan eliminates any mechanical coupling between motor and capstan. Induction motor coupled to the capstan through an eddy-current clutch which gives complete control has 8 speeds from 15/16ips to 120ips. In tape handling, instantaneous speed error (TDE) is  $\pm 5\mu$ sec.; long-term speed error is  $\pm 0.0004\%$ ; and speed response is 50%/sec. over a range of 30% of nominal speed. Handles  $\frac{1}{4}$  in. through 2 in. tape. Sangamo Electric Co., Electronic Systems Div., Springfield, Ill.

Circle 259 on Inquiry Card

## RF SUBMINIATURE CONNECTORS FOR 50-OHM SEMI-RIGID COAXIAL CABLES



### SUBMINIATURE RF CONNECTORS

Featuring exclusive "collet-type" clamping action, which when finger tightened will not permit the cable to be pulled out, these subminiature rf connectors have been designed specifically for use with semi-rigid coaxial cables. 50-ohm semi-rigid coaxial cable is constructed with a solid copper shield and a Teflon dielectric. Electrically similar to RG 188/U, semi-rigid cable has a diameter of .082"

Conhex connectors for use with semi-rigid cables in high frequency applications are available in screw-on types that eliminate all soldering operations other than that of attaching the contact to the center conductor. Conhex connectors also feature captivated contacts to insure proper engagement of the mating parts. Types available now include cable jacks, cable plugs and right-angle plugs.

Write today for detailed information on these radically new connectors to . . .



*Sealectro* CORPORATION

139 HOYT STREET, MAMARONECK, NEW YORK  
PHONE: OWENS 8-5600 TWX: MAMARONECK NY 5120

"Press-Fit" Teflon Terminals • "Conhex" Subminiature RF Connectors  
"Sealectroboard" Program Boards • "DeTime" Magnetostrictive Delay Lines

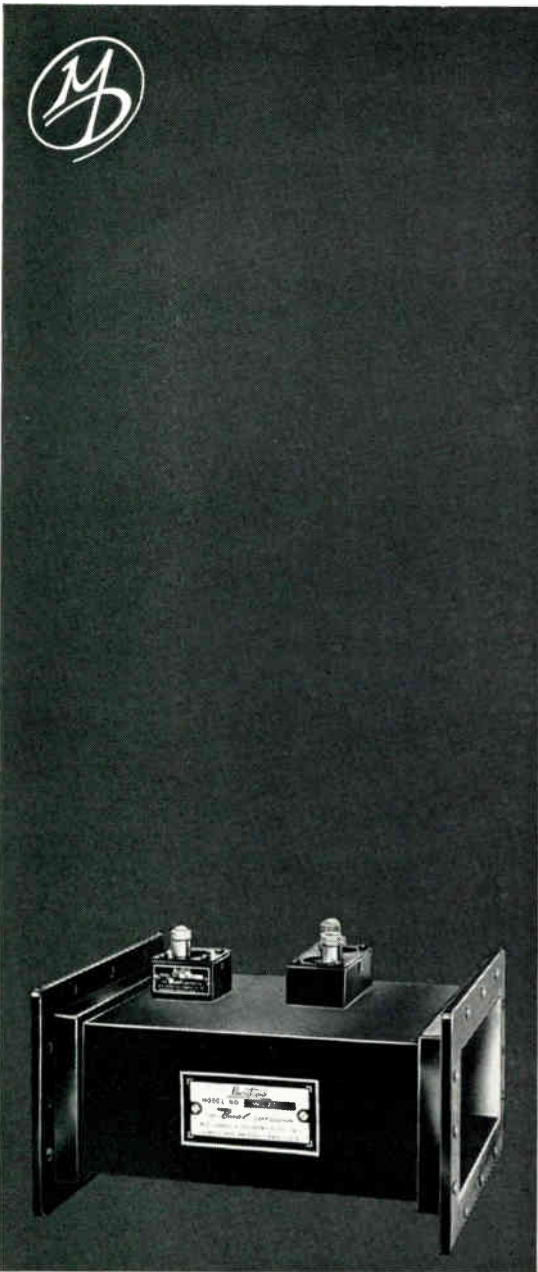

**We've got waveguide directional couplers that practically disappear.**

If space requirements are cramping your style, look to MicroGuide® for the answer to your power and VSWR measurement problems. They're available in any waveguide from WR770 (low L band) to WR75 (high X band).

The model WL4B, shown at right, is an example of our new slim line standard model: L band, 1100-1700 MCs; 2 RF sampling probes calibrated 40 db below main line power; 150 KW average; 30 megawatts peak power. All this in a package 1/10th the size of previous compact waveguide couplers. Additional sampling probes are available with only slight increases in length.

Write us or call, outlining your specifications in terms of frequency range, power level, coupling attenuation, and type of waveguide for L through X band couplers.

**Regional offices**—*Northeast Area* (Connecticut Plant) Farmington; Industrial Park, Farmington, Conn., Area 203,677-9771; *Middle Atlantic Area* (Headquarters) 1445 Research Blvd, Rockville, Md., Area 301,762-1234; *West Coast Area* (Regional Office) 117 E. Providencia Ave., Burbank, Calif., Area 213,849-3961.

**Microwave Devices, Inc.**

(Successor to M. C. Jones Electronics Co., Inc.)



## NEW PRODUCTS

### HEAT DISSIPATOR

*Fan-Top heat dissipator is designed for TO-18 transistors.*



Fan-Top easily installed in new or existing equipment. Thermal control reduces  $T_j$  up to 25% and prevents degrading of temp. sensitive electrical characteristics. Angled "fan" segments induce turbulence and increase convection in forced air. Spring finger design of beryllium copper allows one size to fit all TO-18 cases or others with dia. of 0.178 to 0.196 in. TXBF-019-025B withstands shock and vibration. IERC Div., International Electronic Research Corp., 135 W. Magnolia Blvd., Burbank, Calif.

Circle 260 on Inquiry Card

### DC POWER SUPPLIES

*QB Series has outputs of 5 to 36v at 90 or 180w capacity.*

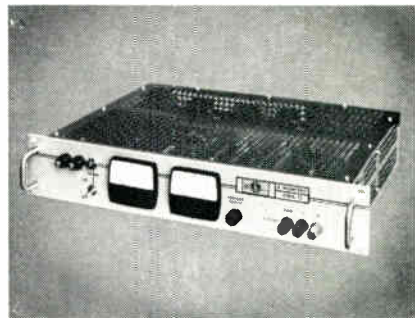

Designed for computers and communications equipment, and for test and instrument uses. The supplies provide regulation of  $\pm 0.01\%$  (line and load combined), ripple of only 300 $\mu$ v RMS and response time of 25 $\mu$ sec. (typical). All models are programmable, can be operated in series or parallel, provide constant current operation and remote sensing with no turn-on, turn-off overshoot. These models extend the QB line to 20 supplies with nominal outputs of 5 to 36v, 12, 24, 48, 90, and 180 w output capacities. Sorensen, Unit of Raytheon Co., Richard Ave., S. Norwalk, Conn.

Circle 261 on Inquiry Card



**read this**

**see this**

**use this**

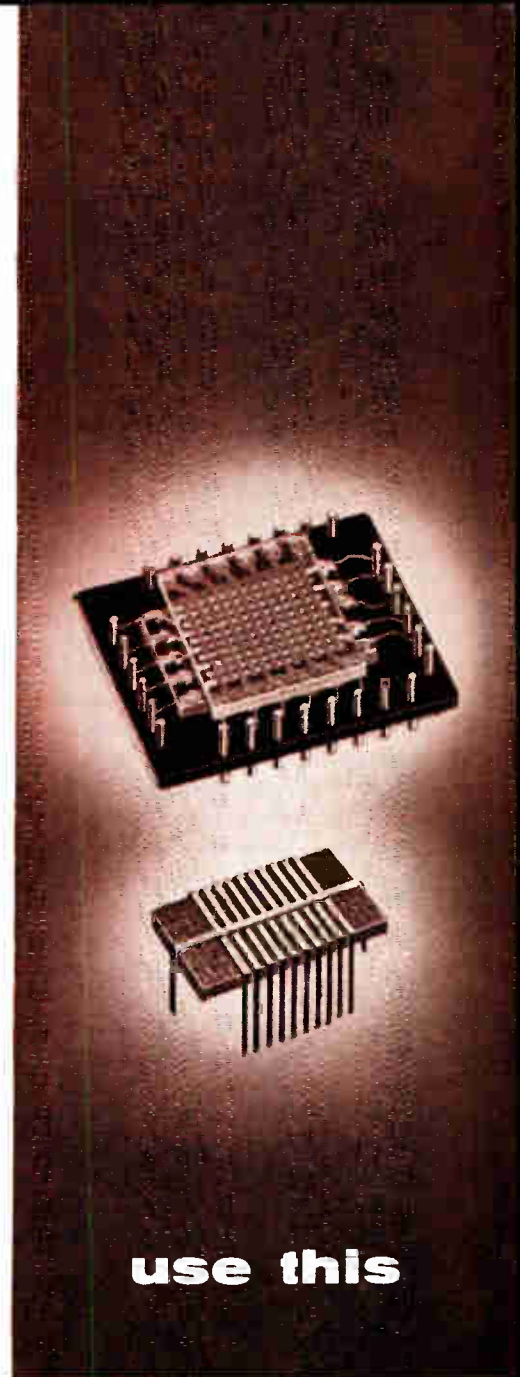
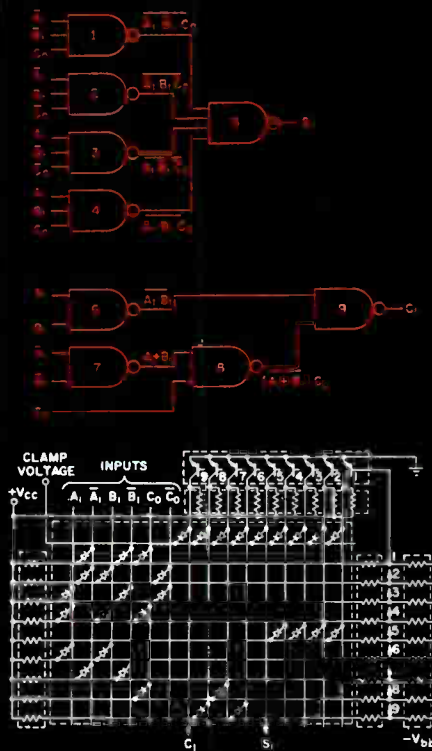

Now there is a new approach to micro-circuit packaging . . . BIPCO<sup>®</sup> Diode Matrices and Transistor Strips. They provide the only approach combining:

- Total function logic
- Connection oriented packaging
- Connection oriented batch manufacturing

See how these unique features will benefit you.

Above is the logic diagram for a full adder and its equivalent BIPCO circuit. Note how "total function" logic is performed with matrices of diodes and strips of transistors and resistors. Since the interconnections are always the same, other functions (counting, decoding, accumulating, etc.) can be performed by simply changing the arrangement of the diodes within the matrix. You can specify parameters, logic levels.

BIPCO devices containing up to 100 silicon diodes and 10 silicon transistors are available as individual packages or as printed circuit assemblies for counting, decoding and code-converting applications. Because the diodes and transistors are manufactured and connected in batches, the cost of these units is competitive with that of conventional components and less than that of other micro-circuit devices.

Write today for our newest brochure . . . "BIPCO Logic | the Total Function Approach".





# Design for MINIATURIZATION

## *Thin Wall* **VARGLAS** Silicone Rubber **SLEEVING**

Varglas Silicone Rubber Sleeving with its space-saving thin wall construction and precision ID, is the answer for insulation in the trend toward miniaturization.

The ultimate in flexibility and dielectric strength, Varglas retains its protective properties over a wide temperature range, from minus 70° to plus 400°F. Tough and abrasion-resistant, this supported silicone rubber sleeving resists deterioration and "cut through"; will not crack or craze. Dielectric protection provided up to 8,000 volts and certified to meet government specification MIL-I-18057A.

Available in brilliant, non-fading colors for instant, easy color-coding in a complete range of sizes from .010" to 3" ID, and obtainable in coils or on spools as well as in individual 36" lengths. Deliveries made promptly off-the-shelf or produced on order within one week.

Let Varflex engineers work with you in developing special types of sleeving and tubing to meet your particular specifications. No obligation.

• WRITE FOR FREE FOLDER Containing Test Samples

Makers of Electrical Insulating Tubing and Sleeving

# Varflex

Never Satisfied Until You Are  
VARFLEX SALES CO., Inc. • 308 N. Jay St., Rome, N. J.



## NEW PRODUCTS

### MINIATURE RELAY SOCKET

Socket for crystal can relays with 0.2 in. contact spacing.

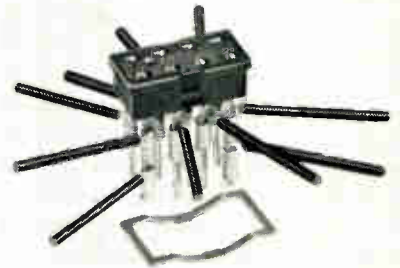

This miniature relay socket has been developed incorporating wire wrap<sup>®</sup> gold plated terminals for numbers 22 and 24 AWG wire sizes. It is available from stock for crystal can relays with 0.2 in. contact spacing. Above can be supplied in clip assemblies. Augat, Inc., 38 Perry Ave., Attleboro, Mass.

Circle 262 on Inquiry Card

### THIN FILM BONDER

A thin film bonder and micropositioner in a unitized work station.

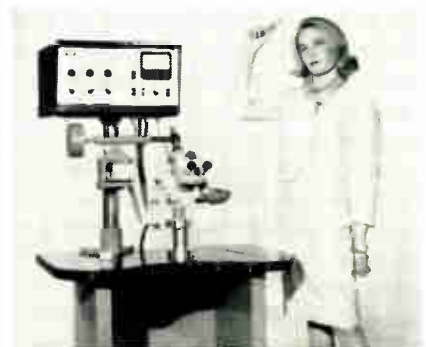

Microbond Model 1090 single surface welds wire to 1/2 mil dia. and ribbon 1/2 mil thick by 0.020 in. wide to thin film 500 Å thick. Unit features a chessman actuated micropositioner with reduction of 30:1. Magnification is 20X to 40X stereo zoom. Model 1090 works from an input voltage of 100-130v, 50/60cps, 1 φ ac. Three sequential cycles of weld power are controllable for weld pulse duration and amplitude. Optional features include limp wire, stiff wire, and ribbon feeds; an 8 position turret mount for various tools, wire and ribbon feeds; and ink markers. Overall 62.5 x 35 x 24 in. Weldmatic Div./Unitek Corp., 950 Royal Oaks Dr., Monrovia, Calif.

Circle 263 on Inquiry Card



Rewirable—Control Cable



High Temperature—1500°F.—Cable

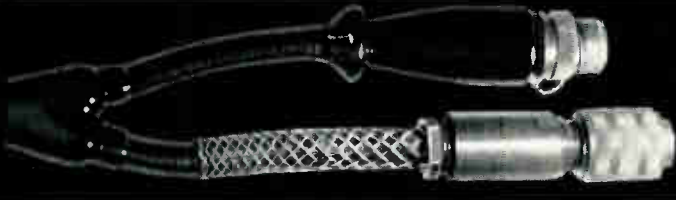

Heavy Duty—Ground Support Cable



Benseal Missile Control Cable

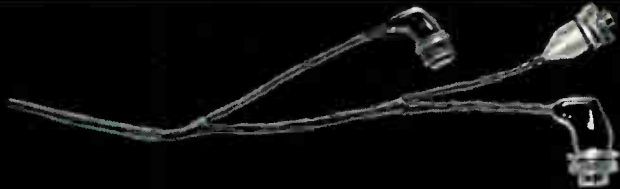

Fabric Braided—Aircraft and Missile Control Cable



Metal Braid—Aircraft and Missile Control Cable



High Temperature—Radiation Resistant Cable



High Temperature—Lightweight—Missile Cable



"Wet Wing" Aircraft Fuel Cell Cable

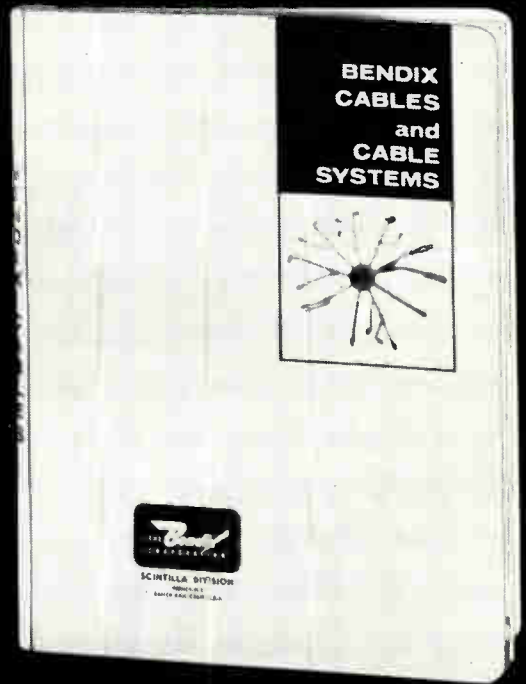

## We're strong in special-purpose cable systems.

Our specialty is producing complex cables for unusual applications to meet our clients' specifications. And we've made some pretty weird looking cables.

A few of the more spectacular types are pictured here. They include metal conduit types available in a variety of metal braids and inner core designs; fabric and metal braid which practically defies limited-space applications; radiation resistant cables; hydrostatic assemblies for critical undersea

## You can be too.

service; flexible or rigid sealed thermocouple types which operate from  $-65^{\circ}$  to  $1500^{\circ}$ .

We've found that the best way to sell cable is to have one of our engineers call on a customer and help him solve his particular problem. You know the problem; we know the cable. So why not call us even before you need us. We can be reached at Santa Ana, California, or Sidney, New York. In the meantime, send for our catalog.

**Scintilla Division**



Circle 97 on Inquiry Card  
World Radio History

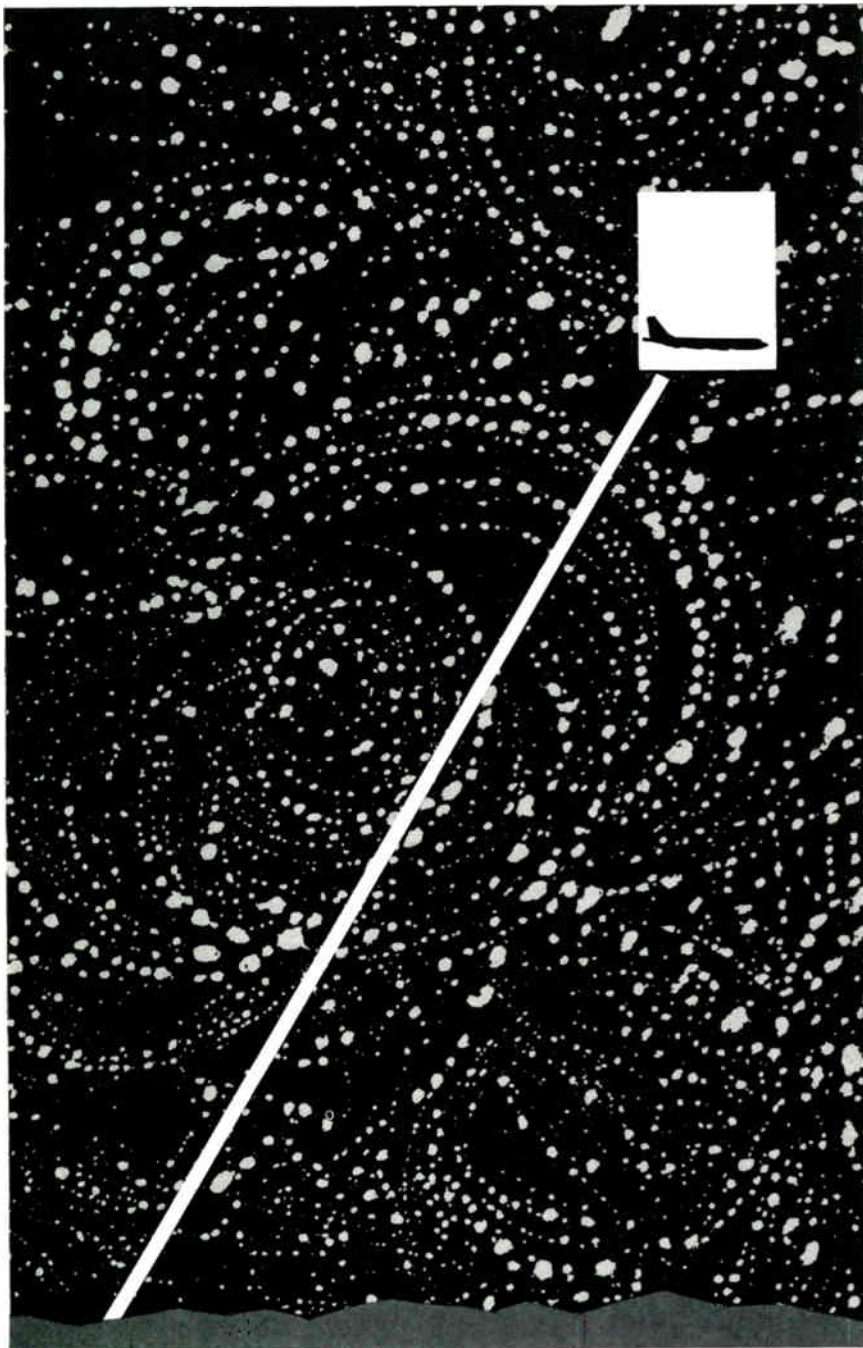

## ERCO MEANS EXTRA-RELIABLE COMMUNICATIONS

The business of ERCO Radio Laboratories Inc. is solely the design/manufacture of high-performance, reliable radio communications equipment for use in airport towers, control communications stations, and other vital communicating centers. Since 1929 ERCO'S traditional advanced thinking and its intensified specialization has enabled it to incorporate in its equipment the latest advances to meet the most stringent needs of critical communication uses ■ ERCO'S unique modular construction technique enables it to custom-design to your requirements with significant savings in time and cost. ERCO engineers are always ready to discuss your particular radio communications problem with you.



*Pioneers in Quality Radio Communication Equipment*

**ERCO RADIO LABORATORIES, INC. • GARDEN CITY, N. Y.**

## NEW PRODUCTS

### POWER METER

*Model 66.11 is a low-drift r-f power measuring instrument.*



Service is in the freq. range from 10Mc to 12.4Gc, when used with appropriate Microline® temperature-compensated thermistor mounts. Measures power accurately over the range of 10 $\mu$ w to 10mw full scale in a straightforward measurement procedure. The unit is completely transistorized and power consumption is 1.5w. May be operated from a 115 or 230v, 50 to 440cps line source, or from an internal rechargeable 24v battery. Sperry Microwave Electronics Co., Div. of Sperry Rand Corp., P. O. Box 1828, Clearwater, Fla.

Circle 264 on Inquiry Card

### QUICK CONNECTOR

*Quick connect/disconnect feature is in a series of electrical connectors.*

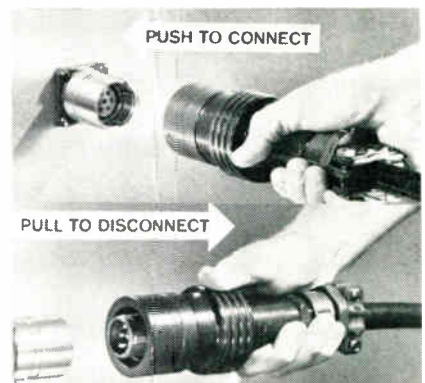

Pyle-Star-Line Class Q heavy-duty connectors are coupled with a push action; and uncoupled with a pull on the coupling ring. Used in ground support equipment. Designed with field indexable keying for use in control, power, and communication circuits. Available in shell sizes of 12, 16 and 20, they accommodate both MOD I (captive) or MOD II (removable) contact inserts. By an axial push motion, the connector is engaged, locked, and environmentally sealed. Connector Div., Pyle-National Co., 1334 N. Kostner, Chicago 51, Ill.

Circle 265 on Inquiry Card



**LOW**  
 **$\tau_s$**

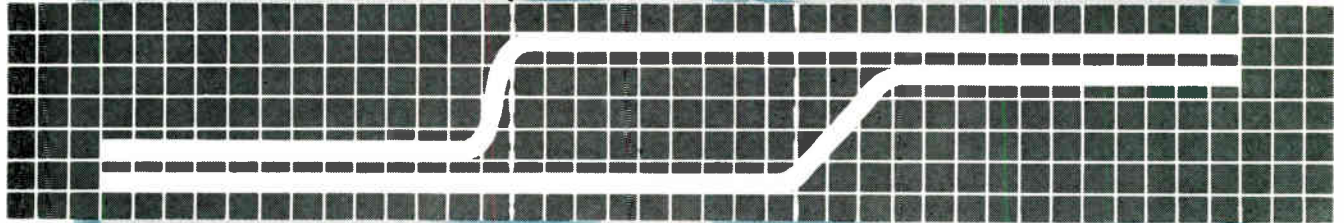

TO-5  
2N2537-38



TO-18  
2N2539-40



**NEW LOW STORAGE TIME**

**SILICON EPITAXIAL STAR\* PLANAR TRANSISTORS**  
**from MOTOROLA...types 2N2537-40**

In addition to the high-speed, high-current features of the original optimized-geometry STAR transistor developed by Motorola, the low-storage capability of this new Low  $\tau_s$  series makes possible even faster switching performance at current levels up to 0.5 amp.

**... Featuring a storage time of only 20 nsec maximum!**

Rise and fall time are also faster than any other 0.5 amp saturated-switching device now available.

And, the high-frequency response of 400 mc (typical) combined with extremely low output capacitance (8 pf max.) makes this new series the most versatile NPN transistors for all high-speed, high-current switching applications.

Production quantities are available in both TO-5 (2N2537, 38) and TO-18 (2N2539, 40) packages. For additional technical information, or if you have an immediate application for these devices, contact your Motorola District Office or Distributor today.

**SWITCHING CHARACTERISTICS**

(At 25°C unless otherwise noted)

Characteristic	Symbol	Max.	Unit
Total Control Charge	Q <sub>r</sub>	750	pico-coulombs
Storage Time (I <sub>c</sub> = I <sub>B1</sub> = I <sub>B2</sub> = 20 mAdc, V <sub>cc</sub> = 5 V)	$\tau_s$	20	nsec
Active Region Time Constant	$\tau_A$	2.0	nsec
Turn-on Time (I <sub>B1</sub> = I <sub>B2</sub> = 15 mAdc, I <sub>c</sub> = 150 mAdc, V <sub>cc</sub> = 7 Vdc, R <sub>L</sub> = 40 $\Omega$ )	t <sub>on</sub>	40	nsec
Turn-off Time (I <sub>B1</sub> = I <sub>B2</sub> = 15 mAdc, I <sub>c</sub> = 150 mAdc, V <sub>cc</sub> = 7 Vdc, R <sub>L</sub> = 40 $\Omega$ )	t <sub>off</sub>	40	nsec

\*Trademark of Motorola Inc.

another **Si** series from...



**MOTOROLA**

Semiconductor Products Inc.

A SUBSIDIARY OF MOTOROLA INC. E 33 016

5005 EAST McDOWELL ROAD · PHOENIX 8, ARIZONA

# Exact "Yes" or "No" Contacting

UP TO

# 1000 Operations per Second!

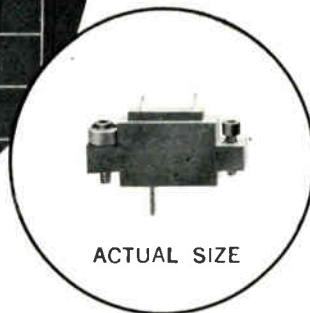
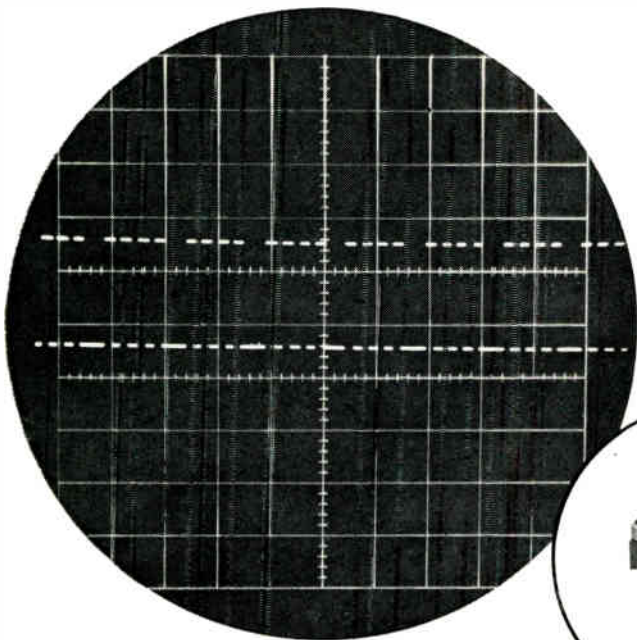

## NEW!

# VG<sup>T.M.</sup>

## Switching MODULE

for precision switching and scanning at the microvolt level

- high speed
- low noise
- no bounce
- small motion
- light pressure

Extreme sensitivity (Mechanical Actuation Pressure less than 30 grams... Closure Motion less than .005") combined with proven durability and accuracy (test-operated for 1 billion closure cycles without failure), make the "VG" Switch ideal for mechanical gauging, motion detection, and commutation. Exact "yes" or "no" contacting at rates up to 1000 operations per second. Any thermal bias or electrical noise generated at the contact interface is much lower than 10 microvolts. Duration and time sequence of closing is continuously adjustable while switch is in operation! Write for complete specifications and ordering information.

# Vitramon

Incorporated Box 544, Bridgeport 1, Connecticut

## NEW PRODUCTS

### FM FILTER

Upper sideband mechanical filter meets missile telemetry specifications.

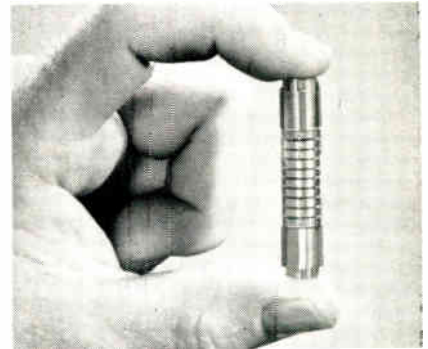

Filters are key elements in development of SS-FM telemetry technique for NASA. Modified ferrite transducer increases mechanical strength of the filter thus reducing insertion loss; also gives a reduction in passband ripple. Nickel-alloy discs serve as the filter's resonant elements to reduce drift to less than 1 ppm/°C over a temperature range of -25° to +85°C. Collins Radio Co., Dallas, Tex.

Circle 266 on Inquiry Card

### MECHANICAL PUMP CART

Model L2M obtains a working vacuum in the 1 to 10 micron range.

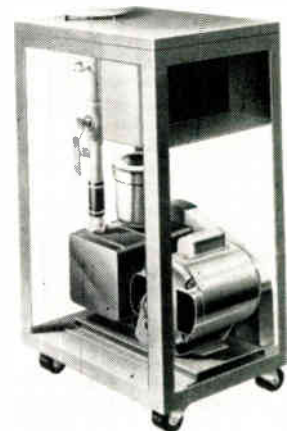

The pump attains an ultimate pressure of 2.3cfm. The components, a 2cfm Model KCV-2 vane-type pump, a 15 sq. in. nickel plated base plate, and a 3/4 in. ball type isolation valve with manifold, are all mounted within a 15 in. sq. open frame for accessibility. The unit features, quick-disconnect coupling in the manifold for servicing; shelf for a vacuum gauge; air admittance valves for the pump and manifold; silver soldered manifold joints, and vacuum gauge tapped hole in the base plate. Kinney Vacuum Div., The New York Air Brake Co., 3529 Washington St., Boston 30, Mass.

Circle 267 on Inquiry Card

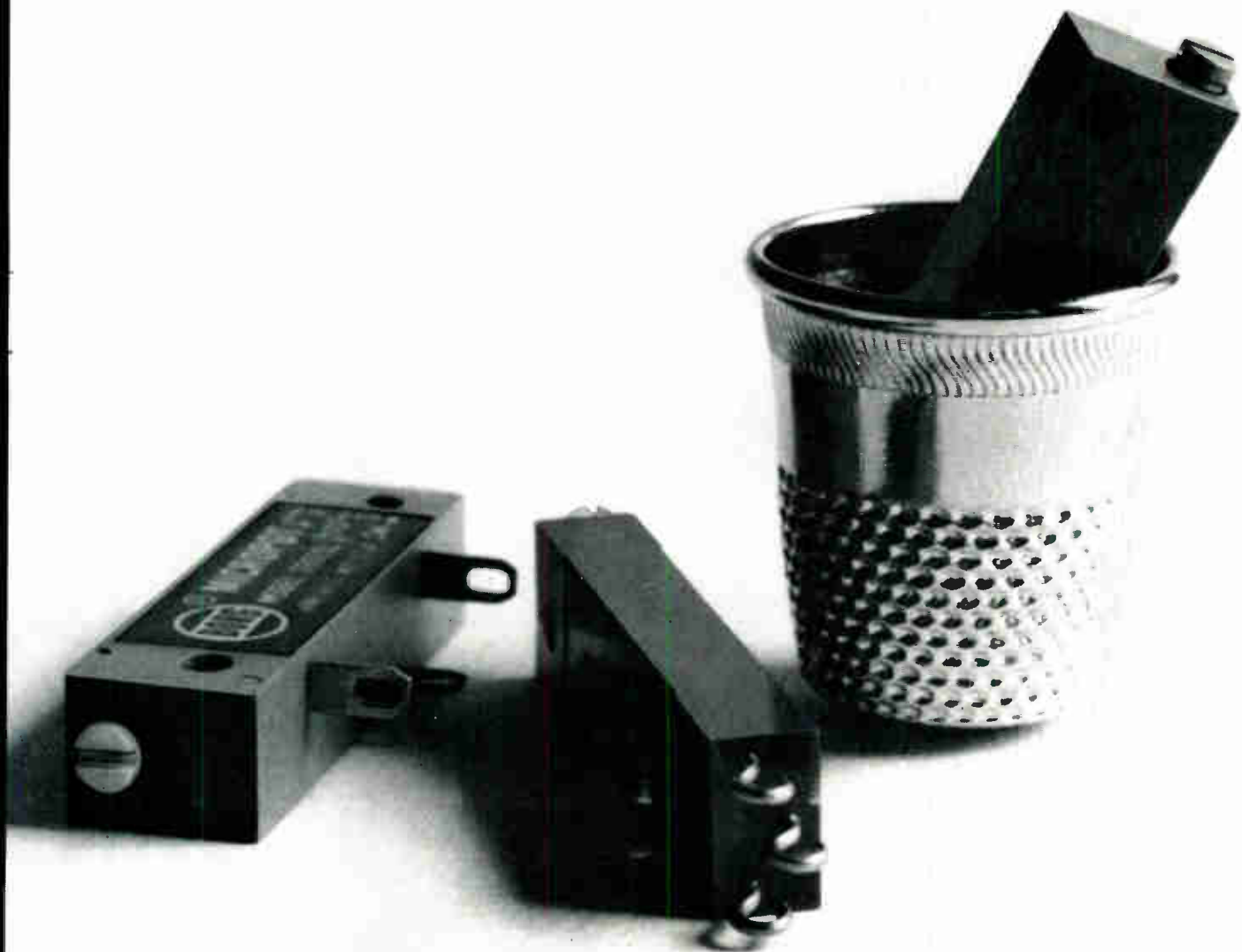

## Little...

These three Micropot® potentiometers illustrate how you can pack as much trimmer into just about as small a space as you'll ever require.

The middle trimmer (our 1.25 x .32 x .19" 2750 series) gives you 47% more density than the one on the left (1.25 x .28 x .36" 2800 series); the trimmer on the right (1 x .32 x .19" 2700 series) offers 86% more density than the one on the left.

Environment a problem? No more. We have a trimmer to provide the solution—be it temperature, humidity, or what-have-you. (See chart at right.)

Delivery? Authorized Amphenol-Borg Industrial Distributors located through-

## Littler...

out the country can now deliver as many Borg trimmers as you need from their stock at factory prices. There's bound to be one near you.

However you look at trimmers—from component density, environment, reliability, delivery, or price—the Micropot line is a good bet to meet your requirements. And if you need specials, take advantage of our *Quick Reaction Facility*. You can get prototypes built to your own specifications almost as fast as you can ask for them.

Save time, money, and embarrassing trimmer failures by contacting your nearby Borg representative or distributor. Or a

## Littlest...

note to R. K. Johnson, Sales Manager, will bring you complete information by return mail.

Series	Miniature	High Temperature	Humidity Proof	Wire-wound	Carbon
2700	X	X	X	X	
2750		X	X	X	
2800		X	X	X	
990		X		X	
992				X	
993					X
994			X	X	
995			X		X



### BORG EQUIPMENT

A Division of Amphenol-Borg Electronics Corporation  
Janesville, Wisconsin

Circle 110 on Inquiry Card





## CHAINED DOWN TO DRAWING REPETITIVE SYMBOLS and DETAILS?

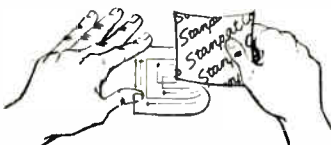

*STANPAT save you money in drafting time*

Your own repetitive symbols and drawing details pre-printed for instant use! Valuable, costly man hours pile up when routine details have to be continually drawn. Now, with amazing STANPAT, engineers and draftsmen save hundreds of man hours each week.

STANPAT engineers have developed a new adhesive formula containing a miracle additive that gives permanent adhesion—without ghosting! No matter what type of tracing media, material or fabric you use . . . this new revolutionary formula assures crisp, clean reproduction. No ghosting problems!

Repetitive symbols . . . in fact any drafting blueprint or specification detail items . . . can be applied in seconds, rather than drawn in hours. Three hours can actually be reduced to 15 seconds! That's why STANPAT is used by thousands of companies, in every industry.



Prove it yourself . . . send for STANPAT literature and samples, or enclose your symbols for quote.

### STANPAT COMPANY

Whitestone 57, N.Y., Dept. C4, telephone 212-359-1693.

## NEW PRODUCTS

### MULTI-PIN CONNECTORS

*LE Series Multi-Pin for quick insertion at minimum force.*

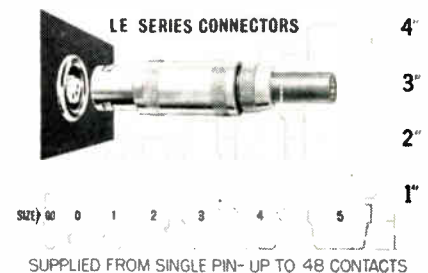

No screwing or turning is required. Connectors are multi-pin, power and coaxial fittings. Chrome finished, flush mount panel receptacles eliminate bulky projections from panel wall. Single contact carriers for up to 20,000v, coaxial fittings of 50, 75 and 90Ω, multiple connections with up to 48 contacts, and combinations of coaxial and multiple contacts can be supplied. Seven sizes of connectors range from ¼ to 1¾ in. dia. Automatic Metal Products Corp., 315-323 Berry St., Brooklyn 11, N. Y.

Circle 268 on Inquiry Card

### C-BAND AMPLIFIERS

*Two C-band microwave amplifiers feature 30db gain, 10w min. output.*

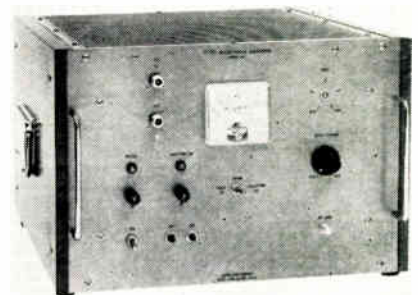

Amplifiers use a PPM focused TWT. The external grid of each instrument can be either pulse or amplitude modulated. Model 529 covers freq. from 4 to 86c; Model 529-S1, 4.8 to 0.56c. At 1w output, gain is 30db min.; at 10w output, gain is 27db min. Helix overcurrent protection is provided. Uses: power amplification of complex modulated r-f signals; amplification of nsec. rise time pulses; isolate load from a microwave signal; as a stable microwave power oscillator at a fixed freq. or tunable using an external resonant feedback network. Alfred Electronics, 3176 Porter Dr., Palo Alto, Calif.

Circle 269 on Inquiry Card

# NEW!



# volt-pac<sup>®</sup>

variable transformers

10.0 Amperes

### DOLLAR SAVINGS—

19 Basic Ratings—  
Wider Selection  
Industry's Most  
Complete Line

### LONGER LIFE—

30-100% Greater  
Overload Capability

### SPACE SAVINGS—

Up to 33% Greater  
Over-all Capacity  
in Same  
Physical Size



You benefit three big ways with General Electric's new volt-pac variable transformer line.

First, G.E.'s wider selection offers big dollar savings. You can choose from nineteen basic G-E 120- and 240-volt, single-core ratings—more than ever before—to more precisely meet your applications. By making smaller jumps between ratings, you save the difference in dollars. And G.E.'s 2-65 amp single-core current range, 15 amps more than previously available, means one volt-pac unit can replace two stacked units in these higher ratings. You lower costs and space requirements too!

Second, you get longer life—the result of three exclu-

sive volt-pac features. General Electric's ① new unique heat-sink ring\* located beneath the gold-plated brush track quickly dissipates heat from the hot spot. The ② solid-carbon, grain-oriented brush and the ③ quick-transfer current collector\* provide more reliable operation. Total effect: up to 100% greater overload capability than previously available.

Third, you get up to 33% more over-all capacity—in existing core sizes. And in the popular sizes through 10 amps, G-E units are directly interchangeable with your present mounting arrangements.

For the full story on G.E.'s manual and motor-operated volt-pac lines, and the automatic line with solid-state SCR control, see your G-E Sales Engineer or authorized G-E Electronics Distributor. Or write for Bulletin GEA-7751 to Section B458-02, General Electric Company, Schenectady 5, New York. \*Patent Pending

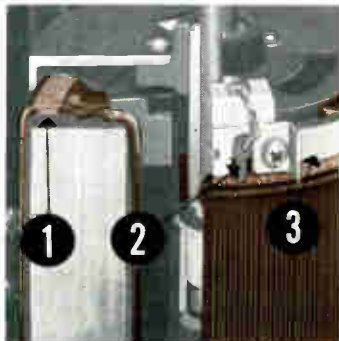

*Progress Is Our Most Important Product*

# GENERAL ELECTRIC

Circle 105 on Inquiry Card  
World Radio History





**NOW** Priced for  
**ALL** Your  
Power Supply Needs...



# SILICON Transpacs®



- Ultra Stable
- Meets High Temperature Requirements
- All Components Accessible for Repair and Replacement
- Miniaturized . . . Replaces Bulky, Expensive Equipment
- Complete Line . . . Over 30 Models to Choose From

**Compare Silicon Transpac Prices with Other Make  
Germanium Power Supplies and Compare Specs!**

#### SPECIFICATIONS

Input: 105-125 VAC 50-400 cps  
Output Voltage Ranges (nom): 6, 12, 18, 24, 28, 32 VDC Models  
Adjustment Range:  $\pm 1$  volt  
Output Current Ranges: 500 MA, 1 amp, 2 amp, 4 amp, 8 amp Models  
Ripple: Less than 800 Microvolts RMS  
Line Regulation: Less than  $\pm 0.01\%$  or 5 millivolts for full input change  
Load Regulation: Less than 0.05% or 8 millivolts for 0-100% load change  
Transient Response: Less than 50 Microseconds for step line or load change  
Maximum Operating Temperature: 71°C, free air, full ratings  
Maximum Permissible Temperature (Stud): 110°C  
Temperature Coefficient: Less than 0.01% per degree C or 3 MV

Long Term Stability: Within 5 millivolts for 8 hours, after 20 minute warmup (line, load, temperature constant)  
Interconnection: Series or parallel operation permissible  
Voltage Adjustment: External screw driver voltage control  
Remote Voltage Control: Provision for external control of output voltage  
Remote Sensing: Remote sensing facilities available  
Short Circuit Protection: Automatic short-circuit protection with automatic recovery  
Output Connection: Ungrounded outputs, either positive or negative terminals may be grounded  
Physical: Modular construction, all components fully accessible  
Heat Sinking: Internal, Convection cooled. Provision for remote location of internal heat sinks

Price Range: \$115. to \$395. Off-the-Shelf Delivery on Most Units.

. . . and for Low Cost Applications, Use GERMANIUM TRANSPACS

for literature and detailed information, write:



**ELECTRONIC RESEARCH ASSOCIATES, INC.**

Dept. EI-4, 67 Factory Place • Cedar Grove, N. J. • Center 9-3000

## NEW PRODUCTS

### PLUG-IN RECTIFIERS

Solid state units replace tube types 6BIV4, 6X4, 5U4, 5Y4, 5R4, etc.

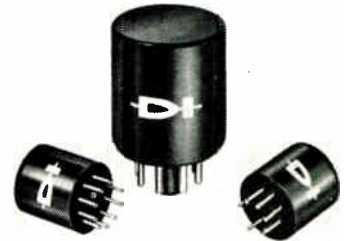

Features include: very long life; very low heat dissipation; extremely low forward voltage drop; eliminates need for filament transformers; and ability to withstand high overloads and surges. Advantages over the tubes they replace include: more power handling capacity and no inherent shock and vibration problems, produce very little heat, extremely long life. Case heights vary from 0.750 to 1.406 in.; case dia. from 0.750 to 1.250 in. Diodes, Inc., 7303 Canoga Ave., Canoga Park, Calif.

Circle 270 on Inquiry Card

### AUDIO CONNECTOR SERIES

Q-G (Quick-Ground) audio connectors for electrical/electronic use.

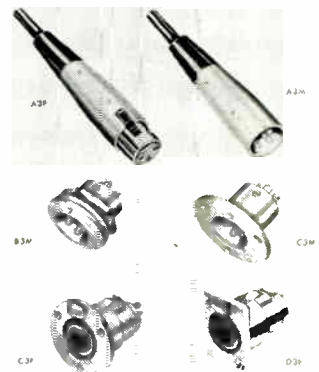

Q-G 3-contact audio connectors are available in 10 models: A3F, female cord plug; A3M, male cord plug; B3M, male panel receptacle; C3M, male wall receptacle; C3F and D3F female panel receptacles; H3M, H3MS 2 gang male wall plates; G3M, G3MS single gang male wall plates. All have these features: Ground Terminal for continuity with connector shell; Ground Contactors provide grounding between mating connector shells upon engagement; and Captive Design insert screw is loss-proof. Switchcraft, Inc., 5555 N. Elston Ave., Chicago 30, Ill.

Circle 271 on Inquiry Card



# MIL IMPACT



**HIGH SHOCK  
AND VIBRATION  
PROOF RELAYS**

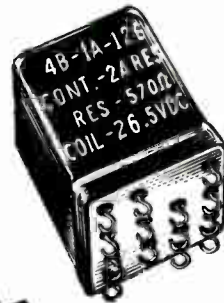
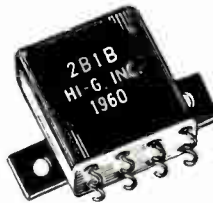
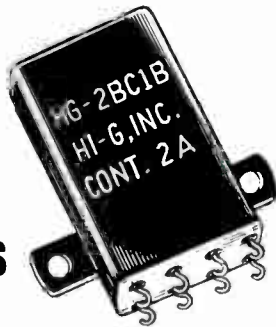

. . . longest line of Military-type miniature and micro-miniature relays in the industry. Time delay, latching, ultra-sensitive, and extra-small compacts, and every one a leader in reliability and performance. Send for complete catalog . . .

**HI-G**  
INC.

SPRING STREET and ROUTE 75, WINDSOR LOCKS, CONN.

Circle 107 on Inquiry Card

World Radio History

# A Quality Source for MACHINED CERAMIC INSULATORS

Extruded or Pressed ALUMINA or STEATITE

Beveling • Notching • Slotting • Grooving • Counterboring  
Milling • Tapering • Threading (internal or external)

Glazing: white or colors—  
complete or selected area

Exceptional accuracy can be maintained at low cost where tolerances are not less than  $\pm 1\%$ . Consulting our engineers at the design stage may effect additional savings.

# Saxonburg

CERAMICS, INC.  
800 3rd Avenue  
SAXONBURG, PA.

*Quality Ceramics for Industry Since 1924*

Circle 108 on Inquiry Card

**EISLER** manufactures a complete line of resistance butt welders, band saw welders, spot welders, soldering & brazing machines, bench or pedestal type, foot or air operated . . .

EISLER MAKES THE LARGEST ASSORTMENT OF SPECIAL STANDARD WELDING TIPS, ACCESSORIES & WATER COOLED HOLDERS

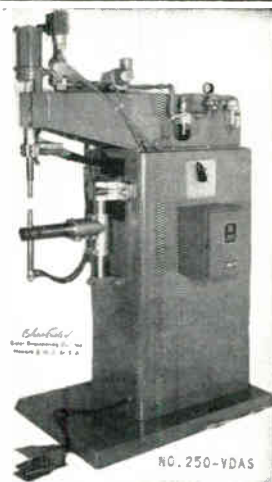
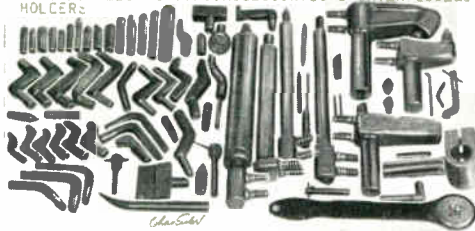

WIRE BUTT WELDER WITH HYDROGEN JET



We also carry in stock welding tips, holders and other welding accessories

• Write for full details



**EISLER ENGINEERING CO., INC.** / 770 So. 13th St., NEWARK 3, N. J.

Circle 109 on Inquiry Card

## NEW PRODUCTS

### CIRCUIT CONNECTOR

Molded connector for use with multiple layers of flat conductor cables.

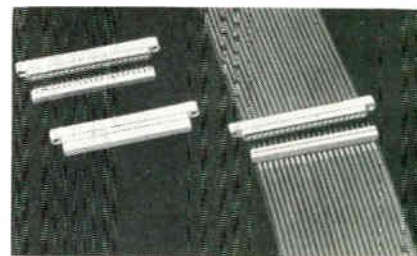

Mod-U-Con female contacts are beryllium copper. Four tines of the contact exert an equalizing force at separate points on mating male contact, for stable and low contact resistance. Basic male contact of selected phosphor bronze per QQ-P-330 compensates for minor misalignment. Housing of compound MEI-1360 equals or exceeds flexural and compressive strength specified in standard GDI-30 for the "as molded" condition. Alternate body materials in phenolic and alkyds. Modular Electronics, Inc., 21 Fourth St., Osseo, Minn.

Circle 272 on Inquiry Card

### HYBRIDS AND MIXERS

Orthotee hybrids and balanced mixers for use in missile and airborne radar.

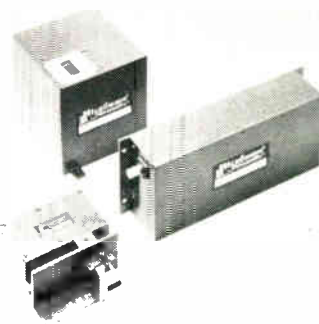

The mixers for X, Ku, and Ke-band applications use an Orthotee hybrid that has good electric specs. (input VSWR, isolation between E and H arms and parallel arms, and power split imbalance) equivalent or superior to standard H-plane folded hybrid tees. The i-f outputs can be left separate or combined to suit the user. The crystal mounts are functionally separated from the hybrid power-dividing section. Mixers retain their performance characteristics into the higher freq. ranges. Any standard diode can be used with mixer. Microwave Associates, Inc., Burlington, Mass.

Circle 273 on Inquiry Card

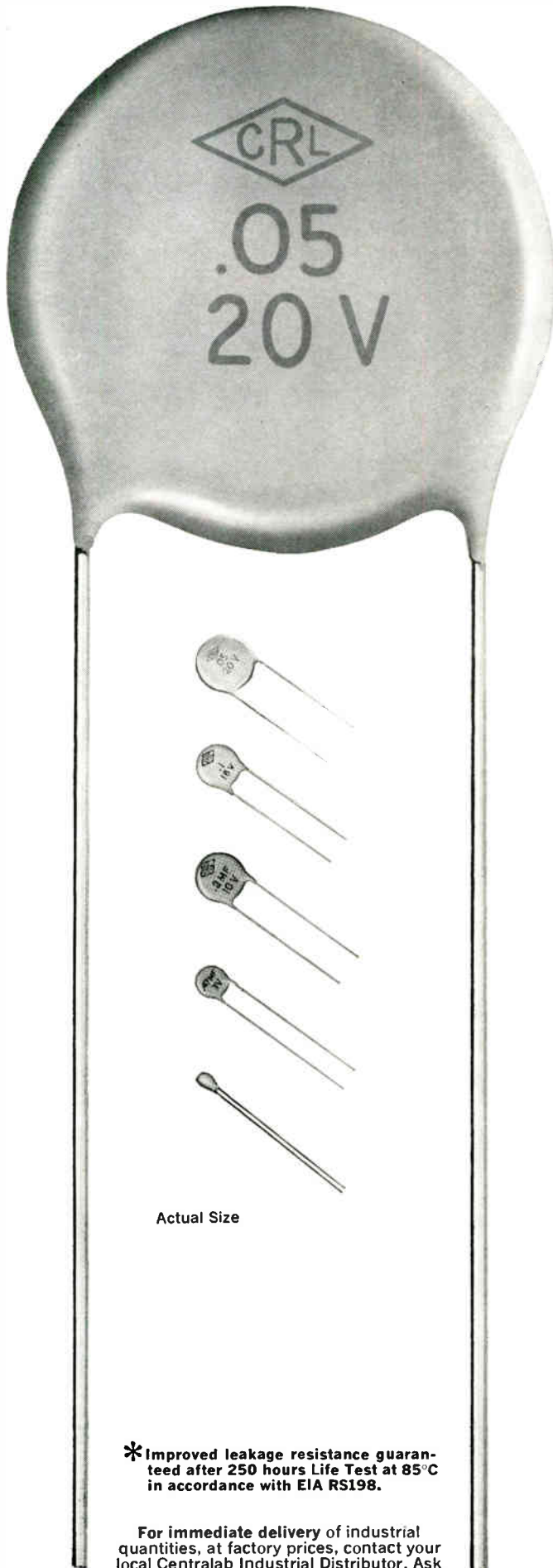

# FIELD-PROVEN DEPENDABILITY WITH CENTRALAB ULTRA-KAPS® SEMICONDUCTOR CIRCUIT CERAMIC CAPACITORS

**ULTRA-KAPS** . . . the original low voltage, high capacity ceramic capacitors are manufactured under Centralab patents. With years of production experience behind them, these units are *dependable*—in *rating*, in *performance*, in *delivery*.

Ultra-Kaps are exceptionally reliable. Electrical failure is virtually unknown among the millions of units now in the field.

They exhibit no deterioration of leakage resistance after Life Test with excellent temperature stability from  $-55^{\circ}\text{C}$  to  $+85^{\circ}\text{C}$ .

Compared to papers or electrolytics of equivalent values, Ultra-Kaps offer the important advantages of smaller size, higher reliability and easier production handling. For additional information, write for Engineering Bulletin EP 1245R.

**20 Volt Ultra-Kaps**—Rating: 20 VDCW, Tolerance:  $\pm 80\%$ —20%. Dissipation factor at 1 KC: 10% maximum.

Capacity, mF	.05	.1	.2
Maximum Diameter, inches	.408	.590	.844
Min. Leakage Resistance*	400K	200K	100K

**16 Volt Ultra-Kaps**—Rating: 16 VDCW, Tolerance:  $\pm 80\%$ —20%. Dissipation factor at 1 KC: 10% maximum.

Capacity, mF	.05	.1	.2
Maximum Diameter, inches	.408	.590	.844
Min. Leakage Resistance*	600K	300K	150K

**10 Volt Ultra-Kaps**—Rating: 10 VDCW, Tolerance:  $\pm 80\%$ —20%. Dissipation factor at 1 KC: 10% maximum.

Capacity, mF	.05	.1	.2	.47
Maximum Diameter, inches	.290	.408	.590	.844
Min. Leakage Resistance*	400K	200K	100K	50K

**3 Volt Ultra-Kaps**—Rating: 3 VDCW, Tolerance: GMV.

Cap. Mfd. (uF)	Max. Diam.	Dissipation Factor Max. — 1KC	Minimum Leakage Resistance*
.005	.120"	10%	30K
.01	.120"	10%	30K
.02	.120"	10%	30K
.1	.220"	10%	12K
.22	.290"	5%	8K
.47	.408"	5%	3K
1.0	.590"	5%	2K
2.2	.844"	5%	1K

\*Improved leakage resistance guaranteed after 250 hours Life Test at  $85^{\circ}\text{C}$  in accordance with EIA RS198.

For immediate delivery of industrial quantities, at factory prices, contact your local Centralab Industrial Distributor. Ask for UK series.

## Centralab®

THE ELECTRONICS DIVISION OF GLOBE-UNION INC.  
9380 E. Keefe Avenue • Milwaukee 1, Wisconsin  
In Canada: Centralab Canada, Ltd., P.O. Box 400, Ajax, Ontario



# NEW PRODUCTS

**GREATLY EXCEEDS  
GOVERNMENT EXPECTATIONS**

**... AND COSTS LESS**

## DC-10 GC COAXIAL ATTENUATORS & TERMINATIONS

*STODDART brings to the electronic art attenuators and terminations spanning the frequency range DC - 10 GC—guaranteed to meet published specifications—and by pass all competition.*

### DC-10 GC ATTENUATOR

- VSWR maximum 1.4—Impedance 50 ohms
- Power rating 1 watt average
- Type N, male and female connectors
- Cost: 20 db—\$100.00, 40 db—\$130.00, 60 db—\$155.00

### DC-10 GC TERMINATION

- VSWR maximum:
- Type N 1.15—Type TNC 1.30 Impedance 50 ohms
- Power rating 2 watts average
- Male and female connectors
- Cost: Type N — \$35.00  
Type TNC — \$40.00

ANOTHER NEW PRODUCT LINE BY

## STODDART

AIRCRAFT RADIO CO., INC.  
6644 Santa Monica Blvd. • Hollywood 38, Calif  
Subsidiary of TAMAR ELECTRONICS, INC.

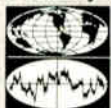

## BUTTON SWITCHES

*MBS-1 and MBS-2 Series are "A" form (SPST) momentary contact types.*



Miniature switches designed for computer, data processing, control and missile guidance systems. Gold plated beryllium copper contacts rated at 100ma at 120v non-inductive. Life exceeds 1 million operations at rated current. For panels 1/16 to 1/8 in. thick, the MBS-1 Series projects 1 in. behind the panel. The MBS-2 Series is designed for panels to 1/2 in. thick. Both types have gold plated solder lug/taper tab terminals. 10 button colors in standard EIA color code. Tec-Lite Div., Transistor Electronics Corp., Box 6191, Minneapolis 24, Minn.

Circle 274 on Inquiry Card

## HIGH FREQUENCY SCOPE

*Using direct coupled dual channel amplifiers with 0.5nsec. rise time.*

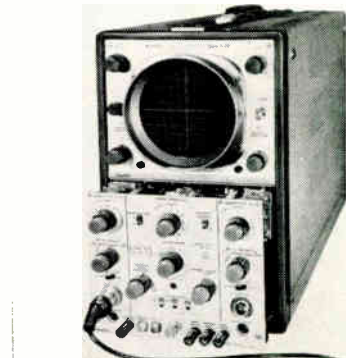

Portable Type 1120 Dual-trace Scope with dual channel Type 701 Sampling and Sweep plug-in. Completely self-contained plug-in has matched delay lines for internal triggering and display of single- or dual-channel displays. Sweep ranges from  $\mu$ sec. to psec. No pre-trigger signals or generators or external delay cables are required. Sweep delay permits observation of a selected portion of waveform. Sensitivity to 2mv/cm. High impedance passive and cathode-follower probes available. Analab Instrument Corp., Canfield Rd., Cedar Grove, N. J.

Circle 275 on Inquiry Card

## NEW PRODUCTS

### PISTON TRIMMER CAPACITOR

Capacitance values from 1 to 40pf up to 1 to 90pf.

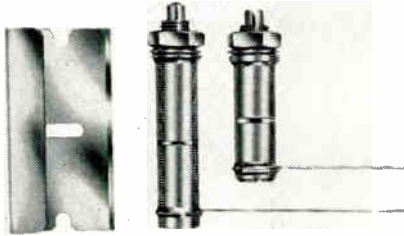

These capacitors have no capacitance reversal and have a Q factor of 500 min. at 1mc. Operating temp. is  $-55^{\circ}$  to  $+125^{\circ}$ C. Tuning torque is 1 to 5 in.-oz. Length (behind panel) for 90pf capacitance is 2 in. Also features solid metal electrode bands permitting user to solder directly to the electrode at any point. Series includes SG-540, capacitance 1 to 40pf; SG-560, 1.2 to 60pf; SG-580, 1.2 to 80pf; and SG-590, 1.2 to 90pf. Elcom Dept., Roanwell Corp., Roanwell Bldg., 180 Varick St., New York 14, N. Y.

Circle 276 on Inquiry Card

### POWER TRANSISTOR

Stud-mounted pnp germanium transistors for low-freq. power uses.

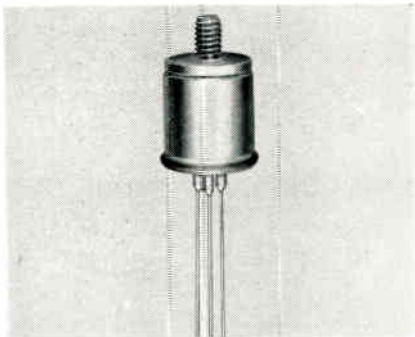

This line of 8 transistors were designed for use as relays, servo motor controls, and audio power amplifiers. Types CK-256, CK258, CK411 through CK415, and 2N1504 are electrically equivalent to bolt-mounted types N156, 2N158, CK311 through CK315, and 2N158A. V<sub>CB</sub> is  $-30$ v for CK256,  $-60$ v for CK258 and CK411 through CK415 and  $-80$ v for 2N-1504. V<sub>CE</sub> is  $-30$ v for CK256 and  $-60$ v for the other 7 types. The devices have a metal and glass base, tin-plated leads and a metal case measuring 0.635 in. high and 0.580 in. wide. The stud extends  $\frac{1}{4}$  in. from the case. Raytheon Co., Semiconductor Div., 900 Chelmsford St., Lowell, Mass.

Circle 277 on Inquiry Card

# Speed Production... Lower Costs!

with **KÄHLE**

## AUTOMATIC PRECISION ASSEMBLY MACHINES

KAHLE service encompasses the complete responsibility for special machine projects from design to final testing. KAHLE designs and builds high efficiency production machines for manufacturers in electronics, glass and general industry. The machines illustrated are typical of the thousands of different types now in use.

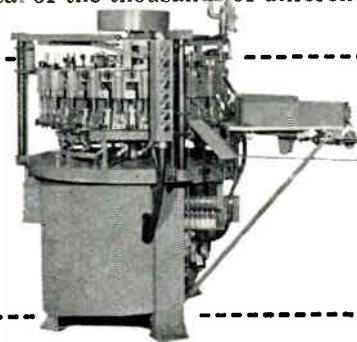
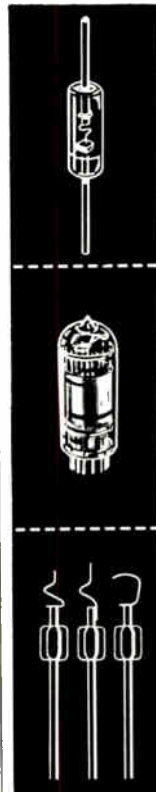

**Assembly Machine No. 3383**—Automatically makes the final seal on crystal diodes. Capacity 2,200 seals per hour.

**Sealing-Exhaust Machine No. 2187** — Automatic machine features 16 positions for high speed production.

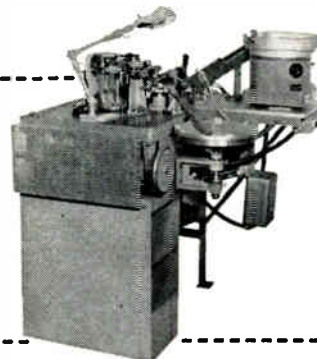
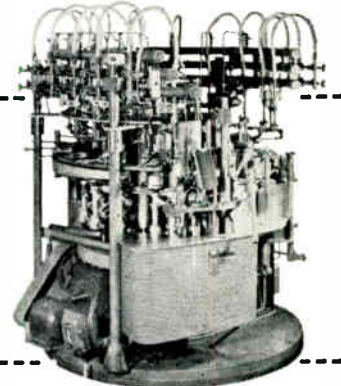

**Assembly Machine No. 3711** — Cat-whisker welder for crystal diode assembly. Automatically welds 3,000 units per hour.

### KAHLE Engineers have the Experience and Facilities to Solve Your Production Problems!

Call or write KAHLE for recommendations on your specific assembly and production problems. KAHLE automatic high speed, precision machines are in use by hundreds of leading manufacturers where they have earned an industry-wide reputation for high efficiency and dependable performance!



3320 HUDSON AVENUE, UNION CITY, NEW JERSEY

Telephone: UNion 7-6500 (Area Code 201)

DESIGNERS & BUILDERS OF AUTOMATIC MACHINES FOR HIGH SPEED, PRECISION PRODUCTION



# SWITCHCRAFT PATCH CORDS

## New! Quality Nylon Covered Patch Cords

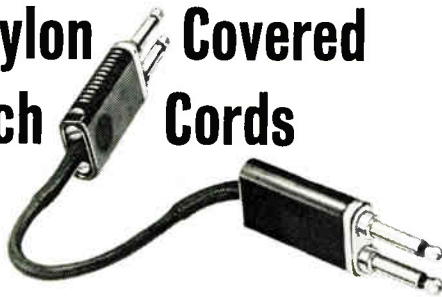

### How Much Better Are Switchcraft's Patch Cords? **PLUG ONE IN AND TRY IT!**

Built-in Switchcraft quality assures dependable, reliable connections in switchboard, instrument and broadcast studio applications. A complete line of cords featuring bronze tinsel conductors insulated with thermoplastic, over which a braided shield and black Nylon braid are woven, is available in 3 series. Lengths from 6 inches to 10 feet. Cords are assembled with Switchcraft's Mil-Type 2 and 3 conductor phone plugs and 2 conductor twin-plug.

Available at all leading electronic distributors or contact us direct for Bulletin 121.

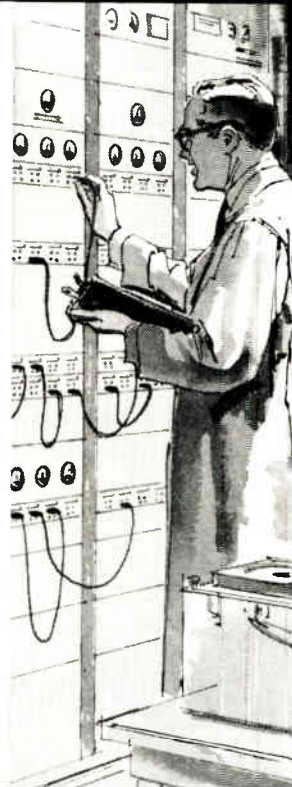

**SWITCHCRAFT**  
INC.

5543 N. Elston Ave., Chicago 30, Ill.  
Canadian Rep.: Atlas Radio Corp., LTD.  
50 Wingold Ave. Toronto, Ontario, Canada

Circle 160 on Inquiry Card

## SHOCK STOP PACKAGING

Possible?

Yes.

Competitive?

No.

You can, however, package to eliminate damage caused by shock and vibration, save with less handling, have greater packing control, at comparatively lower costs.

### **pak/control** T.M.

Molded Cushion Packaging offers you a complete service in development and production of bonded and virgin foam packaging elements.

Relatively new, these materials have gained wide recognition as *the* protective packaging for precision equipment and sensitive instrumentation. Request literature and samples.



INDUSTRIAL PACKAGE DIVISION  
DELVALTEX CORPORATION  
34 Parker Avenue, Trenton 9, New Jersey

Circle 161 on Inquiry Card

## YOU CAN SAVE UP TO **50%** ON SMALL PARTS LIKE THESE

by using  
TRADEMARK

### BEAD CHAIN Multi-Swage PRODUCTS

Every year Bead Chain produces *billions* of tubular metal parts for electronic and mechanical applications. Multi-Swage eliminates costly turning, drilling, stamping and forming—automatically swages from flat stock into strong precision forms with positive, tight seams. If you're a volume user of such parts, in any metal, up to 1/4" diam. x 1 1/2" long, find out how much Multi-Swage can save you. Send sketch or standard parts for prompt estimate. Write for catalog today.



**THE BEAD CHAIN MANUFACTURING CO.**  
201 Mountain Grove St., Bridgeport, Conn.

Circle 162 on Inquiry Card

## NEW PRODUCTS

### CERMET TRIMMING POTS

Model 55 is a low priced pot with cermet resistance element.



Model 55 Helipot® trimming potentiometer's element is composed of a glass and precious metal mixture fused to a steatite base providing infinite resolution with high reliability, and environmental stability. The Model 55 is available in both lead and pin types, with a resistance range of 10Ω to 2 megohms. This trimming potentiometer meets or exceeds spec. Mil-R-22097B (non-wirewound) and the applicable specs. of Mil-R-27208A (Wirewound). Helipot Div. of Beckman Instruments, Inc. 2500 Harbor Blvd., Fullerton, Calif.

Circle 278 on Inquiry Card

### COAXIAL CONNECTORS

Precision Coaxial Connector with VSWR repeatable to within 0.05%.

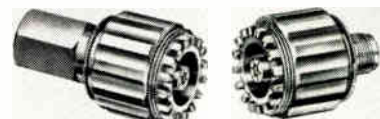

Type 900-BT is the first of a series of precision coaxial connectors. These are butting connectors, any two of which, although identical, mate. VSWR is less than 1.002 to 1000Mc, 1.01 up to 9000Mc, with VSWR repeatable to within 0.05%. Other members of the 900 line are precision air-line sections, terminations, and adaptors to other connectors. Type 900-LB Precision Slotted Line, equipped with Type 900 connectors, extends the range of VSWR measurements down to a few tenths of 1%. General Radio Co., West Concord, Mass.

Circle 279 on Inquiry Card



# Now available!

# THREE NEW FILTER FAMILIES

## designed to improve future systems!

If you are concerned with new systems development, and would like to take advantage of advanced technology and the kind of sophistication that will improve transient response and eliminate obsolete circuitry . . . then here are three new filter families, that have advanced the state of the art, which you can immediately incorporate in your network designs — exclusive from Burnell. Call or write today for literature and technical assistance.

Burnell offers the most complete line of communications network components available to the electronics industry, with a versatility of experience unmatched in the production of filters, delay lines and toroids for interpretation of *complex signals*. Burnell will custom design filter networks to your specifications which may include special delay, attenuation, and transient response, involving precisely specified rise time, overshoot and ringing.

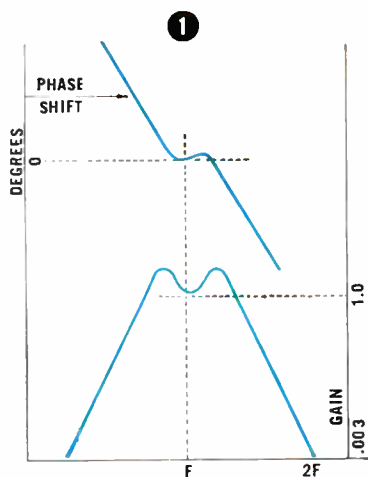

ZERO PHASE FILTERS

Impedance	1000 ohms/Grid 400 cps Center		
<b>ATTENUATION &amp; PHASE CHARACTERISTICS</b>			
OP SERIES	OP400 L	OP400 M	OP400 H
Pass Band (3 DB)	±20 cps	±20 cps	±20 cps
Harmonic attenuation 2nd harmonic and all higher frequencies	50 DB		
Harmonic attenuation (2nd)	>15 DB	>25 DB	
Harmonic attenuation (3rd)	>40 DB	>60 DB	
Max. phase ±20 cps	±1°	±1°	±1°
Max. phase ±30 cps			±5°
Phase shift at Center Frequency	0° ± 1/2°	0° ± 1/2°	0° ± 1/2°
Gain =	UNITY	UNITY	UNITY
60 cps equivalent filters are also available having a pass band of ±5% with phase of ±1°.			

For the Servo Engineer . . .  
By specifying Burnell's new line of Zero Phase shift networks, it is possible to recover, without phase shift, the fundamental frequency from any periodic wave form without using complex squaring circuitry. This advancement in the state of the art is accomplished by combining zero phase shift in the vicinity of the center frequency — with high attention in the stop bands.

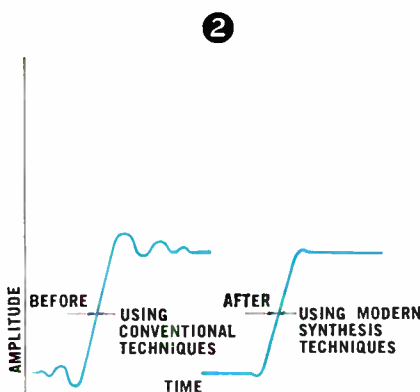

### LOW PASS FILTERS WITHOUT DISTORTION

This family of filters is designed with modern synthesis techniques to have specified transient characteristics such as fast rise time, low overshoot and ringing.

60/3 DB Shape Factor	Ringing (over/undershoot)
2:1	< 5%
3:1	< 2%
4:1	< 1%

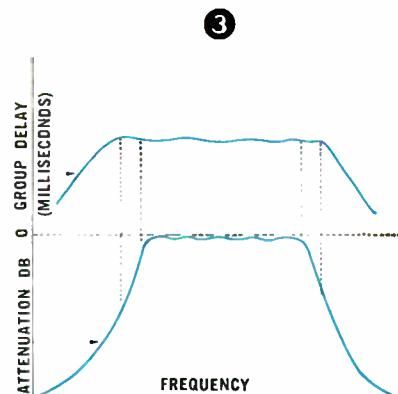

### CONSTANT DELAY BAND PASS FILTERS

This is part of a family of constant delay band pass filters of unusual characteristics, for example:

- 1—Group delay is constant well into the stop band!
- 2—Matched delay—as an example of delay matched band pass filters, we have produced a set of four filters having the same band widths of 500 cycles at 1 1/2 DB with center frequencies ranging from 680 cycles to 2720 cycles; having a 20 DB band width of 710 cycles with group delay constancy of ±3 1/2% over the pass band and between channels.
- 3—Constant flat delay band pass filter.

Frequency	Attenuation
5210 cps to 8336 cps	< .5 DB
1,000 cycles & below	> 20 DB
10,000 cycles & higher	> 20 DB
Delay: Group delay constant ±1% from 3,500 cps to 9,900 cps.	

Copyrighted 1962

## Burnell & Co., Inc.

PIONEERS IN microminiaturization OF TOROIDS, FILTERS AND RELATED NETWORKS

SUBSIDIARIES: Gray & Kuhn, Inc., Pelham, New York • GLP Electronics, Inc., Bristol, Conn.

EXECUTIVE OFFICE  
AND PLANT  
DEPT. EI-34  
PELHAM, NEW YORK  
PELHAM 8-5000  
TELETYPE PELHAM 3633



PACIFIC DIVISION  
SOUTH PASADENA, CAL.  
MFD. IN CANADA  
BY EDO (CANADA) LTD.  
CORNWALL, ONT.  
WELLINGTON 2-6774

# NEW PRODUCTS

## PULSE TRANSFORMER

Sub-miniature RX molded units in a 0.300 in. cube.



Designed for installation in a variety of transistorized circuits where space is a critical factor. These compression molded pulse transformers, enclosed in flame-proof epoxy, are all of identical size. PCA Electronics, Inc., 167 Schoenborn Street, Sepulveda, California.

Circle 280 on Inquiry Card

## POWER TUBES

Two beam power pentodes have output ratings of 40W.

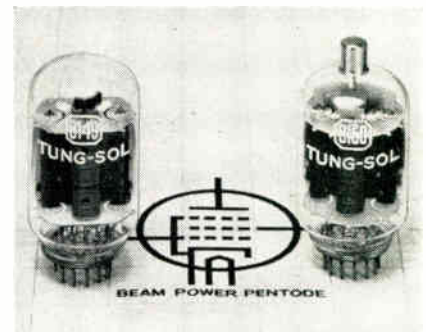

For use as r-f power amplifiers and oscillators. Type 8149 is single end T-12 and Type 8150 is double end T-12. Both types feature a center-tapped heater. Absolute max. ratings on the two types for freqs. up to 175mc include dc plate voltage of 450v; screen grid voltage, 250v with power dissipation rating of 3.3w; control grid voltage, -150v. Max. bulb temp. is 240°C. Heater current is 1.20a with 6.5v. Transconductance is 7500  $\mu$ mhos and amplification factor, triode connected is 4.5. Type 8149 is in standard JEDEC 12-57 outline and Type 8150 in JEDEC 12-86. Both tubes have 12 pin button bases and cathodes coated unipotential. Tung-Sol Electric, Inc., 1 Summer Ave., Newark 4, N. J.

Circle 281 on Inquiry Card



CTS now offers Type 211 selector switch to meet Amendment 1 of MIL-S-3786A. Designed for precision military and industrial applications requiring long life and accurately controlled torque. Color orientation on each wafer virtually eliminates danger of reassembly errors. Contact positions are easily identified by numbers on the rear plate. Unprecedented switch uniformity and elimination of human error are achieved through automated wafer manufacture. Terminal lugs, center contact ring and stator contacts remain an integral circuit pattern because they are stamped from a single metal piece. Insulation is not affected by soldering. Available with one-to-twelve wafers.

Type  SRO3  S  30  A  3  M  P and Type  SRO3  N  30  A  3  M  P

**SRO3** STYLE  
1. 2. 1. 1 Covered  
in MIL-S-3786/3A

**S** or **N** CONSTRUCTION 1. 2. 1. 2 Symbol  
N: Open construction without sealed shaft or bushing; Symbol S: Open construction with sealed shaft & bushing

**30** ANGLE OF THROW 1. 2. 1. 3  
30° between adjacent detent position also 60°

**A** TEMPERATURE-LIFE CHARACTERISTIC 1. 2. 1. 4;  
10,000 Rotational Cycles at -65°C to +125°C

**3** VIBRATION GRADE 1. 2. 1. 5;  
10 to 2000 cps.

**M** SHOCK TYPE 1. 2. 1. 6; Medium Impact

**P** INSULATION 1. 2. 1. 7; Plastic

Founded



1896

T. M.

**CTS CORPORATION • ELKHART, INDIANA**

West Coast: Chicago Telephone of California, Inc., 1010 Sycamore Avenue, South Pasadena, California • In Canada: CTS of Canada Ltd., Streetsville, Ontario



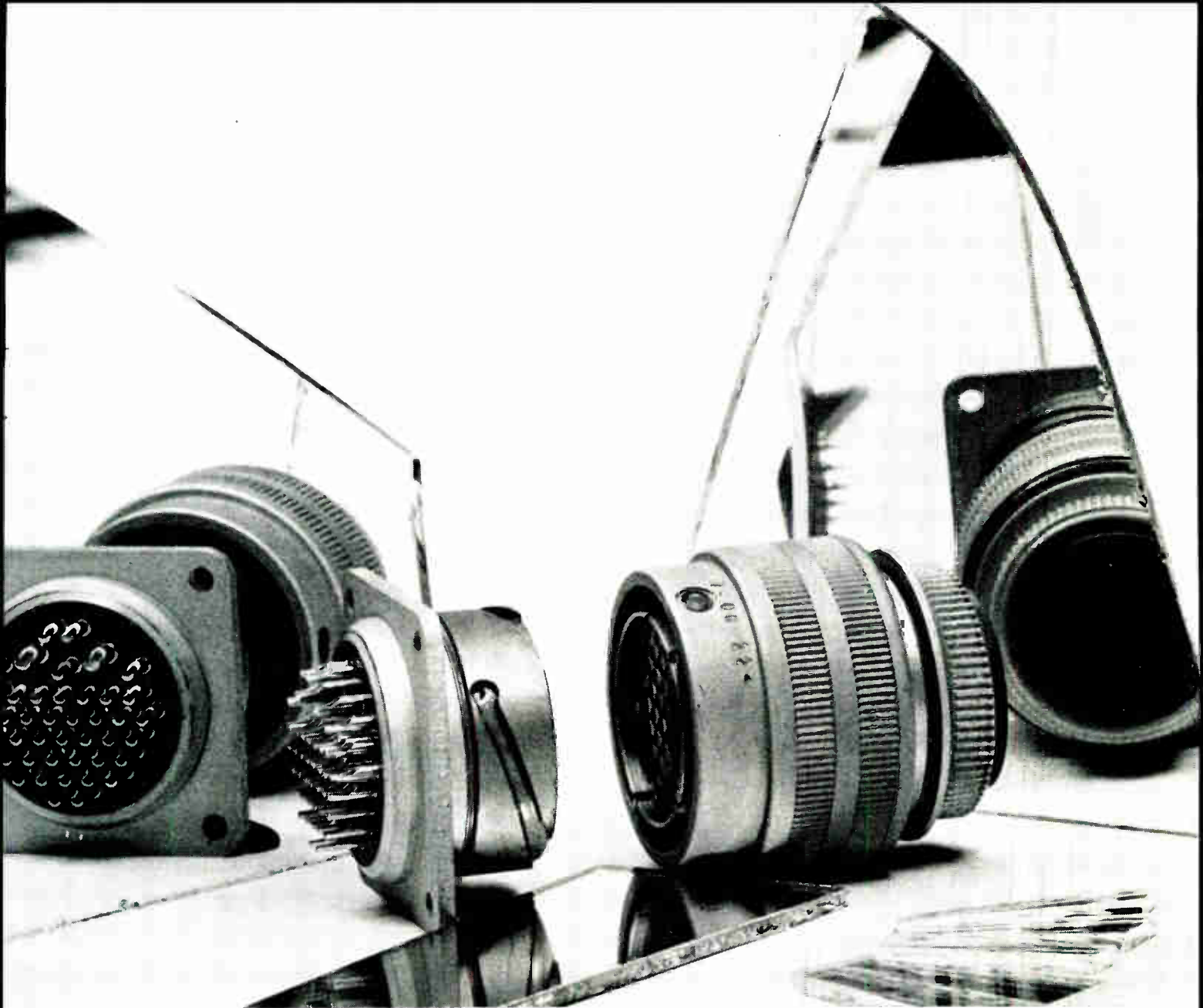

# Showoff

The Amphenol Minni E<sup>®</sup> connector does more than conform to MIL-C-5015. On the really important points, it far exceeds requirements.

For example, during and after a twenty-day moisture resistance test, Minni E insulation resistance is 1,000 megohms minimum. 100 megohms is plenty to meet the specifications. Minni E's withstand 2,000 cycles of vibration testing at 20 g's. MIL-C-5015 specifies 500 cycles. And, after three cycles of grueling altitude-immersion testing, Minni E's have an in-

sulation resistance of 1,000 megohms. MIL-C-5015 doesn't even contain an altitude-immersion test requirement.

It's tough enough just meeting specs. Why deliberately design connectors to exceed them?

Dependability is why.

Amphenol engineers use specs as a starting point—not the last word. If their experience in connectors (how to design them for what they'll have to do) tells them added performance is needed—

added performance is added.

That's the only way we can be certain of getting the highest possible dependability built into connectors.

A wealth of technical information on Amphenol Minni E connectors is yours for the asking. Just write Dick Hall, Vice-President, Marketing, Amphenol Connector Division, 1830 S. 54th Avenue, Chicago 50, Illinois. Or, if you prefer, contact an Amphenol Sales Engineer or Amphenol Industrial Distributor. He'll be happy to "show off" the Amphenol Minni E.

**AMPHENOL**

**Connector Division / Amphenol-Borg Electronics Corporation**

Circle 116 on Inquiry Card

World Radio History



**what's our  
Marketing  
Vice  
President  
doing in the  
Quality  
Control Lab?**



HE'S WITNESSING RELIABILITY IN ACTION at one of the many check-points where you may find him anywhere in our new Plant. For product reliability is his major interest, as it is with everyone at ELCO. That is why the ELCO Connector, sold under the trade-mark VARICON, is the industry's most respected; and specified by the world's most critical quality users over all others. Send for our VARICON® Connector literature today to learn how you, too, may benefit from its proven reliability!

*if it's new . . . if it's news . . . it's from . . .*



ELCO CORPORATION—New Main Plant and Offices: Willow Grove, Pennsylvania  
OLdfield 9-7000, Area Code 215

Also Licensees, Importers, Distributors, Representatives Throughout the World



Leo Kagan, Vice President—Marketing, observes Quality Control Manager, James S. Koukidas, test withdrawal force of VARICON® Contacts to ascertain correct tension for optimum performance. Unique Master Test Fixture shown checks 4 coined mating surfaces of VARICON® Contact tuning-fork nose; also calibrates similar ELCO Test Fixtures in the field. For complete information, write Dept. QC on your company letterhead.

# NEW PRODUCTS

**NEW**  
FROM WESTON

## CAPACITANCE ANALYZER

*For capacitance, dissipation factor, and polarization voltage measurement.*



Model 510 also shows leakage current directly. To operate, the desired polarizing voltage is adjusted, the capacitor to be measured is connected, then capacitance, DF and leakage current are directly indicated. Capacitance between 0.01 and 3000 $\mu$ f may be measured. Four DF ranges are provided having full-scale sensitivities of 3%, 10%, 30%, and 100%. Measurement test freq. is 120cps. Polarizing voltages between 0 to 450v may be adjusted and leakage currents as low as 0.01 $\mu$ a may be measured. Dytronics Co., Inc., 5485 N. High St., Columbus 14, Ohio.

Circle 284 on Inquiry Card

## TAPE READER AND SPOOLER

*Units operate for 10,000 hrs. minimum with normal maintenance.*

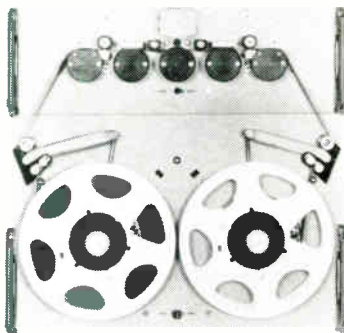

The RR-300 MB Bidirectional Tape Reader and RS-300M Tape Spooler conform to military specs. for this type. Reader can sense tape of 8 levels plus sprocket hole at 300 characters/sec. continuously and stop on-character. Also capable of reading in asynchronous line-at-a-time mode at speeds of 100 c/sec. normally and 200 c/sec. for special applications. Spooler uses standard 8 in. NAB reels and provides forward and reverse at 200 in./sec. Customized models of both units are available. Rheem Electronics Corp., 5200 W. 104th St., Los Angeles 45, Calif.

Circle 285 on Inquiry Card

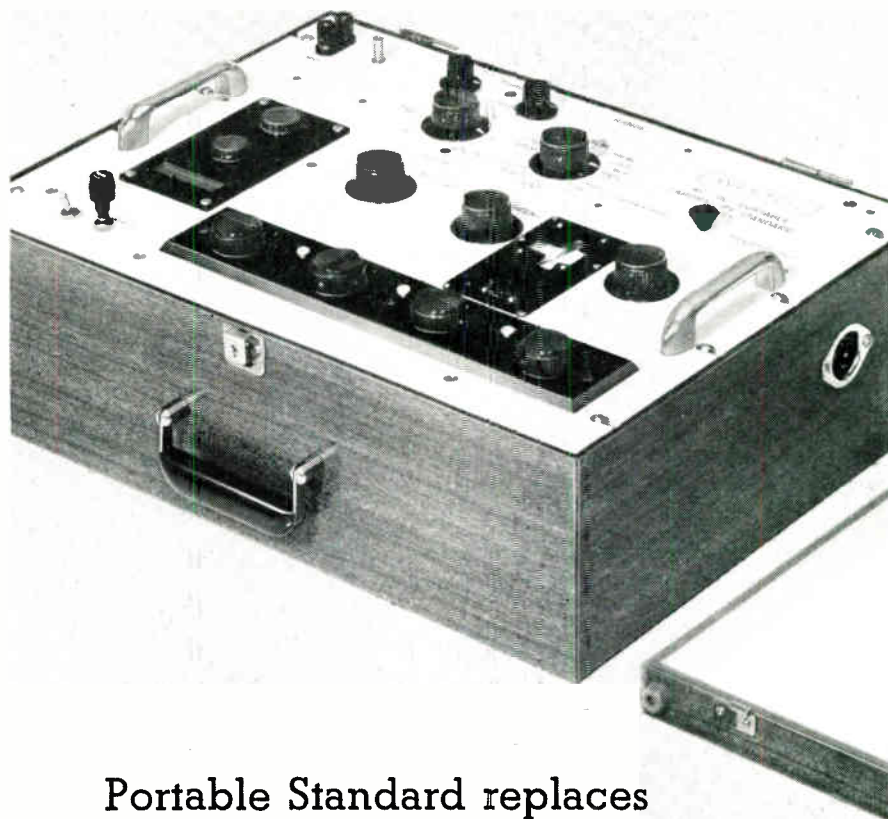

## Portable Standard replaces eleven other standards

New Weston Portalab® is an ac-dc portable laboratory voltammeter with unusual features. It combines  $\pm 0.05\%$  accuracy of indication, plus light, rugged construction for field and production testing. Truly portable, it performs the measurements of eleven precision instruments, permitting lab accuracy on location.

Direct readout and a movable, lighted decimal point eliminate interpolation, make reading easy. A highly-stable Zener reference source is contained in a temperature controlled oven. The Portalab is designed for use from  $-10$  to  $+40^{\circ}\text{C}$ , ambient. Fuses and instrument relays protect measuring circuit against overload, and a diode network guards thermo elements against damage.

Range, dc: 0.01 to 1,500v; 100  $\mu$ a to 1.5 amperes. True RMS response is provided in ac measurements: 1 to 1,200v; and 0.01 to 12 amperes. Frequency span: dc and 50 to 2,500cps (5,000cps to 120v). Input power: 105/130v, 50/440cps. Write for details on Model 1572 Portalab.

**WESTON**   
**Instruments & Electronics**  
614 FRELINGHUYSEN AVENUE, NEWARK 14, NEW JERSEY

*Division of  
Daystrom,  
Incorporated*

# NEW TECH DATA

for Engineers.

## Silicones Guide

A 20-page general reference classifying available silicone materials by product and application. The new, "Guide to Dow Corning Silicones," coded 0-005, describes the physical forms and applications of fluids, lubricants, resins, adhesives, dielectrics, and water repellents. Dow Corning Corp., Midland, Mich.

Circle 286 on Inquiry Card

## Digital Packages

This 8-page catalog describes transistorized digital logic elements, digital teaching console, power supply, etc. Includes descriptions and specs. Tech Serv, Inc., 5451 Holland Dr., Beltsville, Md.

Circle 287 on Inquiry Card

## Meter Catalog

Catalog 35, 16 pages, contains selection tables that show meters available by model number, ranges, resistance for each meter size, specs., dimensions, and prices. Honeywell Precision Meter Div., Grenier Field, Manchester, N. H.

Circle 288 on Inquiry Card

## Transistor Brochure

A 32-page illustrated booklet "The Sperry Silicon Planar Transistors," presents information concerning circuit applications, test data, weight reduction, volume, and cost. Also included are detailed parameter distributions and variation curves. Requests should be made on company letterhead to Sperry Semiconductor, Div. of Sperry Rand Corp., Norwalk, Conn.

## Test Equipment

This 24-page catalog describes new electronic measuring equipment and provides applications, specs., and performance data. Daven Div. of General Mills, Inc., Livingston, N. J.

Circle 290 on Inquiry Card

## Magnetic Components

A 20-page bulletin on high-performance r-f and i-f magnetic components is available from Relcoil Products Corp., Div. of Hi-G, Inc., Spring St. & Route 75, Windsor Locks, Conn. Includes performance specs. and test-circuit schematics.

Circle 291 on Inquiry Card

## Wire Terminals Chart

A new full-color illustrated 21 x 23 in. wall chart, publication No. T-42, that illustrates solderless Sta-Kon wire terminals (nylon insulated and non-insulated), is available from Thomas & Betts Co., 36 Butler St., Elizabeth, N. J. Shown are insulated terminals, dimensions, and specs. for all terminals from No. 8 AWG through 250 MCM.

Circle 292 on Inquiry Card

## Low-Noise Cable Charts

Instrumentation low-noise cables are described in Bulletin CBL-3a, offered by Microdot Inc., 220 Pasadena Ave., So. Pasadena, Calif. Charts of electrical and physical characteristics of coax, twinax, and triaxial cables are featured.

Circle 293 on Inquiry Card

## Modular Power Packs

A 2-color catalog sheet describes the all-silicon high-temperature modular-power packs available from Electronic Research Associates, Inc., 67 Factory Place, Cedar Grove, N. J.

Circle 294 on Inquiry Card

# Taylor works magic

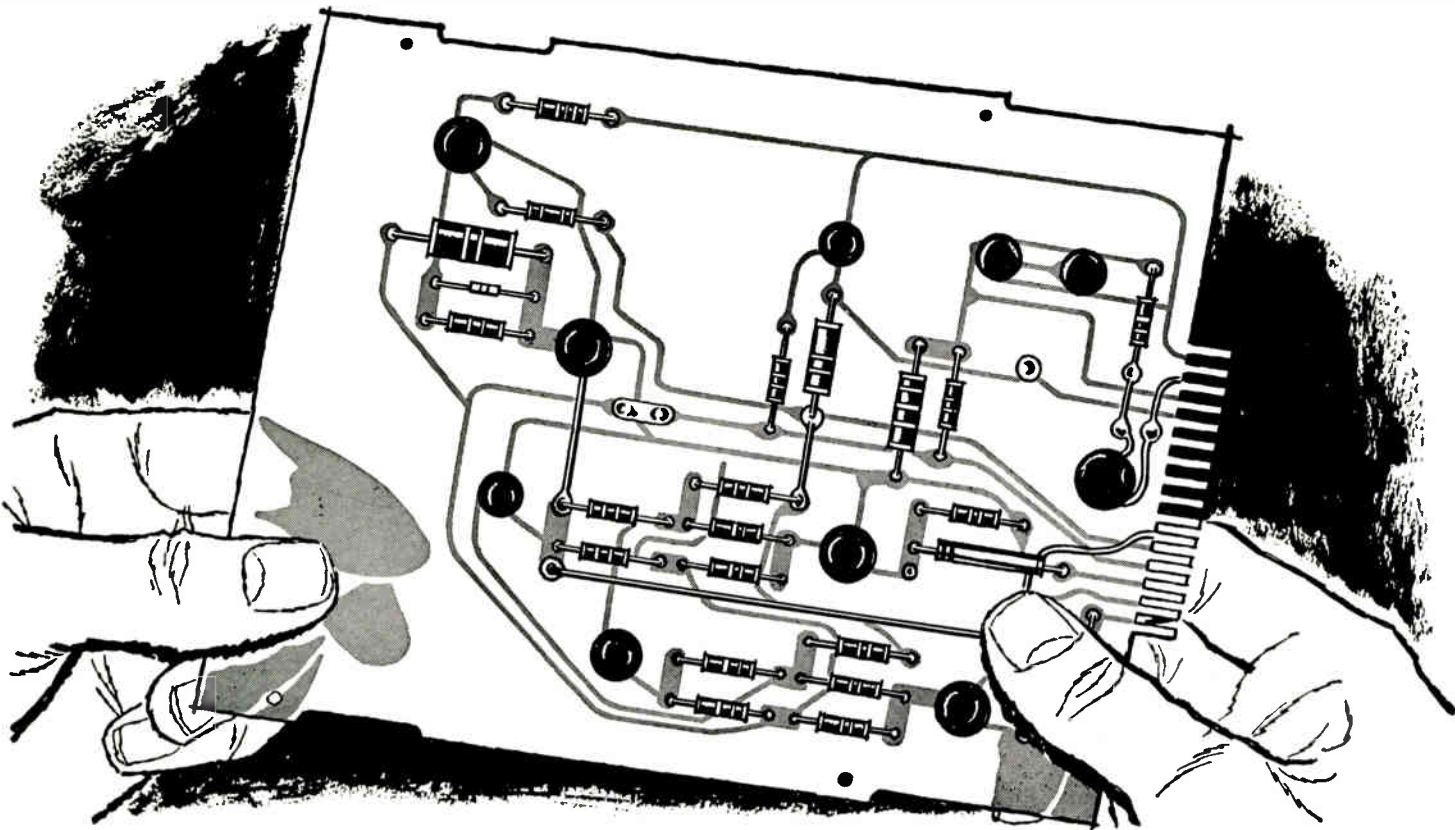



# NEW TECH DATA

for Engineers.

## Forced Air Cooling Primer

The 28-page pocket-size handbook is for the engineer who designs forced-air cooling systems. It provides a basic design outline and check lists of factors that should be considered in cooling-system design. Requests on company letterhead should be made to The Henry G. Dietz Co., Inc., 12-16 Astoria Blvd., Long Island City 2, N. Y.

## Telemetry Systems

A 12-page illustrated brochure, which discusses spacecraft PCM telemetry systems, explains engineering and production problem-solving techniques used in the development of missile and satellite electronics. PCM telemetry package to be used in the Nimbus satellite, the 8 lb., 120-channel PCM telemetry package used in Telstar, and the PCM spacecraft data-handling and experimental data-handling telemetry system supplied for the OAO satellite are discussed. Radiation Inc., Melbourne, Fla.

Circle 296 on Inquiry Card

## Connector Brochure

Bulletin M-101, 32-pages, details the characteristics, capabilities, dimensions, and specs. of Pyle-Star-Line Neptune Series of stainless-steel connectors designed for Mil-CO26500B requirements. Uses include airborne electronics, test, checkout, and ground support equipment. The Pyle-National Co., Connector Div., 1334 N. Kostner Ave., Chicago 51, Ill.

Circle 297 on Inquiry Card

## Instrument Catalog

A short-form catalog of test instruments, which describes test equipment for incoming inspection, engineering evaluation and manufacturing final test, is available from Fairchild Semiconductor, 545 Whisman Rd., Mountain View, Calif.

Circle 298 on Inquiry Card

## Switches & Relays

A revised catalog, showing the various types of precision snap switches, relays, and motor products which it manufactures is available from Robertshaw-Fulton's Acro Div., Columbus, Ohio.

Circle 299 on Inquiry Card

## Soldering-Methods Handbook

Complete information on new resistance-soldering methods, equipment, and tools are condensed in a 12-page handbook and catalog. It aids in making quick analysis of resistance soldering. Includes specific data on equipment, performance, outputs, weights, sizes, and the miniature tools now being introduced. Wassco Glo-Melt Div., American Electrical Heater Co., 6110 Cass Ave., Detroit 2, Mich.

Circle 300 on Inquiry Card

## Panel Instruments

A 16-page, illustrated catalog listing new panel instruments. Includes information on dimensions, ranges, tolerances, and price. Triplett Electrical Instrument Co., Bluffton, Ohio.

Circle 301 on Inquiry Card

## Ferrite Cores

A new line of medium-temp. ferrite cores that operate over the  $-55^{\circ}\text{C}$  to  $+85^{\circ}\text{C}$  range are described in a bulletin from Electronic Memories, Inc., 9430 Bellanca Ave., Los Angeles 45, Calif.

Circle 302 on Inquiry Card

# with glass-base laminates

Which grade has the unusual combination of properties you need?

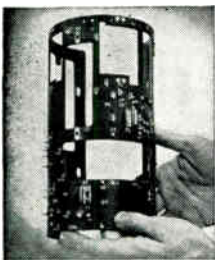

Almost magical combinations of resin formulations and glass reinforcements have enabled Taylor to develop a number of glass-base laminates that have outstanding characteristics for electrical and mechanical applications. For example, the glass silicone grades offer very high heat

resistance combined with excellent mechanical and electrical properties plus the highest arc resistance. If you require extremely high strength, excellent chemical resistance, low moisture absorption and high strength retention at elevated temperatures select one of the glass epoxy grades. These grades are ideally suited for high reliability printed circuitry. Other grades have equally important characteristics.

Write to us for complete technical data.

**Taylor corporation**  
ENGINEERED PLASTICS

Valley Forge 53, Pa. • West Coast Plant: La Verne, Calif.  
(Formerly Taylor Fibre Co.)

## TAYLOR GLASS-BASE LAMINATES

Taylor Grade	NEMA Grade	Military Specification	Resin Used	Principal Characteristics
GSC	G-7	MIL-P-997 Type GSG	Silicone	High heat resistance. Excellent electrical properties, highest arc resistance. Will not support combustion.
FIREBAN 1011	G-10 G-11 FR-4 FR-5	MIL-P-18177 Types GEE and GEB	Epoxy	Combines all desirable properties of G-10 (GEE) and G-11 (GEB), plus flame retardance in one grade.
GEC-500	G-10	MIL-P-18177 Type GEE	Epoxy	Extremely high flexural, impact and bond strength. Low moisture absorption. High insulation resistance.
FIREBAN 600	FR-4	MIL-P-18177 Type GEE	Epoxy	Self extinguishing. Excellent electrical properties under high humidity conditions. Extremely high flexural, impact and bond strength.
GEC-111	G-11	MIL-P-18177 Type GEB	Epoxy	High mechanical strength retention at elevated temperatures. Will not support combustion.
G-5	G-5	MIL-P-15037 Type GMG	Melamine	High mechanical strength. Excellent arc resistance and electrical properties. Will not support combustion.
G-3	G-3	None	Phenolic	Good mechanical strength. Good heat resistance.

NOTE: Taylor Glass-Epoxy, Copper-Clad Grades are available to meet MIL-P-13949B, Types GE, GB and GF.

## MIDGET RELAYS FOR AC OR DC OPERATION

Price Electric Series 1000 Relays Now Feature . . . • AC or DC Operation • Solder or Printed Circuit Terminals • Open or Hermetically Sealed Styles

These versatile, midget, general-purpose relays, formerly available only for DC operation, are now being offered for operation directly on AC. The AC relays, of course, have the same basic features, including small size, light weight, and low cost that made the DC relays pace setters in their fields of application.

**TYPICAL APPLICATIONS** Remote TV tuning, control circuits for commercial appliances, radiosonde, auto headlight dimming.

**GENERAL CHARACTERISTICS** Standard Operating Voltages: 3 to 32 VDC; 6 to 120 VAC 60 Cycle. Maximum Coil Resistance: 13,000 ohms. Sensitivity: 0.05 watt at standard contact rating; 0.3 watt at maximum contact rating for DC relays; 1.2 volt amperes for AC relays. Contact Combination: SPDT. Contact Ratings: Standard 1 amp.; optional ratings, with special construction, to 3 amps. Ratings apply to resistive loads to 26.5 VDC or 115 VAC. Mechanical Life Expectancy: 10,000,000 operations, minimum. Dielectric Strength: 500 VRMS, minimum.

# PRICE ELECTRIC CORPORATION

323 Church St.  
Frederick, Md.  
Phone: 301/663-5141  
TWX 301/553-0462

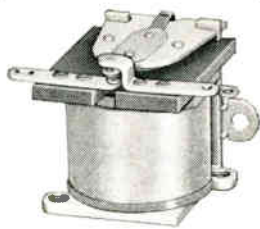

STYLE 1001  
SPDT

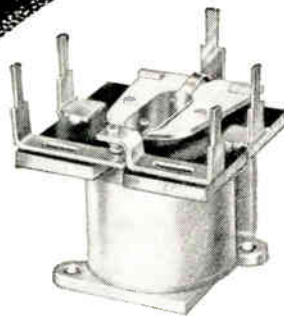

STYLE 1005  
SPDT

## NEW TECH DATA

### SCR Power Supplies

This 12-page catalog presents information on silicon-rectifier power supplies featuring 5 types of regulation: constant current/statically regulated, magamp/series-transistor regulated, magnetic amp regulated, silicon-controlled rectifier, and semi-regulated and unregulated. Photos are provided and tech. material is listed in tabular form. Christie Electric Corp., Box 43187, Los Angeles 43, Calif.

Circle 303 on Inquiry Card

### Reverse-Field Transducers

Information about a new reverse-field transducer for magnetostrictive devices which increases the dynamic range of rod-type filters and delay lines is available. A magnetic-bias circuit permits the use of a field-cancelling coil; undesired feedthrough is reduced without appreciable signal loss. Spectran Electronics Corp., 146 Main St., Maynard, Mass.

Circle 304 on Inquiry Card

### Antenna Catalog

Catalog F, 16-pages, list antennas, Foam Heliax<sup>®</sup> cables, connectors and mounts applicable to base-station installations for mobile radio services. Electrical and mechanical specs. are included. Andrew Corp., P.O. Box 807, Chicago 42, Ill.

Circle 305 on Inquiry Card

### Paper Tubular Capacitors

Bulletin 1121B1 contains electrical and mechanical specs. for Aerovox Type P161N Polycap Series of paper tubular capacitors. Graphs show typical temp. characteristics in addition to max. permissible ac voltage ratings. Aerovox Corp., New Bedford Div., New Bedford, Mass.

Circle 306 on Inquiry Card

### Immittance Chart

A new immittance chart, which measures 17 x 22 in., permits direct conversion from impedance to admittance. An aid to engineers engaged in r-f design, it consists of a Smith impedance chart which provides a graphic tool for rapid design of coupling and impedance matching networks, and may also be used to determine circuit Q. Avco Corp., Electronics Div., Dept. 121, Cincinnati 41, Ohio.

Circle 307 on Inquiry Card

### Low-Noise Diode

Subminiature silicon-zener diodes with low-noise and high-performance characteristics are described in bulletin from Western Semiconductors, Inc., 2200 S. Fairview St., Santa Ana, Calif. Ranging from types WZ 522 to WZ 544, they offer a noise voltage below that of a conventional gaseous regulator. Suitable for missile telemetry links, airborne radar, and communications gear.

Circle 308 on Inquiry Card

# LOW EXOTHERM "SCOTCHCAST" RESINS

## REDUCE YOUR INSULATING COSTS

Package your product faster, safer, more securely with "Scotchcast" Semi-Flexible Room-Curing Epoxy Resin systems. Their low exotherm prevents heat and curing strain, the major problems in potting delicate electronic parts.

"Scotchcast" Room-Curing systems eliminate the need for baking ovens, provide longer pot life. Cure safely at 72°F. in 24 hours. Or if faster cure is desired, 2 hours at 140°F. is recommended. By either method, "Scotchcast" Resin's low heat rise assures that heat-sensitive parts can be safely embedded.

"Scotchcast" Resin's built-in flexibil-

ity prevents strain on delicate components. The resins soak up temperature change stresses and resist mechanical shock. No need to worry about thermal cracking from varying coefficients of expansion of components.

And these "Scotchcast" Resins give you these additional cost-saving product advantages.

**1. Simplicity.** 1 to 1 mixing ratio by weight or volume assures complete uniformity from batch to batch. Costly mixing errors are avoided.

**2. Safety.** Low toxicity potential keeps production people happy. Prevents skin problems and unnecessary downtime.

**3. Reliability.** Exceptional mechanical,

electrical and chemical properties. Superior adhesion to glass, plastic, most metals.

Choose the ideal resin for your needs from the complete family of "Scotchcast" semi-flexible Room-Curing resins below. And for specific assistance see your 3M "IQ" Man.\* "Scotchcast" Resins are also listed in VSMF.



"IQ" means Insulation Qualified. Your 3M Man is trained and qualified to help you with your electrical insulation problems. Call him, or write: 3M Co. Bldg. 220-5W, St. Paul 19, Minn.



Both resins (1,000 gram quantities) are room-curing epoxies. "Scotchcast" No. 8 is at right, ordinary epoxy resin is at left.

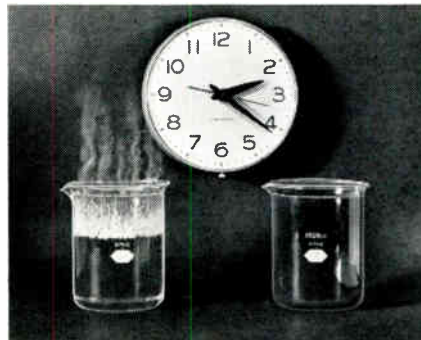

After 20 minutes, evidences of heat build-up and stresses are visibly apparent in the ordinary epoxy resin.

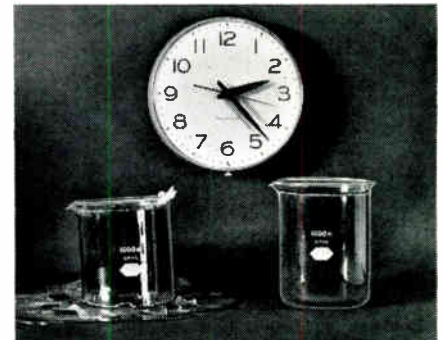

At 23 minutes, ordinary resin shatters the glass container. "Scotchcast" No. 8 remains stress-free, assures longer pot life.

### BASIC CHARACTERISTICS—"SCOTCHCAST" SEMI-FLEXIBLE ROOM CURE RESINS

	UNFILLED	FILLED	THIXOTROPIC	FLAME OUT FILLED
PRODUCTS	8	9	10	XR-5059
DESCRIPTION	Low viscosity. Excellent wetting and adhesion for impregnation of fine wire coils.	Medium viscosity. Extreme low exotherm. Excellent shock resistance. Better heat transfer.	Ideal sealing and patching epoxy. Spreads like peanut butter. Won't sag. Apply by spatula or extrusion.	Like No. 9 but with immediate flame out characteristics.
MIXING RATIO A TO B Wt. or Vol.	1 to 1			
SPECIFIC GRAVITY	1.11	1.50	1.52	1.40
INITIAL VISCOSITY	5700 cps	25,000 cps	PASTE	18,500 cps
POT LIFE MIXED RESIN	1 to 2½ HOURS (depending on mass)			
CURE CYCLES	72°F for 24 hours Or 140°F for 2 hours			
LINEAR SHRINKAGE DURING CURE	Less than 1%			
HARDNESS SHORE D	70	75	75	80
GUIDE TO AIEE TEMP CLASS	B	B	B	B

"Scotchcast" Resin is a 3M Electrical Insulation TAPES • RESINS • TUBING • VARNISHES • COATED FABRICS • LAMINATES • MICA PRODUCTS

**3M** MINNESOTA MINING & MANUFACTURING CO.

"SCOTCHCAST" IS A REGISTERED TRADEMARK OF 3M CO., ST. PAUL 19, MINN.



**NEW**  
FROM WESTON

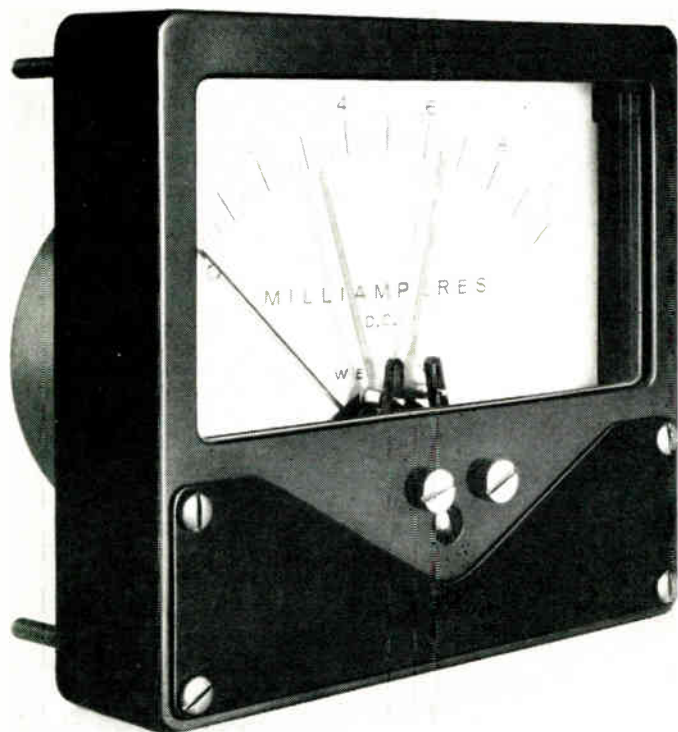

## Eliminate contact failure!

Seventy-five percent of all relay failure is due to contact failure. Weston has solved this problem by completely eliminating physical contacts in the new Model 1075 Meter Relay. Thus, pitting, arcing, chatter and contamination are also eliminated!

Model 1075 is a continuous-reading meter relay with built-in automatic reset. Non-physical contacting is achieved through use of light beams and photoresistive cells. When the pointer reaches a set point, it blocks a tiny beam of light shining on the cell and actuates the instrument's internal transistorized switching circuit. This outstanding Weston design allows a set-point separation of only 5 degrees. Contact repeatability is  $\pm 1\%$ .

In addition, increased sensitivity is provided by a Weston taut-band suspension mechanism. Fail-safe circuitry and illuminated dial are added features.

The new  $4\frac{1}{2}$ " relay has an accuracy of  $\pm 2\%$ , full scale, and is available with single or double index arms in a variety of d-c ranges. Switching capacity with load relay: 5 amperes. Operating temperature:  $-20$  to  $+50^\circ\text{C}$ , ambient. Operating voltage: 105/125v, 60cps. Write for details.

**WESTON**  
**Instruments & Electronics**  
614 FRELINGHUYSEN AVENUE, NEWARK 14, NEW JERSEY



Division of  
Daystrom,  
Incorporated

## NEW TECH DATA

### Wire Enamel

The characteristics of ISONEL 200<sup>®</sup> wire enamel are explained in a 15-page brochure. The new enamel combines features of many magnet wire coatings, and maintains balanced properties through temp. classifications of A, B, F, H, and above. It has high burn-out and cut-through resistance, and high hydrolysis resistance. Schenectady Chemicals, Inc., Section H-2, Schenectady 1, N. Y.

Circle 309 on Inquiry Card

### High-Wattage Resistors

Filmistor<sup>®</sup> carbon-film resistors meet characteristic D of Military Spec. MIL-R-10509D. The resistors are watt rated at  $\frac{1}{4}$ ,  $\frac{1}{2}$ , and 1w. Bulletin No. 7000.A shows typical life test data of 10,000 and 20,000 hr. tests. Requests should be made on company letterhead to Technical Literature Service, Sprague Electric Co., No. Adams, Mass.

Circle 310 on Inquiry Card

### Temperature Transducers

An illustrated report, 4151, describes Alumina Temperature Transducers, available from Trans-Sonics, Inc., P. O. Box 328, Lexington 73, Mass. Designed to measure temps. between  $0-1200^\circ\text{F}$  within re-entry bodies and also to study and determine thermal gradients within large masses.

Circle 311 on Inquiry Card

### Patchcords

Bulletin 7030, 4 pages, covers a broad line of patchcords. Includes specs. on contact materials, cable-lengths, color-coding, wire sizes, insulation, withdrawal force, and sizes of mating jacks. The UCINITE Co., Div. of United-Carr Fastener Corp., Newtonville 60, Mass.

Circle 312 on Inquiry Card

### Molded Terminal Strips

Catalog 9000, available from CTS Corp., Elkhart, Ind., contains illustrations, diagrams and technical data on compact glass-alkyd terminal strips. The metal terminals and high insulation material are molded together into an integral body, and are available with interconnected terminals.

Circle 313 on Inquiry Card

### Electronic Hardware

An illustrated  $18 \times 24$  in. wall chart, which gives simplified spec. data on 76 different types of self-locking nuts for aircraft, missiles, and spacecraft, is available from Standard Pressed Steel Co., Box 899, Aircraft/Missile Div., Jenkintown, Pa. Featured are SPS deflected-beam type self-locking nuts and Nutt-Shel anchor nuts and related products useful for securing chassis and components.

Circle 314 on Inquiry Card



## Metrology Instruments

A fully illustrated, 9-page catalog of Angstrom's new metrology instruments is available. Provided are operating characteristics, function and purpose, operating principles, design and construction features (including schematics), and technical notes. Angstrom Precision Inc., Greenbush Ave., N. Hollywood, Calif.

Circle 315 on Inquiry Card

## Decade Counters Catalog

A 48-page illustrated catalog, covering EECo N-series miniature plug-in decade counters and R-series Minisig<sup>®</sup> indicators, is available from Engineered Electronics Co., 1441 E. Chestnut Ave., Santa Ana, Calif. Included are product descriptions and unit specs., dimensional drawings, applications, and detailed coverage of related equipment.

Circle 316 on Inquiry Card

## Linear Temperature Tape

An illustrated brochure, giving complete technical data and application information on linear temperature tape, explains tape operation, including electrical and mechanical characteristics. Control Indicating Corp., Bradley Field, Windsor Locks, Conn.

Circle 317 on Inquiry Card

## Compact Transformers

New cvs type, 400-cycle constant-voltage transformers are illustrated in report, CV 2075. The transformers are designed to satisfy size requirements for data-processing, missile-support, inverter and air-ground support uses. Available in the 60—1000va range. Sola Electric Co., 1717 Busse Rd., Elk Grove Village, Ill.

Circle 318 on Inquiry Card

## Frictionless Potentiometer

Bulletin No. 8644 describes the Photopot, a light-actuated frictionless potentiometer. Information includes power rating, input resistance, linearity, resolution, operating temp., schematic diagrams, and an instrument selection chart. Giannini Controls Corp., 1600 S. Mountain Ave., Duarte, Calif.

Circle 319 on Inquiry Card

## Fused Resistance Decade

An illustrated report on Model 1400 describes the instrument's features of fused decades, independent wiring, and extended power dissipation. Matronic Instrument Co., P.O. Box 304, Newark, Del.

Circle 320 on Inquiry Card

## AC and DC Relays

Bulletin 703 lists various ratings of Model DOS ac and dc relays approved under the Underwriters' Laboratories Re-examination Service. Ohmite Mfg. Co., 3634 Howard St., Skokie, Ill.

Circle 321 on Inquiry Card

## Tender Loving Care

... goes into all the circuits we run in these columns (in addition to a good, hard look at performance and price considerations to give you the most efficient circuit possible at the lowest cost). So, here are a couple more tender loving examples. This time out the heart of the circuitry is the unijunction transistor.

As you know, one little unijunction transistor in a TO-5 or TO-18 case can often replace up to nine unnecessary components ... reduce overall circuit cost ... simplify circuitry ... and improve stability over a wide temperature range. (If you don't know, it certainly isn't because we haven't been telling you to these many years.) This time delay circuit using the new 2N2647 unijunction not only gives you all these advantages ... but it makes possible time delays up to 2½ minutes (with a 50 µf capacitor at C1) at a total semiconductor cost of less than \$10 (in 100 to 999 quantities). And wouldn't that be lovely?

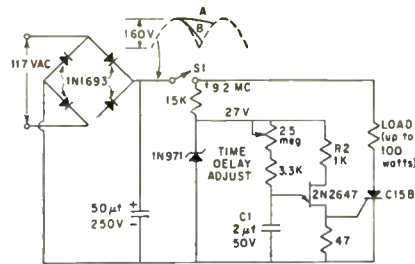

PRECISE SOLID STATE TIME DELAY CIRCUIT

This all-silicon circuit can operate directly from a 117 volt line without separate power supplies. It can handle loads (like incandescent lamps) up to 100 watts, with timing range from 8 milliseconds to 5 seconds with

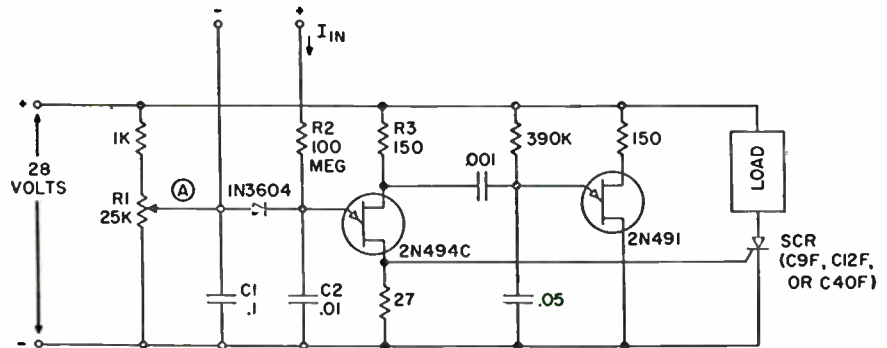

NANOAMPERE SENSING CIRCUIT WITH 100 MEGOHM INPUT IMPEDANCE

valves indicated. Another feature: the circuit has very good timing accuracy with variations in line voltage or ambient temperature.

Now, let's consider the tender loving nanoampere sensing circuit using the 2N494C. This one can be used as a sensitive current detector or as a voltage detector having high input impedance. R1 is set so that the voltage at point (A) is ½ to ¾ volts below the level that fires the 2N494C. An input current as little as 40 nanoamperes will charge C2 and raise the voltage at the emitter to the firing level. When the 2N494C fires, capacitors C1 and C2 discharge through the 27 ohm resistor, which generates a positive pulse with amplitude enough to trigger an SCR, or other pulse sensitive circuitry. And again, in

addition to a beautifully efficient little circuit, you save on overall circuit cost, simplified circuitry, and get improved stability with temperature. Love that unijunction!

In the literature department: we have several Application Notes on unijunctions that you might be interested in. We have a 79-pager called "Notes on the Application of the Silicon Unijunction Transistor" (ask for bulletin 90.10), we have "Characteristics and Applications of the ZJ95, A New High Performance Unijunction Transistor" (bulletin 90.11) by T. P. Sylvan and V. A. Bluhm, and we have the D. V. Jones opus called "Unijunction Temperature Compensation" (90.12). They're all free. Just write Section 13D147.

## A New Concept

... in transistor manufacturing! The new 2N2711 series silicon planar passivated transistor is manufactured and marketed strictly for entertainment applications ... it is not a "fallout" from existing product types. You get silicon performance at germanium prices, high power gain, low noise, high gm, high Beta, low I<sub>CEO</sub>, high mechanical strength and small size (fits TO-18 outline) for TV, hi-fi and portable radio. No high-cost glass-to-metal seal because a unique new solid-epoxy housing is used. AND ONE MILLION LIFE TEST HOURS BACK UP THE RELIABILITY OF THE 2N2711 SERIES. Ask your G-E Semiconductor District Sales Manager for complete details, or write to us.

Any questions? Write to Section 13D147, Semiconductor Products Department, General Electric Company, Electronics Park, Syracuse, New York. In Canada: Canadian General Electric, 189 Dufferin St., Toronto, Ont. Export: International General Electric, 159 Madison Ave., New York 16, N. Y.



# GENERAL ELECTRIC

our stock  
answer is  
**YES**

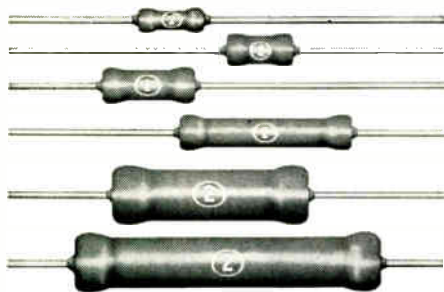

ALL UNITS ACTUAL SIZE

**ALL AXIAL LEAD  
BLUE JACKET  
RESISTORS**

*in 1, 2, 3, 5, 7 and 10-watt  
power ratings are carried in  
factory stock for immediate  
delivery. Place your order now  
with your nearest Sprague  
District Office or Sales  
Representative. Key  
Sprague Industrial Distributors  
carry most popular ratings  
in local stocks.*

**SPRAGUE ELECTRIC COMPANY**  
233 Marshall Street, North Adams, Mass.



Circle 126 on Inquiry Card

**Pulse Network Problems  
Solved by Experienced  
Systems Engineers**

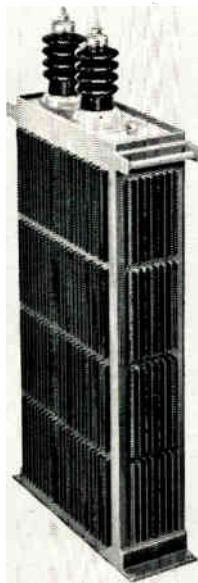

Typical Large Pulse-Forming Network designed by Sprague to meet a specific customer need.

Prompt cooperation on customers' pulse network problems is readily available from Sprague Electric Company's Pulse Capacitor and Network Section.

Sprague has much to offer to designers of radar systems, laser systems, tube testing systems, and other specialized systems. A highly-technical special engineering section devoted exclusively to pulse capacitors and networks includes systems as well as pulse network engineers. Sprague can help you with your problems because Sprague fully understands your problems!

But Sprague service does not end here. Following up the design aspect, these specialists can quickly and efficiently estimate pulse network sizes and prices for bidding purposes. They are also equipped to give quick reaction capabilities for your breadboard and prototype units.

A pioneer in pulse networks, Sprague is a major supplier of custom units from less than 1 KV up to 500 KV over a broad range of power levels.

For application engineering assistance, or additional information, write to Pulse Network Section, Sprague Electric Company, 233 Marshall St., North Adams, Massachusetts.

Circle 127 on Inquiry Card

**NEW TECH DATA**

**Semiconductors Catalog**

"1963 Condensed Raytheon Semiconductors Catalog," 24 pages, describes germanium and silicon, miniature and sub-miniature transistors and diodes, silicon rectifiers, and Circuit-Pak and Weld-Pak circuit modules. Includes charts, drawings, and photos. Raytheon Co., Semiconductor Div., 350 Ellis St., Mountain View, Calif.

Circle 328 on Inquiry Card

**Pressure-Sensitive Tape**

A 6-page brochure entitled, "Reliability . . . another word for Tape of Teflon<sup>TM</sup>" contains a description of 8 pressure-sensitive tapes, a physical properties table, and electrical, mechanical and chemical applications. The Connecticut Hard Rubber Co., 407 East St., New Haven 9, Conn.

Circle 329 on Inquiry Card

**Digital Circuit Modules**

A 20-page color catalog details Scientific Data Systems line of all-silicon semiconductor digital-logic modules. Complete specs. and circuit drawings are given. Scientific Data Systems, 1649 17th St., Santa Monica, Calif.

Circle 330 on Inquiry Card

**Thin-Film Microcircuits**

Information on thin-film resistor and capacitor design parameters is presented in CF-11.00 from Corning Electronic Components, Corning Glass Works, Raleigh, N. C. Includes resistor range, max. voltage, capacitor range, power rating, tolerance, and min. substrate thickness.

Circle 331 on Inquiry Card

**Ceramics**

A 24-page illustrated bulletin includes topics on materials, fabrications, tolerances, finishes, and uses. A good reference for engineers in electronic, nuclear, mechanical, or chemical fields. American Lava Corp., Manufacturers Rd., Chattanooga 5, Tenn.

Circle 332 on Inquiry Card

**Voltage-Tunable Magnetrons**

Tech. bulletin PT-68, 28 pages, details information on VTM theory, construction, operating precautions and application, including fixed- and swept-freq. operation. Also discusses use in severe environments and power-supply design. General Electric Co., Power Tube Dept., Schenectady, N. Y.

Circle 333 on Inquiry Card

**Ultrasonic Cleaning**

A new line of high-intensity cleaning and micro-burring systems are available from Durasonics Div., Rua-Bond Bearing Co., 3201 Ash, Palo Alto, Calif. The systems feature no tuning, high-efficiency lead zirconate massloaded transducers, field replacement of transducers, and frequencies of 20kc—90kc.

Circle 334 on Inquiry Card



# NEW HIGHS IN LOW-LEVEL SIGNAL RECORDING

Whether your problem is testing, measurement, or shaping an electronic signal for transmission, you may well find its solution here—in one or more of the instruments that form the integrated line now available off-the-shelf from the Instrumentation Division of Microdot Inc.

**SENSING:** A variety of rugged, miniaturized sensing elements are available, right from stock. These include:

**WELDABLE STRAIN GAGES** by Microdot install in 60 seconds to provide precise static or dynamic measurements of strain resulting from pressure, force, acceleration and other physical quantities at temperatures up to 650°F (static) and 1500°F (dynamic). Hermetically sealed, integral lead types are available for underwater testing. Get details in Bulletin SG-1A.

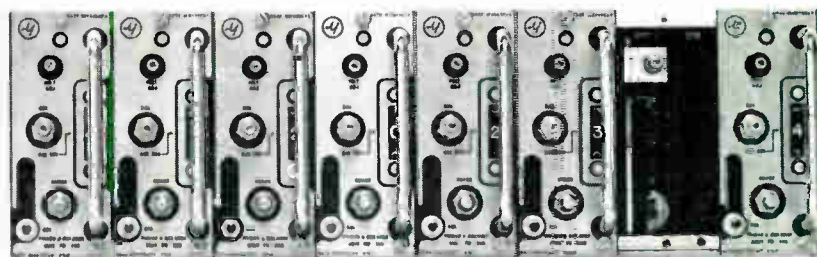
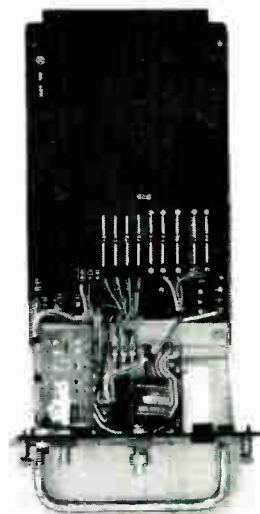

**CONDITIONING:** These rack-mounted units have been designed to pack a variety of performance in minimum space. For example:

**TRANSDUCER SIGNAL CONDITIONING UNITS** by Microdot utilize a radically new packaging concept and advanced circuitry to deliver high accuracies at low cost-per-channel. Both Power Supply and Power Supply & Balance units incorporate plug-in card circuits for up to eight channels in 5 1/4" of standard rack. Read Bulletin PB-1.

**VOLTAGE AND BALANCE PANELS** by Microdot combine digital readout voltmeter, bridge output meter and null indicator at less than usual combined cost of separate instruments. Units fit 3 1/2" of standard rack, have four-digit read-out with a fifth digit available by interpolation. Get Bulletin VB-3.

Whatever your need or application for these or related instruments, contact your nearby Microdot representative. Or, write us direct.

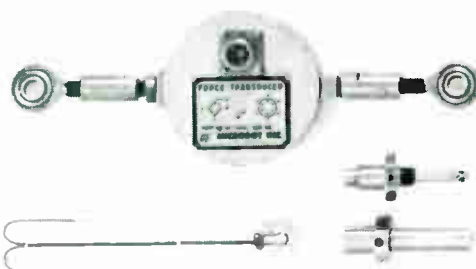

**FORCE TRANSDUCERS** by Microdot are rugged, ring-configuration load cells utilizing Microdot Weldable Strain Gages to measure both tension and compression loads over a full scale of 100 to 50,000 lbs. with  $\pm 1\%$  accuracy over a temperature range of  $-300^\circ\text{F}$  to  $+650^\circ\text{F}$ . Write for Bulletin FMT-1.

**TEMPERATURE TRANSDUCERS** by Microdot are available in both surface-mounting and probe types. Utilizing unique platinum-film-on-ceramic sensing elements, they make fast-response measurements at  $-450^\circ\text{F}$  to  $+800^\circ\text{F}$  Miniaturized and qualified for missile vibration environments. Bulletins TT-1, STT-1 and STT-2 have full information.



**AMPLIFYING:** DC Amplifiers by Microdot are solid-state, less than five cubic inches in volume and under six ounces in weight—yet deliver DC gain of 50 to 1000  $\pm 0.75\%$ . Input capability is 5 millivolts differential at maximum gain; output capability is  $\pm 5$  volts into not less than 20K (single-ended).

These rugged instruments are available in models with and without self-contained power supplies; with solder, plug-in, coax or combination header arrangements; and with a variety of mountings. For details, ask for Bulletin DCA-1B.



**MICRODOT INC.**

220 Pasadena Ave., South Pasadena, Calif.  
Overseas: Microdot AG, Zug, Switzerland

Circle 128 on Inquiry Card

## NEW WALL CHART

can help you solve

# high voltage connector problems

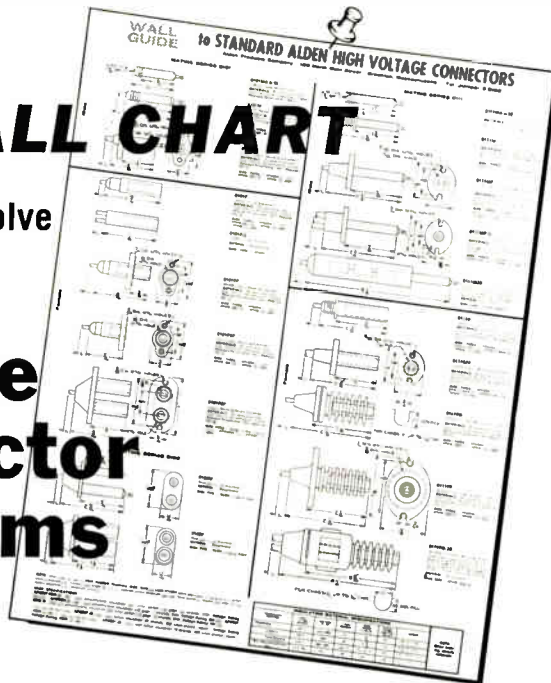

You can choose from a complete series of standard designs and specify your particular connector environmental needs.

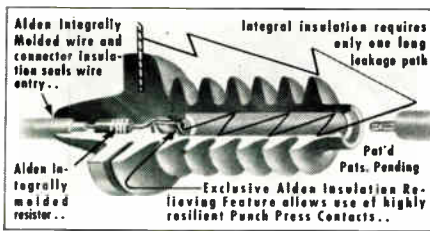

**Engineering samples can be in your hands by return mail!**

The Alden High Voltage Wall Chart contains full scale engineering, drawings, connector specs, wire types, and insulating material descriptions to simplify your planning, layout and specifying.

Unique Alden High Voltage Connectors are more reliable, simpler and less expensive than conventional designs; will tame arc-over and corona problems at voltages up to 30 KVDC.

The exclusive Alden "IMI" (integrally molded insulation) makes it possible to mold insulation forming the connector body in a single hot shot directly around leads, contacts, and any special circuit components such as chokes, resistors or corona shells.



A few of the many Alden IMI High Voltage Connectors and tube caps available for solving your problems.

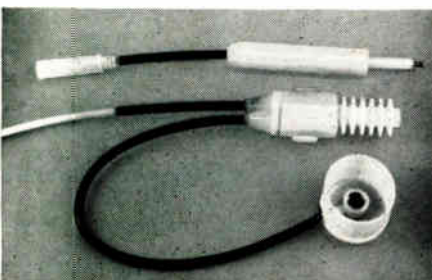

Connectors with leads tailored to meet your specs — operating voltage, circuitry layout and environmental conditions, or can be molded into Unit Cables.

*This one shot technique actually adds reliability yet saves production costs and these savings are passed on to you.*

Send for the free Alden High Voltage Wall Chart — use it to determine the best standard design for your particular application then contact us for a sample connector or proposal tailored specifically to your needs. Write to:

# ALDEN

PRODUCTS COMPANY  
4123 N. Main St., Brockton, Mass.

### Motor Catalog

Catalog 500 contains photos, line drawings, performance curves, graphs, diagrams, spec. data, size designation, and model number for new fractional horsepower motors. Engineered Products Div. of U. S. Industries, 6312 Hollister Ave., Goleta, Calif.

Circle 335 on Inquiry Card

### Light Measuring

Light measuring instruments are described in circular 06-400 from Weston Instruments and Electronics Div. of Daystrom, Inc., 614 Frelinghuysen Ave., Newark 14, N. J. Listed are sightmeters, illumination, foot-candle, and foot-lambert meters.

Circle 336 on Inquiry Card

### Insulation Tester

Bulletin IT-52, 4 pages, discusses design, construction, and operating features of the Model IT-52 insulation tester, which is used with either ac or dc hipotting. Schematic, specs., and performance data are included. Western Electrodynamics Inc., 707 Hathaway Dr., Dynamics Park, Colorado Springs, Colo.

Circle 337 on Inquiry Card

### Trimming Potentiometers

Data sheet 63367 describes Helitrim<sup>®</sup> Model 50 and introduces the new Helitrim Model 55 trimming potentiometers. Included are electrical, mechanical, and environmental specs. Helipot Technical Literature Service, 2500 Harbor Blvd., Fullerton, Calif.

Circle 338 on Inquiry Card

### Enclosures

A new 36-page illustrated catalog, "KSE Enclosures," illustrates and describes glove, vacuum and dry boxes; controlled-atmosphere enclosures; dust-free enclosures; and special TDC enclosures for semiconductor manufacture. Kewaunee Scientific Equipment, 4012 Logan St., Adrian, Mich.

Circle 339 on Inquiry Card

### High-Dielectric Flooring

A new nonslip, high-traction, high-dielectric flooring is available from H. Koch & Sons, Inc., Corte Madera, Calif. The high-dielectric qualities make this an ideal surface for raised flooring which covers power cables. The flooring is portable and helps deaden industrial noise.

Circle 340 on Inquiry Card

### Yoke Equations

A new tech. bulletin, containing equations and typical uses, assists in obtaining exact values of current, anode voltage, inductance, or deflection angle and yoke-use time when any of these parameters change. Celco, 70 Constantine Dr., Mahwah, N. J.

Circle 341 on Inquiry Card

# NEW Subscription Order

I wish a new complimentary Subscription to

## ELECTRONIC INDUSTRIES

Company Name \_\_\_\_\_ Mail Stop \_\_\_\_\_  
 or  
 Div./Dept. \_\_\_\_\_

Name \_\_\_\_\_ Position/Title \_\_\_\_\_

Company Address \_\_\_\_\_

City \_\_\_\_\_ Zone \_\_\_\_\_ State \_\_\_\_\_

### IMPORTANT

FOR OUR STATISTICAL RECORDS PLEASE CHECK THE ONE APPROPRIATE CATEGORY THAT BEST DESCRIBES YOUR COMPANY OR DEPARTMENT. Failure to do so will delay your subscription.

- Mfr. of non-military electronic receiving and transmitting equipment.
- Mfr. of non-military electronic instruments, measuring, control and test equipment.
- Mfr. of non-military electronic computers, data processing, analysers, business machine.
- Mfr. of Guided Missiles and Accessories; Aircraft and Accessories. All Type of Military Products and Equipment
- Mfr. of electronic components, parts, tubes and like products.
- Mfg. Co. (non electronic) using any of the above equip. in mfr., research or development work.
- Broadcasting or telecasting station.
- Commercial communication user (Tel & Tel, Police, Airports, Recording Studio, Etc.).
- Independent research, test, design laboratories and independent consultants—not part of a mfg. Co.
- Gov't Bureaus, Gov't laboratories, Gov't research center, military installation.
- Wholesaler, mfg. representative, service firm.
- University (educational) Public Library.
- Other (Please explain) .....

## CHANGE OF ADDRESS

I wish to continue receiving **ELECTRONIC INDUSTRIES**  
Change my address as indicated.

<u>OLD</u>	<u>NEW</u>
Paste wrapper imprint here, or Write in complete old address	Company _____ Mail Stop or Div./Dept. _____ Title/Position _____ Company Address _____ City _____ Zone _____ State _____ Signature _____

### IMPORTANT

FOR OUR STATISTICAL RECORDS PLEASE CHECK THE ONE APPROPRIATE CATEGORY THAT BEST DESCRIBES YOUR COMPANY OR DEPARTMENT. Failure to do so will delay your address change.

- Mfr. of non-military electronic receiving and transmitting equipment.
- Mfr. of non-military electronic instruments, measuring, control and test equipment.
- Mfr. of non-military electronic computers, data processing, analysers, business machine
- Mfr. of Guided Missiles and Accessories; Aircraft and Accessories. All Type of Military Products and Equipment.
- Mfr. of electronic components, parts, tubes and like products.
- Mfg. Co. (non electronic) using any of the above equip. in mfr., research or development work.
- Broadcasting or telecasting station.
- Commercial communication user (Tel & Tel, Police, Airports, Recording Studio, Etc.).
- Independent research, test, design laboratories and independent consultants—not part of a mfg. Co.
- Gov't Bureaus, Gov't laboratories, Gov't research center, military installation.
- Wholesaler, mfg. representative, service firm.
- University (educational) Public Library.
- Other (Please explain) .....



FIRST CLASS  
PERMIT NO. 36  
PHILA., PA.

**BUSINESS REPLY MAIL**

No Postage Stamp Necessary if Mailed in U. S. A.

POSTAGE WILL BE PAID BY

**ELECTRONIC INDUSTRIES**

Chilton Company

Chestnut & 56th Sts.

Philadelphia 39, Pa.

Att: Circulation Dept.



FIRST CLASS  
PERMIT NO. 36  
PHILA., PA.

**BUSINESS REPLY MAIL**

No Postage Stamp Necessary if Mailed in U. S. A.

POSTAGE WILL BE PAID BY

**ELECTRONIC INDUSTRIES**

Chilton Company

Chestnut & 56th Sts.

Philadelphia 39, Pa.

Att: Circulation Dept.



# TRW Electronics



# Ultra-Stable COMPENSATED ZENERS

- STABILITY BETTER THAN 20 PARTS PER MILLION
- 10 TIMES GREATER STABILITY THAN STANDARD CELLS
- 1000-HOUR DATA FURNISHED WITH EACH UNIT



New PS-1200 series Ultra-Stable Compensated Zeners provide accurate reference under a wide range of environmental conditions. Each unit is backed by more than 1,000 hours of certified test data. These units provide long term stability from 20 to 200 parts per million. This is substantially better than any competitive zener reference device available.

PS-1200-1205's are ideal replacements for standard cells in precision instrument applications. Not only do these extremely small units offer long term stabilities ten times greater than standard cells, but they also give you the added advantage of extreme ruggedness. These devices easily withstand a wide range of temperature variations, temperature cycling, and vibration, and are completely insensitive to "positioning" problems usually associated with standard cells. They are particularly adaptable to portable equipment. TRW Electronics compensated zeners can even be shorted and operated under load without damage.

Apply the new PS-1200 series to high precision instrument designs and other applications requiring ultra-stable reference.

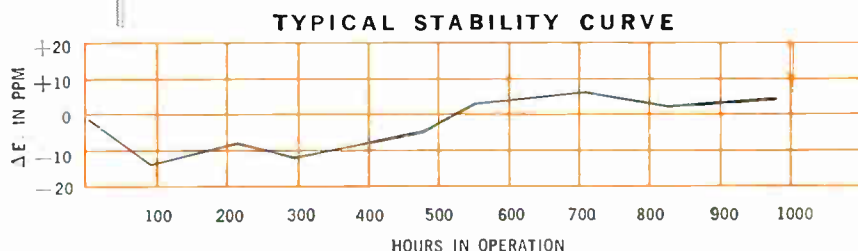

Circle 130 on Inquiry Card

Type (2) Number	Long-Term Stability (1)	Reference Voltage @ 10 mAdc @ 25°C	Dynamic Impedance @ 10 mAdc and 1 mA rms Max. @ 25°C
PS-1200	±0.02% (200 ppm)	8.0 - 8.8V	15 ohms
PS-1201	±0.01% (100 ppm)	8.0 - 8.8V	15 ohms
PS-1202	±0.0075% (75 ppm)	8.0 - 8.8V	15 ohms
PS-1203	±0.005% (50 ppm)	8.0 - 8.8V	15 ohms
PS-1204	±0.0035% (35 ppm)	8.0 - 8.8V	15 ohms
PS-1205	±0.002% (20 ppm)	8.0 - 8.8V	15 ohms

#### NEW TECHNICAL INFORMATION

Write today on your company letterhead for new application note entitled "Ultra-Stable Reference Elements" and complete technical information on the new PS-1200 series.



**Pacific Semiconductors, Inc.**  
**TRW Electronics**  
THOMPSON RAMO WOOLDRIDGE INC.

#### (1) Long Term Stability

Prior to the stability test each unit has been power aged and submitted to various stabilizing processes. Each unit is identified and serialized and a complete production and test history is kept. The stability test consists of 1000 hours of operation during which the zener voltage is recorded at periodic intervals. Each unit is shipped with a stability vs. time graph giving a complete certified record of the actual readings.

#### (2) Temperature Coefficient

"B" type units: ±0.007 V max. change in E<sub>z</sub> from 25°C over range of -55°C to +100°C (average TC of 0.001%/°C)

"A" type units: ±0.014 V max. change in E<sub>z</sub> from 25°C over range of -55°C to +100°C (average TC of 0.002%/°C)

Regular units: ±0.028 V max. change in E<sub>z</sub> from 25°C over range of -55°C to +100°C (average TC of 0.004%/°C)

14520 AVIATION BLVD., LAWDALE, CALIF. • OS 9-4561, OR 8-0561 • TWX: 213 647-5113 • Cable Address: PSISOCAL

Malco

WIDEST  
SELECTION  
OF ELECTRONIC  
HARDWARE

Low cost—Fast delivery



SPADE AND RING  
TERMINALS



SOLDERLESS TERMINALS

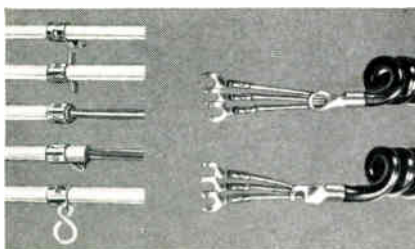

CORD CLAMPS

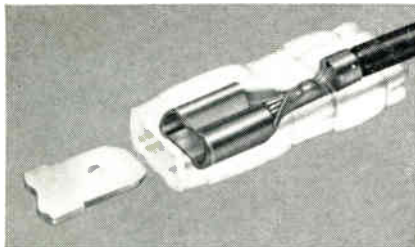

TABON TERMINALS  
AND INSULATING SLEEVES

REQUEST BULLETIN NO. 612.  
SEND B/P OR SPECS.  
FOR QUOTATION.

Malco MANUFACTURING COMPANY

4037 W. LAKE ST., CHICAGO 24, ILL.

Circle 139 on Inquiry Card

## NEW TECH DATA

### Microwave Tubes

A 36-page illustrated summary and review of product capabilities is available from Marketing Dept., Litton Industries, Electron Tube Div., 960 Industrial Rd., San Carlos, Calif. More than 60 new products are included. Specs. and photos are given for magnetrons, klystrons, traveling-wave, millimeter-wave, fibre-optic, and beam-switching tubes.

Circle 342 on Inquiry Card

### Variable Transformers

Catalog No. 500 describes all the existing frame sizes of the Ohmite line of variable transformers from the 1.75 to 25a ratings. Also included are the low-voltage, high-current models, the "LN" series, used in power supplies for semiconductor apparatus. Ohmite Mfg. Co., 3642 Howard St., Skokie, Ill.

Circle 343 on Inquiry Card

### Ceramic Capacitors

High-reliability spec. brochure S-1003, 32 pages, contains spec. information and sequential testing plan for "VK" general-purpose ceramic capacitors. Spec. included for barium-titanate ceramic capacitor. Vitramon, Inc., P.O. Box 544, Bridgeport 1, Conn.

Circle 344 on Inquiry Card

### Instrumentation Modules

Applications and key specs. for instrumentation amplifiers, signal conditioning modules, and standard assemblies for custom timing systems are described in this 12-page catalog. Also covered are servo-analyzers, data acquisition and processing systems. Astrodats Inc., 240 E. Palms Rd., Anaheim, Calif.

Circle 345 on Inquiry Card

### Programmed Test Station

A new, comprehensive 24-page brochure entitled, "Model 1500 Automatic Transistor Test Station," is available from Optimized Devices, Inc., 220 Marble Ave., Pleasantville, N. Y. The brochure outlines features of the unit, including a punched-tape programming test routine.

Circle 346 on Inquiry Card

### Analog/Digital Components

This bulletin entitled "Analog/Digital Building Blocks" gives complete descriptions and specs. on A/D converters, sample-and-hold and dc amplifiers, multiplexers, and D/A converters. The 8-page bulletin is available from Scientific Data Systems Inc., 1649 17th St., Santa Monica, Calif.

Circle 347 on Inquiry Card

### Printed Circuits

This 2-color, 4-page folder on printed circuits describes the 14 basic steps in producing circuit boards with pictures and descriptions. Electralab Electronics Corp., P. O. Box 548, Encinitas, Calif.

Circle 348 on Inquiry Card

# PLUGS JACKS

GC  
ELECTRONICS  
CONNECTORS  
ADAPTORS  
SWITCHES  
OTHER  
COMPONENTS



## 1 or 1,000

GC ships from stock. No tooling charges. All quantities and colors. Specials to meet your requirements are available. Inquiries invited. Send for big FREE catalog Dept. 18

GC ELECTRONICS Co.

DIVISION OF TEXTRON ELECTRONICS, INC.  
400 So. Wyanan St.  
ROCKFORD, ILL. USA

Circle 140 on Inquiry Card

- SCAN CONVERSION
- FLICKERLESS DISPLAY STORE
- VIDEO STORAGE

### RECORDING STORAGE TUBE SYSTEMS

Single-gun, dual-gun, multi-tube systems to convert scan for radar, sonar, television, and to perform analog processing, data analysis, contract or expand time scale, auto correlation.

- SLOWED TELEVISION TRANSMISSION

by telephone line or other narrow-band systems.

- IMAGE ENGINEERING

OPTICAL CHART READERS, FLYING SPOT SCANNERS, LOW-LIGHT-LEVEL CAMERAS, and IMAGE RECTIFICATION. Automatic inspection and recognition of size, shape, color, and texture.



Write or call for complete information:

IMAGE INSTRUMENTS, Inc.



2300 Washington Street  
Newton 62, Massachusetts  
617 WOODWARD 9-8440

Circle 141 on Inquiry Card



# NEW TECH DATA

## Direct Writing Recorder

This 20-page illustrated 8½ x 11 in. booklet describes the uses of the direct writing recorder as applied in supervision, troubleshooting and maintenance of telecommunications equipment. Entitled, "Recording for Operational Analysis of Telecommunications Systems," it includes methods for obtaining pulse signals, pulse train analysis, dc signal pulse checks and relay performance measurements. Brush Instruments, div. of Clevite Corp., 27th & Perkins, Cleveland 14, Ohio.

Circle 349 on Inquiry Card

## New Connectors

Two new low-cost connectors, DKF-2 and DK60-P, are described by the Dow-Key Co., Thief River Falls, Minn. Connector DKF-2 is a general-purpose, locking-type UHF connector of nonconstant impedance; DK60-P is a miniature UHF connector. Both operate at freqs. up to 200mc at 500v (peak).

Circle 350 on Inquiry Card

## Tubing Catalog

A 20-page catalog, No. AT 63, features a 12-page section of FIT shrinkable tubing products. Includes applications and properties charts and an illustrated description of irradiated tubing theory, special applications and operating procedures. Alpha Wire Corp., 200 Varick St., New York 14, N. Y.

Circle 351 on Inquiry Card

## Controls

A 10-page short-form catalog, No. 103, describes precision potentiometers, turn-counting dials, and trimming potentiometers available from Spectrol Electronics Corp., 1704 So. Del Mar Ave., San Gabriel, Calif. Included are prices, actual-size photos, electrical, mechanical, and environmental specs.

Circle 352 on Inquiry Card

## Cryogenic Brochure

A 12-page, 2-color brochure entitled, "Norelco<sup>®</sup> Cryogenerators for Low Temperature Applications" is available from Cryogenerators, Div. of North American Philips Co., Inc., Mendon & Angell Rds., Ashton, R. I. Illustrated with photos, drawings, charts, and tables, the booklet includes design and operating data.

Circle 353 on Inquiry Card

## Voltage-Control Handbook

"Handbook of Voltage Control with the Variac<sup>®</sup> Autotransformer," 40 pages, includes the principles and applications of autotransformers, and descriptions and diagrams of many Variac circuits. Included are 80 circuit diagrams, charts, and photos. General Radio Co., W. Concord, Mass.

Circle 354 on Inquiry Card

# Sub-Miniature Indicator Lights

Conform to applicable Military Specifications.

Mount from FRONT of Panel in 15/32" Clearance Hole

## NEON

Assemblies with Built-in Resistor

(A patented DIALCO feature—U.S. Pat. No. 2,421,321)

Conform to MS25257 ... Accommodate T-2 Neon Glow Lamps; Type NE-2D (MS25252)



T-2



(actual size)

No. 137-8836-931

**Features:** Stovepipe lens molded of high-heat plastic gives 180° light spread; available in choice of signal colors... Two terminals... Rugged construction; phenolic insulation of Mil. Spec. grade... *Anti-rotation* (locking) features prevent rotation of unit while being tightened to panel... For complete data request Brochure L-159C.

## INCANDESCENT

Assemblies conform to MS25256

Accommodate T-1-3/4 Incandescent bulb with midget flanged base, in voltages ranging from 1.3 to 28 (the 6 V. and 28 V. conform to MS25237).

For complete data request Brochure L-156E.

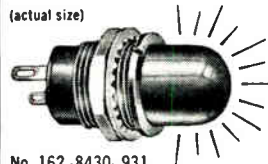

(actual size)

No. 162-8430-931



T-1¾

Samples on Request— at Once— No Charge



PILOT LIGHTS

"The Eyes of Your Equipment"



Foremost Manufacturer of Pilot Lights



50 STEWART AVENUE, BROOKLYN 37, N. Y. • Area Code 212, HYacinth 7-7600

Circle 142 on Inquiry Card

# SWITCH to the Best

## MODEL 78 SWITCH

- 2000 volt peak flashover at 60 cps
- 20 ampere current carrying capacity
- Low loss silicone impregnated steatite stators and rotors
- Current carrying members heavily silver plated
- Stainless steel detent assembly
- Coin silver contact shoes
- 18 positions maximum
- Sleeve bearing

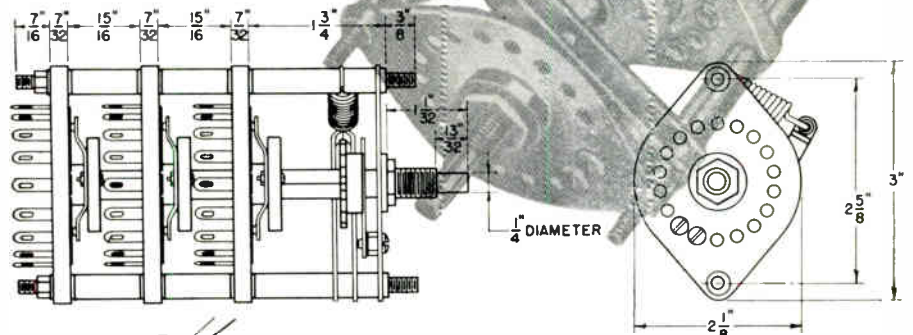

RADIO SWITCH CORPORATION

MARLBORO, NEW JERSEY - Tel. 462-6100 (Area Code 201)

# WHAT'S NEW

## NEW PROGRAMMING CONCEPT (Continued)

Basic matrix pinboard is a series of bussed SPST switches arranged on X-Y coordinates where switching is done by inserting a shorting pin to connect two circuit busses. Matching pre-programmed template is designed to be used with the pinboard.

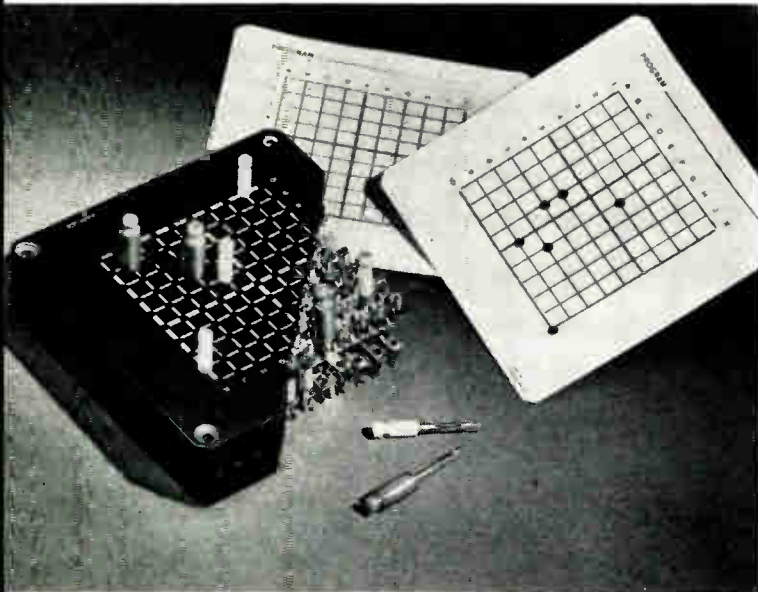

nections between ganged boards can be made with taper pin jumpers. Special matrix arrangements are available with up to 6,000 crosspoints.

Shorting pins are equipped with a nylon insulated grip for easy insertion and extraction and are available in a wide range of colors to provide programming via color codes. Colored pins also permit rapid identification and location even with a fully loaded board. Diode pins are also available to provide isolated circuit interconnections. Pin board buss springs and pins are available nickel plated or gold plated for low voltage uses. Temperature and moisture stabilized phenolic boards can be silk screened with any type of special identification. All materials used in their construction meet MIL specs.

Also being introduced is a matching pre-programmed template designed to be used in conjunction with the pinboard. It allows filing a permanent record of programs for future use without the need of retaining a fully programmed pinboard. The template fits over the pinboard and contains perforated holes that can be punched out with the shorting pin.

Corner holes allow for positive registration of the card to the board. This feature makes possible large savings since less time is needed for programming and a single board can be re-used an unlimited number of times, eliminating costly board storage.

## AT WM. A. FORCE

# ENGRAVING IS OUR BUSINESS

Since 1875, whenever engraved parts are specified, the call goes out for the Force representative. Force manufactures engraved components to your particular requirements, such as numbering units, wheels, type, etc.—from the most complex assembly in elec-

tronic scanning to a single part. For many firms, engraved components by Force specialists has meant increased production rates, fewer rejects, all reflected in savings. Force products are turned out by the latest, automatic high-speed machines.



**DATING AND NUMBERING UNITS**  
Furnished as complete assemblies and designed for many uses, such as certifiers, endorders, postage devices, metering machines, etc.



**WHEELS**  
Precision engraved, ready for assembly with gears and ratchets. Mounting holes and internal broaching included as specified.

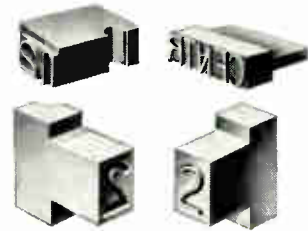

**ENGRAVED TYPE**  
Any variety to meet any specification. Expertly machined and supplied with holder and attachments as required.

Tell us your needs and we will be happy to send you further information.

WM A **FORCE** & CO., Inc.  
216 Nichols Ave.  
Brooklyn 8, N. Y.





## ANYWHERE TV SYSTEM

ON THE GROUND OR IN THE AIR, this TV system will be there. The system was originally designed for missile ground observers. It is also used in the air for zoom-close-ups prior to launch. The observers can continuously monitor all stage separations, and other happenings to destruct time, in the case of flight abort.

The compact, light-weight system is the result of a joint effort by Cubic Corp. and Colu Electronics, Inc., both of San Diego, Calif. Cubic produced the 5w, 5 lbs. (including power supply) transmitter. Its design is based on a model originally developed for the USAF's MATTS system.

The carrier frequency is frequency-modulated by the video signal. Power requirement is 45w, supplied by the 28v dc-dc converter.

The 5 lbs., 14 oz. camera, built by Colu, is in a temperature, moisture, noise, altitude, and dynamic pressure proof housing. A zoom-lense for detailed close-ups is included within the 3 inch diameter camera. A derivation of the Kin Tel 2000 series miniaturized TV system, the 2000 camera can be used to provide a minimum of 700 lines horizontal resolution (525-line synchronizing generator). It will produce 500 lines horizontal resolution with a 729-line synch generator.

Helicopter easily carries complete TV transmission system. The 3-inch diameter camera weighs 5 lbs., 14 oz. Portable camera control unit beneath cameraman's leg furnishes all camera operating and control voltages.



The Cubic ground equipment includes an r-f pre-amplifier, a frequency converter, an i-f amplifier, an FM discriminator and a video amplifier. The pre-amplifier is a compact, all solid state, broadband unit with a maximum noise figure of 3.5db and a gain of 26db.

The portable camera control unit, packaged with an optional battery power supply, furnishes all camera operating and control voltages using standard cables and connectors. The camera system can be operated up to 2000 feet from its control unit.



# 99.999 ER\*

## ESTABLISHED RELIABILITY

■ MIL-R-55182, the newly released established reliability specification, recognizes reliability levels as measurable parameters of fixed film resistors. For several years Electra has been supplying precision carbon and metal film resistors to customers who demand components with an established reliability index. Four Electra resistor styles have been designed to meet the highest levels of MIL-R-55182 (99.999 ER reliability index,  $\lambda = 0.001 \overline{\text{ER}}$ ).

■ The HRM series is produced in the RNR57, RNR63, and RNR70 sizes of this established reliability specification. The CHM  $\frac{1}{8}$  offers  $\frac{1}{8}$ - $\frac{1}{4}$  watt high reliability performance at 125/70°C, yet dimensionally it is smaller than most RNR55 or RN55 MIL styles. Electra's staff of reliability oriented field engineers is available to assist you in your high reliability application and procurement efforts.

■ Look to Electra for excellence in carbon and metal film resistors, high reliability resistors, tantalum capacitors, integrated circuits, and micromodular components.

\*ER=PER CENT PER 1,000 HOURS



**ELECTRA MANUFACTURING COMPANY**

**INDEPENDENCE, KANSAS**

PHONE: 316 331-3400 TWX: 316-331-0210





**DECITRAK®**

*All New*

**SHAFT  
ENCODER**

**For INDICATION and  
DATA LOGGING**

**DECIMAL OUTPUT** Generates 10 wire/digit code directly. No expensive translation from binary, BCD or Gray.

**LOWER COST** Less than half the price of conventional encoders.

**ON-THE-FLY OUTPUT** Instantaneous, continuous output to lampbanks or printers.

**5 TIMES LONGER LIFE** Absence of brush logic ensures 5-10 times longer life.

**DIRECT LAMPBANK OR PRINTER ACTUATION** Simply connect. Converters not required.

Write today for complete technical and application brochures.

*Theta*

**INSTRUMENT CORPORATION**

520 Victor Street • Saddle Brook, N. J.  
Area Code 201 HUBbard 7-3508

Circle 146 on Inquiry Card

**LETTERS**

to the Editor

**"Technician Training"**

*Editor, ELECTRONIC INDUSTRIES:*

Thanks very much for your February 6, 1963 letter telling me of your having published my letter to you concerning the Technical Education Act of 1962 last year.

I believe you may be interested to know that in his education message of January 29, 1963, President Kennedy urged congressional action this year on a program of college level technical education.

The pertinent quotations from the President's message are as follows:

"There is an especially urgent need for college level training of technicians to assist scientists, engineers, and doctors. Although ideally one scientist or engineer should have the backing of two or three technicians, our institutions today are not producing even one technician for each three science and engineering graduates. This shortage results in an inefficient use of professional manpower—the occupation of critically needed time and talent to perform tasks which could be performed by others—an extravagance which cannot be tolerated when the nation's demand for scientists, engineers, and doctors continues to grow. Failure to give attention to this matter will impede the objectives of the graduate and post-graduate training programs mentioned below.

"I recommend, therefore, a program of grants to aid public and private non-profit institutions in the training of scientific, engineering and medical technicians in two-year college-level programs covering up to 50 percent of the cost of constructing and equipping as well as operating the necessary academic facilities."

The education bill supported by the Administration, H.R. 3000, contains, in title 2, part C, a proposal for college level technical education which authorizes \$20,000,000 for fiscal year 1964 and such sums as are necessary for each of the next two years for project grants to institutions of higher education for two year college level programs to train semi-professional technicians in engineering, science,

and health occupations. The measure would include construction and equipment of academic facilities. Up to 50 percent of the construction or program costs can be supported with a Federal grant. Both public and private non-profit institutions are eligible.

Several members of the House Education and Labor Committee, both the Democrats and Republicans, who were the original sponsors last year of the Technical Education Bill have again introduced this proposal in this Congress. I am sending you a copy of my own bill, H.R. 446.

I hope very much of course that Congress will act this year on this legislation and that it will have the support of readers of your journal.

John Brademas  
Member of Congress

Congress of the United States  
House of Representatives  
Washington, D. C.

**"Designer's Guide to Lamps"**

*Editor, ELECTRONIC INDUSTRIES:*

Congratulations on those inter-related three articles . . . "Designer's Guide to Lamps, Indicator Lights, & Illuminated Switches."

Many members of our staff, including yours truly, have worked on control-display projects for quite some time. Our primary efforts are in relation to Systems Analysis, Human Factors Research, Human Factors Engineering, Technological Industrial Design, Vision, Maintainability/Reliability, and Computers.

In short, we're well-entrenched in those areas that the articles talked about . . . and therefore we truly appreciate your timely, well-written, and comprehensive triumvirate as a valid contribution.

On behalf of our crew . . . Thanks again!

Byron Bloch  
Staff Industrial Designer  
Human Factors Engineer

Dunlap and Associates, Inc.  
1532 Third Street  
Santa Monica, California

## "Directed Energy Weapons"

Editor, ELECTRONIC INDUSTRIES:

It may be of interest to you to learn that as a direct result of one of your articles we have come up with an acceptable concept for a military application of a DEW device.

I refer, of course, to Dr. Jack De Ment and Dr. Gene De Ment's original article, "Directed Energy Weapons," Aug. 1962.

Funding is presently going forward and we can only state that keeping it simple and plausible the end use has been established, the concept approved as sound, and the prototype under way.

Walter F. Conrad  
President

Conrad-Carson Electronics, Inc.  
1347 Broadway  
El Cajon, California

## "Women Engineers"

Editor, ELECTRONIC INDUSTRIES:

We have delayed replying to your letter of September 21, 1962, in response to ours of September 17, 1962, until the enclosed booklet, "Women in Professional Engineering," became available. Please accept this copy, with our compliments.

Although it provides meaty reading, we do believe it substantiates our position that women engineering graduates have found industrial acceptance.

In particular, we refer you to page 64, where Mrs. Stella Manor of the United States Department of Labor states, "Employers with whom the Women's Bureau has had contact, who have hired women engineers, tell us that they would be happy to hire more." It is doubtful we could cite a more critically authoritative source.

You might also try to obtain the June 1962 issue of the Journal of the American Society of Engineering Education, which contains a resolution pertaining to their efforts to interest girls in engineering careers.

Patricia L. Brown  
President

Society of Women Engineers  
345 E. 47th Street  
New York 17, N. Y.

(Continued on page 204)

# 11" x 17" X-Y RECORDER

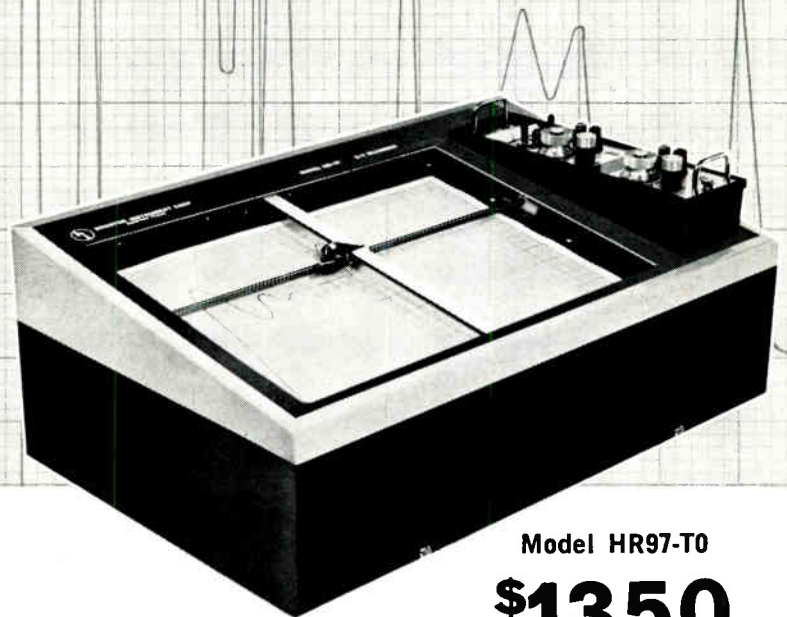

Model HR97-T0

**\$1350**

**Performance:** 1 mv/in. basic sensitivity, 15 in./sec. pen speed, 0.25% overall accuracy, 600 in./sec<sup>2</sup> peak acceleration, 0.1% resetability.

**Reliability:** Special emphasis on a simple, straightforward design insures continued trouble-free performance. The HR-97 is fully warranted for one year.

**Flexibility:** Plug-in control modules and compatibility with all standard converters and accessories, including the complete Houston Instrument line, assure the capability of the HR-97 to perform all recording functions.

**Accessibility:** Modular construction plus a specially designed, easily removable case permits complete access to all electrical and mechanical components in seconds.

**Price:** \$1350 No time base  
\$1450 With time base

8 page brochure available upon request



**houston instrument** corporation

4950 Terminal Avenue/Bellaire 101, Texas

MOhawk 7-7403/Cable: HOINCO

TWX 713-571-2063

# In RF VOLTAGE MEASUREMENTS

Voltmeters from Boonton Electronics give you

- Accuracy up to 3%
- Voltage readings: 300  $\mu$ v to 300 v
- Frequency range: 10 Kc to 1200 Mc
- VSWR better than 1.2 up to 1200 Mc
- True RMS response up to 3 v
- Temperature stability inherent in probe design

See condensed specification chart below. For complete data contact Boonton Electronics Corporation or our local representative.

VOLTMETER MODEL NO.	VOLTAGE RANGE	FREQUENCY RANGE	ACCURACY	INCLUDED ACCESSORIES	PRICE
91D	300 $\mu$ v to 300 v	10 Kc to 1200 Mc	50 Kc - 50 Mc $\pm$ 3% 25 Kc - 200 Mc $\pm$ 5% 10 Kc - 1200 Mc $\pm$ 10%	RF Probe "TEE" Adapter 50 $\Omega$ termination Voltage Divider "N" Adapter	\$750
91CA	300 $\mu$ v to 3 v	10 Kc to 600 Mc	25 Kc - 200 Mc $\pm$ 5% 10 Kc - 600 Mc $\pm$ 10%	RF Probe 50 $\Omega$ Adapter	\$550
91C	1 mv to 3 v	10 Kc to 600 Mc	25 Kc - 200 Mc $\pm$ 5% 10 Kc - 600 Mc $\pm$ 10%	RF Probe 50 $\Omega$ Adapter	\$450

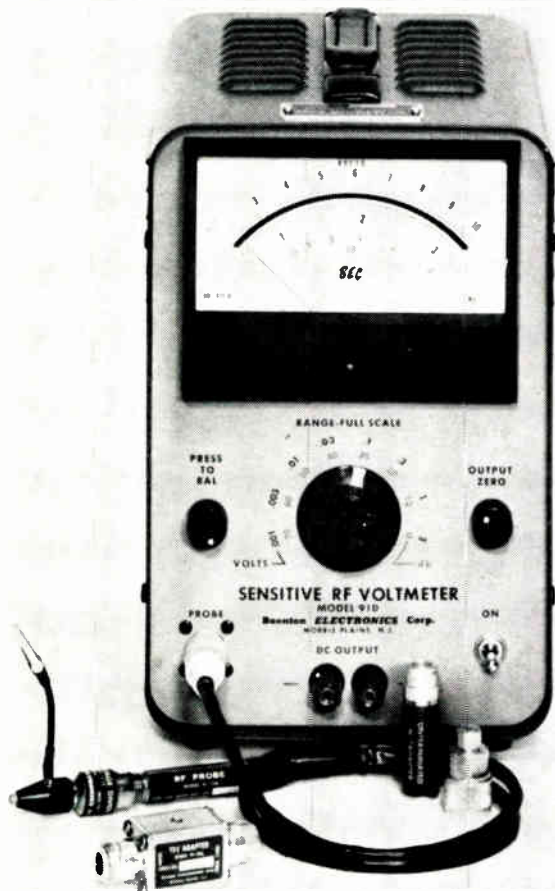

**BOONTON  
ELECTRONICS**  
CORPORATION

RF VOLTMETERS • CAPACITANCE  
BRIDGES • INDUCTANCE BRIDGES  
RF ADMITTANCE BRIDGES • DC  
METERS • RF DISTORTION METERS  
MORRIS PLAINS, N. J.

## LETTERS

to the Editor

### "Variac" Trademark

Editor, ELECTRONIC INDUSTRIES:

The interesting article entitled "For X-Y Plotting . . . Saturable Reactor Sweep Supply" which appeared in your January, 1963, issue makes several references to motor-driven "vari-iac" supplies.

The word "Variac" is a registered trademark of this company (Registration Nos. 715,045 and 717,480) and should, therefore, be capitalized with a footnote reference that it is a registered trademark.

We call this to your attention with the hope that you will find it possible to note this in some early issue of your excellent magazine and to advise your editorial staff about this for future reference.

As I am sure you understand, the "Variac" trademark associated with variable autotransformers and motor-driven power supplies is one of our most valuable trademarks, and it is incumbent upon us, as the owner, to call attention to that fact and to urge that the word not be used as a generic noun.

We shall greatly appreciate your cooperation in this regard.

Arthur E. Thiessen

Chairman of the Board  
General Radio Company  
West Concord, Massachusetts

### "R-F Radiation Hazards"

Editor, ELECTRONIC INDUSTRIES:

I would like to congratulate you for publishing, and the authors Salati, Anne and Schwan, for compiling the information contained in the excellent article "Radio Frequency Radiation Hazards," in the November 1962 issue of Electronic Industries.

The warning contained in this article has been long overdue, and to keep up the good work initiated by the authors, this article should be read by everybody who is likely to come in contact with this type of radiation.

L. F. E. Krajenbrink

Senior Electronic Engineer  
E-M-I Electronics Ltd.  
P. O. Box 176,  
Salisbury, Adelaide  
South Australia



FACTS, CIRCUIT APPLICATIONS, TEST DATA, AS PRESENTED  
IN SEMINARS CONDUCTED AROUND THE COUNTRY

## Now Available in Print



**The First Complementary Silicon Planar Transistors** for a broad range of applications are discussed in a new 32-page brochure. □ The aim of this "printed seminar" is to familiarize potential users of advanced silicon planar transistors with the advantages and applications of Sperry's new low-level, low-noise, high beta complementary NPN and PNP transistors. The brochure comprehensively reviews the advantages in reducing weight, volume and cost of equipment in circuit applications in addition to detailed parameter distribution and variation curves. □ Requests for the Sperry Silicon Planar Transistor Brochure are to be made on company letterhead. □ Sales Offices: Chicago, Illinois; Los Angeles, California; Oakland, New Jersey; Medford, Massachusetts; Sykesville, Maryland; Bethpage, Long Island, New York. □ SPERRY SEMICONDUCTOR, Norwalk, Connecticut.

**SPERRY**

DIVISIONS OF  
SPERRY RAND  
CORPORATION

# NOW TIME TICKS VIA 60KC VLF

## INDUSTRY NEWS

**James H. Cannon** — appointed Vice President — New Products, Cannon Electric Co., Los Angeles, Calif.; **Paul G. Kaponya**—named Vice President— Industrial Relations; **Melvin H. Lockett** — appointed Vice President — Finance, and **Dr. Edward Witting** — named Director of Research & Development.

**Edwin F. Rousch**—named Vice President — Administration, Fairbanks, Morse & Co., Yonkers, N. Y.

**H. P. Weirich** — appointed General Manager, Rectifier-Capacitor Div., Fansteel Metallurgical Corp., N. Chicago, Ill.; **Glen C. Iaggi**—named Sales Manager, R-C Div.

**Paul W. Wheaton** — appointed Vice President, Noble-Oak, Ltd., Tokyo, Japan, a company jointly owned by Oak Mfg. Co., Crystal Lake, Ill., and Teikoku Tsushin, Ltd., of Japan.



P. W. Wheaton



P. G. Tomy

**Paul G. Tomy** — appointed General Marketing Manager, Cinch Mfg. Co., Chicago, Ill.

**R. A. Stonesifer**—named Technical Marketing Manager, Microwave Device Div., Sylvania Electric Products, Inc., Mountain View, Calif.

**J. Reed Stovall, Jr.**—named Manager of Market Development, International Resistance Co., Philadelphia, Pa.

**R. F. Musson**—named Sales Manager, Packard Bell Computer, Los Angeles, Calif., subsidiary of Packard Bell Electronics; **H. S. Davis**—named Marketing Programs Manager, Packard Bell Computer.

**Joseph E. Levelle**—elected President of the New England Section, American Rocket Soc. He is a senior engineer with Ion Physics Corp., Burlington, Mass.

**Forrest G. Hogg**—named Manager for NASA Programs, Motorola Military Electronics Div., Phoenix, Ariz.

## RECEIVER TO PICK UP NEW NBS STATION WWVB

Time ticks similar to those on WWV are now going on the air via the new NBS Station WWVB. This 60 kc signal is useful in calibrating timing systems, synchronizing events, and calibrating any clock. Interstate's new solid state Model LF-610 Receiver was specifically designed to receive WWVB. Complete VLF Time/Frequency Standard Systems are available. Write for details.

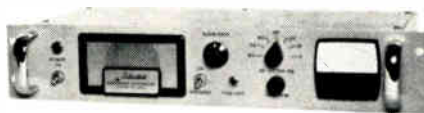

30 day delivery

WRITE TO:

*Interstate* ELECTRONICS CORPORATION

707 East Vermont Avenue • Anaheim, California • Telephone 714-772-2222

(A subsidiary of Interstate Engineering Corporation)

NATIONWIDE REPRESENTATIVES

ANOTHER *Interstate* SOLID-*state* INSTRUMENT

# INDUSTRY NEWS

**Calvin K. Casey**—named Director of Marketing, Industrial Div., Custom Component Switches, Inc., Chatsworth, Calif.; **Robert A. Miller**—appointed Director of Marketing, Airborne Div.

**Guy Arnold**—named Eastern Sales Manager, Elco Corp., Willow Grove, Pa.; **Ron Lyons**—appointed Midwestern Sales Manager; **Alex Paul**—named Manager, Western Sales, and **Steve Barr**—appointed Distributor Sales Manager.

**Edmund F. Larrabee**—appointed Marketing Manager, Electro-Mechanical Div., Cornell-Dubilier Electronics, Fuquay Springs, N. C.; **Wayne A. Peterson**—named divisional Engineering Manager.

**Robert O. Dehlendorf II**—elected a Vice President of Microwave Electronics Corp., Palo Alto, Calif.



R. O. Dehlendorf II



R. E. Wolin

**Robert E. Wolin**—appointed General Manager, Industrial Div., Cubic Corp., San Diego, Calif.

**Philip A. Johnson**—appointed Director of Sales, Wakefield Engineering, Inc., Wakefield, Mass.

**Donald N. Yates**—appointed Vice President and General Manager, Space & Information Systems Div., Raytheon Co., Lexington, Mass.; **Dr. Martin Schilling**—named Vice President and General Manager, Missile Systems Div.; **Fritz A. Gross**—appointed Vice President and General Manager, Equipment Div., and **W. Rogers Hamel**—named General Manager, Submarine Signal Div. All the above divisions were recently formed by Raytheon.

**Charles R. Denny**—named Vice President and Managing Director, RCA International Div., New York, N. Y.; **Douglas Y. Smith**—appointed Vice President and General Manager, RCA Electronic Components and Devices. He will manage the RCA Electron Tube Div. and the Semiconductor and Materials Div.

**R. W. Lee**—appointed Executive Vice President and General Manager, Information Systems Group, General Precision, Inc., Glendale, Calif.; **William P. Hilliard**—named President of GPL Div., Pleasantville, N. Y.; **Thomas D. Bryant**—appointed Vice President, Librascope Div. of General Precision, and **Sidney L. Briggs**—appointed Vice President—Administration, for the Information Systems Group.

**Murray H. Feigenbaum**—named Assistant to the President of Polarad Electronic Instruments, a division of Polarad Electronics Corp., Long Island City, N. Y.

**Paul Harris**—named Precision Potentiometer Sales Manager, and **Tom Golden**—appointed to head the new Industrial Sales Group, Clarostat Mfg. Co., Inc., Dover, N. H.

(Continued on page 208)

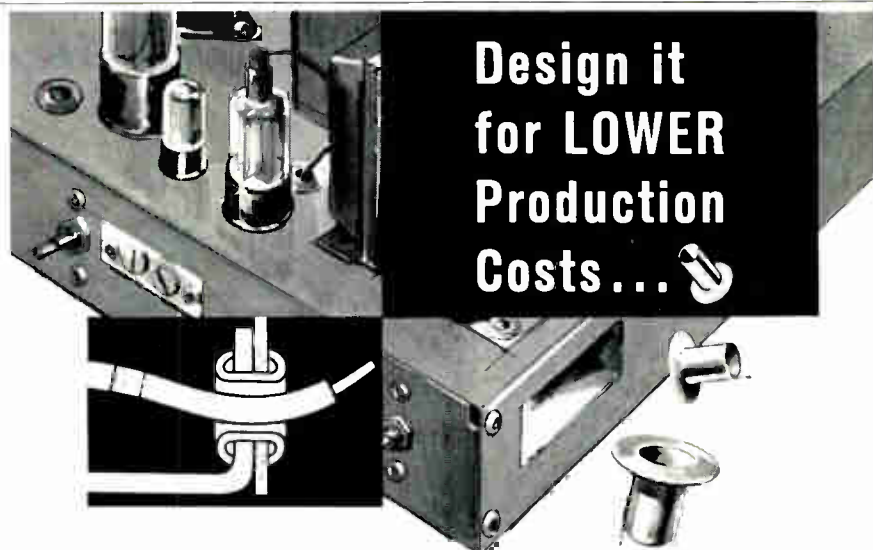

## RIVET it with EYELETS Instead!

Every year, more and more assemblies and sub-assemblies for electric and electronic equipment are being riveted with United's Eyelets, because manufacturers are discovering that eyelets provide uniformly strong, dependable fastenings—and in addition, help cut production time and costs, because both the initial and the all-important in-place costs are far less!

When you tackle your next product design or re-design project, investigate United's Eyelets for **your** riveted assemblies. Chances are you'll be able to reduce production costs—and you can probably reduce your own design time too, because United offers a complete Engineering Service, ready to work with you on your specific application requirements. Phone the United Office in your area... or write direct to Fastener Division, United Shoe Machinery Corporation, 1458 River Road, Shelton, Connecticut.

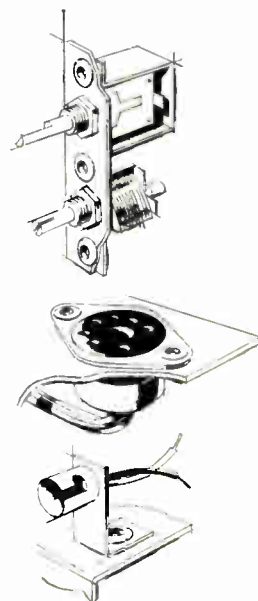

### United's Eyelets

FASTENER DIVISION

United Shoe Machinery Corporation

SHELTON, CONNECTICUT



Branches: Atlanta, Ga. • Boston, Mass. • Chicago, Ill. • Cincinnati, Cleveland, Ohio  
 • Dallas, Texas • Sun Valley (Los Angeles), Calif. • Lynchburg, Va. • Milwaukee, Wisc.  
 • Nashville, Tenn. • New York, N.Y. • Rochester, N.Y. • St. Louis, Mo.



# OUNCER AUDIO TRANSFORMERS and REACTORS



**"O" Series**



**STANDARD  
OUNCER**

**"P" Series**



**PLUG-IN  
OUNCER**

**IMMEDIATE  
DELIVERY**  
From Stock

THE UTC OUNCER line consists of a full range of input, mixing, interstage, output transformers and reactors for both transistor and tube application. OUNCER items are ideal for aircraft, portable broadcast, hearing aid, concealed service, and similar applications. High fidelity characteristics are provided. These units, weighing only one ounce, are fully impregnated in a drawn aluminum housing  $\frac{7}{8}$ " diameter. A hipermalloy shield is available providing 25 db shielding. Power levels run from milliwatts to 1 watt. Frequency range runs from 30 cycles to 20 KC. Impedances are available in practically any value from 7.5 ohms to 1 megohm.

"P" series units are identical to UTC OUNCERS but are sealed in bakelite housings of submersion proof design, weighing 2 ounces, with plug-in base to fit standard octal socket.

## UNITED TRANSFORMER CORPORATION

150 Varick Street, New York 13, N.Y.

PACIFIC MFG. DIVISION

3630 Eastham Drive, Culver City, Calif.

EXPORT DIVISION

13 East 40th Street, New York 16, N. Y.

**WRITE FOR LATEST CATALOG**

## INDUSTRY NEWS

**Louis J. Metevier**—elected Vice President — Aerospace, The Hallicrafters Co., Chicago, Ill.; **Robert W. Jorgenson**—elected Vice President—Commercial Products; **William H. Shaw** —elected Vice President—Commercial Contracts.

**William P. Sharpe**—named General Sales Manager, Potter Instrument Co., Inc., Plainview, L. I., N. Y.

**Shelby R. Henson**—appointed Manager of Manufacturing, Western Electro-dynamics, Inc., Colorado Springs, Colo.

**John J. Shenk**—named Research & Development Sales Administrator, Industrial Components Div., Raytheon Co., Newton, Mass.

**Howard E. Kaepplein**—named General Sales Manager, Silicon Transistor Corp., Carle Place, N. Y.



H. E. Kaepplein



C. K. Hines

**C. Kenneth Hines** — named General Manager, DeVar-Kinetics Div., Consolidated Electro-dynamics Corp., Pasadena, Calif.

**Dr. Robert T. Watson**—elected President, ITT Industrial Laboratories Div.; **W. J. Cheesman**—named Group Manager — Telecommunications, International Telephone & Telegraph Corp.; **Corbin A. McNeil**—elected Vice President—Director of ITT Industrial Relations, and **Frank P. Barnes**—elected Vice President—Director of ITT Telecommunications Marketing.

**Col. Bernt Balchen**—appointed Special Assistant to the Vice President—Government Marketing, General Precision, Inc., Tarrytown, N. Y.

**Frederick M. Hoar**—appointed Advertising and Information Manager, RCA Electronic Data Processing, Cherry Hill, N. J.; **Robert G. Dee**—named Manager, Product and Market Planning, RCA Electronic Data Processing; **Mrs. F. Edward (Patty) Cavin**—appointed RCA Public Affairs Manager, Washington, D. C.

**Roland Haskins** —appointed Product Sales Manager, Space & Systems Div., Packard Bell Electronics, Los Angeles, Calif.

**Charles T. Lee**—appointed Marketing and Sales Manager of Philco Corporation's International Div., New York, N. Y.

**Thomas B. Quinn** — named General Manager, Arnold Magnetics Corp., Los Angeles, Calif.

**Robert M. Andrews**—named Sales Director, International Div., Tung-Sol Electric, Inc., Newark, N. J.

**Robert P. Scott**—appointed Coordinator of Subsidiary Operations, CTS Corp., Elkhart, Ind. Scott is a Vice President of the company.

**Gary R. Zanzig**—appointed Assistant Sales Manager—Instruments, Victor-teen Instrument Co., Cleveland, Ohio.



G. R. Zanzig



J. Ogg

**Jack Ogg**—named Western Regional Sales Manager, Electronic Memories, Inc., Los Angeles, Calif.

**Dr. E. M. Pritchard**—appointed Vice President, Lockheed Electronics Co., and General Manager of its Military Systems Div., Plainfield, N. J.

**William F. Winget**—appointed Director of Contracts, Midwest Operations, Data Products Corp., Culver City, Calif.

**James A. Robinson** — named Market Research Manager, Weston Instruments Div., Daystrom, Inc., Newark, N. J.

**Paul S. Mirabito**—appointed Corporate Vice President, Administrative Programming, Burroughs Corp., Detroit, Mich. Burroughs also announces these appointments in its Defense & space Group, Paoli, Penna.; **E. Gary Clark**—named Vice President, Defense & Space Systems Marketing Div.; **Dr. Charles L. Register**—named Vice President, Burroughs Laboratories; **Harry B. Rottiers**—appointed Vice President, Contracts Administration.

ELECTRONIC INDUSTRIES

a Chilton Publication

# ELECTRONIC INDUSTRIES



**A BIWEEKLY**  
(26 Issues)

**B WEEKLY**  
(52 Issues)

**C MONTHLY**  
(14 Issues)

48.3 Pages

24.5 Pages

21.4 Pages

20.9 Pages

The publication that serves electronic engineers first serves advertisers best. ELECTRONIC INDUSTRIES' editorial service is outstanding in quality and quantity. In competing for the readers' time, EI is read first because it offers readers more useful theory and applied engineering information than is available from any other source. Comparison, above, shows leadership of ELECTRONIC INDUSTRIES in feature editorial articles of two pages or more per issue.

ELECTRONIC INDUSTRIES grows with the size of the market, each month delivers the largest audience of

engineering decision-makers in the industry. This vast 64,000-plus audience is located in over 6100 plants that comprise 96% of the electronic market.

Ask your local ELECTRONIC INDUSTRIES representative for full details. Also ask him to show you the 14-minute film presentation on ELECTRONIC INDUSTRIES' exclusive Marketing Assistance Program. M-A-P helps you spot trends...plan marketing strategy...locate product applications...identify key buying influences. ELECTRONIC INDUSTRIES is the keystone of any well planned electronic marketing program.



# ELECTRONIC INDUSTRIES

*The Source of Useful Theory and Applied Engineering*

A Chilton Publication

Chestnut and 56th Streets • Philadelphia 39, Pa.



# SPECIFY Stromberg-Carlson TELEPHONE-TYPE RELAYS

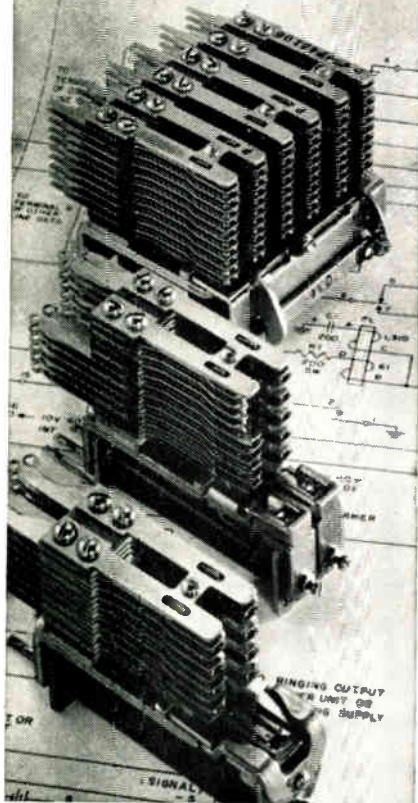

The sound design and long, reliable life of these Stromberg-Carlson relays have been proved by many years of successful use in the exacting field of telecommunication:

**Type A:** general-purpose relay. Up to 20 Form "A" spring combinations.

**Type B:** multi-contact relay. Up to 60 Form "A" spring combinations.

**Type BB:** multi-contact relay. Up to 100 Form "A" springs.

**Type C:** two relays on one frame; mounts in same space as one Type A.

**Type E:** general-purpose relay; universal mounting; interchangeable with relays of other manufacturers.

All standard spring combinations are available in these telephone-quality relays. For complete technical data and details on special features, write to Industrial Sales Department.

**STROMBERG-CARLSON**  
A DIVISION OF GENERAL DYNAMICS  
115 CARLSON ROAD • ROCHESTER 3, N. Y.  
Circle 155 on Inquiry Card

## INTERNATIONAL NEWS

### EUROPE

Rome—Charles F. Adams, Pres. of Raytheon Co., Lexington, Mass., has been awarded one of Italy's highest honors, the "Commenda al Merito della Repubblica Italiana." It was presented to him for Raytheon's role in developing the Italian electronics industry.

Paris—Electronic Assoc., SARL, has been formed in France by Electronic Assoc., Inc., Long Branch, N. J. It will handle French sales and service of the American firm's instrument line.

London—A new radar technique developed by Marconi enables height, range and bearing information to be obtained from one radar. Transmission is swept through a band of frequencies using a new type antenna. This electronically tilts the beam in an arc through a vertical plane.

London—W. G. Pye & Co., Ltd., has developed a panchromatograph for unusual types of laboratory analysis. It has already analyzed steroids using temp. programming, fatty acids with C<sup>14</sup> counting, air pollution using ionization, heat detecting systems in parallel, pesticides, petroleum and many other materials under varied conditions.

London—The UNIVAC 1004 Card Processor will be marketed in Great Britain and other Commonwealth countries by Int'l. Computers & Tabulators, Ltd. ICT controls about 80% of the Commonwealth market for this type of equipment.

London—Marconi's Wireless Telegraph Co., Ltd., has begun installing 10 Ampex/Marconi Pilot Landing Aid TV systems aboard U. S. aircraft carriers. Each system uses four Marconi cameras.

Paris—Teleregister Corp., Stamford, Conn., has formed a French subsidiary here. The firm, Teleregister France, will market in Europe the electronic on-line data systems and services of the U. S. firm.

London—An inexpensive electronic photographic plate which will give an immediate picture without any development.  
(Continued on page 211)

## the aristo TRANS-LUMINATOR

Replaces Carbon Arcs for Finer Reproduction

- COOL—film cannot warp or shrink.
- EVEN—light is uniform across entire diffusion surface.
- FAST—(White) Approximately equal to two 35 Amp arcs. (Blue) Two times faster.
- QUALITY—tone reproduced exactly as on original.
- CLEAN—No dust, no fumes.
- ECONOMICAL—No carbon costs, uses approximately 10% of present power consumption.

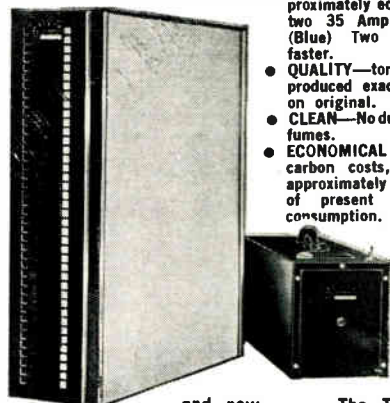

and now . . . The Trans-Luminator Features Two New Sources from Aristo For Exposing High Resolution Plates & KPR-KMER

**Aristo FYG-54**—for exposing high resolution plates is a narrow band source peaking at 548mu. This unit gives greater precision and dimensional stability in producing microphotographs and is superior to either conventional or improved sources in speed, accuracy, uniformity, coolness, cleanliness & economy.

**Aristo-B-3642**—for exposing KPR-KMER peaks at 365mu and 420mu matching the sensitivity response of this material. This new lamp provides: faster, cooler, cleaner reproductions of printed circuits and micro-miniature circuits. It is from 3 to 15 times faster than conventional sources and consumes only a fraction of their power.

For further information write:

**ARISTO GRID LAMP PRODUCTS INC.**  
65 Harbor Rd., Port Washington No., L.I., N.Y.

Circle 156 on Inquiry Card

## How To Get Things Done Better And Faster

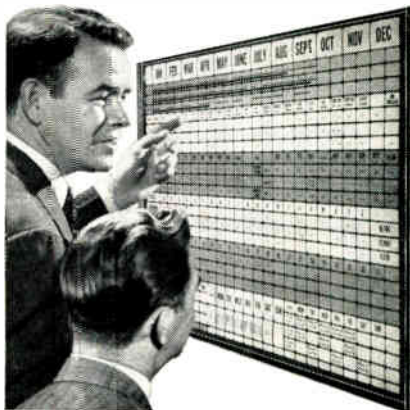

### BOARDMASTER VISUAL CONTROL

- ☆ Gives Graphic Picture—Saves Time, Saves Money, Prevents Errors
- ☆ Simple to operate—Type or Write on Cards, Snap in Grooves
- ☆ Ideal for Production, Traffic, Inventory Scheduling, Sales, Etc.
- ☆ Made of Metal. Compact and Attractive. Over 750,000 in Use.

Full price **\$49<sup>50</sup>** with cards

**FREE** 24-PAGE BOOKLET NO. Z-10  
Without Obligation

Write for Your Copy Today  
**GRAPHIC SYSTEMS**  
Yanceyville, North Carolina  
Circle 157 on Inquiry Card



# SPECIAL TOOLS FOR SPECIAL PROBLEMS

Odd as they look, these are actual production tools. They were manufactured by Xcelite to increase efficiency on special assembly work where conventional hand tools proved inadequate.

Chances are that "special function" tools can speed your production. Supply prints (model if available) of part on which tool will be used. Prototype designed and tooled for your approval. Any quantity . . . to meet your production schedule. Contact factory direct.

Complete information in new "Custom-made Tool" Brochure No. 660. Request on your letterhead.

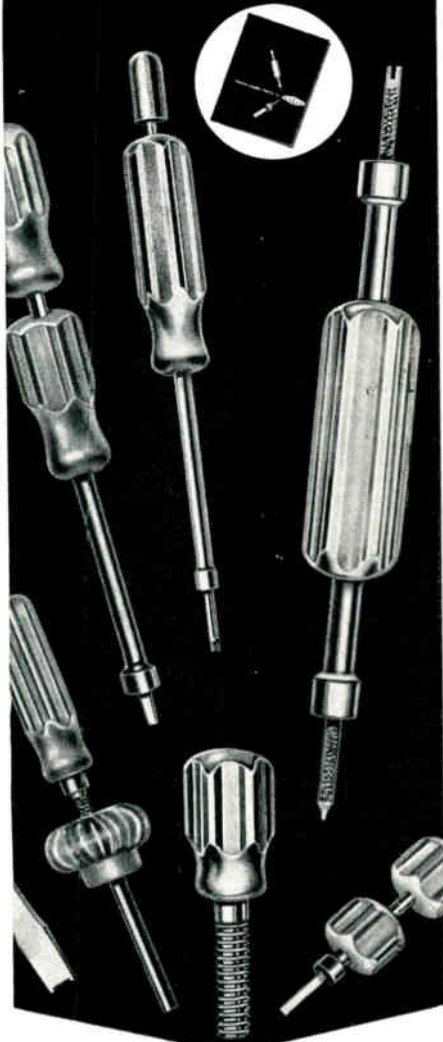

## XCELITE

### INDUSTRIAL HAND TOOLS

XCELITE, INC. • 28 BANK ST., ORCHARD PARK, N. Y.

Circle 158 on Inquiry Card

## INTERNATIONAL NEWS

(Continued from page 210)

oping and which can be used at least 10,000 times has been developed by Thorn Electrical Industries, Ltd. It is sensitive to both light and invisible radiation.

### SOUTH AMERICA

Caracas—Radio Caracas TV, C. A., has signed a \$750,000 contract with RCA for transmitters, microwave relays and other equipment for the expanded Venezuelan TV network. It will place 97.5% of the country's population within range of TV signals.

Rio de Janeiro — ITT Corp. has reached an interim agreement on payment for its expropriated Brazilian telephone properties. Part of the payment will be available for investment in Brazil. Some of this will be invested in Standard Electrica, S. A., an ITT subsidiary there.

### NORTH AMERICA

Ottawa—Aviation Div. of S. Smith & Sons (Canada), Ltd., reports the Smith Series 4 Miniature Rate Gyro has been specified by the Sperry Phoenix Co. for the SP 50 auto flight control system aboard the Boeing 727 3-jet airliner.

Washington—"Market Indicators for Africa," a pamphlet published recently by the U. S. Commerce Dept., describes in detail market opportunities for U. S. products on that continent. Copies may be obtained from the U. S. Govt. Printing Ofc., or any Dept. of Commerce Field Ofc., at 20 cents each.

Chicago — Two Latin American firms have signed manufacturing licensing agreements with Jensen Mfg. Co. Fapartel S. A., Juarez, Mexico, and Ucoa Radio S. A., Buenos Aires, will make Jensen loudspeakers and allied products for distribution in their respective countries.

Chicago — An *International Trade Handbook* containing 1,200 pages of information on foreign trade potentials has been published by Dartnell Corp., a research publishing house here.

New York—The Navy Dept.'s Bureau of Ships awarded the ASA a one-year, \$5,000 contract to arrange for developing international standards for mechanical shock and vibration.

(Continued on page 212)

# NEW

MODEL "V"

## Water Welder\*

WITH VARIABLE  
VOLTAGE DIAL AND  
GAS PRESSURE GAGE

ONLY  
12" WIDE  
WEIGHT  
36 LBS.

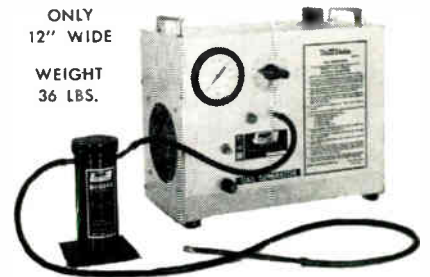

## DIAL THE FLAME SIZE YOU WANT

The new model "V" Water Welder is our second oxy-hydrogen gas generator with self-contained power supply and electrolytic reactor. It operates with distilled water as its primary fuel, but with 100% increased capacity it handles a wider range of metal working operations. And it meets more miniature and sub-miniature electronic requirements of space age technology. It will even butt-weld exotic metal wires as fine as three ten-thousandths diameter up to 1/10 inch diameter. For welding, annealing, brazing, glass polishing, and silver soldering its performance is unequalled when correctly operated. Also welds stainless steel in the 300-400 series and other nickel base alloys. Produces temperatures over 6000°F where needed. Plugs into any 110-120 V.A.C. outlet. Uses only one oz. distilled water per hour. Operating cost only a few cents a day. Write for bulletin V-1 giving complete specifications and technical information.

Write for Bulletin V-1

**HENES  
MANUFACTURING  
COMPANY**

Electronics Division

4300 East Madison St.  
Phoenix 34, Arizona

Canadian Dist:

Canadian Curtiss-Wright Ltd., Toronto

\*Trade Mark Registered U. S. Patent Office

Circle 159 on Inquiry Card

# INTERNATIONAL NEWS

## ASIA

Manila—The Republic Broadcasting Co. here has ordered an educational TV system from EMI Electronics, Ltd. The equipment, including vidicon TV camera, studio equipment and film and slide projection facilities, will be operated by one man.

Ankara—Four large 12 KW transistorized inverters for the 3,000-mile communications net from here to Karachi are being completed at Studebaker Corp.'s Onan Div. plant, Minneapolis, Minn. They will change 48-v. dc battery power into 220-v., 50 cps ac when municipal power becomes unavailable. At the heart of each inverter are 120 germanium transistors from Honeywell.

## TOKYO TRADE CENTER



Fourth U. S. Overseas Trade Center opened recently in Tokyo to a crowd of over 20,000 industrial and trade reps. Over 500 U. S. industrial instrument and laboratory apparatus products were exhibited. Below, members of 30 Japanese publications are briefed on exhibit and center opening. Other centers: London, Bangkok, Frankfurt. U. S. Commerce, Agriculture Depts. operate the centers.



**you can solder directly to the solid metal electrode bands of**

**ROANWELL PRECISION PISTON TRIMMER CAPACITORS**

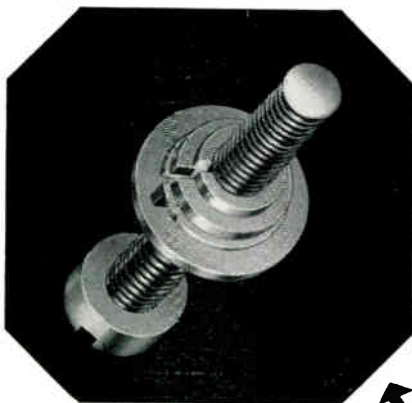

There's improved reliability in Roanwell piston capacitors — improved stability, linearity, accuracy, ruggedness — because of its new construction approach. Its design features . . .

### solid brass, gold plated, electrode bands:

- Permits soldering directly to metal electrode band with no effect on capacitance.
- Ideal for high frequency application.
- Eliminates built-in stresses since there is no firing process of silver to glass.
- Unit becomes inherently more rugged since solid brass bands act as main support for the dielectric.

### new drive mechanism (pat. applied for):

- Eliminates gold flaking.
- More uniform torque.
- Backlash eliminated radially and transversally.

### more capacitance per size:

- Because both I.D. and O.D. of dielectric are controlled.

will meet or exceed applicable requirements of spec. MIL-C-14409A.

Write for catalog EI-4

*For Your Custom Needs...*

we can either modify standard units or create new trimmer designs. It all depends on what best suits your specific applications.

**ROANWELL CORPORATION**  
**ELCOM DEPARTMENT**  
**ROANWELL BUILDING**  
**180 VARICK STREET, NEW YORK 14, NEW YORK**  
**TEL: (212) YUKON 9-1090 • TWX: (212) 640-4791**





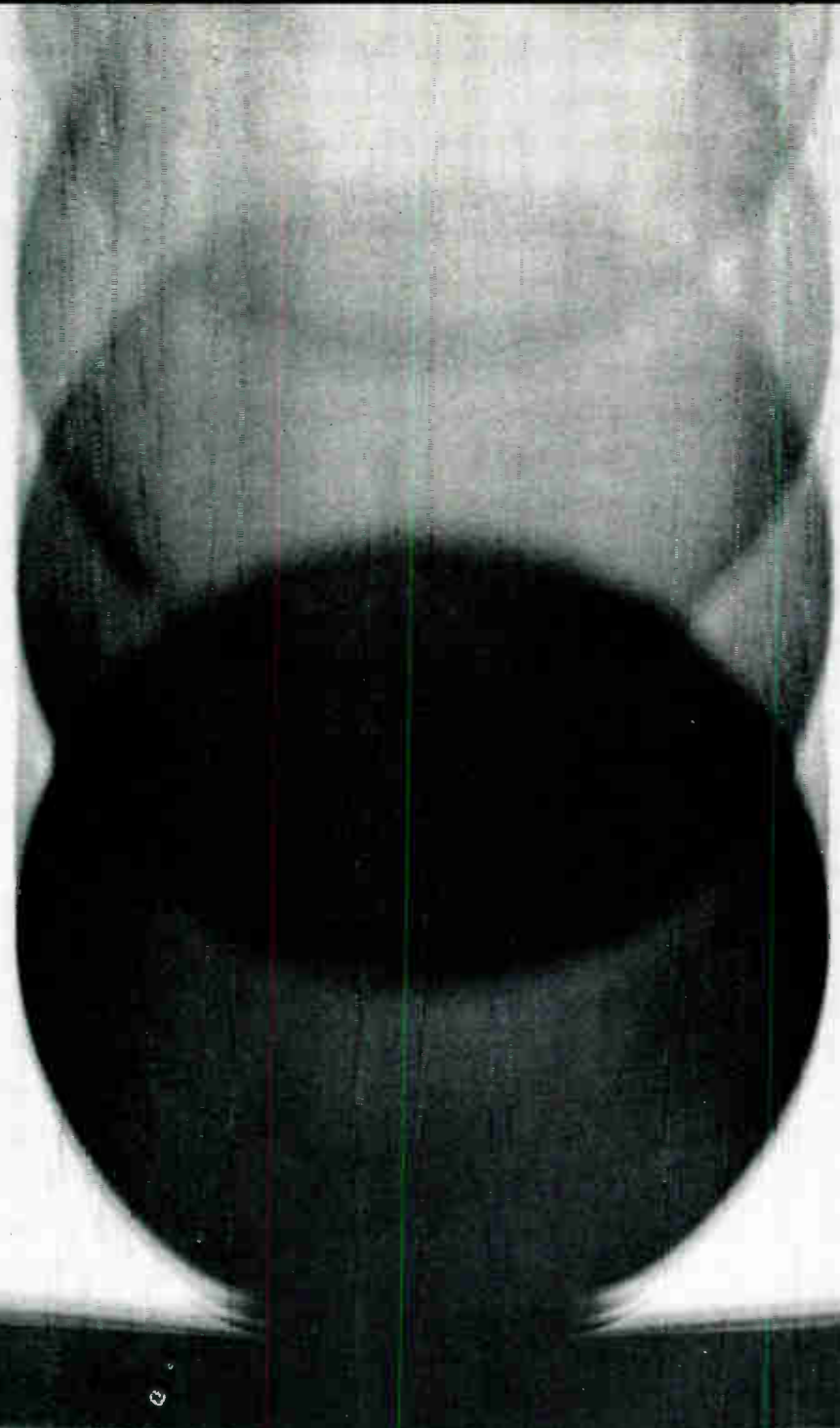

## HUGHES HIGH-SHOCK SILICON RECTIFIER STACKS WITHSTAND 1,000 G'S!

Recent customer tests verified that Hughes stacks meet or exceed the requirements of Type 1 shock tests of MIL-T-17113. Hughes is ready to fill your custom requirements—to incorporate your specifications into a high-reliability unit.

- Designed with Hughes standard or fast-switch "Golden Line" rectifiers.
- Superior efficiencies at kilocycle frequencies.
- Rated to 35 amps with peak reverse voltages to 60 KV.
- Made with MIL components to meet MIL specifications.
- Large heat fins and open frame construction for efficient cooling.

□ Can be cooled by natural convection, forced air or liquid.

□ Available in encapsulated assemblies.

For additional details on local delivery or export, contact your Hughes representative; or write Hughes Semiconductor Division, Marketing Department. □ Ask for your copy of the "Golden Line" Rectifier Brochure (C-22). □ Inquiries originating outside the U.S.A. should be directed to: HUSINT S.A., 3 rue Ami Lullin, Geneva, Switzerland.

**HUGHES**

HUGHES AIRCRAFT COMPANY  
SEMICONDUCTOR DIVISION  
NEWPORT BEACH, CALIFORNIA

DIODES • TRANSISTORS • RECTIFIERS • SPECIAL ASSEMBLIES • CRYSTAL FILTERS

Circle 163 on Inquiry Card

World Radio History





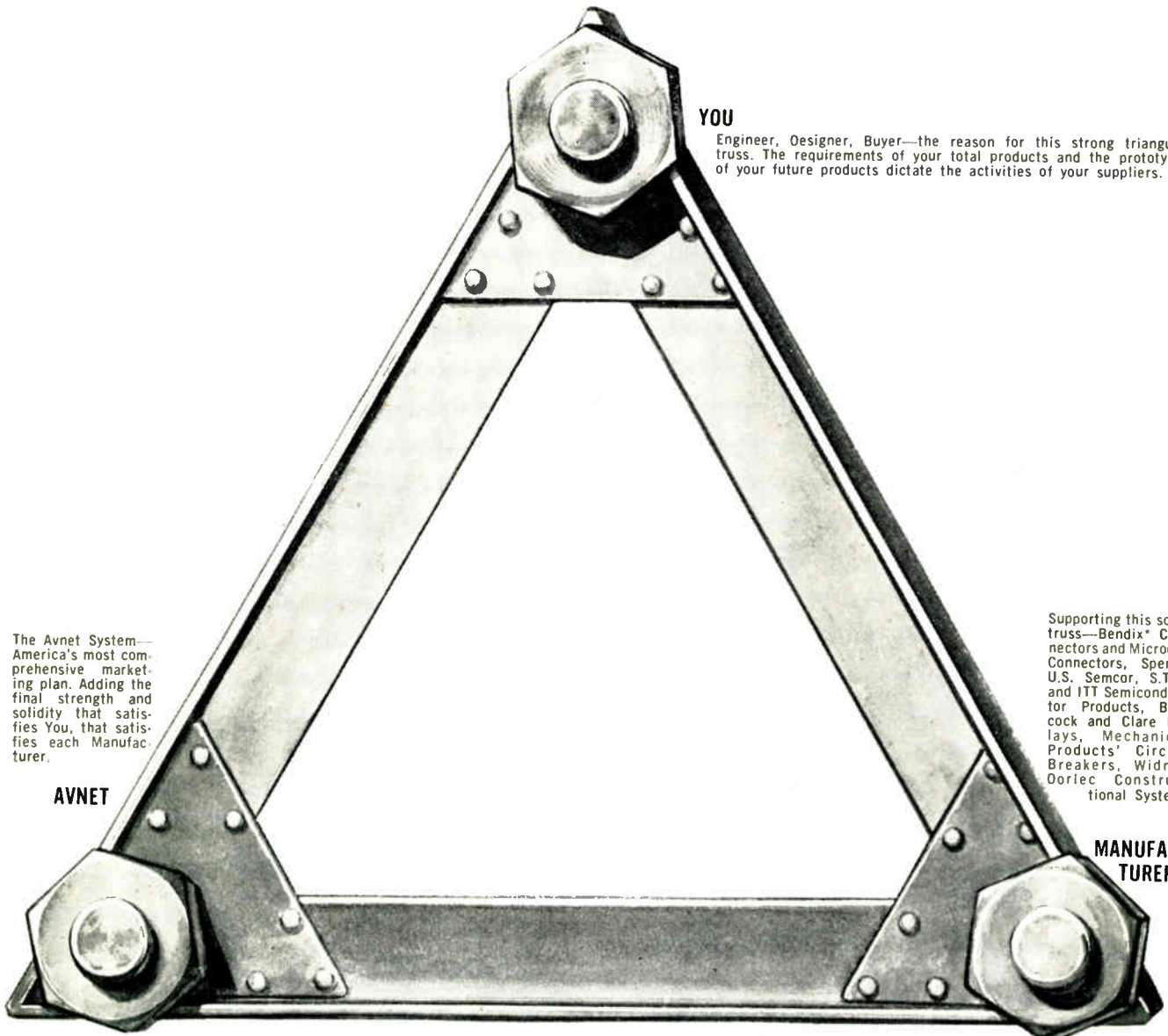

**YOU**

Engineer, Designer, Buyer—the reason for this strong triangular truss. The requirements of your total products and the prototypes of your future products dictate the activities of your suppliers.

The Avnet System—America's most comprehensive marketing plan. Adding the final strength and solidity that satisfies You, that satisfies each Manufacturer.

**AVNET**

Supporting this solid truss—Bendix\* Connectors and Microdot Connectors, Sperry, U.S. Semcor, S.T.C. and ITT Semiconductor Products, Babcock and Clare Relays, Mechanical Products' Circuit Breakers, Widney Oorlec Constructional System.

**MANUFACTURERS**

# STRONG SOLID

A triangular truss is strong, solid. It gives support where required, gives a rigid foundation upon which to build. You, a few key Manufacturers, and Avnet have built such a truss. It is a unique marketing operation in any industry—the strongest in the electronics industry. You can rely on it—for the right deliveries, the right application data, the right service, the right amount of support exactly where, when and how you want it. **THE AVNET SYSTEM**



Avnet Electronics Corp.  
Men/Methods/Materials/Management

LOS ANGELES, CAL. phone 213-UP 0-6141; SUNNYVALE, CAL. phone 408-RE 6-0300; SEATTLE, WASH. phone 206-GL 4-4911; PHOENIX, ARIZ. phone 602-273-1261; SALT LAKE CITY, UTAH phone 801-486-7566; CHICAGO, ILL. phone 312-GL 5-8160; SYRACUSE, N. Y. phone 315-454-3238; WESTBURY, L. L., N. Y. phone 516-EO 3-5800; BURLINGTON, MASS. phone 617-BR 2-3060. \* REG. T.M. of BENOIX CORP.

# ELECTRONIC OPERATIONS

## SYSTEMS WISE

### TV PINPOINTS SCIENCE LECTURE DETAILS

Closed-circuit television is used in Northeastern University, Boston, classrooms so that students may sight-in closely on science laboratory demonstrations. While physics professor Thomas Wallace explains laws of motion to students, the television camera is focused on his hands.

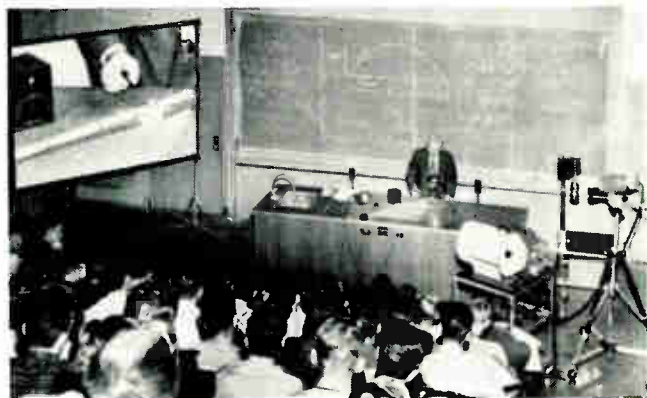

The FCC made its 100,000th grant for operation in industrial radio services to the Altoona Gas Service, Inc., Tampa, Fla., for a base station and 15 mobile units—call letters KCV705—in the special industrial category. Industrial radio service has grown from 17,000 grants in 1953 to about 100,000 within ten years. Authorizations are increasing at more than 1,000 a month.

National Association of Broadcasters endorsed proposed rules to bar Community Antenna Television (CATV) systems served by microwave facilities in the business radio service from duplicating programs from local television stations "operating at disadvantage in competition with CATV." NAB also suggested a rule to bar microwave stations from re-broadcasting signals of TV stations without written consent.

Northrop Nortronics, Anaheim, California, has developed a "flicker" range-finding technique that improves coincidence range-finder accuracy up to five times, based on rapid alternating of two target images to produce a lateral shimmer that stops when the target is correctly ranged. The development extends the low-light-level capability of coincidence range-finders, and permits halving the size of the equipment.

Theater color TV network was announced by GE and National General Corp., nationwide 220-theater chain. Based on GE's new Talaria color TV projector, the system will permit nationwide showing of live Broadway shows, sports and cultural events on standard theater screens with a brightness equal to movie color films.

"Climates" in future buildings will be controlled by small computers that will forecast weather, then use data to operate temperature-control systems, predicted John E. Haines, Minneapolis-Honeywell vice president. Honeywell is studying how to integrate computers and control systems.

DuMont Laboratories' electronic microscope and Tele-Beam Large Screen TV, by Waltham Precision Instrument Co., were used in tandem to demonstrate closed circuit microscope television at "Electronics for the Television Industry" in New York. Part of a centipede's stinging leg, only  $1/32$ ", was enlarged to fill a 50-foot square screen. The microscope combines high resolution TV with high magnification Elgeet microscopes. Tele-Beam uses the improved Schmidt optical system and a new high-voltage supply.

Race track officials at Jefferson Downs, alert for hidden portable transmitters to relay advance race tips, became suspicious at code signals amid background noise in the judges booth. An FCC engineer investigated and found that a track cameraman, who photographed each finish, was listening to practice code tapes between races to prepare for a ham license. The FCC closed the case by suggesting the use of earphones.

### DAILY RENTALS FOR UHF ANTENNAS

Antennas up to 60 feet wide (above) and transmitting towers are offered for daily rental on five year-round ranges at Treviso, Pa., by the I-T-E Circuit Breaker Co. Wide band UHF transmitters and antennas at the ranges cover the 40 mc to 40 gc frequency ranges. Technicians and engineering staff are also available on the site.

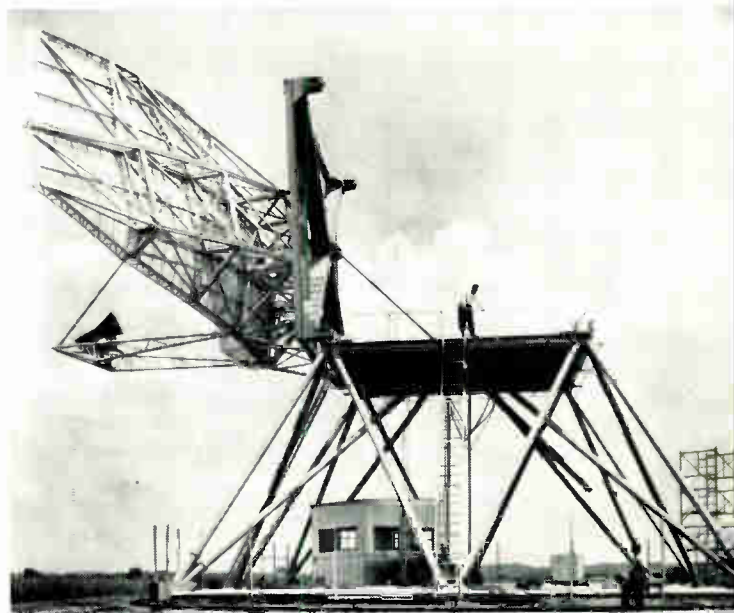

# A TESTER FOR WIRING SHORTS

As electronic assemblies become more complex, more thorough testing of the wiring becomes necessary. Here we describe two devices that can be built for performing circuit isolation tests. These devices will test large and small assemblies, with savings in both equipment and time.

MOST ELECTRONIC EQUIPMENT built today is very complex and makes use of many circuits. As the number of circuits increase, so does the possibility of short-circuits.

Unless these "shorts" are detected and corrected before the equipment is turned on, there can be costly burn-outs. Not only is time lost in making repairs, but there is the cost of the damaged parts.

This article describes two similar techniques that can be used to checkout wiring for errors quickly and economically. The wiring tests can be done manually or automatically by lower level technical help. These wiring testers can be built with the ideas described here.

\* \* \* \* \*

The ring-out of wiring in newly constructed and complex electronic systems is an important phase of checkout. The usual practice has been to make a continuity check of all or some of the circuits. The companion operation, a verification of electrical isolation between unconnected circuits, is also important, but not often done.

Shorts between circuits are not uncovered by the continuity tests, except where a terminal missing from the continuity sequence implies that the wire was incorrectly connected to a nearby terminal. In particular, modifications to electronic gear frequently cause circuits to be overlaid and shorts to occur.

To defer detection of shorts until power has been applied and signals are being traced is poor practice. For one thing, damage may be done to the system; for another, mixture and interaction of two unrelated signals may cause symptoms that defy logical interpretation. Waste of valuable engineering checkout time can result. Hence, it is very useful to make isolation tests before power is applied, and methods for doing this will be given. One method uses in-

expensive test devices for aid in manual testing; the other provides fully automated and complete testing.

## Mathematics of Test Partition

If a system contains  $N$  wired terminals,  $\frac{N(N-1)}{2}$  operations are needed to verify that each terminal is isolated from all others. Since many large systems contain 10,000 or more terminals, an isolation test carried out solely on a terminal by terminal basis is impractical.

The division of a large system of  $N$  terminals into  $n$  equal parts results in a great reduction in the number of tests. Each sub-system is given a terminal by terminal test, resulting in  $\frac{n}{2} \left[ \frac{N}{n} \left( \frac{N}{n} - 1 \right) \right]$  tests over all sub-systems. Then each sub-system's terminals are connected together. The  $n$  sub-systems as units can now be checked for isolation in  $(n-2)(n-1)$  more operations.

The optimum partition of the large system is very nearly  $n = \sqrt[3]{\frac{N^2}{2}}$

However, this is rather academic because the obvious sub-division to use is the receptacle (etched cards, plug-in, etc.).

## Practical Problems in Isolation Checking

Isolation checking is made both easier and more difficult because most circuits appear at several places within the system being checked. Easier, because the number of terminals that need to be checked is

**By WILLIS E. DOBBINS**

Member of Technical Staff  
Mesa Scientific Corp.  
12838 Weber Way  
Hawthorne, Calif.



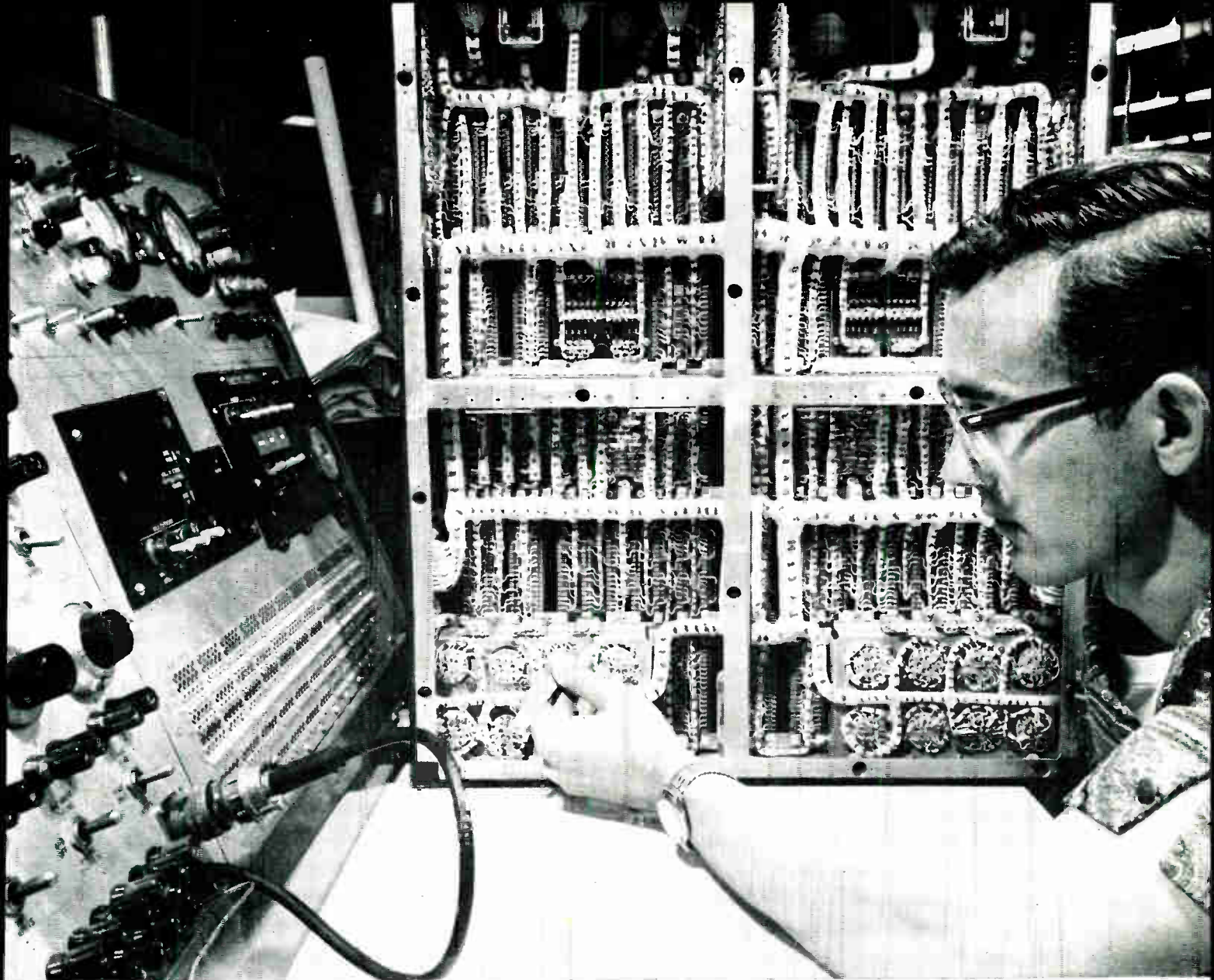

Complex wiring such as that depicted above requires some form of automatic check-out. Here an automatic system is being used

by Minneapolis-Honeywell's Aeronautical Division to check-out an intricate wiring maze used in their autopilot system.

reduced, and more difficult because many indicated shorts are legitimate connections.

The first phase of the isolation test will be the intra-receptacle test. Each terminal of the receptacle will be tested for isolation from all other terminals on the receptacle. In general, a circuit will appear but once on a receptacle. However, most circuits will appear at other points in the unit. Hence, each intra-receptacle test also checks many terminals over and above the ones actually on the receptacle.

In sequence, all receptacles are so checked. It is certain that much redundant testing will occur. However, the intra-receptacle test is so easily done by the test device, to be described later, that the repeated testing costs much less time than that needed to list and eliminate the redundant tests.

Finally, an inter-receptacle test is made. In ordinary production testing, it is not necessary to test

each receptacle against all others. The testing is continued only to the point of diminishing returns. In other words, inter-receptacle testing is stopped when no new shorts have been discovered for a prescribed time. It is then assumed that few shorts remain, and location of them is no great burden on the circuit analysis phase of testing.

The above method assumes that engineering judgment is applied to the testing. Some receptacles are selected for inter-receptacle testing, and some are left out. For instance, receptacles having circuits which fan out to many terminals in the equipment and receptacles having few common circuits will be used.

Receptacles having mostly short jumpers to adjacent receptacles are not tested to remote receptacles. Also, the intra-receptacle test directs what is probably the most common short, a connection between adjacent soldered terminals. For critical systems, such

## WIRING TESTER (Continued)

as missiles, where every circuit should be tested to all other circuits, the simple test devices proposed here are inefficient. Too much plugging and unplugging of the test device is needed. A system whereby every receptacle in the unit can be monitored simultaneously is the best way for complete isolation testing.

### Inter-Receptacle Test

The inter-receptacle test consists of temporarily connecting all terminals on one receptacle, then all on a second receptacle, and finally testing for a short between the two groups. If a connection is found, circuits common to the two cards are isolated at one receptacle only. If the short persists, the circuits on receptacle one are isolated from the indicator until the fault clears. With only that terminal connected to one side of the indicator, the circuits on the other receptacle are isolated one by one until the exact pair of incorrectly connected circuits is defined. When two receptacles have been cross-checked, they are connected together and then checked to a third receptacle. Each receptacle added to the sequence adds to the effectiveness of the test. But, for low cost manual testing, it is a good idea to test between a small number of carefully selected receptacles, using several series of batching operations.

If the number of independent circuits on 4 receptacles are  $k$ ,  $m$ ,  $n$ ,  $p$ , respectively, the test between the first two receptacles provides  $k \times m$  tests. Combining them and testing to the third brings about  $(k + m) \times n$  more tests, and finally, all four receptacles provide  $(k + m + n) \times p$  more tests.

### Test Equipment

The device used for intra-receptacle tests is a pair of etched discs ganged together. The circuits from the receptacle are connected to each disc through wipers. One disc selects one of the circuits. At the same setting, the other disc isolates that circuit while connecting the remaining circuits together. A sketch of the device is shown in Fig. 1a.

A quick spin of the dial can check each terminal against all others. If a circuit appears more than once on the receptacle, the redundant terminals are isolated from the indicator by opening appropriate toggle switches. This circuit isolation is needed to permit identification of individual shorts, where two or more are present on one receptacle.

The inter-receptacle test consists mainly of toggle switch banks, each having one switch for each of the terminals to be tested. The switches permit con-

necting together of isolated circuits and isolation of circuits connected to different receptacles. Fig. 2 shows the schematic of a 4 receptacle tester. For testing between the top two receptacles, switches 1, 2 and 3 are set as shown. To test between the top two and the third receptacle, SW1 is reversed, SW2 is thrown to the right. To test to the fourth receptacle, SW2 is reversed, and SW3 is thrown to the right.

Shorts found on each new receptacle are located on the new receptacle by opening the terminal toggle switches one by one. Further tracing to the earlier tested groups is expedited by the plug isolation toggles. This permits easy assignment of the fault to one receptacle, before individual circuits on that receptacle are removed, one by one.

If the isolation toggle switches are made SPDT, the intra-receptacle test can be made on the same switch bank used for the inter-receptacle test (Fig. 1b). Each terminal is tested by setting one switch, all others are reset. Two switch operations are needed to check each terminal, so the disc system is much faster. Furthermore, the layout of Fig. 1a is more flexible unless 3 position (neutral off) toggle switches are used in Fig. 1b.

### A Suggested Test Procedure

The continuity tests should be made first. Next, the intra-receptacle tests are made, in sequence. Use of two testers will speed the job. It seems possible that 500 receptacles can be checked in one day using two devices.

Before testing a receptacle all toggles are closed, unless two terminals are used for ground, a supply voltage, etc. In that case, one of the grounds or voltage terminals can be isolated.

As the receptacles are tested, shorts are noted. A pair of circuits shorted together can be identified by reading two settings of the dial. Multiple circuit

Fig. 1: Rough sketch shows an intra-receptacle tester setup.

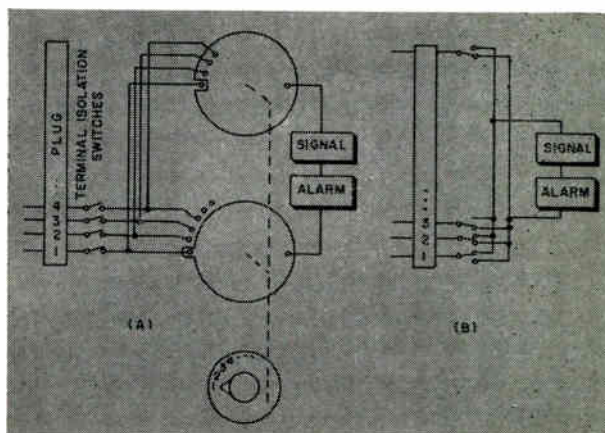



shorts can be identified only by using the dial and the toggles.

As receptacles pass the internal test, they are released to the inter-receptacle test. The procedure may be changed, but it should essentially connect all of the circuits in one group which do not appear in the other group. One may start with the toggles all closed, or all open. The former is faster if few shorts are found; the latter is faster if many shorts are met.

As newly tested receptacles are added to the large tested group, care must be taken to assure that each circuit appears on only one terminal therein. If this is not done, searching within the batch is difficult. Isolation of common circuits on the next receptacle provides this automatically.

After several series of inter-receptacle tests have been made, and the finding of new shorts becomes very infrequent, it may be inferred that the point of diminishing returns is approaching. Remembering that finding one short may save several hours of expensive testing, it is a good idea to continue this test program for several hours, despite negative results.

If modifications are made on a system, every receptacle involved should be checked, both internally and mutually. Changes to a wired system are prone to create shorts.

### Continuity Testing

The switch setup of Fig. 2 can be used for continuity testing. By closing only the toggles on a particular circuit, and then momentarily closing the master isolation switches in pairs, a circuit can be verified. The indicator is placed between one receptacle and the others. The master switches are closed in pairs, one being to the isolated receptacle. Only two master switches may be closed at one time, otherwise continuity to each terminal is not verified.

The continuity check of special circuits, such as power, grounds, and short jumpers, is not always a good idea by this method. Too much plugging and unplugging of connectors is needed to effect a complete ring-out of widely distributed circuits which appear on only a few terminals.

### Automation of Test Procedure

In cases where the wiring lists have been prepared by a computer, and where a complete isolation test program is needed, automation of wiring tests becomes an attractive idea.

A paper tape program for the wiring tests can be punched as a by-product to the preparation of wiring lists. The tester will include a tape reader, a small printer, and some programming stepping switches for fault isolation. The switches in the man-

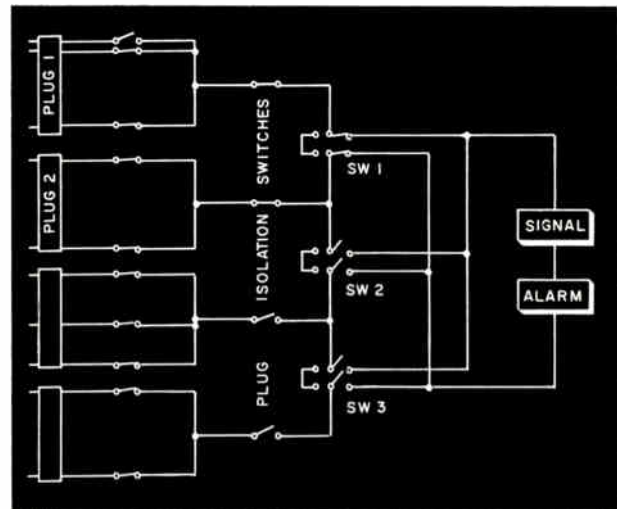

Fig. 2: Sketch shows a setup for an inter-receptacle tester.

ual unit will be replaced by relays in an automated unit.

The printer will instruct the operator when and where a test connector is to be moved. It also will tabulate incorrect connections by terminal numbers.

If connectors are provided for all, or a large fraction (say one bay or relay rack) of a system, the inclusion of continuity testing becomes more practicable. A very thorough wiring test can then be programmed for the automated tester, and operator intervention is not needed until a new section is to be checked.

### Estimating Test Time

A rough time estimate for the automated checking can be made. As an example, a 20,000 terminal system, fully monitored by 500 connectors, will be used. The continuity check requires testing 20,000 terminals. Each check comprises:

- A. Reading of 5 tape frames—0.5 sec.
- B. Unlatching a relay (prev. terminal)—0.1 sec.
- C. Latching the next receptacle selector—0.1 sec.
- D. Latching new terminal select relay—0.1 sec.
- E. Miscellaneous—0.2 sec.
- F. Total—1.0 sec.

In about six hours, the continuity test is complete.

If few shorts appear, the isolation test goes quickly. However, each fault may cause a lengthy search to find which circuit, of the large group already batched, is connected to the circuit just found to show a short.

The time needed to perform 500 intra-receptacle tests will approximate 2.5 hours.

*(Continued on page 220)*

---

A REPRINT OF THIS ARTICLE CAN BE OBTAINED  
by writing on company letterhead to  
The Editor  
ELECTRONIC INDUSTRIES  
Chestnut & 56th Sts., Phila. 39, Pa.

---



Large production gives you low prices!  
— that's why . . .

Over 100 O.E.M.s  
have standardized  
on

# AMPERITE

## Thermostatic DELAY RELAYS



### 2 to 180 Seconds

Actuated by a heater, they operate on A.C., D.C., or Pulsating Current.

Hermetically sealed. Not affected by altitude, moisture, or climate changes. SPST only—normally open or closed.

Compensated for ambient temperature changes from  $-55^{\circ}$  to  $+80^{\circ}$  C. Heaters consume approximately 2 W. and may be operated continuously. The units are rugged, explosion-proof, long-lived, and—inexpensive!

TYPES: Standard Radio Octal, and 9-Pin Miniature . . . List Price, \$4.00.

Also — Amperite Differential Relays: Used for automatic overload, under-voltage or under-current protection.

**PROBLEM? Send for Bulletin No. TR-81**

## BALLAST REGULATORS

Amperite Regulators are designed to keep the current in a circuit automatically regulated at a definite value (for example, 0.5 amp.)

. . . For currents of 60 ma. to 5 amps. Operate on A.C., D.C., or Pulsating Current.

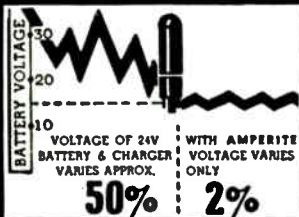

Hermetically sealed, they are not affected by changes in altitude, ambient temperature ( $-50^{\circ}$  to  $+70^{\circ}$  C.), or humidity . . . Rugged, light, compact, most inexpensive . . . . . List Price, \$3.00.

Write for 4-page Technical Bulletin No. AB-51

# AMPERITE

561 Broadway, New York 12, N. Y. . . . CAnal 6-1446  
In Canada: Atlas Radio Corp., Ltd., 50 Wingold Ave., Toronto 10

## WIRING TESTER (Concluded)

- A. To read four tape frames to address receptacle—0.4 sec.
- B. To read 40 x 2 tape frames to address terminals—8.0 sec.
- C. To latch and unlatch 80 relays sequentially—8.0 sec.
- D. Miscellaneous—2.0 sec.
- E. Total seconds per receptacle—18.4.
- F. Total time=500 x 18.4 sec.=2.5 hrs.

The time needed to make the inter-receptacle tests is about 1.5 hours.

- A. To latch an average of 20 relays on a connector—8.0 sec.
- B. Miscellaneous—2.0 sec.
- C. Total—10 sec.
- D. Total time=500 x 10 sec.=1.4 hrs.

The average time to track down one inter-receptacle short is estimated by assuming 250 receptacles are in the large group, distance back to faulty receptacle is 125 relay operations, and 20 operations are needed to find the faulty terminal. At 0.1 second per operation, 14.5 seconds are needed per fault. Repeated binary division of a large batch of receptacles, having somewhere within it the other of a shorted pair, can bring about more rapid homing on the faulty receptacle.

The tape data for the continuity test amounts to about 110,000 frames, and about 60,000 frames for the isolation test.

**FOR MORE INFORMATION . . .** we suggest that you see the following articles that have appeared in recent issues of "Electronic Industries."

- "Automatic Check-Out for Automated Wiring," September, 1962
- "Missile Computer Has 'Self-Checking' Capability," July, 1961
- "Design of Automatic Test Equipment," January, 1961

**GOVT. TO COMMERCIALIZE DOD R&D?**—Commerce Dept. may undertake key role in developing patents resulting from defense R&D. Under experimental program, Commerce would seek ways to broaden uses of such R&D to make commercial products.

**IT PAYS TO ADVERTISE**—Some weeks ago Republic Aviation inserted full-page ads in some trade papers and consumer magazines, advertising "Immediately Available: Tactical Weapon System," and concluding, "Avail NOW. F-105D Thunderchief, Republic Aviation Corp., Farmingdale, L. I., N. Y." Result: Not only did college boys and a housewife answer, but some Pentagon officials reportedly did also.

# SINGLE MOLECULAR LAYER BONDS METAL TO THERMOPLASTIC

A METHOD OF BONDING METALS to thermoplastics with a single layer of molecules as an adhesive has been developed at Bell Telephone Laboratories. Such a bond between aluminum and polyethylene is more permanent than any previously achieved and more resistant to tearing and pulling than the plastic itself.

Up to now it has not been possible to form a direct bond between metals and polyethylene that will withstand mechanical stress if the humidity and temperature are high. An aluminum-polyethylene-aluminum bond, prepared by this method, has held up for months under 600 pounds psi of tensile-shear stress at 100% relative humidity and 80-120°F. These materials were bonded together with a monolayer of stearic acid ( $\text{CH}_3(\text{CH}_2)_{16}\text{COOH}$ ).

The method could find a number of uses. For example, a permanent bond between polyethylene insulators and copper conductors could improve the mechanical properties of telephone cables; or, increase the reliability of a printed circuit.

A method developed in 1935 by Irving Langmuir and Katherine Blodgett and used since by chemists to study the structure of single molecules, was applied. The method, which allows deposit of a single layer of molecules ("monolayer") of a substance on a water surface, had never been applied before to adhesion.

If certain long chain hydrocarbon acids are used as the monolayer, the acid end of the molecule will form a chemical bond with the metal and the hydro-

Lower diagram shows stearic acid molecules adhering to a metal plate as it is pulled through monolayer on water's surface. Sketch on right shows final chemical bond between metal plate and acid, and physical bond to hydrocarbon part.

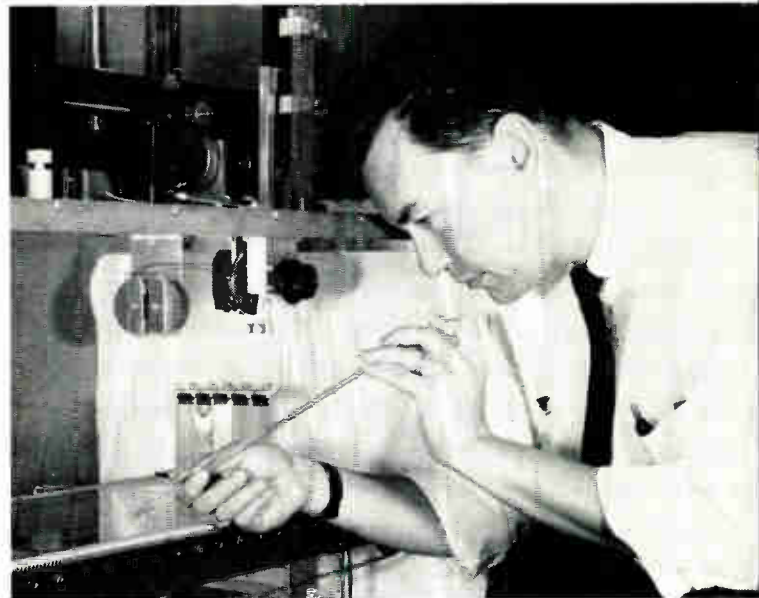
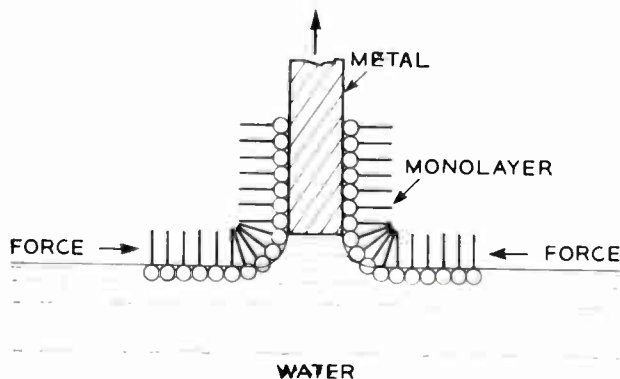
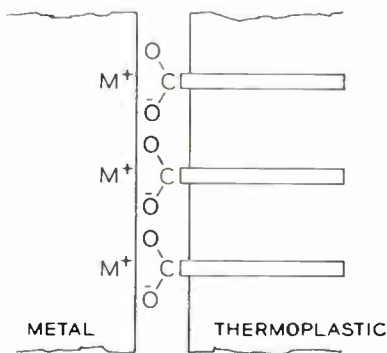

Dr. Harold Shanhorn, Bell Telephone Labs., uses a pipet to deposit a monolayer of stearic acid onto surface of water in a water trough. Acid creates a tough bonding material.

carbon part will form a physical bond with the thermoplastic. One end of the stearic acid formed aluminum stearate with the metal plate; the other end became immersed in the polyethylene. These reactions account for the permanence of the bond.

*(Continued on page 222)*

## In the Best of Circuits...



## Hollingsworth Solderless Terminals

- Speed Production
- Cut Assembly Cost

Used by industry leaders because Hollingsworth specializes in solderless terminals and connectors. All types, all wire sizes. Fast delivery.

SEND FOR CATALOG & SAMPLES

**hollingsworth** PHOENIXVILLE, PA.  
SOLDERLESS TERMINAL COMPANY



# HIGH RELIABILITY...

## Fully Interchangeable **Midget 482** CONNECTOR MIL-C-0026482



Proof of Methode product reliability and versatility. The new **Midget 482 Connector** not only solves the "space problem" but is fully interchangeable with existing MS type miniature connectors with **Bayonet Lock**. It meets the environmental requirements of MIL-C-26482 and meets or exceeds the requirements of MIL-C-0026482 where applicable.

### PLUS THESE FEATURES, TOO:

- Crimp style removable contacts using standard MIL-T-22520 tool modified locator
- Shells of high strength impact extruded aluminum
- Cadmium plated with olive drab irridite finish
- Bayonet coupling with positive lock for easy mating
- Closed entry sockets meeting or exceeding MIL-C-26636 requirements where applicable
- Resilient inserts permanently bonded to shell designed for moisture resistance and protection against vibration failure and five (5) key polarization.

And, as always with Methode, you'll find the product performance and service "extras" you always get. Write for informative literature.



**Methode Electronics, Inc.**  
7447 W. Wilson Ave. • Chicago 31, Ill.  
Telephone: UNderhill 7-9600

## BONDING METAL TO THERMOPLASTIC (Continued)

To prepare the monolayer, scientists dissolved the stearic acid in benzene and spread the solution on water contained in a long trough. The volatile benzene evaporated and left a monolayer of stearic acid on the surface. He then used a float to push these molecules close together. The hydrocarbon portion of the stearic acid is insoluble in water and tends to stand up straight when the film is compressed. The acid portion dissolves and lies just below the surface of the water.

Next, they lowered an aluminum plate through the monolayer into a rectangular well at one end of the trough. During its descent the plate contacted the hydrocarbon portion of the monolayer. Since this part of the stearic acid molecule has no affinity for aluminum, it did not adhere to the plate. But when the scientists raised the aluminum plate it contacted the acid portion of the molecule to form a chemical bond. The molecules adhered to the sides of the plate so that the hydrocarbon part faced out.

Once coated with such a monolayer, metals cannot absorb appreciable amounts of water or gases from the atmosphere and can be stored for months before they are bonded to thermoplastics. Unprotected metals become contaminated by the atmosphere in a short time and must be specially treated before they are suitable for bonding.

In the final stage of the experiment, polyethylene was melted onto the monolayer. The hydrocarbon portion of the stearic acid molecule became immersed in the polyethylene, itself a long chain hydrocarbon. This completed the bond.

Ordinarily, stearic acid and other long chain hydrocarbon acids are used in thicker films to release parts from molds. However, so long as these compounds are used in a single molecular layer, they act as adhesives. Bell Lab scientists have also bonded aluminum, stainless steel and copper to polypropylene and polystyrene using octadecylamine and octadecylphosphonate. By varying the adhesive, they can in principle, bond other thermoplastics and metals together.

---

### NASA FIGHTS FOR BUDGET SUPPORT —

NASA officials, with strong White House support, are battling to sell the Congress on the need for their record \$5.7 billion budget for the next fiscal year. The substantial budget increase is being quietly and carefully documented to lawmakers, particularly those who might pare it. Space officials and White House liaison men rely on phone calls, personal visits, even cocktail conversation, plus obvious Russian successes in space, to keep the funds coming for moon landings and other projects.



## ELECTRON MIRROR MICROSCOPE

UNTIL RECENTLY, DETECTION AND MEASUREMENT METHODS which would provide information on the electrical and magnetic properties of solid surfaces, have been lacking.

To advance the general state-of-the-art of electron and surface physics, General Mills has developed a basic instrument which has the capability of providing this detailed information. This instrument, the electron mirror microscope, promises to become an increasingly valuable research tool. It will extend microscopic observations into areas which are not at all accessible or not easily accessible by other means. The applications research program is being conducted by the Materials Testing Laboratories of the Magnaflux Corp., 2735 E. Slauson, Huntington Park, Calif., in cooperation with General Mills, Inc. What makes this device even more interesting and versatile is the fact that not only static electric and magnetic patterns but also a specimen's dynamic behavior can be observed.

Electron mirror microscopy has already proved to be valuable in the fields of magnetism, semiconductor physics, surface physics. It may also prove to be extremely valuable in such fields as surface chemistry, particularly in the study of oxidation processes, and eventually in the study of the transition region into the superconductive state.

In electron mirror microscopy the electrons do not penetrate the specimen as they do in conventional electron transmission microscopy nor do they originate from the specimen as they do in the different categories of electron emission microscopy. In elec-

*(Continued on page 224)*

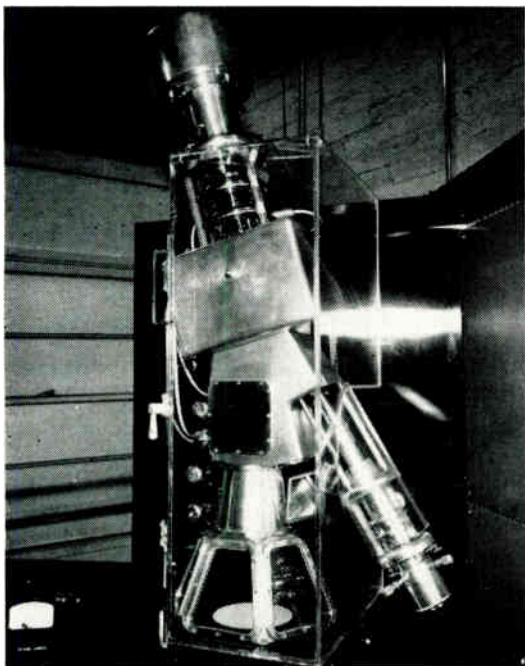

A plastic enclosure surrounds the electron mirror microscope. A magnified image is visible in portholes below on round viewing screen.

## THE WORLD'S LARGEST AND MOST DEPENDABLE LINE OF HIGH VACUUM PUMPS

Single Stage, Compound and Triplex High Vacuum Pumps from 2 to 1100 cfm

### KINNEY'S TRIPLEX HIGH VACUUM PUMPS Series KT

MODEL KT-300

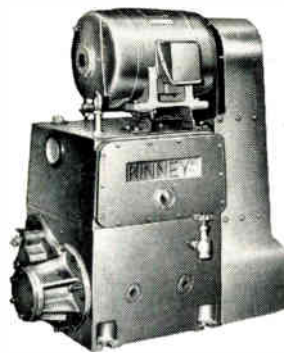

Triplex High Vacuum Pumps use the rotary-piston principle developed by Kinney. A new and original balancing technique utilizing three sets of cams and pistons offer compactness and vibration-free operation not available with any other pumps of comparable size. The complete line of Triplex pumps offers a range of displacements from 15 to 1100 cfm.

### KINNEY'S COMPOUND HIGH VACUUM PUMPS Series KC

Kinney Compound Mechanical Pumps maintain lower pressures than are attainable with single stage pumps. Six models provide a range of displacements from 2 to 46 cfm. On test, each pump is required to produce an absolute pressure reading of 0.2 micron; readings of 0.1 micron are typical of standard production models. Dynamic balancing assures vibrationless performance.

### KINNEY'S SIMPLEX HIGH VACUUM PUMPS Series KS

Kinney Simplex Pumps employ a single cam and piston principle, in a rotary piston design providing maximum performance, minimum wear and maintenance. They attain an ultimate pressure of 10 microns and have a displacement range from 13 to 47 cfm.

MODEL KC-5

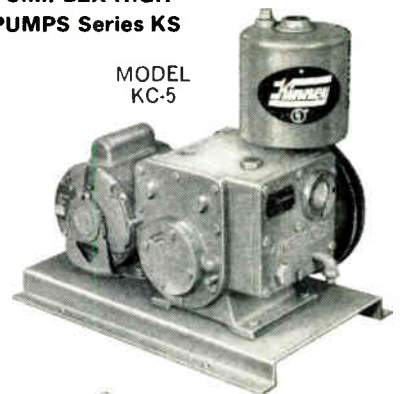

## KINNEY VACUUM

DIVISION THE NEW YORK AIR BRAKE COMPANY

3529 WASHINGTON ST. • BOSTON, MASSACHUSETTS

**KINNEY . . . EVERYTHING IN VACUUM**

Over 4,000,000 Successful Installations  
Establish the **HOWARD UNIT BEARING MOTOR** as the All-Time Champion in  
*Air Movement Applications*



**GUARANTEED FOR 5 YEARS**

The number of Howard Unit Bearing Motors in service has now reached a total of over *four million*, with a performance record that enables Howard to guarantee a minimum of 5 years' continuous operation without lubrication maintenance. For the *guarantee* instead of the hope of long, maintenance-free performance, make sure your air movement units are powered by Howard . . . Write for blower-and-fan bulletin.

POWERED BY

**HOWARD**

**HOWARD INDUSTRIES, INC.**  
1730 STATE ST., RACINE, WISCONSIN

Divisions: Electric Motor Corp., Cyclohm Motor Corp., Racine Electric Products, Loyd Scruggs Co., Micro Gear Inc.

Circle 169 on Inquiry Card



**It stands alone**

You can't buy HYDRAZINE-ACTIVATED FLUX<sup>®</sup> or Core Solder under any other brand name. Fairmount is the sole producer.

Hydrazine-Activated Flux and Core Solder offers an exclusive combination of advantages:

- High wetting properties for good "bite."
- Non-corrosive connections.
- Residues removed by heating or water rinse.
- No change on aging.

These performance characteristics were confirmed in a recent evaluation of leading fluxes used in the fields of printed wiring and etched circuitry.

No one flux is best for all purposes. TEST HYDRAZINE FLUX AND CORE SOLDER FOR YOURSELF. The liquid permits pre-fluxing, is useful for soft-soldering a wide range of copper and copper-based alloys. The core solder flows at an ideal rate, leaves a minimum of soldering residues. Write for samples of either, or technical literature.

\*U.S. Patent No. 2,612,459 and others

Available only from Fairmount and its sales agents.

**Fairmount**  
CHEMICAL CO., INC.  
136 Liberty St., N. Y. 6, N. Y.

Circle 170 on Inquiry Card

## ELECTRON MIRROR MICROSCOPE (Continued)

tron mirror microscopy the electrons are reflected, but they are not reflected by the material of the specimen as is the case in conventional electron reflection microscopy; they are reflected without any scattering at the equipotentials in front of the specimen.

The characteristic feature of General Mills' electron mirror microscope is an electron optical mirror playing a dual role. The mirror serves as an electron optical element and simultaneously constitutes the specimen. In general, the mirror-specimen remains untouched by the image-forming electrons because the specimen, being an electron optical mirror, is biased slightly negative with respect to the source of the electrons. The electrons approaching the mirror-specimen are slowed down to zero axial velocity shortly before reaching it and then reverse their direction of motion.

Any irregularity on the mirror-specimen capable of deflecting the approaching and receding electrons will modify the spatial density distribution of the returning electron beam. This returning electron beam, therefore, carries back information about the distribution of the irregularities it encountered during the time it was close to the mirror-specimen. Electron mirror microscopy uses the fact that such information can be presented on a phosphorescent screen as a magnified, visually observable image of the distribu-

Details of the electron mirror microscope are shown below. It was developed by the Electronics Div. of General Mills.

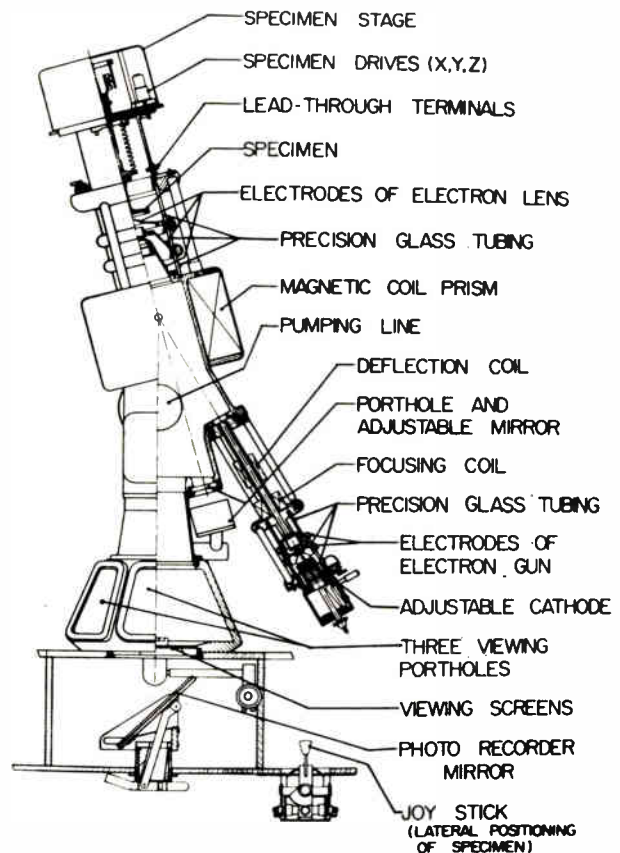



tion of the electron-deflecting irregularities on the mirror-specimen.

A unique feature of the system is its capability of imaging purely electrical patterns. In addition to depicting contact potential or surface charge distributions, it can depict the electrical conductivity distribution of layers of very low conductivity above conductive substrates.

This can be achieved by letting a few electrons from the tail end of the Maxwellian distribution impinge on the mirror specimen, using the majority of the electrons, however, for image forming purposes. The electrical charge movements can then be visually followed. A thin film of amorphous or non-crystalline selenium deposited on a germanium substrate can be shown to have a pronounced wavelike pattern moving from the outside toward the center. This is clearly seen in moving pictures of the fluorescent screen.

The observation of the conductivity distribution in thin films of semiconductors deposited on insulating substrates can be easily obtained. A potential pattern related to the conductivity pattern can be obtained by applying a potential gradient across the film. Changes in potential gradient across the surface are transformed into light and dark areas on the viewing screen.

With electrical potentials applied, potential gradient distributions across p-n junctions or low angle grain boundaries and dislocation lines in semiconductors can be observed.

Electron mirror microscopy is well suited for the observation of magnetic domain patterns. Magnetic domain patterns in materials with a uniaxial direction of easy magnetization or several directions of easy magnetization are revealed. Of equal importance is the ability to view the domain patterns in motion. It is also possible to separate the electrical properties from the magnetic properties through manipulation of the sample.

**VALUE ENGINEERING CLAUSE**—DOD says defense contracts will henceforth carry "value engineering clauses." This is effort to get "more for the buck"—better performance for less money. Such military leaders as Vice Adm. Hyman G. Rickover and Seymour Lorber, Chief of Quality Control Br., Army Materiel Command, have criticized industry for poor quality control.

**MILITARY COMSATS**—DOD continues effort to create its own full-time, jam-free, radiation-resistant, ultra-reliable, defense comsat system. Even with several civilian types now up, Air Force has asked for new industry proposals for medium altitude system. Identical comsats would be in polar orbits.

## For Fast, Precise Miniature and Sub-Miniature Soldering



**IDEAL THERMO-TIP®**

### RESISTANCE SOLDERING TOOLS

No Cold Flow • No Burn Damage • No Set-Up

Cut time, cost and damage on all precision miniature and sub-miniature soldering jobs. Ideal Thermo-Tip Soldering Tools use resistance heating principle to concentrate *all heat on the job*—instantly, without set-up or pre-heating. Versatile "Pencil Grip" handle is easily manipulated for close-quarter soldering of aircraft connectors, printed circuits, pin type plugs, terminals—practically any job requiring pin-point assembling accuracy. Thermo-Tip is activated only on contact with work—doesn't waste current, can't damage adjacent parts, can't burn operators. Solder immediately flows all around to form stronger, neater, more uniform joints. Unit is so lightweight a woman can use it all day without tiring. Has a perforated aluminum sleeve which dissipates heat for exceptionally cool operation. Available with "pencil grip" and "pistol grip" style tools.

IDEAL SOLDERING EQUIPMENT FITS EVERY NEED

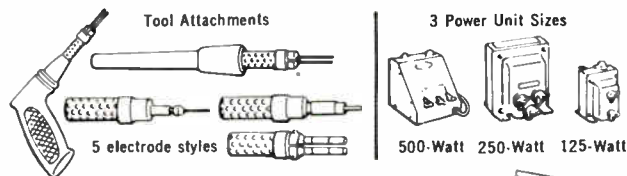

Write Today for Catalog Data

IDEAL INDUSTRIES, Inc.  
5127-D Becker Place  
Sycamore, Illinois  
Please send Catalog data on  
Ideal Soldering Equipment

IDEAL



Name \_\_\_\_\_  
Company \_\_\_\_\_  
Address \_\_\_\_\_  
City \_\_\_\_\_ Zone \_\_\_\_\_ State \_\_\_\_\_

\*\*\*\*\* SOLD THROUGH AMERICA'S LEADING DISTRIBUTORS \*\*\*\*\*  
In Canada: Irving Smith, Ltd., Montreal



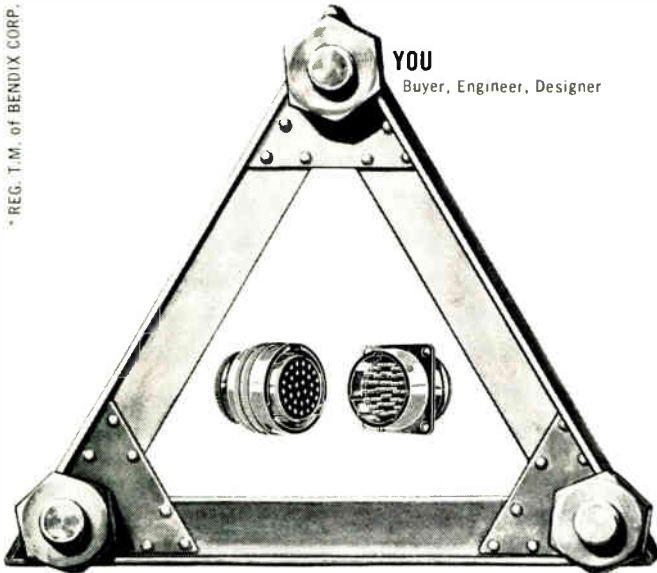

**YOU**  
Buyer, Engineer, Designer

**AVNET**  
Satisfying the needs  
of you and  
the manufacturer

**MANUFACTURER**  
Bendix\* Connectors

**Avnet service is strong, solid . . .**

. . . like a triangular truss. Gives support where required, gives a rigid foundation. Rely on this strength for on-time deliveries of your emergency or prototype Bendix Connector needs. For the right support, call Avnet.

**AVNET**  
THE AVNET SYSTEM  
Men Methods  
Materials Management  
Avnet Electronics Corp.



Los Angeles, Sunnyvale, Cal., Seattle, Salt Lake City, Phoenix, Chicago, Westbury, L.I., N.Y., Syracuse, N.Y., Burlington, Mass.

Circle 172 on Inquiry Card

## Weckesser Cable Clamps



In Stock—  
Complete  
Range of Sizes . . .

**NYLON • ETHYL-CELLULOSE  
BUTYRATE • TEFLON**

Write for Free Samples, Prices, Complete Details

**Weckesser COMPANY, Inc.**  
5711 Northwest Highway • Chicago 46, Illinois  
Circle 173 on Inquiry Card

## SOLID STATE BULK TANTALUM CAPACITOR

A STEP FORWARD IN MINIATURIZATION of one of the three basic components of electronic circuits has been disclosed. General Instrument Corp., Newark, N. J., has developed—and placed in production—"the first true solid state" bulk tantalum capacitor. The device takes up only 600 one-millionths of an in.<sup>3</sup> but matches or betters the performance of comparable conventional capacitors 10 times its size and six times its weight.

The new unit, called the Hi-VolTan, contains no

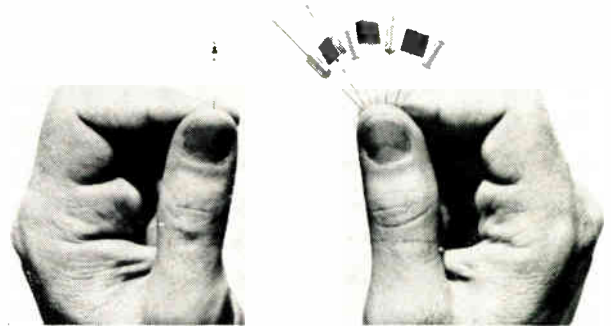

electrolyte, either "wet" or solid, and operates at up to 125 v. It combines size and weight advantages which have made tantalum devices invaluable in aerospace and other military circuitry with the low "leakage" and high stability of other advanced capacitors, such as Mylar. It has advantages over—and can replace—at least five other major types of capacitors, according to General Instrument.

### DIFFUSION FURNACE TEMPERATURE TEST



Diffusion furnaces for alloying and doping semiconductors are temperature-profiled to establish characteristics at GE's new Microelectronics Lab, Utica, N. Y. Furnaces produce prototype, experimental single-crystal circuits for GE design engineers.

The new devices are guaranteed to withstand test (breakdown) voltages of up to 200 v. and working voltages of up to 125 v.—hitherto not possible with conventional solid electrolyte tantalum capacitors—and operate safely and reliably at temperatures as low as  $-100^{\circ}\text{C}$  and as high as  $+125^{\circ}\text{C}$ .

The new devices are being marketed in four different series, with capacitances up to 10,000 pf.

All four are the same size, (smaller than a lighter flint), measuring only 0.065 of an inch in diameter, and 0.183 of an inch in length, with total volume of only .0006 in.<sup>3</sup> It takes 250 of the devices to tip a one-ounce scale, each weighing only 0.004 oz.

The new capacitor contains no electrolyte. Heart of the device is a needle-thin tantalum wire electrochemically coated with a thin film (measurable in angstrom units) of tantalum penta-oxide, which acts as the dielectric. Cathode connection to this dielectric is metallic, not electrolytic or semiconductive.

Due to the absence of any electrolyte, the possibility of electrolytic ionization is eliminated. There is no inherent potential for instability and no ionic exchange to produce chemical or physical alterations during the life of the unit.

When tested, the Hi-VolTans were found to have advantages in operating performance over solid electrolyte tantalum, "wet" tantalum, metallized paper and high quality high-K ceramic devices of similar capacity. They were found to be equal in performance to Mylar devices 10 times their size.

Initially, the Hi-VolTan capacitors are available in four series: 200 v test, 125 working volts, 400 to 3000 pf.; 100 working volts, 400 to 3000 pf.; 50 working volts, 3100 to 5000 pf.; and 25 working volts, 5100 to 10,000 pf.

### COLOR TV TUBE MERRY-GO-ROUND

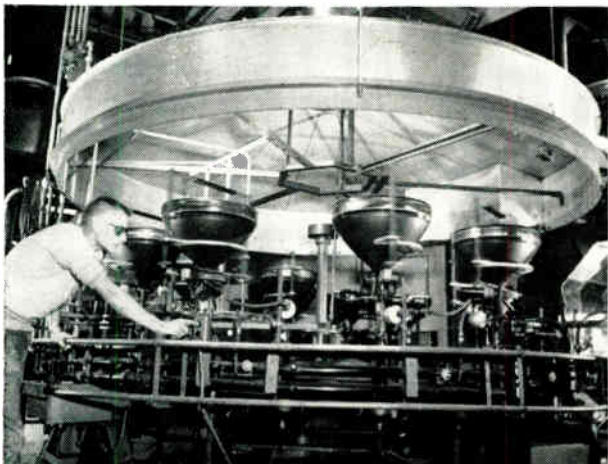

Employee starts large sealing machine at RCA color TV picture tube plant, Marion, Ind. In this step electron gun is sealed into tube neck. Gun must be oriented so beams will hit proper color dots when tube operates. Plant operates day and night.

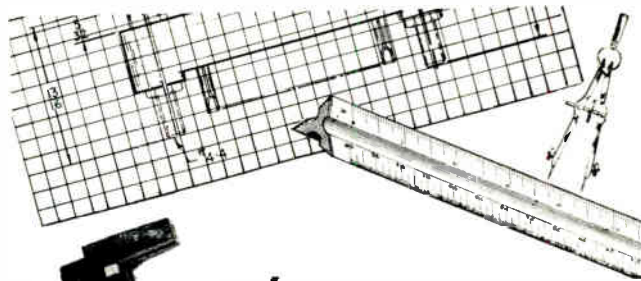

**chances are,  
the Connector  
you  
are looking for  
hasn't  
been made**

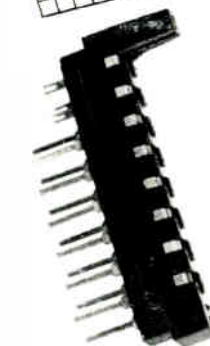

Who knows this better than Eby! Eby has been working with industry leaders on their connecting problems for more than 40 years. Eby's unparalleled, practical experience—combined with new, youthful imagination and vision—has led to many dramatic advances in electronics and communications components. It's a combination that can quickly solve your connecting problems.

And why not check the broad line of connectors, hardware and related accessories produced by Eby. The component you've been searching for might well be there.

A phone call is the fastest way to start Eby thinking about your connector application. Or write for Eby's catalog of standard components and explain your problem.

### HUGH H. EBY CO.

4701 Germantown Avenue  
Philadelphia 44, Pa.

Phone 215, DAvenport 4-7000



TM

NOW

A Division of REDM CORP





# SYSTEMS & CIRCUITS

**CIRCUIT COMPONENT FAILURE** data has been compiled by the Electronic Industries Association. EIA has published a compendium of failure data on 61 types of electronic components compiled from operating data supplied by 28 organizations. This information, along with a report "EIA's Reliability Program Guide," are both available in one package from EIA's Engineering Department, 11 West 42nd Street, New York 36, N. Y. for \$2.50.

**A DATA PROCESSING SYSTEM** will serve as a "language link" between test instruments and computers in the Polaris weapon system testing program at Cape Canaveral. The equipment, designed and made by Systems Engineering Laboratories, Inc., Fort Lauderdale, Fla., will be installed at Cape Canaveral.

The system will be used by the Applied Physics Laboratory of The Johns Hopkins Univ. to speed up reduction of data obtained by new Polaris submarines as they arrive from test runs. It is expected to reduce data processing time by a full day.

Two types of information will be processed by the system: Telemetry data from the Polaris missile and data from the submarine's digital computers which collect information on the vessel's operations and positions.

**CIRCUIT DESIGNERS** will be missing a good bet if they don't at least check the 1963 Electronic Components Conference program. Many of the papers being presented at the International Inn, Washington, D. C. on May 7, 8 & 9 contain information that must be known by design engineers. While many of the papers reflect the latest trends, the "older" components are not being neglected at these sessions.

**CIRCUITS USING DISCRETE SUBMINIATURE COMPONENTS** may be replaced directly with integrated circuits in "Minuteman" missiles according to the latest rumors. An off-the-cuff disclosure says that Autonetics is contemplating the elimination of any interim steps in circuitry in favor of the integrated circuits for this top reliability missile.

**IMPROVED CIRCUITS** will result from tests conducted at Holloman AFB, New Mexico. Many NASA missiles may fly with a set of new devices better guaranteed to keep their numerous circuits at "go." The recent tests were accomplished by simulating the conditions of a missile launch with a series of rocket sled runs on Holloman's 35,000 foot captive missile test track. The device's advantages include elimination of soldered connections, many pounds of missile weight, short-circuits, and broken or frayed connections. A series of six sled runs at near-sonic speeds with accelerations up to 20g's carried the sled-borne connectors through every vibrational stress to prove their value as missile components. Three of the new connectors were tested during each of the six sled runs—using duplicate runs for reliability. Maximum vibration for the tests was obtained by mounting the connectors just above a sled slipper (the U-shaped metal sliders which keep the sled on the track rails) and along three orthogonal axes, laterally, vertically, and longitudinally.

## rfi FILTERS to military specifications

- Reliable
- Precise
- Flexible
- Proven



### MODEL 1100 SERIES

- Series 100-1100 filters conform to MIL-S 15733D.
- Ratings from 1/4 amp. to 20 amps. @ 220V A.C./400V D.C.
- 60 db attenuation 150 to 1000 mc.
- Basic units adaptable to specific requirements for voltage, current and attenuation.

Call—  
Wire—  
Write—



**STANDARD ELECTRONICS CO.**  
1611 W. 63rd ST. • CHICAGO, ILL  
Area Code 312 PRospect 8-4222

Circle 175 on Inquiry Card

## Read INSULATION RESISTANCE to FIVE MILLION MEGOHMS

**VIBROTEST®** Megohmmeters provide direct reading resistance measurements to five million megohms of electronic circuits, cable assemblies, transmission lines, motors, generators, servos, components and insulating materials. Push-button operation makes possible high speed production testing. Self-contained high voltage supply eliminates cranking and leveling. Write for complete manual.



Model 250 VIBROTEST Megohmmeter with ranges to 50,000 megohms. Complete \$279.50.

## HIGH VOLTAGE BREAKDOWN Insulation Leakage Current

**HYPOT Test Sets** provide direct reading of insulation leakage current in accord with military and commercial test specifications. Models are available to supply a-c and d-c test potentials to 150 kv and higher. Optional features include automatic rate of voltage rise control, automatic test cycling and others to meet every test application.



Model 424 HYPOT provides 0-5000 v d-c for testing cables, condensers, coils, transformers and assemblies. Measures leakage 0.1 to 100 microamperes over four scale ranges. Rapid charging of capacitors with 5 ma. output. Self-contained power supply. Complete \$497.00.

Write for Manual H-66



**ASSOCIATED RESEARCH, Incorporated**  
"Electrical Testing Instruments Since 1932"

3787 W. Belmont Avenue • Chicago 18, Illinois

10-35-20

Circle 176 on Inquiry Card



# NEW PRODUCTS

...for the Electronic Industries

## Ka BAND NOISE SOURCE

Model 2200-10 for use over the freq. range of 26.5 to 40.0gc.

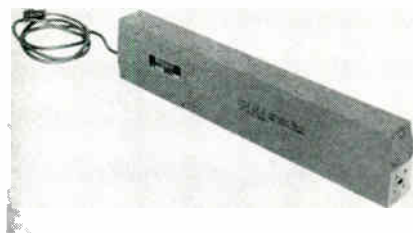

This noise source contains a tube which emits an excess noise ratio of 16.0  $\pm$  0.5db. Insertion loss is held to a 0.5db max. and both the hot and cold vswr characteristics do not exceed a value of 1.15. The mechanical mounting arrangement enables this noise source to be used as either laboratory equipment or it may be built into a specific operating system. The standard unit contains UG-599/U cover flanges and an alternate version is available with UG-381/U circular contact flanges. Waveline Inc., Caldwell, N. J.

Circle 394 on Inquiry Card

## SQUARE WAVE CONVERTER

Transistorized Model 63A is a source of square waves.



For general laboratory design and development and various testing. Has low output impedance for testing transistors and diodes supplying up to 100ma. Consists of a Schmitt trigger with shaping and low output impedance driving circuit. Provides constant rise and fall time of 0.03 $\mu$ sec. independent of load in the freq. range of 1cps to 1mc. No load output is 4v pk-pk. Driven by any signal generator with an output of 2v rms. Powered by a self-contained Hg cell or from an auxiliary supply. Applied Polytechnic Research Corp., 62 West St., Annapolis.

Circle 395 on Inquiry Card

## POWER PACKS

Series M Power Packs feature small packaging for high voltages.

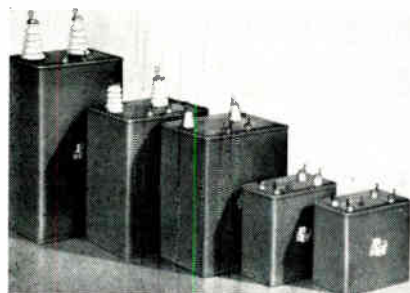

This power pack series has the following characteristics: input 0 to 118v from 60 to 500 cps; output to 5ma dc to rated voltage; output ripple 1%<sub>RMS</sub> at rated voltage and load with 60 cps input; outputs of 2 to 20Kvdc can be varied from 0 to rated voltage by means of a variable auto-transformer; 2 output terminals; ambient temp. range from -55° to +85°C. Container size from 3 $\frac{3}{4}$  x 2 $\frac{1}{4}$  x 3 $\frac{3}{8}$  to 3 $\frac{3}{4}$  x 4 9/16 x 8 in. Weight ranges 2 $\frac{1}{2}$  to 12 $\frac{1}{8}$  lbs. Plastic Capacitors, Inc., 2620 N. Clybourn Ave., Chicago 14, Ill.

Circle 396 on Inquiry Card

## SPECTROMETERS

For electron paramagnetic resonance at X, K and Ka bands.

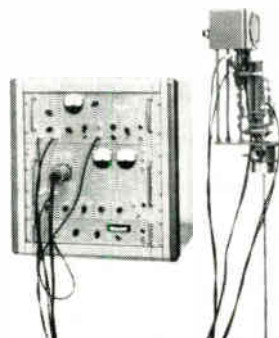

Spectrometers Model 601-AKA and Model 602-AKA operate between 35 and 36 gc. For spectroscopy work in which economy and long klystron life are important, X-band E.P.R. spectrometers Model 601-AX and Model 602-AX are offered. The Model 601-AX operates at freqs. between 8.5 and 9.6gc. For investigations in which high microwave power is required, these X-band spectrometers can be furnished with a klystron capable of delivering at least 200mw of power to the sample cavity. Strand Labs, Inc., 294 Centre St., Newton 58, Mass.

Circle 397 on Inquiry Card

## WAVE TUBE AND MOUNT

Power traveling wave tube and magnet focusing mount are featured.

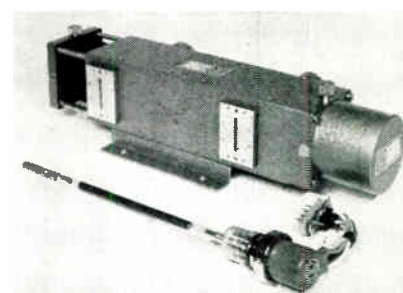

The N1029 TWT is a wide band power amplifier operating in freqs. from 5.8 to 7.2gc. Nominal gain is 43db and working output is 5w. Max. ratings: Collector, helix and grid-2 voltages are 3300v; collector current is 40ma. This TWT operates in the periodic permanent magnet focusing mount type N4047, or equivalent, although a solenoid type is satisfactory. Mount ambient temp. ranges from -10° to +55°C max. English Electric Valve Co. Ltd., Chelmsford, England.

Circle 398 on Inquiry Card

## MAGNETIC DRUM

Random access speeds computer program storage and retrieval.



Any character may be random selected, from up to 1.1 million, and moved into computer for processing in an average of 8.6msec. The 7320 can move intermixed alphabetic and numeric information sequentially into a computer at 203,000 characters/sec. Mechanism based on read-write heads which "float" over surface, on wafer-thin layer of air. The 10.7 x 12 in. drum can hold 625 information bits—about 104 characters in 6-bit code—on each inch of each track. IBM Corp., Data Processing Div., 112 E. Post Rd., White Plains, N. Y.

Circle 399 on Inquiry Card

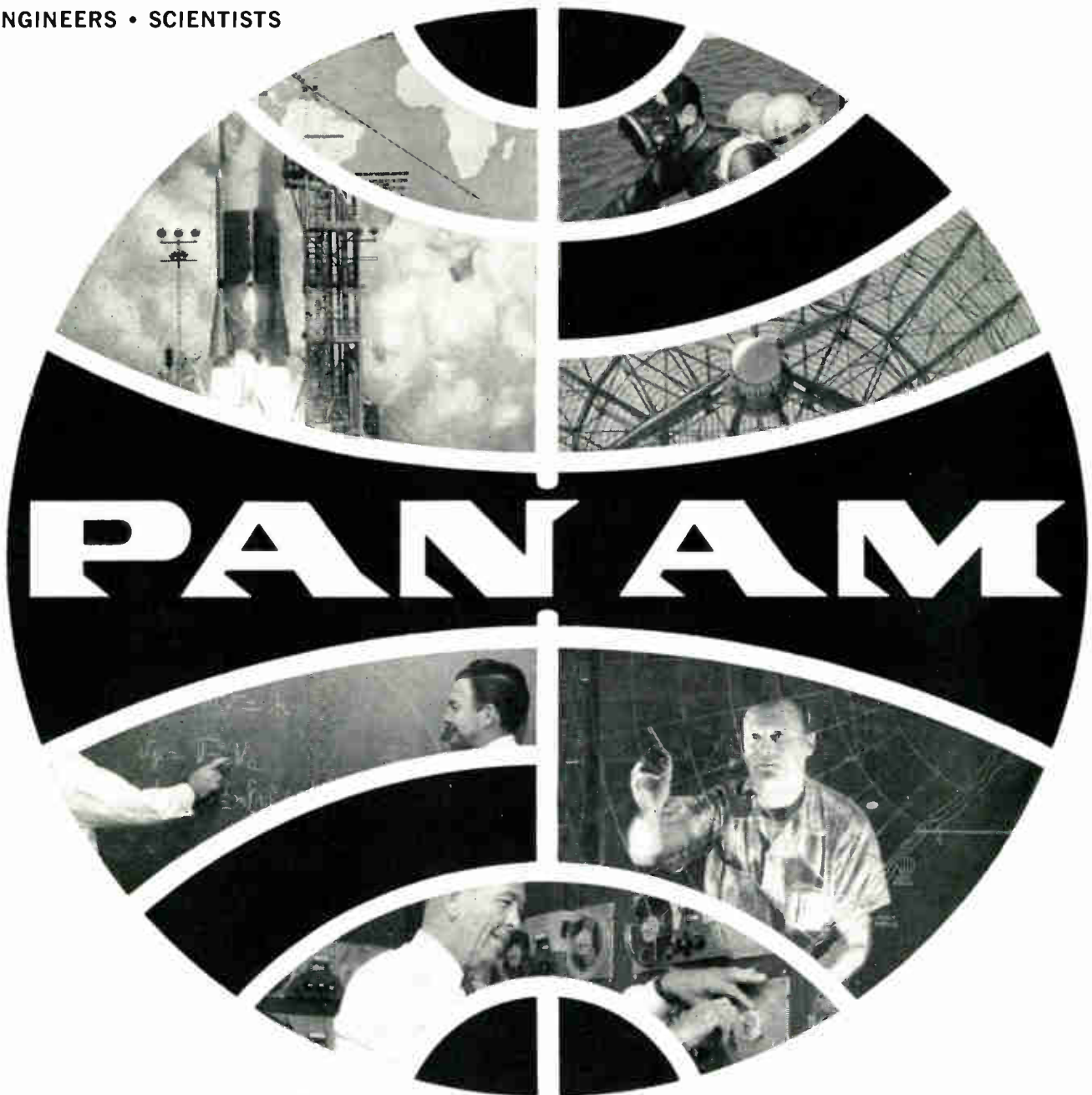

## encyclopedic exposure to the whole world of space vehicle & missile technology

is basic to engineering with PAN AM<sup>®</sup> at the Atlantic Missile Range. □ The reason: engineers and scientists here strive to **match** the capabilities of each new launch vehicle with range test systems of equal or greater accuracy. Our engineers and scientists have pushed the past and present instrumentation systems to their operational limits—and have gone on to create a **whole new range technology**. They have developed design criteria and are providing technical direction for global tracking and telemetry systems, combining the latest techniques from all areas of electronics, optics and infrared. □ Today, forward looking groups at PAN AM's Guided Missiles Range Division are not only planning for this year's and next year's tests but are considering range requirements five through fifteen years ahead—requirements to test manned space vehicles still on the drawing boards or "existing in concept" only.

**OPPORTUNITIES NOW EXIST** to join PAN AM at the Cape in developing range systems hemispheric, global and celestial in scope—and share in the exceptional professional development implicit in these assignments.

**Systems Engineers—EE's, Physicists & Mathematicians** capable of assuming complete project responsibility for new range systems.

**Instrumentation Planning Engineers—EE's, Physicists** to be responsible for specific global range instrumentation concepts.

**Senior Engineers & Scientists—PhD's in Math, Physics, Celestial Mechanics, Astronomy or Electronics.**

**Experience in one or more of these areas:** Pulse radar, CW techniques, telemetry, infrared, data handling, communications, closed circuit TV, frequency analysis, command control, command guidance, underwater sound, timing, shipboard instrumentation.

Why not write us today, describing your interests and qualifications in any of the areas above. Address Dr. Charles Carroll, Dept. 32D, Pan American World Airways, Incorporated, P.O. Box 4336, Patrick Air Force Base, Florida.

\*Carrying on Range Planning, Engineering and Operation of Atlantic Missile Range for the USAF since 1953. An equal opportunity employer.



**GUIDED MISSILES RANGE DIVISION**

**PATRICK AIR FORCE BASE, FLORIDA**



# PROFESSIONAL OPPORTUNITIES

Design Engineers  
Development Engineers  
Administrative Engineers  
Engineering Writers  
Physicists  
Mathematicians  
Electronic Instructors  
Field Engineers  
Production Engineers

Reporting late developments affecting the employment picture in the Electronic Industries

## OVER HALF OF NDEA STUDENTS TOOK ELECTRONICS

Over half of the 150,000 persons enrolled in the 630 schools offering technical training under the National Defense Education Act last year were taking electronics courses.

The figure was near 78,000. The NDEA program grew out of the increasing national need for technical workers. It is estimated that 100,000 new technicians will be needed each year during the 1960's.

Heaviest enrollments—over 95,000—were in refresher courses to upgrade skills of employed adult technical workers. About 40,000 more were enrolled in preparatory two-year study programs at the junior college level, and 14,000 students were enrolled in secondary schools.

Other subjects covered in the education aid program besides electronics are plastics, nucleonics, mechanical, electrical, aeronautical, chemical, metallurgical, civil and construction technology, including drafting and design, and instrumentation, data processing and computer programming.

The NDEA, which went into effect in 1958, has spurred action in every state to construct or expand vocational-technical institutions, and to introduce technical education to many junior colleges. About 80% of larger public junior colleges—those with 1,100 or more in enrollment—now offer NDEA technical programs.

Some 90% of students completing NDEA non-refresher training programs last June found jobs immediately. Average starting salaries were \$4,900 a year for graduates of post high school preparatory programs and \$3,800 for secondary school technical grads.

FOR MORE INFORMATION . . . on opportunities described in this section fill out the convenient resume form, page 234.

## CLASSROOM CAMERA



Blonder-Tongue Observer 2 camera is designed especially for educational TV. Besides high-quality vidicon tube and transistorized circuitry, it has 8 in. viewfinder to let the operator see what camera is viewing, adjust picture. Self-contained camera includes an automatic 2,000-1 range light compensator, and can operate with 0.5 ft.-c. reflected light using a standard F 1.9 lens.

## AWARDS OF ENGINEERING GRADUATE DEGREES INCREASE

The number of engineering graduate degree awards each year is increasing much faster than that for other fields. Graduate engineering enrollments are growing, too.

During the past seven years, the rate of increase in number of engineering doctorates was triple the rate of increase for all other fields combined.

At the master's level, the growth rate was about double that of other fields. The number of doctor's and master's degrees awarded has about doubled.

The number of engineering Ph.D.'s awarded during the year ending June 30, 1962, was about 1,200. It increased nearly 28% over 1961. Enrollments for the doctorate in fall, 1962, increased by about 24% over 1961 (to about 9,750).

The number of engineering master's degrees awarded during the past year was about 8,900, nearly a 9% increase over 1961. Also, enrollment for the master's degree increased by approximately 9%, to 35,800.

## BLS REPORTS ENGINEERS SALARIES ROSE 2.6% IN '62

Results of the third national salary survey by the Bureau of Labor Statistics reveal the average of professional and administrative salaries, including those of engineers, scientists and engineering technicians, rose about 2.7% last year.

The average salary for engineers went up 2.6%. Salaries for chemists and draftsmen jumped 3.9 and 3.8%, respectively. Those of engineering technicians could not be compared, as they were included in the survey this year for the first time.

The 75 job categories surveyed included several levels in each occupational group. The annual BLS survey was designed, among other uses, to provide a basis for comparing Federal pay levels with salaries for comparable private industry positions.

Average salaries of engineers, the biggest professional group studied, ranged from \$559 a month for recent college graduates to \$1,631 for those in the highest of eight levels surveyed.

Chemists averaged less than engineers on the beginning level (\$510), but the percentage difference tended to narrow at more advanced levels. At level IV, representing fully experienced employees, engineers averaged \$854 a month and chemists, \$828.

Engineering technicians, included for the first time in the survey, were divided into five groups. For intermediate levels III and IV, at which most were classified, salaries averaged \$521 and \$589, respectively.

Senior draftsmen, defined to include fully experienced employees, averaged \$550 a month.

The 57-page bulletin is "BLS Bulletin 1346—National Survey of Professional, Administrative, Technical and Clerical Pay, Winter 1961-62." Send 40¢ in check or money order to the Supt. of Documents, Washington 25, D. C., or any BLS Regional Office.



The methods of manufacturing and of personnel supervision that work best in the U. S. are not necessarily the best for other forms of society, particularly in primitive areas. The level of education, religious practices and capacity for supervision are just a few of the items to be considered.

IN THIS COUNTRY we have grown so used to thinking in terms of greater and greater mass production that we tend to forget how to produce profitably at lower volume levels. However, when working with manufacturing problems of underdeveloped countries, it often is necessary to fall back on still sound methods which sometimes have been bypassed here in a hurly-burly rush to mechanize and automate.

The major problem in planning and implementing a manufacturing program in a growing country is to insure that the facilities which finally evolve are suited to the market, financial and labor conditions of an industrial economy which bears no resemblance to ours and probably never will. Unfortunately, there have been many excellently engineered factories built which would be models in Detroit or St. Louis, but which are monuments to poor planning in countries emerging from a peasant or jungle economy or even a few more steps down the road to industrialization.

No blanket disparagement of United States manufacturing operations overseas is intended, as many fine plants have been turning in enviable performances for years and good ones are being built every day. It is only intended to stress the importance of seeing to it that more credit be given to their creators and help the local economies as well as the owners by producing well and profitably.

In planning the establishment of manufacturing operations in underdeveloped countries, the first factor to be taken into consideration, obviously, is the market. While the existing and immediate future market is important, a projection of that market potential for as long a period as is practical is even more important. In making such a market analysis, the obvious elements of economic growth, competition and effect of imports must be given full consideration. But, there are other less obvious factors which also must be gauged as accurately as possible.

In most countries which are growing to maturity,

## LOW VOLUME MANUFACTURING IN UNDERDEVELOPED COUNTRIES

the political situation merits close attention. Granted that it is almost impossible to arrive at any accurate conclusions regarding future political conditions, it nevertheless is essential that they be given close scrutiny and some attempt be made to analyze the available information as to the effect on the economy and business operations in the foreseeable future.

### Labor Climate

Of fundamental importance to any manufacturing operation is the labor climate. In most of the countries of the world the labor situation is closely tied in with political policies and great weight must be given to them in assaying future trends in labor availability and cost. The trends in social legislation and governmental attitudes toward labor many times can wreck optimistic estimates of labor costs.

Another labor factor which varies widely from country to country is the religious situation. Particularly in some of the Latin American countries, the incidence of church holidays may have a serious effect on factory operations, especially where continuous process industries are involved. Not only will added cost for holiday overtime be incurred, but in many cases it is difficult to secure adequate personnel for operation on days of particular religious significance.

In determining the parameters of the labor situation, the more evident elements of ready availability of personnel, their educational background, their aptitudes and the determinable wage rates and normal rate of wage increase are, of course, of basic importance. In our experience, the most uncertain and potentially dangerous labor situation lies in the area of supervision at the foreman and group leader level.

---

By **GERALD C. JONES & ASSOCIATES**

P. O. Box 762  
Rutland, Vermont

Trained personnel from outside a country is not the lasting answer. With the nationalistic fervor in most of the growing countries at high pitch, it is essential in any business operation to use a maximum of indigenous personnel, right up to and including top local management, if possible.

### Supervisory Personnel

Usually the few people necessary for the higher echelon positions can adequately be developed from even a small number of well educated men and women available. It is in filling the more numerous lower level supervisory positions that trouble is encountered. If people who have had no prior experience in handling others are suddenly pushed into positions of responsibility, some rather horrible results can be expected.

Perhaps the most serious result of a sudden accession to misunderstood authority is a tendency to assume a superior attitude and to close eyes to any sensible understanding of a worker's problems. Pompousness or domineering attitudes might be tolerated in someone with whom there is little or no direct contact, but even a little of this in an immediate superior can produce trouble which is hard to root out.

When various new industries were established in Korea, for instance, as part of the United Nations rehabilitation program, we were amazed at the ease with which peasants fresh from the rice paddies learned new and strange tasks, and particularly with the hand dexterity which was shown in mastering precise mechanical operations. On the other side of the coin, the problems in securing and training adequate supervisory personnel were manifold and serious. During the more than forty years that Korea had been under the dominance of Japan, Korean nationals had not been permitted to fill even the lowest foreman jobs, which were reserved to Japanese. As a result, they had not the slightest concept of how to handle people.

Had it not been for the seriousness of the situation, some of the results would have been comical. One that comes to mind is the case of the man who was selected as foreman of a rather dirty operation. Having never worked at anything but a labor job, his ego was immensely bolstered. On his first day he appeared for work in a business suit and wearing white gloves and was quite incensed when he found that a glass topped desk was not among his prerogatives.

There were many instances such as this, all of which added up to a very serious problem of selection and training to develop a foreman group which could adequately serve as that most important link between

management and labor. There are many other labor problems to be solved in most developing countries, such as the habit of padding payrolls with relatives and political favorites, all of which make a thorough analysis of the labor situation imperative before any definite steps are decided upon. Part of the solution to these problems lies in a knowledge and appreciation of their depth and local significance.

The labor situation also has a very definite determining effect on the choice of machinery and facilities. Here again, the uncertainty of supervisory ability becomes a source of concern. Especially in those industries where accurate control of continuous processes is essential, it is extremely important that the equipment involved be as foolproof as possible and that as much of the control be taken out of human hands as can be done without unnecessarily complicating the operations.

### Operating Safety

Another element to be considered when supervision is unreliable concerns matters of operating safety. Perhaps one of the most serious problems in this regard is that of adequate maintenance, particularly preventive maintenance. Where failure of any piece

*(Continued on page 235)*

Work inspection methods are explained to West African Labor Officials while on a tour of industries in the United States.



# ELECTRONIC INDUSTRIES Professional Profile

The ELECTRONIC INDUSTRIES Job Resume Form for Electronic Engineers

Name \_\_\_\_\_ Tel. No. \_\_\_\_\_

Street \_\_\_\_\_  
Address \_\_\_\_\_ Zone \_\_\_\_\_

City \_\_\_\_\_ State \_\_\_\_\_

Single     Married     Citizen     Non-Citizen    Date of Birth \_\_\_\_\_

Will Relocate  Yes  No. If Yes  Another City  Another State

Salary Desired to Change Jobs in present area \_\_\_\_\_

Salary Desired to Change Jobs and relocate in another area \_\_\_\_\_

Professional Memberships \_\_\_\_\_

College or University	Major	Degree	Dates

## RECENT WORK EXPERIENCE

Company	Div. or Dept.	Title	Dates

## SIGNIFICANT EXPERIENCE AND OBJECTIVES

STATE ANY FACTS ABOUT YOURSELF THAT WILL HELP A PROSPECTIVE EMPLOYER EVALUATE YOUR EXPERIENCE AND JOB INTERESTS. INCLUDE SIGNIFICANT ACHIEVEMENTS, PUBLISHED PAPERS, AND CAREER GOALS.

Mail to: ELECTRONIC INDUSTRIES—Professional Profile—56th & Chestnut Sts.—Philadelphia 39, Pa.  
This resume is confidential. A copy will be sent only to those Companies whose number you circle below.

800      801      802      803      804      805      806      807      808      809      810



## LOW VOLUME MANUFACTURING (Continued)

of equipment may entail major machine damage or personal injury, every care must be taken to minimize risks.

An example of this problem was found in planning a window glass plant in the Far East. Because of the peculiar climatic conditions prevailing, it was highly desirable from an operating standpoint to use a Venturi type stack on the melting furnace. However, such an arrangement required blower motors to be located at the bottom of the stack outside the plant buildings. The failure of such motors while the furnace was in operation would mean the loss of some seventy-five per cent of the draft and attendant danger of explosion. Major damage to a million dollar furnace and possible death or serious injury to a number of people normally working in the area might readily be the result. Our decision was to resort to the old fashioned brick stack with some slight loss in efficiency, but with no worries.

In other areas of the world, such as the Middle East, we have found a rather different problem resulting from inexperience in supervision of modern manufacturing facilities. In Turkey, for instance, we found it necessary to minimize instrumentation to a great degree because of an inordinate penchant for experimenting with complicated apparatus. Thus, it is only with a thorough knowledge of the local situation that sensible decisions can be reached as to the best facilities to do the job with the type of supervision available.

### Labor Rates

Of course, the nature and quality of the available labor, skilled and unskilled, have a great bearing on choice of facilities. In areas where labor is cheap and plentiful we have eliminated much in the way of material handling equipment, for instance, because it was more economical to use brawn than to install and try to maintain expensive and complex conveyor systems. Paradoxically enough, this situation existed in some places where it was necessary to go overboard in the matter of instrumentation and controls to offset poor supervision. Again, it is only with knowledge of what you are up against that you can decide.

Particularly with regard to labor in underdeveloped countries, care must be exercised that short-range planning does not hamper development on a long-range basis. In many cases the prospect of cheap labor can be a snare and a delusion, as in this day of modern communication it does not take long for word of higher wages in other parts of the world to seep

through. And, when wages are low, productivity per man usually is equally low and the added force needed has a way of offsetting low wages. Also, the trend toward increased social legislation everywhere may quickly add very substantially to labor costs.

In view of the inevitable increase in such costs, every care must be taken to plan for future changes in facilities. Where it may be cheaper today to carry coal on A-frames on coolies' backs, modern gantry cranes and conveyors may be necessary tomorrow. Therefore, layouts should be planned to permit easy expansion and alteration as conditions warrant.

### Designing for Expansion

This question of future expansion of manufacturing facilities in underdeveloped countries merits most serious consideration in the original planning. Many times it is possible to design along modular lines so that growth can be achieved with a minimum of disruption and additional engineering. A glass manufacturing plant in the Far East is a good example of this type of planning. In the original planning, provision was made for a 50% increase in output by the simple addition of extra forming equipment. Within the three year period for which this addition was planned, the extra capacity was added with no interruption of normal production. Then, two years later the entire plant was duplicated at no extra engineering cost, using the original drawings. Sound planning paid off.

Manufacturing requirements of less industrialized countries make it imperative that no door be left unopened when deciding upon the best facilities to serve the purpose at hand. Usually it is necessary to look far beyond the United States for facilities and equipment. We are so preoccupied in this country with high speed mass production that there are many blanks in our ability to supply equipment and processes suitable to low volume production.

A good example of this was found in determining the feasibility of manufacturing glass bulbs and tubing for making incandescent and fluorescent lamps in Central America. In the United States the only machines available for producing bulbs, for instance, would produce the entire year's requirement in two or three weeks and then would lie idle for the rest of the year. However, quality standards had to be the same as ours.

After a careful search for available equipment, a manufacturing facility was developed using a glass melting unit designed here for another purpose, a bulb forming machine developed in France and made in Italy, a tube drawing device made in England and

*(Continued on page 236)*

For Military and  
Commercial  
Applications

## Grayhill Miniature Rotary Tap Switches

These switches are designed to meet military and commercial specifications and ruggedly built to precision standards.

Grayhill No. 5000, No. 12, and No. 24 Series. 1.01" dia. Break 1 amp., 115 VAC, resistive. Carry 5 amps. 1 to 10 decks, 2 to 10 positions per deck—1 or 2 poles per deck—shorting or non-shorting. Life 100,000 cycles. Also No. 24 Series, spring return switch.

Concentric Shaft. No. 6 (1 to 3 decks per shaft—Total 6 decks) and No. 36 Series (1 or 2 decks per shaft. Total 4 decks). 1.01" dia. 2 to 10 positions per deck. Break 1 amp., 115 VAC, resistive. Carry 5 amps. Two switches in one. 1/4" shaft controls 1/2 of the decks, 1/8" shaft controls the other half.

No. 45 Series Midget. .640" dia. Single deck only. 60° indexing. Break 1 amp., 115 VAC, resistive. Carry 5 amps. Life 100,000 cycles.

✓ Switch  
✓ Test  
✓ Connect  
with  
GRAYHILL



"N. Gineer"

Grayhill offers a full line of Rotary Tap Switches, Push Button Switches, Test Clips, Binding Posts, and other miniature electrical and electronic components.

ASK FOR CURRENT CATALOG.



**Grayhill**  
INC.

Phone: Fleetwood 4-1040  
543 Hillgrove Avenue,  
LaGrange, Illinois

"PIONEERS IN MINIATURIZATION"

## LOW VOLUME MANUFACTURING (Concluded)

a bulb frosting plant developed in South America. All auxiliary equipment was of United States design and manufacture. The plant designed around these elements was modular in concept and could be enlarged or made smaller by the simple addition or subtraction of units. The success of this concept is attested by its serving as a prototype for several others which have been built and are operating successfully in several other countries.

Certainly the greatest opportunity for expansion and growth lies in the underdeveloped countries of the world. But, in order properly to realize this tremendous potential for both profitable business and international good will, it is necessary to adapt our experience and know-how to fit the local situation.

## MANAGEMENT OVERHAUL

(Continued from page 88)

an organization is aware of his own job responsibilities and limitations. But Roberts refused to take this for granted. He asked Ampex's top 25 managers for a "job description." He says, "It's amazing what comes out of the woodwork when you have the top 25 people define their jobs. This was purely and simply for clarification, to eliminate overlaps. Managers must absolutely, clearly, understand their jobs. As chief executive officer, I am given certain responsibilities by the company's board of directors. I delegate a portion of that responsibility to each of the key management personnel in the company. If I am going to delegate responsibility, I should certainly be able to write it out simply, in the King's English."

Roberts himself analyzed job descriptions through the top three levels of management. He then requested that his managers use the technique down through their own ranks to the foreman level.

## Inventory, Controls & Computers

One of the problems Bill Roberts inherited was an inventory problem. Ampex had over-forecast, then over-produced. "We have applied very stringent controls and regulations within the corporation at this time, trying our darndest not to be a bunch of string savers. If we can identify a piece of bad inventory, no matter how large or small, it's written off the books in the month in which it's uncovered. We do not wait for year-end write offs," Roberts explains. "I am not satisfied, I never have been satisfied, since I have been in business that inventory has ever been fully under control. It is one of the most dynamic, volatile items that management can play with. You can lose very substantially by having inadequate inventory controls." (Continued on page 238)



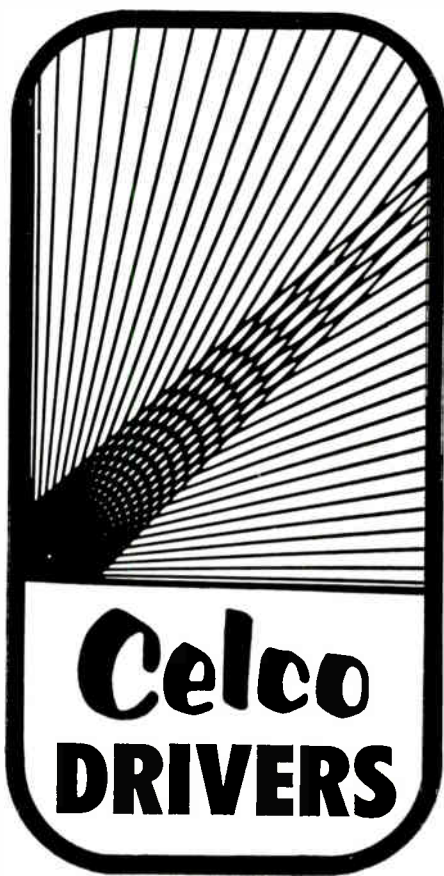

# Celco DRIVERS

## Beam Position & Write with CELCO DRIVER YOKE PACKAGE

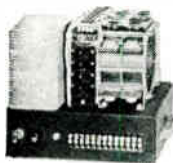

CELCO SOLID STATE DEFLECTION AMPLIFIER AND CELCO DEFLECTION YOKE were used to create the above display.

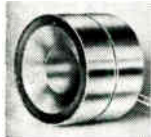

CELCO YOKE for ultra-high precision — spots smaller by 25% — faster recovery time.

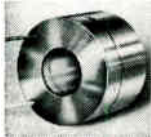

CELCO FOCUSER — up to 4,000-6,000 line resolution at higher frequencies.

All units are available individually or as a package for any of your CRT display problems — write or call:

# Celco

CONSTANTINE, ENGINEERING LABORATORIES COMPANY

Mahwah, N. J. Area Code: 201 DAvis 7-1123 Ed Ryder	Miami, Fla. Area Code: 305 PLaza 1-1132 Walt Faust	Upland, Cal. Area Code: 714 YUKon 2-0215 Bob Reese
---	---	---

Circle 117 on Inquiry Card

## AIRLINE LOWERS FREIGHT RATES ON RADIO EQUIPMENT

Manufacturers or volume purchasers of radios and radio components can save up to 43% on some domestic airfreight shipments under a new tariff schedule of the Flying Tiger Line, Burbank, Calif. The reductions affect shipments of receiver or transmitter sets (other than consoles), tubes, transistors and parts.

The rate drop stems partially from the lower operating costs of Tiger's CL-44 turboprop airfreighters. The airline has shifted from volume-vs.-density to straight commodity rates.

## AF ESTABLISHES FIRST BIONICS RESEARCH FACILITY

The Air Force will establish its first facility entirely for bionics research this fall at the Aeronautical Systems Div. of the AF Systems Command, Wright-Patterson AFB, Ohio.

The ASD does bionics research to improve information processing techniques and to create devices with self-adaptive learning ability. These would perform such functions as self-repair, and would "learn" from "experience" to select alternatives.

## PULSE / WAVEFORM GENERATORS



Parabam Model P-1A

Provides PULSE • SINE • SQUARE or TRIANGULAR Wave outputs from .008 cps to 2000 cps . . .

The Parabam Model P-1A electrically simulates mechanical and electro-mechanical phenomena. Has output to drive power transistors and relays, electro-hydraulic valves, etc. directly from output terminals. APPLICATIONS: test and development of servomechanisms, computers, input-output devices, aircraft flight test equip., geophysical and medical instruments.

### SPECIFICATIONS

- WAVEFORMS: Sinusoidal, square and triangular (virtually transient free).
- FREQUENCY: Continuously variable in 10 ranges . . . .008 cps to 2000 cps.
- PULSE durations: 100 micro-seconds to 10 sec.
- Cabinet or rack mounted.
- Available with Waveforms only (Mod. W-2A)

Write Today for Technical Bulletin No. 1162-17

**PARABAM, INC.**  
subsidiary of Houston Fearless Corp.

12822 Yukon Ave., Hawthorne, Calif. ■ OSborne 9-3393

Circle 48 on Inquiry Card

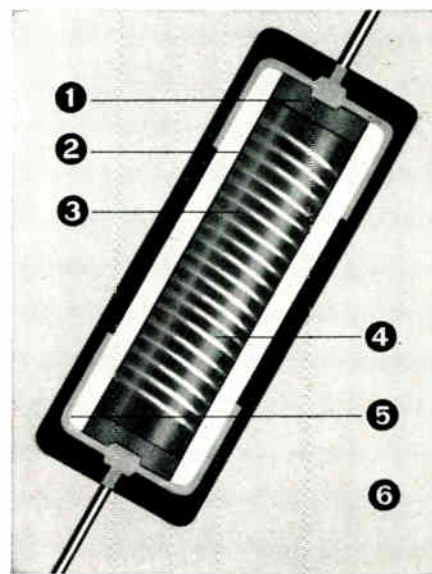

## 6 reasons why: WESTON® VAMISTORS

PRECISION METAL FILM RESISTORS

## have lowest noise... highest reliability

Weston Vamistors, the most reliable precision metal film resistors available, have the lowest average noise level. Using NBS resistor measurement techniques, Vamistors average below -33db (0.023  $\mu\text{V}/\text{V}$ ), and are guaranteed to have a level no greater than -20db (1  $\mu\text{V}/\text{V}$  in a decade of frequency).

The Vamistor's lowest noise and, therefore, outstanding reliability is a result of superior Weston design and specialized production techniques. Six major factors contribute to its remarkably low noise level:

- 1 Silver terminations are treated to prevent migration;
- 2 Tough glaze seals out moisture;
- 3 Resistance alloy is thermally bonded into glaze with patented Weston process;
- 4 Resistance spiral is precision-cut and controlled;
- 5 Capping method assures virtually perfect contact;
- 6 Incoming materials inspection, in-process control, testing and quality assurance programs guarantee specifications!

Weston Vamistors are available with the highest resistances and voltage ratings in sizes from 1/8 to 2 watts. Tolerance: to 0.05%. Temperature coefficient: 0  $\pm$  25 or 50 ppm/ $^{\circ}\text{C}$ . Stability: exceeds all MIL R-10509D specs. Write for details. We'll include Weston Spec 9800 covering High Reliability Vamistors.

**WESTON**   
Instruments & Electronics

Division of Daystrom, Incorporated, Newark 14, N. J.  
Circle 118 on Inquiry Card



## MANAGEMENT OVERHAUL (Concluded)

Ampex's chief executive sees the company turning eventually to electronic data processing for inventory control. At present, planning has not progressed beyond the study phase for a computer/punch data system. "You can get an awful lot of information fast in a machine system. And just by being able to turn on a dime at any given moment, you can save very appreciably in material."

Roberts does not predict that computerized management will take place tomorrow. But, he says, "In the next decade or two we will find many more useful applications for the whole computer technology. The speed with which we approach it has got to be thoroughly thought through. You can become over-computerized very quickly, and very easily. We are going to approach it very cautiously."

### Cost Control & Quality

Bill Roberts has made a few innovations in cost control at Ampex. "In order to gain management control and knowledge of what the actual costs of the products are, and to intelligently develop a forecast, it was necessary to install a standard cost system. It is also necessary in determining the areas where cost reduction efforts are warranted. If you do not

have such a system, you may improperly price products. You look at total net results instead of individual products or product line results.

Of Quality Control, Roberts ventures, "As long as I am in business, my product, regardless of how urgently they need it in the field, is not going to leave these doors until it has been checked out. It has to be a very, very good calculated risk from every standpoint of quality assurance and reliability. We have delayed production of certain new products in the past year and a half, that theoretically would have given us very fine added sales volume. But, they were not quite ready for the market. If you do not have very top notch quality control built into your entire organization, R&D to production, you will get indigestion awfully fast. One or two faulty products will pop up in the market. You have to go back and retrofit. You may wind up spending all of your immediate engineering time curing past ills. This can create a major costly fiasco in any organization. We have been very conscious of it. The normal approach in any company is to tighten up, possibly very thoroughly, then over a period of months the standards tend to loosen. You must come back in and quickly re-tighten before you get loose and ineffective. We are very, very aware of the problem potential. Every product division here has done well, so far."

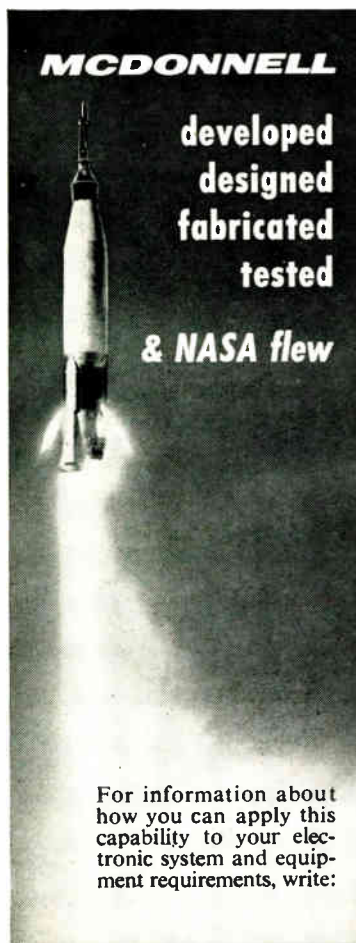

**MCDONNELL**

developed  
designed  
fabricated  
tested

**& NASA flew**

For information about how you can apply this capability to your electronic system and equipment requirements, write:

## ELECTRONICS



### the Mercury Spacecraft Orbital Timing Device

**15 orbits without malfunction**

Operating as a precision time base, it provides an accurate measurement of time of day, time from launch and time to retro-grade signal, controllable via telemetry command link or by the Mercury Astronaut. Operation to date... flawless.

### THAT'S RELIABILITY

W. W. Toole  
Manager of Customer Service  
McDonnell Electronic Equipment Division  
Box 516, St. Louis 66, Missouri

Electronics engineers, who are interested in the design and development of equipment and systems for aerospace applications, will find challenging, broad-scope opportunities at **MCDONNELL ELECTRONICS**

Closely allied to the parent Corporation, the McDonnell Electronic Equipment Division designs and builds a variety of aerospace ground support and airborne, missile and spacecraft equipment. The unique requirements of such programs as the Gemini two-man rendezvous spacecraft; the Phantom II fighter, attack and reconnaissance aircraft; and Mercury, Asset, Talos and Typhon, have opened positions at many supervisory levels as well as a host of engineering design, production, and development positions in the following areas:

Rendezvous Radar • Space Communications • Stabilization & Control • Inertial Guidance • Optical Sensors • Solid State Electronics • Digital Computers • Maser & Laser Studies • Automatic Checkout Equipment • Beacon Tracking • Aircraft Radar • Thin Film Techniques • Antenna & Microwave Techniques • Reliability • Circuit Design • Energy Conversion • Space Navigation • Electronic Maintenance

Cut out and mail this coupon to:  
Engineering Employment,  
McDonnell  
Box 516, St. Louis 66, Missouri

Please send me additional information about opportunities in the McDonnell Electronic Equipment Division.

Name \_\_\_\_\_  
Address \_\_\_\_\_  
City \_\_\_\_\_ State \_\_\_\_\_  
Degree \_\_\_\_\_  
Experience (years) \_\_\_\_\_  
Specialty \_\_\_\_\_

An equal opportunity employer.

## FIRE SIMULATOR



Members of U. S. Forest Service train with fire simulator built by Int'l. Electric Corp., ITT subsidiary. Simulator will teach trainees to handle firefighting command, supply tasks.

## NATION TRIPLES R&D OUTLAY IN 8 YEARS

The United States tripled its spending for basic research and development between 1953 and 1961—and the spending rate may keep going up.

Analysis of R & D spending released by the National Science Foundation shows total R & D outlay in the U. S. during fiscal 1960-61 was \$15 billion. In 1953-54 only \$5.2 billion was spent.

In 1960-61 the Government spent over \$2 billion on projects it carried out itself and financed \$6.1 billion of industry projects. Industry spent \$4.3 billion on its own projects. Other R&D spending was by colleges, universities, non-profit institutes, etc.

The NSF reports government spending for basic research alone increased some 400% in the eight years. This was due mostly to accelerating space research and this year's Federal Budget calls for a record \$6.1 billion outlay for space projects alone.

## COMPUTER SYSTEM SPEEDS NEWS TO CHICAGO NEWSPAPER

A high-speed computing and transmission system is supplying the stock market tables for a Chicago afternoon paper, the *American*, at 1,050 words/-min. and setting them automatically into type.

An IBM computer at the New York Stock Exchange supplies the day's closing market news to a data speed transmitter there. It is accepted in the *American's* composing room on a data speed receiver and spewed out instantly in perforated tape form for use by typesetting machines. Teletype Corp., a Western Electric subsidiary, supplied the transmitting equipment.

IBM, Associated Press and the *American* designed the system.

ENGINEERS / SCIENTISTS / PHYSICISTS / MATHEMATICIANS

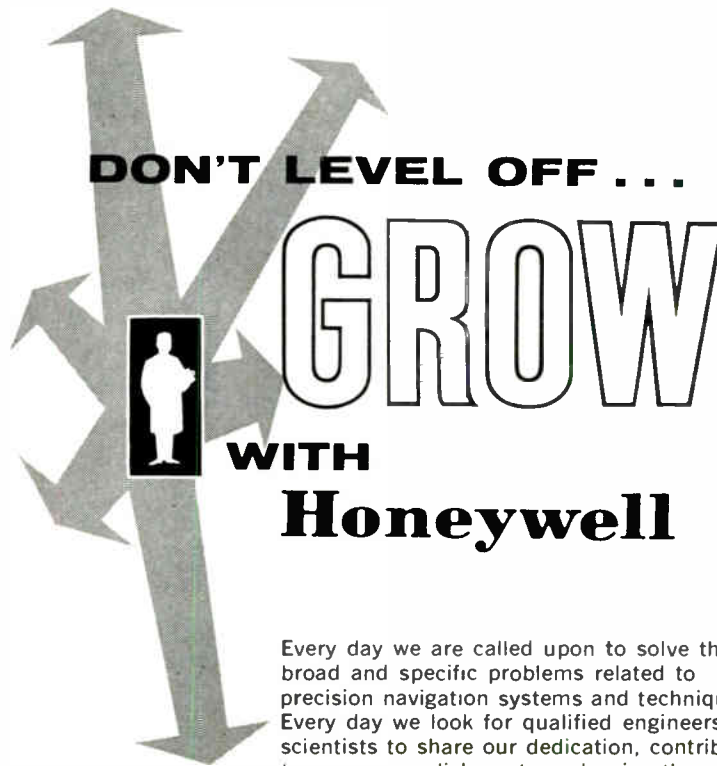

Every day we are called upon to solve the broad and specific problems related to precision navigation systems and techniques. Every day we look for qualified engineers and scientists to share our dedication, contribute to our accomplishments and enjoy the personal and professional rewards of achievement. Such projects as Gemini, Dyna-Soar and Centaur indicate the important space projects with which we are concerned.

If your capabilities and ambitions are guidance oriented, we invite your immediate inquiry. As the following list of requirement areas indicates, long-range opportunities exist at all levels.

**Systems Engineers/Circuit Designers/Logic Designers/Systems Analysts/Programmers/Packaging Engineers/Rotary Component Designers/Systems Test Engineers/Materials & Component Engineers/Test Equipment Designers/Manufacturing Prototype Development Engineers/Reliability Engineers/Quality Control System Engineers.**

And remember, *you and your family* will enjoy Florida's Suncoast living. To learn more about how YOUR career can GROW at Honeywell, write, in confidence, to Mr. L. H. Ericson, Honeywell, 13350 U. S. Highway 19, St. Petersburg, Florida. We'll reply promptly.

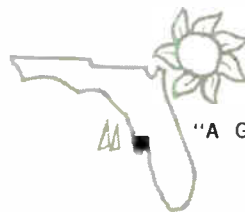

## Honeywell

AN EQUAL OPPORTUNITY EMPLOYER

"A Good Place to Live... A Good Place to Work"

To investigate professional openings in other Honeywell facilities, send your resume to H. F. Eckstrom, Honeywell, Minneapolis 8, Minnesota

HONEYWELL ENGINEERS ARE DOING THINGS IN FLORIDA

## SLIDING SURFACES MOVE MORE FREELY ON FLUOROLIN\* TAPE

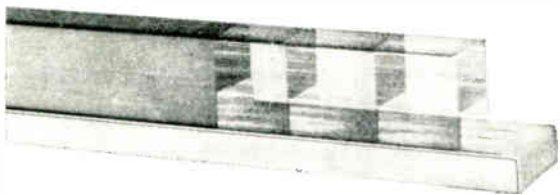

### SLIPPERY ON THE FRONT (it's Teflon®) STICKY ON THE BACK (it's pressure-sensitive)

Wherever moving parts must slide with the lowest possible friction—product components, production lines, feed chutes, sliding chassis assemblies—there's a Joclin Fluorolin Teflon Tape to make the sliding easier... No complex mechanisms or lubrication needed—and it's less expensive.

These rugged pressure-sensitive tapes install in seconds and are available in a wide range of widths and types for any application. Resistant to fuel and chemical action, they stick fast from -100 to +500 F.

Whether the application is mechanical or electrical—commercial or military—Fluorolins by Joclin, the originator of pressure-sensitive Teflon, are the first choice for dependable performance.



THE **joclin** MANUFACTURING COMPANY  
WALLINGFORD, CONNECTICUT

WRITE FOR FREE FACT FILE TODAY

© TM Reg. DuPont \* TM Reg.

Circle 181 on Inquiry Card

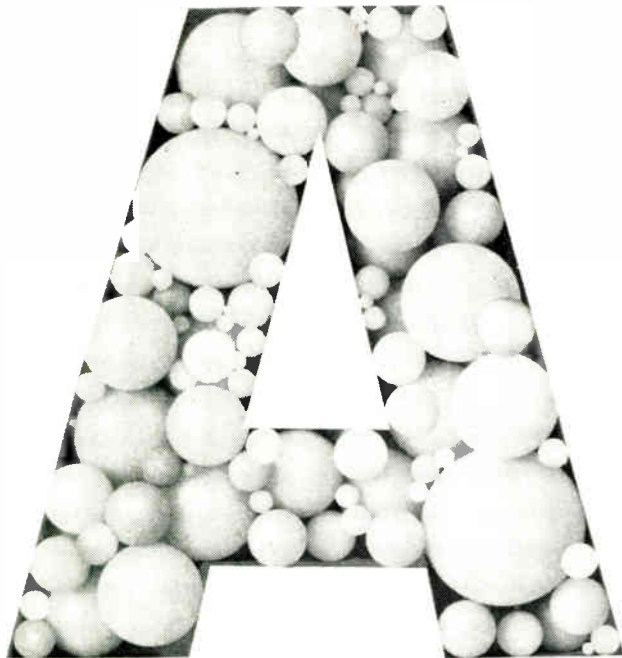

## PRECISION PLASTIC BALLS

ACE is one of America's leading mass producers of seamless plastic balls for almost every commercial and industrial use. Most plastics including nylon and teflon. Complete range of sizes, colors and tolerances. Small runs or large runs. Huge stocks for immediate delivery. Quick, low-cost service on specials. Write, wire or call for samples, price lists and handy new selection chart.

EXTRUDERS SINCE 1931 FABRICATORS

ACE PLASTIC COMPANY 91-22 VAN WYCK EXPWY • JAMAICA 35, N. Y.

Circle 182 on Inquiry Card

## WASHINGTON TRENDS

**FIGHT CONTRACTOR WAGE BOOSTS**—Congressional moves to add fringe benefits to minimum wages set by the Labor Dept. on government projects are raising businessmen's ire. Not only do businessmen oppose adding fringe benefits—but they call for repeal of laws giving the Department jurisdiction over minimum wages on government jobs. Business view was expressed at House Labor subcommittee hearings on a bill to extend the Davis-Bacon Act. This allows minimum wages to be set on federal construction and building projects. Business representatives told the committee the Davis-Bacon Act should be repealed. Until this is done, they said, "the coverage and scope of the law should not be expanded." However, backers of changes are fighting hard to expand the measure to include federal maintenance, as well as construction.

**STUDY EXPORT TAX BREAK**—Congress will again take up proposal that special tax incentives be offered U.S. companies producing goods for export. Bill sponsored by Rep. John D. Dingell, D., Mich. would reduce corporate income taxes paid by manufacturers of goods for sale abroad. This incentive has received attention in the past—but never enough for serious consideration. Administration, particularly the Commerce Dept., has again been studying such incentives. If Administration supports it, export tax incentive may have a chance.

**HIT MILITARY PROCUREMENT**—Criticism of "widespread waste" in DOD buying is mounting in Congress. Number of lawmakers looking for examples of mismanagement in procurement is rising—and they are uncovering ammunition. Rep. Earl Wilson, R., Ind., has asked the Justice Dept., the General Accounting Office, and the Secy. of Defense to investigate recent award for Navy radar antenna. Rep. Wilson charges that the Navy purchasing office certified that only one firm, Chu Associates, Littleton, Mass., had the drawings for the equipment and therefore was the only source. Congressman says he found microfilms of the drawings in Navy's Bureau of Weapons files and he wants the Navy to reschedule the purchase for competitive bidding.

### \$\$\$ for Circuit Designs

Have you come up with any simple or unique circuit designs lately? Do you think that they would be useful to fellow engineers? If so, why not send them to us for possible publication? We pay our usual space rates for those accepted. Please keep them as concise as possible and send to: Circuit Design Editor, ELECTRONIC INDUSTRIES, 56th & Chestnut Sts., Philadelphia 39, Pa.



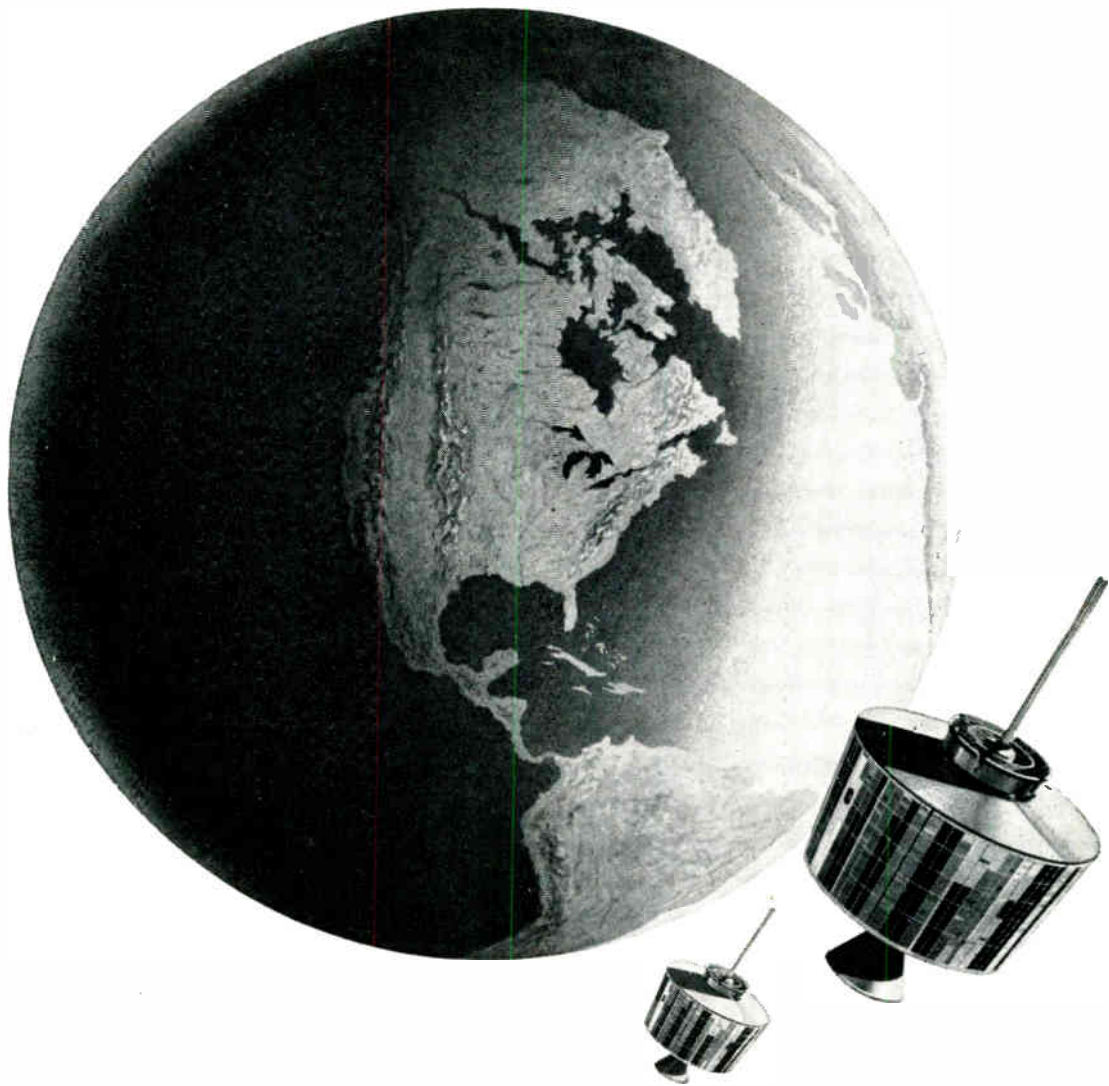

# circuit designers...is your appointment in space with Hughes?

Today, Hughes is one of the nation's most active space/electronics firms. Projects include: MMRBM (Mobile Mid-Range Ballistic Missile—Integration, Assembly & Checkout), TFX(N) Electronics, SURVEYOR, SYNCOM, VATE, BAMBI, POLARIS guidance and others.

This vigor promises the qualified engineer or scientist more and bigger opportunities for both professional and personal growth.

Many immediate openings exist. The engineers selected for these positions will be assigned to the following design tasks: the development of high power airborne radar transmitters, the design of which involves use

of the most advanced components; the design of low noise radar receivers using parametric amplifiers; solid state masers and other advanced microwave components; radar data processing circuit design, including range and speed trackers, crystal filter circuitry and a variety of display circuits; high efficiency power supplies for airborne and space electronic systems; telemetering and command circuits for space vehicles, timing, control and display circuits for the Hughes COLIDAR\* (Coherent Light Detection and Ranging).

If you are interested and believe that you can contribute, make your appointment today.

Please airmail your resume to:  
**Mr. Robert A. Martin**  
**Head of Employment**  
**Hughes Aerospace Divisions**  
**11940 W. Jefferson Blvd.**  
**Culver City 46, California**

We promise you a reply within one week.

*Creating a new world with electronics*

**HUGHES**

HUGHES AIRCRAFT COMPANY  
AEROSPACE DIVISIONS

An equal opportunity employer.

## THE alpha GUIDE TO RELIABLE SOLDERING

**alpha** **CORE SOLDER** Gen-tri-core® (energized rosin), Uni-core (acid filled) and Hi-core (organic flux filled) solders made of virgin metals under controlled conditions. High reliability, fast soldering.

**alpha** **BAR SOLDER** Special Vaculoy® processed bar solder, oxide-free, improved wetting, better reliability, brighter connections, more joints per pound.

**alpha** **SOLDER PREFORMS** Precision-made shapes to assure the proper amount of solder when and where needed. Washers, discs, spheres; other standard and special shapes.

**alpha** **UHP** Indium, tin, lead, gold, aluminum, with P or N type dopants. Purity ranges 99.999+. Washers, discs, spheres, base tabs.

**alpha** **FLUXES** Non-activated and activated liquid rosin fluxes and non-aqueous water soluble fluxes for every soldering problem.

**alpha** **GET THE FACTS WRITE OR CALL FOR PRODUCT BULLETINS OR CATALOG A-103.**

**alpha** **alpha metals, inc.**  
56 Water St., Jersey City, N. J. Henderson 4-6778  
Los Angeles, Calif. • Alphaloy Corp. (Div.) Chicago, Ill.  
• Alpha Metals, Inc. (U. K.) Ltd., London, England  
Circle 183 on Inquiry Card



**IMMERSED  
IN 150° F.  
OIL ...  
Still Stick Tight!**

**BRADY**  
Self-Sticking B-400  
*Electronic*  
Wire Markers

8½ million\* revolutions of tumbling in 150° F. machine oil has no effect on the adhesion, physical characteristics or appearance of Brady B-400 Wire Markers. Amazing? That's only part of the story! B-400 Markers stick to all types of electronic wire, even Teflon . . . resist heat up to 250° F. . . are super-thin for least bulk . . . withstand effects of solvents, acids, detergents. Dispenser Card Mounted for fast application. 1100 stock items.

Write for Free Testing Samples, \*Test Data and Fact-Filled Bulletin.

W. H. **BRADY** CO., 749 W. Glendale Ave., Milwaukee 9, Wis.  
EST. 1914

Manufacturers of Quality Pressure-Sensitive Industrial Tape Products, Self-Bonding Nameplates, Automatic Machines for Dispensing Labels, Nameplates, Masks and Tape

## RADARSCOPE

(Continued from page 5)

**GOVERNMENT EYES RELOCATION COSTS**—Restrictions may soon be placed on defense contractor payments to employees for relocation. General Accounting Office says defense contractors are spending too much on moving expenses for newly hired scientists and engineers. These bills, which ultimately show up in contract costs, amount to millions of dollars each year. GAO told Congress that sample check of 21 major aerospace contractors showed 1,400 relocated personnel quit their jobs or were fired within a year. Some of these people shift between government contractors "at their own discretion and receive relocation allowances for each move," GAO says.

**FIGHT NASA PATENT RULE**—Battle over NASA's decision to permit contractors the right to use patents developed under their contracts grows hotter. Sen. Estes Kefauver (D. Tenn.) Chairman of Senate Anti-trust Subcommittee, wants Congress to step in and stop NASA plan. He says if NASA follows through on earlier decision to waive exclusive government rights on inventions developed under its contracts, he will attempt to reverse the move. But Rep. Emilio Daddario (D. Conn.) is moving the other way. He wants a law to uphold NASA's policy. The battle will get warmer in the months ahead.

**SEEKS SPOTLIGHT ON DEFENSE CONTRACTS**—Discussions on defense contracts should be well publicized to prevent undue political or other pressures, Sen. Clifford Case, R., N.J., insists. Sen. Case, sponsoring a bill to require all discussions involving defense contracts to be made public, says political and other pressures are not always resisted by Pentagon purchasing officers. His measure would require all discussions involving defense contracts to be made public, whether they are in writing or oral, and whether a potential contractor, Congressman, or the White House is involved.

**TOTAL R&D COSTS** for the nation, including U. S. government and private industry, will probably hit \$17 billion in 1962-63 fiscal if the latest Federal R&D estimates hold firm. U. S. expenditures for R&D reached an estimated \$15 billion in 1961-62, an increase of about \$1 billion dollars over the previous year. Basic and pure scientific research expenditures, aside from product development, accounted for about 10% of the 1961-62 R&D total, or approximately \$1.5 billion.

(Continued on page 244)

# ELECTRONIC INDUSTRIES Advertisers - April 1963

This index is published as a convenience. No liability is assumed for errors or omissions.

Ace Plastic Company	240	Specialty Devices Operation	155	Standard Electronics Co.	228
Acme Electric Corporation	149	Transformers	171	Sylvania Electric	
Adams & Westlake Company	145	General Motors Corporation		Subsidiary of General Telephone	
Alden Products Company	194	Delco Radio Division	39	& Electronics	22, 23, 72, 73, 143, 191
Alfred Electronics	131	General Radio Company	135	Switchcraft	178
Allen-Bradley Company	Insert following p. 124	Gertsch Products, Inc.	154		
Allied Chemical Corp., General Chemical Div.	150	Gibson Electric Company	134	Taylor Corporation	184, 185
Allied Control Company, Inc.	123	Graphic Systems	210	Tektronik, Incorporated	74
Alpha Metals, Inc.	242	Grayhill Incorporated	236	Thermonetics Incorporated	244
American Electronic Laboratories, Inc.	153			Theta Instrument Corporation	202
American Optical Company	71	Henes Manufacturing Company	211	Transistor Electronics Corporation	120
AMP Incorporated	75	Hewlett Packard Company	Inside Back Cover	Transitron Electronic Corporation	129
Amperex Electronic Corporation	136, 137	Hi-G Incorporated	173	TRW Electronics, Pacific Semiconductor	197
Amperite	229	Hollingsworth Solderless Terminal Co.	221	Tung-Sol Electric	47
Amphenol-Borg Electronics Corporation		Honeywell	Insert following p. 52, 239		
Borg Equipment Division	169	Houston Instrument Corporation	203	United Shoe Machinery Corporation	207
Connector Division	181	Howard Industries, Inc.	224	U. S. Components, Inc.	81
Andrew Corporation	142	Hughes Aircraft Company		United Transformer Corp.	208
Arco Electronics Inc.	146	Aerospace Divisions	241	Unitron Incorporated	132
Aristo Grid Lamp Products Inc.	210	Semiconductor Division	213		
Armco Steel Corporation				Varflex Sales Company, Inc.	164
Armco Division	30	Ideal Industries, Inc.	225	Victoreen Instrument Company	138
Associated Research Incorporated	228	Image Instruments, Inc.	198	Vitramon Incorporated	28, 29, 168
Automatic Electric, Subsidiary of General Telephone & Electronics	Insert following p. 16	Industrial Electronic Engineers, Inc.	133		
Avnet Electronics Corporation	214, 226	International Electronic Research Corp.	190	Weckesser Company, Inc.	226
		Interstate Electronics Corporation	206	Westinghouse Electric Corp.	152, 153
				Weston Instruments & Electronics	183, 188, 237
Bead Chain Manufacturing Co.	178	Jennings Radio Mfg. Corp.	148		
Beckman Instruments, Inc.		Joclin Manufacturing Company	240	Xcelite Industrial Hand Tools	211
Helipot Division	91	Johnson, E. F., Company	82		
Bell Telephone Laboratories	16				
Bendix Corporation		Kahle Engineering Company	177		
Microwave Devices, Inc.	158	Keithley Instruments	144, 145		
Scintilla Division, Cables	165	Kelvin Electric Company	156		
Scintilla Division, Connectors	118	Kinney Vacuum Div. of New York Air Brake	223		
Semiconductor Division	14				
Boonton Electronics Corporation	204	Lockheed Missiles & Space Company	51		
Bourns, Incorporated	85				
Brady, W. H., Company	242	McDonnell Electronics	238		
Brush Instruments Division of Cleveite Corporation	92	Magnecraft Electric Company	49		
Burgess Battery Company	84	Magnetics Incorporated	50		
Burndy	83	Malco Manufacturing Company	198		
Burnell & Company, Inc.	179	Mandex Manufacturing Company, Inc.	146		
Burroughs Corporation	163	Methode Electronics, Inc.	222		
Bussmann Manufacturing Division		Microdot Incorporated	193		
McGraw-Edison Company	40	Minnesota Mining & Manufacturing Co.			
		Magnetic Products Division	119		
Cambridge Thermionic Corporation	244	Resin Division	187		
Centralab		Motorola Semiconductor Products Inc.	167		
the Electronics Division of Globe-Union, Inc.	175	Mucon Corporation	137		
Cinch Manufacturing Company	117				
Clare, C.P., & Company	89	National Radio Company, Inc.	36		
Clarostat Mfg. Co., Inc.	37				
CEICO Constantine Engineering Laboratories Co.	237	Ohmite Manufacturing Company	141		
Continental Connector Corporation	90				
Continental Electronics Systems, Inc.	21	Pan-Am Guided Missiles Range Division	230		
Controls Company of America		Parabam, Inc., Houston Fearless	237		
Control Switch Division	127	Phelps Dodge Electronic Products Corp.	139		
CTS Corporation	180	Philco Corporation			
		Lansdale Division	26		
Dage Electric Company, Inc.	156	Sierra Electronic Division	15		
Dale Electronics, Inc.	Inside Front Cover	Price Electric Corporation	186		
Delvaltex Corporation		Prodelin, Incorporated	140		
Industrial Package Division	178	Pyle-National Company	31		
Dialight Corporation	199				
Dickson Electronics Corporation	149	Radio Corporation of America	Back Cover		
		Radio Switch Corporation	199		
Eby, Hugh H., Company	227	Rayclad Tubes Incorporated	25		
E-H Research Laboratories, Inc.	48	Raytheon Company	8		
Eisler Engineering Company, Inc.	174	Roanwell Corporation	212		
Elco Corporation	182				
Electra Manufacturing Company	201	Saratoga Semiconductor	150		
Electro Motive Mfg. Co., Inc.	147	Sarkes Tarzian, Inc.	52		
Electro Scientific Industries	151	Saxonburg Ceramics, Inc.	174		
ELECTRONIC INDUSTRIES	209	Sealectro Corporation	157		
Electronic Research Associates, Inc.	172	Singer Manufacturing Company			
Engineered Electronics Company	12	Singer Metrics Division	78, 79		
Erco Radio Laboratories, Inc.	166	Spectrol Electronics Corporation	41		
		Sperry Semiconductor	205		
Fairmount Chemical Company, Inc.	224	Sprague Electric Company	7, 10, 192		
Force, Wm. A., & Company, Inc.	200	Stackpole Carbon Company	121		
		Stanpat Company	170		
GC Electronics Company Div. of Textron	198	Stoddard Aircraft Radio Co., Inc.	176		
General Electric Company		Stromberg-Carlson	210		
Semiconductor Products Department	189				

## ELECTRONIC INDUSTRIES REGIONAL SALES MANAGERS

Philadelphia (39)—56th & Chestnut Sts.  
(Area Code 215) Sherwood 8-2000  
JOSEPH DRUCKER  
HERMANN W. BOZARTH  
(Classified Advertising)

New York 17—100 East 42nd St.  
(Area Code 212) OXFord 7-3400  
GERRY PELLISSIER  
HUGH ROBINSON

W. Hartford, Conn.—62 LaSalle Rd.  
(Area Code 203) 236-4237  
AL KAISER

Boston (10), Mass.—10 High St.  
(Area Code 617) Liberty 2-4460  
JOHN PICKERING, Jr.

Chicago (1)—540 N. Michigan Ave.  
(Area Code 312) 467-9960  
JOHN W. BERNHARDT  
PHILIP T. CLARK

Cleveland (15)—930 Keith Bldg.  
(Area Code 216) Superior 1-2860  
ROBERT COBURN

Los Angeles (57)—198 S. Alvarado St.  
(Area Code 213) DUNkirk 7-1271  
GEORGE F. KELLEY  
BURT UNDERWOOD

San Francisco (3)—1355 Market St.  
(Area Code 415) 861-7107  
DON MAY

Atlanta (9)—1776 Peachtree St., N.W.  
(Area Code 404) 875-1255  
JOHN W. SANGSTON

Dallas (6)—Meadows Bldg.  
Expressway at Milton  
(Area Code 214) Emerson 3-6426  
HAROLD E. MOTT

## EUROPEAN SALES OFFICES

London, S. W. (1)—67/68 Jermyrn St.  
St. James  
MAX F. HOLSINGER

Dusseldorf—Huttenstrasse 17  
Am Ernst-Reuter-Platz  
MAX F. HOLSINGER

## FAR EAST SALES OFFICE

Tokio Marunouchi, Japan  
C. P. O. Box #1572, Room 814  
Tel: 211-3506-3509  
Togin Bldg.  
CLARENCE T. SAKAGUCHI



# Temperature

## MEASUREMENT & CONTROL

Thermistors for precise sensing in exacting instrument and control applications. Interchangeable probes, discs, plates and rods. Provide high negative coefficients with greater sensitivity and linearity over wide temperature ranges at low initial resistance values • exceptional stability • resistance tolerances  $\pm 1\%$ ; ratios to  $\pm 0.5\%$  • time constants to 0.4 sec. • temperatures to 400°C • stringent QC procedures. Application engineering and custom designs to meet unique requirements.

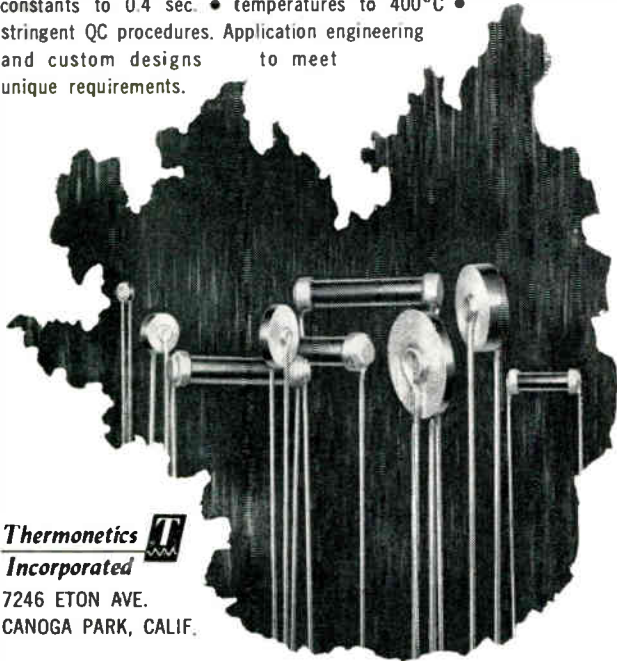

**Thermonetics**   
**Incorporated**  
7246 ETON AVE.  
CANOGA PARK, CALIF.

Circle 185 on Inquiry Card



*Standard Terminals  
Better Reliability*

Reliability is higher when you specify terminals of proven design . . . and the standard terminals you need are available from CAMBION®. Solder terminals are stocked in 77 basic types, more than 400 standard styles (feed-through, double-end, hollow, flare, split designs — single, double, triple turrets). Insulated terminals, even greater in variety, come in 5 different materials for rivet, female and male thread mounting: diallyl phthalate, Teflon\*, ceramic, melamine and phenolic. Press-mount terminals are all of Teflon.

By specifying standard terminals you also save special tooling costs, gain time on deliveries. And CAMBION quality assurance guarantees consistent high workmanship. Ask for the full-line CAMBION catalog, for specific prints, or for sales engineering assistance in selecting the best standard terminal for your every design requirement. Write to Cambridge Thermionic Corporation, 330 Concord Avenue, Cambridge 38, Massachusetts.

**CAMBION**

Standardize on CAMBION...The Guaranteed Electronic Components

\*Reg. DuPont T.N.

Circle 186 on Inquiry Card

## RADARSCOPE

**A NEW SUPERCONDUCTING ALLOY**, niobium-tin ( $Nb_3Sn$ ) can be deposited in films of various geometries, and can be drawn into continuous lengths of wire sufficiently ductile for winding on diameters as small as one inch, the Air Force announces. The alloy has the highest transition temperature presently known ( $18^\circ K$ ). It can carry sizable currents and can be used in making large superconducting solenoids for fields up to 170,000 gauss.

**ULTRASONIC-ASSISTED GRINDING** will become a reality for civilian production after some refining, according to Department of Commerce special study. The new technique of machining extra-hard materials, already proved out in Air Force-sponsored research and considered far superior to previous methods, uses an ultrasonic transducer to provide up to 40,000 vibrations/sec to the working tool, which contacts and works directly on material. The new method, unlike "Ultrasonic Impact Grinding," is more effective and less costly than other methods now used on such materials as titanium, beryllium, columbium, molybdenum and tantalum.

## SATELLITE TRACKING ANTENNA

Collins Radio Company has developed this aluminum, monopulse antenna array of log periodic dipole antennas, to track and monitor low-level earth satellites. The antenna can lock-in on a signal—30 to 300 mc—from any object passing above the horizon. Its control box, elements and steel back-up structure weigh a total of 2,400 lbs.



# ONLY WITH THE 175A:

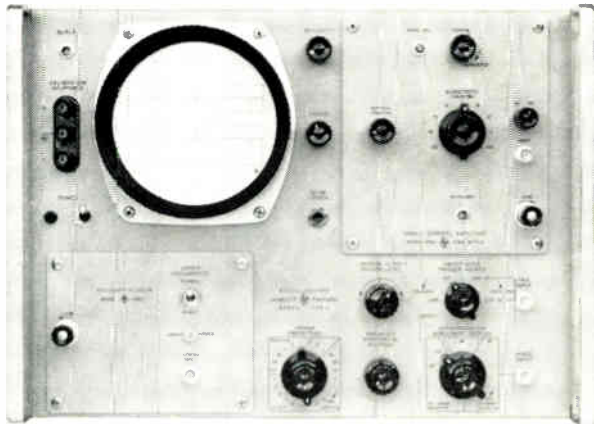

175A Universal Oscilloscope and 1751A Fast Rise Vertical Amplifier

*Less than 7 nsec  
rise time!  
Full  
6x10 cm display!*

The 175A Universal Oscilloscope challenges comparison! Rise times of less than 7 nsec at all sensitivities (50 mc bandwidth) even at the input probe and a sharp, full 6 x 10 cm no-parallax display make this the greatest scope value available today. Sweep speeds to 10 nsec/cm for measuring fast rise times. Both vertical and time axis

plug-ins for maximum versatility. Simplified circuitry with no distributed amplifiers speeds maintenance and insures stability. Only 7 tube types and 5 transistor types are used. Check the specs of the 175A and plug-ins, then check with your Hewlett-Packard representative for a close-up, convincing demonstration in your own lab.

## SPECIFICATIONS, 175A OSCILLOSCOPE

<b>SWEEP GENERATOR</b>	
Internal Sweep:	0.1 $\mu$ sec/cm to 5 sec/cm, $\pm$ 3%; vernier extends slowest speed to 12.5 sec/cm
Magnification:	x10; extends fastest sweep to 10 nsec/cm, $\pm$ 5%
Triggering:	Internal, from vertical input signal causing 2 mm or more vertical deflection, or from power line; external, from signal 0.25 v p-p or more
Triggering Point:	Controls allow selection of level and slope
<b>HORIZONTAL AMPLIFIER</b>	
Bandpass:	DC to 500 kc
Sensitivity:	2 ranges, 0.1 and 1 volts/cm; vernier provides continuous adjustment to 10 volts/cm
<b>VERTICAL AMPLIFIER</b>	
Rise Time:	Less than 7 nsec
<b>GENERAL</b>	
Power Requirements:	115 or 230 v ac $\pm$ 10%, 50 to 60 cps; maximum of 425 watts, depending on plug-ins used
Weight:	Maximum of 70 lbs., depending on plug-ins used
Price:	\$1325

Data subject to change without notice. Prices f.o.b. factory

## SPECIFICATIONS, 175A PLUG-INS

### VERTICAL PLUG-INS

**1750A 40 MC Dual Channel Amplifier:** Permits viewing of two phenomena simultaneously, bandpass dc to 40 mc, rise time 9 nsec, sensitivity 50 mv/cm to 20 v/cm; differential input for common mode rejection, \$285

**1751A Fast Rise Vertical Amplifier:** Rise time, < 7 nsec, dc to 50 mc; sensitivity, 50 mv/cm to 20 v/cm; vernier extends sensitivity to 50 v/cm, \$160

**1752A High Gain Amplifier:** Provides 5 mv/cm sensitivity dc to 18 mc with differential input for high common mode rejection, \$225

### HORIZONTAL PLUG-INS

**1780A Auxiliary Plug-in:** Normal and single sweep, \$25

**1781A Sweep Delay Generator:** For detailed examination of complex signals or pulse trains; permits viewing expanded waveform segment while still retaining presentation of earlier portions of the waveform; delay time 1  $\mu$ sec to 10 sec.; delaying sweep, 2  $\mu$ sec/cm to 1 sec/cm, \$375

**1782A Display Scanner:** Provides output to duplicate on X-Y recorder any repetitive wave appearing on scope; resolution with permanent records higher than CRT photograph, \$425

**1783A Time Mark Generator:** Permits easy time measurements by providing intensity modulated time markers on scope trace; range, 10  $\mu$ sec, 1  $\mu$ sec and 0.1  $\mu$ sec intervals,  $\pm$  0.5%, \$130

**HEWLETT  
PACKARD  
COMPANY**

1501 Page Mill Road, Palo Alto, Calif., Area Code 415, DA 6-7000  
Sales and service representatives in all principal areas; Europe,  
Hewlett-Packard S. A., 54 Route des Acacias, Geneva; Canada,  
Hewlett-Packard (Canada) Ltd., 8270 Mayrand Street, Montreal



8241

Circle 187 on Inquiry Card



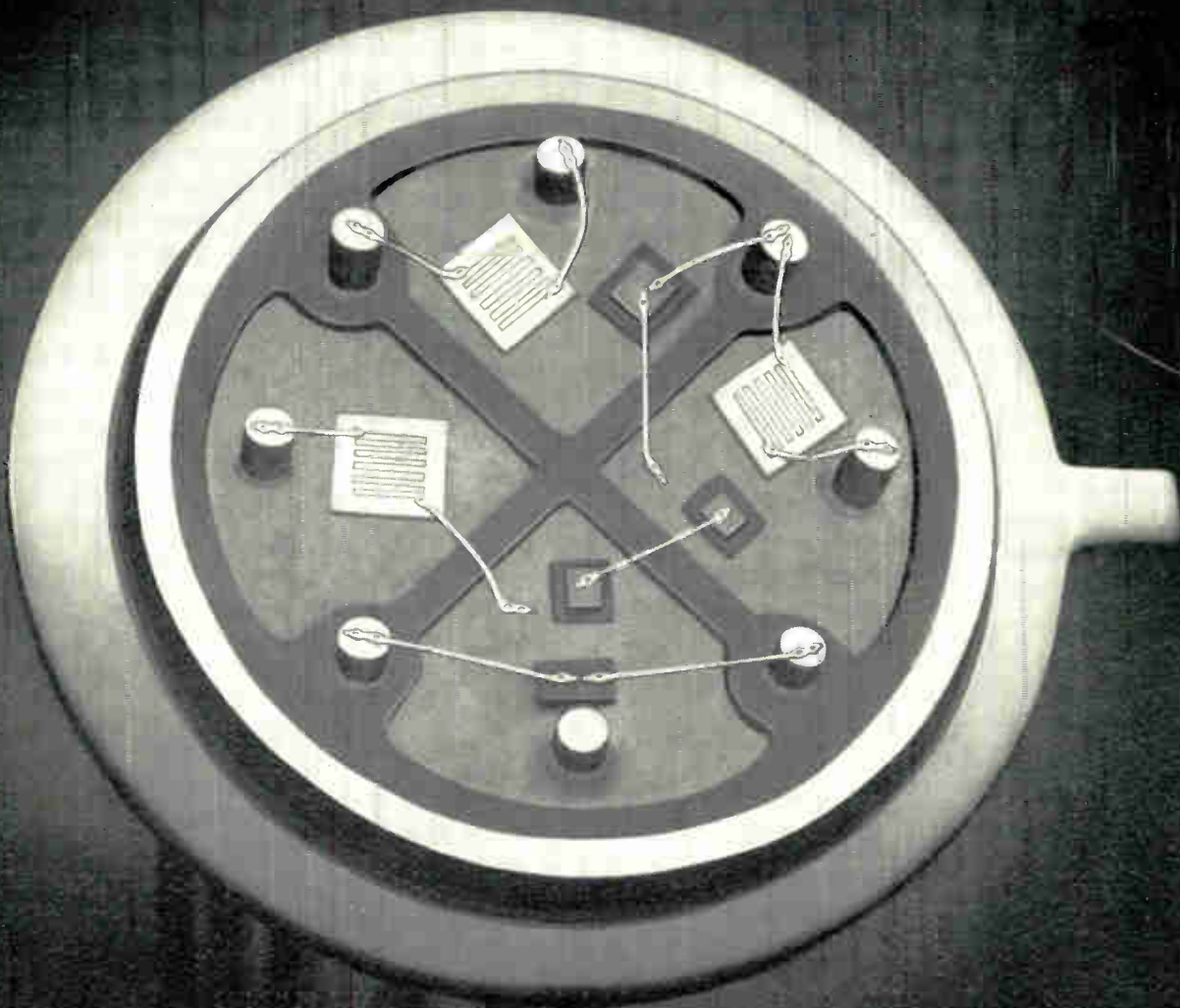

## New RCA Digital Micro Circuits Offer 7 Nanosecond Stage Delay

RCA announces the DMC 100 package—First in a series of compact logic-circuits with advanced active and passive elements for ultra-high-speed and new design flexibility.



ACTUAL SIZE

RCA's new low-cost Digital Micro Circuits bring faster switching speeds, better reliability and greater compactness to computer logic circuits. Here's why:

**Faster Switching**—New ultra-high-speed silicon switching devices provide extra-fast switching because stray capacities and lead lengths are reduced to a minimum in RCA's exclusive DMC package design.

**Better Reliability**—Overall circuit reliability is increased in the RCA DMC because all internal connections are either diffused paths or thermal compression bonds.

**Greater Compactness**—The ultra-compact, low-profile, ceramic-to-metal, DMC package is made possible by RCA's exclusive ceramic

header, already reliability-proved in millions of RCA devices.

Here are some of the outstanding features of the DMC 100, a positive NAND circuit version of RCA's new Digital Micro Circuits:

- Excellent noise immunity... $\pm 50\%$  of signal
- High speed...7 nanoseconds typical stage delay
- Low circuit dissipation...14 mw typical
- Wide operating temperature range... $-55$  to  $+125^{\circ}\text{C}$
- Max. Fan-Out of 5
- Broad Application...RCA DMC 100 is designed for use as an Inverter, Amplifier, Logic Gate (positive NAND or negative NOR), Flip-Flop, and Shift Register

• Immediate Availability...in production quantities

• RCA's unique, 8-lead, 100-mil high, "TO-5 type" package

**New Flexibility in Customer-Specified Circuits...RCA is ready to combine silicon planar transistors and silicon switching diodes—in your circuit designs—with a wide variety of high-temperature, precision passive components into Digital Micro Circuit form. And, these are available to you without costly tooling charges. Circuit changes can be made quickly and easily, at any time, eliminating costly delays.**

Call your RCA Representative today for complete price and delivery information. For further technical data, write RCA Semiconductor and Materials Division, Commercial Engineering, Section CJ4, Somerville, N.J.

AVAILABLE THROUGH YOUR RCA DISTRIBUTOR



The Most Trusted Name in Electronics

Circle 188 on Inquiry Card

RCA SEMICONDUCTOR & MATERIALS DIVISION FIELD OFFICES... EAST: Newark, N.J., 744 Broad St., HU 5-3900 • (Camden-Philadelphia Area) Erlton, N.J., 605 Marlton Pike, HA 8-4802 • Syracuse, N.Y., 731 James St., Rm. 402, GR 4-5591 • Baltimore, Md., EN 9-1850 • NORTHEAST: Needham Heights 94, Mass., 64 "A" St., HI 4-7200 • SOUTHEAST: Orlando, Fla., 1520 Edgewater Dr., Suite #1, GA 4-4768 • EAST CENTRAL: Detroit 2, Mich., 714 New Center Bldg., TR 5-5600 • CENTRAL: Chicago, Ill., Suite 1154, Merchandise Mart Plaza, WH 4-2900 • Indianapolis 5, Ind., 2132 East 52nd St., CL 1-1405 • Minneapolis 16, Minn., 5805 Excelsior Blvd., WE 9-0676 • Denver 11, Colorado, Continental Terrace Bldg., Suite 301, 2785 N. Speer Blvd., 477-1688 • WEST: Los Angeles 22, Calif., 6801 E. Washington Blvd., RA 3-8361 • (San Francisco Area) Burlingame, Calif., 1838 El Camino Real, OX 7-1620 • Seattle 4, Wash., 2250 First Ave. S., MA 2-8816 • SOUTHWEST: Dallas 7, Texas, 7905 Carpenter Freeway, ME 1-9720 • GOVT: Dayton, Ohio, 224 N. Wilkison St., BA 6-2366 • Washington, D. C., 1725 "K" St., N.W., FE 7-8500 • RCA INTERNATIONAL DIVISION, 30 Rockefeller Plaza, New York 20, N. Y. Cable Address: RADIOINTER, N. Y.