

# ELECTRONIC INDUSTRIES

& TELE-TECH

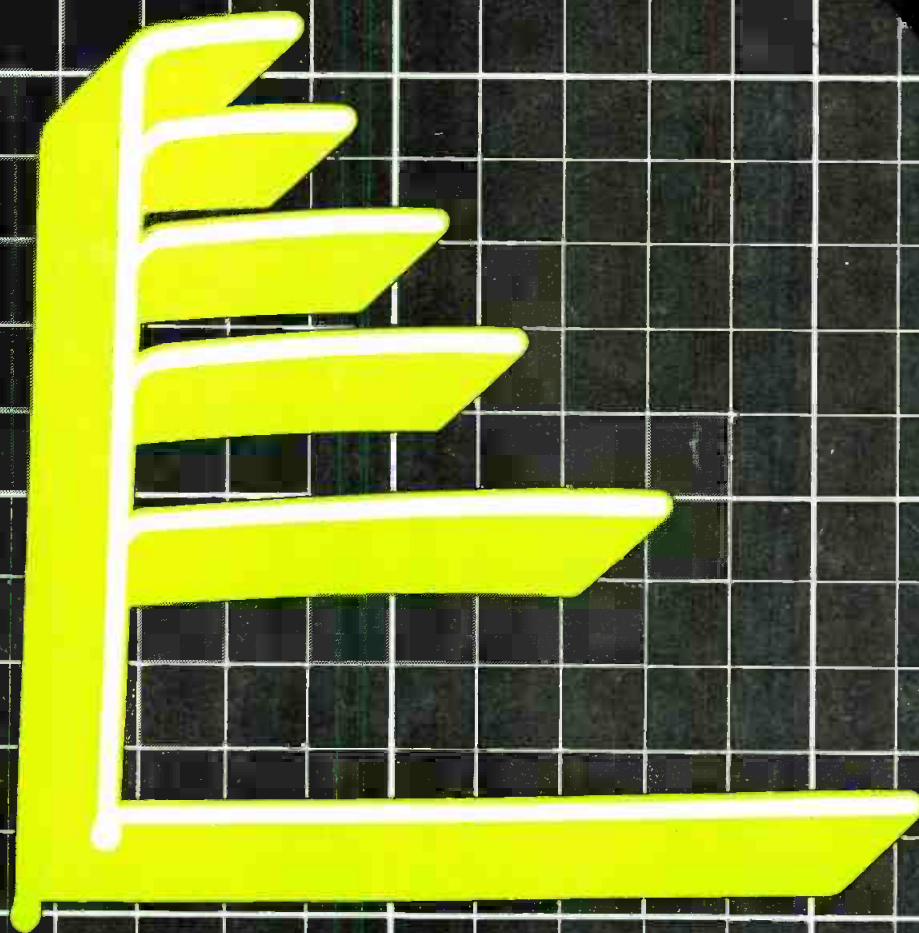

TRACING HIGH-POWER TRANSISTOR CHARACTERISTICS

New Portable TV Cameras  
Cover the Political Conventions

See p. 52

SHARE THIS COPY!  
Please Route to

September • 1956

A Chilton Publication



progress  
in  
development  
through  
continued  
research

RMC's modern research laboratory is manned by skilled technicians who are continuously at work improving the ceramic dielectrics used in DISCAPS. Increasing leadership in the field of ceramic disc capacitors is due to this continuing research program and improved manufacturing methods.

If you use ceramic capacitors write today for information on the design and use of RMC DISCAPS.

**RMC DISCAPS**

DISCAP  
CERAMIC  
CAPACITORS



**RADIO MATERIALS CORPORATION**  
GENERAL OFFICE: 3325 N. California Ave., Chicago 18, Ill.  
Two RMC Plants Devoted Exclusively to Ceramic Capacitors  
FACTORIES AT CHICAGO, ILL. AND ATTICA, IND.

One of the Publications  
Owned and Published by  
CHILTON COMPANY

Address all mail to  
Chestnut & 56th Sts., Phila. 39, Pa.  
SHerwood B-2000

BERNARD F. OSBAHR, Editor  
MAURICE CLEMENTS, Publisher  
ORESTES H. CALDWELL  
Editorial Consultant

CREIGHTON M. MARGOTT  
Associate Editor  
ARNOLD LOOK  
Assistant Editor  
JOHN GRUENBERG, 2nd  
Assistant Editor  
DR. A. F. MURRAY  
Contributing Editor  
STANLEY GERSTIN  
Contributing Editor  
ROLAND C. DAVIES  
Washington News  
ELMER KETTERER  
Art Editor  
ELMER DALTON  
Circulation Manager  
BARBARA CROWERS  
Editorial Secretary

**BUSINESS STAFF**

Philadelphia Office—  
BLAIR McCLENACHAN  
Sales Manager  
GORDON HERNDON  
Production Manager  
WILLIAM McCARNEY  
Sales Promotion Manager  
New York Office—JOSEPH DRUCKER  
District Manager  
GERALD B. PELISSIER  
District Manager  
MENARD DOSWELL III  
District Manager  
Chicago Office—201 N. Wells St.  
RAndolph 6-9225  
GEORGE FELT  
District Manager  
Cleveland Office—859 Leader Bldg.  
SUperior 1-1081  
SHELBY A. McMILLION  
District Manager  
Los Angeles Office—  
198 S. Alvarado St.  
DUnkirk 7-4337  
B. WESLEY OLSEN  
District Manager  
San Francisco Office—1355 Market St.  
Underhill 1-9737  
DON MAY  
District Manager

**OFFICERS and DIRECTORS**

JOS. S. HILDRETH Board Chairman  
G. C. BUZBY, President  
Vice Presidents: P. M. Fahrendorf,  
Harry V. Duffy, Treasurer, William H.  
Vallar; Secretary, John Blair Moffett;  
George T. Hook, Maurice E. Cox,  
Frank P. Tighe, Leonard V. Rowlands,  
Robert E. McKanna, Irving E. Hand,  
Everit B. Terhune, Jr., Russell W. Case,  
Jr., John C. Hildreth, Jr.



ELECTRONIC INDUSTRIES & Tele-  
Tech, Sept., 1956, Vol. 15, No. 9. A  
monthly publication of the Chilton  
Co. Executive, Editorial & Advertising  
offices at Chestnut & 56th Sts., Phila.,  
Pa. Accepted as controlled circulation  
publication at Phila., Pa. Additional  
acceptance at N. Y., N. Y. 75¢ a  
copy. Subscription rates U. S. and  
U. S. Possessions: 1 yr. \$5.00; 2 yrs.  
\$8.00; 3 yrs. \$10.00. Canada 1 yr.  
\$7.00; 2 yrs. \$11.00; 3 yrs. \$14.00. All  
other countries 1 yr. \$10.00; 2 yrs.  
\$16.00. Copyright 1956 by The Chilton  
Co., Inc. Title Reg. U. S. Pat. Off.  
Reproductions or reprinting prohibi-  
ted except by written authorization.

# ELECTRONIC INDUSTRIES

## & TELE-TECH

Vol. 15, No. 9

September, 1956

FRONT COVER: Oscillogram of a family of power transistor collector curves taken in a grounded emitter configuration at Fairchild Guided Missiles Div., Wyandanch, N. Y. For full details on power transistor characteristic testing see page 58.

**MONTHLY NEWS ROUND-UP**

As We Go To Press .....	9
Coming Events .....	15
Electronic Industries News Briefs .....	36
Washington News Letter .....	76
New Tech Data For Engineers .....	80

<b>TOTALS: RETMA Sales Production Figures .....</b>	<b>3</b>
<b>Editorial: Electronic Operations, The Weather—Electronically....</b>	<b>49</b>
<b>Radarscope: What's Ahead For The Electronic Industries? .....</b>	<b>50</b>
<b>First Design Data on New Portable TV Camera-Transmitters. A. Look</b>	<b>52</b>
<b>Designing "Free Power" AM &amp; FM Transistorized Receivers</b>	<b>54</b>
<i>Dr. H. E. Hollmann</i>	
<b>Effects Of Radiation On Electronic Components .....</b>	<b>57</b>
<i>Dr. R. D. Shelton</i>	
<b>Characteristic Tracer For Power Transistors . S. I. Kramer &amp; R. F. Wheeler</b>	<b>58</b>
<b>A Less-Than-Minimum Phase Shift Network</b>	<b>60</b>
<i>R. F. Destebelle, C. J. Savant, &amp; C. J. Savant, Jr.</i>	
<b>Predicting The Reliability Of Airborne Equipment .....</b>	<b>62</b>
<i>C. J. Hedetniemi</i>	
<b>Review of NBS Technical Services .....</b>	<b>65</b>
<b>Radioactive Fallout Computer.....</b>	<b>67</b>
<b>Cathode-Follower Design Curves .....</b>	<b>68</b>
<i>L. H. Estabrook &amp; R. A. Goundry</i>	
<b>A Discussion Of Precision Computer Transformers .....</b>	<b>70</b>
<i>D. Wildfeuer</i>	
<b>Cues For Broadcasters .....</b>	<b>73</b>
<b>'Bandwidth' and Noise Sensitivity .....</b>	<b>74</b>
<i>D. S. Radmacher</i>	

**NEW ELECTRONIC EQUIPMENT**

New Lab. Equipment .....	77	New Test Equipment .....	78
New Technical Products .....	79		

**DEPARTMENTS**

Tele-Tips .....	22	Books .....	42
Industry News .....	30	Personals .....	132
News of Manufacturers' Reps .....	130		

**International ELECTRONIC SOURCES..... 97**

# look to Stemco Thermostats first for precise, sensitive temperature control

If your product requires precise, sensitive temperature control . . .  
if it's scheduled for volume production—look to Stemco thermostats first.  
Since Stevens produces the broadest range of bimetal thermostats  
in the industry, chances are you can use a standard production-line  
unit to satisfy all your special requirements exactly. This saves design,  
development and tooling expense . . . cuts down on lead time . . .  
gives you a better, proven thermostat at lower cost—sooner.

- 1 TYPE 5 Adjustable Positive-acting, with electrically independent bimetal. Adjusting stem and terminals to customer specification. See Bulletin F-2006.
- 2 TYPE 5 Non-Adjustable. Electrically identical to adjustable Type 5. Single-stud mounting. Operates to 650°F. Rating: 15 amps at 115 volts AC, 10 amps at 230 volts AC. See Bulletin F-2006.
- 3 TYPE SA Adjustable. Snap-acting with electrically independent bimetal. Also single-pole, double-throw. Adjusting stem and terminals to customer order. See Bulletin L-6397-A.
- 4 TYPE SA Non-Adjustable. Is electrically identical to adjustable Type SA. Non-inductive-load rating 15 amps at 115 volts AC, 10 amps at 230 volts AC. See Bulletin L-6397-A.
- 5 TYPE SM Manual Reset. Mechanically and electrically same as adjustable and non-adjustable Type SA except for manual reset feature. See Bulletin L-6397-A.
- 6 TYPE W. Adjustable (shown) or non-adjustable types. Snap action prevents arcing. Operation to 350°F. Rated at 12 amps at 115 volts AC, 8 amps at 230 volts AC. See Bulletin L-6395.
- 7 TYPE A Semi-Enclosed. Insulated, electrically independent bimetal disc gives fast response and quick, snap-action control. Operation from -40° to 400°F. Various mountings and terminals. See Bulletin L-9070.

8 TYPE A Hermetically Sealed. Electrically identical to semi-enclosed Type A. Rated at 8 amps at 115 volts AC, 4 amps at 230 volts AC, and 4 amps at 28 volts DC. For appliance, electronic, apparatus applications. See Bulletin L-9070.

9 TYPE C Semi-Enclosed. Small, positive-acting. Electrically independent bimetal strip for operation from -75° to 300°F. Terminals and mountings to customer specifications. See Bulletin L-6934.

10 TYPE C Hermetically Sealed. Electrically identical to semi-enclosed Type C but sealed in crystal can. Also supplied as double thermostat "alarm" type. Rated at approximately 3 amps, depending on application. See Bulletin L-6934.

11 TYPE R. Sealed, non-adjustable (shown) or adjustable styles. Positive acting for operation to 650°F. Rated at 15 amps at 115 volts AC, 10 amps at 230 volts AC. See Bulletin F-2003.

12 TYPE M Semi-Enclosed. Compact unit with electrically independent bimetal disc for appliance and electronic applications from -60° to 400°F. Virtually any type terminal. See Bulletin F-2009.

13 TYPE M Hermetically Sealed. Electrically same as semi-enclosed Type M. Rating: 8 amps at 115 volts AC, 4 amps at 230 volts AC, 4 amps at 28 volts DC. See Bulletin F-2009.

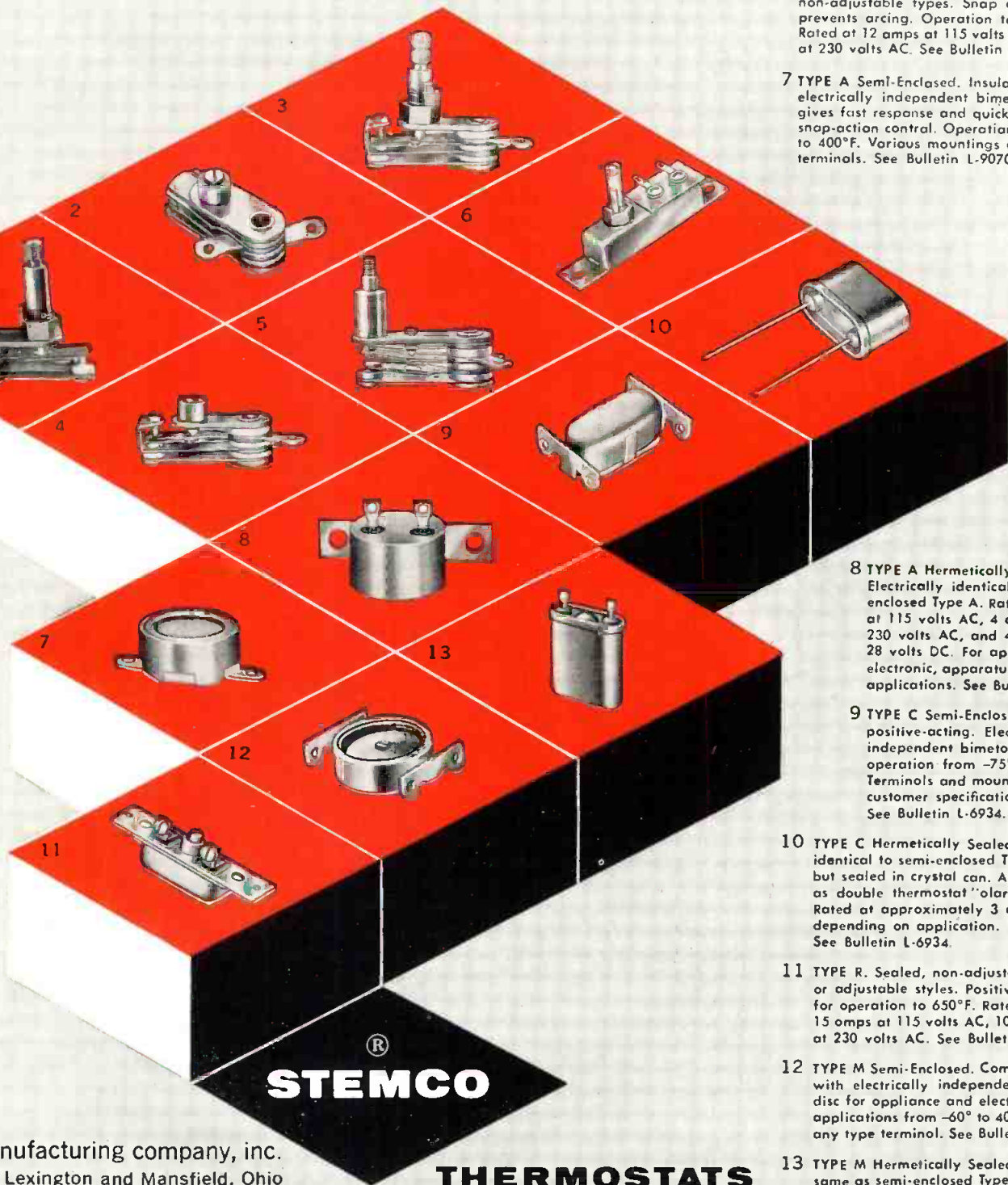

**STEMCO**

**THERMOSTATS**

STEVENS manufacturing company, inc.  
Lexington and Mansfield, Ohio

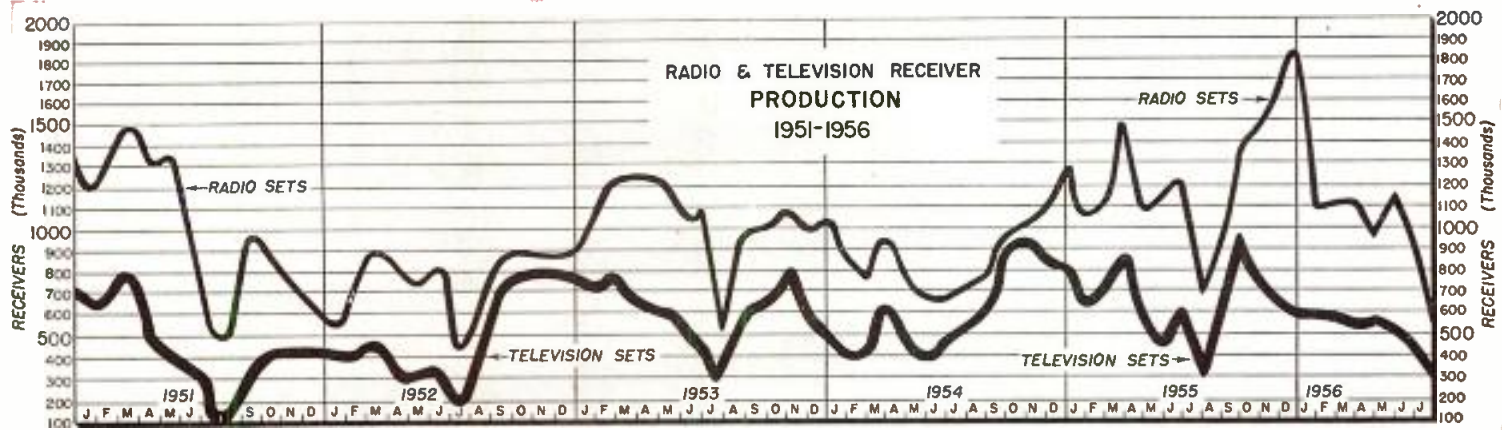

**COMPARISON BETWEEN USA AND USSR SCIENTIFIC PERSONNEL**

USA	USSR
<p>1. Living graduates in all scientific fields (with first-level degrees)—1955</p> <p>A. 1,536,000—Natural Science, Psychology, Agriculture, and Engineering</p> <p>of which</p> <p>B. 575,000 were engineers</p>	<p>1. Living graduates in all scientific fields—1955 (roughly equivalent to our first-level degree)</p> <p>A. 1,158,000—</p> <p>of which</p> <p>B. 555,000 were engineers (535,000 engineers by rigid criteria—excludes 31,000 other included below—+20,000 agricultural engineers)</p>
<p>2. Science field graduates—1955</p> <p>A. 59,000 graduates (first-level degrees)—in all scientific fields (including agriculture)—represents about 20% of total first level degrees</p> <p>of which</p> <p>B. 22,600 graduates (first-level degrees) were in engineering</p>	<p>2. Science field graduates—1955</p> <p>A. 126,000 graduates in all scientific fields (including agriculture)—represents 49% of total graduates</p> <p>61,000 Engineering 20,000 Agriculture 25,000 Science Teachers 10,000 University Graduates in Science 10,000 Other—Science</p> <p>126,000</p> <p>of which</p> <p>B. 59,000 graduates were in engineering—(57,000 engineers by rigid criteria—2,000 agricultural engineers)</p>

**GOVERNMENT ELECTRONIC CONTRACT AWARDS**

This list classifies and gives the value of electronic equipment selected from contracts awarded by government procurement agencies in July, 1956.

Amplifiers	5,245,171	Indicators	5,839,088	Radio Sets	12,790,004
Amplifiers, Servo	2,069,769	Indicators, Azimuth	1,435,019	Radio Transceivers	2,972,895
Antennas	3,014,140	Kits, Modification	1,684,401	Radio Transmitters	689,872
Batteries, Dry	236,848	Kits, Radar Modification	389,747	Radomes	678,185
Batteries, Storage	7,155,705	Kits, Radio	141,668	Recorders	802,756
Cable Set, Interconnecting	565,771	Meters	122,008	Relays	387,878
Calibrators	373,842	Meters, Noise & Field	102,962	Simulators	1,866,562
Capacitors	178,898	Meters, Volt	117,557	Switches	331,500
Computers	4,831,052	Microwave Equipment	1,158,930	Syncros	497,746
Computers, Airborne	16,123,902	Navigation, Air Radar	11,238,000	Telemeter Equipment	232,669
Converter, D C Coordinate	314,556	Radar Target Simulators	1,181,464	Teletype	1,224,569
Converters, Frequency	297,897	Radar Components & Spares	1,330,881	Television Equipment	223,732
Directional Couplers	327,441	Radar Equipment	17,506,856	Test Sets	290,199
Fire Control, Radar	13,550,434	Radio Direction Finders	671,805	Transmitters, Rate of Fuel Flow	918,950
Generators, Electric	12,083,465	Radio Receivers	4,141,086	Tubes, Electron	1,474,967
Generators, Signal	1,691,580	Radio Receivers-Transmitters	6,633,539	Wire & Cable	2,652,543

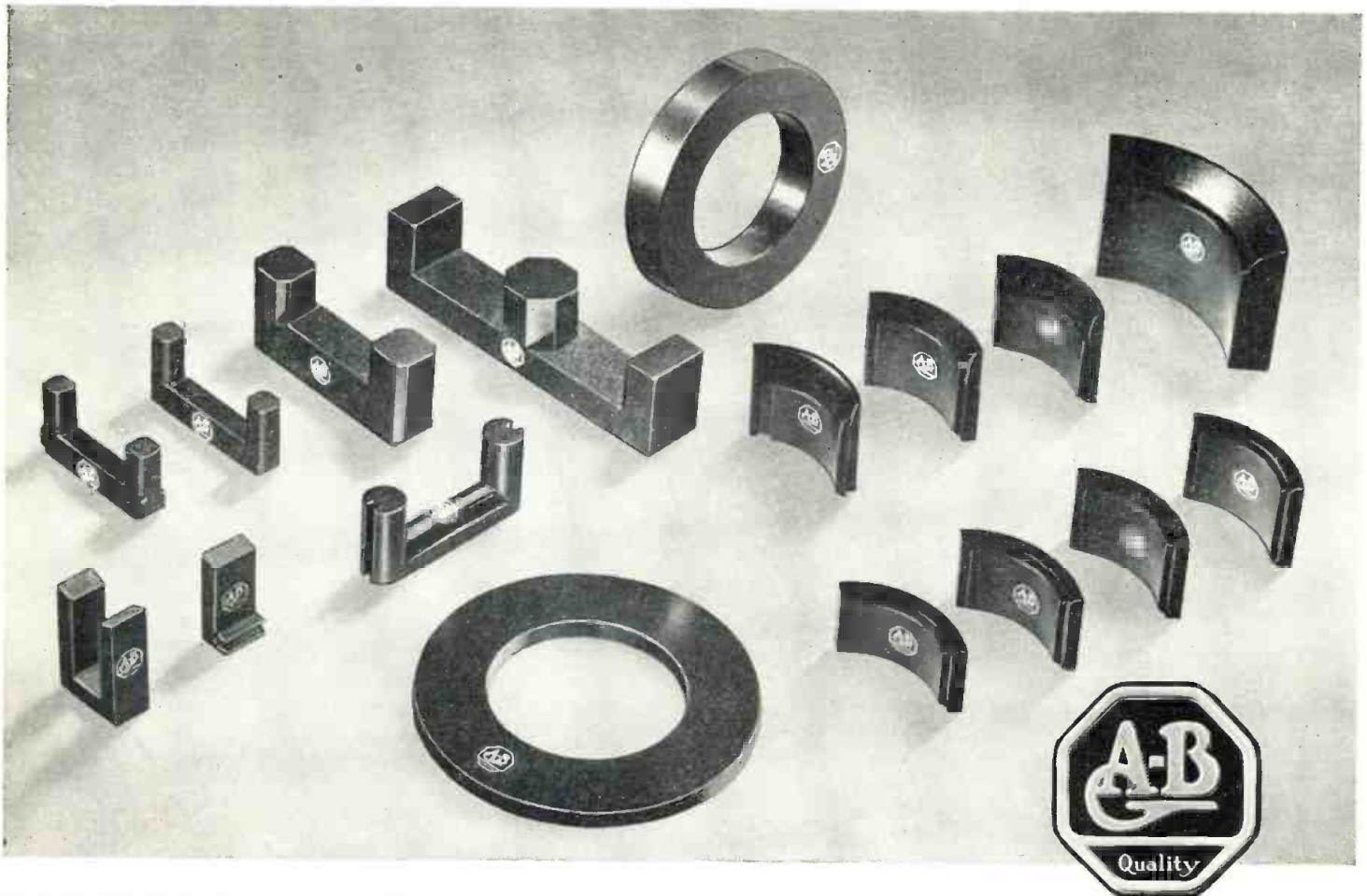

# HERE'S GOOD NEWS

## *about* ALLEN-BRADLEY FERRITES!

Allen-Bradley ferrites have been discovered to be superior for deflection component applications in television receivers. As a result, the demand has kept Allen-Bradley in delivery troubles—a situation that has been annoying to both customers and ourselves. Therefore, you will be glad to learn that Allen-Bradley's production capacity has been considerably expanded—our shipment problems should be a thing of the past.

Comprehensive tooling for practically every size and shape of ferrite core currently being used in

both black and white and color television receivers, makes Allen-Bradley an ideal source for your ferrite core requirements.

Use Allen-Bradley Class WO-1 ferrites for deflection yoke application and Class WO-3 ferrites for flyback transformer applications and enjoy superior TV receiver performance.

Uniform dimensions of Allen-Bradley ferrites enable low-cost, efficient assembly. Uniform magnetic characteristics eliminate necessity of individual adjustments or compensations.

Allen-Bradley Co., 1342 S. Second St., Milwaukee 4, Wis. • In Canada—Allen-Bradley Canada Limited, Galt, Ont.

### OTHER QUALITY COMPONENTS FOR RADIO, TV & ELECTRONIC APPLICATIONS

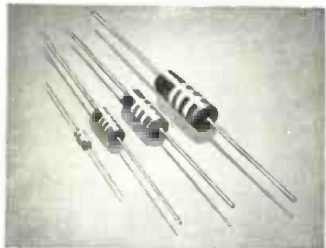

Fixed Molded Resistors  
1/10, 1/2, 1 & 2 watt



Variable Molded Resistors  
1/2 & 2 watt

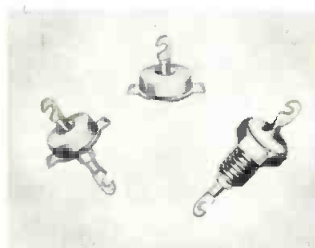

Stand-off and Feed-thru  
capacitors

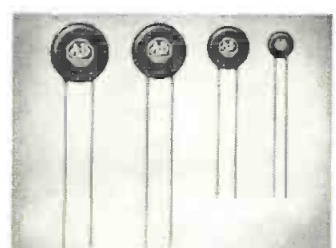

Ceramic Dielectric Capacitors  
for by-pass and filtering

# ALLEN-BRADLEY

## RADIO, ELECTRONIC AND TELEVISION COMPONENTS

# CODE MODULATED MULTIPLE-PULSE MICROWAVE SIGNAL GENERATOR

**Model B**

**950-10,750 mc**

*Generates multi-pulse modulated carrier for beacons, missiles, radar... provides 5 independently adjustable pulse channels, 4 interchangeable r-f oscillator heads, precision oscilloscope, self-contained power supplies ... all in one integrated mobile instrument.*

The Polarad Model B is an essential instrument for testing beacons, missiles, radar, navigational systems such as DME, Tacan, H. F. Loran, etc., where multi-pulse modulated, microwave frequency energy with accurately controlled pulse width, delay, and repetition rate is required for coding.

**A fully integrated self-contained equipment with these features:**

**Four Interchangeable Microwave Oscillator Units**—all stored in the instrument... each with UNI-DIAL control... precision power monitor circuit to maintain 1 mw power output reference level... keying circuit to assure rapid rise time of modulated r-f output... non-contacting chokes.

**Five Independently Adjustable Pulse Channels**—each channel features variable pulse width and delay; has provisions for external pulse-time modulation.

**Precision Oscilloscope with Built-In Wide Band RF Detector** for viewing the modulation en-

velope and accurately calibrating the r-f pulse width, delay, and group repetition rate. Equipped with built-in calibration markers.

**Self-Contained Power Supplies**—Model B operates directly from an AC line through an internal voltage regulator. The coded multi-pulse generator is equipped with an electronically regulated low voltage DC supply. Klystron power unit adjusts to proper voltage automatically for each interchangeable band.

Contact your Polarad representative or write to the factory for detailed information.

Variable width—width of each of 5 pulses can be adjusted independently.

Variable delay—delay between each of 5 pulses can be adjusted independently.



**CODE MODULATED MULTIPLE-PULSE  
MICROWAVE SIGNAL GENERATOR  
Model B**

Pulse-time modulation—input provided in each of 5 pulse channels for external pulse-time modulation.

Variable repetition rate—repetition rate of each group of pulses can be varied.

## SPECIFICATIONS:

### Frequency Range:

- Band 1... 950 to 2400 mc
- Band 2... 2150 to 4600 mc
- Band 3... 4450 to 8000 mc
- Band 4... 7850 to 10,750 mc

Frequency Accuracy...  $\pm 1\%$

RF Power Output... 1 milliwatt maximum (0 DBM)

### Attenuator:

- Output Range... 0 to -127 DBM
- Output Accuracy...  $\pm 2$ db
- Output Impedance... 50 ohms nominal

### RF Pulse Characteristics:

- a. Rise Time... Better than 0.1 microsecond as measured between 10 and 90% of maximum amplitude of the initial rise.
- b. Decay Time... Less than 0.1 microsecond as measured between 10 and 90% of maximum amplitude of the final decay.
- c. Overshoot... Less than 10% of maximum amplitude of the initial rise.

### Internal Pulse Modulation:

- No. of Channels... 1 to 5 independently on or off
- Repetition Rate... 40 to 4000 pps
- Pulse Width... 0.2 to 2.0 microseconds
- Pulse Delay... 0 to 30 microseconds
- Accuracy of Pulse Setting... 0.1 microsecond
- Minimum Pulse Separation... 0.3 microsecond
- Initial Channel Delay... 2 microseconds from sync. pulse
- Internal Square Wave... 40-4000 pps (separate output)

### Pulse Time Modulation:

- Frequency... 40-400 cps any or all channels
- Required Ext. Mod... 1 volt rms min.
- Maximum deviation...  $\pm 0.5$  microsecond
- Power Input (built-in power supply) 105/125 v. 60 cps 1200 watts.

AVAILABLE ON EQUIPMENT LEASE PLAN

FIELD MAINTENANCE SERVICE AVAILABLE THROUGHOUT THE COUNTRY



**ELECTRONICS CORPORATION** 43-20 34th STREET, LONG ISLAND CITY 1, N. Y.

REPRESENTATIVES: Albuquerque, Atlanta, Baltimore, Boston, Buffalo, Chicago, Cleveland, Dayton, Denver, Fort Worth, Kansas City, Los Angeles, New York, Philadelphia, Portland, St. Louis, San Francisco, Schenectady, Syracuse, Washington, D. C., Winston-Salem, Canada; Arnprior, Ontario. Resident Representatives in Principal Foreign Cities

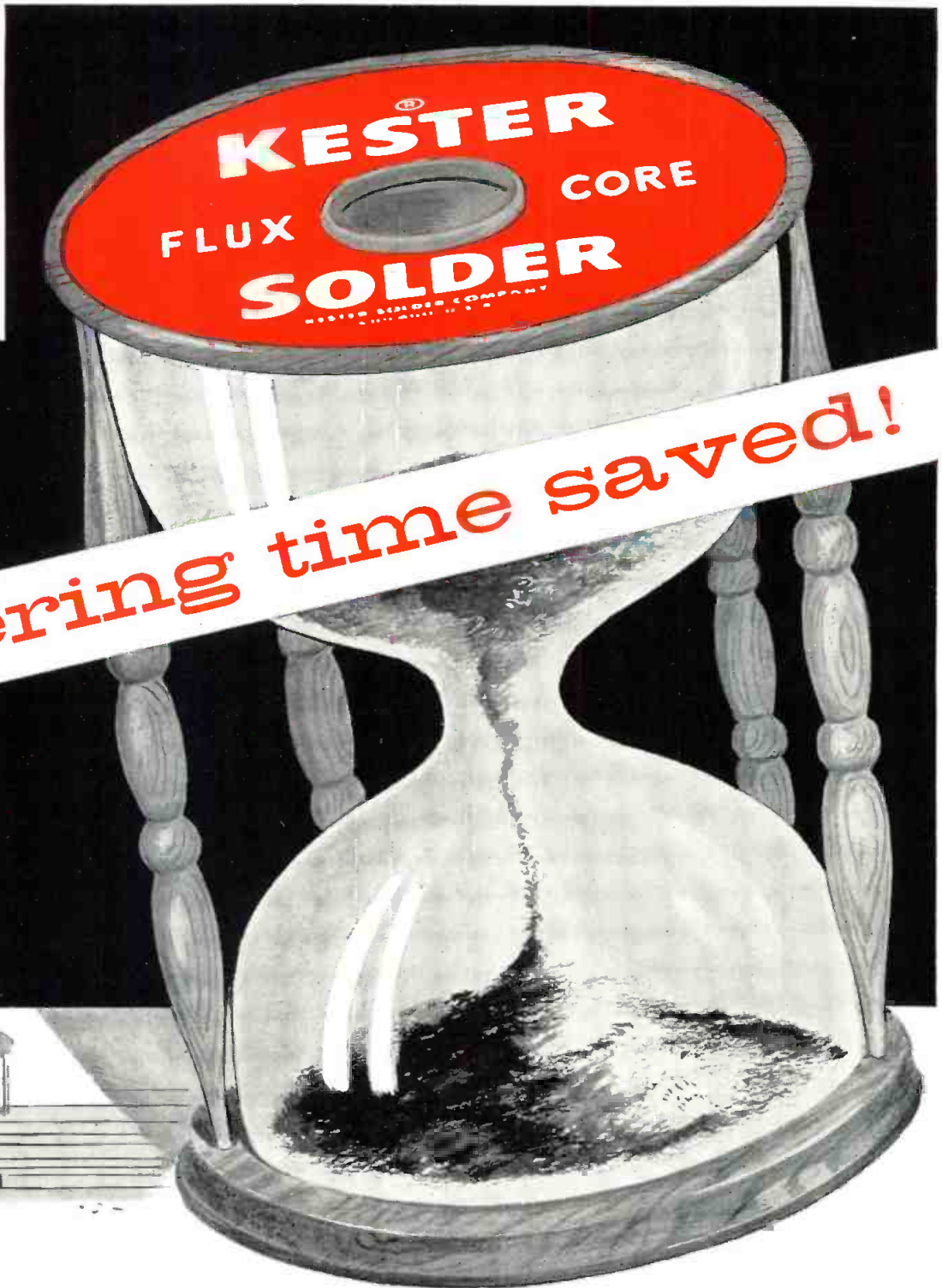

soldering time saved!

KESTER "44" RESIN, PLASTIC ROSIN AND "RESIN-FIVE" FLUX-CORE SOLDERS are tried-and-proved remedies for almost every production situation where soldering time gets out of hand. Kester's great adaptability to widely divergent soldering requirements has time and again helped

so many manufacturers combat rising production costs. It could be the solution you've been looking for!

*THIS IS IT . . . the informative 78-page free Kester textbook "SOLDER . . . Its Fundamentals and Usage." Send for your copy today!*

# KESTER SOLDER

COMPANY 4210 Wrightwood Avenue, Chicago 39, Illinois; Newark 5, N. J.; Brantford, Canada



# solving logical problems with Burroughs pulse control systems

## detecting coincidence between two random trains of pulses

The diagram below shows a quick, easy logical method of detecting coincidence between random pulses on two different lines—pulses which might occur simultaneously, well within the switching time of even the fastest units. In this case, the systems approach proved to be more feasible than increasing the precision of the components.

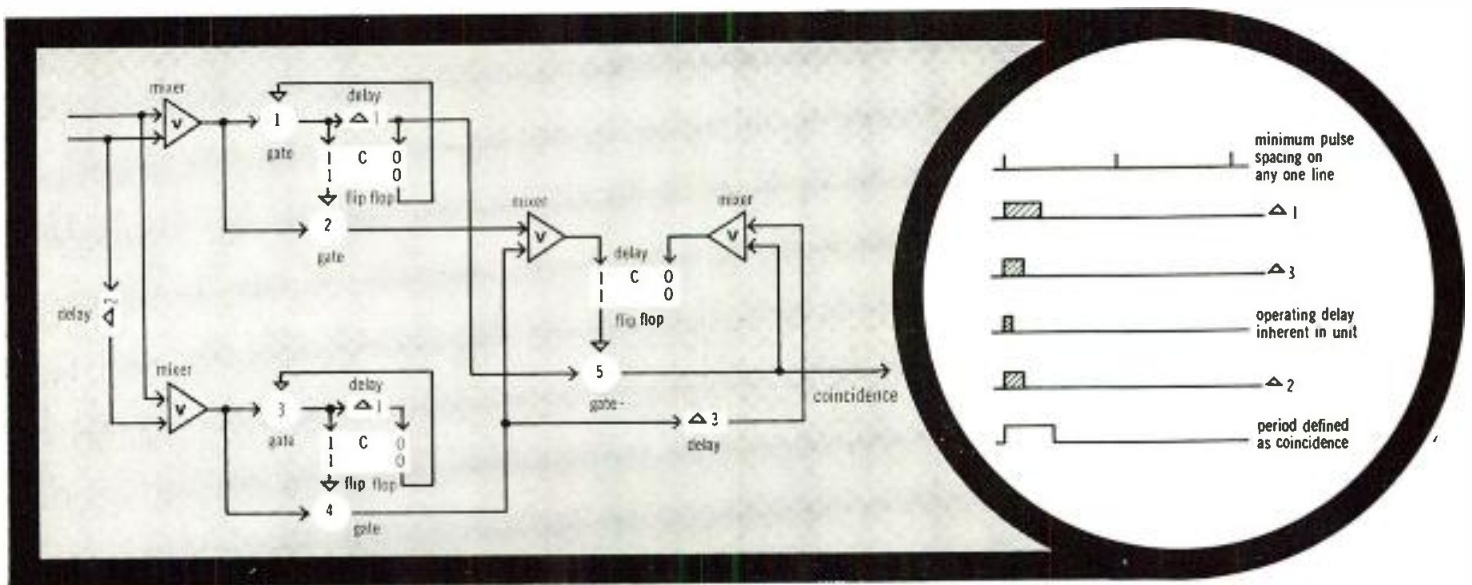

TOOLS FOR ENGINEERS



Logical problems such as this one still tie up most of today's engineers... making them design breadboard equipment to prove out their solutions... relegating their creativeness to secondary projects. Burroughs Pulse Control Systems cut through these time-consuming operations by giving the engineer a quick, logical method for checking his results.

Each unit in the Burroughs System represents a basic logical function. The engineer has only to hook up a number of these units to correspond with his block diagram, and the solution is ready for proof. Intermediate breadboarding is completely eliminated... his concept is proved or disproved quickly... and he is free to concentrate on the end result.

You can give your engineers this creative edge by letting Burroughs Pulse Control Systems take over the burden of proof. A Burroughs engineer will be glad to call on you—at your convenience—and show you how to save hours of engineering time and production headaches. Or, write for Bulletin 236.

BURROUGHS CORP. • ELECTRONIC INSTRUMENTS DIVISION  
Department D • 1209 Vine Street • Philadelphia 7, Penna.

**CLASS H PLUS**



**THERE IS ONLY ONE MAGNET WIRE  
WITH AN EXTREMELY HIGH SPACE FACTOR  
CAPABLE OF SUCCESSFUL,  
CONTINUOUS OPERATION AT**

**250°C**

CEROC is an extremely thin and flexible ceramic insulation deposited on copper wire. This ceramic base insulation is unaffected by extremely high temperatures. Thus, in combination with Silicone or Teflon overlays, Ceroc insulations permit much higher continuous operating temperatures than are possible with ordinary insulations.

There are three standard Ceroc Wires: Ceramic Single-Teflon and Ceramic Heavy-Teflon for operation at 250°C. feature unique characteristics of flexi-

bility, dielectric strength and resistance to moisture. They have been used successfully to 300°C in short time military applications. Ceramic Single-Silicone, for 200°C application, pairs the ceramic with a Silicone reinforcement to facilitate winding.

All three Ceroc Wires have far superior cross-over characteristics to all-plastic insulated wire—all provide an extraordinarily high space factor that facilitates miniaturization with high-reliability standards. ★ ★ ★ ★

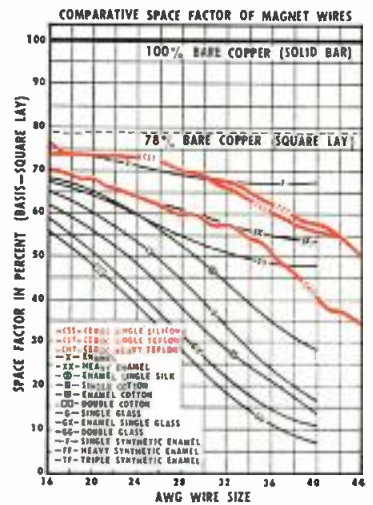

**IT IS SPRAGUE'S...**

**Ceroc**®

**CERAMIC INSULATED MAGNET WIRE**



**ENLARGED CROSS-SECTIONS OF CEROC® COPPER MAGNET WIRE**



**FOR COMPLETE ENGINEERING  
DATA ON CEROC WIRES,  
WRITE FOR BULLETIN 400A.**

**SPRAGUE** ELECTRIC COMPANY • 233 MARSHALL ST. • NORTH ADAMS, MASS.



# As We Go To Press...



Lockheed's X-7 supersonic test vehicle, used in the ramjet development program and other missile component tests.

## Warning Plane, New Missiles Announced

Looking like a flying saucer that captured an airplane, according to Lockheed Aircraft Corp., the builder, a new early warning research plane has been completed for the U. S. Navy to test advanced ideas in flying radar stations—outposts against surprise attack.

Lockheed has also announced the X-7, a supersonic test vehicle designed and built by the firm's Missile Systems Div., Van Nuys, Calif., and a hypersonic missile with which critical problems of the Air Force's intercontinental ballistic missile program are being probed.

The research plane is a Navy WV-2 Super Constellation made bizarre by a huge, disc-shaped structure spreading over it like a parasol. Measuring over 30 feet across, this ellipsoid is a radome which houses the craft's distance-determining radar antenna; the aircraft is powered by four turbo-compound piston engines.

Exact performance of the X-7 is classified, but it has been revealed that this needle-nosed vehicle flashes through the stratosphere in level flight at speeds well beyond the velocity of sound. The X-7 has been used in the ramjet development program and also as

a test bed for other missile components. This test vehicle is taken aloft by a B-29 and then launched; a rocket booster drives it up to the speed where the ramjet operates efficiently and takes over to accelerate the vehicle. So as to be used again for test flights, the vehicles are recovered by 'chute.

Lockheed's hypersonic missile, also still classified, is called a "key link" in the Nation's ballistic missile program, which includes the inter-continental vehicles Atlas and Titan, and Thor, the intermediate range missile. Rocket-powered for hypersonic speeds and undisclosed altitudes, this missile is concerned with research into the problems of bringing the inter-continental ballistic missile back into the earth's atmosphere from outer space.

A product of combined effort by Lockheed and the USAF Western Development Div. (ARDC), the missile is being used in the investigation of atmospheric heating effects, suitability of various metals and other factors contributing to the design of missile nose shapes. Launchings of the missile are done at Patrick Air Force Base in Florida, the AF's long-range missile firing area.

## Cable Makes Progress

Preparatory to laying the second deep-sea segment of the trans-Atlantic telephone cable system, the cables ship HMTS Monarch recently left Erith, England, with 1,200 nautical miles of cable aboard.

The cables ship was scheduled to reach an Atlantic Ocean point at which the end of 450 miles of cable already laid from Scotland was buoyed. The ship then was to begin laying operations westwardly at the rate of 6 knots/hour, according to the Long Lines Dept. of AT & T.

## RADAR "YARDSTICK"



This Signal Corps "radar ruler," used for great distances, enables a surveyor to survey 50 miles at a time accurately and in any weather.

—Official U. S. Army Photo

## Report A-Bombs Have No Effect on Weather

Although there seems to have been an increase in unusual and undesirable weather in the last 10 years, a section of the National Academy of Science reports that the A-bomb was probably not responsible—the report's principal point being that "the occurrences are not outside those which could have happened by chance."

The Academy findings went on to say that the energy of even a large thermonuclear explosion is small in comparison with the energy of any large-scale weather movement. Also, the debris thrown up into the air by the explosions has been shown to be ineffective as a cloud-seeding agent, and the amount of electrification of air produced by radio-active matter is insignificant in any general atmospheric process.

More News on page 13



# NEW HERMETIC POWER COMPONENTS

**HIGHEST RELIABILITY  
FOR MILITARY AND  
INDUSTRIAL USE**

Listed below are just a few of the 50 new stock items in the United hermetic power series. These MIL-T-27 power components add to the 200 other hermetic stock items of filter, audio, and magnetic amplifier types.

Through the use of proven new materials and design concepts, an unparalleled degree of life and reliability has been attained, considerably exceeding MIL-T-27 requirements. Test proved ratings are provided, not only for military applications but for industrial, broadcast, and test equipment service (55°C. ambient).

**For complete listing of these new items, write for Catalogue #56.**



## MIL-T-27 RATINGS IN REGULAR TYPE

## INDUSTRIAL RATINGS IN BOLD TYPE

### TYPICAL POWER TRANSFORMERS, PRI: 115V., 50-60 cycles.

Type No.	HV Sec. C.T.	Approx* DC volts	DC MA	Fil. Wdg.	Approx* DC volts	MA DC	Fil. Wdg.	MIL Case
H-81	500	L 180	65	6.3VCT-3A 5V-2A	L 170	75	6.3VCT-3A 5V-2A	HA
		C 265	55		C 240	65		
	L 200	60	L 190		70			
	C 300	50	C 280		60			
H-84	700	L 255	170	6.3V-5A 6.3V-1A 5V-3A	L 240	210	6.3V-6A 6.3V-1.5A 5V-4A	KA
		C 400	110		C 360	150		
	L 275	160	L 260		200			
	C 420	105	C 380		140			
H-87	730	L 245	320	6.3V-6A 6.3V-2A 5V-4A	L 210	420	6.3V-6A 6.3V-2A 5V-4A	NB
		C 390	210		C 350	310		
	L 275	300	L 245		400			
	C 440	200	C 400		300			
H-93	L 370	280	6.3V-8A 6.3V-4A 5V-6A	L 340	340	6.3V-10A 6.3V-5A 5V-6A	DA	
	L 465	250		L 455	300			

\*After appropriate H series choke. L ratings are choke input filter, C ratings are condenser input.



United "H" series power transformers are available in types suited to every electronic application. Proven ratings are listed for both high voltage outputs... condenser and choke input filter circuits... military and industrial applications.

United "H" series filter reactors are extremely flexible in design and rating. Listings show actual inductance for four different values of DC. Bold type listings are industrial applications maximums.



### A FEW TYPICAL LISTINGS OF FILTER REACTORS.

Type No.	Ind. @ Hys.	MA DC	Ind. @ Hys.	MA DC	Ind. @ Hys.	MA DC	Ind. @ Hys.	MA DC	Res. Ohms	Max. DCV* Ch. Input	Test V. RMS	MIL Case
H-71	20	40	18.5	50	15.5	60	10	70	350	500	2500	FB
H-73	11	100	9.5	125	7.5	150	5.5	175	150	700	2500	HB
H-75	11	200	10	230	8.5	250	6.5	300	90	700	2500	KB
H-77	10	300	9	350	8	390	6.5	435	60	2000	5500	MB
H-79	7	800	6.5	900	6	1000	5.5	1250	20	3000	9000	9x7x8

\*Based on maximum ripple voltage across choke in choke input filter circuit, in terms of DC output voltage.

### TYPICAL FILAMENT TRANSFORMERS, PRI: 105/115/210/220V., 50-60 cycles.

Type No.	Sec. Volts	Amps. (MIL)	Amps. (Ind)	Test Volts RMS	MIL Case
H-121	2.5	10	12	10000	JB
H-124	5	3	3	2000	FB
H-127	5	20	30	21000	NA
H-131	6.3CT	2	2.5	2500	FB
H-132	6.3CT	6	7	2500	JA
	6.3CT	6	7		
H-136	14, 12, 11CT	10	14	2500	LA



United "H" series filament transformers have multi-tapped primaries, good regulation, and are rated for industrial as well as military service.

United "H" series plate transformers incorporate dual high voltage ratings and tapped primaries to provide versatile units for a wide range of military and industrial electronic applications. Large units have terminals for opposite mounting for typical transmitter use.



### TYPICAL PLATE TRANSFORMERS, PRI: 105/115/210/220V., 50-60 cycles.

No. Type	Sec. V. C.T.	Approx.* DC volts	MA DC	Choke No.	MA DC	Choke No.	Case
H-110	1050	380	275	H-75	385	H-77	MB
	1200	465	250	H-75	350	H-77	
H-113	2500	1050	280	H-77	340	H-77	5 1/4 x 6 x 7
	3000	1275	250	H-76	300	H-76	
H-115	3500	1500	265	H-77	350	H-77	8 1/4 x 6 1/2 x 8
	4400	1900	225	H-77	300	H-77	
H-117	5000	2125	900	H-79	1100	H-79	13 1/2 x 11 x 14 1/2
	6000	2550	800	H-79	1000	H-79	

\*After filter choke. All ratings are for choke input filter.

## UNITED TRANSFORMER CO.

150 Varick Street, New York 13, N. Y. • EXPORT DIVISION: 13 E. 40th St., New York 16, N. Y.

CABLES: "ARLAB"



## How much should a Tape Recorder cost?

**\$45,000\*** The new Ampex Videotape Recorder at \$45,000 achieves flawless reproduction of TV picture and sound. The system not only promises to revolutionize network telecasting but will actually reduce material costs by 99%. In hundreds of TV stations throughout the country Ampex Videotape Recording will repay its cost in less than a year.

**\$1,315\*** The Ampex Model 350 studio console recorder at \$1,315, costs less per hour than any other similar recorder you can buy. Year after year it continues to perform within original specifications and inevitably requires fewer adjustments and parts replacements than machines of lesser quality.

**\$545\*** The Ampex Model 601 portable recorder at \$545 gives superb performance inside and outside of the studio. This price buys both the finest portable performance available and the most hours of service per dollar.

**YOU CAN PAY LESS FOR A TAPE RECORDER BUT FOR PROFESSIONAL USE  
YOU CAN'T AFFORD TO BUY LESS THAN THE BEST**

\*Net price as of August 1, 1956 and subject to change.

**SIGNATURE OF PERFECTION IN MAGNETIC TAPE RECORDERS**  
934 Charter Street • Redwood City, California



# COLLINS NEW *TV-STL* Microwave Relay System

*Combines  
convenience and reliability*

Collins has given careful consideration to the operating engineer in the design of this new 6875-7125 mc STL system. The result of this consideration is a combination of maximum convenience — from installation to the last detail of maintenance — with Collins reliability.

The system, which operates NSTC color or monochrome and FM audio, has a number of features — it can be completely installed indoors; the IF amplifier is permanently tuned, requiring no adjustments; all components are conservatively operated, and circuits, except the klystron, operate from 130 volt plate supplies.

A complete line of quality STL accessories, including parabolic antennas and passive reflectors, also is available.

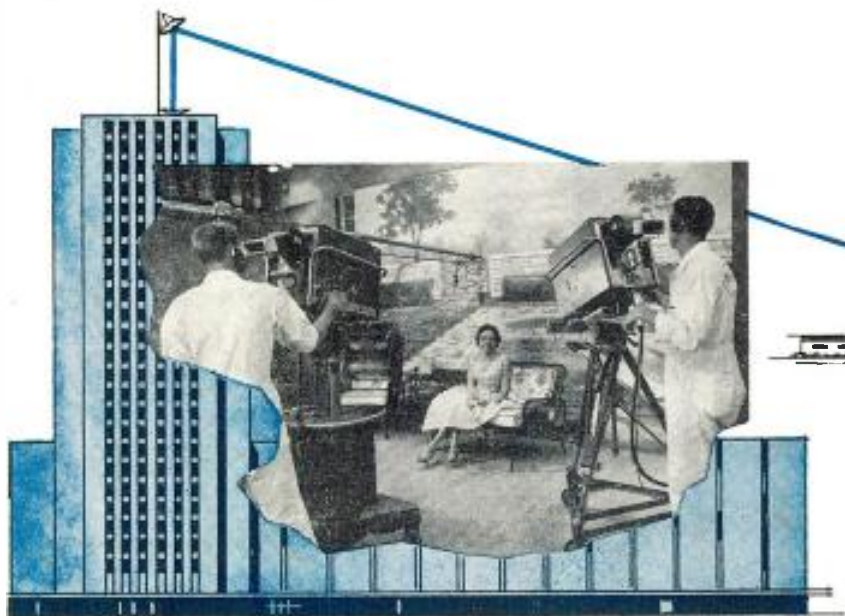

Miss Gerry Johnson, KRLD-TV, Dallas

## FEATURES

- NSTC color specifications
- High fidelity FM audio
- Compact — each terminal contained in single rack or cabinet
- Provisions for locating parabolic antennas up to 75 feet from RF Units
- Minimum differential phase shift
- Accessibility — in both operating controls and plug-in subunits
- All important circuits are metered
- Long-life, inexpensive klystrons
- Ease of installation, maintenance and expansion
- Built-in test facilities provide a means of checking overall performances.

*Contact your nearest Collins representative for complete information on Collins TV-STL Microwave Relay System.*

*Collins*

CREATIVE LEADER IN COMMUNICATION



COLLINS RADIO COMPANY, 315 2nd Avenue S.E., Cedar Rapids, Iowa • 1930 Hi-Line Drive, Dallas 2 • 2700 W. Olive Ave., Burbank  
261 Madison Ave., New York 16 • 1200 18th St. N.W., Washington, D.C. • 4471 N.W. 36th St., Miami 48 • 1318 4th Avenue, Seattle  
Dogwood Road, Fountain City, Knoxville • COLLINS RADIO COMPANY OF CANADA, LTD., 11 Bermondsey Road, Toronto 16, Ontario

## As We Go To Press . . . (Continued)

### 11th Annual ISA Meet Opens on Sept. 17th

THE 11th annual Instrument-Automation Conference and Exhibit (International), sponsored by the Instrument Society of America, will be held at the new Coliseum, New York City, Sept. 17-21, 1956. The Exhibit—85,000 sq. ft. of booths—500 exhibitors—will be the largest ever held by the ISA and will feature the Instrument Maintenance and the Analytical Instruments Clinics, along with an extensive technical paper program.

The Exhibit of millions of dollars worth of new production equipment will be held on all 5 days. The Instruments Maintenance Clinic will start prior to the Conference and Exhibit and will run for 3 consecutive days starting Sept. 15. Three simultaneous schedules of instruction will be presented at Hamilton Hall, Columbia Univ.

The Analytical Instruments Clinic will be conducted at the Statler Hotel on Sept. 19, 20. The course will consist of five 3-hr. sessions on theory, design, and application of instruments for both continuous process stream analysis and laboratory analysis.

Designed for maximum information and participation, the Data Handling Workshop will be at the Hotel New Yorker on Sept. 17, 18.

Complete information may be obtained from the Instrument Society of America, 313 6th Ave., Pittsburgh 22, Pa.

### GE at Work on Noses For Newest Missiles

Nose cone carrying controls and a warhead for two guided missiles are being worked on in General Electric's Special Defense Projects Dept., recently established in Philadelphia. This effort, for the Air Force, is concerned with the missiles Atlas and Thor.

The GE unit announced that engineers and scientists working on the projects would have to "push back frontiers of science" in chemistry, metallurgy, electronics and other basic sciences to find metals able to withstand great heat.



—Official U. S. Army Photo

Forward scout reports back to his squad through his tiny combat radio, which is built into his helmet.

### Combat Helmet Radio Simplifies Contact

Soldiers can now talk to each other—through their hats—by using the Army Signal Corps' new combat helmet radio.

Allowing for two-way conversations, the new radio is similar to its big brother, the famed walkie-talkie. Individual riflemen thus have walkie-talkie communications for the first time with this radio developed by the Signal Corps Engineering Labs at Fort Monmouth, N. J.

The experimental helmet looks like a football player's headgear; the tiny radio weighs just one pound, using transistors instead of vacuum tubes. Pre-set for short-range conversations among squad members, the radio is thus designed to prevent enemy inter-



—Official U. S. Army Photo

These two small units make up the tiny two-way Army combat radio; they contain ear-phone, switches and batteries, plus the radio's "guts."

ception of messages at the front lines. By attaching an auxiliary antenna, however, the range can be quickly increased to long distances.

Able to "net in" with standard Army radios, this combat FM set can reach radios up to a mile away and pulls in powerful stations even farther removed.

### Auto Research Aided By Television Camera

For quick answers in automobile test work, a small, bomb-shaped television camera gives engineers a picture of what goes on underneath a car when it's cornering sharply or bouncing over a rough test road.

Motion picture cameras and film are slower and less flexible than live TV on a closed circuit which is transmitted to a 14-in. monitoring screen in the test car's rear. Camera is attached to proper position for observation, and an en-



Bomb-shaped TV camera is on front of car, under bumper, for quick engineering observation in auto research.

gineer-observer sits in the back seat to watch the remote action.

Said to be used for the first time in automotive research, the system was developed at General Motors' Technical Center in cooperation with the TV camera maker, General Precision Lab., Pleasantville, N. Y.

### N. Y. Times Offers "Fax" Edition to GOP

Edited and made up in New York, and printed in San Francisco at 4 a.m. the same morning, facsimile copies of the New York Times International Edition were made available daily to delegates

More News on page 15

now

**OHMITE®**

offers the ONLY  
complete line of  
**RESISTORS**  
to meet MIL-R-26C  
characteristics

**Y** HIGH TEMPERATURE  
350C CHARACTERISTIC  
HIGH INSULATION RESISTANCE

**V** HIGH TEMPERATURE  
350C CHARACTERISTIC

AND **G**

**TAB-  
TERMINAL  
TYPE**

Characteristics  
V and G

Style	Over-all		*Watts	††Watts
	Length	Diameter		
RW-29	1 3/4"	1/2"	8	11
RW-30	1"	19/32"	8	11
RW-31	1 1/2"	19/32"	10	14
RW-32	2"	19/32"	12	17
RW-33	3"	19/32"	18	26
RW-35	4"	29/32"	38	55
RW-36	4"	1-5/16"	54	78
RW-37	6"	1-5/16"	78	113
RW-38	8"	1-5/16"	110	159
RW-47	10 1/2"	1-5/16"	145	210

**TAB-  
TERMINAL  
TYPE**

Characteristic  
Y

Style	Over-all		†Watts
	Length	Diameter	
RW-30	1"	19/32"	11
RW-33	3"	19/32"	26
RW-37	6"	1-5/16"	113
RW-47	10 1/2"	1-5/16"	210

**FLAT TAB-  
TERMINAL  
TYPE**

(Stack Mounting)  
Characteristics  
V and G

Style	Over-all Length	Width and Thickness of Core	*Watts	††Watts
RW-21	3 1/4"	1-3/16"	22	31
RW-22	4 3/4"	x	37	53
RW-23	6"	1/4"	47	68
RW-24	7 1/4"		63	91

**AXIAL-  
TERMINAL  
TYPE**

Characteristics  
V and G

Style	Length of Core**		*Watts	††Watts
	Diameter			
RW-55	1 3/8"	15/32"	5	7
RW-56	2"	15/32"	10	14
RW-57	1"	5/16"	5	6.5
RW-58	1 7/8"	11/32"	8	11
RW-59	1/2"	3/16"	2.5	3

\*Watts free air MIL Characteristic "G."  
†Watts free air MIL Characteristic "Y."  
††Watts free air MIL Characteristic "V."  
\*\*1-1/2" wire leads.

Even including resistors  
wound with the finest  
wire size (.00175)

The Ohmite resistor types shown in the table above can withstand a continuous operating temperature of 350C—the high temperature requirement of MIL-R-26C, Char. "V." These resistors also meet Characteristic "G." The new Char. "Y" combines all requirements of Char. "V" and "G" plus extremely high insulation resistance at the end of the moisture-resistance test. Under all three Char., "V," "Y," and "G," Ohmite resistors have to satisfy severe moisture-resistance tests, thermal shock tests, vibration tests, and many others. The Ohmite line of wire-wound resistors is the most extensive available in the industry.

ALL  
CHARACTERISTICS  
\*  
ALL SIZES  
\*  
ALL RESISTANCE  
VALUES

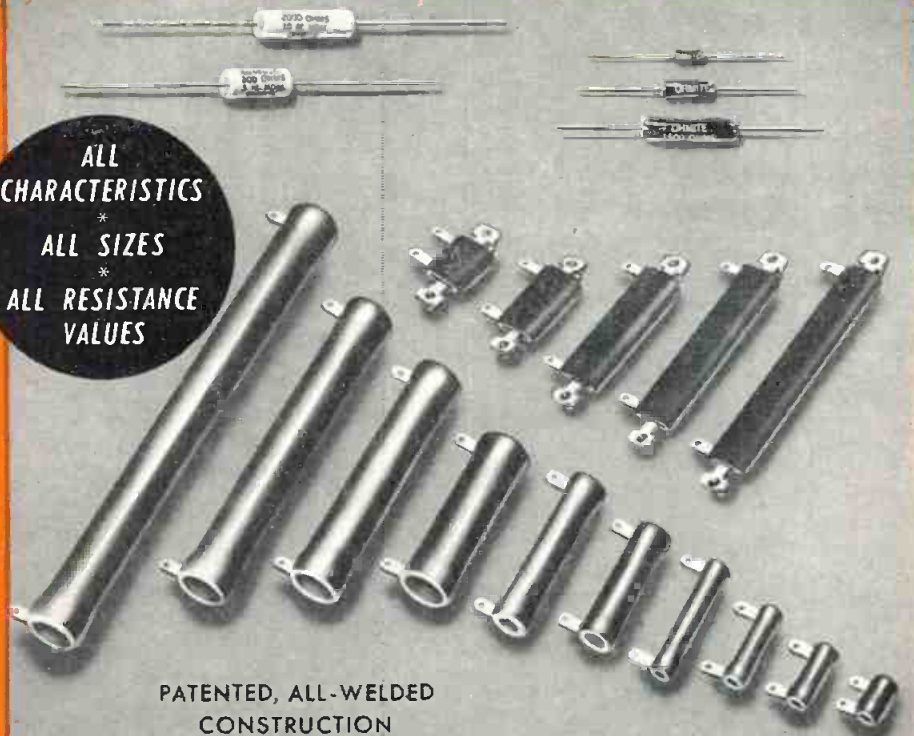

PATENTED, ALL-WELDED  
CONSTRUCTION

Be Right with **OHMITE®**

RHEOSTATS  
RESISTORS  
RELAYS  
TAP SWITCHES  
TANTALUM CAPACITORS

OHMITE MANUFACTURING COMPANY, 3662 Howard Street, Skokie, Illinois



# As We Go To Press

(Continued)

and visitors during the Republican National Convention the week of Aug. 20.

An experimental venture, the 10-page special Convention edition was made possible by high-speed fax transmission over a portion of TV circuit provided by the American Telephone and Telegraph Company's Long Lines Dept. Copies, carrying no advertising, were printed in San Francisco for distribution at hotel rooms by 6 o'clock each morning.

The facsimile equipment is a specially - developed high - speed, large-sized version of the equipment used for sending wirephotos and radiophotos. As each page of the regular Times International Edition was set in type at the West 43rd St. composing room, it was rushed to the Times Facsimile Corp. transmitter on West 58th St. Two sending drums each the size of a newspaper page transmitted the copy to a pair of receiving drums in San Francisco.

The West Coast drums, duplicates of the sending drums in New York, were connected with AT & T's long lines office. It took four minutes to transmit each two-page series across the U. S.

Work on this project started in the Summer of 1955 between AT & T and the Times' Facsimile unit. Details were completed in June of this year.

*Electronic Industries Sidelights—*  
**Maritime Administrator Clarence G. Morse** said in Washington recently that the U. S. hopes to have the world's first atomic-powered merchant ship in service before 1960. It was said that the vessel will be "other than a tanker"—possibly a passenger-and-cargo or a dry cargo ship. . . . **Three out of four American households** had TV in February-March, 1956, as against two out of three in June, 1955, says the Advertising Research Foundation; the Census Bureau reported 73 per cent of all American homes had TV sets in February, 1956, com-

# Coming Events

**A listing of meetings, conferences, shows, etc., occurring during the period September to November, 1956, that are of special interest to electronic engineers**

Sept. 10-12: Inf. Theory Symposium, sponsored by IRE-PGIT and M.I.T.; at Cambridge, Mass.

Sept. 11-12: Second RETMA Conference on Reliable Electrical Connections, at Irvine Auditorium, University of Penna., Philadelphia.

Sept. 12-14: Third National Conference on Tube Techniques, sponsored by the Working Group on Tube Techniques of the Advisory Group on Electron Tubes; at Western Union Audit., 60 Hudson St., New York.

Sept. 14-15: Prof. Gp. on Broadcast Transmission Sys., 6th Ann. Fall Symposium; tech. sessions at Mellon Institute Auditorium, Pittsburgh, Pa.

Sept. 14-15: Conf. on Communications, Cedar Rapids Section, IRE, sponsor; at Roosevelt Hotel, Cedar Rapids, Ia.

Sept. 17-18: Adv. Gp. on Electron Tubes, Working Gp. on Semiconductor Devices—Transistor Reliability Symposium; at Western Union Audit., 60 Hudson St., New York.

Sept. 17-21: Symposium on radiation effects on materials, sponsored jointly by The Atomic Industrial Forum and ASTM; at ASTM Pacific Area National Meeting, Los Angeles.

Sept. 17-21: 11th Annual Instrument-Automation Conference and Exhibit, sponsored by the ISA, at the New York Coliseum, New York.

Sept. 27-30: New York High Fidelity Show, sponsored by Inst. of High Fidelity Mfrs.; at New York Trade Show Bldg., 36th St. and 8th Ave., New York.

Oct. 1-3: 12th Annual Conference of the NEC; at the Hotel Sherman, Chicago.

Oct. 1-3: Canadian IRE Convention and Exposition; in the Automotive

Bldg., Canadian Natl. Exhibitn. Park, Toronto.

Oct. 8-9: Second National Symposium on Aeronautical Communications, sponsored by the IRE Prof. Gp. on Communications Systems; at the Hotel Utica, Utica, N. Y.

Oct. 9-10: Conference on Computer Applications, sponsored by Armour Research Foundation of Illinois Institute of Technology, Chicago.

Oct. 15-17: Radio Fall Meeting, sponsored jointly by the IRE and RETMA, at the Hotel Syracuse, Syracuse, N. Y.

Oct. 16-18: Conference on Magnetism and Magnetic Materials, sponsored by the Magnetics Subcommittee of the Basic Science Committee of AIEE, at the Hotel Statler, Boston.

Oct. 25-26: 2nd Annual Tech. Mtg. of IRE Prof. Gp. on Electron Devices; at Shoreham Hotel, Washington.

Oct. 25-26: Annual Display of Aircraft Electrical Equipment, by the Aircraft Electrical Society, at Pan-Pacific Auditorium, Los Angeles.

Oct. 29-30: Third Annual East Coast Conference on Aeronautical and Navigational Electronics, sponsored jointly by the Baltimore Section of IRE and the IRE Prof. Gp. on Aeronautical and Navigational Electronics; at the Fifth Regiment Armory, Baltimore.

Oct. 31-Nov. 2: 20th Anniv. Nat'l Time & Motion Study & Management Clinic, sponsored by Industrial Management Society; at the Sherman Hotel, Chicago.

Nov. 8-9: Ann. Tech. Conf., Kansas City, Kans.. IRE Section; at Town House Hotel, Kansas City, Kans.

#### Abbreviations:

ASTM: American Society for Testing Materials  
AIEE: American Institute of Electrical Engineers

IRE: Institute of Radio Engineers  
ISA: Instrument Society of America

RETMA: Radio-Electronics-TV Manufacturers

pared with 67 per cent in June a year ago—and 12 per cent in 1950. . . . Curtiss-Wright plans to spend an additional \$50,000,000 (in addition to \$20,000,000 spent in the past year) in expanding its research and development center near Clearfield, Pa.; the 106,000-acre facility is used for flight testing and experimentation with jet aircraft engines. . . . A combina-

tion helicopter and plane, jet-powered, has been patented by Isidor B. Laskowitz, head of Laskowitz Helicopter Co., Brooklyn, N. Y. Patent No. 2,756,007, issued in Washington, lists several features, including long overhead (rotor) blades and wings, plus a pair of steering jets that can be opened separately by the pilot with his feet to turn right or left. . . .

# Dual Directional Couplers for reflectometer measurements on coaxial systems



## 4 all-new couplers!

**Complete coverage,  
216 to 4,000 MC**

**Ideal for power measurements**

**Flat response, high directivity**

**Low SWR, wide band  
performance**

These new *hp*-couplers save your time by making possible, for the first time, convenient reflectometer measurements on coaxial antennas, transceivers, counter-measures and TV equipment, etc. Each unit centers on a major band but offers 2:1 frequency coverage. Directivity is high, units handle powers to 50 watts cw, and insertion loss is low for permanent installation. The couplers can be used to measure forward or reverse power or to adjust system flatness.

*hp*-760 series couplers are compact, sturdy, and precision built of highly heat stable materials for long-term accuracy.

### SPECIFICATIONS

	-hp- 764D	-hp- 765D	-hp- 766D	-hp- 767D
Frequency Range:	216 to 450 MC	450 to 940 MC	940 to 1,900 MC	1,900 to 4,000 MC
Coupling Attenuation:	20 db	20 db	20 db	20 db
Coupling Accuracy:	$\pm 1$ db	$\pm 1$ db	$\pm 1$ db	$\pm 1$ db
Max. Prim. Line SWR:	1.10	1.15	1.20	1.25
Max. Second. Line SWR:	1.10	1.20	1.30	1.35
Minimum Directivity:	30 db	30 db	26 db	26 db
Prim. Line. Insert. Loss:	Approx. 0.15 db	Approx. 0.20 db	Approx. 0.25 db	Approx. 0.35 db
Price:	\$125.00	\$125.00	\$125.00	\$125.00

All models: Power handling capacity 50 watts CW or 10 Kw peak. Primary Line Connectors: Type N, Male & Female. Secondary Line Connectors: Type N, Female. Reflectometer Detectors: 764D/765D take *hp*-476A; 766D/767D take *hp*-420B. Size all units: 9" long; weight 2 lbs. Prices f.a.b. factory. Data subject to change without notice.

**HEWLETT-PACKARD COMPANY**  
3634T PAGE MILL ROAD • PALO ALTO, CALIFORNIA, U.S.A.  
Sales engineers in all principal areas  
Cable "HEWPACK" • DAVenport 5-4451



**highest quality, value, complete coverage**

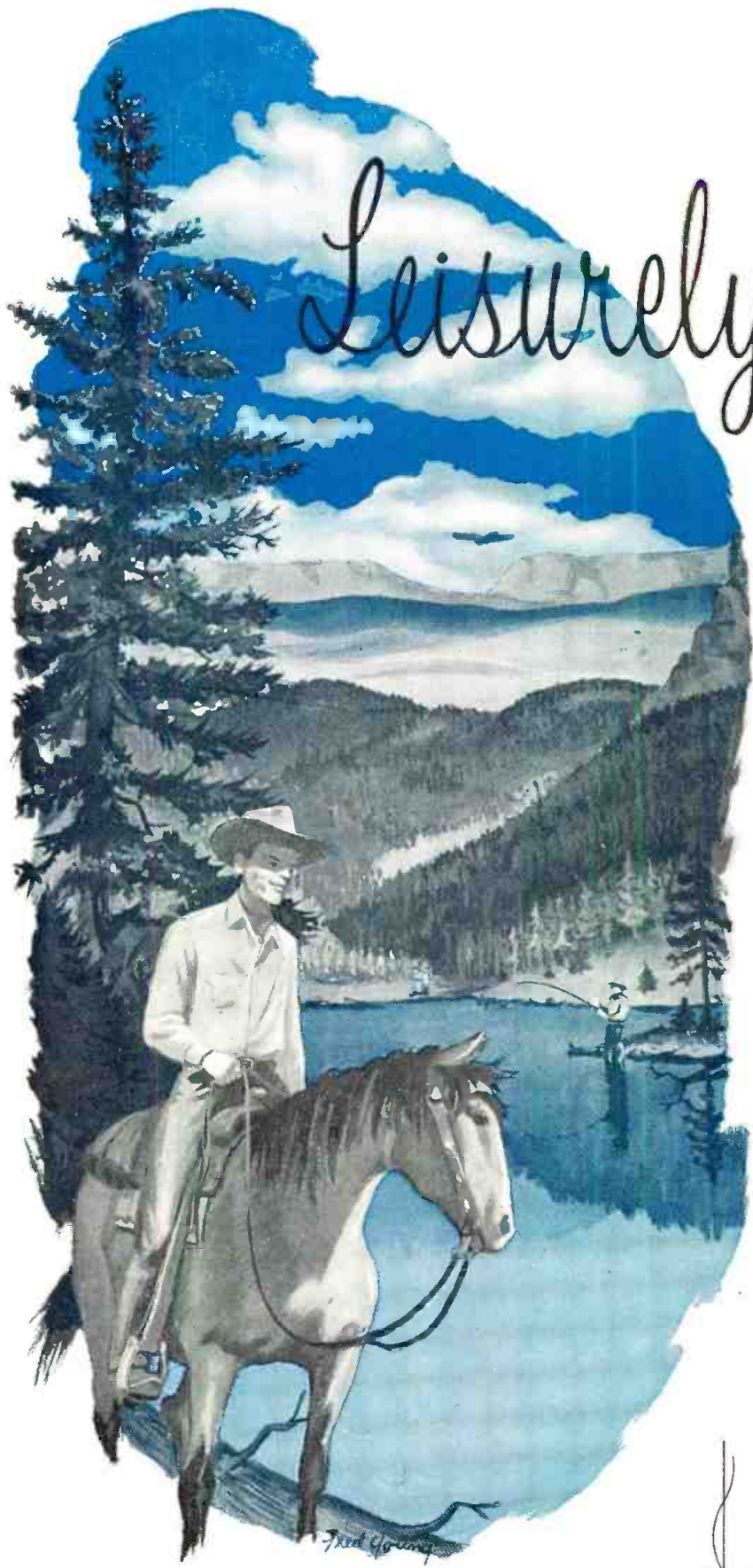

Los Alamos Scientific Laboratory is located in a delightful small city, high in the pine forests of northern New Mexico. It is a city of

# Leisurely living...

## and Career Opportunities in Engineering

The Laboratory has immediate openings for:

### MECHANICAL ENGINEERS

Challenging problems in the design of weapon components, their fabrication and testing; design, control, and testing of reactors; support of programs in nuclear physics research including an intriguing variety of work in controls, machine design, gaging.

### CHEMICAL ENGINEERS

Development and research in formulation and fabrication of new materials; design and preliminary manufacture of weapon components for systems testing; studies in fluid flow and heat transfer, particularly in systems at high temperatures and pressures, recovery and purification of radioactive materials by remote control processes.

### ELECTRICAL AND ELECTRONICS ENGINEERS

Creative development of instrumentation for recording the history of events which occur in times as short as milli-microseconds; a wide variety of instrumentation including scintillation counters, fast pulse amplifiers, fast oscilloscopes.

### CHEMISTRY AND METALLURGY

Work in these fields includes high temperature thermodynamics, properties of rare metals, development of high temperature fuels and structural materials for nuclear reactors, radiochemistry, radiation chemistry, uranium and plutonium metallurgy and chemistry, complex ion chemistry, microanalysis, isotopic analysis.

If you feel you are an above-average candidate, if you want to join the scientists at Los Alamos working at the very frontiers of their field, write:

*Director of Scientific Personnel  
Division 1205*

los  alamos  
scientific laboratory

OF THE UNIVERSITY OF CALIFORNIA

LOS ALAMOS, NEW MEXICO

*Los Alamos Scientific Laboratory is operated by the University of California for the U. S. Atomic Energy Commission.*

# Truscon's on top of the world at Thule

When engineers built the mighty Thule Air Base near the Polar Icecap, they discovered that interference from the aurora borealis and other arctic phenomena played havoc with radio communications. To solve this problem, they literally went over the disturbance by erecting a gigantic 1260-foot Truscon® Guyed Tower.

Today, as an integral part of our vital defense communication system, messages from this tower are relayed around the world in 32 seconds.

Truscon can build a tower for you, whatever your requirements. Our modern and efficient manufacturing facilities, plus our experienced staff of engineers, have designed towers of every type . . . guyed or self-supporting . . . tapered or uniform in cross section . . . for AM, FM, TV and Microwave transmission.

And regardless of the forces exerted upon them, including winds of hurricane velocity, they stay in the air to keep you on the air year in and year out.

For dependable performance, you can't top a Truscon Tower. If you have a tower problem, we will be glad to discuss it with you. Simply write or call your Truscon District Office or "tower headquarters" in Youngstown.



Long elevator ride takes men up to within 24 feet of top. They mount ladder for final ascent.



**TRUSCON STEEL DIVISION  
REPUBLIC STEEL**

1092 ALBERT STREET  
YOUNGSTOWN 1, OHIO



**A NAME YOU CAN BUILD ON**

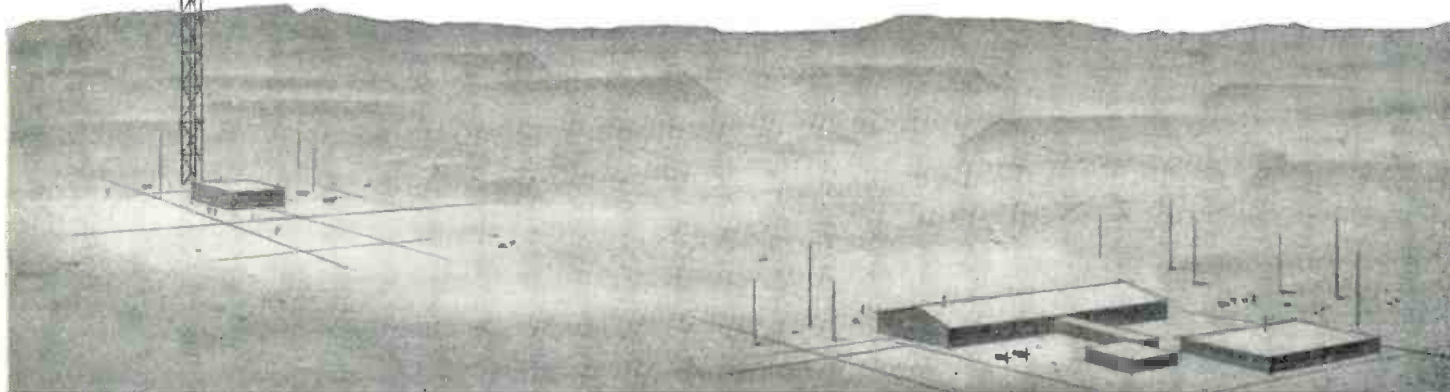



**NEW**

# Variable Air Capacitors

## Very Low Losses

## Low Residual Inductance and Resistance

## High Mechanical and Thermal Stability

- ★ **LOW DIELECTRIC LOSSES:** with grounded rotor, losses correspond to a  $D_0C_0$  product of less than  $.01 \times 10^{-12}$ ; rotor-to-ground capacitance has a similar loss of  $0.1 \times 10^{-12}$ , which is in parallel with the main capacitance only for grounded-stator connection
- ★ **HIGH INSULATION RESISTANCE:** greater than  $10^{11}$  ohms
- ★ **LOW TEMPERATURE COEFFICIENT OF CAPACITANCE:** approximately  $+.003\%$  per deg. C
- ★ **LOW INDUCTANCE:** approximately  $0.006 \mu h$
- ★ **EXCELLENT LINEARITY:** variation of capacitance with angle of rotation guaranteed linear within  $\pm 0.2\%$  of full scale. Angular range of variation is  $160^\circ$ . Typical linearity better than  $\pm 0.1\%$
- ★ **PASSES MIL-T-945-A TESTS** for shock and vibration
- ★ **LOW GROUNDED CAPACITANCE:** rotor-to-ground is about  $2 \mu \mu f$  and stator-to-ground about  $6 \mu \mu f$  for all sizes
- ★ **VERY COMPACT:** Maximum diameter of all is  $1\frac{1}{8}$  inches. Depth behind panel:  $1\frac{1}{4}$ ,  $2\frac{1}{8}$  and  $2\frac{3}{8}$  inches

These new Type 1420 Capacitors were developed especially for use in high-quality laboratory instruments and in other circuits where a precision-type, low-cost capacitor is required. New manufacturing techniques—unique mechanical and electrical construction—now result in a remarkably good condenser at a very reasonable price.

Type	Nominal Max. $\mu \mu f$	Min. $\mu \mu f$	Range for Linear Variation	Price
1420-F	70	13	$54 \pm 5 \mu \mu f$	\$20.00
1420-G	130	14	$108 \pm 5 \mu \mu f$	21.50
1420-H	250	16	$216 \pm 5 \mu \mu f$	22.50

Write for Complete Data

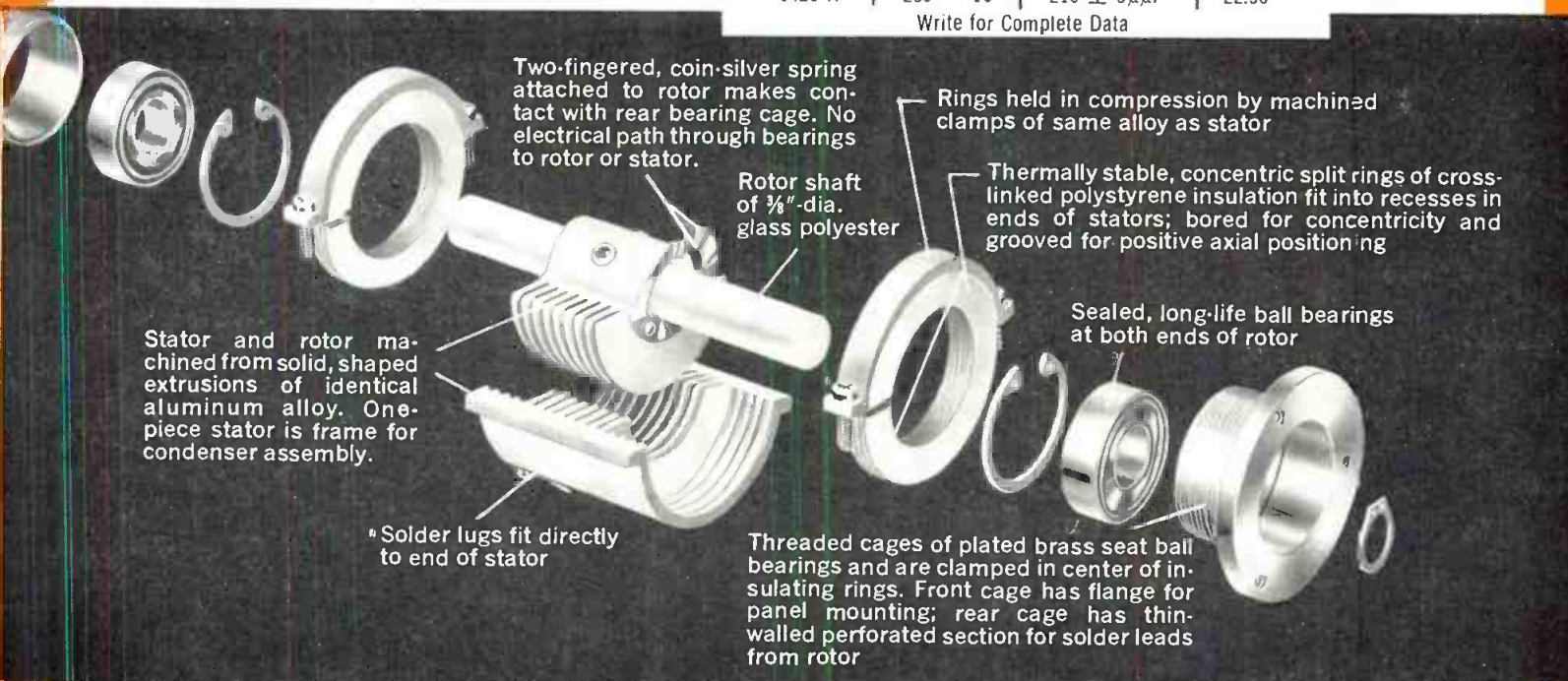

Two-fingered, coin-silver spring attached to rotor makes contact with rear bearing cage. No electrical path through bearings to rotor or stator.

Rings held in compression by machined clamps of same alloy as stator

Rotor shaft of  $\frac{3}{8}$ "-dia. glass polyester

Thermally stable, concentric split rings of cross-linked polystyrene insulation fit into recesses in ends of stators; bored for concentricity and grooved for positive axial positioning

Stator and rotor machined from solid, shaped extrusions of identical aluminum alloy. One-piece stator is frame for condenser assembly.

Sealed, long-life ball bearings at both ends of rotor

\* Solder lugs fit directly to end of stator

Threaded cages of plated brass seat ball bearings and are clamped in center of insulating rings. Front cage has flange for panel mounting; rear cage has thin-walled perforated section for solder leads from rotor

## GENERAL RADIO Company

275 Massachusetts Avenue, Cambridge 39, Massachusetts, U.S.A.



**WE SELL DIRECT**  
Prices are net, FOB Cambridge or West Concord, Mass.

90 West Street NEW YORK 6

8055 13th St., Silver Spring, Md. WASHINGTON, D. C.

1150 York Road, Abington, Pa. PHILADELPHIA

920 S. Michigan Ave. CHICAGO 5

1000 N. Seward St. LOS ANGELES 38

# the majority use T/I transistors!

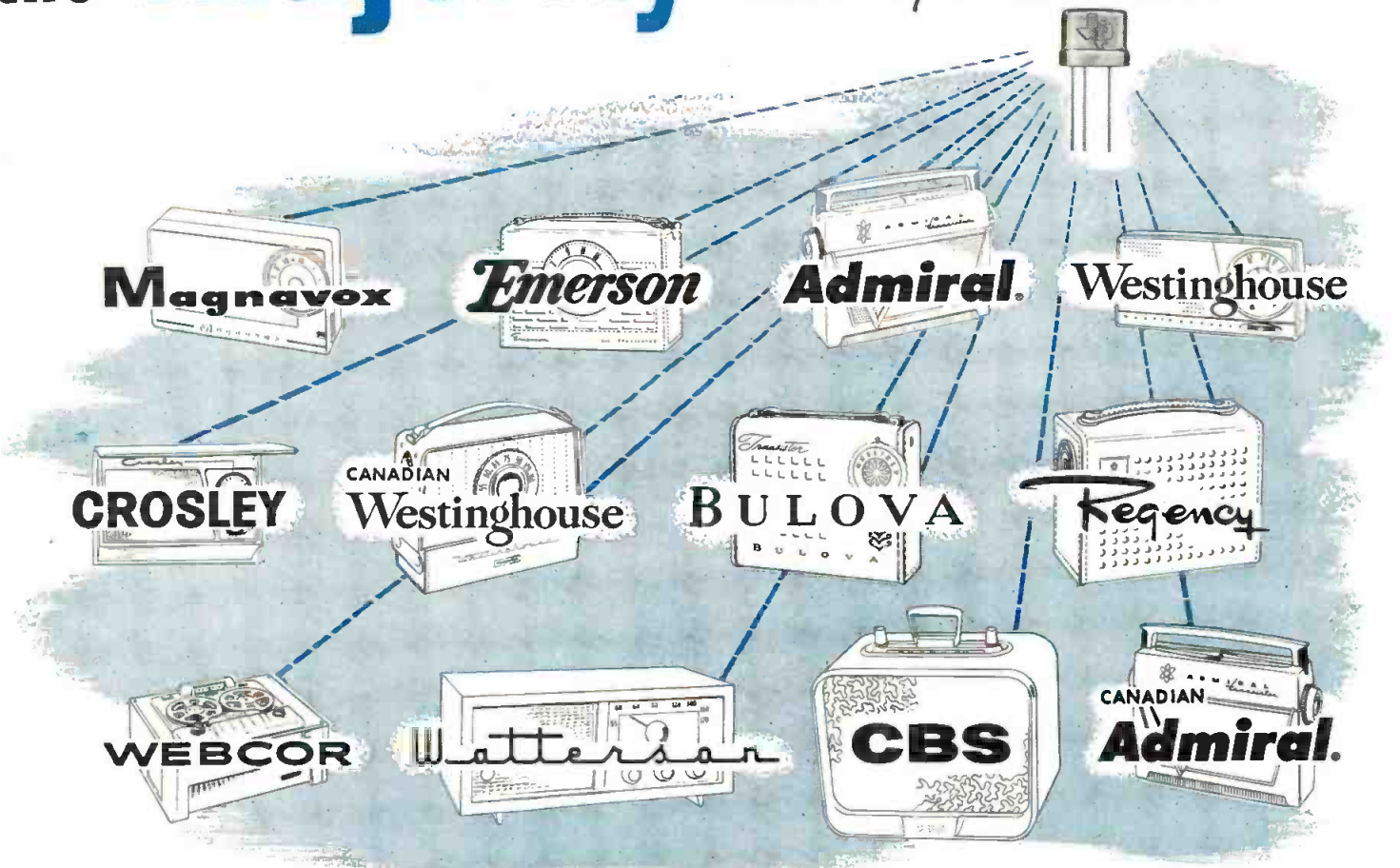

The overwhelming majority of transistorized radios — including these and other brands — use Texas Instruments transistors. This is simple proof of TI's leadership in research, development, and manufacture of transistors.

The constantly growing line of economical TI transistors — high in gain, frequency, power, and reliability — offers your transistorization program increasing design freedom and flexibility.

**ALL THESE UNITS ARE IN PRODUCTION AND IMMEDIATELY AVAILABLE!**

**VHF GERMANIUM TETRODE** — Maximum oscillation frequency above 250 mc; typical amplifier gain, 12 db at 100 mc. A "grown-diffused" product!

**GERMANIUM POWER TRANSISTOR** — For Class A and B amplifiers; low distortion, linear beta, high current capacity.

**GERMANIUM HF TRANSISTOR** — Converter in 455 kc commercial receivers; conversion gain, 22 db minimum at 1800 kc input.

**GERMANIUM AUDIO OUTPUT TRANSISTOR** — Designed for driver and Class B audio applications; low distortion, linear beta.

**GERMANIUM IF AMPLIFIER TRANSISTORS** — High gain in common emitter applications. In 262 kc and 455 kc types; all with fixed value of neutralizing impedance.

**GENERAL PURPOSE GERMANIUM TRANSISTORS** — Three types for general application; featuring narrow beta spread.

**LOOK TO TI FOR:** GERMANIUM VHF, POWER, RADIO, AND GENERAL PURPOSE TRANSISTORS  
SILICON HF, POWER, AND SMALL SIGNAL TRANSISTORS • SILICON DIODES AND RECTIFIERS

**pioneer producer  
of  
radio transistors!**



**TEXAS INSTRUMENTS  
INCORPORATED**  
6000 LEMMON AVENUE DALLAS 9, TEXAS

**NOW... custom designs  
available in volume!**

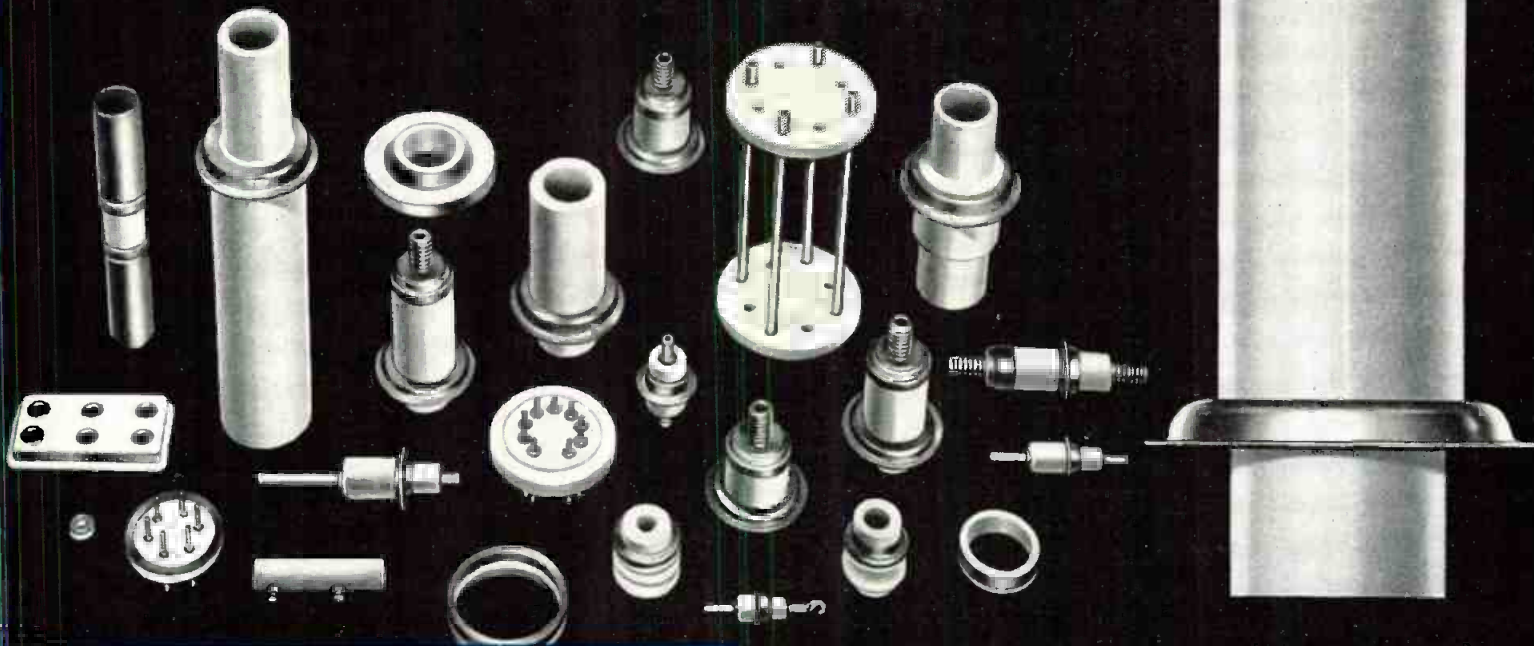

**ALSiMAG<sup>®</sup>**  
**HIGH TEMPERATURE  
METAL-CERAMIC SEALS**

Outstanding results over wider temperature/frequency ranges. Available for silver solder brazing, hard or soft solder. Rapid, volume delivery of both custom and standard designs from greatly expanded production facilities.

Dependable, permanent bonding . . . close dimensional tolerances . . . strong Alumina

ceramics with extremely low dielectric loss . . . excellent insulation resistance . . . high softening temperature . . . outstanding mechanical and electrical characteristics over entire temperature range . . . improved glaze with superior surface resistivity . . . high tensile and impact strengths . . . greater resistance to chipping and spalling.

To assure optimum performance, American Lava engineers cooperate in establishing proper specifications and configurations on custom designs.

For complete information on ALSiMag Metal-Ceramic Seals for your application—in either high or low temperature fields—send blueprint with your planned installation and operating temperatures, electrical requirements or other pertinent data.

A Subsidiary of  
Minnesota Mining and  
Manufacturing Company



**AMERICAN LAVA  
CORPORATION**

**CHATTANOOGA 5, TENN.**  
55TH YEAR OF CERAMIC LEADERSHIP

For service, contact Minnesota Mining & Manufacturing Co. Offices in these cities (see your local telephone directory): Atlanta, Ga. • Boston: Newton Center, Mass. • Buffalo, N. Y. • Chicago, Ill. • Cincinnati, O. • Cleveland, O. • Dallas, Texas • Detroit, Mich. • High Point, N. C. • Los Angeles, Calif. • New York: Ridgefield, N. J. • Philadelphia, Pa. • Pittsburgh, Pa. • St. Louis, Mo. • St. Paul, Minn. • So. San Francisco, Calif. • Seattle, Wash. Canada: Minnesota Mining & Manufacturing of Canada, Ltd., P. O. Box 757, London, Ont. All other export: Minnesota Mining & Manufacturing Co., International Division, 99 Park Ave., New York, N. Y.

SUBMINIATURE TRIMMING  
POTENTIOMETERS FOR THE  
**HOT SPOTS**  
IN YOUR ASSEMBLIES



**BOURNS** Model 160  
**TRIMPOT**<sup>®</sup>  
—new high temperature,  
high power design

This instrument operates reliably in high ambient temperatures, or wherever closely massed components generate localized hot spots. The TRIMPOT will withstand temperatures up to 175° C. (347° F.) with unimpaired efficiency. Lead wires are Teflon insulated. High power dissipation—0.6 watt at 50° C. (122° F.)

You'll find every outstanding feature of the original Model 120 TRIMPOT—standard of the industry—built into the Model 160. 25-turn adjustments are made with a screwdriver on the slotted shaft. The shaft is self-locking, to provide stable settings. Resistance element is precision wound with low temperature-coefficient resistance wire. Unit withstands severe shock, vibration and acceleration. To assure its dependable performance under extreme environmental conditions, Bourns designed the Model 160 TRIMPOT to meet or exceed rigid government specifications.

*Write for new descriptive literature.*

**B** **BOURNS LABORATORIES**

General Offices: 6135 Magnolia Avenue Riverside, California  
Plants: Riverside, California—Ames, Iowa

COPR. BL

**TELE-TIPS**

**ELECTRONIC FASHION NOTE.** In the fashion news out of New York last month we spotted an eye-catching picture of a fair young miss wearing a 6BA6-size vacuum tube as an earring. We can't help but wonder what would happen if the fad caught on and our womenfolk went on to apply the same subtle touch to vacuum tubes that they have applied to perfume. For instance, if the damsel's date with her favorite TV design engineer called for an intimate gathering at the neighborhood nite spot she might wear a 6BE6 (mixer-local oscu—pardon, oscillator). And for those evenings when she was open to advances, but only from the right parties, she might find appropriate a 6AL5 (discriminator). For an evening of dancing what would be more chic than a 6SN7 (vertical oscillator)—but she would have to be very careful here that her intentions were not misunderstood—and she would have to be doubly careful about the date code!! (Of course, what every good little engineer would be looking for would be a combination 6AL5-6SN7-6BQ6, but as G. Gobel would say, "You can't hardly find none of them no more.")

**EIGHT SAFARIS** to Africa big game country are the grand prizes in Admiral Corporation's \$250,000 contest for distributors and principal sales personnel, which ends September 27. The three week, 18,000 mile African trip will go to the top personnel salesmen in the company's distributor and branch organization. In keeping with the spirit, Admiral has established 8 sales districts named after African areas, including Congo, Somaliland, Kenya, Zanzibar, and Uganda.

**PATTERN FOR SUCCESS** in large corporations requires that men move through the rank of foreman and be ready for middle management by the time they  
(Continued on page 24)





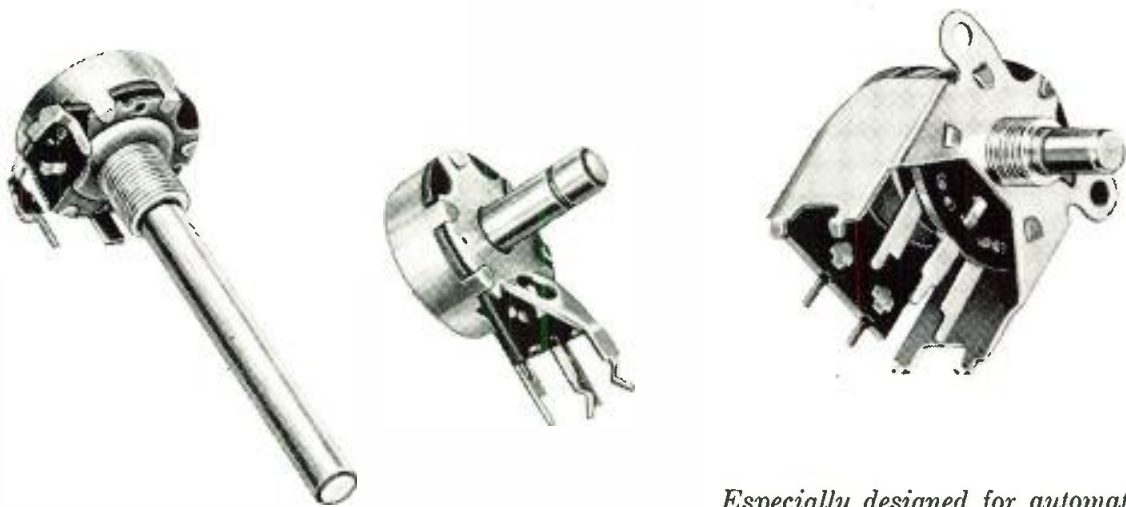

*Especially designed for automatic assembly methods, this line of Mallory controls provides superior performance on printed circuit applications.*

## New Mallory Controls for Printed Circuits

### ECONOMICAL STRIP TYPE CONTROLS FOR PRINTED CIRCUIT USE



This simplified series of controls, a Mallory "first", consist of resistance wafers attached directly to a phenolic panel, in single, dual and triple units. You save in installation cost, for multiple units can be mounted as easily as a conventional single. You save in component cost, too . . . for these Mallory controls give you multiple units at substantially lower price than that of a corresponding number of individual controls. Resistance values cover the range from 250 ohms to 10 megohms. Numerous adaptations available. Write to Mallory for technical data.

#### Serving Industry with These Products:

**Electromechanical**—Resistors • Switches • Tuning Devices • Vibrators  
**Electrochemical**—Capacitors • Rectifiers • Mercury Batteries  
**Metallurgical**—Contacts • Special Metals • Welding Materials

*Parts distributors in all major cities stock Mallory standard components for your convenience.*

**F**OR your printed circuit designs, plan to take advantage of the simplified assembly and extra performance values offered by this new series of Mallory carbon controls.

A variety of designs is available. Included are self-supporting snap-in models for top of panel mounting . . . threaded bushing models . . . and types for mounting directly on the circuit panel. All are built with mounting lugs and terminals, precision-positioned for foolproof, fast assembly by automatic production machines. All incorporate these Mallory features:

**High stability** resistance element, made by special Mallory process, minimizes drift under severe humidity and temperature variations . . . gives long life.

**Unusually low electrical noise.**

**New "floating ring" line switch**, using a unique contact action, can be supplied on the new controls . . . far outlasts ordinary switches, gives clean, sharp make and break.

A complete selection of resistance values and tapers is available to match your circuit requirements. For complete data, write or call Mallory today.

**Expect more . . . get more from**



# 4 NEW

## SUBMinax®

(shown actual size)



27-27



27-801



27-800



27-28

AMPHENOL now adds modified versions of the LT series of RF connectors to its large availability listing. Specifically designed for use with Teflon RG-117/U coaxial cable (also made by AMPHENOL), the LT series 82-116 plug and its matching 82-117 receptacle are made largely of aluminum to keep weight low and cadmium-plated for durability. Impedance is 50 ohms, maximum voltage rating is 5000 volts.

Write for data.



AMPHENOL ELECTRONICS CORPORATION  
 chicago 50, illinois  
 AMPHENOL CANADA LIMITED • toronto 9, ontario

# look to AMPHENOL for RF Connector PROGRESS

AMPHENOL's Subminax have provided the electronic industry for the first time with extremely reliable subminiature RF connectors. Where space and weight savings are important, but not at the expense of reliability, AMPHENOL Subminax are finding ever-increasing utilization. Now, four new 50 ohm connectors have been added: 27-27 hermetic seal receptacle, 27-801 cable termination, 27-800 printed circuit receptacle and 27-28 Subminax to BNC adapter. Write for data sheet, which includes a listing of all thirty available Subminax RF connectors.

# NEW LT SERIES

(shown one-half size)



82-116

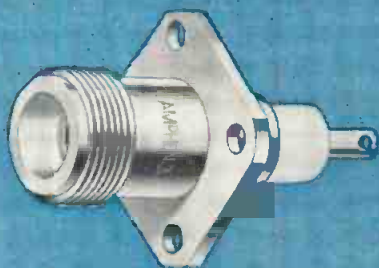

82-117



(Continued from page 22)

reach 35. Upward movement of this group must take place before 40, or at maximum, 45, according to a study being conducted at the University of Chicago.

**GERMAN TV ENGINEERS** devised a unique short cut to find the most favorable height for a planned TV antenna. They mounted a TV transmitter in a helicopter and let the whirly-bird slowly rise and descend till the best spot was found.

**NEW LOUDSPEAKER** that has no moving parts, no resonances, requires no power of audio frequencies and reportedly responds from .0 cycles to beyond audibility was demonstrated to a meeting of the Audio Engineers Society. Principles on which it operates consist of modulating the wind produced by Corona currents. The modulation is effected by a metal grid positioned between two sets of opposed needles and appears to operate in much the same manner as a triode vacuum tube. The inventor is a New Zealand born engineer. Dr. David M. Toomes. Tele-vex Company, New York, has exclusive American rights.

**HEAT DUCT AUDIO.** A new central entertainment system that sends sound into any room in the house through the warm air heating ducts is being marketed by Alsto Company, 4007 Detroit Avenue, Cleveland 13, Ohio. Key unit is especially developed speaker which is attached to the plenum or dome of any warm air heating system or to air-conditioner ducts. The manufacturer claims that volume stays constant through the house with tone rich and full.

**AUTOMATION WEEK** has been officially proclaimed by New York City for the week of November 26 to November 30. Key attraction is the third International Automation Exposition, to be held at the new Trade Show building, 500 Eighth Avenue.

## GUARANTEED CHARACTERISTICS

CHARACTERISTIC	CONDITION	VALUE
"ON"	$I_b = -3 \text{ ma}$ , $I_c = -2 \text{ ma}$ . $I_b = -2.5 \text{ ma}$ , $I_c = -8 \text{ ma}$ .	$V_{ce} = -0.07 \text{ V MAX.}$ $V_{ce} = -0.10 \text{ V MAX.}$
"OFF"	$V_{be} = -0.10 \text{ V}$ , $V_{ce} = -4.5 \text{ V}$	$I_c = -150 \mu\text{a MAX.}$
$h_{fe}$ (COMMON EMITTER CURRENT GAIN)	$V_c = -3 \text{ V}$ , $I_c = -5 \text{ ma}$ .	16 MIN.
$C_{ob}$ (COMMON BASE OUTPUT CAPACITY)	$V_c = -3 \text{ V}$ , $I_c = -5 \text{ ma}$ .	6 $\mu\text{f MAX.}$
$I_{cs}$ (COLLECTOR CUTOFF CURRENT)	$V_{cs} = -5 \text{ V}$	3 $\mu\text{a MAX.}$
$I_{es}$ (EMITTER CUTOFF CURRENT)	$V_{cs} = -5 \text{ V}$	3 $\mu\text{a MAX.}$

## MAXIMUM RATINGS

$V_{ce} = -6 \text{ V}$      $I_c = -15 \text{ ma}$      $P_c = 10 \text{ mw}$   
@ 40°C.

## PULSE RESPONSE

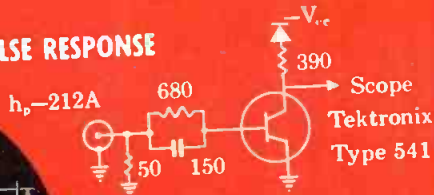

Test Conditions:  $V_{ce}$  is set to  $-6 \text{ V}$  and pulse input is adjusted until transistor is just in saturation.  $V_{ce}$  is then lowered to  $-1.5 \text{ V}$  for saturated pulse curve.  $t_s$  = hole storage time.



## COLLECTOR CHARACTERISTIC IN SATURATION REGION

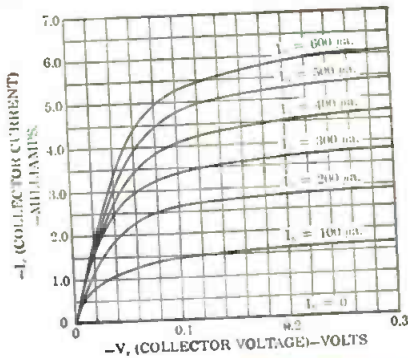

## INPUT CHARACTERISTIC

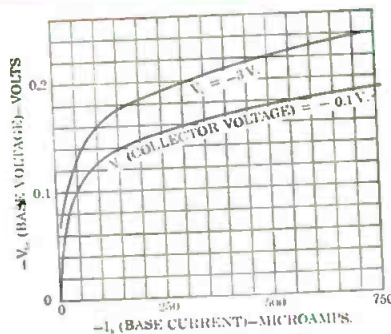

# PHILCO

## SBT\*2N240

## HIGH SPEED SWITCHING TRANSISTOR

with response time in millimicrosecond range

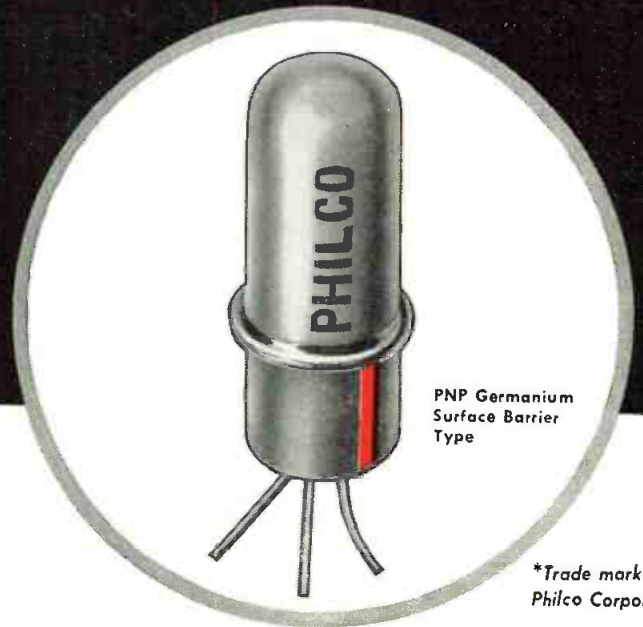

PNP Germanium Surface Barrier Type

\*Trade mark of Philco Corporation

## FEATURES

- Low saturation resistance
- Low saturation voltage
- Ideal electrical characteristics for direct coupled circuitry
- Extremely fast rise and fall time
- Absolute hermetic seal
- Available now in production quantities

Proven performance of the Philco Surface Barrier Transistor has made it the basis for design of both military and commercial computers where speed and reliability are the major considerations. And now this transistor goes even farther . . . by giving reliable performance in 20 megacycle switching circuits!

*Make Philco your prime source of information for high speed computer transistor applications.*

Write to Dept. TT, Lansdale Tube Company Division, Lansdale, Pa

# PHILCO CORPORATION

## LANSDALE TUBE COMPANY DIVISION

### LANSDALE, PENNSYLVANIA

# Direct Reading Spectrum Analyzer

- for**
- Visual frequency calibration — high resolution
  - Leakage and interference measurements
  - Standing wave measurements
  - Pulse modulation analysis
  - Sensitive receiver

## The **BASIC SCOPE** for **VISUAL** **MICROWAVE**

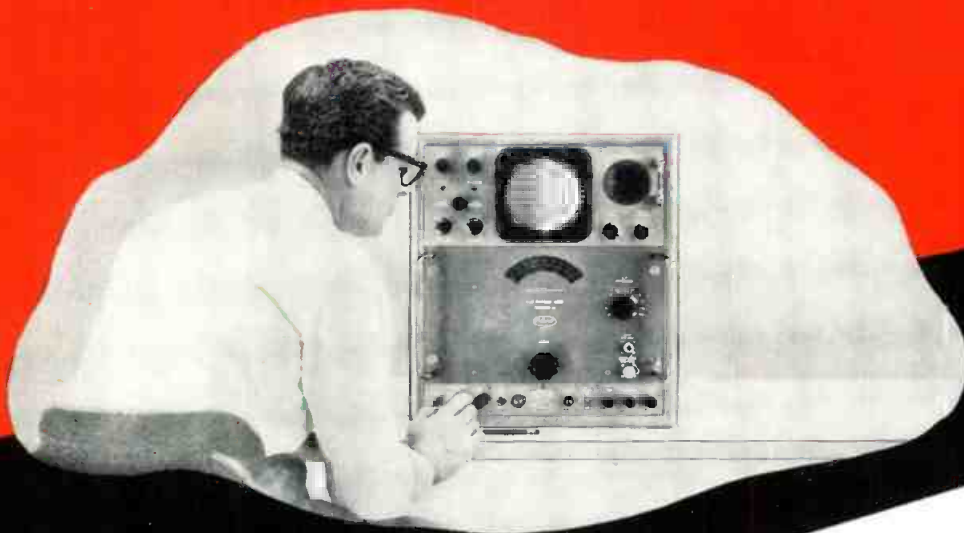

### SPECIFICATIONS

Model No.	Equipment
Model Du.....	Spectrum Display and Power Unit
Model STU-1...	RF Tuning Unit 10-1,000 mc.
Model STU-2A.	RF Tuning Unit 910-4, 560 mc.
Model STU-3A.	RF Tuning Unit 4,370-22,000 mc.
Model STU-4...	RF Tuning Unit 21,000-33,000 mc.
Model STU-5...	RF Tuning Unit 33,000-44,000 mc.
Frequency Range: 10 mc to 44,000 mc.	
Frequency Accuracy: $\pm 1\%$	
Resolution: 25 kc.	
Frequency Dispersion: Electronically controlled, continually adjustable from 400 kc to 25 mc per one screen diameter (horizontal expansion to 20 kc per inch)	

Frequency differences as small as 40 kc measurable by means of variable frequency marker with adjustable amplitude. Portable and completely self-contained.

Input Impedance: 50 ohms—nominal  
Overall Gain: 120 db  
Input Power: 400 Watts  
Sensitivity: (minimum discernible signal)  
STU-1: 10-400 mcs—89 dbm  
400-1,000 mcs—84 dbm  
STU-2A: 910-2,200 mcs—87 dbm  
1,980-4,560 mcs—77 dbm  
STU-3A: 4,370-10,920 mcs—75 dbm  
8,900-22,000 mcs—60 dbm  
STU-4: 21,000-33,000 mcs—55 dbm  
STU-5: 33,000-44,000 mcs—45 dbm  
Attenuation:  
RF internal 100 db continuously variable (STU-1, STU-2A, STU-3A)  
MF 60 db continuously variable

# Broadband 10-44,000 mc

Now, the Polarad Model TSA Spectrum Analyzer provides the same visual advantages for microwave testing as the standard oscilloscope accomplishes for low frequency signals. This is a "must" instrument for microwave work! It displays with high sensitivity on a bright easily defined CRT, pulse modulation components, frequency differences, attenuation and band width characteristics, leakage detection, radiation and interference signals, and VSWR information.

This is visual instrumentation—it provides immediate and complete information because of the high resolution obtainable.

Frequencies are read directly on the linear dial with 1% accuracy as the set is tuned. Maximum reliability and long life are assured through use of non-contacting oscillator plungers. A variable frequency marker with both frequency and amplitude adjustable is provided.

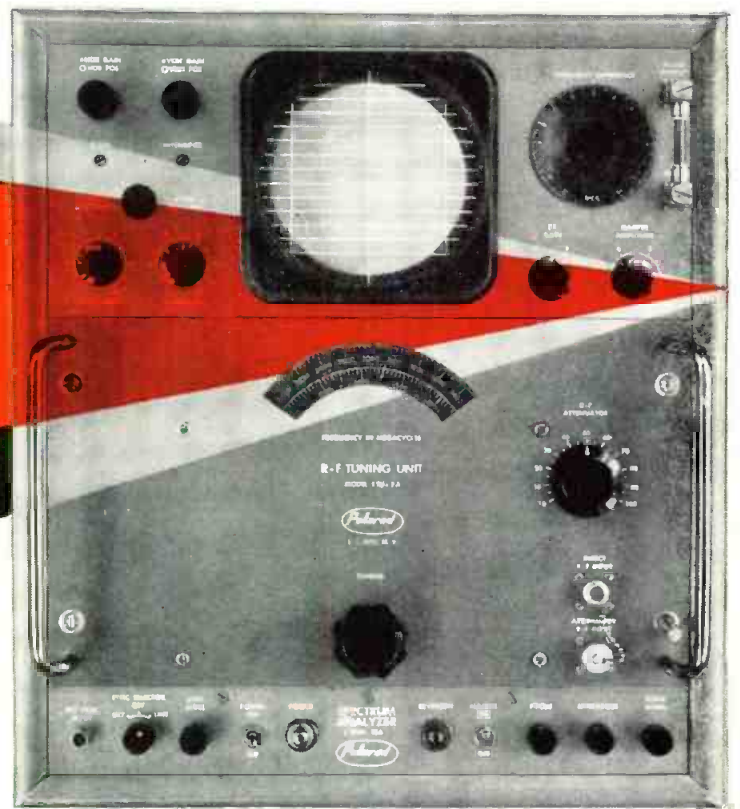

## ANALYSIS

Write today—directly to Polarad, or your nearest Polarad representative—to find out how the Model TSA Spectrum Analyzer can speed your research and solve your microwave measurement and testing problems.

Write for your copy of the Polarad "Handbook of Spectrum Analyzer Techniques". 50c per copy. Includes discussion of Spectrum Analyzer operation, applications and formulae for analysis techniques.

AVAILABLE ON EQUIPMENT LEASE PLAN

FIELD MAINTENANCE SERVICE AVAILABLE THROUGHOUT THE COUNTRY

Phone Polarad Collect for information regarding the Spectrum Analyzer, Model TSA. EXeter 2-4500



**ELECTRONICS CORPORATION**  
43-20 34th Street, Long Island City 1, N. Y.

REPRESENTATIVES: Albuquerque, Atlanta, Baltimore, Boston, Buffalo, Chicago, Cleveland, Dayton, Denver, Fort Worth, Kansas City, Los Angeles, New York, Philadelphia, Portland, St. Louis, San Francisco, Schenectady, Syracuse, Washington, D. C., Winston-Salem, Canada; Arnprior, Ontario. Resident Representatives in Principal Foreign Cities

Plan **NOW** to participate in Audio Devices

**\$16,000**

# educational awards

*72 awards totaling over \$16,000 worth of Sound Recording Equipment and tape or discs will be donated by Audio Devices, Inc.*

**H**ERE'S A once-in-a-lifetime opportunity for any high school or college that wishes to expand its recording facilities or to start a new sound recording program. First award, in *each* of two classifications, will be \$2,000 worth of tape or disc recording equipment, plus \$500 worth of tape and/or discs, plus a bonus of \$250 worth of tape or discs for Distributor endorsement of entry blank. These and 70 other valuable equipment and tape or disc awards will be donated by Audio Devices, Inc., to the schools which, in the opinion

of qualified judges, plan to make the most effective and beneficial use of the recording facilities offered. You can select your own recording equipment, as well as the types of Audiotape or Audiodiscs that best meet your requirements. There's nothing to buy — no strings attached.

For complete details and official entry blank, see your Audiotape Distributor . . . or write to Audio Devices, Inc., Educational Dept. T, 444 Madison Avenue, New York 22, N. Y.

## HERE'S THE BOOK YOU'VE BEEN WAITING FOR

how to make **good tape recordings**

### THE COMPLETE HANDBOOK OF TAPE RECORDING

by C. J. LeBel, Vice President, Audio Devices, Inc.

This completely new handbook of tape recording contains up-to-the-minute information of interest and real practical value to *every tape recordist*. Profusely illustrated with photographs, charts and diagrams prepared especially for this book, it contains 150 pages of valuable information on all phases of modern tape recording. The author, Mr. C. J. LeBel, is one of the country's foremost authorities on sound recording.

"How to Make Good Tape Recordings" can be

read and easily understood from cover to cover by even the most inexperienced of home recordists. Yet it contains such a wealth of practical information that it will be a valuable aid to professional tape recordists as well.

Available in deluxe cloth-bound edition at \$2.50, or economy paper-bound edition at \$1.50. Get a copy from your Audiotape distributor or send check or money order direct to Audio Devices, Inc., Dept. T-1, 444 Madison Avenue, New York 22, N. Y.



## **AUDIO DEVICES, Inc.**

444 MADISON AVENUE, NEW YORK 22, N. Y.

IN HOLLYWOOD: 1006 N. Fairfax Ave.

IN CHICAGO: 6571 N. Olmsted Ave.

Export Dept.: 13 East 40th St., New York 16, N.Y., Cables "ARLAB"

# Close-up of a diode

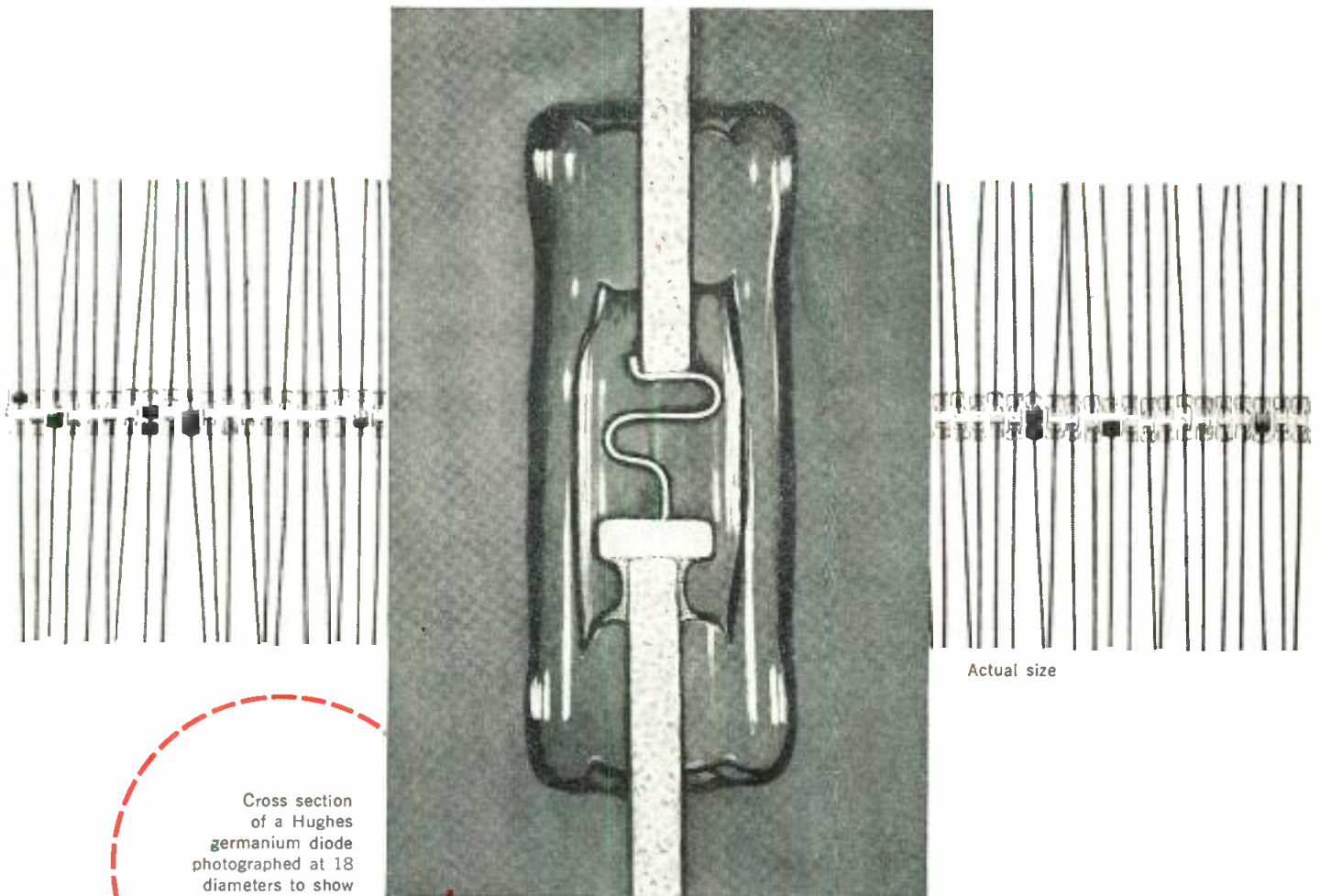

Cross section of a Hughes germanium diode photographed at 18 diameters to show structural detail.

Actual size

Inside, where it counts, a Hughes germanium diode is rigid, sturdy—well able to stand up under conditions of severe shock and vibration. With a microscope, you can see why clearly...the germanium crystal permanently bonded to one lead...the whisker firmly welded to the second lead...the point of the whisker welded to the crystal...the fusion-sealed glass envelope. Such positive mechanical stability (basic to every Hughes diode type) is vital to the achievement of electrical stability—and reliability. Hughes diodes are manufactured, first of all, for reliability. So specify Hughes, and be *sure* of successful application to your electronics and communications equipment.

For descriptive literature please write:

HUGHES PRODUCTS  
SEMICONDUCTORS  
International Airport Station  
Los Angeles 45, California

**HUGHES PRODUCTS**

A DIVISION OF THE HUGHES AIRCRAFT COMPANY

HUGHES



SEMICONDUCTORS

© 1956, H. A. C.



Send for the  
most widely used  
**Electronic  
Supply  
Guide**

*Free*  
ON REQUEST

## ALLIED'S 1957 356-PAGE CATALOG

*World's largest Stocks* OF

### ELECTRONIC SUPPLIES FOR INDUSTRY

Simplify and speed your purchasing of electronic supplies and equipment: send your orders to ALLIED—the reliable one-supply-source for *all* your electronic needs. We make fastest shipment from the world's largest stocks of electron tubes (all types and makes), transistors, test instruments, audio equipment, electronic parts (transformers, capacitors, controls, etc.), and accessories—*everything* for industrial and communications application, for research, development, maintenance and production. Our expert Industrial supply service saves you time, money and effort. Send today for your FREE copy of the 1957 ALLIED Catalog—your *complete* Buying Guide to the world's largest stocks of Electronic Supplies for Industrial and Broadcast use.

ultra-modern facilities for the  
fastest service in Electronic Supply

Our 36th Year



100 N. WESTERN AVE., DEPT. 18-J-6, CHICAGO 80, ILLINOIS

ONE COMPLETE DEPENDABLE  
SOURCE FOR EVERYTHING IN ELECTRONICS

**ALLIED RADIO**

Donald J. Hughes has been named advertising manager of the Electronic Products Sales Dept. of Sylvania Electric Prod., Inc. He was formerly advertising and sales promotion supervisor for electronic products.

Edward C. Wagner has been appointed Director for Marine Equipment of Ford Instrument Co., Div. of Sperry Rand Corp.

Dr. Robert R. Johnson has been named manager of digital-computer-engineering for the Industrial Computer Section, G.E. William O. Hoverman as manager of sales for GE's Semiconductor Prod. Dept.

Henry J. Morley was recently appointed Factory Manager of the Dover Plant of Clarostat Mfg. Co., Inc., Dover, N. H.

Robert S. Caruthers has joined the executive staff of International Telephone and Telegraph Corp. as director of telephone systems research and development.

Elise Harmon, Chief Research Printed Circuit Engineer with Aerovox Corp., is the recipient of the 1956 Society of Women Engineers' Award.

Oscar E. Holt has been appointed manager of the W. L. Maxson Corp. plant at Old Forge, Pa. He was formerly asst. plant manager and, prior to that, manager of R&D DIV., Electro-Mechanical Engr. Dept.

Harold W. Rice is now director of the West Coast R&D Lab of Robertshaw-Fulton Controls Co.

John Meck has been appointed director of technical product merchandising for the Martin Co., Advertising, Chicago.

Harry R. Wege has been named Manager, RCA Missile and Surface Radar Dept.

Richard Chamberlin is the manager of the newly-created Receiving Tube Dept., Eitel-McCullough, Inc., San Bruno, Calif.

William L. Dunn has been named Vice Pres. of Sales Engr. of the recently announced Government Electronics Div. at Emerson Radio and Phonograph Corp.

Howard Ostran has been appointed to the new position of factory superintendent of the semiconductor products plant of Bendix Aviation Corp. Red Bank div.



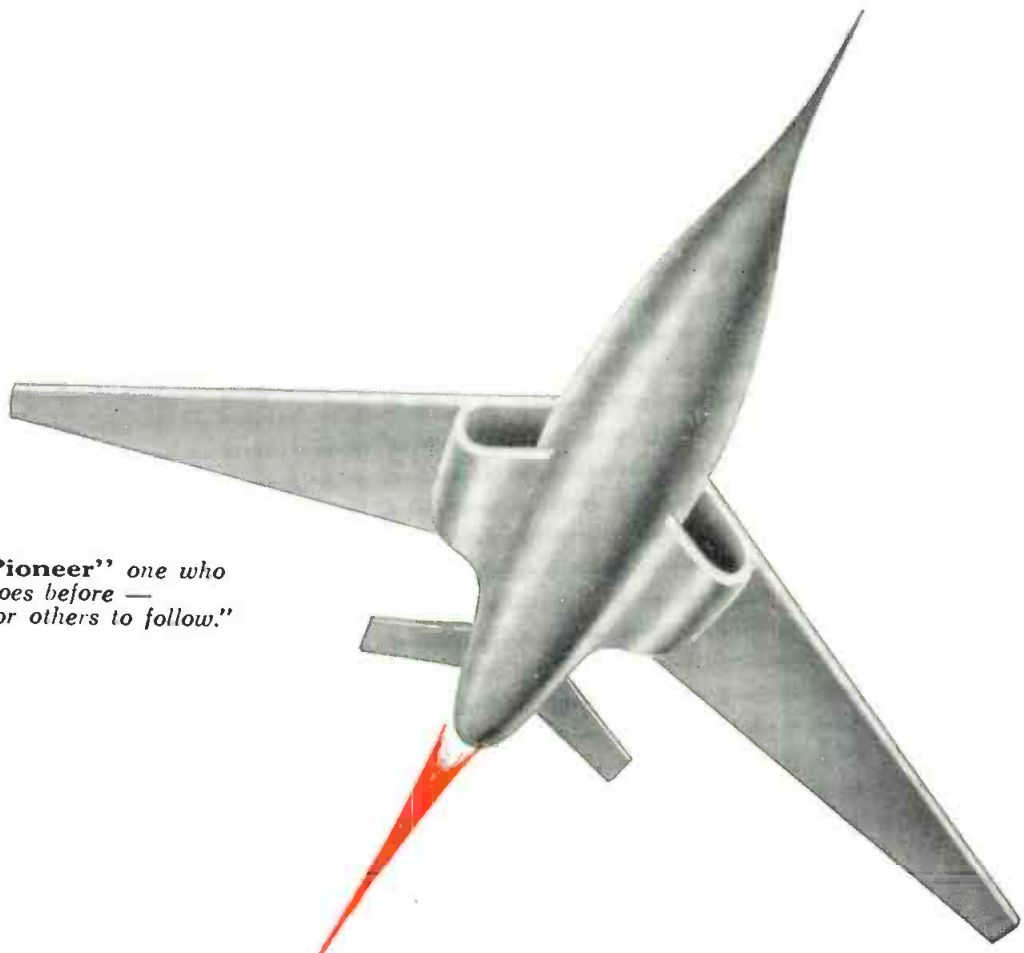

**“Pioneer”** one who  
goes before —  
for others to follow.”

**IF WEBSTER IS RIGHT —**  
Then Midland Has Done It Again, this time with

# glass holders for crystals!

Absolute and permanent vacuum attainable only with glass, isolates the crystal from all factors detrimental to dependable performance. Truly, here are crystals designed with the future in mind — future requirements of application and design as well as the long life of the unit far into the future.

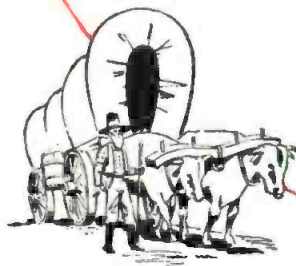

**Midland**

**MANUFACTURING COMPANY, INC.**

3155 Fiberglas Road • Kansas City 15, Kansas

World's Largest Producer of Quartz Crystals

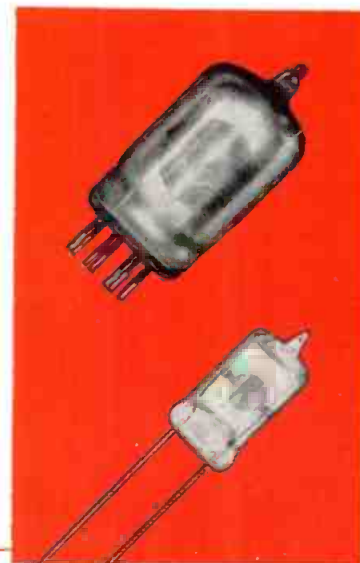

# ERIE DISC CERAMICONS<sup>®</sup>

**FOR**

Radios  
TV's  
Computer Assemblies  
Instruments  
Record Players  
Military Equipment  
Communication Equipment  
Test Devices  
Business Machines  
Electronic Organs  
Automatic Industrial Controls

The three types in which ERIE Disc Ceramicons are available are offered in a wide range of values. The capacitors have flat ceramic dielectrics with fired silver electrodes to which lead wires are firmly soldered. The completed units are given a protective coating of phenolic which is vacuum wax impregnated for excellent moisture seal. Disc Ceramicons are made in six sizes ranging from 5/16" max. to 3/4" max. diameter. Write for complete description and specifications.

**AVAILABLE  
IN 3 TYPES**

### TEMPERATURE COMPENSATING

Disc Ceramicons offer a wide combination of temperature coefficient and capacitance values. They meet all requirements for RETMA REC-107A Class 1 ceramic capacitors. Available in capacity ranges from 1.5 to 2810 mmf at 500 V.D.C.W. and temperature coefficients ranging from P120 through N5600.

**GENERAL PURPOSE** Disc Ceramicons have low series inductance which assures efficient high frequency operation. Values from 1.5 mmf to .02 mfd. Rated at 500 Volts D.C. Working.

**HIGH VOLTAGE** Disc Ceramicons employ the same basic diameters and design that have been standardized in 500 volt ceramic capacitors. Conservative voltage rating beginning at 1 KV D.C.W. are based on extensive life test data.



H. R. Loxterman was advanced to general sales manager, and Edward W. Pottmeyer to manager of engineering and development of the Blaw-Knox Equip. Div., Blaw-Knox Co.

Joseph P. Gordon is now asst. director of the Tube Research Div., Allen B. DuMont Labs., Inc.

Robert W. Hubner is now director of recruitment for IBM Corp., with headquarters in NYC.

Morgan A. Gunst, Jr., has been named vice president of Chromatic Television Labs, Inc., and general mgr. of its West Coast development lab in Emeryville, Calif.

B. M. Brown has been named manager of Westinghouse Electric Corp.'s Baltimore, Md., divisions.

Pekka Ahonen, Andrew Foundation scholar, after advance research studies at Stanford Univ., has returned to Finland, where he is Technical Director of Helvar Co., producers of TV receivers. He was chairman of the club that demonstrated that Finland could own and operate its own TV broadcasting service.

Charles H. Berry is the new gen. manager of Kearfott's Western Div.

John M. Spooner appointed manager of the Findlay, Ohio, plant of RCA.

Howard W. Grossbohlin is head of the tube and component dept., and Robert M. Peterson is asst. chief engineer at Stromberg-Carlson, San Diego.

John E. Lowe, of American Machine & Foundry Co. at Boston, was appointed director of personnel and public relations, Rochester missile plant.

Anthony L. Conrad was elected vice pres. of Missile Test Project, RCA Service Co., Inc.

Henry Schmalz is now chief engineer for Thomas Electronics, Inc.

John R. Crawford has joined Parameters, Inc., as Sales Manager.

Robert C. Harper appointed director of Pacific Coast sales for Sylvania Electric Products, Inc.

Phil G. Kerr appointed national sales manager-electronics div. for Admiral Corp.

Allan S. Robertson is now vice-pres. in charge of sales for Fenwal, Inc.

John R. Crawford has joined Parameters, Inc. as sales manager.

Donald E. Pierce now manager of Brush Electronics Co.

Dr. Russell Varian now chairman of the board for Varian Associates.

Joseph W. Semkow named manager of the Dalmo Victor Co. Dayton office.

**ERIE**  
electronics

**ERIE ELECTRONICS DIVISION**  
**ERIE RESISTOR CORPORATION**  
Main Offices and Factories: **ERIE, PA.**  
Manufacturing Subsidiaries:  
HOLLY SPRINGS, MISSISSIPPI • LONDON, ENGLAND • TRENTON, ONTARIO

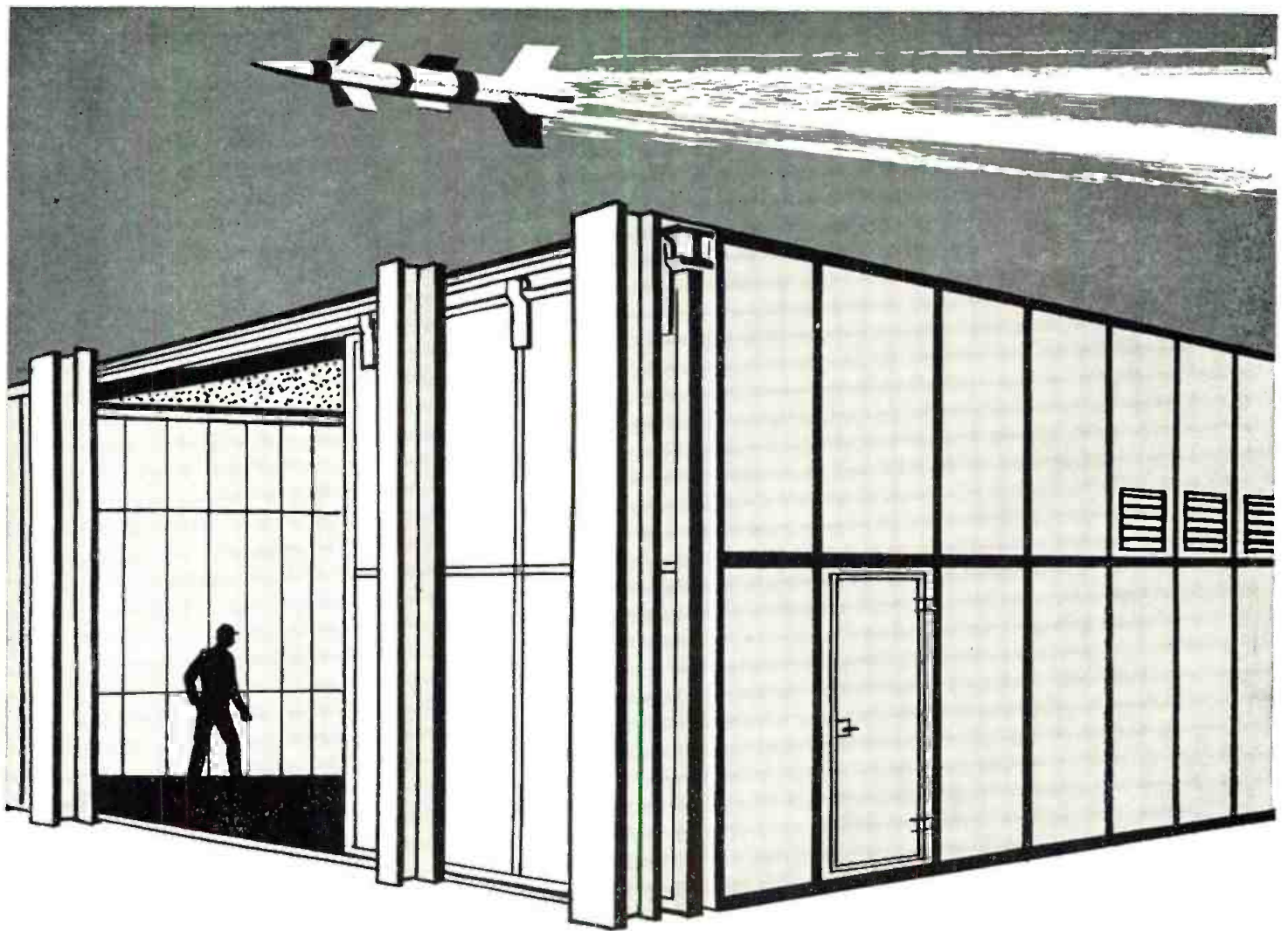

## HUGE ENCLOSURE SHIELDS GUIDED MISSILES FOR RADIO-FREQUENCY TESTS AT BELL

Current F.C.C. regulations governing radio-frequency interference give much publicity to the need for adequate shielding. But an even greater need arises from those who must conduct electronic tests *without interference from external sources*.

This was the need at Bell Aircraft Corporation, Buffalo, N. Y. But further, Bell asked ACE to design, build, and install an enclosure large enough to shield a guided missile in its entirety. The result is the largest prefabricated shielded enclosure ever built.

This gigantic shield measures 40 feet long, 35 feet wide, and stands 18 feet high. Made of ACE prefabricated panels of galvanized sheet steel, the entire structure can be taken down, moved, and reassembled at another location if necessary. Yet it provides the high levels of attenuation required

to test aircraft electronic equipment for conformance with all military interference specifications.

Other unique features include electrically controlled sliding doors for maximum opening of 16 feet high by 21 feet wide . . . air operated contact fingers around the door periphery for positive r-f seal . . . two personnel access doors . . . air-conditioning . . . electric and pneumatic service entrances . . . 5000 watts of lighting . . . and a specially reinforced floor capable of supporting extremely heavy loads.

ACE can solve your shielding problems with comparable success — from small bench-size “boxes” to huge enclosures even larger than the Bell “hangar” described above—meeting all the varied requirements of industry, military, and medical work. An Ace sales engineer will be glad to show you how. Or, write for free catalog on ACE standard enclosures.



**First and Finest in Shielded Enclosures**

ACE ENGINEERING & MACHINE CO., INC. 3644 N. Lawrence St. • Phila. 40, Pa.

**RUGGED, LONG LIFE  
EIMAC 4X5000A CERAMIC  
TETRODE DELIVERS 10kw  
FOR SINGLE SIDEBAND**



**4X5000A RADIAL-BEAM POWER TETRODE  
TYPICAL OPERATION  
FREQUENCIES BELOW 30 mc.**

	Class C CW	Class AB* R-F Linear Amplifier
D-C Plate Voltage	7500v	7500v
D-C Screen Voltage	500v	1250v
D-C Grid Voltage	-350v	-300v
D-C Plate Current	2.8 amps	1.9 amps
Driving Power	150w	0w
Plate Dissipation	5 kw	4.2 kw
Plate Power Output	16 kw	10 kw

\*Class AB figures shown are under Peak Envelope or Modulation Crest Conditions.

Top Single Sideband performance plus the advantages of great immunity to damage by thermal or physical shock are combined in the metal and ceramic Eimac 4X5000A radial-beam power tetrode.

Developed especially for Single Sideband communication systems the 4X5000A delivers 10kw power output and has a maximum plate dissipation rating of 6000 watts. High output is easily developed without going into the positive grid region.

A unique integral-finned anode permits the 4X5000A to be cooled with low air pressures. Simple coaxial construction provides low inductance multiple terminals.

Now available for optimum socketing and cooling of the 4X5000A is the Eimac SK300 air-system socket.

For further information about the 4X5000A and its companion socket write our Application Engineering Department.

*Eimac*

**EITEL-McCULLOUGH, INC.**

SAN BRUNO CALIFORNIA

The World's Largest Manufacturer of Transmitting Tubes

# variable "L" by BURNELL

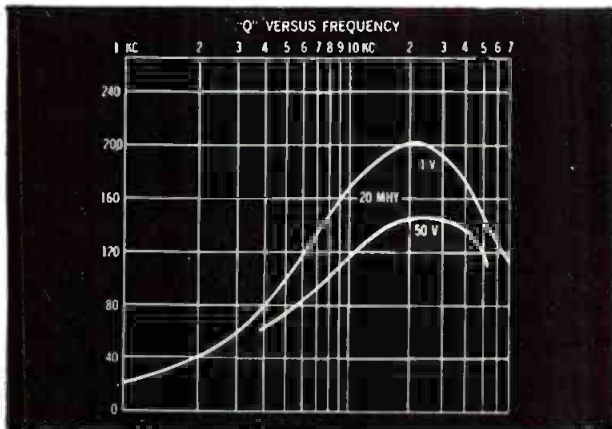

Typical Q vs. frequency characteristics of AT-10.

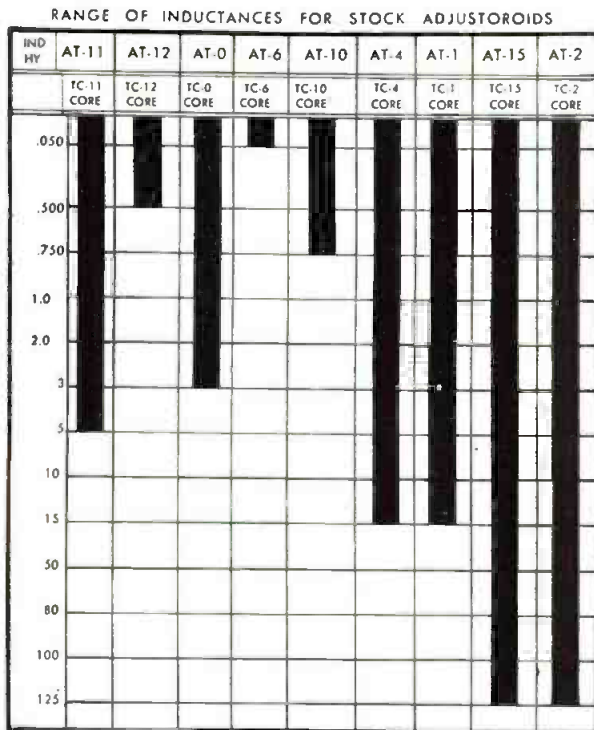

For nominal D. C. R. values refer to Burnell catalog No. 103.

COMPLETE TECHNICAL INFORMATION UPON REQUEST.  
 © copyrighted, patent applied for.

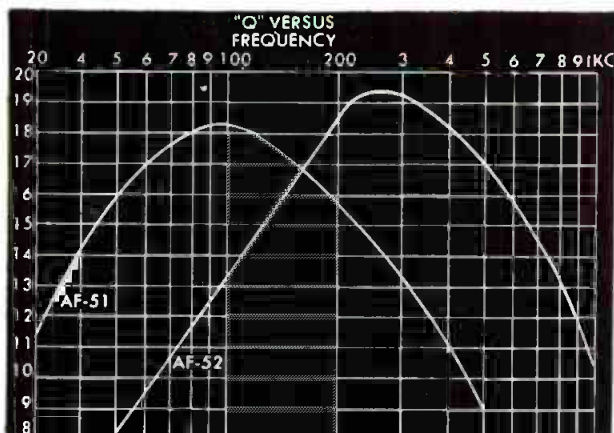

Typical Q vs. frequency characteristics of Variable Inductors.

## ADJUSTOROID<sup>®</sup>

The Adjustoroid, a low cost adjustable toroid, exclusively developed by Burnell & Company, Inc., contains an actual complete toroid which relays all the excellent characteristics of the non-adjustable types. Adjustment is obtained by a completely stepless function with magnetic biasing.

The nominal inductance value for an Adjustoroid is the maximum value, and the inductance range is the nominal value minus approximately 10%.

Hermetically sealed to meet Government MIL specifications. Many types of networks in tuned circuits are being produced which employ the Adjustoroid in completely hermetically sealed packages.

Intermediate inductance values as well as special taps and extra windings available on special order with minimum delay.

For additional technical data on Adjustoroids, refer to equivalent toroid in catalog.



AT-0, AT-6, AT-10, AT-4



AT-1, AT-2, AT-11, AT-12

ADJUSTOROID & VARIABLE INDUCTOR DIMENSION CHART

	LENGTH/DIA	WIDTH	HEIGHT
AT-0, AT-6	1-1/16"		1"
AT-10, AT-4	1-19/64"		1-1/4"
AT-15	1-31/32"		1-7/8"
AT-11, AT-12	45/64"	45/64"	3/4"
AT-1	1-3/4"	1-3/4"	1-1/4"
AT-2	2-3/4"	2-3/4"	2-1/4"
AF-51, AF-52	1-19/64"		2"

and now ...

## VARIABLE INDUCTORS

# AF-51 AF-52

(30-500 cycles)

Maximum Q at 100 cycles

(50-1000 cycles)

Maximum Q at 250 cycles

Burnell Variable Inductors have the similar characteristics to the Adjustoroid except they are especially designed for low frequency applications or for conditions where high inductance values are required. Variable Inductors are available in all inductance values up to 1000 Hys. With variation of —10% from nominal.

**BURNELL & CO., INC.**

YONKERS 2, NEW YORK Teletype: Yonkers, N. Y. 3633

Pacific Division: 720 Mission St., S. Pasadena, Calif.



# Electronic Industries News Briefs

Capsule summaries of important happenings in affairs of equipment and component manufacturers

## EAST

**STROMBERG-CARLSON DIV., GENERAL DYNAMICS CORP.**, recently established an Electroacoustics Research Group in the Research and Advanced Development Dept. under Frank H. Slaymaker, formerly Chief Engr. of the Special Products Div.

**E. I. DU PONT DE NEMOURS AND CO. (INC.)** has bought a 10,500-acre tract near Brevard, N. C., as a possible site for future expansion of its silicon business.

**SERVOMECHANISMS, INC.**, has changed its Components Div. name to Mechatrol Div., effective July 2, 1956. Servomechanisms has acquired 17,000 sq. ft. additional space at Garden City, N. Y., for its Eastern Div.

**NATIONAL BUREAU OF STANDARDS'** E. F. Florman was awarded Dept. of Commerce Silver Medal for outstanding contribution to knowledge of velocity of radio wave propagation at vhf.

NBS has selected a 550-acre tract near Gaithersburg, Md., for relocation of its Washington labs.

"**AIRBORNE ELECTRONICS WEEK**" has been proclaimed by Baltimore Mayor Thomas D'Alesandro, Jr., as the week of Oct. 29, 1956 in honor of the Third Annual East Coast Conference on Aeronautical and Navigational Electronics, which will be held Oct. 29-30.

**RADIO AND TELEVISION DIV., SYLVANIA ELECTRIC PRODUCTS INC.** will transfer operations to the modern 422,000 sq. ft. facilities at Batavia, N. Y.

**AMPLIFIER CORP. OF AMERICA** announces the appointment of Electronic Maint. Co., 172-24 Jamaica Ave., Jamaica 32, N. Y., as a factory authorized repair facility.

**GENERAL ELECTRIC CO.** has established a new district sales office for tubes and electronic components at 3 Penn Center Plaza, Room 925, Phila. 2.

**GE's LIGHT MILITARY ELECTRONIC EQUIP. DEPT.** has been awarded a substantial USAF production contract for advanced electronic countermeasures equipment.

**CURTISS-WRIGHT CORP.** will establish a new Nuclear Materials Laboratory consisting of a reactor and radioactive hot cells at the company's Research and Development Center, Quehanna, Pa.

**NUCLEAR CORP. OF AMERICA, INC.** has acquired Isotope Specialties Co., Inc., Burbank, Calif., manufacturer of organic and inorganic radiochemicals and Central Sales & Manufacturing Corp., Denville, N. J., now to be known as Central Electronic Manufacturers, Inc.

**NUCLEAR SCIENCE & ENGINEERING CORP.**, Pittsburgh, subsidiary of Norden-Ketay Corp., is building an additional laboratory facility on a 3½ acre site near the Allegheny County Airport.

**ORRADIO INDUSTRIES, INC.**, will soon break ground for a new \$300,000 plant in Opelika, Ala.

## MID-WEST

**ADMIRAL CORP.** has sold the tools and dies of its Belmont Div. to Hallicrafters Co. for manufacturing private brand TV and radio receivers. Admiral has decided to devote full time to production of its brand models.

**HUPP CORP.** has formed the Hupp Aviation Div. to coordinate its activity in the aircraft industry in all its manufacturing plants. T. V. Purvin, general mgr. Hupp Subsidiary Amgears, Inc., has been named president of the div.

**TECHNOGRAPH PRINTED ELECTRONICS, INC.**, has granted a license to the National Cash Register Co. to manufacture printed circuits by the Technograph process. NCR's initial use of printed circuits will be in electronic computers.

**UTRAD CORP.** has been formed to continue operation of the transformer div. of Utah Radio Prod., Inc. New company address is 812 E. State St., Huntington, Ind.

**BURROUGHS CORP.** has acquired ElectroData Corp., mfrs. of electronic data processing systems. James R. Bradburn, president of ElectroData Corp., has been named a VP of Burroughs and General Manager of the new division.

**THORDARSON-MEISSNER** has purchased the transformer div. of Mark Electronics, Bloomfield, N. J. All of Mark's transformer production facilities will be moved to the T-M plant at Mt. Carmel, Ill.

**WRIGHT-PATTERSON AFB** has announced that the procurement of electronic countermeasures equipment will be handled by Dayton AF Depot, Gentile AF Station, Wilmington Pike, Dayton, O.

**SANGAMO ELECTRIC CO.** recently moved the sales dept. of its electronic capacitor div. at Marion, Ill., to the home office in Springfield, Ill. The move will more closely integrate the sales of all products.

## WEST

**BERNARD HECHT & ASSOCIATES**, Los Angeles, has established a personnel procurement and placement service strictly in the field of Quality Control and Reliability.

**ARMOUR RESEARCH FOUNDATION, ILL. INST. OF TECH.**, had established its first branch lab at 443 S. Stone Ave., Tucson, Ariz. Alfred J. Hoehn, asst. mgr. of the EE research dept., will head ARF's Southwestern Labs.

**LEAR, INC.**, Santa Monica, has entered a 10-yr. license agreement to manufacture and sell in US the turbine engine control equipment developed by Ultra Electric, Ltd., London.

**GENERAL ELECTRIC CO.** is temporarily renting facilities at Stanford Research Institute, Menlo Park, Calif., where it has established a computer lab as the first step in expansion in the industrial computer field.

**RAMO-WOOLDRIDGE CORP.**, Los Angeles, has recently broken ground for a new 140,000 sq. ft. production facility near Englewood, Colo., where it will produce electronic systems.

**INTERNATIONAL TELEPHONE AND TELEGRAPH CORP.** has announced that expansion plans for Federal Telecommunications Labs, Nutley, N. J., will include a 22,400 sq. ft. structure in the San Fernando Valley and an 80,000 sq. ft. bldg. at Nutley.

**IT&T's Federal Telephone and Radio Co.**, Clifton, N. J., has purchased certain assets of an Electronics Specialty Co., Los Angeles, subsidiary, which will be merged with FTR's Instrument Div.

**HUGHES AIRCRAFT CO.** has acquired all stock of the Santa Barbara Research Ctr. David H. Evans, founder and president of the Center, continues in charge of operations.

**VARIAN ASSOCIATES**, Palo Alto, Calif., recently broke ground for an 80,000 sq. ft. Instrument Bldg. on their 33 acre leasehold in Stanford Industrial Park.

**DON LARSON ADVERTISING, INC.**, has moved to larger quarters at 369 S. Robertson Blvd., Beverly Hills, Calif. The firm handles public relations and advertising for electronics mfrs. of Calif. Mr. Larson is General Mgr. of the West Coast Electronics Mfrs. Assn.

**BECKMAN INSTRUMENTS, INC.**, has delivered 2 Beckman 200-channel Recorders to Douglas Aircraft Co., Long Beach, Calif. The instruments will speed tests on AF C-133 turbo-prop cargo plane.

**SYLVANIA ELECTRIC PRODUCTS, INC.**, has opened a modern 87,000 sq. ft. warehouse and sales office at 6505 E. Gayhart St., Los Angeles. Supervising the warehouse is Burley T. Cram, regional mgr. of distribution services.

**THERMO MATERIALS, INC.**, 1275 Harrison St., San Francisco, has been formed for the purpose of manufacturing high temperature ceramic items for the electronic and fabricated metal industries.

**LOGISTICS RESEARCH, INC.**, Redondo Beach, Calif., has sold an ALWAC III-E digital computer to Champlin Refining Co., Fort Worth. The ALWAC will be used to increase refinery operation efficiency.

**AIMO AND CREUTZ ELECTRONICS, INC.** has been established with offices at 1936 Pontius Avenue, Los Angeles 25.

**AMPEX CORP.**, Redwood City, Calif., manufacturer of magnetic tape recorders, will build a \$4,000,000 plant in Stanford Industrial Park.

**HOUSTON - FEARLESS DIV., COLOR CORP. OF AMERICA**, has announced the appointment of Anderson-McConnell as its advertising agency.

**LOGISTICS RESEARCH INC.**, Redondo Beach, Calif., has delivered an ALWAC computer to the Canadian Armament Research & Development Establishment at Valcartier, Quebec.

## FOREIGN

**COLLINS RADIO CO. OF ENGLAND, LTD.**, a subsidiary of Collins Radio Co., Cedar Rapids, has appointed Jos. R. Pernice as Managing Director. Pernice was till recently Chief of the Electronics Section of NATO's Production and Logistics Div.

**BODENSEWERK PERKIN-ELMER & CO.**, G.M.B.H., Ueberlingen, W. Germany, will double its manufacturing facilities by year's end. The increased capacity is required to keep pace with European demand for analytical instruments.

**SEOUL CENTRAL TELEPHONE OFFICE** has ordered \$2,000,000 worth of "step-by-step" automatic dial equipment from Federal Telephone and Telegraph. The apparatus will add 8,500 lines to the exchange, doubling its capacity.

# AROUND THE WORLD *again and again!*

**A** fair idea of the extent to which Stackpole fixed composition resistors are used may be gained from this illustration.

Laid end to end, the total number of these tiny components produced to date by Stackpole would extend many times around the world.

Such acceptance is a tribute, both to the high quality of the resistors and to the dependable, personalized service, that Stackpole puts behind each resistor order.

*Electronic Components Division*  
**STACKPOLE CARBON COMPANY**  
*St. Marys, Pa.*

Type CM-1/32  
( $\frac{1}{2}$  watt)

## PACKAGED FOR YOUR CONVENIENCE!

... in "strip pack"; "stack pack"; or "reel pack" assemblies. Ask your Stackpole field engineer for details.

Type CM-2  
(2 watts)

Type CM-1  
(1 watt)

# STACKPOLE RESISTORS

FIXED COMPOSITION



Available for your convenience through leading parts distributors.



Weather radar with brilliant half-tone picture.



Narrow band, slow scan. Closed-circuit TV.



Freeze action until intentionally erased.

HUGHES PRODUCTS

*proudly announces*

# TONOTRON

- Full circle persistence
- Displays complete spectrum of gray shades
- Controllable persistence
- Controllable rate of decay
- No hood needed, even in direct sunlight
- 5-inch screen



## DIMENSIONS

- Over-all length:  $11\frac{3}{8}$  inches,  $\pm \frac{3}{8}$  inch.
- Bulb diameter:  $5\frac{3}{8}$  inches, maximum.
- Neck diameter: 1 inch,  $\pm \frac{1}{16}$  inch.



Single transient pulse, 20 micro-seconds wide with a one micro-second rise time, showing writing capabilities of one million inches per second. This photo was taken in full daylight without a hood.



# MEMOTRON

Memotron gives instant and permanent display of one or successive transients.

## HUGHES PRODUCTS

A DIVISION OF THE HUGHES AIRCRAFT COMPANY

ELECTRON TUBES 

For descriptive literature write to  
 HUGHES PRODUCTS  
 ELECTRON TUBES  
 International Airport Station, Los Angeles 45, California



# SPIRAFIL COAXIAL CABLE

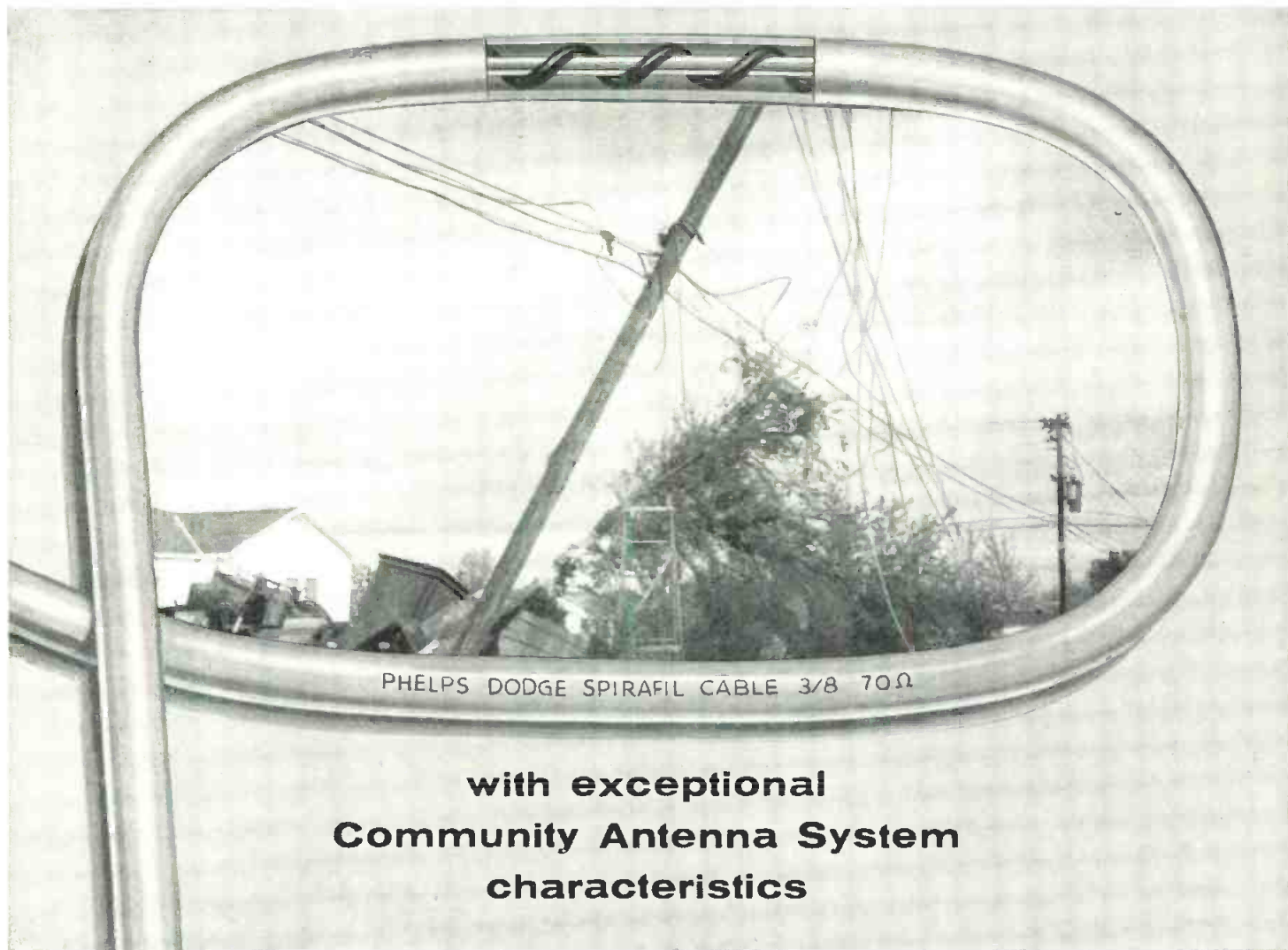

PHELPS DODGE SPIRAFIL CABLE 3/8 70Ω

with exceptional  
**Community Antenna System**  
characteristics

## **OPERATES EVEN UNDER TORNADO CONDITIONS!**

During a recent tornado in Bryan, Texas, Spirafil coaxial cable clearly demonstrated its outstanding electronic features and its ability to withstand rugged weather conditions.

When the powerful twister hit Bryan, many rooftop television antennas were toppled, and power services were interrupted. The Spirafil-equipped com-

munity antenna system of the Midwest Video Corporation, however, continued to operate normally throughout the violent storm, wherever its supporting poles remained standing.

\* \* \*

We invite your inquiries about specific applications for this unique type of coaxial cable.



## **PHELPS DODGE COPPER PRODUCTS**

### **CORPORATION**

300 PARK AVENUE, NEW YORK 22, N. Y.

# COMPACT 5 IN 1 INSTRUMENTS

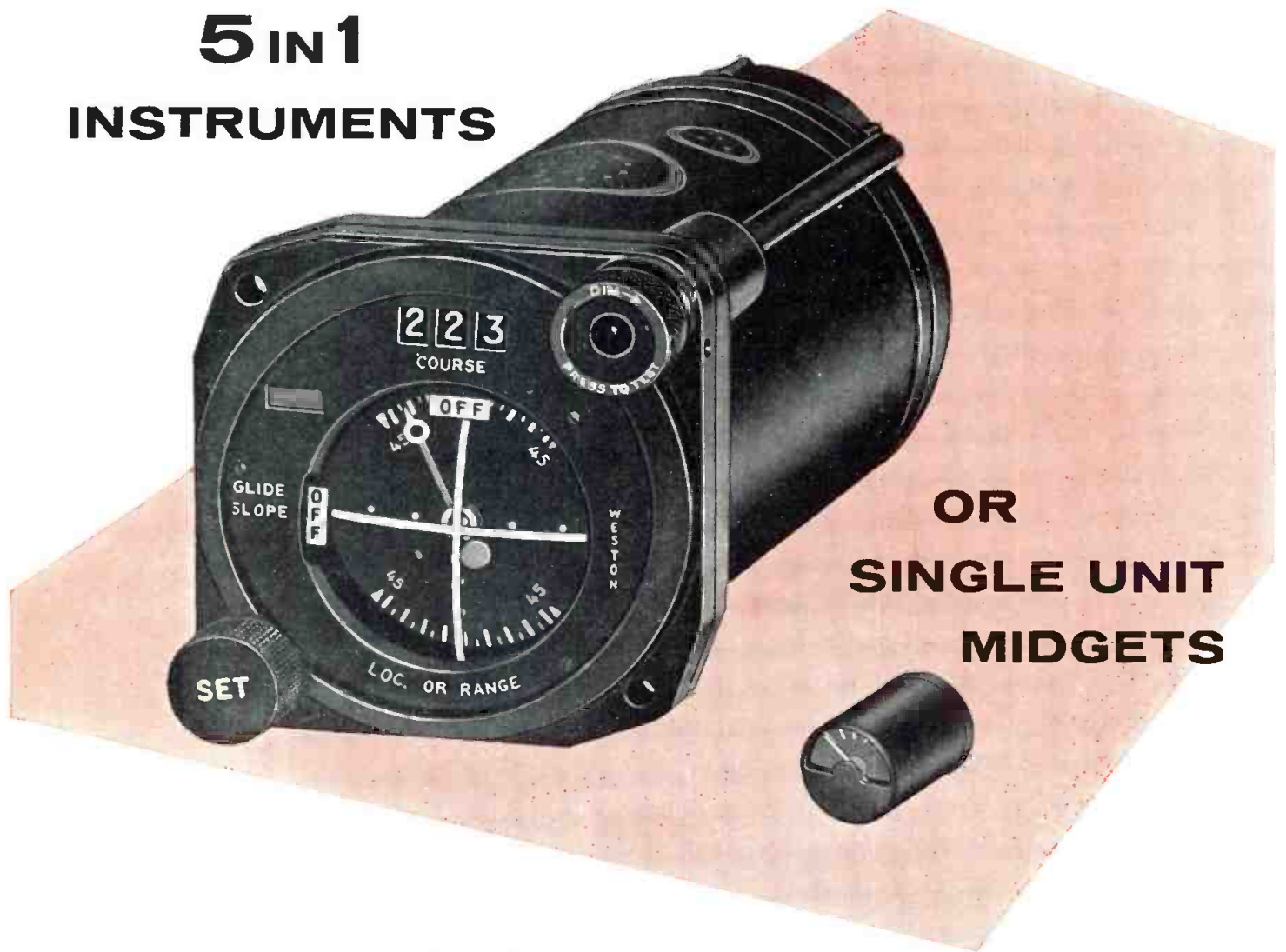

OR  
SINGLE UNIT  
MIDGETS

*... Instrument headquarters  
can meet your design requirements, exactly!*

Why compromise on your instrument needs? Whether your design calls for miniature size, or an instrument with several mechanisms within a compact case... instruments with high torque, high sensitivity, internal shielding, special ballistics, or with pointers of special size or shape... Weston's wide variety of designs no doubt includes an instrument which will fit your needs exactly. But for new or

unusual needs, engineering cooperation is freely offered to assist you at the drawing board stage. In either case, Weston's long leadership in instrument design is your best assurance of obtaining instruments *tailored to your specific requirements*. Acquaint your local Weston representative with your problem, or write *Weston Electrical Instrument Corporation, 614 Frel-inghuysen Avenue, Newark 5, New Jersey*.

## WESTON

*Instruments*



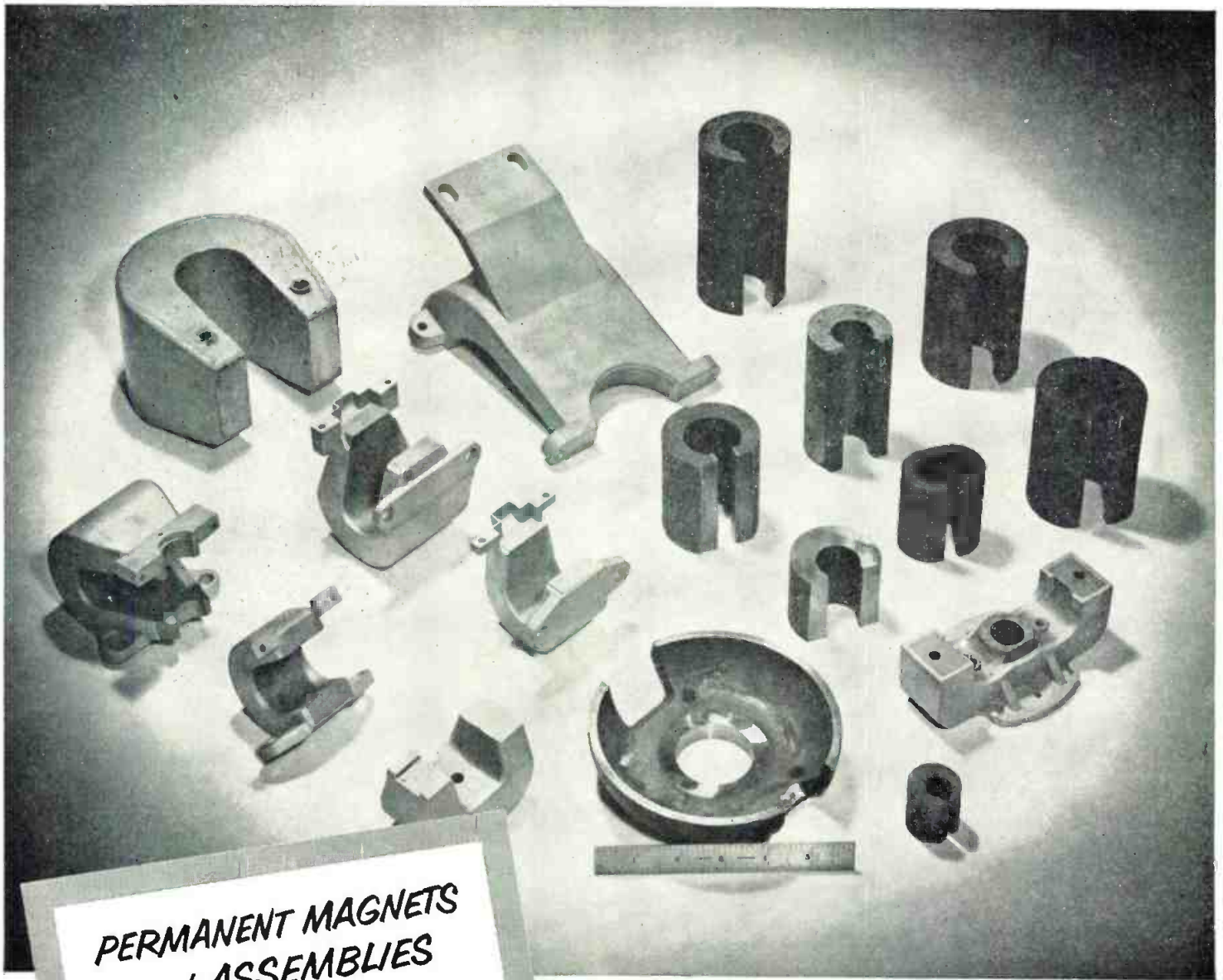

**PERMANENT MAGNETS  
and ASSEMBLIES  
for Wave Guides, Traveling  
Wave Tubes and Magnetrons**

**We can handle  
ANY requirements you have**

- ★ Made to your specifications
- ★ Any size, shape or coating required
- ★ Send us your drawing for quotation

Write for your copy of  
Bulletin GC-106 B

**"ARNOLD MAGNETIC MATERIALS"**

32 pages of general data on all Arnold products: cast and sintered Alnico magnets; tape wound cores; Silectron C and E cores; bobbin cores; Mo-Permalloy powder cores; iron powder cores; special magnetic materials, etc.

ADDRESS DEPT. T-69

The group of magnets illustrated above are indicative of the great scope of Arnold production in this field. We can supply these permanent magnets in any size or shape you may need; in weights ranging from a few ounces to 75 pounds or more; and with die-cast or sand-cast aluminum jackets, Celastic covers, etc., as required. Complete assemblies may be supplied with Permendur, steel or aluminum bases, inserts and keepers as specified—magnetized and stabilized as desired. • Let us handle your magnetron, traveling wave tube and wave guide permanent magnet requirements, or any other magnetic material specification you may have.

WSW 5996 C

**THE ARNOLD ENGINEERING COMPANY**



SUBSIDIARY OF ALLEGHENY LUDLUM STEEL CORPORATION

General Office & Plant: Marengo, Illinois

DISTRICT SALES OFFICES . . . New York: 350 Fifth Ave.

Los Angeles: 3450 Wilshire Blvd.

Boston: 200 Berkeley St.



Rx

*Prescribed for design headaches*

Take as many TRIAD miniature and sub-miniature transformers as required for good electrical performance with adequate protection against failure due to environmental conditions, and extremely small size.

TRIAD miniature transformers are ideal for printed circuit use. 32 designs, available in hermetically sealed and open types for all tube and transistor applications, are listed in TRIAD's 1956 General Catalog. TRIAD's Engineering Dept. is available to solve your transformer design headaches.



4055 REDWOOD AVE. • VENICE, CALIF.



## BOOKS



### Electronics in Industry

By George M. Chute. Published 1956 by McGraw-Hill Book Co., Inc., 330 W. 42nd St., New York 36, N. Y. 431 pages. Price \$7.50.

In supplementing rather than duplicating the material found in more specialized texts, this book awakens interest in various phases of industrial electronics so that the reader is encouraged to use other texts to obtain a more complete coverage of the desired subjects.

The material is designed to be used as a general text for technical students, or a supplementary text in electrical engineering.

The book presents basic fundamentals of electronic devices used in industry, and explains how these devices are used in practical circuits. The uses of vapor or gas tubes are stressed, as well as many non-electronic devices often used in electronic equipment.

### Electronic Engineering

By Samuel Seely, Ph.D. Published 1956 by McGraw-Hill Book Co., Inc., 330 W. 42nd St., New York 36, N. Y. 525 pages. Price \$8.00.

Although this book, together with its companion volume, Radio Electronics, is a revision and enlargement of the author's Electron Tube Circuits, both books are written as independent, self-contained texts.

This book has as its objective a detailed discussion of a large variety of electronic circuits which are important in such diverse fields as radar, television, electronic control and instrumentation, and computers. Most of the text is devoted to an analysis of circuit operation.

Both physical and mathematical analyses are presented. In all analyses considerable care has been taken to include the requisite reference conditions for potential polarities, current directions, and transformer-winding sense, without which the ultimate choice of a positive or negative sign would require a major decision.

### Transistors in Radio and Television

By Milton S. Kiver. Published 1956 by McGraw-Hill Book Co., Inc., 330 W. 42nd St., New York 36, N. Y. 324 pages. Price \$6.50.

This book is written for radio and television technicians and all other technical workers who desire to gain a working knowledge of transistors and transistor circuits. The discussion starts with modern electron theory and then progresses to the operation of point-contact, junction, and other transistors. This is followed by the analysis of a variety of transistor circuits, particularly those



**WARREN A. MARRISON.** Tompian Gold Medal, Warshipful Company of Clockmakers of the City of London, for pioneer work on development of quartz crystal oscillators as precision standards of time.

**W. G. PFANN.** Mathewson Gold Medal, American Institute of Mining and Metallurgical Engineers, for discovery of and pioneering research in zone melting.

**H. T. FRIIS.** Medal of Honor, Institute of Radio Engineers and Valdemar Poulsen Gold Medal, Danish Academy of Technical Sciences; important work in application of short and ultra-short radio waves.

**CLAUDE E. SHANNON.** Stuart Ballantine Medal, Franklin Institute of the State of Pennsylvania, for contributions to a comprehensive theory of communication.



$$C = W \log_2 \left( 1 + \frac{S}{N} \right)$$

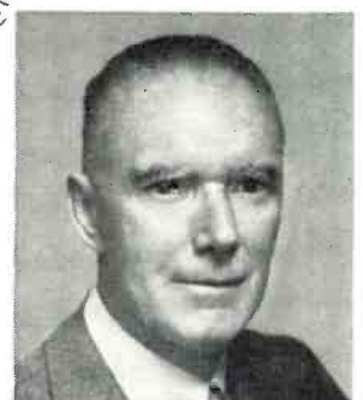

**AXEL G. JENSEN.** David Sarnoff Gold Medal, Society of Motion Picture and Television Engineers, for technical contributions to television; G. A. Hagemann Gold Medal for Industrial Research, Royal Technical College, Copenhagen.



**H. F. DODGE.** Shewhart Medal, American Society for Quality Control, for original contributions to the art of statistical quality control.

## PIONEERS OF PROGRESS

These are some of our recent medal winners at Bell Laboratories. The awards they have won symbolize recognition for outstanding achievement in the many sciences that bear on telephony. Bell Labs is extremely proud of them—and of the thousands of scientists and engineers who work with them to keep the American telephone system the greatest in the world.



**R. KOMPFFNER.** Duddell Medal, Physical Society of England, for his original work on the traveling wave tube.

**WALTER H. BRATTAIN.** Co-winner with Dr. John Bardeen of John Scott Medals, City of Philadelphia, for invention of the transistor.



BELL TELEPHONE LABORATORIES

WORLD CENTER OF COMMUNICATIONS RESEARCH AND DEVELOPMENT

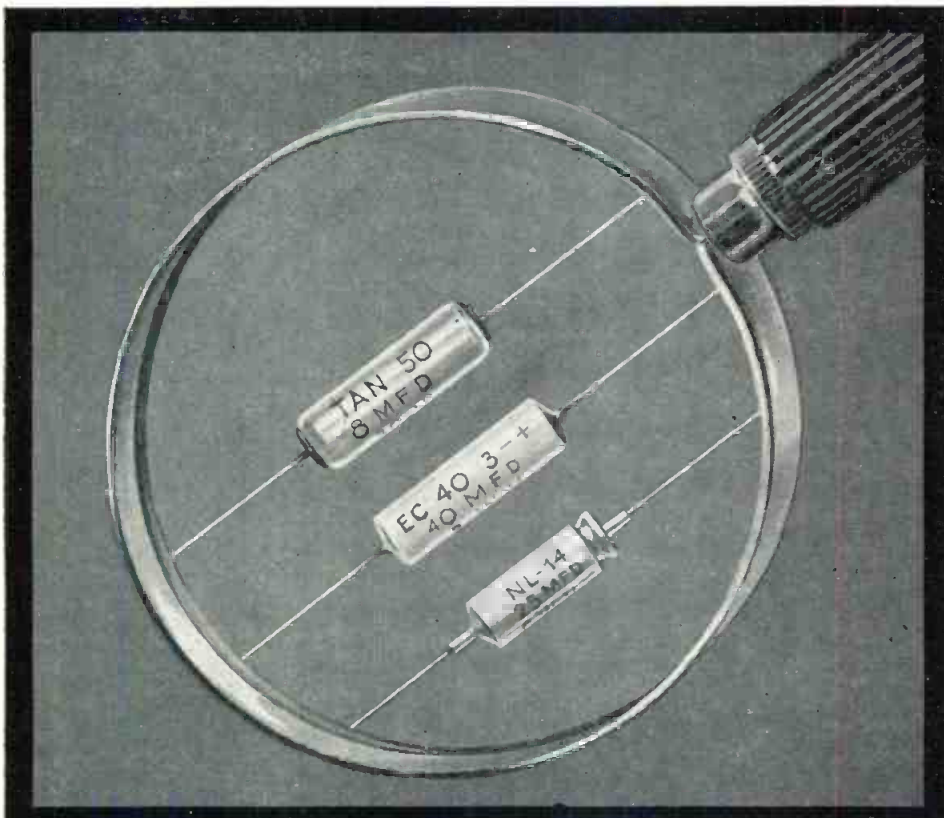

*if it's a capacitor...*

**C-D** *makes it...*

*and makes it better!*

### The World's Tiniest! Miniature and Sub-Miniature Electrolytics!

*Designed particularly for applications where space is at a premium.*

C-D's Type "EC" ceramic-cased electrolytic capacitors are less than  $\frac{1}{4}$ " in diameter, only  $\frac{3}{4}$ " long. Ideal for hearing aids, transistorized devices, remote control assemblies etc.

For sub-miniature applications, C-D's 3 Tantalum Type capacitors feature low P-F; hermetic seal, long shelf life. Type "TX" with sintered anode; "TAN" miniature foil-type; "NT" sub-miniature, wire anode-type.

For all-around reliable service, C-D's type "UP" is made in the smallest tubular aluminium can for any given capacity and voltage.

For printed circuit applications, C-D now has available the type "NL" hermetically sealed electrolytics.

For the finest capacitors in miniature and sub-miniature sizes — specify *Cornell-Dubilier: consistently dependable since 1910.* Engineering samples sent on request. Write for Engineering Bulletins to Cornell-Dubilier Electric Corporation, South Plainfield, N. J.



## CONSISTENT HI-DEPENDABILITY CORNELL-DUBILIER CAPACITORS

SOUTH PLAINFIELD, N. J.; NEW BEDFORD, WORCESTER & CAMBRIDGE, MASS.; PROVIDENCE & HOPE VALLEY, R. I.; INDIANAPOLIS, IND.; SANFORD, FUGUAY SPRINGS & VARINA, N. C.; VENICE, CALIF.; & SUBSIDIARY, THE RADIART CORPORATION, CLEVELAND, OHIO; CORNELL-DUBILIER ELECTRIC INTERNATIONAL, N. Y.

which are used in radio and television receivers. No mathematics of any difficulty are employed in the text.

A very useful chapter on servicing transistor circuits and a practical chapter on experiments with transistors complete the book. Also included are tables of transistor data.

Extensive illustrations, including perspective diagrams, give a clear insight into the workings of transistors.

### Automatic Garage Door Control

By L. R. Chase. Published 1955 by Richards-Lawrence Book Co., 13339 Debby St., Van Nuys, Cal. 40 pages, paper bound. Price \$1.50.

A Do-It-Yourself book intended for the person of average skill with tools and average knowledge of electrical and mechanical devices, who wishes to construct his own garage door control system.

### ASTM Standards on Metallic Electrical Conductors

Published 1955 by American Society for Testing Materials, 1916 Race St., Phila. 3, Pa. 308 pages, paper bound. Price \$3.50.

This publication presents standard and tentative specifications and methods of test pertaining to metallic electrical conductors, whether for use in uninsulated or uncovered form or for subsequent use in making insulated or covered conductors.

### Time-Saving Network Calculations

By Harry Stockman. Published 1956 by SER Co., 543 Lexington St., Waltham, Mass. 120 pages, paper bound. Price \$1.75.

Gives a set of general rules for network calculations, and describes the use of Thevenin's Theorem, the Potentiometer Method, and other techniques for transient and steady states.

### NEL Reliability Bibliography

Published 1956 by U. S. Navy Electronics Laboratory, San Diego 52, Calif. Available to Dept. of Defense activities and to a limited extent to government contractors upon request.

Includes material published since 1950, listed under the following headings: Circuit design, Components, Electron tubes, Failure analysis, General, Human engineering, Maintenance, Mechanical design, Systems, and Testing.

### The Generation of Electricity by Wind Power

By E. W. Golding. Published 1956 by Philosophical Library, Inc., 15 E. 40th St., New York 16, N. Y. 336 pages. Price \$12.00.

This book will be of interest to all concerned with the provision of power, both in industrialized countries and in under-developed parts of the world.

The book deals with the important matter of wind surveys for the choice of suitable sites, with the structure and behavior of the wind and with techniques for measuring it. There is an interesting study of the use of wind power through the ages, a full account of present-day activities, and a survey of future prospects.

Another  
product  
surprise  
from  
Helipot!

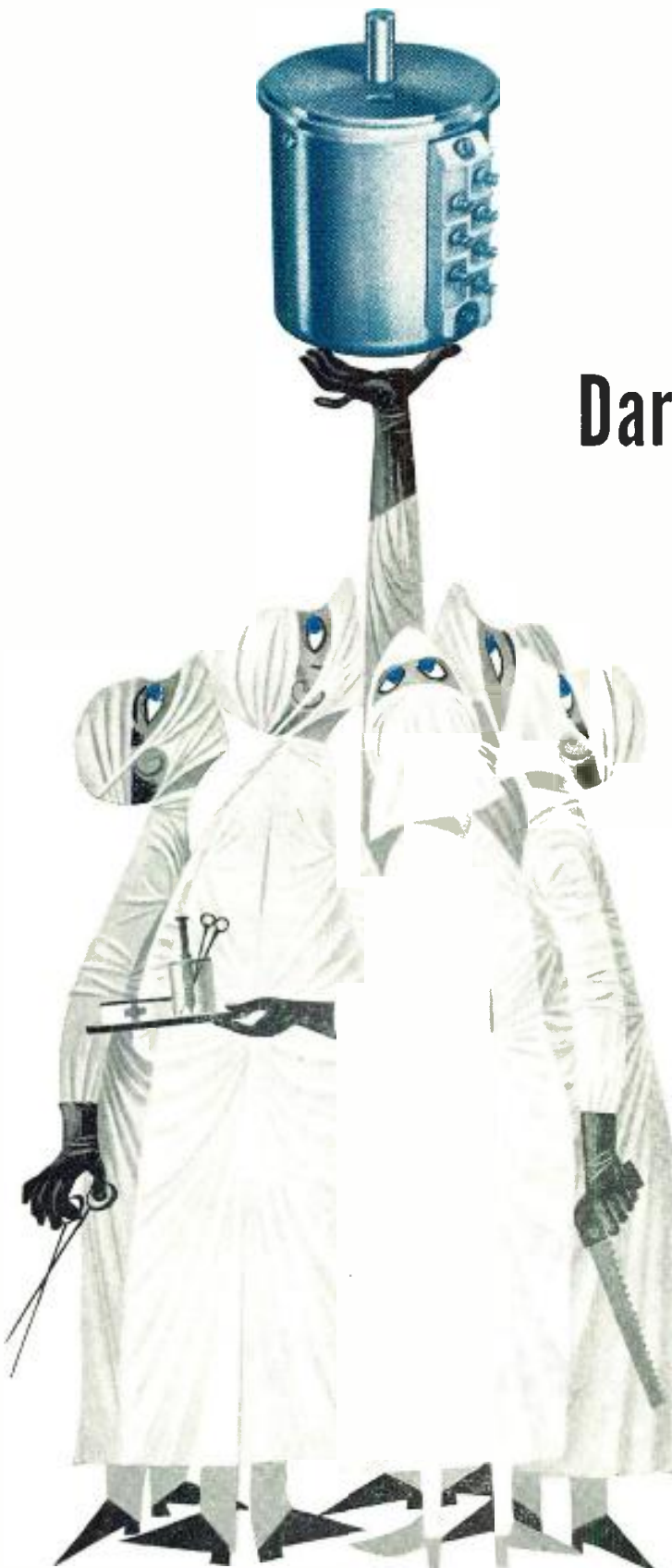

## Daring operation

Delicate design surgery by the Helipot staff removed the mandrel from our new ten-turn series 7700 . . . and left nothing but fresh air inside the turns of resistance wire!

Startling . . . but so advantageous.

The post-operative picture shows temperature, pulse and pressure normal. Prognosis *excellent* . . . because with air-core winding† linearity approaches the resolution of the unit and phase-shift is less than 0.1° in AC circuitry.

The splendid 7700 . . . 1-13/16" in diameter, with all-metal housing . . . is available for servo or three-hole pilot mounting. Eleven mechanical coil turns provide 180° overtravel at each end. Mechanical stops are standard, with stop-load strength of 50 inch-pounds. Incidentally, air-core winding is used for units with total resistance of 200 to 5,000 ohms . . . copper-mandrel winding, from 5,000 to 200,000 ohms.

The complete clinical records of this fascinating case are presented in data file 904. A copy has been set aside for you.

† The air-core winding system was developed by Vestal Laboratories of I. B. M.

Helipot makes precision potentiometers . . . linear and non-linear . . . in the widest choice of sizes, mounting styles and resistances. Many models are stocked for immediate shipment. Our engineers will gladly adapt standard models to your requirements, or design entirely new HELIPOT\* precision potentiometers for you.

 **Helipot**<sup>®</sup>

*first in precision potentiometers*  
Helipot Corporation, Newport Beach, California  
Engineering representatives in principal cities  
a division of Beckman Instruments, Inc.

777\* REG. U.S. PAT. OFF. See Beckman Automation . . . for Production Control . . . for Business and Research . . . at the I. S. A. Show, New York Coliseum, Sept. 17-21

# 1-KW OUTPUT

From  
3 to 32 MC.



a Reservoir of POWER

Here is a new Gates high frequency transmitter with a conservative rating at 1000 watts output, high level modulated and continuously variable from 3 to 32 Mc. Model HF-1M is one of four similar Hi-Watter models manufactured on the same production line, assuring advanced commercial quality, yet eliminating a premium price tag. This new Gates transmitter may be employed for telegraph, telephone or wide response short wave broadcasting. FSK or high speed keying up to 400 WPM may be added with ease.

HF-1M is a big and husky commercial grade equipment with excellent cooling facilities and a complete complement of laboratory proven components for long trouble-free service. Fully described on Page 98 of Gates catalog No. 59, yours for the asking.

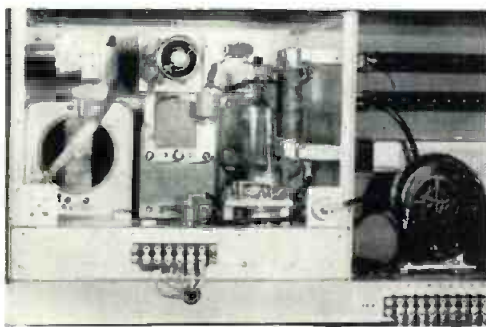

Two control veeeder counter logging covers 3-32 Mc range of tank and output Tee network. A total of 4 RF stages select into 10 crystal positions. All stages are self-neutralized.

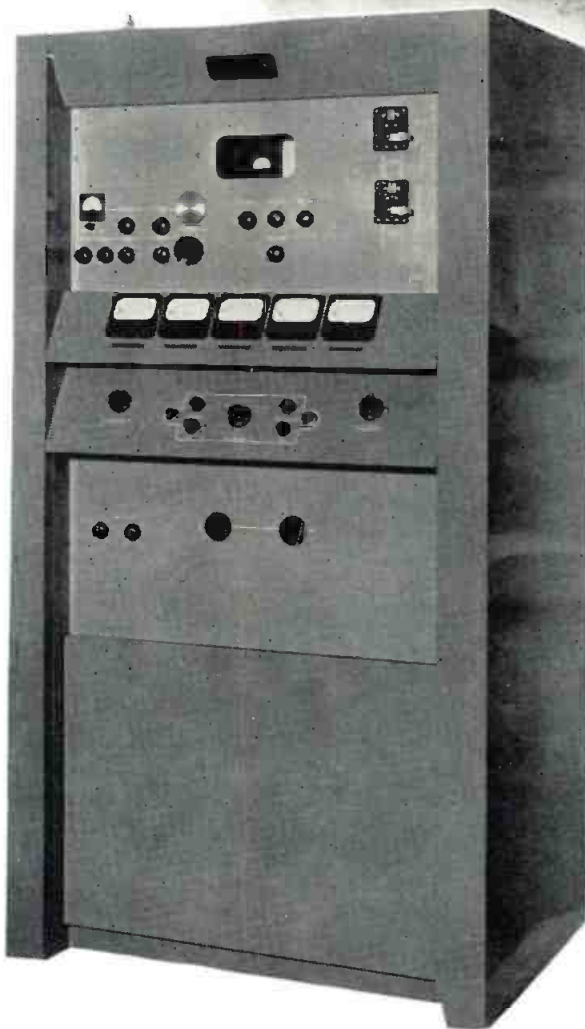

MODEL HF-1M: Range 2-32 Mc, continuously variable 3-32 Mc from front panel control. Single ended output full Tee network to 49/73 ohm line. Power amplifier single 4-1000A forced air cooled. High level Class B modulation (two 833A tubes)  $\pm 2\frac{1}{2}$  Db. 30-10,000 cycles or for voice when used with M5263 amplifier (below);  $\pm 2\frac{1}{2}$  Db. 200-2500 cycles. For 230 volts, one phase, 50/60 cycles.



M5263 LIMITER/FILTER AMPLIFIER: Optional accessory to meet FCC requirements for voice transmission in communications service. Accommodates microphone and 600 ohm line. Includes fast action limiter circuit and audio cut-off filter. Gain 86 Db. For 115 volts, 50/60 cycles.



GATES RADIO COMPANY • Manufacturing Engineers Since 1922 • Quincy, Illinois, U. S. A.



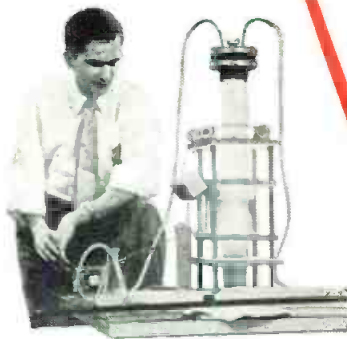

### RESEARCH

Solid state devices for not-so-distant future applications command continuous study by Tung-Sol engineers. In this instance the purifying of silicon is under close scrutiny.



### DESIGN

Efficiency and utility are among the foremost considerations of all Tung-Sol semiconductor blue-printing. Here the resistivity of single germanium crystals is being measured.

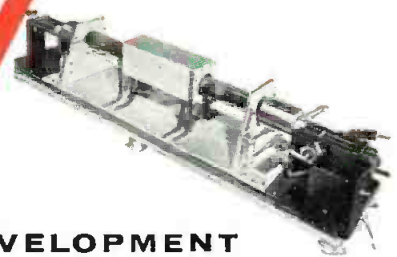

### DEVELOPMENT

Ever alert to the intensified and varied demands made by transistorizing, Tung-Sol provides full-scale development of new semiconductor types. Here the latest techniques of germanium diffusion are explored.

# New Production Facilities for Tung-Sol Semiconductors

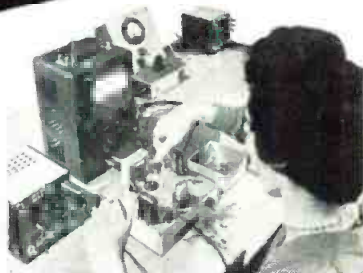

### TESTING

100% testing—life, mechanical and electrical—characterizes the Tung-Sol manufacturing program. In this illustration, transistors are 100% checked for noise factor.

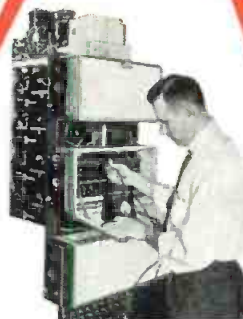

### QUALITY CONTROL

Every step of Tung-Sol semiconductor manufacture is subjected to intensive quality control that permits no compromise with premium quality. Here transistors are life-tested under conditions in excess of their ratings.

### PRODUCTION

A complete manufacturing division—with its own full-time engineering and management staffs—handles every phase of the critical production process from metal refining to finished product. Here germanium ingots are being sliced into 15/1000" blanks.

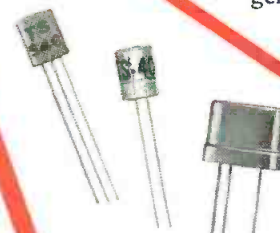
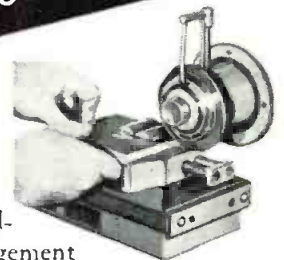

**ts TUNG-SOL<sup>®</sup>**  
**SEMICONDUCTORS**



For technical information write to Commercial Engineering Division

**TUNG-SOL ELECTRIC INC., Newark 4, N. J.**

SALES OFFICES: ATLANTA, COLUMBUS, CULVER CITY, DALLAS, DENVER, DETROIT, MELROSE PARK (ILL.), NEWARK, SEATTLE



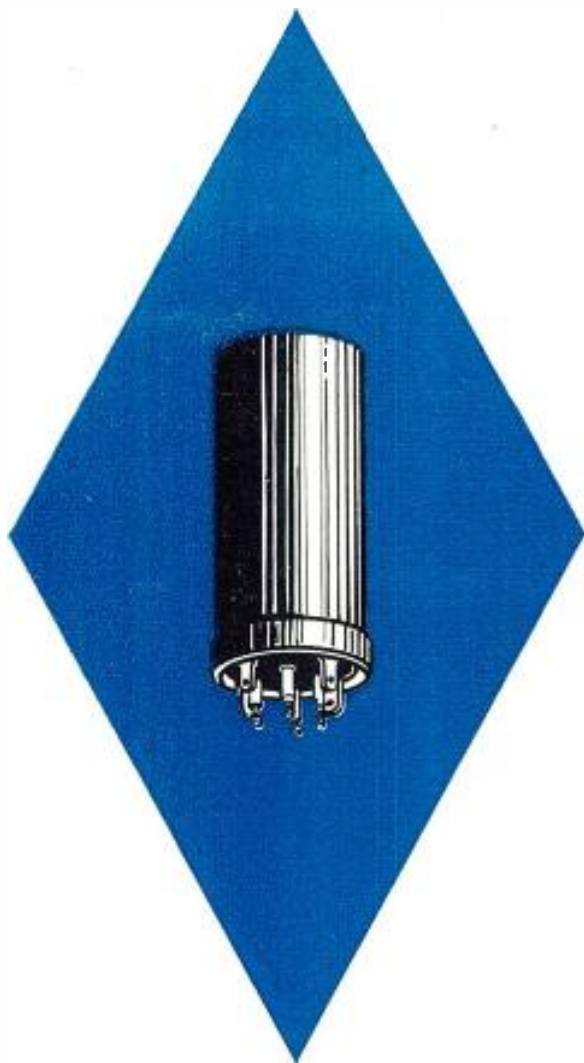

## **EXTENDED LIFE ELECTROLYTIC CAPACITORS**

*now available for*

**military electronics**

**computers**

**laboratory test instruments**

**industrial controls**

**other electronic applications**

HERE ARE CAPACITORS OF THE SAME *MAXIMUM RELIABILITY* which Sprague has long supplied to the telephone systems . . . now available for your own high reliability electronic applications.

The use of especially high purity materials . . . utmost care in manufacture, constant observation and quality control of all operations have made Sprague Extended Life Capacitors outstanding for their long life and faultless performance.

Type 17D Extended Life Electrolytics have turret terminals and twist-mounting lugs. A special vent construction is molded right into the cover, as are the numbers identifying each terminal. The aluminum cans are covered with a corrosion-resisting insulating coating.

Nineteen standard ratings, all characterized by low maximum leakage current and remarkable life test capabilities are available in the new series. Complete technical data are in Engineering Bulletin 340, available on letterhead request to the Technical Literature Section, Sprague Electric Company, 233 Marshall Street, North Adams, Massachusetts.

# **SPRAGUE**<sup>®</sup>

*world's largest capacitor manufacturer*

Export for the Americas: Sprague Electric International Ltd., North Adams, Massachusetts. CABLE: SPREXINT.

# ELECTRONIC INDUSTRIES

## & TELE-TECH

M. CLEMENTS, Publisher ★ O. H. CALDWELL, Editorial Consultant ★ B. F. OSBAHR, Editor

### Electronic Operations

Electronic Operations . . . that's the name of a new section that will be appearing monthly in ELECTRONIC INDUSTRIES & Tele-Tech starting next January. Since World War II, the electronic industries have been growing at a phenomenal rate. Some industry leaders, for example, predict that by 1965, the electronic industries will account for a \$22 billion annual volume as compared to the \$9 billion for this year. Obviously, to keep pace with this industrial expansion our editorial coverage must also expand.

Electronic Operations will be a section devoted exclusively to communication engineering. It will report the latest developments, operational techniques, and solutions to engineering problems in such fields as radio and television broadcasting, mobile radio systems and microwave communica-

tions—in short, a monthly operations manual.

In keeping with our controlled circulation policies, this special section will only be bound into those copies destined for practicing communication engineers. Of course, where a communication editorial feature has an industry-wide appeal, it will be published in the magazine for across-the-board distribution.

The additional pages that the new Electronic Operations section will provide will also enable us to serve all of the other segments of the electronic industries more fully. We believe that communication engineers will find the new section of utmost benefit and we hope that they will let us know from time to time what topics that are most important to them.

Watch for it! Electronic Operations starting in January.

### The Weather—Electronically

When it comes to tropical storms, we are "sitting ducks." After they strike, it is too late to flee, and the resulting damage is most costly. In the West, for example, tornadoes cause losses of \$200,000,000.00 annually. Along the Atlantic and Gulf coasts, hurricane damage exceeds \$1,000,000,000.00. No wonder there is a popular demand for a warning system that provides earlier and more accurate advice concerning these storms.

The Weather Bureau is now doing something about this—electronically. Along the East and Gulf coasts, they have 15 radar installations and in the West, 45 installations. These are 10 cm., medium power installations with a nominal range of 200 miles. Early this year they placed an equipment order for 31 new installations. These units, especially designed for weather reporting, have a peak power of 0.5 megawatts; 10 cm wave length; narrow beam (1.8°). First deliveries are expected late in 1958 at the rate of five (5) per month.

How does radar help in forecasting storms? Experience at Hatteras shows that the "eye" of a hurricane can be traced continuously at a distance of 160

miles. This means a warning can be given to the expected areas about 11 hours before the storm strikes. (Storm reports from ships and even aircraft "storm-hunters" are not continuous and hence not very accurate.)

In the West, tornadoes are traced by radar. Also, heavy rainstorms can be seen as far as 100 miles away so that warnings of possible floods can be telephoned to areas likely to be involved.

Why has radar not been used more fully before by the Weather Bureau? First, operational research, (now in progress) with this new tool was necessary. Personnel had to be trained to identify what the scope revealed and, most important, money had to be appropriated. Nearly all of this is now being done and we soon will be ready to match wits with the coming hurricanes. It will be interesting to observe the speed and accuracy of forecasts coming from the Weather Bureau Hurricane Forecasters Center at the National Airport, Washington and at Miami, Florida. Success in this project will open the door to a new avenue of business for the electronic industries.

# RADARSCOPE

Revealing important developments and trends throughout the spectrum for radio, TV and electronic research, manufacturing and operation

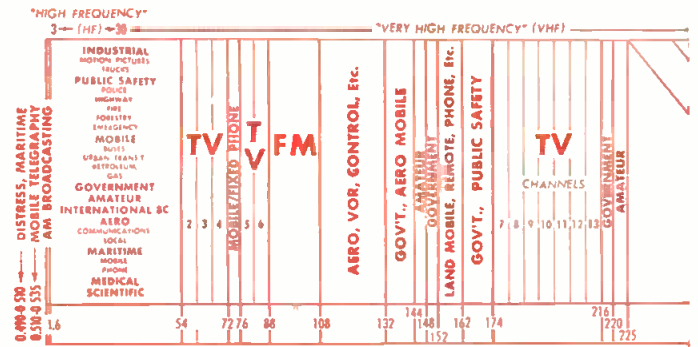

**PINCER MOVEMENT** developing in the TV industry, and working against UHF, was described to the Senate's Commerce Committee by CBS president Frank Stanton. He pointed out that on the high end of the price scale is the comparatively expensive color set, without UHF tuner, which is killing off expensive black and white models. On the low end is the small portable receiver which, first, is so compact that it is difficult to put a UHF tuner in it, and, second, because it is sold at a price sometimes under \$100, there isn't enough margin to include the all-channel tuner. Stanton added a recommendation that the excise tax be removed on color TV sets.

**IMPROVED TRANSISTORS** are in sight with the discovery of a new method for extracting boron during the manufacture and commercially available silicon. Discovered at Bell Telephone Laboratories, the method utilizes the reaction of molten silicon with water vapor. This reaction oxidizes the boron, and the oxidation products evaporate.

## "AVALANCHE" DIODE



Bell Labs' Dr. H. S. Veloric checks a new diffused junction silicon "avalanche" diode, so-called because it exhibits a very sharp reduction in impedance at a certain specific inverse voltage. New units find application in voltage regulation or control devices.

**COMPUTER INDUSTRY** is speaking of as many as 150 "giant" computer installations—the size of the Univac and IBM 700 series models—by the end of 1957. Pressing problem for the industry is the lack of trained mathematicians and programmers. Lack of trained personnel could seriously impede future progress.

**STORM WARNINGS** are up over the potential of the videotape recorder. CBS has already signed a pact with The American Federation of Television and Radio Artists designed to cover actors from TV shows telecast from tape. Jurisdictional battle developing here as the Screen Actor's Guild regard video recording as just another form of pre-recorded show. Big question before the industry is the role of networks. Why expensive live hookups when the same effects can be achieved by merely shipping a roll of tape to the station. With video tape-recorded programs only weeks away, the problem demands a quick solution.

**U. S.-SOUTH AMERICA TV LINK** is visualized by Dr. Du Mont. He foresees live telecasting between the United States and Venezuela in the near future by means of "forward scatter" facilities between Florida and Cuba. Final jumping off point for the signal would be a transmitter site located on a 9,000-foot mountain near Port-au-Prince, Haiti.

**NEW SOLID "ELECTROLYTE"** for electrolytic capacitors, developed by Bell Labs, does away with the leakage and evaporation problems which are common with liquid electrolytes. Semi-conducting oxide replaces the liquid; the anode may be any one of the film-forming metals, but tantalum is preferred. Voltage ratings as high as 35 volts are readily achieved with the new capacitor, and the units are highly resistant to aging.

**SUPERSONIC AIR CARGO PLANES** flying at speeds of 1,000 miles per hour non-stop between any two points on the earth's surface were described to the meeting of The International Civil Aviation Organization as background material to aid them in their planning for air navigation aids and services for the next 20 years. At the same time, the value of helicopters as cargo- or passenger-carrying commercial transports was minimized. Instead, the organization was advised to anticipate new radically designed aircraft having short take-off and landing distances and using devices such as jet flaps.

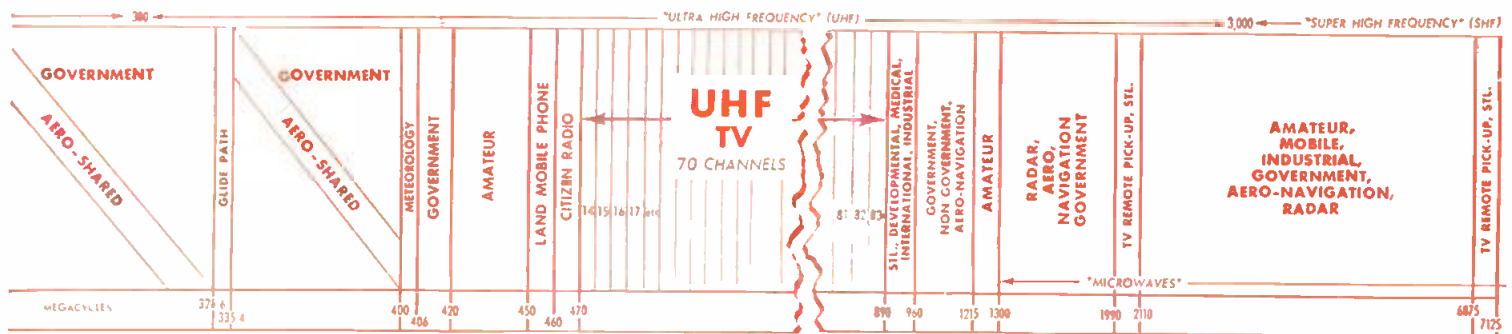

"FLAME CERAMICS," a new method of coating metals and other substances with ceramic materials, may be the solution to the "thermal barrier" problem encountered in the high speed flights of rockets and missiles. Coatings consist of powders, usually a single oxide, such as alumina or zirconia, with necessary additives, that are sprayed through a flame torch, either oxy-acetylene or oxy-hydrogen. Tests have shown that underlying metals actually can be melted without causing coating failure.

ATOMIC AGE MATHEMATICS is showing up the weaknesses in present day math teaching methods. The Carnegie Corporation last month announced a \$277,000 grant to the Univ. of Illinois to develop better ways of teaching mathematics in high school. Completely new approach is necessary because the increasingly acute national shortage of scientists and engineers is largely due to the fact that students in college have had inadequate preparation in mathematics.

RADAR STORM WARNING network will be installed by the U. S. Weather Bureau. Units will be able to detect and track hurricanes and tornadoes up to 250 miles away, allowing meteorologists to make continuous checks on storm progress and development. Newly developed radar units are reportedly able to penetrate deeper into severe storms than those of existing weather radar, so that weather experts will now be able to plot the storm's depth as well as its frontal edge, to better gauge the location and shape of the storm's eye. Raytheon Mfg. Co. has been awarded a \$3,800,000 contract to supply the equipment.

### ENGINEERING EDUCATION

RETIRED SCIENTISTS AND ENGINEERS are being recommended as a partial solution to the present shortage of science and mathematics teachers. Recommendation was made by the advisory committee on science manpower appointed by the New York City Board of Education. Report of a survey made June 26, 1956, showed a lack of 47 full-time science teachers needed to staff 235 science classes in New York City high schools in September. To ascertain how many retired scientists and engineers are qualified to teach, and will be willing to teach, all those retired scientists and engineers interested in the program are being urged to contact the local Board of Education. At this stage, only part-time

teaching is planned in order to alleviate the shortage of science teachers in the secondary schools.

ANOTHER PLAN for encouraging more college graduates to enter teaching in the sciences and mathematics, known as the Lexington Plan, is being tested by the Arthur D. Little, Inc., research staff in Cambridge and the high schools of Lexington, Newton, and Acton-Boxboro in Massachusetts. Two graduates with degrees in the specific subject are being hired jointly by the firm and a school on a three-year basis. While one of the pair is teaching, the other works in the laboratory, then half-way through the school year the two change positions. Although the men will be paid half at industrial and half at teaching rates, the differential will be partially eliminated by the fact that both will be doing lab work during the summer vacation period. Those appointed should earn approximately \$1,000 more per year than a starting teacher's salary.

### GRAPHIC FURY

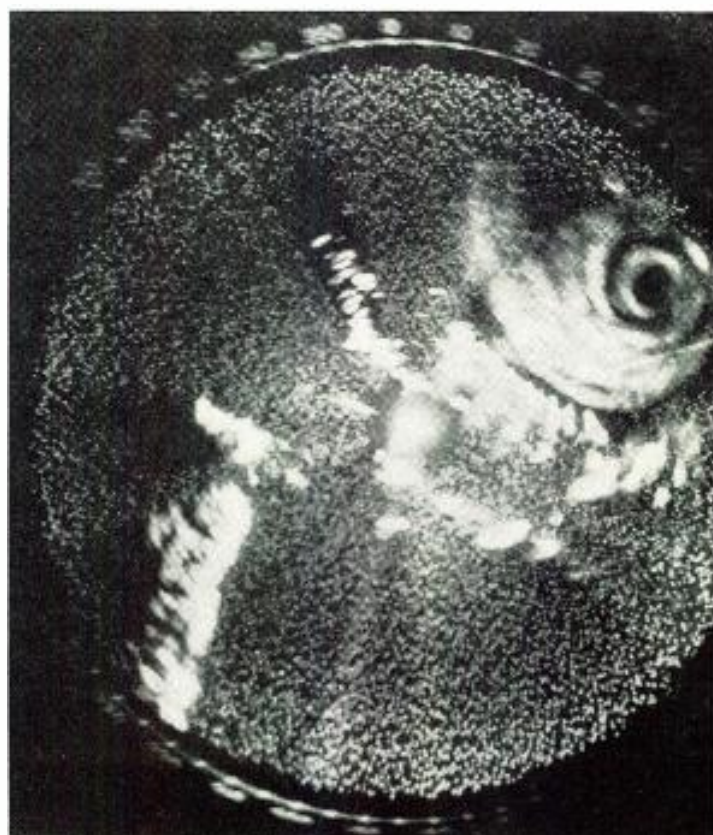

Here is how Typhoon "Clara" looked on the radarscope as it passed within range of the USS Oriskany near Okinawa last August. Swirling "Clara" is shown at upper right, with eye and tail clearly visible. Scope is a GE AN/SPS-8.

## First Design Data on

# New Portable

Extensive use of transistors has made possible a light weight, back-pack video transmitter for remote TV pickups. Equipment components are suitable for use as remote, studio, or closed circuit.

By **ARNOLD E. LOOK**

Assistant Editor, *ELECTRONIC INDUSTRIES & Tele-Tech*



Fig. 1: Portable TV in use

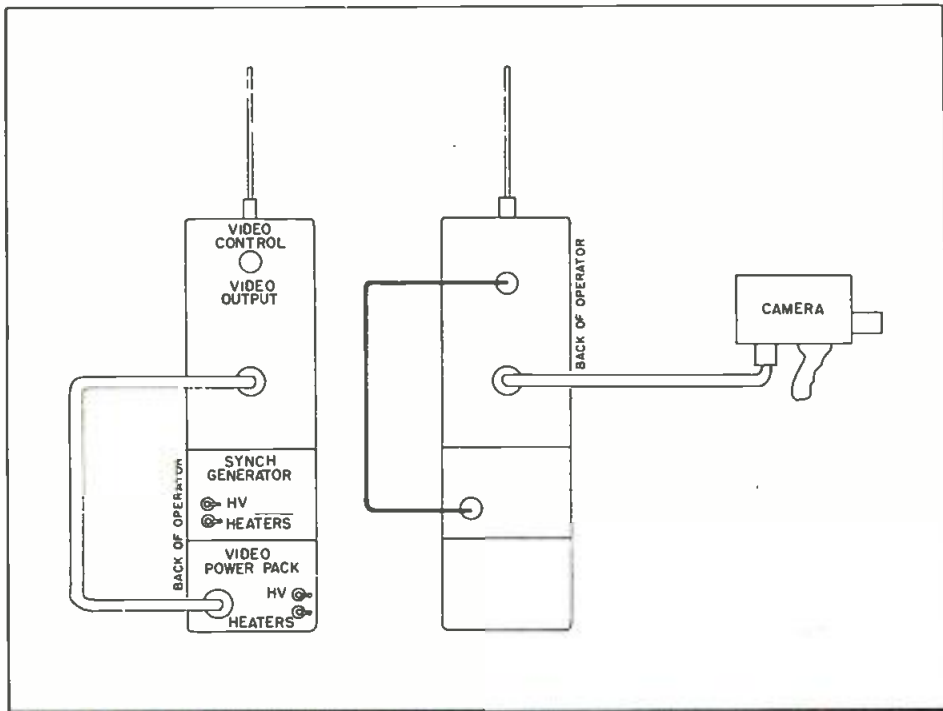

Fig. 2: Outline of equipment identifying components

Fig. 3: Block diagram of portable TV equipment

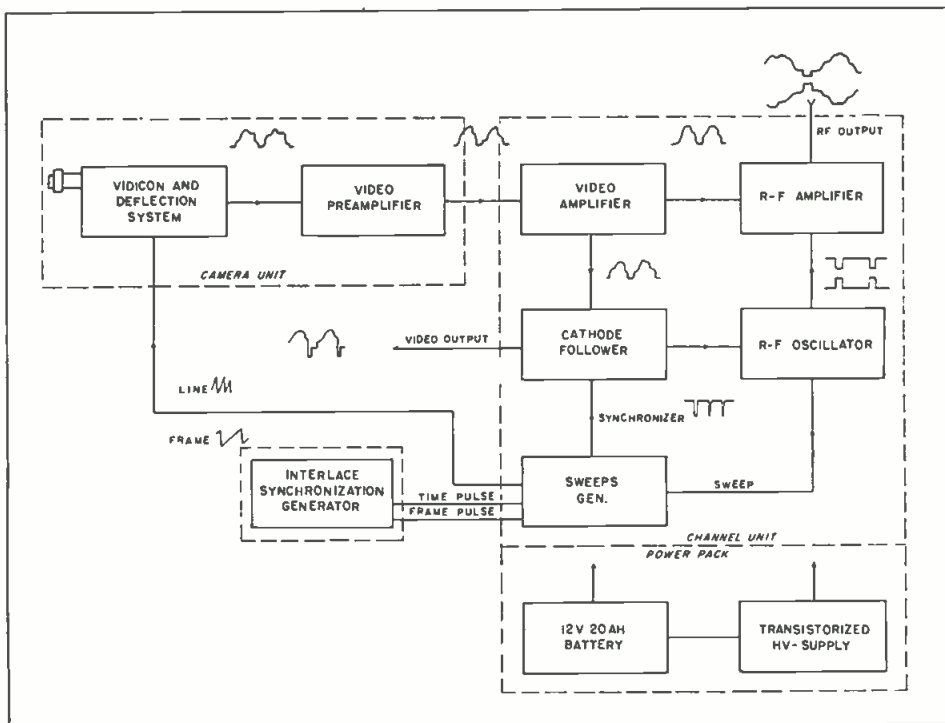

Fig. 4: Total weight—28 lb.



**B**IG TV news both here and abroad is the completely self-contained portable video camera and transmitter now in use by CBS. This portable equipment, a product of Intercontinental Electronics Corp., Mineola, N. Y., closes one of the last major gaps in TV broadcast equipment. The new equipment, weighing only 28 pounds, enables a cameraman to operate with complete independence for at least three hours—transmitting to a remote pickup receiver located up to a mile in distance (depending on the terrain). With two additional sections added to his back-pack, the cameraman can operate up to 5 miles from the pickup point. Careful system design has resulted in a versatile camera. By the use of various component combinations, the broadcaster can use this equipment either as a remote, studio, or closed circuit camera system.

# TV Camera-Transmitters

## Modulation

Among the more novel features of this equipment is the use of positive modulation. The advantage of this for portable equipment is immediately evident with the realization that such operation causes sync. pulses and black level to occur at minimum rather than at maximum output power. Elimination of pulse power demands is a major factor in the low weight of the equipment. A further advantage is simplified AGC (automatic gain control).

Further weight savings result from the use of a silver cell battery and a completely transistorized power supply. Transistors have been used where possible,

but the use of transistors for video circuits was precluded by inherent noise, and where this problem arose tubes were used. Video bandwidth is 7 MC, although this is limited to 4.5 MC at the transmitter in order to conform

to FCC standards. Similarly, the sync. generator is crystal controlled, although good stability is evidenced if the crystal is pulled and the generator left free-running.

(Continued on page 129)

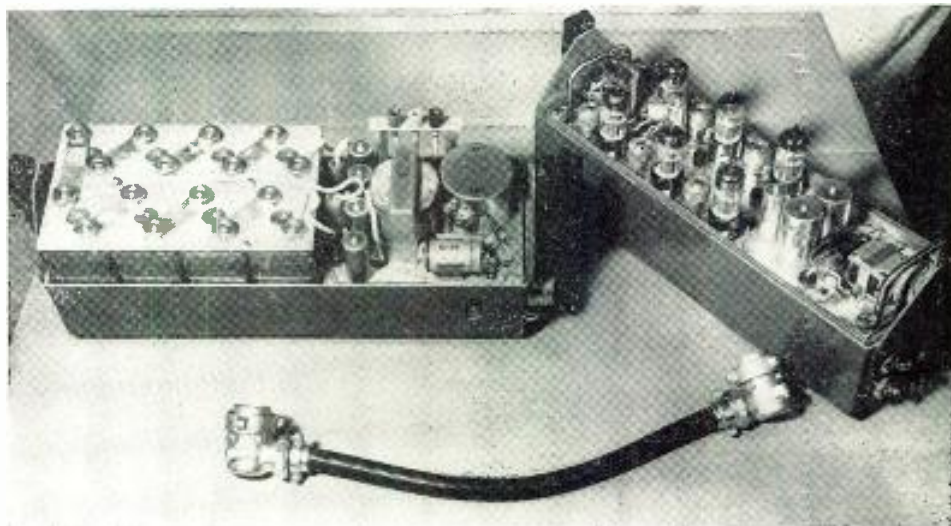

Fig 5: Power supply (I) and sync gen. (R)

## NBC and ABC Convention Cameras

Spot news telecasting and TV field pick-up functions in general for the Democratic and Republican National Conventions in August were greatly improved with the development of new small cameras by the three major TV networks.

Radio Corp. of America employed a transistorized miniature TV camera and portable transmitter able to transmit at least a mile from a base station. Used by NBC during the Chicago and San Francisco conventions, this experimental equipment includes a 4-lb. camera having an electronic viewfinder, and a 15-lb. back-pack transmitter.

American Broadcasting Co., which pooled TV coverage of the conventions with the Columbia Broadcasting System and NBC, came up with a 10-oz. TV camera called the "pipsqueak" that must,



Fig. 1: Operating test of RCA experimental portable TV camera and back-pack transmitter. Electronic viewer is in operator's right hand. Tiny unit in other hand is Vidicon camera unit.

however, be linked to a home base by a half-inch cable. CBS has a cable-connected camera weighing 1½ lbs., as well as their portable transmitter unit. The ABC sub-miniature camera, resembling a flashlight in size and shape, is four inches long, and two inches in diameter; the lens is only a quarter of an inch in diameter.

RCA and NBC used portable cameras and transmitters for coverage of both 1952 political conventions, but claim important advances with this year's equipment. Seventy transistors are used in the entire RCA assembly, with all but the transmitting and pick-up tubes being transistorized. Camera is built around RCA's Vidicon TV camera tube which is one-half inch in diameter, and has an electronic viewfinder which may be detached from the camera and hung around the cameraman's neck.

The camera used by RCA and NBC is 2½ in. high, 3 in. wide and 8½ in. long, exclusive of the viewfinder; back-pack transmitter, also completely transistorized, is 12 in. wide, 13 in. high and 3 in. deep. Batteries for the unit last about five hours, according to L. E. Flory, a member of RCA's Princeton Research team.

# Designing "Free-Power" Transistorized

Milliwatt-powered units rectify the r-f carrier transmitted by broadcast stations and utilize it as operating voltages. Described are practical circuits that operate successfully at distances up to 12 mi. from the transmitter.

By Dr. H. E. HOLLMANN,

Director of Research,  
Marvelco Electronics Div., National Aircraft Co.  
3411 Tulare Ave., Burbank, Calif.

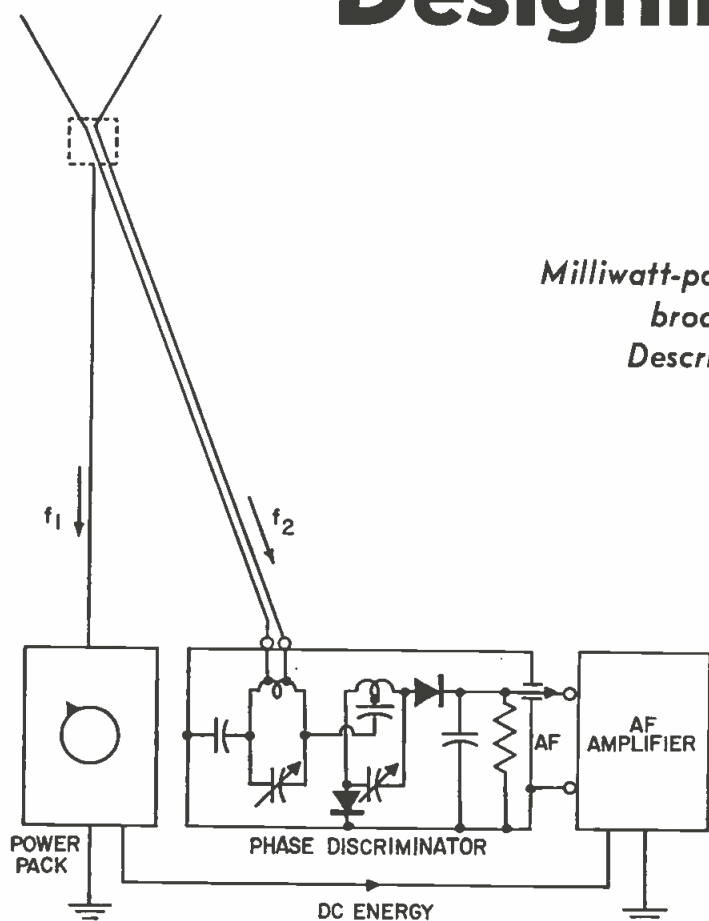

Fig. 1: Schematic of semi-passive FM receiver.

FREE power is the energy which can be recovered from energy reservoirs and energy fields in our environment at no extra cost. Thanks to the remarkably low power requirements and high energy conversion efficiency of transistors, free power has become significant for the supply of electronic and radio devices.

In the first article of this series, "Designing 'Free-Power' Transistor

Apparatus" (Aug. ELECTRONIC INDUSTRIES), different types of free power and free-powered transistor apparatus were described.

Within the realm of "free" power, the radio energy for the driving of transistorized communication apparatus and communication systems is termed "Secondary Power." The electromagnetic radiation of one communication system, for example the broadcast network, after

having fulfilled its original purpose, is utilized a second time in the same field, namely for the detection and amplification of radio signals, for the conversion of frequencies and modulation, for the transmission of new intelligence signals, and finally for duplex or multiplex communication around the master transmitter.

In order to obtain a useful insight into the level of available secondary power, certain rules of thumb are convenient. In the lower band of the radio frequency spectrum, a transmitter with the power  $P_{TR}$ , an omnidirectional antenna with an efficiency  $k$ , and at a distance of  $D$  kilometers produces the field strength

Fig. 2: (l) Block diagram of semi-passive AM receiver Fig. 3: (r) Schematic of semi-passive AM receiver.

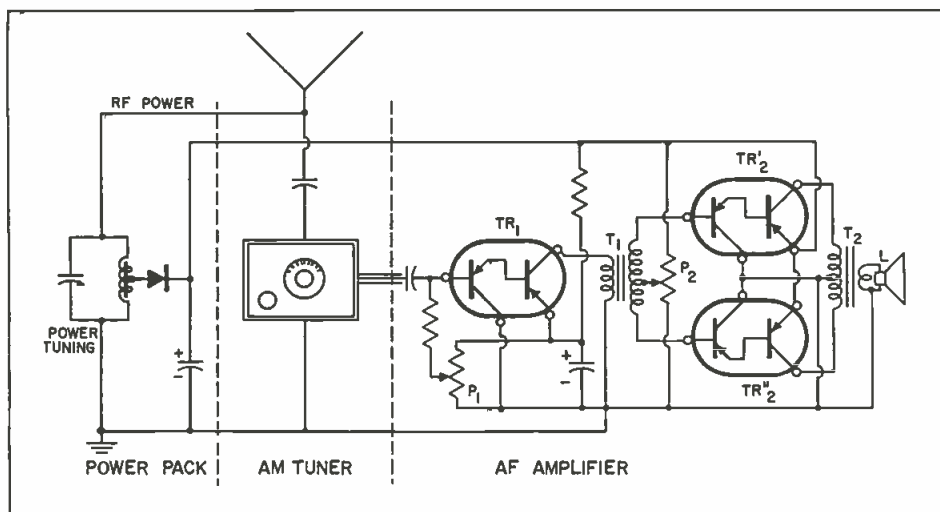
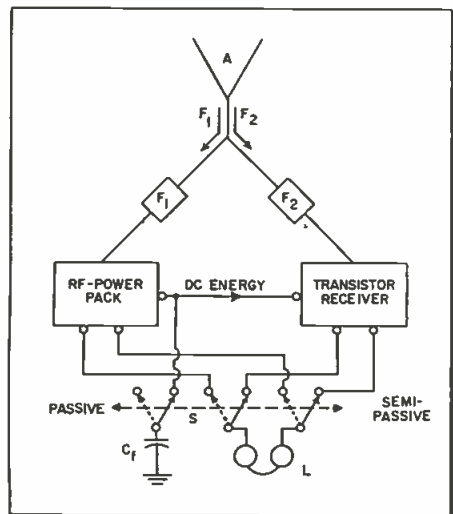



# AM & FM Receivers

$$E_{mV/m} = \frac{300}{D_{km}} \sqrt{k P_{TR_{kw}}} \quad (1)$$

On the other hand, the power through a given area is

$$P_{\mu w/m^2} = \frac{(E_{mV/m})^2}{377 \text{ ohms}} \quad (2)$$

wherein 377 ohms is the impedance of free space. At the lower end of the radio spectrum, the simplest antenna is a quarter-wave wire with the length  $\rho < \lambda/4$  and resonating with the incoming rf. The collecting ability of such an antenna can be expressed in terms of its intercept area which, in a first order approximation, is a rectangle with the length  $\rho$  and the width  $\rho/2$ . Consequently, the received rf energy becomes

$$R_{rec_{\mu w}} = 1.3 \left[ E_{mV/m} l_m \right]^2 10^{-3} \quad (3)$$

Only a fraction of this amount can be converted into dc energy depending upon the antenna gain, antenna efficiency, impedance match, conversion efficiency, and many additional factors. If we assume an over-all efficiency as high as 50%, a secondary energy in the order of

$$P_{dc_{\mu w}} = 6 \left[ E_{mV/m} l_m \right]^2 10^{-4} \quad (4)$$

is available. The introduction of eq. (1) into (4) yields the formula for secondary power

$$P_{dc_{\mu w}} = 50 P_{TR_{kw}} \left( \frac{l_m}{D_{km}} \right)^2 \quad (5)$$

For example, a broadcast transmitter having an rf energy of 25 kw and an antenna efficiency of 80% may be 5 km away. With the aid of a 10 m wire, dc power in the vicinity of five milliwatts can be collected.

## Semi-Passive Receivers

The most illustrative application of secondary power is the driving of sensitive transistor receivers. If the secondary power is recovered

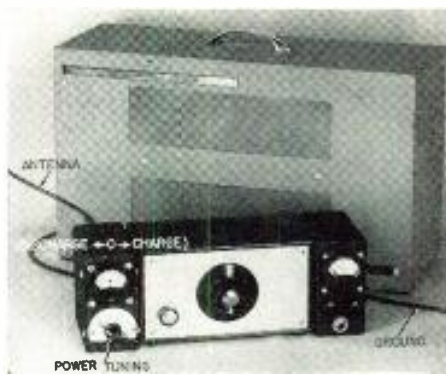

Fig. 4: Lab model of Fig. 3 with crystal sets and transistor audio amplifier.

from a telegraph or telephone transmitter, the primary modulation signals must be suppressed so that the receiver is fed by pure DC energy. In such a way, a passive receiver is obtained without the necessity for a local power source but nevertheless exhibiting all the characteristic features of an active device. An rf-driven radio receiver, therefore, may be termed "semi-passive." Carrier energy from a local broadcast station can be utilized for the detection and amplification of signals from weaker and distant stations. Interesting legal questions may arise from such utilization of radio energy.

Fig. 2 is the block diagram of a semi-passive receiver illustrating the underlying principle. The various forms of rf energy, i.e., the modulated large signal oscillations of the local broadcast station with the frequency  $f_1$  on the one hand and the much weaker signals of a remote station with the frequency  $f_2$  on the other hand, are picked up by the common antenna A. Filter networks  $F_1$  and  $F_2$  provide an rf switch and direct the powering frequency  $f_1$  to the rf power pack at the left and the intelligence signals to the active receiver at the right side. The power pack is a well-matched crystal set having such a large filter capacitor  $C_r$  that all modulation signals are eliminated and a pure dc voltage develops across its terminals. Any arbitrary type of transistor receiver with a minimum requirement for driving energy may be used with this power pack. The simplest form is a standard crystal set driving a transistor audio amplifier. The latter then is fed by the dc energy delivered by the rf power pack. The en-

tire receiver, therefore, exhibits two tuning knobs, one for "power tuning" and the other for the tuning of the desired signals.

Switch S permits the earphone or loudspeaker L to be connected with the output terminals of the active part of the receiver, or the end stage of the audio amplifier or with the output of the power pack in which case the large filter capacitor  $C_r$  is disconnected. This permits the accurate power tuning and, at the same time, a passive detection of the powering transmitter.

It is clear that the active part of a semi-passive receiver, in our example the audio amplifier, must be very efficient, more accurately, must combine a high sensitivity or gain with a minimum supply energy but not, of course, at the expense of noise and fidelity. A transformer-coupled cascade of tandem transistors with push-pull output was found most satisfactory, in particular with respect to the necessary compromise between gain and fidelity.<sup>(2)</sup> Fig. 3 illustrates the developed circuitry while Fig. 4 is a photograph of an experimental model. The passive crystal set for the detection of the incoming signals, in this case a hi-fi AM tuner—Miller 595—is in the center with the rf power pack at the left and the audio amplifier at the right side. The receiver exhibits several unique features which will be explained in more detail.

The AM tuner directly feeds the driver stage without the help of a coupling or matching transformer. The preamplifier,  $TR_1$ , via push-pull transformer  $T_1$ , controls the two tandem transistors  $TR_2'$  and

Fig. 5: AM semi-passive receiver deriving power & intelligence from single station

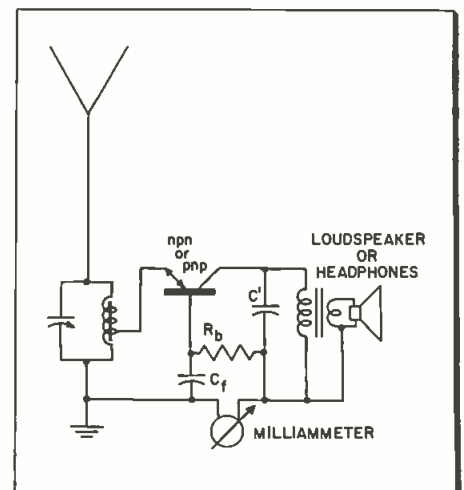

## Free Power (cont.)

TR<sub>2</sub>'s which, in turn, drive the loudspeaker L via the push-pull output transformer T<sub>2</sub>. Variable bias voltages are taken across the potentiometers or voltage dividers P<sub>1</sub> and P<sub>2</sub> and permit proper adjustment of the dc levels and the quiescent operating points of both stages. Potentiometer P<sub>1</sub>, at the same time, is a volume control in that its bias controls the preamplifier's gain. The bias of the push-pull stage must be adjusted for class-AB operation with a minimum cross-over distortion.

### Volume Compression

The amplifier exhibits an inherent form of automatic volume compression and thus protects itself against overcontrol and clipping. Since the rf power pack has a high internal impedance, it feeds the amplifier with constant current rather than with constant voltage. The net result is that the class-AB operation is suppressed and that the driving voltage fluctuates according to the signal amplitudes. Because the input bias and the associated gain of the preamplifier is a function of the supply voltage, the preamplifier keeps a constant output level.

### Filter Cell

The automatic gain compression can be eliminated with the aid of a very large filter capacitor C<sub>f</sub> which, during the periods of weak signals, stores enough electrical energy to cover the peaks. Instead of such a condenser, a minute storage cell or wet cell may be utilized to

help the transistor amplifier to operate as a perfect class-AB stage. The polarization voltage of the wet cell adjusts itself automatically in such a way that the average battery current is close to zero.

Whatever the supply energy amounts to, whether there is enough to drive only an earphone or whether several milliwatts are available for the driving of an efficient loudspeaker, the described semi-passive receiver permits the detection of a multiplicity of remote stations with excellent quality.

### FM Receiver

A semi-passive fm receiver is illustrated in Fig. 1. The previous am tuner is replaced with a passive fm tuner in the form of a phase-discriminator directly operating at the incoming uhf. A double antenna is used for power and the fm signals, namely a metal mast connected with the power pack and an fm dipole on top with a feeder line going to the phase discriminator. A prerequisite for successful operation of the experimental semi-passive fm receiver is not only a powerful local station for power but, at the same time, a powerful fm station for the input signals. Whether the passive fm tuner can eventually be replaced with an active one sensitive enough to be fed with the minute amount of secondary power available is a matter of future transistor development.

A semi-passive receiver with simplified circuitry can be constructed if it is limited to obtaining both power and intelligence from the same transmitter.

Since the powering frequency  $f_1$



Fig. 8: Lab model of receiver in Fig. 7.

and the signal frequency  $f_2$  are the same, the receiver has only one tank circuit from which supply energy and signals are recovered simultaneously. Fig. 5 illustrates the circuitry of such a receiver whose transistor performs a multiplicity of functions.

The transistor can easily be seen in common-base configuration. Its emitter diode takes the place of a conventional detector and performs the necessary rectification of the modulated carrier amplitudes. At the same time the emitter diode charges the large filter condenser C<sub>f</sub> and thus provides power for the collector. In addition, a small dc voltage develops across the emitter diode and provides bias for the emitter. The collector is loaded with an output transformer by-passed by the condenser C' while the base return resistor R<sub>b</sub> provides the proper dc level and thus the optimum loading of the power pack.

Since the transistor converts incoming rf energy into its own supply energy, its type of conductivity does not matter and, without altering the circuitry, the receiver may

(Continued on page 92)

Fig. 6: (l) Experimental passive power receiver of Fig. 5.

Fig. 7: (r) Receiver with volume control and audio amplification.

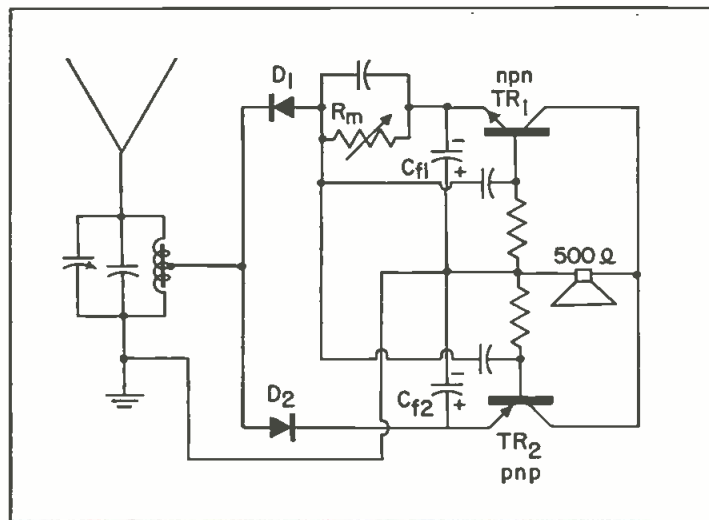
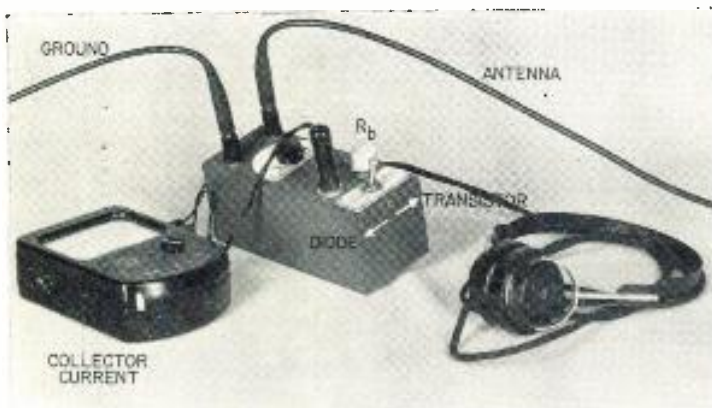

# Effects of Radiation On Electronic Components

By Dr. R. D. SHELTON

Admiral Corp.,  
Chicago 47, Ill.

*Damage resulting from nuclear radiation is a function of the type and energy distribution of the radiation as well as temperature, humidity, stress, and rate of irradiation*

THE advent of nuclear power has made it necessary for electronic components to withstand the additional environmental factor of nuclear radiation. A complete description of the radiation field at a point in the vicinity of a reactor requires a knowledge of the amount and energy distribution of the neutron and gamma flux, although the usual compromise is to divide the nuclear radiation into three parts, viz., gamma, fast neutron and thermal neutron.

The gamma field intensity is commonly measured in Roentgens/hr or in gammas/(cm<sup>2</sup> sec) at some average energy. Thermal neutrons, being easily removed by thin layers of boral or cadmium, are often ignored, and the remaining neutron flux is divided into two parts, fast and epithermal.

The energy distribution of the radiation may vary considerably with position, and is extremely difficult or impossible to measure or calculate in many cases; however, the neglect of the energy spectrum may lead to large errors in the calculation of damage. Even if the reactor spectrum is known initially, the selective transmission and moderation usually leads to a different spectrum after a few mean free paths in the shield.

## *Damage Factors*

The damage resulting from nuclear radiation is a function of the type and energy distribution of the radiation as well as of the other environmental factors such as temperature, humidity, stress, and rate of irradiation. The possible number of variables to consider makes it difficult from a time and space point of view to do a thorough testing of a large number of electronic components under all conditions.

In addition to environmental problems, statistical problems must be considered also. All components satisfying a given electronic requirement are not identical: A manufacturer may change the materials in a vacuum tube type during production. The electronic characteristics may be unaffected by the change, but the resistance to radiation damage may be changed radically. A life test of vacuum tubes may yield widely dispersed data; and the effects of radiation may be superimposed in some fashion on the already scattered data points. The number of electronic components which should be tested together to yield statistically reliable data will, of course, depend on the component and the test being made.

Radiation damage may be indirect, i.e., radiation may produce a situation that enables damage to proceed from other causes. For example, a capacitor could be damaged by heating if leakage were increased by nuclear radiation.

An electronic component may be unsatisfactory for operation in a radiation field either because it is influenced immediately by the field or else because it deteriorates in the field or both. For example, immediately on being placed in a radiation field, a capacitor will exhibit an increased dissipation factor, dark current will increase in a photo-cell, and the resistance of a resistor will fall. The radiation effects listed here are called rate effects because they are functions of the intensity or rate of irradiation. These rate effects may vary as the irradiation progresses. In almost all cases the component will deteriorate under continued radiation, the degree of deterioration being a function of the integrated

flux. In this case we have an integral effect.

Damage by neutron and gamma radiation is selective and not additive. Gamma radiation may produce one chemical reaction and neutron radiation another. It is conceivable that a component may fail in one way in a neutron field and in another way in a gamma field.

It is quite impossible to anticipate the exact environments to be expected for electronic components in nuclear power applications. For example, a nuclear-powered space rocket would be expected to present a different problem than a nuclear-powered cargo vessel. Resistance to shock may decrease with irradiation whereas the electrical characteristics may remain the same.

## *Variables*

There are many variables involved in the study of radiation effects, and each application of nuclear power will create a different environment. However, a few reasonable assumptions will make it easier for the engineer to evaluate his particular problem.

(1) The total dose at which the component deteriorates is relatively insensitive to the dose rate.

(2) An adequate interpretation of damage does not require a knowledge of the energy spectrum of the radiation.

(3) If a component operates satisfactorily in a given environment, it should operate satisfactorily in a less severe environment.

(4) Most of the rate effects arise from gamma radiation. These gamma effects include ionization leakage, photo-electric effects in the case of photosensitive surfaces, photoconduction in transistors and resistors, etc.

*(Continued on page 123)*

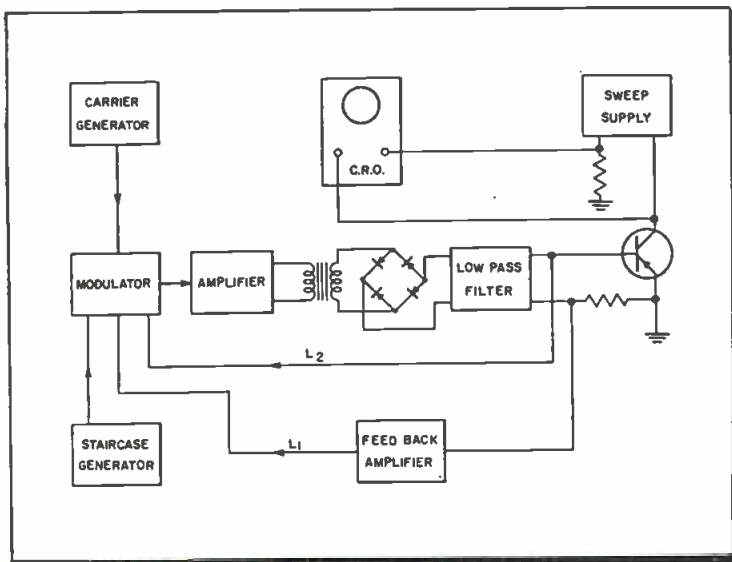

Fig. 1: Block diagram of curve tracer

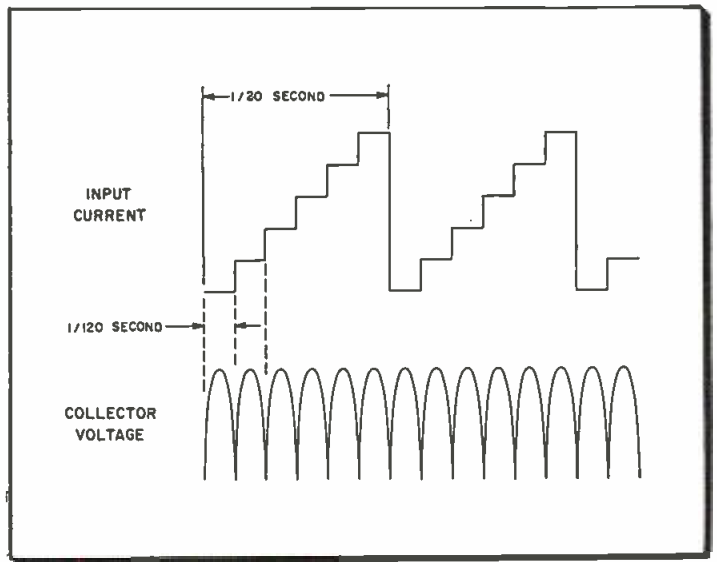

Fig. 2: Staircase generator output

# Characteristic Tracer

By S. KRAMER and R. WHEELER



S. I. Kramer R. F. Wheeler  
Fairchild Guided Missiles Division, Wyandanch, N. Y.

*Power transistor characteristics can be presented on a cathode ray oscilloscope with circuitry capable of handling peak power levels up to 1 kw. Design considerations and experimental results are presented.*

ONE of the most significant advances in transistor development has been the vast increase in their power handling capabilities. Progress in this sphere has been so rapid that techniques and the de-

Fig. 3: Typical family of collector curves

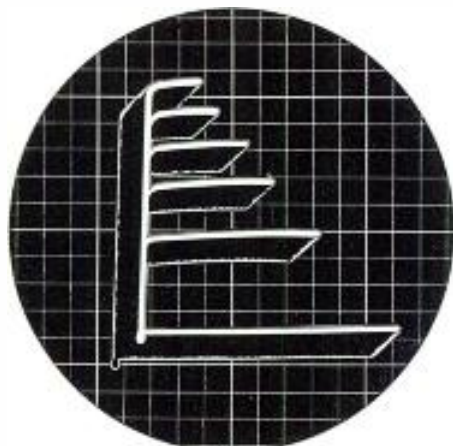

velopment of equipment for effectual measurements at these increased levels has lagged behind.

One approach which is available to the user of these new units is the brute force application of small-transistor measuring techniques. However, cursory examination of the requirements, which include a constant current supply of several amperes for the input circuit together with a collector supply of up to 100 v at perhaps 10 a. will dissuade all but the most persistent.

It should be pointed out, in addition, that these supplies must be capable of generating special waveforms for tracing the characteristics on an oscilloscope or recorder since small signal parameters which might be observed on a meter are not very useful for studying the behavior of power transistors.

### Static Characteristics

The method which is used extensively for plotting static characteristics of low power transistors is to

generate a staircase voltage which is then fed to the base or emitter through a resistor, to provide a constant current, and to sweep the collector using a rectified sinusoidal or sawtooth waveform.

Consider first the problem of supplying 10 a. of collector current ( $i_b$ ) at up to 100 v. A preliminary investigation showed that a sawtooth sweep based on a low duty cycle was ineffectual due to the fact that an extremely short sweep in the collector circuit ( $100\mu s$ ) could not be used because of capacitance in the larger power transistors which resulted in serious phase shift. To minimize flicker, a minimum repetition rate of 20 families per second was decided upon which meant that for a six curve presentation a  $2000\mu s$  sweep length would provide a duty cycle of 24%. A  $2000\mu s$  sawtooth sweep is marginal in respect to phase shift errors but does not provide a retrace, which, though not essential, is certainly highly desirable in disclosing pos-

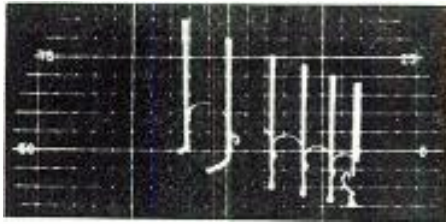

Fig. 4: 2N95 grounded base coll. curves

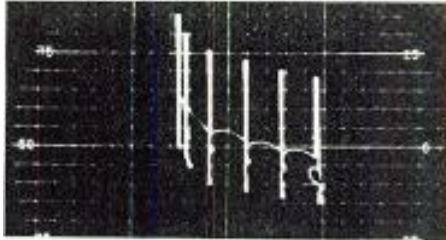

Fig. 5: 2N95 transfer characteristics

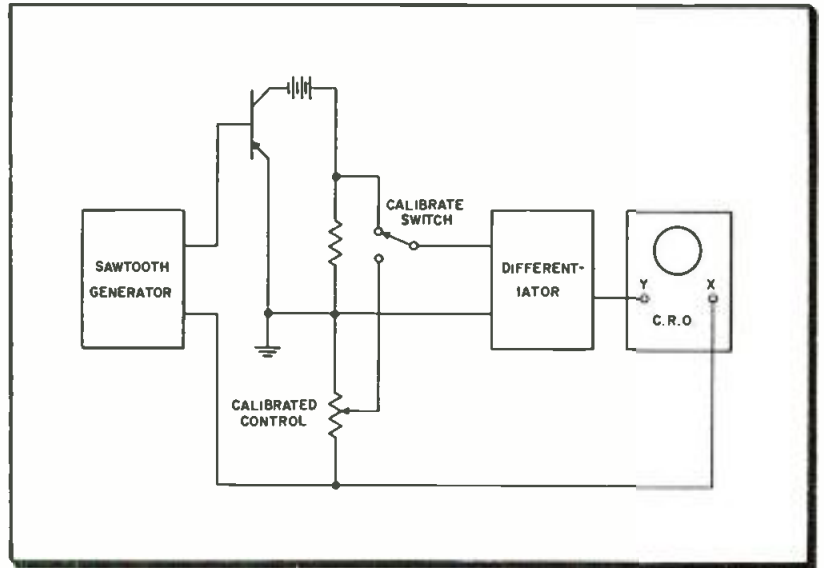

Fig. 6: System used for alpha or beta curves for small transistors

# for Power Transistors

sible hysteresis. Since the line provides a virtually unlimited source of 60 cps sine wave and requires only isolation, rectification, and a means for varying the amplitude, it was chosen to supply the collector current ( $i_b$ ). The problems mentioned were resolved by means of 1:1 isolation transformer, germanium bridge rectifier, and variable autotransformer, respectively.

## Staircase Generator

Having simplified the problem of supplying the  $i_c$ , the problem of providing several amperes of  $i_b$  or  $i_c$  from a high impedance source is magnified because of the 100% duty cycle. An electronic staircase generator reduces the average current to roughly half that required by a system using manual switching for both the input and collector circuits and is desirable for that reason plus having the obvious virtue of a simultaneous display of a family of curves. Most high power transistors, when operated near their maximum rating, have rather poor current gain figures and to utilize the capabilities of the collector supply, a maximum input current of 3 a. was decided upon.

To obtain 3 a. from a voltage source in series with a resistor requires the generation of power which is astronomical. The use of vacuum tubes and transistors to

supply the current was considered but was finally discarded in favor of a stepdown transformer to supply current gain, and feedback to provide the high impedance. Several problems were immediately encountered. The problem of passing the staircase waveform at a high power level through a transformer of practical dimensions proved a most formidable task even with large amounts of feedback. Since the collector is swept out and back, any slope in the horizontal portion of the waveform results in severe hysteresis. An even more serious problem was encountered in attempting to clamp the waveform at the transformer secondary. Due to the low voltages, and high currents, involved, no diode was found which was capable of clamping adequately. Balancing supplies were also tried but proven ineffectual due to the variability of the transistors under test, which affected the balance.

## Modulating Signal

These problems were finally resolved by generating a carrier with the staircase waveform as the modulating signal. A simplified block diagram of the system is shown in Fig. 1. The staircase generator<sup>1</sup>, delivers a waveform having a total of six steps, zero plus five. Each step is equal in width to half a

period of the 60 cps collector sweep frequency and the complete period of the staircase is 1/20 sec. See Fig. 2.

The carrier frequency was chosen as a compromise. A high frequency is desirable since it simplifies the filtering problem in the detector, and might permit the use of a simple air core transformer. However, the only available rectifiers for the detector circuit were rated for a maximum frequency of 50 KC and, in the interests of obtaining good efficiency in both the rectifiers and the iron core transformer, a frequency of 20 KC was finally selected. The output transformer is a 30 w extended range audio unit. The secondary of the transformer feeds the detector which consists of a high power germanium bridge rectifier and a low pass LC filter. Negative current feedback is taken from a resistor in series with the detected output and is fed back to the modulator.  $I_2$ , an auxiliary feedback loop, provides a small amount of positive voltage feedback for an additional increase in the output impedance.

The step size is varied by means of an attenuator in the output circuit of the staircase generator and the polarity of the output is deter-

(Continued on page 86)

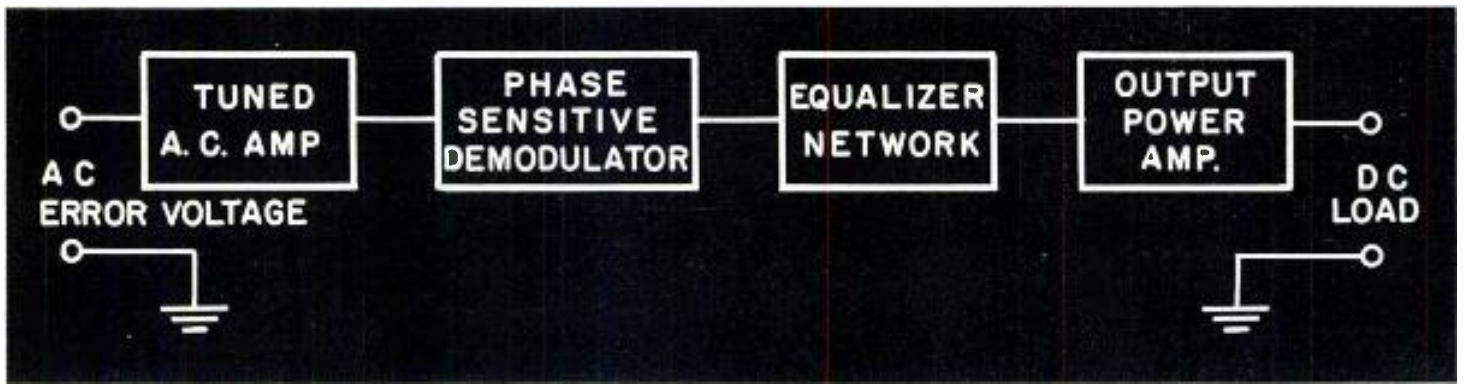

Fig. 1: Block diagram of typical servo system in which the input is carrier suppressed modulated and the output is demodulated

# A Less-Than-Minimum Phase Shift Network

Combination of a tuned amplifier and a phase sensitive demodulator obviates instabilities, permits use of high Q amplifiers

By R. F. DESTEBELLE,  
C. J. SAVANT  
and C. J. SAVANT JR.

IT is well known that for linear systems a particular attenuation is accompanied by a minimum phase shift.<sup>1</sup> The relations common to most servo designers, however, break down when non-linear circuits, such as phase sensitive demodulators, are used in the system. Often the non-linearities work to the advantage of the designer. In numerous applications, for example, a tuned amplifier is used to increase the signal-to-noise ratio. Frequently instability results if the Q of the tuned amplifier is too large. An exceptionally interesting and useful combination of a tuned amplifier and a phase sensitive demodulator obviates this instability.

Typical of many servo systems is the situation where the input is carrier suppressed modulated and the output is demodulated, as shown in the block diagram of Fig. 1. Because of the less-than-minimum phase character of the tuned amplifier-demodulator combination it is shown that one obtains a slope of 12 db per octave with a total phase shift of 90° rather than 180°. This saving of 90° lag is most helpful in stabilizing the closed loop system.

Often the servo designer is puzzled at the results of his analysis since the performance does not agree with what is expected from linear analysis. The effect of the Q of the

amplifier must be considered for a solution.

## Transfer Function

The gain of an amplifier stage can be shown to be

$$1. \quad K = G_m \Xi_1$$

where  $g_m$  is the stage transconductance and  $\Xi_1$  is the effective load impedance. Using the shunt equivalent tuned circuit of Fig. 2 one obtains the load impedance of a tuned amplifier as follows:

$$2. \quad \Xi_1 = \frac{R L / C}{L / C + j (R \omega L - R / \omega C)}$$

$$3. \quad = \frac{R}{1 + j R / L (\omega L C - 1 / \omega)}$$

Defining

$$4. \quad LC = 1 / \omega_o^2$$

Eq. 3 becomes

$$5. \quad \Xi_1 = \frac{R}{1 + j Q (\omega / \omega_o - \omega_o / \omega)}$$

where, by definition,

$$6. \quad Q = R / \omega_o L$$

Combination of Eqs. 1 and 5 results in the transfer function of an amplifier with one tuned stage.

$$7. \quad T(\omega) = \frac{A}{1 + j Q (\omega / \omega_o - \omega_o / \omega)} = \frac{A}{1 + j Q \frac{(\omega + \omega_o)(\omega - \omega_o)}{\omega_o \omega}}$$

For the systems under consideration, the input is a carrier suppressed modulated signal. The term  $\omega$  in Eq. 7 is one of the side band frequencies:

$$8. \quad \omega = \omega_o \pm \omega_m$$

For the case where the signal frequency,  $\omega_m$ , is much less than the carrier frequency it follows that

$$9. \quad \left. \begin{aligned} \omega_o \omega &\cong \omega_o^2 \\ \omega + \omega_o &\cong 2 \omega_o \\ \omega - \omega_o &= \omega_m \end{aligned} \right\}$$

With a dimensionless parameter,

$$10. \quad \sigma = \frac{\omega_m}{\omega_o}$$

substituted into Eq. 7, the transfer function becomes

$$11. \quad T = \frac{A}{1 + j 2 Q \sigma}$$

Shown in Fig. 3 is a circuit of a peaking type phase sensitive demodulator where the input is a carrier suppressed modulated signal.

Fig. 2: Shunt equivalent tuned circuit

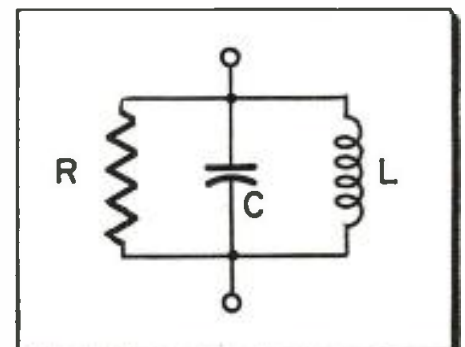

R. F. DESTEBELLE, C. J. SAVANT, C. J. SAVANT, Jr., Univ. of Southern Calif. Engineering Center, Los Angeles 7, Calif.

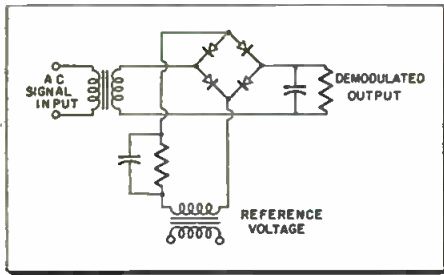
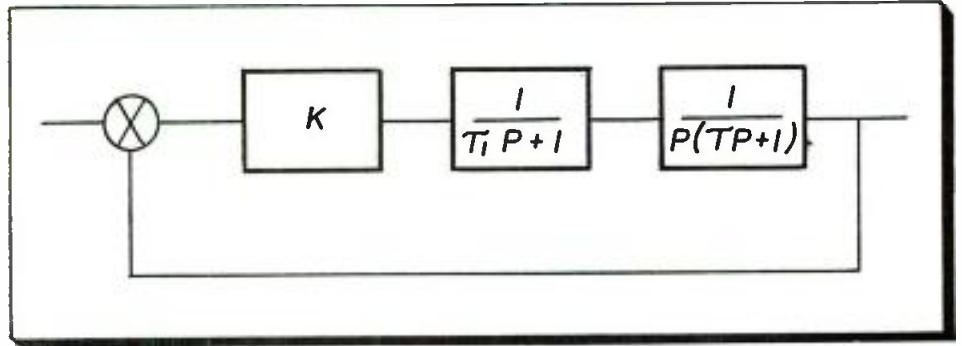
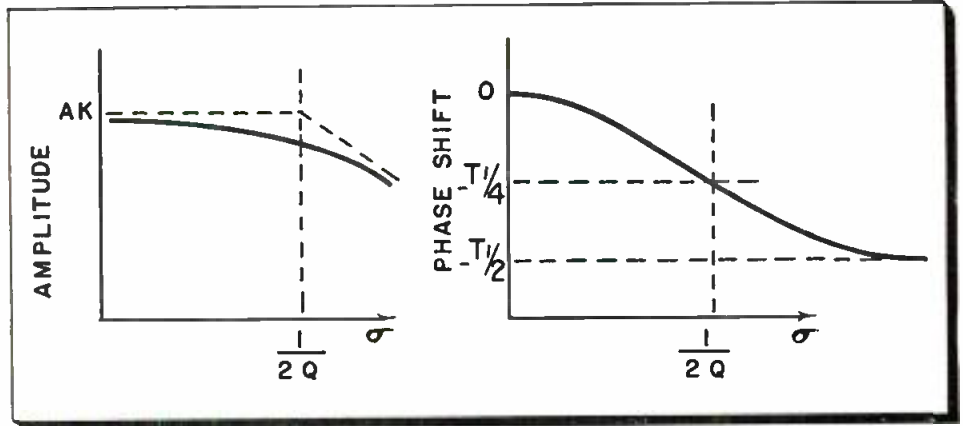
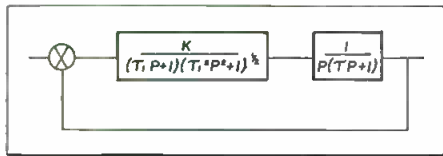

Fig. 3: (above) Schematic of demodulator

Fig. 4: (above, right) Transfer function of tuned amplifier and demodulator. Phase shift is only 90°

Fig. 5: (below, right) Single loop servomechanism. Carrier amplifier demodulates signal, drives motor

Fig. 6: (below) Servo of Fig. 5, but with amplifier now tuned, and with the filter removed



The circuit is arranged so that if the modulating signal is constant the carrier suppressed modulated signal will be exactly in phase or 180° out of phase with the reference voltage. The transfer function of the demodulator is, for low modulating frequencies

$$12. \quad K = K_0 \cos \phi$$

where  $\phi$  is the phase shift of the carrier suppressed modulated input signal with respect to the reference voltage. From Eq. 11

$$13. \quad \phi = \tan^{-1} 2Q\sigma$$

Eq. 13 is solved trigonometrically to obtain:

$$14. \quad \cos \phi = \frac{1}{\sqrt{1 + 4Q^2\sigma^2}}$$

The desired non-linear characteristics are shown in Fig. 4 and in Eq. 15. The amplitude response behaves like a standard double lag network with a time constant of  $2Q/\omega_0$ , however, the phase response is identical to a single lag network with the same time constant,  $2Q/\omega_0$ .

The standard methods of analysis are still applicable when dealing with systems containing the less than minimum phase shift network, but certain alterations become necessary. When using the log Nyquist Method for stability considerations, the D.B. (decibel) Gain curve for a system must be less than zero db before the system phase shift reaches -180°. These principles still

can be applied but the method of plotting this special network is somewhat different.

The entire transfer function of the tuned amplifier and demodulator is

$$15. \quad T = \frac{AK_0}{\sqrt{1 + 4Q^2\sigma(1 + j2Q\sigma^2)}}$$

as shown in Fig. 4. The break point is at  $1/\tau$  with a high frequency asymptote slope of 12 db per octave. The function produces only 90° of phase shift as shown in Fig. 4. The curve of phase shift behaves as a factor of the form,

$$\frac{1}{1 + j\tau\omega}$$

The Root Locus method of analy-

sis can also be employed to handle the less-than-minimum phase shift network. The network is basically a device which has a double pole at  $P$  equal to  $-\omega_0/2Q$  for gain considerations, but a single pole at the same point for phase shift characteristics. When plotting the root locus for a particular system, the angle criterion is used such that the summation of angles, from the roots, to a point on the locus is equal to some odd multiple of 180°. In this method the pole at  $P = -\omega_0/2Q$  is treated as a single pole. The second step in the analysis is to determine the gain at various points along the locus. For this operation the pole at  $-\omega_0/2Q$  is considered as a double pole.

### Numerical Example

Consider the single loop servomechanism shown in Fig. 5. In this servo a carrier amplifier, of gain  $K$ , phase sensitivity demodulates the signal and drives a motor  $1/P(\tau P + 1)$  through a filter  $1/\tau_1 P + 1$ . The designer has chosen the following conditions:

$$16. \quad 1/\tau \triangleq A$$

$$1/\tau_1 = 1.2A$$

$$\xi = 0.1 \text{ per unit critical damping}$$

The root locus plot of the loop transfer function is shown in Fig. 7. The damping characteristics are shown in Fig. 8 as a function,  $\tau_1$ . The gain  
(Continued on page 106)

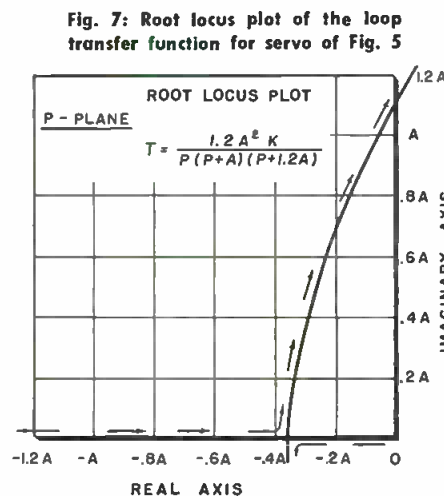

Fig. 7: Root locus plot of the loop transfer function for servo of Fig. 5

# Predicting The

'Life' tests on various pieces of airborne equipment reveal that a large percentage of malfunctions occur shortly after previous failure. Measures to eliminate this problem include periodic overhaul and maintenance programs.

By **C. J. HEDETNIEMI**

Aeronautical Radio, Inc.  
1700 K Street, N. W., Washington 6, D. C.

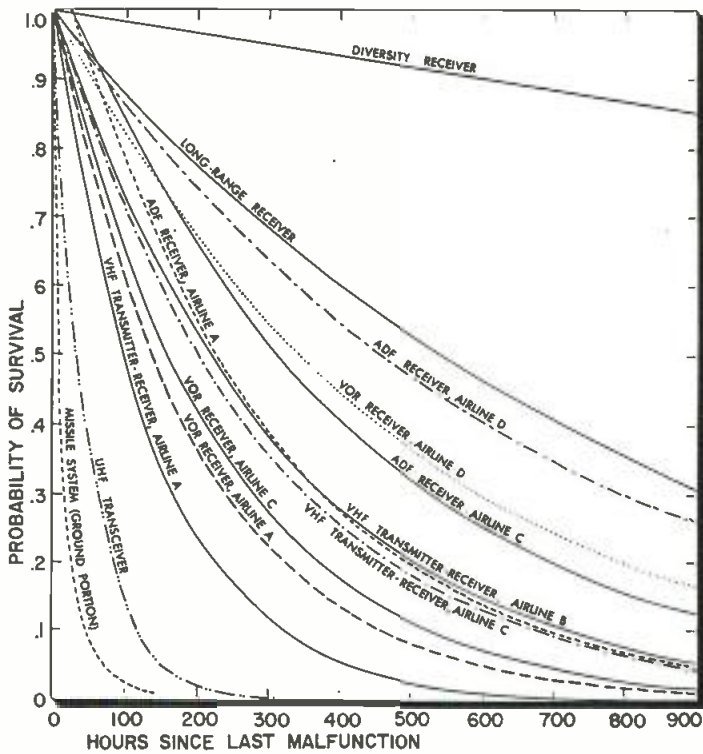

Fig. 1: Reliability functions based on time-between-malfunctions.

TO electronics engineers generally, equipment unreliability has traditionally been a problem best summed up by the question, "What's wrong with the equipment?" But the future of electronics requires of the profession considerably more than the ability to correct deficiencies. The kind of reliability that is increasingly needed by both military and commercial users cannot be achieved merely by a continuing series of post-mortem investigations. Predictable reliability is becoming an absolute necessity.

Reliability of electronic equip-

ment is the subject of much current research and study, and a number of papers have been published. Relatively few of these papers, however, have been based upon observed data, this situation presumably being due to the time factor involved in obtaining such information. To provide a broader factual basis for determining the performance that can be expected from particular types of equipment, data concerning military and commercial electronic equipment in current use have been collected and analyzed.<sup>1</sup>

Fig. 1 gives a limited view of

the reliability of four types of military equipment and three types of equipment in use by commercial airlines, based on observational data giving over-all measures of reliability.

Certain basic terms are used in this paper in accordance with the definitions given below:

(a) Reliability of an electronic equipment: The probability that the equipment will give satisfactory performance for a given period of time when used in the manner and for the purpose intended.<sup>2</sup> The conditions of use for the equipment types

Fig. 2: ADF receivers, Airline A: Malfunctions by hours of operation.

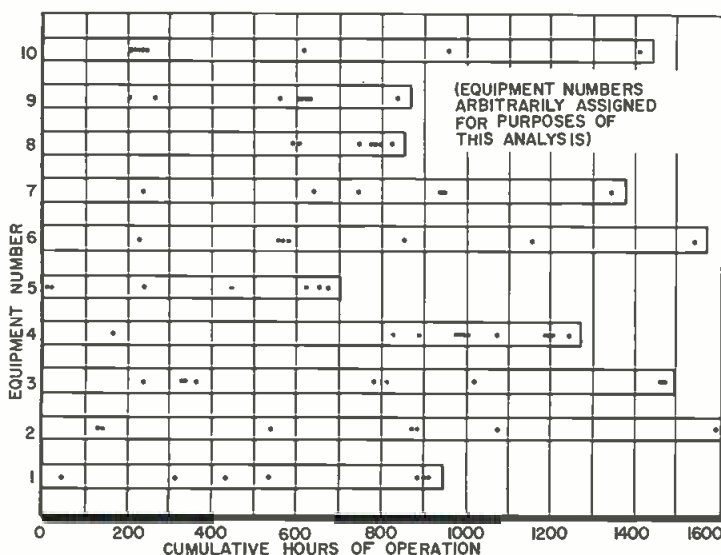
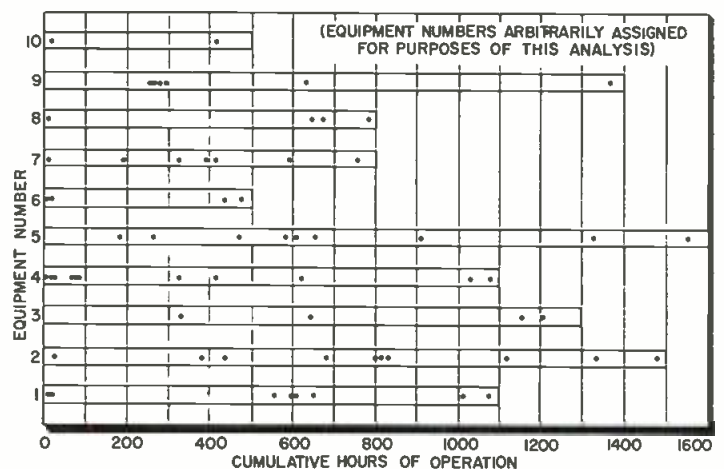

Fig. 3: ADF Receivers, Airline C: Malfunctions in each of ten random pieces of equipment by hours of operation.





# Reliability of Airborne Equipment

discussed in this paper are not beyond the range generally expected for these types; hence, the phrase "when used in the manner and for the purpose intended" is satisfied in all cases reported upon here. The specific conditions are indicated for each equipment and each base of operations.

(b) Reliability function: The probability that a product will give satisfactory performance for a given period of time as a function of that time interval. This function may also be called the "survival function."

(c) Equipment: An assembly of parts and/or components which may be used either by itself or in association with other assemblies.

(d) Malfunction: Failure of the equipment to perform satisfactorily.

(e) Satisfactory performance: Performance that satisfies the operator or the maintenance technician.

(f) Censored observations: Observations on equipments where the observed quantity is operation time and the time-to-failure is longer than the period of observation. The only information on the time-to-failure in this situation is that it is longer than some known value. In one sense, the observation is incomplete, for a complete observation would be from time zero up to the time of failure.

In this analysis of the reliability of seven equipment types employed under various conditions, the observation unit for each type is the time-between-equipment-malfunctions. The reliability of the equipment will therefore be expressed as the probability that it will perform satisfactorily for a given period of time upon its restoration to service after malfunction.

When a periodic overhaul schedule is in effect, the overhaul of a

particular equipment does not depend upon its performance. In such situations, a better understanding of the equipment reliability will be obtained if the observations which are terminated by the overhaul are considered as censored, or incomplete observations, and not as equipment malfunctions. This has been done in the analysis of the data which follow. In regard to those equipment types which are subject to periodic overhaul, no inference should be drawn concerning their reliability for a period of time which is longer than the time between scheduled overhauls.

## Equipment Types

The seven equipment types discussed in this paper are listed in Table 1. Also shown, for each type of equipment, are: the number of equipments of each type under observation; the calendar period of surveillance; the location or user of the equipments; and the method or basis employed for measurement of operation time.

## UHF Transceiver

The first equipment type listed in Table 1 is an airborne UHF

transceiver used in the military services. The 27 equipments of this type under surveillance were used in the early phase of flight training, and the pilots were relatively unfamiliar with electronic equipment and its operation. The maintenance procedure was to let each equipment remain in service until a malfunction occurred, at which time the unit was sent to a central repair shop, where a military technician performed the maintenance. The qualifications of the technicians included—in addition to the usual Navy electronic-technician-school training—a training program on this equipment type, and prior experience in maintaining it.

Fig. 5 presents two reliability functions, or "survival functions", for these equipments—the observed function, and a theoretical function based upon the exponential distribution. Both are calculated from data on time-between-equipment-malfunctions, derived from the 27 equipments under surveillance during the period from January, 1953 to December, 1953. As shown in Table 1, time for these equipments was recorded on the basis of airframe hours.

Fig. 4: Airline VOR Receivers: Malfunctions per 1000 hours of flight.

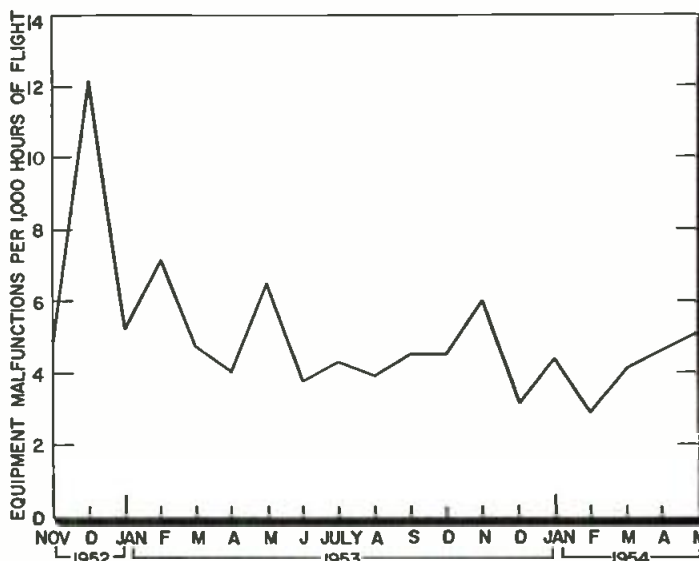

# Reliability (cont.)

A "reliability function" was defined above as the probability that a product will give satisfactory performance for a given period of time as a function of that time interval. In Fig. 5, the observed function is an estimate of this probability, expressed as a percentage of the total of 228 observations of time-between-malfunctions which survive a given number of airframe hours. The curve for the theoretical function, on the other hand, is calculated on the basis of an exponential distribution. The actual values for this function are computed by the equation

$$R(t) = e^{-t/\xi}$$

$R(t)$  representing reliability as a function of time,  $t$  representing time in hours, and  $\xi$  representing mean time between equipment malfunctions. For these equipments,  $\xi$  is estimated from the sample of 228 observations as 51 hr.

The theoretical function thus shows as a mathematical quantity the probability that, following a malfunction and repair, an equipment of this type will perform satisfactorily for a given number of hours. As an example, the probability is about .37—that is, there are about 37 chances in 100—that the equipment will perform satisfactorily for 50 hr. For a 200-hr. period, the probability of survival is less than .03.

Fig. 5 shows good agreement between the observed and the theoretical reliability functions. If the probability of malfunction of an equipment were constant—i.e., the same for all stages of equipment life, the exponential distribution for the time-between-malfunctions would be a good fit.

## Missile System

Data were obtained from the ground-based portion of a ground-to-air missile system, used in a training battalion. The military maintenance personnel assigned to these equipments had received specialized training, in addition to the regular technical-school course.

TABLE 1. EQUIPMENTS UNDER SURVEILLANCE

Type of Equipment	Number of Equipments	Period of Surveillance	Location	Operating Time Basis
UHF Transceiver	27	Jan. '53-Dec. '53	Naval air station	Airframe hours
Ground-Based Portion of a Missile System	4	June '53-June '54	Army base	Elapsed-time meters
Single side band long-range Receiver	5	Mar. '53-July '54	Army radio receiving station	24 hours per day
Diversity Receiver	29	July '52-July '54	Army radio receiving station	24 hours per day
VHF Transmitter Receiver	26	Nov. '52-June '54	Airline A	Hours per day of flight } 7 8 9
	25	Aug. '50-July '54	Airline B	
	16	Jan. '50-July '54	Airline C	
ADF Receiver	24	Oct. '52-June '54	Airline A	7 9 10
	25	Jan. '50-July '54	Airline C	
	21	Feb. '50-July '54	Airline D	
VOR Receiver	25	Oct. '52-June '54	Airline A	7 9 10
	25	Mar. '53-June '54	Airline C	
	25	June '53-July '54	Airline D	

TABLE 2. SUMMARY OF THEORETICAL RELIABILITY FUNCTIONS WHICH BEST DESCRIBE THE RELIABILITY OF 7 EQUIPMENT TYPES, BASED ON TIME-BETWEEN-MALFUNCTIONS

Type of Equipment	Number of Tubes	Theoretical reliability function where constants are estimated from sample
UHF Transceiver	55	$R(t) = e^{-t/51}$
Ground-based Portion of Ground-to-Air Missile System	1633	$R(t) = e^{-.195t^{.64}}$
Long-range Receiver*	51	$R(t) = e^{-t/781}$
Diversity Receiver*	19	$R(t) = e^{-t/5715}$ for $t \leq 2000$
VHF Transmitter-Receiver* Airline A Airline B Airline C	22	$R(t) = e^{-t/138}$
		$R(t) = e^{-t/315}$
		$R(t) = e^{-t/295}$
ADF Receiver* Airline A Airline C Airline D	15	$R(t) = e^{-(t-25)/291}$
		$R(t) = e^{-(t-25)/419}$
		$R(t) = e^{-t/668}$
VOR Receiver* Airline A Airline C Airline D	29	$R(t) = e^{-t/201}$
		$R(t) = e^{-t/230}$
		$R(t) = e^{-t/500}$ for $t \leq 900$

\* Periodic maintenance considered as censored observation.

The maintenance procedure provided for maintenance only when a malfunction occurred.

The observed and theoretical reliability functions presented for the missile-system equipment in Fig. 6 show an appreciable departure from the situation of a constant probability of malfunction. The probability distribution of the time-between-malfunctions is not

exponential, but it can be described by a Weibull distribution. The particular Weibull distribution which describes the data indicates that the probability of a malfunction decreases as the time since the last opening increases<sup>3</sup>; however, the raw data show that some of the malfunctions occur in groups. These are probably correlated mal-

(Continued on page 114)

# NBS' Technical Services

*Describing the regularly scheduled program of standard radio and audio frequencies, time signals and radio propagation forecasts provided by National Bureau of Standards stations WWV and WWVH.*

THE NBS radio stations WWV and WWVH broadcast 6 widely used technical services:

1. Standard radio frequencies,
2. standard audio frequencies,
3. standard time intervals,
4. standard musical pitch,
5. time signals,
6. radio propagation forecasts.

The radio bands in which these services are broadcast are: 2500  $\pm$  5 kc (2500  $\pm$  2 kc in Region 1); 5000  $\pm$  5 kc. These bands were allotted by international agreement, in 1947, for exclusive standard-frequency-broadcast use.

The NBS radio stations are WWV, Beltsville, Md. (Box 182, Route 2, Lanham, Md.) and WWVH, Maui, Territory of Hawaii (Box 901, Puuene, Maui, T. H.)

The broadcast program is shown schematically in Fig. 1.

## Standard Radio Frequencies

WWV broadcasts on 2.5, 5, 10, 15, 20, and 25 MC. The broadcasts are continuous, except that WWV is off the air for approximately 4 mins each hour. The silent period commences at 45 mins, plus 0 to 15 secs, after each hour.

WWVH broadcasts on 5, 10, and 15 MC. The broadcast is interrupted for 4 mins following each hour and half hour and for periods of 34 mins each day beginning at 1900 UT (Universal Time).

## Accuracy

The accuracy of each frequency is better than 1 part in  $10^7$ . The stability at the transmitter is normally 1 part in  $10^9$  at WWV and 5 parts in  $10^9$  at WWVH. Deviations at WWV are about 2 in  $10^{10}$  each day; frequency adjustments are made if necessary at 1900 UT.

If received accuracies better than 3 parts in  $10^7$  are desired it is necessary to make measurements over a long interval, e.g., 24 hrs, to obtain an accuracy of 1 part in  $10^8$ . Such long-interval measurements should be a strip chart record of frequency or phase changes during the measurement interval. During intervals of about 10 hrs or less, one may obtain highest accuracy when ionospheric conditions are normal and when measurements are made at the optimum time of day which is when sunrise or sunset does not occur over the radio propagation path.

Final corrections to the broadcast frequencies are available on a quarterly basis from the National Bureau of Standards, Boulder Laboratories, Boulder, Colorado.

## Standard Audio Frequencies

Two standard audio frequencies, 440 cps and 600 cps, are broadcast on each frequency. The audio frequencies are given alternately starting with 600 cps on the hour for 3 min., interrupted 2 min., followed by 440 cps for 3 min., interrupted 2 min. Each 10-min. period is the same except for interruptions mentioned above.

The 2 standard audio frequencies are useful for accurate measurement or calibration of instruments operating in the audio or ultrasonic regions. The frequencies were chosen because 440 cps is the standard musical pitch and 600 cps has the maximum number of integral multiples and sub-multiples; also, 600 cps is conveniently used with the standard 60 cps power-frequency.

The accuracy of the audio frequencies is better than 1 in  $10^7$ .

Fig. 1: Schedule of WWV broadcasting. Length of broadcasts is shown at bottom

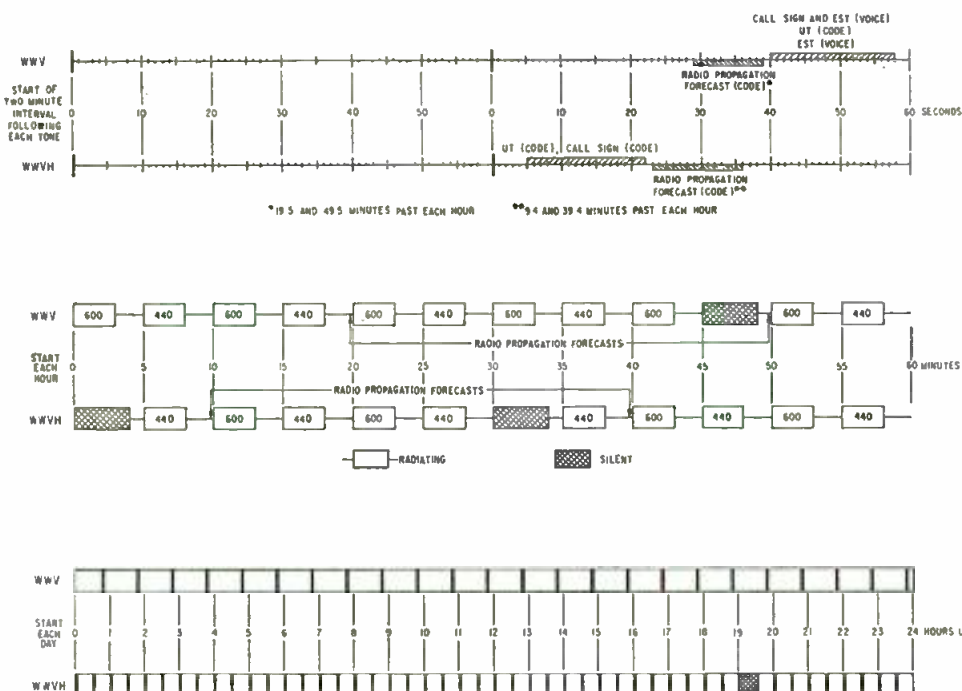

# NBS' Services

Changes in the transmitting medium (Doppler effect, etc.) result at times in fluctuations in the audio frequencies.

## Standard Time Intervals

Seconds pulses at intervals of precisely 1 sec. are given as double sideband amplitude modulation on each radio frequency. The pulse duration is 0.005 sec. The pulse wave form is shown in Fig. 2. At WWV each pulse consists of 5 cycles of a 1000 cps frequency. At WWVH each pulse consists of 6 cycles of a 1200 cps frequency. The pulse spectrum is composed of discrete frequency components at intervals of 1.0 cps. The components have maximum amplitudes at approximately 995 cps and 1194 cps for the WWV and WWVH pulses respectively. At WWV the tone is interrupted 0.040 sec for the seconds pulse. The pulse commences 0.010 sec. after commencement of the interruption.

The seconds pulses provide a useful standard time interval for quick and accurate measurement or calibration of time and frequency standards and timing devices.

A time interval from WWV is accurate to 1 part in  $10^8 \pm 1 \mu\text{sec}$ . Received pulses have random phase shifts or jitter because of changes in the propagating medium. The magnitudes of these changes range from practically zero to about 1000  $\mu\text{secs}$ . Multiple pulses and echos are sometimes received because of propagation around the world and reflection from objects. The beginning of the first pulse received is most accurate and should be used. A frequency standard can be checked in a few hours versus WWV a precision of about 1 part in  $10^9$ ; use intervals of 24 hrs for this precision.

In using the time interval markers for high precision work it is necessary to remember that step adjustments of precisely  $\pm 20$  msec. may be made at the transmitter on Wednesdays at 1900 UT; this is explained under Time Signals.

The seconds pulses from WWVH are adjusted during the interval

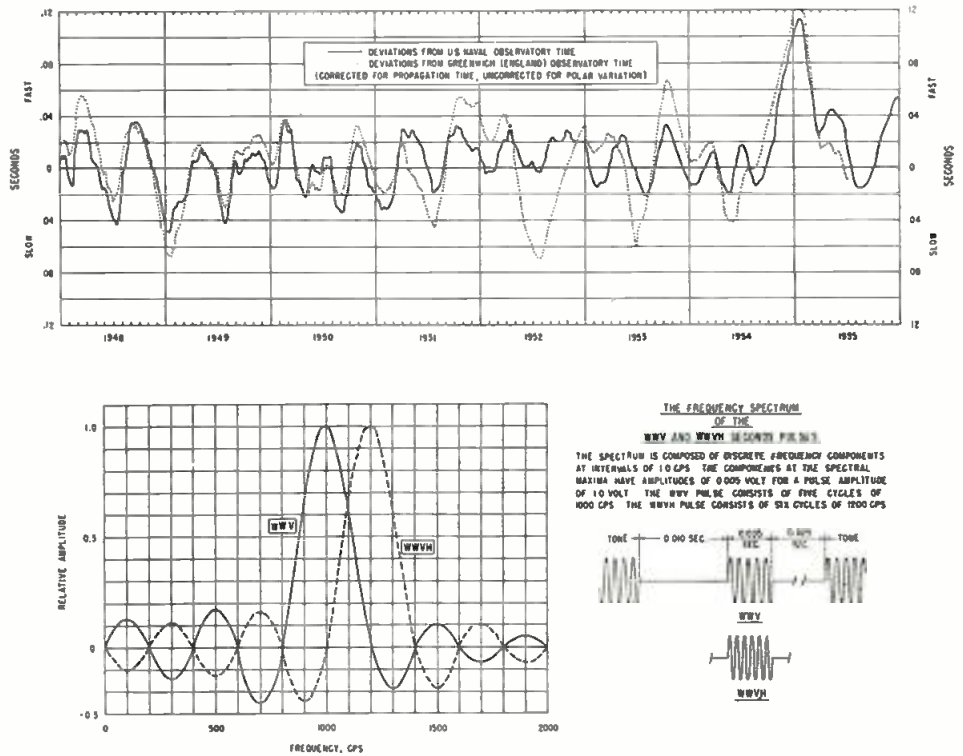

Fig. 2: Deviations of NBS time signals from other standard sources

1900 to 1935 UT so as to commence simultaneously with those from WWV, within  $\pm 500 \mu\text{secs}$ .

## Standard Musical Pitch

The frequency 440 cps for note A above middle C is the standard in the music industry. It is now given 6 times hr, 18 min hr, from WWV and WWVH as shown in Fig. 1. With this broadcast the standard pitch is maintained and musical instruments are manufactured and adjusted with an unvarying standard. Practically no instruments are manufactured which cannot be tuned to 440 cps.

A high frequency or short-wave radio receiver is the only equip-

ment needed to effectively use the musical pitch standard.

## Time Signals

The audio frequencies are interrupted at precisely 2 mins before each hour. They are resumed precisely on the hour and each 5 mins thereafter; they mark accurately the hour and the successive 5-min periods (see Fig. 1).

Time signals from WWV are maintained from the U. S. Naval Observatory. This is done by occasional step adjustments in time, of precisely  $\pm 20$  msec. When required, they are made on Wednesdays at 1900 UT simultaneously at WWV and WWVH.

(Continued on page 108)

TABLE 2: Foreign Standard Frequency and Time Services

Call Sign	Location	Carrier Freq. (mc)	Carrier Power Kw
LOL	Buenos Aires	2.5, 5, 10, 15, 20 and 25	1,440,1000 2
ZUO	Johannesburg, S. A.	5	1 — — 0.1
ZLFS	Lower Hutt, N. Z.	2.5	— — — 0.035
—	Moscow, USSR	10 and 15	1 — — —
MSF	Rugby, England	2.5, 5 and 10	1,1000 0.5
JJY	Tokyo, Japan	2.5, 5, 10, and 15	1,1000 1
IBF	Torino, Italy	5	1,440,1000 0.3
—	Uccle, Belgium	2.5	— — — 0.02

*Electronic analog techniques are used in a new computer to make rapid predictions of fallout based on wind velocities and particle sizes. Intensity and pattern of a CRT display indicate the predicted intensity and distribution of radioactive fallout*

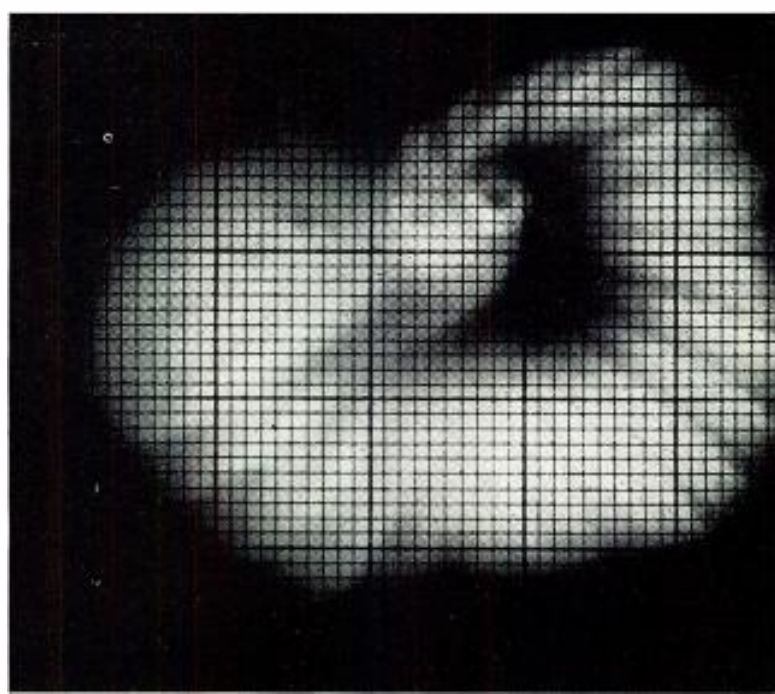

Fig. 2: CRT shows fallout pattern

## Radioactive Fallout Computer

A SPECIAL-PURPOSE computer that gives the geographical fallout pattern of radioactivity resulting from a nuclear explosion has been developed by N.B.S. (See Fig. 3.) Given the necessary weather data together with certain information about the bomb, this analog computer will assist in predicting what the distribution and intensity of radioactivity will be on the ground after the bomb has been detonated. Problem solution is displayed on a CRT, over which a map on a

transparent backing can be laid. Radioactive intensity at any ground point up to 500 miles from the explosion can then be measured by the brightness at the corresponding point on the tube screen. The computer was developed for the Weather Bureau and the AEC by H. K. Skramstad and J. H. Wright of the Bureau's analog computer lab.

Safety is a prime consideration at the nuclear bomb testing grounds. Precautions are taken in advance of a test to prevent

radioactive material from falling on inhabited areas. Such precautions require information about the bomb as well as an intimate knowledge of the weather pattern, and from these data extensive calculations determine the fallout pattern. In the past, fallout predictions have required the laborious hand calculations of a team of mathematicians for  $\frac{1}{2}$  hr. or more for each prediction. The use of high-speed electronic digital computers eliminates most of the manual effort and reduces the calculation time to 15 mins. However these high-speed computers are usually large, permanent, and expensive installations. To provide even faster predictions with portable, relatively inexpensive equipment, the Bureau developed a special-purpose computer that does not require highly-trained personnel for its operation. The machine uses electronic analog techniques to complete the computation almost instantly after the data are inserted. Subsequent changes in weather data can easily be inserted into the machine.

In its use at an atomic proving ground the new computer will  
*(Continued on page 134)*



Fig. 1: Prototype fallout computer

# Cathode Follower Design Curves

Designing a cathode follower circuit can be greatly simplified and systematized by using a family of curves relating the parameters of such a circuit

By L. H. ESTABROOK  
and R. A. GOUNDRY

CATHODE follower design curves can be readily derived from the gain equation for the cathode follower circuit. Referring to the equivalent circuit shown in Fig. 2, the gain may be written:

$$G = \frac{e_o}{e_{in}} = \frac{\mu R_k}{(\mu + 1)R_k + r_p}$$

By simple algebraic manipulations we obtain:

$$\begin{aligned} \mu &= \frac{G}{1 - G} \left( 1 + \frac{r_p}{R_k} \right) \\ &= \frac{G}{1 - G} \left( 1 + \frac{1}{\frac{R_k}{r_p}} \right) \end{aligned}$$

A plot of  $\mu = g_m r_p$  vs.  $\frac{R_k}{r_p}$  is now made for various values of gain G, and is shown in Fig. 3.

## Design Problems

In discussing design problems it will be useful to consider the expression for the output impedance of the cathode follower:

$$\begin{aligned} Z_o &= \frac{r_p R_k}{(1 + \mu) R_k} + r_p \\ &= \frac{r_p}{\mu} \left( \frac{\mu R_k}{(\mu + 1) R_k} + r_p \right) \end{aligned}$$

Fig. 1: Equivalent circuit

Fig. 2: (R) Common grid bias circuits

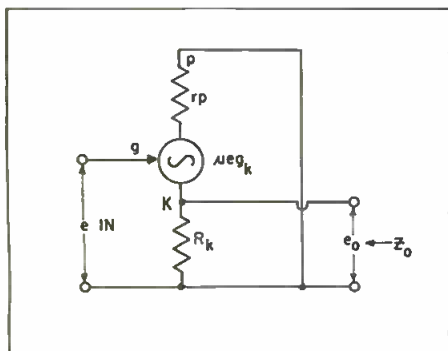

$$\begin{aligned} &= \frac{r_p}{g_m r_p} G \\ &= \frac{G}{g_m} \end{aligned}$$

This result will be used in subsequent discussion and calculation.

The various problems the designer may encounter are tabulated in Table I.

Table I

Case	Given	To Find
I	Tube, $R_k$	G or $Z_o$
II	Tube, G or $Z_o$	$R_k$
III	G or $Z_o$	Tube, $R_k$ , $Z_o$ or G
IV	G and $Z_o$	Tube, $R_k$

It is understood that by "tube" in Table I, we mean  $\mu$ ,  $g_m$ , and  $r_p$ .

## Examples

### Case I.

With  $\mu$ ,  $r_p$ ,  $g_m$  and  $R_k$  known, simply calculate  $\frac{R_k}{r_p}$ . To find G, enter the plot from the left at  $\mu$  and move horizontally until the vertical line for the value of  $\frac{R_k}{r_p}$  is intersected. This intersection will lie on one of the curves for various G. (If the intersection falls be-

tween the curves shown, the value of G is determined by visual interpolation.)

Let Tube = 6AH6

then  $g_m = 9000 \mu\text{mho}$ ,  $r_p = 0.5 \text{ megohm}$   
 $\mu = g_m r_p = 4500$

Let  $R_k$  be given as:

$R_k = 1000 \text{ ohms}$ , then  $\frac{R_k}{r_p} = 2 \times 10^{-3}$

Therefore, from the plot,  $G = 0.900$   
 $Z_o$  is readily found from

$$Z_o = \frac{G}{g_m} = \frac{0.900}{9000 \times 10^{-6}} = 100 \text{ ohms.}$$

### Case II.

With the parameters  $\mu$ ,  $r_p$ ,  $g_m$ , and G or  $Z_o$  known,  $R_k$  is to be found. Remember the relation  $Z_o = \frac{G}{g_m}$  permits the determination of  $Z_o$  and G when either one and the value of  $g_m$  is known.

Enter the plot at the left, at the value  $\mu$ , and move horizontally to the right until the correct gain curve G is intersected. Then move vertically downward from this intersection to determine  $\frac{R_k}{r_p}$ .

Since  $r_p$  is already known,  $R_k$  is readily computed.

Let tube = 6AG7

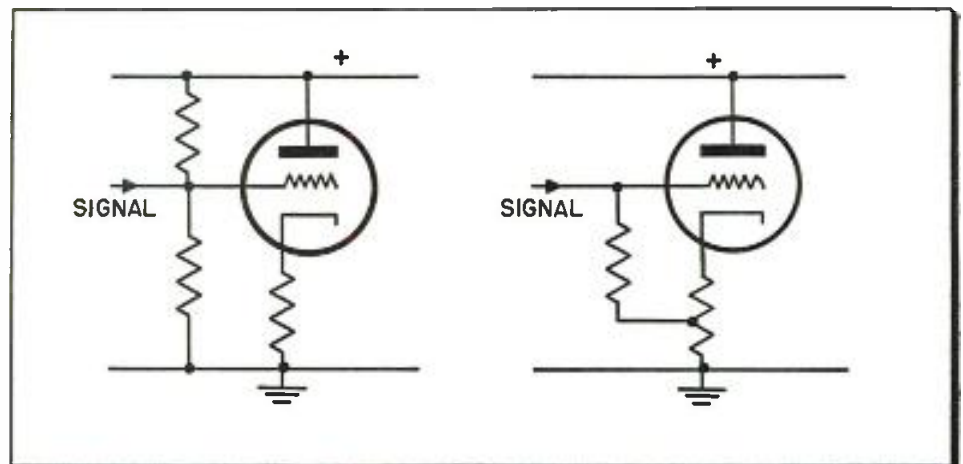

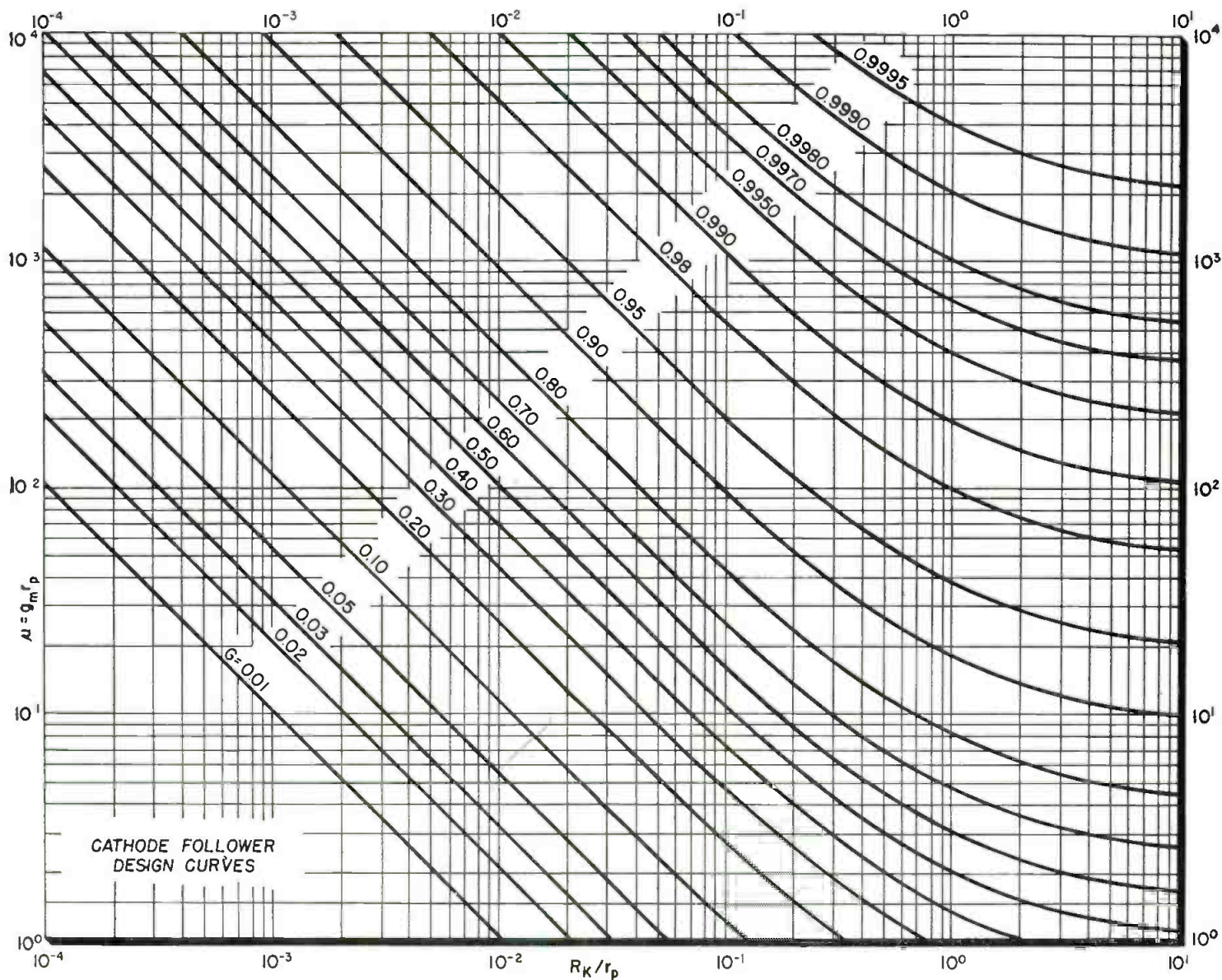

Fig. 3: Cathode-follower design curves

$g_m = 11,000 \mu\text{mhos}$     $r_p = 0.13 \text{ megohm}$   
 $\mu = g_m r_p = 1430$

Desired gain  $G = 0.990$  or the desired  
 $Z_o = \frac{0.990}{g_m} = 90 \text{ ohms}$

Therefore from the plot  $\frac{R_k}{r_p} = 0.072$   
and hence  $R_k = r_p (0.072) = 9350 \text{ ohms}$ .

**Case III.**

There is no unique answer for this situation since there are many combinations of tube and  $R_k$  that will yield the same gain. Therefore, a tube is guessed or selected from other criteria and one proceeds as in Case II.

**Case IV.**

With  $G$  and  $Z_o$  given,  $g_m$  is determined, which in turn determines to a large extent the tube. However, since an infinite number of tubes are not available, one is selected with a  $g_m$  near that specified by

$G$  and  $Z_o$ . Then one proceeds as in Case II.

It should be noted that correct grid bias will, in general, have to be supplied by means other than cathode bias. Two common methods are shown in Fig. 3.

Although the principal use of these curves is for cathode follower design, they may also be useful when there is an external resistance in the plate circuit of the follower. If  $R_L$  is the external resistance, the gain to the cathode becomes:

$$G = \frac{\mu R_k}{(\mu + 1) R_k + r_p + R_L}$$

This expression differs from that of the ordinary cathode only by the presence of the  $R_L$  in denominator. The cathode follower curves of Fig.

L. H. ESTABROOK, General Electric Co., Schenectady, N. Y. and R. A. GOUNDRY, Sylvania Electric Products, Boston, Mass.

3 may also be used for this situation simply by replacing  $r_p$ , in the ratio  $\frac{R_k}{r_p}$ , by  $(r_p + R_L)$  and proceeding as described for the ordinary cathode follower.

If the gain to the plate is desired, it is necessary only to multiply the

gain found above (by using the ratio  $\frac{R_k}{r_p + R_L}$  in place of  $\frac{R_k}{r_p}$ ) by the ratio  $\frac{R_L}{R_k}$ . This can be readily understood by considering the equations below.

Gain to cathode  
 $= G_k = \frac{\mu R_k}{(\mu + 1) R_k + r_p + R_L}$

Gain to plate  
 $= G_p = \frac{\mu R_L}{(\mu + 1) R_k + r_p + R_L}$

and therefore  $G_p = \frac{R_L}{R_k} G_k$ .

# A Discussion of Precision

*Conventional transformer design uses equivalent circuits involving several approximations. Design of precision transformers requires more rigorous treatment.*

**By D. WILDFEUER**

*Arma Corporation  
Roosevelt Field  
Garden City, L. I., N. Y.*

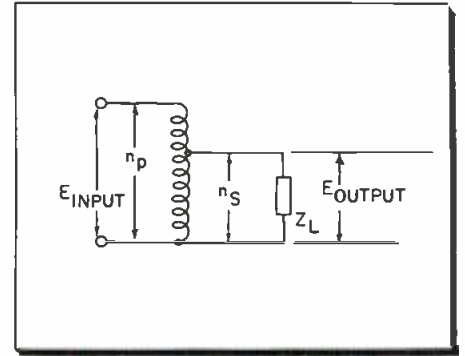

Fig. 2: Internal circuit constants ignored

THE use of analog computing systems to solve military and industrial problems is well known. As analog computing devices become more specialized in their application, increase in precision thereby follows. This increase in preciseness has resulted in a greater precision of the electrical and mechanical components comprising the computing system.

One group of such components is the transformer. Designing transformers with the accuracies required has necessitated a revision in general approach. For many years, the design of transformers has involved the use of approximate equivalent circuits for both the conventional multiple winding transformer and the auto-transformer. In the design of transformers whose function involves the transference of mathematical information to a high

degree of accuracy, the use of approximate equivalent circuits leads to an intolerable error. The accuracies of which we speak require limitation of magnitude transmission error from 0.01% to 0.1% and phase error from 0° (or 180°) to 10 minutes of angle. It is readily apparent that the use of approximate equivalent circuits in the design of precision transformers cannot be tolerated.

In passing mathematical information through a transformer component, the effect of series and shunt impedances are such that the output mathematical information suffers a degradation due to in-phase error, and the introduction of out-of-phase error. With magnitude error, obviously a scaling inaccuracy is introduced; with sufficient phase error dynamic instability may result.

To minimize in-phase and out-

of-phase error, all the elements comprising a transformer such as leakage reactance, copper resistance, shunt resistance, shunt inductance and other shunt reactances (inherent capacity) must be manipulated in order to produce a desired result.

A short analysis of the conventional, isolated winding transformer and a more extended analysis of the auto-transformer are presented in this article. The analysis is based on the non-existence of transients, and the presence of humped impedances.

## Conventional Transformer

The conventional transformer has been treated in great detail in the literature. From the standpoint of computer transformers, a solution is herewith presented in which the various elements, comprising the standard equivalent

Fig. 3: Circuit constants of an ideal auto-transformer. No phase error

Fig. 1: Conventional equivalent circuit

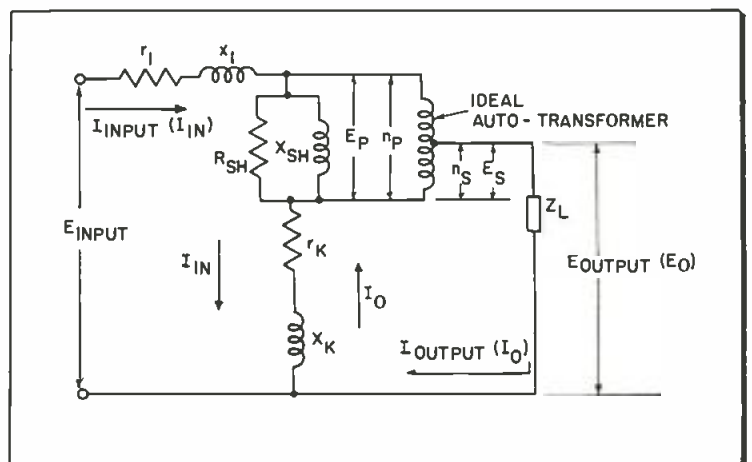
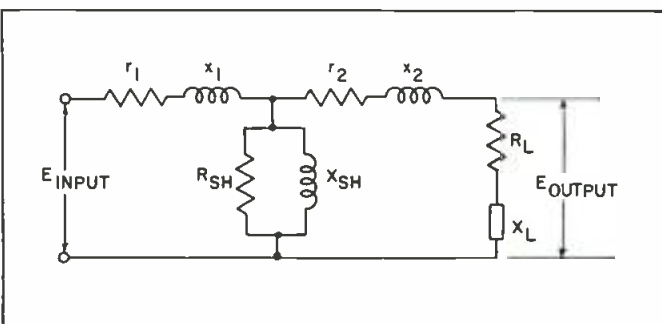



# Computer Transformers

circuit, are shown to influence out-of-phase and in-phase error.

Fig. 1 illustrates the conventional equivalent circuit. The nomenclature is as follows: (All circuit elements referred to the primary)

- $E_{mf}$  = The emf voltage referred to the primary voltage side.
  - $E_{input}$  = Primary voltage level ( $E_{in}$ ).
  - $E_{output}$  = Secondary voltage level ( $E_o$ ).
  - $R_{SH}$  = Core loss resistance.
  - $X_{SH}$  = Shunt reactance.
  - $r_1, r_2$  = Series resistance of the input and output windings.
  - $x_1, x_2$  = Series reactance of the input and output windings.
  - $R_L, X_L$  = Load resistance and reactance (inductive or capacitive).
  - $Z_{11}$  = The parallel impedance of  $R_{SH}$ ,  $X_{SH}$  and  $Z_L, Z_2$ .
  - $Z_1 = r_1 + j x_1, Z_2 = r_2 + j x_2, Z_L = R_L + j X_L, Z = Z_L + Z_2 = (R_L + r_2) + j (X_L + x_2)$ .
  - $a$  = turns ratio = secondary turns/primary turns.
- Note: With slight error,  $Z \approx Z_L$ .

A two part solution is herewith outlined:

The relation between  $E_{mf}$  and  $E_o$  is defined as the ratio between overall secondary impedance and the load impedance:

Thus:

$$E_{mf}/E_o = \frac{Z_L + Z_2}{Z_L} = 1 + \frac{Z_2}{Z_L}$$

An evaluation of  $1 + Z_2/Z_L$  in terms of resistance and reactance yields:

$$\frac{E_{mf}}{E_o} = 1 + \frac{r_2 R_L + x_2 X_L}{|Z_L|^2} + j \frac{x_2 R_L - r_2 X_L}{|Z_L|^2} \quad (1)$$

The relation between  $E_{in}/E_{mf} = (Z_1 + Z_{11})/Z_{11} = 1 + Z_1/Z_{11}$ . Substituting physical resistances and reactances in the expression  $(1 + Z_1/Z_{11})$  yields an equation which defines the behavior of the circuit associated with the primary voltage level.

$$\frac{E_{in}}{E_{mf}} = 1 + \frac{r_1}{R_{SH}} + \frac{x_1}{X_{SH}} + \frac{r_1 R_L + x_1 X_L}{|Z|^2} + j \left( \frac{x_1}{R_{SH}} - \frac{r_1}{X_{SH}} + \frac{x_1 R_L - r_1 X_L}{|Z|^2} \right) \quad (2)$$

$$\frac{E_{in}}{E_o} = \frac{E_{in}}{E_{mf}} \times \frac{E_{mf}}{E_o} \quad (3)$$

Multiplying the results of Eq. 3 by the appropriate turns ratio factor "a", and substituting the actual  $E_{in}$ , will yield an exact value of output voltage and its phase.

Eqs. 1, 2 and 3 define the behavior of the conventional transformer under any conditions of load, series, and shunt impedances. Because of the severity of phase and magnitude tolerances required in computer type transformers certain generalized techniques should be pointed out.

(a) The ideal way of reducing phase errors is by reducing the values of  $x_1, x_2, r_1$  and  $r_2$  to the lowest possible value.

(b) Where severe reduction of series impedances are impractical, compensation of their phase effects is required by equating the imaginary terms of Eq. 1 to the imaginary terms of Eq. 2.

(c) To bring the ratio of  $E_{in}/E_o$  to the value specified by the circuit engineer, turns compensation can be effected by adding or subtracting turns in proportion to the deviation from unity exhibited by the in-phase component of Eq. 3.

Since the isolated winding transformer is treated in great detail in standard texts on machinery, further discussion of the properties of Eqs. 1 and 2 is not called for, except to point out that no element of the transformer net can be ignored as unimportant.

## The Auto-Transformer

The auto-transformer has many valuable properties. Its high efficiency and low inherent phase shift characteristics make its application to computing devices desirable. The auto-transformer can perform the same mathematical functions of addition, subtraction and scaling as the conventional transformer. The basic disadvantage to the use of an auto-transformer is the lack of isolation between input and output. Where this disadvantage is unimportant, the auto-transformer is far superior to the isolated winding transformer.

To be in a position to design an auto-transformer which will perform its mathematical functions adequately, an approach is necessary which parallels that of the conventional transformer. Since the equivalent circuits for an auto-transformer as described in the literature are based on approx-

Fig. 4: The ideal auto-transformer acting as a simple reactor across a generator

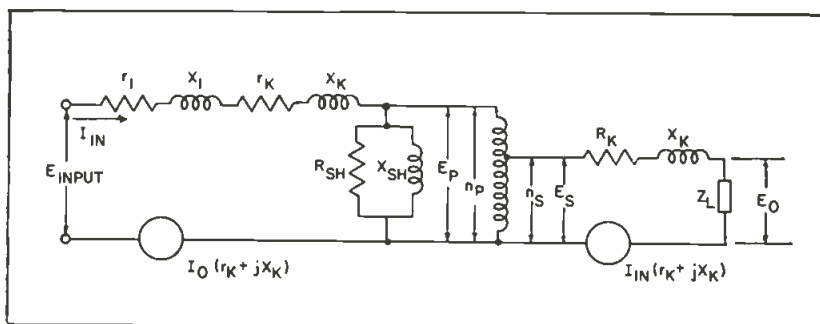
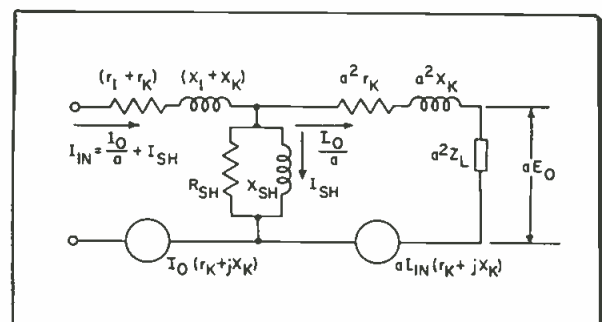

Fig. 5: The complete equivalent circuit



# Computer-Transformers (cont.)

imations (such as ignoring the effects of shunt resistance and shunt reactance, and assuming an inverse turns ratio effect on input and output current), the utility of such equivalent circuits is questionable. A new equivalent circuit is necessary to give a true picture of the auto-transformer's behavior under various conditions of loading.

In the following discussion the conventional assumptions with regard to lumped constants are taken for granted. The literature already covers calculation of transformer constants.

Fig. 2 represents an auto-transformer with internal circuit constants ignored. By introducing the effects of copper resistance, and leakage reactance, a further development results as expressed in Fig. 6. Elements  $r_1$  and  $x_1$  are the resistance and leakage reactance associated with the extension or un-common arm. Elements  $r_k$  and  $x_k$  are the resistance and leakage reactance of the arm common to both input and output circuits.

By adding the effects of shunt resistance ( $R_{SH}$ ) and shunt inductance ( $X_{SH}$ ) plus an ideal auto-transformer (having no phase or transmission error), Fig. 6 evolves into Fig. 3.

$E_p$  and  $E_s$  are the respective input and output emf's generated within the auto-transformer.  $I_{in}$  and  $I_o$  are the input and output currents.  $I_o$  ( $ns/np$ ) =  $I_{in}$ . The input current has components of current due to  $R_{SH}$ ,  $X_{SH}$  and phase relationship to  $I_o$  modified by  $R_{SH}$ ,  $X_{SH}$ ,  $r_k$ ,  $x_k$ ,  $r_1$ ,  $x_1$ .

Fig. 3 has a basic drawback, the common impedance  $r_k + j x_k$  is affected by  $I_{in}$  and  $I_o$ , and also affects  $I_{in}$  and  $I_o$ . The general input and output equations of the auto-transformer expresses this fact mathematically.

$$E_{in} = I_{in} (r_1 + j x_1) + (I_{in} - I_o) (r_k + j x_k) + E_p \quad (4)$$

$$E_o = E_s + (I_{in} - I_o) (r_k + j x_k) \quad (5)$$

$(I_{in} - I_o)^2 (r_k + j x_k)$  represents a VA loss present both in the input and output sections of the auto-transformer.

To what extent it is possible to separate this common loss and common voltage drop will now be made evident.

$(I_{in} - I_o)^2 (r_k + j x_k)$  can be expanded to:

$$I_{in}^2 (r_k + j x_k) - 2I_{in} I_o (r_k + j x_k) + I_o^2 (r_k + j x_k)$$

The term  $I_{in}^2 (r_k + j x_k)$  indicates a VA loss located in the input side of the auto-transformer. The term  $I_o^2 (r_k + j x_k)$  indicates a VA loss located in the output side of the auto-transformer.

$$-2I_{in} I_o (r_k + j x_k)$$

represents a common VA loss. Further expansion is in order:

$$-2I_{in} I_o (r_k + j x_k) = -I_o (r_k + j x_k) I_{in} - I_{in} (r_k + j x_k) I_o$$

These terms have precise meanings.

$-I_o (r_k + j x_k) I_{in}$  denotes a generator of value  $-I_o (r_k + j x_k)$  located in the input side of the auto-transformer.  $-I_{in} (r_k + j x_k) I_o$  denotes a generator of value  $-I_{in} (r_k + j x_k)$  located in the output side of the auto-transformer.

Fig. 3 evolves into Fig. 4. To test the accuracy of this evolution, the general input and output equations should be the same as previously obtained.

$$E_{in} = I_{in} (r_1 + j x_1) + I_{in} (r_k + j x_k) - I_o (r_k + j x_k) + E_p$$

$$E_o = -I_o (r_k + j x_k) + I_{in} (r_k + j x_k) + E_s$$

Re-arranging terms slightly the input and output equations become:

Fig. 6: Resistance and leakage reactance

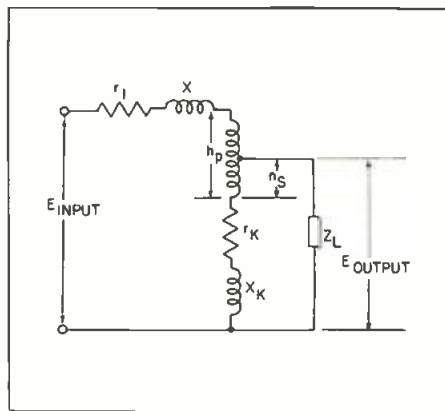

$$E_{in} = I_{in} (r_1 + j x_1) + (I_{in} - I_o) (r_k + j x_k) + E_p$$

$$E_o = E_s + (I_{in} - I_o) (r_k + j x_k)$$

See Eqs. 4 and 5

By referring output voltages and impedances to the input, Fig. 4 now represents the equivalent circuit of the auto-transformer.

Under the conditions  $np = ns$ , the auto-transformer becomes a simple reactor across a generator. The voltage drop from generator to the reactor must equal zero. The equivalent circuit now proposed should exhibit this zero drop.

With  $np = ns$ , and  $r_1 = 0$ ,  $x_1 = 0$ .

Thus:

$$I_{in} (r_k + j x_k) + I_o (r_k + j x_k) - I_{in} (r_k + j x_k) - I_o (r_k + j x_k) = 0$$

An interesting observation with regard to the equivalent circuit of Fig. 5 is the location of the generators. The fact that essentially an "input" generator is located in the output side and an "output" generator is located in the input side is sensible because in the auto-transformer the input and output are directly coupled.

Before proceeding into a mathematical solution of the auto-transformer by relating the ratio between input and output voltages, a brief discussion is in order concerning certain mathematical stratagems which have been employed.

(a) Division of a number by unity plus an increment. If a number such as A is divided by another such as  $1 + \Delta a$  where  $\Delta a$  is .05 less, the division essentially involves

$$\frac{A}{1 + \Delta a} \approx A(1 - \Delta a)$$

(b) Division of two numbers each with an increment.

$$\frac{A}{B} \cdot \frac{(1 + \Delta a)}{(1 + \Delta b)} = \frac{A}{B} \cdot \frac{(1 + \Delta a)(1 - \Delta b)}{1 - \Delta b^2}$$

$$= \frac{A}{B} \cdot \frac{1 + \Delta a - \Delta b - \Delta a \Delta b}{1 - \Delta b^2}$$

Since  $(\Delta a)(\Delta b)$  and  $(\Delta b)^2$  are small,

$$\frac{A}{B} \cdot \frac{(1 + \Delta a)}{(1 + \Delta b)} \approx \frac{A}{B} (1 + \Delta a - \Delta b)$$

(c) With transformer efficiencies of the order of 97% and greater, increments of transformation error and phase error

(Continued on page 127)

# CUES for BROADCASTERS

Practical ways of improving station operation and efficiency

## Power Switching Panel

ELMO DARRAH, Engr.

KANW, Albuquerque, N. M.

A PANEL for remotely starting and stopping turntables and playback tape machines has filled a long felt need at KANW, the Albuquerque public schools' FM station.

The switch panel consists of five regular and one auxiliary sets of push switches, with pilot lights, and corresponding DPST holding relays. The auxiliary set of switches is mounted on the recording desk some distance from the control console and regular switch panel. They control one of the regular turntables when it is necessary to dub from a disc to a tape. The same turntable, of course, is also controlled from the regular switching position.

The "On" switches are momentary "make"; and the "Off" switches are momentary "break." A 110 v ac neon pilot lamp assembly is mounted with each pair of switches. When pressed, the normally open start switch closes the

circuit to its associated 110 v ac relay coil, one of whose contacts is in parallel with the same start switch. The relay contact then "holds" the circuit through the coil until the current is interrupted by pressing the normally closed stop switch.

The other relay contact is connected in series with the regular turntable or tape machine drive switch on the machine. A small "Cue" switch is also mounted at this point so that the normal circuit may be restored for cueing purposes. On tape recorders, only the drive and take-up motors should be remotely controlled. The rewind motor should be left as is.

The wiring should be run in metal conduit, or the circuits should be so arranged that a shielded pair always handles both the outgoing and the returning ac for any one circuit element. Otherwise there may be trouble eliminating hum and switch "pops" in the audio.

Switch-click filters are connected across the pilot lamps; however other installations may require different treatment, such as placing

the filter across the stop switch contacts or the relay coil. When double contact relays are used, click filters may also be needed across the contacts supplying power to the motors.

In operation, the "Cue" switch, alongside the tape machine or turntable is closed, restoring the drive motor circuit to normal (as manufacturer wired it) and the tape or disc is cued in the usual way. The "Cue" switch is then opened and the drive or "forward" switch on the machine is engaged.

## Time Delay Modifications

MARVIN S. SEIMES, Ch. Engr.

WKIP-WGNY, Poughkeepsie, N. Y.

THE widely-used RCA Type 250K transmitter employs a very efficient time delay relay, E<sub>1</sub>. However, E<sub>1</sub> frequently becomes quite noisy with age. After exhausting all the known tricks of the trade trying to quiet this relay, we decided to change the entire time delay setup.

We discovered a very fine one manufactured by Price Electric Corp., Frederick, Md., their Type 4092-R2. No doubt it could easily be adapted for use in other type transmitters, too. The diagram shows the circuit of the time delay device and the connections when used with the 250K transmitter. The 4092-R2 was mounted on a small aluminum chassis and placed in the base of the transmitter.

It is not necessary to remove either E<sub>1</sub> or E<sub>2</sub>. Remove the link connecting 9B and 10B. Disconnect the coil leads of E<sub>1</sub>, tape and  
(Continued on page 82)

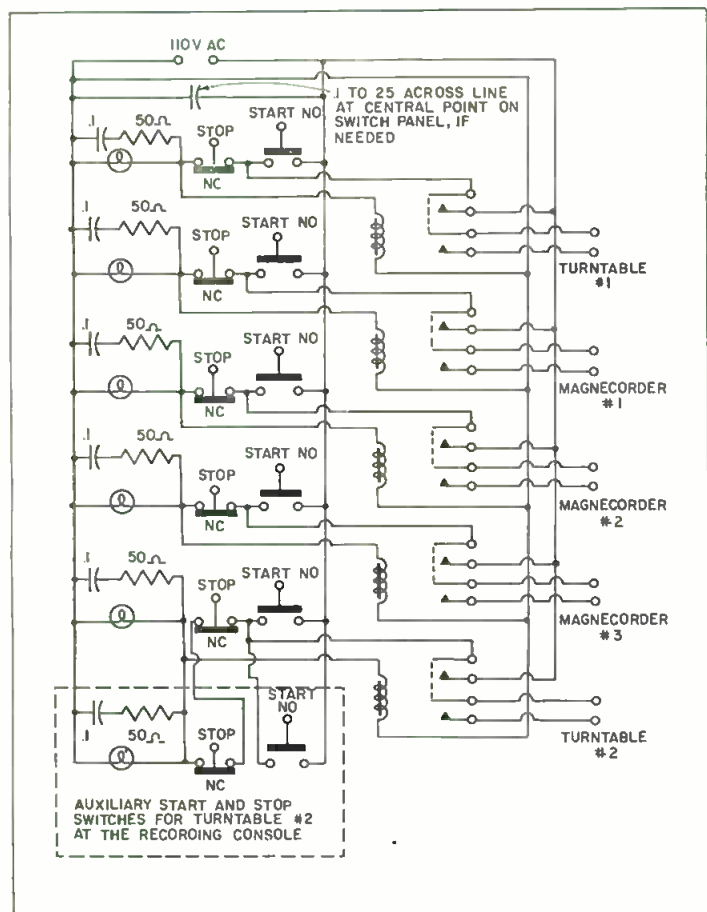

Start switch energizes holding circuit, powering equipment.

Substituting a time delay relay on RCA 250K.

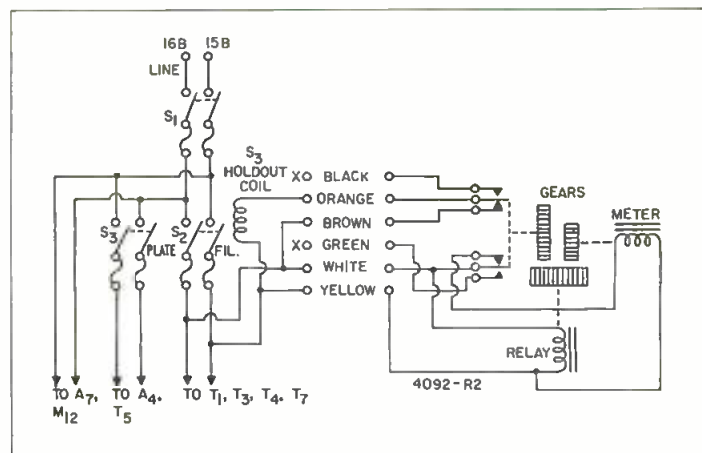

# Bandwidth and Noise

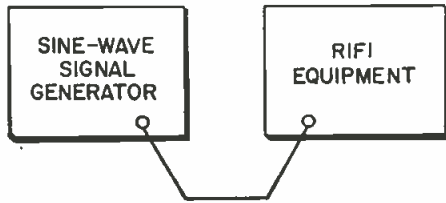

Fig. 1: Set up for "circuit bandwidth" data

**D**ESPITE the fact that selective circuits may display the same maximum response and the same frequency selectivity according to the customary definition, they can nevertheless display different sensitivities to noise. The term "circuit bandwidth" will be used for the customary concept of bandwidth wherein only the selectivity or frequency discriminating properties of a network are described.

The term "effective bandwidth" is often referred to. It is an index of the network response to "noise" or other transient phenomena, the components of which are continuous and distributed throughout the frequency spectrum. For this reason, the effective bandwidth is often referred to as the "noise" bandwidth.

There are two basic types of broadband radio "noise" or inter-

ference; impulse and random type. "Impulse interference" is defined as one or more electrical disturbances whose duration in seconds is very much less than the reciprocal of the bandwidth in cycles of the measuring instrument. If a series of such impulses is considered, it is assumed that they are of constant amplitude and that the interval between them is such that the effect of any one impulse has died out by the time the next one is received (i.e., no overlapping). Random interference consists of electrical disturbances of random amplitude and phase angles and of spacing so small that considerable overlapping occurs. A selective circuit will respond differently to these basic interference types.

*Noise sensitivity may vary among circuits of similar response and selectivity. Measures of establishing effective "noise free" bandwidth are treated.*

By **D. S. RADMACHER**

*Asst. Chief Engr.*

*Stoddart Aircraft Radio Co., Inc., Hollywood, Calif.*

The "effective random noise bandwidth" is defined as the frequency interval,  $\Delta f_r$ , for which a power gain equal to the gain at mid-band,  $f_0$ , would transmit the same noise energy as does the actual power gain frequency curve. The effective random noise bandwidth of any selective circuit can be obtained by dividing the area under the power response curve by the gain at the center frequency.

The "effective impulse bandwidth" is defined as the ratio between the maximum value of response and the spectral intensity of noise times the gain at mid-band. The effective impulse bandwidth of any selective circuit can be obtained by (1) dividing the area under the pulse response curve

Fig. 2: Ratio of reference voltage response at and off resonance. Note "circuit bandwidth" at the 3 and 6 db reduced voltage gain levels

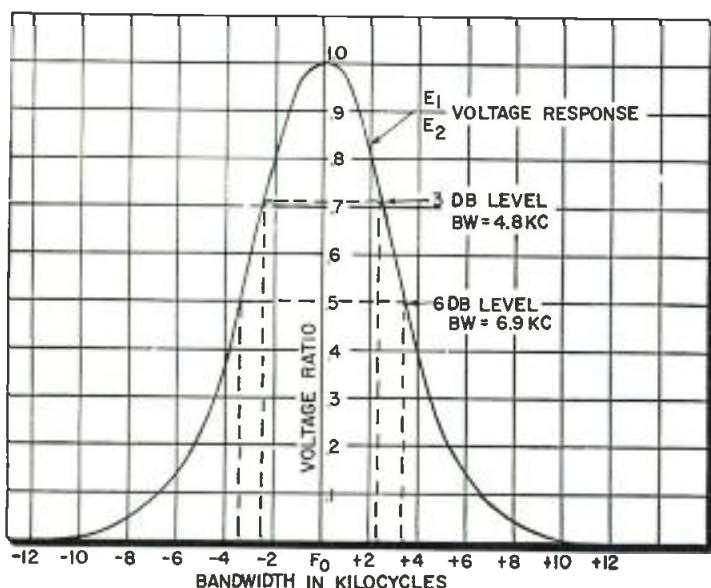
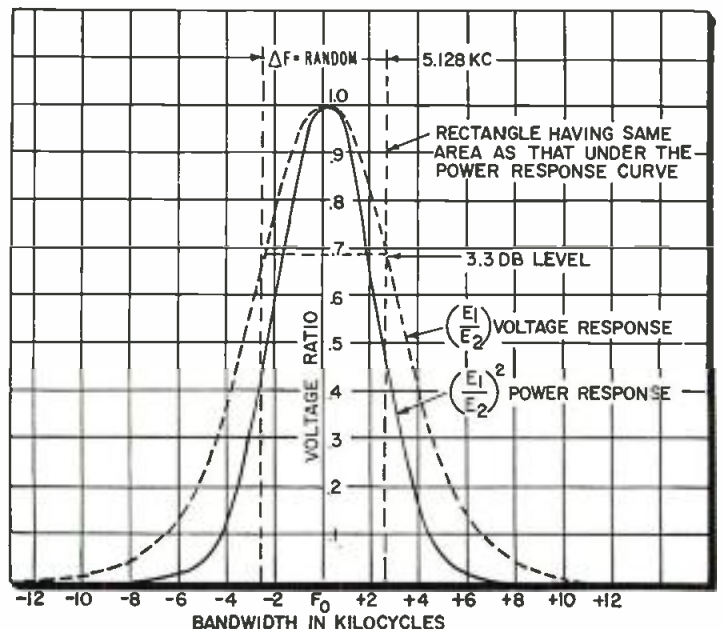

Fig. 3: The random noise bandwidth rectangle from power response



# Sensitivity

by the gain at the center frequency to obtain effective pulse length and (2) converting pulse length into duration in seconds. The reciprocal of the duration in seconds is the impulse bandwidth in cycles.

Several types of bandwidths associated with a bandpass network or amplifier can be resolved from the "circuit bandwidth" data. This can be illustrated with data taken on a typical Radio Interference and Field Intensity (RIFI) equipment. A signal generator was used to obtain the bandwidth versus the ratio  $E_1/E_2$  data where,

$E_1$  = generator output voltage required at resonance of RIFI equipment to give a reference output meter reading.

$E_2$  = generator output voltage required off resonance of RIFI equipment to give the same meter reading.

The equipment set up is shown in Fig. 1. Recorded data is shown in Table I.

Fig. 2 is a plot of the  $E_1/E_2$  data. This provides the usual voltage response curve. Note the "circuit bandwidth" at the 3 db and 6 db reduced voltage gain levels.

Fig. 3 shows (1) a plot of the  $\left(\frac{E_1}{E_2}\right)^2$  data or the power response curve, (2) the voltage response curve, same as Fig. 1, and (3) a rectangle the same height and area as the power response curve. The area under the power response curve was measured with a planimeter. It can also be done by counting squares. The width of this rectangle in cycles is the effective random noise bandwidth. Note that the random noise bandwidth in this particular example is the same as the 3.3 db circuit bandwidth.

If a rectangle of same height and area as the voltage response curve were drawn, its width in cycles would be the "integrated bandwidth." If there were no phase shift across the bandpass this bandwidth would be the "impulse bandwidth." Since phase shift is present in a practical amplifier the

Fig. 4: Impulse response & effective test pulse rectangle

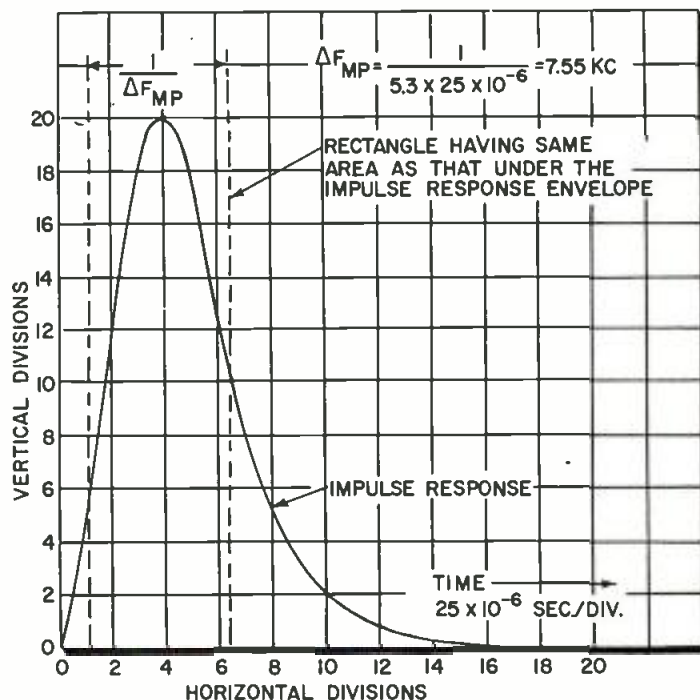

impulse bandwidth must be obtained by other means. One method is to apply a pulse signal of short duration to the input of the amplifier and to observe the pulse shape at the amplifier output with an oscilloscope. When a suitable second detector is used, the signal for the oscilloscope should be from the detector load resistor. The following precautions must be taken:

1. The pulse duration in seconds must be short with respect to the reciprocal of the bandwidth in cycles. A ratio of 5 to 1, or greater, is recommended, this to assure that the signal appears impulsive.
2. The pulse repetition frequency should be sufficiently high to provide a clear pattern on the

oscilloscope.

3. The pulse amplitude should be constant and at a level where linear operation of the amplifier is assured.

4. The oscilloscope time base must be accurately calibrated.

5. When a detector is used its time constant (product of the detector load resistance in ohms by the circuit capacitance in farads) should be smaller than  $\frac{1}{5 \Delta F}$  where  $\Delta F$  is the 6 db bandwidth of the amplifier in cycles. This detector circuit will provide an accurate reproduction of the pulse envelope as shaped by the amplifier bandpass. If the oscilloscope is connected directly

(Continued on page 121)

TABLE I—BANDWIDTH DATA

Test Freq. $f_0$ mc	Bandwidth in kc		$E_1$ in $\mu v$	$E_2$ in $\mu v$	Voltage Ratio $\frac{E_1}{E_2}$	Power Ratio $\left(\frac{E_1}{E_2}\right)^2$
	below $f_0$	above $f_0$				
3.0	0	0	100	100	1	1
3.0	.86	.86	100	103	.97	.941
3.0	1.14	1.14	100	106	.943	.889
3.0	1.30	1.30	100	110	.91	.828
3.0	1.7	1.7	100	120	.833	.694
3.0	2.0	2.0	100	130	.769	.592
3.0	2.3	2.3	100	141	.707	.499
3.0	3.2	3.2	100	170	.588	.345
3.0	3.4	3.4	100	200	.50	.25
3.0	4.3	4.3	100	300	.333	.111
3.0	5.2	5.2	100	500	.200	.04
3.0	6.7	6.7	100	1000	.100	.01
3.0	7.6	7.6	100	2000	.050	.0025
3.0	9.8	9.8	100	10000	.01	.0001



# WASHINGTON

## *News Letter*

---

Latest Radio and Communication News, from The National Capital, and Previews of Things to Come

---

**BACKED BY SENATE**—The FCC decision for the plan of deintermixture of television and more use of the UHF band with possible eventual transition of all telecasting into UHF has received the sanction of the Senate Interstate and Foreign Commerce Committee which has jurisdiction over broadcasting, television and communications. Highly significant to our magazine's readership as indicative of expansion of research and development in this field was the Senate Committee's warning that the FCC must not delay implementation by the radio-electronics industry of its proposed "crash" program of UHF research. All-channel receivers' manufacture must be a primary target of the industry and the Senate Committee expressed the view that the FCC should formally promulgate a date for the requirement of VHF-UHF broadcasting by all VHF television stations.

**OPERATION ALERT RESULTS**—Broadcasting, along with telephone and telegraph services, proved fully capable of withstanding the effects of simulated destructive nuclear bombing and continuing to furnish essential services in such an emergency during the recent 1956 Operation Alert exercise, according to an analysis given Electronic Industries by the top Office of Defense Mobilization officials who had charge of the broadcasting-telecommunications phases of the exercise. The week-long test assumed atomic destruction of 76 key target areas in the U. S. After the exercise started the ODM issued a series of orders on the emergency powers and responsibilities of a War Communications Administration. Besides top officials of all communications companies as consultants at the main Operation Alert center outside of Washington was Columbia Broadcasting System President Frank Stanton.

**NEW DEFENSE PROCEDURE**—Establishment of a new procedure to be followed by the military departments in approving new electronic systems and equipment has been announced by the Department of Defense. The department stated that since "a significant cause of unreliability of electronic equipment has been the initiation of quantity production before product design is matured, the procedure is intended to assure adequate design development and test prior to the equipment's release to production." The new procedure requires pilot production of

newly developed equipment and systems to verify the producibility of the design, to supply enough models to permit a statistically sound determination of system reliability and to correct design deficiencies before quantity production for service is commenced.

**OTHER SERVICES' NEEDS**—In its "interim" report on television problems on the FCC's long-range program aimed at shifting much or all television to UHF, the Senate Interstate & Foreign Commerce Committee signified awareness of the spectrum needs of non-broadcast radio services such as aeronautical, industrial and mobile radio operations. The Senate committee stated that "as a byproduct" in the possible future shift of television to UHF frequencies "at least the low-band VHF channels might be made available for other radio services." The report noted that the other radio services "are presently severely restricted and need additional frequencies," and that the demands upon frequencies "by various types of radio services in this electronic age are increasing every day."

**KEY FCC ASSIGNMENTS**—The two veteran FCC Commissioners—Rosel H. Hyde and T. A. M. Craven who respectively have had their FCC careers in the legal and engineering fields—have recently been given key governmental assignments. Commissioner Hyde is the FCC member on the Telecommunications Advisory Board, recently-established high-level body set up to advise the Office of Defense Mobilization on the relationship of national telecommunications problems to specific mobilization plans. Commissioner Craven is the FCC member of the Telecommunications Planning Committee, the interdepartmental group coordinating government activities in the communications field.

**MICROWAVES IN INDIA**—A three-week survey of American government agencies and industries by Indian Minister of Communications Raj Bahadur was highlighted by his interest in the use of microwave in his country. His intensive study of microwave is expected to be significant to major American manufacturing concerns like General Electric, IT&T, RCA and Westinghouse.

*National Press Building  
Washington 4*

*ROLAND C. DAVIES  
Washington Editor*

# New Lab Equipment

## Q-METER JIG

New Model 10-B Series Jig for low impedance measurements with Boonton 160-A or 260-A Q-Meters. This jig facilitates measurements of inductance and Q of small coils,

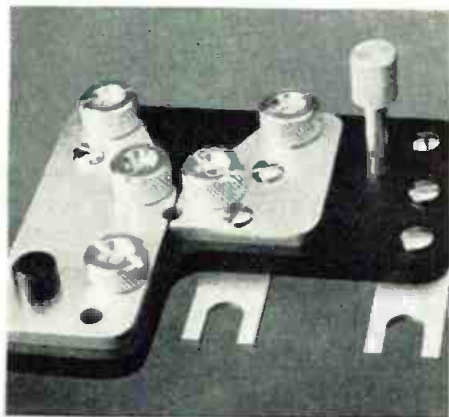

large capacitors, transistor parameters, transmission line characteristics, resonant y-pass capacitors, VHF and UHF tuner parameters, r-f impedance of electrolytic capacitors, and other low impedance components. Radio Instrument Labs., 12-05 Sumner Place, Fair Lawn, N. J. ELECTRONIC INDUSTRIES & Tele-Tech (Ask for 8-39).

## TEST JACK EYELET

New low-cost, insulated miniature test jack with an integral molded eyelet for fast, secure mounting. Jack No. 110BCI was designed as a low-cost approach to providing points of check for circuitry. Jack does away with mounting nuts and washers. Con-

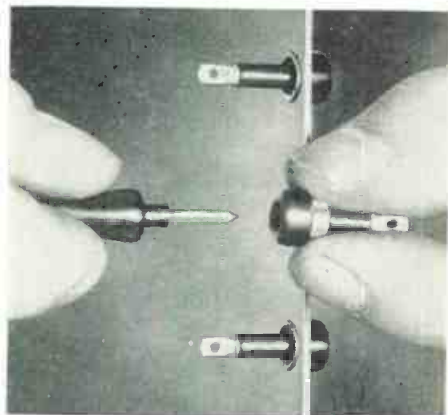

tact insulation is nylon rated for 3.5 kvDC. Eyelet is cadmium plated brass. Available in colors. Customer Dept., TJ60, Alden Prods. Co., Brockton, Mass. ELECTRONIC INDUSTRIES & Tele-Tech (Ask for 9-209).

## SWEEP OPERATED RELAY

For study of single transient phenomena with a CRO, the "Sweep Operated Relay" initiates the transient at a convenient pre-set portion of the trace on the face

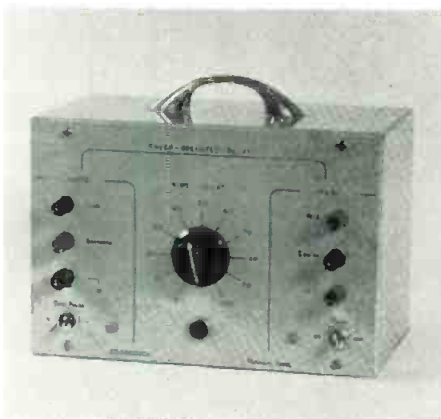

of the tube. Consists of a DC amplifier which compares the sawtooth voltage from the scope against an adjustable reference voltage. Input impedance: 10 meg. Frequency range: 0 to 20 cycles — up to 35 cycles at reduced accuracy. Engelhardt Engineering Co., 38 Burritt Ave., So. Norwalk, Conn. ELECTRONIC INDUSTRIES & Tele-Tech (Ask for 8-30).

## CAPACITORS

Tiny mica capacitors having the same capacity but only  $\frac{1}{2}$  to  $\frac{1}{4}$  the size, may be manufactured from new "K" gauged mica. "K" gauging is a new electronic method of accurately gauging

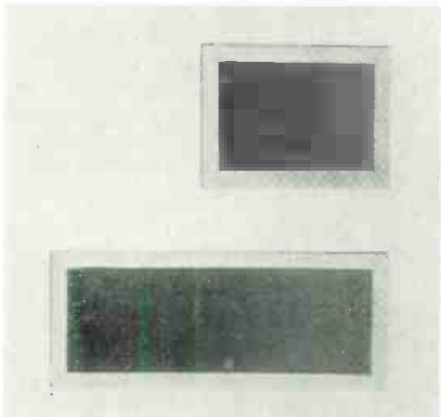

mica film to predetermined capacity. Desired tolerance can be held. Wastage is cut 40% to 50%. Perfection Mica Co., 20 N. Wacker Dr., Chicago 6, Ill. ELECTRONIC INDUSTRIES & Tele-Tech (Ask for 9-208).

## INDUCTION MODULATOR

New induction modulator is essentially a Weston moving coil mechanism; the coil is positioned by a d-c signal current through it. A-C field coils which are mounted

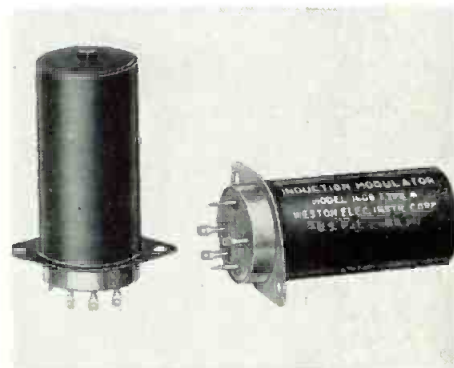

directly on the magnets induce an ac voltage in the moving coil proportional to its position. Modulator presents a constant resistance to the d-c signal input. Conversion gain in the order of 28 db. Weston Electrical Instr. Corp., 614 Frelinghuysen Ave., Newark 5, N. J. ELECTRONIC INDUSTRIES & Tele-Tech (Ask for 8-36).

## RADIO INTERFERENCE ACCESSORY

Another accessory for radio interference measurement work, the 91296-1 Threshold Indicator may be used with any of the Stoddart Radio Interference-Field Intensity measuring equipments covering the frequency range of 30 CPS to 1000 MC. Primarily intended to



actuate a signalling device when radio interference exceeds a predetermined level. Stoddart Aircraft Radio Co., Inc., 6644 Santa Monica Blvd., Hollywood 38, Calif. ELECTRONIC INDUSTRIES & Tele-Tech (Ask for 9-204).

# New Technical Products

## SILICON DIODES

Types 660 through 663 high conductance silicon junction diodes are hermetically sealed, miniaturized units which have forward current ratings of 25 ma and re-

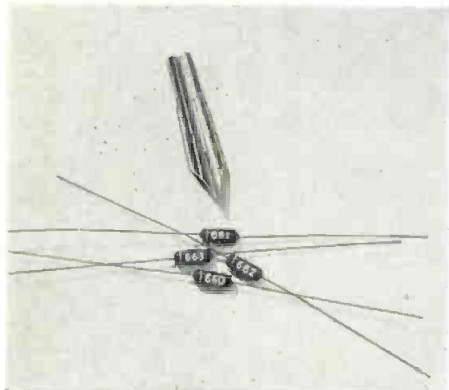

verse currents of 30  $\mu$ a. at 150°C. At 25°C, they have 100 ma forward current ratings and reverse currents of only 0.1  $\mu$ a. Forward currents are independent of breakdown voltages. Peak reverse voltage ratings are 30, 70, 150, and 200 v. Texas Instruments, Inc. Semiconductor Products Div., 6000 Lemmon Ave., Dallas 9. ELECTRONIC INDUSTRIES & Tele-Tech (Ask for 8-32).

## CONTROLS

Versatile, ¼-w. miniaturized controls, which can be sealed or potted, are designed for miniature amplifiers, geophysical equipment, guided missiles. Twenty-eight selections, with tolerance of 20% and resistance ranges from 1000 ohms to 2.5 megohms. Model JP has a plain round shaft ⅛ in. di-

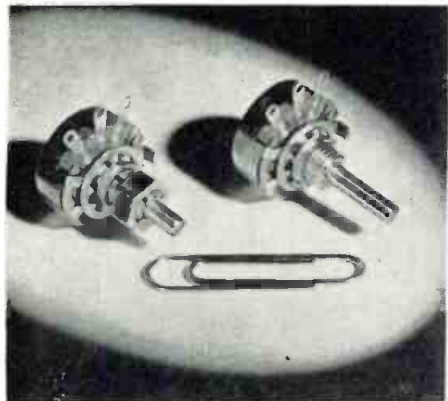

ameter and ½ in. long. The model JL is screwdriver-slotted ⅛ in. diameter. Centralab, Div. of Globe-Union, Inc., 900 E. Keefe Ave., Milwaukee 1. ELECTRONIC INDUSTRIES & Tele-Tech (Ask for 8-44).

## FREQUENCY METER

Model 802 covers the range of 2400 to 10,200 mc. Over the entire band the loaded Q is in excess of 750 from 2400 to 6500 mc and in excess of 1500 from 6500 to

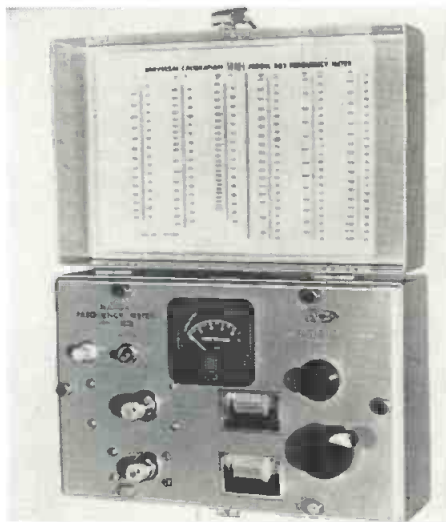

10,200 mc. Exceptional micrometer readability as a result of a new reading line with an expansive viewing area. Includes a universal nomograph type calibration chart. Narda Corp., Mineola, L. I., N. Y. ELECTRONIC INDUSTRIES & Tele-Tech (Ask for 8-41).

## TRIMMER POT

Sealed trimming potentiometer, Trimpot Model 230, subminiature in size, meets or exceeds Military Humidity Specifications (MIL-E-5272A). Furnished with wire-wound or carbon resistance element. Wire-wound unit operates at 135°C, and dissipates 0.4 watts



at 50°C. Screwdriver adjusted over 25 turns, with a self-locking shaft for stable settings Bourns Labs., 6135 Magnolia Ave., Riverside, Calif. ELECTRONIC INDUSTRIES & Tele-Tech (Ask for 8-25).

## TRAVELING WAVE TUBE

6651/BL850 S-Band traveling wave tube has peak power output of 1 kw, obtained with an accelerating voltage of 5800. A magnetic field of 1000 gauss is re-



quired to focus the electron beam. Driving power needed is approx 1 w. Average power output without forced air cooling is 1 w. Tube is mounted in a metal capsule which supports the tube in the focusing solenoid and also houses the input and output matching cavities. Bomac Labs., Inc., Beverly, Mass. ELECTRONIC INDUSTRIES & Tele-Tech (Ask for 8-42).

## ELECTRONIC COUNTER

A multipurpose electronic counter measuring frequency 10 CPS to 1.1 MC, period 0.00001 CPS to 10 KC, and time interval 3  $\mu$ sec to 27.8 hrs, Model 523B presents direct reading results. Compact etched circuitry and component ratings increase reliability and portability. The etched circuits are laid out for optimum visibil-

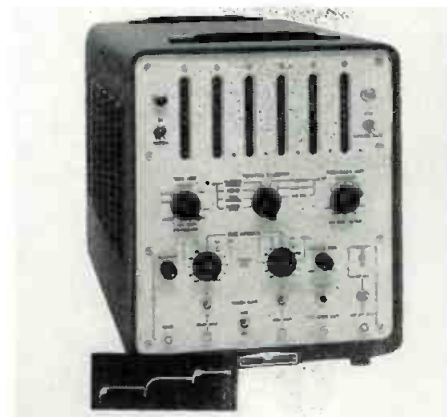

ity with trouble localizing lights to ease servicing. Used readily by non-technical personnel. Hewlett-Packard Company, 275 Page Mill Rd., Palo Alto, Calif. ELECTRONIC INDUSTRIES & Tele-Tech (Ask for 9-207).



# New Technical Products

## RATE GYRO

New oil-filled rate gyro, Model 36129, incorporates a non-heated temperature sensitive mechanism to maintain a linear damping over the ambient temperature range of



—54°C to +71°C. Exceptionally accurate and rugged, it has a precision potentiometer pickoff which provides rate signals up to 70 v. with a linearity of  $\pm 1.5\%$  or better and repeatability of  $\pm 0.4\%$ . G. M. Giannini & Co., 918 East Green St., Pasadena 1, Calif. ELECTRONIC INDUSTRIES & Tele-Tech (Ask for 8-24).

## FREQUENCY CONVERTER

Model 400A, light-weight frequency converter delivers 100 v.a. of 400-cycle power. No moving parts; uses standard components and has only 8 tubes. Voltage regulation, no load to full load, is  $\frac{1}{4}\%$ ; frequency regulation, no load to full load, is better than  $\pm 1$  cps; total harmonic distortion



is better than 3%. Output frequency is variable from 380 to 420 cps and the output amplitude from 90 to 130 volts. Tel-Instrument Electronics Corp., Carlstadt, N. J. ELECTRONIC INDUSTRIES & Tele-Tech (Ask for 8-20).

## SILICON RECTIFIER

New high power Silicon rectifier weighing 5 lbs. and occupying  $\frac{1}{4}$  ft.<sup>3</sup> is rated at 100 a, 200 v. It will rectify 20 kw of ac power with an efficiency exceeding 98%.



Efficiency is such that automatic regulating equipment can, in most cases, be eliminated. Particularly suitable where high power direct current requirements exist and only alternating current sources are available. Bogue Electric Mfg. Co., 52 Iowa Ave., Paterson 3, N. J. ELECTRONIC INDUSTRIES & Tele-Tech (Ask for 8-8).

## MOBILE RADIOPHONE

Mobile two-way radio rated at 100 watts transmitter power output on any channel in the 25-54 MC band incorporates a new dynamotor power supply which, at a power intake equivalent to conventional 60 watt mobile radios, provides full rated transmitter output. Transmitter is capable of up to 4-channel operation with



each frequency crystal-controlled. Dimensions—6 x 15 x 20 in. Motorola Communications and Electronics, Inc., 4501 W. Augusta Blvd., Chicago 51. ELECTRONIC INDUSTRIES & Tele-Tech (Ask for 8-10).

## 14-IN. CRT

Three new 14-in. rectangular TV picture tubes for portable TV applications. A 14-in. 90° tube, 14SP4, offers 8% larger area and space savings; glass, aluminized,



with a standard neck diameter. Electrostatic focus with ion trap, anode voltage rating of 15.4 kv, screen area of 104 sq. in. The two 70° tubes 14QP4 and 14QP4A, screen areas of 96 sq. in., electrostatic focus, and standard neck diameter. Rectangular, their anode voltage rating is 12.1 kv. Sylvania Electric Prods, Inc., 1740 Broadway, New York 19, N. Y. ELECTRONIC INDUSTRIES & Tele-Tech (Ask for 9-202).

## MICA CAPACITORS

High-temperature molded mid-gate mica-dielectric capacitors for operation up to 130° C and 160° C, without voltage derating. Maximum capacitance is 15,000 mmf. in the 130° C types and 7500 mmf. in the 160° C types. Voltage ratings are 300 v and 500 v dc work-

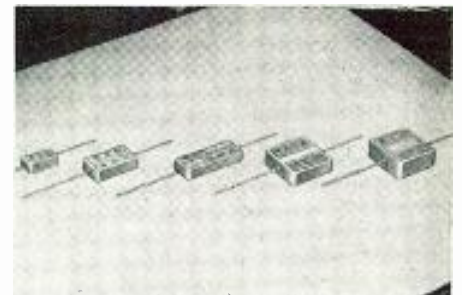

ing (depending on capacitance) with temperature coefficient Characteristics B, C, D, E, F available. Cornell-Dubilier Electric Corp., So. Plainfield, N. J. ELECTRONIC INDUSTRIES & Tele-Tech (Ask for 8-43).

# New Tech Data for Engineers

Resumes of New Catalogs and Bulletins Offered This Month by Manufacturers to Interested Readers

## Resistor Guide

A new data sheet presented by International Resistance Co., 401 N. Broad St., Philadelphia 8, lists comprehensive data on IRC's complete line of resistors and special products. Data includes JAN or MIL equivalent, rated wattage, standard tolerances, temp. rise, temp. coeff., max operating temp. (Ask for B-8-1)

## Electronics Courses

The attractive aspects of electronics are presented in a booklet recently released by Capitol Radio Engineering Institute, 3224 16th St. NW, Washington 10. A complete outline of CREI home study courses in radio-electronic engineering is included. (Ask for B-8-2)

## Proximity Transducers

A new series of proximity transducer systems is described in an illustrated four-page bulletin published by Electro Products Laboratories, 4501 N. Ravenswood Ave., Chicago 40. Systems capable of sensing operations in excess of 1000 per second are described. (Ask for B-8-3)

## Analog Computers

Berkeley Div., Beckman Instruments, Inc., 2200 Wright Ave., Richmond 3, Calif., has issued a catalog listing newly developed systems for data handling and a new series of analog computers, including control system components: amplifiers, electronic multipliers, and function generators. (Ask for B-8-4)

## Navigation Aids

A 20-page brochure made available by Pacific Division, Bendix Aviation Corp., 11600 Sherman Way, North Hollywood, Calif., describes the functioning of the Bendix-Decca system for obtaining accurate, reliable, and continuous position fixing for helicopters, fixed wing aircraft, ships and land vehicles. The booklet explains technical details and points to safety and economic advantages of the system. (Ask for B-8-5)

## Relays

A newly released four-page catalog gives complete information on the DOS, DOSY, DO, and CRU relays of Ohmite Manufacturing Co., 8637 Howard St., Skokie, Ill. (Ask for B-8-6)

## Microphones

All microphones currently produced by The Astatic Corporation, Conneaut, Ohio, are illustrated and described in a 14-page catalog recently released. Full information on microphone accessories and cartridges is included. (Ask for B-8-7)

## Thermistors

Fenwal Electronics, Inc., Mellon St., Framingham, Mass., describes its complete line of precision thermistors, including beads, rods, discs, washers, and built-up assemblies in a 12-page catalog containing dimensional drawings, descriptions, and complete electrical specifications. (Ask for B-8-8)

## Thin-Wall Tubing

Large diameter thin-wall tubing is described in literature prepared by Superior Tube Co., Norristown, Pa. Tables list over 20 analyses including stainless, nickel and nickel alloy, beryllium copper, and titanium; size tolerances, straightness, and length. (Ask for B-8-10)

## Microwave Silicon Diodes

An 8-page brochure made available by Microwave Associates, Inc., 22 Cummington St., Boston, is intended to bridge the gap between the specification and application of microwave diodes. Recent advances are highlighted. Performance curves and data for mixer and video diodes for the 1000 to 75,000 mc range are included. (Ask for B-8-22)

## Test Equipment

A line of coaxial and UHF equipment, microwave test equipment, and bolometers and thermistors is covered in a 28-page catalog published by The Narda Corp., Mineola, L. I. Included are recently added items such as fixed and variable attenuators, high power impedance meters, fixed and sliding terminations. (Ask for B-8-23)

## Waveguides

Circular bends, assemblies, and flexible ridge wave guides are described in a series of 3 technical catalog sheets just published by Airtron, Inc., 1103 West Elizabeth Ave., Linden, N. J. These components are designed for broad band transmission lines operating from 4,700 to 11,000 mc. (Ask for B-8-24)

## Potting Compounds

A variety of electronic potting compounds are described in a recent catalog of Electronic Plastics Corp., 675 Barbey St., Brooklyn 7, N. Y. (Ask for B-8-25)

## Vibration Meter

Eastern Precision Resistor Corp., 675 Barbey St., Brooklyn 7, N. Y., in a recent 4-page bulletin, describes a vibration indicator meter for the 10 to 1000 cps range. (Ask for B-8-26)

## Frequency Detector

Magnetic frequency meters with an average voltage output proportional to frequency are described in a bulletin published by The Airpax Products Co., Middle River, Baltimore 20. (Ask for B-8-27)

## Microwave Components

A 136-page catalog containing extensive technical information as well as illustrations and specifications for a wide range of precision instruments and components for microwave has been published by Polytechnic Research and Development Co., Inc., 202 Tillary St., Brooklyn 1, N. Y. (Ask for B-8-28)

## Conversion Chart

A new chart presented by American Silver Co., 36-07 Prince St., Flushing 54, N. Y., lists gauge, diameter, and cross-sectional areas of standard copper wires with the equivalent width of copper tape in thicknesses from .00017 to .001 in. (Ask for B-8-29)

## Antennas

Antennas for the 50 to 400 mc range are listed in bulletins published by Technical Appliance Corporation, Sherburne, N. Y. (Ask for B-8-30)

## Alloy Wires

New bulletins of the Driver-Harris Co., Harrison, N. J., describe new resistance and heating element wires, and a new thermocouple. (Ask for B-8-31)

## Metal Plating

Two new brochures introducing the Silvrex bright silver plating process and the Lectro-Nic process, nickel plating, have been released by Sel-Rex Precious Metals, Inc., 229 Main St., Belleville 9, N.J. (Ask for B-9-1)

## Switches

Catalog C, 1956 covering push, slide, toggle, and rotary for a variety of applications is now available from Carling Electric, Inc., 505 New Park Ave., W. Hartford 10, Conn. (Ask for B-9-2)

## Transmitting Tubes

A new 256-page manual of technical data on 112 types of power tubes and 13 types of associated rectifier tubes has been published by the RCA Tube Div. 5 classification charts speed selection of power and rectifier tube. Price \$1.00. (Ask for B-9-3)

## Power Rectifiers

International Rectifier Corp., El Segundo, Calif., has released a bulletin, 10-0306, describing the characteristics of their line of selenium industrial power rectifiers. (Ask for B-9-4)

## Telescoping Masts

Bulletin 8416, Andrew Corp., 363 E. 75th St., Chicago 19, describes and illustrates hydraulic and pneumatic masts for mobile use manufactured by the company. (Ask for B-9-5)

## Rate Gyro

A 4-page folder is available describing a few of the G. M. Giannini & Co., Inc., Pasadena, Calif., rate gyros. (Ask for B-9-6)

## Remote Counter

Anatron Corp., 165 E. California St., Pasadena, Calif., has issued Bulletin 801-264 giving complete specifications on its line of remote indicating and mechanical counters. (Ask for B-9-7)

## Stepping Switches

Illustrated, 12-page folder on versatile circuit selectors and stepping switches giving complete engineering data is available from G. H. Leland Inc., Dayton 2, Ohio. (Ask for B-9-8)

## PC Connectors

A new 12-page technical brochure is available from DeJur-Amsco Corp., 45-01 Northern Blvd., Long Island City 1, N.Y., describing printed circuit connectors. (Ask for B-9-9)

## Silicon Rectifiers

New colorful handbook from Sarkes Tarzian, Inc., Bloomington, Ind., describes S-T's complete new line of silicon rectifiers. Engineering data is particularly interesting. Price \$1.00. (Ask for B-9-10)

## Electronic Cable

"Electronic Cable as a Systems Component" is the title of a 4-page bulletin explaining cable design, fabrication, installation, and testing, which has just been released by Pacific Automation Prod., Inc., Glendale, Calif. (Ask for B-9-11)

## Volume Controls

Centralab has announced the availability of their Pocket Control Guide No. 4. This is a handy control cross reference. (Ask for B-9-12)

## Power Rectifiers

A selection chart (ETD-1322) listing the essential characteristics of 75 power rectifiers and control tubes now is available from General Electric Co. (Ask for B-9-13)

# new developments



No. 22724

## Edge Connector

This 25 contact printed wiring edge connector is designed for  $\frac{1}{16}$ " copper laminates. Contacts are mounted on .150 centers. .125 diameter mounting holes are on 4.33" centers. Contacts are of phosphor bronze, gold plated. Connectors are available in melamine or diallylphthalate insulation. Polarizing contact can be placed in any position.



No. 22743

## Octal Stand-Off Type Printed Wire Socket

Designed for  $\frac{1}{16}$ " copper clad laminates. Mounts in eight .1" diameter mounting holes located on a 1.064" pin circle. Insulation—black general purpose bakelite.



## Sub-Miniature Hi-Temperature Sockets

Insulation is glass filled silicone resin for high temperature applications. Contacts are of beryllium copper with annealed tails. These sockets are provided with "J" lock shield bases for use with various length shields. The tails can be supplied straight as shown on Part #22021 or with a .04 loop as shown on Part #22377.



No. 22377

No. 22021



Exp. 9422

Exp. 9421

## Jan Type Printed Wire Sockets with Shield Bases

Designed for both  $\frac{1}{16}$ " or  $\frac{1}{8}$ " copper clad laminates. These sockets are of the "Stand Off" type, made of molded mica insulation with silver plated phosphor bronze contacts.

## Cinch-Jan Shield Insert

For Increased Cooling Efficiency

Aids in maintaining lower operating tube temperatures. Equipments have fewer failures, greater reliability, less maintenance and tube replacement costs. These inserts may be adapted to operating equipments presently in use with no chassis modification or additional space requirements.

Centrally located plants  
at Chicago, Shelbyville,  
Pasadena and St. Louis

*Cinch will design, or re-design components to fit specific needs and will assist in the assembly of components through proven automation technique.*

*You Can Depend On CINCH*

Complete printed circuit  
service available at our  
Pasadena plant — Engi-  
neering, Development and  
Manufacturing.



**Cinch**  
ELECTRONIC  
COMPONENTS

## CINCH MANUFACTURING CORPORATION

1026 South Homan Ave., Chicago 24, Illinois

Subsidiary of United-Carr Fastener Corporation, Cambridge, Mass.

www.americanradiohistory.com

# exceptionally stable by-pass capacitors

— Solar ceramic bodies DA, WA & WG



Constantly advancing Solar research brings you small-size discs in unusually stable bodies. Solar's technically proven ceramic formulations provide flat temperature coefficient and low power factor throughout a broad capacity range. These discs are available not only in GMV, but due to their stability can be produced to 10% and 20% tolerances.

A ceramic formulation can be furnished to yield optimum performance under conditions of your particular application. Capacities for typical ranges are shown below. Note the unusual stability of the new "WG" Body for radio and television temperature range.

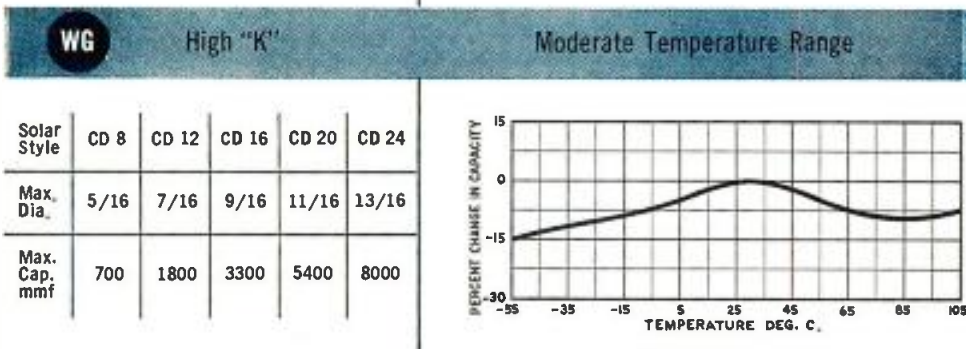
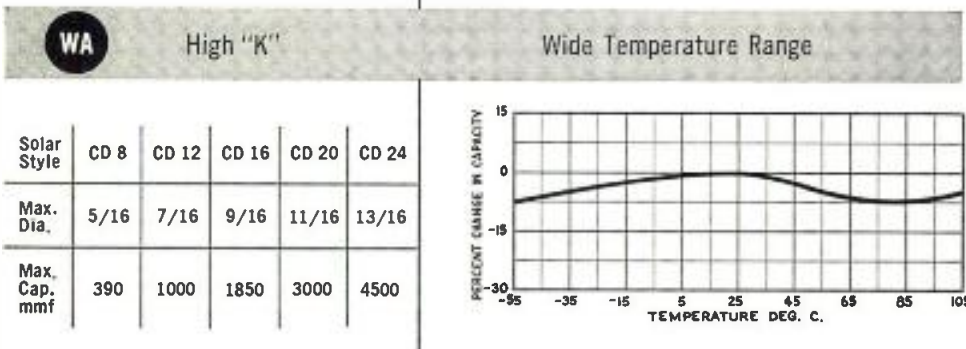
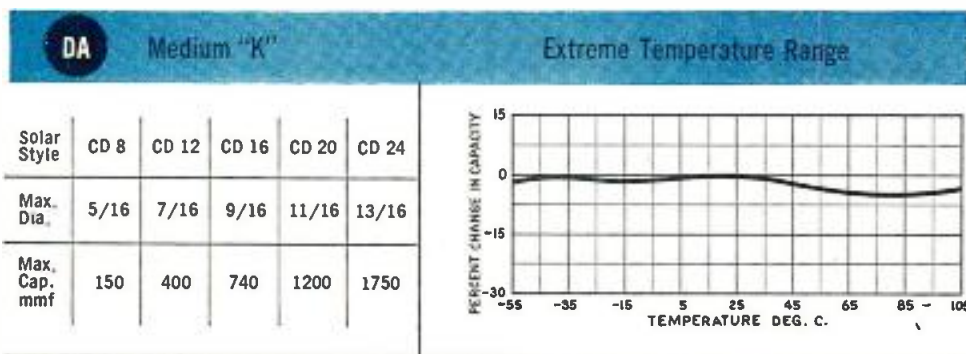

Normal Ratings: 500 V; 1½% max. PF; min. IR; 7500 Meg.

Write for literature, or the complete Solar catalog.

**SOLAR MANUFACTURING CORP.**  
New York, N. Y.



SALES OFFICES: 46th & Seville, Los Angeles 58, Calif.  
4000 W. North Ave., Chicago 39, Ill.

CERAMIC CAPACITORS • PRINTED NETWORKS • PIEZO CERAMICS

## CUES—

(Continued from page 73)

fold back out of the way. Remove and discard the short lead between one bottom connection of S<sub>2</sub> and one of the terminals of the holdout coil of S<sub>3</sub>. Determine which of the two remaining S<sub>3</sub> holdout coil leads connects to the primary windings of the filament transformers. This lead should be connected to the now vacant bottom connection of S<sub>2</sub>. The other should be taped and turned back.

### Economical Echo Chamber

LYLE C. MOTLEY, Ch. Engr.

WBTM, Danville, Va.

VARIOUS echo effects can be produced by playing back a recorded signal and mixing it with the "live" as it is being recorded. There will be a delay of the playback signal, the timing of which depends on the spacing of the recorder heads and the tape travel speed. At 7½ ips you get a complete repeat of an oscillating nature while at 15 ips you get more of the echo chamber effect. Varia-

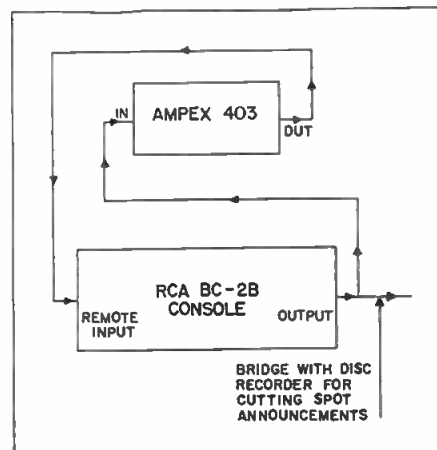

Mixing "live" and recorded signals

tions in the effects produced can be made by varying the ratios of the levels of the "live" and delayed signals.

We use an Ampex 403 recorder and an RCA BC-2B console and feed either the broadcast buss or the audition buss, depending upon whether we are making local production spots or doing a live program. Bridge the appropriate buss with the recorder input and at the same time feed the output of the recorder into a remote input on the console. Open the remote gain control to give you the desired effect. The recorder must be running and in the record mode of operation. The remote switch can be used to bring the echo in and out at will when certain phrases are to be echoed.

Shock, Vibration  
and Pressure Changes...

NO PROBLEM HERE

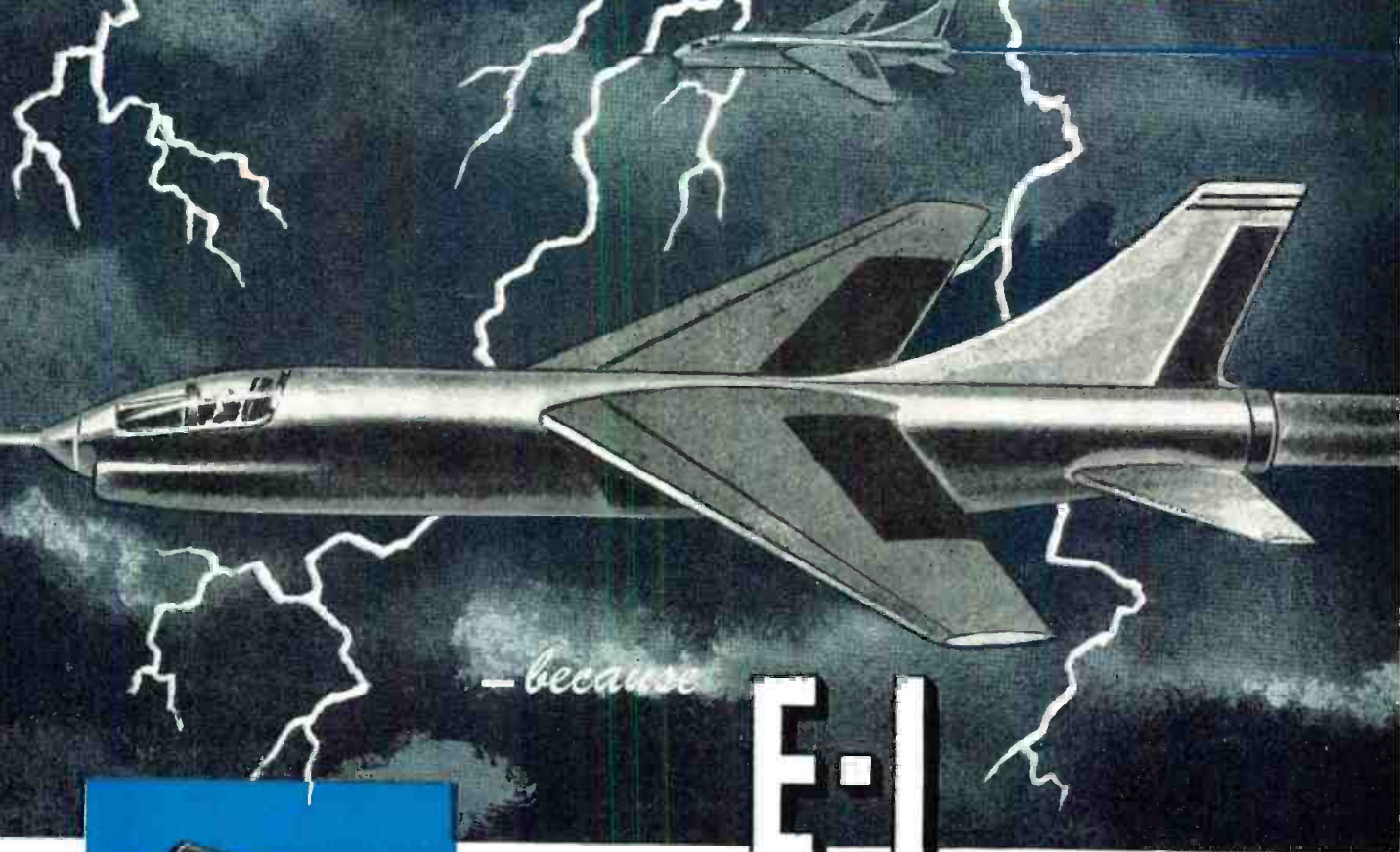

-because-

E-I

## COMPRESSION END SEALS\*

- are practically indestructible!

E-I Compression End Seals are the most effective seals available today for tubular components. Specially developed by E-I to exceed every requirement of the most critical modern application, they afford the highest degree of immunity to shock and vibration, violent change in pressure, temperature and humidity yet attained. Years of rigorous application experience prove this fact.

High performance E-I Compression Type Terminations are also available in multiple headers, single lead terminals and plug-in connectors. Volume production and a tremendous range of standard types offer two-way economy that makes it possible to specify the extra dependability afforded by E-I terminations at no extra cost.



THREADED  
COMPRESSION  
END SEALS



BEVELED  
COMPRESSION  
END SEALS

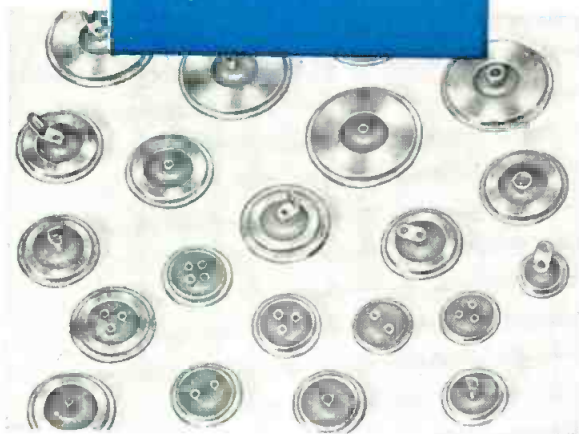

Contact your nearest E-I field engineer  
for complete information on —

- SPECIAL APPLICATION AND CUSTOM SEALS
- CRYSTAL AND SUB-MINIATURE CLOSURES
- DIODE AND TRANSISTOR CLOSURES
- PLUG-IN CONNECTORS
- MULTI-LEAD HEADERS
- SINGLE LEAD TERMINALS

\*PATENT PENDING —  
ALL RIGHTS RESERVED



**ELECTRICAL INDUSTRIES**

44 SUMMER AVENUE, NEWARK 4, NEW JERSEY



### PERMEABILITY-TUNED VFO's (Mfd. by Collins Radio Co.)

Mechanically stable—sealed against atmospheric changes—temperature and voltage compensated. Available as complete packages for incorporation into your equipment. Superior accuracy, stability and linear dial calibration for your transmitters, receivers, test equipment or frequency standards.



### AUTOTUNES (Mfd. by Collins Radio Co.)

Electro-mechanical position systems. Ideally suited for components requiring rotary or linear motion. Positioning accuracies of 0.05 angular degrees with reset accuracy to 0.0001 inch relative to 1/4 inch shaft size. Designed for the lifetime of any equipment. Fast—versatile—high torque—accurate—dependable.

SEE  
YOUR  
C-A-C MAN



**NEW YORK**—H. Gray Assoc. YE 2-3825  
21-10 33rd Rd. Long Island City 6, N. Y.  
**PHILADELPHIA**—C. R. Hille Co. Elgin 6-2266  
Hillview Road, Box 144. Paoli, Pa.  
**BALTIMORE**—C. R. Hille Co. Northfield 5-4500  
L. G. Korman, 5006 Kenwood, Baltimore 6, Md.  
**CHICAGO**—Gassner & Clark Co. Rogers Pk. 4-6121  
6644 N. Western Ave., Chicago 45, Ill.  
**LOS ANGELES**—S. O. Jewett. State 9-6027  
13537 Addison St., Sherman Oaks, Calif.  
**SYRACUSE**—Naylor Elec. Co., 2-3894  
1115 Hills Bldg., Syracuse 2, N. Y.  
**MERIDEN**—H. Lavin Assoc. Beverly 7-4555  
H. Lavin, P.O. Box 196, Meriden, Conn.  
**NEEDHAM**—H. Lavin Assoc. 3-3446  
R. V. Curtin, 82 Curve St., Needham, Mass.

**CLEVELAND**—E. Kohler Assoc. Olymple 1-1242  
8905 Lake Ave., Cleveland 2, O.  
**DAYTON**—Ernie Kohler Assoc. Oxmoor 2813  
2600 Far Hills Ave., Dayton 9, O.  
**SEATTLE**—Testco Mohawk 4895  
D. Thompson, Boeing Field, Rm. 105, Seattle 8, Wash.  
**INDIANAPOLIS**—R. O. Whitesell & Assoc.  
Fleetwood 9-5374  
6620 East Washington, Indianapolis 1, Ind.  
**DALLAS**—Norrell Assoc. Forest 8-4180  
5622 Dyer Street, Dallas 6, Tex.  
**ST. PAUL**—Northport Engineering, Inc.  
Midway 4-7884  
186 N. Fairview St., St. Paul 4, Minn.  
**ST. LOUIS**—E. W. McGrath Co. Parkview 5-6550  
1110 South Brentwood, St. Louis 17, Mo.

## COMMUNICATION ACCESSORIES CO.

World's Largest Exclusive Producer of Toroidal Windings  
HICKMAN MILLS, MISSOURI • PHONE KANSAS CITY, SOUTH 1-6111

*A Subsidiary of Collins Radio Company*

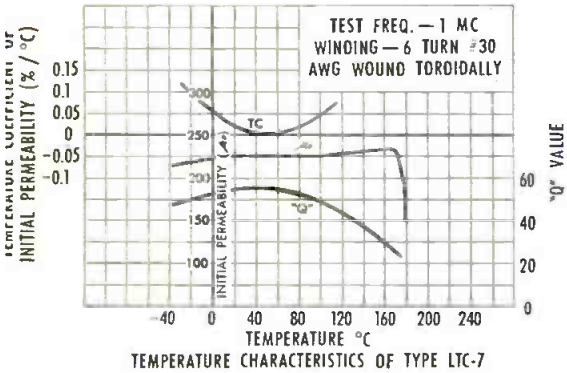

### FERRITE CORES (Mfd. by Collins Radio Co.)

Requirements for extreme temperature stability and consistently reproducible cores encouraged the Collins Radio Company to enter the magnetic materials field. Now, after several years of intensive research and development, these cores are available through CAC in many standard or custom forms for all applications. Temperature characteristics developed exhibit 10 times improvement over previous materials. Special saturation and other properties are presently available. Technical bulletins upon request.



### TUBE SHIELDS (Mfd. by Collins Radio Co.)

Heat treated beryllium copper corrugated liner and socket insert are highly resilient and accommodate wide variations of tube diameter. Base liner reduces bulb temperature in most critical tube area. Interchangeable with standard JAN equipment. Tube cannot work out of socket through long term vibration. Maximum electrostatic shielding.

*Catalogs on Individual Components are Available on Request.*

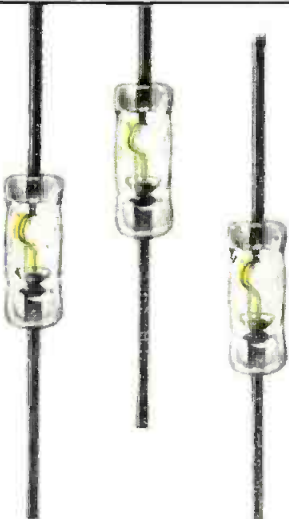

**GOLD BONDED**

# NOW... a complete range of **RADIO RECEPTOR GERMANIUM DIODES**

*that meets the exacting requirements  
of the GOLD standard*

These subminiature glass diodes, the result of Radio Receptor's controlled gold bonding process, are long lived and dependable. They include such desirable characteristics as high conductance, low leakage and fast reverse recovery, all at a low cost that makes them practical for every type of service. Individually tested in our factory, RRco. gold bonded diodes give superior service in the field under the most rigorous conditions.

*Production quantities  
available for immediate delivery*

**general purpose types**

**high temperature types**

**high conductance types**

**computer types**

**military types**

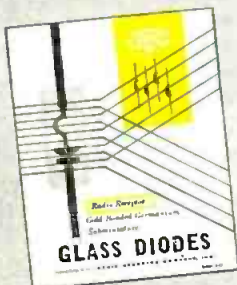

If your production includes computers, receiving equipment, transistor biasing, magnetic amplifiers, modulators, demodulators, pulse circuitry, logic circuitry, metering, varistors, or any other circuitry requiring diodes, write for our comprehensive new catalog today. It includes

typical characteristic charts and additional information pertaining to our complete line.

Semiconductor Division, RADIO RECEPTOR CO., INC.  
240 Wythe Avenue, Brooklyn 11, N. Y.

*Please send me your new diode catalog No. G-60*

Name..... Position.....

Company.....

Address.....

City..... Zone..... State.....



Radio and Electronic Products Since 1922

T

# NEW!---IMPROVED!



## TORKRITE

Your answer for smooth torque without stripping!

**NEW TORKRITE** tubing is now scientifically brushed and lubricated to give that extra protection which ensures better performance.

**IMPROVED TORKRITE** is internally threaded and embossed to provide a smooth and constant torque action, engineered to meet every requirement.

**ONLY TORKRITE COIL FORMS** have these **NEW** built-in qualities.



Write for our latest brochure showing complete line of CLEVELITE\* Phenolic tubing.

\* Reg. U.S. Pat. Off.

**THE CLEVELAND CONTAINER COMPANY**

6201 BARBERTON AVE. CLEVELAND 2, OHIO

**PLANTS AND SALES OFFICES:**

CHICAGO • DETROIT • MEMPHIS • PLYMOUTH, WIS. • OGDENSBURG, N.Y. • JAMESBURG, N.J. • LOS ANGELES

ABRASIVE DIVISION at CLEVELAND, OHIO

Cleveland Container Canada, Ltd., Prescott and Toronto, Ont.

**Representatives:**

NEW YORK AREA: R. T. MURRAY, 604 CENTRAL AVE., EAST ORANGE, N. J.

NEW ENGLAND: R. S. PETTIGREW & CO., 62 LA SALLE RD., WEST HARTFORD, CONN.

CHICAGO AREA: PLASTIC TUBING SALES, 5215 N. RAVENSWOOD AVE., CHICAGO

WEST COAST: IRV. M. COCHRANE CO., 408 S. ALVARADO ST., LOS ANGELES



## Power Transistors

(Continued from page 59)

mined in the detector. Provision is also made for reversing the polarity of the feedback signal in accordance with the output polarity.

Fig. 3 is an oscillogram of a family of collector curves taken in the grounded emitter condition. The base current steps are 300 ma each and the total  $i_c$  is approximately 1.5 a. Figs. 4 and 5 show grounded base, collector, and transfer curves with the step size increased to 500 ma. The maximum  $i_c$  in this case is about 2 a.

### Current Gain vs $i_i$ or $i_o$

The method generally employed to obtain swept alpha or beta curves for small transistors is to superimpose in the input, a small h-f probe current and a low frequency sweep current. If the sweep frequency is limited to 20 cps this sets a minimum on the probe current frequency. The minimum value of the ratio of probe frequency to sweep frequency is largely subjective but should certainly not be less than 50. This value would give, for a 4 in. linear sweep,  $12\frac{1}{2}$  cpi which is usable but not entirely satisfactory. If the sweep frequency is raised to 60 cps, the minimum probe current frequency increases to 15 KC for marginal performance. This frequency is entirely suitable for  $\alpha$  measurements but is too high for  $\beta$  measurements on many large power transistors.

Another approach to the problem is based on the definition of the transistor current gain.

$$\beta = \frac{\delta i_c}{\delta i_b}, V_c = \text{constant} \quad (1)$$

Differentiating  $i_c$  with respect to  $i_b$  is rather complex but if  $i_b$  is made proportional to time, then the differentiation can be made with respect to time.

$$\text{let } i_b = kt \quad (2)$$

$$\text{then } \beta = \frac{1}{K} \frac{\delta i_c}{\delta t} \quad (3)$$

The derivative of  $i_c$  can be taken with a simple RC time constant and the proportionality constant, k, can be cancelled in the calibration circuit.

A block diagram of the system is shown in Fig. 6. The sawtooth gen-



erator must be capable of generating the necessary current at an impedance which is high compared with the input impedance of the transistor. A carrier is not neces-

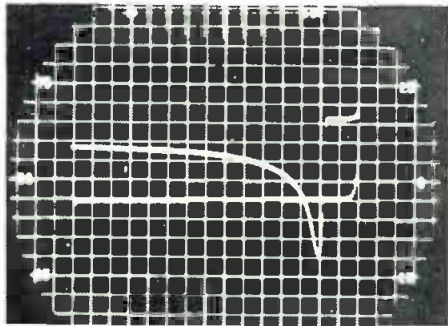

Fig. 7: Oscillogram, beta vs. base current

sary since the l-f requirements are not so formidable. Clamping is not necessary since it is desirable to start the sweep slightly below the baseline to display the region around the zero point. For applications where 50 or 100 ma of  $I_1$  is sufficient, a voltage source in series with several thousand ohms gives completely adequate performance. The repetition rate was selected for convenience and the sweep length was chosen to provide a low duty cycle. This not only simplifies the power supply but permits measurements at peak currents considerably beyond the continuous duty ratings of the transistor. A lower limit is placed on the sweep length by the frequency response of the transistor.

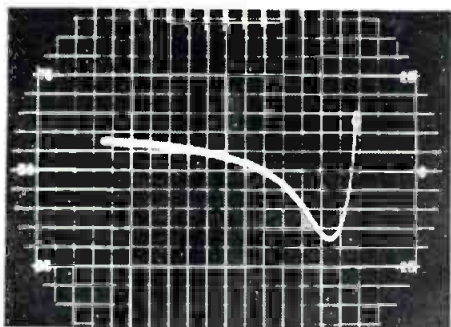
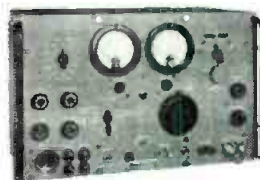

Fig. 8: Beta vs. collector current

The harmonic content of the sawtooth waveform cannot be determined from a simple Fourier analysis because of the difficulty of separating the components which are associated with the ramp function from those due to the sharp trailing edge which are of no concern in this particular problem. An analysis based on the response of a



## Test with **ARC Precision** ... Fly with **ACCURACY**



Type H-14A  
Signal Generator



Type H-16  
Standard Course Checker

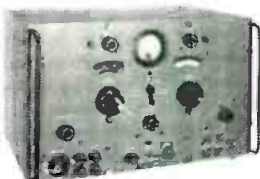

Type H-12  
UHF Signal Generator

Radio technicians and pilots trust ARC test equipment to keep airborne instruments in tune for precision navigation and communication.

**The Type H-14A Signal Generator** has two uses: (1) It provides a sure and simple means to check omnirange and localizer receivers in aircraft on the field, by sending out a continuous test identifying signal on hangar antenna. Tuned to this signal, individual pilots or whole squadrons can test their own equipment. The instrument permits voice transmission simultaneously with radio signal. (2) It is widely used for making quantitative measurements on the bench during receiver equipment maintenance.

**The H-16 Standard Course Checker** measures the accuracy of the indicated omni course in ARC's H-14A or other omni signal generator to better than  $\frac{1}{2}$  degree. It has a built-in method of checking its own precision.

**Type H-12 Signal Generator** (900-2100 mc) is equal to military TS-419/U, and provides a reliable source of CW or pulsed rf. Internal circuits provide control of width, rate and delay of internally-generated pulses. Complete specifications on request.

Dependable Airborne Electronic Equipment Since 1928

# Aircraft Radio Corporation

BOONTON, NEW JERSEY

Omni/ILS Receivers • Course Directors • UHF and VHF Receivers and Transmitters • LF Receivers and Loop Direction Finders • 10-Channel Isolation Amplifiers • 8-Watt Audio Amplifiers • Interphone Amplifiers • Omnirange Signal Generators and Standard Course Checkers • 900-2100 Mc Signal Generators



It's **AEROVOX** for  
**HIGH VOLTAGE**

**CAPACITORS FOR DC OR HIGH-CURRENT  
DISCHARGE APPLICATIONS**

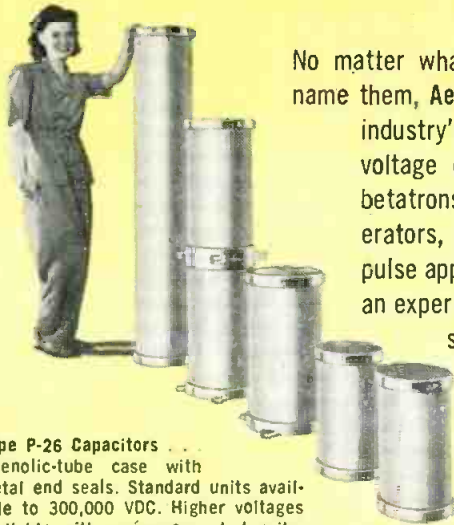

Type P-26 Capacitors . . . phenolic-tube case with metal end seals. Standard units available to 300,000 VDC. Higher voltages available with series-connected units.

No matter what the voltage requirements—you name them, Aerovox meets them. Aerovox is the industry's leading supplier of special high-voltage capacitors for radio-transmitters, betatrons, X-ray equipment, nuclear accelerators, radar, sonar and all military and pulse applications. Which accounts for such an experienced engineering staff with wide-scale knowledge of high-voltage equipment for high-current pulsing and minimum inductive reactance applications.

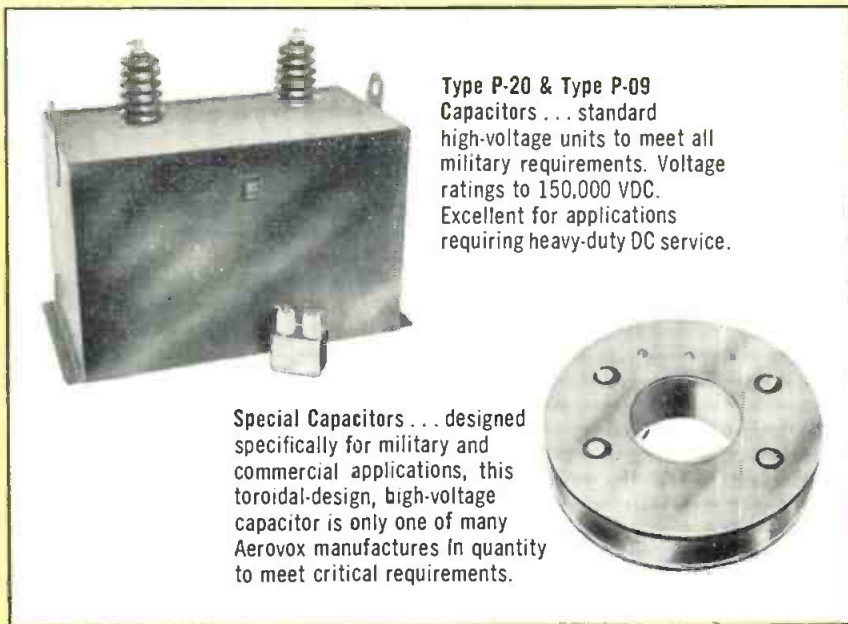

Type P-20 & Type P-09 Capacitors . . . standard high-voltage units to meet all military requirements. Voltage ratings to 150,000 VDC. Excellent for applications requiring heavy-duty DC service.

Special Capacitors . . . designed specifically for military and commercial applications, this toroidal-design, high-voltage capacitor is only one of many Aerovox manufactures in quantity to meet critical requirements.

*Write*

For complete information on how Aerovox can assist you with your capacitor needs.



**AEROVOX CORPORATION**

**NEW BEDFORD, MASS.**

In Canada: AEROVOX CANADA, LTD., Hamilton, Ont.  
Export: Ad. Auriema, 89 Broad St., New York, N. Y. • Cable: Auriema, N. Y.

simple low pass filter to a ramp function can be found in the literature<sup>2</sup>. Suffice to say that inadequate high frequency response will result in distortion of the initial portion of the sawtooth. As an example; with a 1 ms sawtooth, the error will be reduced to less than 3% in the first 10% of the sweep if the transistor cutoff frequency is 5500 cps. This figure is based on an elementary (one section) low pass filter and a transistor will give an even lower frequency, about 30% lower, if the delay line analogy is used<sup>3</sup>.

With a 1 ms sweep and a repetition rate of 60/sec, the average current for a peak of 10 a is approximately 300 ma. A power supply of this capacity is used to maintain the potential on a 1200 $\mu$ fd. capacitor which feeds the collector. If the average current during a sweep is assumed to be 5 a, the voltage drop during the sweep is just over 4 v, which is not considered excessive. A larger capacitor can be used if necessary at the very low collector voltages. Calibration is performed by comparing the amplitude of the output and input currents in the differentiator. This comparison method is capable of yielding a precision which is considerably in excess of the 1% tolerance of the resistors.

**References**

1. Kramer, S. I., "Staircase Generator," Electronics, February 1956.
2. Locke, A. S., Guidance, Van Nostrand, 1955.
3. Shea, R. F., Principles of Transistor Circuits, Wiley, 1953.

**Radar Now Being Used To Measure Distances**

Surveyors using the "radar ruler," developed by the Signal Corps, now have 20-league boots, thanks to the application of radar for measuring great distances.

The Army's Signal Corps Engineering Labs at Fort Monmouth, N. J., have come up with a radar yardstick that enables a surveyor to measure 50 miles in a single giant leap, instead of 20 or 30 small hops requiring careful sighting each time. Designed under Signal Corps contract by Motorola, Inc., of Chicago, the new system uses two separate jeep-portable radar stations, one at each end of the distance to be measured.

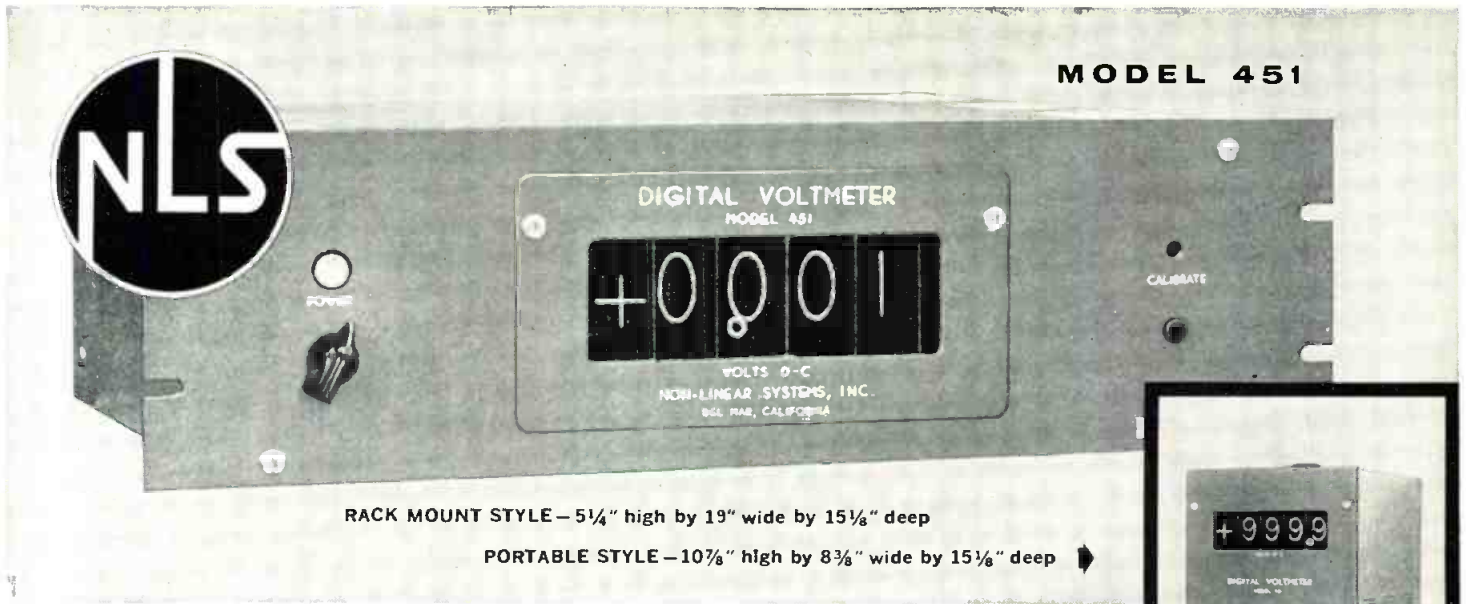

RACK MOUNT STYLE — 5¼" high by 19" wide by 15½" deep

PORTABLE STYLE — 10¾" high by 8¾" wide by 15½" deep

## Now! Accurate automatic measurements for varied industrial applications...

NOW EVERY FEATURE you want in a precise, automatic Digital Voltmeter is available in these new Non-Linear Systems models. Their performance features automatic measurement from zero to  $\pm 999.9$  volts DC with high accuracy and resolution. *Fast readings* are presented in a brilliant, in-line luminous numerical display. *Automatic features* simplify operation, enable you to use non-technical employes. Assured *long life* results from exclusive NLS *oil-sealed* stepping switch system, plus top-quality components. Thorough *quality control* ensures reliable operation. And unitized construction means *simplified maintenance*, saving you time and money.

Yet NLS Model 451 Digital Voltmeters are priced far below instruments offering only a fraction of these advantages! These low costs are possible because NLS, as originators of the Digital Voltmeter, has the advantage of pioneering design and production techniques. Furthermore, NLS quantity production results in additional savings.

You can save time and money, and assure automatic accuracy in precision measuring, with an NLS

Digital Voltmeter. Mail coupon today for more information on how these quality instruments can assist your operations.

### YOU GAIN THESE ADVANTAGES

- Automatic operation** — Simple operation plus brilliant numerical readout and recording allows use of non-technical personnel.
- Exhaustive quality control** — Sustained accuracy assured by systematic testing procedure throughout all engineering, production phases.
- Unitized, standardized construction** — Each instrument can be quickly disassembled into three functioning subassemblies.
- Quality components**, including mercury-cell reference standard, stepping switches built to NLS specifications, precision resistors and other high standard components.
- Oil-sealed stepping switch subassembly** cuts maintenance, boosts switch life, ensures reliability under all operating conditions.
- Long-life stepping switches** — Life tests corresponding to 21,000,000 readings completed, with switches still operating!

Simplified maintenance, resulting from unitized construction, saves you time and money.

**No-lost-time service** — Interchangeable subassemblies and complete instruments available promptly.

**Automatic recording** by electric typewriter, printer, summary punch.

**Low initial cost**, based on NLS integrated, efficient production methods, and on advanced engineering developments.

**New! Automatically-standardized reference power supply** eliminates manual adjustment; available instead of internally-mounted mercury-cell battery pack.

### APPLICATIONS

- Automatic measurement, digital display and recording of DC voltages for:**
  - Manufacturing** — Development, production and process control testing.
  - Laboratories** — Precision standardization procedures.
  - Special test equipment** — Analog computers, missile components, control systems.
- Many more!** Our application engineers are available to work with you.



## NON-LINEAR SYSTEMS

TWX: Del Mar 6-345 — PHONE: Skyline 5-1134

ORIGINATORS OF THE DIGITAL VOLTMETER

Digital Ohmmeters • AC-DC Converters • Digital Readouts  
Data Reduction Systems • Peak Reader Systems  
Digital Recording Systems • Binary Decimal Converters

### NON-LINEAR SYSTEMS, INC.

Dep. B-15, Del Mar Airport, Del Mar, California

Send new '56 catalog on complete line of precision instruments, and current price list.

NAME \_\_\_\_\_

COMPANY \_\_\_\_\_

ADDRESS \_\_\_\_\_

CITY \_\_\_\_\_ STATE \_\_\_\_\_

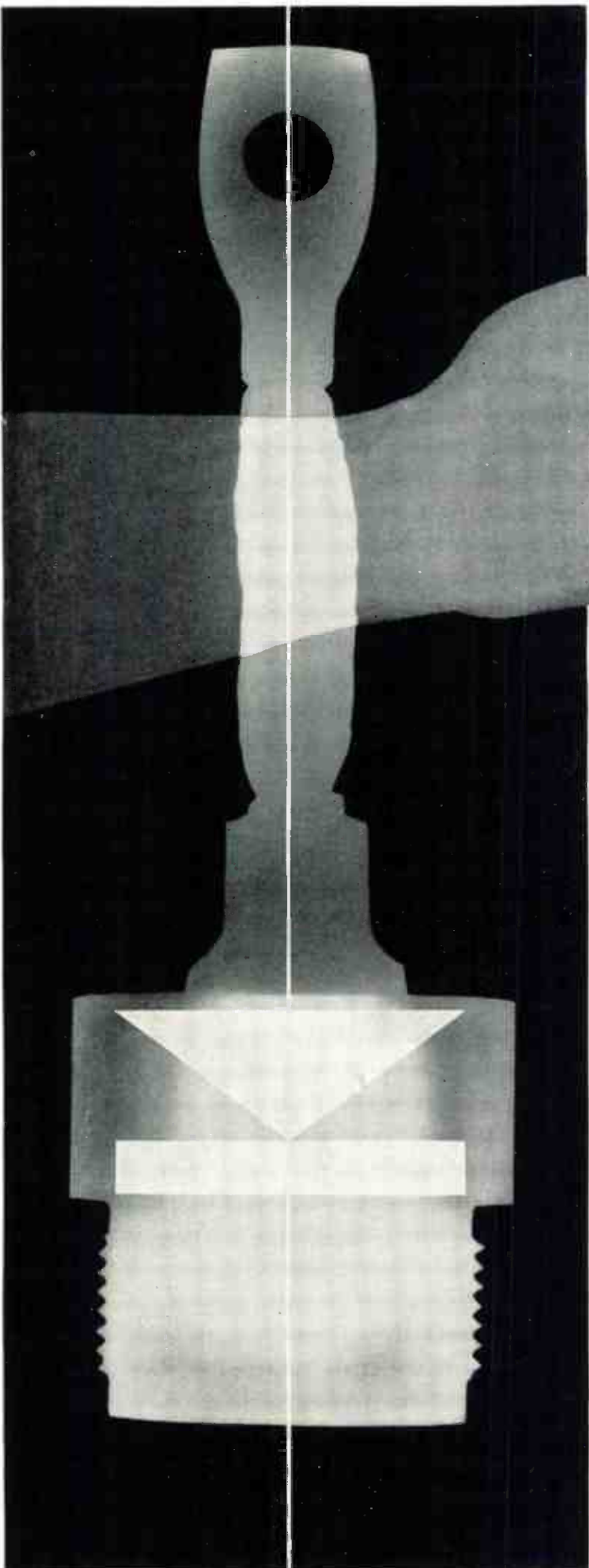

NEW WESTINGHOUSE  
HIGH-POWER  
SILICON RECTIFIER

*475 amperes d-c . . .  
300 volts PIV*

Highest power silicon rectifying cell commercially available . . . that's the Westinghouse WN-5082!

Ambient temperatures present no heat problems for these silicon cells—units operate in temperatures up to 175° C. Curve below shows forced air-cooled, three-phase bridge ratings.

This diode is ideally suited for railway, elevator, arc welder, battery charger and other industrial high-power applications.

Production quantities are available immediately. For more information on the WN-5082, or any other silicon rectifier requirements, regardless of voltage and current, call your nearest Westinghouse apparatus sales office. Or write Westinghouse Electric Corporation, 3 Gateway Center, P. O. Box 868, Pittsburgh 30, Pennsylvania. J-09004

**WATCH WESTINGHOUSE!**  
WHERE **BIG THINGS ARE HAPPENING TODAY!**

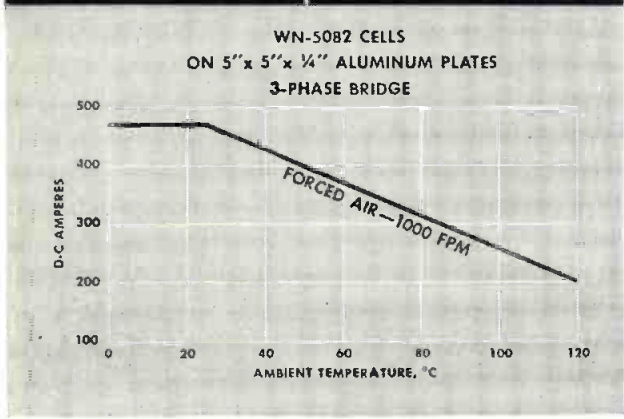

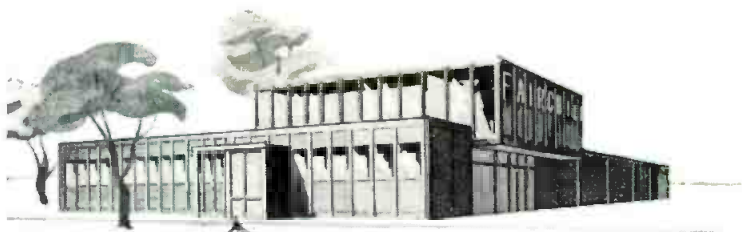

Los Angeles, Cal.

Fairchild's new Los Angeles plant affords expansion of the manufacturing, sales and service activities of the Components Division to provide equal facilities both in the East and West. It meets the growing needs of the expanding West Coast electronics and avionics industries for Fairchild potentiometers, pressure transducers and other components. This new plant is fully equipped for the manufacture of these products and is staffed to provide complete engineering service and fast deliveries.

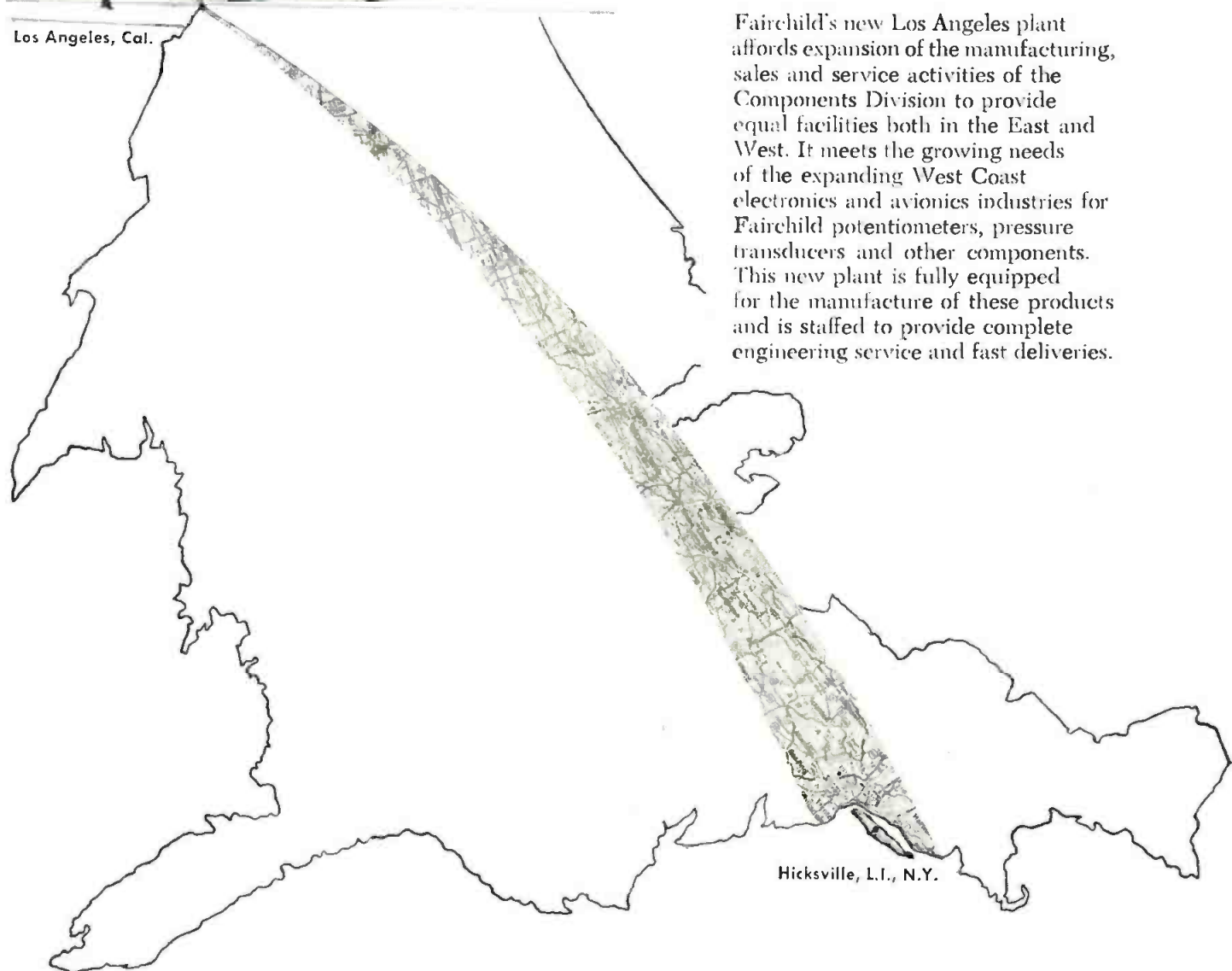

Hicksville, L.I., N.Y.

## AVAILABILITY AND SERVICE

### from L.I. to L.A.

The name "Fairchild" means the finest in precision components, and now — through the facilities of the West Coast plant — it means faster deliveries and better service, too. Now you are able to get complete engineering service, quotations, order handling, delivery and other customer services from either plant, whichever is more convenient to you. This is another example of the way Fairchild strives to be of maximum service to you no matter what factors govern your choice of precision components. Write to Fairchild Controls Corporation, Components Division, Dept. 140-76E.

EAST COAST  
225 Park Avenue  
Hicksville, L. I., N. Y.

WEST COAST  
6111 E. Washington Blvd.  
Los Angeles, Cal.



**FAIRCHILD**  
**PRECISION POTENTIOMETERS**  
**and COMPONENTS**

# CERAMIC CARTRIDGES

## NEW! American "Clearamic" LOADED with PROFIT

- Lightweight, miniature size, greater compliance
  - New mechanical construction gives higher output
  - New "throwaway" element
  - Simple replacement, snap-in action
  - Assorted stock orders totaled for maximum discount
- "Clearamic" The "new look in good listening"

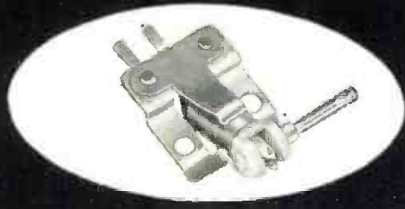

Turnover Type  
Response . . . 40-12,000 cycles  
Output . . . 1-1.2 volts  
Sapphire needle



Single Needle Type  
Response . . . 40-12,000 cycles  
Output . . . 1-1.2 volts  
Sapphire or osmium needle

Now! Elgin presents the new AMERICAN "Clearamic" line . . . ceramic cartridges specially designed for today's hi-fidelity equipment. Turn-over type features "throwaway" element offering users a snap-in replacement of both element and needle assembly for essentially the price of a good replacement needle. Single needle type features self-locating needle replacement.

Both "Clearamic" types fit most tone arms now in use . . . offer big sales potential.

Write today for descriptive literature . . . microphones, accessories, tone arms and cartridges . . . watch for the attractive new "window" package.



**ELECTRONICS DIVISION**  
ELGIN NATIONAL WATCH COMPANY

For cartridges:

370 South Fair Oaks Avenue, Pasadena 1, California  
Sales representatives in principal cities.

## Free Power

(Continued from page 56)

be provided with an npn or a pnp type transistor.

### Power Utilization

Superiority of such a semi-passive receiver over a simple crystal set can be understood through an analysis of the power utilization of each. The passive crystal set derives its audio output power from the modulation envelope of the received rf energy. Energy of the carrier is not utilized for output power. In the semi-passive set, on the other hand, the carrier is rectified to provide dc power for the operation of active portions of the set. Thus, the semi-passive set utilizes the total rf signal and is capable of delivering greater output than the simple detector circuit.

### Experimental Set

Fig. 6 is a photograph of an experimental receiver. It is provided with a switch which permits the set to be used in either the passive or the semi-passive mode for experimental comparisons. Whether the incoming rf has sufficient power to drive a small loudspeaker or only an earphone, the gain of semi-passive detection as compared to passive detection is quit surprising.

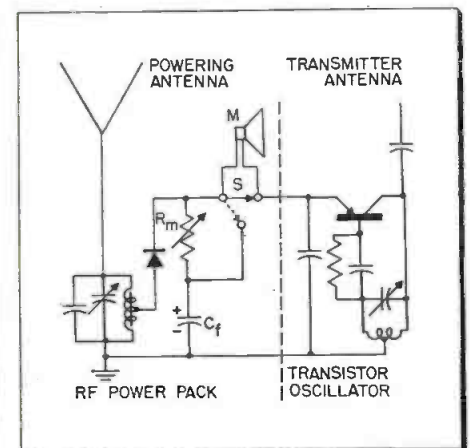

Fig. 9: Diagram of a secondary oscillator

On the other hand, there is an input signal threshold below which the transistor semi-passive receiver is not superior to the crystal set. This minimum input level is determined by the supply energy at which the transistor's gain drops to one. Since sensitive audio transistors begin to amplify with a col-

lector current around 10 microamps, the full advantage of semi-passive signal detection becomes apparent at 50 microamps and more.

The efficiency of the developed receiver is limited by the fact that the single transistor performs four different functions at the same time. Since audio amplitude and maximum gain are closely related with the dc level, various transistor types differ greatly in performance and efficiency. Considerable improvement can be obtained by separate rectification and amplification, in other words, by separate rf and af circuits. At the same time, qual-

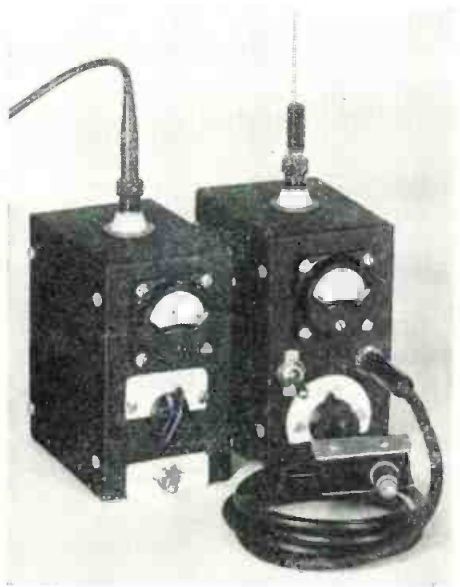

Fig. 10: Secondary xmtr for radio control

ity can be improved by use of a complementary-symmetric push-pull stage.

Fig. 7 illustrates the circuitry of such a passive power receiver which operates in the following way: two diodes  $D_1$  and  $D_2$ , across the large filter capacitors  $C_{r1}$  and  $C_{r2}$  produce two supply voltages with opposite polarity which feed the two transistors  $TR_1$  and  $TR_2$  of opposite types of conductivity. Audio signals according to the modulation envelope are derived across resistor  $R_m$  in one of the diode circuits and are impressed in single phase upon the input bases of both transistors in their common-emitter configurations. The amplified audio signals drive a 500-ohm loudspeaker inserted into the diagonal branch of a bridge circuit.

Fig. 8 is a photograph of the first laboratory model. The volume control is resistor  $R_m$ . Depending on

## TDI TYPE 1202A VOLTAGE CONTROLLED OSCILLATOR\*



**TINY!** Only 8 oz. in weight, 3 $\frac{3}{8}$  inches in height, 1 $\frac{5}{16}$  inches in width and 1 $\frac{1}{16}$  inches in depth!

**TOUGH!** Environmentalized for extreme variations in temperature, altitude, acceleration, shock, vibration and humidity!

**TERRIFIC!** Provides stable, linear signal and exceptional reliability under all of the above

conditions. For use in missiles, drones and piloted aircraft.

Complete technical data and specifications on TDI Type 1202A Voltage Controlled Oscillator, or other TDI remote instrumentation components and systems sent on request.  
\*Pat. Pending

## TELE-DYNAMICS INC.

*A Raymond Rosen Corporation*

32ND & WALNUT STREETS, PHILADELPHIA 4, PA.

Western Regional Office: 15016 Ventura Blvd., Sherman Oaks, Los Angeles, Calif.  
Formerly Raymond Rosen Engineering Products, Inc.

### INDEXING TURNTABLES OF EVERY DESCRIPTION

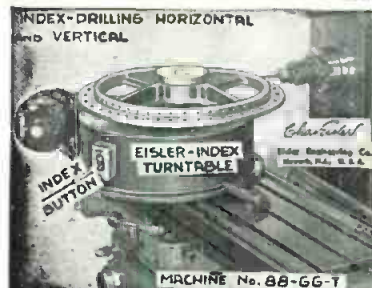

EISLER MAKES MANY TYPES OF AUTOMATIC EXHAUST MACHINES FOR MANY PURPOSES, 24, 36 AND 48 HEADS. THIS IS NOT A NEW DEVELOPMENT WITH EISLER. THIS MACHINE HAS BEEN MADE BY US FOR OVER 35 YEARS.

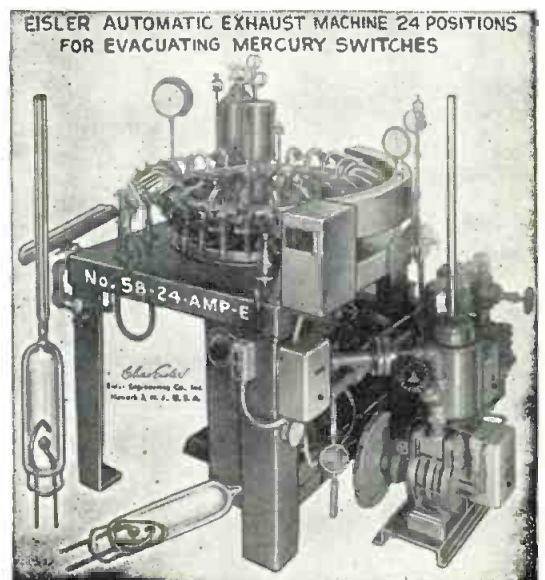

Dr. Chas. Eisler, M.E. Founder  
CHAS. EISLER, JR., PRES.

**EISLER ENGINEERING CO., INC.**

770 So. 13th St., NEWARK 3, N. J.

SEND FOR  
CATALOG

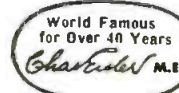

# UNION

## "Selenium Slim" Rectifiers Quality First....TO LAST

### 5200 UNION Selenium Rectifiers used without a single failure!

Here is what Mr. P. W. Aitkenhead,  
General Manager, Electro-Air Cleaner Company,  
Pittsburgh, Pa., says  
about UNION Selenium Rectifiers:

"We decided to use selenium rectifiers in our electronic air cleaners because, in the interest of building service-free vacuum rectifier tubes.

Our experience in the use of selenium rectifiers has been one hundred per cent satisfactory. At the present time, we have some four thousand  $\frac{3}{16}$ " rectifier pencils in service and about twelve hundred  $\frac{3}{16}$ " rectifiers. Some of these selenium rectifiers are in the third year of operation and I am certain that continued satisfactory operation is assured. We have not had a single rectifier failure to date."

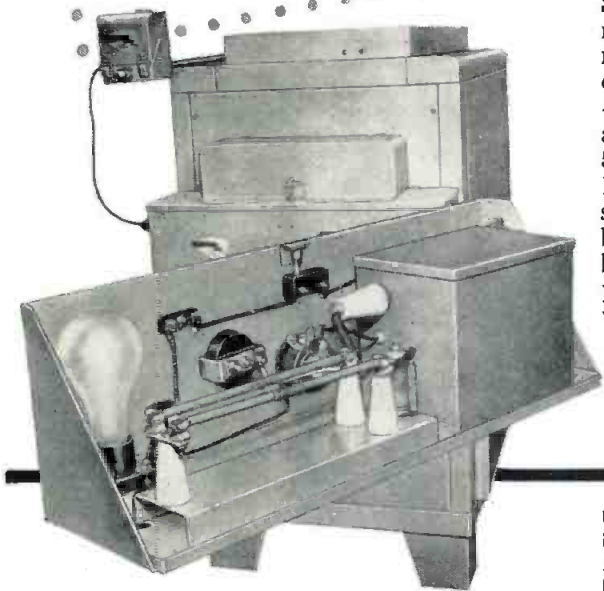

Standard UNION selenium rectifier cells, pencil type, range in size from  $\frac{1}{8}$ " to  $\frac{1}{2}$ " diameter, rated from 2.5 to 40.0 milliamperes per cell; and stack-type, 1" x 1" to 5" x 6", rated from .180 to 10.0 amperes per cell in a single-phase full-wave bridge basis. Special combinations can be made to fit practically any current and voltage conversion requirements in various housings and special shapes. Write for complete information.

UNION Selenium Rectifiers in place in the power pack of the "Electro-Air" electronic air cleaner assure long, trouble-free operation.

# 75 Years

1881



1956

OF EQUIPMENT AND SYSTEMS ENGINEERING . . . . .

**UNION SWITCH & SIGNAL**  
DIVISION OF WESTINGHOUSE AIR BRAKE COMPANY  
PITTSBURGH 18, PENNSYLVANIA

the available energy level in each particular case and on the tolerable distortions, the output volume of the complementary-symmetry type exceeds that of a single crystal set by a factor as large as 10.

### Secondary Oscillators

In the same way as with an amplifier, the rf power pack can be utilized for the driving of a small transistor oscillator. Basically, such a secondary-powered oscillator is a frequency converter, but since the secondary frequency is generated via frequency zero, there is no relationship whatsoever between the driving or primary frequency and the outgoing or secondary frequency. At the same time, the new carrier may reradiate the primary modulation signals in their original form or new modulation signals may be impressed upon the new carrier in the form of am, fm, pm, and the like.

Fig. 9 is the simplified circuitry of a secondary oscillator. With switch S in the solid position, the Hartley oscillator is "hum-modulated" by the audio signals across resistor  $R_m$ . With switch S in the dotted position, local modulation signals produced by the microphone M or any other source of information are impressed upon the secondary carrier so that the secondary oscillator emits new intelligence signals. Instead of simple collector modulation, there may be an extra modulator such as a diode for load modulation, a ferroelectric capacitor or saturable reactor for fm, and the like.

One form of modulation is switching or keying in the form of on-off signals for telemetry or radio control. Fig. 10 is the photograph of a crystal controlled transmitter converting the energy of a local broadcast station or any other powerful transmitter in the vicinity into the RC frequency of 27,255 mc. With the aid of such frequency conversion, local broadcast energy can be utilized for the radio control of a model car, a model boat, a model airplane, etc.

Using the techniques developed for secondary powered receivers and transmitters, transceivers can be developed without local power sources but exclusively powered by rf energy from local transmitters.



Duplex communication may be performed between a multiplicity of such secondary transceivers within the power range of the master transmitter.

More efficient energy transmission is achieved at higher frequencies and with the aid of directional antennas. Thus, an fm or TV transmitter may provide a greater amount of secondary power than a broadcast station. This fact points to the possibility of using microwave power beams to drive unattended transistorized equipment such as TV or communications repeater stations and radio navigation aids. Application of the principle of free power to transistorized equipment opens up many intriguing lines of investigation, the practical consequences of which can hardly be predicted.

#### References

- 1) H. E. Hollmann: "Free Powered Transistor Apparatus," *Electro-Technik*, 9 Oct. 1954.
- 2) H. E. Hollmann: "Applications of Tandem Transistors," *Tele-Tech*, Feb. 1956.
- 3) H. E. Hollmann: "Designing Free-Power Transistor Apparatus," *ELECTRONIC INDUSTRIES*, Aug. 1956.

## Closed-Circuit TV Set For N. Y. Hotels Soon

Using the closed-circuit facilities of New York hotels equipped with TV master systems and receivers, Hotel TV Broadcasting Corp., 730 Fifth Ave., New York, plans a new television program service this Fall; information about goings-on in Manhattan for all guest rooms in the circuit.

Headed by Will Baltin, the corporation will operate the hotel TV stations in association with Wells Closed-Circuit Television, Inc., and provide facts about places to visit, sights to see, and current attractions at movies, theatres, night clubs, and sports events.

The program service will be transmitted to individual rooms by Vidicon equipment in each hotel. Programs are to include a 30-minute film on what to do and see in Manhattan; scenes from current movies; seasonal fashions; and other entertainment highlights. An eventual intra-city and, later, a Nation-wide service are planned by Hotel TV Broadcasting Corp., according to spokesmen.

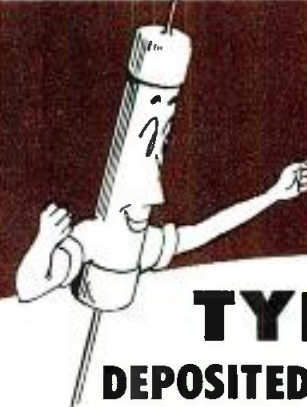

*I'm DALOHM...  
miniature but mighty!*

You can depend on 

# TYPE DC

## DEPOSITED CARBON RESISTORS



Manufactured under the most rigid quality control standards to deliver matchless performance and economy. Dalohm Type DC resistors now supplied with an improved coating material which incorporates extreme toughness, low temperature cycling, humidity resistance, and high temperature characteristics — making these resistors suitable for printed circuit solder dipping without the added space required for sleeving.

Eight basic sizes, six wattage ranges— $\frac{1}{8}$  watt;  $\frac{1}{4}$  watt;  $\frac{1}{2}$  watt; 1 watt, 2 watts, 5 watts.

- From 1 ohm to 500 megohms, depending on type
- Temperature coefficient 140 PPM to 500 PPM per degree C
- 1% accuracy (other tolerances available)

Meet MIL-R-10509-A Specifications

Write for Bulletin R-24A

**DALE PRODUCTS, INC.**  
PHONE 2139  
1304 28th Ave., Columbus, Nebraska, U.S.A.

Export Dept.: Pan-Mar Corp.  
1270 Broadway, New York 1, N.Y.  
In Canada: Charles W. Pointon, Ltd.  
6 Alcina Ave., Toronto



**★ ULTRA LOW** capacitance & attenuation

TYPE	$\mu\text{mf}/\text{ft}$	IMPED., $\Omega$	O.D.
C 1	7.3	150	.36"
C 11	6.3	173	.36"
C 2	6.3	171	.44"
C 22	5.5	184	.44"
C 3	5.4	197	.64"
C 33	4.8	220	.64"
C 4	4.6	229	1.03"
C 44	4.1	252	1.03"

WE ARE SPECIALLY ORGANIZED TO HANDLE DIRECT ORDERS OR ENQUIRIES FROM OVERSEAS  
SPOT DELIVERIES FOR U.S. BILLED IN DOLLARS—SETTLEMENT BY YOUR CHECK  
CABLE OR AIRMAIL TODAY

**NEW** 'MX and SM' SUBMINIATURE CONNECTORS  
Constant 50 $\Omega$ –63 $\Omega$ –70 $\Omega$  Impedances

TRANSRADIO LTD. 138A Cromwell Rd. London SW7 ENGLAND CABLES: TRANSRAD, LONDON

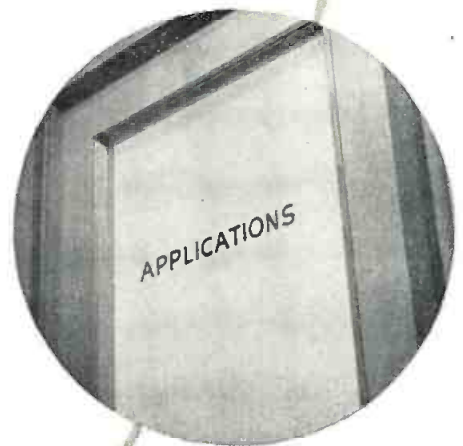
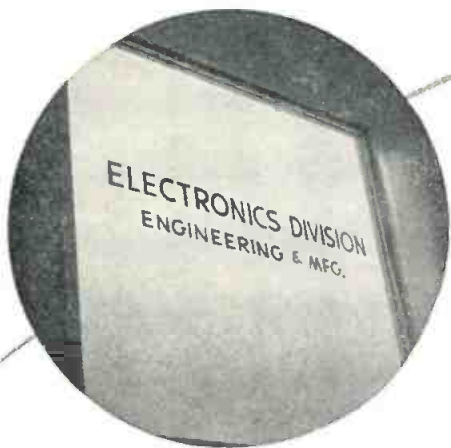

## BEHIND THESE DOORS...

The formula for success in the field of electronics might be resolved to the equation, "Scientific ability plus engineering skill plus modern plant facilities equals achievement." You will find all three behind these doors of Marvelco Electronics. Scientific ability represented by some of the finest electronic scientists in the nation . . . dedicated scientists whose research not only has produced such achievements as the Tandem Transistor, but practical scientists who have the ability to apply the fruits of their research to industry. They are backed up by skilled engineering technicians working with modern production facilities to make their formulas a finished product. If you have an electronics problem or a research and development project why not query Marvelco today?

**MARVELCO**  
(*Electronics Division*)

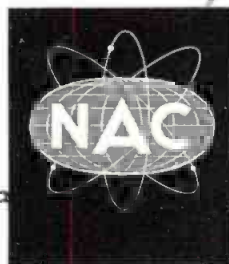

**NATIONAL AIRCRAFT CORPORATION**

3411 Tulare Avenue      Burbank, California



ABSTRACTS & REVIEWS of  
**WORLDWIDE**  
ELECTRONIC ENGINEERING

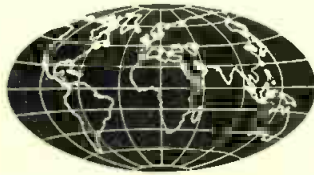

International  
**ELECTRONIC**  
**SOURCES**

**PUBLICATIONS REVIEWED IN THIS ISSUE**

Abbreviation	Publication Name	Abbreviation	Publication Name	Abbreviation	Publication Name
Arc. El. Uber.	Archiv der elektrischen Ubertragung	El. Eng.	Electronic Engineering	Onde	L'Onde Electrique
Auto. Con.	Automatic Control	El. Eq.	Electronic Equipment	Phil. Tech.	Phillips Technical Review
BC News	Broadcast News	El. Ind.	<b>ELECTRONIC INDUSTRIES &amp; Tele-Tech.</b>	Proc. IRE	Proceedings of the Institute of Radio Engineers
Bell J.	Bell System Technical Journal	El. Rund. Freq.	Elektronische Rundschau Frequenz	Radiotek.	Radiotekhnika
Bell Rec.	Bell Laboratories Record	Inst. & Auto.	Instruments & Automation	RCA	RCA Review
Bul. Fr. El.	Bulletin de la Societe Francaise des Electriciens	NBS J	Journal of Research of the National Bureau of Standards	Rev. Tech. Tech. Rev.	Review Technique
Cab. & Trans.	Cables & Transmission	Nach. Z	Nachrichtentechnische Zeitschrift	Tech. Haus.	Technische Hausmitteilungen
Con. Eng.	Control Engineering			Wirel. Eng.	Wireless Engineer
El.	Electronics				
El. Des.	Electronic Design				

Also see government reports and patents under "U. S. Government."



**ANTENNAS, PROPAGATION**

The Reception of Teleprinter Signals from Low Frequency Transmitters with A1 and F1 Modulation, by W. Kronjaeger and R. Vogt. "Nach. Z." May 1956. 3 pp. Interference is predominantly due to other transmitters and atmospheric pulses of about 10  $\mu$ sec duration.

The Structure of the Television Tower on the Feldberg (Schwarzwald), by E. Wunsch. "Tech. Haus." March-April 1956. 5 pp. The structural design of the television tower on the Feldberg/Schw. was dictated in particular by climatic conditions and by the desire to maintain the natural amenities. The building was given the shape of a tower which itself serves as support for the unguyed tubular slot aerial.

The Television Transmitting Station on the Feldberg (Schwarzwald), by A. Kolarz and A. Hein. "Tech. Haus." March-April 1956. 6 pp. On account of the severe climatic conditions existing on the Feldberg/Schw., it was necessary, in the design and construction of the building and especially in designing the aerial, to pay particular attention to the formation of ice and to prevailing winds. For this purpose, a tubular slot aerial was installed, with special covering for the slots and means of heating. It was cantilevered in the reinforced conical top section of a concrete tower. The television transmitter accommodated on the top floor has outputs of 10 KW for vision and 2 KW for sound. Extensive reserve power-supply installations insure uninterrupted operation even in the event of a power failure.

Investigations on Earth Antennas (Directional aerials for long waves), by W. Kronjaeger and K. Vogt. "Nach.Z." June 1956. 5 pp. This paper is a report of measurements and experience with earth antennas for the long-wave range.

Propagation of Microwaves Over Large Distances Beyond the Line of Sight, by V. N. Troitsky. "Radiotek." May 1956. 18 pp. This paper examines the problem of long-distance propagation of microwaves through the troposphere under the assumption that this phenomenon is caused by inhomogenities in E which are both of a turbulent and laminar character.

The Determination of Aerial Diagrams by Means of Helicopters, by E. Bauermeister. "Tech. Haus." March-April 1956. 12 pp. The paper describes a field-strength recording installation which may be installed in helicopters and which is used for measuring the free-space field-strength in the proximity of a transmitting aerial operating in the frequency range of 47 to 223 MC. Details are given of measuring methods used to determine vertical and horizontal radiation diagrams from recordings made of the free-space field-strength. The accuracy of the measuring process is discussed. In conclusion, the author discusses the measured radiation diagrams.

Some Effects of Magnetic Field Strength on Space-Charge-Wave Propagation, by G. Brewer. "Proc. IRE." July 1956. 8 pp. An analysis is made of the propagation of space-charge waves in an axially symmetric electron beam originating at an emitting surface threaded by an arbitrary amount of magnetic flux.

Review of Ionospheric Effects at VHF and UHF, by C. Little, W. Rayton, and R. Roof. "Proc. IRE." Aug. 1956. 27 pp. A summary of the present-day knowledge of ionospheric effects at VHF and UHF, excepting forward scattering by the ionosphere, is presented. Covered are the following: radar echoes from aurora, radar echoes from meteors, the Faraday effect and radar echoes from the moon, radio noise of auroral origin, absorption of radio waves by the ionosphere, refraction of radio waves by the ionosphere, and the scintillation of the radio stars.

The Determination of the Height Required for Television Masts by Means of Helicopters, by W. Knofel. "Tech. Haus." March-April 1956. 5 pp. The paper describes methods used for appraising proposed sites and the required mast height for television transmitters. These methods, which involve the use of a helicopter equipped with a transmitter receiving its power supply by cable from the ground, have produced very accurate results.

Oblique Transmission by the Meteoric E-Layer, by R. Naismith. "Wirel. Eng." July 1956. 3 pp. Observations made in the winter of 1951 and the summer of 1952 indicate that propagation on frequencies of 22.7, 25, and 27 MC over distances of 900 to 1900 KM take place by means of first reflections from that part of the ionosphere designated as the meteoric E-layer. A discussion of the characteristics of the meteoric E-layer is included.

Earth Antennae, by J. Grosskopf. "Nach.Z." June 1956. 3 pp. An approximative theory of earth antennae is given, and it is shown that their performance may be explained qualitatively and quantitatively by well known concepts.

FOR MORE INFORMATION ON SUBJECTS REVIEWED HERE

Contact your nearest library subscribing to publications noted. Excellent technical periodical sections are maintained by many large public libraries, engineering universities and electronic companies.

To obtain copies of any articles or complete magazines reviewed here, contact the respective publishers directly. Names and addresses of publishers may be obtained upon request, stating publications of

interest, by writing to: "Electronic Sources" Editors, ELECTRONIC INDUSTRIES, & Tele-Tech Chestnut & 56th Sts., Philadelphia 39. The editors can recommend translation agencies.

To obtain copies of U.S. patents, and research reports on military and government projects reviewed here, send payment indicated directly to federal agency as instructed in section entitled "U.S. Government."



## AUDIO

Notes on the Acoustic Properties of Materials, by Th. Vogel. "Onde." May 1956. 7 pp. An incidence method is suggested for use in acoustical engineering to replace Sabine's formula when dealing with rooms which do not have a relatively high absorption coefficient.

Architectural Acoustics, by J. Matras. "Onde" May 1956. 31 pp. In the first section of this paper definition, measurement and physiological effects of noise—its attenuation, transmission, and propagation through openings—as well as sound insulation and its measurement are presented. The second section is devoted to interior acoustics for small, average, and large size interiors.

Acoustics of Large Auditoria, by R. Lamoral. "Onde" May 1956. 3 pp. The desired sound insulation is determined from an investigation of the optimum reverberation time, an investigation of the shape of the rooms (graphically or by means of models), and a determination of sound absorption.

Modern Studios of the Radio Center of Marseille, by J. Pujolle. "Onde." May 1956. 3 pp. This center, constructed between 1952 and 1954 comprises one large studio (3000 m<sup>2</sup>), one medium studio (800 m<sup>2</sup>) and 3 smaller studios treated by a new process with plastic material specially produced for this purpose.

Visual Display of Sonic and Ultrasonic Waves, by F. Canac. "Onde" May 1956. 6 pp. Sound waves are propagated by alternate compression and rarefaction of the medium in which they travel. Hence light waves will be subject to refraction and this permits visual observation. Acoustic and magnetic wave guide equivalences are introduced.

Acoustic Insulation of Heavy Structures, by F. Pujolle. "Onde" May 1956. 6 pp. Tests are reported to find the most economical building structures (a number of combinations of 2 and 3 brick walls with cement ties) to acoustically insulate adjacent studios. 3 walls, each 20 cm deep, separated by 2 air gaps of 15 cm, and bonded with cement ties and attenuated with mineral wool were found best.

New Acoustic Characteristic of Rooms and the Development of a Multi-Purpose Electronic Meter, by R. Lamoral. "Onde" May 1956. 9 pp. The reverberation time being insufficient to characterize the acoustical properties of a room, diffusion as a function of frequency is suggested. An apparatus to measure a suitable diffusion index has been designed; it may also be used to measure reverberation time, sound insulation, irregular damping, etc.

Noise Measurements: Physical and Physiological Problems, by P. Baron. "Onde" May 1956. 16 pp. The acoustic power of sound sources and the calculation of sound pressure at any point within a medium are dealt with and applied to machine noise. Various apparatus for measuring, analyzing and recording noise are considered and physiological considerations are set forth.

Study of Audiometer Standardization, by R. Lehmann. "Onde" May 1956. 12 pp. Difficulties met with in the use of audiometers are outlined, particularly in connection with the threshold of hearing, artificial ear measurements, etc. Results obtained in different countries are compared and present French standardization is explained.



## CIRCUITS

A Less-Than-Minimum Phase Shift Network, by R. Destebelle, C. Savant, and C. Savant, Jr. "El. Ind." Sept. 1956. 4 pp. Design considerations are given for networks comprising a combination of a tuned amplifier and a phase-sensitive demodulator which obviates instabilities and permits use of high Q amplifiers.

Cathode Follower Design Curves, by L. Estabrook and R. Goundry. "El. Ind." Sept. 1956. 3 pp. A family of curves is presented which simplifies and systematizes designing a cathode follower circuit. Explanation and derivation are included.

Novel Circuit for a Stable Variable Frequency Oscillator, by D. Makow. "Proc. IRE." Aug. 1956. 6 pp. An unusual method for gaining crystal control of a variable frequency oscillator is described. Within the multiloop circuit, three oscillations are maintained at separate frequencies such that one is the sum of the other two. The sum frequency is crystal controlled, and since the drifts of the upper and the lower frequencies tend to be in the same direction, frequency shifts are blocked by the crystal oscillator.

Bridged-T Filters with One or Two Cut-Off Frequencies, by J. Colin. "Cab. & Trans." July 1956. 42 pp. The author establishes formulas giving the values of the image parameters of bridged-T filters with one or two cut-off frequencies, and presents a classification of these filters in low-pass, high-pass band-pass and band elimination types, with the purpose of finding structures having an infinite attenuation frequency for a zero or an indefinitely increasing frequency. It is shown that symmetrical bridged-T filters cannot fulfill the latter condition. A discussion of some special cases of non-symmetrical bridged-T networks is included.

The Production of a Short Duration Pulse of High Velocity Electrons, by D. Le Croisette. "El. Eng." Aug. 1956. 3 pp. An apparatus is described which produces a pulse of electrons of duration 0.2  $\mu$ sec suitable for initiating ionization in gas-filled systems. The pulse is repeated 50 times per second occurring during the time-base sweep of an oscillograph, so enabling the simultaneous display of the ionizing pulse and the resulting discharge build-up.

Electronic Circuitry, by M. Aronson and C. Kezer. "Inst. & Auto." June 1956. 2 pp. Article contains descriptions of an ionization gage using a 3C24 triode, a transistorized dc-to-dc power converter, and a frequency-shift altitude telemeter.

How to Design Transistorized Schmitt Triggers, by R. Hurley. "El. Eq." Aug. 1956. 3 pp. An analysis of Schmitt Trigger operation and design considerations for transistorized versions are included in this article.

Design Considerations for Semiconductor Regulated Power Supplies, by S. Sherr and P. Levy. "El. Des." July 15, 1956. 4 pp. The introduction of the reference silicon diode, power rectifiers, and power transistors have made possible all-semiconductor power supplies. This article describes the combinations which have been discovered to result in the simplest effective circuits.

Design of Transistorized Amplifier Stages by Means of the Regeneration Method, by A. A. Rizkin. "Radiotek." May 1956. 9 pp. This paper develops a simple method for designing transistorized amplifier stages, which is based upon

introducing the coefficient of regeneration. The frequency response and transient response of the stage are evaluated, and a single stage with external feedback is analyzed.

The Equivalent Noise Four-Terminal Network as Wave Four-Terminal Network, by H. Bauer and H. Rothe. "Arc. El. Uber." June 1956. 12 pp. A four-terminal noise source may be represented by wave propagation terminology. The relationship between the scattering matrix, T-matrix, and impedance matrix is derived in an appendix. Equivalent wave circuits are illustrated and a method for the measurement of the elements of such an equivalent circuit is discussed.

New Hybrid Circuits for the Combination and Distribution of Electrical Power at High Frequencies, by A. A. Lvovich. "Radiotek." April 1956. 8 pp. The article discusses the operation of a multi-pole hybrid circuit which is designed for the combination of the power outputs from any number of oscillators, or for the distribution of the power output of an oscillator among any number of loads.

Generalization of the Kotelnikov Theorem, by I. T. Turbovich. "Radiotek." April 1956. 10 pp. The Kotelnikov Theorem can be used to determine any time function with a limited spectrum by means of the discrete values of the functions at specified instants in time.

A Method of Calculation and Design for Triode, Tetrode and Pentode Oscillators, by M. S. Neyman. "Radiotek." April 1956. 9 pp. The paper examines a method for designing triode, tetrode and pentode oscillators. The original design quantities are the specified useful load power and the impedance of the unloaded plate tank circuit.

Interference Rejection of a Filtered Autocorrelational Pulse Receiver, by V. I. Chaikovskiy. "Radiotek." April 1956. 7 pp. The paper examines the signal-to-interference ratio at the output of a filtered autocorrelational receiver when the interference is of a fluctuating nature. It is shown that several improvements in interference rejection (compared to the usual receiver which employs a square-law detector) may be obtained only when the input filter has a bandwidth which is not optimum.

Contribution to the Dimensioning of Automatic Level Control Systems, G. Kraus. "Arc. El. Uber." May 1956. 11 pp. The dimensioning of the level control is determined by the choice of the pilot frequencies and the equalizers; linearity between pilot levels and positioning quantities is assumed. The transient of regulators and positioning elements are studied. The effect of the relative numbers of equalizers and pilots and the order and grouping of the equalizers are considered.

A. Piezoelectric Low-Frequency Filter, by Ya. I. Velikin, Z. Ya. Gelmont, and E. V. Zelyakh. "Radiotek." April 1956. 8 pp. The paper discusses the theory and design method of one particular circuit for a piezoelectric filter which is designed for low frequencies. The paper cites the measured characteristics for the operational damping of a filter which has been designed according to the proposed method.

Compensation Method for Decreasing Non-linear Distortion, by A. A. Gorbachev. "Radiotek." April 1956. 8 pp. The paper investigates the fundamental theoretical postulates which are involved in the method of decreasing non-linear distortion by means of compensating the distortion in the load circuit of the last stage. The results of the experimental verification of this method are provided.

Amplitude Modulation by Means of Diodes, A. D. Artym. "Radiotek." May 1956. 9 pp. This paper describes a simple method of amplitude modulation, which is carried out by means of two diodes. It is shown that the possibility



exists for modulation and detection at high modulating frequencies which are close to the magnitude of the carrier frequency.

**A Method of Harmonic Synthesis and its Application to Problems of Radio-Engineering**, by A. M. Zaedny. "Radiotek." May 1956. 12 pp. This paper proposes an analytical method of harmonic synthesis which permits the equation of the synthesized curve to be obtained in a closed form. Examples are given of the application of this method to radio-engineering problems; 1) to the calculation of transient responses; 2) to the calculation of the characteristic of a nonlinear element according to the specified shape of the transformation.

**Comparison of Filters According to the Image Parameter Theory and Filters According to the Insertion-Loss Theory with Filters According to Modern Methods of Filter Computation**, by V. Fetzer. "Arc. El. Uber." June 1956. 14 pp. The image parameter theory, prescribing image impedance and image transfer constant, cannot freely choose the zeros of attenuation in the pass region. The recently developed insertion-loss theory prescribes operative and echo attenuation. The advantages and disadvantages of the two methods are compared.

**Dimensioning and Analysis of a Voltage-Feedback Transistor-Oscillator**, by G. Ledig. "Freq." June 1956. 6 pp. Tensor analysis of a conventional voltage-feedback transistor-oscillator is presented to illustrate the method also applicable to other transistor circuits.

**The Various Four-Terminal Representations of the Transistor**, by W. Taeger. "Freq." June 1956. 4 pp. The operating characteristics of a transistor in emitter-base connection and in collector-base connection are compared. Formulas for converting one set of characteristics into the other are derived, and the mathematical relationships between the characteristics and open and short circuited values are considered.

**Curves for Circuit Elements Used in H-F Engineering**, by H. Fark. "Freq." June 1956. 3 pp. Formulas and curves for easy references of inductance, capacitance, and resistance of copper rings, cylindrical coils, mutual inductance of coaxial parallel rings and of cylindrical coils, and some wave resistances are presented.

**Interference Rejection of the Correlation Method of Reception**, by A. E. Basharinov. "Radiotek." May 1956. 9 pp. This paper discusses the relationships which characterize the general case of correlational reception which is based upon obtaining a product averaged over the observation interval. The paper examines different variants of correlation-type receivers and calculates the average value of the above product, the dispersion, and the correlation function of the input voltage. Comparative indices of interference rejection are evaluated.

**Some General Properties of Nonlinear Elements—Part I. General Energy Relations**, by J. Manley. "Proc. IRE." July 1956. 10 pp. Two independent equations relating the average powers at the different frequencies in nonlinear inductors and capacitors are derived. These equations involve the assumption of a single-valued characteristic for the nonlinear element and are independent of the particular shape of the characteristic, the power levels at various frequencies, and the external circuit.

**Parallel-T RC Network**, by G. V. Buckley. "Wirel. Eng." July 1956. 5 pp. A simplified method of analysis is presented with the intent to avoid the usual laborious mathematical solution in obtaining a mental picture of the mode of operation, so essential when the effect of a variable element is to be considered.

**The Design of Tetrode Transistor Amplifiers**, by J. Linvill and L. Schimpf. "Bell J." July 1956. 28 pp. Practical considerations imposing constraints on the range of terminations that can be employed are discussed. Methods are developed by which suitable terminations can be selected. Illustrative tetrode amplifiers are described, including a common base 20-MC video amplifier, a common-emitter 10-MC video amplifier, an IF amplifier centered at 30 MC, and an IF amplifier centered at 70 MC.

**Transient Responses of Linear Circuits Subjected to Irregular EMF's**, by Yu. I. Samoilenko. "Radiotek." May 1956. 7 pp. The paper develops a method of analysis for the transient responses of linear circuits when they are subjected to a stationary irregular signal. This method is utilized to compare the interference rejection of a receiver using the principle of synchronous accumulation with that of an ordinary receiver which utilizes frequency selection.

**Improving the Accuracy of a Derivation Found in Textbook Literature**, by A. P. Belousov. "Radiotek." April 1956. 5 pp. This paper discusses a more accurate derivation of the relationships which determine the design of a transformer input circuit of an amplifier under the conditions which are imposed if it is required to obtain a minimum coupling coefficient between the coils.

**A Transformation Diagram for a Lossy Four-Terminal Network**, by F. Gemmel. "Arc. El. Uber." June 1956. 3 pp. The graphical method described permits finding independently the transformation due to the section having losses and due to the purely reactive section from measured input reactances and the associated output reactances. The input impedance associated with any terminating impedance can then be found graphically.



## COMMUNICATIONS

**Hybrid Auto Radios, The Next Step**, by W. Bevirt. "El. Des." Aug. 1, 1956. 2 pp. The author describes hybrid receivers designed to utilize the new tubes requiring only 12 v plate supply and a 12 v power output transistor.

**Designing "Free-Power" AM & FM Transistorized Receivers**, by H. Hollmann. "El. Ind." Sept. 1956. 4 pp. Transistorized receivers have been designed which are powered completely by rectified carrier signals. Design considerations and practical experimental circuits are presented.

**Transmission of Business Machine Data Over Standard Telegraph Channels**, by F. Bramhall. "Tech. Rev." July 1956. 7 pp. Business machine data may be transmitted readily over telegraph communication circuit facilities. Although minor modifications in terminal equipment may be desirable, the telegraph company's standard FM channels are not susceptible to conditions that disturb AM operation. Wave distortion and timing of signal impulses delivered to data processing apparatus, and propagation delays are discussed.

**Control System for Integrated Data Processing**, by P. Easterlin. "Tech. Rev." July 1956. 10 pp. Fast transmission of business data is accomplished readily with devices and techniques perfected for message telegraph services. Punched tapes, automatic routing characters, automatic sequence number check and fast cross-office switching present a familiar pattern. A new system of flexible controls for an efficient integrated data processing installation is described.

**Third Symposium on Information Theory**, by W. Endres. "Nach. Z." June 1956. 5 pp. This paper is a summary of the lectures on information theory given during a meeting at the Imperial College, London, October 1955.

**A Private Automatic Branch Exchange Using High-Speed Uniselectors**, by B. H. Geels. "Phil. Tech." June 18, 1956. 12 pp. After an introduction dealing with the general development of private telephone exchanges, a description is given of the UB 49 exchange. This operates on the register system in which the characteristic disadvantage (slower action) of register systems is overcome by the use of a high-speed unisector.

**Improvement of the Signal-to-Noise Ratio by Repetition of the Signal**. "Freq." June 1956. 10 pp. An improved signal-to-noise ratio can be obtained by transmitting several repetitions of the original signal or a selected section thereof. At the receiving end, these signals are suitably shifted in time and superposed. The statistical study presented yields an improvement of the ratio between  $n^{1/2}$  and  $n$ , where  $n$  is the number of repetitions.

**Single-Side-Band Communication Equipments**, by J. L. Delvaux and M. Byk. "Onde." June 1956. 12 pp. Operational characteristics of the transmitter-receiver TH 861 (10 W), the transmitter TH 863 (50 W), the amplifier TH 911 (400 W), and the receiver TH 864, all by the French Thomson-Houston Co., are given. It is concluded that for distances less than 1000 km, a power of 10 watts is usually sufficient, while a distance of 2000 km can be covered with 50 watts.

**Exciters Multiplex F-M Carriers**, by H. Stratman. "El." Aug. 1956. 3 pp. Audio modulation of two separate exciters through serrasoid circuits is used to obtain the main carrier and the multiplexed subcarrier. The circuits are discussed and inherent characteristics described.

**A New Interpretation of Information Rate**, by J. Kelly, Jr. "Bell J." July 1956. 10 pp. An approach is made to the problem of attaching a value measure to a communication system in which errors are being made at a non-negligible rate, i.e., where optimum coding is not being used.

**Transistorized Rural Carrier System**, by R. Clark. "Bell Rec." Aug. 1956. 4 pp. After extensive field trials, a versatile carrier system has been evolved for use in rural areas. The article includes a general description of the equipment and design considerations.

**A Flat-Bed Facsimile Telegraph Transmitter**, by W. Buckingham. "Tech. Rev." July 1956. 5 pp. One of a number of experimental "flat-bed" facsimile transmitters designed by Western Union engineers is described.



## COMPONENTS

**Design of a Selenium Rectifier with a Capacitor Filter**, by Yu. E. Nosovitsky. "Radiotek." May 1956. 8 pp. The paper clarifies the reason for the large error which results when a capacitor-filter selenium rectifier is designed according to the simplified method. A straight-line-segment approximation to the volt-ampere characteristic of the selenium rectifier is introduced; this approximation permits an increase in the accuracy of the calculations made according to the simplified method. The paper also investigates the external characteristic of the rectifier circuit and derives the equation for the external characteristic in explicit form.



**A Discussion of Precision Computer Transformers**, by D. Wildfeuer. "El. Ind." Sept. 1956. 3 pp. After pointing out several assumptions used in conventional transformer design, the author discusses more precise methods, with special attention to the design of precision autotransformers.

**Effects of Radiation on Electronic Components**, by R. Shelton. "El. Ind." Sept. 1956. 3 pp. The author describes the many factors involved in radiation damage to electronic components and summarizes some of the findings to date.

**Directional Channel-Separation Filters**, by S. Cohn and F. Coale. "Proc. IRE." Aug. 1956. 7 pp. A class of frequency-selective networks is described that combines the properties of a directional coupler and a conventional filter. Design information and experimental data are included.

**Use Taps to Compensate Pot Loading Errors**, by J. Gilbert. "Con. Eng." Aug. 1956. 5 pp. The author discusses the use of two, four, and five taps to compensate potentiometer loading errors.

**Investigation of an Interdigital Delay Line**, by F. Paschke. "Arc. El. Uber." May 1956. 12 pp. The fundamental mode of an interdigital all-pass delay line has, over a wide range, a phase velocity having a direction opposite to that of the energy flow, indicating it as suitable for a carcinatron. The properties and design considerations of these structures are studied.

**High-Speed Magnetically-Operated Coaxial Switch**, by A. Volz. "Bell Rec." Aug. 1956. 4 pp. A high speed switch for 70 MC, meeting impedance and crosstalk requirements of the TD-2 automatic protection switching system, is described.

**Tantalum Solid Electrolytic Capacitors**, by D. McLean and F. Power. "Proc. IRE." July 1956. 7 pp. A general description is given of the construction and characteristics of small tantalum capacitors having advantageous low temperature and shelf-aging characteristics.

**Subminiature Pulse Transformers**, by P. Wiederhold. "El. Mfg." Aug. 1956. 5 pp. Core materials and their properties are discussed with emphasis on their application to pulse transformer design.

**Applications for Glass-Bonded Synthetic Mica**, by J. DuBois, R. Humphrey, and N. Ederer. "El. Mfg." Aug. 1956. 4 pp. A class of materials using synthetic instead of natural mica is described which possesses significantly higher thermal endurance. A molded radome made from glass-bonded synthetic mica, and other applications are described.

**Encapsulating Techniques for Electronic Equipment**, by J. Briggs and R. Calicchia. "El. Eq." July 1956. 2 pp. The experimental encapsulation of functional electronic parts and assemblies and the effects of the encasing medium on such operating characteristics as Q factor, capacitance, inductance, are discussed.

**Transformer Odd-Impedance Nomograph**, by R. Thorpe. "El. Des." July 15, 1956. 2 pp. The author presents a nomograph for obtaining unrated odd impedances between various secondary taps of multiple winding transformers when the impedance values between the different taps and common are known.

**Magnetic Core Components for Digital Control Applications**. "Auto. Con." July 1956. 4 pp. This article is an explanation of the methods and components used in the construction of the CORDAT data processing device. Included are logical circuits, quantized counters, air flight control, magnetic shift registers, and series systems.

**Ferrite Core Loading Coils**, by A. Pierrot. 30 pp. July 1956. "Cab. & Trans." Replacement of agglomerated powder by ferrite in loading coil cores is associated with a number of technical problems relating to effective resistance value, inductance value stability, non-linear distortion and crosstalk in coils and loading units. It is shown how these problems have been solved in the present manufacturing of ferrites.

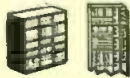

## COMPUTERS

**Grid-Switched Gas Tube for Display Presentation**, by F. Maynard, J. Carluccio, and W. Poelstra. "El." Aug. 1956. 3 pp. A display tube is described within which a lattice of cathode strips and anode wires enables the generation of lighted spots at any crossover point between selected anode and cathode conductors. Use for electronic integration purposes is suggested.

**A Nine's Complement Decade Counter with Recorder**, by J. Phillips. "El. Eng." Aug. 1956. 6 pp. A brief outline of decimal counting using weighted binary digits is given with special reference to systems giving complements of nine. A binary decade electronic counter arranged so as to allow the reading of nine's complements, which may be used to represent negative numbers is also described.

**What's Inside Transac—II**, by A. Cavaliere, Jr. "El. Des." July 15, 1956. 3 pp. High speed, reliable computer operation has been achieved using transistors in direct coupled circuits. In Part I of this article describing the Transac, basic circuits and arithmetic units for basic operations were discussed. This part discusses control, memory circuits, and communications with the computer.

**Design of Unit Elements for a Fast Acting Memory Device Employing Ferrite Rings**, by H. Gillert. "Nach. Z." June 1956. 3 pp. The requirements for transmission between line selector and lines as well as between column selector and columns in matrix memory devices are investigated. The result is a number of relationships between currents and coil data for the selector cores.

**Magnetic Shift-Register Correlator**, by R. Kelner and M. Glauberman. "El." Aug. 1956. 4 pp. A magnetic shift register is described which uses digital-to-analog converters at each stage to obtain recognition of printed decimal digits from 0 to 9. The register is designed to be insensitive to noise resulting from imperfectly formed digits.

**Triangular—Wave Analog Multiplier**, by R. Meyers and H. Davis. "El." Aug. 1956. 4 pp. An electronic multiplier for analog computers is described which achieves independence from tube characteristics and balancing adjustments.

**First Realization of New Resonance Lamp Bulbs at Low Voltage**, by M. Marcel Laporte. "Bul. Fr. El." May 1956. 9 pp. The inside surface of a glass bulb, filled with mercury vapor, is covered with a suitable fluorescent material. The mercury vapor is excited to resonance radiation by electrons emitted by a hot cathode and traveling towards a plate, both arranged in the bulb, and in turn activates the fluorescent material. Extensive research resulted in a specially designed indirectly heated cathode and voltages slightly exceeding the ionization level, which combination furnished bulbs of any desired shape requiring no starter and no stabilizer, and operating at voltages below 14 volts.

**Control Elements in the Computer**, by E. Bolles and H. Engel. "Con. Eng." Aug. 1956. 6 pp. A general discussion of control elements and basic design techniques is given.



## INDUSTRIAL ELECTRONICS

**Review of Industrial Applications of Heat Transfer to Electronics**, by J. Kaye. "Proc. IRE." Aug. 1956. 15 pp. The general thermal problem of a given piece of electronic equipment is discussed and analyzed in terms of different modes of heat transfer. Heat removal by means of natural convection, radiation, forced convection, and evaporative cooling are compared and illustrative equipment presented.

**Modified Oscilloscope Analyzes Engine Performance**. "El. Des." Aug. 1, 1956. 2 pp. A description, circuit diagrams, and typical displays are given for equipment modified to analyze the functioning of automotive ignition systems without interfering with the normal operation of the system.

**QC Computers for Machine Control—II**, by G. Amber and P. Amber. "El. Mfg." Aug. 1956. 9 pp. In this second part the basic quality-control equations previously developed are applied to the design of machine-mean computers, standard-deviation computers, and closed-loop control systems with feedback for machine drift correction and excessive variation alarm.

**Transient-Controlled Magnetic Amplifier**, by G. Schohan. "El." Aug. 1956. 3 pp. A half-wave bridge type magnetic amplifier is described which avoids loading the amplifier and the signal source by using biased diodes which effectively insert impedance during the power half cycle.



## MATERIALS

**Weather Testing of Encapsulating Materials**, by E. Linden. "El. Eq." July 1956. 3 pp. Both polyester and epoxy resins are shown to be satisfactory for outdoor use in desert and subarctic environments. Hot melt materials should be avoided for use under arctic conditions since they tend to crack and fall away when subjected to differential thermal expansion stresses at low temperatures.

**Polyurethane Potting Resins**, by M. Malootian. "El. Eq." July 1956. 3 pp. Polyurethane resin of castor oil with m-tolylene diisocyanate is studied in a search for an elastomer with low acoustic transmission loss and good mechanical properties to be used for casting under-water-sound transducers.

**Machines and Methods for Applying Casting Resins**, by J. Sensi and P. Franklin. "El. Eq." July 1956. 2 pp. The authors describe the construction and operation of a typical machine designed to ease the use of multiconstituent casting resins.

**Polysulfide Liquid Polymer and Modified Epoxy Resin Casting Compounds**, by A. Breslau and K. Cranker. "El. Eq." July 1956. 3 pp. Physical, chemical, and mechanical properties of polysulfide liquid polymers and their epoxy resin reaction products are discussed as well as the effects of time and temperature on them.

# ELECTRONIC SYSTEMS ENGINEERS and SCIENTISTS in

RADAR • COUNTER MEASURES • MISSILE GUIDANCE

DATA REDUCTION • AIR DEFENSE • COMMUNICATIONS • UNDERWATER ORDNANCE

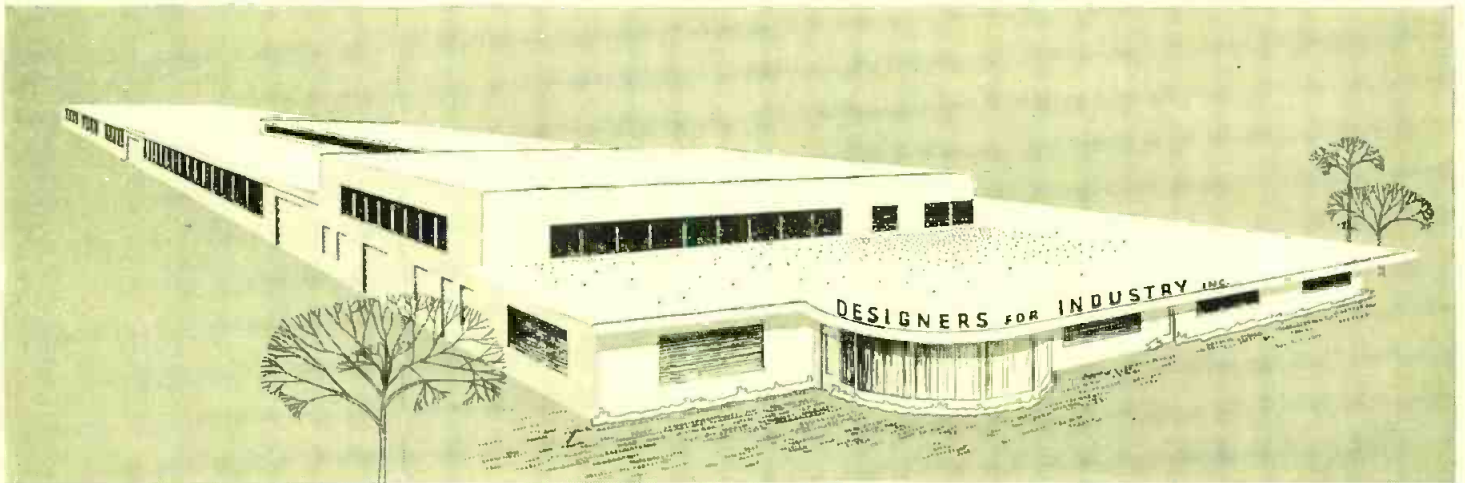

For trained, experienced men (advanced degree preferred) with creative ability, DESIGNERS FOR INDUSTRY INCORPORATED offers challenging work and an unusual opportunity.

We are looking for those who have grown into the systems field via the equipment research and development road — and who have the ability to conceive completely new approaches to highly difficult problems . . . *men who can spearhead major technical break-throughs.*

In return we offer permanent career opportunities at DFI where:

You will work in an independent research and development organization incorporated in 1935 and showing a history of steady growth serving both military and commercial clients

the employees own the corporation (over 70 senior employee-stockholders)

a pension trust and a merit bonus return 62½% of all profits to the employees in a combination of annuities, cash and stock

the “fringe” benefits include such things as a paid vacation schedule providing two weeks per year after one year, three weeks per year after five years and five weeks every fifth year after ten years

professional freedom, mutual trust, challenging work and a dynamic, growing organization are combined into the proper atmosphere for stimulating creative development.

If you are interested write — all information will be treated in complete confidence — to James E. Burnett, Vice President, giving pertinent professional information.



## Designers for Industry

Incorporated 1935

4241 Fulton Parkway • Cleveland 9, Ohio



**Epoxy-Polybutadiene Resins**, by C. Fitzgerald, A. Carr, M. Maienthal and P. Franklin. "El. Eq." July 1956. 3 pp. Liquid polybutadiene was epoxidized with peracetic acid in chloroform solution in an effort to combine the thermal and electrical properties of cross-linked polybutadiene with the low-temperature curing properties of epoxy resins. The properties of the resulting resins are considered good.

**Potting Aircraft Electrical Connectors**, by C. Nadler, P. Mallard, and J. H. Bowen, Jr. "El. Eq." July 1956. 4 pp. Polysulfide, modified epoxy resin, and silicone rubber potting compounds are tested to determine their suitability for the potting of aircraft electrical connectors.

**Dielectric Properties of Casting Resins**, by R. Tucker, J. Cooperman, and P. Franklin. "El. Eq." July 1956. 4 pp. Electrical properties — dielectric constant, dissipation factor, and volume resistivity — of casting resins vary widely with temperature, frequency, and composition. This article presents data on these variations to aid the designer in selecting a resin for a given application, and provides a comparison of various resin types.

**Potting Glass Vacuum Tubes and Ceramic Capacitors**, by A. Benderly, J. Tidler, and B. Green. "El. Eq." July 1956. 4 pp. Batches of glass vacuum tubes and ceramic capacitors were potted according to several different procedures, temperature cycled between  $-65^{\circ}$  and  $+160^{\circ}$  F, and electrically tested. The procedures that resulted in the least damage to tubes and that appear promising are indicated. No ceramic capacitors failed.

**Thermal Properties of Encapsulating Materials**, by E. Linden. "El. Eq." July 1956. 4 pp. Properties considered in this article are: impact resistance at low temperatures, thermal conductivity and expansion, specific heat, curing exotherms, softening points, first and second order transitions, heat distortion, thermal decomposition at elevated temperatures, changes in electrical properties with variations in temperature, shrinkage, and thermal shock.

**Gamma Radiation Cures Resins**, by T. Callinan. "El. Eq." July 1956. 3 pp. An account is given of Naval Research Laboratory studies to determine the radiation dosage required to polymerize commercial resins suitable for embedding such electronic components as resistors, capacitors, and transistors.

**Properties of Commercial Plastics and Primers**, by R. Ihling. "El. Eq." July 1956. 1 p. This article presents an engineering evaluation of some commercially available plastics and primers for plastics. Mechanical properties are described.

**Corrosion of Copper Wire by Resins**, by N. Doctor and P. Franklin. "El. Eq." July 1956. 3 pp. Corrosive effects of various casting resins on bare copper wire were evaluated by an electrical resistance method.

**Control of Factors Arising in Application of Casting Resins**, by P. Nichols, Jr. "El. Eq." July 1956. 3 pp. First, a general review of the chemical nature of various classes of casting resins is given. Problems arising as a result of exothermic curing reactions and heat transfer are then discussed.

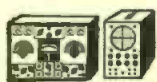

## MEASURING & TESTING

**Review of NBS Technical Services**. "El. Ind." Sept. 1956. 1 p. A description is given of services provided, including: Standard radio fre-

quencies, standard audio frequencies, standard time intervals, standard musical pitch, time signals, radio propagation forecasts.

**Characteristic Tracer for Power Transistors**, by S. Kramer and R. Wheeler. "El. Ind." Sept. 1956. 3 pp. Design considerations and experimental results of a cathode ray oscilloscope characteristic plotter are presented. Associated circuitry is designed to handle peak power levels up to 1 kw.

**Predicting the Reliability of Airborne Equipment**, by C. Hedetniemi. "El. Ind." Sept. 1956. 4 pp. A program for obtaining data from which reliability of airborne equipment can be predicted is described. Actual tests on several kinds of equipment reveal that a large percentage of malfunctions occur shortly after previous failure.

**'Bandwidth' and Noise Sensitivity**, by D. Radmacher. "El. Ind." Sept. 1956. 3 pp. Measures for establishing effective noise-free bandwidth are discussed.

**Radioactive Fallout Computer**. "El. Ind." Sept. 1956. 3 pp. A description is given of a new computer using electronic analog techniques to make rapid predictions of fallout based on wind velocities and particle sizes. Intensity and pattern of a CRT display indicate the predicted intensity and distribution of radioactive fallout.

**A New Technique for the Measurement of Microwave Standing-Wave Ratios**, by A. MacPherson and D. Kerns. "Proc. IRE." Aug. 1956. 7 pp. A description is given of a microwave standing-wave-ratio measurement technique involving subtraction of the phase angle of the unknown reflection coefficient to arbitrary, known variations such as that possible with a sliding load.

**Transistor Contour Curves**, by K. Pullen, Jr. "El. Des." July 4, 1956. 3 pp. Recently compiled grounded emitter characteristics are presented, including transistor contour curves using  $g$  parameter on the SB-100, L-5117, and the 2N96.

**New Ultrasonic Pulse Apparatus for Concrete Testing**, by O. Steinkamp. "El. Rand." June 1956. 2 pp. The instrument indicates the travel time of centimeter waves for the purpose of concrete testing. The received amplitude is indicative of flaws, while the travel time permits evaluation of the elasticity modulus and thus is related to the behavior under pressure.

**Distortion-Voltage Measurements of Carrier-Frequency Systems for Symmetrical Lines**, by G. Martin. "Nach Z." May 1956. 12 pp. This experimental investigation is concerned with the law for the superposition of the effect of a series of amplifiers in multi-channel long-distance telephone systems. Extensive measurements are reported and graphs are presented. Various computing methods are coordinated with the results.

**An Emission Electron Microscope for Research at High Temperatures**, by G. Baas and G. W. Rathenau. "Phil. TEch." June 1956. 10 pp. A description is given of an emission electron microscope having a resolving power of about 1000 Å and an adjustable magnification of up to 3000 X. Since this microscope is primarily intended for the investigation of metals at high temperatures, thermionic emission is used.

**Simple Wide-Band Impedance Measurements**, by E. Shepard, Sr. "Con. Eng." Aug. 1956. 2 pp. A convenient variation of the three-voltmeter method of determining electrical impedance is described.

**Transistor Frequency Meters**, by L. Blake and A. Eames. "El. Eng." Aug. 1956. 6 pp. The design of a frequency meter based on the switched capacitor principle and using a transistorized switching circuit is discussed.

**On the Measurement of the Efficiency of a Four-Terminal Network**, by R. Harmegnies. "Cab. & Trans." July 1956. 8 pp. The author recalls two known methods for the determination of the power efficiency of a network terminated by a known impedance. The methods, based on the use of Smith's diagram, require only measurements effected with an impedance measuring bridge. A third method is described, leading to simpler computation formulae than the former ones: in particular the wanted value may be expressed as the half logarithm of its reciprocal, i.e. as an attenuation value in Nepers.

**Response Function of Thallium-Activated Sodium-Iodide Scintillation Counters**, by Martin J. Berger and J. Doggett. "NBS J." June 1956. 12 pp. Measurements of gamma rays with NaI (TI) crystals yield pulse height distributions related to the true energy spectrum by an integral equation whose kernel (response function) is the probability that an incident photon of energy  $E$  will give rise to a pulse of size  $E'$ . The response function has been calculated by the Monte Carlo method for photons with energies from 0.279 to 4.45 MEV. Results are presented for cylindrical crystals ranging in size from 0.25 (radius) by 0.5 inch (length) to 2.5 by 9 inches.

**Pulse Echometer for the Test of Coaxial Line Repeater Sections**, by G. Comte, M. Boudier, and A. Ponthus. "Cab. & Trans." July 1956. 14 pp. A technical description is given of a pulse echometer designed for the test of the impedance regularity of coaxial cable repeater sections after cable laying. The echometer uses raised cosine pulses with a half-amplitude duration of 0.17  $\mu$ sec.; it includes a phase-and-amplitude corrector which allows the impedance irregularities of the line under test to be measured without the errors caused by the phase and amplitude distortion undergone in propagation by the echo pulses.

**Response of a Sodium-Iodide Scintillation Spectrometer to 10- to 20-Million-Electron-Volt Electrons and X-Rays**, by H. W. Koch and J. M. Wyckoff. "NBS J." June 1955. 8 pp. The response of a large-crystal sodium-iodide spectrometer was studied for individual monoenergetic electrons extracted from a 50-million-electron-volt betatron operated between 1 and 20 Mev.

**Magnetic Tape Signal Transmitter for Ocean Cables**, by E. Finnegan. "Tech. Rev." July 1956. 6 pp. Distortion correcting networks for submarine cable amplifiers have been adjusted customarily from observation of oscillograph patterns produced by repetitive "shaping signals." For generating shaping signals, there has been devised, recently, a magnetic tape recording procedure which is simpler and more reliable than employment of multiplex distributor equipment.

**Transmission Loss Due to Resonance of Loosely-Coupled Modes in a Multi-Mode System**, by A. King and E. Marcatili. "Bell J." July 1956. 8 pp. An FM radar technique for measurement of atmospheric attenuation at millimeter wavelengths is described. Some practical results are described.

**Fingerprinting Relays**, by H. Hermance and T. Egan. "Bell Rec." Aug. 1956. 5 pp. A method is described whereby relay surfaces, including contaminating particles, are accurately "fingerprinted" by making an impression in a transparent plastic blank. Use of this plastic replica technique as a micro-analytical tool is explained.

**Thermal Shock Testing of Casting Resins**, by M. Riley. "El. Eq." July 1956. 3 pp. Commercial casting resins are used to encapsulate fluorescent light bulbs to produce pressure-proof fixtures, and in bronze and fabricated steel enclosures, to produce pressure-proof connectors.





**A Valve Curve Tracer**, by R. James. "El. Eng." Aug. 1956. 6 pp. A description is given of an instrument using a long persistence CRT to trace families of mutual and anode characteristic curves together with calibration graph lines and a variable load line. Circuits and typical traces are presented.

**Measurement of the Self-Capacitance of an Inductor at High Frequencies**, by J. Newsome. "El. Eng." Aug. 1956. The author defines and briefly discusses self capacitance. A detailed survey of methods of measurement of this quantity is then undertaken. Certain of the methods described are not well known, while one is novel and can give a result of improved accuracy.

**Casting Resin Investigations at Naval Ordnance Plant**, by C. Brown. "El. Eq." July 1956. 2 pp. A report is given on work done in investigating casting resins for embedment of circuit subassemblies of a fire-control system and for impregnating windings of small servo motors and toroidal coils for magnetic amplifiers.

**Gate Selects Pulses for Spectrum Analysis**, by A. Ross and L. Simon. "El." Aug. 1956. 3 pp. A system is described which uses gating to switch a spectrum analyzer, thereby isolating one pulse of a multipulse group for detailed analysis.

**LF-Noise Generator of Small Bandwidth**, by D. Steffen. "El. Rund." July 1956. 4 pp. A generator is described supplying in the tone frequency range near any desired frequency a small bandwidth noise spectrum destined for frequency response and distortion measurement. Bandwidth is variable between approx. 10 to 165 cps.

**Magnetron Tester Detects Lost Pulses**, by P. Koustas and D. Mawhinney. "El." Aug. 1956. 5 pp. Test specifications for radar magnetrons include measurement of number of missing pulses, pulses below a predetermined percent of normal output power or at other than desired frequency. Cancellation or coincidence measuring techniques can be used. The authors describe a coincidence tester and present some of its operating advantages.

**Practical Hi-Pot Testing**, by J. Keefe. "El. Mfg." Aug. 1956. 8 pp. The author presents some practical considerations for setting up both AC and DC high-voltage insulation test stations.



## RADAR, NAVIGATION

**Servo Accelerometer Uses R-F Oscillator**, by V. Corey. "El." Aug. 1956. 3 pp. A null-balance accelerometer not depending on spring deflection is described. Essentially, the system is based on balancing inertial forces on a pivoted capacitor plate, in the tuned circuit of an RF oscillator, by torque derived from the plate current of the oscillator.

**D. F. Plotting Aid**, by H. G. Hopkins. "Wirel. Eng." July 1956. 3 pp. A simple plotting aid is described for use in determining the contour enclosing the area within which the transmitter lies with a given probability. It is in the form of a transparent graticule which is placed on the map over the most probable point.

**Transistor Amplifier for Radar Video**, by R. Leslie. "El." Aug. 1956. 4 pp. The author traces the steps involved in design of a transistorized counterpart of conventional radar video amplifiers.

**Illumination of Radar Screen Monitoring Rooms**, by K. Ohlsen. "El. Rund." July 1956. 1 p. Afterglow radar screen images are often to be monitored in rooms where other work requires illumination. This must not, owing to image screen excitation possibilities, contain yellow light. In order to avoid eye accommodation troubles of the operators due to monochromatic illumination, a tri-color lamp described in detail has been developed emitting white light by mixture of red, blue and green.

**Some Limiting Cases of Radar Sea Clutter Noise**, by A. Schooley. "Proc. IRE." Aug. 1956. 5 pp. The author presents the results of an analysis showing some limiting values of the effective radar scattering area per unit area of the sea surface with respect to radar depression angle for perfectly smooth and perfectly rough surfaces.



## SEMICONDUCTORS

**Current Derived Resistance-Capacitance Oscillators Using Junction Transistors**, by D. Hooper and A. Jackets. "El. Eng." Aug. 1956. 5 pp. The basic criteria of resistance-capacitance oscillators are discussed, and 0° and 180° phase shift circuits for transistorized oscillators are described.

**The Effect of Surface Treatments on Point-Contact Transistor Characteristics**, by J. Forster and L. Miller. "Bell J." July 1956. 45 pp. A description is given of the electrical properties of formed point contacts on germanium. A useful technique for observation of the equipotentials surrounding such contacts is described.



## TELEVISION

**First Design Data on New Portable TV Camera-Transmitters**, by A. Look. "El. Ind." Sept. 1956. 3 pp. Specifications and block diagrams for a completely self contained portable video camera and transmitter are presented. Equipment components are suitable for use as remote, studio, or closed circuit camera systems.

**A Possible Method for Improving the Definition of a Television Image**, by V. S. Samoilov and V. M. Rodionov. "Radiotek." April 1956. 5 pp. The article discusses a new method for improving the visual definition of a television image by means of increasing the peak-to-peak swing of the signal which corresponds only to the minor details of the picture.

**Standardization of Television Equipment at Radiodiffusion-Télévision Française**, by L. Goussot. "Onde" May 1956. 8 pp. For several years the Radiodiffusion Télévision Française has been redesigning its equipment. The final technical features are given and tabulated for easy reference. The characteristics of the television signal and pattern as well as components are included.

**A Self-Synchronizing Line Selector for Television**, by O. Macek. "Freq." June 1956. 4 pp. The apparatus permits the selection of an arbitrary line for representation on an oscillograph screen, provided the complete TV signal is available.

**Sampling Detector for Intercarrier TV Sound**, by K. Schlesinger. "El." Aug. 1956. 4 pp. A TV-sound detector using a conventional double triode is described. The system uses synchronous oscillation and detection.

**Television Picture Quality**. "Wirel. Eng." July 1956. 2 pp. In anticipation of eventual establishment of color television for Great Britain, the relative merits of present TV standards are reviewed. Number of lines, bandwidth, and resolution are discussed.

**The Television Picture Tube**, by H. Rothe and E. Gundert. "Arc. El. Uber." May 1956. 7 pp. A survey of the essential characteristics of TV picture tubes, and in particular of modulation and resolving power, is given. The beam-generating system, the focussing system (magnetic and electrostatic lenses), and the deflection system are discussed.

**Pedestal Processing Amplifier for Television Studio Operation**, by R. Kennedy. "RCA". June 1956. 6 pp. The pedestal processing amplifier is a device capable of removing the synchronizing pulses from either a color or monochrome television signal so as to permit simultaneous presentation of pictures from separate locations.

**Recent Improvements in the 21AXP22 Color Kinescope**, by R. Janes, L. Headrick, and J. Evans. "RCA". June 1956. 24 pp. The quality of the 21AXP22 color kinescope has been steadily improved since the tube was first announced in September 1954. After a brief review of the principles of the tube and data on its operation, there is a discussion of the changes which have been made in the tube and in the lighthouses used to produce the tubes. Equipment used to obtain data for the changes is also described.

**Effect of Magnetic Deflection on Electron Beam Convergence**, by P. Kaus. "RCA". June 1956. 22 pp. The image curvatures of deflection yokes are calculated and minimized using third-order perturbation theory. It is found that the mean image curvature is too large to dispense with dynamic convergence when a point focus is needed. Proper field shaping, however, can produce a good line focus over the whole screen without dynamic convergence.

**TV Aids Acceleration Studies**, by J. Boston. "El. Eq." Aug. 1956. 2 pp. The author reports on use of ITV to monitor direct-reading test instruments undergoing acceleration tests on a revolving test table.

**How to Convert Color TV Receivers for Video Drive**, by E. R. Klingeman. "BC News" July 1956. 4 pp. Many television stations have acquired a collection of color television receivers. These receivers may be converted to dual-purpose instruments, capable of receiving a telecast off the air or from video line drive. Their usefulness is greatly increased because they may be used as an emergency or spare monitor.

**The Superorthicon Video Camera Tube**, by R. Theile. "El. Rund." July 1956. 5 pp. Utilization of the storage screen charge image and signal generation are dealt with, the electron optical fundamentals of operative adjustment, also the conditions or origin and effects of back current are entered upon. The calculation of image signal distance from noise level is discussed extensively. Results of pertinent practical measurements are specified.

**Satellites for Bands I, III, and IV as Television Transmitters**, by B. Pick. "Tech. Haus." March-April 1956. 8 pp. Satellites have proved to be useful in supplementing television coverage in orographically difficult areas. The paper describes the development and construction of such satellites and discusses the possibilities of their application and the results obtained.



## U. S. GOVERNMENT

**Industrial Preparedness Study: Silicon Power Rectifiers, Quarterly progress report, Jan. 1, 1955 to April 1, 1955 (PB 111819),** Transistron Electronic Corp. 38 pp. \$1. (OTS) Process improvements, including development of soldering the silicon junction wafer directly to the base and further development on welding the lead at the final sealing operation, have increased the yield and improved the mechanical and electrical characteristics of silicon power rectifiers. The process is now already partly mechanized, and is rapidly being more completely mechanized.

**Adhesive for Composite Material Used in Printed Circuitry (PB 111869),** Houghton Laboratories, Inc. March 1955. 41 pp. \$1.25. (OTS) The best adhesive system used to bond copper foil to silicone laminates was a rubber-phenolic-epoxy type. When rubber-phenolic adhesive was used in conjunction with epoxide impregnated glass cloth, peel strengths in the order of 12 lb/in strip could be obtained. Work done on the evaluation of filler content of plastics on both water absorption and moisture permeability is reported.

**The Principles of Computer Simulation (PB 121200),** ONR. Sept. 1955. 158 pp. \$3. (OTS) This basic reference book covers rudiments of operation and maintenance common to all analog-computer simulators, and is intended to bridge the gap between the better-understood synthetic trainer, such as the basic Link flight simulator, and increasingly complex modern trainers.

## PATENTS

**Coding Apparatus for Television Transmitters, #2,752,415.** Inv. E. M. Roschke. Assigned Zenith Radio Corp. Iss. June 26, 1956. The coding system for changing the mode of a video signal derived during a series of successive trace intervals applies alternate sequences of the signal to two storage devices, changes the mode of one or both outputs from the storage devices and recombines the modified outputs.

**Signal-Operated Automatic Control Circuit, #2,752,417.** Inv. D. H. Pritchard. Assigned R.C.A. Iss. June 26, 1956. A television receiver for monochromatic and color reception separates a color identifying waveform from a received color signal. This waveform is used to control conduction or cut-off of a gas discharge tube which in turn supplies a color disabling signal if the identifying waveform is received.

**Scanning Method and Television System Using Same, #2,752,421.** Inv. K. F. Ross. Iss. June 26, 1956. A message is linearly scanned at a much higher speed than it is intended to reproduce it; any intensity change exceeding a predetermined amount and the location of such a change is measured. At these scanning positions, scanning is interrupted for a time interval short compared to the reproduction time but long enough to make successive measurements at approximately equal time intervals. The measurements are registered as two series of pulses.

**Vertical Synchronizing Pulse and Separation System, #2,752,422.** Inv. S. B. Alexander. Assigned Emerson Radio and Phonograph Corp. Iss. June 26, 1956. A negative bias voltage equal in amplitude to the peak amplitude of the vertical synchronizing signal component is superposed on the composite signal. The subsequent separator tube has a very large output resistor in series with its anode

and a capacitor between anode and ground, the time constant of the resistor-capacitor combination being long compared to the recurrence frequency of the vertical synchronizing component.

**Grounded-Grid Amplifier, #2,753,404.** Inv. J. M. Miller. Assigned Bendix Aviation Corp. Iss. July 3, 1956. The input signal is applied between cathode and ground across a resistor, the grid being grounded. A capacitor-inductance circuit, resonant at the signal frequency, is connected between plate and plate supply, while the output is derived from the plate through a capacitor. A resistor connects the output terminal to the cathode.

**Radio-Wave Pulse System, #2,753,448.** R. H. Rines. Iss. July 3, 1956. The carrier waves in a radio system are pulse-amplitude modulated and subsequently phase-modulated in response to a signal. At the receiver a network is provided which produces different phase-shifts for the successive phase-distorted components of each pulse carrier wave to compensate for the phase distortion of the successive amplitude-modulated pulse carrier waves and to reproduce the signal.

**Synchronizing Signal Separation System, #2,753,452.** Inv. B. L. McArdle. Assigned General Dynamics Corp. Iss. July 3, 1956. The synchronizing component of a composite signal has a fundamental frequency. A square wave is developed having this frequency, which is transformed into a plurality of equal-frequency sinusoidal waves equally spaced in phase. A radial beam tube converts these waves into a train of equally spaced pulses which render a clamping and sampling circuit, to which the composite signal is fed, non-conductive.

**Frequency Divider, #2,753,455.** Inv. L. Diven and R. W. Waer. Assigned International Tel. and Tel. Corp. Iss. July 3, 1956. The input tube is normally responsive to input pulses. Conduction of the input tube causes the generation of a blocking pulse potential in an associated circuit connected to the input tube by a first signal path, while a second signal path, including a time delay device, causes termination of the blocking pulse. The blocking pulse is fed to the input tube rendering it nonresponsive to input pulses.

**Indirectly Heated Cathode Structure and Method of Assembly, #2,753,480.** Inv. W. K. Batzle and W. C. Dale. Assigned RCA. Iss. July 3, 1956. The thermionically emissive coating is applied to a sleeve. The electrically insulated heater is arranged inside the sleeve and having facing surfaces with the sleeve for heat transfer. An insulated conducting member spaces the heater and the sleeve at relatively small portions of their facing surfaces, leaving large facing surfaces for effective heat transfer.

**Point Contact Translators, #2,753,495.** Inv. J. F. Barry. Assigned Bell Tel. Labs. Iss. July 3, 1956. A conductive member is in ohmic connection with a semiconductive body. Chisel edges of two wires engage the semiconductive body with a parallel critically spaced relationship, the contact area being covered with a buffer mass of fluid material surrounded, together with the semiconductive body, by a resinous bead. An anchoring irregularity of each wire is embedded in the bead and the portion of the wires within the buffer mass are maintained on the semiconductive body as transversely loaded cantilevers.

**Electromechanical Pulse-Storage Lines, #2,753,527.** Inv. R. Adler. Assigned Zenith Radio Corp. Iss. July 3, 1956. A piezo-electric input transducer is arranged adjacent to and mechanically coupled to a piezo-electric output transducer. One or more passive vibratory elements are mechanically coupled to both transducers to provide a closed path for wave propagation.

**Possibilities for Using Television Transmitters of Very Low Power,** by W. Knopf. "Tech. Haus." March-April 1956. 3 pp. Use is made in mountainous regions, of television transmitters of very low power as auxiliaries to high-power television transmitters, in order to improve the coverage. The paper discusses the possibilities of application and the resulting structure, including operational supervision.

**The Superorthikon Video Tube,** by R. Theije. "El. Rund." June, 1956. 5 pp. Design details of the "image orthikon" or "superorthikon", a sensitive image storage tube, are given and its operation is described. The processes in the storage plate, consisting of conducting glass, are set forth and the resulting operational behavior is explained.



## TRANSMISSION LINES

**Waveguide Components with Non-Reciprocal Properties,** by J. Brown and P. Clarricoats. "El. Eng." Aug. 1956. 5 pp. This first of two articles explains the physical mechanism causing Faraday rotation and the related ferromagnetic resonance.

**A Low-Loss Wave Guide without Phase- and Attenuation Distortion,** by H.-G. Unger. "Arc. El. Uber." June 1956. 8 pp. In a circular wave guide with tubular dielectric insert, the attenuation of a  $TE_{01}$ -mode has a minimum at a certain frequency. If this frequency coincides with one of the two extreme values of the envelope velocities, the  $TE_{01}$ -wave will be transmitted without phase or attenuation distortion. The diameter and wall thickness of the tubular dielectric insert must be small for a wide-band wave guide of this type.

**The Effect of the Distance Between Dipoles Upon the Resonant and Directional Properties of a "Wave-Channel" System of Dipoles,** by V. M. Vysokovsky. "Radiotek." May 1956. 5 pp. A calculation is performed to determine the amplitudes and phases of the currents in dipole systems of the "wave-channel" type when the distances between dipoles vary from  $0.1\lambda$  to  $0.4\lambda$ .

**The Field Displacement Isolator,** by S. Weisbaum and H. Seidel. "Bell. J." July 1956. 36 pp. Use of a single ferrite element, spaced from the sidewall of the guide to obtain high reverse to forward loss ratios is described.



## TUBES

**The Calculation of the Basic Parameters for Electronic Tubes which are Utilized for Measuring Acceleration,** by L. A. Goncharsky. "Radiotek." April 1956. 10 pp. The paper describes the basic types of electronic tubes which are used for the measurement and registration of acceleration in mechanical experiments involving vibrational stability, discontinuous load stability, impact-load stability, and stability under conditions of large acceleration values.

**Electrolytic Transport Phenomena in the Oxide Cathode,** by R. Plumlee. "RCA." June 1956. 41 pp. An experiment is described in which some of the chemical changes produced in a BaO cathode by the process of drawing electron emission were detected.

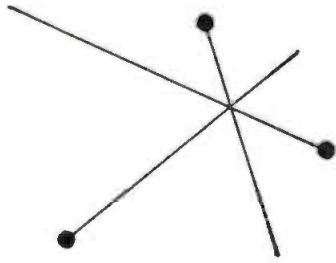

# ERMA

**electronic recording machine accounting**

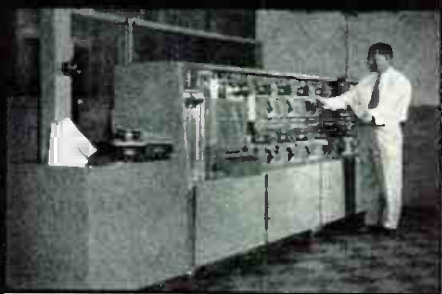
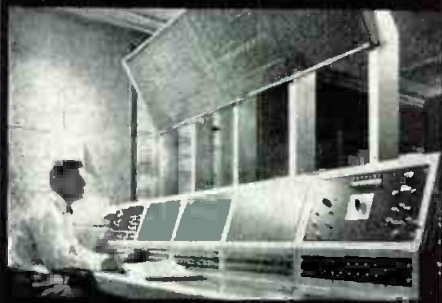

Brilliant career opportunities for . . .

- EXPERIENCED COMPUTER ENGINEERS
- LOGICAL DESIGNERS
- TRANSISTER APPLICATIONS ENGINEERS
- COMPUTER CIRCUIT ENGINEERS
- DESIGNERS ELECTRO MECHANICAL DEVICES
- ELECTRONIC PACKAGING ENGINEERS

*YOU are URGENTLY NEEDED at once to work on the General Electric Team for the ERMA Program.*

*Technical Assignments available in Palo Alto, California and Syracuse, New York.*

**FIRST** industrial data processing system designed to solve entire checking account bookkeeping.

**FIRST** such system ordered into quantity production. (The Bank of America to convert to ERMA.)

**FIRST** production computer designed with modern solid state components.

**FIRST** of a line of tailored data processing for business, industry and Government.

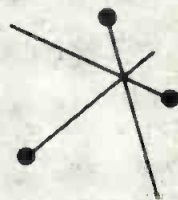

**ERMA IS REVOLUTIONARY IN CONCEPT AND EXECUTION**

. . . solves entire bookkeeping problem from time check is entered until monthly statement is issued.

. . . originally conceived by Bank of America and developed to the bank's specifications by Stanford Research Institute.

. . . refinement to continue through joint effort of General Electric and Stanford Research Institute.

*Please send your resume to*  
**Engineering Administration**  
**Industrial Computer Section**

**GENERAL  ELECTRIC**

**3001 James Street • Syracuse, New York**

# THE **NEW** ARTOS AUTOMATIC wire-stripping and TERMINAL-ATTACHING MACHINE

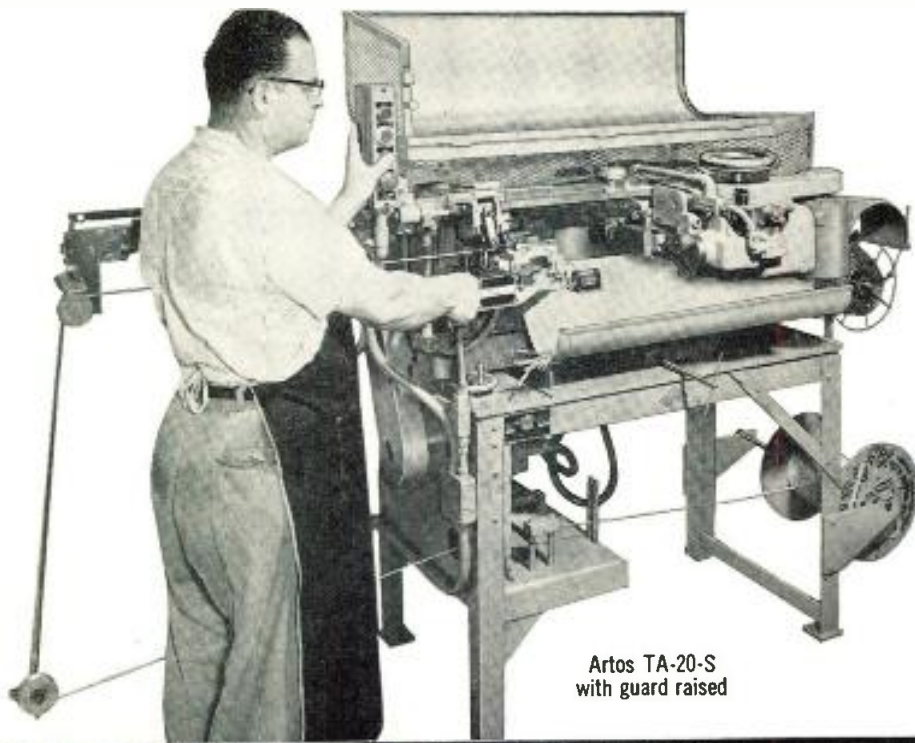

Artos TA-20-S  
with guard raised

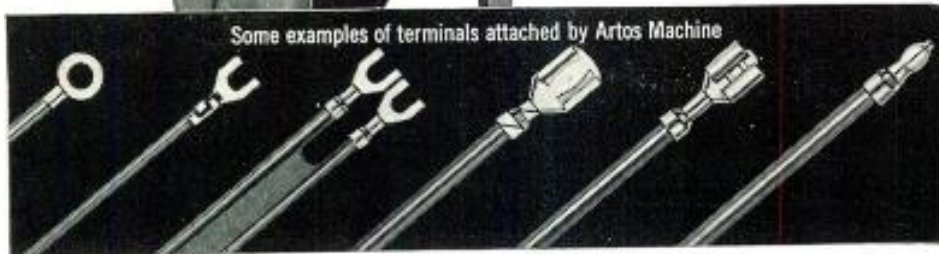

Some examples of terminals attached by Artos Machine

This new Artos TA-20-S brings still greater speed and production economy to large-quantity users of wire leads with terminals attached. It *automatically* performs the following services *all in one operation*:

1. Measures and cuts wire to predetermined lengths.
2. Strips one or both ends of wire.
3. Attaches practically any prefabricated terminal in strip form, to one end of wire.
4. Marks finished wire leads with code numbers and letters. (Optional attachment not standard part of machine.)

**ALL OPERATIONS ARE AUTOMATIC.** Machine can be operated by unskilled labor. It is easily set up and adjusted for different lengths of wire and stripping. Die units for different type terminals simply and quickly changed. Production speeds up to 3,000 finished pieces per hour.

**ARTOS MACHINES ARE USED** by electric appliance, automotive, aircraft, electronics and other industries that want automation in the production of wire leads in quantity. Agents throughout the world.

Engineering consultation and recommendations given without obligation.

**WRITE FOR  
BULLETIN**

No. 655 on the  
Artos TA-20-S



## ARTOS ENGINEERING CO.

2753 South 28th Street • Milwaukee 46, Wisconsin

## Phase Shift

(Continued from page 61)

margin or increase in gain,  $K$ , necessary to produce instability is  $0.46A$  or 49%. The gain sensitivity is

$$17. \quad \frac{\partial \xi}{\partial K} = \frac{0.277}{A} @ \xi = 0.1$$

Consider the servo shown in Fig. 6.

This servo is almost identical with the first case except that the amplifier has been tuned and the filter has been removed. The circuit parameters are chosen to be the same as those in Eq. 16 which fixes the  $Q$  of the amplifier to be

$$18. \quad Q = \omega_0/2 (1.2A)$$

The root locus plot is the same as the first case as shown in Fig. 7. Hence, the servo characteristics are the same as the first case with the exception of the amplifier gain. The damping characteristics are shown in Fig. 8 as a function,  $T_2$ . The gain margin is  $1.38A$  or 76.6%. The gain sensitivity is

$$19. \quad \frac{\partial \xi}{\partial K} = \frac{0.113}{A} @ \xi = 0.1$$

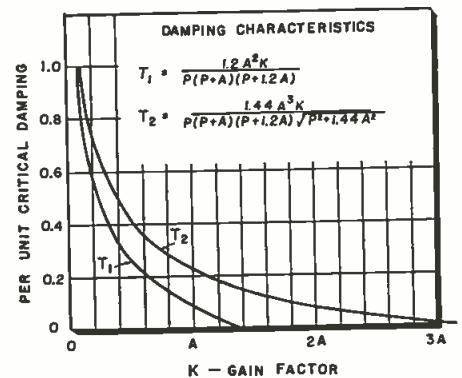

Fig. 8: Damping characteristics

Although with both cases the overall transfer function is the same for damping, time constant, and frequency response, the gain margin is increased 27.6% in the second case. The gain in case two can increase 145% more than the first case to yield the same per unit critical damping change.

### References

<sup>1</sup> H. W. Bode, "Network Analysis and Feedback Amplifier Design," Van Nostrand Company 1949, p. 305.

38% of 1955 television sales  
involved a trade-in



**Why you can  
rely on BUSS  
Fuses . . .  
for dependable  
electrical  
protection!**



*Makers of a complete line of fuses for home, farm, commercial, electronic, automotive and industrial use.*

To make sure of top quality and proper operation—BUSS fuses are tested in a sensitive electronic device. Any fuse not correctly calibrated, properly constructed and right in all physical dimensions is automatically rejected.

That's why BUSS fuses provide maximum protection to users' equipment against damage due to electrical faults. And just as important, BUSS fuses by their unfailing dependability, help safeguard users of your equipment against irritating, useless shutdowns by eliminating needless blows.

When you specify BUSS fuses you can be sure of fuses that will operate properly and help safeguard the reputation of your equipment for quality and service.

To meet your needs, a complete line of BUSS fuses is available . . . plus a companion line of fuse clips, blocks and holders.

*If you have an unusual or difficult protection problem, let the BUSS fuse engineers work with you and save you engineering time. If possible, they will suggest a fuse already available in local wholesalers' stocks, so that your device can be easily serviced.*

**BUSSMANN MFG. CO.**  
(Div. McGraw Electric Co.)  
University at Jefferson St. Louis 7, Mo.

*For information on BUSS and Fusetron small dimension fuses and fuseholders . . . Write for bulletin TT.*

**THE WRONG POT . . .  
CAN MEAN TROUBLE!**

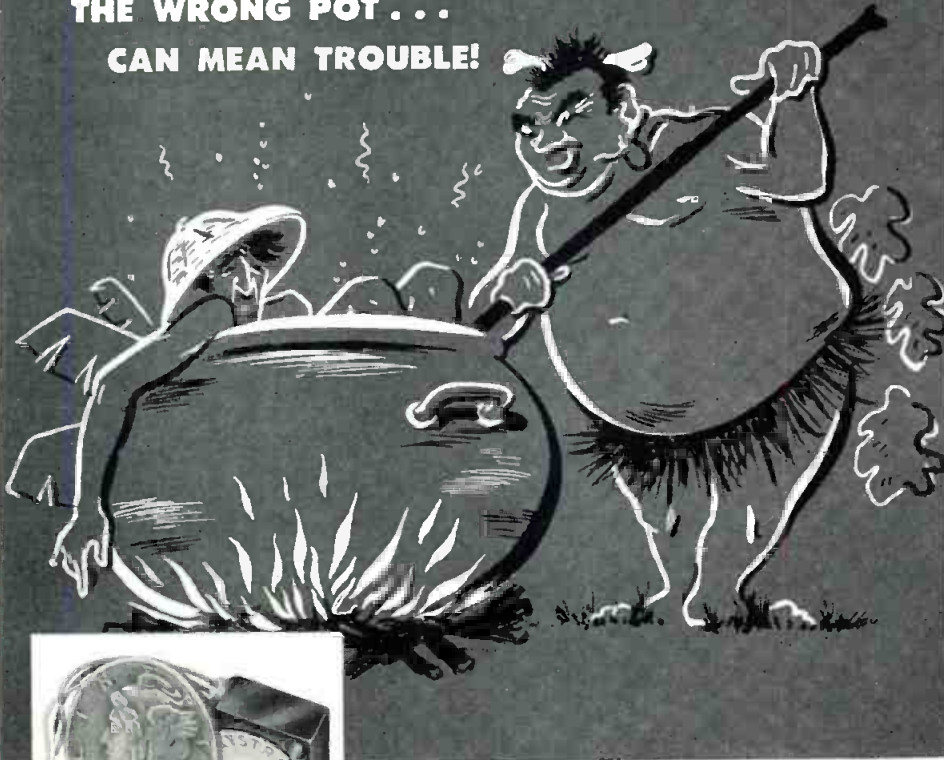

For the *right* pot,  
rely on **DAYSTROM!**

Model 300-00 is the tiniest, precision-built, wire-wound trimming potentiometer this side of "Lilliput." Despite its flyweight size, it easily handles **exacting** jobs throughout extreme temperature ranges.

For higher resistance ranges, the Model 303-00 fills the bill — using very little more space than the Model 300-00.

The **Potentiometer Division** of Daystrom Pacific Corporation is staffed with highly skilled engineers and technicians who dearly love to grit their teeth and come up with optimum solutions to all kinds of potentiometer problems.

So, rely on **DAYSTROM** for your right pot!

**Some outstanding characteristics:**

	Model 300-00	Model 303-00
Size .....	0.5" square by 0.187" thick	0.75" square by 0.28" thick
Weight .....	2 grams	7 grams
Resistance Ranges ...	10 ohms to 50K	5K to 125K

Write today for literature on these or any of the many other production or custom-made precision potentiometers available. Names of local representatives on request.

Openings exist for highly qualified engineers.

**NBS' Services**

(Continued from page 66)

Universal Time is announced in telegraphic code each 5 mins from WWV and WWVH. This provides a quick reference to correct time where a timepiece may be in error by a few minutes. The 0-24-hour system is used starting with 0000 at midnight. The first 2 figures give the hour and the last 2 figures give the number of minutes past the hour when the tone returns.

At Station WWV a voice announcement of Eastern Standard Time is given before and after each telegraphic code announcement.

**Radio Propagation Forecasts**

A forecast of radio propagation conditions is broadcast in telegraphic code on each of the standard radio carrier frequencies: from WWV at approximately 19.5 and 49.5 mins past each hour, and from WWVH at approximately 9.4 and 39.4 min past each hour, as shown in Fig. 1.

The forecast announcement tells users the condition of the ionosphere at the regular time the forecast is made and how good or bad communications conditions are expected to be in the succeeding 6 or more hours.

From WWV the forecasts refer only to North Atlantic radio paths, such as Washington to London or New York to Berlin. The times of issue are 0500, 1200 (1100 in summer), 1700, 2300 UT.

From WWVH the forecasts refer only to North Pacific radio paths, such as Seattle to Tokyo or Anchorage to San Francisco. The times of issue are 0200 and 1800 UT, with these forecasts first broadcast at 0239 and 1839 UT respectively.

The forecast is broadcast as a letter and a digit. The letter portion of the announcement identifies the radio quality at the time the forecast is made. The letters denoting quality are "N" "U," and "W," signifying that radio propagation conditions are normal, unsettled, and disturbed. The digit portion is the forecast of the radio propagation quality on a transmission path during the 6 or more

**POTENTIOMETER  
DIVISION**

*Daystrom* **PACIFIC** CORPORATION

11150 La Grange Ave. West Los Angeles 25, Calif.

A SUBSIDIARY OF DAYSTROM, INC.

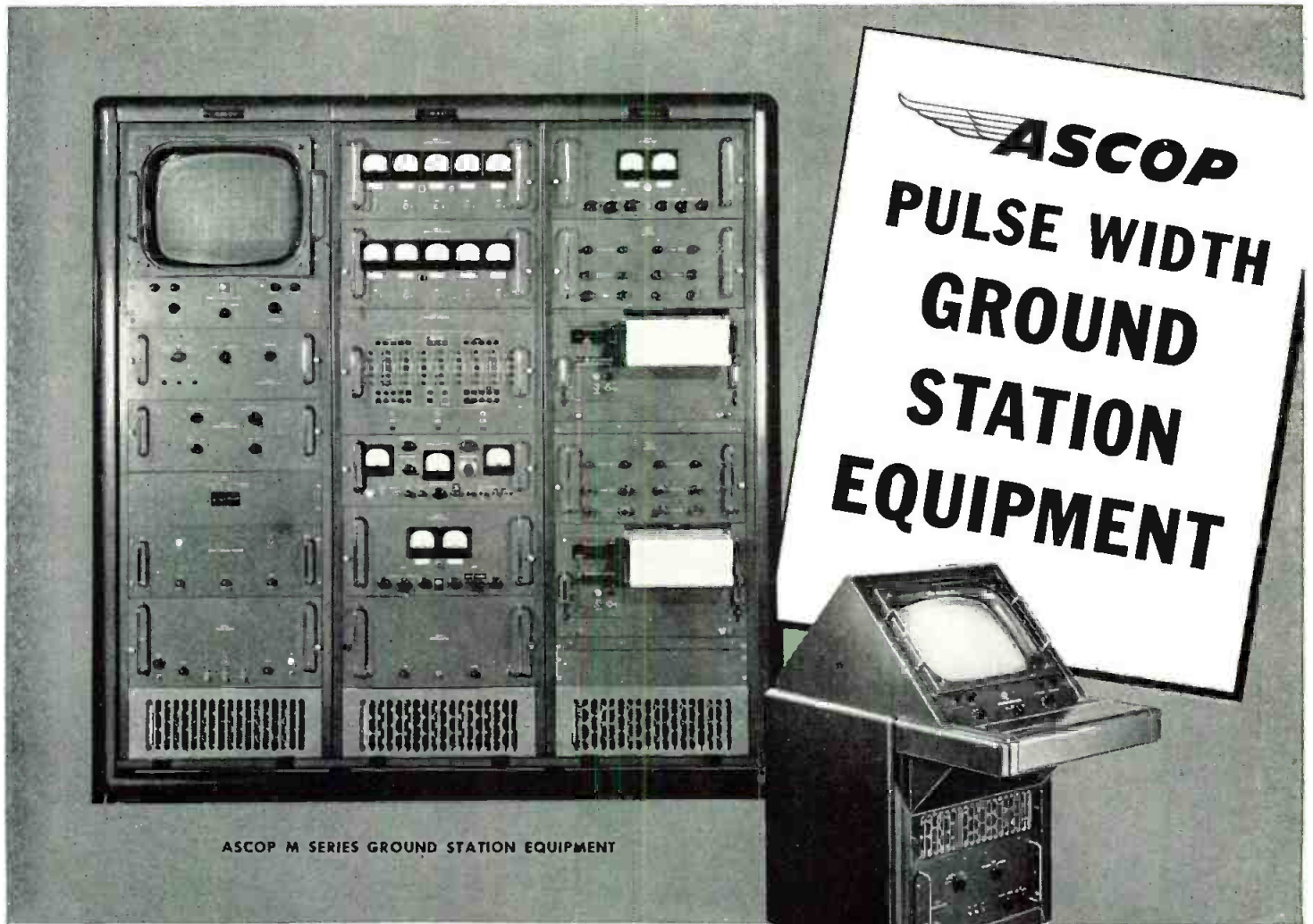

ASCOP M SERIES GROUND STATION EQUIPMENT

ASCOP MC-1 MONITOR CONSOLE GROUP

# ASCOP PULSE WIDTH GROUND STATION EQUIPMENT

## Achieves System Accuracies of Better Than 1%



ASCOP Pulse Width Ground Station equipment, pictured above, complements ASCOP's PW Multicoders and Radio Telemetry Sets to provide complete "packaged" systems for operational testing of aircraft, missiles and other vehicles... and for static testing of engines, rockets, nuclear reactors and other powerplants.

Continuous automatic compensation of system zero and scale factor eliminates the need for critical components and frequent manual adjustment.

The M Series Ground Station uses intermediate magnetic tape speed change to operate directly from pulse width signals of 30x30, 45x20, or 90x10 configurations—or from any non-standard configuration having 30, 45 or 90 channels. All data channels may be visually monitored simultaneously.

All ASCOP equipment is designed for dependable accuracy, simplicity of operation, maximum life with minimum maintenance attention. ASCOP engineers will gladly consult with you, without obligation, on your current projects. Or write for detailed information, outlining your system requirements.

Stations are sold only as combinations of standard or special tape recorder, monitor, decommutation or output recorder groups.

### PROVIDES FOR:

- Advance Station-Calibration, using locally generated setup signals
- Continuous Automatic Compensation for system zero, scale factor changes
- Simultaneous Visual Monitoring of all data channels
- Missing Data Point Correction, for continuous synchronization
- Real Time Reduced Output Records for any or all channels
- Easy Access to Slide Mounted Chassis, even during operation

## ENGINEERS

This fast growing organization has immediate openings for:  
SYSTEMS & PRODUCT ENGINEERS • SENIOR R.F. ENGINEERS  
TRANSISTOR ENGINEERS • SALES ENGINEERS  
Send Resumes to our Princeton Office.

### APPLIED SCIENCE CORP. OF PRINCETON

P. O. Box 44, Princeton, N. J. • Plainsboro 3-4141  
1641 S. La Cienega Blvd., Los Angeles, Calif.  
Crestview 1-8870



# HOW *Vacu-Flo* AIR-COOLING SIMPLIFIES INSTALLATIONS OF ONAN ELECTRIC PLANTS

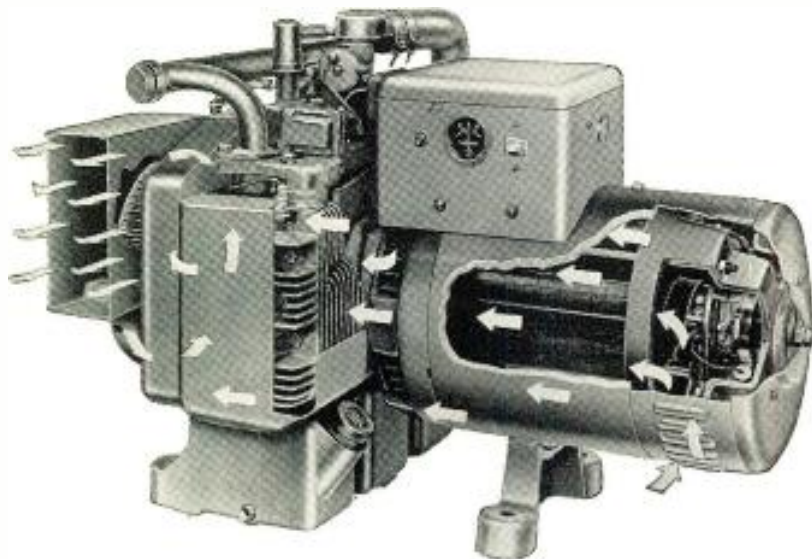

## VENTILATES INSTALLATION AREA

Vacu-Flo cooling takes air from the room, through the electric plant, and expels it outside through a single duct. Eliminates fumes; keeps room filled with fresh air.



## DUCT CARRIES EXHAUST LINE

On the Onan CW series of electric plants (7½ and 10KW), the exhaust pipe is carried through vent duct to the outside making only a single opening necessary.

## Heated air expelled outside through single vent. Units can be enclosed or "buried"

Air-cooled Onan Electric Plants can now be installed in small, enclosed compartments; in isolated or underground rooms; or "buried" within a vehicle, far from the outside air. Previously impossible or difficult installations are now easy and practical with Onan Vacu-Flo cooling.

This exclusive system is a factory-equipped item, optional on any Onan air-cooled electric plant. A quiet-running, centrifugal blower in a specially-designed housing PULLS cooling air through the generator and over the engine . . . then EXPELS heated air through a duct to the outside.

The space required in a "buried" installation need be only a little larger than what the unit itself requires. Air-intake and vent openings plus an exhaust line are all that are necessary.

On vehicles such as trailers, display vans, fire and rescue trucks, and concession wagons, Vacu-Flo cooling makes it possible to mount the Onan plant anywhere in the body where space is available. On pleasure and work boats, Vacu-Flo cooling makes below-deck installations of air-cooled electric plants practical . . . cooling efficiently and quickly eliminating fumes from the area.

Onan Electric Plants with Vacu-Flo cooling operate more quietly than blower-cooled models . . . an important added advantage in many installations.

Write for Special Vacu-Flo folder.



## D. W. ONAN & SONS INC.

3908 University Avenue Southeast, Minneapolis 14, Minnesota

hours after the forecast is made. Quality is graded in steps from 1 to 9 as follows:

- Disturbed Grades (W)
  - 1—useless
  - 2—very poor
  - 3—poor
  - 4—poor-to-fair
- Unsettled Grade (U)
  - 5—fair
- Normal Grades (N)
  - 6—fair-to-good
  - 7—good
  - 8—very good
  - 9—excellent

If, for example, propagation conditions at the time the forecast is made are normal but are expected to be only "fair-to-poor" within the next 6 or more hours, it would be broadcast as N4 in International Morse code.

## Radiated Power

Radiated power is shown in the Table 1.

Freq. (MC)	Power, Kw WWV	Power, Kw WWVH
2.5	1	
5	8	2
10	9	2
15	9	2
20	1	
25	0.1	

The broadcast on 2.5 MC is from a vertical  $\lambda/4$  antenna. The broadcasts on all other frequencies are from vertical  $\lambda/2$  dipoles. The radiation is omnidirectional.

The percent amplitude modulation, double sideband is:

- audio frequencies, 440 or 600 cps—75%
- voice and seconds pulses, peak—100%

At WWV, the tone frequency 440 or 600 cps, except on 25 MC, is experimentally operated as a single upper sideband with full carrier. Power output from the sideband transmitter is about one-third the carrier power. Single sideband tone on 25 MC may be added at a later date. Other signals are double sideband, 100% amplitude modulation.



### Range of Reception

Reliable reception is in general possible throughout the U. S. and the North Atlantic and Pacific Oceans, and reception at times throughout the world. One should select the frequency that gives best reception at any particular place and time. This can be done by 2 methods:

a. By tuning to the different frequencies and selecting the one most suitable at that time.

b. By making use of techniques of prediction of usable frequencies.<sup>1</sup>

### Other Signal Services

The U. S. Naval Observatory, Department of the Navy, broadcasts time signals at regular intervals from NSS (Annapolis, Maryland), NPG (Mare Island, California), NPM (Pearl Harbor, Hawaii), NBA (Balboa, Canal Zone).

The Dominion Observatory, Ottawa, Canada, broadcasts time signals continuously over Station CHU on frequencies of 3330, 7335, and 14670 kc.

Standard frequencies and time signals are broadcast by other stations as indicated in Table 2.

<sup>1</sup> "Basic Radio Propagation Predictions" and "Instructions for the Use of Basic Radio Propagation Predictions." Supt. of Documents, Washington 25, D. C.

## Less Skill Needed With Automation

Less skill will be required from industrial workers with the increase of automation, according to James R. Bright, a lecturer from Harvard University's Graduate School of Business.

Mr. Bright recently reported, after a study of 13 industrial plants, that workers can handle automatic operations with only 4 to 24 hours' training. He told an Armour Research Foundation conference in Chicago that "only in its early stages does automation require a great degree of skill." As automatic machinery becomes more widespread in plants, said Mr. Bright, taking over many of the skilled operations, more people will be qualified to fill production jobs operating the mechanical marvels.

# To the creative engineer...



*AiResearch two stage lightweight gas turbine compressor provides pneumatic power for aircraft main engine starting and serves as auxiliary power source for a variety of ground and in-flight services.*



▼  
▼  
▼  
The rapid scientific advance of our modern civilization is the result of new ideas from creative minds that are focused on the future. Our engineers not only have ideas but have the ability to engineer them into products.

That's why The Garrett Corporation has grown in both size and reputation to leadership in its areas of operation. That's why we are seeking more creative engineers to help us maintain and extend our leadership. If you fall in that category, you'll find working with us fulfilling in stimulation, achievement and financial rewards.

All modern U.S. and many foreign aircraft are Garrett equipped. We have pioneered such fields as refrigeration systems, pneumatic valves and controls, temperature controls, cabin air compressors, turbine motors, gas turbine engines, cabin pressure controls, heat transfer equipment, electro-mechanical equipment, electronic computers and controls.

We are seeking engineers in all categories to help us advance our knowledge in these and other fields. Send resume of your education and experience today to: Mr. G. D. Bradley



9851 S. SEPULVEDA BLVD., LOS ANGELES 45, CALIFORNIA

DIVISIONS:

AIRESEARCH MANUFACTURING, LOS ANGELES • AIRESEARCH MANUFACTURING, PHOENIX  
AIRESEARCH INDUSTRIAL • REX • AERO ENGINEERING  
AIRSUPPLY • AIR CRUISERS • AIRESEARCH AVIATION SERVICE

# New! Space-Saving

## These Advanced Features:

- Compact—requires only 10½" rack space.
- 1500 ma output at 280 volts regulated.
- High efficiency. Less power lost as heat.
- Uses only 6 tubes.
- New high-efficiency germanium rectifiers.
- Two-chassis construction for maximum flexibility.
- Only \$675 complete.

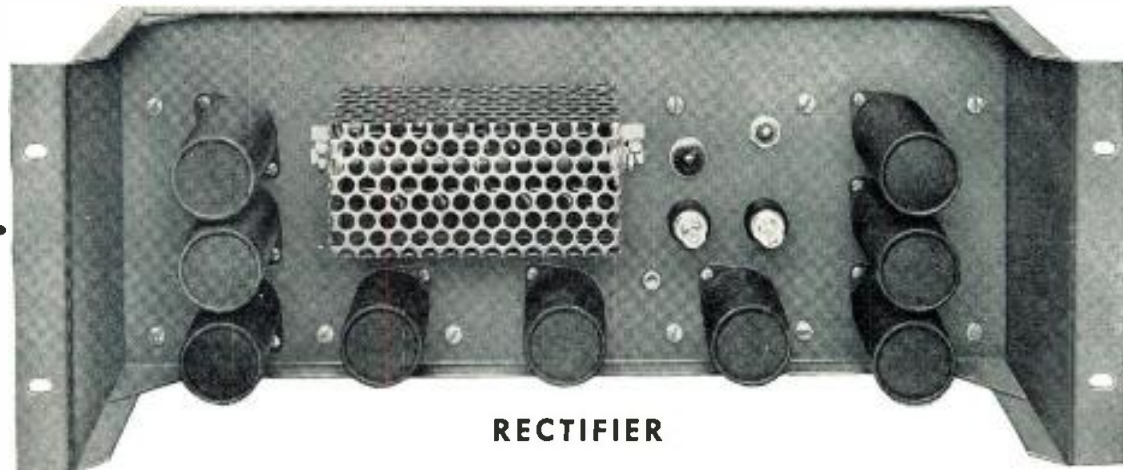

RECTIFIER

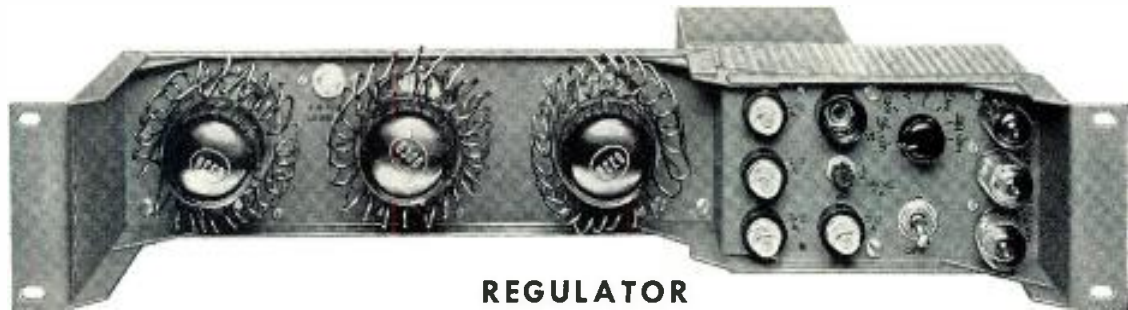

REGULATOR

## New RCA WP-15 Power Supply

highlights two-chassis construction. The rectifier chassis contains all the rectifier and filter elements. The regulator chassis contains a full complement of 6 tubes and regulating elements.

### System Simplification

By separating the functions of rectification and regulation it has made it possible to place all the rectifier chassis at one location. Regulator sections can thus be arranged in a location adjacent to equipment loads. If desired the rectifier and regulator chassis can be mounted together as a complete power supply, occupying only 10½" space.

### New Safety Features

Heavy-duty on/off switches are provided on both rectifier and regulator. Both can be remote controlled from regulator, eliminating presence of high voltage when the regulated voltage may be off. Indicating type fuses are used in ac power input line. Each regulator tube is individually fused to prevent overload in case of failure of any other regulator tubes. Indicator lamps on front and rear of both chassis warn of presence of high voltage. Entire power supply is completely covered to prevent contact with terminals carrying high voltage.

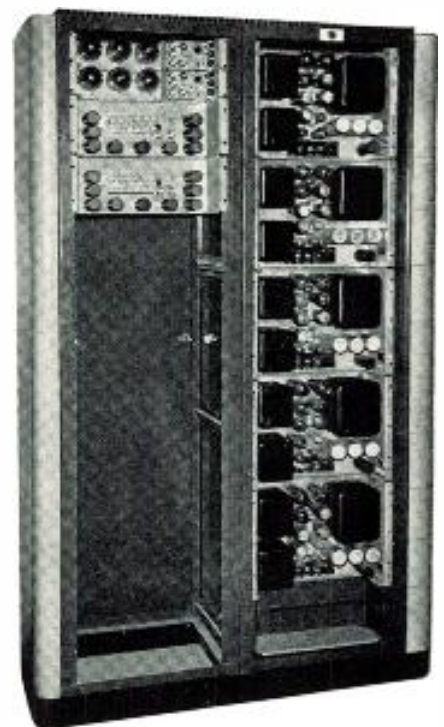



Two WP-15's (mounted at left) are equivalent to five WP-33R's.

# RCA Power Supply

**Up to 70% Reduction in Rack Space  
Priced at Only 45c per Milliampere!**

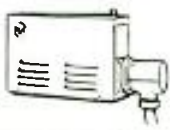
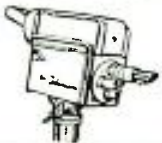
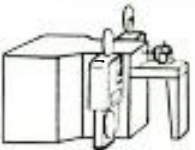
**Check and Compare!** Use this chart to find out your own savings potential.

EQUIPMENT USED	PREVIOUS POWER SUPPLY AND SPACE NEEDED	POWER SUPPLY AND SPACE NOW NEEDED	WP-15 SAVING
 <p><b>TK-21</b> Black and White Film Camera</p>	<p>2 WP-33B's 28"</p>	<p>1 WP-15 10½"</p>	<p>17½"</p>
 <p><b>TK 11/31</b> Black and White Live Camera</p>	<p>2 WP-33B's 1 580D 38½"</p>	<p>1 WP-15 10½"</p>	<p>28"</p>
 <p><b>TK-26</b> Color Film Camera</p>	<p>2 WP-33B's 3 580D's 59½"</p>	<p>2 WP-15's 21"</p>	<p>38½"</p>
 <p><b>TK-41</b> Color Live Camera</p>	<p>3 WP-33B's 2 580D's 63"</p>	<p>2 WP-15's 21"</p>	<p>42"</p>

NOTE: Comparisons are based on the number of WP-33B and 580D power supplies necessary to provide 1500 ma.

High current capacity, small size, light weight and lowest cost per milliampere make the WP-15 excellent in television broadcasting, closed circuit and laboratory applications. Your RCA Broadcast and Television Sales Representative will be glad to supply additional information. IN CANADA: write RCA VICTOR Company Limited, Montreal.



**RADIO CORPORATION of AMERICA**

BROADCAST AND TELEVISION EQUIPMENT • CAMDEN, N. J.

# TOP careers for TOP ENGINEERS

at "FTL"

*One of the world's great centers of electronic research and development*

Top opportunities for achievement and recognition are available at Federal Telecommunication Laboratories, a division of the world-wide International Telephone and Telegraph Corporation.

Here, a man works with the finest facilities . . . with recognized leaders in his field. As a part of FTL's long-range development program he has a dependable road into the future . . . a future of stability, achievement, and commensurate rewards.

Why not write today for your copy of the booklet that tells the fascinating story of FTL . . . the broad and generous employee benefits . . . the many opportunities for permanence and satisfying progress.

**Interesting Assignments in:**

- Radio Communication Systems • Electron Tubes
- Microwave Components • Electronic Countermeasures
- Air Navigation Systems • Missile Guidance
- Transistors and other Semiconductor Devices • Computers
- Antennas • Telephone and Wire Transmission Systems

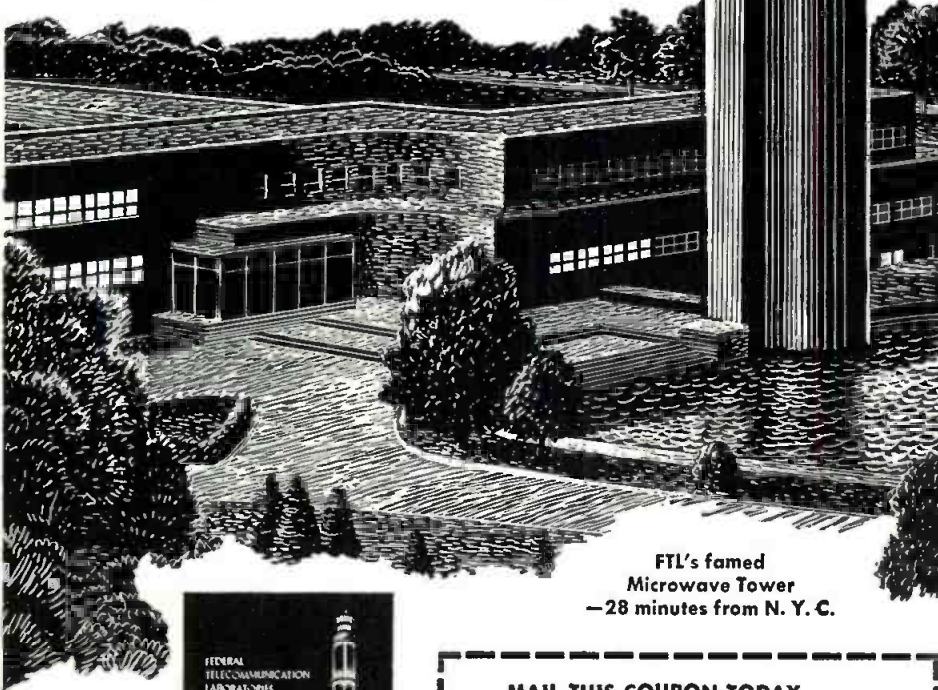

FTL's famed Microwave Tower  
—28 minutes from N. Y. C.



**MAIL THIS COUPON TODAY**

Federal Telecommunication Laboratories  
500 Washington Avenue, Nutley, N. J.  
Please send a copy of your booklet describing opportunities at FTL.

Name \_\_\_\_\_  
Address \_\_\_\_\_  
City \_\_\_\_\_ Zone \_\_\_\_\_ State \_\_\_\_\_



**Federal Telecommunication Laboratories**  
A Division of INTERNATIONAL TELEPHONE AND TELEGRAPH CORPORATION

## Reliability

*(Continued from page 64)*

functions stemming from a common cause which has not been corrected because of inability of maintenance personnel to diagnose the basic trouble—a common problem with complex equipments.

### Long Range Receiver

The third type of military equipment considered in this survey is a single side-band, long-range receiver incorporated in a complete radio receiver unit which, in turn, is part of a permanent installation at an Army radio receiving station.

The equipments from which information was obtained were old and had been in operation for a long period of time; the tubes utilized were all of the standard type. Maintenance follows a scheduled routine which includes three basic types of inspection: (1) a daily routine operation check; (2) a monthly sensitivity test to determine if the performance characteristic of the equipment is up to standard; and (3) a quarterly overhaul which includes a tube-checker test of all tubes and the replacement of weakened or faulty ones. The reliability function for this equipment is presented in Fig. 1.

### Diversity Receiver

The fourth military equipment type is a wide-band diversity receiver, capable of receiving radio teletype signals in the frequency range from .54 mc to 54 mc.

The 29 equipments from which data were obtained were located at an Army radio receiving station and functioned in a dual-diversity receiving system of radio-teletype signals. They had seen long service. The maintenance personnel had become thoroughly familiar with the equipment through experience; the system which they employed was a scheduled periodic maintenance like that used for the long-range receiver previously discussed. Causes of repair of the equipment were dominated by the periodic overhaul and preventive maintenance practices. The reliability function shown in Fig. 1 is applicable only through the first 2000 hours of operation, since observa-

tions beyond that time are clouded by censorship.

### VHF Transmitter-Receiver

One of the three types of airline equipments under consideration is a VHF communications transmitter-receiver. The equipments under surveillance had been long in service and had accumulated many hours of operation, with the result that the components were at various stages of life.

For each of the three airlines, the method used for measuring equipment time was to multiply the number of days on which the equipment was in service by a number of hours of equipment operation per day of flight representing a mean for the fleet of the airline concerned. For all three airlines, the equipment maintenance schedules were generally the same, in that they called for (a) maintenance at the time of equipment malfunction or unsatisfactory performance, and (b) overhaul of equipment at specified intervals. At Airline A, the periodic overhaul took place approximately every 90 days of flight; at Airline B, approximately every 1,000 hours of flight; at Airline C, approximately every 110 days of flight. During the periods for which data are presented, the maintenance personnel of all three airlines were thoroughly familiar with the type of equipment and its repair. Fig. 1 presents the reliability function for the equipments of each airline.

The second type of airline equipment is an ADF receiver incorporating both aural and visual presentation, which is used by the commercial airlines for automatic direction-finding. It operates on 150 to 1750 KC.

In the equipments under surveillance, all of the tube complements were made up of standard-type tubes. Maintenance schedules of the three airlines provided for maintenance when necessary, as well as for a periodic overhaul. The latter was accomplished at Airlines A and D approximately every 90 days of flight, and at Airline C, approximately every 110 days of flight.

Twenty-five percent of all malfunctions observed in the equip-

# Quick and Easy...

## Pilot Light Selection!

from Johnson... the "preferred" line!

Now you can save valuable replacement or specification time with Johnson Panel Indicators. Available in a wide variety of types, Johnson "preferred" units are immediately available at parts distributors throughout the country. Careful standardization, with an eye to replacement as well as interchangeability, makes Johnson Pilot Lights the first choice of leading manufacturers.



### NEW PILOT LIGHT CATALOG!

Write for your copy today. Complete specifications, prices and technical data... everything you need to pick a unit for original equipment manufacture or "in the field" replacement.



Available types include: continuous indication neon types; models for high and low voltage incandescent bulbs; standard or wide angle glass and lucite jewels in clear, red, green, amber, blue or opal. Specials, including those meeting military specifications are also available in production quantities. For full information, write today!



### KNOBS AND DIALS

Dramatic in appearance and functional in design, these rugged knobs and dials are made of tough, scratch resistant black phenolic (To MIL-P-14) with heavy, integral molded brass inserts. Three basic diameters: 1 1/8", 1 3/8" and 2 3/8" — available with matching skirts of black phenolic, calibrated nickel silver finish skirts or chromium dial plates. Write for information, to:



## E. F. Johnson Company

2311 SECOND AVE. S.W. • WASECA, MINNESOTA

CAPACITORS • INDUCTORS • KNOBS • DIALS • SOCKETS • INSULATORS • PLUGS • JACKS • PILOT LIGHTS

# ENGINEERS, *Electronic & Mechanical* PHYSICISTS:

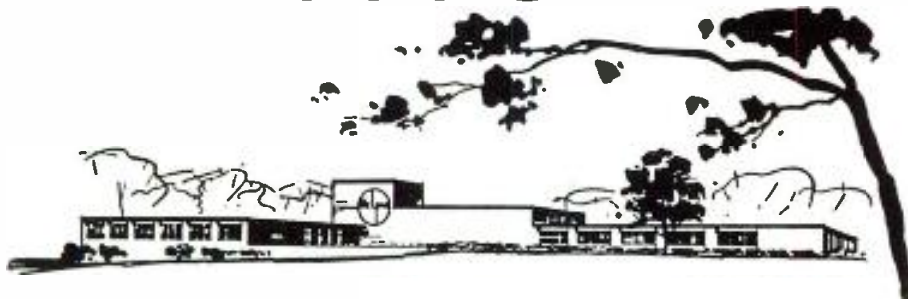

## Choose your location when you join Melpar

Melpar's R & D operations are centered near and in two of the country's more desirable communities: Washington, D. C., Watertown and Boston, Massachusetts, each of which affords engineers the opportunity to enjoy research, cultural and recreational resources well above the average.

Regardless of which locale he selects, the engineer will find that our advancement policies and organizational structure provide opportunities uncommon to the industry as a whole.

Individual performance heads the list of factors which determine progress. Regardless of age, experience or tenure, an engineer is given more complex responsibilities *as soon as he is ready*. There is always room to move ahead at Melpar, because we have doubled in size every 18 months for the past 10 years, with a proportionate increase in top and middle level openings.

Our engineers gain comprehensive experience in all phases of engineering problems. Each is assigned to a project team which is charged with responsibility for *whole* problems, from design concept to completion of prototype.

The engineer will find each of Melpar's laboratories splendidly equipped with an eye to both present and future needs. Fully air-conditioned, each laboratory has recently acquired additional facilities.

We extend financial support to those who intend to pursue advanced study. Fully accredited courses are available at our main laboratories.

Write for *complete* information, indicating geographical preference. Qualified candidates will be invited to visit Melpar laboratories at Company expense.

### Top Level Openings Exist in These Fields:

Network Theory • Systems Evaluation • Microwave Technique • UHF, VHF, or SHF Receivers • Analog Computers • Magnetic Tape Handling • Digital Computers • Radar and Countermeasures • Packaging Electronic Equipment • Pulse Circuitry • Microwave Filters • Flight Simulators • Servo-mechanisms Subminiaturization • Electro-Mechanical Design • Small Mechanisms • Quality Control and Test Engineering

Write: Technical Personnel Representative



## MELPAR Incorporated

A Subsidiary of Westinghouse Air Brake Company

3199 Arlington Boulevard, Falls Church, Virginia

Positions also available at our laboratories in Boston and Watertown, Mass.

ments of Airline A followed a previous malfunction by less than 25 hours. This phenomenon, which is graphically illustrated in Fig. 2, is attributable to correlated malfunctions stemming from one basic difficulty which was not corrected by the maintenance performed at the time of the initial malfunction.

Data for the equipments of Airline C show 17.6 percent of the 290 observations to be of less than 25 hours duration. The exceptionally high proportion of malfunctions occurring within 25 hours from the time of last repair—as reflected in Fig. 3—indicates the presence of related (or incipient) equipment troubles. The reliability functions shown in Fig. 1 for Airlines A and C are based upon only those observations which exceed 25 hours.

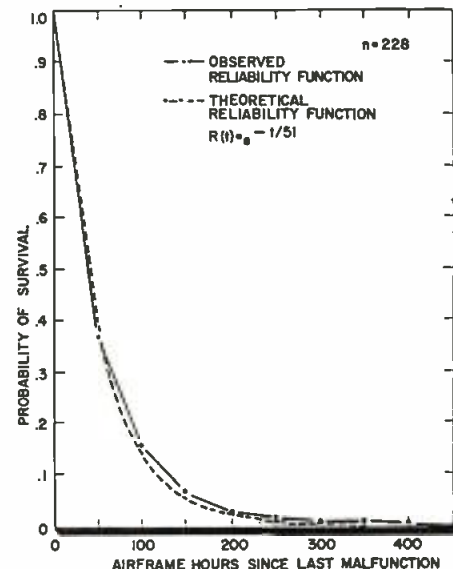

Fig. 5: Based on 228 observations

A VOR navigational receiver (VHF) used for airborne operations is the third type of airline equipment considered in this paper. It is regarded as the most complex of the equipment types with which airline maintenance personnel are concerned. The sets from which data were obtained were relatively new at the start of the period of observation.

Maintenance schedules of the three airlines were similar to the extent that all provided for maintenance to correct equipment malfunctions and for periodic overhaul. Airlines A and D required a periodic overhaul approximately every 90 days of flight; Airline C, approximately every 120 days of

flight. Fig. 1 presents the reliability functions for this equipment. In the case of Airline D, the reliability function should not be applied beyond 900 hours; at that point, the data begin to be obscured by censored observations.

The reliability functions which best describe the reliability of the seven equipment types—presented graphically in Fig. 1—are shown in Table 2 in conjunction with the number of tubes used in each type of equipment. The most startling feature of these data is the great variability in the reliability func-

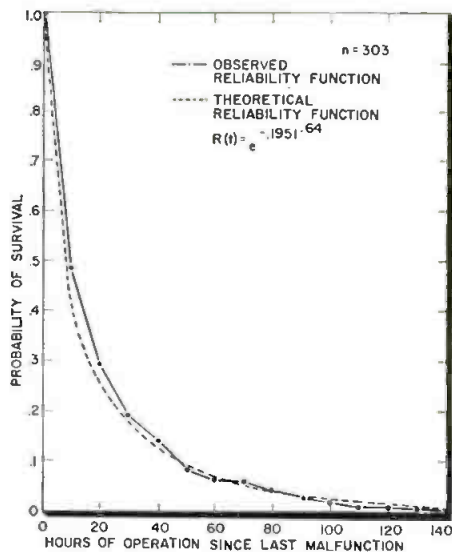

Fig. 6: Probability decreases with time

tions of the several equipment types, but almost as startling is the variability among equipments of the same type used by different airlines.

To understand the basic causes of the variability in the data, it is necessary to consider the six factors which affect reliability. They are:

- (a) performance criteria,
- (b) environment of operation,
- (c) the time duration,
- (d) maintenance and operation,
- (e) equipment design, and
- (f) component parts.

Each of these factors makes some contribution to the differences in equipment reliability which are evident in Fig. 1, but performance criteria and maintenance seem to make the greatest contribution. Here it should be borne in mind that the effects of these factors are confounded, i.e.: inseparable, in the data under analysis. The effects of

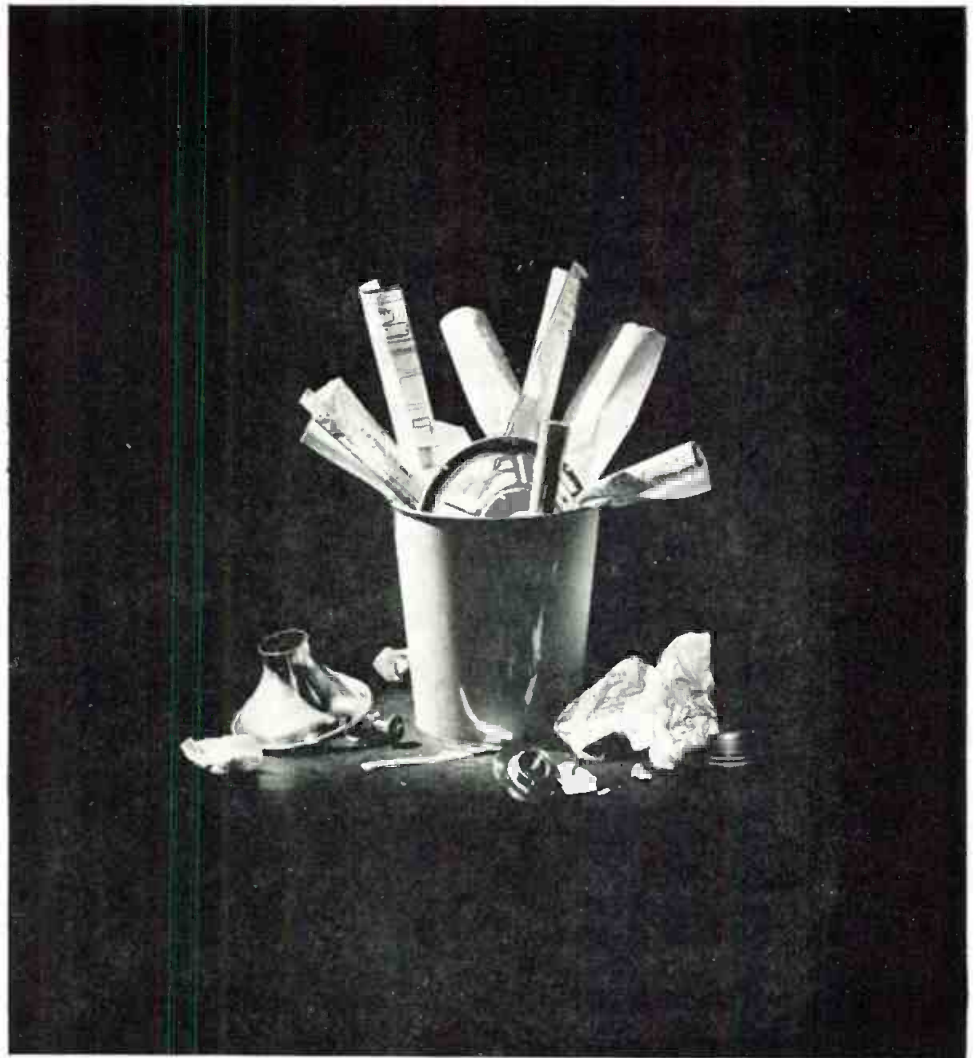

## PROGRESS MAKES WASTE

It takes courage to discard plans and models . . . especially when they involved time and effort. Yet, we at University, do just that!

In our almost fanatic dedication to achieving perfection, we carry the development of new products to the highest degree possible. In this exacting process, things which do not meet our rigid requirements find their way into the waste basket. Actually *this* kind of waste makes *real* progress.

Too often items are rushed onto the market before they are ready. *We* introduce products only when they've conformed to traditionally high University standards (customers have always found them worth waiting for).

This philosophy of business has made us countless friends who look to *University* for the latest developments in loudspeakers. Today—*University* is the leading specialized speaker manufacturer. There are more satisfied users of *University* speakers than of all other speakers combined. *The University label on a speaker is a guarantee of trouble-free operation and performance that conforms to specs.*

That's why *University* "sells on sound." Our engineering department will gladly consult with you on any technical requirement.

UNIVERSITY LOUDSPEAKERS, Inc., 80 So. Kensico Ave., White Plains, N. Y.

LISTEN

*University sounds better*



# TECHNICIANS : ARE YOU NOW QUALIFIED FOR ENGINEERING WORK ?

THEN HERE IS YOUR OPPORTUNITY FOR  
AN ENGINEERING ASSIGNMENT WITH  
THE RCA SERVICE COMPANY !

... And you'll be eligible for educational benefits through RCA's liberal Tuition Refund Plan, a real boost toward that actual engineering education you're interested in! Many other company-paid benefits, of course. Excellent starting salaries • pleasant suburban locations • relocation expenses paid.

Which of these engineering fields do you prefer ?

- Missile Electronics
- Navigational Aids Planning & Design
- Naval Electronic Systems Installations Planning
- Specifications Engineering Writing

---

ARRANGE FOR CONFIDENTIAL INTERVIEW WITH  
REPRESENTATIVES OF RCA ENGINEERING MANAGEMENT  
AT A LOCATION CONVENIENT TO YOU

*Please send complete resume to:*

Mr. John R. Weld  
Employment Manager, Dept. Y-7J  
Radio Corporation of America  
Camden 2, New Jersey



**RCA SERVICE CO., INC.**

some factors are obvious; the effects of others are more subtle and need particular emphasis and attention.

The factor of time is not a problem if elapsed-time meters are used, since all data can be put on a per-unit basis; but where the time is estimated, any comparisons will be affected by the variability of the estimates of time. Time was estimated for six of the equipment types under consideration; elapsed-time meters were used for the seventh.

Equipment design is a factor to be considered when comparisons are made between different types of equipments. In three instances presented in Fig. 1, the same equipment type was used by different airlines, and the variability appears as great among sets of the same type as among different types.

Environment of operation must be regarded as a factor, since stationary, well-ventilated equipment can be expected to show a difference in reliability when compared with an airborne equipment which cannot be ventilated as well.

Component parts should be considered—particularly when, as in the VHF transmitter-receiver and in the VOR receiver, improved tubes have been used in place of standard tubes. Among the users of each of these two equipment types utilizing improved tubes, there is high variability, just as there is among the airlines using the ADF receivers, which contain standard tubes. This may indicate that other factors have a dominating effect on any difference attributable to components.

Maintenance undoubtedly is a contributor to the differences between equipment types. Its influence is demonstrated by the examples of correlated failures in Figs. 2 and 3. However, maintenance is a restricted factor in that it cannot have an effect unless a decision is made to perform maintenance.

The decision as to when to perform maintenance (excepting the scheduled periodic overhaul of equipments) is based upon the criterion of satisfactory performance. Once the decision is made to work on an equipment, replace-



ment of parts is generally based upon criteria other than equipment performance. In many instances, maintenance personnel do not employ a particular level of equipment performance as a guide to determine when to stop working on an equipment. In any given case, this decision may result from some subjective criteria which have never been crystallized into a definite procedure even by the technicians themselves.

Since it appears that much depends on the criteria of satisfactory performance—which, in turn, is basic to the definition of reliability — any comparisons of equipment reliability must take into account the differences in these criteria. The solution to the problem of comparison may be provided by a concept called a "weighting function."<sup>2</sup>

#### *Stability of Probability of Malfunction*

The stability of the probability of malfunction for old (long-in-service) equipments, with which the maintenance personnel are well acquainted, is illustrated in Fig. 6. This chart shows, for the VOR receivers of one airline, the number of malfunctions per 1000 hours of flight in each calendar month from November, 1952 through May, 1954.

At the beginning of this period, these equipments were new not only as equipments, but also as an equipment type to the maintenance personnel. Fig. 4 shows that the number of malfunctions per 1000 hours of flight fluctuated considerably; however, as the personnel became better acquainted with the equipment, and as the age composition of the components shifted, the mean number of malfunctions dropped and leveled off in the neighborhood of 4 malfunctions per 1000 hours of flight. During the 1-year period after the initial 6 months, the number of malfunctions per 1000 hours of flight remained relatively stable.

#### *Conclusions*

1. As shown in Table 2, there are substantial variations in reliability both among equipments of the same type used by different

# Quality-Minded Engineers Specify CONRAC MONITORS

Conrac Monitors are designed for continuous, trouble-free service. Engineered to prevent costly repair bills, down time and to save valuable man hours, Conrac Monitors are found wherever exact monitoring is needed. You'll see them in use at all of the major networks and a majority of stations.

**Color Monitor**—Conrac's CH 21 is a self-contained picture monitor that can be operated from NTSC encoded color video signals or from simultaneous red, green and blue video signals. It employs a three-gun tri-color picture tube—type 21AXP22. All operating and set up controls, as well as a test point for Y, I, Q, R, G and B, are accessible from the front.

Schematic, engineering data and specifications furnished on request.

**Monochrome Monitors**—Conrac manufactures three monochrome monitors: the CB 17-A, a professional monitor of the highest quality and the CF and CG Series general purpose monitors.

The CB 17-A, designed for control room and on-stage use, employs a 17" aluminized rectangular picture tube. It may be rack mounted in a standard 19" relay rack (No. CB 17A/R), or furnished in utility heavy gauge steel cabinet with carrying handles (No. CB 17A/C).

The CF and CG Series of video monitors are general purpose monitors intended for broadcast or industrial use. They present bright, high definition pictures in continuous operation with a minimum of maintenance.

The CF Series uses a 70° deflection system for both 17" and 21" kinescopes. The CG Series has a 90° deflection system for 24" and 27" kinescopes. All chassis are supplied with picture tube. The CF 17 is available for 19" relay rack mounting, in a utility cabinet or as a chassis. Model numbers are as follows:

- CF 17-N CF chassis with 17" picture tube.
- CF 17-R CF chassis with 17" picture tube in mounting for standard 19" relay rack.
- CF 17-C CF chassis with 17" picture tube in steel housing equipped with carrying handles.
- CF 21-N CF chassis with 21" picture tube.
- CF 21-C CF chassis with 21" picture tube in steel housing equipped with carrying handles.
- CG 24-N CG chassis with 24" picture tube.
- CG 27-N CG chassis with 27" picture tube.

Schematics, engineering data and specifications available upon request.

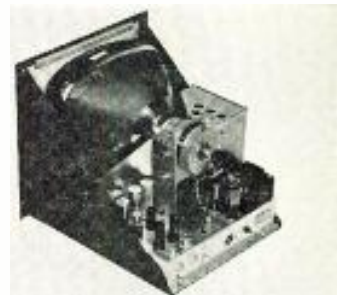

#### **Audio-Video Tuner**

The AV-12A is designed especially for re-broadcast applications—both color and monochrome. It tunes any 12 channels. The AV-12A is ideal for unattended operation because any one channel may be crystal controlled, which prevents drift even under extreme conditions. Schematics, engineering data and specifications furnished on request.

# CONRAC, INC.

SINCE 1939

GLENDORA, CALIFORNIA

# New!



## Miniature Precision Rotary Selector Switch

Here's the exceptionally positive action only a multi-leaf wiper, button-contact switch can offer—now in the smallest sizes consistent with the quality and dependability required for today's compact, precision equipment:

- Features solid silver alloy button-type contacts, collector rings, and spring suspension leaf-type wiper arms for low contact resistance—0.002 ohms.
- Integral lugs and contacts staked in glass-fibre Silicone-laminate stators. Lugs cannot turn or loosen. Stator material will not carbonize even if severely overheated. Terminations can be made mechanically secure *before* soldering.
- Molded Melamine rotor covering entire contact circle provides high voltage breakdown between decks.
- Outstanding moisture, humidity, and salt-spray resistance through use of passivated stainless steel, nickel-plated brass, Steatite, Nylon, molded Melamine, and Silicone-base glass-fibre laminate parts.
- Adjustable stainless steel stops—easily positioned.
- Uniformly high quality—cost-reducing mechanized production and assembly.
- Small size—only 1 3/4" square. 1" deep for first deck, only 5/8" deep for additional decks.

### CONDENSED SPECIFICATIONS

#### Shallcross "Miniature Series"

- POLES PER DECK—1 to 4.
- INDEXING (detent)—11 1/4°, 15°, 22 1/2°, 30°.
- MOUNTING—Single or 2-hole, with non-turn tang.
- OPERATING VOLTAGE—to 1500 volts.
- BREAKDOWN VOLTAGE—to 4000 volts.
- BREAKING CURRENT—5 amp @ 125 V. ac.
- CARRYING CURRENT—15 amp.

# Shallcross

SHALLCROSS MANUFACTURING COMPANY, 518 Pusey Avenue, Collingdale, Pa.

airlines and among equipments of different types. The differences in the data presented for equipments of the same type indicate the importance of factors other than equipment design and component quality. The types of precautionary maintenance and periodic overhaul must be considered in order to interpret reliability data.

2. Additional information is needed to permit a clearer understanding of the patterns for time-between-equipment-failures.

3. Complex equipments are subject to correlated malfunctions because of the inability of the maintenance personnel to identify the true causes of trouble.

4. Equipments seem to attain a stability of the probability of malfunction at a relatively early stage of life, and thereafter show an exponential distribution for time-between-malfunctions. If the equipments are new or if maintenance is inadequate, or if both of these factors are present, the probability of malfunction will fluctuate and a true exponential distribution may never be realized.

5. In order to compare and interpret reliabilities of different equipment types, it is necessary either to adopt a common definition of satisfactory performance, or—if the satisfactory-performance criteria are different — to introduce weighting functions.

#### References

- <sup>1</sup> Aeronautical Radio, Inc., Inter-base Report No. 1, A Preliminary Study of Equipment Reliability, March 15, 1955.
- <sup>2</sup> Knight, C. R., Jervis, E. R., and Herd, G. R., "Terms of Interest in the Study of Reliability," Transactions of IRE, PGQC-5, April 1955, and ARINC Monograph No. 2, May 25, 1955.
- <sup>3</sup> Herd, G. R., "Failure Rates," ARINC Monograph No. 2, May 25, 1955.

## NARTB Aids in Hurricane Alerts

Cooperation is being given the U. S. Weather Bureau's Warning Service by the NARTB to help get advance information to radio and TV broadcasters concerning the Bureau's Emergency Warning.

The Weather Bureau plans to provide background material, in areas where hurricanes may be expected this Fall, explaining how hurricane forecasts are prepared, cautions to be observed in hurricane areas, and definitions of terms used in hurricane forecasts.

## 'Bandwidth'

(Continued from page 75)

across the detector load resistor the input capacity of the oscilloscope and its connecting cable must be added to the detector circuit capacitance when computing the time constant.

For these tests, a 5  $\mu$ sec duration pulse with repetition rate of 1000 was used. The pulse shape (impulse response) observed on the oscilloscope at the output of the second detector is shown in Fig. 4, plotted from data in Table 2. The vertical and horizontal divisions have the same linear length and the oscilloscope horizontal amplifier gain was adjusted so the time base equaled 25  $\mu$ sec per division. The effective width of the pulse is the width of a rectangle of the same height and area as the impulse response envelope. The effective pulse duration is 5.3 divisions  $\times$  25  $\times 10^{-6}$  or 132.5  $\times 10^{-6}$  sec. The reciprocal of the pulse width in seconds is the effective impulse bandwidth in cycles.

$$\frac{1}{132.5 \times 10^{-6}} = 7550 \text{ cycles}$$

The several bandwidths for the example discussed, taken from curves of Figs. 2, 3, and 4 are:

3 db bandwidth .....4.8 KC  
 3.3 db bandwidth .....5.128 KC  
 Effective Random Noise  
 Bandwidth .....5.128 KC  
 6 db bandwidth .....6.9 KC  
 Effective Impulse Bandwidth .....7.55 KC

In a tunable bandpass amplifier such as a receiver or RIFI meter, the bandwidth usually varies over the frequency range under the influence of the tracking and of the Q of the r-f circuits. An enormous amount of effort would be involved in deriving the effective bandwidth data as outlined above at many points across the frequency range. Instead, an assumption is made that the shape of the voltage response curve and the impulse response curve remain approximately the same. Then, just one of the bandwidth types is measured across the range and the others determined from simple ratios derived

# engineers . . . physicists NEW opportunities at Motorola in Riverside CALIFORNIA



## WORK IN A VACATIONLAND (your family will love year-round outdoor living) WHILE YOU ADVANCE YOUR CAREER

This new Motorola Research Laboratory is expanding—creating outstanding career opportunities for engineers, working on military research and development principally related to guided missiles and weapons systems. You'll enjoy working in air conditioned comfort and well instrumented laboratories . . . with liberal employee benefits, including an attractive profit sharing plan.

Here in relaxing Riverside you'll find planned communities, with modern shopping centers, advanced schools, and many fine buys in homes available (moving and travelling expenses paid for family). Living will be easier and more fun in Riverside, where there's more room to grow.

### MOTOROLA IN RIVERSIDE HAS OPENINGS FOR: Electronic Engineers, Mechanical Engineers, Physicists and Mathematicians.

#### Research Laboratory

- Military Operation Analysis
- Analog Computer Flight Simulation
- Digital Computer Analysis
- Digital Computer Design
- Dynamics Analysis
- Microwave Systems
- Missile Systems
- Circuit Design
- Servo Mechanisms
- Aerophysics

for above positions write to:

Mr. C. Koziol  
 Dept. C  
 8330 Indiana Ave., Riverside, Calif.

### Excellent opportunities in PHOENIX and CHICAGO

#### OPENINGS IN PHOENIX

Electronic Engineers, Mechanical Engineers,  
 Physicists, Metallurgists & Chemists.

#### RESEARCH LABORATORY

Microwave Antennas  
 Pulse and Video Circuitry  
 Radar Systems Design  
 Circuit Design  
 Electro-Mechanical Devices  
 Systems Test  
 Transistor Applications

For above positions write:

Mr. C. Coulter  
 Dept. C  
 3102 N. 56th St.,  
 Phoenix, Ariz.

#### SEMI-CONDUCTOR DIVISION

Transistor Application  
 Transistor Devices  
 Solid State Physics  
 Physical Chemistry  
 Metallurgical Engineering  
 Production Engineering

For above positions write:

Mr. V. Sorenson  
 Dept. C  
 5005 E. McDowell Rd.,  
 Phoenix, Ariz.

#### OPENINGS IN CHICAGO

Challenging positions in Two-Way  
 Communications, Microwave,  
 Radar and Military equipment,  
 Television (Color), Radio Engineer-  
 ing and Field Engineering.

For above positions write:

Mr. L. B. Wrenn  
 Dept. C  
 4501 Augusta Blvd.  
 Chicago 51, Ill.



# MOTOROLA

# missile engineers

CONTROL GUIDANCE SERVO COMPUTERS RECORDING OPTICAL RELIABILITY ELECTRO-MECHANICAL TELEMETERING

With 16 years leadership in the vital field of missile research and development, Northrop Aircraft offers unusual opportunities for advancement in the categories listed below. Where better could you be, and grow, than with a pioneer? There's an interesting position for you in one of the following groups:

**Guidance and Controls**, encompassing research and development of advance automatic guidance and flight control systems for both missiles and piloted aircraft. Specific areas of development include: radio and radar systems, flight control systems, inertial guidance systems, instrument servo systems, digital computer and magnetic tape recording systems, airborne analog computer systems, optical and mechanical systems, and systems test and analyzer equipment. Within these areas activities include: original circuit development, electronic and electro-mechanical design, laboratory and field evaluation of systems under development, and reliability analysis both at a system and component level.

**Flight Test Engineering Section**, which plans the missile test programs and establishes test data requirements in support of the programs. The data requirements are predicated on the test information required by the Engineering analytical and design groups to develop and demonstrate the final missile design, and are the basis from which the instrumentation requirements are formulated.

The analysis work performed consists of aerodynamic, missile systems, dynamics, flight control, propulsion and guidance evaluation. The Flight Test Engineering Section is also responsible for the field test program of the ground support equipment required for the missile.

**Flight Test Instrumentation Section**, which includes a Systems Engineering Group responsible for the system design concept; a Development Laboratory where electronic and electro-mechanical systems and components are developed; an Instrumentation Design Group for the detail design of test instrumentation components and systems; a Mechanic Laboratory where the instrumentation hardware is fabricated; and a Calibration and Test Group where the various instrumentation items and systems are calibrated and tested.

There are now a number of openings available for engineers in each of these groups at all experience levels.

If you qualify for any of these challenging opportunities, we invite you to contact Engineering Industrial Relations, Plant 2, Gate 3B, Broadway & Prairie, Northrop Aircraft, Inc., Hawthorne, California; or write Manager of Engineering Industrial Relations, Northrop Aircraft, Inc., 1024 East Broadway, Hawthorne, Calif.

## NORTHROP AIRCRAFT, INC.

PIONEERS IN ALL WEATHER AND PILOTLESS FLIGHT

Producers of Scorpion F-89 Long-Range Interceptors and Snark SM-62 Intercontinental Missiles.



5-A-65

from the more comprehensive data taken at one frequency. For example, if the 6 db bandwidth is known, then, for the above example:

$$\text{Impulse BW in KC} = 6 \text{ db BW} \times K_1$$

$$\text{where } K_1 = \frac{7.55 \text{ KC}}{6.9 \text{ KC}} = 1.093$$

$$\text{Random noise BW in KC} = 6 \text{ db BW} \times K_2$$

$$\text{where } K_2 = \frac{5.128 \text{ KC}}{6.9 \text{ KC}} = .743$$

Quite often only "effective random noise bandwidth" data is supplied with RI-FI equipment. The

**Table 2—Pulse Shape Data**

Vertical Oscilloscope Divisions	Horizontal Oscilloscope Divisions
0	0
1.0	0.1
2.0	0.3
4.0	0.8
12	1.9
18	2.8
20	3.7
17	5.0
12	6.0
8.0	7.0
4.0	8.5
2.0	10.0
0.8	12.0
0.1	15.0
0	17.0

impulse bandwidth can be obtained by multiplying by a similar factor, as in the above example:

$$\frac{\text{Impulse BW}}{\text{Random Noise BW}} = \frac{7.55 \text{ KC}}{5.128 \text{ KC}} = 1.47$$

Bandwidth ratios can vary considerably with different types of circuits and equipments. Even small changes occur between two models of the same equipment or at the extremes in the tuneable frequency range of the same model. As the voltage response curve changes toward steeper skirts and a flatter top, the various bandwidths approach each other in value.

### REFERENCES

1. "Investigations of the Measurement of Noise," Report No. 25, July 15, 1952, and Report No. 35, January 15, 1955, University of Pennsylvania.
2. "Noise Characteristics," London, V. D., Proc. IRE, 25, 1514-1521, November, 1936.
3. "Effective and Circuit Bandwidths," Kessler, W. J., AIEE Proc., p. 590, July, 1949.

## Radiation Effects

(Continued from page 57)

(5) If a component survives a dose comprised of gamma, fast neutron, and slow neutron doses, it will survive one of the constituent doses alone, i.e., radiation doses do not nullify one another.

Thermal neutrons are not important in producing damage<sup>1</sup>. Transmutations produced by thermal neutron capture are not important even in transistors, which are very sensitive to impurities. The capture gamma radiation is not important since most of the capture gammas are of the order of 8 mev and escape from a small collection of components. Decay gammas are likewise relatively unimportant. Beta decay may contribute significantly to damage in high thermal neutron fields, for the betas, being rather easily stopped, lose all their energy in solids within a fraction of an inch of the parent nuclei.

Components whose operation depends on an ordered crystalline state are likely to suffer most from fast neutron bombardment. In this class would come transistors, germanium and silicon diodes, photoconducting devices. Fast and epithermal neutrons can derange the lattice structure by imparting enough energy to atoms to move them into interstitial positions. Gammas, on the other hand, are poor at transferring momentum to atoms, as are the secondary electrons produced by photoelectric, Compton recoil, and pair production processes.

### Wires and Connecting Cables

As a rule, the resistivity of insulators falls in a radiation field. In a field of  $10^{11}$  gammas/cm<sup>2</sup> sec, the resistance between 5 ft. of copper wire, covered with 1/32 in. of insulation, and a metal drum on which the wire was wound was measured. The resistance dropped immediately to  $10^{11}$  ohms for polyethylene insulation and  $2 \times 10^9$  ohms for polyvinyl chloride. The initial readings were of the order of  $10^{12}$  ohms for polyethylene and  $7 \times 10^{10}$  for polyvinyl chloride. It is not unusual for an insulator to change resistivity by a factor of



**Completely checks both transmitter and receiver operations in the field or on the production line**

\* Available for Ku, C, or X-Band Frequencies

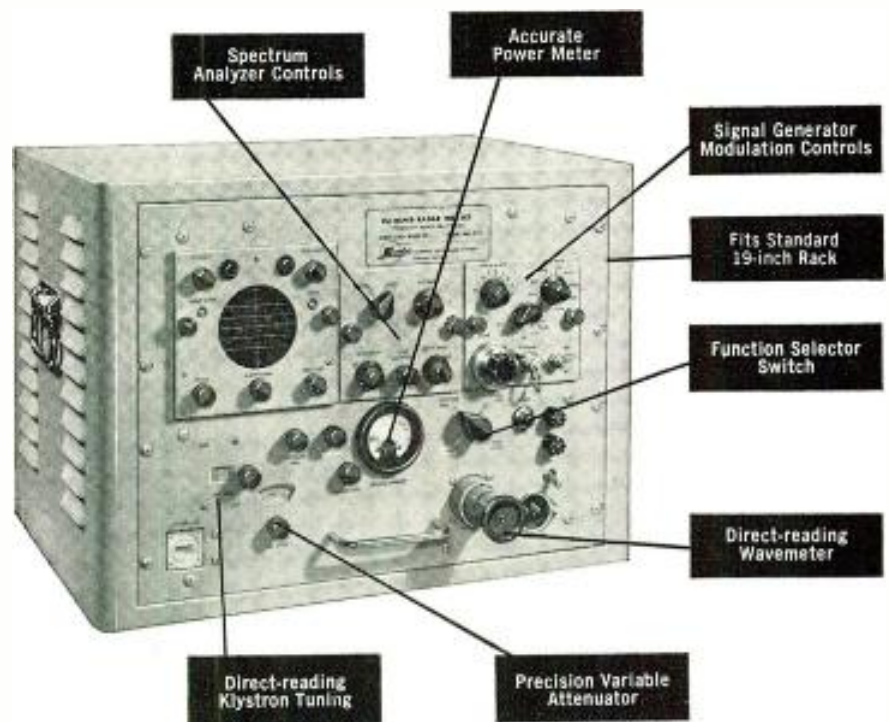

## KEARFOTT UNIVERSAL RADAR TEST SETS

A complete radar testing facility — includes Spectrum Analyzer, accurate Power Monitor, direct-reading Frequency Meter, versatile Signal Generators complete with variable pulse, saw tooth and square wave modulation. New improved design reduces testing time with increased accuracy. Operates on 60, 400 or 1200 cycles power.

Write for Bulletin W-104 for detailed information on the versatile Kearfott Test Sets . . . available for Ku, C or X-Band Frequencies.

See Kearfott for PRECISION NAVIGATION INSTRUMENTS and Servo Systems Components.

Custom Microwave Components to your blueprints or ours. Send today for information on Kearfott Microwave Equipment.



SALES OFFICES  
 EASTERN OFFICE 1378 Main Ave. Clifton, N. J.  
 MIDWEST OFFICE 188 W. Randolph St. Chicago, Ill.  
 SOUTH CENTRAL OFFICE 6115 Denton Drive Dallas, Texas

PORTABLE <sup>TM</sup>  
**TRANSISTOMETER**  
 (COMPLETELY TRANSISTORIZED CIRCUIT)



MODEL = 101

SCALES: calibration, high beta, collector cut-off current, low beta.

..... sequence prevents meter damage—permits beta and  $I_{CO}$  measurements without removal of unit under test.

**F E A T U R E S**

- Measures characteristics of both NPN and PNP junction transistors with accuracy of  $\pm 5\%$
- Measures beta 0.50 and 0.250
- Measures collector cut-off currents ( $I_{CO}$ ) 0.50 microamperes
- All functions are controlled by a single switch
- Useful for laboratory and development requirements as well as production testing, incoming inspection, and servicing
- Permits rapid testing with one switch setting for units having like polarity
- Battery operation, (very low current drain) protects transistors against damage from surges and provides complete portability (Wt. less than 6 lbs.)
- Eyeleted and electro-tin plated etched circuit board for mounting and wiring of components (including meter connections)
- All components of the highest quality and latest design
- Designed for maximum ease of assembly, wiring, and operation
- All components guaranteed for one year if used in accordance with instructions (meter and batteries 90 days under normal usage)
- Complies with the latest requirements for transistor testing

*Beta of transistor under test is compared with a known attenuation factor using a self contained signal source and linear amplifier. Potentials and biases for all measurements based on established standards.*

**ORDER BY MAIL \$67.50**

(POSTPAID IN U.S.)

... Includes transistor reference material and complete simplified assembly and operating instructions

FREE BROCHURE AVAILABLE

**DURSON** COMPANY

Dept. C-1  
 10416 National Blvd. Los Angeles 34, Calif.

$10^3$  in intense radiation fields.

The entire air space around an electronic system in a radiation field behaves much as an ionization chamber and currents of the order of milli-microamperes can easily flow between bare wires with a few volts difference of potential. Small nuclear batteries are effectively produced by thermal-neutron-induced beta decay in copper wire, and theoretical potentials of several volts are available in high impedance circuits<sup>2</sup>. Betas escaping from the wire through the insulation tend to leave the wire charged positively with respect to the surroundings. Currents of the order of milli-microamperes are expected from theoretical considerations.

For most applications, the principal problem with wires is insulation breakdown after continued irradiation, and the small currents and voltages associated with the irradiation are important only if circuit impedances of the order of 100 megohms are needed. Consider, for example, the problem of three wires, each 5 ft. long, connected to the plate, grid, and cathode of a triode. If the leakage resistance between the plate and grid wires is  $2 \times 10^9$  ohms, which is quite reasonable for polyvinyl chloride wires in a field of  $10^{12}$  gammas/cm<sup>2</sup> sec, and if  $10^7$  ohms is between grid and cathode, 0.5% of the plate voltage will appear on the grid.

**Vacuum Tubes**

Vacuum tubes are generally considered to be rather resistant to radiation fields, although there appear to be some exceptions to the rule. Gamma radiation can produce in vacuum tubes a number of stray electrons. In a field of  $10^8$  R/hr the usual photo-electric effects, Compton collisions, and pair production phenomena can produce electron current densities of the order of  $10^{-9}$  amp/cm<sup>2</sup> in the tube, and the operation of the tube is impaired if currents of this order of magnitude are important. There is naturally the random noise associated with these small currents.

Irradiation is known to release gas in many materials. Gas evolution from glass envelopes could lead to the usual troubles associated with a gassy tube. Seals could

deteriorate under irradiation, allowing the tube to become gassy, and sensitive cathode surfaces could be damaged by the cold working effects produced by continued neutron and gamma bombardment. The resistance to shock could be markedly reduced without harming the electronic operation extensively.

Various tubes were irradiated in the CP-5 reactor to an integrated thermal flux of  $10^{18}$  NVT (roughly  $10^8$  rads) during a time interval of one week. This is a more severe environment than would be expected in most power applications. Some of the tube types tested were 6J5 triodes, 6BQ6, 6AK5, and 6AU6 pentodes, a 5U4 rectifier, and an OBS gas regulator. All of these tubes operated in some manner to the end of the test. Preliminary tests on other tube types indicated early failures in the same kind of environment.

**Resistors**

Resistors vary widely in the ability to withstand radiation. Power resistors showed practically no change on being irradiated a week in the CP-5 reactor at Argonne National Laboratory. As a rule, the larger the resistance the greater the relative change resulting from irradiation. Any parallel paths offered by ionization will of course effectively change the resistance in a circuit, and resistances of the order of  $10^9$  ohms may be troublesome for this reason.

**Capacitors**

Capacitors, like resistors, are made of a variety of materials and present a varied problem in the radiation field. Electrolytics deteriorate rapidly and may explode. Oil-filled capacitors suffer from gas production in the oil, and may split, dripping oil over the remainder of the components in the system. Ceramic and mica capacitors are resistant to radiation but may show an increase in the dissipation factor as the radiation level is increased.

**Other Components**

Transistors and germanium and silicon rectifiers are unusually susceptible to fast neutron irradiation. A fast neutron may be as effective as a thousand gammas in displac-

Speed  
Experimental  
Work with

a \$17.00  
value only  
**\$14<sup>95</sup>**



You get instant response—full soldering heat, 250 watts—in just 5 seconds from Weller Soldering Gun, Model 8250A. Triggermatic control for quick-as-a-flash "on-off" operation—no need to unplug between jobs. No waiting or tedious assembly. Always ready for a wide range of research, testing, design and development work in laboratories, model shops and industrial plants.

**KIT GIVES EXTRA VALUE**—Kit (8250AK) contains streamlined Soldering Gun with balanced pistol grip, dual spotlights; ample supply of famous Kester Solder, general purpose type; sturdy metal carrying case; tip for cutting plastic materials; smoothing tip for heat-sealing, joining thermo-plastics, etc.; 2 valuable instruction booklets.

**FULLY GUARANTEED FOR 1 YEAR**—Order from your Electronic Parts Distributor or write for catalog bulletin.

*Weller*

**ELECTRIC CORPORATION**  
601 Stone's Crossing Rd., Easton, Pa.

## Mobile Radio Sales Engineer

Bendix Radio has a few choice territories open for qualified Sales Engineers. Must have all around proven experience and ability to meet and sell top management. Salary commensurate with qualifications plus liberal company benefits. Send complete resume to

Mr. A. E. Jones, Manager  
Mobile Products Sales  
Bendix Radio  
8633 Loch Raven Blvd.  
Baltimore 4, Maryland



→ **TELEFUNKEN**

→ **INDISPUTABLY...**

**the world's best  
professional  
microphones**

**\$390.00**

Ask about the  
new C.M.-51  
(only 4 1/2" high)  
Write for complete  
details →

**AMERICAN  
ELITE. INC.**

Dept. TT  
7 Park Ave.  
New York 16, N. Y.



# TRACER-GUIDED DRILLING

100 HOLES P. M.

WITH NEW HERMES *Engravo* graph

for  
printed  
circuit  
plates

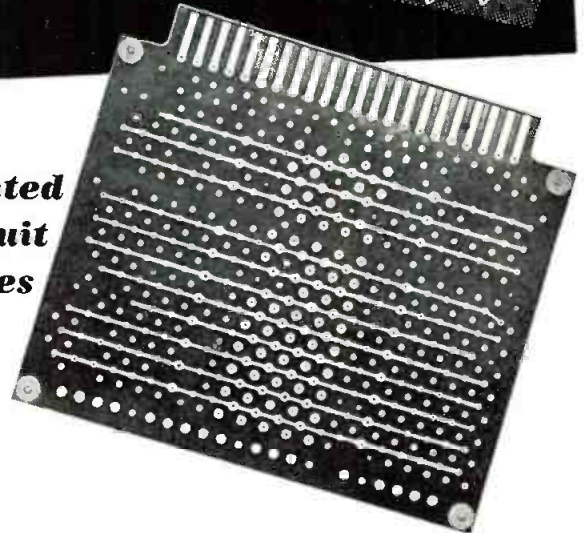

- Pantograph reproduces drill pattern from template in any reduction ratio — assuring high accuracy.
- Allows drilling and routing of different size holes in one operation without changing tools.
- Pneumatic attachment with adjustable feed gives high speed production.

Also for tracer-guided  
**ENGRAVING • PROFILING  
GRADUATING**

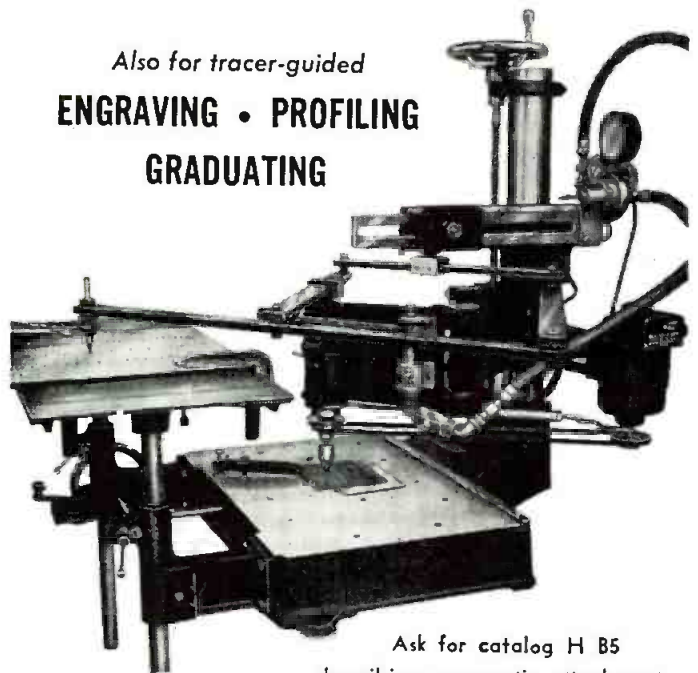

Ask for catalog H B5  
describing pneumatic attachment.

**new hermes**  
**ENGRAVING MACHINE CORP.**  
13-19 University Place, New York 3, N.Y.

# 3 Relay Types by FILTERS, Inc.

Now a Leader in the  
Sub-Miniature Relay Field

**NEW—DPDT SUB-MINIATURE**  
Actual Size

Engineered for critical  
Airborne and Guided  
Missile Applications

TYPE: M26FC6

CONTACT RATING:  
2 A. Res. at 26.5 vdc  
or 115 vac  
Dia.: .635  
Mtg. Ctrs.: .875  
Shock: 50 G  
Vibration: 10 G  
at 5 to 2000 cps  
Amb. Temp.: -65°C to +125°C.  
Weight: 1.3 oz.



**NEW-LATCHING SUB-MINIATURE**  
Magnetically Held—**6PDT**  
Electrically Reset Actual Size

UNBELIEVABLY SMALL  
FOR A  
LATCHING  
RELAY

TYPE: L26F18

CONTACT RATING:  
3 A. Res. at 26.5  
vdc or 115 vac  
Mtg. Ctrs.:  
1.406  
Shock: 50 G  
Vib.: 10 G at 5  
to 500 cps  
Amb. Temp.: -65°C  
to +125°C  
(Also available in  
2PDT and 4PDT)  
Weight: 3.3 oz.



**SUB-MINIATURE 4PDT**  
Actual Size

The Smallest  
Hermetically-Sealed  
4PDT Relay  
Available Today

TYPE: 26SR12

Mtg. Ctrs.:  
1.406  
Shock: 50 G  
Vib.: 10 G at  
5 to 500 cps  
Amb. Temp.: -65°C  
to +125°C  
Weight: 2.6 oz.



MIL SPECIFICATIONS  
All Made to MIL-R-5757B and MIL-R-25018  
(USAF)

DRY CIRCUIT RELAYS AVAILABLE  
IN PRODUCTION QUANTITIES

Write Today For New Catalog Listing  
Sales & Engineering Office Nearest You

## FILTERS, INC.

30 Sagamore Hill Drive  
Port Washington, L. I., N. Y.

Canadian Office:  
MJS ELECTRONIC SALES, LTD.  
P.O. Box 240, Ajax, Ontario  
Tel.: Empire 8-3806

Export Office:  
MAURICE I. PARISIERS & CO.  
1860 Broadway, New York 23, N. Y.  
Cable Address:  
MIPARISIERS NEW YORK

ing atoms in the crystal lattice. Atomic displacement appears to be the principal mechanism of damage in solid state devices, which show failures at irradiations far below that required to damage the usual resistor or vacuum tube.

Radiation damage to electronic components is a function of many variables other than the radiation field. At present, there is very little knowledge available, but several groups, such as Admiral Corp., are at present embarking on a test program which should do much to define the problem and point the way to the development of electronic components for the nuclear age.

The work described in this article was performed under the supervision of the Electronic Components Laboratory, WADC, Patterson AFB, Ohio.

<sup>1</sup>E. R. Pfaff and R. D. Shelton, Admiral Corp., The Effect of Nuclear Radiation on Electronic Components, Scientific Report No. 2, p. 74, January 1, 1956.

<sup>2</sup>E. R. Pfaff and R. D. Shelton, Admiral Corp., The Effect of Nuclear Radiation on Electronic Components, Scientific Report No. 1, p. 44, October 10, 1955.

## Phototube Helps Check Subterranean Areas

Capable of multiplying a signal several hundred thousand times, a ¾-in. multiplier tube has been developed by Allen B. Du Mont Labs., Clifton, N. J., for reaching subterranean areas to probe for vital information in oil field and uranium surveys and other investigations where structural properties of sub-surface strata must be identified. Rated average gain for this 10-stage tube is 300,000 at 105 volts per stage.

Freedom from leakage allows the tube (Du Mont Type K1382) to be submerged deep into the earth where humidity may be exceedingly high. Uses include: scintillation counter work; spectrometry; and certain medical probing procedures.

## TV SHORTS

New York and Los Angeles offer excellent sales possibilities for a second TV set. Both cities have seven TV stations.

Approximately 50 per cent of telecast revenue goes to the networks.

About 250 studios are making films for TV.

**CONALERT  
MONITORS  
CONELRAD**



- Fail-Safe • 5 Channels
- Low Cost • Silent Monitoring
- FCDA Listed
- Meets FCC Requirements

Effective as of Jan. 2nd, 1957—

**MANDATORY FOR OPERATORS  
OF ALL RADIO TRANSMITTERS!**



For complete information write:  
**ENGINEERING CORP.**

2982 Middlefield Road  
Palo Alto, California

## NEW PHOTOTRANSISTOR

General Transistor Corp., Richmond Hill, N. Y., manufacturers of transistors and other semiconductor products, announced the production of a new germanium P-N-P alloyed junction 3-lead phototransistor. Known as type GT-66, it is a light-sensitive photocell intended for use in circuits employing AC amplification for modulated light. It may also be used as a two-lead device with DC (unmodulated) light. Even though it is a miniature it is capable of performance at a level sufficient to operate a relay.

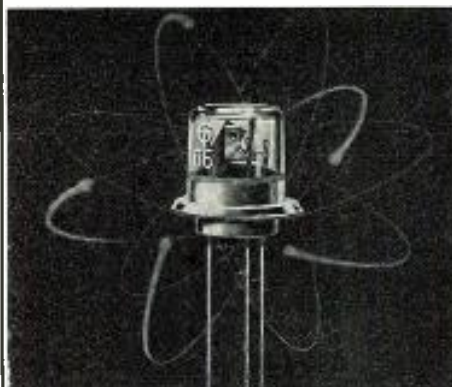

Some possible applications include: automobile headlight dimmers, tape and punch card reading, optical sound play-back, liquid level control, TV receiver automatic brilliance control, industrial safety devices, automatic door openers and a host of others. It is also sensitive to relative position of the light source making it useful in positioning controls. For detailed specifications write to the manufacturer requesting Bulletin GT-66.



## Transformers

(Continued from page 72)

which are multiplied together such as  $(x_1/x_{SH}) (x_K/x_{SH})$  and terms of similar nature are ignored compared to terms such as  $x_1/R_{SH}$ , etc. These approximations are borne out by past practice.

To simplify the solution, the following nomenclature will be used

$Z_1 = r_1 + jx_1$ ;  $Z_K = r_K + jx_K$ ;  $Z_L = R_L + jX_L$ ;  $Z_{SH} = R_{SH}$  paralleled by  $X_{SH}$ ;  $a = np/ns$ ;  $b = (a - 1)$ ;  $E_{mf}$  = the voltage across shunt impedance  $R_{SH}$  and  $X_{SH}$ .

The ratio of  $\frac{E_{mf}}{E_o} = \frac{a + bZ_K/Z_L}{1 + aZ_K/Z_{SH}}$ ; in

conformity with the minor dissertation on division of numbers with an increment

$$\frac{E_{mf}}{E_o} = a \left( 1 + \frac{bZ_K}{aZ_L} - \frac{aZ_K}{Z_{SH}} \right)$$

By following elementary principles of circuit analysis, the ratio between  $E_{in}/E_o$  is obtained.

$$\begin{aligned} \frac{E_{in}}{E_o} = & a \left( 1 + \frac{bZ_K}{aZ_L} - \frac{aZ_K}{Z_{SH}} \right) \\ & + \frac{Z_1 - bZ_K}{aZ_L} + \frac{a(Z_1 + Z_K)}{Z_{SH}} \\ & + \frac{bZ_K(Z_1 + Z_K)}{Z_L Z_{SH}} - \frac{a^2 Z_K(Z_1 + Z_K)}{Z_{SH}^2} \end{aligned}$$

The last two terms of the preceding equation represents the difference between two terms, each consisting of a product of increments and consequently of negligible importance. To a fine approximation, the relationship between input and output voltage is:

$$\frac{E_{in}}{E_o} = a + \frac{a(Z_1 - bZ_K)}{Z_{SH}} + \frac{Z_1 + b^2 Z_K}{aZ_L} \quad (6)$$

Replacing the "Z" terms with actual resistances and reactances,

$$\begin{aligned} \frac{E_{in}}{aE_o} = & 1 + \frac{r_1 - br_K}{R_{SH}} + \frac{x_1 - bx_K}{X_{SH}} \\ & + \frac{(r_1 + b^2 r_K)R_L + (x_1 + b^2 x_K)X_L}{a^2 |Z_L|^2} \\ & + j \left[ \frac{x_1 - bx_K}{R_{SH}} - \frac{r_1 - br_K}{X_{SH}} \right. \\ & \left. + \frac{(x_1 + b^2 x_K)R_L - (r_1 + b^2 r_K)X_L}{a^2 |Z_L|^2} \right] \quad (7) \end{aligned}$$

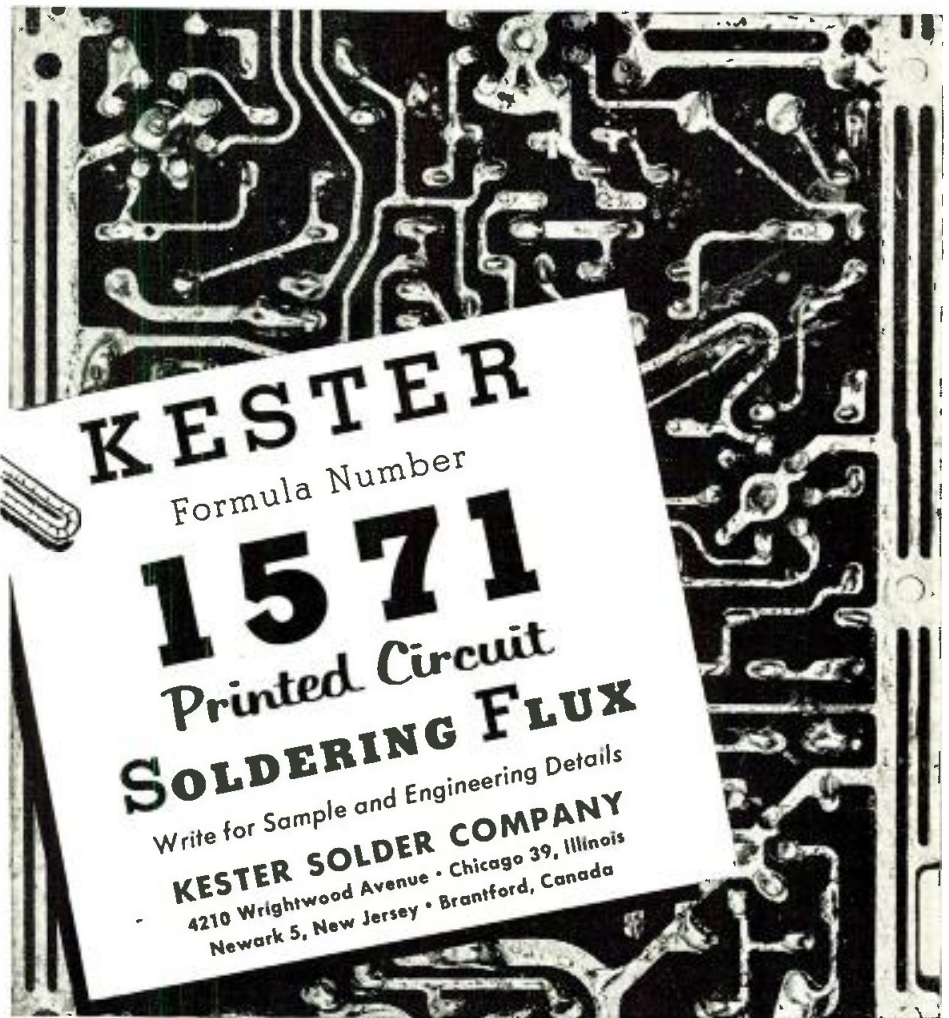

Make your  
**Ferrites** with

These reactive synthetic MAPICOS, some especially developed for ferrite manufacture, are over 99% pure  $Fe_2O_3$ . Choice of suitable characteristics is made easy—many variations in particle-size and shape are available. Careful control contributes to uniformity of packing and shrinkage. Our iron oxide production experience and our ferrite research can help you accomplish best results. Manufactured in modern plants by modern methods. Experienced Columbian



technicians are ready to cooperate in any problem involving the use of iron oxides for ferrite manufacture. Use your letterhead for working sample.

**COLUMBIAN CARBON COMPANY • MAPICO COLOR UNIT • 380 MADISON AVENUE NEW YORK 17, N. Y.**

“Concentrated  
coverage  
of the most  
influential  
engineers.”



**Electronic  
Industries**

and TELE-TECH

## ENGINEER

# TUBE and TRANSISTOR APPLICATION

General Electric's growing Radio Receiver Department is seeking an engineer who is acquainted with the latest techniques of tube and transistor development. Must be capable of recommending development of new tubes and transistors and be up-to-date on "the state of the art."

We will consider you if you have tube experience and want to learn transistor theory and application. You must be able to write purchase specifications for tubes and transistors and approve applications.

The plant is located in Utica, New York, a city accessible to the many vacation resorts that abound in this lake-mountain region.

Excellent technical facilities. Small project area system of work. Notable benefits program. High starting salary. Relocation expenses paid.

Please send resume in confidence to:

Mr. R. P. Stitt

RADIO RECEIVER DEPARTMENT

# GENERAL ELECTRIC

869 Broad Street, Utica, New York

Eq. 7 presents certain general qualities with regard to the behavior of auto-transformers. First, with respect to the in-phase term, notice the subtractive effects of  $r_1$  and  $r_K$ ,  $x_1$  and  $x_K$ . These subtractive effects indicate high efficiency. With respect to the quadrature terms note the same type of subtractive effects, indicating low phase shift.

To determine the criteria for zero phase, the quadrature term of Eq. 7 is set equal to zero.

One set of criteria exists as:

$$R_L(x_1 + b^2x_K) = X_L(r_1 + b^2r_K)$$

$$\text{or } \frac{X_L}{R_L} = \frac{x_1 + b^2x_K}{r_1 + b^2r_K}$$

( $X_L$  must be inductive)

$$\frac{x_1 - bx_K}{R_{SH}} = \frac{r_1 - br_K}{X_{SH}}$$

$$\text{or } \frac{R_{SH}}{X_{SH}} = \frac{x_1 - bx_K}{r_1 - br_K}$$

Another set of criteria exists as:

$$x_1 - bx_K = 0 \quad \text{or} \quad x_1 = bx_K$$

$$r_1 - br_K = 0 \quad \text{or} \quad r_1 = br_K$$

$$R_L(x_1 + b^2x_K) = X_L(r_1 + b^2r_K)$$

$$\text{or } \frac{X_L}{R_L} = \frac{x_1 + b^2x_K}{r_1 + b^2r_K}$$

In practice it is not too easy to achieve these criteria. However, by equating the entire quadrature expression of Eq. 7 to zero, and by properly adjusting the various elements comprising the auto-transformer equivalent circuit, values of phase shift can be designed to a very small amount.

It is instructive to see Eq. 7 undergo changes with respect to loads consisting of pure resistance, inductive and capacitive reactance.

Case No. 1  $Z_L = R_L$

$$\frac{E_{in}}{aE_o} = 1 + \frac{r_1 - br_K}{R_{SH}} + \frac{x_1 - bx_K}{X_{SH}}$$

$$+ \frac{r_1 + b^2r_K}{a^2R_L} + j \left[ \frac{x_1 - bx_K}{R_{SH}} - \frac{r_1 - br_K}{X_{SH}} + \frac{x_1 + b^2x_K}{a^2R_L} \right] \quad (8)$$

Setting the quadrature terms equal to zero results in:

$$-\frac{x_1 - bx_K}{R_{SH}} + \frac{r_1 - br_K}{X_{SH}} = \frac{x_1 + b^2x_K}{a^2R_L} \quad (9)$$

Case No. 2  $Z_L = X_L$  (inductive)

## HIGH ENERGY, PRECISION ALNICO PERMANENT MAGNETS

When you need them—as you need them  
Experimental or production quantities

Catalog upon request

PERMAG CORP., 210 TAAFFE PLACE, BROOKLYN 5, N. Y.

WE CARRY IN STOCK  
ALL SIZES,  
ALL SHAPES,  
ALL ALNICO GRADES

## PERMAG

Services include:

- ENGINEERING
- PRECISION CUTTING
- PRECISION GRINDING
- MAGNETIZING

24 HOUR  
DELIVERY

Phone:  
MAin 2-0114

**Auricon  
Hollywood**

16mm SOUND-ON-FILM EQUIPMENT FOR TELEVISION NEWSREELS,  
TV FILM INSERTS AND KINESCOPE RECORDINGS... SOLD WITH  
A 30-DAY MONEY-BACK GUARANTEE. YOU MUST BE SATISFIED!

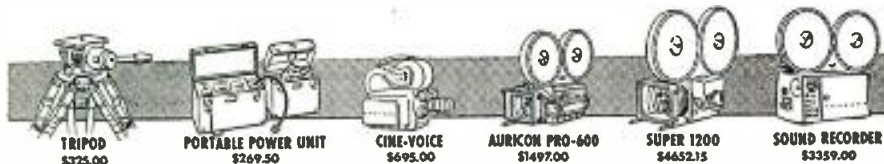

TRIPOD  
\$325.00

PORTABLE POWER UNIT  
\$269.50

CINE-VOICE  
\$695.00

AURICON PRO-600  
\$1497.00

SUPER 1200  
\$4652.15

SOUND RECORDER  
\$3359.00

WRITE FOR FREE  
ILLUSTRATED  
INFORMATION

**BERNDT-BACH, Inc.**  
6926 Romaine St., Hollywood 38, Calif.

MANUFACTURERS OF SOUND-ON-FILM RECORDING EQUIPMENT SINCE 1931

$$\frac{E_{in}}{aE_o} = 1 + \frac{r_1 - br_K}{R_{SH}} + \frac{x_1 - bx_K}{X_{SH}} + \frac{x_1 + b^2x_K}{a^2X_L} + j \left[ \frac{x_1 - bx_K}{R_{SH}} - \frac{r_1 - br_K}{X_{SH}} - \frac{r_1 + b^2r_K}{a^2X_L} \right] \quad (10)$$

Setting the quadrature terms again equal to zero:

$$\frac{x_1 - bx_K}{R_{SH}} - \frac{r_1 - br_K}{X_{SH}} = \frac{r_1 + b^2r_K}{a^2X_L} \quad (11)$$

Case No. 3  $Z_L = -X_L$  (capacitive)

$$\frac{E_{in}}{aE_o} = 1 + \frac{r_1 - br_K}{R_{SH}} + \frac{x_1 - bx_K}{X_{SH}} - \frac{x_1 + b^2x_K}{a^2X_L} + j \left[ \frac{x_1 - bx_K}{R_{SH}} - \frac{r_1 - br_K}{X_{SH}} + \frac{r_1 + b^2r_K}{a^2X_L} \right] \quad (12)$$

The criterion for zero phase shift is expressed as:

$$\frac{r_1 - br_K}{X_{SH}} - \frac{x_1 - bx_K}{R_{SH}} = \frac{r_1 + b^2r_K}{a^2X_L} \quad (13)$$

It is noted that because of the preponderance of negative terms in the in-phase term grouping, negative regulation can and is experienced. This is a well known fact.

Case No. 4  $Z_L = \alpha$

$$\frac{E_{in}}{aE_o} = 1 + \frac{r_1 - br_K}{R_{SH}} + \frac{x_1 - bx_K}{X_{SH}} + j \left[ \frac{x_1 - bx_K}{R_{SH}} - \frac{r_1 - br_K}{X_{SH}} \right] \quad (14)$$

As can be noticed even under open circuit conditions, the voltage ratio is not "a". Phase shift is also experienced. Under conditions of open circuit, zero phase shift is experienced when:

$$\frac{x_1 - bx_K}{r_1 - br_K} = \frac{R_{SH}}{X_{SH}} \quad \text{or } x_1 = bx_K, r_1 = br_K \quad (15)$$

Because the auto-transformer is a non-symmetrical (L-type) network, the relationship between input and output voltages in a step-down transformer differs from the relationship of voltages in a step-up transformer.

Keeping the terminology the same as presented, the general relationship between input and output voltages of a step-up auto-transformer is:

$$\frac{E_{in}}{aE_o} = 1 - \frac{br_K}{R_{SH}} - \frac{bx_K}{X_{SH}} + \frac{(a^2r_1 + b^2r_K)R_L + (a^2x_1 + b^2x_K)X_L}{a^2|Z_L|^2}$$

$$+ j \left[ \frac{-bx_K}{R_{SH}} + \frac{br_K}{X_{SH}} + \frac{(a^2x_1 + b^2x_K)R_L - (a^2r_1 + b^2r_K)X_L}{a^2|Z_L|^2} \right] \quad (16)$$

The comments previously applied to a discussion of the step-down transformer apply similarly here.

The analysis, previously described, covers an overall picture of auto-transformer behavior. The application is general for computer transformers as well as other types such as instrument transformers.

#### REFERENCES

- (a) Fitzgerald & Kingsley, *Electric Machinery*.
- (b) Lawrence, *Principles of A.C. Machinery*.
- (c) Puchstein and Loyd, *A.C. Machines*.
- (d) Goodale and Holbreck, Field Determination of Current Transformer errors by Secondary Voltage Method, *Trans. AIEE*, Dec. 1944.
- (e) Camilli and Ten Broeck, A Proposed Method for Determination of Current Transformer Errors, *Trans. AIEE*, Sept. 1940.
- (f) Upson, General Theory of Auto-Transformer, *Trans. AIEE*, June 1926.

## TV Cameras

(Continued from page 53)

### Range

The equipment shown in Figs. 1 and 4 includes all necessary components for remote video pickup and transmission for at least three hours. A 200 milliwatt transmitter contained in the upper case feeds a quarter-wave vertical antenna mounted on the top of the pack. Range with this equipment is about one mile, depending on obstacles in the transmitting path. With an additional 5 watt transmitter unit and its separate power supply, the range on the ground can be extended to several miles. Fig. 2 identifies the component sections and Fig. 3 is a block diagram of the complete camera-transmitter.

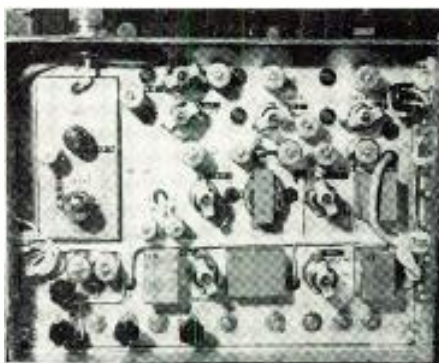

Fig. 6: Video and r-f section

**Stable Performance**

**Low Noise Level**

**Moisture Resistance**

**S.S. White**

**65X RESISTORS**

**Values up to...**

**10,000,000 megohms**

Here is a line of compact, high value molded resistors designed to meet the demands of a wide range of commercial, industrial and scientific applications.

Their excellent performance characteristics and wide range of values are ideally suited for atomic survey meters, radio and television service, scientific measuring devices, as well as many precision instruments.

They are subjected to an aging process in production to insure stability of resistance values in actual service.

Get full information on S.S. White 65X Resistors today. You will find they will meet and in many cases exceed the most stringent military requirements.

#### BULLETIN 5409

has full details. Send for a copy. Attention Dept. QR.



## S.S. WHITE INDUSTRIAL DIVISION

10 EAST 40th STREET • NEW YORK 16, N. Y.

Western Office:

1839 West Pico Blvd., Los Angeles 6, Calif.

Let Williams  
help you apply

**FERRIC  
OXIDES**

to the manufacture  
of your

**FERRITES**

You'll be well repaid by getting the facts on a special group of Pure Ferric Oxides, developed by Williams especially for use in the manufacture of ferrites.

Williams Ferric Oxides analyze better than 99% Fe<sub>2</sub>O<sub>3</sub>. They contain a minimum of impurities. They are available in a broad range of particle sizes and shapes. Among them, we're certain you'll find one that's "just right" for your requirements. The proper application of Ferric Oxides to the manufacture of Ferrites is our specialty.

Tell us your requirements . . . we'll gladly send samples for test. Chances are good that our Ferric Oxide "Know How" can save you considerable time and money. Address Dept. 30, C. K. Williams & Co., Easton, Pa.

**WILLIAMS**  
COLORS & PIGMENTS

C. K. WILLIAMS & CO.  
Easton, Pa. • East St. Louis, Ill.  
Emeryville, Cal.

**P.S.** We also produce IRN Magnetic Iron powders for the Electronic Core Industry, the Magnetic Tape Recording Industry and others. Write for complete technical information.

Physically, the camera is about 3½ x 4¼ x 7½ in., and weighs about three pounds. It is connected by a short cable to the Video Control Unit in the back-pack.

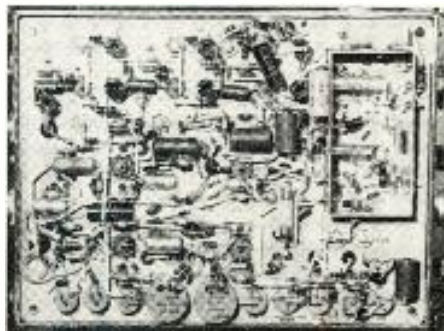

Fig. 7: Back of video and r-f unit

#### Camera

The camera unit is designed around the 6198 Vidicon or similar tube, and includes a two-tube preamplifier using 6AK5 tubes. Only the Vidicon focusing control is mounted on the camera itself, all other controls are accessible within the back-pack after the outer cover is removed. For portable operation the camera is equipped with a pistol-grip handle, but it can also be mounted on a standard camera pedestal. The optical system uses standard 16 mm movie lenses, and an optical viewer is mounted on the side of the camera.

#### Back-Pack

The basic back-pack for commercial broadcast work is made up of three sections. The upper section is the Video Control Unit, the center section is the Interlace Synchronization Generator, and the lower unit is the Power Pack. Total weight of the combined units, including the camera, is 28 pounds. The sync. unit can be omitted for ITV applications where interlace may not be necessary; or a second power supply and a 5 watt transmitter section can be added to extend the range to several miles. The additional long range sections add about 10 pounds to the weight of the pack.

#### Video Control Unit

Figs. 6 and 7 show the Video Control Unit with covers removed. This unit contains the video amplifier, the sweeps generator, the

RF section with 200 milliwatt output, and Vidicon gun and target potential controls. The unit contains a total of 23 tubes, and can be used to provide a non-interlace signal for closed circuit work. The signal can be taken off at video or at RF. Characteristics are shown in Table 1.

TABLE 1

Frame frequency—approx. 50 to 60 CPS
Line frequency—adjustable from 400 to 819 interlaced
RF Channel—adjustable to 10 MC max.
Nominal Channel—204-216 MC or 2000 MC
Transmitter power—0.2 watt or 5 watt
Sense of modulation—positive
Video band-width—up to 7 MC
Range on the ground—200 yards minimum, extended to several miles by addition of 5 watt transmitter and power pack.
Endurance—3 hours per battery, with safety factor of 1.5. Time for battery change—30 seconds.

Fig. 5 shows the transistorized power supply (left) and the crystal-controlled interlace synchronization generator (right). The sync. generator provides crystal controlled 15750 CPS, and, by divider circuits, 60 CPS frame control pulse. This unit is required to meet FCC broadcast standards, but is not necessary for closed circuit applications.

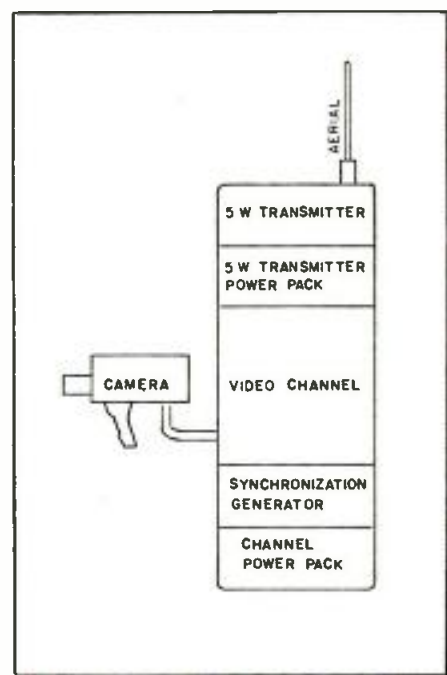

Fig. 8: Upper two units give long range

#### Power

The power supply contains a twelve volt silver cell battery and a completely transistorized high voltage power supply. The battery is conservatively rated for three hours continuous operation on one charge.

# SWITCH to **TR** Heat-dissipating Electron Tube Shields



For information regarding your tube failure problems write for "TR" technical bulletin, today!

\*Cross-licensed with North American Aviation, Inc.

**IERC's** answer to proper cooling, longer tube life and reliability!

It's simple to make the switch to TRs. They fit standard JAN 7 and 9 pin miniature sockets like the TS102P01, TS103P01, etc., and give complete electrostatic shielding. IERC's exclusive, patented liner effectively dissipates heat and dampens vibration to eliminate these causes of "premature" tube failures.

TRs, available now, are the first heat-dissipating tube shields ideally suited for retrofitting existing military, aviation, communication, computer and commercial electronic equipment from JAN types to the modern TR shield — or for new equipment applications.

## International

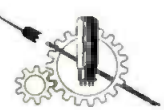

**electronic research corporation**  
145 West Magnolia Boulevard, Burbank, California

There is an IERC heat-dissipating tube shield for every type of miniature, subminiature, octal and power tube.

## MAGNETIC AMPLIFIERS • INC

AUTOMATIC UNIVERSAL  
**TRANSISTOR AND  
POWER TRANSISTOR  
CURVE TRACERS**

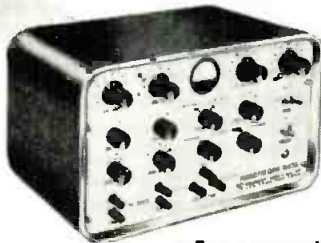

—For research, circuit development and quality control of transistors.

- High accuracy ( $\pm 2.5\%$ )
- Dynamic tracing of entire family of curves simultaneously, including —
- Internally generated calibration axes displayed at all times
- Retrace not blanked; anomalies clearly seen
- For all types of transistors and power transistors. Permits rapid determination of parameters. For selecting, matching and detecting anomalies and rejects.

Model 200A—Transistor Curve Tracer Request Bulletin S393.

Model 300A—Power-Transistor Curve Tracer. Request Bulletin S667.

and

**PHASE  
ANALYZER  
AND VACUUM TUBE  
VOLTMETER**



- Phase and Voltage of AC signals measured simultaneously and read directly from dial and meter scales.
- Useful frequency range from 20 cps. to 10 kc.
- AC signal under test need not be a pure sinusoid, but may be greatly distorted.
- Indispensable for alignment of servo systems, measurement of input requirements of non-linear loads and determination of amplifier input impedances even in presence of noise feedback from amplifier.
- Provision included for dynamic recording of internally demodulated AC transients.

Request Bulletin S675

**Magnetic Amplifiers • Inc**

632 TINTON AVE., N. Y. 55, N. Y. — CYPRESS 2-6610  
West Coast Division  
136 WASHINGTON ST., EL SEGUNDO, CAL. — EASTGATE 2-2056



## Increased Insulation BETTER CONNECTIONS **JONES BARRIER TERMINAL STRIPS**

Leakage path is increased — direct shorts from frayed terminal wires prevented by bakelite barriers placed between terminals. Binder screws and terminals brass, nickel-plated. Insulation, BM 120 molded bakelite. Finest construction. Add much to equipment's effect.

**Jones Means Proven Quality**



No. 2-142



No. 2-142-3/4 W



No. 2-142-Y

Illustrated: Screw Terminals — Screw and Solder Terminals — Screw Terminal above Panel with Solder Terminal below. Every type of connection.

Six series meet every requirement. No. 140, 5-40 screws; No. 141, 6-32 screws; No. 142, 8-32 screws; No. 150, 10-32 screws; No. 151, 12-32 screws; No. 152, 1/4-28 screws.

Catalog No. 21 lists complete line of Barrier Strips, and other Jones Electrical Connecting Devices. Send for your copy.



**HOWARD B. JONES DIVISION**  
CINCH MANUFACTURING CORPORATION  
CHICAGO 24, ILLINOIS  
SUBSIDIARY OF UNITED-CARR FASTENER CORP.

# If it's **ECONOMY** you want, specify **ROHN Towers!**

**AMERICA'S FINEST  
COMMUNICATIONS  
TOWER OF ITS KIND  
... WITH EXCLUSIVE  
BUILT-IN ECONOMY**

- **REDUCE COSTS** by getting the right tower for the right job. When a job calls for a medium weight tower from 200-300 ft. guyed, or self-supporting from 50-66 ft., a Rohn tower can do the job at far less cost. Check your particular tower needs against the "job-rating" a Rohn tower has and you'll save money.

- **HOT DIPPED GALVANIZED** finishes are available. The erection is quick and easy as all towers are in 10 ft. sections. Rohn towers are designed for economy in erection as no specially trained help is required.

- **PROVEN DESIGN** that has been tested with thousands of installations. Workmanship is unexcelled. Mass production machinery is used for precision fabrication yet a big reduction in labor cost.

Remember, there's a **ROHN** tower to fit your particular needs. Write, wire or phone for data and prices and nearest source of supply. **ROHN** representatives are coast-to-coast to serve you.

**ROHN Manufacturing Co.**

116 Limestone, Bellevue  
Peoria, Illinois

"Pioneer Manufacturers of TV and Communication Towers of All Kinds."



Rudolph G. Miller is now Chief Engineer of the Special Products Div. of Stromberg-Carlson, a Div. of General Dynamics Corp., in Rochester, N. Y. Mr. Miller succeeds Frank H. Slaymaker, recently named Manager of Electroacoustical Research at Stromberg-Carlson.

Erwin Bernstein has been appointed Mobile Communications Engineer in the Bendix Radio Div., Bendix Aviation Corp., Baltimore. He will be responsible for customer relations, sales, service of Bendix two-way communication systems in N. J. and Eastern Pa.

Dr. Herbert Bandes is in the newly-created post of Chief Engineer-Semiconductors, Electronics Div. of Sylvania Electric Products, Inc., Woburn, Mass.; Jerome R. Steen has been named Quality Manager-Semiconductors at Woburn. Robert Thalner has been appointed Chief Engineer, Radio-TV Div., Sylvania, at Buffalo, N. Y.



Dr. Hang C. Lin



Dr. Herbert Bandes

Dr. Hang C. Lin has been appointed Senior Engineer in charge of the Semiconductor Applications Laboratory at CBS-Hytron, a Div. of CBS. Dr. Lin came to the U. S. from China in 1947, and has had wide experience in the field of transistor applications.

Lionel Glauberman has been made Asst. Chief Engineer at Assembly Products, Inc., Chesterland, O. (near Cleveland).

Louis G. Pacent, Jr., is now Vice President in charge of Engineering and Manufacturing in the Radio-TV-Phonograph Div. Emerson Radio and Phonograph Corp., Jersey City.

Sidney F. Musselman is now Director of Engineering Operations of American Machine & Foundry Co., New York.

Clement Joseph Savant, Jr., has been appointed Chief Engineer, Western Div., Servomechanisms, Inc., Hawthorne, Calif.

David F. Bowman heads the new RF Design Dept. in the Special Products Div. of I-T-E Circuit Breaker Co., Philadelphia.

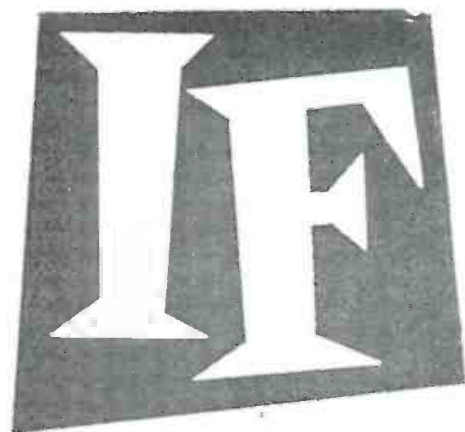

**PRECISION  
MANUFACTURING  
IS YOUR  
REQUIREMENT**

... then

Boehme practical experience in the design and manufacture of mechanical, electrical and electronic products for automation and instrumentation can solve your most exacting demands. Learn more about Boehme's prompt, efficient, economical service and how readily it applies to your needs.

Send for your copy of The Boehme Brochure, now! There is no obligation, of course.



**H. O. Boehme, Inc.**

Designers and Manufacturers

Communication Equipment

Precision Electro-Mechanical

Apparatus Since 1917

915 Broadway

New York 10, N. Y.



**REPS WANTED**

Manufacturer of sensitive switching relays seeks reps for Chicago-Milwaukee, South Carolina-Florida, Texas and Missouri-Kansas-Oklahoma areas. (Ask for R9-1).

Jack Carney and Associates, 905 Knott Building, has recently added as sales engineers: Frank E. Newberry, Jack E. Haacke, Lloyd E. Brown, and Miss Barbara Leasure.

Microphase Corp., Greenwich, Conn., mfr. of antenna filters, r-f and microwave components, has appointed four new sales engineering reps: The Thorson Co., 7361 Melrose Ave., Los Angeles, for southern Calif. and Ariz.; R. L. Pflieger Co., 23 37th Avenue, San Mateo, California, for northern Calif. and Nev.; Tower Engineering Co., 627 Salem Ave., Dayton, O., for Ohio, Mich. and W. Va.; Cappels-Rhodes & Associates, 1214 W. Madison St., Chicago will cover Ill., Ind., Ia., and Wis.

Astron Corp., East Newark, N. J., has added three new sales reps: Samuel N. Stroum Co., 1612 Broadway, Seattle 22, Wash., rep. in Wash. and Ore. Sid Lohmann, 18682 Perovost, Detroit 35, Mich., for the state of Mich.; Frank W. Taylor Co., DeWitt, N. Y., for the state of New York exclusive of the N. Y. metropolitan area.

Burt C. Porter Co., Seattle, Wash., has been appointed sales representative for the Northwest by Non-Linear Systems, Inc., Del Mar, Cal.

Raymond J. Brown has been appointed West Coast field rep of the Copper & Brass Research Ass'n. with offices in Los Angeles, Cal.

Kee Enterprises, Inc., instrument rep. in the N. Y. area, announces election of the following officers: Robert Crane, president and Samuel S. Egert, secretary-treas.

King-Moon Co., Inc. is the new Arizona rep for Kaar Engineering Corp., Palo Alto.

H. H. Scott, Inc., 385 Putnam Ave., Cambridge, Mass., announces the appointment of the Jack Fields Sales Co., 5 Howard St., Verona, N. J., as their sales rep in northern N. J. and New York City.

ORRadio Industries, Inc., Opelika, Ala., announces three new reps: John T. Stinson Co., 219 Sagamore Rd., Havertown, Pa.; Thomas H. Beil, 3623

Jacksonwald Ave., Reading, Pa.; Mel Foster, 2402 Hennepin Ave., Minneapolis, Minn.

Gerard G. Leeds Co., manufacturers' reps of Great Neck, N. Y., have appointed Gene Rotondi Sales Engineer-in-Charge for New England with new offices in Boston, Mass.

Robert Bergman, formerly of CBS Columbia, Inc., has joined the staff of the Samuel S. Egert Co.

Diamonite Products Div. of United States Ceramic Tile Co., Canton, Ohio, has named Henry Lavin Associates, Meriden, Conn., and Needham, Mass., rep for its alumina ceramics in the six New England states.

Jay C. Angel & Co., Chicago, Ill., has been appointed mid-western sales rep for the Electronics Div. of Metal Textile Corp., Roselle, N. J.

George Vincent McMahon, R. P. E., has been appointed western technical and sales rep for Newman Electrographics, N. Y. printed circuit mfr. with offices at 381 W. 7th St., San Pedro, Cal.

The Hammel-Dahl Co., Providence, R. I., manufacturers of automatic control equipment, announces the appointment of the George Haynes Co., 406 W. 34th St., Kansas City 11, Mo. as additional sales and service rep.

Feedback Controls, Inc., appointed Electro Sales Associates, 281 East 216th St., Euclid, Ohio, as its engineering reps in western Pa., Ohio, southern Ind. and Mich.

The Electronics div., Elgin National Watch Co. appoints three new reps: Grady Duckett Sales Co., 26 E. Andrews Dr., N. E., Atlanta, Ga.; Gene Piety, of 2030 Home Rule St., Honolulu; and Eastern Electric and Engineering Co., 127 Mahatma Gandhi Rd., Bombay.

Gulton Industries, Metuchen, N. J. appoints reps and field engineers: Reynolds, Inc., Providence, R. I.; Pitchford Scientific Instrument, Pittsburgh, Pa.; J. A. Reagan Co., Albany, N. Y.

Robert B. Barnhill & Associates, 412 Woodbine Ave., Towson 4, Md. were appointed reps for Kaar Engineering Corp.

Erie Resistor Corp. has appointed Fred Rich as sales rep for the N. Y. sales office.

New and Complete  
—with important  
**EXCLUSIVE FEATURES**

**PRINCIPLES OF  
COLOR TELEVISION**



By the  
**HAZELTINE  
LABORATORIES  
STAFF**  
Compiled and edited by  
**KNOX McILWAIN and  
CHARLES E. DEAN**

- The complete story on engineering design of receivers—including synchronization; RF, IF, and video amplifiers; and decoders
- A full chapter devoted to a discussion of gamma
- A thorough discussion of the FCC specifications
- A full, authoritative glossary of color TV terms

This new book starts where you are—and carries you deftly from monochrome to color TV thinking. Based on a series of reports already used successfully by engineers and researchers, *Principles of Color Television* gives a unified presentation of the whole field. It not only gives basic principles, clearly and concretely stated, but also provides answers to the common problems you encounter as you make the transition. General design procedures and formulas are stressed rather than descriptions of particular apparatus.

**Information-packed chapters include such subjects as:**

Light and Photometry—Color Perception—Color Space and Color Triangles—Colorimetry—Color in Television System—Required Information Content—Choice of Color Components and Their Inter-leaving in the Composite Signal—Synchronization—Non-linear Amplitude Relations and Gamma Correction—Equipment for Producing the Transmitted Signal—Separation of Chrominance and Luminance—Picture Tubes—One-Gun Displays—Three-Gun Displays—Test and Measuring Methods.  
1956. 595 pages. 252 illus. \$13.00

**Mail this coupon now for your 10-day trial copy. No obligation to buy.**

**JOHN WILEY & SONS, Inc. TT-96**  
440 Fourth Ave., New York 16, N. Y.

Please send me **PRINCIPLES OF COLOR TELEVISION** to read and examine **ON APPROVAL**. In 10 days I will return the book and owe nothing or will remit \$13.00, plus postage.

Name .....

Address .....

City ..... Zone ..... State .....

( ) **SAVE POSTAGE!** Check here if you **ENCLOSE** payment, in which case, we pay postage. Same return privilege; refund guaranteed.

# GET THE FACTS

LOW and constant contact drop  
 LOW electrical noise  
 HIGH current density  
 LONG life...



**HIGH PERFORMANCE**



# BRUSHES CONTACTS SLIP RINGS

**& Slip Ring Assemblies**

BRUSH HOLDERS, CONTACT ASSEMBLIES,  
 BRUSH ASSEMBLIES



USED EXTENSIVELY IN:

**SERVOS • GUN-FIRE CONTROLS  
 TELEMETERING • ROTATING  
 THERMOCOUPLE and STRAIN  
 GAGE CIRCUITS • ROTATING  
 JOINTS • DYNAMOTORS**

Wide range of grades available for standard and special applications. Call on our 40 years of design experience to help solve your problems.

**OTHER GRAPHALLOY**

**PRODUCTS:** Unique (oil-free) self-lubricating Bushings and Bearings (applicable -450° to +700°F.; with expansion coefficient half that of steel will not seize shaft at low temperature); Oil-free Piston Rings, Seal Rings, Thrust and Friction Washers, Pump Vanes.



## Fallout

(Continued from page 67)

provide the test manager with immediate knowledge of the effect of any changes in the winds. For civil defense, the computer can be used in research studies or in case of an actual attack. Forecasting could be expected to help determine and speed up the emergency procedures to be used after a bomb explosion, with a consequent saving in lives.

The prototype computer (Fig. 1) is contained in two 6-ft relay racks, including power supplies and one oscilloscope. A 21-in. display oscilloscope is mounted separately.

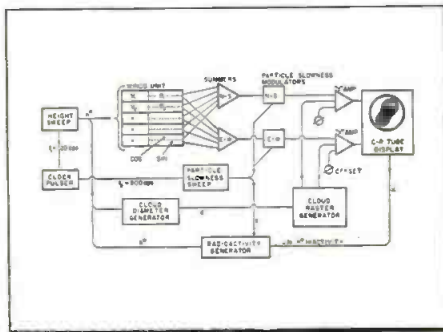

Fig. 3: Block diagram of fallout computer.

While this is not a simulation analog computer, it uses analog techniques to mechanize the fallout problem. In particular, time in this computer is used for sequencing only and has no direct significance in terms of the time variable in the original physical model.

The computer obtains the ground coordinates and radioactivity intensities of all the particles by producing continuously varying voltages proportional to the slowness of the particles and to the height intervals, by scanning these voltages over the full ranges of the variables, and simultaneously developing the corresponding fallout positions and intensities as voltages. The position voltages deflect the beam of a cro, and the radioactivity voltage modulates the intensity of the beam. The display on the crt then provides a map of the fallout of the radioactive dust while the luminance (brightness) of the tube represents the total intensity of fallout at any geographical location. (See Fig. 2.)

*Engineers*

*Advance  
 in the  
 mushrooming field of*

## MICROWAVE TUBES

KEY  
 to your future  
**SYLVANIA'S**  
 Microwave Tube  
 Laboratory



Write Gordon McClure  
**SYLVANIA ELECTRIC PRODUCTS INC.**  
 500 Evelyn Avenue  
 Mountain View, California

## MEGACYCLE METER



For determining the resonant frequency of tuned circuits, antennas, transmission lines, by-pass condensers, chokes, etc. For measuring inductance and capacitance. May also be used as an auxiliary signal generator, and in many other applications. Available in the following frequency ranges:

Model 59-LF 0.1 to 4.5 Mc  
 Model 59 2.2 to 420 Mc  
 Model 59-UHF 420 to 940 Mc

*Laboratory Standards*

**MEASUREMENTS CORPORATION**  
 BOONTON • NEW JERSEY

## GRAPHITE METALLIZING CORPORATION

1002 Nepperhan Ave. • YONKERS, NEW YORK

Please send data on Graphalloy BRUSHES and CONTACTS.  
 Send data on BUSHINGS.

NAME & TITLE \_\_\_\_\_  
 COMPANY \_\_\_\_\_  
 STREET \_\_\_\_\_  
 CITY \_\_\_\_\_ ZONE \_\_\_\_\_ STATE \_\_\_\_\_



# ELECTRONIC INDUSTRIES & Tele-Tech Advertisers—Sept., 1956

ACE ENGINEERING & MACHINE CO. .... 33 Agency—The Harry P. Bridge Co.	FAIRCHILD CONTROLS CORP. .... 91 Agency—G. M. Bosford Co.	OHMITE MFG. CO. .... 14 Agency—Fensholt Advtg.
AEROVOX CORP. .... 88 Agency—Austin C. Lescarboura & Stoff	FEDERAL TELECOMMUNICATION LABS .... 114 Agency—J. M. Mathes, Inc.	ONAN & SONS INC., D. W. .... 110 Agency—Graves & Associates
AIRCRAFT RADIO CORP. .... 87 Agency—Burke Dowling Adams, Inc.	FILTORS, INC. .... 126 Agency—LoPorte & Austin, Inc.	PERMAG CORP. .... 128 Agency—Joseph P. Schneider, Inc.
ALFORD MFG. CO., INC. .... 136 Agency—Engineered Advertising	FREED TRANSFORMER COMPANY .... 136 Agency—Franklin Advertising Service	PHELPS DODGE COPPER PRODUCTS CORP. ... 39 Agency—Compton Advertising, Inc.
ALLEN-BRADLEY CO. .... 4 Agency—Fensholt Advertising	GARRETT CORP., THE .... 111 Agency—J. Walter Thompson Company	PHILCO CORP., LANSDALE TUBE CO. DIV. 25 Agency—Hutchins Advtg. Co.
ALLIED RADIO CORP. .... 30 Agency—George Brodsky Advtg., Inc.	GATES RADIO COMPANY .... 46 Agency—Helmer & Holbach Advtg.	POLARAD ELECTRONICS CORP. .... 5, 26, 27 Agency—Howard A. Harkavy, Inc.
AMERICAN ELITE, INC. .... 125 Agency—Robert W. Orr & Assoc.	GENERAL ELECTRIC CO. .... 105, 128 Agency—Deutsch & Shea	RADIO CORP. OF AMERICA 112, 113, 118, Cover 4 Agency—Al Paul Lefton Co., Inc.
AMERICAN LAVA CORPORATION .... 21 Agency—Power & Condon	GENERAL RADIO CO. .... 19 Agency—K. E. Morang Co.	RADIO MATERIALS CORP. .... Cover 2 Agency—Turner Advtg.
AMPEX CORPORATION .... 11 Agency—Boland Associates	GENERAL TRANSISTOR CORP. .... 126 Agency—A. D. Adams Advtg.	RADIO RECEPTOR CO., INC. .... 85 Agency—Walter J. Zimmerman Assoc.
AMPHENOL ELECTRONICS CORP. .... 24 Agency—Burton Browne Advertising	GRAPHITE METALLIZING CORP. .... 134 Agency—Katula Company	ROHN MANUFACTURING CO. .... 132 Agency—Jackson, Haerr, Peterson & Hall, Inc.
APPLIED SCIENCE CORP. OF PRINCETON ... 109 Agency—Paul M. Healy Advtg. Service	HELIPOT CORP. .... 45 Agency—Charles Bowes Advtg., Inc.	SHALLCROSS MFG. CO. .... 120 Agency—The Harry P. Bridge Co.
ARNOLD ENGINEERING CO. .... 41 Agency—W. S. Walker Advertising	HEWLETT-PACKARD CO. .... 16 Agency—L. C. Cole Co.	SOLAR MFG. CO. .... 82 Agency—Allen, Dorsey & Hatfield, Inc.
ARTOS ENGINEERING CO. .... 106 Agency—Cramer-Krosselt Co.	HUGHES AIRCRAFT CO. .... 29, 38 Agency—Foote, Cone & Belding	SPRAGUE ELECTRIC CO. .... 8 Agency—Stuart Sande Advtg.
AUDIO DEVICES, INC. .... 28 Agency—Marsteller, Rickard, Gebhardt & Reed, Inc.	INTERNATIONAL ELECTRONIC RESEARCH CORP. .... 131 Agency—Jaycraft Company	SPRAGUE ELECTRIC CO. .... 48 Agency—The Harry P. Bridge Co.
BELL TELEPHONE LABS, INC. .... 43 Agency—N. W. Ayer & Son, Inc.	JOHNSON CO., E. F. .... 115 Agency—Firestone-Goodman Advtg.	STACKPOLE CARBON CO. .... 37 Agency—The Harry P. Bridge Co.
BENDIX AVIATION CORP. .... 125 Agency—MacManus, John & Adams, Inc.	JONES, DIV., HOWARD B., CINCH MFG. CO. .... 131 Agency—Symonds, MacKenzie & Co.	STEVENS MFG. CO. .... 2 Agency—Palm & Patterson, Inc.
BERNDT-BACH, INC. .... 128 Agency—Van der Boom Hunt McNaughton, Inc.	KAAR ENGINEERING CORP. .... 126 Agency—Evans, McClure & Assoc.	SYLVANIA MICROWAVE TUBE LABS. .... 134 Agency—Deutsch & Shea
BOEHME, INC., H. O. .... 132 Agency—William A. Bottista, Inc.	KEARFOTT CO., INC. .... 123 Agency—Western Advertising Agency, Inc.	TELE-DYNAMICS, INC. .... 93 Agency—Al Paul Lefton Co., Inc.
BOURNS LABORATORIES .... 22 Agency—Allen, Dorsey & Hatfield, Inc.	KESTER SOLDER CO. .... 6, 127 Agency—Paul J. Steffen Co.	TEXAS INSTRUMENTS INCORPORATED .... 20 Agency—Don L. Baxter, Inc.
BURNELL & CO., INC. .... 35 Agency—Mohr Associates, Inc.	LOS ALAMOS SCIENTIFIC LABS. .... 17 Agency—Ward Hicks Advertising	TRANSRADIO LTD. .... 95 Agency—Reynell & Son Ltd.
BURROUGHS CORP. .... 7 Agency—The Harry P. Bridge Co.	MAGNETIC AMPLIFIERS INC. .... 131 Agency—George Homer Martin Associates	TRIAD TRANSFORMERS CORP. .... 42 Agency—Mann Advtg. Co., Inc.
BUSSMANN MFG. CO. .... 107	MALLORY & CO., INC., P. R. .... 23 Agency—Aitkin-Kynett Co.	TRUSCON STEEL DIV., REPUBLIC STEEL CORP. .... 18 Agency—Meldrum & Fewsmith, Inc.
CHILTON CO., INC., THE .... 127	MEASUREMENTS CORP. .... 134 Agency—Frederick Smith Advtg.	TUNG-SOL ELECTRIC, INC. .... 47 Agency—E. M. Freystadt Assoc.
CINCH MFG. CO. .... 81 Agency—D. T. Campbell, Inc.	MELPAR, INC. .... 116 Agency—M. Belmont Ver Standig, Inc.	UNION SWITCH & SIGNAL DIV., WESTING- HOUSE AIR BRAKE CO. .... 94 Agency—Batten, Barton Durstine & Osborn, Inc.
CLEVELAND CONTAINER CO. .... 86 Agency—Nesbitt Service Co.	MIDLAND MFG. CO. .... 31 Agency—Potts-Woodbury, Inc.	UNITED TRANSFORMER CO. .... 10 Agency—Shappe, Wilkes, Inc.
COLLINS RADIO COMPANY .... 12 Agency—W. D. Lyon Co.	MOTOROLA, INC. .... 121 Agency—Kolb & Abraham	UNIVERSITY LOUDSPEAKERS, INC. .... 117 Agency—Promotion Affiliates
COLUMBIAN CARBON CO. .... 127 Agency—Samuel Croot Co., Inc.	NATIONAL AIRCRAFT CORP. .... 96 Agency—The Essig Company	WELLER ELEC. CORP. .... 125 Agency—Arndt, Preston Chapin, Lomb & Keen, Inc.
COMMUNICATION ACCESSORIES CO. .... 84 Agency—Carl Lawson Advtg. Co.	NEW HERMES ENGRAVERS, INC. .... 125 Agency—Lester Harrison, Inc.	WESTINGHOUSE ELEC. CORP. .... 90 Agency—Fuller & Smith & Ross, Inc.
CONRAC, INC. .... 119 Agency—Leech Advertising Co.	N. J. E. CORP. .... Cover 3 Agency—Art-Copy Advtg.	WESTON ELECTRICAL INSTRUMENT CORP. 40 Agency—G. M. Bosford Company
CORNELL-DUBILIER ELEC. CORP. .... 44 Agency—Friend-Reiss Advertising	NON-LINEAR SYSTEMS, INC. .... 89 Agency—Phillips-Ramsey Co.	WHITE INDUSTRIAL DIV., S. S. .... 129 Agency—Peterson & Kempner, Inc.
DALE PRODUCTS, INC. .... 95 Agency—Ayers Swanson & Assoc., Inc.	NORTHROP AIRCRAFT, INC. .... 122 Agency—West-Morquis, Inc.	WILEY, JOHN & SONS, INC. .... 133 Agency—Waterson & Frisch, Inc.
DAYSTROM PACIFIC CORP. .... 108 Agency—P. W. Voorhees Advertising		WILLIAMS & CO., C. K. .... 130 Agency—Emery Advtg. Co., Inc.
DESIGNERS FOR INDUSTRY .... 101 Agency—Fulton, Smith & Ross, Inc.		
DURSON COMPANY .... 124 Agency—Danken Associates		
EISLER ENGINEERING CO., INC. .... 93 Agency—Walter J. Zimmerman Associates		
EITEL-McCULLOUGH, INC. .... 34 Agency—Evans, McClure & Associates		
ELECTRICAL INDUSTRIES .... 83 Agency—George Homer Martin Assoc.		
ELECTRONICS DIV., ELGIN NATIONAL WATCH CO. .... 92 Agency—Woldie & Briggs, Inc.		
ERIE RESISTOR CORP. .... 32 Agency—W. S. Hill Co.		

While every precaution is taken to insure accuracy, we cannot guarantee against the possibility of an occasional change or omission in the preparation of this index.

**FOR PRECISION LABORATORY  
OR PRODUCTION TESTING**



**F R E E D  
1110-AB INCREMENTAL  
INDUCTANCE BRIDGE**

**AND ACCESSORIES**

Accurate inductance measurement with or without superimposed D.C., for all types of iron core components.

- INDUCTANCE — 1 Millihenry to 1000 Henry
- FREQUENCY — 20 to 10,000 Cycles
- ACCURACY — 1% to 1000 Cycle, 2% to 10KC
- CONDUCTANCE — 1 Micromho to 1 MHO
- "Q" — 0.5 to 100
- SUPERIMPOSED D.C. — Up to 1 Ampere
- DIRECT READING — For use by unskilled operators.

**ACCESSORIES AVAILABLE:**

- 1140-A Null Detector
- 1210-A Null Detector - V.T.V.M.
- 1170 D.C. Supply and 1180 A.C. Supply.



**F R E E D  
VARIABLE TEST VOLTAGE  
MEGOHMMETER NO. 1620**

The Freed Type 1620 Megohmmeter is a versatile insulation resistance measurement instrument with a continuously variable DC test potential from 50 to 1000 volts.

Components such as transformers, motors, printed circuits, cables and insulation material can be tested at their rated voltage and above, for safety factor.

- Resistance — 0.1 megohms to 4,000,000 megohms.
- Voltage — variable, 50 - 1000 volts.
- Accurate — plus or minus 5% on all ranges.
- Simple — for use by unskilled operators.
- Safe — high voltage relay controlled.
- Self contained — AC operated.

**ALSO AVAILABLE**

- Type 1620-C — a type 1620 with additional circuitry for testing capacitors.
- Type 1020-B — a 500 volt fixed test potential.
- Type 2030 Portable Megohmmeter — battery operated, 500 volt test potential.

**SEND FOR COMPLETE TRANSFORMER  
AND INSTRUMENT CATALOGS**

**F R E E D  
TRANSFORMER CO., INC.**  
1724 Weirfield Street  
Brooklyn (Ridgewood) 27, N.Y.

A height sweep unit within the computer produces a sawtooth voltage rising linearly with time, repeated 20 times per second. This 20-cps repetition rate is the basic cycle of the whole computer operation, and the entire problem solution is completed once each cycle. The sawtooth voltage is applied to the winds unit, which in turn produces voltages proportional to the x- and y-components of the displacement of a "standard" particle — one having unit fall time—as affected by the magnitudes and directions of the various winds. The winds unit (Fig. 4) contains 20 channels, one for each cloud layer. The outputs are fed into two summing units to generate voltages corresponding to north-south or east-west displacements of the particles. The height sweep voltage is also applied to the computer's cloud diameter generator.

A second sawtooth voltage is generated by a particle slowness sweep unit. This unit scans through the range of particle sizes twice while going through each cloud layer. The amplitude of this sweep is then modulated in one of the particle slowness modulators by the output from the winds unit. The effect is to multiply each component of displacement of the "standard" particle by a suitable scaling factor of "slowness" in order to modify this displacement for other particle sizes. In this computer no conventional multipliers are necessary.

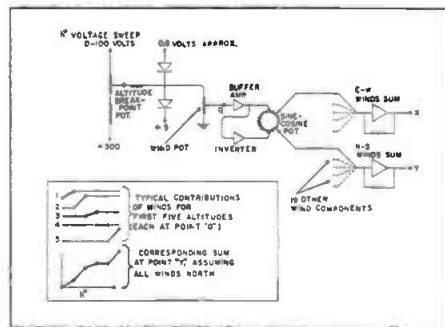
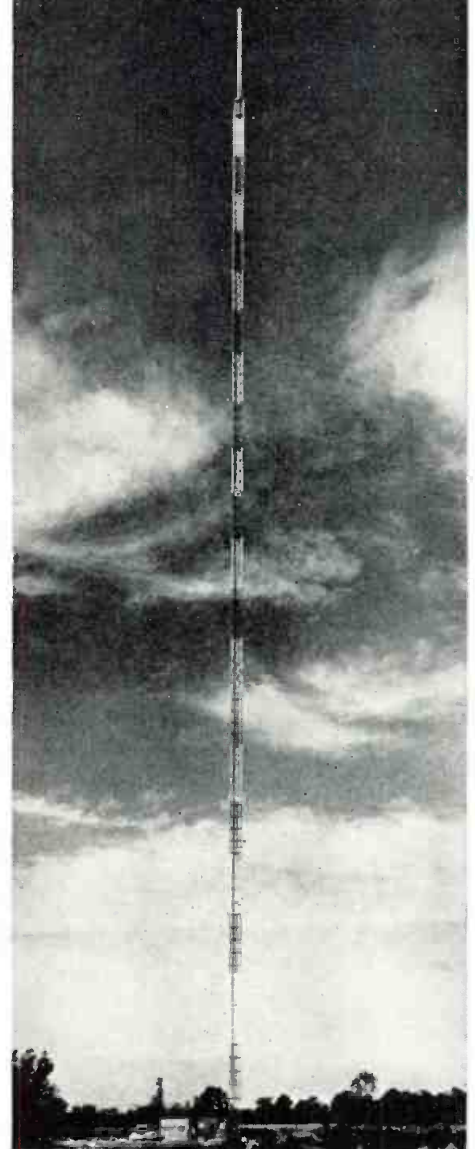

Fig. 4: The twenty channel winds unit.

For further technical details see "An Analog Computer for Radioactive Fallout Prediction, H. K. Skramstad and J. H. Wright. Proceedings of the National Simulation Conference, Dallas, Texas, Jan. 21, 1956 (in press).

**HIGH-GAIN  
omnidirectional  
VHF TV transmitting  
ANTENNA**



**AMCI TYPE 1046  
Channels 7 through 13**

Shown above is the five-bay array recently installed for Station with Channel 7, in Washington, North Carolina. With a gain of 19.4, a single 6-1/8" coaxial transmission line feeder and in conjunction with a 20 kw transmitter, the antenna radiates an ERP of 316 kw AMCI Type I null fill-in assures proper coverage even in close to the tower. Write for Bulletin T-105.

ANTENNA SYSTEMS — COMPONENTS  
AIR NAVIGATION AIDS — INSTRUMENTS



**ALFORD**  
Manufacturing Co., Inc.  
299 ATLANTIC AVE., BOSTON, MASS.

# HERE'S THE EASY WAY TO GET *more information*

ABOUT PRODUCTS ADVERTISED IN



## **ELECTRONIC INDUSTRIES**

& TELE-TECH

Use the convenient postage-free cards below to get information on products advertised in this issue. The extra card is for the use of pass-on readers.

Here is a coded list of all advertisers in this issue. To get more information simply enter code numbers in boxes below, fill out card and drop in mail.

- |                                                                                                                                                                                                                                                                                                                                                                                                                                                                                                                                                                                                                                                                                                                                                                                                                                                                                                                                                                                                                                                                                                                                                                                                                                                                                                                                                                                                                                                                                         |                                                                                                                                                                                                                                                                                                                                                                                                                                                                                                                                                                                                                                                                                                                                                                                                                                                                                                                                                                                                                                                                                                                                                                                                                                                                                                                                                                                                                                          |
|-----------------------------------------------------------------------------------------------------------------------------------------------------------------------------------------------------------------------------------------------------------------------------------------------------------------------------------------------------------------------------------------------------------------------------------------------------------------------------------------------------------------------------------------------------------------------------------------------------------------------------------------------------------------------------------------------------------------------------------------------------------------------------------------------------------------------------------------------------------------------------------------------------------------------------------------------------------------------------------------------------------------------------------------------------------------------------------------------------------------------------------------------------------------------------------------------------------------------------------------------------------------------------------------------------------------------------------------------------------------------------------------------------------------------------------------------------------------------------------------|------------------------------------------------------------------------------------------------------------------------------------------------------------------------------------------------------------------------------------------------------------------------------------------------------------------------------------------------------------------------------------------------------------------------------------------------------------------------------------------------------------------------------------------------------------------------------------------------------------------------------------------------------------------------------------------------------------------------------------------------------------------------------------------------------------------------------------------------------------------------------------------------------------------------------------------------------------------------------------------------------------------------------------------------------------------------------------------------------------------------------------------------------------------------------------------------------------------------------------------------------------------------------------------------------------------------------------------------------------------------------------------------------------------------------------------|
| <p>301 Ace Engineering &amp; Machine Co.—Shielded enclosures</p> <p>302 Aerovox Corp.—High voltage capacitors</p> <p>303 Aircraft Radio Corp.—Test equipment for airborne instruments</p> <p>304 Alford Mfg. Co., Inc.—High-gain omnidirectional VHF TV transmitting antenna</p> <p>305 Allen-Bradley Co.—Ferrites</p> <p>306 Allied Radio Corp.—Electronic supplies and equipment</p> <p>307 American Elite, Inc.—Microphones</p> <p>308 American Lava Corp.—High temperature metal-ceramic seals</p> <p>309 Ampex Corp.—Video and audio tape recorder</p> <p>310 Amphenol Electronics Corp.—Subminiature RF connectors</p> <p>311 Applied Science Corp. of Princeton—Pulse width ground station equipment and engineering personnel</p> <p>312 Arnold Engineering Co.—Permanent magnets for microwave</p> <p>313 Artos Engineering Co.—Automatic wire-stripping and terminal-attaching machine</p> <p>314 Audio Devices, Inc.—Sound recording equipment</p> <p>315 Bell Telephone Labs, Inc.—Communications research and development</p> <p>316 Bendix Aviation Corp.—Engineering personnel</p> <p>317 Berndt-Bach, Inc.—16mm sound-on-film equipment</p> <p>318 Boehme, Inc., H. O.—Communications design and manufacture</p> <p>319 Bourns Laboratories—Subminiature trimming potentiometers</p> <p>320 Burnell &amp; Co., Inc.—Adjustable toroids and variable inductors</p> <p>321 Burroughs Corp., Elec. Inst. Div.—Pulse control systems</p> <p>322 Bussmann Mfg. Co.—Fuses</p> | <p>323 Cinch Mfg. Corp.—Edge connectors, printed wire sockets, and shield inserts</p> <p>324 Cleveland Container Co.—Phenolic tubing</p> <p>325 Collins Radio Co.—Microwave relay system</p> <p>326 Columbian Carbon Co.—Red ferric oxides for ferrites</p> <p>327 Communication Accessories Co.—Communication accessories</p> <p>328 Conrac, Inc.—TV monitors</p> <p>329 Cornell-Dubilier Elec. Corp.—Miniature and subminiature capacitors</p> <p>330 Dale Products, Inc.—Deposited carbon resistors</p> <p>331 Daystrom Pacific Corp.—Miniature wire-wound trimming potentiometer</p> <p>332 Designers for Industry—Engineering personnel</p> <p>333 Durson Company—Transistorized transistor characteristics meter</p> <p>334 Eisler Engineering Co., Inc.—Automatic exhaust machines</p> <p>335 Eitel-McCullough, Inc.—10 kw ceramic tetrode</p> <p>336 Electrical Industries—Compression end seals</p> <p>337 Electronics Div., Elgin National Watch Co.—Ceramic phonograph cartridges</p> <p>338 Erie Elec. Div., Erie Resistor Corp.—Ceramic capacitors</p> <p>339 Fairchild Controls Corp., Components Div.—Precision Potentiometers and components</p> <p>340 Federal Telecommunication Labs.—Engineering personnel</p> <p>341 Filtors, Inc.—Sub-miniature relays</p> <p>342 Freed Transformer Co.—Incremental inductance bridge and variable test voltage megohmmeter</p> <p>343 Garrett Corp., The—Engineering personnel</p> |
|-----------------------------------------------------------------------------------------------------------------------------------------------------------------------------------------------------------------------------------------------------------------------------------------------------------------------------------------------------------------------------------------------------------------------------------------------------------------------------------------------------------------------------------------------------------------------------------------------------------------------------------------------------------------------------------------------------------------------------------------------------------------------------------------------------------------------------------------------------------------------------------------------------------------------------------------------------------------------------------------------------------------------------------------------------------------------------------------------------------------------------------------------------------------------------------------------------------------------------------------------------------------------------------------------------------------------------------------------------------------------------------------------------------------------------------------------------------------------------------------|------------------------------------------------------------------------------------------------------------------------------------------------------------------------------------------------------------------------------------------------------------------------------------------------------------------------------------------------------------------------------------------------------------------------------------------------------------------------------------------------------------------------------------------------------------------------------------------------------------------------------------------------------------------------------------------------------------------------------------------------------------------------------------------------------------------------------------------------------------------------------------------------------------------------------------------------------------------------------------------------------------------------------------------------------------------------------------------------------------------------------------------------------------------------------------------------------------------------------------------------------------------------------------------------------------------------------------------------------------------------------------------------------------------------------------------|

Only one simple form to fill out Listings continued on next page

Write in boxes the code numbers of products for which you want information. See list above and on next page.

Your company .....

Company address .....

Your name .....

Your title .....

**ELECTRONIC INDUSTRIES & Tele-Tech—SEPTEMBER 1956**  
CHILTON CO., Chestnut & 56th Sts., Philadelphia 39, Pa.

INQUIRY CARD Not good after Nov. 1, 1956

Write in boxes the code numbers of products for which you want information. See list above and on next page.

Your company .....

Company address .....

Your name .....

Your title .....

**ELECTRONIC INDUSTRIES & Tele-Tech—SEPTEMBER 1956**  
CHILTON CO., Chestnut & 56th Sts., Philadelphia 39, Pa.

INQUIRY CARD

# PRODUCT INFORMATION?

Use the cards below to get it quickly through . . .

## ELECTRONIC INDUSTRIES

& TELE-TECH

Listings continued from preceding page

- 344 Gates Radio Co.—1-kw high frequency transmitter  
345 General Electric Co., Radio Receiver Dept.—Engineering personnel  
346 General Electric Co., Ind. Computer Sect.—Engineering personnel  
347 General Radio Co.—Low loss variable air capacitors  
348 General Transistor Corp.—Phototransistor  
349 Graphite Metallizing Corp.—Brushes, contacts, and slip rings  
350 Helipot Corp., Beckman Insts., Inc.—Air-core potentiometers  
351 Hewlett-Packard Co.—Dual directional coaxial couplers  
352 Hughes Aircraft Co.—Variable persistence display tubes  
353 Hughes Aircraft Co.—Germanium diodes  
354 International Electronic Research Corp.—Heat-dissipating electron tube shields  
355 Johnson Co., E. F.—Pilot lights  
356 Jones Div., Howard B., Cinch Mfg. Co.—Barrier terminal strips  
357 Kaar Engineering Corp.—Conalert and conelrad monitors  
358 Kearfott Co., Inc.—Universal radar test sets  
359 Kester Solder Co.—Printed circuit soldering flux  
360 Kester Solder Co.—Flux core solder  
361 Los Alamos Scientific Lab.—Engineering personnel  
362 Magnetic Amplifiers Inc.—Transistor curve tracers and phase analyzers  
363 Mallory & Co., Inc., P. R.—Controls for printed circuits  
364 Measurements Corp.—Megacycle meter  
365 Melpar Inc.—Engineering personnel  
366 Midland Mfg. Co., Inc.—Glass crystal holders  
367 Motorola Inc.—Engineering personnel  
368 National Aircraft Corp.—Electronics research and development  
369 New Hermes Engravers Inc.—Drill and router for printed circuit plates  
370 N J E Corp.—Power supplies  
371 Non-Linear Systems, Inc.—Digital voltmeter  
372 Northrop Aircraft, Inc.—Engineering personnel  
373 Ohmite Mfg. Co.—MIL-R-26C resistors  
374 Onan & Sons Inc., D. W.—Electric plants for enclosed spaces  
375 Permag Corp.—Permanent magnets  
376 Phelps Dodge Copper Products Corp.—Coaxial cable  
377 Philco Corp., Lansdale Tube Co. Div.—High speed switching transistor  
378 Polarad Elec. Corp.—Direct reading microwave spectrum analyzer  
379 Polarad Elec. Corp.—Code modulated multiple-pulse microwave signal generator  
380 Radio Corp. of America—High current power supply  
381 Radio Corp. of America—Test instruments  
382 Radio Corp. of America Service Co., Inc.—Engineering personnel  
383 Radio Materials Corp.—Ceramic disc capacitors  
384 Radio Receptor Co., Inc.—Germanium diodes  
385 Rohn Mfg. Co.—TV and communication towers  
386 Shallcross Mfg. Co.—Miniature rotary selector switch  
387 Solar Mfg. Corp.—Ceramic by-pass capacitors  
388 Sprague Elec. Co.—High temperature insulated magnet wire  
389 Sprague Elec. Co.—Extended life electrolytic capacitors  
390 Stackpole Carbon Co.—Fixed composition resistors  
391 Stevens Manufacturing Co.—Thermostats  
392 Sylvania Microwave Tube Labs—Engineering personnel  
393 Tele-Dynamics Inc.—Voltage controlled oscillator  
394 Texas Instruments Incorporated—Transistors  
395 Transradio Ltd.—Coaxial cable and subminiature connectors  
396 Triad Transformer Corp.—Miniature and subminiature transformers  
397 Truscon Steel Div., Republic Steel Corp.—Antenna towers  
398 Tung-Sol Electric Inc.—Semiconductors  
399 Union Switch & Signal Div., Westinghouse Air Brake Co.—Selenium rectifiers  
400 United Transformer Co.—Hermetic power components  
401 University Loudspeakers, Inc.—Loudspeakers  
402 Weller Elec. Corp.—Soldering gun  
403 Westinghouse Elec. Corp.—High-power silicon rectifier  
404 Weston Elec. Instrument Corp.—Instruments  
405 White Industrial Div., S. S.—High value molded resistors  
406 Wiley, John. & Sons, Inc.—Color TV text  
407 Williams & Co., C. K.—Ferric oxides for ferrites

DON'T DELAY—MAIL CARD TODAY

NOT GOOD AFTER NOVEMBER 1, 1956

FIRST CLASS  
PERMIT NO. 36  
(Sec. 34.9, P.L.&R.)  
PHILA., PA.

FIRST CLASS  
PERMIT NO. 36  
(Sec. 34.9, P.L.&R.)  
PHILA., PA.

**BUSINESS REPLY CARD**

NO POSTAGE STAMP NECESSARY IF MAILED IN UNITED STATES

**POSTAGE WILL BE PAID BY**

**ELECTRONIC INDUSTRIES  
& Tele-Tech**

**CHESTNUT & 56th STS.,  
PHILADELPHIA 39, PA.**

Chilton Company

**BUSINESS REPLY CARD**

NO POSTAGE STAMP NECESSARY IF MAILED IN UNITED STATES

**POSTAGE WILL BE PAID BY**

**ELECTRONIC INDUSTRIES  
& Tele-Tech**

**CHESTNUT & 56th STS.,  
PHILADELPHIA 39, PA.**

Chilton Company



# MEMO

FROM: T. C. GAMS

TO: SYSTEM DESIGN ENGINEERS

SUBJECT: . . . and we mean **UNLIMITED!**

During the past 12 months, our research effort has been devoted to five advanced development programs. We selected these problems because we felt that the nation's missile and jet-frame programs would soon demand practical answers to them.

If you are up against the temperature, vibration, shock, reliability, size, and weight barriers, these new techniques are available to you at NJE—because NJE (as we have so often said) can create **POWER SUPPLIES UNLIMITED.**

1. **TRANSISTORIZED POWER SUPPLIES**  
Duplicate the regulation precision of vacuum-tube supplies at higher efficiency, with tubeless reliability and freedom from shock and vibration effects. Save weight and space. High-temperature types available in low power ranges.
2. **ULTRA-COMPACT SUPPLIES**  
Class H transformers, silicon diodes, ingenious mechanical configurations, new insulating and constructional materials lead to significant size and weight reductions at relatively high efficiencies.
3. **HIGH SPEED MAG-AMP SUPPLIES**  
All the stability and reliability of high-power magnetic-amplifier-regulated equipment without the crippling time-lag normally encountered.
4. **MIL-SPEC TECHNIQUES**  
Hermetically sealed supplies, splash-proof equipment, fully JAN-ized versions of commercial supplies. Complete environmental test facilities available for inplant inspection.
5. **HIGH ALTITUDE, HIGH VOLTAGE SUPPLIES**  
New techniques permit corona-free, regulated high voltage at 50,000 feet. Wide-range voltage adjustment, stabilities adequate for nuclear and photometric work, as well as CRT supply.

If you have a difficult power supply problem that fits into one of the above categories, talk it over with NJE...the one power supply source with competence and experience in every modern power supply technique.

Don't try to solve jet-age problems with propeller-age equipment.

*T. C. Gams*  
Director of Research



# NJE Corporation

Electronic Development & Manufacturing

345 COLUMBIA AVENUE, HENLWORTH, NEW JERSEY

Competent Engineering Representation Everywhere

Rapid, complete, competitive custom quotes from 1000 Amperes (or Voltage) to 250KV (or current)

P O W E R   S U P P L I E S   U N L I M I T E D



5" SCOPE — WO-91A

Dual-band; medium-priced; excellent for lab, production-line.



5" SCOPE — WO-78A

Dual-band; "engineer's choice" for research, service, color-TV production lines.



7" SCOPE — WO-56A

Direct-coupled identical "V" and "H" amplifiers; invaluable for phase measurements or vector display.



UHF SWEEP GENERATOR — WR-86A

Invaluable for UHF-TV, 300 to 950 Mc; wide sweep range, high output, excellent amplitude linearity.



AUDIO SIGNAL GENERATOR — WA-44A

Compact; 4-ranges, continuously tunable 11 cps to 100 Kc; for hi-fi measurements.

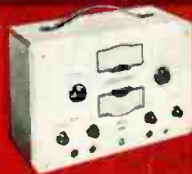

RF SIGNAL GENERATOR — WR-49A

Six ranges, continuous tuning, 85 Kc to 30 Mc, for signal tracing, aligning AM and FM sets, low-frequency TV if-channels.

5" SCOPE — WO-88A

General-purpose; direct-coupled; low in cost, yet high in quality.



DOT-BAR GENERATOR — WR-36A

Provides small-size dot pattern, "H" and "V" bars, fine-line crasshatch patterns.



MARKER-GENERATOR — WR-89A

Crystal-calibrated; has features required for accurate color or black-and-white TV alignment and trouble-shooting.



TV SWEEP GENERATOR — WR-59C

Covers 50 Kc to 50 Mc. Tops for aligning, trouble-shooting color and black-and-white TV.



COLOR-BAR GENERATOR — WR-61B

Generates signals for producing 10 different color-bars simultaneously; has four crystal-controlled oscillators.



DC MICROAMMETER WV-84A

Ultra-sensitive; measures extremely "feeble" currents, unusually high resistances, completely portable; self-contained batteries.



JUNIOR VOLTOHMYST — WV-77B

"Best VTVM value;" for general applications in industry, communications, electronics fields.



ELECTRON-TUBE MICROMHOMETER — WT-100A

Versatile tube tester with accuracy approaching that of tube-factory equipment for measuring true gm. Has many operational features especially suited for electronics equipment manufacturers, research and development, and maintenance groups... anyone desiring to test tubes under actual voltage and current conditions.



SENIOR VOLTOHMYST — WV-98A

Rugged die-cast case; high accuracy; wide-visibility meter (6 1/2" w.); for lab, production-line, general service.



MASTER VOLTOHMYST — WV-87A

Current facilities; large meter (7 1/2"); excellent for TV, radar, pulse, and other lab applications.

TAKE YOUR PICK OF THE BEST!

# RCA Test Instruments

for service • production • research

Your RCA Tube Distributor offers the most comprehensive line of high-quality test instruments available. Call him for complete details, fast delivery.



## TEST EQUIPMENT

Radio Corporation of America • Tube Division • Harrison, N. J.