

TELE-TECH

Formerly ELECTRONIC INDUSTRIES

TELEVISION • TELECOMMUNICATIONS • RADIO

**5 NY TV STATIONS
& 3 FMs, STACKED
ON NEW EMPIRE-
STATE MAST**



1466 FT. ABOVE STREET LEVEL
215 FT.

PROBABLE WCBS-FM ANTENNA LOCATION
(101.1 MC)

WCBS-TV
VIDEO 55.25 MC
AUDIO 59.75 MC

WABD
VIDEO 77.25 MC
AUDIO 81.75 MC

PROBABLE WJZ-FM ANTENNA LOCATION
(95.5 MC)

WJZ-TV
VIDEO 175.25 MC
AUDIO 179.75 MC

WPIX
VIDEO 199.25 MC
AUDIO 203.75 MC

PROBABLE WNBC-FM ANTENNA LOCATION
(97.1 MC)

WNBT
VIDEO 67.25 MC
AUDIO 71.75 MC

MICROWAVE
REMOTE
PICKUPS

- Improved Video Recordings
- G Curves for Pentode Design
- Wide-Range Decade Generator

SHARE THIS COPY!
Please Route to:

November • 1950

HIGH FREQUENCY INDUCTANCE HEADACHES?



CORNING HAS THE CURE!

**HERE ARE A FEW
OF THE UNLIMITED
DESIGN POSSIBILITIES**

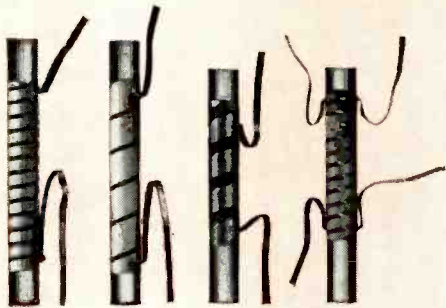

Corning Metallized Inductances are superior in every way for high frequency applications. Their electrical characteristics include low temperature coefficients, high Q and high stability. The smooth glass wall insures noiseless tuning and fine adjusting screws permit rapid and accurate alignment.

CORNING GLASS WORKS

ELECTRONIC SALES DEPARTMENT

Inductances used in television and F.M. tuners have a whale of an effect on the ultimate performance of the set. If they are unstable when subjected to vibration or temperature changes, you're in for trouble. You can forget about these problems by using Corning Metallized Glass Inductances.

With Corning Inductances, the integral contact of fired-on metallizing with specially selected glass forms, provides unusually high temperature stability. Drift is negligible, even under extreme temperature changes. And the unique, rugged construction of Corning Inductances makes them unaffected by rough handling or vibration. *This all adds up to inductances that are completely trouble-free.*

There is no limit to the design possibilities of Corning Inductances. Your most exacting specifications can be met in fixed tuned, permeability tuned or permeability inductance-trimmer combinations. Variable, double pitch or uniform windings are easily supplied. Assembly is quickly and simply accomplished by ordinary soldering or grommeting methods.

Put your inductance headaches in the hands of Corning engineers. Find how easy it is to get improved tuner performance at low cost. Further information on request. Write today.



CORNING, N. Y.

Corning means research in Glass

METALLIZED GLASSWARE: INDUCTANCES · CAPACITORS · BUSHINGS · ALSO A COMPLETE LINE OF TELEVISION TUBE BLANKS

TELE-TECH

Formerly ELECTRONIC INDUSTRIES

TELEVISION • TELECOMMUNICATIONS • RADIO

Edited for the 15,000 top influential engineers in the Tele-communications industry, TELE-TECH each month brings clearly written, compact, and authoritative articles and summaries of the latest technological developments to the busy executive. Aside from its engineering articles dealing with manufacture and operation of new communications equipment, TELE-TECH is widely recognized for comprehensive analyses and statistical surveys of trends in the industry. Its timely reports and interpretations of governmental activity with regard to regulation, purchasing, research, and development are sought by the leaders in the many engineering fields listed below

Manufacturing

TELEVISION • FM
LONG & SHORT WAVE RADIO
AUDIO AMPLIFYING EQUIPMENT
SOUND RECORDERS &
REPRODUCERS
AUDIO ACCESSORIES
MOBILE • MARINE • COMMERCIAL
GOVERNMENT
AMATEUR COMMUNICATION
CARRIER • RADAR • PULSE
MICROWAVE • CONTROL SYSTEMS

Research, design and production of special types
TUBES, AMPLIFIERS, OSCILLATORS,
RECTIFIERS, TIMERS, COUNTERS,
ETC. FOR
LABORATORY • INDUSTRIAL USE
ATOMIC CONTROL

Operation

Installation, operation and maintenance of telecommunications equipment in the fields of
BROADCASTING • RECORDING
AUDIO & SOUND • MUNICIPAL
MOBILE • AVIATION
COMMERCIAL • GOVERNMENT

NOVEMBER, 1950

COVER: AN ENGINEER'S DRAWING of the television antennas which will be operating on New York City's Empire State Building late this year or early 1951. Sketch on the left shows artist's conception of the completed tower. Photo on the right was taken during initial stages of construction. NBC and ABC temporary TV antennas can be seen projecting above the scaffolding. See page 45 for detailed account.

TESTING AND ALIGNING VIDEO AMPLIFIERS. .F. E. Cone and N. P. Kellaway 24
Relatively new technic of equipment adjustment for television amplifiers is discussed and logical system indicated

A 30-ELEMENT ELECTROSTATICALLY-FOCUSED RADIAL BEAM TUBE
A. M. Skellett and P. W. Charton 26
Trend in tubes based on control by electron beam deflection typified by high-speed sequential switching tube

AIR-COOLED 5 KW BROADCAST TRANSMITTERE. L. Petery 28
Trend away from water cooling is emphasized by simplicity of operation and elimination of ancillary cooling devices

CUES FOR BROADCASTERS 30

VIDEO RECORDINGS IMPROVED BY THE USE OF CONTINUOUSLY MOVING FILMW. D. Kemp 32
Elimination of line structure obtained by optically "stopping" the film and applying a 10-15 MC modulation to beam

WIDE RANGE DECADE FREQUENCY GENERATORJ. M. Shaul 36
When filtered outputs of 100 KC source are used with auxiliary harmonic generator, many markers may be obtained

USE OF CONDUCTANCE CURVES FOR PENTODE CIRCUIT DESIGN
K. A. Pullen 38
Solution of circuit problems involving electron tube characteristics simplified by method of tube curve presentation

PAGE FROM AN ENGINEER'S NOTEBOOK — NUMBER 10 41
Modified Resonant Circuits Match Impedances—P. G. Sulzer

MODIFIED TV FIELD SWITCHERC. J. Auditore 43
Minor changes in TS-30A switcher increase usefulness of equipment by providing additional camera control facilities

GRADE OF FELLOW CONFERRED ON 41 BY IRE 44

EMPIRE STATE MAST CARRIES 5 TV AND 3 FM ANTENNAS 45

MILITARY CONTRACT AWARDS 57

DEPARTMENTS: Tele-Tips 4
Editorial 21
Radarscope 22
Washington News Letter . 46
New Equipment 48
Personnel 53
News 54, 55
Bulletins 66

CALDWELL-CLEMENTS, INC., Publication, Office, Orange, Conn., Editorial & Executive Offices 480 Lexington Ave., New York 17, N. Y., Tel. Plaza 9-7880
Publishers also of RADIO & TELEVISION RETAILING

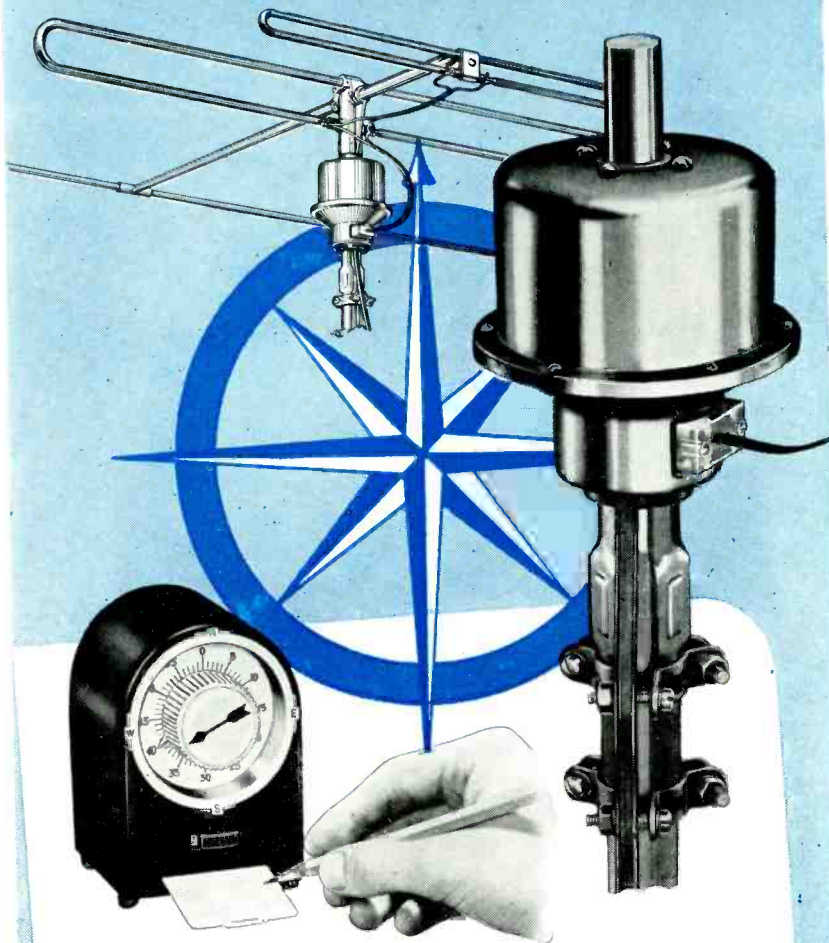

"AUTO-DIAL" TV ANTENNA ROTATOR

With *Automatic* TRAVEL ACTION

AMPHENOL takes pride in announcing the new "Auto-Dial" TV Antenna Rotator. It features an entirely new and different principle of rotator control called "automatic travel action," and represents the greatest single advance in antenna rotators.

There are no tiresome buttons or switches to hold while the antenna is turning. An effortless turn of the knob to the correct setting and "Auto-Dial" takes over. Automatically—just like magic—the antenna follows to point directly at the TV station—then stops!

So accurately does it perform that even a child can "log" antenna positions, accurately returning to them time after time. Rotation is in steps of 6 degrees, accurately calibrated on the indicator. Because of this important feature, servicemen can now determine whether an antenna is functioning properly, whether it has the required front-to-back ratio and whether it is properly located for the best possible picture.

FEATURES

- Completely Automatic—no tiresome buttons or switches to hold while antenna turns!
- Antenna Rotates Rapidly—one revolution every 22 seconds!
- Heavy-Duty Motor, Sturdy Construction—easily handles stacked arrays!
- Housing of cold-rolled steel, copper flashed and with attractive baked-on enamel finish!
- Neoprene Sealed at Factory Against Dirt and Moisture!
- Accommodates Mast Sizes from 3/4" to 2" Diameter!

See It At Your Jobber Or Write For Illustrated Folder
Another AMPHENOL Development For Your Greater TV Enjoyment

AMPHENOL

AMERICAN PHENOLIC CORPORATION

TELE-TECH

TELEVISION • TELECOMMUNICATIONS • RADIO
Formerly ELECTRONIC INDUSTRIES

O. H. CALDWELL
Editorial Director

M. CLEMENTS
Publisher

BERNARD F. OSBAHR
Associate Editor

JOHN H. BATTISON
Associate Editor

H. D. WULFORST
Assistant Editor

CHARLES DREYER
Art Director

R. C. DAVIES
News Editor
National Press Bldg.
Washington, D. C.

DR. A. F. MURRAY
Consulting Editor
4707 Windom Pl.
Washington, D. C.

CIRCULATION

B. V. SPINETTA, Circulation Director

M. GROENING

Subscriptions, List Compilation

BUSINESS DEPARTMENT

M. H. NEWTON, Business Manager
HOWARD A. REED, Sales Manager
JOSEPH DRUCKER, District Manager
480 Lexington Ave., New York 17, N. Y.

S. M. GASKINS, Western Manager
201 N. Wells St., Chicago 6, Ill.
Telephone RAndolph 6-9225

CHRIS DUNKLE & ASSOCIATES
Southern California Representative
2506 W. 8th Street, Los Angeles 5, Calif.
Telephone DUmkirk 7-6149

W. W. SWIGERT,
Credit Manager

N. McALLISTER, Director Reader Service

M. IMMEL, Production Supervisor

M. TEMMEL, Editorial Secretary

TELE-TECH*, November 1950, Vol. 9, No. 11. 40 cents a copy. Published Monthly by Caldwell-Clements, Inc. Publication office, Orange, Conn. Editorial, Advertising and Executive Offices, 480 Lexington Ave., New York 17, N. Y. M. Clements, President; Orestes H. Caldwell, Treasurer. Subscription rates: United States and Possessions, \$3.00 for one year, \$5.00 for two years. Canada, \$4.00 for one year, \$6.00 for two years. All other countries, \$5.00 for one year, \$7.00 for two years. Please give title, position and company connection when subscribing. Entered as second class matter June 9, 1947 at the post office at Orange, Conn., under the act of March 3, 1879. Copyright by Caldwell-Clements, Inc., 1950. Printed in U. S. A. *Reg. U. S. Pat. Off.

Standardize on Dependability

AUTOMATIC  ELECTRIC

CHICAGO

RELAYS

In Automatic Electric's complete line of relays, there are over forty basic types—offering spring and coil combinations in almost infinite number. They are dependable and proved products of an organization that has made electrical remote control its business for more than fifty years.

New Class "B" Relays

The newest and most outstanding member of Automatic Electric's relay family is the Class "B"—even better than the widely used, *widely copied* Class "A" Relay. Designed for ordinary relay service—opening, closing or switching circuits—and for extremely high-speed operation. Independently operating twin contacts assure perfect contact operation. Contact points are dome-shaped to maintain uniformly low contact resistance. May be arranged in one or two pileups with maximum of 16 contacts on 13 springs in each pile.

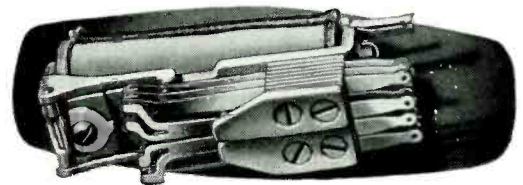

Hermetic Sealing Available To Maintain Automatic Electric Quality

All Automatic Electric Relays can be obtained in hermetically sealed housings to maintain the high quality for which these relays are famed. The "sealed-in" controlled atmosphere protects them from electrical or mechanical failure resulting from varying conditions of temperature, dust, humidity, acid, fungus or air pressure—and makes them completely tamper-proof.

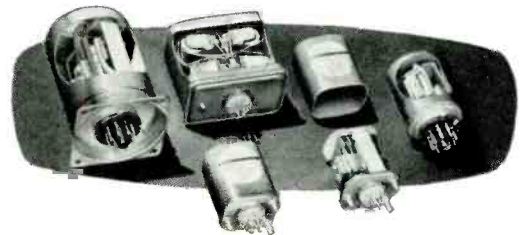

SWITCHES

Automatic Electric Stepping Switches are designed and built to assure exceptionally long life. A complete range of Automatic Electric Switches is available for all remote control applications.

The New Type 45 Switch

Here, for example, is a rotary switch that's new and better! *Faster*... 70 steps a second. *Greater capacity*... up to 10 (or more) 25-point bank levels, with single-ended wipers available for 50-point operation. *Simpler*... only one field adjustment.

Compact rotary and re-set type switches are also available with 10-point bank levels and speeds of 35 steps a second for automatic or remote-control operations.

And there's the famous "Two-Motion Switch" that selects one circuit from among two hundred in just 2 seconds or less. It's a re-set type switch adaptable to either automatic or remote control.

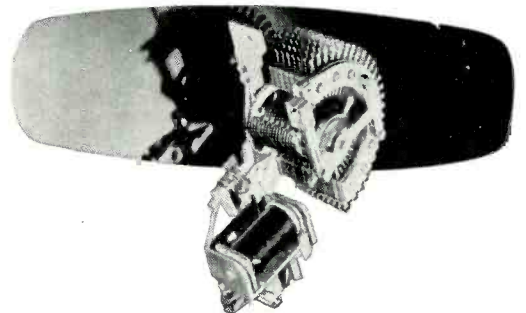

For help in the field of remote control, call in an Automatic Electric field engineer. Meanwhile, send for helpful literature. Address AUTOMATIC ELECTRIC SALES CORPORATION, Chicago 7, Ill. In Canada: Automatic Electric (Canada) Ltd., Toronto.

RELAYS

SWITCHES

AUTOMATIC  ELECTRIC

CHICAGO

"Have some pudding?"

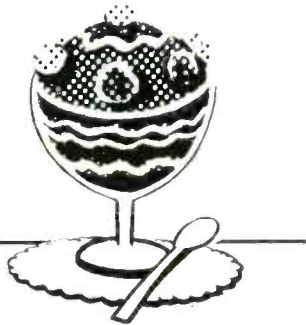

You have to try it before you can appreciate the taste—until then—you can't prove it's good.



"The proof of the pudding is in the eating" is a time-worn adage—and, if it's been around so long, there's a chance that there is a lot of common sense packed in those few words.



We don't mean to suggest that Soundcraft discs taste good. What we would like to get over is that, until you try Soundcraft products, we can talk our heads off about how good they are.



Use Soundcraft products in your operations—you'll prove for yourself that all Soundcraft recording media will guarantee you the one thing they are designed for—the best possible performance in recording sound.

SOUNDCRAFT'S ONLY CLAIM IS ITS PROOF OF PERFORMANCE

REEVES — "20 YEARS WITH SOUND RECORDING MEDIA."

REEVES Soundcraft CORP.

35-54 36th STREET, LONG ISLAND CITY 6, N. Y.

EXPORT—REEVES EQUIPMENT CORP. • 10 E. 52ND, N. Y. 22, N. Y.

TELE-TIPS

PROJECTION SAMPLER—A new motion-picture projector for outdoor theatres provides for showing on two screens at right angles, simultaneously, by means of a "stripe mirror" interposed in the projection beam. This mirror has vertical half-inch clear-glass stripes between half-inch mirror stripes. Thus half the total picture light-flux goes on through to the screen in front,—while the other half is reflected onto a second reversing mirror which re-directs the reflected beam onto screen No. 2 in another section of the theatre lot. While each screen thus gets only one-half the usual illumination, the pictures appear "solid", since the slitted reflector is not at the beam focus and the otherwise dark strips are filled in.

PULLMAN RESERVATIONS—

Like all other fields wherein electronic methods are involved, the communication art is taking on added
(Continued on page 14)

FUSES

*Precision
Engineering
Your
Guarantee*



WE WILL BE TO
THE FUSES DIV.

LITTELFUSE

4757 N. RAVENSWOOD AVE., CHICAGO 40, ILL.

**Better TV picture resolution
... better picture gamma**

**...with this
SYLVANIA Type 1N60
Germanium Diode**

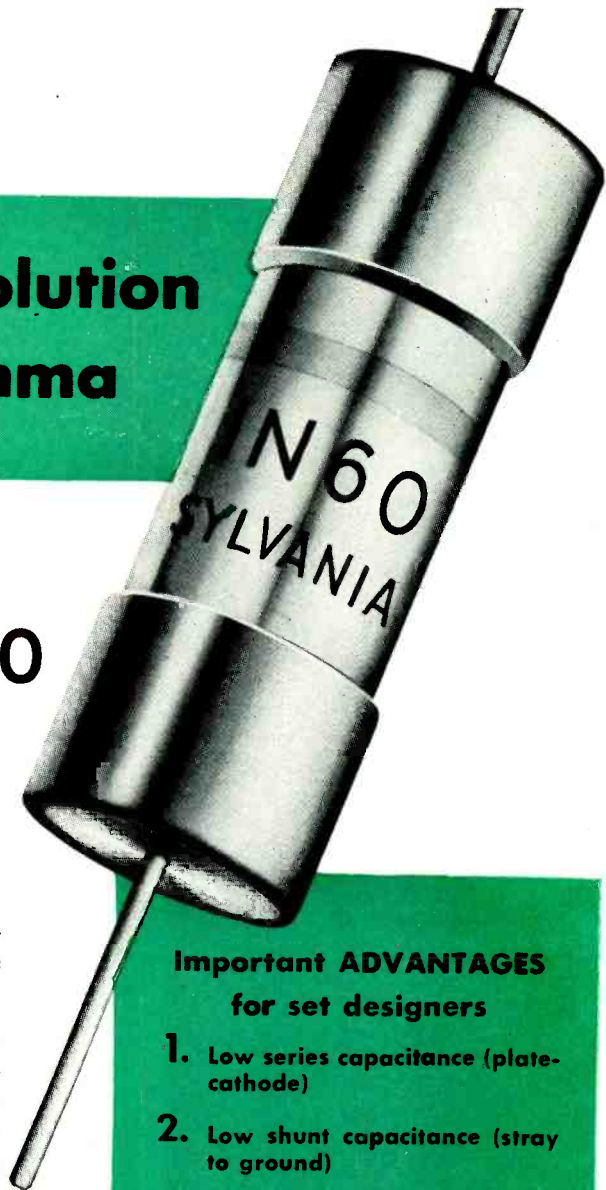

This diode is a point contact rectifier, designed for efficient and dependable service as a video detector diode for TV receivers.

In terms of set performance, the efficiency of this Sylvania Germanium Diode means better picture resolution, especially at low signal levels. The improved linearity means better picture gamma, or range of picture contrast, in the near white regions where human vision is most critical.

Rugged Construction

The Sylvania 1N60 has construction features which assure long, trouble-free life and electrical stability. Flexible tinned leads are swaged to nickel end caps which are welded to threaded brass plugs. These plugs are screwed and firmly cemented into a strong ceramic body, thus providing a thermal reservoir, insulating the pig-tails from the active element and permitting close soldering. For further information mail the coupon today.

**Important ADVANTAGES
for set designers**

1. Low series capacitance (plate-cathode)
2. Low shunt capacitance (stray to ground)
3. Complete freedom from hum
4. Absence of contact potential
5. Compact size and ease of mounting
6. Ruggedness and permanence of ceramic
7. Built-in thermal insulation ... (no soldering danger)

ELECTRONIC DEVICES;
RADIO TUBES; TELE-
VISION PICTURE TUBES;
ELECTRONIC TEST
EQUIPMENT; FLUORES-
CENT TUBES, FIX-
TURES, SIGN TUBING,
WIRING DEVICES; LIGHT
BULBS; PHOTOLAMPS;
TELEVISION SETS

SYLVANIA

ELECTRIC

Sylvania Electric Products Inc.
Advertising Dept. E-1211
Emporium, Pa.

Please send me ratings and full information
about Sylvania Germanium Diode, Type 1N60.

Name _____
Company _____
Street _____
City _____ Zone _____ State _____

the 4-400A

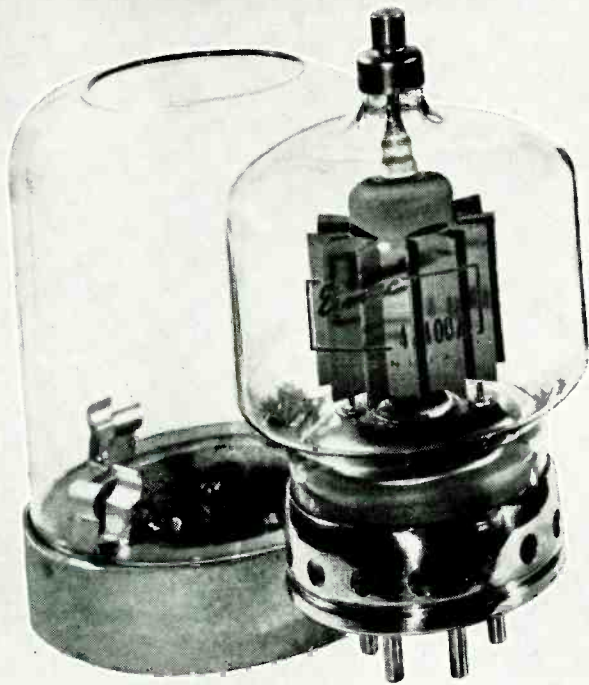

- ★ Long Life
- ★ Low Drive
- ★ RF Amplifier
- ★ Audio Amplifier
- ★ Simplified Cooling
- ★ Pyrovac Plate
- ★ Non-Emitting Grids
- ★ And . . . thoroughly proved in service.

EIMAC 4-400A POWER TETRODE
TYPICAL OPERATION
AUDIO FREQUENCY POWER AMPLIFIER
AND MODULATOR

Class AB₁ (Sinusoidal wave, two tubes,
unless otherwise specified)

DC PLATE VOLTAGE	3000	4000	Volts
DC SCREEN VOLTAGE	750	600	Volts
DC GRID VOLTAGE (approx.)*	-136	-116	Volts
ZERO SIGNAL DC PLATE CURRENT	160	130	Ma
MAX. SIGNAL DC PLATE CURRENT	620	510	Amp
ZERO SIGNAL DC SCREEN CURRENT	0	0	Ma
MAX. SIGNAL DC SCREEN CURRENT	28	10	Ma
EFFECTIVE LOAD PLATE TO PLATE	9200	16,000	Ohms
PEAK AF GRID INPUT VOLTAGE (per tube)	136	116	Volts
DRIVING POWER	0	0	Watts
MAX. SIGNAL PLATE POWER OUTPUT	1100	1280	Watts

Adjust to give stated zero-signal plate current.

A pair of Eimac 4-400A tetrodes provides the ideal answer for a one-kilowatt AM or FM broadcast power amplifier stage. The 400-watt plate dissipation rating of these tubes allows extremely conservative operation at the 1-kw level, thus assuring long, trouble-free tube operation.

In AM service, the 4-400A is FCC rated for 500 watts output per tube in high level modulated amplifiers. In FM applications, the superlative performance of the 4-400A at VHF allows an easy 1-kw of useful power output from a pair of tubes.

The low driving-power requirement of these tetrodes allows the driving equipment to be reduced to simple low power stages employing low cost tubes. The rugged construction of the 4-400A, plus a Pyrovac plate and the use of other time-proven materials and manufacturing processes, contributes to the tube's long life and ability to withstand both physical and electrical abuse.

To simplify transmitter design, an Eimac air system socket and chimney assembly is available for the 4-400A. This assembly provides a balanced flow of cooling air to the tube with minimum air waste, as well as completing the shielding between input and output circuits.

The low driving-power required by the 4-400A makes it an ideal choice for audio as well as r-f application. High audio power at low distortion can easily be obtained with zero driving power. (See accompanying data.)

For tube economy in one-kilowatt equipment, consider the service-proven 4-400A developed by America's foremost tetrode manufacturer . . . Eimac. Complete technical data are available . . . write today.

Follow the Leaders to

Eimac
TUBES

The Power for R-F

EITEL-McCULLOUGH, INC.
San Bruno, California

Export Agents: Frazar & Hansen, 301 Clay St., San Francisco, California

When television won its wings

How multiple uses for airborne cameras and equipment were revealed by experiment

No. 10 in a series outlining high points in television history

Photos from the historical collection of RCA

• Put a television camera in the nose of an observation plane, and generals—many miles away—can watch and direct the course of a battle. Such, in World War II, was one of the suggested uses of airborne television as an “optic nerve.”

Feasible? Absolutely—yet this is only one of the many ways in which television can serve in fields outside those of news and entertainment. The entire subject of the use of television cameras and receivers in the air has been carefully investigated by RCA.

Not too long ago, at the time when plans for our inter-city television networks were in discussion, the

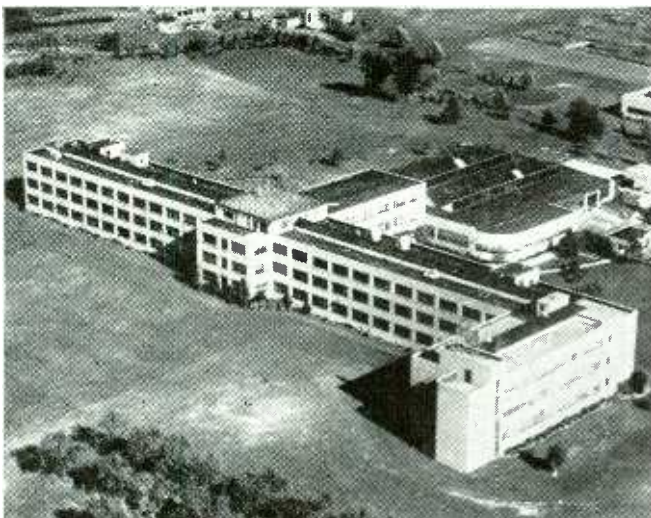

RCA Laboratories in Princeton, N. J., as seen from the air. New uses for television—including, for example, its adaptation to aviation—are one part of this progressive institution's research program.



Mounted in the nose of an airplane, special RCA airborne television equipment will give ground observers a sharp, clear, bird's-eye view of land and sea.

idea of making telecasts from planes high in the air was proposed.

From New York, a plane equipped with a television receiver, set off on a flight to Washington—200 miles away. When above Washington, at an altitude of 18,000 feet, passengers in the plane clearly saw Brig. General David Sarnoff, of RCA, talking to them from Radio City! Later, RCA placed a camera and transmitting equipment in an airliner, and a bird's-eye view of New York was successfully telecast to observers below!

It has also been proposed by authorities, that a television camera might be used as the “eye” of a guided missile. Placed in a rocket's nose it would let a distant operator see where the missile was headed. If need be he could steer it in any direction to hit a moving target.

But less on the destructive side, and more important to us now, are the possible uses of television in “blind flying” conditions, when airports would normally be closed in from bad weather. With a television receiver in the cockpit, and a transmitter sending information from the landing field ahead, the pilot could clearly see conditions on runways and approaches—come in with far greater security than when guided by radio alone!



Radio Corporation of America
WORLD LEADER IN RADIO—FIRST IN TELEVISION

now **color** tv for industry!

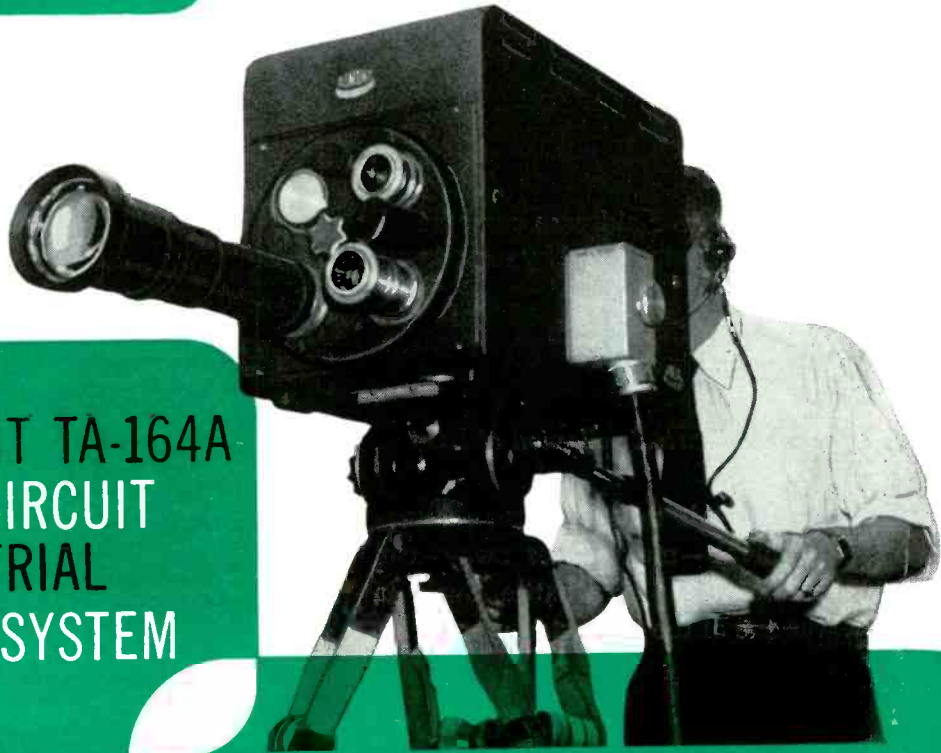

THE DU MONT TA-164A CLOSED CIRCUIT INDUSTRIAL COLOR TV SYSTEM



Now available! The Du Mont tried-and-proved industrial color television system in a complete, packaged, ready-to-operate form. Designed specifically for industrial applications, the new Du Mont TA-164A Industrial Color TV system provides bandwidth of 18 mc. and picture resolution of 525 lines. Full high-fidelity color from light pastels to deep colors.

Engineered to provide dependable day-in day-out service required by industry, research, medicine, merchandising and countless other fields. Compact, lightweight, portable units are joined by interconnecting cables utilizing the famous Du Mont "Jiffy" connectors assuring complete flexibility and the Du Mont kind of dependability. May be plugged into power line anywhere. Operates on 110-volt 60-cycle AC.

► DETAILS ON REQUEST

DU MONT



First with the Finest in Television

ALLEN B. DU MONT LABORATORIES, INC.
Television Transmitter Division, Clifton, N.J.

3 NEW RMC SPECIAL PURPOSE CONDENSERS FOR YOUR SPECIAL PURPOSE PROBLEMS!

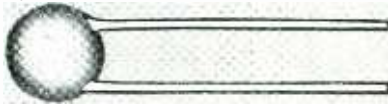

1/2"

..... RMC Type 2K DISCAP

Rated at 2000 Volts

Negative 750TC – available in capacities between 25-75 MMF. in tolerances of $\pm 5\%$, $\pm 10\%$, $\pm 20\%$. Tested at 4000 V.D.C. Developed especially for deflection yoke applications.

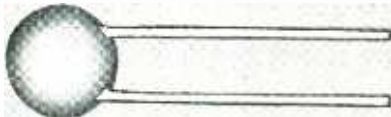

9/16"

..... RMC Type 3K DISCAP

Rated at 3000 Volts

Negative 1400TC – available in capacities between 75-180 MMF. in tolerances of $\pm 5\%$, $\pm 10\%$, $\pm 20\%$. Tested at 6000 V.D.C.

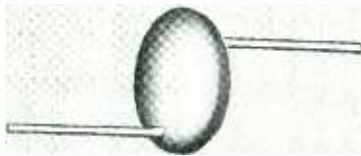

3/4"

..... RMC Type 6K DISCAP

Rated at 6000 Volts

Negative 750TC – available in capacities between 10-40 MMF. in tolerances of $\pm 5\%$, $\pm 10\%$, $\pm 20\%$. Tested at 12000 V.D.C. Designed for use as a damper tube by-pass.

RMC Type B-GMV and Type C Temperature Compensating DISCAPS

RMC DISCAPS are approved by leading makers of TV sets, tuners and high frequency electronic equipment. Type B-GMV DISCAPS are available in the following capacities: .001, .0015, .002, .005, 2x.001,

2x.0015, 2x.002, 2x.004, 2x.005 MFD. Type C temperature compensating DISCAPS are available in a range between NPO and N2200TC and in capacities from 5 to 150 MMF.

Every DISCAP is 100% Tested for Capacity, Leakage Resistance and Breakdown

SEND FOR SAMPLES AND TECHNICAL DATA

DISCAP
CERAMIC
CONDENSERS



RADIO MATERIALS CORPORATION

GENERAL OFFICE: 1708 Belmont Ave., Chicago 13, Ill.

FACTORIES AT CHICAGO, ILL. AND ATTICA, IND.

Two RMC Plants Devoted Exclusively to Ceramic Condensers

A complete line

for
RESISTORS
too!

Unusual combinations of characteristics required in today's critical electronic circuits demand a complete range of resistor types.

Specializing in resistors, IRC makes the widest line in the industry. This means ease of procurement—a single dependable source of supply for *all* your resistance

needs. It also means unbiased recommendations—no substitution of units "just as good". IRC's complete line of products; complete research and testing facilities; complete network of licensees for emergency production—all add up to complete satisfaction for you.



PRECISION RESISTORS

IRC Precision Wire Wounds offer a fine balance of accuracy and dependability for close-tolerance applications. Extensively used by leading instrument makers, they excel in every significant characteristic. Catalog Bulletin D-1.

IRC Deposited Carbon PRECISTORS combine accuracy and economy for close-tolerance applications, where carbon compositions are unsuitable and wire-wound precisions too expensive. Catalog Bulletin B-4.

IRC Matched Pairs provide a dependable low-cost solution to close-tolerance requirements. Both Type BT and BW Resistors are available in matched pairs. Catalog Bulletin B-3.

IRC Sealed Precision Voltmeter Multipliers are suitable and dependable for use under the most severe humidity conditions. Each consists of several IRC Precisions mounted and interconnected, encased in a glazed ceramic tube. Catalog Bulletin D-2.

CONTROLS

IRC Type W Wire Wound Controls are designed for long, dependable service and balanced performance in every characteristic. These 2-watt variable wire wound units provide maximum adaptability to most rheostat and potentiometer applications within their power rating. Catalog Bulletin A-2.

IRC New Type Q Controls feature small $1\frac{1}{16}$ " size, rugged construction and superior performance. Increased arc of rotation permits same resistance ratios successful in larger IRC Controls. Catalog Bulletin A-4.

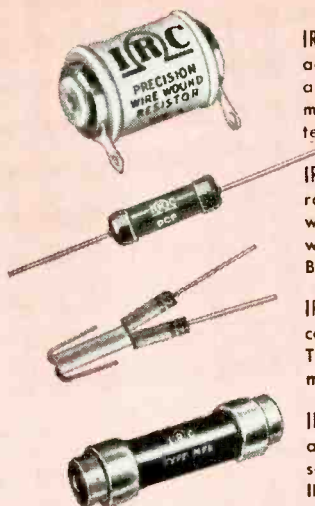

is essential

HIGH FREQUENCY and HIGH POWER RESISTORS

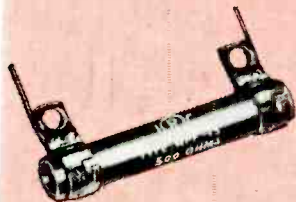

IRC Type MP High Frequency Resistors afford stability with low inherent inductance and capacity in circuits involving steep wave fronts, high frequency measuring circuits and radar pulse equipment. Available in sizes from 1/4 to 90 watts. Catalog Bulletin F-1.



Type MV High Voltage Resistors utilize IRC's famous filament resistance coating in helical turns on a ceramic tube to provide a conducting path of long, effective length. Result: Exceptional stability even in very high resistance values. Catalog Bulletin G-1.

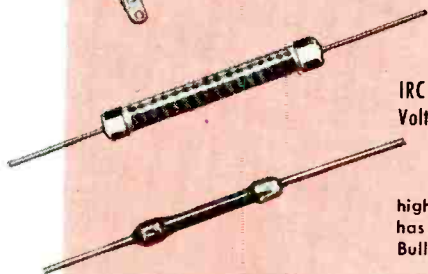

IRC Type MVX High Ohmic, High Voltage Resistors meet requirements for a small high range unit with axial leads. Engineered for high voltage applications, MVX has exceptional stability. Catalog Bulletin G-2.

IRC Type MPM High Frequency Resistors are miniature units suitable for high frequency receiver and similar applications. Stable resistors with low inherent inductance and capacity. Body only 3/8" long. Catalog Bulletin F-1.

INSULATED COMPOSITION and WIRE WOUND RESISTORS

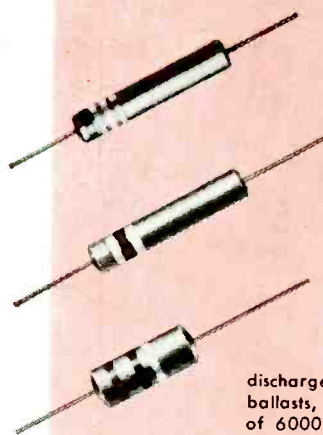

IRC Advanced Type BT Resistors meet and beat JAN-R-11 Specifications at 1/2, 1 and 2 watt combine extremely low operating temperature with excellent power dissipation. Catalog Bulletin B-5.

IRC Type BW Wire Wound Resistors are exceptionally stable, inexpensive units for low range requirements. Have excellent performance records in TV circuit meters, analyzers, etc. Catalog Bulletin B-5.

IRC Type BTAV High Voltage Resistors, developed for use as discharge resistors in fluorescent "Quick Start" ballasts, withstand momentary peak surges of 6000 volts. Also suited to TV bleed circuits. Catalog Bulletin B-1.

POWER RESISTORS

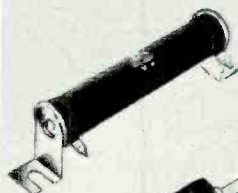

IRC Fixed and Adjustable Power Wire Wounds give balanced performance in every characteristic — are available in a full range of sizes, types and terminals for exacting, heavy-duty applications. Catalog Bulletin C-2.



IRC Type FRW Flat Wire Wound Resistors fulfill requirements of high wattage dissipation in limited space — may be mounted vertically or horizontally, singly or in stacks. Catalog Bulletin C-1.



IRC Type MW Wire Wound Resistors offer low initial cost, lower mounting cost, flexibility in providing taps, and saving in space. Completely insulated against moisture. Catalog Bulletin B-2.

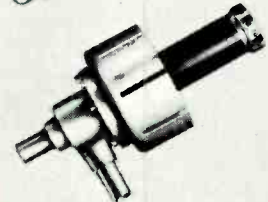

IRC Type LP Water-Cooled Resistors for TV, FM and Dielectric Heating Applications. Cooled internally by high velocity stream of water; adjustable to local water pressure and power dissipation up to 5 K.W.A.C. Catalog Bulletin F-2.

Wherever the Circuit Says 

- Power Resistors • Voltmeter Multipliers
- Insulated Composition Resistors • Low Wattage Wire Wounds • Volume Controls • Voltage Dividers • Precision Wire Wounds • Deposited Carbon Precistors • Ultra-HF and High Voltage Resistors • Insulated Chokes

25 YEARS YOUNG
IN 1950!



INTERNATIONAL RESISTANCE COMPANY

PHILADELPHIA 8, PENNSYLVANIA

In Canada: International Resistance Company, Ltd., Toronto, Licensee

INTERNATIONAL RESISTANCE CO.
407 N. BROAD ST., PHILADELPHIA 8, PA.

Please send me Technical Data Bulletins checked below:

- | | | |
|--|--|---|
| <input type="checkbox"/> Bulletin A-2 (W) | <input type="checkbox"/> Bulletin B-4 (DC) | <input type="checkbox"/> Bulletin F-1 (MP) |
| <input type="checkbox"/> Bulletin A-4 (Q) | <input type="checkbox"/> Bulletin B-5 (BW) | <input type="checkbox"/> Bulletin F-1 (MPM) |
| <input type="checkbox"/> Bulletin B-1 (BT) | <input type="checkbox"/> Bulletin C-1 (FRW) | <input type="checkbox"/> Bulletin F-2 (LP) |
| <input type="checkbox"/> Bulletin B-1 (BTAV) | <input type="checkbox"/> Bulletin C-2 (PW/W) | <input type="checkbox"/> Bulletin G-1 (MV) |
| <input type="checkbox"/> Bulletin B-2 (MW) | <input type="checkbox"/> Bulletin D-1 (WW) | <input type="checkbox"/> Bulletin G-2 (MVX) |
| <input type="checkbox"/> Bulletin B-3 (M/P) | <input type="checkbox"/> Bulletin D-2 (MF) | |

NAME

TITLE

COMPANY

ADDRESS

CITY ZONE STATE

THE TOWER OF STRENGTH

IDEAL FOR
COMMUNICATIONS
MICROWAVE
TELEVISION
LIGHTING

Superior construction features give **LOW COST Vee-D-X sectional towers** the highest safety factor of any tower in its price class.

If you have an elevated installation problem, absolute permanency of your installation is assured when you use a VEE-D-X sectional tower. Strength is a major factor. Don't take chances with structural failure. Be sure with VEE-D-X!

- *Rugged, all-welded construction diagonally laced with angle iron for maximum rigidity.*
- *Can be erected on ground or on flat or peaked roof.*
- *Patented plate spaced at two foot intervals prevents twisting and affords rigidity found in no other tower.*
- *Safe and easy to climb.*
- *Completely galvanized, light weight tubular steel . . . 20 ft. section 72 lbs.*

PRE-ASSEMBLED for fast, inexpensive installation

VEE-D-X towers are designed for use at any height from 10 to 140 feet. They are self-supporting up to 20 feet and, where space is limited, *semi-guyed** type installations may be used at 30, 40, and 50 foot heights. Sketch at right shows the basic parts and necessary accessories for a complete installation. Three types of top mount are available. VEE-D-X towers may be ordered in separate units or as a complete package for a specific height. (Either guyed or semi-guyed.) Write the LaPointe-Plascomold Corporation of Unionville, Conn. for complete information.

*Semi-guyed towers employ one set of guy cables attached at a height of 10 ft. up the tower and anchored at a 6 ft. radius from the base.

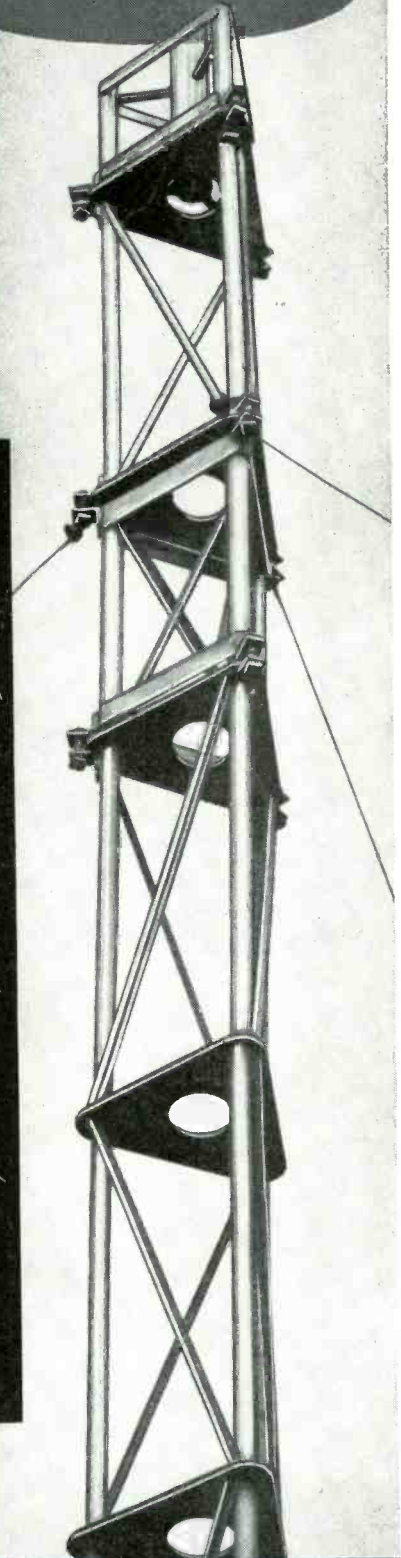
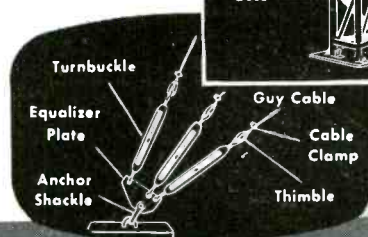
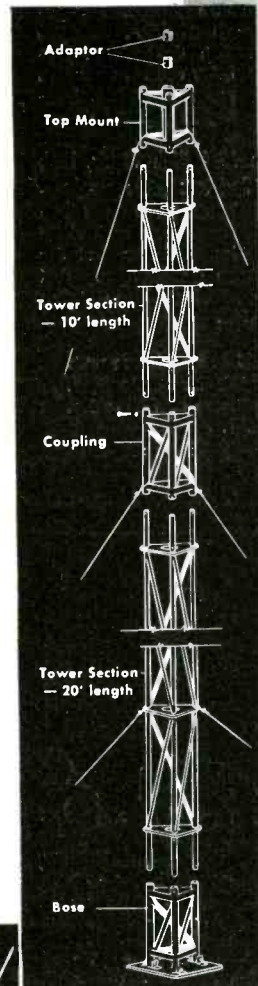

VEE-D-X

BUILDERS OF THE WORLD'S MOST POWERFUL ANTENNAS

AN IMPORTANT MESSAGE FROM *Federal* FOR USERS OF RG TYPE CABLES



Federal Telephone and Radio Corporation has received approval to manufacture – and can supply – RG type cables with the

NEW LOW-TEMPERATURE NON-CONTAMINATING THERMOPLASTIC JACKET

(An original development by Federal)

This modification is in accordance with "Exceptions to Specification JAN-C-17A," dated March 21, 1949, and amendments thereto.

THESE ARE THE TYPES APPROVED TO DATE—

RG-5B/U RG-6A/U RG-8A/U RG-9B/U RG-10A/U RG-11A/U
RG-12A/U RG-13A/U RG-21A/U RG-22B/U RG-59A/U
RG-58C/U RG-62A/U RG-63B/U RG-65A/U RG-79B/U

Review your requirements now—to insure prompt delivery!

*For further details on present and subsequent approvals,
write or wire Dept. D-466 or telephone NUtley (N.J.) 2-3600*

ANOTHER "Federal FIRST"

Federal Telephone and Radio Corporation



SELENIUM and INTELIN DIVISION, 100 Kingsland Road, Clifton, New Jersey
In Canada: Federal Electric Manufacturing Company, Ltd., Montreal, P. Q.
Export Distributors: International Standard Electric Corp., 67 Broad St., N.Y.

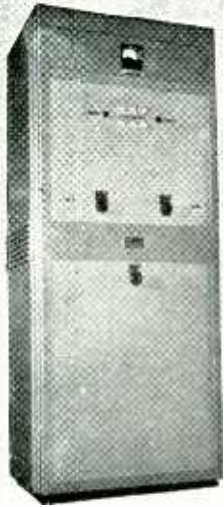

Exactly As Specified

JOHNSON

ANTENNA PHASING EQUIPMENT

Typical phasing unit in JOHNSON cabinet. We can match in design and finish any make of transmitter cabinet.

Careful attention to specifications is an outstanding characteristic of JOHNSON Antenna Phasing Equipment. It is made possible principally because each installation is individually designed. There are no "standard units" which must be adapted, no need of compromises with good engineering. You get what your consultant specifies!

Does this cost a lot? Emphatically no! Because JOHNSON manufactures nearly every component in an adequate variety of ratings and types, our engineers have available just the right material for any application. The cost is no more — frequently it is lower than less flexible, less generously rated equipment.

The same appreciation of technical and economic requirements is evident in other related JOHNSON equipment such as, coaxial line, phase sampling loops, isolation filters, tower lighting filters, RF contactors, pressurized capacitors, variable inductors and open wire line supports. For detailed information on any of these products write:

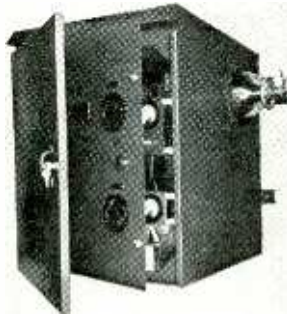

Weatherproof antenna coupling unit. Features an interior door which remains closed during adjustments.

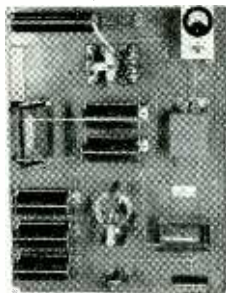

Panel mounted coupling network saves money where a tuning house is used. Every major component but the meter is JOHNSON built.



JOHNSON . . . a famous name in Radio!
E. F. JOHNSON CO., WASECA, MINNESOTA

Tele Tips

(Continued from page 4)

duties. This is evident in many applications aimed at speeding up service and relieving the operators of some of the monotonous parts of the work. An excellent example is shown in the recent installation of new ticket reservation systems in large railroad stations. Instead of having to wait while record clerks look up and report by telephone on the availability of reservations, such information is stored in a form so that it can be reported back immediately by automatic electronic searching units. The Pennsylvania Railroad system is now starting to use these methods in its Pullman operations.

INVENTORY CONTROL! There are many everyday business problems where forms of electronic reporting are finding support — notably in inventory control, production scheduling, and the handling of customer orders in large retail organizations. In the future it may be no longer necessary to talk over communication systems except by the fast-growing language of bits.

HAPPY SICK-LEAVE! Government workers are entitled to eight paid holidays, plus 26 days annual leave or vacation, plus up to 15 days sick leave. Based on the five-day week, employees may take off 49 working days, or 9.8 weeks a year.

In many government bureaus, it is customary to treat sick leave as "extra" annual leave. On one bulletin board there recently appeared a list of names under this heading: "The following employees will take their sick leaves according to these dates."! Sick leave may be accumulated up to 90 days; annual leave up to 60 days.

ICE-BREAKER—Great success has attended the idea of having an informal "hobby" discussion precede the technical paper of the evening, as initiated by the New York Section IRE a couple of seasons ago, indicating that the plan could be used beneficially elsewhere. Kick-off topic was presented by F. X. Lamb, of Weston Instrument Corp., who has made a hobby of increasing the efficiency of his home oil-burner. He reduced the oil consumption of his burner from 2,700 gallons per heating season to 1,200 gallons. At this and following seasons, the attending membership was both highly entertained and thoroughly educated by "hobby talk." Having engineers discuss their "hobbies" has proved an excellent social ice-breaker.

NEW INDICATOR ION TRAP

Now in all
**Rauland
Tubes**



The response to Rauland's new Indicator Ion Trap, after its introduction in the 12LP4-

A, has been so enthusiastic that this feature has now been incorporated in all Rauland tubes—as a standard feature of the new Rauland Tilted Offset Gun.

In the field or on the assembly line, this new Indicator Ion Trap reduces Ion Trap Magnet adjustment time to a matter of seconds, eliminates mirrors and guesswork, and assures accuracy of magnet adjustment. It can increase profits for every service man and service dealer—and at the same time assure better customer satisfaction.

A bright green glow on the anode of the picture tube signals when adjustment is incorrect. Correct adjustment is made instantly, by moving the magnet until the glow is extinguished or reduced to minimum.

Only Rauland offers this advanced feature—one of a half-dozen important post-war developments from Rauland.

RAULAND

The first to introduce commercially these popular features:

Tilted Offset Gun

Indicator Ion Trap

Luxide (Black) Screen

Reflection-Proof Screen

Aluminized Tube

THE RAULAND CORPORATION



Perfection Through Research

4245 N. KNOX AVENUE • CHICAGO 41, ILLINOIS





How a whiff of stibine led toward lower telephone costs

At the New York Telephone Company's Triangle exchange in Brooklyn, emergency batteries stand ready to deliver 3000 amperes for several hours.

In the Bell System there are a million lead storage battery cells connected to telephone circuits in the central offices. Current seldom flows in or out of these cells beyond the trickle which keeps them charged. In the rare event of power failure, however, they stand ready to supply the current for your telephone service.

Even in this stand-by service, cells require water to make up for electrolysis. And they consume power and eventually wear out. But Bell Laboratories chemists discovered how to make a battery which lasts many more years and requires less attention — by changing a single ingredient, the clue to

which came unexpectedly from another line of their research.

The clue was a minute trace of stibine gas in battery rooms which electrochemists detected while on the lookout for atmospheric causes of relay contact corrosion. In small traces the gas wasn't harmful but to battery chemists it offered a powerful hint.

For stibine is a compound of antimony—and antimony is used to harden the lead grids which serve as mechanical supports for a battery's active materials. Tracing the stibine, the chemists discovered that antimony is leached out of the positive grid and enters into chemical reactions which

hasten self-discharge and shorten battery life.

Meanwhile, in the field of cable sheath research Bell metallurgists had discovered that calcium could be used instead of antimony to harden lead. And theory showed that calcium would not react destructively in a battery. The result is the new long-life calcium-lead battery which cuts battery replacement costs, goes for months without additional water, and needs but $\frac{1}{5}$ the trickle current to keep its charge.

It demonstrates again how diverse lines of research come together at Bell Telephone Laboratories to keep down the cost of telephone service.

BELL TELEPHONE LABORATORIES

Working continually to keep your telephone service big in value and low in cost.



Another exclusive
GPL Development

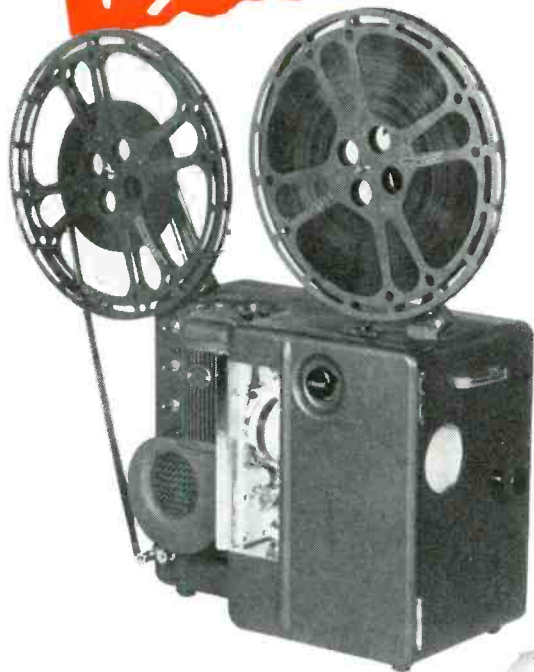

ABC

Pioneers New Telecast Technique with **GPL**

UTILITY PROJECTOR



Mobile Unit Handles Film Commercials on the Spot for Better Control and Economy

Using the new GPL 16-mm Utility Projector, the American Broadcasting Company scored another television "first" by handling filmed commercials direct from its mobile units at football games. This new technique eliminates the need for expensive studio stand-by facilities and film-chain tie up. It results in smoother programming. And it gives the director on location full control of timing.

The GPL Utility Projector (PA-101) is used with a standard image orthicon camera without special phasing facilities. It projects either direct into the camera, or on an intermediate screen in

a shadow box. With the latter, one of the cameras used for game pick-up can be swung around to the shadow box to take commercials.

The PA-101 is not only a professional auxiliary projector for the larger station, it is ideal for studio as well as field work in smaller stations. Easily portable, it may be used for film preview or rear screen projection. And for film telecasts, it may be used with regular studio cameras to provide quality equal to specialized iconoscope film-chain equipment.

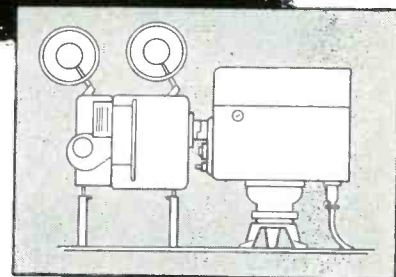

ABC ENGINEERS designed a special projector-camera mount for their mobile units. Set-up is easily removable; camera rotates on base for adjustment. Split coupling keeps out light.

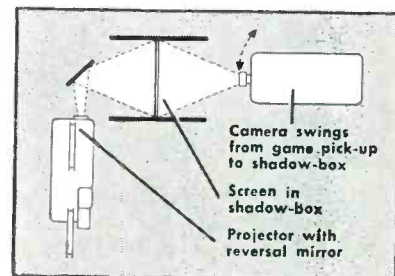

NO EXTRA CAMERA required with this alternate arrangement which uses shadow-box screen in stadium camera booth. Camera used for game pick-up may be swung to shadow-box to make commercials.



Write, wire or phone for details . . .

TV Camera Chains • TV Film Chains
 TV Field and Studio Equipment
 Theatre TV Equipment

General Precision Laboratory

INCORPORATED

PLEASANTVILLE

NEW YORK

NEW DESIGN THRILLS AT YOUR FINGER TIPS...

Type SRE Bantams*—The smallest electrolytics yet. Especially suitable for personal radios, filter circuits and similar functions. Hermetically-sealed aluminum can with diameter-reducing stud terminals. Improved processing and materials combined with more efficient space utilization, means smaller sizes—but no reduction in life.

Type '87 Aerocons—Self-molded plastic tubulars with new impregnant, Aerolene*; new rock-hard Duranite* end seals. All the performance characteristics of molded-plastic capacitors at a price close to that of conventional paper tubulars. Excellent heat and humidity resisting qualities. Operating temperatures of -30°C to $+100^{\circ}\text{C}$.

Type 89ZXY Aerolites*—Aerovox-improved metallized paper capacitors were developed to meet present-day requirements for capacitors of improved reliability and reduced size. Type 89ZXY Aerolites* are metallized-paper capacitors in hermetically-sealed metal cases. Other Aerolite* capacitors are available in tubular, bathtub and other case designs.

Type P123ZG Miniatures—Metal-cased, metallized-paper capacitors featuring vitrified ceramic terminal seals for maximum immunity to climatic conditions—heat, cold, humidity. For severe-service applications and for usage in critical as well as ultra-compact radio-electronic assemblies.

Type P83Z Micro-Miniatures*—Smaller than previous "smallest"—a distinct departure from conventional foil-paper and previous metallized-paper constructions. Radically new metallized dielectric makes possible exceptionally small physical sizes. Available in two case sizes ($3/16" \times 7/16"$ and $1/4" \times 9/16"$); voltages of 200, 400, 600; operating temperatures range from -15°C to $+85^{\circ}\text{C}$ without derating.

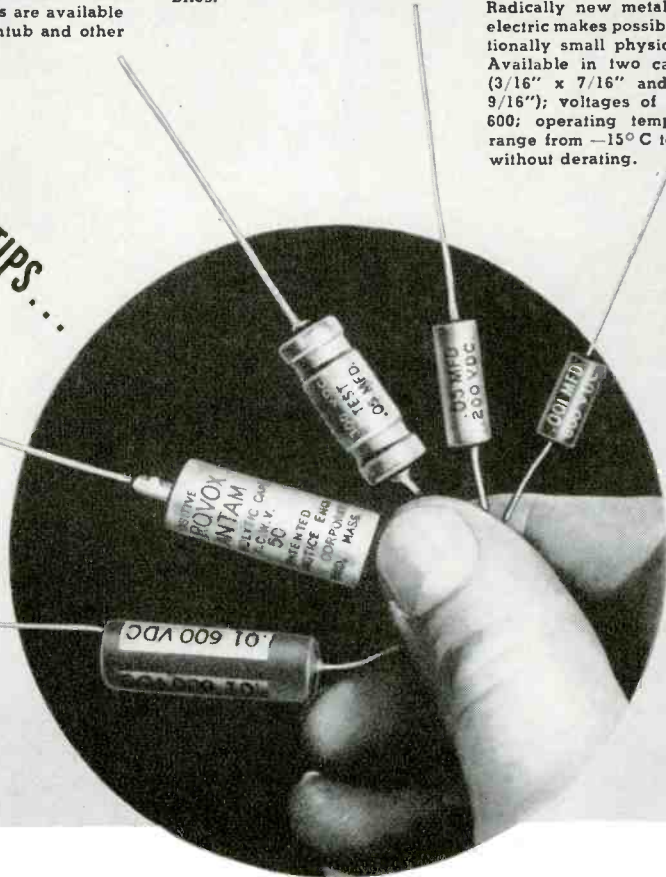

*Trade-mark

AEROVOX

"Space Miser"

CAPACITORS

● Tell us what you are designing or producing. Our engineers will gladly show you better assembly possibilities with marked economies. Literature on request. Write on your letterhead to Aerovox Corporation, Dept. DF-65, New Bedford, Mass.

There is something new in sizes!

● Never was so much capacitance packed into so little bulk. And with improved performance and life, too. Aerovox Research and Engineering have developed capacitor materials that now challenge the thinking of the progressive radio-electronic designer on several counts:

For **elevated temperatures**: Immunity of Aerolene impregnant and Duranite end fills. For **humidity extremes**: perfected hermetically-sealed metal-can casings

even in tiniest sizes. For **miniaturizations**: perfected metallized-paper sections. For **compact filters**: smallest electrolytics yet. For **maximum reliability**: the most conservative ratings. For **lower prices**: advanced engineering backed by highly mechanized fabrication.

New design thrills at your finger tips! That's what these latest Aerovox capacitors mean to you by way of still better radio-electronic assemblies.

CAPACITORS • VIBRATORS • TEST INSTRUMENTS



For Radio-Electronic and Industrial Applications

AEROVOX CORPORATION, NEW BEDFORD, MASS., U. S. A. • Sales Offices in All Principal Cities

Export: 41 E. 42nd St., New York 17, N. Y. • Cable: AEROCAP, N. Y. • In Canada: AEROVIX CANADA LTD., Hamilton, Ont.



CLEVELITE* AND COSMALITE*

LAMINATED PHENOLIC TUBING

is used also for many other electrical products at a considerable saving where exacting specifications must be carefully followed.

For the best . . . "Call Cleveland."

Those in the Radio and Television Industries know from actual use the fine performance of these Tubes. They also know that our large production capacity assures them of a dependable source of supply with prompt delivery.



*Trade Marks

Ask us about these spirally laminated paper base phenolic tubes in diameters, wall thicknesses and lengths that will meet your needs.

The **CLEVELAND CONTAINER Co.**
6201 BARBERTON AVE. CLEVELAND 2, OHIO

PLANTS AND SALES OFFICES at Plymouth, Wisc., Chicago, Detroit, Ogdensburg, N. Y., Jamesburg, N. J.
 ABRASIVE DIVISION at Cleveland, Ohio
 CANADIAN PLANT: The Cleveland Container, Canada, Ltd., Prescott, Ontario

- REPRESENTATIVES
- | | |
|---------------|--|
| NEW YORK AREA | R. T. MURRAY, 614 CENTRAL AVE., EAST ORANGE, N. J. |
| NEW ENGLAND | R. S. PETTIGREW & CO., 968 FARMINGTON AVE.
WEST HARTFORD, CONN. |
| CANADA | WM. T. BARRON, EIGHTH LINE, RR #1, OAKVILLE, ONTARIO |



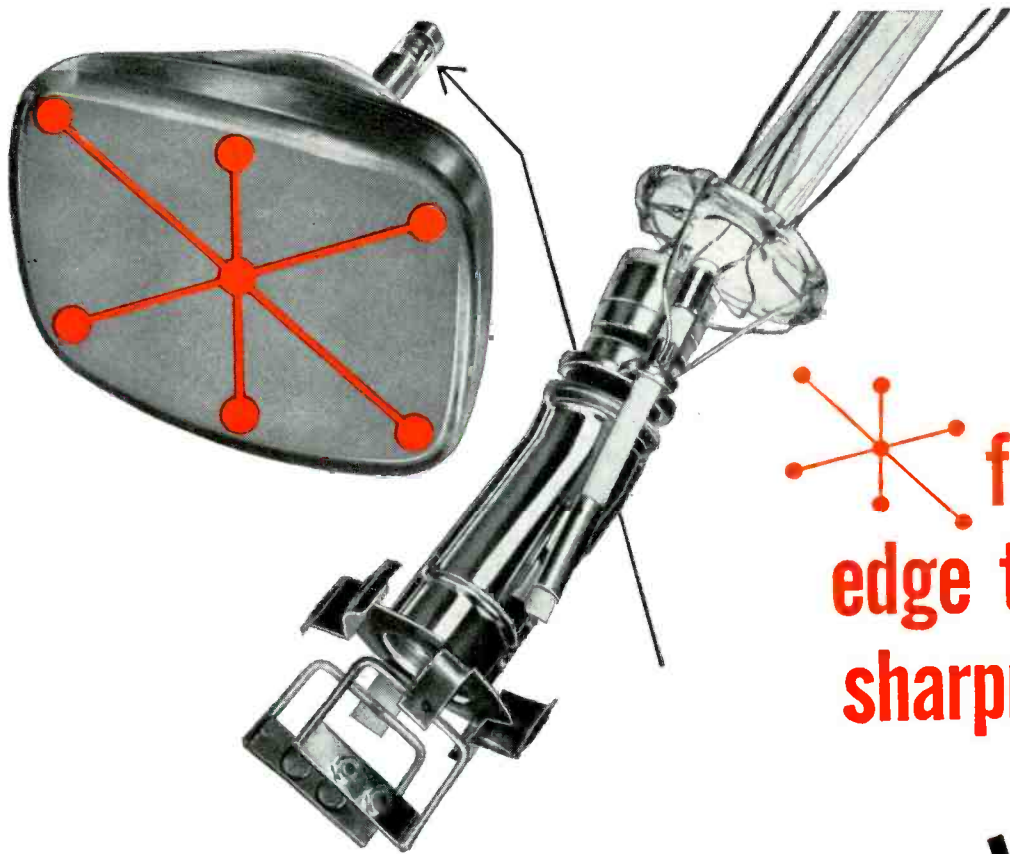

for
edge to edge
sharpness...

the **New** Du Mont Bent-Gun

Uniform sharpness of trace to the very edges of the screen distinguishes the new Du Mont Bent-Gun.

A higher degree of pre-focusing passes a smaller-diameter beam through the deflection field. Spot distortion is reduced and a uniform overall focus results. Other design changes are: Improved bulb spacer insures proper anode contact and electron gun centering; rounded corners on pertinent gun parts eliminates stray emission at higher anode voltages; new grid-cathode assembly allows a longer G-2 (second grid) without increasing overall length.

This new Du Mont Bent-Gun is now being incorporated in ALL Du Mont Teletrons. Therefore, whether planning a new TV receiver or modifying an old one, be sure to include the Du Mont Teletron for the best in TV pictures. Simply specify DU MONT.

FIRST WITH THE FINEST IN **T-V** TUBES

DU MONT

*Teletrons**

ALLEN B. DU MONT LABORATORIES, INC.,
Tube Division, Clifton, N. J.

*Trade-mark.

TELE-TECH

TELEVISION • TELECOMMUNICATIONS • RADIO

O. H. CALDWELL, Editorial Director ★ M. CLEMENTS, Publisher ★ 480 Lexington Ave., New York (17) N. Y.

"The Public Interest" and Color-TV

Each FCC Commissioner upon beginning his term takes a solemn oath "to serve the public interest." It is this central idea of the "best public interest" which underlies the whole radio law and the administration of that law by the Commission.

Fantastic authorizations of standards incomplete and not yet even given first laboratory tests, were never contemplated by the framers of the radio legislation.

Nor is it in the public interest —

To obsolete 10,000,000 present TV sets in which the public has invested three billion dollars.

To require future TV purchasers to spend \$40 to \$130 extra for gadgets they may never use.

To degrade TV picture quality, and limit pictures to small sizes which the public has already discarded.

To risk plant shut-downs, unemployment and financial disaster for manufacturers, distributors and dealers.

To force upon the public an incompatible color system which cannot even be launched without driving away existing audiences.

To promote color-TV at a time when color gadgets and circuitry must siphon off radio parts and components needed by the military.

To disrupt the entire television industry.

★ ★ ★ ★ ★ ★

Good sportsmanship provokes admiration for the achievements of Inventor Peter Goldmark and Strategist Adrian Murphy in advancing the CBS non-compatible low-detail small-picture system to its present political status.

But from the standpoint of "the public interest" demanded by the radio law, the majority of the Commissioners have obviously failed in their sworn duty. In contrast, the dissenting opinions of Engineer-Commissioner George Sterling and Lawyer-Commissioner Frieda Hennock revealed at least their convictions that the FCC final action of Oct. 10, was contrary to the public interest. With these exceptions, the actions of the technically-informed Commissioners and staff in going along with this absurd and destructive color-TV ruling have created amazement throughout the radio engineering fraternity.

FCC TV STANDARDS INCORPORATING COLOR, EFFECTIVE NOVEMBER 20

The FCC has announced its decision to standardize sequential color, a change in the bracket requirements, and new TV standards.

1) In view of the adoption of CBS color only two scanning frequencies are required, obtained by a two-position switch.

2) Standards for color TV; scanning lines per frame—405; interlaced two to one in successive fields of the same color; frame freq. 72; field freq. 144; color frame freq. 24;

color field frequency 48; line frequency 29,160 per second. Maximum luminance less than 15% of peak carrier level.

Color sequence: successive fields—red, blue, green. Transmitted signals shall produce correct color rendition on receivers having trichromatic coefficients based on International Commission of Illumination standards of: Red X = 0.674, Y = 0.326; Blue X = 0.122, Y = 0.142; Green X = 0.227, Y = 0.694. For

phasing the color disc a series of pulses of the same shape and amplitude as horizontal pulses at twice frequency and half width is inserted at start of vertical blanking on red field.

Following changes made in monochrome standards for color: vertical blanking 0.07 V limits no change. Horizontal blanking same as monochrome, limits different—plus 0.02H; minus limits no change.

REARMAMENT

COMPONENTS SURVEY—Intensive study of the radio-electronic components' situation for military production, both as to likely and current critical shortages and need for expansion of manufacturing facilities for certain component types, was undertaken during October by the Munitions Board's Electronics Division, headed by Marvin Hobbs. More than a dozen subcommittees, which were established through the cooperation of the MB's Electronics Equipment Industry Advisory Committee and its chairman, Western Electric vice-president Frederick Lack, met in lengthy sessions at the Pentagon on a variety of military "production-outlook" plans for the different components, including transmitter tubes, receiving tubes, quartz crystal, resistors, capacitors, transistors, sonar traducers, indicating instruments etc. As a result of their surveys both the armed services' Interservice Advisory Committee to the Electronics Division and the radio industry's advisory committee will be able to make a more exact blueprint in sessions to be held in November on the handling of the military procurement load.



This new handie-talkie for Infantry, weighing 6½ lbs., has been redesigned to operate as an FM transceiver. It has a range of approximately one mile and will "net" with a greater number of other sets including the walkie-talkie. The latter equipment (SCR-300 in WW-II) has also been redesigned to about half its previous weight and bulk. These improved equipments will weld Infantry Armor and Artillery into a more coordinated team.

MILITARY TV

NEW PLATE-POWER SOURCE for portable TV sets. The Army's Engineers Research and Development Labs. at Ft. Belvoir have had built two electrostatic generators furnishing 20,000 v. and 6,000 v. respectively. These devices, each weighing only about 10 lbs., are spring-driven and will furnish power at low current up to 19 mins. at one winding. These results are due to the use of new insulating materials, new plastics and new techniques of hermetic sealing. Between the spring motor and the generator is a 14-to-1 gear reduction. A governor is also used.

The rotor of the generator consists of plastic laminated with metallic foil. It turns between charged metal plates so that a voltage is built up by induction on the foil. First the plates are weakly charged by a friction-type generator. Next in the process is the building up of the desired voltage and its continuous transportation to the plates where the charges are accumulated. Corona-discharge tubes act as voltage regulators of the output.

AVIATION

TELEVISION HELPS take the risk out of aviation. Although not the first time it has been done, the latest and most practical application of TV to testing aeroplanes leaves the pilots on the ground while remote-control flies the aircraft, and television cameras in the cockpit transmit instrument readings to the testpanel in the laboratory. Thus if the plane cracks up it is only a camera chain which has to be replaced instead of a test pilot!

900-1200 MC

AVIATION NAVIGATION equipment in the 900 to 1200-MC region is not panning out exactly as expected, and there is a move afoot to attempt a transfer of some of these functions to the 500 to 900-MC band. In fact, and this may be news to many broadcasters, there are already some experimental operations in this band—which is supposed to be for television use. If this frequency range is good for aviation radio purposes the next thing may be aviation moving in with UHF-TV. Why not just make an exchange of all or part of the UHF-TV band for more VHF-TV spectrum space?

TV AUDIENCE

MORE REALISTIC approach to calculating population served by television stations is shown by new NBC plans to use the 0.1 M/V contour in arriving at audience counts. This takes into account only the *unduplicated* viewers in areas of coverage overlap from two or more stations. An equal intensity 0.1 M/V contour is drawn and viewers on the respective sides of this contour are credited to the station in their zone.

Situations of Significance in the Fields of TV and Tele Communications

UHF CONDUCTION

ENAMELED WIRE in place of coaxial cables or rigid wave guides, for the transmission of ultra-high-frequency signals, is forecast in a report (PB-100-712) now available from the Office of Technical Services of the Department of Commerce. The novel UHF transmission means, developed by Dr. Georg Goubau for the Army Signal Corps, utilizes the hitherto-unexploited principle that non-radiating cylindrical surface waves can be guided by a conductor that is coated with a dielectric layer, or the surface of which has been otherwise modified, for example, by being threaded.

According to the report, surface wave transmission lines, using special horn-shaped signal-launching devices, can be built to operate with lower loss than coaxial cables, or even than rigid wave guides.

PICTURE TUBES

BUTTERFLY BURNS are the latest problem encountered by manufacturers of glass rectangular picture tubes. Due, apparently, to the different shape of the bulb, the effect of the earth's field on the ions differs from the more familiar center burns on round tubes, and produces discoloration of the screen at the top and bottom. The outer edges of these burns curve inwards thus producing an appearance similar to the wings of a butterfly. The cure for this seems to be to improve the conductivity of the coating; sometimes by using graphite, which is employed by one manufacturer.

MATERIALS

BORON-CARBON RESISTORS—A markedly improved type of deposited carbon resistor, expected to find widespread use in the communications field, has been developed at Bell Telephone Laboratories. In this new resistor, the element boron, as well as carbon, is pyrolytically deposited in a thin film on a suitable ceramic core. The addition of boron, it has been found, gives considerably lower temperature coefficients of resistance than those possessed by plain carbon re-

sistors, as well as good stability. In addition, the new borocarbon resistors provide access to resistance ranges heretofore impossible to attain in stable, accurate film-type resistors. These advantages are expected to permit widespread substitution of borocarbon resistors for the larger and more costly wire-wound types.

MINIATURES

"THE FIELDISTOR", a sub-miniature vacuum tube, 1/90th the size of a present-day tube, is being developed by the Air Materiel Command's Components and Systems Laboratory, Dayton, O. This tube which is about the size of a match-head, may be the answer to how to reduce size and weight of air-borne equipment. Only 250 handmade samples, (which appear to have too high a noise output) are now in existence. If and when they become available for civilian use, they may be found advantageous for portable radio sets and TV receivers, hearing aids, and other devices requiring compactness and light weight.

MANAGEMENT

EXECUTIVE SALARIES in the radio-TV field seem pretty well stacked against the radio engineer who creates the merchandise the other well-paid officials sell. From a study recently made in the radio-TV industry, the averages came out as shown below. It will be noted that total-compensation figures do not equal the sum of base salary and bonus figures, since some sources were not able to differentiate or furnished base salaries only. Bonus figures available for design engineers did not permit compilation of averages, although in some instances it was recognized that bonuses were paid ranging up to 40% of base salary.

	Base Salary	Bonus	Total
General sales managers	\$22,300	\$11,300	\$27,400
Merchandising managers	16,800	6,600	19,900
Salesmen	5,500	3,300	7,100
Purchasing agents	11,800	—	11,800
Chief design engineers	13,000	(Up to 40%)	15,000

40 TV CHANNELS BY EXTENDING PRESENT VHF BAND

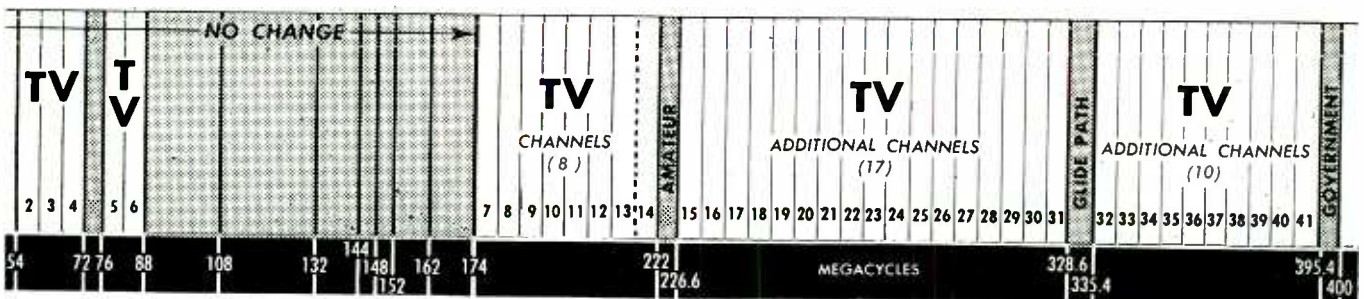

TELE-TECH'S proposal for a continuous TV-spectrum extension (instead of a jump to the uhf) has met encouragement from unexpected quarters. Now word comes from Washington that some of the military authorities would like to trade their present VHF

channels in this region for UHF frequencies which are better adapted for field purposes. Such a switch would largely clear the way for the continuous band of 40 channels sought by TV broadcasters and manufacturers—and everybody would be happy!

Testing and Aligning Video

The relatively new technic of equipment vision amplifiers is discussed and a logi-

By F. E. CONE and N. P. KELLAWAY,

TV Terminal Equipment Engineering, Radio Corporation of America, Camden, N. J.

IT is the purpose of this article to provide a general guide or approach for the testing and alignment of video amplifiers¹ as well as specific information for setting up the test equipment. Television station engineers and technicians concerned with the operation and maintenance of video amplifiers and other TV equipment should find this information particularly useful. Since many of the video testing procedures and technics are relatively new and must be performed at relatively high frequencies, suitable test methods, adequate test equipment (which is available commercially) and sufficient care in making measurements are recommended.

The video signal is made up of many frequencies of varying amplitudes and characteristics. Faithful reproduction of this signal is obtained only when the amplifiers are relatively free from frequency, amplitude, and phase distortion over the required frequency band. Therefore, the testing procedures described in this article are confined to those characteristics which are most likely to affect the performance and quality of the video signal.

The frequency response characteristic of an amplifier indicates frequency distortion directly and is a means of judging phase distortion. This characteristic may be obtained by the well known point-by-point method. However, this is a time consuming task and is too cumbersome. A more convenient method uses a sweep frequency generator, a crystal detector, an oscilloscope with good low frequency response, and a square wave generator for 30 cps and 7.5 KC.

The sweep generator recommended is the RCA WA-21A. It consists

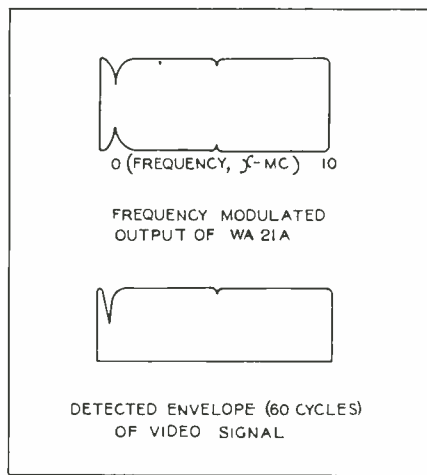

Fig. 1. Desired test generator characteristics

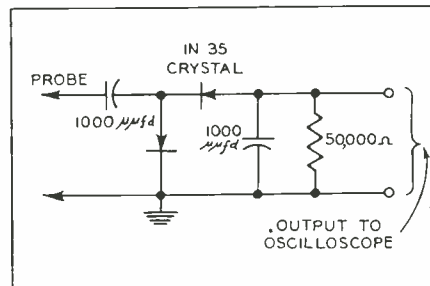

Fig. 2. Peak-to-peak diode detector circuit

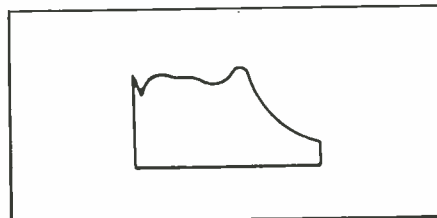

Fig. 3. Undesirable amplitude variation

of a fixed frequency oscillator and a sweep oscillator, frequency modulated at 60 cps. The swing of the frequency modulated oscillator ranges from a few kilocycles on one side of the frequency of the fixed oscillator to 10 MC on the

other side. The beat frequency output over the usable range (100 KC to 10 MC) is of constant amplitude within 1 db. This gives a well-defined zero frequency reference. The frequency marker pip which is available covers the usable range of the sweep.

Blanking is provided internally (60 cps) to blank out the signal during retrace.

In conjunction with the sweep, a crystal detector is used, which is shown schematically in Fig. 2. It is a voltage doubler and rectifier which converts the frequency modulated signal to its envelope.

The efficiency of rectification is about 90%; hence in setting up a specific output level of 1.5 v., the signal output of the detector should be approximately 1.35 v. In constructing such a detector it is important that leads to components be kept as short as possible. Distributed capacity should be reduced to a minimum.

High Frequency Response

For this measurement, the sweep generator, the crystal detector, and the oscilloscope are used. The method consists of coupling the low impedance output of the sweep generator to the grid of an amplifier stage, the plate circuit of which contains the circuit to be checked or adjusted. The detector should be connected to some low impedance point of the following stage such as the unbypassed cathode.

The circuit of Fig. 4 indicates a typical video amplifier stage. Removing the cathode bypass capacitor makes this second stage a cathode follower. The cathode resistance is on the order of 100 ohms so that the effect of feed-through capacity will be negligible.

An alternative to this scheme is to leave the cathode bypass capacitor in place and connect a 100-ohm resistor across the peaking coils of the second stage to shunt both the series and shunt peaker. Attach the detector across this resistor. This stage would then be a plate output stage.

¹J. H. Roe, "How to Adjust Frequency Response in Video Amplifier for TV", Broadcast News, No. 58, March-April, 1950, pp. 54 to 65, incl.

Amplifiers

adjustment for tele- cal system indicated

Most of the amplifiers of television terminal equipment are terminated with low impedance plate output stages or cathode followers. This affords a convenient point to attach the detector since the effect of the added capacity falls outside the frequency band being considered. Hence, the detector is usually left there for the duration of the test.

The video sweep signal is then injected at the grids of the preceding stages, starting at the output end and progressing towards the amplifier input. Care should be exercised not to overload the amplifier, creating the illusion of a good response. The test signal should be the same as that handled by the amplifier during normal operation.

The specification given for various responses is representative of typical production equipment. Reasonable variations in response can be expected between units of the same type due to normal manufacturing tolerances.

In amplifiers where clamping, blanking, and sync signals are added, precautions are taken to maintain normal operating conditions. Clamping tubes add considerable capacity and affect circuit tuning. Such a tube is replaced with a tube of the same type *that has its filament pins removed*. A temporary grid leak resistor is added (470,000 ohms K for 6AC7) to the opened grid.

Blanking is usually inserted by an amplifier, the plate of which shares a common plate load resistance with one of the video amplifiers. In addition to the circuit capacity it contributes, quiescent voltages of the video amplifier are dependent on the current drawn by the blanking amplifier. Thus, blanking cannot be removed by simply removing the blanking amplifier. Instead, the tube which drives the blanking amplifier (usually $\frac{1}{2}$ 6SN7) is replaced by a tube with its *grid, plate, and cathode pins removed*. These tubes should be plainly marked, possibly with red paint, to identify them.

Fig. 4. Typical video amplifier stage used in television transmission terminal equipment

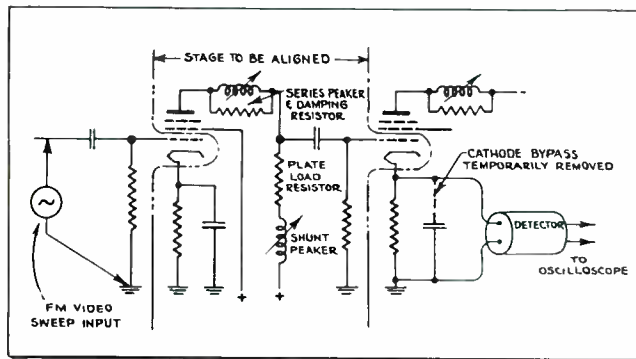
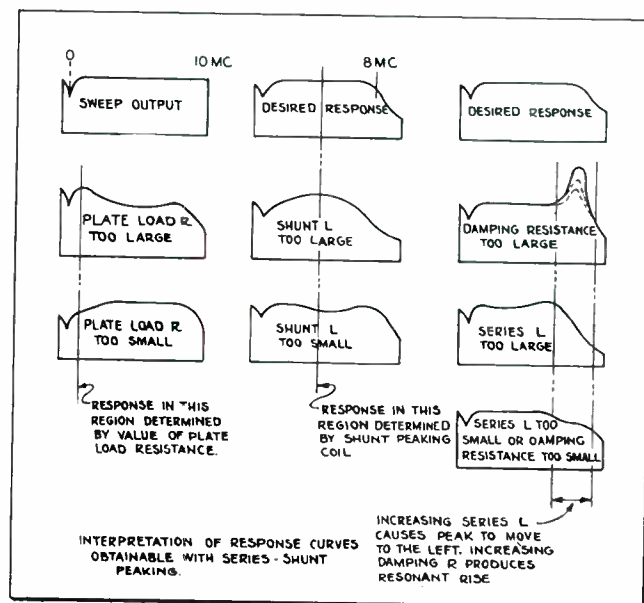

Fig. 5. Interpretation of response curves obtained with variations in the values of series-shunt peaking elements



This will help prevent them from being left in the equipment.

It may occur that a high gain amplifier tends to regenerate and oscillate due to leads being attached to it. In such cases the alternative of disrupting the amplifier in the middle and checking the amplifier in parts will be sufficiently accurate to insure proper performance.

Beware of rapid variations in amplitude as shown in Fig. 4. Such variations of frequency response are accompanied by severe variations of the phase characteristic of the amplifier and may cause ringing or reflections in the video signal.

In carrying the frequency response of the typical series-shunt peaked stage out to 6 or 7 MC, the phase response should be good out to 5 or 6 MC. Assuming this phase response to be adequate, the difficulty in making phase measurements is eliminated.

The response of an amplifier at the low frequency end is usually determined by the time constant of the inter-stage coupling networks. The low frequency response requirements vary from unit to unit depending on their relationship with clamping. With clamping oc-

curing at a horizontal rate, 60 cycle response is not necessary. However, the amplifier should pass a 7.5 KC square wave with less than the specified maximum amount of tilt. This requires good phase response down to 7.5 KC which implies good amplitude response down to 1/10 or less of this frequency when no special low frequency compensating circuits are employed. The 7.5 KC square wave corresponds to a signal such as a bar extending the full width of the scene.

After clamping, the amplifier response should be such that the tilt should be less than the specified maximum for a 30 cps square wave.

After alignment of any amplifier the final check should be the passage of a signal through it and close inspection of the signal on a monitor. The RMA Resolution Chart* is a very useful signal source. The wide range of picture resolution gives rise to a wide range of frequency components and will be a good overall check.

*See Bulletin #ED-2502-A prepared by TR4 Committee on Television Transmitters, Transmitter Section, RMA Engineering Department.

A 30-Element Electrostatically-

Trend in tubes based on control by electron beam tube found useful in time division communication,

By **A. MELVIN SKELLETT** and **PAUL W. CHARTON**

National Union Radio Corp., Research Div., Orange, N. J.

AS the communication field expands many attempts to get greater efficiency in the utilization of facilities have brought about many systems which utilize some form of time division of those facilities among a number of services. Again, in the field of testing and measurement there arises problems of spot checking system currents or voltages, at a rapid rate. By electronic methods, speeds greatly in excess of anything possible with mechanical methods are obtainable. Numerous attempts at using deflected beams as a switching means have been suggested and tried. One form of switching tube that is exceptionally versatile for such application, is shown in Fig. 1. In this tube a radial beam is rotated continuously across a number of electrodes arranged on the circumference of a circle.

This radial beam type of switching tube or electron commutator finds its way into many new applications because of the inherent advantages it possesses in comparison with other types of tubes designed for similar purposes. These latter types usually employ an elec-

tron gun similar to that in a cathode ray tube, and consequently the operating voltage is high, usually one or two KV. Experience shows that the secondary electrons in such tubes sometimes prove troublesome although their effects have been solved in a number of cases by finding a use for these secondaries. This expedient, however, results in considerable non-uniformity from element to element because of the difficulty of maintaining uniform secondary characteristics from one target element to another. The radial beam tube suffers from neither of these handicaps; the maximum ac and dc voltages applied to the tube need not be greater than 400 or 500 volts. Secondary emission is not employed and it is easily suppressed by considerations in the structural design.

The combination of electrostatic fields by which it is possible to focus a radial beam of electrons in a coaxial cylindrical structure has been described¹ referring to a 12-element radial beam tube employing this principle. Increasing the number of elements to 30 required a

larger radius for the structure. Although this modification brought in new problems, such as mica charging at the top and bottom of the focusing space, a practical design has resulted.

During this development it was found that if the length along the axis of the working structure of the tube was not less than the diameter, no serious distortion of the focusing field occurred because of end mica charging. Presumably this condition holds because the electrons in the beam do not stray far enough in the axial direction to reach the micas. To handle 30 separate grids and anodes the necessary increase in the radius permits the electrons to reach the micas and thereby distort the beam at the ends (top and bottom) so that the focus at the screen structure (see Figs. 1 and 2) assumes a sort of hour-glass form. No means has been found to restore the field exactly to the correct configuration, but practically, a good enough approximation can be obtained by placing shielding elements on the micas near the screen elements and around the cathode. This expedient, along with that of limiting the beam length slightly, gives a good rectangular focus for the 30-element tube.

Fig. 1 shows a section through

Fig. 1: Sectional view through the tube perpendicular to axis

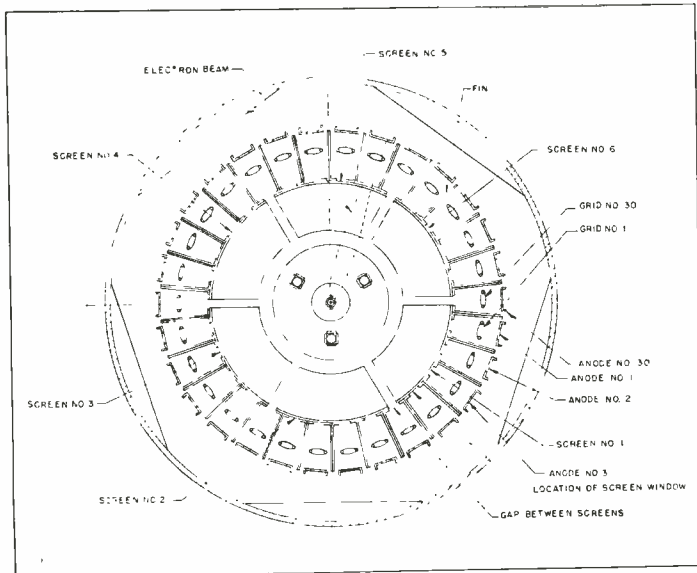
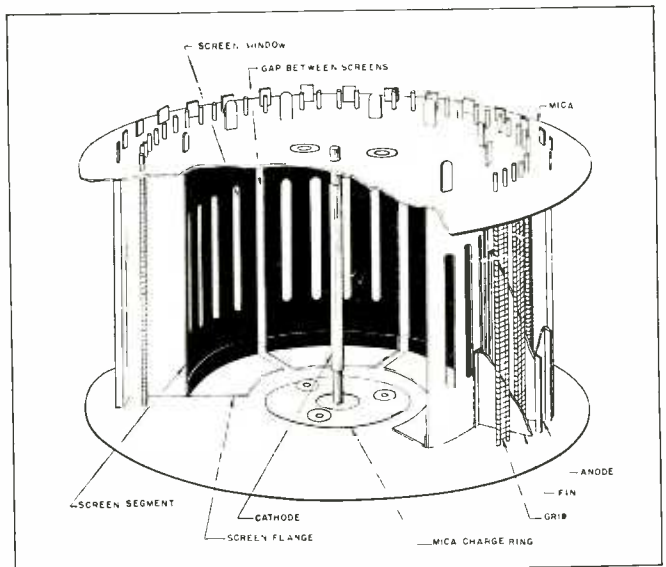

Fig. 2: Cut-away view of tube showing the interior structure



Focused Radial Beam Tube

deflection is typified by this high-speed sequential switching measurements, telemetering, sampling and spot checking.

the tube at right angles to the axis. Fig. 2 is a cut-away view looking into the tube structure. A standard cylindrical cathode is positioned on the axis at the center. There are no grids or other elements between it and the screen elements to which the six phases of voltage are applied. The electron beam is focused and rotated in this region by the action of these polyphase potentials in conjunction with a focusing bias applied to the cathode.

Screen Segment Structure

Each screen segment has 4 windows and there are 6 additional windows located between the adjacent screen elements, giving 30 windows in all for the beam to pass through. Back of each window there is a control grid and an anode. Fins attached to the screen elements segregate the sections and prevent crosstalk.

The mica shielding flanges and charge ring that are attached to the

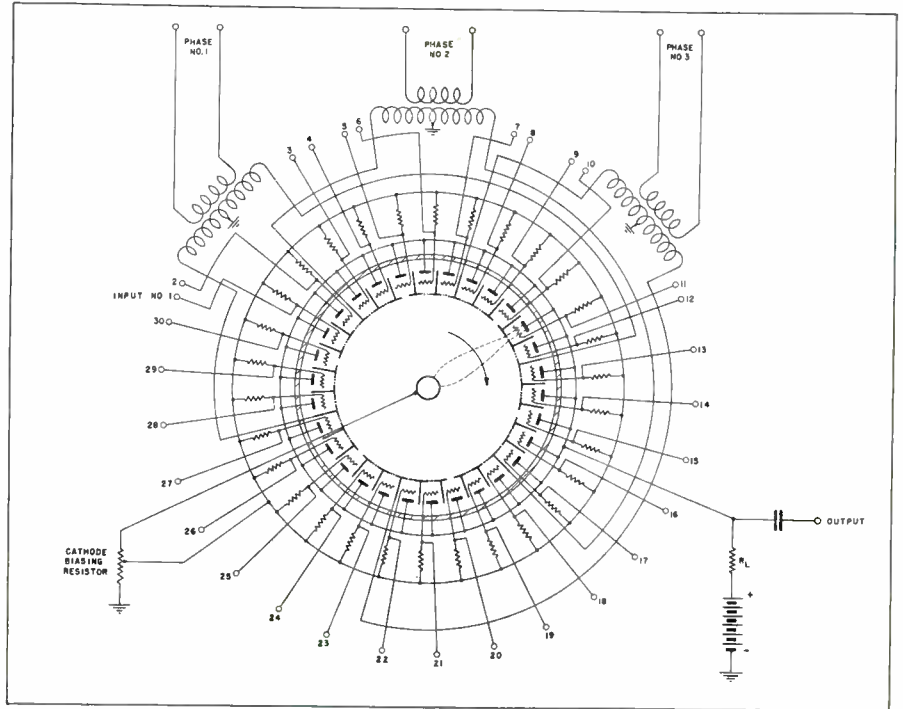
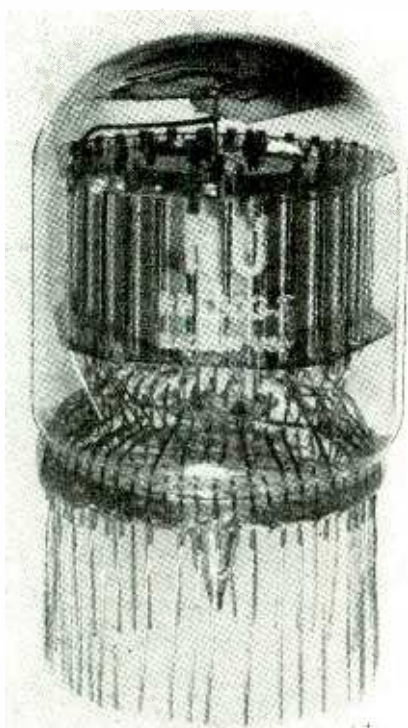

Fig. 4: Typical tube circuit. Voltage drop across cathode resistor provides the focus

Fig. 3: Photo of unbased thirty element tube



bottom mica can be seen in both figures. Each flange is welded directly to its adjacent screen element and a separate lead is brought out of the tube for the two rings (top and bottom). These rings are operated at a negative potential with respect to the cathode and provide some axial focusing for the beam.

The grids are of standard receiving tube design and since the electrons must pass through the laterals on both sides, they are very effective in controlling the current and in providing a low voltage cutoff, approximately 5 volts in the present design. This is obtained by grid design and placement. If a greater cut-off voltage can be tolerated the grids may be located just in back of the windows and made with fewer laterals and the resultant anode current will be increased considerably. Furthermore, the cut-off is made sharp since it is not so easy for stray electrons to get around the side of the grid laterals.

To meet industrial requirements two types of tubes were made available, identical in construction. In one, all of the grid leads are brought

out separately with all the anodes but one tied together, and in the other, the anode leads are brought out separately and all the grids but one tied together. This saves 28 leads and for most applications, one of these two types, or one of each, is required. The separate channel element is often used for synchronization or other marking signals.

Fig. 3 is a photograph of this tube (without a base). It has a diameter of $2\frac{3}{8}$ in. Each section has a transconductance of $12\ \mu\text{mhos}$, a 5 megohm plate resistance, and an amplification factor of 60.

The operation is nominally at a 450 volt anode potential with a beam current of $60\ \mu\text{amp}$. It requires a focusing (cathode bias) voltage of 76 volts at this level, and a six phase deflection voltage of 300 volts rms.

Fig. 4 shows a typical circuit diagram. The voltage drop across the cathode biasing resistor provides the focusing voltage. The three transformers split the 3-phase input into 6 phases for application to the screen elements. In this particular

(Continued on page 58)

An Air-Cooled 5-10 KW

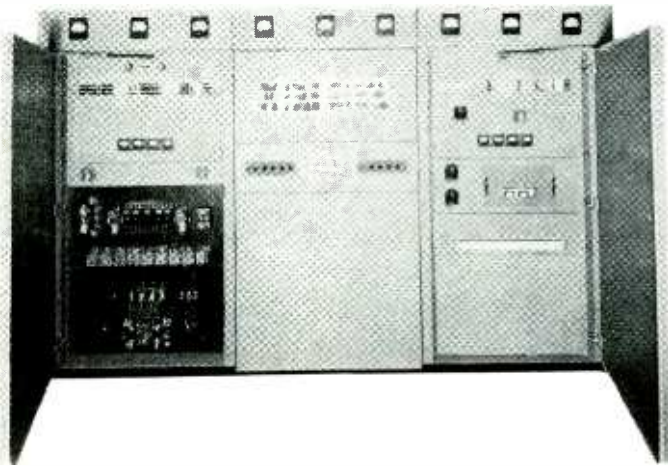

Trend away from water cooling of operation and elimination of

Fig. 1: Front view with false fronts open. Primary power controls are visible on lower half of left panel. Exciter Unit (right) plugs in

By **L. B. PETERY**, Design Engineer
Gates Radio Co., Quincy, Ill.

MANY years ago, the development of the water cooled tube made possible transmitter powers above 1 kw. Later, these same tubes were equipped with fins so that the problems inherent with water cooling were solved eliminating the water. For broadcast transmitters in the 5 and 10 kw power range, output tubes have remained unchanged almost since the development of the original tube type.

With the initial problems of air cooling solved, the development of air cooled tubes for industrial use was accelerated. Also, a number of new types were developed for television, frequency modulation, radar, loran, and other specialized services.

The BC-5B and BC-10B transmitters break away from the tradition of an 892-R tube in the final amplifier and either 891-R or 892-R

tubes in the modulator, by introducing the 3X2500F3 as both power amplifier and modulator. In searching for a suitable tube, this was found to be the most acceptable, having successfully served for several years in other radio applications.

The transmitter is constructed in three cubicles, the power amplifier and modulator being located in the center cubicle. These tubes mount in an air chamber, which is supplied by a single blower. Each tube requires 125 cubic feet of air per minute at 1.6 in. pressure. The blower delivers 800 cubic ft. at 1.75 in. pressure. Since the motor and blower unit are rubber cushioned to the housing, and the entire unit is on shockmounts, no transmission of vibration occurs. Surplus air is taken from the ends of the air chamber for unit ventilation. A

diaphragm type pressure switch mounts on the air chamber insuring positive air protection.

The power amplifier tank occupies a frame half the width of the cubicle above the blower, and behind the power amplifier tube location. Tuning is by a variable inductance tapped across the bottom few turns of the main tank coil. This parallel operation of the tuning coil permits operation of the coil at low currents. Coupling to the transmission line is in two sections, the first coil being fixed, and the output coil adjustable from the front panel for power adjustment. This network provides high harmonic attenuation, permits the use of standard capacity condensers, and gives a flexible frequency and line load coupling. A pickup loop with a change relay automatically sets the modulation monitor for proper pickup on either of two operating powers. Neutralizing is obtained by a fixed vacuum condenser coupling from the power amplifier tank to the r-f driver tank.

Operation of R-F Driver

The r-f driver consists of two type 810 tubes, operating with 1500 v. on the plates. This stage is also tuned with a variable inductance across a portion of the tank coil. The 813 buffer operates with 1000 v. on the plate and 200 v. on the screen. This is driven by the frequency control unit consisting of a 6V6 oscillator and 807 output tube.

The 3X2500F3 modulator tubes are driven by four 845's in push-

Fig. 2a: Curves showing noise levels for various output powers and modulation levels measured below 100% modulation at 1000 cps

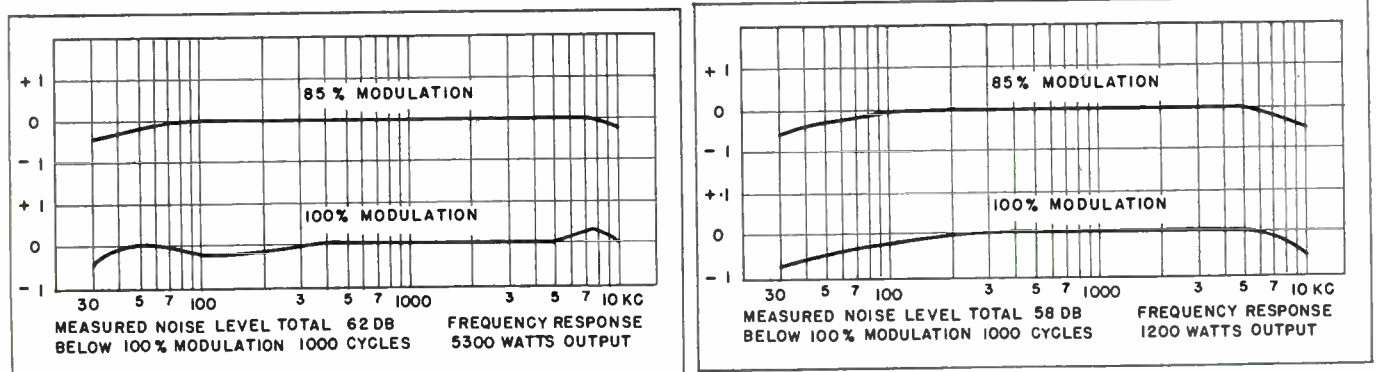

AM Broadcast Transmitter

**is emphasized by simplicity
ancillary cooling devices**

pull parallel with conventional transformer coupling. Preceding the 845's is a push-pull stage using 807's with triode connections. The main feedback is introduced to the cathodes of the 807's, and amounts to 8 db. The transmitter was designed for optimum audio response before feedback was introduced. The result is that the presence or absence of feedback is not detectable aurally, although it can be detected with distortion measuring equipment. The input audio stage consists of two triode-connected 6J7's in pushpull. This stage has a feedback loop so arranged that the frequency response may be slightly varied by modifying the feedback characteristic. Thus, overall response may be changed to suit the station engineer without encountering the difficulties attendant to an overall feedback loop.

Power reduction in the BC-5B from five kilowatts to one kilowatt is obtained by changing the power amplifier plate supply to half voltage obtained from the center tap on the power transformer. Power change from ten kilowatts to one kilowatt requires both voltage reduction and radio frequency load tap change. A pad in the audio input automatically adjusts the audio level to the proper value for the power. Power change is by a switch on the front panel taking only a fraction of a second. The circuit is readily adaptable to phasor switching control circuits.

The main rectifier uses six 8008 rectifier tubes for five kilowatts, and six 673 rectifiers for ten kilo-

Fig. 3: Rear view of transmitter showing power cubicle and exciter

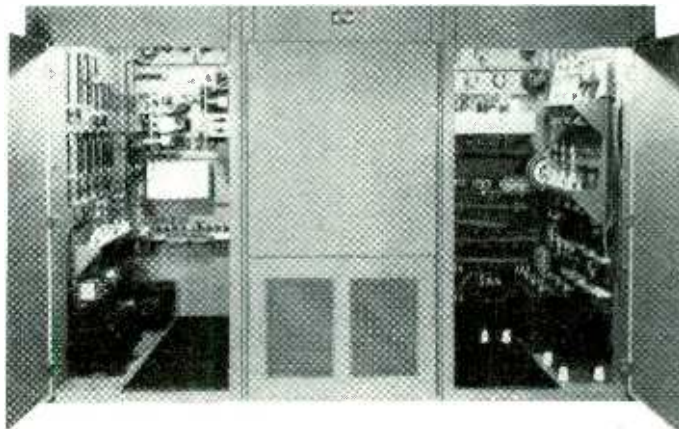

watts. Mountings and filament transformers are designed so that the two types are interchangeable. The operating plate voltage is 5000. This reduces the insulation requirements, and makes high voltage cable more readily obtainable. The filter system consists of two branches with separate filtering for the modulator and power amplifier. The filter condensers are equipped with surge limiting resistors. The high voltage, low voltage and bias rectifiers have grounding relays.

Low Voltage Rectifier

The low voltage rectifier supplies 1500 v., and uses two 8008 rectifier tubes. Low voltages, such as for the frequency control unit and first and second audio stages, are taken from separate voltage dividers to minimize interaction and to stabilize the voltages on these units. The bias rectifier supplies 300 v. and is loaded to 1 amp., and also uses two 8008 tubes.

All stages with the exception of the frequency control and first two audio stages, are protected by over-

load relays. Both power amplifier and modulators are protected against under-bias. The primary power circuits are protected by magnetic circuit breakers. The high voltage primary also has a primary disconnect for safety and for testing control circuits. The modulation transformer primary and secondary, and the modulation reactor, have safety gaps so that transient surges will be dissipated through the gap.

The control circuit is designed so that the transmitter will recycle until the fourth overload. This automatic reset is so arranged that opening a door will de-energize the circuit and require manual application of plate voltages. Thus, there is no danger that an operator might be trapped inside the transmitter by the accidental closure of a door, with the automatic reset applying the high voltage.

Low voltage wiring is by short connecting jumpers between matched terminal boards on each cubicle. This makes the control circuit very adaptable to modifications as required by the phasor, or other special modifications.
(Continued on page 64)

Fig. 2b: Distortion curves for transmitter and modulation circuits using quarter and full power, and 85% and 100% modulation respectively.

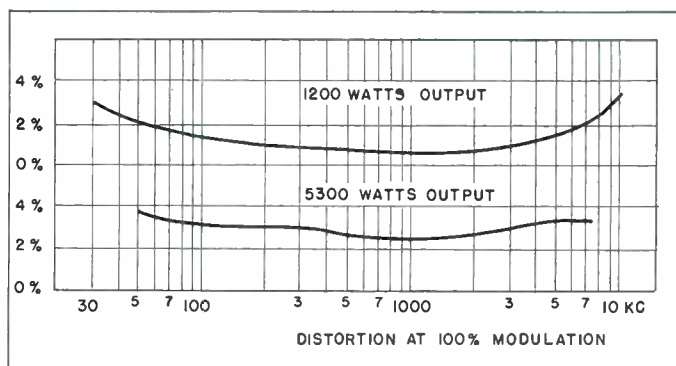
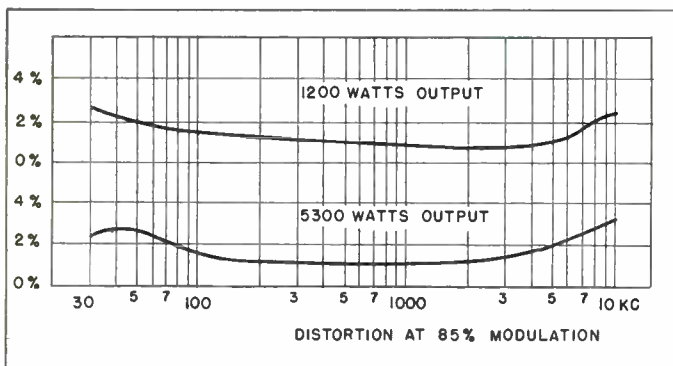

CUES for BROADCASTERS

Practical ways of improving station operation and efficiency

Edited by John H. Battison

Program Monitor for AM-FM

R. D. HOUGH, Chief Engineer,
WPDX, Carlsburg, W. Va.

THE device is automatic in operation and can be switched out instantly. It is mechanical in construction requiring only one 12v. dc telephone type relay, a telechron clock motor and a micro switch. The one RPM clock motor has a cam already installed. The size and shape of the cam is shown on the diagram. A roller-leaf actuating type of micro-switch is mounted above the cam so it makes contact when the longest portion of the cam strikes the roller. This cycle occurs twice during a revolution thus energizing the relay every other 15 seconds and holding it in an energized position for 15 seconds. This gives 15 seconds of the AM monitor and then 15 seconds of the FM monitor and then repeats or for each minute thus sampling the AM twice and the FM twice.

A three pole two position wafer type switch is used to turn the motor on and set the monitor circuits up for the relay contacts. The switch in the off position connects the monitor amplifiers to separate speakers for tracing trouble or monitoring when the two transmitters are carrying different programs. Before this switch is turned to the off position the motor should be al-

\$\$\$ FOR YOUR IDEAS

Readers are invited to contribute their own suggestions which should be short and include photographs or rough sketches. Typewritten, double-spaced text is preferred. Our usual rates will be paid for material used.

lowed to turn until the contacts of the micro-switch are in the open position.

Transmitters can also be equipped with carrier failure alarm circuits so that if one goes off during the fifteen-record cycle that it is not being monitored it will be known at once.

Semi-Automatic Antenna Change Circuit

H. N. BLACK, Chief Engineer,
KSMO, San Mateo, Calif.

HAVING damaged several antenna relays due to accidental operation while supplying power to the antennas, the following system was devised which has proven very effective. The system prevents operation of the antenna relays while under load thus preventing contact arcing and subsequent burn-out.

The preset switch is operated to the desired position then at change-over time the transmitter final plate

voltage control circuit is momentarily de-energized and re-applied. During this off air instant the antenna relays are operated automatically. They will then remain in this position during any later transmitter or until the preset switch is reversed. Then at the next outage the antenna relays will reverse their positions.

The point CCT is any portion of the transmitter final plate control circuit de-energized when the plate voltage is off. Can be one side of the plate primary contactor, etc. (Must be at a point 115 v. to ground.) Point 115 v. HOT is one side of the transmitter filament primary, 115 v. to ground.

Turntable Motor Switch and Attenuator

TONY VACCARO, Chief Engineer,
Portsmouth, N. H.

OCCASIONALLY it is necessary to install turntables in a small, or remote studio, or even in the announce booth. This means the announcer starts the turntable motor, attenuates output of the reproducer and also switches each turntable to either "Broadcast" or "Cue Record" positions. The main problem here is to start the turntable, throw "Broadcast-Cue" switch to broadcast position, and open the attenuator. In a set-up of this type it is

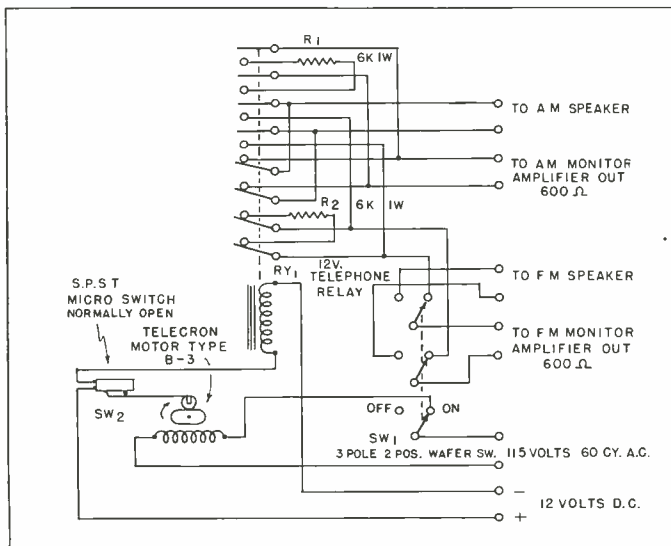

(Left) Circuit for monitoring AM-FM transmitters automatically
(Below) Prevention of antenna relay operation while under load.

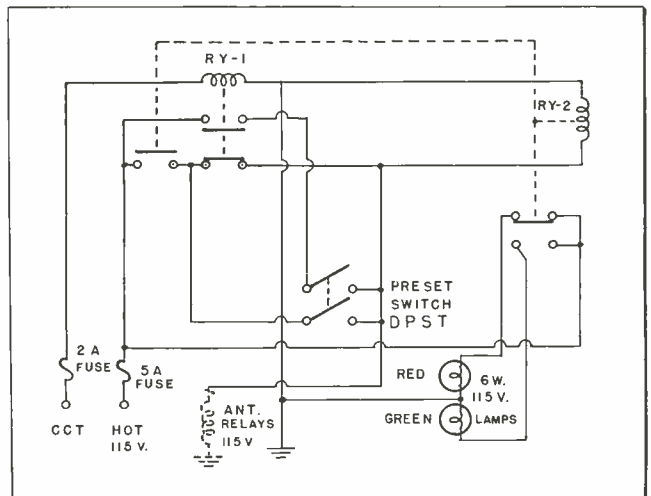

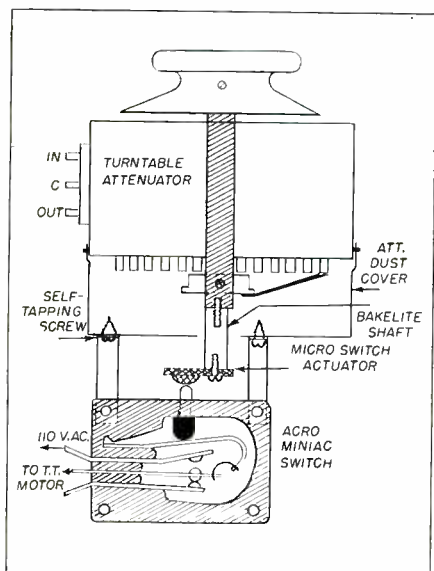

Combination micro-switch and attenuator

usually standard procedure to provide a lever switch and a variable pad. The problem is not one of turning on the turntable motors, as this is usually done by providing a spare pair of terminals on the lever switch, but one of hum induction, and key clicks whenever the turntable is turned on or off. There are two alternatives: to provide a separate switch away from the low level, lever switch; or provide a 6 volt direct current source to energize a relay which in turn applies the 110 volts A.C. to the motor. The latter requires relays, batteries, and additional wiring. The problem is to have the switch as convenient as possible and still eliminate hum pick-up and clicks.

A small "Miniac" type 3MD4-1A snap-action micro-switch, manufactured by the ACRO, is mounted on the Att. This switch carries a push button actuator with generous over-travel, and is capable of handling 15 amp. 115 v. AC.

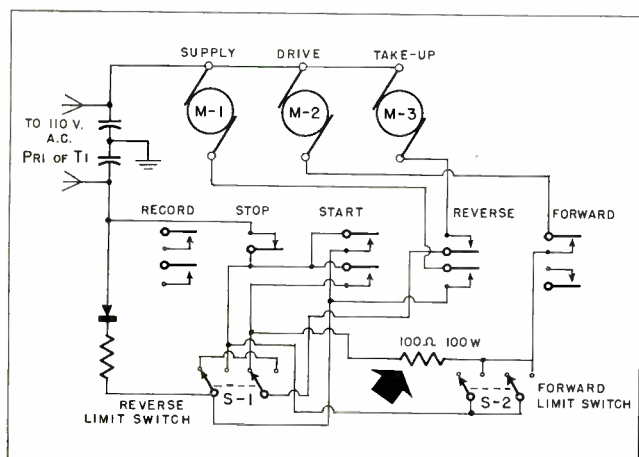

(Left) 100 ohm switching circuit improves Soundmirror operation

(Right) Simple audio in the vicinity of the monitor system for checking noises in transmitter

the start button is pressed, the resistor is in the drive motor circuit, until the take-up motor has a chance to pull the tape taut and close the forward limit switch S2. The resistor is not in either motor circuit, until the operator allows the start button to return to normal, and at that time the resistor is switched in the take up motor circuit. During the fast forward operation when the tape bypasses the heads, capstan, and limit switch, the start button must be held down. Hence full voltage is applied to the take-up motor. During the rewind cycle, when the stop button is pressed, full brake voltage is applied to the motor.

Transmitter Tuning House Monitor

Q. V. PROCHASKA, Chief Engineer, KDIX, Dickinson, N. Dak.

HERE is a handy transmitter room monitoring setup especially adaptable to small station operation. The block diagram shows sound originating in the transmitter room and picked up by the microphone, amplified and fed to the remote monitoring speakers. Ordinarily no additional equipment is required as most stations have emergency announce microphone and associated amplifiers at the transmitter.

Monitor speakers can be located at the tuning house, in the basement and outside. The operator can hear the output of the regular program monitor, the telephone or any other sound originating from the transmitter room while he is at the tuning house, in the basement or even watering the lawn.

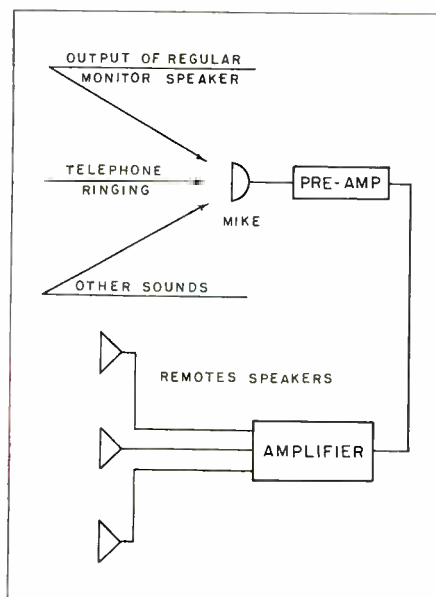

On mounting switch to the attenuator, it had to be done so that the latter would actuate the switch in the same way as a standard AC-DC receiver is turned on by using a switch on the volume control.

The problem was to attach the micro-switch to the attenuator, and then provide some means of actuating the micro-switch plunger. This was accomplished by securing a cam to attenuator shaft. The completed switch is shown in the cross sectional drawing. Material needed includes a piece of brass or bakelite rod $\frac{1}{4} \times 1$ " long, two right angle brackets, two small bolts, two small self-tapping bolts and one headless bolt $\frac{1}{2}$ " long.

Procedure—Tap a hole completely through the one inch rod for the headless bolt available.

Remove dust cover from attenuator and drill a half inch hole through its center.

Tap a hole $\frac{1}{4}$ " into center shaft of attenuator, with same thread as headless bolt.

Drill a hole through one end of a piece of flat copper or brass stock $\frac{3}{4}$ " long and $\frac{1}{8}$ inch thick.

On opposite end of flat stock, drop a large ball of solder, this is the cam.

Attach switch to brackets and secure brackets to dust cover by using the self tapping screws.

Upon completion it was found that 110 volts could be connected directly to the switch terminals without interference. To start turntable motor turn attenuator knob approx. $\frac{1}{8}$ ". Reverse movement turns motor off.

Soundmirror Modifications

GERALD J. BOOS, WDLB, WDLB-FM, Marshfield, Wis.

IN the forward operation when the forward button is depressed and

Video Recordings Improved by the Use of Continuously Moving Film

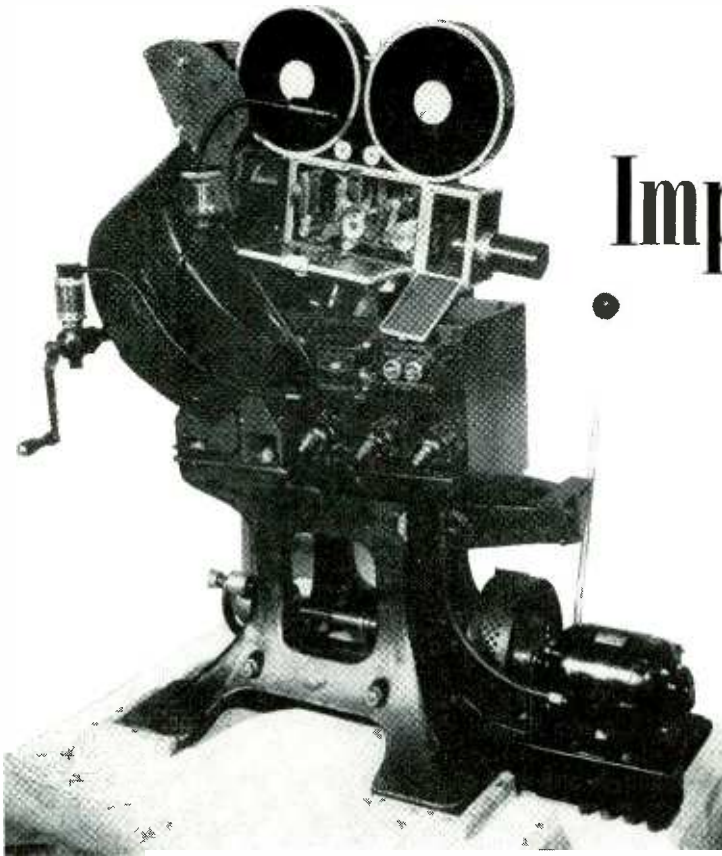

The elimination of line structure in film recordings is obtained by optically "stopping" the film and applying 10-15 MC modulation to beam

By WALTER D. KEMP, Development Engineer, British Broadcasting Corp., London, England

THE advent of television recording has made it possible to store and reproduce the television program at will. Much effort has been expended in perfecting the various technics employed, and the purpose of this article is to describe some of the work which has been carried out by the B.B.C. on this process.

In sound broadcasting, considerable use is made of recordings, and although the reasons for recording television programs are similar in some respects, it may be of interest to review some of the principal purposes for which recordings are used in Britain, before considering the technical problems in detail.

Many of the important topical events occur at times when the majority of viewers are unable to see the direct transmission. It is therefore desirable to make a record of the event as televised, which can either be transmitted as a complete item in that evening's program, or can form an item of the current newsreel.

Most drama productions, and some of the more ambitious light entertainment programs are repeated a few days after the original performance. At present, this is done by the staff and artists repeat-

ing the whole show, but this involves the tying up of studio space, which could be better used for rehearsal of another production.

Transcriptions

With the growth of television abroad, there is an increasing demand for cheap but good program material. The high cost of elaborate studio productions must inevitably render them relatively infrequent in countries where television is only becoming established, and there is no doubt that a recording of a good play, or an important outside broadcast of world-wide interest (such as the Olympic Games, etc.) would be welcomed outside Britain. As B.B.C. television recordings are recorded at a speed of 25 frames/sec. and have no line structure, they are suitable for reproduction on television film projectors, or standard cinematograph projectors anywhere in the world.

In motion picture photography, a complete image is formed on each film frame and after the exposure period a shutter closes and a new unexposed frame is pulled into position, registered, then exposed. At any instant during the exposure

period every picture element of the emulsion is receiving light from the subject, and the exposure time is the same for all picture elements, being, as a rule, about 50% of the total time of the cycle, or 1/48th sec. at 24 frames/sec.

Recording a cathode ray tube image is fundamentally different, since the image is scanned line by line, and each picture element on the film receives the major part of its exposure in an extremely short period. This period corresponds to the time when the electron beam exciting the fluorescent screen is actually directed upon the element of the screen concerned, and on British standards is about 0.3 μ sec. There is, of course, some exposure due to the afterglow produced, but this dies away in a short period, so that the total effective exposure time is very small when compared with motion picture practice. This means that figures of emulsion speed, etc., obtained by normal photographic technic cannot be relied on for photographing television images, even if correction is made for the different spectrum of the light emitted by the cathode ray tube, because the exposure produced on the film is not proportional to the

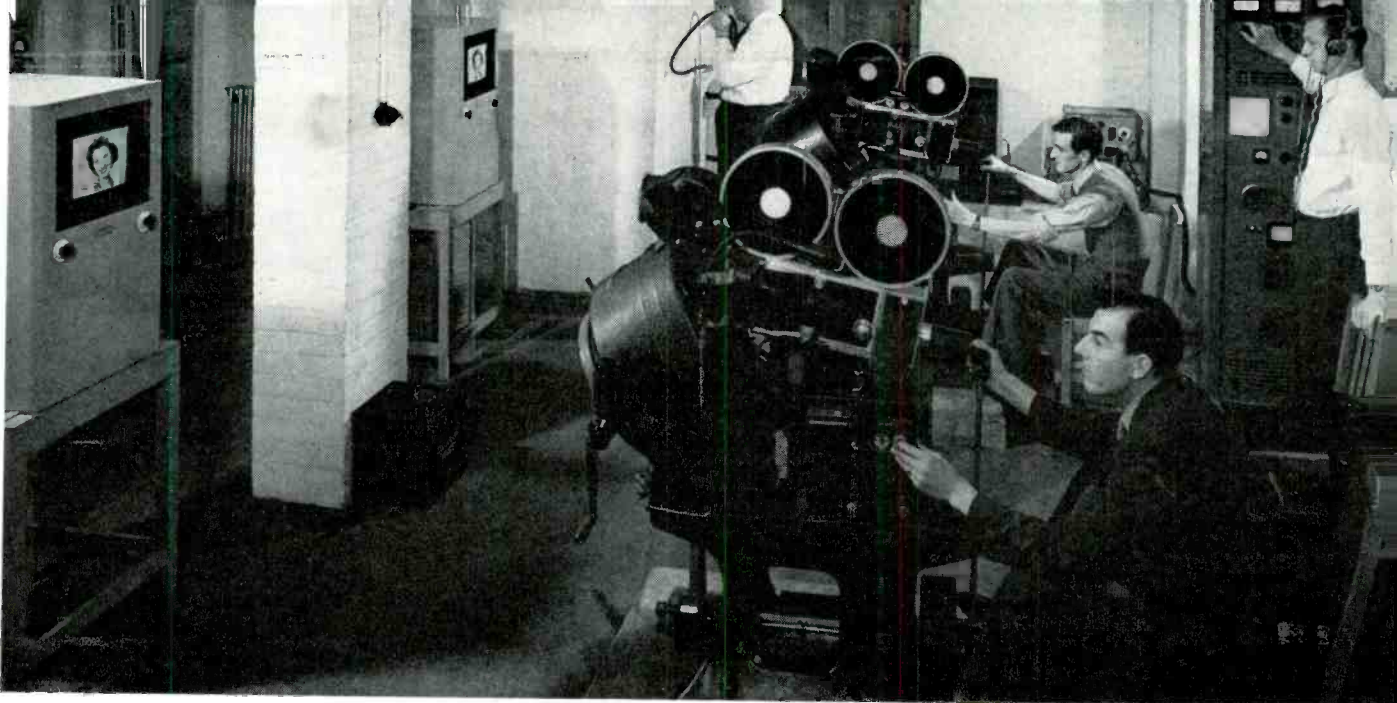

Fig. 1: Telefilm recording room at Alexander Palace. Normally the room is in subdued light, or darkness, for photographing the images on the two screens on the left. A closer view of a camera is shown on the opposite page. The lever controls the film speed

multiple of the intensity and the exposure time over such a wide range.

The process is therefore more analogous to that of recording sound photographically on film. The image obtained by photographing a television picture is a variable density photographic recording of the electrical signals composing that picture, each line of the picture being an individual "sound track". There is no necessity to make the individual variable density tracks form an image at all, but it is obviously desirable not to arrange them in one straight line, since the linear velocity or writing speed is so high. There is thus no fundamental reason why television programs should be recorded in the form of recognizable images on the film, but this method has overwhelming advantages for editing and re-transmitting, since standard apparatus can then be used. In view of this, it has been the constant aim of those responsible for the development of television recording in the B.B.C. to produce an absolutely standard motion picture film in every respect. The only variation from cine standards that has so far been tolerated is operation of recording and reproducing equipment at 25 frames/sec., the television picture repetition rate on British standards. This enormously simplifies both functions, and the 4% reduction in speed should such films be projected at 24 frames, is relatively unimportant, as greater variations are tolerated in the commercial theater due to variations in supply frequency.

All methods of recording televi-

sion, so far, have used a cathode ray tube as the modulating device, and hence have produced variable density recordings. It is interesting to speculate on the possibility of making a variable area recording. If this could be done, processing would not affect the gamma of the image produced, and this might be an advantage. At present, however, we lack a suitable modulator.

Principal Recording Problem

One of the principal difficulties of recording television signals is due to the standards which have been adopted. To obtain efficient use of bandwidth, most standards allow a minimum period between pictures; thus in Britain the frame suppression period is 14 lines or 3.46% of the picture period. In the United States, the figure is about 3.75%, but as the picture period is slightly less, due to operation at 30 pictures/sec. instead of the British 25 pictures/sec., the time interval is actually somewhat smaller. The time available on British standards is about 1.4 millisees. and for any intermittent method of recording, the film would have to be pulled down and registered in this period. So far as is known at present, no camera has been made which can achieve this rapid pull down, as the high film accelerations needed require forces to be exerted which damage the sprocket holes.

Attention was therefore focussed on the use of continuous motion for the film, with optical or electrical compensation. A method at present used by the B.B.C. for 35 mm. re-

ording employs continuous motion with optical compensation.

Intermittent methods of recording have been devised (as in the Eastman Television Recording Camera) which take advantage of the difference between Television and Film repetition rates. These do not require as fast a pull down as mentioned above, but they cannot record all the information present in the original television signal. The information lost may not be vital to the picture quality since the original television signal may have been more than adequate in this respect.

Systems of Telefilm Recording may therefore be divided into two fundamental categories — those which employ an intermittent movement, and those employing continuous motion of the film.

Intermittent Motion

Experiments in Telefilm Recording were made shortly after the war, using a standard cine camera driven by a synchronous motor at 25 frames/sec. and phased so as to be in step with the television signals. Due to the fact that pull down consumed about 50% of the total picture period, only half the active number of lines were recorded. The results obtained, however, showed that telefilm recording was a practicable proposition, although severe interference patterns were produced when the film was re-scanned.

These interferences, or moiré patterns, are caused by the opaque areas between lines, since it is impossible to arrange that the re-scanning of the film exactly follows

VIDEO RECORDING (Continued)

the original scanning which produced the image. Even when the full number of lines are recorded, patterns can be produced, particularly when the re-scanning is done by the "flying spot" system, which involves no storage. Fortunately, however, a technic has been perfected which enables the line structure of the image to be completely eliminated, and present B.B.C. recordings can be scanned on any standards with no sign of this effect.

A recent invention by the author* enables a process akin to step printing to be carried out in the cameras, and an experimental camera is now being built on this system using 16mm film. The advantage gained is that the film speed is 25 frames/sec. and so sound can be recorded in the usual manner; moreover, since no high rates of pull-down are involved, there is time to register the film accurately. The latter point is extremely important when using 16mm.

Continuous Motion Systems

In 1948 experiments were carried out using a 35mm continuous motion projector, the "Mechau" (made by A.E.G. in Germany) as a camera for television recording. These experiments were so successful that it was decided to construct two cam-

eras using parts of this projector, which could be used for recording on an operational basis. This was done and the channel is now in service.

This continuous motion system of recording is described in detail, as, although it is normally used to record at 25 frames/sec. from a television picture repetition rate of 25 p.p.s., a relatively simple modification will enable it to record at 24 frames/sec. from a television picture repetition rate of 30 p.p.s.

The Camera

Fig. 2 shows a schematic arrangement of the camera and cathode ray tube. The optical system of the camera, comprising the lens L.1, the fixed mirror M, an iris, pivoted mirror M.1 mounted on a rotatable drum D, and focusing lens L.2, serves to form a succession of images of the cathode-ray-tube screen upon the continuously moving film F.

The mirror drum D and film F are driven at fixed relative speeds by the motor which is mechanically coupled (by means indicated diagrammatically by broken lines) to the drum D and to the film driving sprockets S.1 and S.2. The path of the film is from the feed magazine through the curved gate, round the sound recording drum and back to the take-up magazine, as shown by

the arrows in Fig. 2. The field curvature of the lens L.2 is designed to be equal to the curvature of the gate. A correcting lens, not shown, is fitted immediately in front of the curved gate to compensate for the field curvature of L.2 at the sides of the film frame.

In Fig. 2 an image of the point P on the cathode ray tube screen is shown formed at a point P' on the film in the gate. As the film moves downwards through the gate the mirror M.1 in use is tilted by a cam mechanism in the drum in such a manner as to cause the image P' to move downwards with the film at the same velocity, so that the image P' is held stationary relative to the film. A recording of the image is made during the exposure period. The tilting of the mirror can in fact be analyzed into two angular displacements, one radial, referred to above, and the other tangential. The tangential displacement compensates for the fact that the mirrors are rotating in a curved path at an angle to the incident beam of light.

Fig. 4a shows a plan of the mirror drum. There are eight glass, back-silvered, pivoted mirrors disposed equally round the periphery of the drum. The circle C.1 indicates the area over which the light falls from the point P when the image P' is in the center of the gate (Fig. 2) —at this particular distance of time the light reaching the film at P' is reflected from mirror M.1 only. Rotation of the drum causes the area C.1 (Fig. 4a) to move relative to the mirrors in the direction indi-

Fig. 2: (left) Diagrammatic view of the interior of the recording camera.

The large black drum visible in the photographs contains the rotating mirrors. Fig. 3: (right) Graphic representation of waveforms and time sequences involved in recording 24 frames and 30 frames per second.

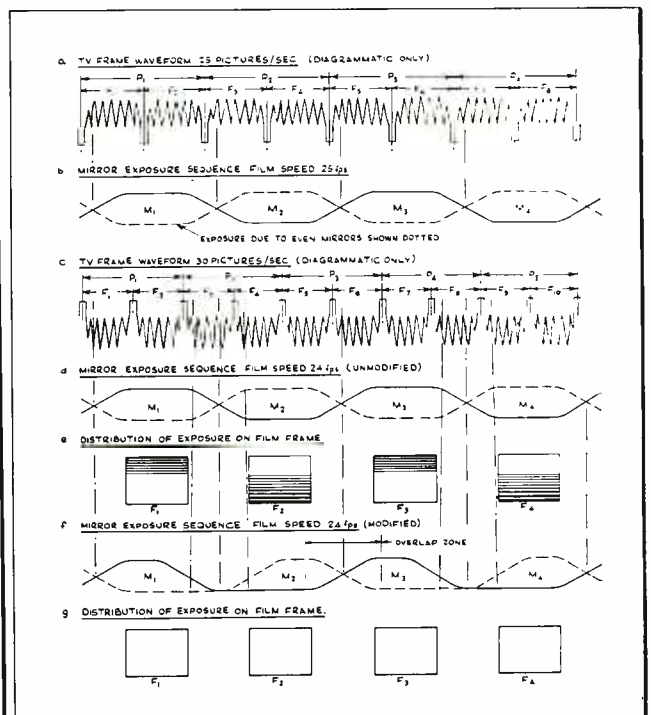
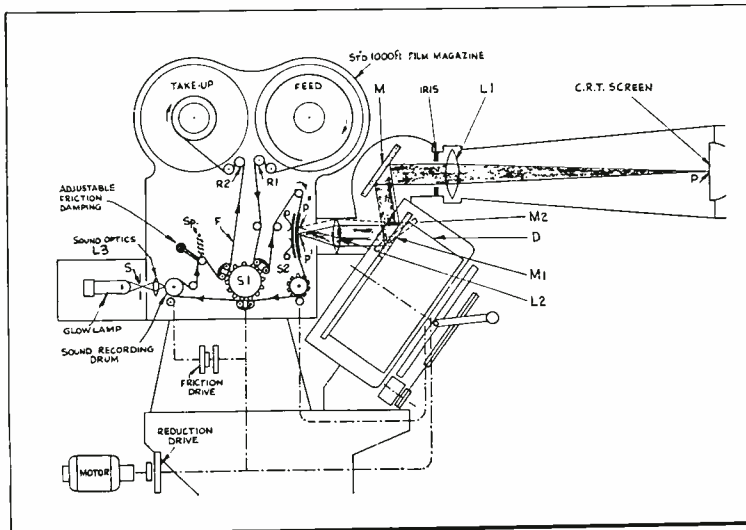

cated by the arrow, and the shaded area bounded by the circle C.2 indicates the zone over which the light falls from the point P (Fig. 2) when the image P' is nearing the lower end of the gate.

It will be seen from Fig. 6a that light falling over the shaded area is partly reflected from the mirror M.1 and partly from the mirror M.2. The light reflected from the mirror M.2 forms a second image P'' (Fig. 2) on the film in the gate, and the mirror M.2 is tilted with the rotation of the drum to hold P'' stationary in relation to the film as in the case of P'. The disposition of the mirror tilting cams is such that the displacement between the image P' and P'' is equal to the distance between adjacent frames on 35mm film. For a fraction of the exposure period, therefore, there are two frames of the film being exposed simultaneously, but each film frame receives its exposure from one mirror only.

In this way a succession of television images is formed on the film as it passes through the gate. The brilliance of each image rises from zero, being low at first when the image is at the top of the gate, then increases to a constant intensity, and finally fades out to zero when the image reaches the bottom of the gate. This is shown graphically in Fig. 3b.

Exposure is Continuous

With this arrangement exposure is taking place continuously, and no shutter is required. Moreover there is no period when intelligence is not being recorded on the film. For example, assuming the camera is running at a speed corresponding to 25 frames/sec., a film frame F.1 enters the gate at the commencement of a television frame scan T.1. It takes the film frame F.1 approximately 1/25th of a second to pass through the gate, and in that time T.1 is recorded on F.1, and in addition the interlaced frame scan T.2 is also recorded on F.1, so completing the recording of one television picture. When F.1 is in the lower half of the gate, however, and the exposure of F.1 to T.2 is diminishing towards the zero, the next film frame F.2 occupies the upper half of the gate and is beginning to receive an increasing amount of exposure from the next frame scan T.3. When the film frame F.2 is in the lower half of the gate the next television frame scan T.4 is recorded on the film frame F.2. The recording cycle is then repeated.

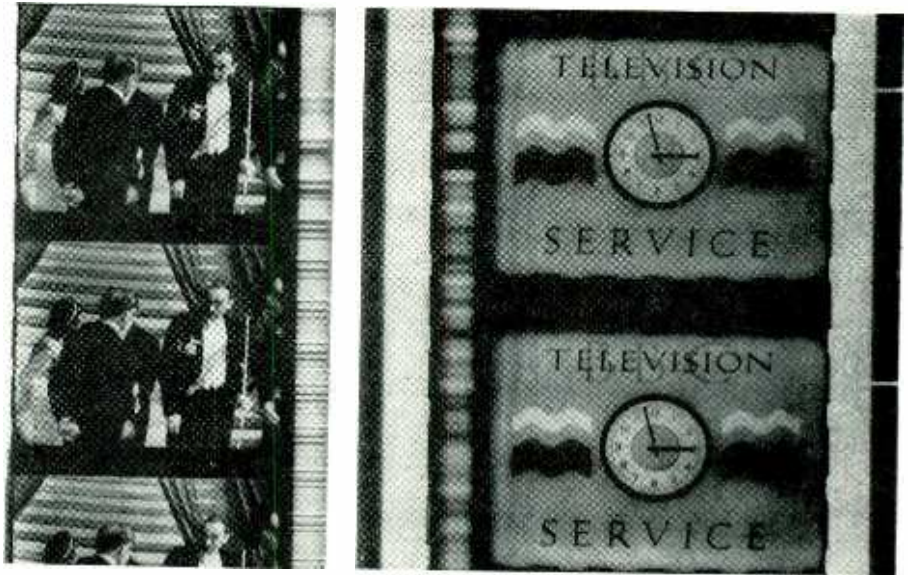

Fig. 5: Prints from film recordings made by the BBC process. That on the left was taken at Covent Garden Opera House, the one on the right is a shot of the BBC time signal and tuning signal. The 2.5 MC lines in the clock center show good definition

When it is desired to record a 30 frame/sec. television signal so that a 24 frame/sec. film is produced, it is necessary to black out a portion of the mirrors to avoid more than two fields being recorded on one film frame. The portions of each mirror which it is required to black out are shown in Fig. 4b, and the modified exposure cycle in Fig. 3f. Fig. 3d shows what would happen if the mirrors were left unmodified, and the camera was run at 24 frames/sec. when recording a 30 frames/sec. television signal. In this case, it will be seen that each frame on the film receives an extra portion of a field scan and that this portion occurs alternately at the top and bottom of a frame. This is shown in Fig. 3e. Hence, when the film is projected, a severe 12 cycle flicker is noticed. If 1/5th of each mirror is blacked out in the manner shown, one field in five is not recorded, and this produces the required 1/5th reduction in repetition rate. The blacked out areas have not been spaced regularly around the mirror drum; as if this were the case, the position of the "overlap zone" would change every alternate frame, and this might give rise to 12 cycle flicker on projection. The overlap zone is shown in Fig. 3f. It is the area of the film frame in which the exposure of one set of lines of the interlace has been due to two superimposed scans of less than full intensity. The total exposure produced is the same as that which would be produced by one scan at full intensity, because the exposure curves are symmetrical about the time axis. This symmetry is a con-

sequence of the circular shape of the cone of rays falling on the mirrors (Fig. 4a). The duration of the overlap zone is determined by the diameter of this cone of rays at the mirror drum, and hence by the aper-

(Continued on page 62)

Fig. 4: (a) Mechau mirror drum, showing the eight mirrors, and position of light spot. (b) Amount of mirror which has to be blacked out to accommodate TV speed of 30 frames/sec.

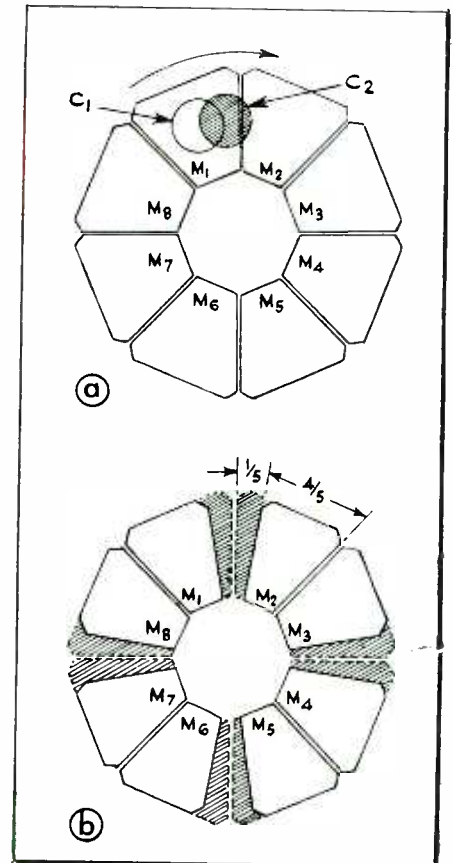

Wide Range Decade

Laboratory measurements are aided by precise and easily identifiable source are available, and when used with auxiliary harmonic gen-

By J. M. SHAULL, National Bureau of Standards,
Washington 25, D. C.

LABORATORY frequency measurements and calibrations are greatly facilitated by having precise and easily identifiable marker frequencies available throughout the radio spectrum. A decade frequency generator supplying separate filtered outputs of any or all of the harmonics of a 100-KC frequency standard in the range of 100 to 1000 KC is shown in Fig. 1. If used with auxiliary harmonic generators a great number of precise markers may be obtained throughout the high-frequency and microwave ranges. Additional multiplier-converter units and an adjustable oscillator of high stability may be used to obtain a high-precision frequency generator having complete coverage of any desired frequency band.¹

The decade frequency generator consists of limiting and pulse-shaping circuit arrangements, grid filters for separating the desired harmonics of 100 KC and ten output amplifier stages. The output power is 0.1 watt at each frequency at a nominal impedance of 100 ohms. The tube plates are coupled to the output jacks through tuned transformers and a separate switch is provided in the plate supply lead of each stage for controlling the output. All undesired components, such as harmonics and multiplier side frequency in each output are attenuated by more than 60 db. When the outputs are used to drive fre-

quency converters or make critical measurements, such as exploring resonances of quartz-crystal units, these spurious frequencies can cause considerable difficulty if not greatly attenuated.

A power output of 0.1 watt at 100 ohms was adopted as having the greatest utility with the minimum of unfavorable design considerations. The 100-ohm impedance is in the range of most crystal mixers and connecting cables, and at the same time develops sufficient voltage to drive the grids of multiplier or converter stages directly. This nominal output is obtained easily from a class A tuned amplifier with low power drain, while still maintaining a high plate tank Q with its additional attenuation of harmonics. Shielding and decoupling requirements also are much less severe at this low operating level.

The complete circuit schematic for the unit is shown in Fig. 3. For operation, a 100-KC signal from a frequency standard or other stable source, with an output voltage of 2 to 10 v. at about 100 ohms, is supplied to the input jack. The 100-

KC amplifier makes a 100-KC frequency of very low harmonic content available on the front panel jack when S-1 is closed. The 100-KC input is also supplied with considerable increase in voltage through the series tuned transformer T-1 to the first half of V-1 which serves as a limiter and impedance changer. The second half of V-1 and V-2 constitute a pulse shaper and amplifier supplying pulse power of high harmonic content between 100 and 1000 KC to the harmonic bus line.

From the harmonic bus the individual multiples of 100 KC are filtered and supplied to the grids of the amplifier tubes V-4 through V-12. To remove the small amount of harmonic distortion generated in the amplifier tubes and to couple from the tube plates to the output jacks, tuned transformers with low-impedance link windings are used.

Pulse Circuit

The pulse generator consists of the dual triodes V-1 and V-2 and associated circuits. The input triode of V-1 is driven at relatively high amplitude by means of the series-tuned input transformer and generates an essentially rectangular pulse across its cathode resistor. The leading edge of this pulse is differentiated by the RC coupling

Figs. 1 and 2: Panel and rear views of the decade frequency generator. Design is simple and layout conventional.

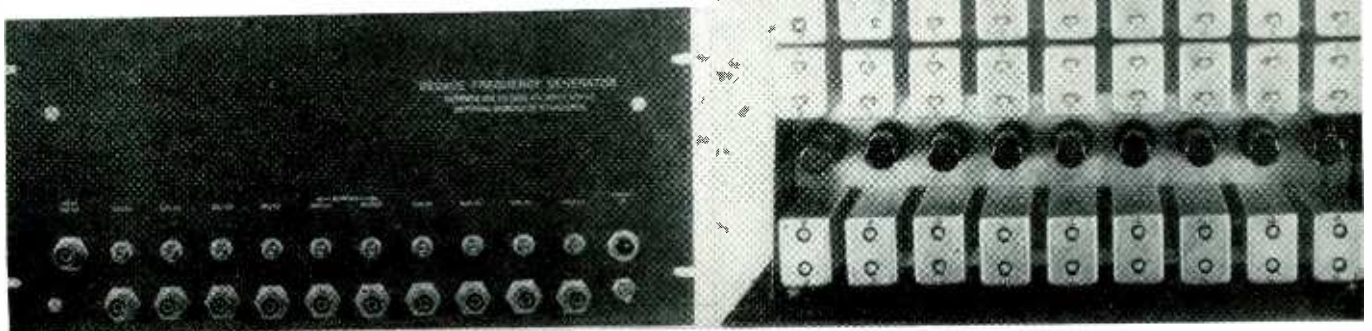

Frequency Generator

able marker frequencies. Filtered or harmonic outputs of 100 KC erator many markers may be obtained throughout microwave ranges

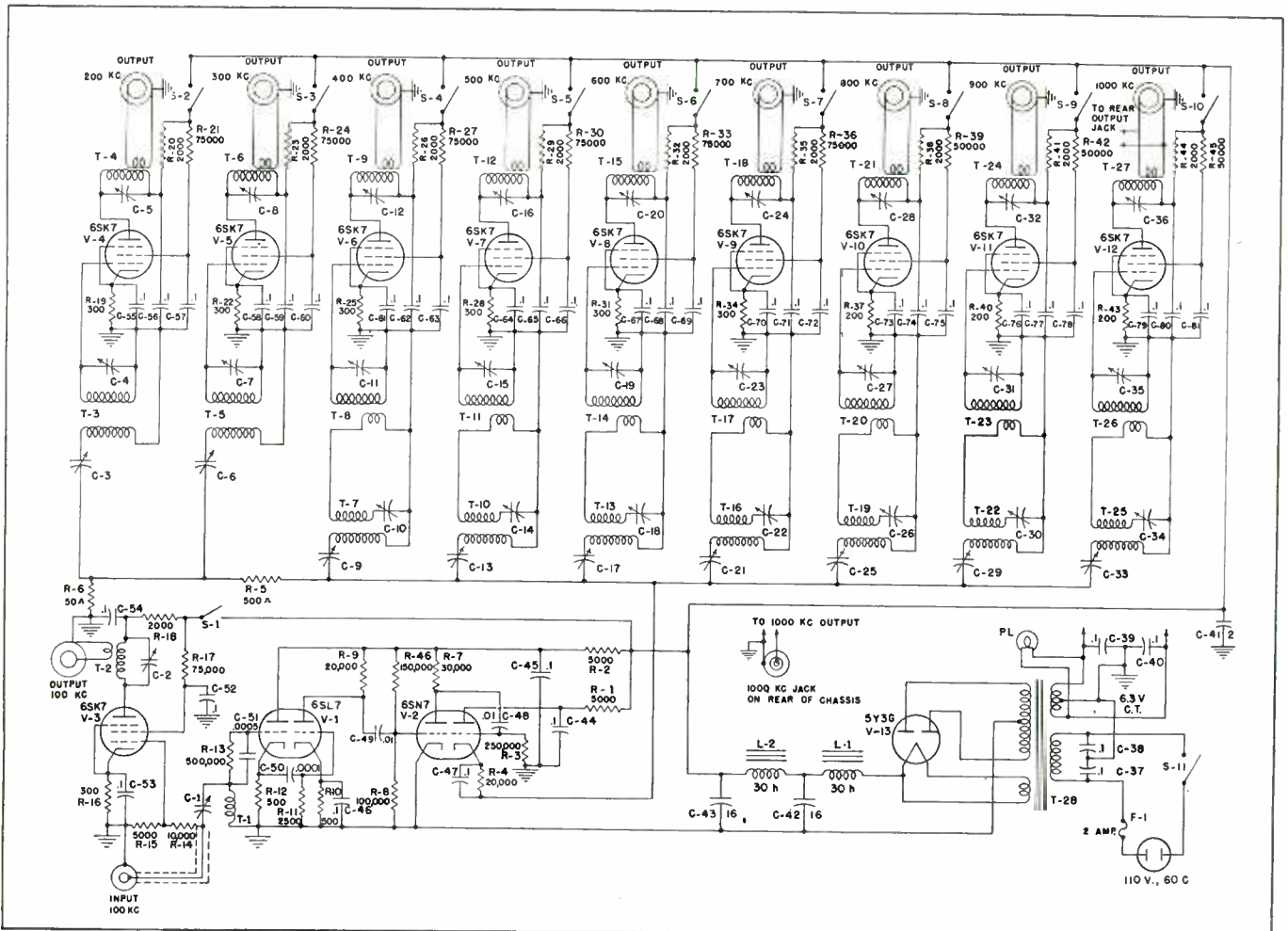

Fig. 3: Schematic diagram of generator. Litz wire is used on the powdered iron cores of the r-f coils. Magnetic shielding is important

network and passed through the next two triode amplifier-clipper stages. A short positive-going pulse with a small negative overshoot is impressed on the grid of the second triode of V-2. This tube serves as a pulsed power amplifier driving the harmonic bus and its resistive load. The bypassed cathode resistor in series with the load supplies sufficient bias to eliminate the negative overshoot and results in a rectangular positive output pulse. The peak pulse power output is approximately one watt.

The differentiator circuit was adjusted to give a pulse width of approximately one-half microsecond, which gave a maximum output for the 1000-KC stage. With this ad-

justment the power in the bus for the lower desired harmonics follows a $\sin x/x$ distribution. The use of an untuned single class C harmonic generator stage at 100 KC was not found satisfactory as it gave very low output at certain frequencies and a drop in amplitude for several of the frequencies, which shifted with changes in excitation level or operating angle.

The grid filter elements were designed to operate at the highest working Q value obtainable with the type of coils used. This was particularly desirable at the 1000-KC end of the range as these frequencies were the most difficult to filter because of the smaller percentage separation and lower am-

plitude. For the wire size and core material used, the parallel-tuned grid winding at 1000-KC was found to have maximum Q at a value of about $180 \mu\text{h}$, while the 400-KC grid coil gave optimum filtering with about $1130 \mu\text{h}$. Intermediate values were geometrically spaced between these limits.

The input series tuned links from the harmonic bus above 300-KC were chosen to operate at inductance values which tuned 20 to $30 \mu\text{m}\mu\text{f}$ in order to obtain the highest practicable working Q and minimum loading of the bus for the other frequencies. The intermediate tuned coupling windings have total inductance values about half-way

(Continued on page 60)

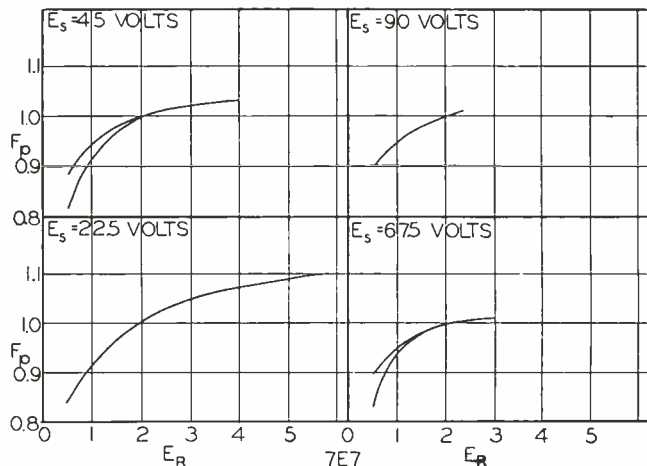
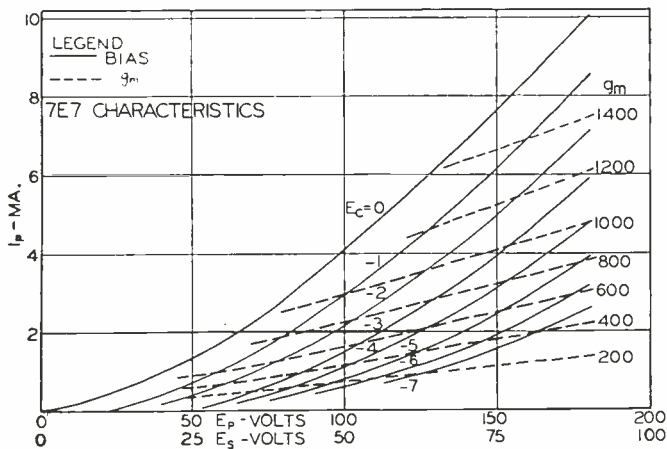

Fig. 1: (left) Curves for 7E7 tube with fixed ratios and varying magnitudes. Fig. 2: (right) The same curves after applying Eq. 1.

Use of Conductance, or G,

Solution of circuit problems involving electron tube is simplified by use of new conception of tube curve

By **KEATS A. PULLEN,**
Ballistic Research Laboratories,
Aberdeen Proving Ground, Md.

THE solution of circuit design problems where the properties of electron tubes must be considered is often a difficult chore. Of late considerable interest has developed among design engineers in the usefulness of the G Curve technic for simplifying these solutions.

The papers presented to date have devoted themselves primarily to the study of triode tube applications.^{1,2,3,4} This article will be concerned primarily with the use of the G Curve technic with pentode tubes. It is based on a recently released report on this subject.⁵

The curves presently available on most pentode tubes offer design data useful for a limited number of possible operating conditions. When one is confronted with a design problem involving somewhat unusual arrangements it is often difficult to make a "paper" guess concerning the operating properties of the proposed stage.

A re-evaluation of the pentode problem has been attempted. Its purpose was to try to organize the data available to give information applicable to as wide a range of operating conditions as possible. At the same time the method of ob-

taining results has been simplified in order to make its use direct and convenient.

Since the value of the screen voltage is the key factor determining operating conditions in a tetrode or pentode tube, it is desirable that curves on these tubes place emphasis on the effect of screen voltage variation. Study of the usual type of plate characteristic with constant screen voltage confirmed the feeling that the variations shown in these curves represented a less significant variation than that due to screen voltage change.

The screen to plate current division, being determined primarily by the ratio of the corresponding voltages, suggested making experimental plots with fixed ratio but varying voltage magnitudes. Such a set of curves with $E_p/E_s = 2$ is shown in Fig. 1. These curves are for a 7E7 tube. A complete set of plate and transconductance characteristics was taken to establish the variation range from the value given in the curves in Fig. 1. These data were reduced to correction multipliers and plotted. The curves appear as in Fig. 2 if the following definitions apply:

$$E_r = E_p/E_s; E_{r0} = 2; F_p = I_{px}/I_{p0};$$

$$F_g = g_{mx}/g_{m0} \dots \dots \dots (1)$$

The range of variation of these curves is shown by the dotted lines plotted on the F_p - E_r portion of Fig.

3. As can be seen, the range of variation is less than $\pm 5\%$. This is adequate since overall tube data vary more than this. The curve for F_g vs. E_r is nearly the same as that for F_p vs. E_r . This is a consequence of the relative dependence of g_m on E_s and independence of g_m and E_p . The current division effect does cause some small variations.

Now to consider a possible design problem with this set of curves we suppose a 7E7 is to be used as a video amplifier for a signal having a peak amplitude of ± 3 volts, and an average transconductance of 1100 μmho is desired.

The first step is to find the minimum screen voltage which will give a reasonably linear output. Examination of Fig. 1 gives the following table.

Table I				
E_g	$G_m (E_c=0)$	$G_m (E_c=-2)$	$G_m (E_c=-4)$	$G_m (E_c=-6)$
25	800	225	0	0
50	1200	775	400	150
75	1500	1175	800	430
85	1650	1280	950	590

Both the 25- and 50-v. conditions can be discarded immediately. Linearity is fair for the other two. The distortion at 75 v. is about 14%, and that at 85 v. about 12%. Only 85 v. will offer a transconductance reasonably close to the desired average of 1100. Hence 85 v. is the minimum screen voltage for this application.

If the plate supply for this tube were 250 v., and the load resistor 10,000 ohms, the minimum plate voltage would be approximately

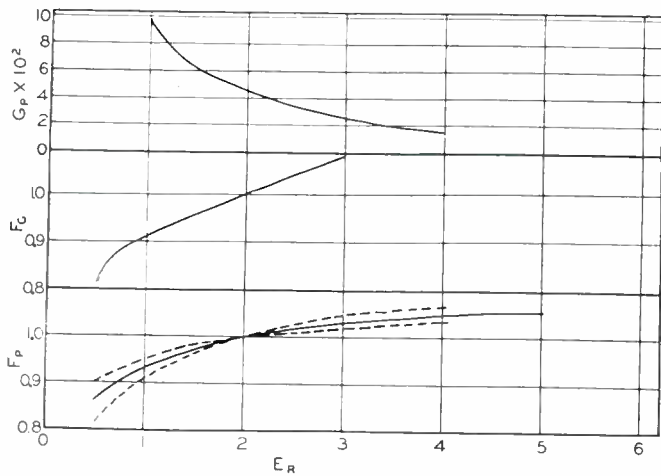
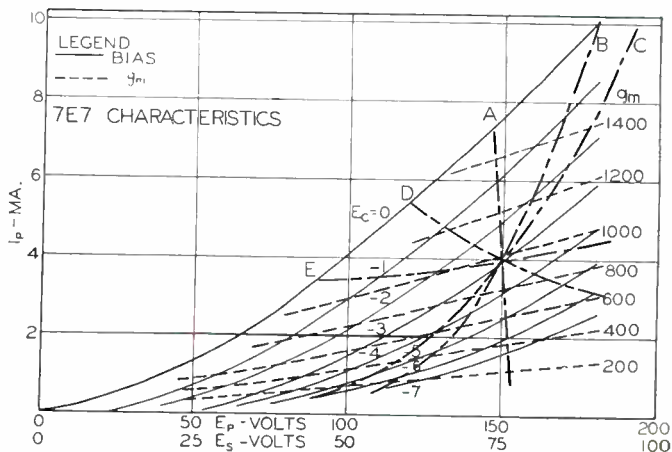

Fig. 3: Range of variation of 7E7 tube curves of Fig. 1. This is less than 5%. Fig. 4: (right) Load lines for various conditions.



Curves for Pentode Circuit Design

characteristics, which is always difficult and tedious, presentation as developed by military laboratories

150 v. For this application it will be shown that g_p may be neglected. Assuming this, the stage voltage amplification ranges from 5.9 to 16.5 at the extremities of the load line. The average is about 11.2.

If this amplifier were an audio amplifier, the attenuation might be quite different. Because of the limit on minimum screen voltage, the load resistance is limited in size. For good operation, it would be unwise to operate to an E_r less than 0.5. For this problem the minimum is chosen to be $E_p = 50$ v. Then R_L has a maximum value of 20,000 ohms. This doubles the available amplification.

Possible effects of g_p must now be considered. The value of g_p is dependent on three factors. These are E_s and I_p for $E_r = 2$ and the slope of F_p . From these facts the equation

$$g_p = G_p (I_{p0} / E_{p0}) \dots \dots \dots (2)$$

may be derived. The factor G_p is proportional to the slope of F_p . I_{p0} and E_{p0} (which is twice E_s) are the nominal plate current and plate voltage corresponding to a given bias. The graph of G_p for the 7E7 is also plotted in Fig. 3. Extrapolation of the value of G_p at $E_r = 0.5$ gives approximately 0.5. This gives $g_p = 26 \mu\text{mho}$. Hence, $g_p R_L = 0.52$. The amplification under this condition is reduced to 2/3 of its nominal value, or 22. At $E_r = -3$, $I_p = 5.5$ ma., giving $E_p = 140$ v. Here, $E_r = 1.6$. The value of g_p is $2 \mu\text{mho}$. Then $g_p R_L =$

0.04. Here the amplification is practically unchanged.

The main difference between the procedure just described and that for triode design are first that here a screen voltage to give desired transconductance and bias ranges is chosen, and second the denominator term $g_p R_L$ often may be neglected.

Where a wide range of plate voltages are developed, one additional step is required. First a table of plate current and transconductance values at different bias voltages is determined. The approximate tube plate voltage is estimated from this. The values of g_m and I_p are corrected from the curves, and the tube plate voltage redetermined. In most cases even the uncorrected values will be within tolerances to be expected from tolerance limits on tubes. If operation into the knee of the curves is desired, then correction will be required. This correction may be repeated if desired.

Variable Screen Voltage

Variable screen voltage operation may be desired for any of several reasons. In a tetrode, grounding the screen to the signal voltage may be necessary to prevent oscillation. Only in this way can grid and plate be adequately isolated. If cathode degeneration is present, a variable screen voltage is introduced.

Allowing the screen voltage to vary may either decrease the vari-

ation of the tube transconductance or increase this variation, as desired. The former is used to decrease distortion; the latter to increase distortion, and as a result the mixing action of the tube.

The characteristic curves of the sort shown in Fig. 1 can be used for design of circuits in this condition also. In screen degeneration a set of curves similar to Fig. 1, but carrying screen current and screen transconductance as determined by screen voltage and bias, and a set of correction curves similar to Fig. 3 would prove convenient. Some means of determining the change in screen voltage as a function of grid bias is necessary.

As an example of variable screen operation, let us examine a cathode degenerated 7E7 with the screen bypassed to ground. Take the case with $E_s = 75$ v., and $R_k = 750$ ohms. The bias voltage then is -3 v., and $g_m R_k$ is approximately 0.8, neglecting the screen transconductance. If the screen transconductance is approximately a quarter that of the plate, then $(g_{mp} + g_{ms}) R_k$ will be about unity.

When $(g_{mp} + g_{ms}) R_k$ is unity, the cathode amplification of the 7E7 is 0.5. The screen voltage variation is now half the incoming signal. Consequently, a screen load line can be plotted on Fig. 1. The load line for this case is labeled "A" in Fig. 4. Once the screen load line is deter-

G CURVES (Continued)

mined, proceed as in the ordinary pentode. Read plate current and transconductance at each bias point, and make corrections as indicated below.

An auxiliary triode or cathode coupled amplifier can be used to vary the screen voltage. The load line for $E_s = 5e_c$ is identified as "B" in Fig. 4. Load line "C" is for $E_s = 10e_c$, "D" for $-5e_c$, and "E" for $-10e_c$. Cases where the change is not linear also can be solved by use of the proper voltage and bias data.

That the value of the transconductance of the tube is varied when the screen voltage is altered is evident from the fact that the plate current rate of variation is changed. Our next problem is to make the corrections necessary to correct for this.

In order to understand how the correction may be carried out, one may recall the arrangement used in the solution of triode circuits. A load line is drawn, and values of g_m and g_p read along the line. Examination of these triode curves further shows that although the plate conductance, g_p , could be approximated from the slope of the constant bias contour, the transconductance cannot be obtained in a similar manner to a reasonable accuracy.

The problem, with a set of pentode curves of this sort, and a load line, looks very much like a typical triode problem. It then can be handled as one for the initial approximation. Then the necessary corrections may be made. The effective transconductance of the

tube, after correction for screen variation, takes the form

$$g_{me} = g_m / (1 + G_{pe}R_{Le}) \quad (3)$$

Here G_{pe} is the slope of the $I_p - E_s$ line at the point being determined, and R_{Le} is the reciprocal of the slope of the screen load line. As long as the same units are used for each of these factors, no error will result, as the product of G_{pe} by R_{Le} is dimensionless.

Solution is Simple

At first glance, the solution appears complicated. But actually, considering the number of variables available, it is surprisingly simple. After the approximate solution is obtained as indicated, corrections of the sort used on the standard pentode circuit will permit the adjustment for plate voltage variations. The E_r at each individual point must be used in the correction.

In Eq. 3, the term $G_{pe}R_{Le}$ may have either a positive or a negative sign. In order to keep the equations of this type strictly rigorous in use of definitions of calculus, this term should carry a minus sign. Then the R_{Le} would have a negative slope. However, in keeping with tradition in the field, we write

$$VA = -\mu R_L / (R_p + R_L) = -g_m R_L / (1 + g_p R_L) \dots (4)$$

rather than

$$VA = \mu R_L / (R_p - R_L) = g_m R_L / (1 - g_p R_L) \dots (4a)$$

Circuits for use of the pentode

for modulation or mixing are designed in a manner which is similar to that of the variable screen circuit. Design is simpler in some respects, however. Since this technique applies to converter tubes as well as pentodes, its application to converters is explained here. Application to pentodes is made in an equivalent manner.

Figs. 5, 6, and 7 present measured data collected on a sample 6SA7 type tube. The first grid, or main control grid, is labeled as C1 and the third, or auxiliary control grid as C2. Managability of the transconductance contours made use of the main control voltage as the abscissa more convenient than use of the auxiliary grid voltage.

A problem in signal mixing is reviewed to indicate the method. This problem takes a signal on C2 large enough so that the transconductance varies when either grid voltage is applied separately. For small signals on one grid, the problem is simpler.

Assume an incident signal on C2 of ± 2 v. amplitude. The grid is biased at -2 v. The local oscillator signal is ± 3 v. with rectification bias. Using $E_s = 67.5$ v., find the conversion transconductance.

The first step in solution is to average the effective transconductances met by the signal which causes the smallest changes in g_m . (This approximation simplifies the general problem somewhat. Strictly, it need not be made.) For this problem, the incident signal trans-

(Continued on page 45)

Figs. 5, 6, and 7: (left to right) Characteristic curves of type 6SA7 tube under various conditions. These curves could be combined into one set if desired.

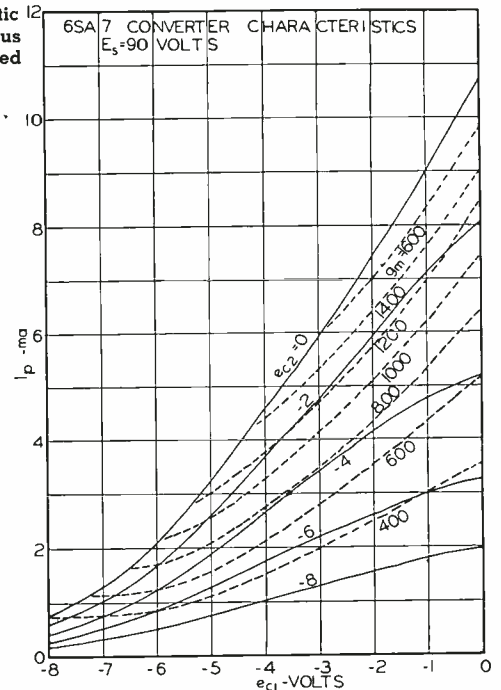
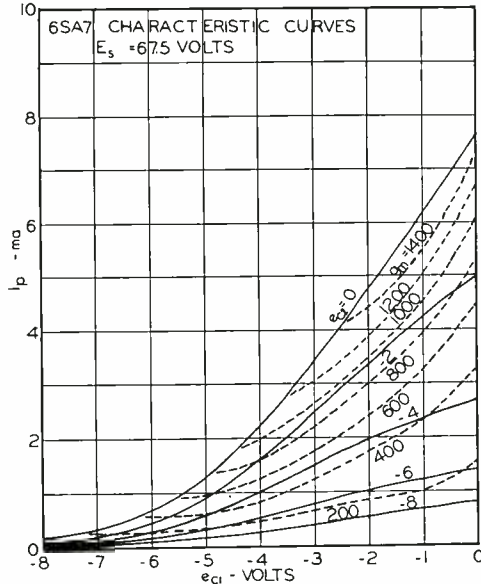
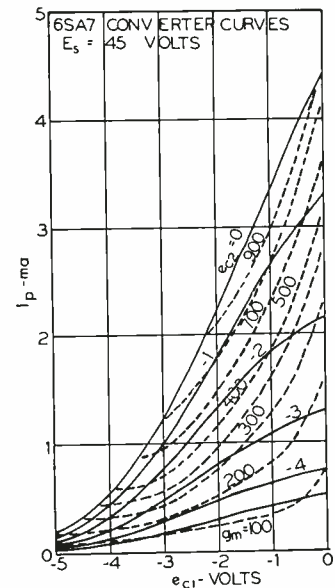

MODIFIED RESONANT CIRCUITS

MATCH IMPEDANCES — Number 10

By **PETER G. SULZER,**

Radio Engineer, Nat'l Bur. Standards
Washington, D. C.

FREQUENCY-selective impedance-matching devices of the inductive type, widely applied to communications equipment, have the disadvantage that variable coupling (or impedance transformation) requires a mechanically complicated coil design. In addition, reactances may appear at the circuit terminals, requiring an additional tuning adjustment for efficient coupling. In one familiar solution, the pi network of Fig. 1, the capacitor C_A is used to determine the coupling. Unfortunately, when the impedance ratio R_2/R_1 is high, C_A becomes excessively high rendering impractical the use of a variable capacitor.

In a less common circuit, Fig. 2, a small capacitor C_1 serves as the coupling adjustment. The parallel circuit LC_2 is adjusted to present an inductive reactance at the operating frequency which combined with R_2 provides an impedance equivalent to R_1 plus an inductive reactance which is tuned out by adjusting C_1 . R_1 , R_2 and the bandwidth are known factors. In Fig. 2, X , X_0 , X_1 , and X_2 are the effective reactances of LC_2 , L , C_1 , and C_2 respectively. When X is obtained from a parallel L-C circuit the impedance-transformation

ratio and the circuit Q can be adjusted separately, which is often desirable.

Assuming matched conditions the equivalent resistance across the tuned circuit is then $R_2/2$. If it is assumed that Q has the value $Q = R_2/2X_0$ (see Appendix), then $X_0 = R_2/2Q$ (1) giving the reactance of L at the operating frequency f_0 . To solve for X and X_2 write the impedance of R_2 and X in parallel, and equate R_1 to the resistive component of Z .

$$Z = \frac{\frac{1}{R_2}}{\left(\frac{1}{R_2}\right)^2 + \left(\frac{1}{X}\right)^2} + j \frac{\frac{1}{X}}{\left(\frac{1}{R_2}\right)^2 + \left(\frac{1}{X}\right)^2} \dots (2)$$

$$X = R_2 \frac{R_1}{R_2 - R_1} \dots (3)$$

$$X_1 = \frac{X}{\left(\frac{X}{R_2}\right)^2 + 1} \dots (4)$$

$$X_2 = \frac{X X_0}{X - X_0} \dots (5)$$

It is of interest to determine the range of impedance transformation available with the circuit. Examination of (2) shows that the real part of Z will be minimized when X has its minimum positive value, which is X . Substituting X_0 from (1) in (2), equaling the real part of Z to R_1 as before, and solving for $R_1 = R_2/(1 + 4Q^2)$, shows the maximum impedance ratio is $1 + 4Q^2$, which becomes $4Q^2$ for $Q \gg 1$. Under this same condition the maximum turns

ratio of the equivalent transformer is $2Q$. The minimum turns ratio is unity, (not a limitation because the network can be reversed end-for-end).

To facilitate the use of a universal chart it is convenient to normalize all reactances with respect to R_2 , indicating normalized values by lower-case letters,

$$x_0 = 1/2Q \dots (6)$$

$$x = \frac{R_1}{R_2 - R_1} \dots (7)$$

$$x_1 = \frac{x}{x^2 + 1} \dots (8)$$

$$x_2 = \frac{x x_0}{x - x_0} \dots (9)$$

Fig. 3 contains plots of (7), (8), and (9) for a wide range of values of Q , R_1 , and R_2 . Values of x might be read from the vertical scale, although x is not used in the final result.

Use of the Chart

At high frequencies where it may be difficult to measure the inductance L accurately, the values of x_1 and x_2 may be determined as above, and then the inductance L is adjusted to resonate with C_2 at some frequency f_1 such that L has a reactance X_0 at f_0 . Considering the parallel circuit LC_2 , $f_1/f_0 = X_0/X_2$, where X_0 and X_2 are the reactances at f_0 . Substituting the value of X_2 obtained from (5), and substituting

Fig. 1: Normal arrangement for matching impedances with pi net. (left) Fig. 2: Modified pi circuit in which C_1 adjusts coupling (right)

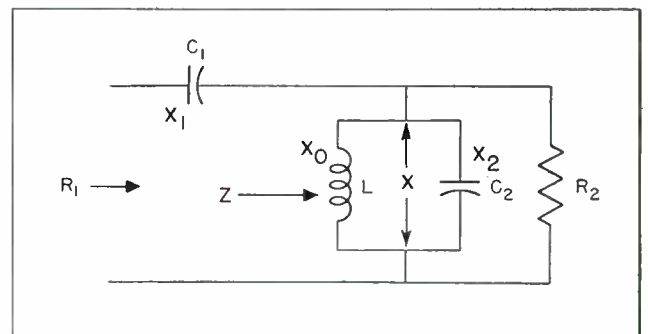
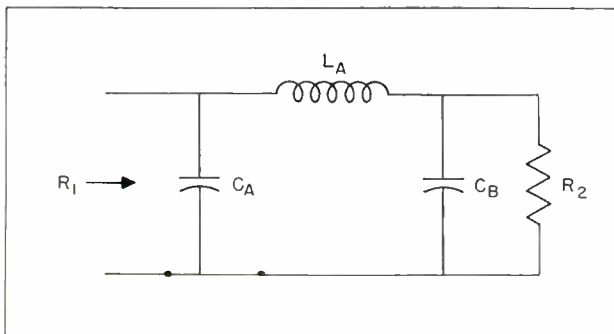

(3) and (4) to eliminate X and X_o.

$$\frac{f_1}{f_0} = \frac{1}{\sqrt{1 - \frac{1}{2Q} \left[\frac{R_2 - R_1}{R_1} \right]}} = \sqrt{1 - \frac{1}{2Qx}} \dots\dots\dots (10)$$

In using the chart, by selecting R₂ on the lower horizontal scale, an intersection is obtained between an ordinate erected at this point and the appropriate curve marked R₁. A horizontal line drawn through the intersection is then used to obtain x₁, x₂, and f₁/f₀. The intersection of the horizontal line with the curve marked x₁ determines x₁, which is read on the upper horizontal scale. This also applies to x₂ and Q; providing that the curves corresponding to the proper value of Q are employed.

(1) Consider the design of the output circuit of an experimental 2.5-KW pulse transmitter operating at a frequency of 3.492 MC. A

loaded Q of 10 is desired with a 50-ohm antenna. With a plate supply of 5000 volts, 3500 volts rms can be assumed across the single-ended tank circuit. Thus R₂ = 5000 ohms for 2.5 KW, while R₁ = 50 ohms and Q = 10. Applying (7), x_o = 0.05. Referring to Fig. 2, a horizontal line drawn through the intersection of the ordinate R₂ = 5000 and the curve R₁ = 50 will intersect the curves marked x₁, x₂, and f₁/f₀. The values at the intersections are then read on the upper scale. For this example, x₁ = x₂ = 0.1, while f₁/f₀ is not used. Multiplying by R₂, X_o = 250 ohms, and X₁ = X₂ = 500 ohms. With the aid of a reactance chart it is found that L = 11.4 microhenrys, and C₁ = C₂ = 92 microfarads.

(2) A good high-frequency example is the design of the input circuit of a broad-band FM booster

using a parallel-connected 12AT7 as a grounded-grid amplifier. A match is required between 50-ohm coaxial cable and the amplifier cathodes, which present an impedance of 250 ohms, while a Q of 5 is necessary for a bandwidth of 20 MC. Referring to Fig. 2, x₁ = 0.4, x₂ = 0.12, and f₁/f₀ = 1.1. Since X₁ = 100 ohms and X₂ = 30 ohms, C₁ = 16 micromicrofarads, and C₂ = 53 micromicrofarads. The inductance L is adjusted to resonate with C₂ at 108 MC (1.1 f₀, where f₀ is 98 MC) with a grip-dip oscillator.

APPENDIX

The properties of Q defined in terms of the effective shunt resistance R may be derived by considering the relations for a parallel RLC resonant circuit. Writing its impedance Z,

(Continued on page 65)

Fig. 3: Universal chart with normalized reactances from which values of R₁, R₂, and Q can be read. X can also be read on the vertical scale.

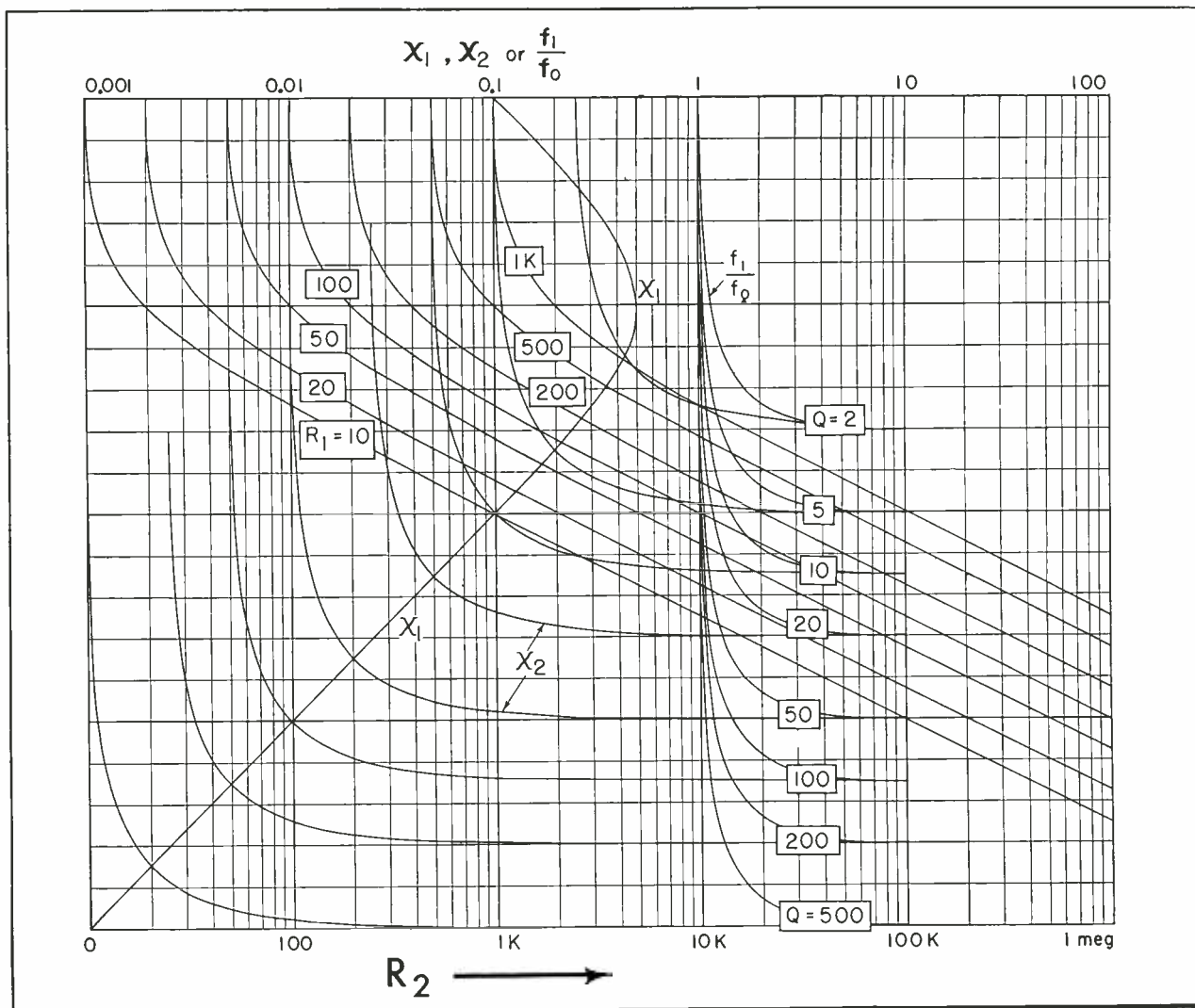

Modified TV Field Switcher

Minor changes in TS-30A switcher increase usefulness of equipment by providing additional camera control facilities

By C. J. AUDITORE
TV Facilities Engineer
WOR-TV, New York City

THE much used RCA TS-30A field switcher provides for direct switching between any of six video signals, four of which are local cameras and the other two auxiliary (normally composite) video signals. Fading to or from black, between signals and the use of super-positions has long been sought by television broadcasters using field pick-up equipment. Recently, RCA has made available an auxiliary field switching control, which when used with the modified TS-30A field switcher, provides these added facilities with certain limitations.

All of the TS-30A and auxiliary field switchers at WOR-TV have been modified to improve performance and add to operational facility. These modifications are: (1) addition of Camera Control 5 and 6 tally lights; intercom and program-cue facilities on the TS-30A; (2) modification of Aux. 5 and Aux. 6 positions to become Cam. 5 and Cam. 6 inputs on the auxiliary switcher; (3) modification of the fader input grounding bus in the auxiliary switcher to reduce switching flashes; and (4) addition of a 6J6 cathode follower in the auxiliary switcher.

Adding Cameras 5 and 6

The addition of camera control 5 and 6 tally, intercom and program-cue facilities on the TS-30A requires the installation of two connectors similar to* J-13, 14, 16, and 17. These connectors may be located on the rear of the TS-30A in the space between the master monitor power connector and the coaxial cable connectors as shown in Fig. 1. Terminals 1, 2, 3, 4, 6, and 8 are connected in parallel with the existing camera control circuits. Terminal 5 for camera controls 5

and 6 are both connected to the switch S7 at the coil side of L1, for intercom. An added tally circuit is paralleled with each of the four existing camera controls, terminal 9, for tally indication out of the auxiliary switcher. Terminal 9 for camera controls 5 and 6 are each tied through to the auxiliary switcher for tally indication on position 5 and 6 respectively. See Table I for a tabulation of the added wiring in the TS-30A.

Two voltages are provided out of the TS-30A for use in the auxiliary switcher. These are, (1) 6.3 v ac for local tally lights in the switcher and the cathode follower filaments, and (2) +280 v dc through R102 for camera tallies and B+ at the cathode follower. "Aux 5" input in the TS-30A is also modified for bridging (high-impedance) input.

Nine pin connectors must be mounted on the TS-30A and the auxiliary switcher to provide for the required circuits. In the auxil-

Cam. Control 5 Connector	to	Cam. Control 6 Connector	Aux. Switcher Connector	Other
1	to	1		to 1 on J-13
2	to	2		to 2 on J-13
3	to	3		to 3 on J-13
4	to	4		to 4 on J-13
5	to	5		to junction of S7 and L1
6	to	6		
7	Blank	7	Blank	
8	to	8		to 8 on J-13
9	to	9	5	
			6	
			1	to 9 on J-13
			2	to 9 on J-16
			3	to 9 on J-14
			4	to 9 on J-17
+280 v d.c. through R-102	7		to S-25 Aux 5 d.c. contacts per RCA
6.3 v a.c.	8		
ground	9		

ary switcher, the camera tally-voltage bus must be extended to "Aux 5" and "Aux 6" positions, the corresponding black and white tally outputs paralleled, and a camera 5 and 6 camera tally circuit connected through to the nine pin connector.

When push-button switching with

Fig. 1. Layout and appearance of rear panel of TS-30A auxiliary field switcher after addition of camera control, tally, and intercom-program-cue facilities

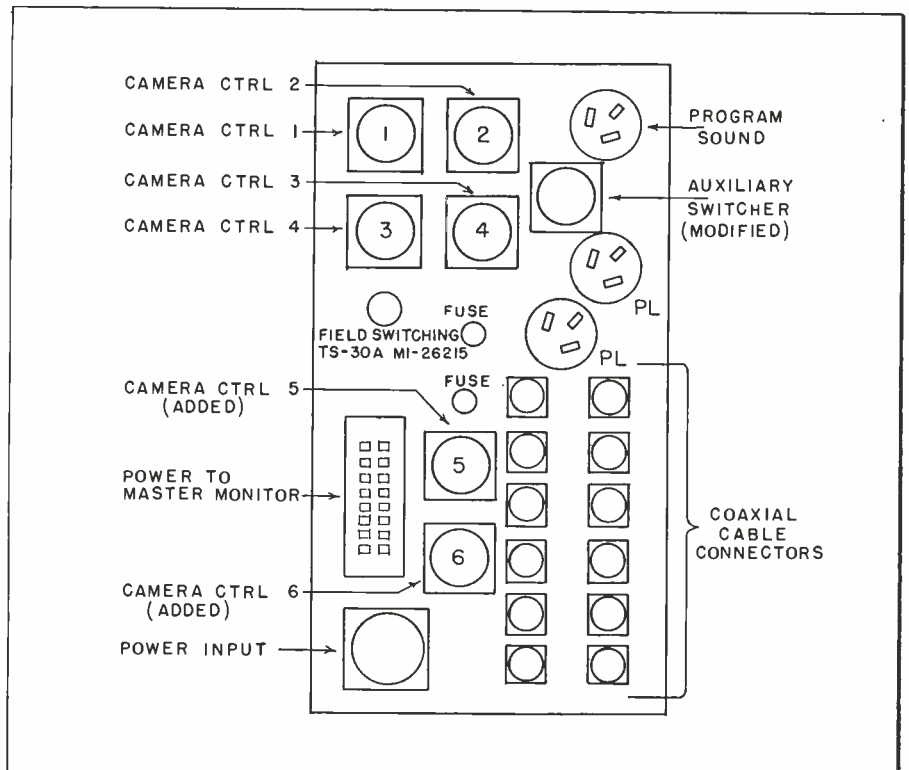

*The specific technical information included supplements and refers to the instruction sheets furnished by RCA with the auxiliary field switching control.

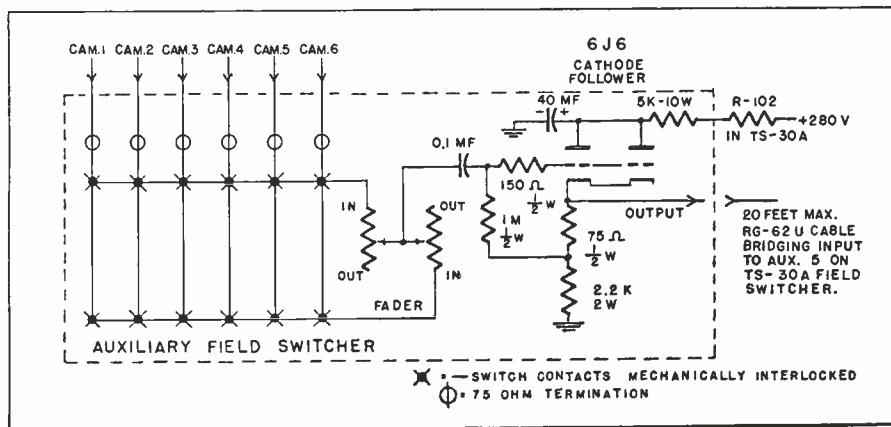

Fig. 2. Circuit of 6J6 cathode follower. This addition enables the switcher to be placed up to 20 feet away from the main unit when connected via RG-62 U cable.

the auxiliary control is used between takes, flashing may be observed in the output signal. This is due to the make-before-break operation of the switches. As a new picture is being pushed-up, the signal which is being released (or vice versa, dependent on sequence) momentarily puts a ground on the fader input via the fader input grounding bus. It is this momentary grounding which produces flashing. This is effectively remedied by using a 120 ohm 1/2 watt resistor in a common return to ground for both fader input grounding buses. This allows for a ground return on the fader input with no signal pushed-up, and at the same time overcomes the switching flashing due to a direct zero resistance ground.

Cathode Follower

The auxiliary switching control as provided by RCA is restricted in its placement with respect to the TS-30A by the 4-foot maximum length of RG-62U low capacity output cable. Furthermore, there are undesirable frequency response variations when fading to, and from, signals set up on the black and the white push-buttons, even when the fader levers are ganged together as recommended by the manufacturer. The overall bandwidth as measured was useable to about 4 MC. These are rather serious limitations.

These restrictions were lifted, however, with the addition of a 6J6 cathode follower at the auxiliary switching control as shown in Fig. 2. This amplifier was easily added since the filament and plate supply voltages are already available at the auxiliary switcher. The tube was mounted externally in a stand-

ard shielded socket in the location occupied by the RCA name plate. A flat metal strip was bent to form a "U" guard around the tube. This location for the tube was chosen to simplify its cooling and replacement as required. The balance of the

circuit components are readily mounted inside the switcher unit.

The advantages derived from this modification are threefold: (1) the frequency response variations with fading are eliminated; (2) the effective bandwidth is increased to beyond six MC with a smooth roll-off beyond flat output; (3) it is possible to extend the output of the auxiliary switcher a full 20-feet with RG-62U low capacity cable without serious degradation of the frequency response. This is most important with respect to convenience of operation and picture quality, especially when the equipment is employed in studio installations.

There is some loss of signal in the cathode follower which is easily made up in the TS-30A switcher.

The transfer in this circuit is:

$$\frac{G_m R_1}{1 + G_m R_1} = \frac{10,600 \times 10^{-6} \times 2200}{1 + 10,600 \times 10^{-6} \times 2200} = 0.96$$

This works out to be close to unity, due to the high effective value of transconductance (G_m) which is obtained by paralleling the two triode sections of the 6J6.

Grade of Fellow is Conferred on 41 by the Institute of Radio Engineers

The grade of Fellow has been conferred upon 41 engineers and scientists in the radio and allied fields by the Institute of Radio Engineers. The awards will be presented at the IRE Annual Banquet in March, 1951. Recipients of the Fellow Award are:

Robert Adler, Research Engineer, Zenith Radio Corporation, Chicago, Ill.; **J. G. Brainerd**, Associate Professor, University of Pennsylvania, Philadelphia, Pa.; **C. G. Brennecke**, Head, Electrical Engineering Dept., North Carolina State College, Raleigh, N. C.; **R. D. Campbell**, Engineer, American Telephone and Telegraph Company, New York, N. Y.; **R. W. Deardorff**, Transmission and Projection Engineer, The Pacific Telephone and Telegraph Company, Portland, Oregon; **John H. De Witt, Jr.**, President, Radio Station WSM, Inc., Nashville 3, Tenn.; **Harold F. Elliott**, Consulting Engineer, Palo Alto, Calif.; **Clifford G. Frick**, Head, Television and Research Laboratory, General Electric Company, Schenectady, N. Y.; **E. L. Ginzton**, Stanford University, California; **William M. Goodall**, Member of Technical Staff, Bell Telephone Laboratories, Inc., Deal, N. J.; **John T. Henderson**, Research Physicist, National Research Council, Ottawa, Ont., Canada; **C. J. Hirsch**, Chief Engineer, Hazeltine Electronics Corporation, Little Neck, L. I., N. Y.; **William E. Jackson**, Chief, Radio Development Division, Civil Aeronautics Administration, Indianapolis, Ind.; **J. B. Johnson**, Physicist, Bell Telephone Laboratories, Inc., Murray Hill, N. J.; **A. G. Kandoian**, Head, Radio and

Radar Components Division, Federal Telecommunication Labs. Inc., Nutley, N. J.; **C. E. Kilgour**, Research Consultant, Crosley Division of Avco Corporation, Cincinnati, Ohio; **T. J. Killian**, Science Director, Office of Naval Research, Washington 25, D. C.; **J. B. Knox**, RCA Victor Company, Ltd., Montreal, Que., Can.; **V. D. Landon**, Research Engineer, RCA Laboratories, Princeton, N. J.; **George Lewis**, Assistant Vice-President, International Telephone and Telegraph Company, New York, N. Y.; **Harry R. Lubcke**, Director of Television, Don Lee Broadcasting System, Hollywood, Calif.; **David G. C. Luck**, Research Engineer, RCA Laboratories Division, Princeton, N. J.; **John F. Morrison**, Technical Staff, Bell Telephone Laboratories, Inc., Whiphany, N. J.; **G. A. Morton**, RCA Laboratories, Inc., Princeton, N. J.; **G. W. Olive**, Chief Engineer, Canadian Broadcasting Corporation, W. Montreal, Que., Canada; **O. W. Pike**, Manager of Engineering, General Electric Company, Schenectady, N. Y.; **L. E. Reukema**, Professor of Electrical Engineering, University of California, Berkeley, Calif.; **H. W. G. Salinger**, Research Physicist, Farnsworth Research Corporation, Fort Wayne, Ind.; **Otto H. Shade**, Research Engineer, RCA Victor Division, Harrison, N. J.; **Dominic F. Schmit**, Vice-President in Charge of Engineering, RCA Victor Division, Camden, N. J.; **W. E. Shoupp**, Westinghouse Electric Corporation, Pittsburgh, Pa.; **P. F. Siling**, Engineer-in-Charge, RCA Frequency Bureau, New York, N. Y.

(Continued on page 61)

CONDUCTANCE CURVES

(Continued from page 40)

conductance is averaged. Using $g_m = (1/4)(g_{m0} + 2g_{m1} + g_{m2}) \dots (5)$ for this, we have, from Fig. 6,

g_m	860	μmho	962	982	902	785	594	332
E_{c1}	0	volts	-1	-2	-3	-4	-5	-6

The second step is to approximate the power series representation of the transconductance. This series takes the form

$$g_m = g_{mn}e^n \dots (6)$$

Determining the coefficients from Table II, we find the series is

$$g_m = 902 + 94e - 5e^2 - 0.5e^3 + \dots (7)$$

Carried out on the basis of $E_{c1} = 0, -3, -6$ volts, the g_m is

$$g_m = 902 + 89e + \dots (8)$$

Since these expressions agree to closer than tube tolerances, it is seen that the simpler solution is adequate. Now, essentially, the two input voltages are added by isolated circuits and intermixed by the transconductance non-linearity. Substitution of $e_1 = e_a \sin \omega_a t + e_b \sin \omega_b t$ in

$$i_p = g_m e_1 = 902 e_1 + 89 e_1^2 + \dots (9)$$

gives the first order mixing term as

$$i_p = 2g_m e_a e_b \sin \omega_a t \sin \omega_b t \dots (10)$$

Neglecting the sum term, Eq. 10 takes the form

$$i_p = (g_m e_a) e_b \cos[\omega_a - \omega_b]t \dots (11)$$

From this it is seen that the conversion transconductance is $g_m e_a$ in this case. For the data computed this is 267. If e_a were rectangular rather than sinusoidal, the conversion efficiency should be somewhat higher.

Experience may show it possible to consolidate curves of the type shown in Figs. 5, 6, and 7 into a combined set. However, availability even of curves of the sort shown in these figures should prove convenient for aiding design of mixer circuits.

It appears that the technics here discussed when used with the methods reported in the earlier TELE-TECH articles offer a very flexible technic for design and analysis in electron tube circuits. In spite of the fact the curves presented apply to tubes having only nominal similarity to the theoretical "Bogie" tube, experience has shown that they make available a simple design technique which appears to permit determinations to be made with surprising accuracy. It is therefore believed that further tests

will prove the suitability of the method for general practical use.

REFERENCES

1. Instrument Design Using G Curves, by K. A. Pullen, The Instrument Maker—January-February 1949. Vol. 17, No. 1.

2. Using G Curves in Tube Circuit Design—Parts 1 and 2, by K. A. Pullen, Tele-Tech, July and August, 1949. Vol. 8, No. 7 and 8.

3. Tube Circuit Design Using the G Curve Technique—Ballistic Research Laboratories Memorandum Report No. 489, Aberdeen Proving Ground, Md.

4. The Use of G Curves in the Analysis of Electron Tube Circuits (Abstract), K. A. Pullen, Proc. IRE, February, 1949. Vol. 37, No. 2.

5. The Use of Conductance Curves for Pentode Circuit Design—Ballistic Research Laboratories Memorandum Report No. 499, Aberdeen Proving Ground, Md.

Empire State Building's 1466-ft. Mast Carrying Five TV and Three FM Antennas

THE 1250-ft Empire State Building, long the showplace of New York and the world's highest building, is about to become the world's most antenna'd tower. Our cover shows constructional details of the 216-foot antenna-mast structure which will mount five television antennas and three FM antennas for five New York television stations, or 13 carriers in all.

For stations WCBS-TV, WABD, WJZ-TV, and WPIX, the new RCA Super Gain Dipole Antenna is being used, and for WNBT-TV a Channel Four super turnstile will surmount the structure. Frequency modulation will be transmitted by WNBC-FM from an antenna probably mounted above the television turnstile. For stations WCBS-FM and WJZ-FM the antennas are expected to be mounted somewhere about the center of the respective TV radiators.

The tower on which all these antennas will be mounted is a work of art in itself and mounting and erecting the antennas along a vertical length of tower section will not be simple. Heating elements are provided to keep ice loading down to a safe limit and a six-foot lightning conductor on the top of the tower takes care of static discharges. An additional CAA requirement which has been added, since the original plans were drawn, is a 300-mm rotating beacon of the type used to mark aerial navigation hazards.

Transmitter Locations

Down below, on floors ranging from the 81st to the 85th will be the transmitters. On floor 81 will be the WPIX installation connected by two 6 $\frac{1}{8}$ inch diameter coaxial cables to the antenna. All the other transmitters will use 3 $\frac{1}{8}$ inch diameter coaxials to connect to their respective radiators. Floor 82 houses

the WABD stations, and number 83 has WCBS-TV and WCBS-FM. The two existing stations, WJZ-TV and WNBT are installed on floor 85 and WJZ-FM will also be added there at a later date.

As previously reported in TELE-TECH, the presence of thirteen carriers in the area of the tower may reasonably be expected to cause some degree of interaction between the stations. Early theories tended to the view that considerable spacing would be required to prevent this. However, tests at the RCA laboratories are reported to have shown that there is little, if any, interference as far as can be ascertained on the scale models used for the experimental work. It is understood that the spacing between the antennas is of the order of inches rather than feet and that mechanical and physical considerations, rather than electrical, set the spacing.

In addition to the television and FM antennas on the tower there are 8 microwave receiving installations on the balcony for the AT&T television remote pickup relay service (see cover photo). Although the sharp vertical directional patterns of the television antennas reduce downward radiation in the vicinity of the tower to a very low figure it will be interesting to discover what effect all the RF in the vicinity will have on the microwave installations.

Although predicted figures can never be taken exactly there is no doubt that the increased height for the stations not previously on the Empire State Building will enlarge their service areas.

The man responsible for television's largest and most complex antenna installation to date is Dr. Frank G. Kear of the firm of Kear and Kennedy, Consulting Radio Engineers, Washington, D. C.

WASHINGTON

News Letter



Latest Radio and Communications News Developments Summarized by TELE-TECH's Washington Bureau

FCC DECISION DEFENDED BY COY—The radio-television industry received in all probability the most extraordinary defense of an FCC decision ever undertaken, in the addresses of FCC Chairman Wayne Coy in Chicago before three groups, the National Electronics Conference, the Chicago Television Council, and the Association of National Advertisers. Mr. Coy undertook to justify in detail the FCC's viewpoint that the move for the establishment of bracket standards for video receivers was not only beneficial in making present sets compatible with the CBS color system, but also held promise of future changes in black-and-white receiver standards to bring about improvements in picture resolution through horizontal interlace and the use of long-persistence phosphors.

COURT TEST WOULD PROVIDE DELAY—Any Federal court test of the FCC-CBS color-television decision, as now being discussed by radio-TV manufacturers opposing the "rush" edict on the designing of bracket standards for receivers, Washington thinks might well be a victory for the FCC in the final judicial determination. But such a legal move, if undertaken by the manufacturers, would be a delaying action of probably two years' duration on the decision's effectiveness. The reason why Washington circles view a defeat in the courts as pretty well a foregone forecast, is that Federal courts follow the policy of accepting unequivocally the findings of fact of a Federal agency because the latter is regarded as an "expert(!)" governmental body and are disposed to upset a Federal agency's ruling only if constitutional rights are violated.

FCC COERCION CHARGED—Probably the only springboard for alleged violation of constitutional rights of the manufacturers would be the purported "coercion" of them in forcing a deadline for the bracket standards' design by the November date. As is now generally recognized there is an almost unanimous united front of engineering opinion among the radio-TV manufacturers against the FCC-CBS ruling. RCA, Philco, General Electric, DuMont Laboratories, Zenith, Motorola, Admiral, Hallicrafters, Andrea, Emerson, Magnavox, Stewart-Warner, Sentinel, Packard-Bell, Tele-Tone and Transvision, in their letters to the FCC all lined up to assail various phases of the FCC decision and the short timetable for the bracket standards' production plan.

RADIO RELAY VALUABLE IN KOREA—Radio relay, despite the numerous mountains in Korea, has proved a most valuable tool of military communications, Maj. Gen. S. B. Akin, Chief Signal Officer of the Army,

reported in a statement to TELE-TECH's Washington news bureau after his return from an inspection of combat communications in the Korean Theater. To overcome the obstacles of the mountainous terrain, Signal Corps communications specialists erected an unusual number of microwave radio relay stations on mountain tops as well as valley floors. Then the Army communications specialists "crossed" the mountains by projecting the radio beams from one valley up to a mountain crest and down from the latter to the valley relay point. In this manner, Gen. Akin cited, messages were bounced for many miles with most reliable communication results along a chain of stations.

MARINE RADIO LAGGING BEHIND—There is a definite lag in the use by the marine radio services of the available radio-electronic navigational aids in contrast with the prompt acceptance of proved new radio systems by the aviation field. This was a keynote sounded at the recent first joint meeting of the Institute of Navigation, Radio Technical Commission for Marine Services and the Radio Technical Commission for Aeronautics. FCC Commissioner E. M. Webster discussed the frequency problems in the radio navigational field and the need to coordinate domestic use of frequencies with the international allocations. The growing use and value of shore-based radar in harbor installations was the subject of an interesting report by Director of Telecommunications E. C. Phillips of the National Federation of American Shipping. And CAA Federal Airways Director C. F. Horne, in describing the progress in the aviation RTCA SC-31 program, stressed that the electronic aids plan is advancing aviation safety just as has the national highway system for the automobile.

MOBILE RADIO VITAL IN CIVILIAN DEFENSE—Mobile radio systems, especially those of police and fire departments and of land transportation services like busses and taxicabs, are considered invaluable links of communications in the civil defense planning of the Federal Government by the National Security Resources Board. In all municipal and state civil-defense plans the NSRB civil defense office has emphasized that the paramount requirement is for adequate basic and standby communications facilities. Broadcasting, television and the telephone networks are the basic and primary methods of alerting populations in event of bombing attacks, and after the destruction of atomic bombing. Since telephone and broadcasting-TV facilities would undoubtedly suffer heavily, the mobile radio systems are vital auxiliary and ancillary communications networks.



*The finest solder made
for all television and radio
work . . . Everything Electrical*

Kester Solder

Uniform

Efficient

Kester Plastic Rosin-Core and Kester "Resin-Five" Core Solders are recognized by the trade as outstanding for the finest type of radio, television and electrical work.

These two Solders, which are available in the usual single-core type, can now also be had in a 3-core form.

Only highly skilled craftsmen are employed by the Kester Solder Company. Flux formulas and specifications are rigidly adhered to for perfect uniformity.

Making Kester Solder is an exact science from the raw material to the finished product. Everyone knows and prefers Kester because it can be relied upon to do the job right every time, even under the most difficult soldering conditions.

WRITE FOR FREE COPY "SOLDER AND SOLDERING TECHNIQUE"



Be sure to get your free copy of Kester's Technical Manual filled with valuable information regarding the most advanced and efficient industrial solders and fluxes.

Kester...Standard for the TV and Radio Fields

KESTER SOLDER COMPANY

4210 Wrightwood Avenue, Chicago 39, Illinois
Newark, N. J. • Brantford, Canada

EASIER TO USE
MADE FROM VIRGIN METALS
FASTER
ELIMINATES REJECTS

DEPENDABLE

SAVES TIME



Random Noise Generators

A series of random noise generators have been designed to produce a known output noise in the frequency range of 2600 to

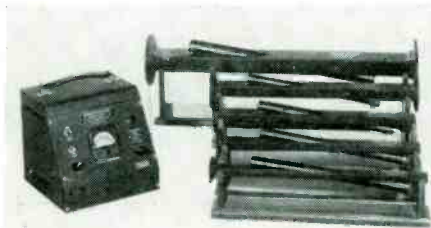

12,400 MC. Available in five separate models, each noise source utilizes a standard commercial fluorescent lamp in a JAN size wave guide. A separate cabinet houses the power supply for the noise sources. Plug-in cables are provided for direct connection of the power supply to any one of the microwave units.—Kay Electric Co., Pine Brook, N. J.—TELE-TECH.

Front-Surface Mirrors

Development of the Zeno-Kote process has resulted in the production of front-surface mirrors which are unusually durable and tar-

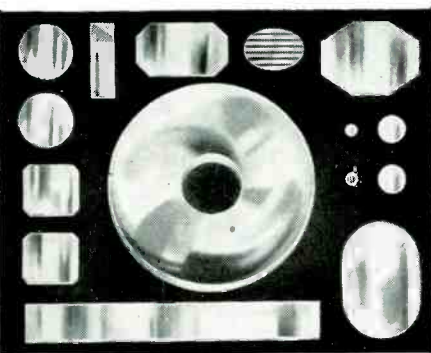

nish-resistant. The reflecting surface is secured by thermal evaporation of a special aluminum alloy under high vacuum. The reflecting surface is then protected by the deposition of an extremely hard but transparent film, which in no way affects the resistivity of the mirrors. Mirrors produced by this new process have a reflectivity of about 93% in the visible spectrum, and they can be made to meet any optical or dimensional tolerances.—Zenith Optical Laboratory, 123 West 46th St., New York 23, N. Y.—TELE-TECH

Double Pulse Generator

Producing two pulses individually controllable in width, amplitude and time relation to each other, the Model 902 double pulse



generator is a basic laboratory instrument, useful for testing TV equipment and checking characteristics of wide band amplifiers. Pulse amplitude is individually adjustable, without cross effect, from 0 to +50 and 0 to -200 v. Amplitude of both pulses after mixing can be varied by means of a continuous fine control a 10 to 1 step generator. Pulse rise time is .05 usec., decay time .10 usec.; duration is individually adjustable from .15 to 1.5 usec. Repetition rate is adjustable in 3 ranges; 1 to 10, 10 to 100, and 100 to 1000 cycles, and can be externally triggered. Output impedance is approximately 400 ohms; maximum output voltage is -200 v. Overall accuracy of control calibrations is $\pm 5\%$ over the entire range.—Berkeley Scientific Co., 6th and Nevins Sts., Richmond, Calif.—TELE-TECH.

Wave Traps

The RLW-006 i-f wave trap (right) has been designed to counteract interference on TV receivers caused by signals at frequencies between 41 and 47 MC, such as police and fire communications, or maritime and mobile services. It can be used on balanced transmission lines, and contains isolating capacitors in each leg. The two series-resonant circuits are tunable by means of screwdriver adjustments. Installation is made at the antenna input terminals on the TV set.

Interference on TV receivers which is caused by FM broadcasting stations operating in the 88 to 108 MC channel is reduced or eliminated by the RLW-005 FM wave trap (left). Tuned by two screwdriver adjustments, the RLW-005 may be used on balanced or unbalanced lines. The trap contains two resonant circuits, one circuit connecting from each side of the transmission line to a com-

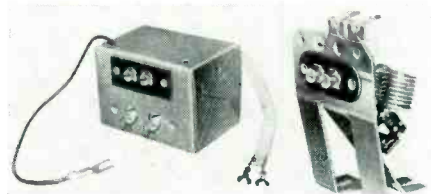

mon grounded connection. Installation is made by means of screwdriver connections at the antenna input terminals on the TV receiver.—General Electric Co., Syracuse, N. Y.—TELE-TECH.

Hermetically-Sealed Coil Holders

A new line of hermetically-sealed coil and transformer holders are being constructed of Allegheny MuMetal-Hydrogen-annealed after

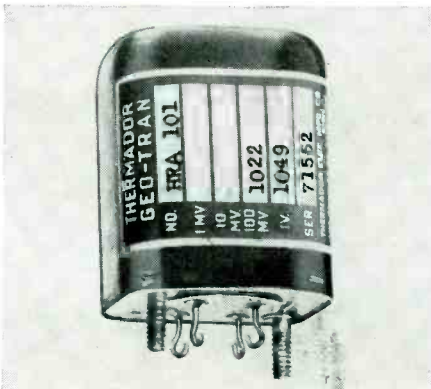

fabrication. They serve the two-fold purpose of magnetic shield and sealed container. Where additional stray shielding is required, close fitting nested shields, consisting of a copper shield and another MuMetal shield, are available. All transformers are of the balanced core type. Coil and core structures are two-coil self-shielding or hum bucking.—Thermador Electrical Manufacturing Co., 5119 District Blvd., Los Angeles 22, Calif.

Video Relays

The class S video relay (Foreground of photo) is said to be free of contact chatter and is unusually compact, measuring only

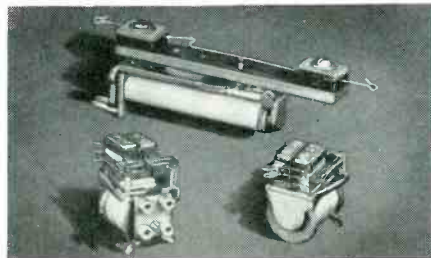

1-19/32 in. in overall length, 1 1/8 in. in height, and 1 in. in width. The class C video relay is in the background. One of its advantages is the small opening space it occupies. A mere 0.687 in. in width, it is 5-15/32 in. long and 2 1/8 in. high.—Automatic Electric Co., 1033 West Vanburen St., Chicago 7, Ill.—TELE-TECH.

Power Supply

Model 515 power supply features one regulated B supply, one regulated C supply and one unregulated filament supply. Excellent



regulation, low ripple content, and low output impedance are characteristics of the unit. The B supply is continuously variable from 500 v. and delivers from 0 to 200 ma. The C supply is continuously variable from 0 to 150 v. and delivers 5 ma. For all output voltages (of the C supply) the output voltage variation is less than 10 mv. for line fluctuations of 105 to 125 v. At 150 v. the regulation is less than 1/2% between 0 and 5 ma. At other settings below 150 v. the internal resistance of the supply will increase to a maximum of 25,000 ohms. Ripple is less than 5 mv.—Kepeco Laboratories, Inc., 119-11 41st Ave., Flushing, N. Y.—TELE-TECH.

TV Monitor

All the controls on the new MTV-12 TV monitor, are located on the front panel making them easily available to operating per-

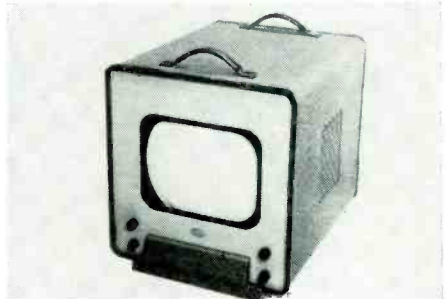

sonnel. In addition to a 12 1/2 in. picture tube the unit contains an audio channel, and speaker which may be used for cueing or monitoring. Its light weight, sturdy construction (as well as the handle grips on the top) make it particularly convenient for remote TV pick-up use. Overall dimensions are 16 x 18 x 21 in.—Raytheon Manufacturing Co., Waltham 51, Mass.—TELE-TECH.

Wire Stripper

Actually permitting mechanical wire stripping in instances where hand methods were thought to be the only safe way, the Rush

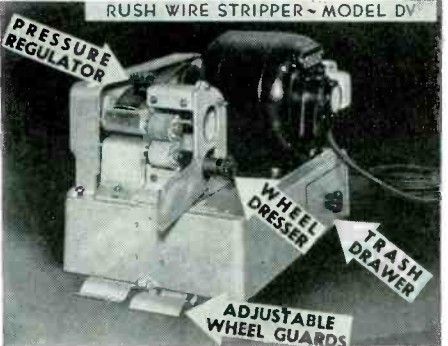

wire stripper is said to be able to increase production as much as 400% over former methods. Model shown will strip wires, gauges 48 through 25, including Litz wire up to 50/44. Stripping wheels may be resurfaced or dressed as they wear, thus keeping wheel costs to a minimum. All present models use principle of frictionally generated heat to melt enamel and Formex type insulation. Through proper selection from large number of different grades of stripping wheels, practically all kinds of insulations can be cleanly removed without damage to the wire.—Rush Wire Stripped Div., The Fraser Co., 104 South State St., Syracuse 2, N. Y.—TELE-TECH.



Capacitors

sealed
for Life
with
silicone
rubber

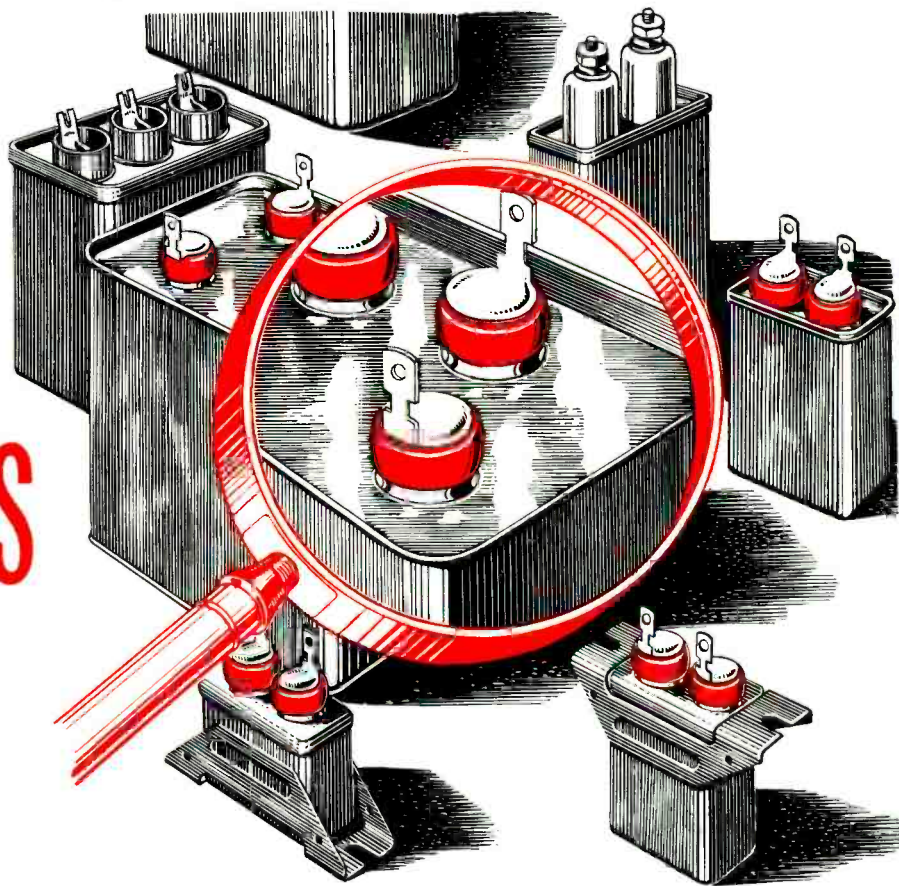

SILICONE—the amazing new synthetic that made headlines when General Electric brought it out—is back in the news again. For today, G-E small capacitors, up through 5000 volts, are hermetically sealed with silicone rubber bushings or gaskets.

This means that your new **G-E capacitor** is sealed positively, permanently—for maximum life. For silicone seals by compression alone, without the use of adhesives. It will never shrink, loosen or pull away—it remains elastic at any operating temperature a capacitor will ever meet. It is impervious to oils, alkalis and acids. Its dielectric strength is permanently high and it is not easily damaged during installation for it has a flexibility that withstands mechanical and thermal shock.

This exclusive **G-E feature**—designed to surpass established installation requirements—makes General Electric capacitors finer and more dependable than ever before. *Apparatus Dept., General Electric Company, Schenectady 5, N. Y.*



Operates at
125° C. with no
derating



These d-c paper-dielectric units can be used up to 125° C. without derating. The impregnant is Permafil which retains its excellent insulating properties at these high temperatures.

Available in case styles 53, 61, 63 and 65. Ratings are up to 2 muf and 400 volts, D.C.

Please address all inquiries to Capacitor Sales Div., General Electric Co., Pittsfield, Mass.

Silicone-rubber bushings, permanently elastic and formed to close tolerances, seal themselves by compression to the capacitor cover. They are used with capacitors 1500-v d-c, or 660-v a-c, and lower. Silicone rubber gaskets with plastic or porcelain stand-offs are used for higher voltages.

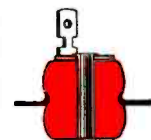

GENERAL  ELECTRIC

407-172

SUPERIOR REPRODUCTION WITH

Gray

RESEARCH

TRANSCRIPTION ARMS

NEW VISCOUS-DAMPED 108-B ARM

For all records — 33 1/3, 45 and 78 r.p.m. Radically new suspension development on the viscous damping principle for perfect tracking of records and elimination of tone arm resonances. Instant cartridge change with automatic correct stylus pressure. Solves all transcription problems. Ideal for LP records. For Pickering, new GE (short), old GE (long) cartridges. Write for bulletin. Price, less cartridges, \$56.00 (effective Sept. 1st). Cartridge slides for both GE and Pickering are furnished.



MODEL 106-SP ARM

Designed to meet strictest requirements of modern highly compliant pick-up cartridges. 3 cartridge slides furnished enable GE 1-mil, 2 1/2-mil or 3-mil cartridges or Pickering cartridge to be slipped into position in a jiffy. No tools or solder! Superb reproduction of 33 1/3, 45 or 78 r.p.m. records. Low vertical inertia, precisely adjustable stylus pressure. Write for bulletin. Price, less cartridges, \$45.15



EQUALIZERS

MODEL 603 EQUALIZER

Latest of the universally adopted Gray Equalizers used, with Gray Tone Arms, as standard professional equipment by broadcast stations. High-frequency characteristics obtainable comprise 5 steps — flat, high roll-off, NAB, good records, poor records. For both GE and Pickering cartridges. Price, \$50.70



MODEL 602 EQUALIZER

Has 4 control positions, highly accurate response curves. Price, \$49.50

Write for bulletins on Gray Equalizers.

GRAY RESEARCH and Development Co., Inc.

22 Arbor St., Hartford 1, Conn.

Division of The GRAY MANUFACTURING COMPANY

Originators of the Gray Telephone Pay Station and the Gray Audograph



Traveling Wave Power Amplifier

A traveling wave power amplifier has been developed to deliver a power output in excess of 10 watts with a power gain of 20 db.

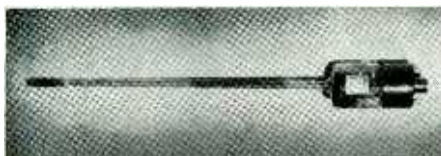

Known as the 5929, it is of the helix type, the r-f terminals are arranged for waveguide circuit and the tube operates with an external electromagnetic field.—Federal Telecommunication Laboratories, Inc., Nutley, N. J.—TELE-TECH

TV Sync Lock

The use of TV-30-A television sync lock unit makes it possible to insert local commercials, special effects or other local pro-

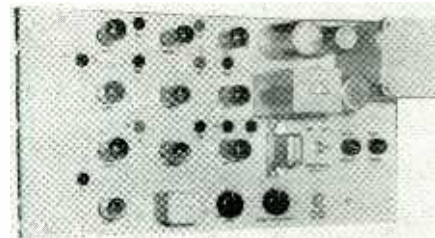

gram material into remote picture signals without disturbance. This is accomplished by means of automatic synchronization of the local sync generator with the remote sync signals. During network shows, local program material can be inserted by means of superpositions, lap, fade or wipe dissolve. On a local remote pickup, the use of the TV-30-A eliminates the necessity of transporting extensive additional equipment to the pick-up point, or of flapping-in to the local sync generator for each commercial.—General Electric Co., Syracuse, N. Y.—TELE-TECH

SPEED UP AND MAINTAIN UNIFORM PRODUCTION



**FREED
NO.
1010**

COMPARISON BRIDGE

This self contained, AC operated bridge is ideal for laboratory and production testing of resistors, condensers and inductors.

Resistors from 10 ohms up to 1 megohm are measured by the comparison method at 60 cycles. Resistors of greater value than 1 megohm can be measured by using the instrument as a limit bridge. Condensers from 500 micromicrofarads up to 10 microfarads are measured by the comparison method at 1000 cycles. Condensers above 10 microfarads are measured by the comparison method at 60 cycles. Small condensers 500 micromicrofarads to 25 micromicrofarads are measured at 1000 cycles, with the instrument used as a limit bridge. Inductors can be measured at 60 cycles, 1000 cycles or 10,000 cycles, depending upon their values.

Ranges: L—100 Hy to 1 Hy F— 60 cycles
L— 1 Hy to .01 Hy F— 1,000 cycles
L—.01 Hy to 1 mHY F—10,000 cycles

SEND FOR NEW FREED CATALOG

FREED TRANSFORMER CO., INC.

Dept. N.K., 1718 Weirfield St., Bklyn (Ridgewood) 27, N. Y.

TV Pointer

A new device enables a narrator or commentator to insert a black and white pointer about 30 lines high and seven lines wide at



point in the television picture, to more effectively describe the action taking place. Known as the "Electronic Pointer (TV-34-A)", it consists of a rack-mounted chassis and a simple control unit, which may be located anywhere a picture is available to the operator. The pointer is operated by a control similar to the "stick" of an airplane. A toggle switch selects either a black or a white pointer.—General Electric Co., Syracuse, N. Y.—TELE-TECH

Preamplifier

Model 230H, a compact, small preamplifier, will equalize low frequencies and provide necessary gain for magnetic pickups. It is



self-powered and operates with any high-quality, high-input impedance amplifier. It is said to be superior to most broadcast station equipment in its frequency response and accuracy of equalization. Furthermore its intermodulation and harmonic distortion is said to be lower than good engineering practice requires of professional equipment.—Pickering & Co., Oceanside, N. Y. TELE-TECH

Soldering Gun

Dual spotlights to eliminate shadows are features of a new light-duty soldering gun. This new model is considerably smaller and



lighter than previous 135-watt guns; yet it has substantially greater soldering capacity. Dual heat (100/135 watts) is provided for all light and delicate soldering. Heating time is 5 sec. A trigger-switch control adjusts heat to the work and eliminates need of unplugging gun between jobs.—Weller Electric Corp., Easton, Pa.—TELE-TECH

Specify BREEZE "Monobloc" Waterproof and Pressure Sealed CONNECTORS



The only APPROVED Monobloc System for Advanced Radar, Communications, and Electronic Equipment

Breeze "Monoblocs", with single piece plastic inserts, offer outstanding advantages in assembly, wiring, mounting and service in the field.

Single piece inserts make a tighter unit, eliminate the air spaces within conventional multiple-piece inserts, greatly reduce the opportunity for moisture shorts.

Removable contact pins make possible bench soldering of leads, quick, error free assembly of Breeze Waterproof Connectors and panel-type "Monobloc Miniatures."

Single-Hole Panel Mounting is all that is required for either Waterproof or Pressure Sealed types.

Pressure Sealed types are available for values up to and including 75 psi, or they can be specially engineered for greater pressures. They meet specified requirements of shock, vibration, salt spray, humidity and temperature cycling from -65° to $+185^{\circ}$ F.

Breeze "Monobloc" Waterproof and Pressure Sealed Connectors are engineered to your requirements in aluminum, brass or steel—in all sizes and capacities. They are fully tested and approved... cost no more than ordinary types.

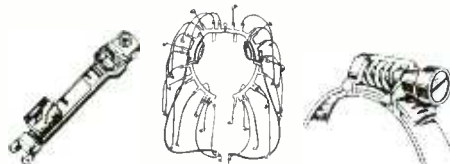

Other Breeze Precision Products

ACTUATORS: All types, sizes. Complete control systems engineered to requirements. Above: Landing gear actuator Fairchild Packet.

RADIO SHIELDING: For any type of high or low tension system. New type "unit leads" or re-wirable leads. Flexible shielded conduit.

"AERO-SEAL" Worm-Drive Hose Clamps. Vibration proof, uniform clamping, use again and again. All clamps have stainless steel bands.

Write for Details

If you have a tough connector problem, ask BREEZE for the answer!

BREEZE

CORPORATIONS, INC.

41L South Sixth Street, Newark 7, N. J.

Distortion & Noise Meter

The fundamental circuit of the type 35-A distortion and noise meter comprises a series of eight fixed band rejection filters covering the 50 cps to 15KC range, followed by a stable, wide range (50 cps to 45 KC), high gain amplifier. There are no tube circuits at other sources of inherent distortion between the input of the 35-A and the filter network input, hence extremely low levels of distortion can be accurately measured over a wide level range. Each filter rejects uniformly a band $\pm 3\%$ of the indicated frequency and

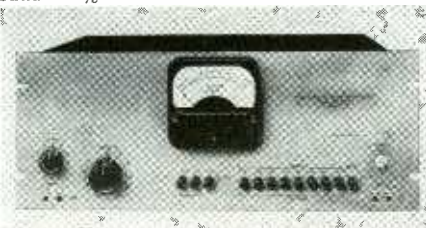

passes uniformly the harmonics of this frequency. A pair of output jacks are provided for connecting an external scope in place of the output meter.—Daven Co., 191 Central Ave., Newark, N. J.—TELE-TECH

UHF Frequency Meter

Accurate measurement of r-f signals throughout the UHF television band can be provided by the 584 UHF frequency meter. The dials are calibrated in MC and a coaxial type cavity resonator is employed in which the center conductor is adjusted by rotation of the frequency dial so as to vary the resonant frequency continuously from 470 to 950 MC.—Polytechnic Research & Development Co., Inc., 202 Tillary St., Brooklyn 1.

Beacon Antenna

A high gain beacon antenna (model 2HW) for the aircraft frequencies has a gain of approximately 3 db, thus effectively multiplying transmitter and receiver power by two. Communication in all directions is possible due to its omni-directional radiation pattern, and a specially designed side lobe facilitates communication with aircraft while aloft.

Operating efficiency is further insured by matching each antenna to the operating frequency, and by a low standing wave ratio. Single-unit construction plus built-in lightning protection substantially eliminates maintenance and assures dependable performance.—The Workshop Associates Inc., 135 Crescent Road, Needham, Mass.—TELE-TECH

Tape Recorder

Two hours of dual track recording at 3.75 in./sec. or one hour of dual-track recording at 7.5 in./sec. are provided by the model



D-37 portable tape recorder. Signal-to-noise ratio is 45 db at 7.5 in./sec. and 40 db at 3.75 in./sec. Twelve hundred feet of tape can be rewound in three minutes. The unit has three outputs, an internal speaker with a 6 in. PM Alnico V heavy-duty 3.2 ohm voice coil; an external speaker with an 8-16 ohm voice coil; and a 500-ohm output to line or external amplifier. One high quality crystal microphone is supplied with 7½ ft. of cable.—Mark Simpson Mfg. Co., Inc., 32-38 Forty-Ninth St., Long Island City 3, N. Y.—TELE-TECH

Crystal Test Set

A portable self-contained mixer crystal test set for measuring conversion loss and noise temperature of silicon crystals has been developed. The compact ALL type 390 instrument is particularly suitable for production testing, incoming inspection, and field tests, and has a correlation accuracy of $\pm 1/2$ db on conversion loss measurements and $1/2$ db on noise temperature mean deviation. It can be used at or below 10,000 MC for direct indication and above 10,000 MC for relative indication. Airborne Instruments Laboratory, 160 Old Country Road, Mineola, N. Y.—TELE-TECH

Mobile Radio

A new 50-watt mobile combination for use in the 148-174 MC band has been developed for use in the 148-174 MC band. Known as



the model combination 204, it features a low-cost tube complement, easily adjustable tuned circuits having triple tuned transformers and a built-in low pass harmonic filter in the antenna output circuit which attenuates harmonics at least 70 db. Receiver circuit elements provide better than 100 db adjacent channel selectivity. Standby battery drain for the new unit is 11 amps. at 6.3 v. and transmit drain is 60 amps and 6.3 v.—General Electric Co., Syracuse, N. Y.—TELE-TECH.

Power Supply

A highly-regulated dc power supply has been developed for any application requiring a voltage between 10 and 50 kv with a maximum current of a 2 ma. Known as the EME-2, it consists of a driver unit and a rectifier unit, and is available with either positive or negative ground. The final output voltage is taken from the rectifier unit and can be continuously varied between 10 and 50 kv. Ripple voltage is held to a maximum of 5 v.—Radio Corporation of America, RCA Victor Div., Camden, N. J.

IT'S KINGS FOR CONNECTORS

Pictured here are some of the more

widely used R. F. co-axial, U. H. F.

and Pulse connectors. They are all

Precision-made and Pressurized

when required. Over 300 types

available, most of them in stock.



Backed by the name KINGS—the leader in the manufacture of co-axial connectors.

Write for illustrated catalogs. Department "T"

Manufacturers of Radar, Whip, and Aircraft antennas
Microphone Plugs and Jacks.

Radar Assemblies, Cable Assemblies, Microwave and
Special Electronic Equipment

KINGS
Electronics
811 LEXINGTON AVE., BROOKLYN 21, N. Y.

PERSONNEL

John M. Miller, Jr. has been named chief engineer of the television and radio research and engineering department, Bendix Television and Broadcast Receiver Division, Bendix Aviation Corp.

W. D. Loughlin has been elected chairman of the board of directors of Boonton Radio Corp., Boonton, N. J. **Dr. G. A. Dounsborough** is the new president of the organization and **Dr. D. M. Hill** has assumed the post of vice president in charge of research and development.

Edmond Sherman, formerly chief engineer of Starrett Television Corp., has been elevated to the post of vice president in charge of engineering.

Harry R. Smith has been named head of the television transmitter development department of Standard Electronics Corp., subsidiary of Claude Neon, Inc. He was formerly associated with the television transmitter division of the Allen B. Du Mont Laboratories, Inc., as senior development engineer in television broadcasting equipment.

Dr. R. G. E. Hutter, head of the electronics research section of the physics laboratory, Sylvania Electric Products Inc., Bayside, N. Y. has been appointed adjunct professor at the Brooklyn Polytechnic Institute.

John Rhoades, since 1946 on the engineering staff of the Hoffman Radio Corp., Los Angeles, has been upped to the post of chief engineer of the special apparatus division.

E. Arthur Hungerford, Jr., a pioneer in television engineering, production expert on many of the nation's first telecasts, and wartime radar specialist for the Navy, has joined the sales staff of General Precision Laboratory, of Pleasantville, New York. He will handle sales work on the video recorders, television film projectors and other electronic units.

Howard E. Anthony, president of Heath Manufacturing Co., Benton Harbor, Mich., has been awarded the honorary degree of Doctor of Science by the University of Hollywood, Hollywood, Calif. He was graduated from Hillsdale College, Hillsdale, Mich., in 1931, and four years later founded the Heath Company.

Richard Sachleben has been appointed production manager of the U. S. Electronics Corp., Lyndhurst, N. J., manufacturers of coil components. Mr. Sachleben comes to U. S. Electronics after having spent more than 20 years in the communications and electronic industries. Prior to joining his present company, he spent five years with Sperry Gyroscope as manager of their transformer division. Earlier, he served with GE as assistant production manager and chief of their engineering-sample section for more than 15 years.

Dr. P. N. Hambleton, formerly of the Philco tube-development laboratory, has been appointed electronic engineer in charge of the electronic laboratory at Superior Tube Co., Norristown, Penna.

you get MORE PERFORMANCE for LESS MONEY with the NEW Browning OSCILLOSYNCHROSCOPE



For only
\$485.00

this new five-inch Browning 'scope gives you the basic laboratory equipment for pulse work — in a single, compact unit with:

- Triggered sweep rate continuously variable from 1.0 to 25,000 microseconds per inch.
- Sawtooth sweep rate 10 cycles to 100 KC.
- Sweep calibration (triggered and sawtooth) in microseconds per screen division accurate to $\pm 10\%$.
- Vertical amplifier flat within 3 db. from 5 cycles to 5 megacycles.
- Sensitivity 0.075 volts RMS per inch.
- Horizontal amplifier d.c. to 500 KC, sensitivity 2 volts per inch.
- Self-calibrating on both X and Y axis.
- Readily portable . . . weighs but 50 pounds.

plus these ELECTRICAL and MECHANICAL features

- 5UP1 cathode-ray tube operates at accelerating potential of 2600 volts
- Sweep starting time is approximately 0.1 microsecond
- Sweep may be triggered or synchronized by positive or negative sine-wave or pulse signals of 0.5 volts (external) or 0.75 inches deflection (from vertical amplifier)
- Three-step attenuator — 100:1, 10:1, and 1:1, plus continuous adjustability over entire range
- Peak-to-peak vertical calibration voltages of 0.2-20-200 at accuracy of $\pm 10\%$
- Cathode connection, brought out to front panel, allows external blanking and marker connection
- All deflection plates are available for direct connection
- Steel cabinet finished in black wrinkle
- Steel panel finished in black leatherette
- Copper-plated steel chassis with lacquer finish
- Controls grouped by function for operating convenience
- Free-view screen has graduated X- and Y-axis scales
- Size: 10" wide, 14½" high, 16¾" deep
- Instrument draws 180 volt-amperes at 115 volts 60 cycles.

NET PRICE, F.O.B. Winchester, Mass. \$485.00

FREE BULLETIN gives further data on this new, low-cost, versatile oscillosynchroscope. Ask for data sheet ON-54E.

In Canada, address Measurement Engineering Ltd., Arnprior, Ontario

Export Sales
9 Rockefeller Plaza
Room 1422
New York 20



BROWNING
Laboratories, Inc.
Winchester, Mass.
ENGINEERED FOR ENGINEERS

WOR-TV and Skiatron Test Subscribervision

A new system of fee television developed by the Skiatron Corp., makers of theatre and large screen television equipment, known as Subscribervision is being tested by WOR-TV, New York City, on channel 9.

The system is simple in principle, but complex in security, in other words "bootlegging" television programs is almost impossible. The system uses a plastic card, or slide, about the size of a 35 mm transparency which has a specific pattern on it. When the television signal is transmitted part of the synchronizing signal is omitted resulting in a scrambled picture on receivers not equipped with a decoder. The decoder itself is very simple and utilizes the flying spot scanner principle.

A small cathode ray tube illuminates the plastic decoder slide; the resulting signal, which is picked up by a photoelectric cell, contains the missing portion of the synchronizing pulse. This is then inserted in the sync circuit of the receiver and decodes, or unscrambles, the picture.

Since no other connections are required, and the signal is received entirely by radio methods the system is eminently suitable for other purposes such as military communications use. The Subscribervision plan envisages the weekly mailing of new keys to the users, who would thus be protected against "stolen" television by the regular change of code keys which require an accuracy of .0001 in.

Test transmissions from WOR-TV are being made between the hours of 8:00 A.M. and 10:00 A.M. daily and at other hours when the station is not normally on the air. The experiment is under the direction of Jack Poppele vice president in charge of engineering for WOR and the Subscribervision equipment is installed at the WOR-TV transmitter at North Bergen, N. J.

Screen Chemicals Developed for Color-TV Tubes

Two groups of fluorescent powders for the development of color television picture tubes which are suitable to several types of electronic color TV systems now being considered have been developed by the Tungsten and Chemical Division of Sylvania Electric Products Inc., according to Dr. Elmer C. Larsen, chief engineer.

Dr. Larsen said that the two groups of TV color phosphors, which are now available in engineering sample quantities, include sulphide and oxide types in the three basic TV colors: red, green and blue. The oxide powders are relatively fine texture while the sulphides are of about the same particle size as those now used in standard black and white picture tubes.

"The development of suitable red phosphor material," Dr. Larsen commented, "has hitherto presented a problem. Conventional red phosphor mixes have lacked color depth due to relatively low brightness obtained and excessive light output in the green and blue region. A new red phosphor which we are now making available for color tube development is a manganese activated zinc phosphate."

Coming Events

October 30-November 1 — IRE and RTMA, Radio Fall Meeting, Hotel Syracuse, Syracuse, N. Y.

November 3-4 — IRE, UHF-Microwave Conference, Kansas City Section, Kansas City, Mo.

November 13-16—National Manufacturers Association, Fall Meeting, Chalfonte - Haddon Hall, Atlantic City, N. J.

January 10-12 — High Frequency Measurements, Conference, Sponsored by the IRE, AIEE, and National Bureau of Standards, Hotel Statler, Washington, D. C.

January 18-20 — Society of Plastics Engineers, 7th Annual National Technical Conference, Hotel Statler, New York City.

January 22-26 — AIEE, 1951 Winter General Meeting, Hotel Statler, New York City.

March 19-22 — IRE Annual Convention, Hotel Waldorf-Astoria and Grand Central Palace, New York City.

June 18-20 — American Society for Testing Materials, Annual Meeting, Atlantic City, N. J.

We're right in Stride at RAYPAR

- QUALITY
- LOW COST
- LONG LIFE
- DEPENDABILITY

Alert to the changing demands of the TV and Radio industry, RAYPAR is right in step with the latest electronic developments and production methods. Components constructed by RAYPAR to your specifications are consistent in performance and dependability. RAYPAR products meet with Underwriters approval. We have a complete line of flyback transformers, with any type core, all types of cathode ray tube socket assemblies with wiring harnesses, high voltage rectifier tube sockets and RAYPAR'S one piece construction innerlock connector. Our RAYPAR family knows that, "Production and precision go hand in hand."

Contact us about your special needs.



RAYPAR Incorporated

7800-10 WEST ADDISON STREET ● CHICAGO, ILLINOIS

Propagation Problems on Empire State TV Site

A glimpse of some of the problems incident to erecting new steel-work during continued operation of television stations appeared recently during the construction work going on the Empire State Building, New York, which is to carry five television antennas. By an error fine mesh wire netting was used to catch rivets at one stage in construction, this was fine until the platform was raised then, since fine mesh wire netting is opaque to VHF radio waves a shadow was produced. Moving the netting solved the problem. Then a sudden poor standing wave ratio was noticed. This turned out to be due to resonant members at channel 4 which when riveted together acquired better conductivity and resulted in an antenna mismatch. Adding a new piece of steel improved the SWR! Finally, one evening some unsecured steel cables were allowed to hand and away in the wind when the steel crew left. Considerable distortion and fading was noticed in the transmissions as a result. Such are the perils of constructing while transmitting.

Field Wire Proves Worth in Combat

A new type military field communication wire is proving effective in combat. Recently developed by the Army Signal Corps, and now being produced in quantity by industry, the new wire has withstood all the rugged conditions of combat encountered in Korea. It can be laid at speeds up to 120 miles per hour from airplanes with good results.

The wire represents a successful effort by Army Signal Corps engineers to combine the substantial talking range and other characteristics of standard field wire with the reduced size and easy carrying of assault wire used by fast moving troops in World War II. It is particularly suited to airborne operations.

RAULAND DEVELOPING METAL RECTANGULAR



A laboratory model of a 17 in. rectangular TV metal tube produced by the Rauland Corp., Chicago 41, Ill. Overall length will be 18 11/16 in. maximum and the screen size will be 11 by 14 5/8 in. Rauland has not disclosed when production of the 17-in. tube will begin

RCA Acquires Cincinnati Plant

A new plant for the manufacture of miniature-type electron receiving tubes will be established by the RCA Victor Division of the Radio Corporation of America in Cincinnati, Ohio. The plant, to be operated by the RCA tube department, is scheduled to be in full production by autumn of 1951. Orders for high-speed tube-making machinery have already been placed in anticipation of the acquisition of the new plant.

GE to Open Clyde, N. Y. Plant

The General Electric Company has announced that it will reopen its Clyde, N. Y., plant and transfer the

production of germanium products now made at the G. E. Thompson road plant in Syracuse to the Clyde factory.

The Clyde plant, formerly used for assembly of small radios, must be completely renovated and specialized machinery installed before germanium product production will begin about December 1. Full production is expected about February 1.

Erratum

Page 42 of the September issue of Tele-Tech contains an error in the switch connections shown for the Cueing Amplifier Bridging-Coupling Circuit by E. W. Hill, chief engineer of WDHL, Bradenton, Fla. The DPDT switch should be shown with a neutral center position instead of the split connections shown.

Choice of new all-in-one front model, or trunk mount unit—both are drawer-type with quick lift cover.

Motorola FM 2-WAY RADIO

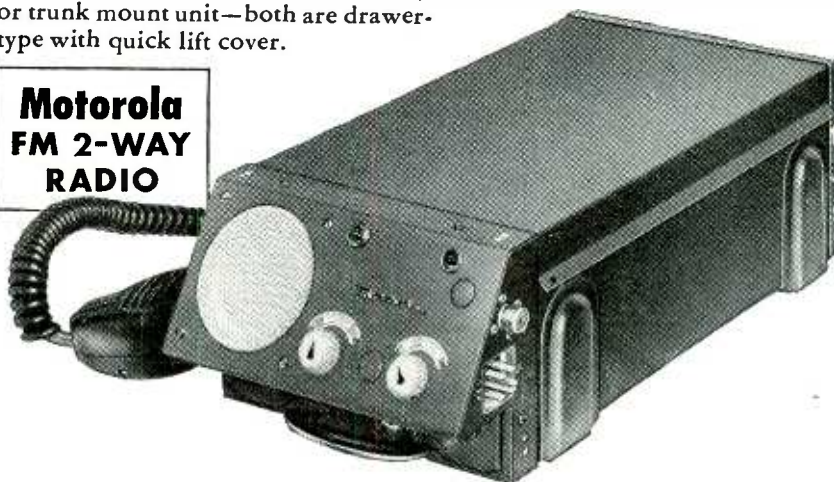

New UNI-CHANNEL SENSICON DISPATCHER—
with the marvelous Sensicon circuit...

Now the best in 2-way radio—in the Utilities and General Industry—Uni-Channel is hitting a new high in performance and a new low in maintenance costs. It will do everything that's being claimed to reduce your time and costs in material and crew handling. Motorola engineered, with eight exclusive features, it guarantees you *permanent* selectivity and reliability—minimum adjacent channel interference and maximum long-term protection against obsolescence and loss of investment. **REMEMBER!** When you add 2-way radio—you're ahead. When you make it **MOTOROLA**, you stay ahead!

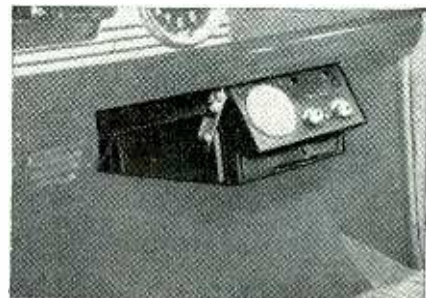

QUICK INSTALLATION

In any of several mounting positions, the complete, permanent installation requires only four screws.

COMPLETE "SHAKE-DOWN" TESTED

—by Motorola's engineering laboratory, the unit undergoes exhaustive tests to meet extreme conditions of service. (Tests made against temperature, humidity, and shock.)

ANTI-DUST HOUSING, with heavy duty construction throughout. Here is truly the all-purpose 2-way radio for every type of mobile application—offering the owner the benefits of advanced design, complete reliability, enduring economy, and freedom from obsolescence.

Motorola

COMMUNICATIONS & ELECTRONICS DIV.

4545 Augusta Blvd., Chicago 51 • in Canada: Rogers Majestic, Ltd., Toronto

BOOKS



Radio Communication at Ultra High Frequency

By J. Thomson. Published by John Wiley and Sons, Ltd., 440 Fourth Ave., New York 16, N. Y., 1950; Price: \$4.50, 203 pages.

This is a welcome addition to the current literature on UHF. While much of the material is basic, it is of a type which will not become of less value as the years pass. Much of the information concerns equipment which is still in the development stage. Although the subject is handled from the British point of view (terminology etc.) it should be interesting to the American reader. A reasonable amount of theory in the form of mathematics is included, but there is also a wealth of practical matter. In short, this is a book which is recommended reading for engineers.—JHB

Handbook of Motion Picture Techniques

By Emil E. Brodbeck. Published by Whittsey House, 330 West 42 Street, New York 18, N. Y., 1950; 311 pages. Price \$5.95

This is a useful book for the television engineer who has to work with films either in a new job or as an extension of his regular work. It describes motion picture techniques and lighting with a clarity which should be of value to the TV cameraman.—JHB

TV Receiver Specifications

Standard Coil Products, Inc., 2329 North Pulaski Road, Chicago 39, Ill., has announced the availability of a complete list of specifications for all TV receivers now being manufactured, reprinted from Radio & Television Retailing for September, 1950, (Caldwell-Clements, Inc., publishers). Marketing and technical data on each of the 724 models is included. Copies will be sent on request.

NEW DYNAMIC MICROPHONE



The American D-33, full vision, dynamic microphone, manufactured by American Microphone Co., Pasadena, Calif., provides full vision for audience and artist. No pre-amplifier is required for the D-33. It weighs 7 oz. and is available in all popular impedances

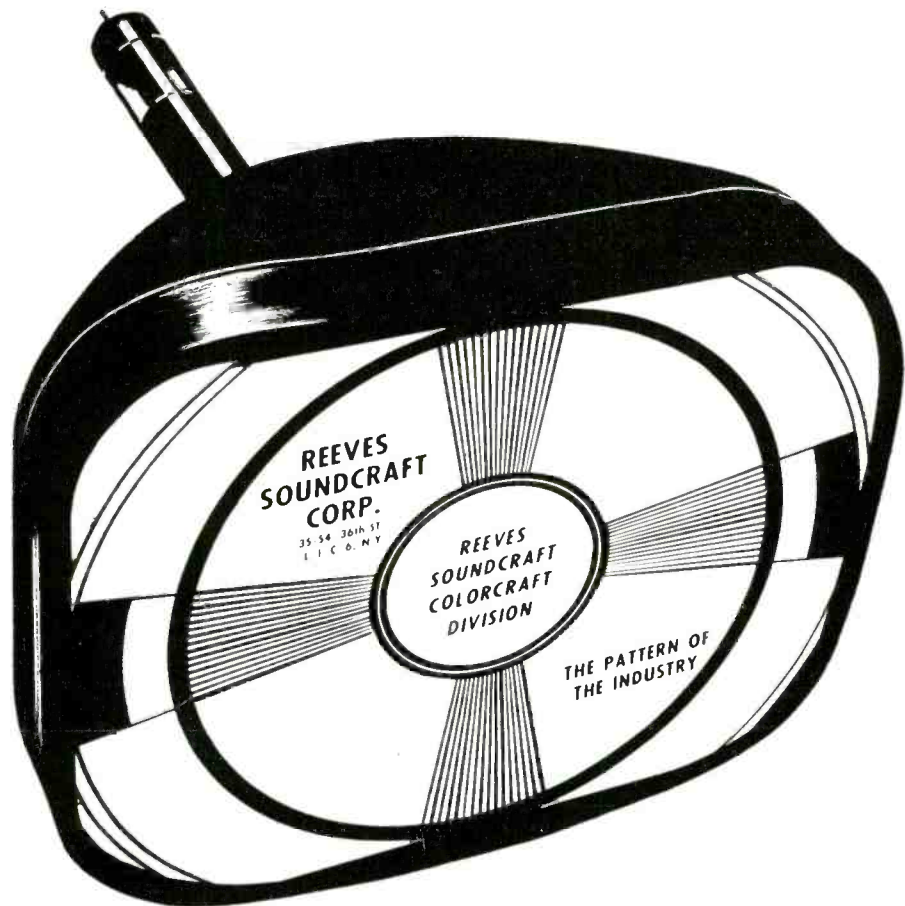

Are COILS Your BOTTLENECK?

Is the manufacture of R.F. Coils a "step-child" operation in your plant? Does it lead to snarled-up production because of inadequate facilities and endless engineering detail? If so, Clippard Instrument Laboratory can help you out in a hurry!

Now at your disposal is efficient new high-speed coil winding equipment of our own design, plus a staff of production and control technicians schooled in laboratory accuracy. We deliver the quality coils and sub-assemblies you want when you want them with a minimum of rejects, fuss and bother.

Call on us, like many of the biggest names in radio and television today, to free your production facilities for more important work. For intelligent help and a prompt quotation, mail your requirements, now, to Department 5-T.

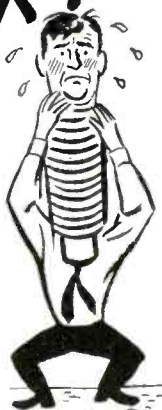

Clippard

INSTRUMENT LABORATORY, INC.

1125 Bank Street

Cincinnati 14, Ohio

MANUFACTURERS OF R. F. COILS
AND ELECTRONIC EQUIPMENT

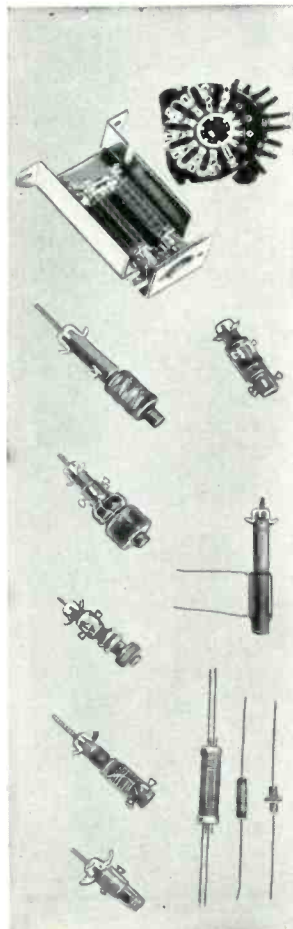

Military Contract Awards

Manufacturers who have received contract awards for producing of radio - radar - electronic equipment for the Armed Services are listed below by name, city, equipment and amount of contract. Subcontractors interested in bidding on performance of any part of each contract should sell their services to these prime contractors. This list, which is current for each month up to our press time, covers the period from August 30 to October 4, 1950.

Connecticut Telephone & Electric Co., Meriden, Conn., Telephone System cl 16C, \$2,544,000.00; Cincinnati Electronics Co., Cincinnati, Ohio, Receivers, R-77a/ARC-3, \$677,243.00;

Federal Tele. & Radio Corp., 100 Kingsland Rd., Clifton, N. J., Radio Set AN/GRC 3-8 Series, \$3,000,000.00; Radio Set AN/TRC-25, \$250,000.00;

General Electric Co., 840 So. Canal St., Chicago 80, Illinois, Capacitor, \$34,125.00;

The Hallicrafters, 5th & Kostner Ave., Chicago 24, Ill., Radio Set AN/GRC-26 & AN/MRC-2, \$2,500,000.00; Hubbell & Miller Co., 81 Willoughby St., Brooklyn, N. Y., Sound Locating Set GR-6, \$29,650.00;

Lavoie Laboratories Inc., Morganville, N. J., Oscilloscope & Maintenance Spare Parts, \$195,525.00; Lear, Inc., 110 Ionia Ave., N. W., Grand Rapids 2, Mich., Actuators: for use on various aircraft, \$35,820.00; Actuator, gear case for F7F-3, 3N, 4N, 2D aircraft, \$46,388.00; Actuator, Linear, elevator trim tab for use on F4U-5, 5N, 5P aircraft, \$62,450.00; Lewyt Corp., 60 Broadway, Brooklyn, N. Y., Radio Set AN/GRC-9, \$200,000.00;

Molded Insulation Co., 335 E. Price St., Philadelphia 44, Pa., Radiosonde Transmitter T-69, \$138,000.00; T-69 () ANT-2, Radiosonde, Transmitter, \$67,000.00;

Radio Corporation of America, Camden, N. J., AN/PRC-10 Radio Set, \$270,000.00; RCA Victor Radio Corp. of America, Harrison, N. J., Tube, Electron JAN 829B;

Sperry Gyroscope Co., Great Neck, N. Y., Radar Set AN/MPQ-10, \$2,000,000.00, Radar Set AN/MPQ-10, \$2,000,000.00, Tube Electron JAN 2K 41, \$242,356.00;

Sprague Electric Co., 201 Beaver St., North Adams, Mass., Capacitor, \$27,105.00; Sylvania Electric Prod., Buffalo N. Y., Radio transmitters, power junction box, cl-02Q, \$2,473,000;

Telephonics Corp., Park Avenue, Huntington, L. I., N. Y., Microphone & Microphone element, \$35,140.00; Microphone, Carbon, low impedance, \$42,085.00; Times Facsimile Corp., Times Bldg., 229 W. 43rd St., New York 18, N. Y., Modification Fit for AN Facsimile Set AN/TRC 1 & AN/TXC-1A, \$28,198.00; Transmitter Equip. Mfg. Co., Inc., 345 Hudson St., New York 14, N. Y., Radio Terminal Set AN/TRC-3, \$192,928.00;

Western Electric Co., Inc., 120 Broadway, New York, N. Y., Radio Set AN/TRC 24, \$400,000.00.

WRITE
FOR
JOB
IN
SAN
DIEGO
NOW

ELECTRONICS ENGINEERS

We need engineers for electronics research development and production. Real opportunity for graduate engineers with 5 or more years experience in basic circuit design, pulse, micro-wave, system analysis, electronic project coordination and administration. Openings for project leaders, senior designers, assistant project leaders and staff specialists.

Congenial associates, and superior living conditions in wonderful San Diego. Write today to H. T. Brooks, Engineering Personnel Office,

CONVAIR

(Consolidated Vultee Aircraft Corporation)
3302 PACIFIC HIWAY, SAN DIEGO, CALIFORNIA

EISLER Television Tube MACHINERY

- ECONOMICAL
- MODERN DESIGN
- PRODUCTION ENHANCING

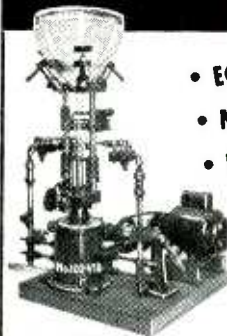

No. 102-VID



No. 57-VID



No. 57-8-4 CT

EISLER'S Electronic Equipment is especially Designed and Built to your exact requirements.
From 5" to huge 24" Television Tube

EISLER specializes in GLASS WORKING MACHINERY for the manufacture of: Cathode Ray; Radio Tubes (Standard, Miniature, Sub Miniature); Fluorescent Lamps; Glass Ampoules; Vials; Incandescent Lamps.

- Consultation without any obligation on your part is cordially invited.



RESISTANCE
WELDERS
•
1/4 to 300 KVA



EISLER TRANSFORMERS
STANDARD • SPECIAL
Air, Oil or Water
Cooled
•
Sizes From 1/4 to 500 KVA

EISLER ENGINEERING CO., INC.
770 SOUTH 13th ST. • NEWARK 3, NEW JERSEY



12 MC OSCILLOSCOPE MODEL **T-601-A**

- 17 TUBES INCLUDING 5" CRT.
- 10 MILLIVOLT SENSITIVITY
- 12 MEGACYCLE BANDWIDTH
- DEFLECTION PLATES AVAILABLE ON TERMINAL BOARD
- CONTINUOUSLY VARIABLE CALIBRATOR
- SWEEP MAGNIFICATION 5 TIMES SCREEN SIZE
- GOOD TRANSIENT RESPONSE
- TRIED AND PROVEN CIRCUITS
- CRT CALIBRATION GRID

WRITE FOR SPECIFICATION DATA SHEET T **\$349⁵⁰** LIST

COMPLETE WITH LOW CAPACITY PROBE



Now! A top quality engineer's oscilloscope combining ALL the features of a laboratory instrument in one convenient size, light-weight, low cost unit. Compare feature for feature with models many times the price!



TELEVISION EQUIPMENT CORP.
238 WILLIAM ST., NEW YORK 7, N. Y.
IN CANADA: THE AHEARN & SOPER CO. LTD., OTTAWA

Welch Duo-Seal Vacuum Pumps

Faster Pumping at all Pressures
Silent Operation
Lowest Pressures
— VACUUM —
1/10 Micron Guaranteed

FREE AIR CAPACITY
58 LITERS PER
MINUTE

DURABLE
ECONOMICAL
EFFICIENT

Dependable
Results

Noiseless
Operation

No. 1405-B
DUO-SEAL VACUUM PUMP
(Motor Driven)

Price \$195.00
complete with motor

IMMEDIATE
SHIPMENT

W. M. WELCH SCIENTIFIC COMPANY

Established 1880

1515 SEDGWICK STREET, DEPT. J

CHICAGO 10, ILLINOIS, U.S.A.

Radial Beam Tube

(Continued from page 27)

tube all of the anodes are tied together as they would be for the input tube of a time division multiplex or telemetering system and the common output appears across the load resistor R_L . The 30 inputs are applied to the 30 grids at the terminals marked 1 to 30. Common grid bias is obtained by tapping along the cathode bias resistor as shown. Fig. 5 shows the pattern of output pulses obtained with all the anodes tied together.

Operating Characteristics

Measurements have shown that with the beam stationary, the tube is no more noisy than a tetrode of usual design operated with the same current. The formation of the electron beam does not seem to introduce any appreciable noise. When the beam is rotated, of course, the noise level of the common anode current is high because it is sharply interrupted 30 times a revolution.

The crosstalk to adjacent channels is at least 30 db down with the beam centered on one of them. This measurement varies with focus as would be expected, becoming worse when the beam is spread out to overlap adjacent slots.

The speed of rotation is limited

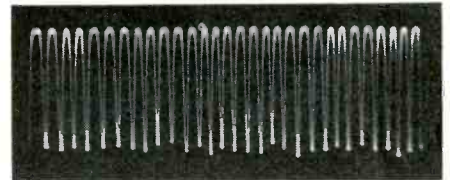

Fig. 5: Oscillogram showing output pulses of tube when the grids are all at zero potential and with anodes tied together

only by the circuit connected to the tube and by its internal capacitances. Rotational speeds in the megacycle range are quite possible.

There are 3 slot positions in the tube where the beam experiences different conditions. The first is at the gap between screen segments. When the beam is in this position each screen element adjacent to the slot has a voltage equal to 0.866 times the maximum or peak ac voltage. The next is the first slot adjacent to the gap and the third is the second slot in. For each there is a slightly different set of voltages near the screen elements with the results that the beam varies slightly in width and speed of rotation between these three positions. These variations are so small as to be

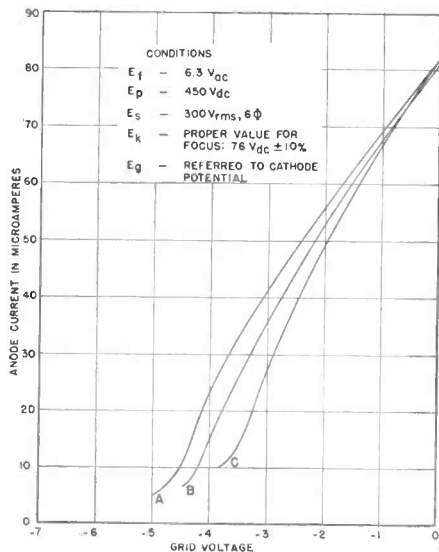

Fig. 6: Curves showing grid characteristics for the three different slot conditions

negligible for most applications. However, they give the variations in the grid characteristics shown by curves A, B, and C in Fig. 6.

The tube is generally applicable wherever it is desired to switch at high speed and with no inertia between as many as 30 separate circuits. For example, one use is in the commercially available instrument known as the SONOLATOR, an instrument which continuously scans the spectrum of an audible signal such as that of the human voice and presents this spectrum instantaneously. Other applications are found in the fields of multiplex telephony and telegraphy, telemetering, various coding and decoding problems, frequency generators and tone generators with special waveforms and various other high speed scanning operations.

The writers wish to acknowledge the very able assistance of Mr. Fred F. Crawford in the development of this tube.

¹"Electrostatically Focused Radial Beam Tubes"
—A. M. Skellett, Proceedings of I.R.E., Vol. 36—
11—November, 1948 (1354-1357 pp)

New Values of Electrical Units Established by Law

By an act approved July 21, 1950 (Public Law 617), the 81st Congress has given formal statutory sanction to a revision of the practical system of electrical units. In large part, the values adopted for these units resulted from research by the National Bureau of Standards, and the present legislation was proposed by the Bureau. The changes in magnitude of the units are small, in no case larger than 1/20 of one per cent, but the new law puts the values on a clear and unambiguous basis which assures the closest practical agreement between electrical and mechanical units. The law previously in effect, enacted 56 years ago, included double definitions of the units.

Coil Insurance FOR FAMOUS PRODUCTS

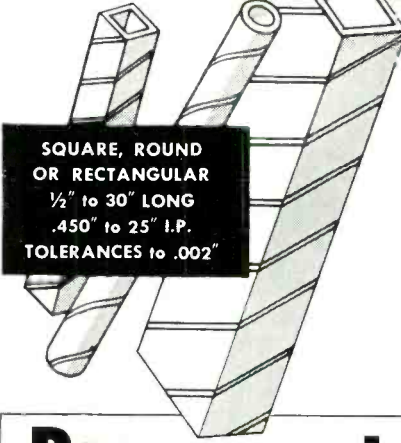

SQUARE, ROUND
OR RECTANGULAR
1/2" to 30" LONG
.450" to 25" I.P.
TOLERANCES to .002"

PARAMOUNT Spiral Wound PAPER TUBES
Protect Coil Accuracy and Stability
in Countless Applications

Years of specialized "know-how" easily enable PARAMOUNT to provide exactly the shape and size tubes you need for coil forms and other uses. *Hi-Dielectric. Hi-Strength.* Kraft, Fish Paper, Red Rope or any combination wound on automatic machines. Wide range of stock arbors. Special tubes made to your specifications or engineered for you.

NEW! Moisture-Resistant *Shellac-Bond* Kraft Paper Tubing. Heated shellac forms a bond which prevents delaminating under moisture conditions.

Paramount PAPER TUBE CORP.
615 LAFAYETTE ST., FORT WAYNE, IND.
Manufacturers of Paper Tubing for the Electrical Industry

WRITE
ON COMPANY
LETTERHEAD FOR
STOCK ARBOR
LIST OF OVER
1000 SIZES

FREE Send for ALLIED'S NEW 1951 CATALOG!

- **ELECTRONIC SUPPLIES for INDUSTRY**
- **BROADCAST STATION SUPPLIES**

World's Largest Stocks • Complete Expert Service from One Central Supply House

Simplify your purchasing problems—send your consolidated orders to ALLIED—the single, complete source for all electronic supplies. Rely on ALLIED for the world's largest stocks of parts, tubes, test instruments, audio equipment, accessories—complete quality lines of electronic supplies ready for immediate shipment from stock. ALLIED'S expert Industrial and Broadcast Station supply service saves you time, effort and money. Send today for your FREE copy of the 1951 ALLIED Catalog—the only complete guide to electronic supplies for industrial and broadcast station applications.

ALLIED RADIO CORP.
833 W. Jackson Blvd., Dept. 18-L-O • Chicago 7, Illinois

Everything in Electronics from ONE Source

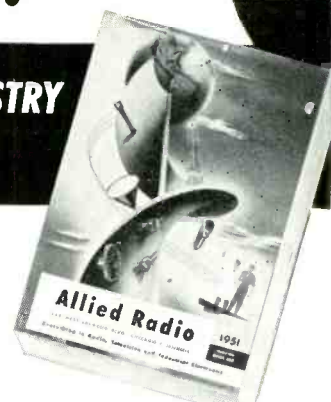

212 PAGES: Equipment for
Research, Development,
Maintenance and Production
Operations

Send for
1951
ALLIED
CATALOG

WHERE FIDELITY COUNTS



ANN BLYTH starring in Universal-International's "Katie Did It"

American D-33 DYNAMIC FULL VISION MICROPHONE

Lovely Ann Blyth, star of Universal-International Pictures, is one of the many stars relying on microphones made by American to reproduce with fidelity the tonal qualities of dramatic interpretations. Many radio, television and motion picture companies throughout the world are using the new American D-33, Full Vision, Dynamic Microphone.

Beautifully designed, attractively finished in Gold and Black. This new dynamic microphone provides superior quality with omni-directional pickup and requires no pre-amplifier. The D-33 is readily adaptable for stand or suspension and is quickly detachable for hand use. Weighs only seven ounces. The D-33 is available in any impedance 30 to 500 ohms and is equipped with "Latch-lock" plug and 25 feet of 2 conductor shielded cable.



D-33 FULL VISION DYNAMIC MICROPHONE

For TV • AM • FM

- Broadcasting
- Recording
- Public Address

WRITE FOR DESCRIPTIVE CATALOG

American Microphone Co.
370 S. Fair Oaks Ave, Pasadena 1, Cal.

DECADE FREQUENCY GENERATOR

(Continued from page 37)

between those of the grid and the bus-coupling windings. Proper grid drive for each stage was obtained by adjusting the spacings and relative turns of these series-tuned link circuits to give about 1.5 v. rms at the tube grids.

The 200 and 300-KC grid filters were of simpler design, consisting of only two tuned circuits as the percentage separation of interfering signals was much greater. They were coupled to a voltage divider on the harmonic generator to prevent overdriving the output stages. The inductance value for these coils, which were spaced for critical coupling, was 1130 μ h each, this being the maximum size coil that could be accommodated conveniently by the shield cans.

Type 6SK7 tubes are used for all output amplifiers with single-tuned transformer output coupling. These tubes have excellent internal as well as external shielding which greatly reduces instability and stray coupling problems where both grid and plate circuits are tuned.

Operating conditions for a tube power output of 0.2 watt (0.1 watt output to load and 0.1 watt loss in tank) were chosen as follows:

$$E_p = 250 \text{ v.}; E_{sg} = 100 \text{ v.}; E_c = -3\text{v.}$$

For minimum harmonic distortion at this level a load impedance of 25,000 ohms was used, corresponding to ωLQ_{cr} with a 100-ohm secondary load.

For a peak grid excitation of 3 v. a maximum class A power output of 0.4 watt may be obtained. For a tube output of 0.2 watt a peak grid excitation of only 2.1 v. or 1.5 v. rms is required which reduces harmonic distortion considerably from the maximum class A value.

Plate Filters

The plate coupling transformers, as indicated above, were designed to operate with a working Q of about one-half their unloaded Q. The powdered-iron-cored coils of the type used had an average unloaded Q of about 120. For a loaded Q of 60 the inductance for each primary was determined by the equation, L in henries = $25000/60\omega$. The output secondaries were wound on separate iron cores to reduce capacitive coupling of harmonics and the two cores were clamped tightly together by means of bakelite nuts on a bakelite rod through the core centers. The outputs were connect-

ed through coaxial lines grounded only at the shielded output jacks. Secondary to primary turns ratio required to drop the Q to one-half for a 100-ohm load was about one-to-six except the 100-KC stage which required a one-to-ten ratio.

Operating the outputs with no secondary load doubles the load impedance seen by the tube and increases the harmonics generated, but the rise in tank Q more than compensates for the increase, so that the harmonic content in the output is not greatly affected by loads of more than 100 ohms. Any load impedance higher than 50 ohms, resistive or reactive, may be used satisfactorily, although the lower values cause appreciable drop in output voltage.

The built-in power supply is of conventional design employing choke input with two stages of filtering. The ac input is bypassed at the entrance point and the filament and plate leads to the amplifier stages are also bypassed to reduce mutual coupling between stages or coupling to other units through the power line. Separate resistance-capacitance decoupling is also employed in the screen and plate leads of each amplifier stage. The unit should preferably be operated from a stable ac source to minimize phase shift which might cause a slight frequency modulation if used to drive very high frequency equipment. Power consumption with all output stages operating is about 75 watts.

Construction Details

The unit is suitable for standard relay rack mounting, having an 8 $\frac{3}{4}$ x 19 in. panel. All jacks and switches controlling the outputs are located on the front panel. A 1000-KC jack is also provided on the rear apron for possible use in driving a similar unit having outputs in the range of 1 to 10 MC.

All r-f coils were universal wound on cylindrical powdered-iron cores using seven-strand, No. 41 litz wire, except the 100-KC plate transformer which was wound with 10/41 litz for increased harmonic attenuation in its output. The location of powdered-iron cores in strong power-frequency fields should be avoided, especially in class C stages, as cross modulation may take place.

The tuning condensers are dual ceramic - mounted, air - dielectric type, shunted by silvered mica

TABLE I.
Output Undesired db down
frequencies frequencies 100-ohm load no load

(side frequencies)			
1000 KC	f ± 100 KC	65	75
	f ± 100 KC	75	85
900 KC	f ± 200 KC	80	85
	f ± 200 KC	100	100
800 to 200 KC	f ± 100 KC	90	100
	f ± 200 KC	100	100
(harmonics)			
1000 to 200 KC	f × 2	60	65
	f × 3	65	70
	f × 4	80	80
100 KC	f × 2	60	70
	f × 3	60	60

fixed condensers where necessary. The coils were mounted on the tuning condensers by means of threaded bakelite rods through the holes in the core material. Bakelite spacers were used between the cores for adjusting the coupling, where necessary, and a threaded bakelite washer was used as a retaining nut. Aluminum shield cans were used on all r-f transformers.

After the 27 tuned circuits are properly aligned further adjustment is seldom required. A wide-band oscilloscope is useful for observing the pulse waveform on the harmonic bus and the ratios of the output stages by obtaining Lissajous figures. In the unit described, after proper adjustment, the output voltages into 100 ohms with all outputs operating ranged from 3.2 to 3.7 v.

Undesired frequency components in the various outputs were measured as shown in Table I. These values were approximately the same with all or only one output stage operating.

¹B. F. Husten and H. Lyons, Microwave frequency measurements and standards. Trans. AIEE, 67, 436 (1948).

IRE Fellows

(Continued from page 44)

Y.; **H. R. Skifter**, President, Airborne Instruments Laboratories, Inc., Mineola, L. I., N. Y.; **B. R. Teare, Jr.**, Head, Dept. of Electrical Engineering, Carnegie Institute of Technology, Pittsburgh, Pa.; **Gordon N. Thayer**, Transmission Development Engineer, Bell Telephone Laboratories, Inc., New York, N. Y.; **Henry P. Thomas**, Engineer, General Electric Company, Syracuse, N. Y.; **William C. Tinus**, Radio Development Engineer, Bell Telephone Laboratories, Inc., Whippany, N. J.; **Ernst Weber**, Polytechnic Institute of Brooklyn, Brooklyn, N. Y.; **R. H. Williamson**, Assistant Section Engineer, General Electric Company, Syracuse, N. Y.; **W. G. Wintringham**, Technical Staff, Bell Telephone Laboratories, Inc., Murray Hill, N. J.; **G. A. Wootton**, Professor of Physics, Director Eaton Laboratories, McGill University, Montreal, Que., Canada.

CABINETS • CHASSIS • PANELS • RACKS

Planning ELECTRONIC EQUIPMENT ? Investigate the ECONOMIES of PAR-METAL HOUSINGS !

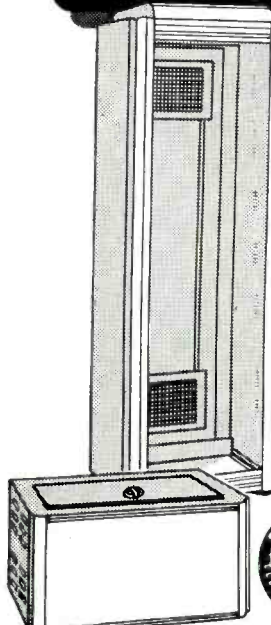

We manufacture Metal Housings for every purpose — from a small receiver to a deluxe broadcast transmitter. And the cost is low!

Because we specialize in the Electronics field, Par-Metal Products excel in functional streamlined design, rugged construction, beautiful finish, and economy.

Remember, Par-Metal equipment is made by electronic specialists, not just a sheet metal shop.

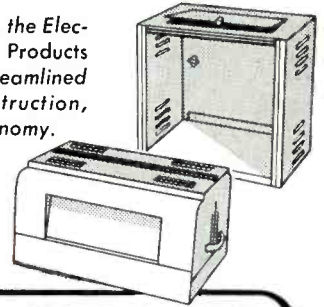

PAR-METAL PRODUCTS CORPORATION

32-62 — 49th ST., LONG ISLAND CITY 3, N. Y.
Export Dept.: Roche International Corp.
13 East 40 Street, New York 16, N. Y.

WRITE FOR CATALOG !

AMPERITE

THERMOSTATIC METAL TYPE

Delay Relays

**PROVIDE DELAYS
RANGING FROM
1 TO 120 SECONDS**



FEATURES: — Compensated for ambient temperature changes from —40° to 110° F
... Hermetically sealed; not affected by altitude, moisture or other climate changes
... Explosion-proof ... Octal radio base
... Compact, light, rugged, inexpensive ...
Circuits available: SPST Normally Open;
SPST Normally Closed.
PROBLEM? Send for "Special Problem Sheet"

Regulators

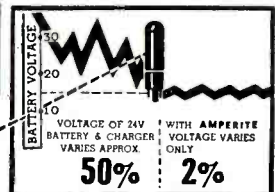

Amperite REGULATORS are the simplest, lightest, cheapest, and most compact method of obtaining current or voltage regulation ... For currents of .060 to 6 Amps. ... Hermetically sealed; not affected by altitude, ambient temperature, humidity.

Write for 4-page Illustrated Bulletin T-1

AMPERITE CO., Inc., 561 Broadway, New York 12, N. Y.
In Canada: Atlas Radio Corp., Ltd., 560 King St., W. Toronto

VIDEO RECORDING

(Continued from page 35)

ture of the camera.

At full aperture, as illustrated, the overlap zone may almost be equal to the frame height. This is undesirable as there must be some loss of definition on moving objects in this zone due to the superimposition of two scans displaced in time. The effect is not pronounced, but may be noticeable on panning the television camera. The remedy would be to stop down the optical system and phase the recording camera so that as much as possible of this zone occurs in the frame suppression period. However, up to the present time, the slight blurring on television camera movements has been tolerated, since normal action in the frame is reproduced quite satisfactorily

Kinescopes and Photographic Technic

A considerable amount of work has been carried out on the types of reproducing cathode ray tube, film stock and processing conditions which are required to obtain a tonal reproduction on re-transmission, as similar to the original as possible.

Since telecine apparatus is normally arranged to give optimum conditions when transmitting normal cine films, it is found satisfactory to attempt to make a telefilm standard as far as contrast gradient and contrast range are concerned. A detailed treatment of this subject is outside the scope of this article, but the main technics at present in use, are as follows:

Negative and Print—A fast panchromatic stock is used, such as Eastman Kodak Plus X. A positive picture is produced on the cathode ray tube screen of contrast gradient approx. 2.0. The negative is developed to a 'control gamma' of approx. 0.5, and printed with a control gamma of about 2.3. Since the television pick-up tubes have a contrast gradient of about 0.5 over the working range, the picture produced on the Kinescope is substantially similar to the original subject, and this when photographed by the above technique, gives a print substantially similar to that which would have been obtained had the original scene been photographed directly, except that the contrast range has been reduced due to distortions in the television system.

Negative and print with electrically reduced contrast gradient—In this case, the contrast gradient of the kinescope tube is reduced electrically to

lower the contrast ratio to about 10 or 20 to 1. This is photographed using a high gamma stock such as Eastman Kodak 1398 and the negative is developed to a control gamma of about 2.0, contrast range on the negative. It is then printed normally. The advantage is that tonal distortions occurring in the Kinescope are minimized due to the low contrast range, and the effective brightness is enormously increased, since the brightness corresponding to picture black can now be raised without crushing on whites.

Direct Positive—In this technic, a negative picture is produced on the kinescope tube by phase reversal. Some electrical contrast gradient correction is employed. The process is the cheapest, but only if one copy is required, since to obtain a second copy, a duplicate negative must be made and a print taken from this.

Negative—For speed and cheapness, it is sometimes convenient to transmit negative film in the telecine machines, and to save the time and cost of printing. As the sound quality attainable is low, unless a separate recording system is used, it is considered that the Direct Positive method is superior.

The kinescopes used for television recording at the present time have a picture of approximately 8" x 6", but it is proposed to replace those with high intensity kinescopes using a 4" x 3" picture. Using an accelerating potential of about 20 kv, these will give a brightness which



The Synthane COMBINATION Gives the Right MATERIAL Answers

If your requirements are strict and your present material in any way unsatisfactory, Synthane may be the answer to your problem. Synthane has an unusual combination of mechanical, electrical and chemical properties which have led to its use in many applications in almost every industry.

Light, hard, strong and dense, Synthane is easily machined. Resistant to corrosion and abrasion, it rates high in electrical properties such as high dielectric strength, low power factor and low dielectric constant.

Find out more about Synthane and its possible advantages to you. Clip and mail the handy coupon for your Synthane catalog.

TECHNICAL PLASTICS
SHEETS • RODS • TUBES
FABRICATED PARTS

SYNTHANE

SYNTHANE CORPORATION
12 River Road, Oaks, Pa.

Please send me a copy of the complete Synthane catalog.

Name _____
Firm _____
Address _____
City _____ State _____

MOLDED-LAMINATED
MOLDED-MACERATED

Ideal for ANTENNA CONNECTIONS PHOTO-CELL WORK MICROPHONE CONNECTIONS

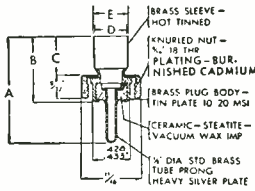

SUPPLIED IN 1 & 2 CONTACT TYPES

JONES SHIELDED TYPE PLUGS & SOCKETS

LOW LOSS PLUGS AND SOCKETS FOR HIGH FREQUENCY CONNECTIONS

For quality construction thru-out, and fine finish, see diagram above.

101 Series furnished with 1/4", .290", 5/16", 3/8", or 1/2" ferrule for cable entrance. Knurled nut securely fastens unit together. Plugs have ceramic insulation; sockets bakelite. Assembly meets Navy specifications.

202 Series Phosphor bronze knife-switch type socket contacts engage both sides of flat plug contacts—double contact area. Plugs and sockets have molded bakelite insulation.

For full details and engineering data ask for Jones Catalog No. 17.

JONES MEANS PROVEN QUALITY



P-101-1/4



P-202-CCT



S-101



S-202-B

HOWARD B. JONES DIVISION
CINCH MANUFACTURING CORPORATION
CHICAGO 24, ILLINOIS
SUBSIDIARY OF UNITED-CARR FASTENER CORP.

**"We have found
Metex Electronic Gaskets
excellent for HF currents
inexpensive to assemble."
Sylvania Electric Products Inc.**

Sylvania has been using Metex gaskets for over a year as conductive shields for their TR tubes used in radar and micro-wave ranging equipment.

To quote their experience: "We have found Metal Textile knitted wire gaskets excellent for conducting high frequency currents without boundary arcing. The gaskets are resilient, and yet do not deform too readily. Best of all, the material is inexpensive to assemble through soft soldering techniques."



**A Sylvania Electric TR tube showing
Metex gasket loose and in position**

The properties—electrical and physical—which make Metex Electronic Gaskets effective in this, and other demanding HF and UHF applications are due to their being made from *knitted* (not woven) wire mesh. The hinge-like action of the knitted mesh permits controlled resiliency of the finished gaskets. These can be die-formed to close dimensional tolerances, when required. There is practically no limit to the metal or alloy which can be used.

If the equipment you are manufacturing or designing requires a resilient conductive or shielding material, our engineers will welcome the opportunity of working with you. A letter, addressed to Mr. R. L. Hartwell, Executive Vice President and outlining your requirements, will receive immediate attention.

**METAL TEXTILE CORPORATION
639 EAST FIRST AVE., ROSELLE, N. J.**

will allow a smaller lens aperture to be used in the camera. This will minimize blurring on movement, will improve definition and will give a greater depth of focus in the film gate. A special feature of the monitors is a device which effectively eliminates the line structure of the image recorded on the film so that no interference patterns result when the film is subsequently scanned for transmission. The method adopted is to deflect the scanning spot with a small sine-wave displacement in the field scan direction, the deflecting frequency being several times higher than the maximum detail frequency of the television system. The deflection amplitude is variable, and is adjusted to the correct value on test, then fixed.

Two corrections can be applied to the incoming electrical signals; these are frequency/phase correction and the contrast gradient correction already mentioned. The frequency response is adjusted to provide a boost at the higher frequencies to compensate for recording losses, and the phase corrector takes the form of a number of filters, introducing their maximum correction at different frequencies, which are set up when observing a test card from the camera before a recording is made.

A satisfactory continuous motion system of 35mm recording has been evolved, and work is in hand to improve the quality of the recordings obtained, and the operational facilities offered.

It is now necessary to produce an equivalent 16mm system, but it is felt that the accuracy required, if a continuous motion system is used, may be difficult to achieve. Work is therefore proceeding on the intermittent system, briefly described earlier, but in parallel with this, it is proposed to experiment with a continuous motion camera of the present type, using a reduction optical system placed after the film gate. This would reduce the image size, and at the same time, its linear speed of travel, so that this matches the lower linear velocity of 16mm film.

Haydu Bros. Acquire West Coast Plant

Recent expansion of the plant facilities and manufacturing operation of Haydu Brothers, Plainfield, N. J., with the addition of a west coast plant to spearhead the firm's entry into the television tube field was announced recently by George K. Haydu, president of the company. The company has recently initiated production of its own line of "North Star" television picture tubes, and the Haydu antenna rotator.

**TESTED
Laboratory
SCREEN ROOMS
for ACCURATE
RADIO-FREQUENCY
MEASUREMENTS**

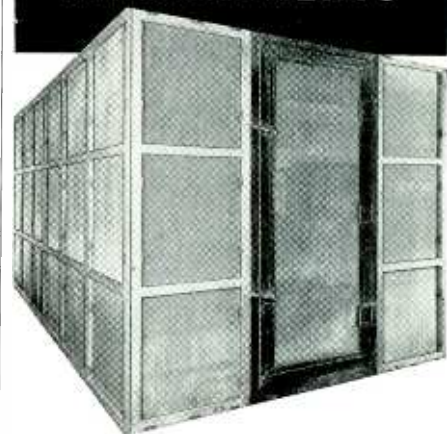

Guesswork is eliminated when you use an ACE Pre-built Screen Room. The area background level of radio interference is suppressed and the room does not introduce any errors in your measurements. Attenuations of 100 db. — and higher — at frequencies as low as 0.15 and as high as 10,000 mc. are readily obtainable. Specially designed Screen Rooms can give attenuations as high as 140 db.

ACE attenuation characteristics have been determined by reputable electronic laboratories. These Screen Rooms are used for various applications such as evaluation and suppression of radio interference; radio and radar calibration, sensitivity, susceptibility, spurious response and radiation; measurements involving electronic instruments used in medical laboratories and many others. Write for descriptive bulletin.

**Easily installed
Easy to move
or to enlarge
Low priced**



**ACE ENGINEERING &
MACHINE CO., INC.**

3644 N. Lawrence Street
Philadelphia 40, Pa. Regent 9-1019

5-10 KW BROADCAST TRANSMITTER

(Continued from page 29)

cial considerations in the installation. As all but the power transformer, modulation transformer and reactor, are inside the transmitter, very little external wiring is required. The 5000 v. plate supply permits the use of readily obtainable high voltage cable.

The transmitter is 78 in. high, 48½ in. deep, and 125 in. long. With

Fig. 4: Modulation and output stages mounted on air chamber supplied by blower

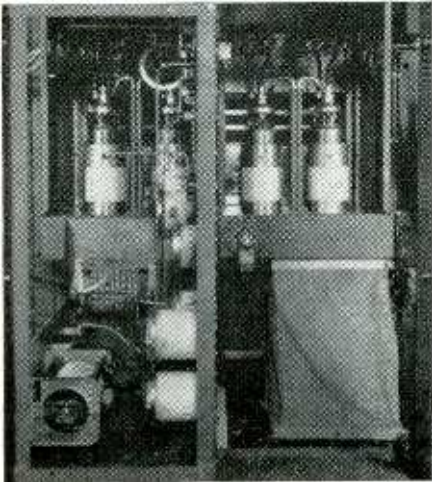

the matching phasor cubicle added to one end of the transmitter, the length becomes 165 in. The phasor can be located separate from the transmitter. With the heavy components mounted on the floors of the cubicles, heavy reinforcing of shelves and brackets is avoided, weight is saved, and installation is made easy.

The output powers of 5 and 10 kw have ample margin to allow for phasor losses. With the 80% efficiency obtainable, the plate dissipation is slightly over half that specified by the tube manufacturer. The power demand on unmodulated carrier is 12.5 kw for 5 kw, and 21 kw for 10 kw output. Average program modulation draws 15.5 and 23 kw respectively.

The frequency response from 100-7500 cps is plus or minus 1 db, but as already shown, the response may be modified to suit individual preferences. The noise with a random selection of tubes and connections of components shows -60 db; with tube matching, phasing of filaments, modulation transformer primary, etc., it has been reduced to -70 db. This indicates that with normal op-

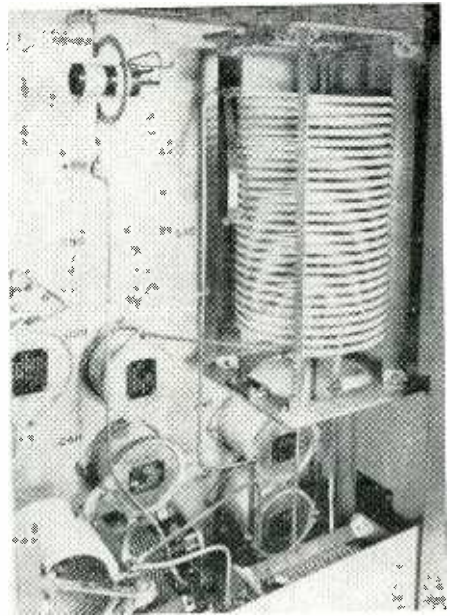

Fig. 5: Antenna coupling network (right). Left, adjustable pickup loop for monitors

eration over a period of time, the increase of noise with aging and changing of tubes will not bring the noise much above -60 db. In the design considerations, some concern was felt that the 3X2500F3 tube might introduce considerable hum due to the close spacing of the ele-

One OF A LINE....

The GUARDIAN Series 220 A.C. RELAY

Series 220 operates as an A.C. Relay capable of breaking currents up to 20 amps. at 230 v., 60 c., A.C., non-inductive load. Contacts are same alloy used in Guardian Solenoid Contactors, specially compounded to withstand high loads. Dual contacts reduce arcing to a minimum. Standard hermetically sealed unit weighs 6.2 ounces. Highly insulated. Compact. Low priced.

GUARDIAN ELECTRIC
1607-L W. WALNUT STREET CHICAGO 12, ILLINOIS
A COMPLETE LINE OF RELAYS SERVING AMERICAN INDUSTRY

New Precision Coil Bobbins

Give You the INSULATION of PLASTIC.... PLUS the FLEXIBILITY of PAPER

New Precision Bobbins with plastic-coated cores are stronger, offer better insulation, moisture resistance, heat dissipation... and anchored flanges. But they also offer high flexibility — such as the movable coil-separating ring shown. That's because they're *not* molded in one piece. What's more... they're light in weight. Precision Bobbin Coil Forms are made round, square, rectangular of any ID, OD, length with an infinite variety of flanges. Write for samples.

PRECISION PAPER TUBE CO.

2057 W. Charleston St., Chicago 47, Ill.
Plant #2: 79 Chapel St., Hartford, Conn.
Also mfrs. of dielectric paper tubes

Langevin AMPLIFIERS



For broadcast, public address, recording, and music services — custom designs for special applications.

Langevin TRANSFORMERS



Open-core, enclosed, hermetically sealed, high-temperature. Built to your own or MIL-T-27 specifications.

Langevin ENGINEERING



Available for the development and manufacture of special electronic devices.

For detailed information on our products and services, write to

Langevin

MANUFACTURING CORPORATION
37 W. 65th St., New York 23, N. Y.

Engineering Opportunities in Westinghouse

Wanted:

DESIGN ENGINEERS.
TECHNICAL WRITERS.

Must have at least one year's experience. For work on airborne radar, shipborne radar, radio communications equipment: micro-wave relay or micro-wave communications.

Good pay, excellent working conditions; advancement on individual merit; location Baltimore.

Send resume of experience and education to: Manager of Industrial Relations.

WESTINGHOUSE ELECTRIC CORP.
2519 WILKES AVE., BALTIMORE 3, MD.

ments, but it was found that the tube was inherently free from hum, and was an excellent and uniform audio tube. With 85% modulation, distortion measured slightly over 1% on the middle frequencies. Measured at 30 cps it was under 3%, and at 10,000 cps 3%.

¹N. B. Ritchey, "Citizen's Band Oscillator", *Radio and Television News*, Dec. 1948; p. 44.

²E. W. Herold, "The operation of Frequency Converters and Mixers for Superheterodyne Reception", *Proc. of I.R.E.*, Feb., 1942; p. 99.

Modified Resonant Circuits (Continued from page 42)

$$Z = \frac{1}{\frac{1}{j\omega C} + j\omega L + R} \dots\dots\dots (1)$$

$$= \frac{R}{1 + jQu}$$

where $u = (\omega/\omega_0 - \omega_0/\omega)$, $\omega_0^2 = 1/LC$, and $R = \omega_0 L$. It is seen that the magnitude of Z is $R/\sqrt{2}$ when $Qu = 1$.

It is next necessary to investigate the properties of u . By definition

$$u = \frac{\omega}{\omega_0} - \frac{\omega_0}{\omega} \dots\dots\dots (2)$$

$$\text{and } \omega = \omega_0 \left(\frac{u}{2} + \sqrt{\frac{u^2}{4} + 1} \right) \dots\dots\dots (3)$$

Insert Cut E

selecting the positive sign for the radical. At the limits of a band $\Delta\omega$ the angular frequencies of ω_1 and ω_2 are defined, with corresponding values u_1 and u_2 . If $\omega_2 > \omega_1$ substitution in (2) shows that $u_1 = -u_2$, while from (3), $\Delta\omega = \omega_2 - \omega_1 = u$, ω_0 or $\frac{\Delta\omega}{\omega_0}$

simply $u\omega_0$. Therefore $u = \frac{\Delta\omega}{\omega_0}$,

where $\frac{\Delta\omega}{\omega_0}$ is the fractional bandwidth.

Thus from (1) the fractional bandwidth (whose limits are defined when $Qu = 1$) of the parallel RLC circuit is equal to $1/Q$, if $Q = \frac{R}{\omega_0 L}$.

This relation in which Q is expressed in terms of the effective shunt resistance R of a parallel RLC circuit, holds for all values of Q , which is not true for Q as usually defined in terms of the effective coil series resistance.

New Components Manufacturer

A new entrant into the radio-TV components manufacturing field is the Tetrand Co., 4921 Exposition Blvd., Los Angeles 16, Calif. Headed by Leonard Juniper, president, the firm will specialize in the manufacture of miniature solenoid coils. Other items include horizontal flyback output transformers, deflection yokes, focus coils for television and miscellaneous coil components. Joseph McGarvey has been named plant manager. He has a record of 20 years as production chief in components manufacture.

THE WIDE BAND POCKETSCOPE

BY WATERMAN



MODEL
S-14-B

Wt. 14 lbs.
12" x 6" x 7"

Another Waterman **POCKETSCOPE** confirming the obsolescence of conventional oscilloscopes. Characterized by wide band amplifier fidelity without peaking as well as amazing portability. **S-14-B POCKETSCOPE** is ideal for laboratory and field investigation of transient signals, aperiodic pulses, or recurrent electrical wave forms.

Vertical channel: 50mv rms/inch, with response within -2DB from DC to 700KC, and pulse rise of 0.35μs. Horizontal channel: 0.3v rms/inch with response within -2DB from DC to 200KC, and pulse rise of 1.8μs. Non-frequency discriminating attenuators and gain controls, with internal calibration of trace amplitude. Repetitive or trigger time base, with linearization, from 1/2cps to 50KC, with ± sync. or trigger. Trace expansion. Filter graph screen. Mu metal shield. And a host of other features.

WATERMAN PRODUCTS CO., INC.

PHILADELPHIA 25, PA.
CABLE ADDRESS: POKETSCOPE

WATERMAN PRODUCTS INCLUDE:

- | | |
|-------------------------|-------------|
| S-10-B GENERAL | POCKETSCOPE |
| S-11-A INDUSTRIAL | POCKETSCOPE |
| S-14-A HI-GAIN | POCKETSCOPE |
| S-15-A TWIN TUBE | POCKETSCOPE |
| S-21-A LINEAR TIME BASE | |

Also **RAKSCOPES**, LINEAR
AMPLIFIERS, RAYONIC® TUBES
and other equipment



Crystal Gazing... Electronics Style

There's no room for "guess work" in the manufacture of crystals! That's why so many so often specify JK stabilized crystals when they want to be sure of utmost dependability.

Happily, this preference for the best costs no more. You, too, will be pleasantly surprised to find that The James Knights Company can furnish you outstanding quality at modest cost -- in single units or production quantities.

JK STABILIZED H17

Frequency range 200 kc to 100 mc. The pin spacing is such that two units can be mounted in a local socket. A small extremely light weight hermetically sealed unit. Moisture and dustproof. Designed especially for use where space is at a premium. The crystal is plated and wire mounted. Will stand maximum vibration. Pin diameter of the H17 is .050.

The H17L and the H17W are also available in the same frequency range except that the H17L has a pin diameter of .093, and the H17W has wire leads.

The James Knights Company
SANDWICH, ILLINOIS

*Formerly manufactured by Western Electric Co., Inc.

FIDELITY...

PRESENCE...

COMPACTNESS



757A—Developed at Bell Telephone Laboratories to reproduce sound over an extended frequency range with arresting presence and fidelity, the 757A Loudspeaker is a complete two-way system combining finest speaker design principles with compactness and adaptability. Its 60-15,000 cps response, 30 watt capacity and wide angle of distribution make the 757A ideal for every service where highest quality sound is required. Input impedance to dividing network is 4 ohms. 757A is 20" high, 30½" wide, 13¾" deep; weighs 82 pounds.

728B—The famous 728B Loudspeaker is widely acclaimed by engineer and music lover alike for its fine musical qualities and unusual presence. It is compactly built, with a depth of only 3-25/32". Overall diameter is 12-11/32". Exceptionally smooth frequency response from 60-10,000 cps. Impedance, 4 ohms. Will handle 30 watts continuously.

755A—The 755A Loudspeaker gives large speaker performance in a small package only 8" in diameter, 3" deep. 70-13,000 cps response. 8 watt power capacity. Impedance, 4 ohms.

1161 N. VINE STREET, HOLLYWOOD 38, CALIFORNIA
161 SIXTH AVENUE, NEW YORK 13, NEW YORK



ALTEC
LANSING CORPORATION

BULLETINS

Vacuum Pumps

Welch Duo-Seal Pumps, products of the W. M. Welch Scientific Co., 1515 Sedgwick St., Chicago 10, Ill., are described in a new bulletin just released by the company. These pumps are capable of producing a vacuum of .05 microns and better.

TV Equipment

Polarad Electronics Corp., 100 Metropolitan Ave., Brooklyn 11, N. Y., is now issuing its new catalog on television equipment for broadcast, manufacturer and laboratory use.

Antenna & Transmission Line

Product Development Co., Arlington, N. J., has announced the availability of a new catalog describing its "Prodelin" line of antennas and transmission lines.

Polystyrene

A guide which summarizes recommended techniques for machining and working with polystyrene has been published by Plax Corporation Division, (P.O. Box 1019) Hartford-Empire Company, Hartford, Conn. Entitled "Fabrication of Polystyrene", the guide covers use of coolants, sawing, turning, milling, drilling, threading, tapping, grinding, annealing, polishing, forming, cementing, die-cutting and checking for stresses.

Resistance Percentage Bridge

A brochure (S142) illustrates and describes operation of a resistance percentage bridge having an accuracy better than one one-hundredth of one per cent (0.01%) throughout its range of indication. The instrument is used for quick, accurate calibration of high-precision potentiometers. The brochure can be obtained from Specialties, Inc., Skunks Misery Road, Syosset, N. Y.

STATEMENT OF THE OWNERSHIP, MANAGEMENT, CIRCULATION, ETC., REQUIRED BY THE ACT OF CONGRESS OF AUGUST 24, 1912, AS AMENDED BY THE ACTS OF MARCH 3, 1933, AND JULY 2, 1946.
Of TELE-TECH, published monthly at Orange, Conn., for Oct. 1, 1950.

1. The names and addresses of the publisher, editor, managing editor, and business manager are: Publisher, M. Clements, Rumson, N. J.; Editor, Orestes H. Caldwell, Catrock Road and Bible St., Cos Cob, Conn.; Associate Editor, B. F. Osbahr, 206 Eighth Ave., Brooklyn 15, N. Y.; Business Manager, M. H. Newton, 533 W. 215th St., New York, N. Y.

2. The owner is: (If owned by a corporation, its name and address must be stated and also immediately thereunder the names and addresses of stockholders owning or holding one per cent or more of total amount of stock. If not owned by a corporation, the names and addresses of the individual owners must be given. If owned by a partnership, or other unincorporated firm its name and address, as well as those of each individual member, must be given.) Caldwell-Clements, Inc., 480 Lexington Avenue, New York 17, N. Y., M. Clements, O. H. Caldwell, Charles A. Petersen, Trustees, 480 Lexington Ave., N. Y. C. M. Clements, Trustee, Rumson, N. J. O. H. Caldwell, Trustee, Catrock Rd. and Bible St., Cos Cob, Conn. Charles A. Petersen, Trustee, 474 Senator St., Brooklyn, N. Y.

3. The known bondholders, mortgager, and other security holders owning or holding 1 per cent or more of total amount of bonds, mortgages, or other securities are: (If there are not any, so state.) None.

4. Paragraphs 2 and 3 include, in cases where the stockholder or security holder appears upon the books of the company as trustee or in any other fiduciary relation, the name of the person or corporation for whom such trustee is acting; also the statements in the two paragraphs show the affiant's full knowledge and belief as to the circumstances and conditions under which stockholders and security holders who do not appear upon the books of the company as trustees, hold stock and securities in a capacity other than that of a bona fide owner.

(Signed) Orestes H. Caldwell
Sworn to and subscribed before me this 25th day of September, 1950.
Belle M. Phillips
Notary Public New York and Westchester County
(My commission expires March 30, 1952.)

ALLISON RADAR

FOR
MULTI-ENGINE
AIRCRAFT

MILITARY • AIRLINES
EXECUTIVES

Models **E ES ESB**
58-65 LBS. OVERALL WEIGHT

1. Long range. 80-150 miles.
2. Exclusive scanning method.
3. Compact. Sturdy.
4. Easy to operate. Pilot control.
5. Simplicity of Maintenance.
6. Gyro-stabilized.
7. JAN components.
8. RACON beacons.

ALLISON RADAR SALES CORP.

Exclusive Manufacturers' Distributors
ALINE RHONIE, President

11 West 42nd St., New York 18

PEnn 6-5811-12

TWIN LEAD, TELEVISION LIGHTNING ARRESTER

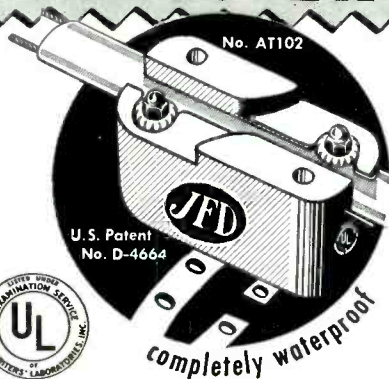

U. S. Patent
No. D-4664



APPROVED for OUTDOOR-INDOOR Use \$ **2²⁵**
Protects Television Sets
Against Lightning and Static
Charges

Twin Lead
JFD SAFE TV GUARD

Simple to install everywhere and anywhere
...no stripping, cutting or spreading of
wires. More than 300,000 in use today!

SEE YOUR JOBBER OR WRITE TO

JFD MANUFACTURING CO., Inc.
6127 16th Avenue, Brooklyn 4, N. Y.
First in Television Antennas & Accessories

TELE-TECH

Advertisers November 1950

Ace Engineering & Machine Co., Inc.	63
Aerovox Corp.	18
Allied Radio Corp.	59
Allison Radar Sales Corp.	67
Altec Lansing Corp.	66
American Microphone Co.	60
American Phenolic Corp.	2
Amperite Co., Inc.	61
Automatic Electric Sales Corp.	3

Bell Telephone Laboratories	16
Breeze Corp.	51
Browning Laboratories, Inc.	53

Cleveland Container Co.	19
Clippard Instrument Laboratory, Inc.	56
Convair (Consolidated Vultee Aircraft Corp.)	57
Corning Glass Works	Cover 2

DuMont Laboratories, Inc., Allen B.	8, 20
-------------------------------------	-------

Eisler Engineering Co., Inc.	57
Eitel-McCullough, Inc.	6
Electrical Reactance Corp.	Cover 3

Federal Telephone & Radio Corp.	13
Freed Transformer Co.	50

General Electric Co.	49
General Precision Laboratory, Inc.	17
Gray Research & Development Co., Inc.	50
Guardian Electric Mfg. Co.	64

International Resistance Co.	10, 11
------------------------------	--------

JFD Mfg. Co., Inc.	67
Johnson Co., E. F.	14
Jones, H. B., Div. Cinch Mfg. Corp.	62

Kester Solder Co.	47
Kings Electronics	52
Knights Co., James	66

Langevin Mfg. Corp.	65
LaPointe-Plascomold Corp.	12
Littelfuse, Inc.	4

Measurements Corp.	67
Metal Textile Corp.	63
Motorola, Inc.	55

Paramount Paper Tube Corp.	59
Par Metal Products Corp.	61
Precision Paper Tube Co.	64

Radio Corp. of America	7, Cover 4
Radio Materials Corp.	9
Rauland Corp.	15
Ray-Par, Inc.	54
Reeves Soundcraft Corp.	4, 56

Sylvania Electric Prods., Inc.	5
Synthane Corp.	62

Television Equipment Corp.	58
----------------------------	----

Waterman Products Co., Inc.	65
Welch Mfg. Co., W. M.	58
Wells Sales, Inc.	68
Westinghouse Electric Corp.	65

While every precaution is taken to insure accuracy, we cannot guarantee against the possibility of an occasional change or omission in the preparation of this index.

CRYSTAL CALIBRATOR

MEASUREMENTS CORPORATION

Model 111

FREQUENCY RANGE: .25Mc. — 1000 Mc.

FREQUENCY ACCURACY:

±0.001%



A Dual-Purpose Calibrator

- CRYSTAL-CONTROLLED OSCILLATOR
- BUILT-IN DETECTOR
- 2 Microwatt Sensitivity

Designed for the Calibration and Frequency Checking of Signal Generators, Transmitters, Receivers, Grid-Dip Meters and other equipment where a high degree of frequency accuracy is required.

Harmonic Range:
.25 Mc. Oscillator: .25-450 Mc.
1 Mc. Oscillator: 1-600 Mc.
10 Mc. Oscillator: 10-1000 Mc.

117 volts, 50/60 cycles; 18 watts,
6" wide, 8" high, 5" deep; 4 lbs.

**MEASUREMENTS
CORPORATION**



Boonton

New Jersey

Special Relays-

OVER A MILLION IN STOCK!

Whether you require large quantities of relays for production runs or single units for laboratory or amateur work, Wells can make immediate delivery and save you a substantial part of the cost.

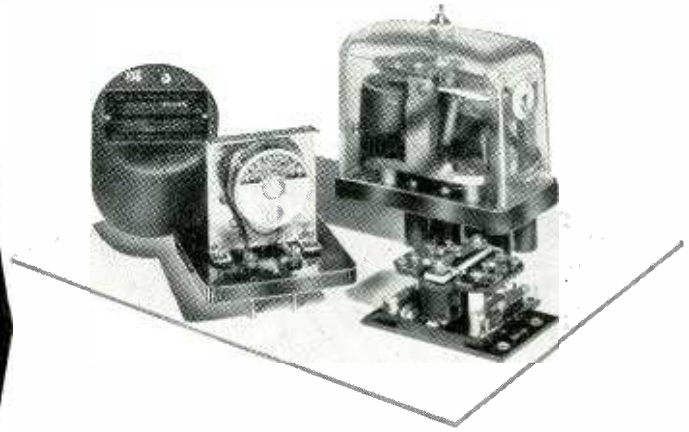

This list represents only a few types of Special Relays. We also have huge stocks of Standard D.C. Telephone Relays, Midget Relays, Contactors, Keying Relays, Rotary and Slow Acting Types as well as many others. Write or wire us about your requirements.

STOCK NO.	VOLTAGE	OHMAGE	CONTACTS	MANUFACTURER & NUMBER	PRICE
R-503	12/32 VDC.	100	3A, 2C	G.E. Ant. Keying 500W 2C6530-653AR1	\$ 2.25
R-749	600 VDC.	...	Max. 28 Amps.	Allen Bradley 810 Dashpot	5.95
R-804	550 VAC.	...	1B/38 Amps.	Culter Hammer C-261173A34 Contactor	3.50
R-250	115 VAC.	...	Adj. Cir. Breaker .04-.16A	Westinghouse MN Overload	12.95
R-579	220 VAC.	...	1B	Adlake 60 Sec. Thermo Delay	6.95
R-294	27.5 VDC.	200	1B	Edison 50 Sec. Thermo Delay	4.25
R-686	115 VAC.	...	2C	Leach 1157T-5/20 Sec. ADJ. Delay	4.95
R-246	115 VAC.	...	1B	Cramer 2 Min. Adj. Time Delay	8.95
R-246A	115 VAC.	...	1A	Cramer 2 Min. Adj. Time Delay	8.95
R-611	24 VAC.	...	1A 30 Amps.	Durakool BF-63	4.25
R-283	12 VDC.	125	AC 10 Amps.	Onan Rev. Current 3H4512/R24	1.00
R-614	18/24 VDC.	60	1A/15 Amps.	Rev. Current Cutout 3H2339A/E1	3.50
R-262	...	200	1C	W. U. Tel. Co. 41C Single Current	3.75
R-245	12 VDC.	25	4 In. Micalox Lever95
R-527	6/12 VDC.	50/50	In Series	277668 For Scr-274N	.95
R-544	12/24 VDC.	60/60	1C	G.E. Push Button Remote Relay #CR2791-R-106C8	1.65
R-255	75 VAC.	400 CYC.	1A	G.E. Pressure Switch #2927B100-C2	.95
R-669	6 VDC.	...	1B, 1A	Clare 400	.95
R-660	6 VDC.	...	3/4" Stroke	Cannon Plunger Relay #13672	.95
R-651	24 VDC.	100	Solenoid Valve	2.50
R-295	12 VDC.	275	Annunciator Drop	Guardian Ratchet Relay	2.15
R-230	5/8 VDC.	2	2A, 1C	Ratchet Relay From Scr-522	4.25
R-813	12 VDC.	12	Wafer	Guardian BK-10	2.75
R-275	12 VDC.	750	1A, 1B, 1C	BK-13	1.45
R-716	24 VDC.	70	2A 5 Amps.	Guardian BK-16	1.05
R-620	6/12 VDC.	35	2C, 1A	Guardian BK-17A	1.25
R-629	9/14 VDC.	40	1C 10 Amps.	Kurman BK-24	2.10
R-778	8 VDC.	4500	1C 5 Amps.	45A High Power	1.35
R-720	24 VDC.	50	2C, Ceramic	Str. Dunn. Latch & Reset	2.85
R-500	12 VDC.	10/10	2C 6 Amps.	Guardian Latch & Reset	2.85
R-816	12 VDC.	10/15	2C, 6 Amps.	Sigma 4R	1.65
R-811	48 VDC.	8000	1C	Edwards Alarm Bell	.95
R-524	24 VAC, DC.	Allen Bradley-Bulletin #702	
R-838	90, 120 VDC.	925	2A	Motor Control	4.50
R-839	100/125 VDC.	1200	3A	Allen Bradley-Bulletin #200E	
R-840	115 VDC.	1200	2A	Motor Control	4.50
R-841	115 VDC.	1200	4A	Allen Bradley-Bulletin #209 Size 1	
R-842	115 VDC.	925	3A	Motor Control W/Type "N" Thermals	5.50
R-843	115 VDC.	1200	3A	Allen Bradley-Bulletin #709 Size 2	
R-844	115 VDC.	1200	3A	Motor Control W/Type "N" Thermals	25.00
R-845	220 VAC.	Intermit.	3A	Allen Bradley-Bulletin #709	
R-831	7.5/29 VDC.	6.5	1A/250A, 1000A Surge	Motor Control W/Type "N" Thermals	5.50
R-837	110 VAC.	...	2A/30 Amps.	Allen Bradley-Bulletin #200	
R-835	24 VDC.	2800	1A Dble. Brk./10 Amps.	Motor Control	4.50
R-836	220 VAC.	...	2A Ddle. Brk./10 Amps.	Allen Bradley-Bulletin #704	
R-566	115 VAC.	Motor Control	4.50
R-710	Leach B-8	3.50
				Leach 6104	2.75
				Wheelock Signal, B1/39	1.95
				Wheelock Signal, A7/37	3.45
				Leach #6104	.75
				Guardian #38187	.50

(Coil only, Not a complete relay)
150-Ohms. Coil Only

Write For New Wells Catalog

Each relay is new, individually boxed, and unconditionally guaranteed by Wells
World's Largest Display of Radio and Electronic Components
9,000 Square Feet of Display All On One Floor



320 N. LA SALLE ST., DEPT. T CHICAGO 10, ILL.

PRODUCED BY THE MILLIONS



Hi-Q
Engineering
Laboratory

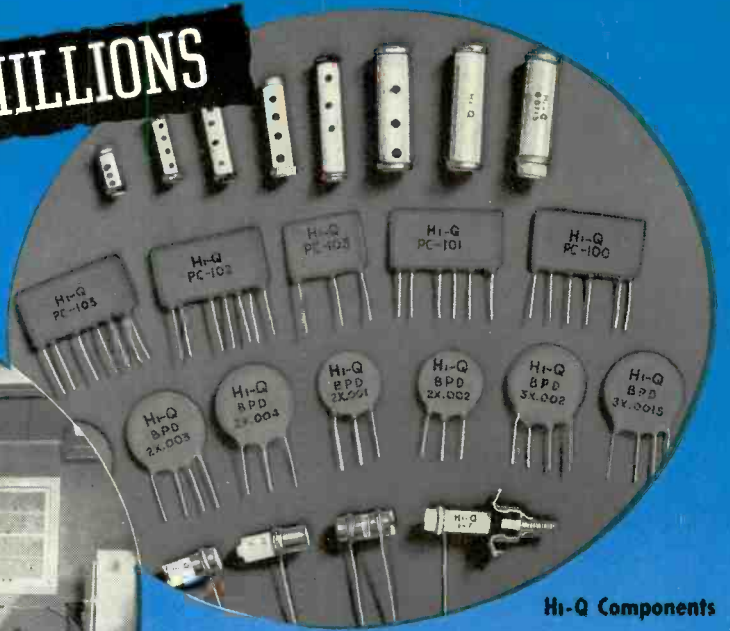

Hi-Q Components

—Under keenly competent engineering supervision

Hi-Q COMPONENTS

Capacitors
Trimmers • Choke Coils
Wire Wound Resistors

BETTER 4 WAYS

- ✓ PRECISION
- ✓ UNIFORMITY
- ✓ DEPENDABILITY
- ✓ MINIATURIZATION

● The engineering laboratory is the alert guardian of **Hi-Q** quality. No component can be put into production until it has proven that it meets **Hi-Q's** exacting standards to the complete satisfaction of these technicians. It is their further responsibility to see that standards are rigidly maintained during production runs. In addition, **Hi-Q** engineers are always available to work with your engineers in the development of components to meet your specific needs. Feel free to call on them whenever and as often as you see fit.

If you haven't received your copy of the new Hi-Q Catalog, write today.

JOBBERS—ADDRESS: 740 Belleville Ave., New Bedford, Mass.

Hi-Q

Electrical Reactance Corp.

OLEAN, N. Y.

SALES OFFICES: New York, Philadelphia
Detroit, Chicago, Los Angeles

PLANTS: Olean, N. Y., Franklinville, N. Y.
Jessup, Pa., Myrtle Beach, S. C.

KEEP POSTED

on Electron Tubes



A



B



C

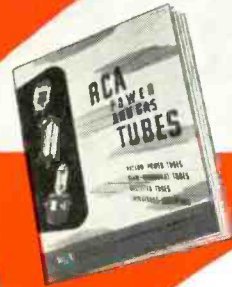

D



E



F



G

with the most authoritative technical literature in the field

A Tube Handbook—All Types HB-3 (7 $\frac{3}{8}$ " x 5") The "bible" of the industry—contains over 2500 pages of loose-leaf data and curves on all RCA receiving tubes, power tubes, cathode-ray tubes, phototubes, and special tubes. Three de luxe 4-prong binders imprinted in gold. Available on subscription basis. Price, \$10.00 including service for first year. Write to Commercial Engineering for descriptive folder and order form.

B Receiving Tube Manual—RC-16 (8 $\frac{3}{8}$ " x 5 $\frac{1}{2}$ ")—300 pages. New, completely up-to-date. Covers technical information on more than 460 RCA receiving tubes and kinescopes. Includes an expanded circuit section, enlarged section on resistance-coupled amplifiers, new data on cathode-follower design, and completely revised tube classification charts, including miniature types and their GT equivalents. Features lie-flat binding. Price, 50 cents.

C Radiotron Designer's Handbook—(9" x 6")—356 pages. Edited by F. Langford Smith of Amalgamated Wireless Valve Company Pty. Ltd. in Australia. Of value to anyone interested in fundamental principles of practical circuit design. Copiously illustrated. Price, \$1.25.

D Power and Gas Tubes for Radio and Industry—Bulletin PG-101-A (11" x 8 $\frac{1}{2}$ ")—20 pages. Contains basic data on more than 150 air-and-water-cooled transmitting tubes,

rectifier tubes, thyratrons, ignitrons, and voltage regulators. Features brief descriptions, applications, terminal connection diagrams, and photos of representative types. Price, 15 cents.

E Phototubes, Cathode-Ray and Special Types—Bulletin CRPS-102A (11" x 8 $\frac{1}{2}$ ")—20 pages. Contains basic data on more than 145 single-unit, twin-unit, and multiplier phototubes, cathode-ray tubes, camera tubes, monoscopes and types for special applications. Includes brief descriptions, applications, terminal connections, and photos of many types. Spectral response curves are given for all phototubes. Price, 15 cents.

F Receiving Tubes for AM, FM, and Television Broadcast—Bulletin 1275-E—24 pages. Completely revised and brought up to date. Contains characteristics on more than 450 RCA receiving tubes including kinescopes and a classification chart which lists all types according to function, and group types having similar characteristics and same cathode voltage. Socket connection diagrams arranged for quick and easy reference. Price, 10 cents.

G Instruction Booklets—Complete authorized information on individual RCA transmitting tubes and other tubes for communications and industry. Be sure to mention tube-type booklet desired. Single copy on any type free on request.

Use this convenient coupon for obtaining the RCA tube literature you need.

RCA, Commercial Engineering
Section K57R, Harrison, N. J.
Send me the RCA publications checked below. I am enclosing \$..... to cover cost of the books for which there is a charge.

Name _____
Address _____
City _____ Zone _____ State _____

- HB-3 Tube Handbook (\$10)* (A)
- RC-16 Receiving Tube Manual (50 cents) (B)
- Radiotron Designer's Handbook (\$1.25)* (C)
- Power and Gas Tubes for Radio and Industry (15 cents) (D)
- Phototubes, Cathode-Ray and Special Types (15 cents) (E)
- Receiving Tubes for AM, FM, and TV (10 cents) (F)
- Instruction Booklet on tube types (Free) (G)

*Prices apply to U.S. and possessions only



RADIO CORPORATION of AMERICA
ELECTRON TUBES
HARRISON, N. J.