

# ELECTRONIC INDUSTRIES

November • 1946

## IN THIS ISSUE:

### **COMMUNICATIONS TECHNICS**

Preventing Carrier Interruptions in Broadcast Service • Micro-Wave Measuring Methods • Disc Recording and Reproduction

### **ENGINEERING AND DESIGN**

Universal Chart for Unbalanced AC Bridges • Latest Trends in Instrumentation Equipment • Signal Generator for Very High Frequency Measurements • CBS's Newest Color Television Camera

### **INDUSTRIAL APPLICATIONS**

Report of Pittsburgh Instrumentation Conference • Radarange for Cooking • Electronic Valve Tester • Supersonic Tire Checker

# Built to Last...

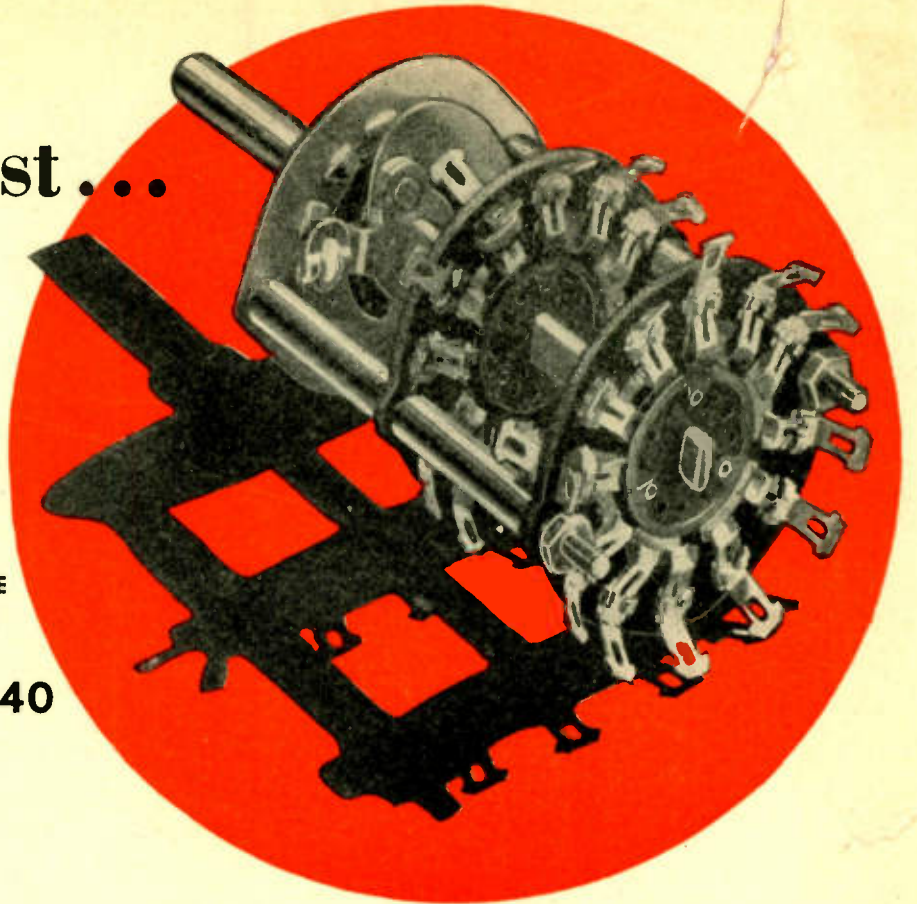

**MULTIPLE  
SECTION  
SWITCH  
RS-40**

## ...With Unlimited Circuit Possibilities

### Ask for RS Specification-Layout Sheets

Printed on thin paper to permit blue-printing, these sectional drawings indicate standard and optional dimensions — make it easy for you to order pre-production samples of RS switches built to meet your requirements exactly. Ask your nearest Mallory Field Representative or write direct for a supply.

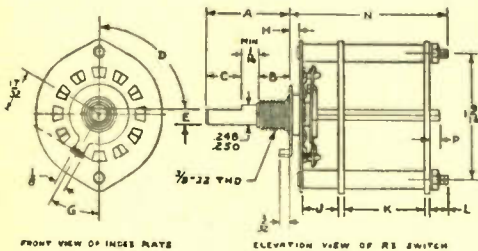

“BUILT TO LAST” tells only part of the story of this Mallory switch which combines compact design with remarkable circuit flexibility.

It's designed specifically for radio receivers where higher-torque, snap indexing is essential. And in common with other members of the Mallory RS line, it has these additional features:

*New, heavier staples and stapling technique, insuring tight terminals . . . New stator design improves rotor and contact alignment . . . Double wiping contacts . . . Silver-to-silver contacts . . . Indium-treated, silver plated rotor segments.*

Sound like a switch that fits your product? Then write today for RS Switch Data Folders and Specifications. If special problems are involved, Mallory engineers are ready to help. Standard Mallory switches may be readily obtained from your Mallory Distributor.

**P. R. MALLORY & CO. Inc.**  
**MALLORY SWITCHES**  
**(INDUSTRIAL AND ELECTRONIC)**

**P. R. MALLORY & CO., Inc., INDIANAPOLIS 6, INDIANA**

# ELECTRONIC INDUSTRIES

Including INDUSTRIAL ELECTRONICS

## Editorial Contents

NOVEMBER, 1946

<b>EDITORIAL</b> .....	47	<b>PROTECTING AGAINST CARRIER FAILURE...</b>	68
Parting of the Ways—"Two Electronic Worlds"— Color television progress—Human relations		<b>H. G. Towlson</b>	
		Practical methods of insuring against interrup- tions and loss of broadcast time due to lightning	
<b>MICROWAVE TEST AND MEASURING EQUIPMENT</b> .....	48	<b>UNIVERSAL CHART FOR UNBALANCED BRIDGE.</b> .72	
<b>Wm. T. Jones</b>		<b>R. C. Paine</b>	
Engineering details of some of important instruments and methods to determine VHF behaviour		By graphic methods detector voltages of unbalanced AC bridges are determined and a chart is derived	
<b>INSTRUMENT TRENDS</b> .....	55	<b>WATER ACTIVATED CELL</b> .....	75
<b>Winfield B. Heinz</b>		Application of water starts action in new silver- chloride-magnesium primary battery for emergencies	
U. S. far ahead in design, development and use of measuring and control equipment. What of Future?		<b>UHF SIGNAL GENERATOR</b> .....	76
<b>TWO ELECTRONIC WORLDS</b> .....	56	Series of five interchangeable Klystron tubes, each for narrow band, covers from 2,600 to 10,300 mc	
Tele-communications puts emphasis on technical en- gineering—Industrial electronics is separate		<b>PHONOGRAPH PICKUP USING STRAIN GAGE</b> 78	
<b>INSTRUMENTATION</b> .....	59	<b>Kenneth J. Germeshausen and R. S. John</b>	
Industrial electronics has important part in first conference and exhibit of Instrument Society		Resistance vs. strain characteristics of carbon re- sults in a new wide-range reproducer design	
<b>HF HEAT LABORATORY</b> .....	62	<b>TUBES ON THE JOB</b> .....	80
Test equipment set up for study of industrial uses of induction and dielectric heat in production work		Radarange for cooking with RF—Carbon black weigh- ing — Electronic valve testing — Thermal expansion	
<b>DISC RECORDING</b> .....	64	<b>SURVEY OF WIDE READING</b> .....	82
<b>Howard A. Chinn</b>		Electron-optical field testing—Computing intermod- ulation effects—Study of multi-path transmission	
With lack of standards, definitions and methods of measurement, when can recording come of age?		<b>NEW PATENTS ISSUED</b> .....	84
<b>RECORDING STYLI</b> .....	65	<b>TELEVISION TODAY</b> .....	90
<b>Isabel L. Capps</b>		CBS shows color television, using live pickup and giving screen brilliancy of 16 foot-lamberts	
Importance of styli contour, cutting edge and bur- nishing facet in determining eventual results			
<b>Washington News</b> .....	86	<b>New Bulletins</b> .....	147
<b>News of Industry</b> .....	88	<b>Personnel</b> .....	150
<b>New Books Reviewed</b> .....	144	<b>Electronic Products</b> . 92, 94, 96, 98, 122	

CALDWELL-CLEMENTS, INC. — TEL. PLAZA 3-1340 — 480 LEXINGTON AVE., NEW YORK 17, N. Y.

BRANCH OFFICES—Chicago 6, R. Y. Fitzpatrick, 201 N. Wells St., RAN 9225; Cleveland 14, D. J. O'Rourke, Citizens Bldg., 850 Euclid Ave., Main 8270; Los Angeles 5, The Robert W. Walker Co., 684 So. Lafayette Park Pl., Drexel 4388; San Francisco, 68 Post St., Sutter 5568.



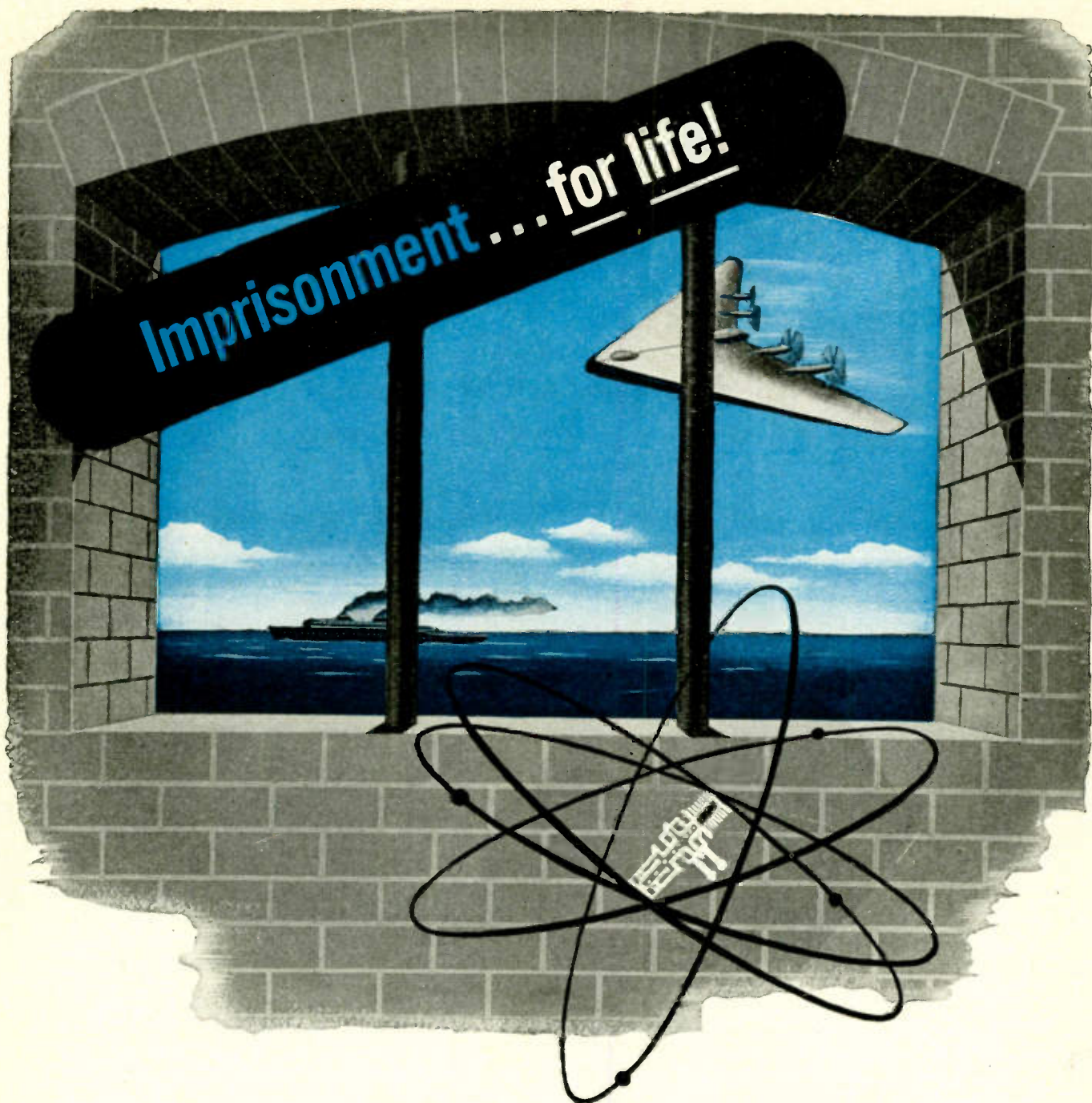

■ Seal up a stream of electrons in a vacuum tube...and you have a space-defying genie that vitalizes industry...and can save countless lives!

■ As far back as 1930 the Sperry Gyroscope Company put electronics to work...introducing electronic control for the Sperry Gyro-Compass.

■ From then on electronics was employed whenever it could extend the usefulness and performance of Sperry products—as in automatic pilots, gun fire control devices, navigation instruments, both aeronautical and marine. And in 1939, came the Klystron, “heart-beat” of Radar.

■ In war, Radar tracked out enemy plane, sub and ship positions, saving numberless lives by advance warning of hostile attack. And today, in peace, Radar brings new safety to mankind...plotting aerial and marine operations with pin-point accuracy, through pea-soup weather and over vast distances.

■ Sperry pioneered in helping develop these and many other services for mankind. But “pioneering” isn’t enough. And that’s why Sperry research and practical applications of electronics go endlessly on...in that search for something better which we call *product improvement*.



## Sperry Gyroscope Company, Inc.

EXECUTIVE OFFICES: GREAT NECK, NEW YORK • DIVISION OF THE SPERRY CORPORATION  
 LOS ANGELES • SAN FRANCISCO • SEATTLE • NEW ORLEANS • CLEVELAND • HONOLULU  
**Aircraft:** Gyropilots • Gyrosyn Compasses • Altitude Gyros • Directional Gyros • Gyro-Horizons • Detonation Indicators • Automatic Radio Direction Finders • Instrument Landing Systems • Traffic Control Systems • **Marine:** Gyro-Compasses • Gyro-Pilots • Gyro-Magnetic Compasses • Incandescent Searchlights • Steering Systems • Radar • Loran  
**Industrial:** Railroad Radio • Microwave Relays • Microline Test Equipment • Klystron Tubes • Strobodrive • Knockometer

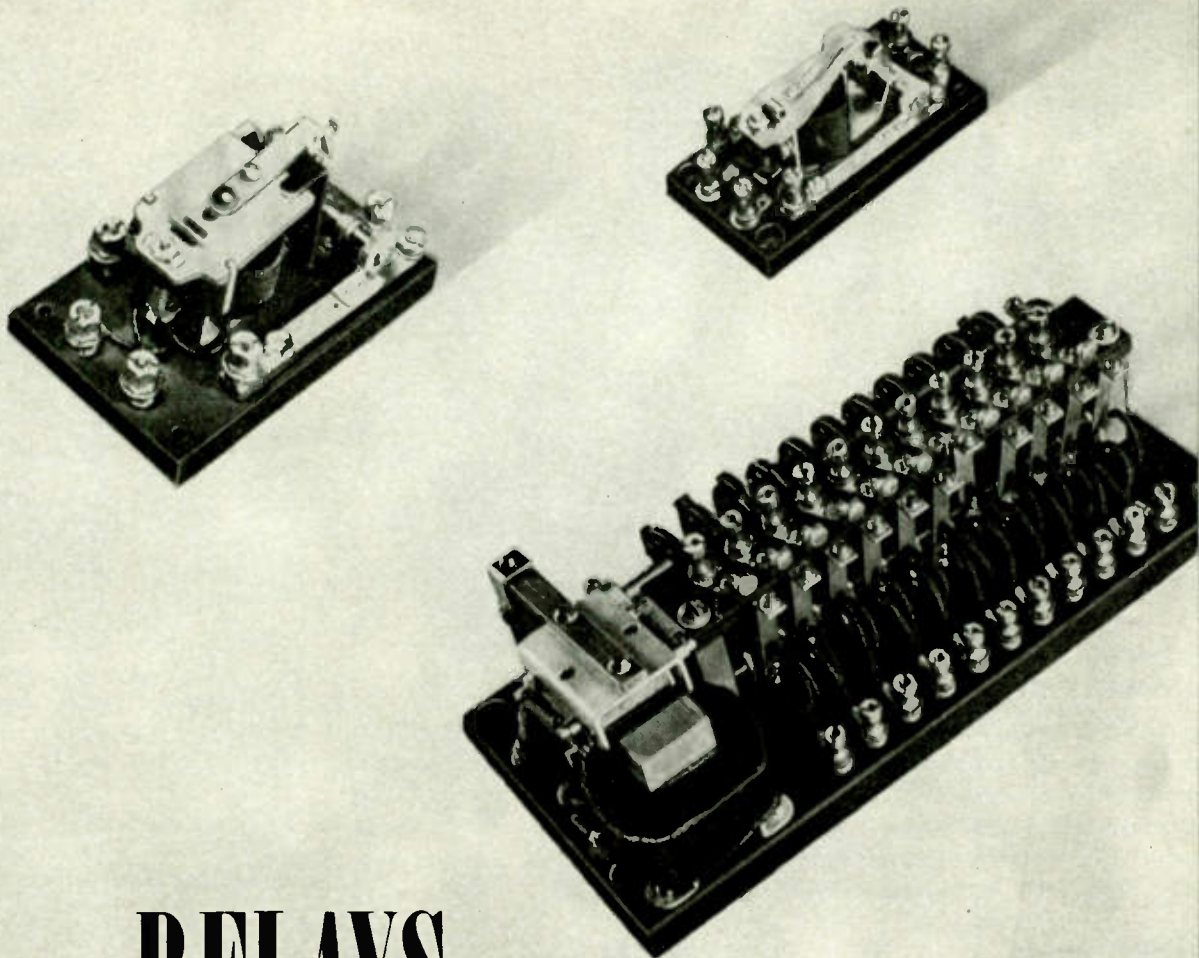

# RELAYS...

THAT COUNT, ADD OR SUBTRACT

*... and have unfailing memories*

Ratchet-type relays, another version of the popular Struthers-Dunn "Memory" Relay Series, are designed to supervise a control pattern for two or more circuits by successive impulses to a single operating coil. They are widely used for street railway safety sig-

nals, capacitor bank switching, single button control of reversing mechanisms, interlocking, and other operations requiring "memory" or "counting" supervision.

Also available with two operating coils for electrical re-set or "forward-and-reverse" stepping.



5,327 RELAY  
TYPES

# STRUTHERS-DUNN

STRUTHERS-DUNN, INC., Philadelphia 7, Pennsylvania

ATLANTA • BALTIMORE • BOSTON • BUFFALO • CHICAGO • CINCINNATI • CLEVELAND • DALLAS  
DENVER • DETROIT • HARTFORD • INDIANAPOLIS • LOS ANGELES • MINNEAPOLIS • MONTREAL  
NEW YORK • PITTSBURGH • ST. LOUIS • SAN FRANCISCO • SEATTLE • SYRACUSE • TORONTO

# ANDREW DRY AIR EQUIPMENT for pressurizing coaxial cable lines

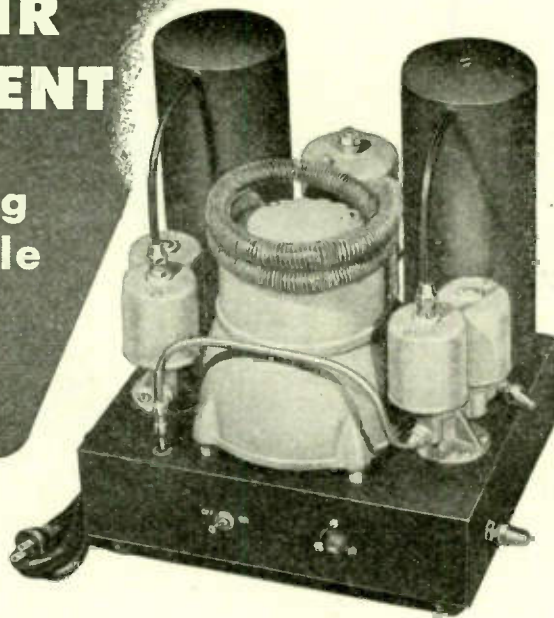

## TYPE 1800 AUTOMATIC DEHYDRATOR

A compact, completely automatic unit that pressurizes coaxial transmission lines with clean, dry air. Starts and stops itself. Maintains steady pressure of 15 pounds. A motor driven air compressor feeds air through one of two cylinders containing a chemical drying agent where it gives up all moisture and emerges absolutely clean and dry. Weighs 40 pounds; 14 inches wide, 14 inches high, 11 inches deep. Power consumption, 210 watts, 320 watts during reactivation.



## TYPE 720 PANEL MOUNTING DRY AIR PUMP

Specially designed for use in equipment requiring a small, built-in source of dry air. Only 2 inches in diameter, 6 inches long. Pressures as high as 30 pounds are easily generated. Piston type compressor drives air through a chemical drier. Pump supplies dry air with only 7 to 10% relative humidity. Additional silica gel refills available at reasonable cost.

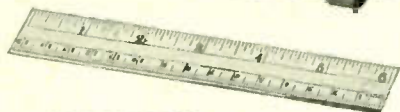

## TYPE 876-B

Designed over the simple tire pump principle, this all-purpose dry air pump has numerous applications. Output of each stroke is about 26 cubic inches of free air. Transparent lucite barrel holds silica gel. Supplied complete with 7-foot length of hose. Height 25½ inches. Net weight 8½ pounds.

Andrew Dry Air Equipment is used in a multitude of other applications. Write for further information.

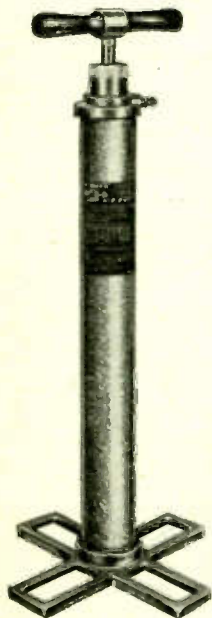

# ANDREW CO.

363 E. 75th ST., CHICAGO 19, ILLINOIS

Pioneer Specialists in the Manufacture of a  
Complete Line of Antenna Equipment

# ELECTRONIC INDUSTRIES

Member of  
Audit Bureau of  
Circulations



**ORESTES H. CALDWELL**  
Editor

**M. CLEMENTS**  
Publisher

STANLEY P. McMINN  
Managing Editor

RALPH R. BATCHER      H. GREGORY SHEA  
Consulting Editor      Associate Editor

JOSEPHA ZENTNER, Ph.D.  
Patents and Foreign Reviews

PAUL H. HUNTER      HENRY JACOBOWITZ  
Instrumentation      New Products

CHARLES DREYER      CARL BUHRER  
Art Director      Circuit Diagrams

FRED C. HOFFMAN  
Editorial Production

ROLAND C. DAVIES  
Washington Editor—1290 Nat'l Press Bldg.

### READER SERVICE

GRACE JESSE      M. TEMMEL      JANE NORMAN

### CIRCULATION

B. V. SPINETTA  
Circulation Director

B. GOLLUB, M. GROENING, B. PUCHAISKY  
Subscriptions, List Compilation

### BUSINESS DEPARTMENT

M. H. NEWTON  
Business Manager

JOHN SAMBORN  
Sales Manager

C. J. STILLMAN  
Eastern Manager

J. E. DRAKE      J. J. BROOKMAN

D. J. O'ROURKE  
Cleveland Manager

R. Y. FITZPATRICK  
Western Manager

S. M. GASKINS      J. J. GREENE

BEN MORRIS  
Promotion Manager

N. McALLISTER      A. O'ROURKE  
Production Manager      Make-Up

W. W. SWIGERT  
Credit Manager

W. KENNETH REYNOLDS      E. CALLAHAN  
H. MIRTEL      F. P. MYERS      F. V. ECKHOFF

Electronic Industries, November, 1946.  
Vol. V, No. 11. Regular price per copy 35 cents. Published monthly by Caldwell-Clements, Inc., 480 Lexington Avenue, New York 17, N. Y. M. Clements, President; Orestes H. Caldwell, Treasurer. Subscription: United States and possessions, Mexico, Central and South American countries, \$3.00 for one year; \$5.00 for two years; \$6.50 for three years. Canada, \$3.50 per year; \$5.50 for two years; \$7.15 for three years. All other countries \$5.00 for one year; \$8.00 for two years; \$10.00 for three years. Entered as Second Class Matter, September 20, 1943, at the Post Office at New York, N. Y., under the act of March 3, 1879. Copyright by Caldwell-Clements, Inc., 1946. Printed in U. S. A. \*Reg. U. S. Pat. Off.

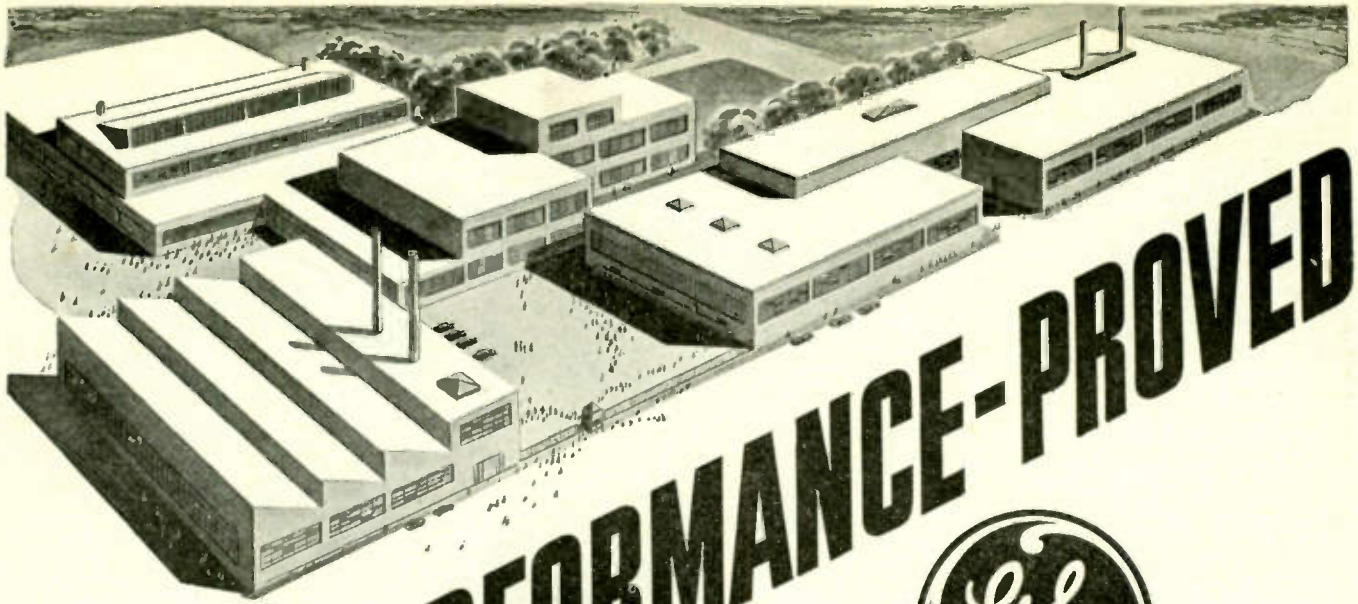

# PERFORMANCE-PROVED



## G-E electronic tubes for industry—like this h-f heating pair—have a background of successful factory service

**B**Y choosing your local G-E distributor or dealer as your source for electronic tubes, you avoid important elements of risk.

- You assure yourself that tubes you buy and install *will do the job*—because G-E tubes *have done the job before*, successfully, in hundreds, perhaps thousands of similar applications! G-E tubes are designed and built with that finest of all proving-grounds—industry itself—available to scan performance, check dollars-and-cents results, and finally say "O.K." in the form of substantial repeat orders. *General Electric leads in industrial electronic-tube volume.*
- You are guaranteed performance-to-specifications from each G-E tube—

because of G-E's ironclad warranty that covers operation *after* you have placed the tube in its socket and switched on the current!

- You are sure of having the tubes you need when you need them—from a competent, well-stocked local source—with delivery usually a matter of hours! Thus equipment shutdowns are avoided, conserving time and profits.

- Phone your G-E distributor or dealer today! Let him tell you about the G-E tube service—*finest and fastest*—which he can make available to you. *Electronics Department, General Electric Company, Schenectady 5, N. Y.*

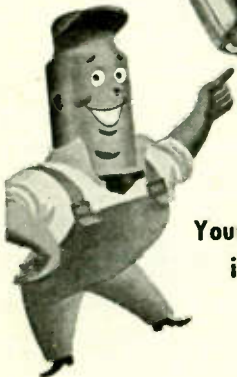

Your SAFEST tube investment!

TYPE GL-889-A, at top, is a high-vacuum oscillator triode with these max anode ratings: voltage 8,500 v, current 2 amp, input 16 kw, dissipation 5 kw . . . TYPE GL-575-A, bottom, is a half-wave mercury-vapor rectifier diode with these anode ratings: peak inverse voltage 15,000 v, peak current 6 amp, avg current 1.5 amp. . . In electronic heating, Type GL-889-A produces the high-frequency current; Type GL-575-A changes a-c power to d-c used by the oscillator tube.

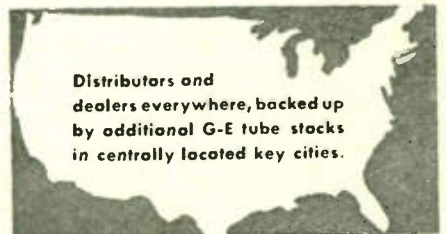

Distributors and dealers everywhere, backed up by additional G-E tube stocks in centrally located key cities.

# GENERAL ELECTRIC

162-E11-8880

FIRST AND GREATEST NAME IN ELECTRONICS

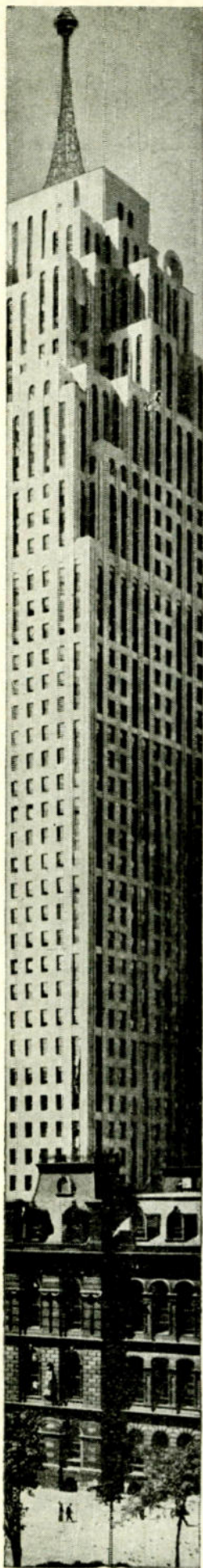

# *Congratulations, Detroit, on your new Television Station*

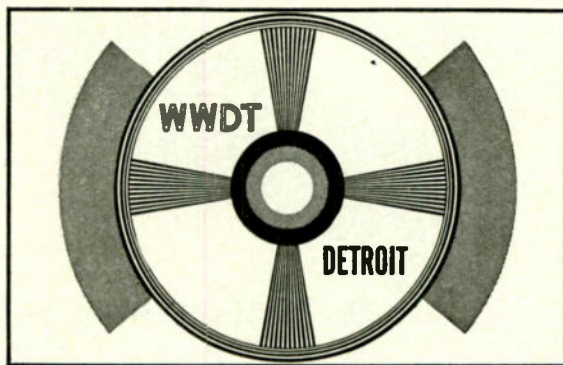

*The tuning "test pattern" that will soon be familiar to Teleset\* owners in and around Detroit.*

Detroit—fourth in sales rank in the nation's cities—has added the salespower of television to its media of distribution.

Pioneering enterprise thrives in the great city of Detroit. And especially noteworthy is the fact that the founder of Michigan's first television station is the *Detroit News*, the same progressive newspaper which launched (August 20, 1920) and still operates WWJ—America's first commercial radio station!

Television Station WWDT broadcasts from a specially designed antenna commanding the Detroit skyline from atop the Penobscot Building, the city's tallest office structure. Antenna, transmitter and station facilities were designed and built by DU MONT, builder of more television stations than any other company. When you choose Du Mont television broadcasting equipment, you choose tested, trouble-free designs. May we tell you more about them?

If you have not read "THE ECONOMICS OF DU MONT TELEVISION," Write for a copy.

\*Trade-mark

Copyright 1946. Allen B. Du Mont Laboratories, Inc.

**DU MONT** *First with the Finest in Television*

ALLEN B. DU MONT LABORATORIES, INC. • GENERAL TELEVISION SALES OFFICES & STATION WABD, 515 MADISON AVENUE, NEW YORK 22, N. Y.  
DU MONT'S JOHN WANAMAKER TELEVISION STUDIOS, WANAMAKER PLACE, NEW YORK 3, N. Y. • HOME OFFICES & PLANTS, PASSAIC, N. J.



# Why there are so many **REVERE METALS**

**T**HERE are so many Revere Metals because no one metal can possibly fill all requirements. For high electrical and heat conductivity, for example, the coppers are supreme, but where heat conductivity *plus* extra strength is required, as in condensers and heat exchangers, alloys such as cupro-nickel or Admiralty metal may be required. Special corrosive conditions likewise may affect the choice of metal. When weight is a factor, as in anything that must be moved by mechanical or manpower, there are Revere aluminum and magnesium alloys. If fabrication costs are an important element, copper in one of its several types will be selected for some products, free-cutting brass rod for screw machine work, brass sheet and strip for severe forming operations, Herculoy for the corrosion resistance of copper with strength of mild steel plus ready weldability. Seldom, however, is there only one factor to be considered in selecting a Revere Metal; usually there are several, and striking the correct balance may not be easy. In such cases, Revere is glad to offer the cooperation of its Technical Advisory Service.

Revere Metals are offered in the form of mill products, as follows: *Copper and Copper Alloys:* Sheet and Plates, Roll and Strip, Rod and Bar, Tube and Pipe, Extruded Shapes, Forgings. *Aluminum Alloys:* Tube, Extruded Shapes, Forgings. *Magnesium Alloys:* Sheet and Plate, Rod and Bar, Tube, Extruded Shapes, Forgings. *Steel:* Electric Welded Steel Tube.

## **REVERE**

**COPPER AND BRASS INCORPORATED**

*Founded by Paul Revere in 1801*

230 Park Ave., New York 17, New York  
Mills: Baltimore, Md.; Chicago, Ill.; Detroit, Mich.;  
New Bedford, Mass.; Rome, N. Y. — Sales Offices in  
Principal Cities, Distributors Everywhere.

Listen to *Exploring the Unknown* on the Mutual Network every Sunday evening, 9 to 9:30 p.m., EST.

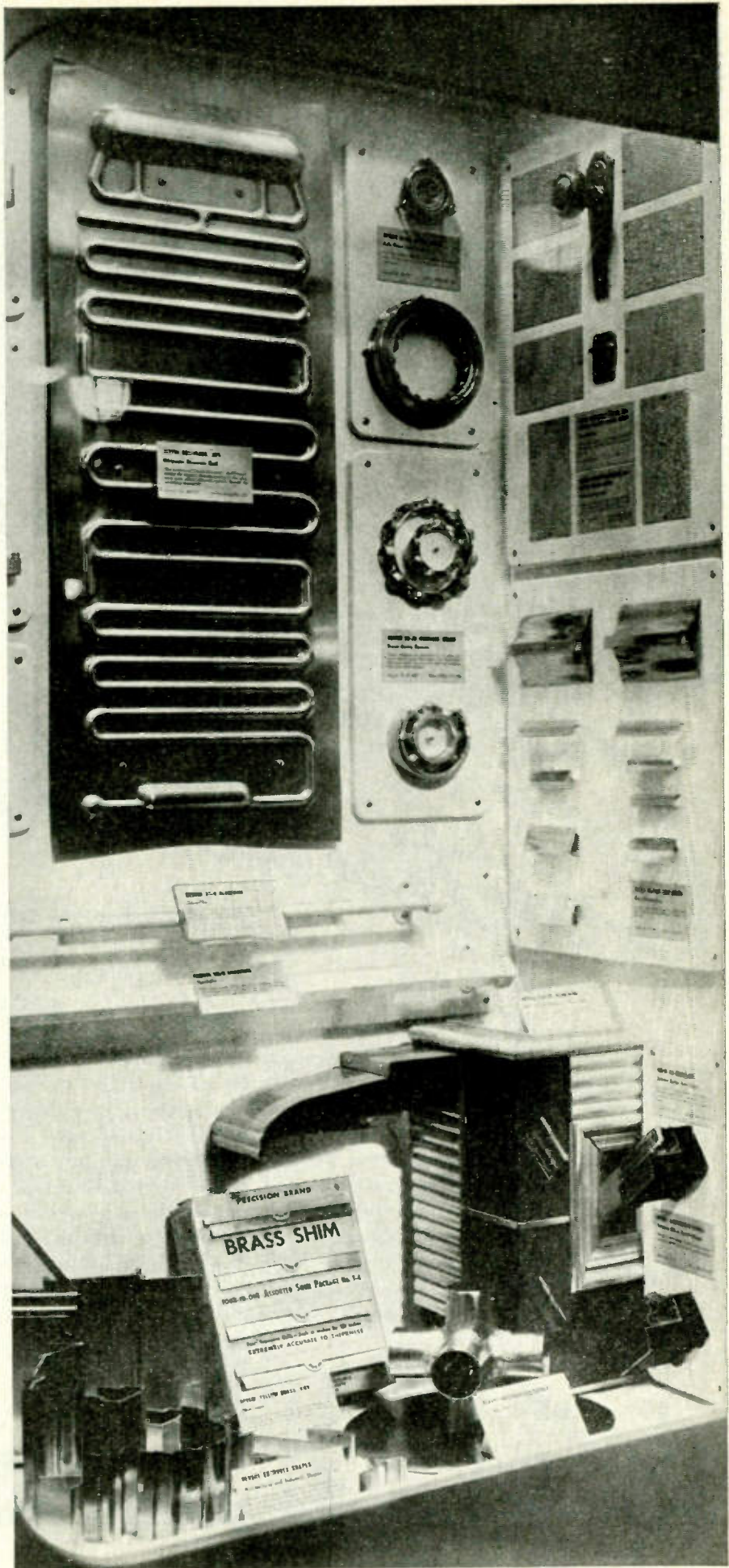

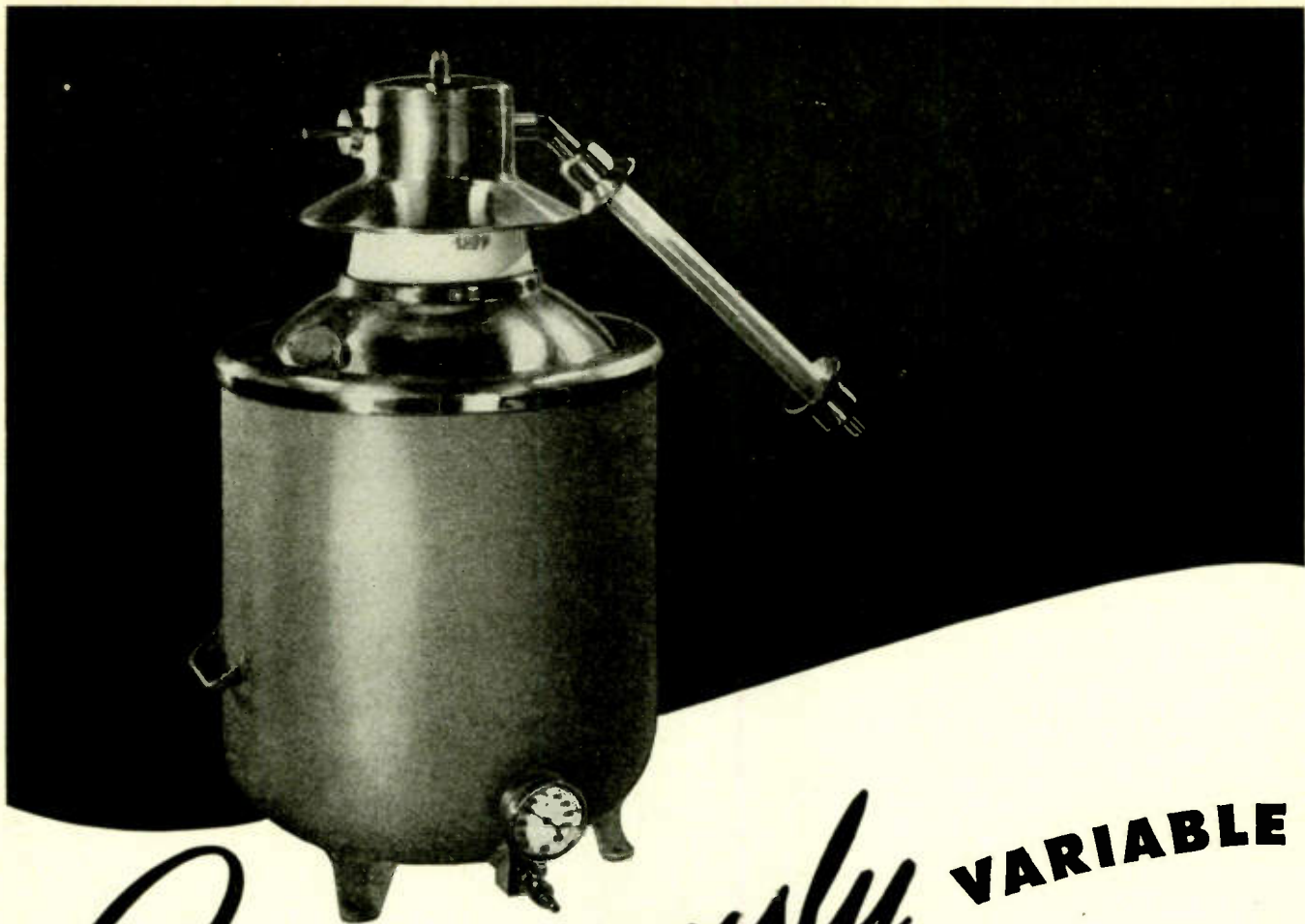

# *Continuously* **VARIABLE**

## **CAPACITANCE "ON-THE-NOSE" FOR HIGH CURRENT, HIGH POWER ELECTRONIC CIRCUITS**

The variable capacitance feature of Lapp Gas-Filled Condensers permits you to "tune-to-a-whisker," with power on, to get the most out of any high current, high power circuit. And once set, this gas-dielectric unit delivers uniformly—no "warm up," no change of capacitance with change in temperature. Non-deteriorating, too, the Lapp unit is truly puncture-proof and will outlast almost any other components of any circuit of which it is a part. In addition to the variable unit, there are adjustable units, continuously adjustable within their range but not designed for frequent "tuning dial" adjustment, and fixed capacitance units. Current ratings range up to 500 amperes R.M.S.; power ratings to 60 Kv peak load. Capacitance to 60,000 mmf. (for fixed units); to 16,000 mmf. (variable and adjustable units). Higher ratings on special design order.

# Lapp

LAPP INSULATOR COMPANY, INC., LE ROY, NEW YORK

# IT'S TOUGH TO FIND A BETTER TRIODE THAN THE BIG, RUGGED EIMAC 750TL

## VERSATILE MEDIUM-MU TRIODE

The Eimac 750TL is a medium-mu triode designed for high efficiency operation whether used as a modulator, oscillator or amplifier. This is an unusually versatile tube capable of many kilowatts of output.

Successful high frequency operation of this triode is assured by unusually low interelectrode capacitances, heavy leads, and a big tough cathode.

The chart below shows power-gain characteristics of the 750TL.

As a Class-C amplifier, the Eimac 750TL will provide plate power output of 1750 watts with 4000 volts on the plate and only 53 watts driving power.

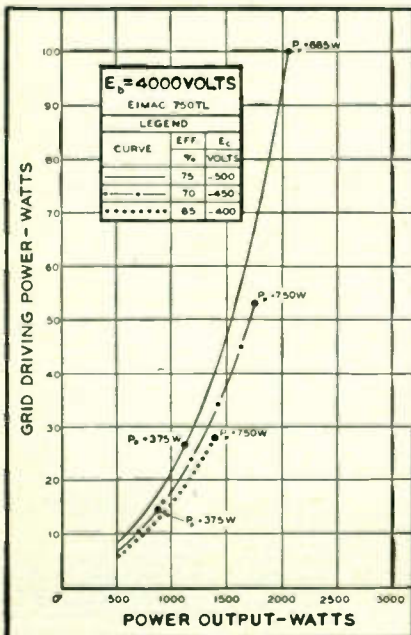

At frequencies below 40 mc, or as a Class-B modulator, the 750TL operates at high plate efficiencies, thus permitting r-f and a-f outputs of many times the plate dissipation rating.

## 3½ KILOWATT AUDIO OUTPUT

As Class-B modulators, a pair of Eimac 750TL's will produce a typical maximum-signal plate power output of 3500 watts, with only 30 watts grid drive.

## THESE ARE RUGGED TUBES

These big, powerful 750TL's are built for long, trouble-free service for a wide variety of uses. Many Eimac 750TL's installed months and years ago are still going quietly and efficiently about their business. Why not ask Eimac today for a price and data sheet giving full details of this versatile triode. Naturally, there is no obligation. Eitel-McCullough, Inc., 1298H San Mateo Ave., San Bruno, Calif. Export Agents: Frazar and Hansen, 301 Clay St., San Francisco 11, Calif., U. S. A.

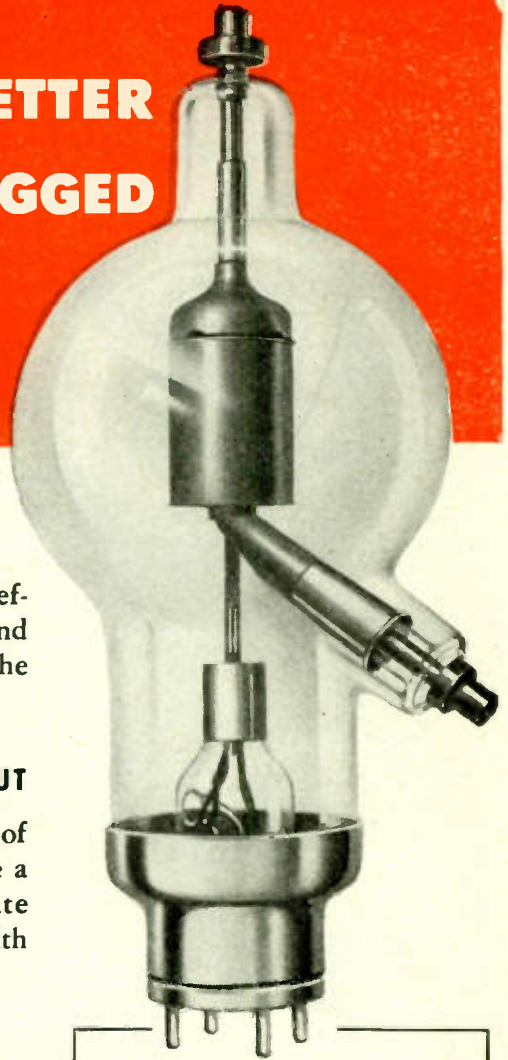

## GENERAL CHARACTERISTICS

### Eimac 750TL

Filament: Thoriated tungsten	
Voltage	7.5 volts
Current	21.0 amperes
Amplification Factor (Average)	15
Direct Interelectrode Capacitances (Average)	
Grid-Plate	5.8 uufd
Grid-Filament	8.5 uufd
Plate-Filament	1.2 uufd
Transconductance (I <sub>B</sub> =1.0 amp., E <sub>B</sub> =5000, E <sub>c</sub> =-100)	3500 umhos
Frequency for Maximum Ratings	40 Mc
Base	Special 4 Pin No. 5003B
Basing	RMA type 48D
Maximum Overall Dimensions:	
Length	17.0 inches
Diameter	7.125 inches
Net Weight	2.75 pounds
Shipping Weight (Average)	8.0 pounds

Follow the Leaders to

**Eimac**  
REG. U. S. PAT. OFF.  
**TUBES**

THE COUNTERSIGN  
OF DEPENDABILITY  
IN ANY ELECTRONIC  
EQUIPMENT



# Shhhh... they're designing a new ADLAKE RELAY

Although there's an Adlake Relay for 999 out of 1000 control jobs, occasionally our engineers—bless 'em—are asked to design one for new or unusual applications.

Helping you solve your out-of-the-ordinary problems is a specialty of ours. Just as giving dependable, trouble-free service is a specialty of Adlake Plunger-type Mercury Relays.

## LOOK AT ALL THESE ADVANTAGES!

- ① *Hermetically sealed* contact mechanism; impervious to dust, dirt, moisture.
- ② Liquid mercury-to-mercury contact; no burning, pitting, sticking; positive in action, chatterless, silent.
- ③ Armored against outside vibration or impact; designed for either stationary or moving equipment.

Write today for free, illustrated Adlake Relay folder!

### HOW ADLAKE RELAYS WORK

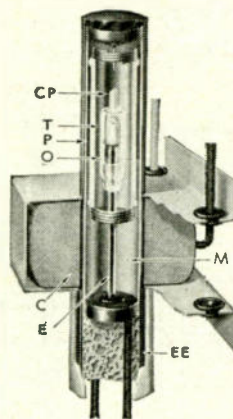

**ENERGIZED**—Coil C pulls plunger P down into mercury M. Mercury thus displaced enters thimble T through orifice O. Inert gas in thimble gradually escapes through ceramic plug CP.

Mercury now fills thimble T, is completely leveled off and mercury-to-mercury contact established between electrodes E and EE. Degree of porosity of ceramic plug CP determines time delay.



# THE ADAMS & WESTLAKE COMPANY

ESTABLISHED IN 1857

ELKHART, INDIANA

NEW YORK · CHICAGO

MANUFACTURERS OF ADLAKE HERMETICALLY SEALED MERCURY RELAYS FOR TIMING, LOAD AND CONTROL CIRCUITS

# SYLVANIA'S R4330



## NEW ELECTRONIC TUBE FLASHES

THOUSANDS OF TIMES!

EMITS "DAYLIGHT" FLASHES  
OF 12,000,000 PEAK-LUMENS  
INTENSITY

The Sylvania Type R4330 Flash Tube, used with suitable equipment, gives a brilliant flash of excellent photographic quality with a duration of only 1/5000th second.

A major application of the Type R4330 is in newly developed electronic flash units for photographic purposes. Here it permits taking pictures without the need for replacing flash bulbs. Its short flash duration "stops" motion, enabling the photographer to take sharp, clear pictures of moving subjects. Excellent color quality permits use with color film.

Each time the circuit switch is closed, the tube emits a single flash. The tube has a life of several thousand flashes.

Other uses of the R4330 are in beacons, obstruction markers, airport boundary markers and signaling devices. See your Sylvania Distributor.

### TYPICAL CIRCUIT DIAGRAM

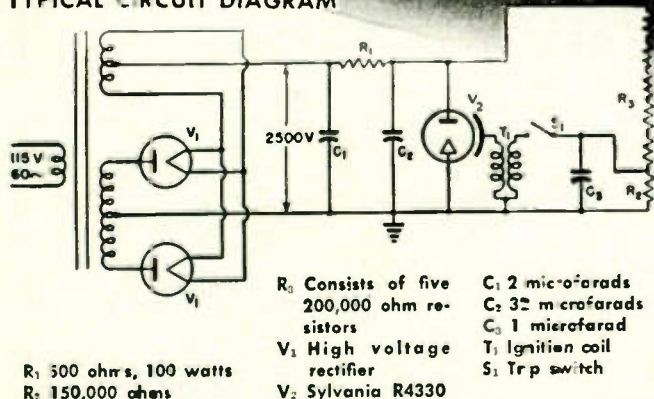

Wobash Portable AC Electroflash Unit — one of the pieces of equipment utilizing Sylvania's electronic flash tube R4330.

# SYLVANIA ELECTRIC

Electronics Division . . . 500 Fifth Avenue, New York 18, N. Y.

MAKERS OF ELECTRONIC DEVICES; RADIO TUBES; CATHODE RAY TUBES; FLUORESCENT LAMPS, FIXTURES, WIRING DEVICES; ELECTRIC LIGHT BULBS

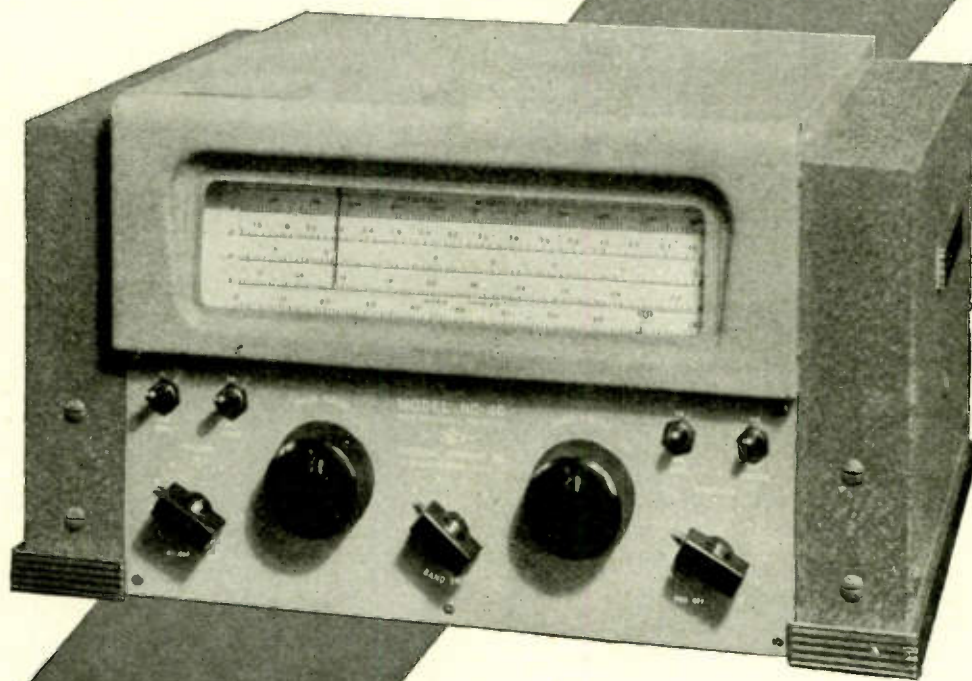

## NC-46

Clean modern styling combines with advanced electrical design to make the NC-46 an outstanding choice for the amateur. Workmanship is of traditional National quality in spite of moderate price. Features of the NC-46 include a series valve noise limiter with automatic threshold control, CW oscillator, separate RF and AF gain controls, and amplified and delayed AVC. Four coil ranges cover from 550 Kc. to 30 Mc. A straight-line-frequency condenser is used in combination with a separate bandspread condenser. Look over an NC-46 at your dealer's, study it inside and out. It's a lot of receiver for your money.

NATIONAL COMPANY, INC.



MALDEN, MASSACHUSETTS



There is a

# DRIVER-HARRIS ALLOY for Every Electrical Resistance Requirement

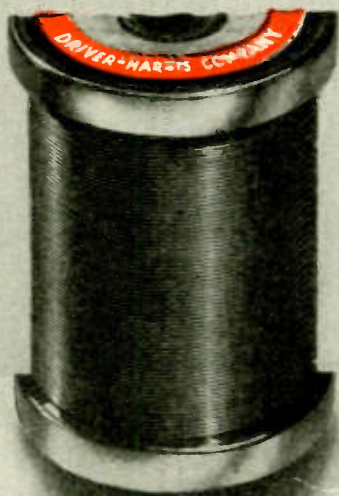

**NICHROME\* & NICHROME V** for winding large value resistors where space factors call for compactness in design without sacrificing dependability. Available in all shapes and sizes drawn down to the extremely fine gauge of .001" diameter—67 miles to the pound.

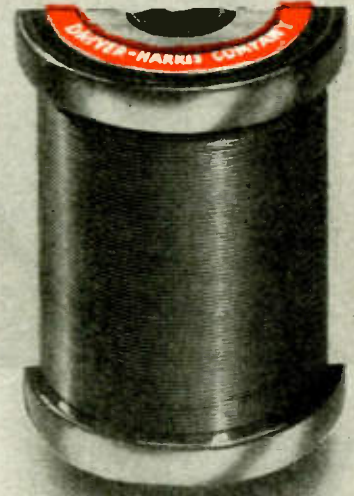

**MANGANIN** for precision bobbins, Wheatstone Bridges, Decade Resistance Boxes, Potentiometers and National Bureau of Standards type resistance standards which require fixed stability and constant resistance under normally variable operating conditions and negligible thermal e.m.f. against copper.

Also the time-tested standard alloys for all vitreous enamel resistor requirements due to the complete absence of occluded gases. **NICHROME V** is particularly recommended when a more constant resistance at variable temperatures is specified.



**ADVANCE\*** for winding precision resistors used in electric meters and laboratory testing devices. In finer sizes its negligible temperature co-efficient of resistance ( $\pm .00002$ ) combined with high resistivity makes it the most desired alloy for this use.

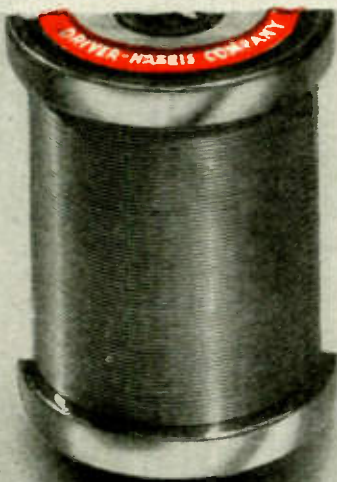

In addition to these we manufacture over 80 different electrical heat and corrosion-resistant alloys. If your resistance requirements are different tell us about them and depend on it... Driver-Harris will develop the alloy best suited to your specifications.

Nichrome is made only by

*Driver-Harris*  
COMPANY

HARRISON

NEW JERSEY

\*Trade Mark Reg.  
U.S. Pat. Off.

BRANCHES: Chicago • Detroit • Cleveland • Los Angeles • San Francisco • Seattle

**LOW FREQUENCIES ACCURACY TO 1/1,000th of 1%**

*Actual Size*

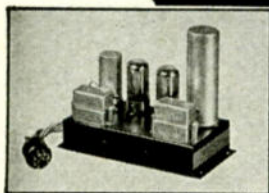

**TOP  
FREQUENCY STANDARD**  
*(60 cycle) for use with  
external power supply*

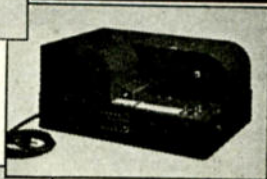

**CENTER  
CHRONOGRAPH**  
*Records time intervals  
with resolution to .001 second*

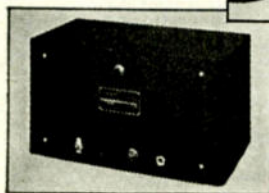

**BOTTOM  
FREQUENCY STANDARD**  
*(120 cycles) with  
self-contained power supply*

These tuning forks which include new engineering principles, provide frequencies from 120 to 1,000 cycles directly with an unqualified guarantee of accuracy to 1 part in 100,000 over a wide temperature range. (Better than 1 second in 24 hours). Closer tolerances are obtainable on special order.

These tuning fork assemblies are available only in single or multi-frequency instruments of our own manufacture which are de-

signed to test, measure or control other precision equipment by mechanical, electrical, acoustical or optical means.

The dependability of these frequency standards is being demonstrated for myriad purposes in all climates and under all working conditions.

If you have need for low frequency standards of exceptional accuracy, your inquiries are invited.

**American Time Products, Inc.**

**580 Fifth Ave.**

**New York, N. Y.**

Dist. of Western Electric &  Watch-rate Recorders



# JACK OF ALL TRADES\*

## SANGAMO METAL-CASED MINERAL OIL PAPER CAPACITORS

Mineral oil filled to assure longer life and more stable performance over a wider range of operating temperatures.



\* A Sangamo Capacitor that will fill your needs

Sangamo Types 20 and 21 Capacitors have attained extreme popularity with their users because of their excellent by-pass and coupling qualities. Vacuum impregnated and filled with the highest grade of mineral oil, their capacity is stable from 55°C below to 85°C above zero. Capacitors are available within the range of 200 to 2000 volts working.

Write for the new Sangamo Capacitor Catalog which contains complete information for your use

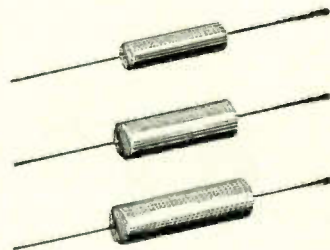

**SANGAMO**  
**ELECTRIC**  **COMPANY**  
SPRINGFIELD • ILLINOIS

"We need Precious Metal Performance . . .  
But Low Cost too"

"Then the Solution is  
**GENERAL PLATE  
LAMINATED METALS**"



Base metal  
steel, copper, nickel,  
etc.

Overlay precious  
metals, one side or  
both sides, any  
thickness.

**SHEET** . . . Available with precious metal on one side, both sides or wholly covered, inlaid and edge laid in practically any combination of precious to base metal. Base to base metal combinations also available.

**TUBE** . . . Solid precious metal, lined, or covered in a wide range of diameters and odd shapes.

**WIRE** . . . Shaped, solder filled, channel, solder flushed, squares, flats, ovals and irregular shaped.

Economy . . . that is one of the many advantages why General Plate Laminated Metals should be given prime consideration whenever your designs call for precious metal performance.

These permanently bonded laminations of precious to base metal combinations give you actual precious metal performance . . . yet their cost is a fraction more than base metals.

In addition, General Plate Laminated Metals . . . sheet, wire or tube . . . give you such advantages as better workability, better spring properties, corrosion resistance, better electrical conductivity, long life, ease of fabrication, ease of soldering and mechanical and structural properties not found in single solid metals.

Better check into the advantages of General Plate Laminated metals, today. Our engineers will gladly help you with your problems. Write:

## **GENERAL PLATE DIVISION**

of Metals & Controls Corporation  
**ATTLEBORO, MASSACHUSETTS**

50 Church Street, New York, N. Y.; 205 W. Wacker Drive, Chicago, Ill.; 2635 Page Drive, Altadena, Calif.; Grant Bldg., Pittsburgh, Pa.



... high octane gasoline



... electric household appliances

o Creative men...engineers and engineering draftsmen...plan and build things to last. By the same token they look for instruments and equipment that will last. The tracing paper they draw on must be permanent. Their drawings must serve as lasting records. They may even have to use these same drawings years later to make new reproductions.

For 79 years there has been a lasting partnership between Keuffel & Esser Co. equipment and materials and the engineers and draftsmen of America. This partnership has been so general, that there is scarcely an engineering or construction project but what K & E products have played their part in it.

One of these products is ALBANENE\* Tracing Paper. Its 100% pure white rag fibers are stabilized and transparentized with Albanite, a K & E synthetic solid. ALBANENE is permanent. Free from oils, it cannot "bleed" nor lose its transparency with time. For complete details, write to your nearest K & E distributor or to Keuffel & Esser Co., Hoboken, N. J.

\*Reg. U. S. Pat. Off.

# partners in creating



**KEUFFEL & ESSER CO.**  
EST. 1867  
NEW YORK • HOBOKEN, N. J.  
CHICAGO • ST. LOUIS • DETROIT • SAN FRANCISCO  
LOS ANGELES • MONTREAL

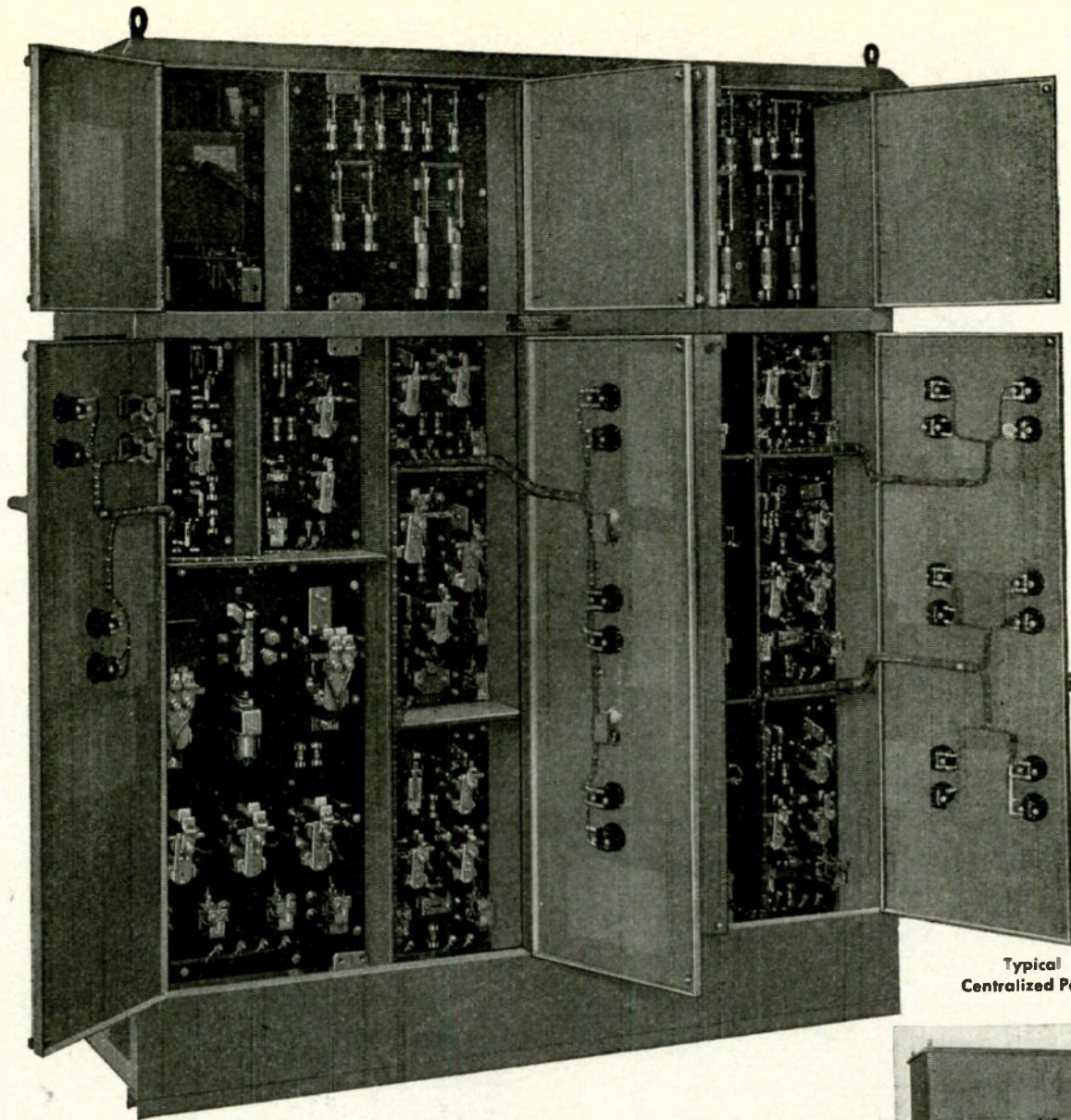

Typical  
Centralized Panel

## WITH CENTRALIZED CONTROL ONE MAN IN ONE PLACE CONTROLS EVERYTHING

Convenience and accessibility of controls are but two of the many potent arguments for centralized control. Here are a few of the advantages:—

**SAFETY** of dead front enclosure with operation of all mechanisms from the front offers greatest protection to your operator.

**SIMPLICITY** of installation and wiring results in reduced costs.

**SPACE SAVING** with the single enclosure is

accomplished. Frameworks and wall supports are not needed.

**ENGINEERED CONTROL** to meet your own requirements at little or nothing above the final cost of individual control units.

These are but a few of the reasons why alert engineers are specifying centralized control for modern plant installations.

Let us show you the benefits. A Ward Leonard engineer will gladly help you to select a centralized control to meet your exact needs.

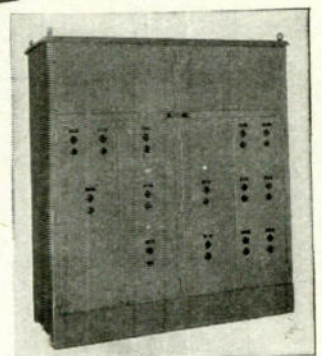

Front View

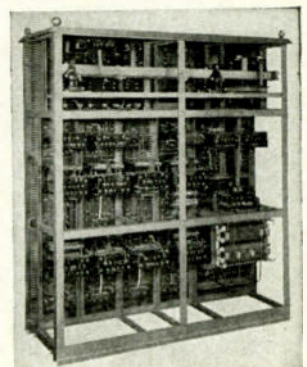

Rear View

# WARD LEONARD

RELAYS • RESISTORS • RHEOSTATS

Electric control  devices since 1892

**WARD LEONARD ELECTRIC COMPANY**

61 SOUTH STREET, MOUNT VERNON, N.Y. • OFFICES IN PRINCIPAL CITIES

# SYLVANIA NEWS

CIRCUIT ENGINEERING EDITION

NOV. Prepared by SYLVANIA ELECTRIC PRODUCTS INC., Emporium, Pa. 1946

## SYLVANIA COMMERCIAL ENGINEERING DIVISION AIDS IN PRODUCING EFFICIENT SET CIRCUITS



*Views of Sylvania Electric's renowned Commercial Engineering Department. Here, new discoveries from Sylvania's laboratories are built into the latest products.*

Helping to engineer the best possible radio circuits for many set manufacturers is one of the numerous achievements of Sylvania's famous Commercial Engineering Department.

Time and again circuits found to be unnecessarily complicated were simplified and made even *more efficient* through the work carried on here.



For nearly twenty years Sylvania's Commercial Engineering Department has contributed to the advancement of circuit design as well as to the development of a great variety of electronic and lighting products.

### SOME PRODUCTS OF SYLVANIA ENGINEERING RESEARCH

- Radio receiving tubes, such as the famous Lock-In.
- Miniature radio receiving tubes, including the tiny T-3.
- 1.4 volt battery tubes.
- 150 ma. line of 6.3 volt tubes.
- Radio transmitting tubes.
- Cathode ray tubes.
- Pirani tubes.
- Silicon Crystal Diodes.
- 1N34 and 1N35 Germanium Crystals.
- Electroflash Tubes and Units.
- Radio tube parts.
- Fluorescent lamps.

# SYLVANIA ELECTRIC

Emporium, Pa.

MAKERS OF RADIO TUBES; CATHODE RAY TUBES; ELECTRONIC DEVICES; FLUORESCENT LAMPS, FIXTURES, WIRING DEVICES; ELECTRIC LIGHT BULBS

# Jensen *Speech Master* REPRODUCERS

...for clear, crisp, intelligible  
Speech\* **Reproduction**

Designed especially for speech reproduction in intercommunication and public address applications, this Speech Master family of JENSEN Reproducers, delivers clean, sharp, understandable announcements and orders. Like all JENSEN products, these Speech Masters were completely engineered to do their job efficiently and well.

**MODEL NJ-300 SPEECH MASTER** (Railroad Type). PM design. Widely used in railroad intercommunication in locomotives, cabooses, signal towers and yards. Rugged case protects against shock and vibration; withstands dust, smoke and the elements. Voice coil impedance 12 ohms; power rating, 10 watts. Space provided inside case for 500-ohm impedance transformer. Overall height 11-3/4"; width 6-25/32"; depth 4-13/16". Foles provided in base for mounting in any position.

**MODEL AR-10 SPEECH MASTER** *ALNICO 5* design. Specially constructed reflex horn increases efficiency in mid-frequency range, giving added effectiveness and "punch" to speech quality; prevents direct access of rain and snow to speaker diaphragm. Voice coil impedance, 4 ohms and 45 ohms; power rating, 3 watts. Space provided inside for 1/2" x 1/2" transformer. Overall diameter 10"; depth 8". Complete with mounting bracket.

**MODEL AP-11 SPEECH MASTER** (Panel mounting). Similar to AP-10 but without base. Mounts in 4-27/64" cut-out; clearance eyelets for mounting screws. Depth 4 1/2" from front panel. Screws and drilling template included. Voice coil impedance 4 ohms or 45 ohms; power rating, 5 watts.

**MODEL AP-10 SPEECH MASTER** (Desk or Wall type). PM design, desk or wall mounting. Complete with base and tilt adjustment. Double dustproofed. Rubber covered 36" cord. Internal mounting bracket for 1/2" x 1/2" transformer. Voice coil impedance 4 ohms or 45 ohms; power rating, 5 watts. Height 6-3/4"; depth 5 1/8"; diameter 5". Finish hammered gray with satin chrome trim.

**MODEL NF-300 SPEECH MASTER** (Navy Type). Developed for use as a loud speaker and microphone. Special case design over-rides wind and background noises for talk-back. Enclosed case and protective screen render this model proof against weather, dust and moisture *ALNICO 5*. PM design. Power rating, 10 watts; voice coil impedance 12 ohms. Mounts in 5 3/8" cut-out; six screw holes in rim. Overall diameter 6-7/16" depth (from front of panel) 2-9/64". Finished in Munsel N4.5 gray enamel.

**MODEL AP-20 SPEECH MASTER** Heavy-duty unit for high-level paging and call systems in noisy industrial installations. PM design. Furnished with eyebolt for overhead suspension but available with stand for wall or table mounting. Voice coil impedance 8 ohms; power rating, 25 watts. Overall diameter 13 1/2"; depth 9"

\*For full discussion of Speech requirements, see Jensen Monograph No. 4.

## JENSEN MANUFACTURING CO.

6605 S. LARAMIE AVENUE, CHICAGO 38, ILLINOIS, U. S. A.  
In Canada: J. R. Longstaffe, Ltd., 11 King Street, West, Toronto, Ont.

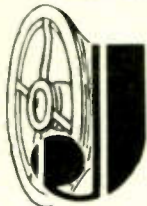

**Jensen**  
SPEAKERS  
WITH *ALNICO 5*

Specialists in Design and Manufacture of Acoustic Equipment

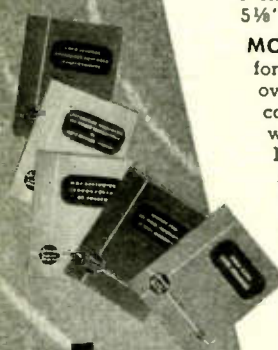
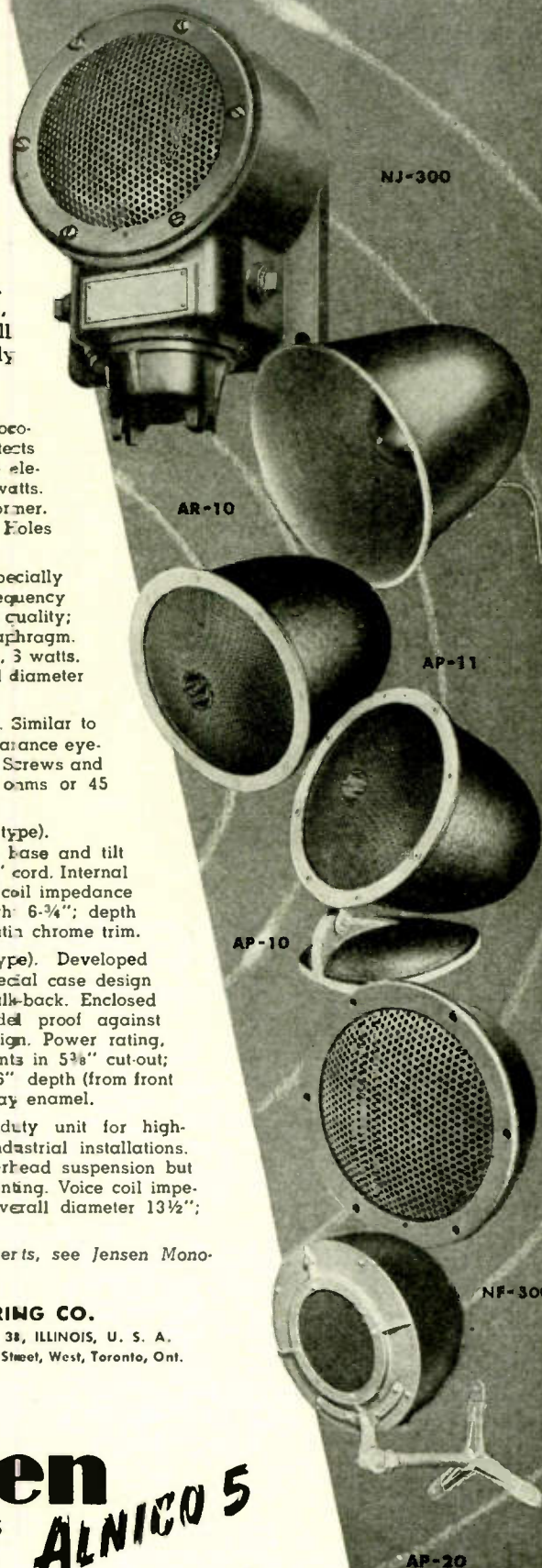

**5**

### MONOGRAPHS AVAILABLE

If you haven't yet procured these five valuable technical booklets, order now—either from your dealer or direct—at 25¢ each.

1. Loud Speaker Frequency-Response Measurements
2. Impedance Matching and Power Distribution
3. Frequency Range in Music Reproduction
4. The Effective Reproduction of Speech
5. Horn Type Loud Speakers

**25¢** each

DESIGNED AND ENGINEERED AT NO. 1 PLASTICS AVENUE



## MORE THAN 16,000,000 MOLDED OF G-E MYCALEX

●Here is an example of precision molding a critical component in G-E mycalex and supplying it by the million. The aircraft engine spark plug terminal sleeve had the advantage of being "self-healing" after exposure to prolonged arcing. It lent itself to ground crew maintenance of our warplanes.

This is but one of the many parts molded in G-E mycalex by General Electric during the war. Why not consult G-E engineers, who have perfected G-E mycalex molding techniques, about your insulation problems? You may

heighten the efficiency of your product and save on over-all insulation costs by using a G-E mycalex precision molded part.

G-E mycalex, a stone-hard, gray-colored material that is produced by fusing special glass with powdered mica, is now available to you in standard rods and sheets . . . fabricated parts . . . or molded to your own design. A new bulletin tells the whole story of unique G-E mycalex—send for it today. Plastics Divisions, T-15, Chemical Department, General Electric Company, 1 Plastics Avenue, Pittsfield, Massachusetts.

### HOW THE G-E MYCALEX SERVICES CAN BENEFIT YOU NOW

You may order fabrication of sample G-E mycalex parts at surprisingly low cost. Test them yourself in your own equipment. Then, if you decide to specify G-E mycalex, your design can be converted to a molding process which permits speedy and economical production runs.

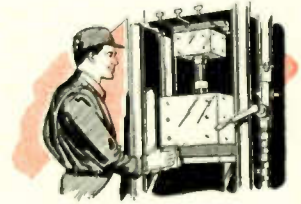

MOLDING SERVICE



FABRICATING SERVICE

Get This Unique Combination  
of Properties with G-E Mycalex

1. High dielectric strength
2. Low power factor
3. Prolonged resistance to electrical arcs
4. Chemical stability—no deterioration with age
5. Dimensional stability—freedom from warpage and shrinkage
6. Impervious to water, oil, and gas
7. Resistance to sudden temperature changes
8. Low coefficient of thermal expansion
9. High heat resistance

Samples Supplied on Request



# MYCALEX

# GENERAL ELECTRIC

CD46-M13

# PERMANENT MAGNETS MAY DO IT BETTER!



## How Permanent IS A Permanent Magnet?

Since its discovery, the permanent magnet has been one of man's most faithful servants (as an aid in transportation and navigation). In most instances the life of the permanent magnet exceeds the life of the instrument it serves. After 65 years of faithful performance the Ritchie spirit compass, illustrated above, is still fit for navigation—the directing power of the permanent magnet is still accurate.

The permanent magnet used in the speedometer normally outlives the life of the automobile, despite the demagnetizing influences, physical strain, and vibration of high speed service. Although modern magnetic materials of greater retentive power have been developed, many of the antiquated permanent magnets are still serving adequately.

With the use of modern magnetic-alloy materials,

infinitely more energy can now be packaged into permanent magnets. They are greater in strength . . . smaller in size . . . more functional in design . . . with greater stability in an electrical and steel age of vastly greater demagnetizing forces.

The Indiana Steel Products Company is a pioneer producer of "packaged energy", having made more than 24,000 applications in the 36 years of specialized permanent magnet production. Permanent magnets may have some application in your industry . . . may do some job or process better for you. Our engineers will gladly help you develop your plans for magnet application. For complete information and valuable technical data on magnet application and materials, please write for our "Permanent Magnet Manual."

## ★ THE INDIANA STEEL PRODUCTS COMPANY ★

PRODUCERS OF "PACKAGED ENERGY"

6 NORTH MICHIGAN AVENUE • CHICAGO 2, ILL.



SPECIALISTS IN PERMANENT MAGNETS SINCE 1910

PLANTS { VALPARAISO, INDIANA  
STAMFORD, CONN. (CINAUDAGRAPH DIV.)

©1946 The Indiana Steel Products Company



**NOW...**  
**SPRAGUE** brings you a  
**2 MIL. METER MULTIPLIER**  
 that gives you a...



**50%**  
**REDUCTION IN**  
**RESISTANCE**  
**VALUE!**

Conventional multipliers wound with ordinary enamelled wire cannot operate safely at much more than the one MA called for in government specifications. Sprague Precision Meter Multipliers, however, can be used at *twice their normal current rating*, with only a slight decrease in long time stability. Plus or minus 1% resistance tolerance should be specified.

This cutting of resistance value in *half*, with approximate halving in meter multiplier cost, results from use of wire that is insulated before winding, with a 1000° C. heat-proof ce-

ramic and wound on special high-temperature plastic forms. *Larger wire sizes* are used through reduction of resistance values.

It all adds up to a net saving of as much as 50% in multiplier cost . . . because it allows exactly half the resistance value and, in some cases, half the number of multipliers, to be used for a given application. Sprague engineers will be glad to make recommendations for your specific application.

Write for the new Sprague Resistor Catalog No. 100E.



SPRAGUE ELECTRIC COMPANY, Resistor Division, North Adams, Mass.

**SPRAGUE** \* **KOOLOHMS**

POWER TYPES • BOBBIN TYPES • METER MULTIPLIERS • MEGOMAX, ETC.

\*Reg. U. S. Pat. Off.



#### APS 6 AIR PUMP

The Dalmo-Victor designed air pump is a slow-speed, single-action piston pump, which requires no extra power source. Air is delivered to rear joint of the antenna wave guide, and will maintain a pressure of 10 pounds per square inch gauge at all altitudes up to 30,000' above sea level against an air leakage of 4 cubic inches of free air per minute.



#### FEED HORN

This feed is a pressurized X-Band rearward directing feed horn for circular paraboloids. The electrical features include high gain, low VSWR, and external tuning adjustment. The mechanical features include 100 per cent pressure tight sealing, light weight, few parts, and ease of fabrication and assembly.



#### MAIN GEAR HOUSING

The AN/APS-6 Antenna is a high-speed spiral type of scanner driven at 1200 r.p.m. through enclosed helical gearing, and simultaneous nod motion is introduced by means of a crank reciprocated rack and pinion mechanism to impart a nod motion of  $\pm 60^\circ$  at a rate of 15 complete nod cycles per minute.



#### APS/6 GENERATOR

Dalmo Victor developed this 2 phase, 20 cycle generator for use on the AN-APS/6 Antenna, using a permanent magnet type rotor and to develop 67 volts r.m.s. at 1200 r.p.m. Total harmonic content does not exceed 5%. Simplicity of construction makes possible ease of assembly and phasing.

# AIRCRAFT RADAR ANTENNA TYPE AN/APS-6

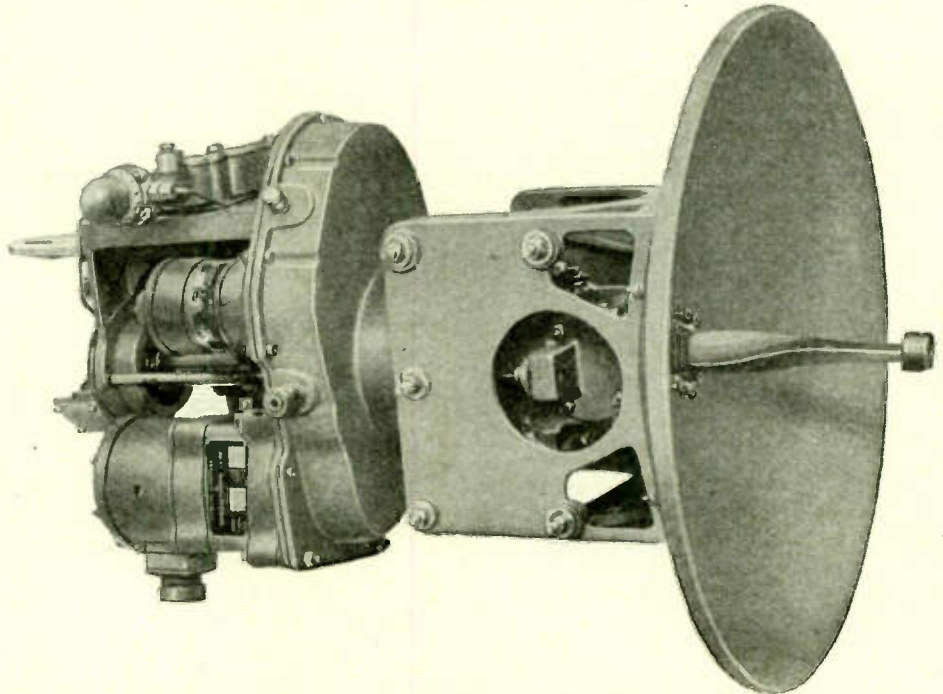

At the close of hostilities Dalmo-Victor was producing and delivering nearly 90% of the night fighter Radar Antenna-Scanners used by the U. S. Navy. We had developed the top quality product in this field.

Our "know-how" is ready for commercial and research development purposes, our engineering and electronic research staff is intact, our manufacturing and testing facilities are ample. We solicit inquiries from electronic engineers, aircraft companies — from all who may be properly interested.

# DALMO VICTOR

SAN CARLOS, CALIFORNIA

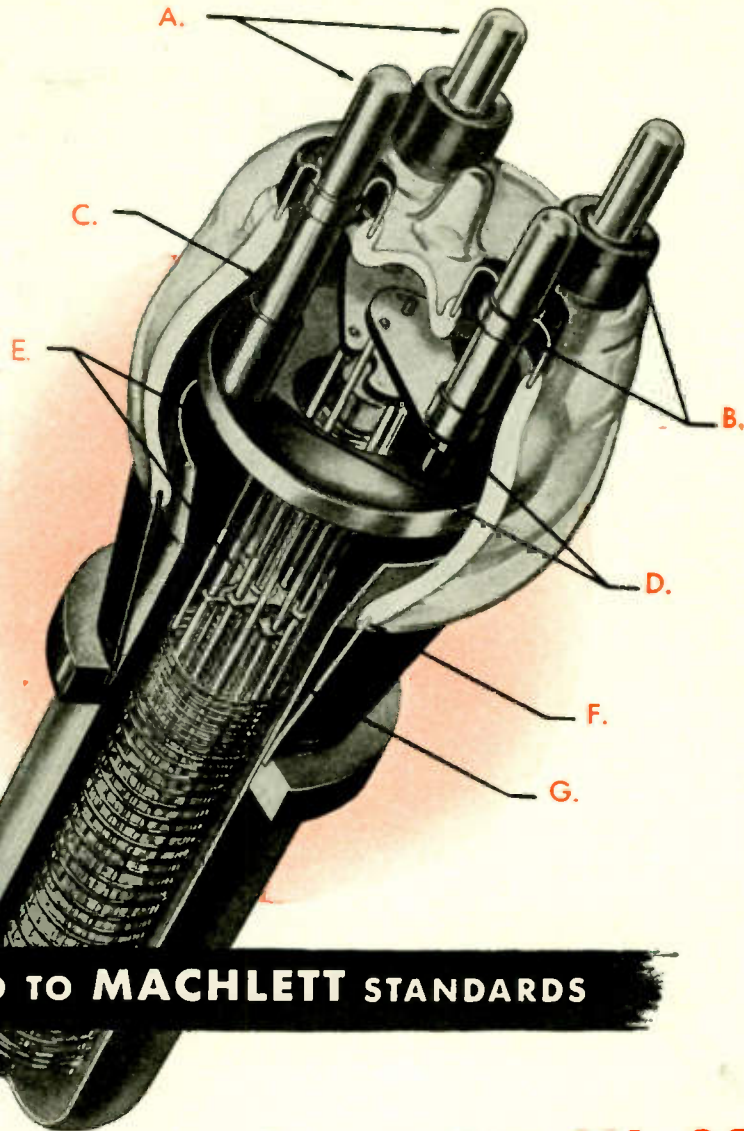

Sectional view of the ML-889-A, showing features typical of Machlett external anode tube construction.

- A. Gold-plated contact surfaces
- B. Rugged Kovar grid and filament seals
- C. One-piece high-conductivity copper grid and filament support leads
- D. Rigidly-supported grid and filament assemblies
- E. Surgically-clean internal parts
- F. Rugged Kovar plate seal
- G. One-piece anode and shield

## REDESIGNED TO MACHLETT STANDARDS

## For better performance and longer life! ML-892

HERE is another outstanding example of Machlett's ability to apply to the design and manufacture of high-power triodes its unique skills acquired in the manufacture of X-ray tubes. Remember, those skills were developed through almost 50 years of X-ray tube production—and an X-ray tube presents manufacturing problems of the greatest severity in the electron-tube art. Machlett's ability to solve those problems has resulted in making it the largest producer of X-ray tubes in the world. Note these features of the ML-892:

1. Heavy Kovar sections for grid and plate seals, instead of feather-edge copper. Result—greatly increased mechanical strength.
2. Grid assembly supported by heavy Kovar cup, for strength and stable inter-element spacing.
3. Filament assembly greatly strengthened to increase life and preserve correct spacing.
4. All internal parts processed by special

Machlett techniques which prevent contamination by foreign particles, assuring permanent outgassing.

5. Tube pumped by unique Machlett continuous, straight-line, high-voltage process, assuring same high standards maintained in Machlett high-voltage X-ray tubes.

• • •  
For complete details of this greatly improved tube, write Machlett Laboratories, Inc., Springdale, Connecticut.

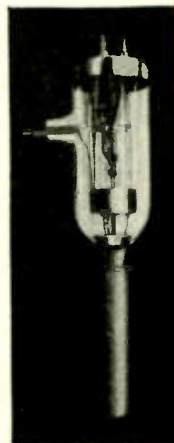

### GENERAL CHARACTERISTICS

	ML-892	ML-892-R
Filament Voltage	22	22 volts
Filament Current	60	60 amps.
Amplification Factor	50	50
Maximum frequency for full power	1.6	1.6 mc.
Capacity grid to plate	27	30 uuf
Capacity grid to filament	18	18 uuf
Capacity plate to filament	2	2 uuf
Cooling	Water	Air
	3 to 8 G.P.M.	400-700 C.F.M.

# MACHLETT

APPLIES TO RADIO AND INDUSTRIAL USES  
ITS 49 YEARS OF ELECTRON TUBE EXPERIENCE

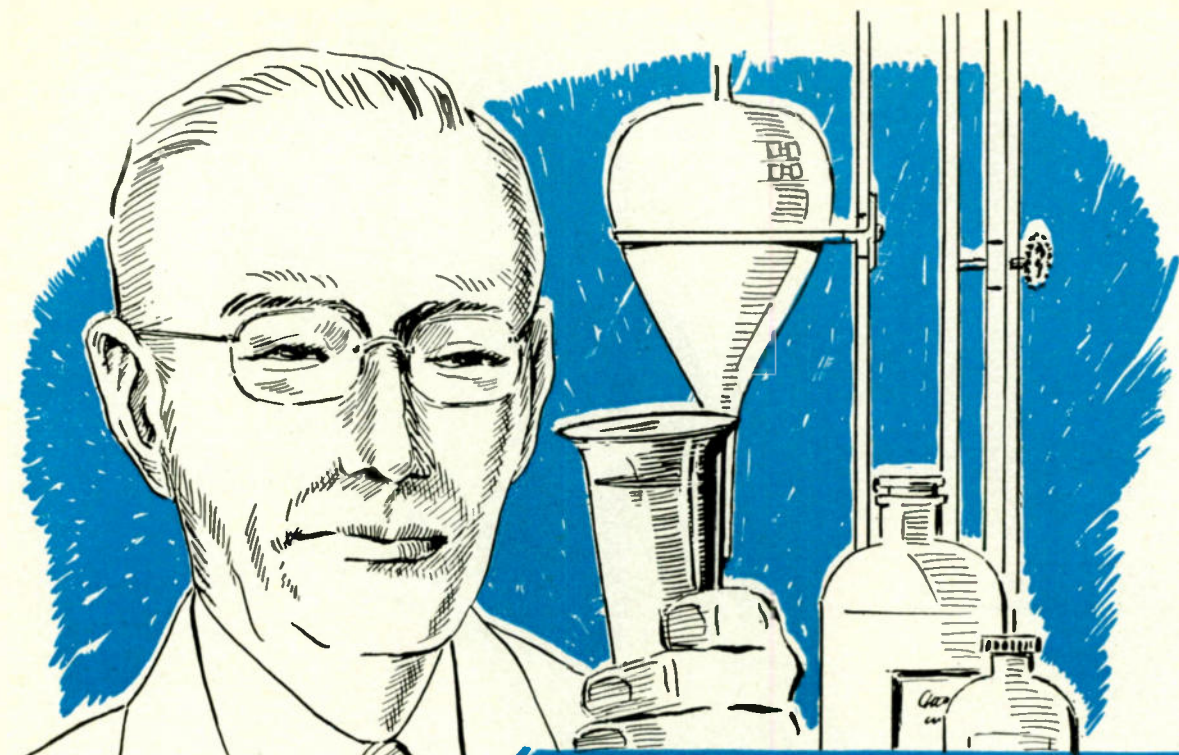

# FORMICA

*for Laminated Plastic Specialties!*

**F**ormica has an extensive research and engineering staff which devotes itself to the development of special products for special purposes.

This development organization has many important "firsts" to its credit, and produces regularly a long list of products that are not available elsewhere.

The organization is exceptionally well equipped to see that you get the right

material for your requirements in the right form to give you maximum service and satisfaction.

Formica also has an unusual quantity and variety of modern fabricating equipment and can turn out parts of exacting specifications for a very wide variety of purposes.

Bring your problems involving laminated engineering to the Formica organization.

**The Formica Insulation Company, 4647 Spring Grove Avenue, Cincinnati 32, Ohio**



# DU MONT'S Type 5RP

## Cathode-Ray Tube

permits visual observation or recording of high-frequency signals possessing writing rates in excess of 2500 km/sec.

### OPERATES UP TO 25,000 ACCELERATING POTENTIAL

By ingeniously subdividing the intensifier into multibands, a total accelerating potential of 25,000 volts may be used without serious loss of deflection sensitivity and practically no distortion with Eb3/EB2 ratios as high as 10. Thus, adequate brilliance is provided for signals which ordinarily could not be seen or recorded on a conventional cathode-ray tube. A low-capacitance deflection system, with leads brought out through the neck of the tube, makes the 5RP particularly useful for high-frequency applications.

Write for descriptive literature.

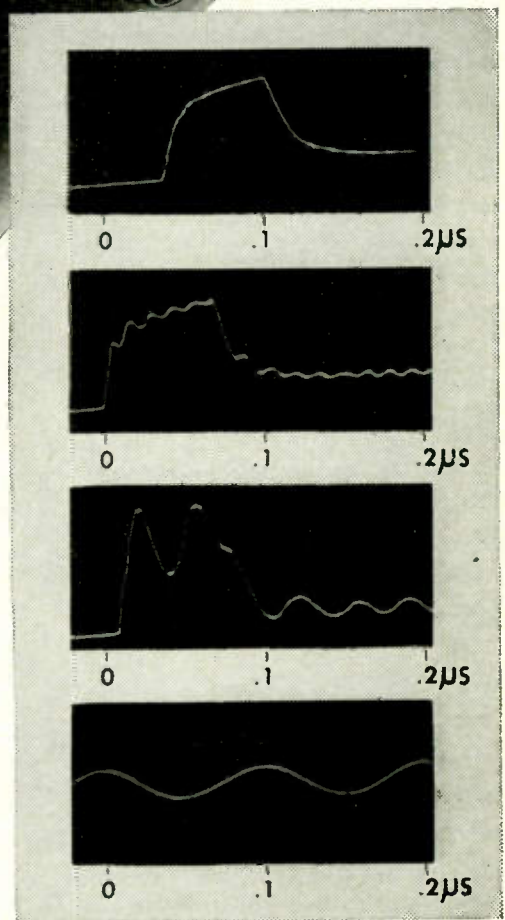

Typical high-speed single-transient recordings with 5RP at 18,000 volts accelerating potential. (Courtesy of Prof. M. Newman, Institute of Technology, University of Minnesota.)

© ALLEN B. DU MONT LABORATORIES, INC.

# DUMONT Precision Electronics & Television

ALLEN B. DUMONT LABORATORIES, INC., PASSAIC, NEW JERSEY • CABLE ADDRESS: ALBEEDU, PASSAIC, N. J., U. S. A.

# The Eye That Never Closes

You are looking at a thermistor — a speck of metallic oxide imbedded in a glass bead hardly larger than a pin-head and mounted in a vacuum. The thermistor was developed by Bell Telephone Laboratories to keep an eye on the amplification in long-distance telephone circuits.

When a thermistor is heated, its resistance to electric current changes rapidly. That is its secret. Connected in the output of repeater amplifiers, it heats up as power increases, cools as power decreases. This change in temperature alters the resistance, in turn alters the amplification, and so maintains the desired power level. Current through the wire at the left provides a little heat to compensate for local temperature changes.

Wartime need brought a new use for this device which can detect temperature changes of one-millionth of a degree. Bell Laboratories scientists produced a thermistor which could "see" the warmth of a man's body a quarter of a mile away.

Thermistors are made by Western Electric Company, manufacturing branch of the Bell System. Fundamental work on this tiny device still continues as part of the Laboratories program to keep giving America the finest telephone service in the world.

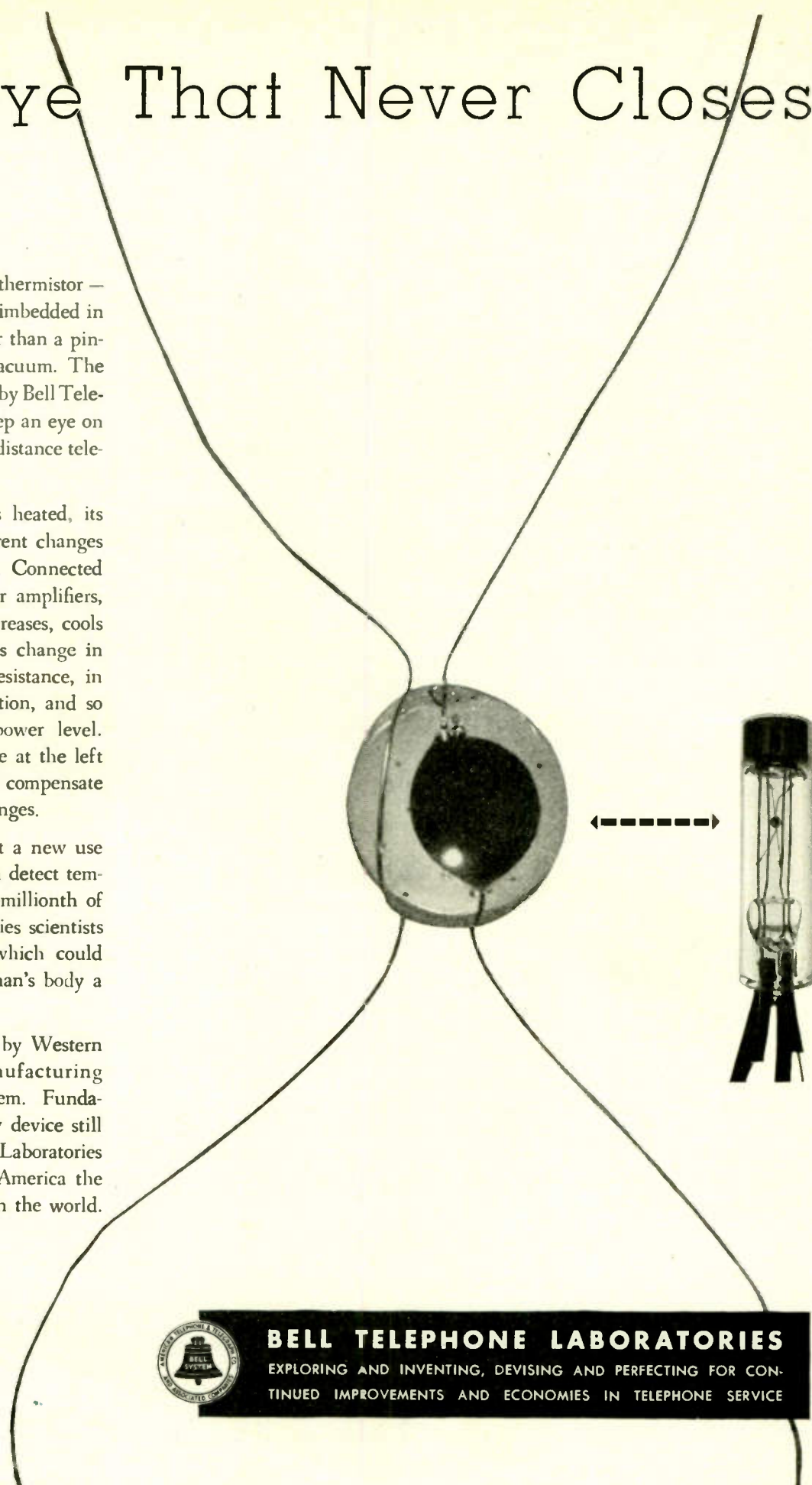

**BELL TELEPHONE LABORATORIES**

EXPLORING AND INVENTING, DEVISING AND PERFECTING FOR CONTINUED IMPROVEMENTS AND ECONOMIES IN TELEPHONE SERVICE

# SELENIUM RECTIFIERS

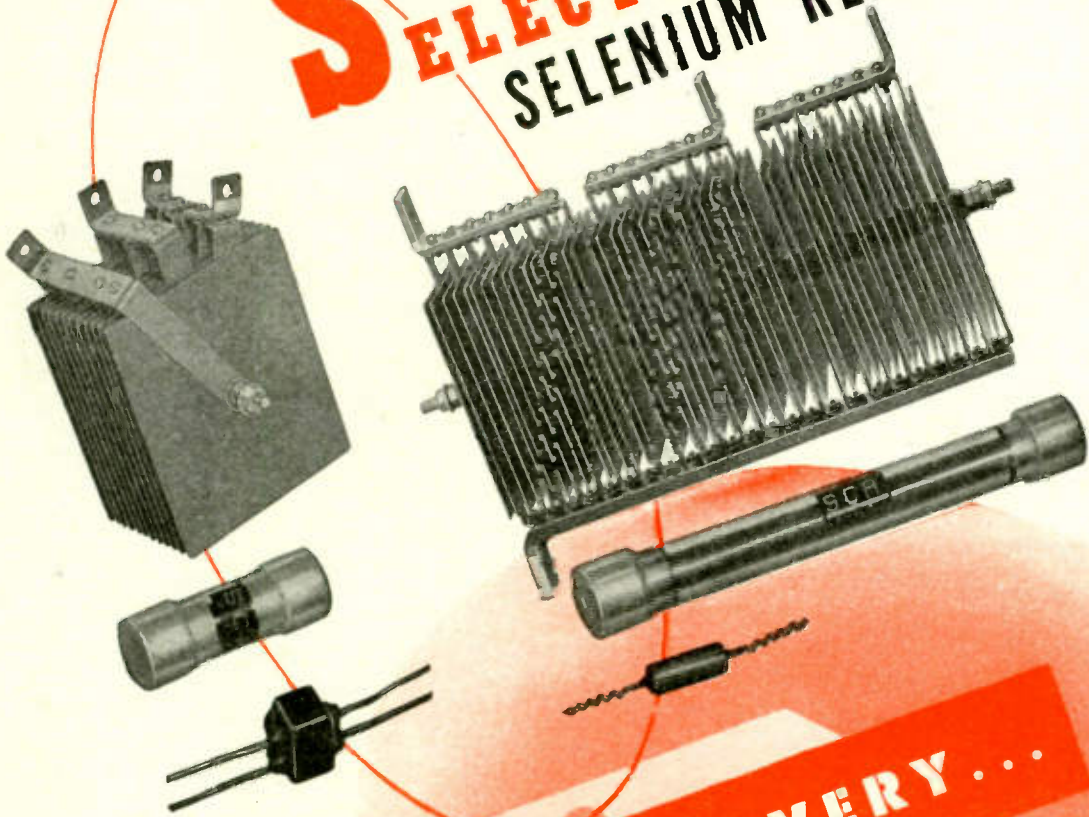

## IMMEDIATE DELIVERY...

Manufacturers of a broad line of SELENIUM Power and Instrument Rectifiers, Photo-Electric Cells and allied scientific products.

Solve your rectification problems with SELENIUM. SELENIUM rectifiers are rapidly becoming standard in industry. Check these outstanding features:

- ✓ Permanent characteristics.
- ✓ Adaptability to all types of circuits and loads.
- ✓ Unlimited life — no moving parts.
- ✓ Immunity to atmospheric changes.
- ✓ High efficiency per unit weight.
- ✓ Hermetically sealed assemblies available.
- ✓ From 1 volt to 50,000 volts RMS.
- ✓ Economical — No maintenance cost.

**SELENIUM CORPORATION OF AMERICA**

Affiliate of **VICKERS, Incorporated**  
 1719 WEST FICO BOULEVARD • LOS ANGELES 15, CALIFORNIA  
 Export Division: Fraser & Hansen, 301 Clay Street, San Francisco 11, Calif.  
 In Canada: Canadian Line Materials, Ltd., Toronto 13, Canada



...a metal for inserts that won't work loose from ceramic insulation as temperatures fluctuate.

**Mycalex Corp.**

...a metal to hold other parts in place under the searing heat of a high-voltage discharge.

**General Electric Co.**

...a metal that won't develop high surface resistance because of corrosion.

**Vendo Corp.**

...a metal whose electrical resistance varies measurably with temperature changes.

**The Simmons Co.**

...a metal for an armature that vibrates continuously 94,000,000 times a year.

**Union Switch and Signal Co.**

...a metal that can stand spark erosion without pitting or burning.

**Scintilla Magneto Co.**

...a metal that will remain non-magnetic during spot-welding.

**General Thermostat Corp.**

THESE ARE TYPICAL METAL SELECTION PROBLEMS THAT WERE SOLVED BY USE OF  
**MONEL  
NICKEL  
INCONEL**

	MONEL	"R" MONEL	"K" MONEL	"KR" MONEL	"S" MONEL	NICKEL	"Z" NICKEL	INCONEL
CORROSION RESISTANCE	HIGH	HIGH	HIGH	HIGH	HIGH	HIGH	HIGH	HIGH
STRENGTH	GOOD	GOOD	HIGH	HIGH	GOOD	GOOD	HIGH	GOOD
TOUGHNESS	GOOD	GOOD	HIGH	GOOD	GOOD	HIGH	HIGH	HIGH
HARDNESS	GOOD	GOOD	GOOD	GOOD	HIGH	FAIR	HIGH	GOOD
MACHINABILITY	GOOD	HIGH	GOOD	HIGH	GOOD	GOOD	GOOD	GOOD
NON-GALLING	NO	NO	NO	NO	HIGH	NO	NO	NO
SPRING PROPERTIES	GOOD	NO	HIGH	NO	NO	GOOD	HIGH	HIGH
ELEC. CONDUCTIVITY	POOR	POOR	POOR	POOR	POOR	GOOD	GOOD	POOR
HEAT RESISTANCE	GOOD	GOOD	GOOD	GOOD	HIGH	GOOD	GOOD	HIGH
HEAT TREATABLE	NO	NO	YES	YES	YES	NO	YES	NO
NON MAGNETIC	NO	NO	YES	YES	YES	NO	NO	YES

Think of the INCO Nickel Alloys first when you need a metal with a hard-to-find combination of properties.

These high-Nickel alloys are Strong... Tough... Hard... Rustless. They resist High Temperatures... Corrosion... Wear... Fatigue. Their use is insurance for long, trouble-free service.

MORE INFORMATION! Tell us the alloy that interests you, and we'll mail more information. Or, send for "List B-100" which lists over 100 bulletins explaining the properties and applications of the INCO Nickel Alloys.

**THE INTERNATIONAL NICKEL COMPANY, INC.**  
67 Wall Street, New York 5, N. Y.

**NICKEL  ALLOYS**

MONEL • "K" MONEL • "R" MONEL • "KR" MONEL  
"S" MONEL • INCONEL • NICKEL • "L" NICKEL • "Z" NICKEL  
\*Reg. U. S. Pat. Off.



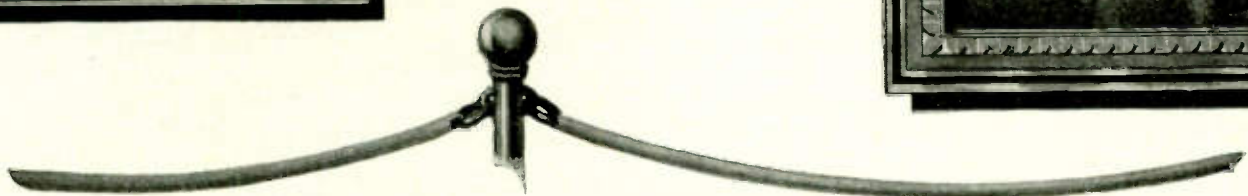
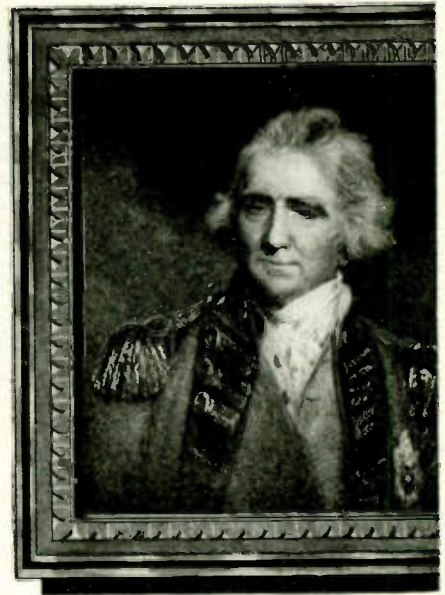
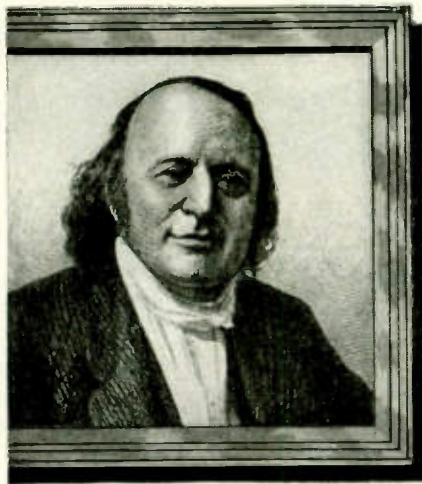
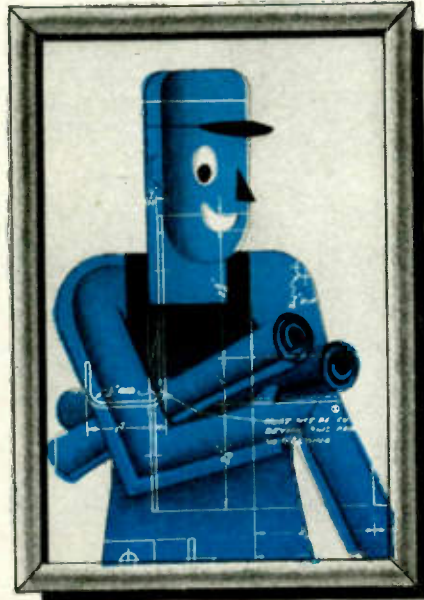
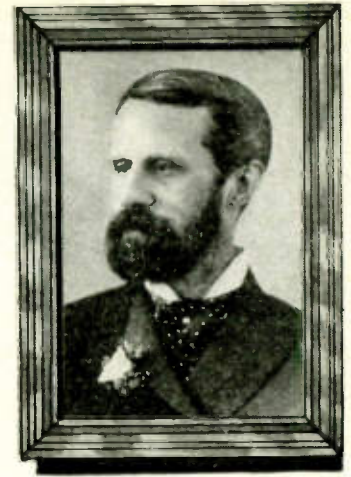
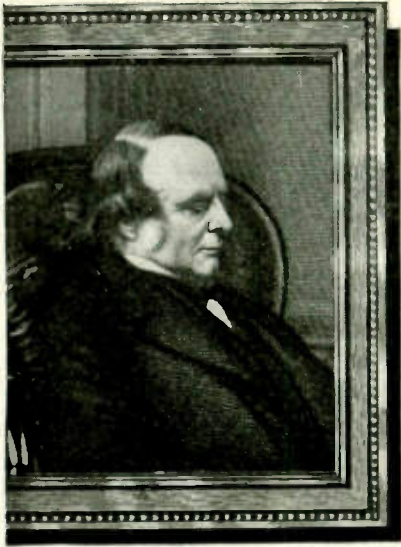

## GOOD COMPANY

**W**E'RE not pretending we belong in any Gallery of the Great. It's just our way of calling attention to the fact that a manufacturing organization, as well as a famous personage, can have character and individuality.

Through the years the Karp organization has become known as a good company to do business with—a company with a likeable personality—a company that understands and practices cooperative service.

Because our experience and craftsmanship in

sheet metal fabrication mean good business for our customers, our services are preferred by many of the "great names" in American industry. We're extremely proud of the outstanding firms we serve.

They like our work. They like the sound value our work represents. They find their relations with us helpful and pleasing.

If you are not already on our list of customers, let's get acquainted. Consult us for superior craftsmanship in cabinets, housings, chassis, racks, boxes, enclosures or any type of sheet metal fabrication.

*Write for our new catalog*

# KARP METAL PRODUCTS CO., INC.

*Custom Craftsmen in Sheet Metal*

126-30th STREET, BROOKLYN 32, N. Y.

**29 DIFFERENT  
RECTIFIER TUBES**

*Now Replaceable*

**WITH THE FEDERAL SELENIUM RECTIFIER**

(No. 40302625)

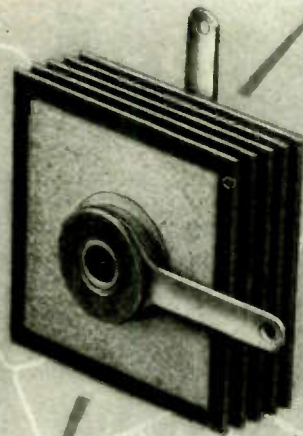

**IT'S SMALLER...**

**COSTS LESS...**

**LASTS LONGER...**

**RUNS COOLER...**

**READILY INSTALLED!**

**-FIRST OF ITS KIND IN THE INDUSTRY!**

NO less than *twenty-nine* different types of rectifier tubes are now replaceable with Federal's new, miniature, 5-plate rectifier. Available now, this replacement is also an *improvement!* For not only does it subtract from your own manufacturing costs, it adds to product quality as well . . . and to consumer satisfaction. Here's how:

- Saves space — only 1 1/4 x 1 1/4 x 11/16 inches — fits where tube won't
- Costs less than tube and socket it eliminates
- Long life — built to last the life of the set
- No warm-up period — starts instantly, runs cooler
- Installed in less time than tube — only two soldering jobs
- Sturdy, all-metal construction — not easily damaged
- Withstands overloads — even when charging deformed electrolytic condensers

Every one of Federal's line of "Center Contact" Selenium rectifiers is designed to give the full measure of performance that have made them the standard of the industry. A Federal engineer will show you how to put this latest model into your circuits. Write for details to Department F414.

**Replacement for these Tubes:**

5T4	5Y3	6Y5	25Z6	50Y6
5U4	5Y4	6Z5	35W4	50Z7
5V4	5Z4	12Z5	35Z3	117Z3
5Z3	6X5	7Y4	35Z4	117Z6
5W4	0Z4	12Z3	35Z5	0Y4
5X4	80	25Z5	35Z6	

**Electrical Characteristics:**

Maximum RMS Voltage	130 Volts
Maximum Inverse Voltage	380 Volts
Maximum Peak Current	1200 ma.
Maximum RMS Current	325 ma.
Maximum DC Output	100 ma.
Approximate Rectifier Drop	5 Volts

Two Federal Miniature Rectifiers in a voltage doubler circuit give 250 volts and 80 milliampere output from 117 volt AC power source.

**Federal Telephone and Radio Corporation**

In Canada:—Federal Electric Manufacturing Company, Ltd., Montreal  
Export Distributor:—International Standard Electric Corporation, 67 Broad St., N. Y. C.



Newark 1,  
New Jersey

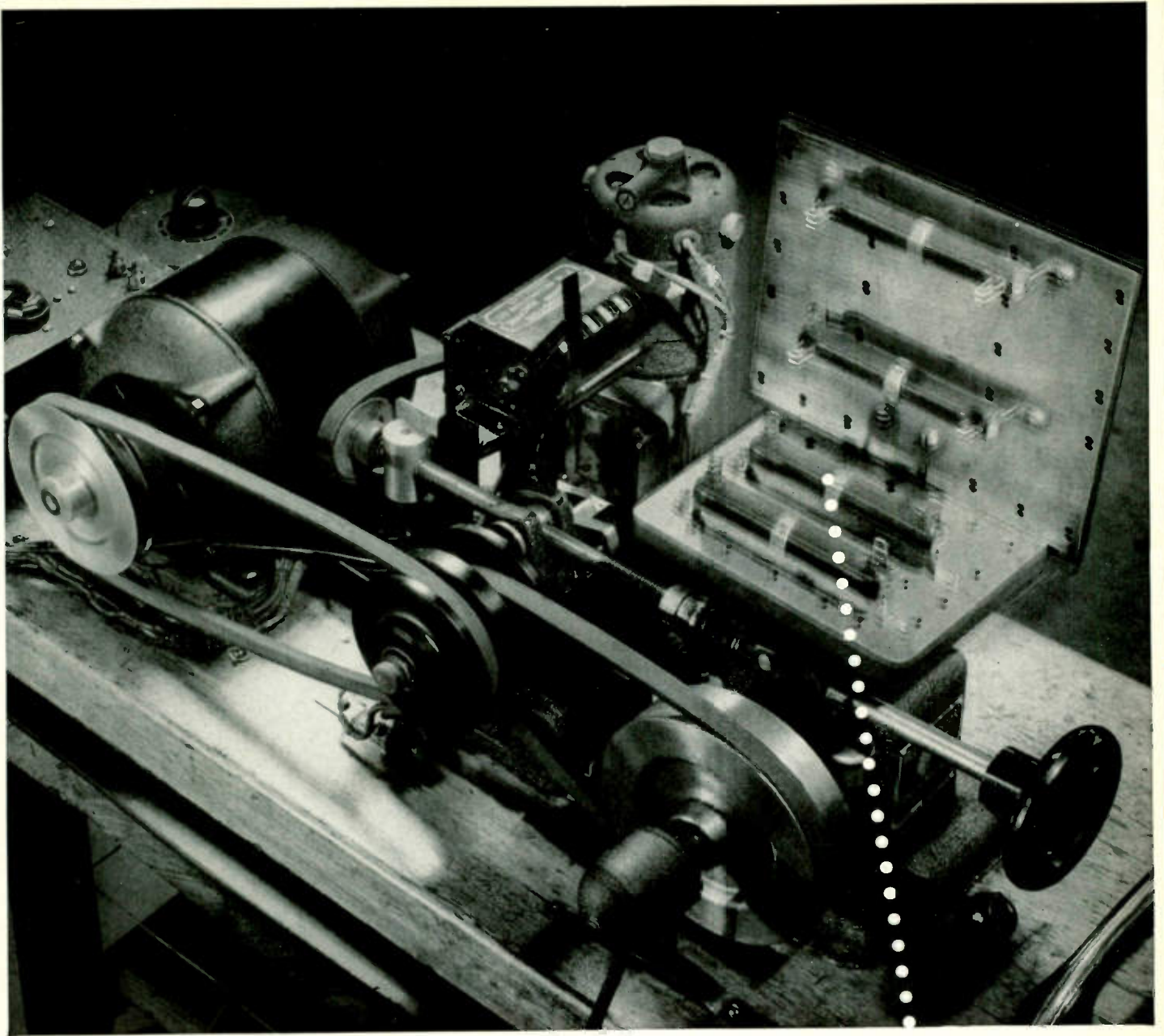

## A Vicious Vibration Test that Shakes Out the "Bugs"

On this vibrating table . . . throbbing 600 to 3,300 times a minute . . . Ohmite resistors are exposed to vibrations many times more punishing than those encountered on industrial machines, planes, automotive vehicles, railroads, and marine craft. First at the lower rate, then at a rate gradually increased to 3,300 vibrations per minute, these standard production-run Ohmite resistors and their resilient mounting brackets prove their ability to stand up for prolonged periods under terrific abuse. When you specify Ohmite resistors you can be sure of years of unfailing dependability—under practically any service.



*Be Right with*

**OHMITE**

RHEOSTATS • RESISTORS • TAP SWITCHES

# Sealed in Vitreous Enamel for

# Life-Time Protection



RESISTS SHOCK,  
VIBRATION, COLD, HEAT, FUMES  
OR HUMIDITY

- 1 VITREOUS ENAMEL COVERING** Special Ohmite vitreous enamel holds the winding rigidly in place and protects it from mechanical damage.
- 2 STRONG CERAMIC CORE** Provides a strong base for the winding, unaffected by cold, heat, fumes, or high humidity.
- 3 EVEN, UNIFORM WINDING** The unsurpassed uniformity of the resistance winding prevents "hot spots" and resultant failures.
- 4 TINNED COPPER TERMINALS** Terminal lugs are tin-dipped for ease in soldering. The resistance wire is both mechanically locked and brazed to the terminal lugs, assuring a perfect electrical connection.
- 5 RESILIENT MOUNTING BRACKETS** Mounting brackets hold the resistor firmly yet resiliently in place. They are simple to mount and can be easily removed by a slight upward pressure at the base.
- 6 RATING STAMPED ON METAL BAND** Each resistor has a metal band upon which the resistance is stamped for clear and permanent identification.

Send for Catalog  
and Engineering  
Manual No. 40

Write now, on your  
company letterhead,  
for your copy of this  
valuable 96-page  
Ohmite catalog.



OHMITE MANUFACTURING COMPANY — 4983 Flournoy St., Chicago 44, U.S.A.



**OHMITE**  
RESISTORS • RHEOSTATS  
TAP SWITCHES

**AEROVOX CAPACITORS**  
 are backed by  
**QUALITY CONTROL**  
 ...eliminating defects at  
 the source

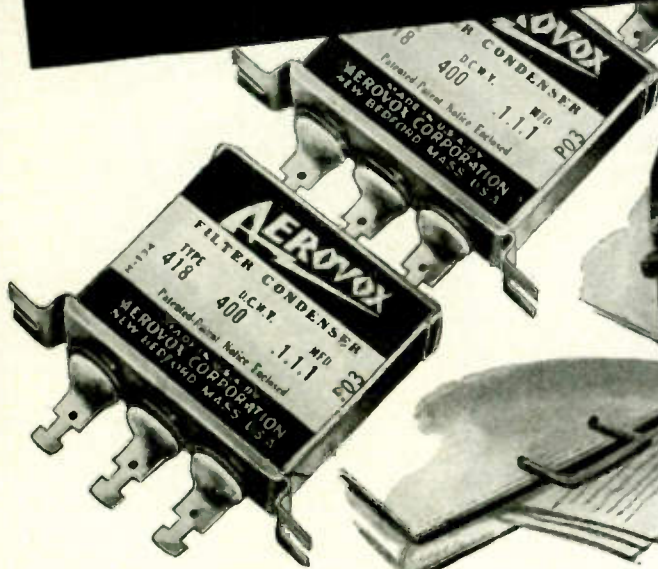

• When that Aerovox sales engineer takes your order, he releases the chain reaction of **QUALITY CONTROL**.

First, he has studied your particular application. From long and specialized experience, he knows circuits, constants, components. He is backed by an engineering staff second to none. So he sells only *that type* capacitor that can render the most service at least cost.

At the Aerovox plant that order reacts all the way back to raw materials.

Aerovox maintains a complete process average of all its vendors. Incoming materials are critically inspected. For example: over 12,000 chemical tests are made each month!

Then there are quality control checks at every step in production. Defective materials or workmanship just can't get by. Defective units are simply not produced.

Finally, the Aerovox Quality Control Department plots daily test data to de-

termine that the process is in control at all times. When any part of the process is out of control, production stops; the situation is investigated and corrected. Thus, the possibility of any defectives screening through is lessened more than ever before. You have utmost assurance that these capacitors are thoroughly dependable.

Yes indeed, Aerovox **QUALITY CONTROL** is your gain quite as well as ours.

• Let us apply **QUALITY CONTROL** to your capacitance problems and needs!



**FOR RADIO-ELECTRONIC AND INDUSTRIAL APPLICATIONS**

**AEROVOX CORPORATION, NEW BEDFORD, MASS., U.S.A.**

SALES OFFICES IN ALL PRINCIPAL CITIES • Export: 13 E. 40th St., NEW YORK 16, N. Y.

Cable: 'ARLAB' • In Canada: AEROVOX CANADA LTD., HAMILTON, ONT.

# Rauland

## ELECTRONIC SOUND

**FOR LABORATORY RESEARCH  
AND DEVELOPMENT, TESTING,  
PRODUCTION CONTROL . . .**

RAULAND Electronic Sound offers industry a versatile and complete line of quality equipment . . . for laboratory applications, production control, testing, and for plant and office intercommunication. Each RAULAND unit is the end product of creative research, precise engineering and careful production. Every RAULAND Electronic Sound unit measures up to the highest requirements for versatility, abundant output, faithful tone quality and dependable performance. Let RAULAND Electronic Sound serve you. Write for details.

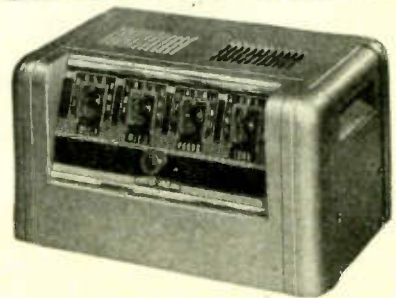

### RAULAND AUDIO AMPLIFIER UNITS

The RAULAND Electronic Sound line includes a selection of precision-built Audio Amplifier units suitable for laboratory, test equipment and general applications. RAULAND audio amplifier design has earned the respect and acceptance of leading radio engineers and researchers.

### INDUSTRIAL PAGING

RAULAND is prepared to supply rack-type Industrial Paging units tailored to fit specific requirements. Proved in hundreds of industrial installations.

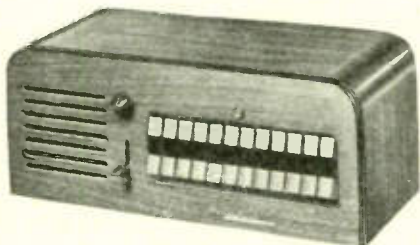
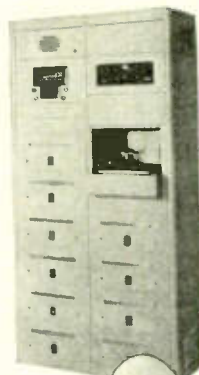

### AMPLICALL INTERCOMMUNICATION

America's preferred 2-way intercommunication unit. Available with up to 24 master stations. Thousands are today serving plants and offices everywhere.

RAULAND  
Weatherproof  
Speaker

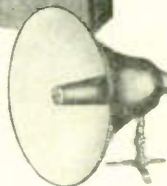

### RAULAND D. R. S. PREAMPLIFIER

A broadcast station type Preamplifier, with special characteristics and performance that make it highly suitable for laboratory use. Absolutely humless. Flat frequency response from 30 to 12,000 cycles. Couples any type microphone to a 200 ohm or 500 ohm line. Complete with linear attenuator, universal input impedances, 50, 300, 500,000 ohms, and 2 megohms.

RADIO • RADAR • SOUND •

# Rauland

COMMUNICATIONS • TELEVISION

*Electroneering is our business*

THE RAULAND CORPORATION CHICAGO 41, ILLINOIS

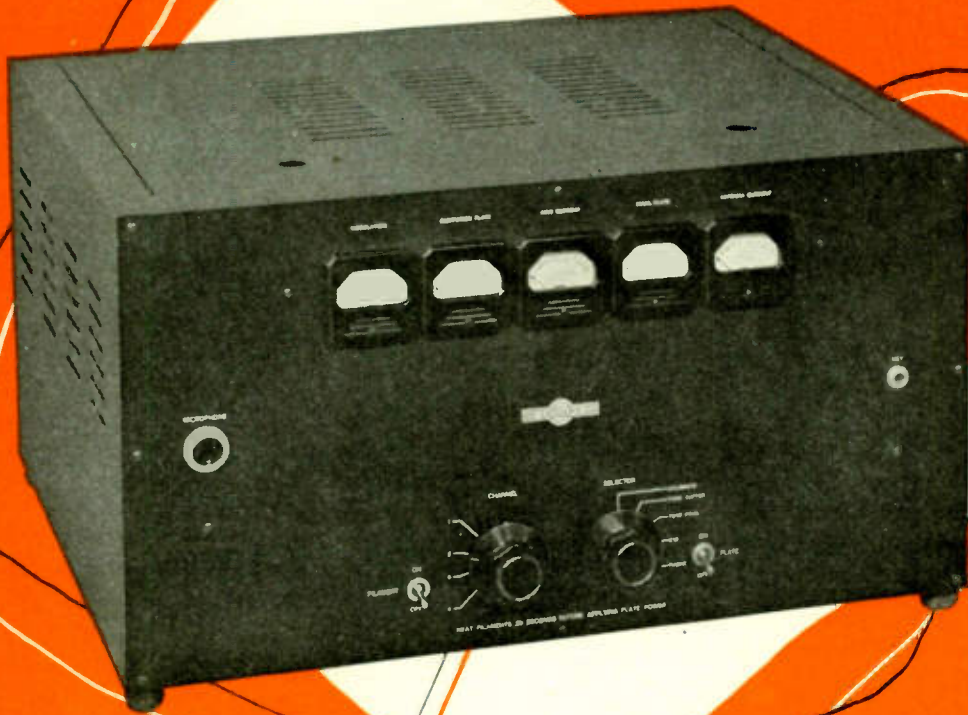

## A deservedly popular 50 watter

The Collins 32RA\* was introduced several years ago as a quality designed, quality built radio communication transmitter, broadly adapted to most applications within its power and frequency scope.

It and the d-c version, the 32RB†, were immediately put into service by airlines for control towers, by oil pipelines for emergency systems, by fishing companies for fleet control, and by other widely different types of industrial users.

The 32RA was found to be rugged, simple to operate, easy to service, and so thoroughly and universally satisfactory that a rising commercial demand was halted only by the war.

Now it is again available for peacetime applications. A large number of orders have already been received and filled, and we are able to ship from stock. If you would like specifications and design data, write us for an illustrated descriptive bulletin.

\*COLLINS 32RA—Power source: 115 volts alternating current. Power output, 50 watts phone; 75 watts CW. Frequency range, 1.5 to 15 mc. Four frequencies instantly selected by panel control.

†COLLINS 32RB—Power source: 12, 24, 32 or 110 volts direct current. Dynamotor, self-contained. Otherwise identical with 32RA.

IN RADIO COMMUNICATIONS, IT'S . . .



**COLLINS RADIO COMPANY, Cedar Rapids, Iowa**

11 West 42nd Street, New York 18, N. Y.

458 South Spring Street, Los Angeles 13, California

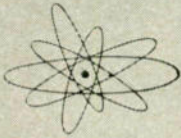

# Designers

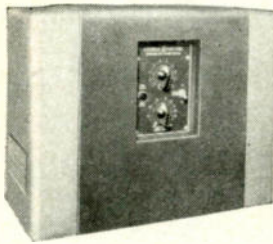

## ACCURATE TIME AND CURRENT CONTROL *for bench welders*

To cut welding time on small-part fabrication, such as welding solid or stranded conductors to terminals, welding electronic tube elements, or other small parts, look into the possibilities of the Thyatron-controlled bench-or-tong, low-capacity spot welder.

These alert, accurate controls, with a suitable transformer, have recorded a two-to-one advantage over soldering and rivet fabrication. Because of Thyatron welding controls' accuracy and split-cycle response, rejects drop to a new low. They are designed for either 230v or 460v, 60-cycle operation, and are rated 77 amperes peak on a duty cycle not exceeding 10 per cent. Equipment for 50-cycle operation is also available. Write for Bulletin GEA-4175A.

## ONE AND A HALF INCHES

*of instrument accuracy*

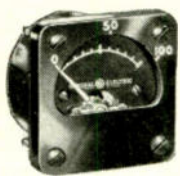

General Electric's 1½-inch panel instruments include direct-current, radio-frequency, and audio-frequency types, in both conventional and watertight construction. All feature the compact,

internal-pivot element and Textolite cases; will withstand 50 G's shock, and are accurate to within  $\pm 2$  per cent. The conventional, direct-current instrument is supplied self-contained for current measurements from 100 microamperes to 10 amperes and for voltage measurements up to 150 volts. For other requirements, combinations of instruments and accessories can be had. Write for Bulletin GEA-4380.

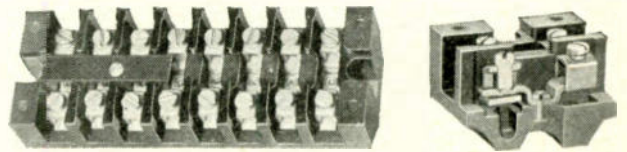

## TERMINAL BOARDS *to cut wiring time*

There's less motion and more wiring speed when terminal boards are G-E Type EB-2. Strip the wire-end, insert it in the connector, tighten a screw, and the connection is made. Each of these solderless, pressure connectors will accommodate one No. 8 stranded conductor, two No. 12 stranded conductors, or three No. 12 solid conductors, all AWG.

Type EB-1 differs from EB-2 only in its terminals, which are the conventional washer-headed screw type. Both boards are molded from strong, long-lasting Textolite, both are available in 4-, 6-, 8-, and 12-pole sizes, and are equipped with marking strips. Covers are optional. Write for Bulletin GEA-1497A.

## *Fast Hook-ups that stay put* with **FLAMENOL WIRE**

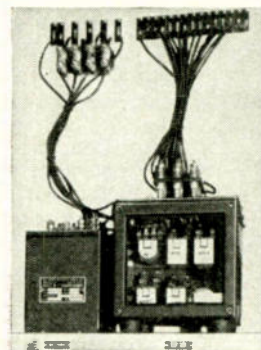

Flamamol hook-up wire's tough, plasticized-polyvinyl-chloride insulation strips clean, bends without cracking, and is available in seven different colors. Normally, it needs no bulky armor-braid for protection. As a result, Flamamol speeds up wiring

operations on electronic apparatus, where voltages do not exceed 600. Flame-resistant, corrosion-resistant, non-oxidizing, and unaffected by most hydrocarbon solvents, mild acids and alkalis, Flamamol rarely needs either attention or replacing. Its glossy finish looks new, and stays that way. Write for Bulletin GEA-4352.

**GENERAL**  **ELECTRIC**



# Digest

## TIMELY HIGHLIGHTS ON G-E COMPONENTS

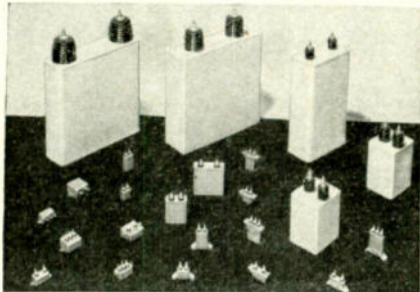

### NEW D-C PYRANOL\* CAPACITORS

*with new quality, sizes, ratings*

New materials, new manufacturing techniques and strict quality control, which were so important in the excellent records d-c Pyranol capacitors made during the war, are now incorporated into a new line of d-c Pyranol capacitors built to meet exacting commercial requirements.

This new line of d-c Pyranol capacitors has a broader range of sizes, ratings, and mounting arrangements, with characteristics that allow operation through the temperature range from  $-55^{\circ}\text{C}$  up to  $85^{\circ}\text{C}$ , at altitudes as high as 7,500 feet. Sizes range from "bathtub" up to large, welded-steel case sizes, capacitance from .01 muf to 100 muf, and voltages from 100v to 100,000v. Write *Transformer Division, General Electric Company, Pittsfield, Mass.*

\*Reg. U. S. Pat. Off.

### MORE "KNOW" MEANS *better "do"!*



To help train new technical personnel, and make supervisory and production men's jobs mean more, G.E. offers this 12 part talking slide film, prepared to teach even non-technical personnel the elements of electronics. It comes complete with 12 slide films and records, 300 review books, instructor's manual and carrying case; price of the kit is \$100. Call your local G-E office, or order direct from *Apparatus Dept., Sect. 642-13, General Electric Co., Schenectady 5, N. Y.*

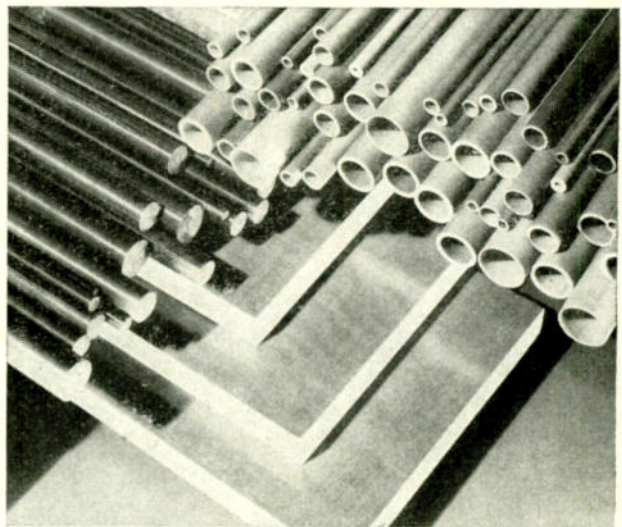

### FITS AND FIT FOR

*any laminated-plastic job*

Because it can be fabricated with machine tools into practically unlimited numbers of shapes, G-E Textolite sheet, tube, and rod stock adds flexibility to electronic apparatus design. Over fifty different grades — each with an individual combination of electrical, mechanical, chemical, and thermal properties — assures you that tube bases, coil forms, bus-bar supports and other components will be exactly right for your job. For additional information on G-E Textolite, write to *Plastics Divisions, Chemical Department, General Electric Company, Pittsfield, Mass*

General Electric Company, Sect. 642-13  
Apparatus Department, Schenectady 5, N. Y.

Please send me

..... GEA-1497A (Terminal Boards)

..... GEA-4175A (Thyatron Welding Controls)

..... GEA-4380 (Small Panel Instruments)

..... GEA-4352 (Flamenol)

Note: More data available in Sweets File for product designers.

Name \_\_\_\_\_

Company \_\_\_\_\_

Address \_\_\_\_\_

City \_\_\_\_\_ State \_\_\_\_\_

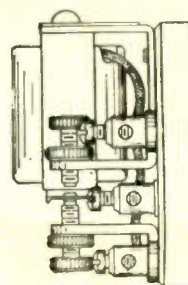
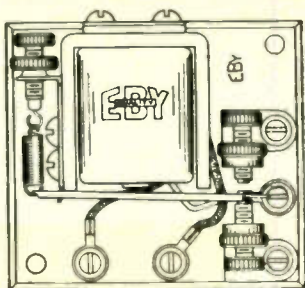
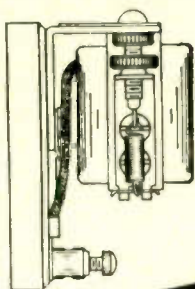

# EBY Sensitive RELAY

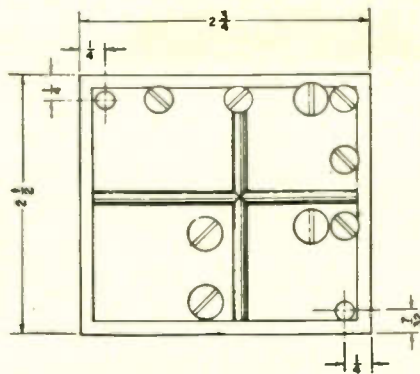
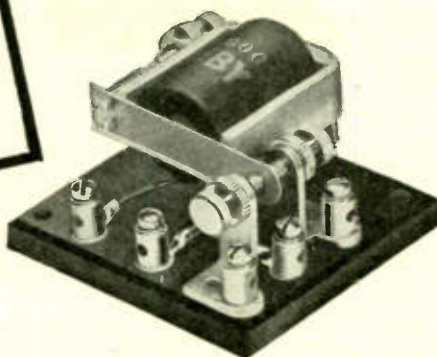
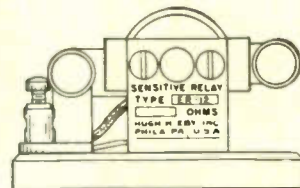
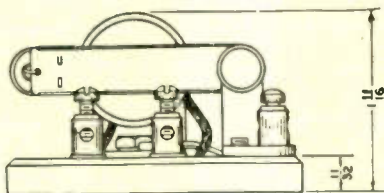

## APPLICATION:

The EBY sensitive relay is designed for direct current (full or half-wave rectified) control circuits where the available power for operation is relatively small. Its low power consumption for positive operation makes it ideal for installation in photoelectric control equipment, vacuum tube amplifier circuits and to protect delicate contacts of sensitive control instruments.

## MAGNETIC CIRCUIT:

The EBY sensitive relay, because of the advanced design of the armature, and by the use of a high quality, special steel alloy in the magnetic circuit, has the outstanding features of low power requirement for posi-

tive action and its unusually high speed of response.

## COILS:

The EBY sensitive relay can be supplied with five different coil sizes covering most of the operational needs in sensitive relay control applications. The standard coil values are: 300, 1000, 2500, 5000 and 10,000 ohms resistance. The relay is rated at 11.25 milliwatts for positive operation; however, it can be adjusted for less when needed. The coils will safely carry 2 watts.

## CONTACTS:

Contacts, single-pole, double throw, are of coin silver and are rated to carry 2.5 amperes at 115

volts A.C., or 0.5 amperes at 115 volts D.C. The contact air gap and spring tension are adjustable for critical applications.

## BASE:

Molded phenolic.

HUGH H.

# EBY

INCORPORATED

18 W. CHELTEN AVE.

PHILA. 44, PENNA.

# ISOLATED IN A LITTLE WORLD ALL ITS OWN

... with



INDIVIDUAL  
METER MOUNTING

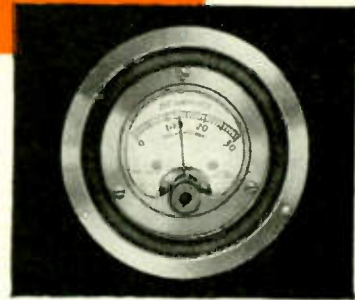

METER INSTALLED  
WITH MOUNTING

AN accurate meter is a sensitive mechanism, and a sensitive mechanism is also a delicate mechanism. It can't stand the buffetings of vibration, and continue its normal functioning. Yet some of the most important services that meters render must be rendered in the midst of chaotic disturbances.

The Lord Meter Mount creates a new environment, an environment of peace and quiet in the midst of turbulent vibration, for the sensitive and delicate instrument, a little world of its own that is limited by the soft circular cushion of rubber that surrounds it. It goes on quietly registering speed, or altitude, or temperature, or amperes, with self-possessed efficiency.

In a generation of pioneering vibration control we have solved thousands of vibration problems which have come to us. The problem which is new to you may be old to us, with the data in our files and the product in our line to meet it. If it's a new problem, remember that every problem was new when we started. We'll find a solution, and if necessary we'll make a new product to put it into effect.

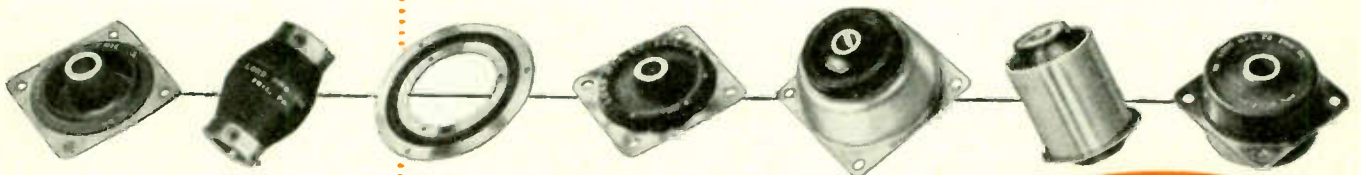

Every genuine Lord Mounting carries the name "LORD" embossed in the rubber or in raised letters on the forgings.

IT TAKES BONDED RUBBER *In Shear* TO ABSORB VIBRATION

## LORD MANUFACTURING COMPANY

ERIE, PENNSYLVANIA

SALES REPRESENTATIVES  
 NEW YORK - - 280 MADISON AVE.  
 CHICAGO - 520 N. MICHIGAN AVE.  
 DETROIT - 7310 WOODWARD AVE.  
 BURBANK, CAL. - 245 E. OLIVE AVE.  
CANADIAN REPRESENTATIVES  
 RAILWAY & POWER ENGINEERING CORP., LTD.  
 TORONTO, CANADA

Originators of Shear Type Bonded Rubber Mountings

# Stupakoff Ceramics



Export Department  
13 E. 40th St., New York 16, N.Y.

Cable Address:  
ARLAB All Codes

**STUPAKOFF CERAMIC  
AND MANUFACTURING CO.**  
LATROBE, PENNSYLVANIA



6

# Precision - Made

to meet your  
most exacting needs

1. **ENGINEERING** of Stupakoff products is based upon practical experience in the application and manufacture of industrial ceramics.
2. **FORMULAS** are carefully worked out to produce a material that fulfills the special requirements of each particular application.
3. **FORMING** by extrusion, pressing or molding, insures the selection of the process best suited to the product being made.
4. **FIRING**, an extremely important operation, is done at controlled temperatures, cycles, atmospheres and other closely regulated conditions.
5. **MACHINING** by modern precision equipment assures dimensional accuracy of finished pieces.
6. **INSPECTION** assures dimensional accuracy, clean edges, correct color of finished parts, dielectric and mechanical strength.

When you use Stupakoff Ceramics, these facilities assure correct application, highest quality and complete satisfaction.

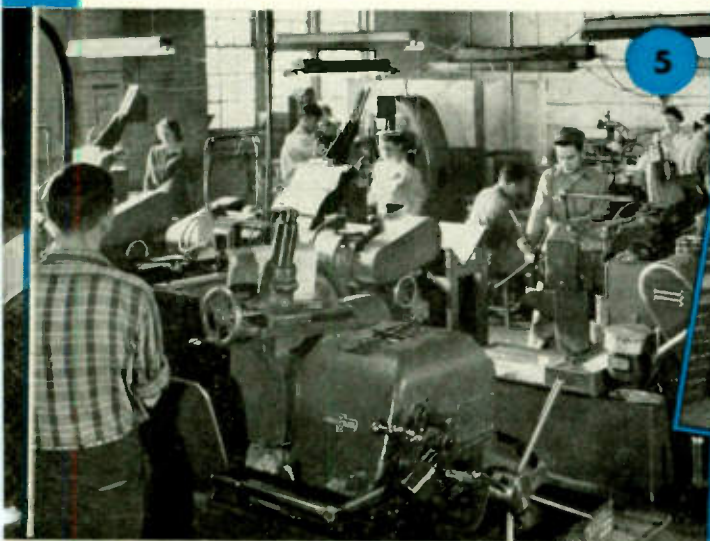
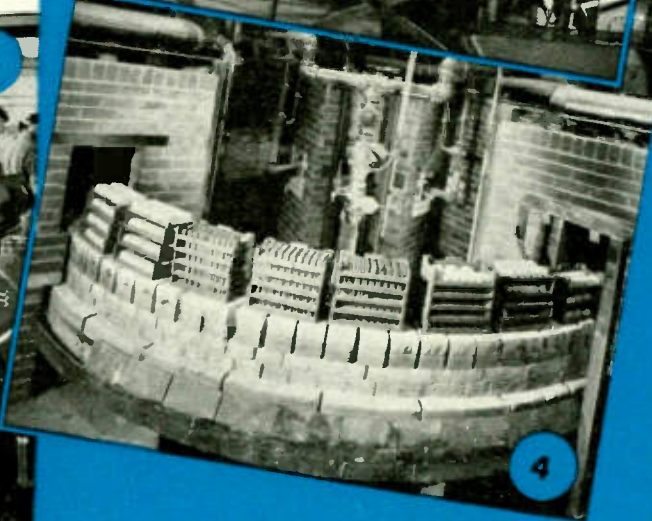

IS YOUR BAKING OPERATION YOUR PRODUCTION . . .

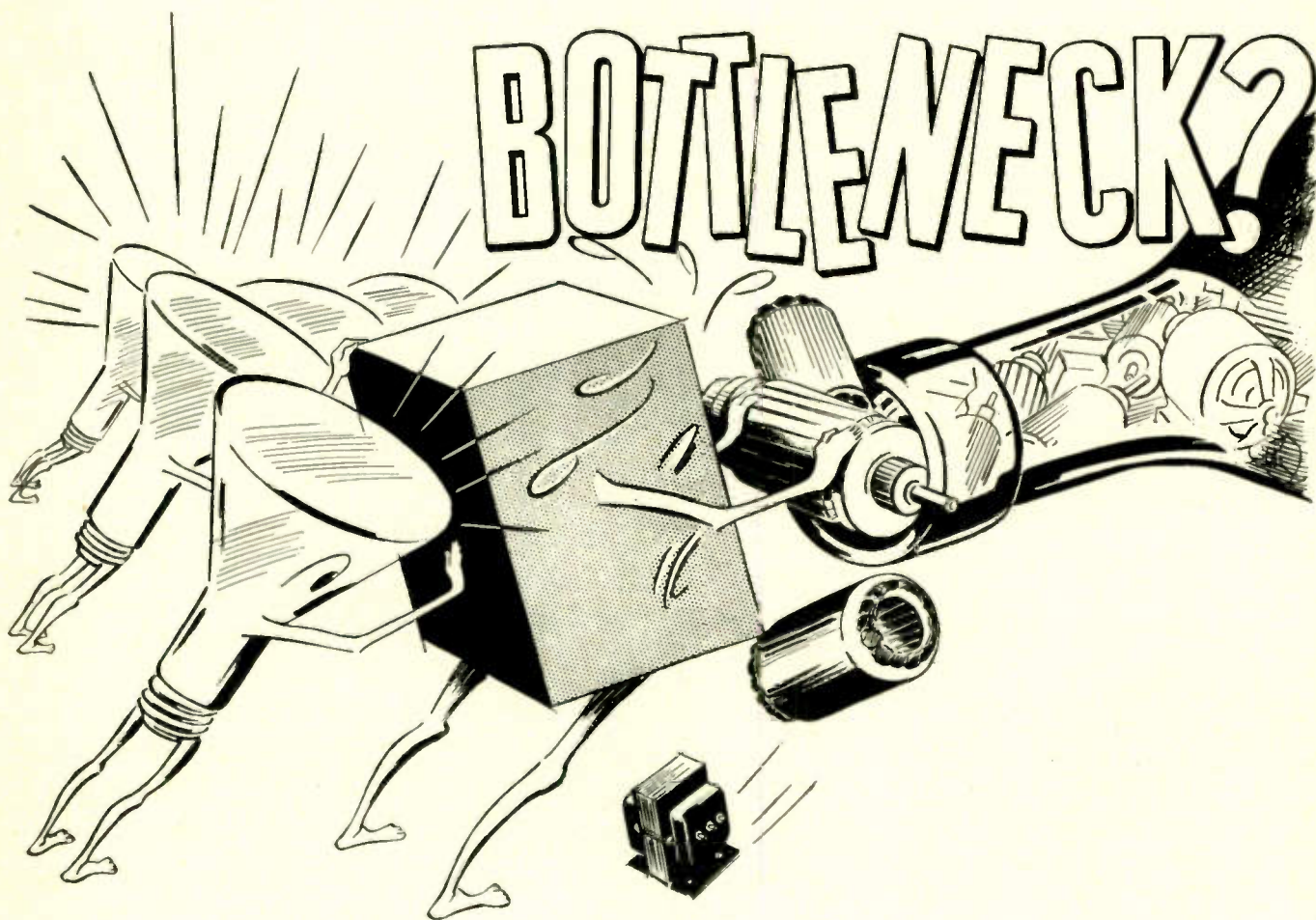

**T**HIS condition which needlessly consumes many production work hours can be found in any number of Electrical Manufacturing Plants today. Two basic causes of this bottleneck are: (1) Limited oven capacities. . . (2) Time required to thoroughly bake out varnish insulation.

As insulating varnish specialists, statement #1 is out of our line, but statement #2 is definitely our "baby." This problem we can handle with a new line of baking varnishes, all members of the proven and recognized SYNTHITE family; a line of varnishes especially formulated to cut baking time

to a minimum, yet retain the maximum of insulation. In this group are grades that will "cure" thoroughly in less than an hour; others will bake out at unusually low temperatures and all of them are highly adaptable to the various approved methods of insulating varnish application.

We are sure there is a varnish in this group that can save time for you. Give us an outline of your particular problem and we will send you without obligation, working samples, technical information, and our experience-backed counsel on adapting one of these varnishes to your production cycle.

*Insulating* **Dolph's** *Varnish Specialists*  
**JOHN C. DOLPH COMPANY**  
1060 BROAD STREET • NEWARK 2, N. J.

*Important advantages  
are yours with  
JOHNSON condensers*

Many evidences of superiority in JOHNSON condensers reflect the twenty-three years of experience that has gone into them. Each type is carefully designed by electronic engineers for maximum circuit efficiency. A primary design objective at JOHNSON'S has been the accomodation of a greater number of specific requirements with a standard condenser or minor modification of a standard. JOHNSON'S search for better design and methods is continuous and employs first class engineering talent and equipment. Many developments, such as the new plate design mentioned below, not only bring increased efficiency but a saving in cost.

JOHNSON offers many standard types from which to choose with capacities to 10,000 mmf, voltage ratings to 30,000. See your distributor or write to **Dept. O today**

Plates for types A and B condensers are of the new heavy rounded edge design recently developed by JOHNSON engineers. Their higher breakdown voltage permits closer spacing, a shorter condenser, lower minimum, and less inductance at UHF. These features combined with new end frame design reduce weight to minimum, yet cost no more, in most cases less because of the saving in material.

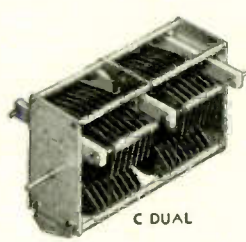
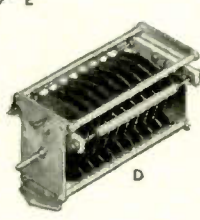
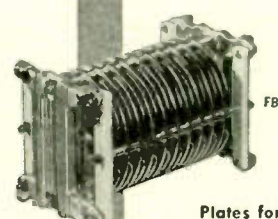
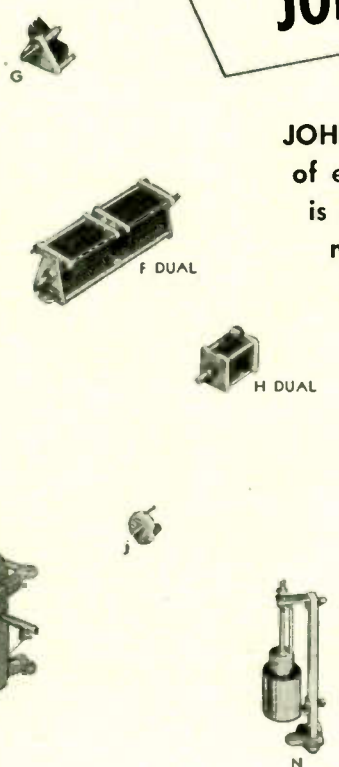
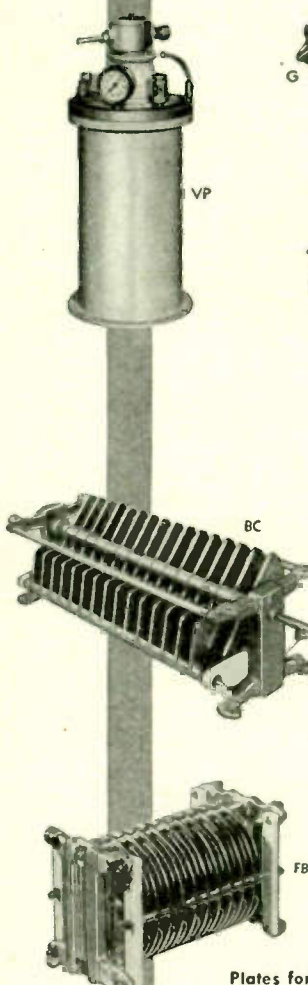

**JOHNSON**

*a famous name in Radio*

*Johnson products include*

- |                               |                      |            |
|-------------------------------|----------------------|------------|
| Condensers                    | Inductors            | Sockets    |
| R. F. Chokes                  | Q Antennas           | Insulators |
| Connectors                    | Plugs & Jacks        | Hardware   |
| Pilot and Dial Lights         | Broadcast Components |            |
| Directional Antenna Equipment |                      |            |

**E. F. JOHNSON CO., WASECA, MINNESOTA**

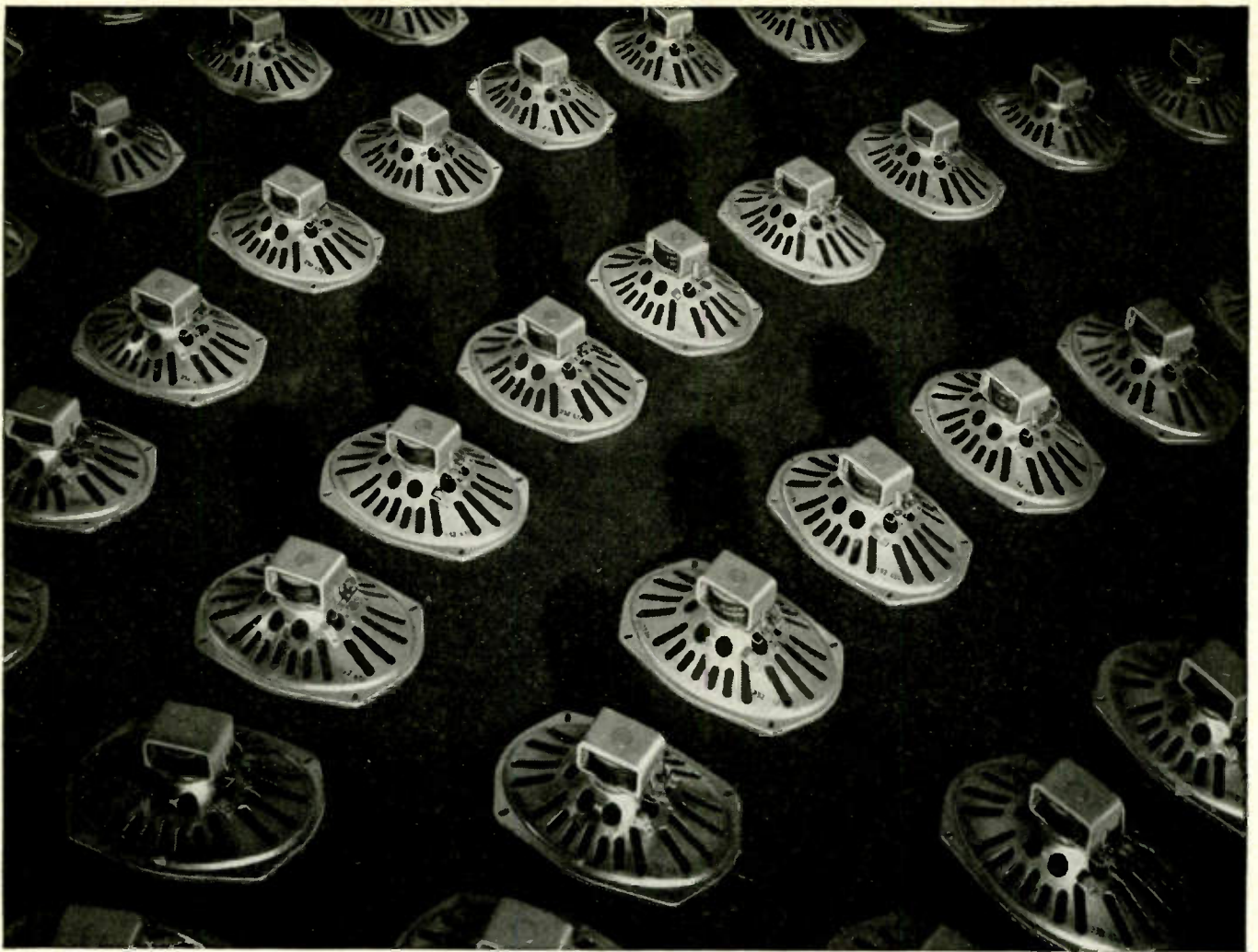

*Almost every radio set made in recent years has a Magnavox speaker or other Magnavox components.*

## **MAGNAVOX... first and foremost in the production of quality speakers**

**F**OR 35 years Magnavox has specialized in speakers and speaker satisfaction. The oldest and largest manufacturer of loud speakers, Magnavox is established as *the standard of quality*.

Magnavox designers and engineers have achieved a breadth of experience and knowledge that enables them to meet your specifications exactly. Over 160 different speakers are produced

expressly for the manufacturing trade.

Hard-to-satisfy research engineers constantly seek better speaker designs and production methods. They stand ready to apply their developments to your speaker problems. When you need speakers, specify Magnavox. There is no substitute for experience: The Magnavox Company, Components Division, Fort Wayne 4, Indiana:

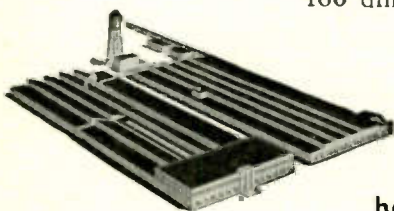

# **Magnavox**

has served the radio industry for over 30 years

**S P E A K E R S • C A P A C I T O R S • E L E C T R O N I C E Q U I P M E N T**



# ELECTRONIC INDUSTRIES

Including INDUSTRIAL ELECTRONICS

O. H. CALDWELL, EDITOR ★ M. CLEMENTS, PUBLISHER ★ 480 LEXINGTON AVE., NEW YORK (17), N. Y.

## Parting of the Ways— “Two Electronic Worlds?”

Guidepost to the electronic future is the significant article on the “fork in the road” which now confronts electronic engineers, published on following pages of this issue.

Most radio-electronic engineers already have been made aware of the widening gap between (1) *communications* and (2) the *industrial* uses of electronic principles. Communications ever becomes more specialized and complex. Industrial electronics demands simple rugged applications, as the new art spreads over a wide range of practical factory operations.

No longer is it possible to straddle these two diverging fields, each vigorously developing its own future.

## Color-Television Progress

Dr. Goldmark and his CBS associates are to be congratulated on producing color-television with a screen brightness approximating 16 ft.-lamberts, so that the pictures are enjoyably visible in a cozily lighted room (1 ft.-candle). As we watched CBS' new 48-frame picture, color break-up was absent. And the 7x10-in. screen, viewed at 10 ft. showed no trace of flicker (though it is likely that larger and brighter pictures, at greater visual angles, may need 60 frames to eliminate flicker).

One discouraging detail is the tremendous light-loss in the revolving color-screen system—for a black-white intensity of 150 ft.-lamberts is required at the tube face to deliver 16 ft.-lamberts at the color picture.

Color-TV experimentation should go ahead, with “open doors” and open minds among all television workers. But this is also not a time to confuse the public with general publicity on a color-TV system which has both *promise* and *problems!*

## Today Engineer Is King

We live in an engineering age. Contemporary civilization is pivoted on the slide-rule of the engineer.

Realizing his key position, the engineer instinctively subscribes to ethical principles. Far from being an unscrupulous, anti-social creature, every possessor of the true engineering temperament feels great moral responsibility to society.

But if the engineer is civilization's best friend, it must also be admitted that during the past four years

he has been its worst enemy. The machines and devilish devices dreamed up overnight in the laboratory have led to the wholesale slaughter of men and women and babes in arms.

The engineer does not subscribe willingly to lethal activities; indeed, he recoils in horror. But he becomes the unwilling tool of war because he does not know what else to do.

International cooperation between engineers can be developed, dedicated to the high ethics of technology and the humanities, and to the abolishment of war.

For there is no war without the engineer.

## Tubes and the New Competition

A large group of electronic engineers is now applying itself to equipping industry with production and control apparatus. These electronic aids can be counted on to speed output, save labor, and up-grade quality.

All of which links, as logically as can be, with the much-heralded New Competition, which promises to be hotter and faster than anything American industry has ever faced.

The New Competition calls for better products for the consumer, better fabrication, production and process methods and higher efficiencies in the use of manpower, equipment, materials, time and capital. It derives from the need of all industry to show profits in spite of higher costs of all kinds. Electronic methods will help.

## Meeting Human Limitations

As aviation, transportation, manufacturing and other mechanical services speed up, more and more dependence must be placed upon electronic aids for control and operation. This means that electronic apparatus must be made more complex, on the one hand, while its operation must be simplified and made more automatic on the other.

Admiral Luis de Florez summed it up before the “Instruments for Tomorrow” Conference at Pittsburgh when he said: “Men have about reached the limit of their ability to think quickly. Men are the limiting factor in an instrumentation, and you've got to design for them. You'll have to make the instrument read in some terms that will be more or less instinctive. If you don't you won't be able to capitalize on the developments of future science.”

# MICROWAVE TEST and

By WM. T. JONES

Evans Signal Laboratory

## Engineering details of some of the more important instruments and methods developed for determining behavior of VHF waves

• The development of microwave generating and receiving equipment and its use in radar and other electronic weapons during the war was paralleled by the development of microwave measuring and test equipment. The necessary basic research and development was carried on simultaneously at the Signal Corps and other Government laboratories, educational institutions under NDRC contract (Radiation Laboratory, Massachusetts Institute of Technology, etc.), and commercial concerns. Naturally, this has resulted in the production of many different types and almost countless variations of these types.

There are two principal types of wavemeters in use—coaxial line resonators and cavity resonators. The principal applications are either as transmission or reaction instruments.

Cavity type wavemeters generally assume the form of cylinders with one end fixed and a movable plate at the other end. A vernier type feed screw or micrometer head is

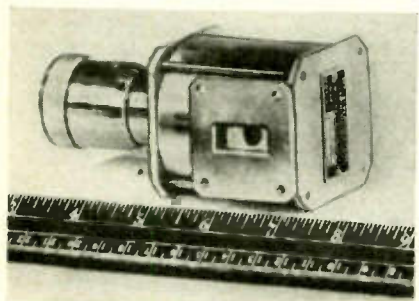

Fig. 1—Cavity type frequency meter for 3 cm

attached to the movable plate so that rotary motion of the knob will cause axial movement of the plate while retaining its parallel relation to the fixed end.

The principal advantage of the cavity type wavemeter is the high Q, hence, greater resolution which may be obtained.

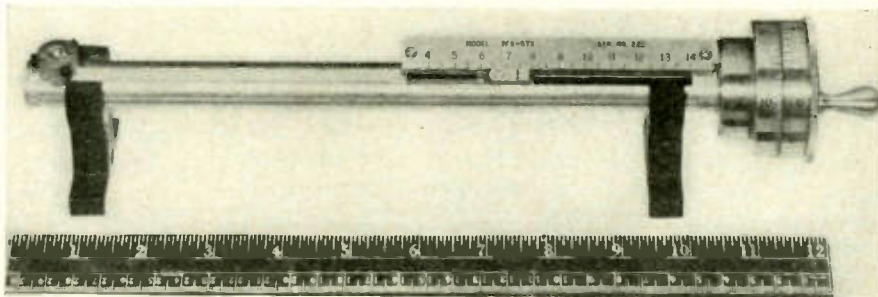

Fig. 3—Coaxial line type wavemeter suitable for measurements between 15 and 3 cm

The principal disadvantage encountered in the early designs of the cavity type of wavemeter was the fact that a cavity, for a given fixed frequency, may resonate at several different dimensions and, also, at different frequencies for one fixed set of dimensions. These resonance problems are reduced in various ways: by the method of coupling; by placing absorbing material behind the plunger; by inserting absorbing material in grooves parallel to the surface currents on the end plate, etc.

The cavity Q, in addition to dependence on the type of material

comprising the inner surface, is also proportional to the volume to surface ratio. Generally, the larger the cavity, the higher the Q.

Standard cavities consist of fixed cylinders. The resonant frequency of each standard cavity is measured and adjusted against a frequency

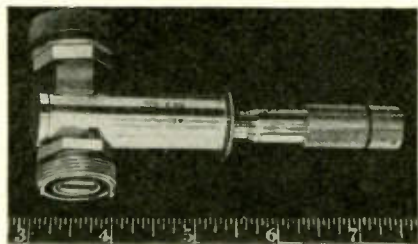

Fig. 2—1 1/2 cm open end coaxial line frequency meter

standard which is calibrated against WWV.

Cavity resonators may be made from Shelby tubing of steel or invar, sheets of copper or from other metals plated inside with copper, gold or silver. In some cases cavities may be constructed from non-conducting materials with the inside painted or covered with a thin layer of metal or metal foil.

Temperature and humidity affect the calibration of frequency measuring cavities. To overcome temperature sensitivity, cavities are constructed of low thermal distortion materials. Humidity effects are difficult to eliminate in tunable

The principal problems of these concerned with the development of test equipment are, the measurement of frequency, the quantity of power generated, propagated and received, the sensitivity of receivers and the impedance of transmission devices. Other types of measurements and tests are necessary and special equipments were developed and technicians devised to meet these special needs. Only a review of the general types and the fundamental principles of operation and equipment developed to measure and test the following quantities will be discussed and illustrated: (a) Frequency; (b) Spectrum Distribution; (c) Power; (d) Attenuation; (e) Standing Wave Ratio (SWR).

# MEASURING EQUIPMENT

cavities, but with standard cavities, the air is pumped out, dry inert gas pumped in and all openings sealed. With this type of instrument only a temperature correction chart need be supplied for extra precision, whereas otherwise a nomograph for relative humidity and temperature correction is necessary. Fig. 1 shows a 3 cm frequency meter.

Coaxial line type wavemeters consist of sections of coaxial line either shorted at both ends or at one end only. The resonant frequency of the assembly is varied by moving the center conductor in and out or by moving a disc, which connects the center and outer conductors, axially along the coaxial line. Coaxial line type of wavemeters can be constructed and used with convenience up to about 25,000 mc. Accuracies of measurement are within 0.3 mc at 3000 mc, 3 mc at 10,000 mc, and 50 mc at 25,000 mc.

With the coaxial line wavemeter shorted only at one end the instrument is tuned so that it resonates at  $\frac{1}{4}$  wavelength. This instrument can be calibrated so as to be direct reading.

With the coaxial line wavemeter shorted at both ends, the wavelength is determined by measuring the distance between the nodes or anti-nodes of the standing waves set up. Fig. 2 illustrates a  $1\frac{1}{2}$  cm open end coaxial line frequency meter. Fig. 3 illustrates a coaxial line wavemeter shorted at both ends, intended for use between 15 and 3

cms. Figs. 4 and 5 illustrate a field type of open end coaxial line frequency meter intended for use at about 10 cm.

## Coupling

There are three principal ways in which energy can be put into and removed from resonators, namely by: (a) Loops (magnetic coupling); (b) Probes (electric coupling); (c) Slots or holes (field linkage).

Microwave wavemeters may be used as transmission or as reaction (absorption) instruments. Examples are illustrated in Fig. 6. At the left the microammeter indicates only if the resonator is tuned to the frequency applied to the input. When the wavemeter is not resonant, it presents a high impedance between the indicating circuit and the signal. When the wavemeter is tuned to resonance, it presents a low impedance and power is coupled through to the indicating circuit. Wavemeter readings are observed when the meter deflection is a maximum.

In Fig. 6, at right, the distance to the point of insertion is such that the wavemeter arm presents a high impedance at the junction when the wavemeter is not resonant. At resonance, however, it presents a low impedance so that less power gets to indicating instrument. It can be seen that the wavemeter does not really act on the absorption principle and the designation "absorption type wavemeter" is somewhat of a misnomer.

Modulated microwave generating

electron tubes generate energy simultaneously at a number of frequencies. In order to determine the energy distribution through the spectrum and the magnitude of the rf energy output at the several frequencies, and the changes in magnitude and frequency that occur when the rf generators are subjected to different loads, the spectrum analyzer was developed.

The spectrum analyzer resolves the energy in the rf signal into separate frequency components and displays these as pips along the horizontal sweep trace of a cathode ray tube. The position of these pips along the baseline corresponds to their frequency; the height, to the power at that frequency in the spectrum of the signal.

A block diagram of spectrum analyzer is illustrated in Fig. 7. It consists of a well-shielded superheterodyne receiver having a crystal mixer and a klystron beat oscillator which is frequency modulated by a sawtooth voltage wave. This wave is also applied to the horizontal deflection plates of an oscilloscope, while the video output of the receiver is applied to the vertical plates.

The receiver bandwidth is made narrow so as to provide adequate selectivity to allow a true picture of the frequency distribution.

A calibrated attenuator is inserted between the pickup antenna and the receiver input to allow accurate determination of the relative amplitudes of various frequency components.

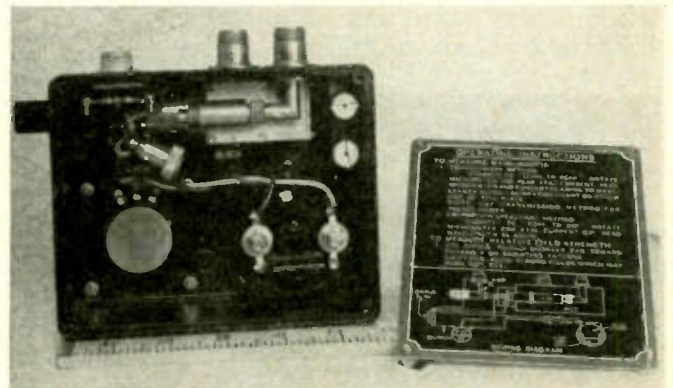
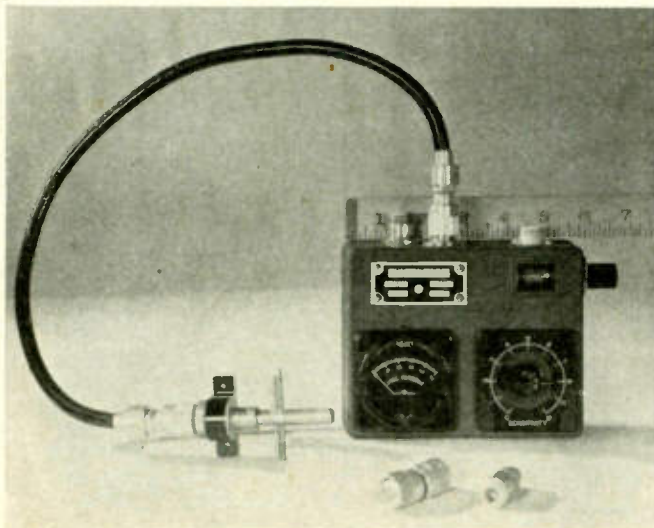

Fig. 4 (Left) and Fig. 5 (Below)—These photos show two types of open end coaxial line frequency meters for field use at 10 cm

When a signal is applied to the input of the receiver a plot of the frequency distribution of the signal is shown on the oscilloscope in

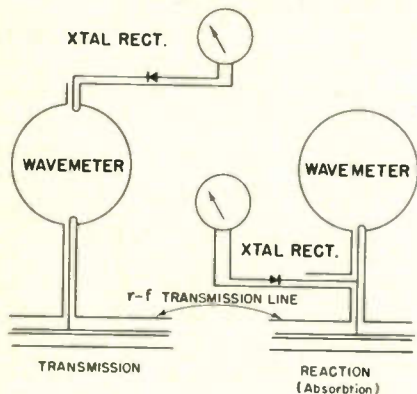

Fig. 6—Reaction type microwave frequency meter operating principles

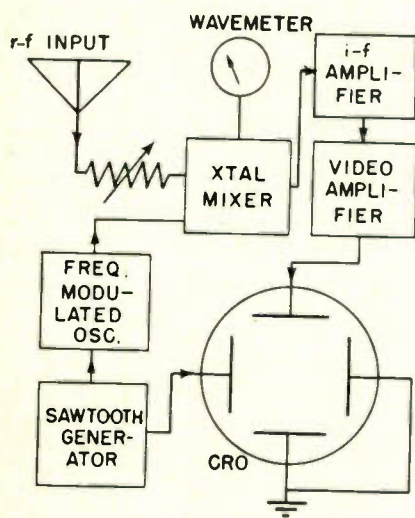

Fig. 7—Block diagram of a spectrum analyzer

the form of a large number of pulses, Fig. 8.

A marker pip for accurately determining the frequency scale on the oscilloscope is provided by the wavemeter connected to the crystal mixer. When the wavemeter is tuned to the frequency at the beat oscillator, it absorbs energy from a narrow portion of the frequency band through which the local oscillator is being swept. The dip in the crystal current produced by the wavemeter is amplified to form a pip which is fed to the receiver video and thence to the oscilloscope.

By tuning the wavemeter, this pip can be made to coincide with any frequency component of the signal appearing on the oscilloscope to measure its frequency. It should be noted that, since the pip is produced in the output of the local oscillator, as it sweeps through the frequency to which the wavemeter is tuned, its frequency differs from the signal frequency by an amount

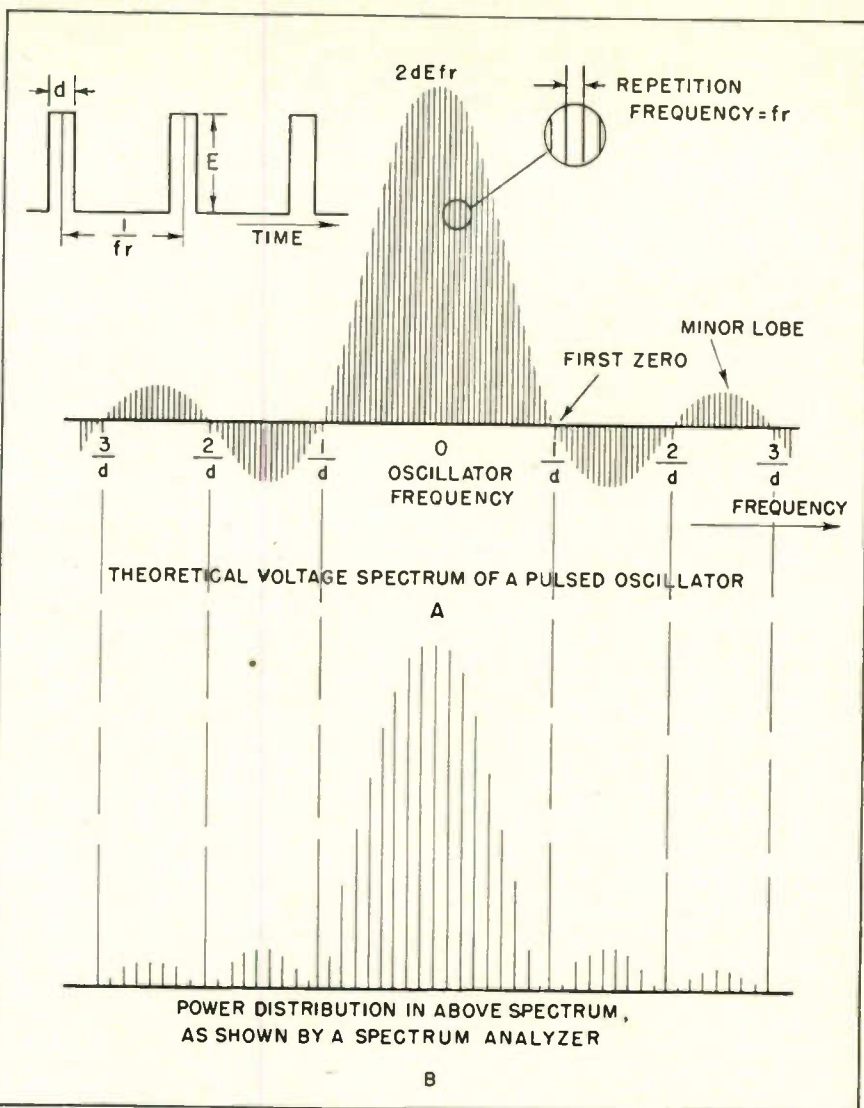
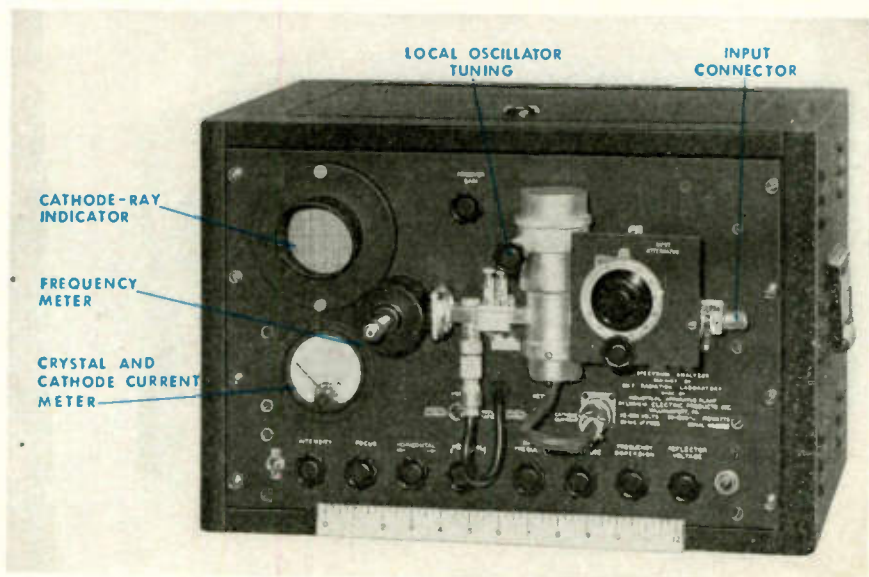

Fig. 8—Appearance of the pulses shown on an oscilloscope when a signal is applied at the input of the receiver. Frequency distribution of signal is illustrated

equal to the amplifier  $if$ . A 3 cm spectrum analyzer is illustrated in Fig. 9.

The rf sensitive elements of microwave power measuring or indicating devices may be divided into

Fig. 9—Spectrum analyzer suitable for 3 cm, with fundamental parts identified



four general classes.\* When placed in a field of microwave energy they indicate the presence of rf energy by: (a) Rectifying the applied energy; (b) Generating voltages; (c) Converting the rf energy into heat; (d) Altering one or more of the electrical characteristics.

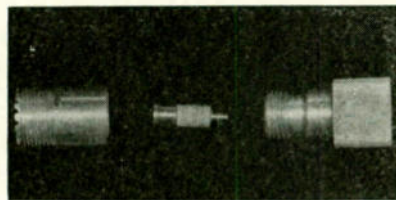
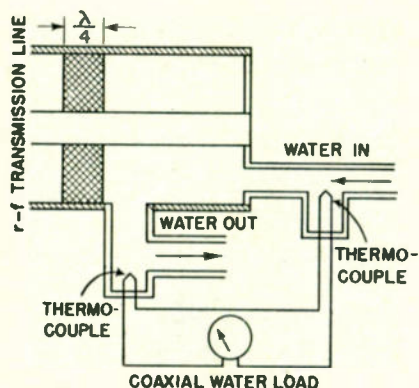

Fig. 10—Crystal and mount for rf power meter  
Fig. 11—Water load for measuring rf power



The principal types of rectifiers are the vacuum tube diode rectifier, the General Electric (GL-582, GL-559 and the 2B22), and the metallic rectifier (the crystals of the 1N20 series). The crystal rectifier was the most widely used of the rectifier types during the war. A crystal holder is illustrated in Fig. 10.

Crystal rectifiers are not recommended for accurate power measurement. They age, are easily damaged both by mechanical shock and electrical overload, and the calibration varies from crystal to crystal.

Thermocouples, which produce voltages when placed in a field of rf energy, were experimented with but not used extensively. Calorimeters are generally used as high level terminations for the rf energy being measured. The change in temperature in the termination, being proportional to the applied rf energy, may be used as a measure of the rf energy. Fig. 11 illustrates a water load. The change in temperature of the water is indicated by the thermocouples which are calibrated in terms of rf power. Water calorimeters are generally very accurate. However, their use is limited to laboratories.

\*SHF Power Measuring—H. Gregory Shea, Electronic Industries, June 1945, pp. 79.

Three devices wherein a change in resistance is brought about by the absorption of rf energy are the "Littlefuse", "Barretter" and "Thermistor".  $\frac{1}{32}$ ,  $\frac{1}{100}$  amp., and  $\frac{1}{200}$  amp. fuses are commonly used for bolometers.

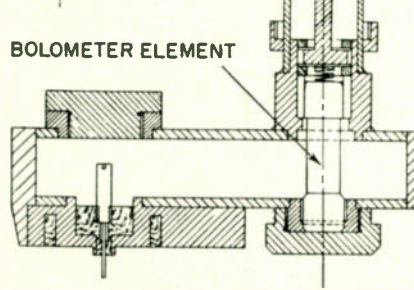
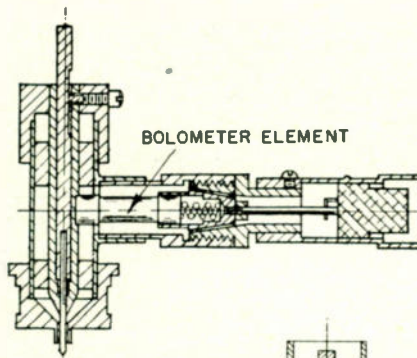
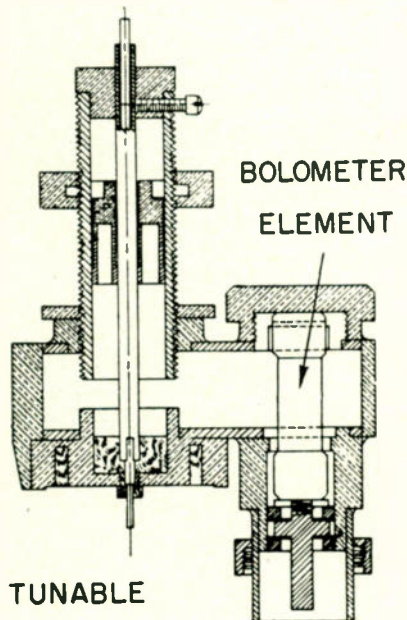

Fig. 12—Bolometer probe mounting construction

The time constant of these units is very small, so if the heating power is modulated at a low-audio frequency rate, the resistance of the fuse will be modulated at that rate. The changing resistance is normally used to modulate a small direct current and thus provide an audio signal that can be amplified. The response of these fuse units is accurately square law so there is generally no need to calibrate them.

The Barretter is a short length of extremely fine platinum wire mounted axially in a cartridge. The resistance of the wire increases with power dissipated.

It is used as one of the arms of a bridge circuit. When rf energy is applied, the resistance increases and the bridge becomes unbalanced.

### Thermistor beads

A thermistor is a mixture of metallic oxides with a high negative temperature coefficient of resistance, mounted on very small lead wires (to minimize heat conduction), and sealed in a glass bead with pigtail leads. Any kind of power dissipated in the thermistor raises its temperature and lowers its resistance. For frequencies in the order of 20,000-30,000 mc, the glass inclosure is omitted.

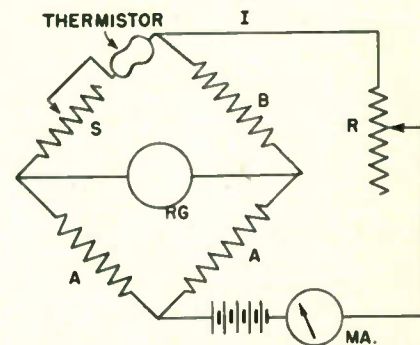
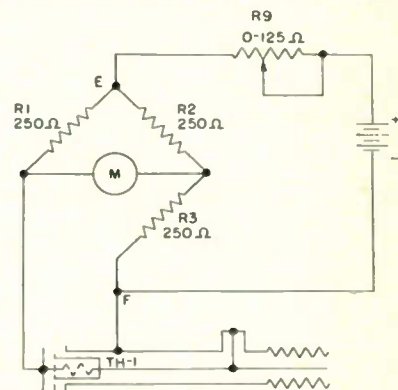

Fig. 13 (Above)—Fundamental circuit for a dc type of balanced bridge. Fig. 14 (Below) is an unbalanced type of Thermistor bridge



B BASIC THERMISTOR BRIDGE

The immediate success of thermistors in low level power measurement and their numerous advantages over other types of power monitoring devices resulted in their widespread use in military equipment. However, the possibilities of the others, such as vacuum thermocouples, coax-mounted lamps, and lamps used with barrier layer photocells warrant investigation.

The thermistor will detect microwatts and even fractions of a microwatt of rf energy if used in the proper type of bridge circuit. Sev-

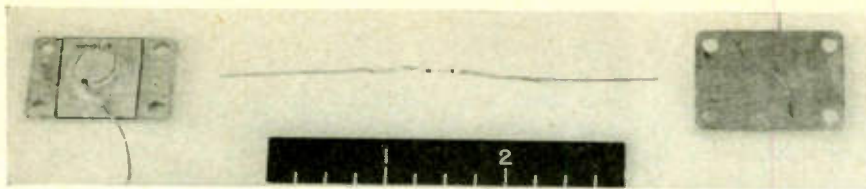

Fig. 16—Samples of disk compensating Thermistor and the Thermistor bead itself

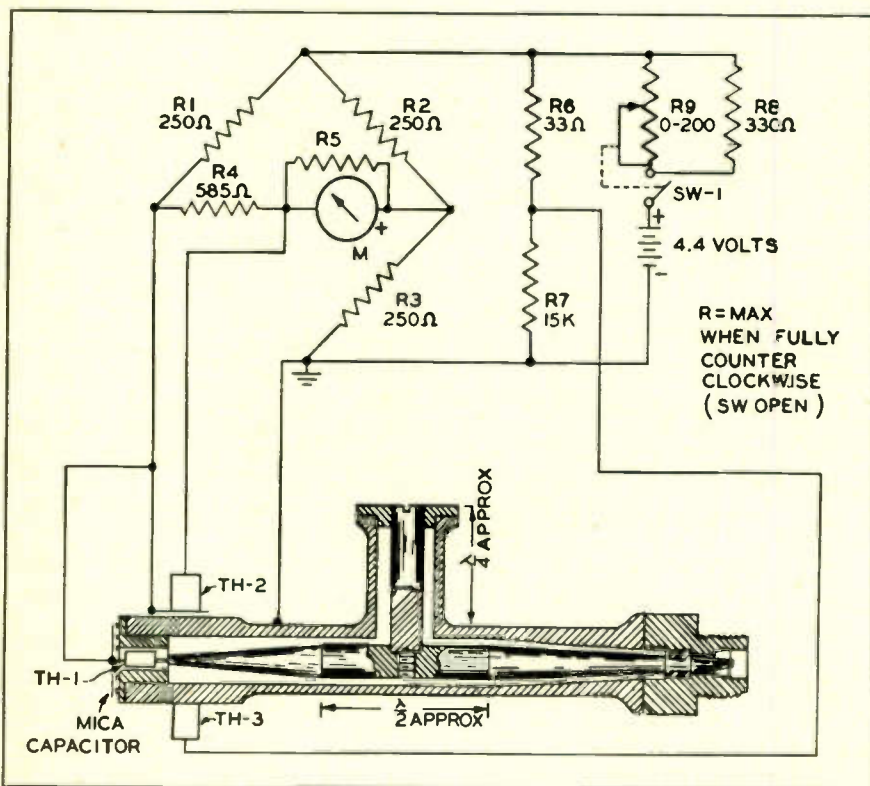

Fig. 15—Illustrating addition of Thermistor disc TH3 and network R6 and R7 to unbalanced bridge to eliminate need for readjusting balance control under ambient changes

eral hundred milliwatts are needed to damage it.

A basic circuit for a dc balanced type of bridge is illustrated in Fig. 13. The dc balance (using R at zero) is made first, and the rf balance is made with S. When the rf energy is applied to the thermistor it lowers its resistance. The difference must be made up by increasing S from zero.

Whereas the balanced bridge is unquestionably the best for precision or laboratory work, it is much too slow and cumbersome for field or even production line service. For such problems, the unbalanced bridge with bridge galvanometer calibrated in terms of rf power is ideally suited. The unbalanced bridge is calibrated with a separate (balanced) bridge, and if properly designed can be expected to hold its calibrations over long periods of time.

A basic circuit of an unbalanced thermistor bridge is illustrated in Fig. 14. The bridge is initially balanced by means of  $R_0$ . If the resistance of  $TH_1$  is changed by some

external means such as a change in temperature or by an rf field, the bridge becomes unbalanced, and the meter indicates a flow of current proportional to the change in resistance of  $TH_1$ .

In this circuit, the power meter always has to be kept at the same

Fig. 17—One type coaxial line Thermistor mount

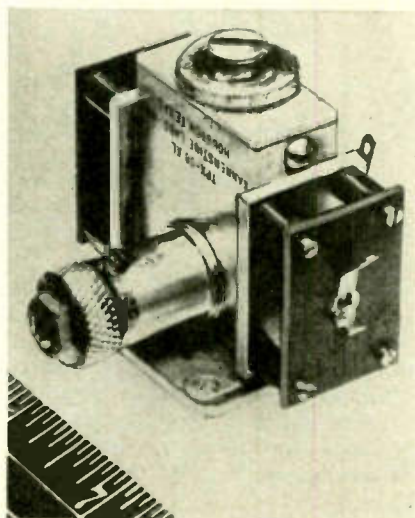

temperature when readings are taken in order to be sure that the bridge has not gone out of balance.

In order to reduce the need for readjustment of the balancing control when the ambient changes, a network consisting of thermistor disc TH3 and resistors R6 and R7, as illustrated in Fig. 15, is added. The thermistor disc is a temperature sensitive element spread out over a large surface. It is generally mounted on the housing for the thermistor bead.

The sensitivity of the thermistor bead is constant over a broad temperature range, but the bridge sensitivity (microamperes meter reading per milliwatt rf power) is not. Without any further compensating network, the thermistor bridge increases in sensitivity at lower ambient temperature.

In order to compensate for the change in sensitivity of the bridge in one direction, a circuit is introduced which causes an opposite

Fig. 18—Other coax line Thermistor mount types

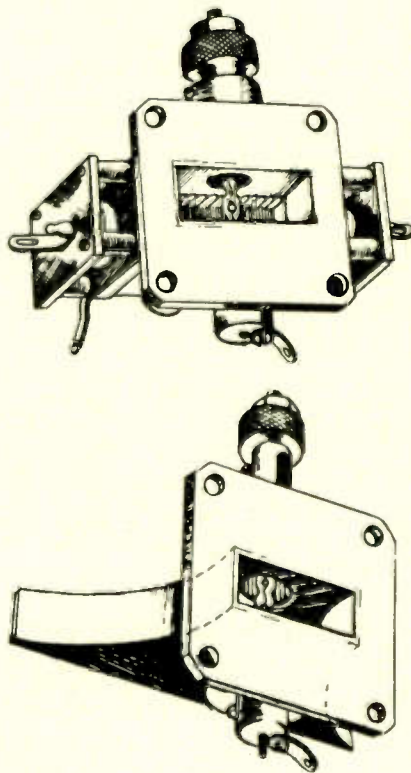

change in sensitivity. This compensation network is composed of R4 and TH-2. A trend toward increased bridge sensitivity at low temperature is offset by an increase in the resistance of the detector network. Increasing the resistance in series with the bridge galvanometer reduces bridge sensitivity. Proper design of the network can stabilize bridge sensitivity over a wide temperature range. Samples

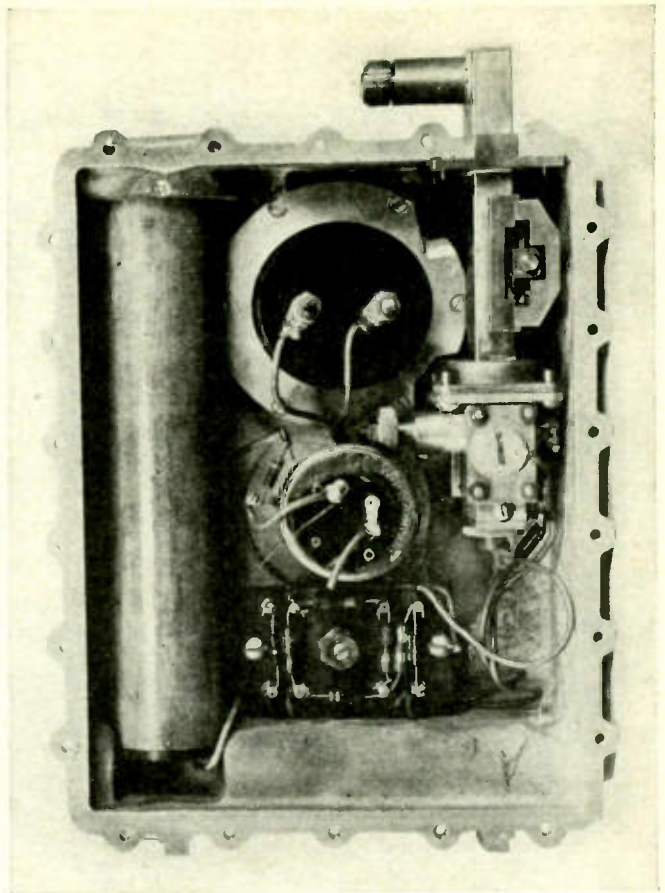

of the disc compensating thermistors and the thermistor bead are illustrated in Fig. 16.

One type of coaxial line thermistor mount is illustrated in Fig. 15. Other types of mounts are illustrated in Figs. 17 and 18. The front and rear views of a field type of power meter intended for 3 cm use are illustrated in Figs. 19 and 20.

#### Attenuation

Microwave attenuators are of two general types. The first class op-

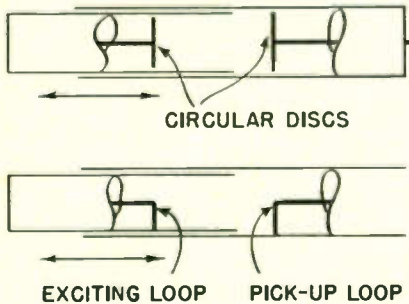

Fig. 21—Cut-off type microwave attenuator

Fig. 22—Resistor strip in dissipative attenuator

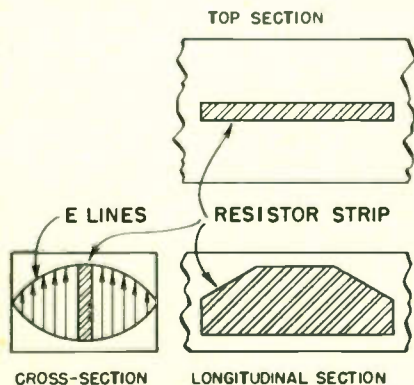
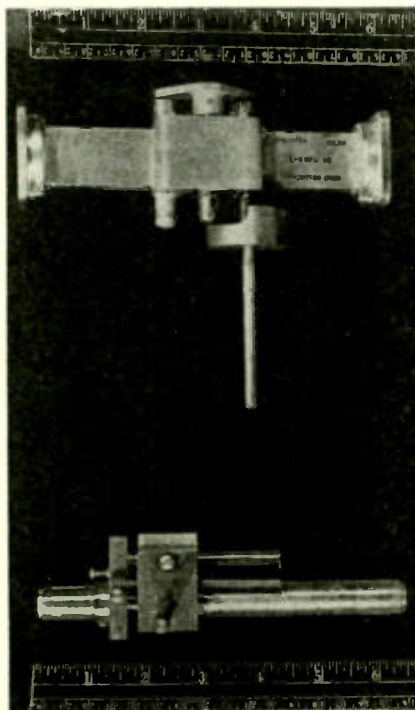

Fig. 19 (Above) and Fig. 20 (Right) — Front and rear views of field type power meter for 3 cm use

erates on the principle of a waveguide below cut-off. The second class operates by introducing dissipative elements to absorb energy. These will be referred to simply as the cut-off type and the dissipative type.

The cut-off type is used exclu-

Fig. 23—Variable resistive attenuator for 3 cm



sively as a variable attenuator. The outline sketches of the two principal kinds are given in Fig. 21. The theory underlying this type of attenuator is as follows:

Propagation through a waveguide takes place without loss provided the diameter or width of the guide is greater than the cut-off value. If these dimensions are below cut-off, then there is no longer any true wave propagation, but instead the fields are attenuated exponentially down the length of the guide. The attenuation per unit length, for any given mode, may be computed directly from theory.

As illustrated, one loop or disc is

Fig. 24—"Flap" type resistive variable attenuator

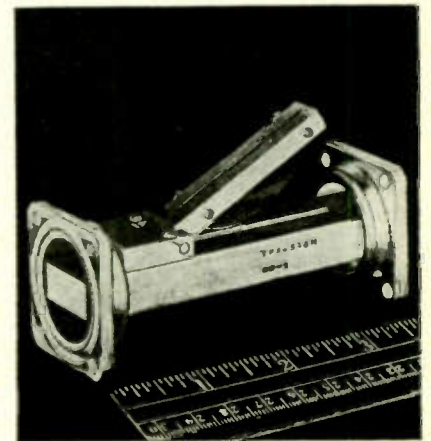

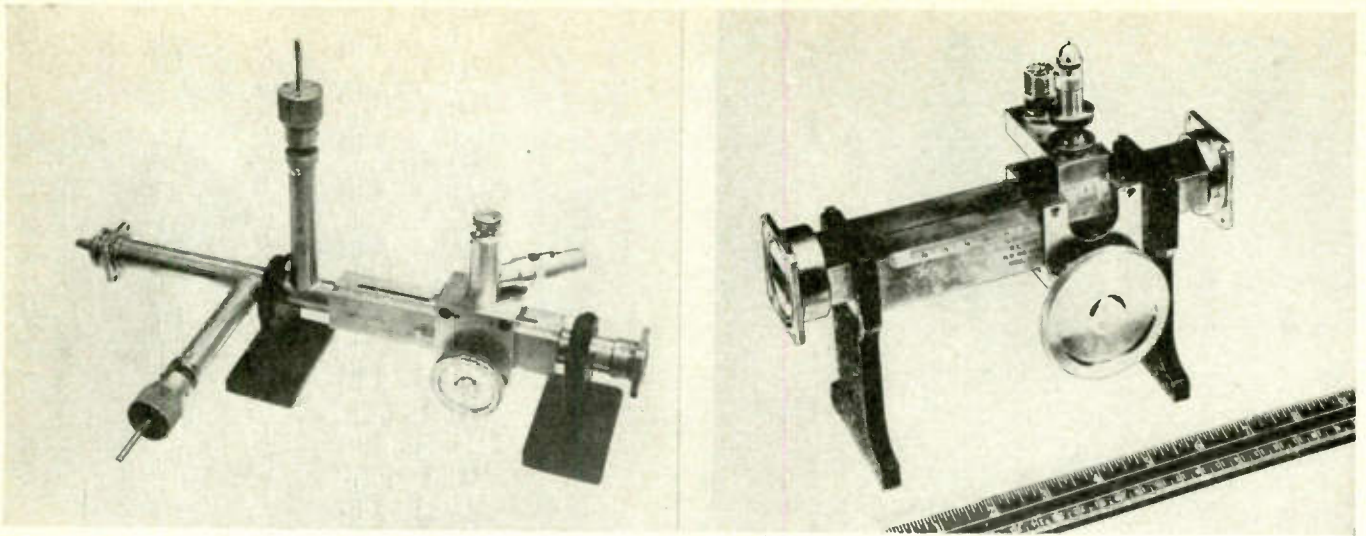

Figs. 25 and 26—Types of coaxial slotted sections useful for the measurement of standing waves

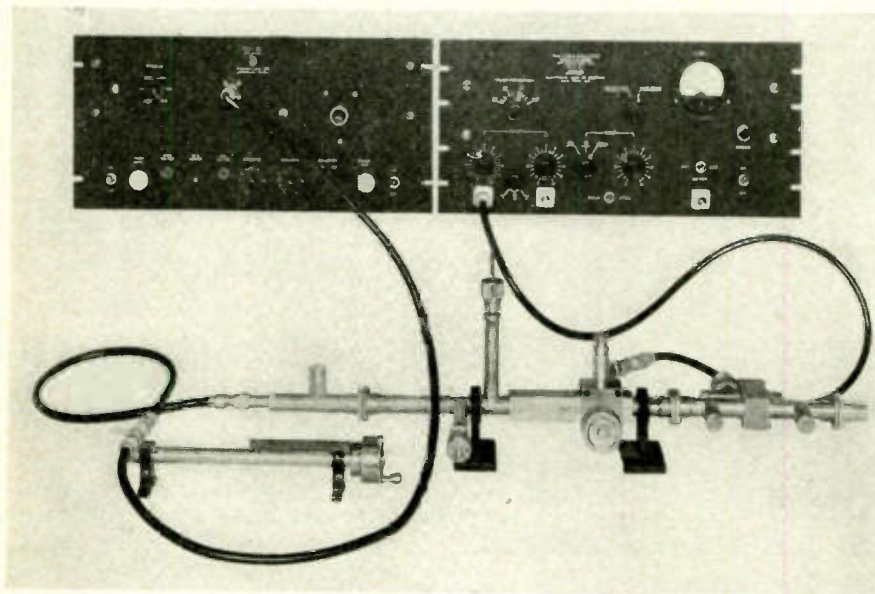

Fig. 27—Bench setup for making standing wave ratio measurements at 10 cm.

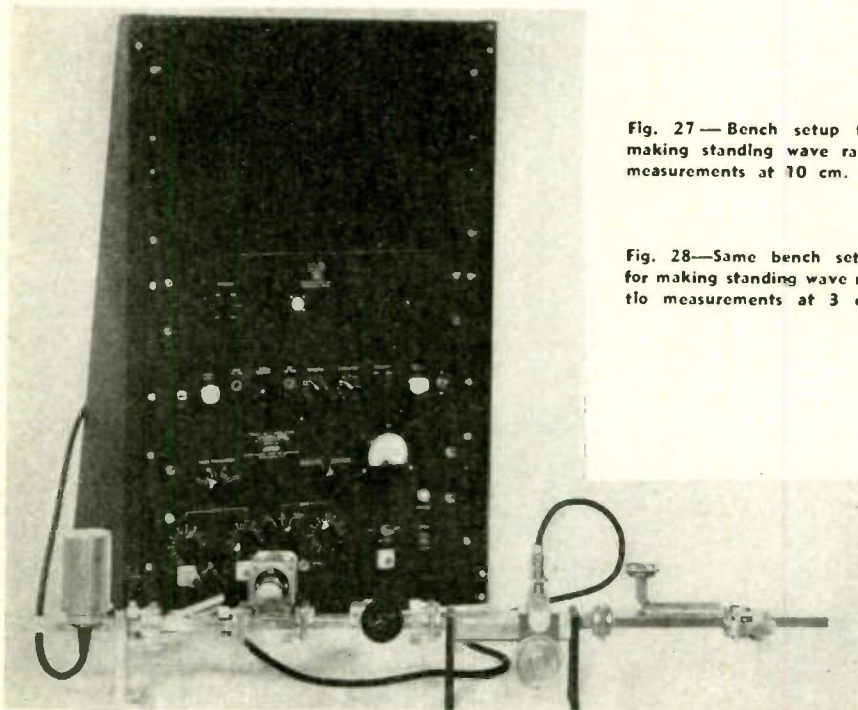

Fig. 28—Same bench setup for making standing wave ratio measurements at 3 cm

fixed, the other loop or disc being mounted at the end of a movable tube. By telescoping the tubes, the effective length of the guide between the discs is varied, changing the attenuation.

The usefulness of a waveguide-beyond-cut-off type of variable attenuator lies chiefly in the fact that it need not be calibrated against another standard of attenuation. Its slope (db vs the distance between the couplings) depends only on such factors as tube diameter, wavelength, and the constants of the fundamental coupling mode for which it is designed. All of these quantities can be readily determined by theory and measurement.

The disadvantage of the cut-off type of attenuator lies in the fact that the above statements are not true over the entire range of variation of attenuation, but are valid only for the range in the excess of a certain number of db,—a number which is known as the "insertion loss" of the attenuator.

In designing a cut-off attenuator, the most troublesome problem is that of reducing the insertion loss to an acceptable minimum. This is particularly difficult if the frequency band to be covered is a broad one.

If the cut-off attenuator is to be used at very large attenuations, it is quite important to guard against rf leakage. This leakage generally occurs through the low impedance coax-line formed by the cut-off tube and a loose-fitting adjustable insert. It is reduced by good finger contacts, rf chokes, and poly-iron sleeves around the insert. Poly-iron is insulated powdered iron such as is used for radio frequency iron cores.

(Continued on page 135)



# INSTRUMENT TRENDS

By WINFIELD B. HEINZ

Consulting Engineer, Bound Brook, N. J.

## ***U. S. far ahead in design, development and use of modern measuring and control equipment—What the future holds***

● The United States has been leading the world in industrial instrumentation to an extent never realized until our instrument engineers got into Germany after V-E Day. Their report\* discloses the surprising fact that Germany was years behind us in the use of instruments for control of manufacture. They underestimated our productiveness in part because they had no conception of what could be done by combining instrument design and manufacturing talents and those of instrument users.

In view of the well-known fact that atomic processes culminating in the bomb would have been humanly impossible without full remote and automatic operation of complicated reactions behind heavy shielding, Germany would have required more time to utilize atomic energy than popular comparisons of scientific progress might suggest. They would have been immeasurably delayed by the gap between scientific knowledge and industrial use of it—because they did not know how to instrumentize their manufacture.

### ***Wartime advances***

The wartime advances in American instrumentation were achieved partly because money became available for the best methods, regardless of cost. Economic doubts which might have prevented management from using the same in peacetime have been dispersed by war production performance; and degrees of automatization which might have required years to prove are now established successes in industrial thinking.

Further advances will be accelerated by realization among instrument manufacturers that their commodities have become essential

industrial components, less frequently requiring special proof that instrument purchases will return profit. No longer must prices be kept at figures which have always held the instrument industry in a low-profit bracket.

### ***Probable developments***

The flow of advance will move in numerous directions. Such channeling as might be predictable probably will draw a goodly proportion into the stream of electronics, particularly for measurement uses. Modern electronic amplifiers and servo-mechanisms for maintaining null balance have made more fully available the inherent advantages of thermo-couples and resistance thermometers for temperature measurement. By these means also have the numerous applications of resistance strain gages become practicable; and although the current surge toward strain gages will probably subside to some extent, those primary elements will no doubt be carried to a considerable level of success.

In automatic control, electrical methods are, as always, handicapped by their final control elements. Electrical valve operators (except for small sizes) are still as they always have been—heavy, complicated, expensive, and probably less reliable as compared with diaphragm valves for pneumatic actuation. No new developments to alleviate this situation seem to be in prospect for the near future years.

Great increases in speeds of electric automatic control actions have been achieved through wartime servo-mechanism development. New types of motor actuators, magnetic clutch devices, etc., will become available for industrial uses.

The strength of hydraulics shows principally in applications requiring transmission of power at high

force levels. There it continues to advance. In automatic control its most notable trait is exceptional stability.

In the field of pneumatic technology the trend is away from the use of pneumatic components merely as accessories in mechanical assemblies of levers. Pneumatic relays now can enter into numerous circuit combinations, just as vacuum tubes do in electronic circuits. Pneumatic amplifiers of great simplicity now multiply forces of any smallness by adjustable factors ranging from unity toward 2000 in single stages.

### ***Remote transmission***

The outputs from conventional types of measuring elements can be introduced into pneumatic circuits for translation into indicated or recorded measurements at hand or remote, and into automatic control actions. Such circuits as developed by several manufacturers possess dynamic characteristics directly analogous to those of electric circuits, and feature a minimum of mechanism.

The current trend toward remote transmission of measurements will be accelerated both by pneumatic and by electrical development. It is to be expected that new servo-mechanisms which helped win the war will reappear in industrial forms.

Experience with war plants has disclosed the fact that too much space is required in control rooms fully instrumented with present-day equipment. Engineers in the field are asking for more multi-record and multi-range instruments for all the variables, and for completely redesigned instruments to achieve greater compactness in panel layout.

Although critical discussion of the

*(Continued on page 136)*

\*Report No. PB-4600, Field Information Agency, Technical, "Study of the Industrial Processing Instrument Industry in Germany," November 17, 1945.

# TWO Electronic

## I. Tele-Communications (Vertical)

### Communications

#### Broadcasting

##### SOUND

AM  
FM  
Pulsed Modulation  
International  
Transmitters  
Receivers

##### PRINT

Facsimile  
Teletype

##### SIGHT

Television, Black-White  
Color  
Transmitters  
Receivers

#### Point-to-Point

##### MARINE

Ship-to-ship  
Ship-to-shore

##### RAILROAD

Signalling  
Point-to-train  
End-to-end  
Terminal  
Yard

##### POLICE

##### FLEET CONTROL

Taxicab  
Truck

##### COMMON CARRIER

Metropolitan  
Highway  
Telegraph  
Multiplex relay

##### AIRPLANE

Airport  
Interplane

##### INTERCOMMUNICATIONS

##### CARRIER SYSTEMS

#### Sound

SOUND PICTURES  
RECORDING  
PUBLIC ADDRESS

#### Airline

##### Landing

##### Navigation

DIRECTION FINDING  
LOCATION MARKERS  
AIRWAY CHANNELS

##### Altitude

##### Anti-collision

#### Musical instruments

#### Radar

Marine  
Airplane  
Train

#### Army, Navy, Coast Guard

Special designs—entire field

● The electronic industry has come to a crossroad, clearly-defined.

Unmistakable is the growing divergence between the basic interests of communications and industrial people, the two main groups in the field.

One group, essentially *communications-minded*, is responsible for product development, manufacture, distribution and operation, in radio, television, facsimile, phonograph and other fields allied with sound or sight reproduction. They have many war-learned lessons to apply and an infinite number of peacetime opportunities to develop.

The *industrial* group on the other hand, uses the same basic electronic concepts and many similar parts—but uses them in other ways, to secure far different kinds of results. This group is putting the electron tube to work in the control of electrical and mechanical quantities, qualities, and operating efficiencies. Its engineers are specifying electronic methods for industrial heat-treating, processing and fabrication, and are using the flexibility and wide range of electronic instrumentation to step up industry technics in automatic operations, in measurement and to improve knowledge in many technical fields.

#### Comes of age

The electronic industry has been growing for over a quarter of a century. Its beginnings were small. It was a part of the electrical field. Its technics were one of the studies of electrical engineers.

As it became more important, it evolved its own methods, its own organization and became substantially separated from the older electrical industry.

A lusty infant, it grew to giant size during the war, absorbing in its intricacies a large proportion of the analytical and inventive genius of the country.

Definitely of full stature now, its growth lately has become two-headed, as increasing use of electronics for other than communications purposes has created a new

class of interest—that of the industrial user of electronics. This industrial group is big.

It is worth recalling, as a measure of jobs already done by the industrial contingent that the total of the rated tube power used today to heat or treat metals or dielectrics electronically is five or six times the tube output ratings of all the commercial broadcasting stations in the United States.

The separate ranges of interests and activities of these two groups already are so extensive that it is worth writing down here some of the accomplishments and areas of growth which each can boast of.

#### On the communications side

Certainly no slackening can be noted in the inventive genius being daily manifested in the communications field. Directly within reach and certainly due for early commercial development are spectacular improvements in black-white and color television, frequency modulation, microwave, facsimile, multichannel as well as regular broadcasting services. The ability of men to communicate with each other rapidly and conveniently for the exchange of intelligence, whether relating to news or information about individuals, the conduct of business, safer and faster transportation or to the exploration of resources is growing daily.

After many years of growth, development and field testing, frequency modulation broadcasting is only awaiting availability and delivery of essential components before becoming a major addition to the fare served up for millions of listeners. Many original and ingenious circuits and components brought forth almost daily occupy the attention of designers and producers in this field. Numerous problems still exist and await the simple and practical solution which only constant use over wide areas will bring forth.

Meanwhile communications has made giant strides in equipping not only police but commercial truck

# WORLDS!

1. **TELE - COMMUNICATIONS.** In the widening communications field there's increasing specialization and continued emphasis on technical engineering.
2. **INDUSTRIAL & INSTRUMENTATION.** Throughout general industry practical applications of electronic methods to plant equipment and to improved processing, are expanding rapidly.

fleet and taxicab operators with dependable radio systems. Important devices for selective calling of one of a number of receivers have been and are continuing to be brought forth. The telephone company has invaded the field with an ambitious plan for giving universal mobile service.

Similar technics are being applied increasingly to the railroad field, and most roads have established electronic groups within their telephone and telegraph departments to pursue further installations in an aggressive manner.

The airplane field, seemingly growing in all directions at once, provides a wide open market for electronic devices not only to transmit flight information but also for numerous navigational purposes such as landing under low visibility conditions, prevention of collisions, measurement of altitude and indication of position and direction. Only economic considerations and development of the best devices present stumbling blocks here.

Other rapidly developing areas of communication are the shipping, teletype, carrier and intercommunication fields.

Much money is being spent for new pulse modulation broadcasting and point-to-point systems as well

as sound devices, recording units and even musical instruments.

Facsimile broadcasting and point-to-point service is on the threshold of major development. Sets are projected for installation in homes to receive morning newspapers, women's pages, instruction and fiction material.

Television is at last not "around the corner" but actually about to burst forth as a major industry within weeks or months!

The Army, Navy and Coast Guards are themselves immense sources of development and users of electronic communications technics.

All of these fields of endeavor are at present related fairly closely by similar technical problems and use of similar equipment.

## Electronics in industry

Electronics in industry is developing along *different* lines.

Almost every alert business executive has had to take repeated looks at his plans and programs for the future to find out just where and how electronic methods could enable him to sponsor improved products, to secure better results and less costly or lengthy intervals for processing or to make his factory operations faster, more eco-

nomical or safer, or all combined.

The extent to which such activities have been reflected in industry remains small in comparison with the exploratory work which has been done. In many instances, proposed plans await only a favorable moment to get production or installation OK. *Electronic methods in industry are due for an expansion of all but incredible proportions.*

To a degree, the problem becomes that of putting standardized units or components to work. Many of the notable electronically-supervised products developed by industry are, as in the case of the machine tools of one well known maker, more accurate, more effective, more reliable and faster in operation than their purely mechanical counterparts.

The glamour days, when emphasis was placed on what electronic methods *might do* in industry, are over. *The job now is a bread-and-butter one of practical realities.*

What do electronic methods do in industry? They are serving no less than six major functions.

## Energy supply

Supplying energy of just the precise characteristics required for the most efficient operation of

## 2. Industrial Applications — Electronic Equipment and Instrumentation

(Horizontal)

### Measuring & Recording

TELEMETERING  
COUNTING  
COMPUTING  
GAGING  
DETONATION  
MICROSCOPY  
TEMPERATURE  
ENCEPHALOGRAPHY  
ELECTROCARDIOGRAPHY  
STRESSES  
DISPLACEMENTS  
POSITION  
VELOCITY

### Detecting & Indicating

CONTAMINATION  
UNBALANCE

### Control & Regulation

#### PROCESS CONTROLS

Flow  
Purity  
Level  
Color matching  
Sorting  
Moisture content  
pH  
Fluid-Heat flow

#### MACHINE CONTROLS

Timing  
Speed  
Torque  
Travel  
Contour  
Alignment  
Welding Cycle

### Energy Supply

FLASH ILLUMINANTS  
RECTIFIERS  
INVERTERS  
POWER SYSTEM COUPLING

### Protection

CRIME PREVENTION  
SAFETY DEVICES  
INSECT EXTERMINATION  
FOOD PRESERVATION  
TRAFFIC CONTROL

### Physical Processing

HEATING  
Induction  
Dielectric  
DRYING  
CASE HARDENING  
SOLDERING  
PRECIPITATIONS  
PLANT STIMULATION  
DIATHERMY  
THERAPEUTIC  
COOKING  
WELDING  
HEAT TREATING  
FOOD DE-FROSTING

## Principal Industry Groups (U. S. Dept. of Commerce Classification)

- |             |              |              |               |                  |                 |                    |
|-------------|--------------|--------------|---------------|------------------|-----------------|--------------------|
| 1. FOOD     | 4. APPAREL   | 7. PAPER     | 10. PETROLEUM | 12. LEATHER      | 15. NON-FERROUS | 18. AUTOS          |
| 2. TOBACCO  | 5. LUMBER    | 8. PRINTING  | & COAL        | 13. STONE, GLASS | 16. ELECTRICAL  | 19. TRANSPORTATION |
| 3. TEXTILES | 6. FURNITURE | 9. CHEMICALS | 11. RUBBER    | 14. IRON, STEEL  | 17. MACHINERY   | 20. MISC.          |

products, machines and industrial equipment. This means that literally every possible variation in methods of applying energy has been harnessed. Such variations include those of voltage, current, frequency, wave form, rectification and amplification.

Practical applications in this category include the installation of large banks of rectifiers for medium or high voltage DC applications, inverters for changing direct into alternating current and inverter-rectifier combinations for coupling 25 cycle and 60 cycle systems. Also available are amplifiers for servo motor applications, supply units for variable speed motors and other similar devices.

#### **Controlling and regulating**

By means of signals obtained from photocells, timing devices, inductance, capacitance and frequency variations, quantities of materials, solid or liquid, hot or cold can be regulated and flow subjected to precision handling. Strength of mixtures and presence of impurities may be determined from dielectric constant variations. Lights can be turned on or off or their intensity varied or held constant. In fact almost any control or regulation problem has an electronic solution.

#### **Protecting**

Industrial operations, processes and equipment can be protected from faults and hazardous conditions detected. Sensitive burglar alarms may be made and electric

fields established to detect immediately the presence of undesired persons or objects.

#### **Measuring, recording and counting**

By electronic means various mechanical, electrical, physical and chemical values can be found to meet production or processing needs. For example, slide fastener manufacturers use quantities of electronic counters to insure that both halves of each fastener will have the same number of teeth. Manufacturers of internal combustion engines observe detonation conditions during operation. Processors of all kinds read meters at a distance by electronics. Unbalance in turbine and motor rotating parts is measured and located. Strain and loading of machines and structures can be observed under operating conditions. In fact, supervision of all kinds of intervals, dimensions, flow changes, intensities, quantities and qualities can be had.

#### **Detecting and indicating**

Either the absence or the presence of foreign materials in package or bulk goods can be determined. Thus finished packages of bandages and other surgical items can be examined continuously in the shipping room without delay or opening.

#### **Altering properties and characteristics**

Various physical, electrical and chemical properties of materials

can be altered during research and processing. Some of the functions here involved are heat treating, drying, case hardening, high speed soldering, electrostatic precipitation and dielectric heating.

#### **Toward progress in each field**

It is easy to see that *communications* men and those responsible for various *industrial* applications have little in common except the tubes and component parts which are used by both. The pre-occupations of the former are likely to be far too theoretical and circuit-minded for the practical specifier of packaged units or factory-designed assemblies intended to upgrade production and trim shop costs.

The relatively ABC viewpoint of the *industrial* man toward electronics is an appreciable hindrance to the establishment with *communications* men of valid common denominators of interest.

Once again, a great engineering art and practice has outgrown the confines of its original concept. But each electronic group now goes forward *separately* and energetically in its own direction. Each will make progress faster, unhampered by the other.

The *tele-communications* technical group is on the march to new achievements.

And the *industrial* and *instrumentation* group is mapping out new victories in control and mass production on a thousand industrial fronts.

## **WHITE'S "TRON FAMILY" GROWS**

In the January issue of *ELECTRONIC INDUSTRIES* there was published a long list of trade names, terms and other words all ending in the suffix "tron" and appearing under the heading "The Tron Family". The list was compiled, over a period of years, by W. C. White, electronics engineer of the General Electric Co., Schenectady. Since appearance of the list a number of additional "trons" have been located by engineer White, as follows:

**Autotron**—A trade name for a photoelectric tube counter of small objects dropping through a chute, manufactured by the Autotron Co., Danville, Ill. *Electronics*, April, 1946, p. 290.

**Barytron**—Another name for a Mesotron. *Electronics Dictionary* by N. M. Cooke and John Markus, published in 1945 by the McGraw-Hill Publishing Co., New York, N. Y., p. 224.

**Cardiotron**—A trade name for an electrocardiograph made by the Electro Physical Laboratories, Inc., New York, N. Y. *Electronics*, April, 1946, p. 274.

**Dynectron**—An evacuated mercury cell acting as a commutator, for use in place of a vibrator for auto receiver 6 volt dc to ac. A trade name of the Ohio Tool Co., Cleveland, Ohio. *Electronic Industries*, March, 1946, p. 68.

**Elastron\***—Trade name for an orna-

mental and functional plastic manufactured by the Industrial Synthetics Corporation, Irvington, N. J. *Electronics Buyers' Guide*, June 15, 1946, p. 123.

**Hartron**—A trade name for a tape recording device formerly called the Recordgraph. Has 115 embossed grooves on a 50-ft. film belt. *Radio Craft*, December, 1945, p. 167.

**Ionotron**—A static eliminator for moving materials uses a foil with a radio-active surface. Made by United States Radium Corp., Electrical Equipment, February, 1946, p. 12.

**Limitron**—Trade name for a limit

(Continued on page 137)

# INSTRUMENTATION

## **Industrial electronics plays important part in first annual conference and exhibit of the Instrument Society of America**

● At the first annual conference of the Instrument Society of America (Pittsburgh, Sept. 16-21) approximately 5000 registrants were shown many advances in process control methods and apparatus—the things that have permitted this country to build up the most gigantic production program ever conceived. Primarily an instrument is any sort of a tool but it was shown that the basic concepts upon which this science is built transcends all simple tools and deals with the regulators and mechanisms that automatically act when changes in a production process are indicated by other instruments: the measuring devices.

During the first three days members of ISA (a group that includes both instrument designers and those who select, install or use such equipment) joined with the Industrial Instruments and Regulators division of the American Society of Mechanical Engineers in a number of meetings dealing with the technical and engineering aspects of instrument design, as applied to combustion control methods, gas analysis and the measuring and control of flow rates.

### **Origin of new society**

ISA was formed last year through the union of ten local societies in industrial centers throughout the country whose members are interested in the various phases of regulation and measurement of the factors affecting production processes and soon had 22 of these local groups as charter members.

The principles of instrumentation spread horizontally across all industries. The regulatory processes that have become essential in one industry once had little resemblance to those in another field. A few years back however, it became evident that there was an underlying basic concept and that most measurement and control systems were combinations of a primary group of simple ideas, al-

though several mediums were selected to carry out the control functions—pneumatics, hydraulics, electronics, etc.

The Instrument Society came into being because this common basis of continuously regulating the components of a production system was found. Following the theme of the conference "Instrumentation for Tomorrow," at both the program and the equipment display, the latest methods of measurement and control were divulged. Many registrants who were active in the electronic field were interested in remarkable systems that satisfactorily handled intricate control problems without the need for vacuum tubes. Then there were those experienced in older methods using hydraulic pneumatic or other arrangements, who were interested in the many possibilities and newer features embodied in the electronic systems. Such competition between the basic control mediums is healthy, and probably the greatest good coming from these conferences is the realization that the best control system may often be that which utilizes

The accompanying graph gives the general range of exhibits at the I.S.A. Conference. It is based on the principle product of each company, rather than on a detailed classification of each instrument in the show, since it is practically impossible to classify the innumerable minor items that were usually offered as accessories to the main products exhibited.

(1) Electronic Instruments for Industry and Laboratory—These were mainly measuring instruments of the semi-portable type, such as electronic gages, timers, computers, etc., though some devices for continuous flow inspection or counting, as well as for physical research, were included.

(2) Industrial Controls and Regulators—This type of equipment includes mechanical, electrical, photo-electric, and electronic devices

the best features of all methods.

Instrumentation is, at present, an enormously diverse field and this diversity was reflected by the papers and exhibits. Yet this convention, big as it was, could provide only a small sampling of the entire instrument field.

Since the term "instrumentation" admits of many definitions, it is not surprising that the conference and exhibits were not always held together by a common purpose, or even a common language. In general, however, the exhibits represented the application of many new technics to the problems of measuring, testing, inspection and control.

### **The human element**

As pointed out by Rear Admiral Luis de Florez of the Office of Research and Invention, U. S. Navy, in his keynote address, "there obviously is a need to take into account the *average* mentality of the man who must base his decisions on instrument reading. We ought to take more time to make the use of these instruments keep pace with the technology behind them."

for permanent installation in manufacturing and process plants.

(3) Instrument Components and Accessories—Mainly primary elements for detecting changes in flow, level, pressure, temperature, etc. Also included are some instrument parts, such as pivots, diaphragms, relays, thermostats, etc.

(4) Instruments for Electrical Measurement—This group included several exhibits of well-known companies from the radio test equipment field.

(5) Tools and Gages (mechanical only)—The participation of the Industrial Instruments and Regulators division of the ASME may have been responsible for the relatively large number of hand tools, gages, dies, small pumps, etc., on display.

(6) Naval Exhibits, and Miscellaneous.

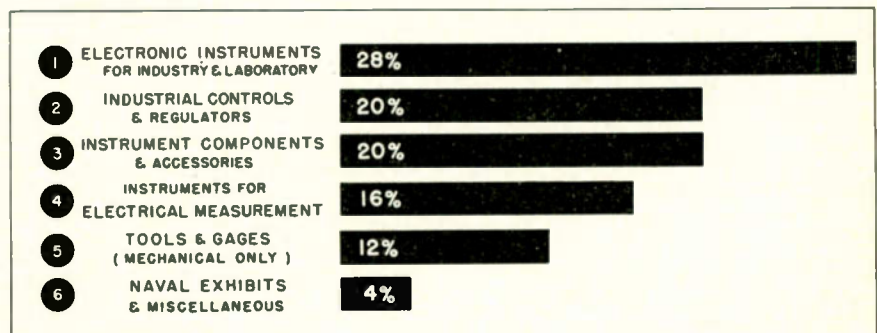



Newly elected officers of the Instrument Society of America include four regional vice-presidents to cover the nationwide activities of the society: Top row—H. E. Ferguson, Treasurer (Peoples Gas, Light & Coke Co.); R. Rimbach, Secretary (Instruments Publ. Co.); J. B. McMahon, Vice-Pres. (Republic Flow Meter Co.). Seated—C. F. Kayan, Vice-Pres. (Dept. of Mech. Eng., Columbia Univ.); H. H. Barnum, Vice-Pres. (Barnum Co.); A. F. Sperry, retiring Pres. (Hubbard Engineering Co.); C. O. Fairchild, President (Consulting Engineer); R. Munch, Vice-Pres. (Monsanto)

### SOME OUTSTANDING CONFERENCE PAPERS

Over fifty technical papers were presented during the five-day conference. Most of them were concerned with specific devices or systems that provided a solution to some particular problem of industrial control or measurement. Only a few of the more generalized discussions can be summarized in this review.

The complete program for the Instrumentation for Tomorrow conference held in Pittsburgh from September 16 to 20 covered over 50 papers. In addition to those listed in *Electronic Industries* in September were:

- "Automatic Neutralization of Large Scale Processes"—P. Ewald, TVA.
- "Control of Continuous Processes"—H. C. Frost, Corn Products Refining Co.
- "Biography of a Research Project"—P. G. Weiller, Engineering Consultant.
- "Instrumentation in the Chemical Process Industries"—A. L. Chaplin, American Cyanamid Co.
- "Elastic-tube Gage for Static & Dynamic Pressures"—E. Wenk, Jr., David Taylor Model Basin, U. S. Navy.
- "Instrument Division at Canada's Synthetic Rubber Plant"—J. W. Graeb, Polymer Corp., Ltd.
- "Principles of Automatic Control"—G. F. Akins, J. Kowalski, N. Koenig, Eastman Kodak Co.
- "Controls on the Chain Reacting Pile"—E. Creuz, Carnegie Institute of Technology.
- "Remote Control of Labs with Intense Radiations"—C. R. Schwob, Carnegie Institute of Technology.
- "Protection of Personnel"—F. Marshall, Westinghouse Research Laboratories.
- "Uncontrollability Factors in Boiler Operation"—J. A. Pelletiere, Gulf Oil Co.

- "Open Hearth Combustion Process"—A. J. Fisher, Bethlehem Steel Co.
- "Blast Furnace"—W. Flanagan, Carnegie-Illinois Steel Co.
- "Combustion Control"—P. S. Dickey, Bailey Meter Co.
- "Quantitative Gas Analysis and Testing"—A. W. Gauger, Penn. State College.
- "Analysis of Engine Exhaust Gas"—C. W. Butler, M. J. Boegel, R. P. Jones, Gulf Research & Devp. Co.
- "NACA Gas Analysis Instrumentation"—W. H. Haynie, H. C. Gerrish, NACA Engine Research Lab.
- "Industrial Gas Analysis"—H. D. Middel, General Electric Co.
- "Automatic Control Systems"—A. A. Markson, M. J. Boho, Hagan Corp.
- "Positive Meter"—E. W. Jacobson, Gulf Research & Devp. Co.
- "Extension of Rotameter Theory"—V. P. Head, Fischer & Porter Co.
- "Nozzle Flow in Pneumatic Force-balance Circuits"—D. B. Kirk, Moore Products Co.

#### Electro-mechanical brains

At the session on computing equipment, a paper on "Electrical Analog Computers" by C. E. Berry (Consolidated Engineering Corp.), showed how simultaneous equations and special problems involving triple-unit strain gages, etc., can be solved by successive balancing of electrical circuits, with resistive or reactive components representing the factors under consideration.

In such systems all arithmetic and some geometric operations (notably vectors), as well as integration and differentiation, can be

carried out by successive adjustments. A problem involving up to twelve simultaneous equations can be solved by a method of successive approximation, where partial solutions are substituted for trial values until values for the coefficient appear with the desired accuracy. By "storing" values as resistance settings on turret

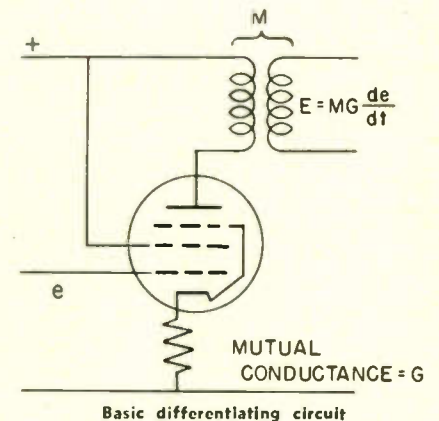

Basic differentiating circuit

mounted resistors, the method is quite rapid. One of the methods suggested for differentiation utilizes the mutual conductance of a tube where:

$$E_{(out)} = M \frac{di}{dt} = MG_m \frac{de}{dt}$$

if the current supplied to the primary comes from a constant source and  $M$  = coefficient of mutual inductance and  $G_m$  = anode-grid mutual conductance.

Examples indicating the solutions to many mathematical problems by the use of mechanical computers were described by Macon Fry (Maxson Corp.), using for illustration several basic problems encountered in gun-fire control equipment. Here again arithmetic, geometric and calculus operations were combined automatically in accordance with the requirements of ballistic equations, giving direct range information.

#### Electric gaging

The history and relative merits of various instruments for dimensional and qualitative measurement by electrical means were expounded in H. C. Roberts' paper on "Some Recent Trends in Electric Gaging Methods." Among the devices mentioned were the mutual inductance type extensometers, the Whiddington ultramicrometer, the electric torsionometer, resistance strain gages, the Identometer, the Metal-sorter and various other methods

(Continued on page 138)

## NEW INSTRUMENTS EXHIBITED

On following pages there is presented a small sampling of the instruments and accessories. Not more than one half of one per cent of the products exhibited are discussed here, the object being merely to suggest the general range of equipment that is now considered to lie within the province of instrument engineering.

Judging from the company affiliations of visitors, it would seem probable that the next instrumentation exhibit will place greater emphasis on purely industrial instruments. Some 70% of the visitors and attendants were associated with either the so-called "process" industries, such as petroleum, metallurgy, chemical products, etc., or with manufacturers specializing in instrumentation for these fields. It is hoped, however, that future exhibits of this sort will continue to approach the subject of instrumentation from a viewpoint broad enough to permit a showing of outstanding instruments for such fields as physical research, electrical measurement and other work pertaining to the laboratory.

Familiarity with the latest in laboratory tools is essential to the future development of instruments for industrial control and supervision, as well as for the proper maintenance and calibration of these increasingly complex automatic devices.

### Precision pulses

Many investigations in the industrial control laboratory are concerned with pulse operated devices, such as timers, relays, welding equipment, fuses, etc. The use of

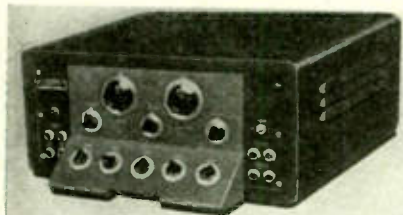

Wide range pulse generator

flexible pulse generators capable of simulating the signals produced by various triggering devices has prompted several manufacturers to design special instruments for this purpose.

On display at the Wilmotte ex-

hibit (Raymond M. Wilmotte Inc., 239 W. 55th St., New York 19, N. Y.) was a pulse generator (Model P54) of new design for the production of pulses of variable amplitude up to 190 peak volts, variable width from 1 to 70 microseconds and variable delay (with respect to a synchronizing pulse) up to 75% of the intervals between pulses. A calibrated dial adjusts the repetition rate from 60 to 100,000 pulses per sec., with either free running operation or locking to an external pulse source. The pulse rise time is 0.75 microseconds, equivalent to a change of 250 volts per microsecond. Two positive and two negative output pulses are available simultaneously, in addition to a synchronizing pulse of 100 volts peak amplitude and 2 microseconds width.

Pulse sources such as this have been widely used for producing synthetic interference on power lines to test the effectiveness of line noise filters. Other applications are: the calibration of peak reading devices; locating discontinuities in long lines (by reflection); operation of stroboscopic flash lamps used for "stopping" the motion of rotating or oscillating mechanisms.

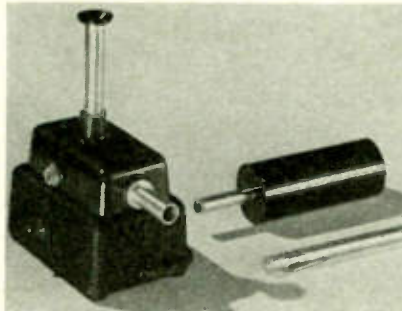

"Fountain pen" ionization chamber

### Radiation protection

Illustrating the high level of engineering in the relatively unpublicized field of radioactivity instrumentation, the exhibit of Victoreen Instrument Co. (5806 Hough Ave., Cleveland, Ohio) introduced a few of the devices that have recently been placed on the non-secret list. The ultimate in compactness and ingenuity seems to have been attained in the "minometer", a pocket sized ionization chamber in the shape of a fountain pen.

This device is standard equipment for the protection of workers who are subject to exposure from

radioactive materials. The accumulated charge is measured (usually after eight hours exposure) by inserting the ionization chamber into a small string electrometer. Deflection of a fine string in response to electrostatic attraction may be observed by means of a low power microscope against a scale calibrated in roentgen units to determine whether exposure has exceeded the safe allowance of 0.1 R per 8 hr. day.

The manufacturer of this instrument has also pioneered in the development of special sub-miniature electronic tubes having control grid currents on the order of  $10^{-14}$  ampere (0.01 micro-ampere) and drawing a filament current of only 10 ma. Production of special resistors, vacuum sealed in glass, was also essential to the operation of radioactivity instruments under all extremes of use and abuse. Such resistors are being manufactured in value from 1 to 1,000,000 megohms.

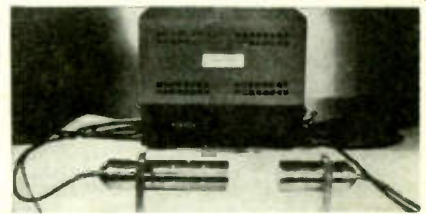

Industrial photoelectric relay

### Control engineering

A significant example of application engineering, involving cooperation between three independent manufacturers of related equipment, was the display set up by the Autotron Co., the Production Instrument Co and Service Recorder Co. These organizations



Industrial electronic counter

have combined their specialty products in a complete system of production counting, control and recording, available in a variety of combinations which are engineered for special applications where high speed batch control of continuous

(Continued on page 140)

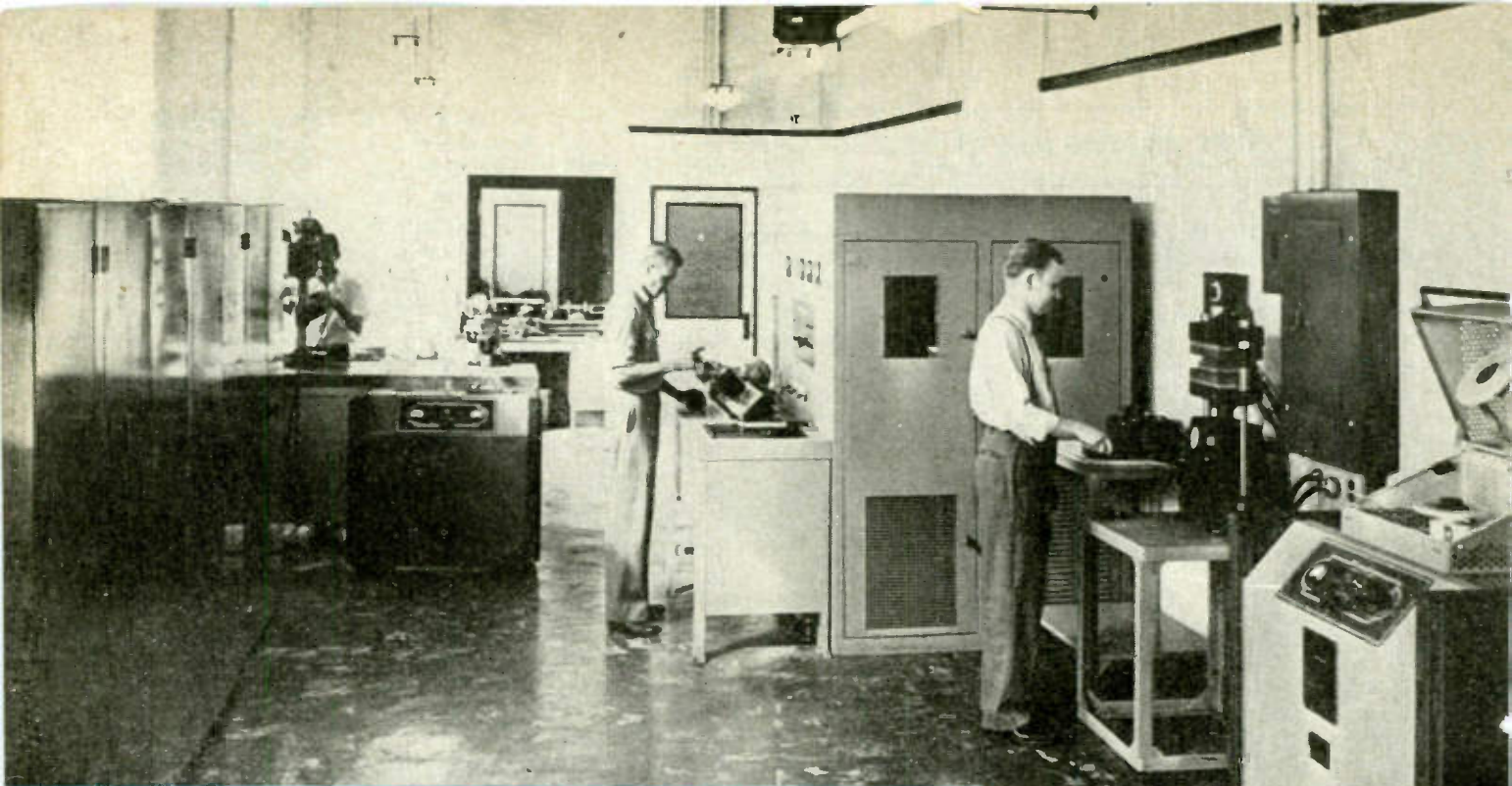

General view of one end of the recently established Westinghouse west coast high frequency demonstration laboratory which is equipped for the solution of work problems

*Test equipment set up for study of industrial uses of induction and dielectric heat in production work*

# HF HEAT LABORATORY

Demonstrating the molding of plastic pre-forms which are brought up to the proper heat in a few seconds by the 5-kw generator at right

With a 20-kw 450 kc generator the ease and speed of hardening triangular mower blades is demonstrated

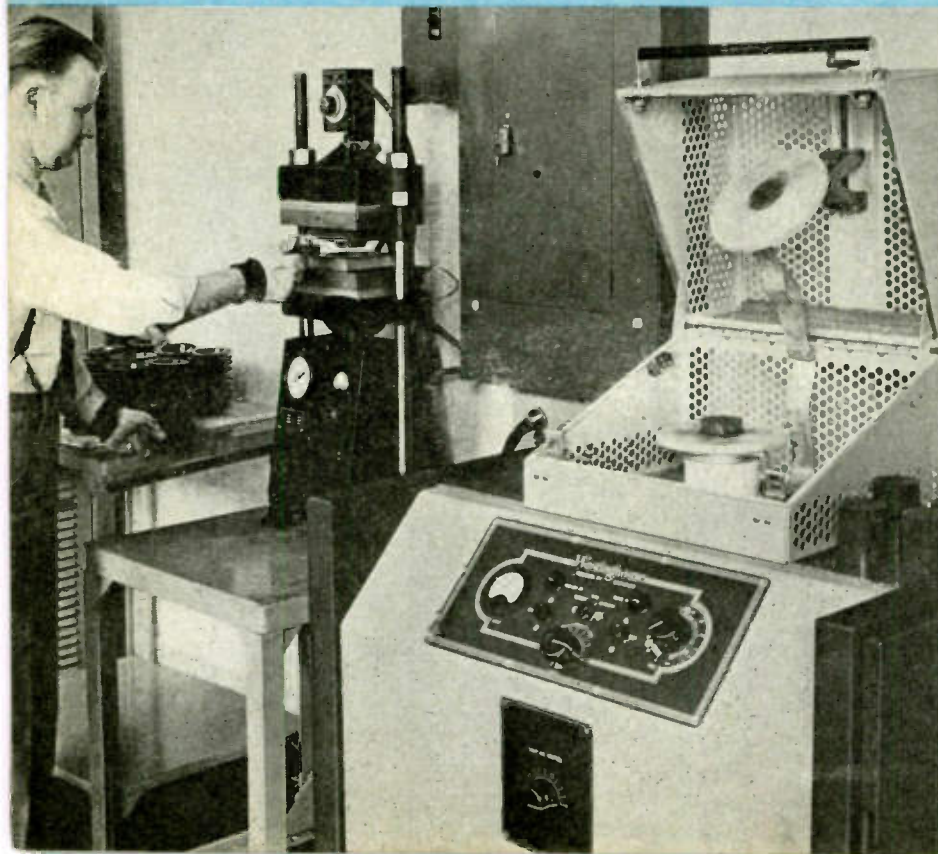





Making power level adjustments on the 20 kw 450 kc Induction heater

A new laboratory to which western industry may bring for study its problems of production by making use of the newest methods of high frequency heating has been opened by Westinghouse Electric Corp., in Los Angeles. In charge of the laboratory is Dr. Russell A. Neilson, formerly connected with the company's research laboratories in East Pittsburgh.

Included in the equipment are several modern types of units adapted for production jobs of all sorts from wood gluing, the pre-heating of plastics, the heat-treating and hardening of metals, soldering, to forging and melting.

Purpose of the laboratory is to demonstrate the usefulness of the equipment on actual production problems. In one case cutting edges of triangular, mower blades which required hardening were brought to 1600° Fahr., and passed into quenching oil at the rate of one completed blade every five seconds, only the desired portions of the blade being hardened, the remainder being left untreated.



In this demonstration the 1-kw dielectric heating generator is being used to show the manner in which thermosetting glue in plywood can be made to set in 15 seconds

General view of the 20-kw induction heating generator showing the pair of 10,000 watt air-cooled oscillator tubes with which this induction type heater does its work

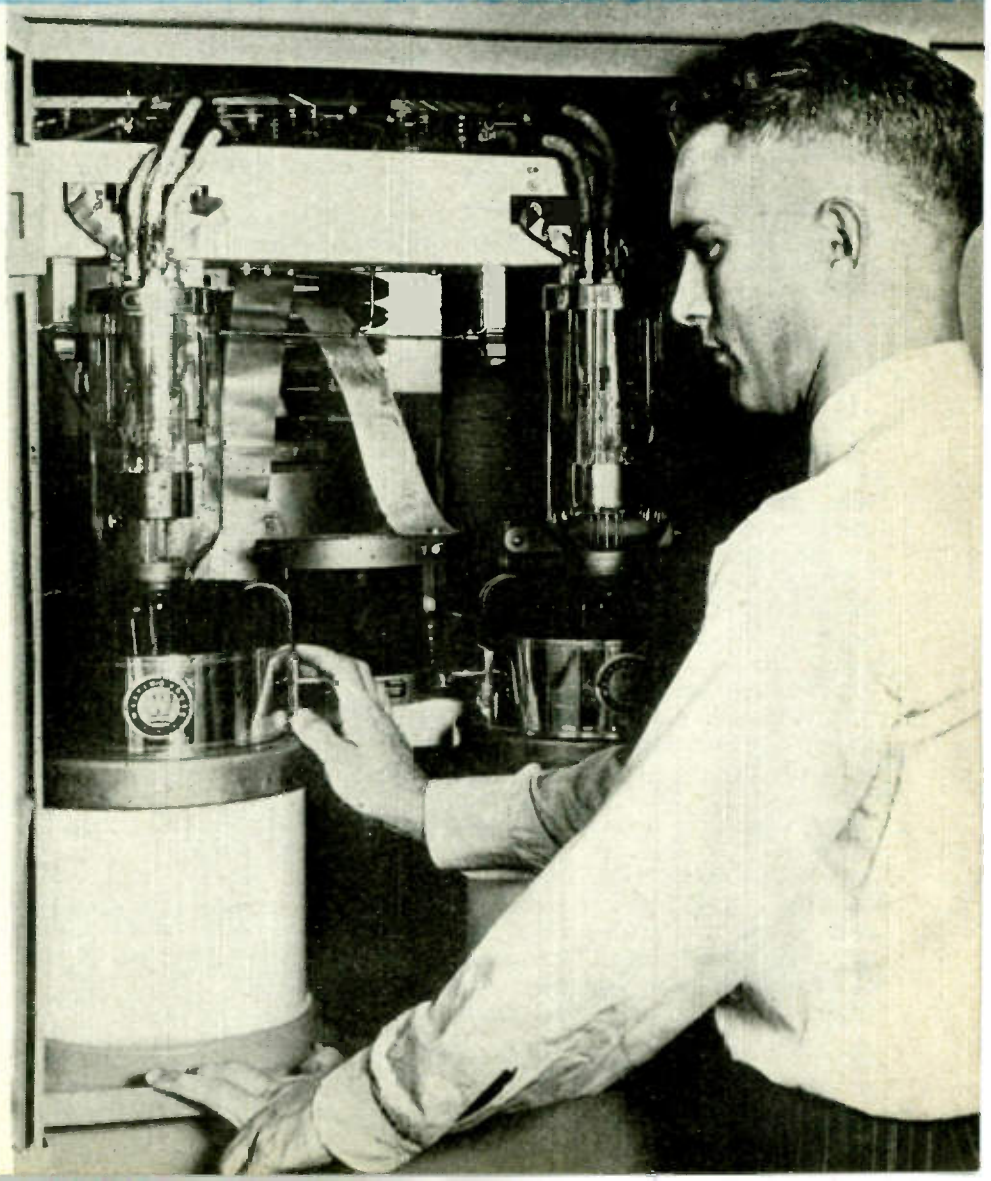

# DISC RECORDING

By **HOWARD A. CHINN**, Chief Audio Engineer  
Columbia Broadcasting System, Inc.

**With lack of standards, definitions and methods of measurements, when can recording come of age?**

● In 1887, Emil Berliner and Eldridge R. Johnson introduced the lateral-cut disc record in the basic form that is now so familiar. Yet today, almost 60 years later, neither the public nor the phonograph industry enjoys the many benefits that can be derived from the adoption of standards covering such items as the recording characteristic, the amplitude of the recorded grooves, the groove cross-section and similar items.

To be sure, the turntable speed has been standardized, by convention, at 78.26 rpm. Furthermore, dimensional standards have been proposed for phonograph records for use in homes. But it is obvious that progress has been made on only those standards that are absolutely necessary to make it possible to play recordings of most manufacturers on most turntables. What *kind* of reproduction is obtained is determined entirely by chance, since no standards have been formulated specifying either the recording or the reproducing characteristic.

## Recording preferences

Every recording company has its own favorite recording characteristic. Similarly, every phonograph designer has his own conception of the reproducing characteristic that makes his favorite records sound best. If you do not happen to agree with his tastes in records and reproduction, then you are likely to be quite disappointed in the resulting performance—and more likely than not you will blame it on the recording! A casual perusal of any record critic's column almost invariably finds mention of "lack of bass," "too bassy," "screeching treble," etc., etc. Actually, of course, if the reproducing characteristic complemented the recording characteristic, this lack of balance could be avoided.

Why does this hit-or-miss situ-

In writing this article Mr. Chinn has expressed the hope that the disclosure of trade secrets by the Capps organization in the companion article on the opposite page will encourage others to do likewise with the goal of establishing coordinated industry standards. As long as each manufacturer persists in going his own merry way, disc recording will never come of age.  
—Editor.

ation prevail in an industry that has sold enough phonographs to support the sale of 500,000,000 records per year? To make a blunt guess, the condition probably arises largely because of a lack of knowledge of the actual technical factors involved.

For example, unbelievable as it may seem, to one not intimately

associated with disc recording, the problem of making measurements of disc recording characteristics is beset with so many parameters that even the expert is sometimes puzzled as to how to steer his course.

## What can be done?

The obvious solution to this problem is a cooperative effort on the part of all concerned to formulate definitions, standards and methods of measurements covering those items that are now left to chance. First and foremost, of course, would be an agreement upon the recording characteristic. With at least this factor specified, phonograph manufacturers could design their instruments with assurances that a single basic playback characteristic would suffice for all records made in accordance with the industry standard.

Second, an agreement is required on a standard groove shape in order that those concerned with the design of reproducing styli can fix upon the size and shape that, in their opinion, results in optimum fit for all records made in accordance with the agreed upon standard.

## Recording and Reproducing Styli

Standardization of the recorded groove shape really concerns the *recording* styli since it is this tool that actually cuts the groove. Unfortunately, standardization of the reproducing and the recording styli shape cannot be undertaken for 78 rpm phonograph records without due consideration of the allied 33-1/3 rpm transcription problem.

Many services, including broadcasting, wired music, educational and entertainment activities, commonly play both 33-1/3 and 78 rpm recordings with the same pickup.

(Continued on page 66)

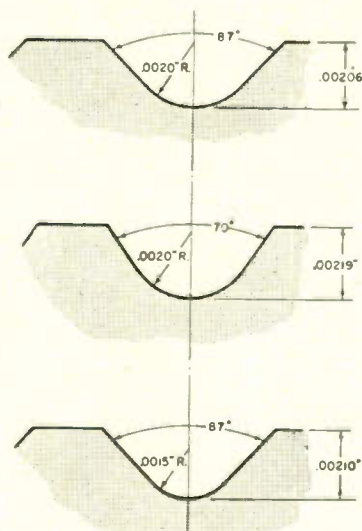

Fig. 1—Three "standard" record groove shapes used by an equal number of prominent transcription companies for lateral recordings. Groove: land ratio is 70:30. (top) Groove A: 124 lines/in.; (center) Groove B: 136 lines/in.; (bottom) Groove C: 133 lines/in.

# RECORDING STYLI

By ISABEL L. CAPPS, President, Frank L. Capps & Co., Inc.  
224 West 49th Street, New York

## Importance of styli contour, cutting edge and burnishing facet in determining eventual result

● The factors that must be taken into account in designing a cutting stylus for lacquer disc recording are more numerous than the facets on the completed jewel itself! This undoubtedly accounts for the complete dearth of factual information on the subject in the contemporary literature or elsewhere.

### Basic styli shape

The general shape of present-day cutting styli used for recording on lacquer discs is shown in Fig. 1, together with the names by which the various faces and edges are commonly known. This figure also illustrates a point that is apparently realized by very few—the fact that only a *very small* fraction of the stylus point actually cuts the groove. It is evident from this illustration that the bulk of the stylus, as seen under the usual microscope, does not enter into determining the groove shape. With this in mind, it is evident that it takes more than a casual glance at the stylus contour in order truly to determine the exact size of the

included angle of the finished groove.

In effect, therefore, the lacquer cutting stylus may be defined as a small piece of sapphire, no larger than the cross-section of the chip<sup>1</sup> that is removed from the record, upon which has been polished a flat cutting face, an included angle, a radius, a clearance angle, and a burnishing facet that extends around the radius and included angle.

Obviously, such a small fragment of sapphire could not be handled either in manufacture or in use. It is necessary, therefore, to use a larger piece of sapphire, only the extreme tip portion of which is functional. But the fact that the larger mass of sapphire is present to facilitate handling must not be allowed to obscure the fact that the cutting portion actually is this microscopically small fragment at its tip. No proper discussion of the lacquer stylus in relation to groove shape, surface noise, frequency response, playback fit and distortion can take place without full appreciation of this fact.

Although a stylus that is used to cut wax masters does not require a burnishing facet, this feature is indispensable on a stylus designed

for lacquers. The function of the facet is indicated by its name—it serves to produce a noise-free polished groove.

### Burnishing facet

It is of importance to understand the nature and function of the burnishing facet.<sup>2</sup> This facet is flat and is fashioned along the "angles" and radius of the sapphire. It makes an angle of approximately 25° with a normal to the sapphire face. Therefore, a front view of the stylus as seen by the shadow-graph technique, shows the outline of the *burnishing edge* rather than that of the cutting edge!

The only place that the burnishing facet can be seen readily is at the extreme tip of the stylus, viewed in lateral aspect. It then appears as a flat plane surface, Fig. 2. The cutting edge and the trailing burnishing edge are as shown; the same relationship of these edges existing along the sides of the stylus as well as at the tip of the radius. Cutting is done by the inner edge, while the plane surface trailing it polishes the groove.

In the production methods developed to establish so tiny a facet

(Continued on page 67)

1. Howard A. Chinn, "Glossary of Disc-Recording Terms," Proc. I.R.E., Vol. 33, No. 11, p. 760 (November 1945).

Fig. 1—(a) Complete stylus; (b) Perspective of sapphire; (c) Back view of sapphire; (d) Side view of sapphire. Fig. 2 (inset circle)—See text

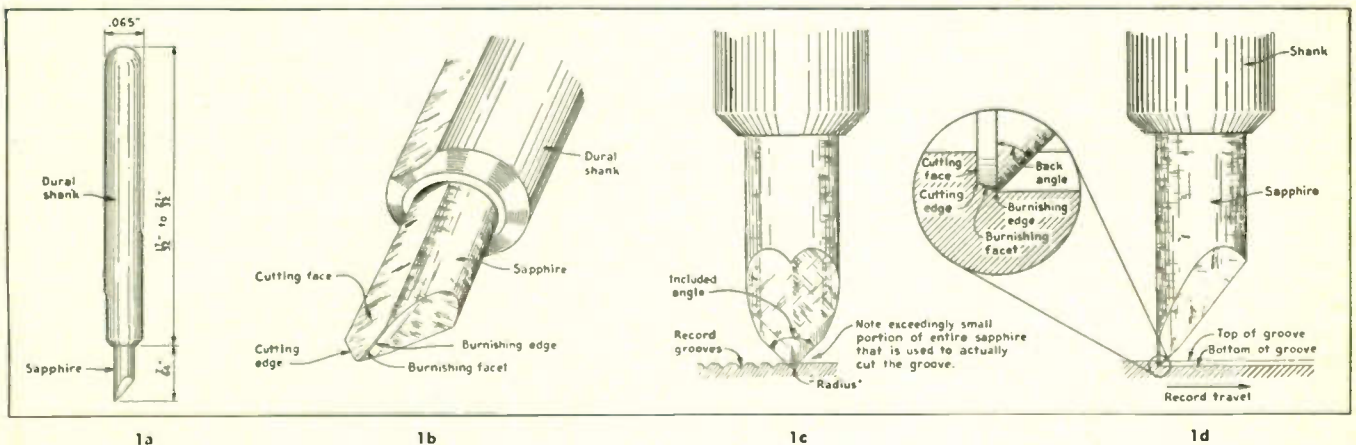

# DISC RECORDING

(Continued from page 64)

Separate equalizers can be provided to accommodate the different recording characteristics that may be used for these two types of records (if different ones are really necessary). But, if different groove shapes are used for the two kinds of recordings, it is evidently not possible with a single reproducing styli to provide the optimum accommodation for both grooves.

A survey of the transcription field shows that currently there are a variety of recording styli

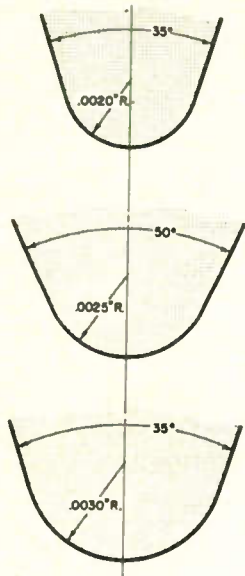

Fig. 2—These three reproducing stylus shapes are currently specified for three well-known, top-grade transcription pickups. Such pickups are also used for reproduction of large numbers of phonograph records. (top) stylus I, (center) stylus II, (bottom) stylus III.

shapes in use. Fig. 1 shows three groove shapes that an equal number of well-known transcription companies claim to be their "standard." Similarly, each manufacturer of reproducers uses a stylus having a tip radius that he considers optimum for the recordings in which he has a special interest. Fig. 2 illustrates the shape of the reproducing styli currently specified for three top-flight transcription pickups.

### "Standard" grooves

It is interesting to study the manner in which these reproducing styli fit into the "standard" grooves. Fig. 3 shows the three styli in groove B, while Fig. 4 shows the same styli in groove C. It is seen that in the case of the

70°, 2 mil groove (Fig. 3), only stylus II provides a proper fit. Stylus I is too small and will rattle around in the bottom of the groove, while stylus III is too large and is unable to enter the groove. In fact, when this latter stylus is used to play back lacquer recordings the edge of the groove has been known to crumple.

### Stylus fit

Groove C, on the other hand, is capable of handling all three styli (Fig. 4). It is evident, however, that stylus B provides the best fit and the greatest tolerance. Stylus A is very close to the bottom of the groove and stylus C, very close to the top. Consequently, even a small deviation from the ideal shapes illustrated might tend to cause these styli to fit poorly. Nevertheless, the C type groove would seem to be a better shape than groove B from the viewpoint of the kind of reproducing stylus

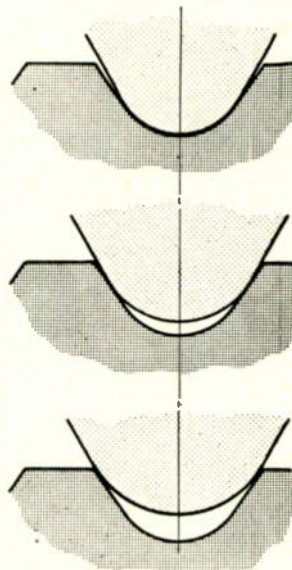

Fig. 3—The manner in which three well-known reproducing styli (Fig. 2) fit into groove B (Fig. 1). Only in the case of stylus II is a good fit obtained. Stylus I is too small and will rattle around in the bottom of the groove; stylus III is too large and cannot enter the groove. (top) stylus I (.002 in., 60°). (center) stylus II (.0025 in., 60°). (bottom) stylus III (.003 in., 60°); all 136 lines/in.

in use today. It is not the intention to imply, however, that this is necessarily the optimum groove shape. Rather, it is an example of the chaos that now exists!

### Experimental data

The styli and groove shapes shown are, of course, idealized drawings. In practice, deviations

from these precise shapes may be expected for one reason or another.

As anyone who is familiar with the art knows, there is a dearth of published information concerning the groove shapes actually experienced in practice. Likewise, there is no material available covering the fine art of recording styli design and manufacture. For these reasons, the accompanying paper on "Recording Styli Design" not only sets a precedent, but also should prove of unusual interest to the recording engineer.

None of the data presented in the paper has ever been published heretofore. In fact, nowhere in the literature will one even find a detailed drawing showing the shape of a modern lacquer recording stylus. Curiously enough, even though this tiny tool is used by many, its real shape is a mystery to most. This comes about simply because the depth of focus of a microscope is so limited that only those portions of the stylus in a single plane are clearly visible for any given focus.

The actual photographs of lacquer groove shapes and the effect of the burnishing facet upon the formation of so-called "horns" at the upper corners of the groove is information that has only recently become available. These data add another chapter to the fund of knowledge on disc recording.

Fig. 4—The manner in which the three styli (Fig. 2) fit into groove C (Fig. 1). In all cases a good fit is obtained although groove B provides the best fit and permits the greatest tolerance in groove and stylus shapes. (top) stylus I (.002 in., 60°); (center) stylus II (.0025 in., 60°); (bottom) stylus III (.003 in., 87°)—all 133 lines/in.

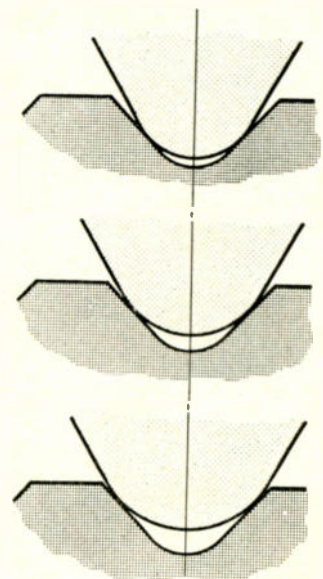

Drawings courtesy of CBS.

# RECORDING STYLI

(Continued from page 65)

upon the microscopic tip portion of the sapphire this facet automatically tapers from around 0.6 mils<sup>3</sup> (0.0006 in.) at the radius tip to a dimension of from 0.1 to 0.25 mils at the point corresponding to the upper corner of the groove. At the same time the final shape of the



Fig. 3a—Polishing the burnishing facet around the peripheral edge of the sapphire in regular production results in some deviation from "ideal" shape. The photograph shows the recorded groove that results. The curvature of the bottom of the groove tends to follow up into the side walls, which should be straight. An increase in the included angle also occurs and a true radius is not obtained.



Fig. 3b—Showing the truer groove shape that is the characteristic of Master styli which are manufactured to accurate tolerances. Straight side walls and a truer bottom radius results



Fig. 4—"Horns" of the magnitude of those photographed were first observed in grooves cut with Master styli which maintain exact included angle specification. This led to intensive research on the subject and to the findings outlined in this article. Horns like these may be troublesome in processing. "Cold flow" which characterizes lacquer also may result in these large horns interfering with the playback stylus



Fig. 5a—Photograph of a groove cut with a 70° feather edge stylus (i.e. a stylus having no burnishing facet). Horns of large proportions are present and substantiate the fact that grooves cut with 70° styli always have larger horns than those cut with wider angle styli (see Fig. 5b). Roughness in the groove also serves to illustrate the importance of the burnishing facet



Fig. 5b—Photograph of a groove cut with a 95° feather edge stylus. A series of feather edge styli ranging from 70° (Fig. 5a) to 100° were used to establish the effect of the included angle upon the formation of horns. It was found that while none of these styli produced absolutely clean upper corners, the horns became progressively smaller as the angle was increased

2. U. S. Patent No. 2,187,512. 3. 1 mil = 0.001 inches.

functional portion of the stylus is altered (Fig. 3a and 3b).

Control of the final shape of a stylus necessarily must be accomplished by treatment of the burnishing facet; since it is the last operation performed upon the stylus and since it is established upon the peripheral edge. There are, however, certain limitations imposed upon its size and shape. For example, a careful study was made of the effect of facets of various widths upon the groove shape (particularly the formation of "horns" at the upper corners of the groove).

## Horn production

It was found that a facet of more than 0.25 mils in width, at points on the sapphire corresponding to the top of the groove, produces excessive horns; particularly in 70° styli, as shown (Fig. 4). In this connection it should be noted that horns are present in grooves cut with feather edge styli (i.e. styli having no burnishing facet) and that these horns become smaller as the included angle of the stylus is increased.

In other words, grooves cut with a 70° feather edge stylus (Fig. 5a) have more prominent horns at the upper corners than those cut with

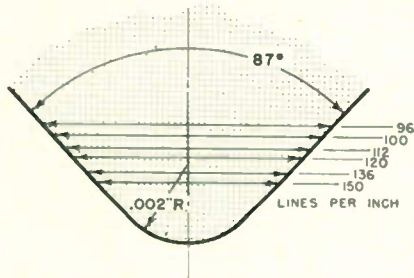

GROOVE : LAND RATIO = 70 : 30

Fig. 6—Illustrates the functional portion of an 87°, 2 mil sapphire cutting stylus. Horizontal lines across the sapphire represent various groove widths at a 70:30 ratio when cutting different number of lines per inch. The point on the sapphire which corresponds to groove width from corner to corner is the upper limit of its functional portion

a 95° feather edge stylus, as shown (Fig. 5b). Increasing the burnishing facet to dimensions in excess of the 0.25 mils mentioned, therefore, has the effect of exaggerating the horns already present.

However, a uniform facet of only 0.25 mils throughout the extent of the included angle is not generally satisfactory from another viewpoint. One of the fundamental requirements of the lacquer groove is that it results in a minimum of "surface" noise. Our studies have made it clear that a stylus which

has a burnishing plane of 0.25 mils throughout the side wall angle and which still results in a quiet groove at 33½ RPM very definitely is an exception. Ordinarily it is necessary to increase this dimension at the bearing point in order to obtain the required reduction of groove noise. Widths of 0.5 to 0.66 mils for 33½ RPM and up to 0.75 to even 1.0 mils at 78 RPM seem to be required.

The tapered burnish of the stylus is, therefore, established as generally best, particularly when taking



Fig. 7—Other factors being equal, the size of the horns at the corner of the groove is a function of the size of the burnishing facet. Therefore, the dimensions of the burnishing facet, at points corresponding to the upper corners of the groove, must be carefully controlled in order to keep the horns to a minimum. Changes in pitch, however, bring a different portion of the stylus into use. This may result in the width of the burnishing facet changing the upper corners of the groove. This is a photograph of deep cuts so that the narrow portion of the burnishing facet affects the corner of the groove.



Fig. 8—Photograph of a light cut (or fine pitch) made with the same stylus used to cut the deep grooves illustrated in Fig. 7. At this finer pitch a wider portion of the burnishing facet affects the corner of the groove, producing larger horns

into consideration the fact that the faithful recording of high frequencies places an outside dimensional limit upon the burnishing facet. Study of such tapered burnishing facets has led to still further appreciation of how critical are the microscopic measurements within the functional portion of a stylus.

It leads to the obvious conclusion that for best results a stylus must be designed (and manufactured) with a full knowledge of the depth of groove for which it is to be used. Since it is common practice to maintain a groove-to-land ratio of 70%-30% (or 60%-40%) this translates itself, to the practical recording engineer, into a specification of the pitch of the recording grooves. That is, once the pitch is determined, then for the given stylus shape, the depth of groove also is fixed.

Keeping in mind the constant groove-to-land ratio, it is evident

(Continued on page 100)

# PROTECTING AGAINST

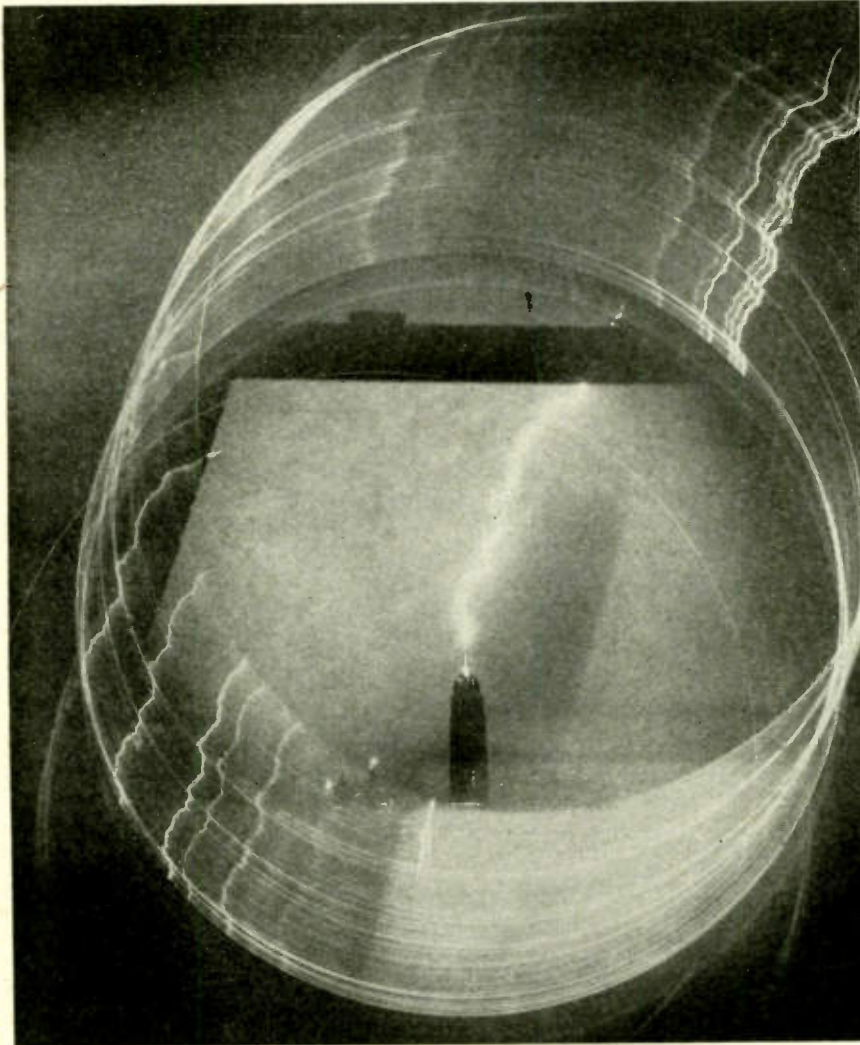

## WHEN LIGHTNING STRIKES

In this photograph of lightning striking the Empire State Building, the central picture was formed by a fixed lens while the surrounding circles were caused by a rotating lens which can be turned at either  $\frac{1}{2}$ , 1 or 2 rps. In this photo the lens made slightly over 1 revolution. The overlap can be seen at lower right. This was a multiple stroke consisting of an initial long continuing discharge building up slowly and containing a large number of current peaks (bright streaks), and a shorter continuous discharge beginning with a steep current rise

● Most broadcast station engineers take considerable pride in the efficiency of their methods of operation and are on the alert for means of improvement. One measure of effectiveness, apparent both to the listening public and to the station accountant, is the amount of lost program time. Some failures on the air due to unpredictable breakdown of components are reasonably unavoidable—but a large percentage of potential failures can be minimized or eliminated by use of protective circuits and by systematic scheduling of maintenance.

One of the main sources of trouble

is lightning which can cause not only carrier interruptions but destruction of equipment. Rising several hundred feet into the air, the modern vertical radiator makes an effective lightning rod and can be expected to receive several direct hits and numerous induced surges during the season.

Of first consideration, in the case of a series fed tower, is the base insulator which must be protected by a spark gap. Protective gaps to ground usually are supplied with the installation, and the only precaution is to see that they are set close enough to protect the insula-

By H. G. TOWLSON

Transmitter Division,  
Electronics Dept.,  
General Electric Co., Syracuse, N. Y.

## **Practical methods of insuring against interruptions and loss of broadcast time due to lightning and other causes**

tor. One method of adjusting the gap is to decrease it to the point where it just flashes with heavy modulation and then to double the spacing for normal operation. The gap electrodes should be cleaned and polished occasionally, especially after storms, so the breakdown setting will not change.

### **Static Drain Chokes**

It is important that there be a conduction path from the tower to ground and from an open wire transmission line to ground. Otherwise, successive surges can charge the system to increasingly higher voltage which eventually must flash to ground. Friction caused by wind, sand or snow storms—even smoke from a passing train—can cause flashovers in a completely insulated system. Fig. 2 shows a commonly used circuit which has a floating tower and transmission line. Fig. 3 is a transmission line termination used in directive systems when a leading phase angle is desired. With base insulated towers, no conduction path to ground exists and must therefore be provided.

It is entirely satisfactory if this path can be found back through the transmitter output circuit—as in the case of an inductively coupled set—or if the usual tower lightning choke acts as a drain, by connecting one side of the light circuit to the tower and grounding one side of the lighting transformer secondary. Otherwise, a copper path must be provided by connecting an rf drain choke across the system to ground.

The design of such a choke is not critical as the normal operating voltage is not great, and the choke impedance can be made so high that the normal current through it will be small. The drain choke can be made of approx. No. 20 dcc wire

# CARRIER FAILURE

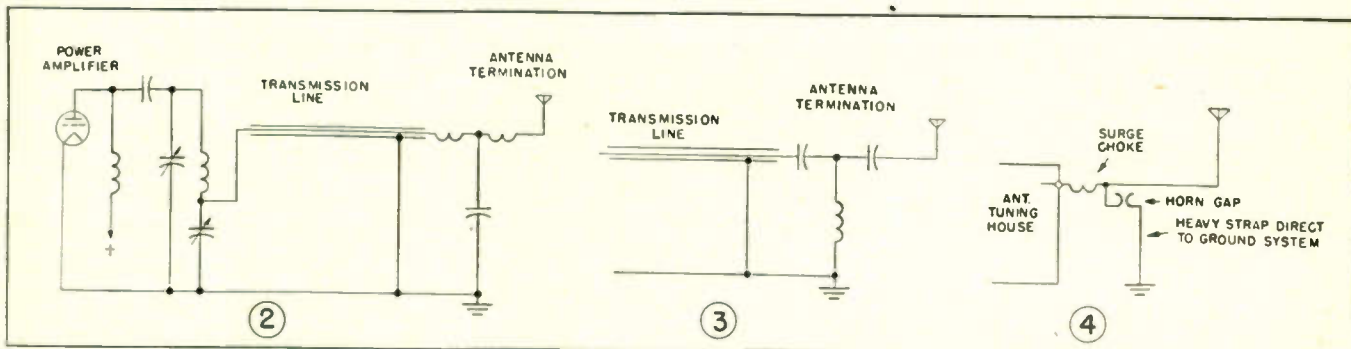

Fig. 2—Common termination which permits tower to float, and requires a static drain choke

Fig. 3—Another termination circuit which requires use of static drain

Fig. 4—Arrangement of horn gap and choke coil for protecting against lightning surges

closely wound on a non-hygroscopic form (the first 10 turns should be triple spaced to reduce possibility of breakdown during surges). It is preferable to make the choke rather long and slender to keep the rf voltage per turn low and to keep the distributed capacity down.

For minimum detuning of the circuit which it shunts, the choke should be approximately anti-resonant at the operating frequency of the transmitter. The resonant frequency of a choke can be estimated by calculating its inductance from the usual formula or charts, and its distributed capacity from the approximate empirical equation:

$$C = 1.8 D$$

Where  $C$  = distributed capacity in micro-microfarads

$D$  = diameter of the coil in inches

The resonant frequency then,

$$F = 10^8 / 2\pi \sqrt{LC}$$

Where  $F$  = frequency in kc

$L$  = inductance in microhenries

To protect the line terminating

equipment, it is advisable to connect a horn-gap from the antenna feeder to ground at the point where the feeder enters the tuning house.

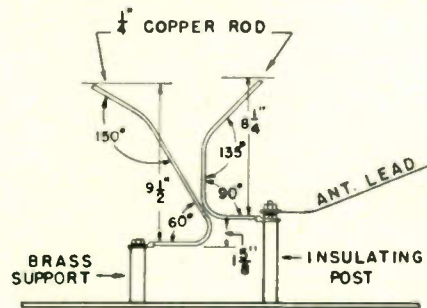

Fig. 5—Horn gap construction that has been successfully used

To increase the effectiveness of the gap it is customary to insert a small choke coil in the feeder on the transmitter side of the gap. This choke can consist of 2 turns wound to 4 in. diameter; No. 4 wire or 3/16 in. tubing makes a rigid self-supporting coil. Fig. 4 shows the connection suggested.

Note that the gap and coil are recommended for grounded tower

installations as well as for insulated, as the section of tower below the feeder tap of a grounded tower presents considerable impedance to the lightning surge. Horn-gaps are here specified rather than the commonly used sphere gaps. When a horn-gap flashes, although the transmitter tries to maintain the arc it is automatically cleared due to the inherent design of the horn gap whereas the sphere gap (especially if the balls are mounted in a vertical line as is sometimes done) has much less tendency to clear, and unless other methods are employed to extinguish the arc it may continue until severe damage has been done.

Fig. 5 shows the arrangement of a successful horn-gap based on one described by J. E. Young in Nov. 1937 Broadcast News.

As additional protection to concentric transmission lines, which are especially vulnerable to destruction from lightning surges, it is advisable to use another horn-gap and choke at the tuning house end of the transmission line. With an open wire transmission line it is advisable to use an additional choke

Fig. 6—Circuit using the conduction method of clearing arcs, as applied to low level modulated transmitter

Fig. 7—Conduction method of clearing arc as applied to high level transmitter

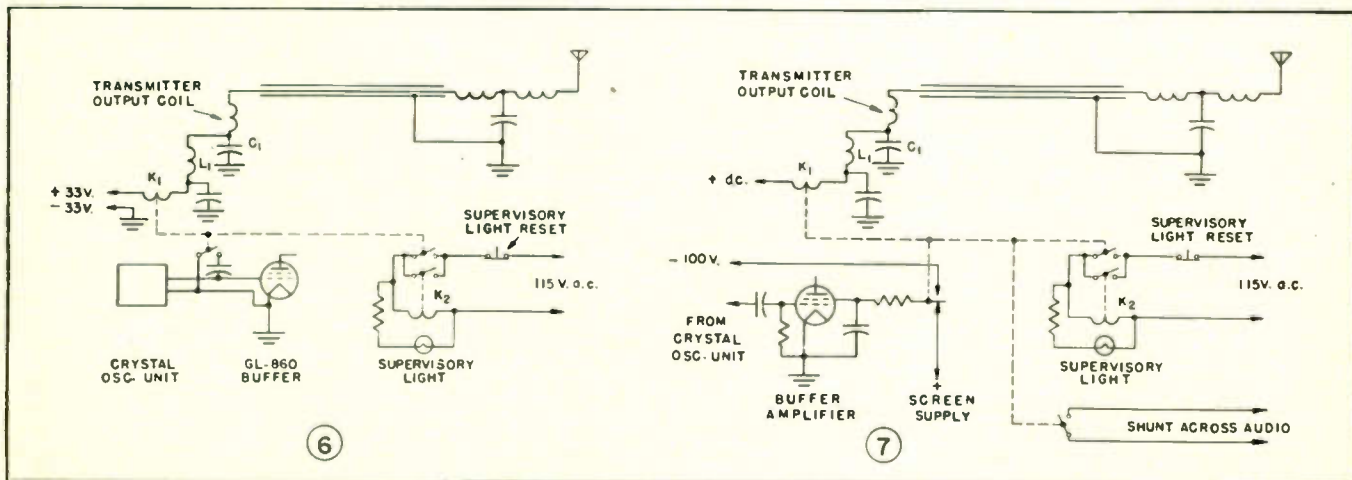

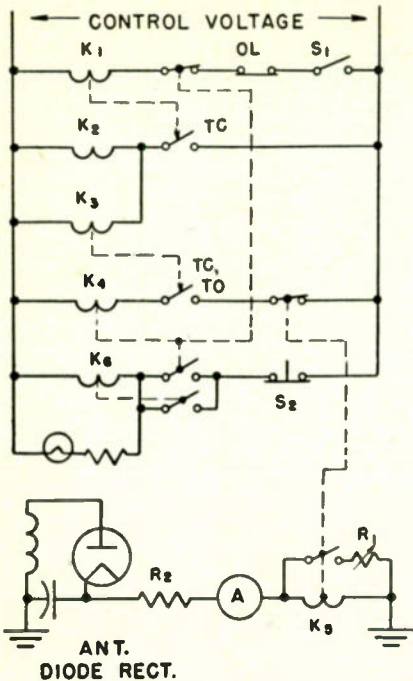

K<sub>1</sub>, Main rect. start contactor—K<sub>2</sub>, Main rect. run contactor—K<sub>3</sub>, TC, to relay, 1 sec. timing—K<sub>4</sub>, Trip relay aux.—K<sub>5</sub>, Diode circuit trip relay—K<sub>6</sub>, Supervisory relay—R<sub>1</sub>, Drop-out adjusting resistor—R<sub>2</sub>, Meter linearity resistor—S<sub>1</sub>, Plate on-off switch—S<sub>2</sub>, Supervisory light reset

Fig. 8—Circuit illustrating carrier drop method of clearing arcs

and horn-gap at the point where the transmission line enters the transmitter building. This gives protection from voltages induced into the open wire line.

### Carrier tripping circuits

The tendency for a transmitter to maintain an arc once a gap has broken down can be largely counteracted by use of the self-clearing horn-gap. At stations where lightning trouble is infrequent, this protection is often sufficient. But most stations find the horn-gap oc-

asionally is slow in breaking the arc, depending on weather conditions, wind direction, etc. Besides increasing the time off-the-air, this condition can result in momentarily high voltages at other points of the system.

With a concentric transmission line the standing waves set up in the line due to loss of proper termination could break down the insulating beads. It is, therefore, highly desirable to have a method of cutting the carrier to permit the arc to be extinguished quickly and positively. There are numerous ways of accomplishing this, and they fall roughly into three categories;

- 1 Use of a phototube actuated by the arc flash. This method is not recommended as it protects at only one point of the system.
- 2 Conduction method—Use of the arc itself as a conducting path for current through a tripping relay.
- 3 Carrier drop method—depending on a drop in antenna current to actuate a tripping relay.

### Lightning trip

This scheme, probably the simplest of the three methods has proved very successful at station WGY. This particular transmitter is low-level modulated with two class B linear amplifiers. Fig. 6 shows the circuit used. A low reactance capacitor, C<sub>1</sub>, was inserted in the ground side of the coupling coil, and the trip relay, K<sub>1</sub>, was connected through a small choke, L<sub>1</sub>, to the 33 v. dc filament bus as shown. If an arc to ground occurs anywhere along the transmission line, terminating equipment or antenna, current flows through K<sub>1</sub>. When K<sub>1</sub> closes, the rf output of the crystal unit is shorted through a blocking capacitor, dropping the transmitter output to a very low level and allowing the arc to ex-

tinguish—whereupon K<sub>1</sub> opens and the carrier returns to normal. It is of course necessary that all transmitter stages following the trip relay be biased to near cut-off. K<sub>2</sub> is a supervisory relay which seals in whenever K<sub>1</sub> operates, to show the reason for the interruption by means of an indicating light. In operation the circuit is so fast that the interruption is scarcely noticeable on the air.

### High level modulation

With high-level modulated transmitters using Class B Audio, which are now so popular, it would not be advisable to short the rf excitation as is done with the low-level modulated transmitter, since high voltage surges in the modulation transformer and its associated reactor might result. One suggested circuit employs a trip relay to apply high negative bias to a control or screen grid through a resistor-capacitor network of about 0.1 seconds time constant.

Fig. 7 shows the circuit as applied to a high-level transmitter (General Electric Type BT-25A). Note that an additional contact on K<sub>1</sub> shorts the incoming audio line (in the BT-25A a 15 db pad is inserted) to further protect the modulation transformer. With high-level transmitters located where lightning surges are not frequent, it may be simpler to let the trip relay merely open the holding circuit of the main rectifier plate contactor. However, the resulting carrier interruption will be more noticeable.

Note that with this conduction method no drain choke should be connected across the system, but a drain path is provided through the protective apparatus.

Another approach to the problem is indicated by Fig. 8, this method being directly applicable to either high or low level modulated transmitters. It acts to remove plate

Fig. 9—Carrier drop method with excitation cut-off

Fig. 10—Modified carrier drop circuit applied to low level modulated transmitter

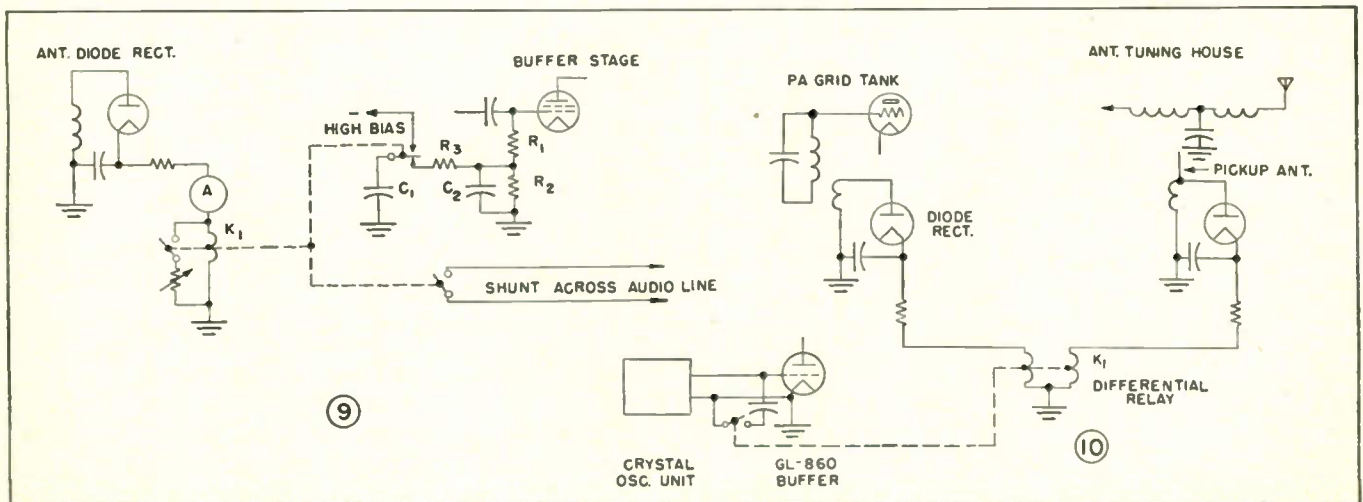



voltage and so causes a more noticeable interruption than does the excitation removal method.  $K_1$  is the usual main rectifier start contactor whose coil is in series with overload relays, interlock circuits, etc.  $K_2$  is the run contactor controlled by a one second time delay closing contact on  $K_1$ . Shunted across  $K_2$  is a relay  $K_3$  which can be of the bellows type to give approximately

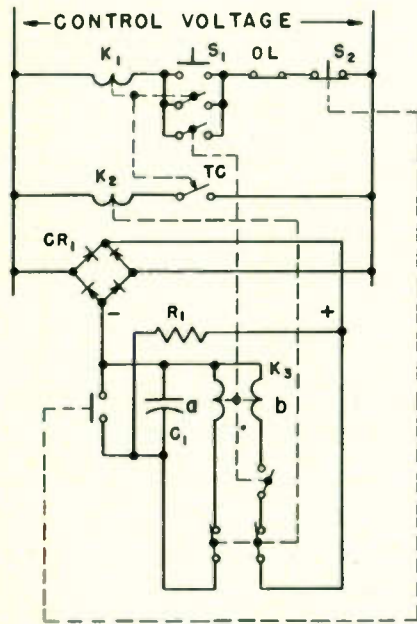

$K_1$ , Main rect. start contactor— $K_2$ , Main rect. run contactor— $K_3$ , Reclosure relay— $R_1$ , Charging resistor 1.5 megohms— $S_1$ , Main rect. on button— $S_2$ , Main rect. off button— $CR_1$ , Copper oxide rect.— $OL$ , Overload relays

Fig. 11—Automatic reclosure circuit giving one reclosure before lockout

one second time delay in both opening and closing a normally open contact. This contact of  $K_3$  is in series with a normally closed contact of  $K_5$ , a relay whose coil is in the dc path of a diode rectifier coupled to the antenna circuit (this diode is usually the remote antenna meter rectifier).  $K_4$  has a normally closed contact in series with the coil of  $K_1$ .

On starting up,  $K_5$  is not yet energized;  $K_1$  is closed by the normal start switch and after one second the circuit to  $K_2$  closes which permits the carrier to come up to full power.  $K_3$  starts to operate, but during the one second required for it to close,  $K_5$  has picked up so that  $K_4$  is not energized. Now if a sufficient carrier drop occurs due to an antenna arc or for any other reason,  $K_5$  drops out allowing  $K_4$  to pull in and open the circuit to  $K_1$  removing plate voltage and allowing the arc to extinguish. After one second  $K_3$  opens, permitting power to be restored, and recycling the device.

Purpose of  $R_1$  is to permit a fine adjustment of the carrier level at

which it is desired to have the circuit operate. If desired,  $K_4$  can be tied in with a reclosure circuit so as to recycle only a definite num-

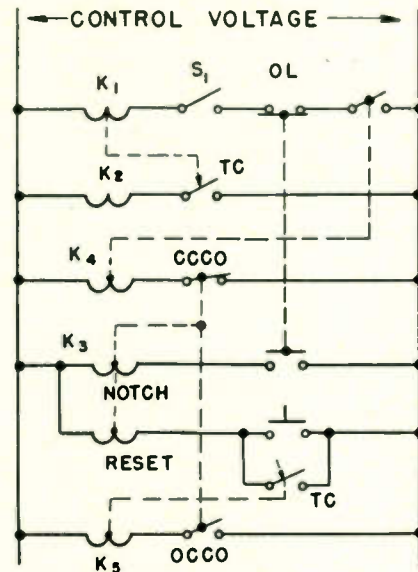

$K_1$ , Main rect. start contactor— $K_2$ , Main rect. run contactor— $K_3$ , Notching relay— $K_4$ , Auxiliary to  $K_3$ — $K_5$ , Reset timing relay, 10 secs.— $S_1$ , On-off switch— $OL$ , Overload relays— $CCCO$ , See text— $OCCO$ , See text

Fig. 12—Multi-shot type of automatic reclosure circuit

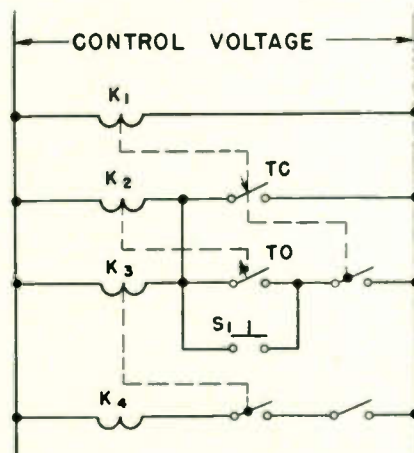

$K_1$ , Fil. time delay relay— $K_2$ , By-pass relay— $K_3$ , Auxiliary relay— $K_4$ , Plate contactor— $S_1$ , Emergency start button

Fig. 13—Circuit permitting immediate restoring of power following momentary voltage drop

ber of times in the event of equipment breakdown.

If it is desired to use the carrier drop method with excitation cut-off, a circuit such as in Fig. 9 can be used.  $K_1$  is the antenna diode rectifier relay.  $R_1$  plus  $R_2$  constitute the regular grid leak. When  $K_1$  picks up on normal operation, one of its contacts permits  $C_1$  to charge from a point of several hundred volts negative potential. If an antenna arc occurs,  $K_1$  falls out permitting  $C_1$  to discharge through  $R_3$ , and apply a high momentary bias on the grid of the buffer tube—

this drops the output to near zero and extinguishes the antenna arc. As soon as  $C_1$  has lost sufficient charge, the rf output comes up and  $K_1$  pulls in permitting  $C_1$  to again charge up in readiness for further trouble.  $R_3$  and  $C_2$  permit shaping of the voltage pulse applied to the buffer grid, as discussed previously, and again a contact on  $K_1$  shorts the audio input during periods of no excitation. All rf stages following the buffer are biased to near cut-off.

### Carrier drop method

There are several modifications of the carrier drop method which involve balancing the rf voltages at two points. One of these is diagrammed in Fig. 10.  $K_1$  is a relay with two windings excited from diodes coupled as shown. Under normal conditions the two diode currents are equal and the differential relay remains open. However, if anything occurs to upset the linear relation existing between rf voltages at the two points shown,  $K_1$  will operate to short the excitation and break the arc, whereupon  $K_1$  opens and the carrier comes up to normal. If this circuit is applied to a transmitter whose final stage is modulated, one diode could couple to the PA plate tank and the other to the antenna matching equipment.

Another source of outages is from overloads due to 'gas-kicks' in the large tubes and 'arc-backs' in mercury vapor rectifiers. These are

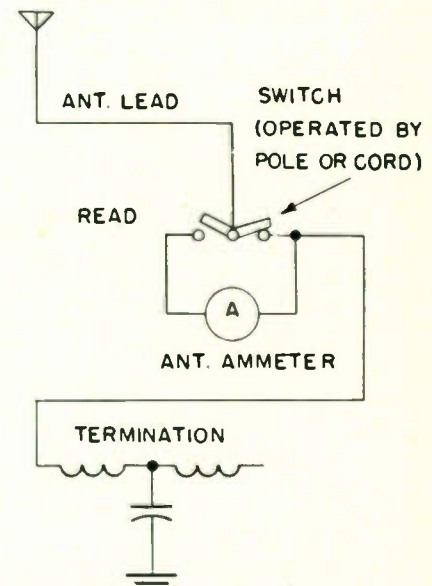

Fig. 14—Circuit for protecting antenna ammeter from burnout when not in use

often of but momentary consequence and the tubes tend to clean themselves by driving the gas molecules back into the anode. However, the tripping of the overcurrent relays removes the plate voltage, and it is desirable to get back on the

(Continued on page 112)

# UNIVERSAL CHART for

By R. C. PAINE

**By graphic methods the detector voltages of unbalanced ac bridges are determined and a universal chart is derived**

● In the design of bridges for the measurement of various circuit constants, it generally is insufficient to know only the balance conditions, or the ratio of branch impedances for a null voltage at the detector, as ordinarily given in text books. It also is necessary to know the voltage developed at the detector when the bridge is unbalanced, to determine plus and minus tolerances for inspection of circuit elements. The same is true of bridges used for industrial controls, as the precision of these controls depends upon voltages available for operating amplifiers or relays in the detector in the unbalanced condition.

The unbalanced detector voltage can be found conveniently by graphic methods, by assuming a

null indicator of high impedance, such as the grid circuit of an amplifier, in the detector branch of the bridge circuit. As an example, consider the Wien frequency bridge of Fig. 2a. The impedance vector dia-

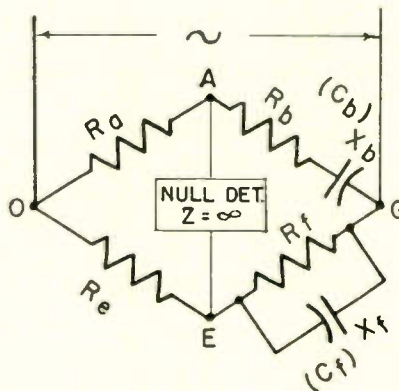

Fig. 2a—Circuit of Wien frequency bridge

gram of the upper, ab, branch and the lower, ef, branch for any given frequency can be drawn separately,

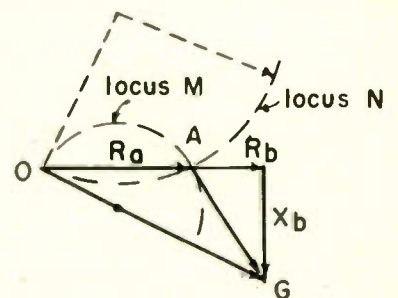

Fig. 2b—Impedance diagram of upper branch

as shown in Fig. 2b and Fig. 2c, respectively.<sup>1</sup> From the impedance diagrams, corresponding voltage

1. "Some Graphic Solutions of Parallel Circuits", "Electronics" pg. 90, Dec. '42.

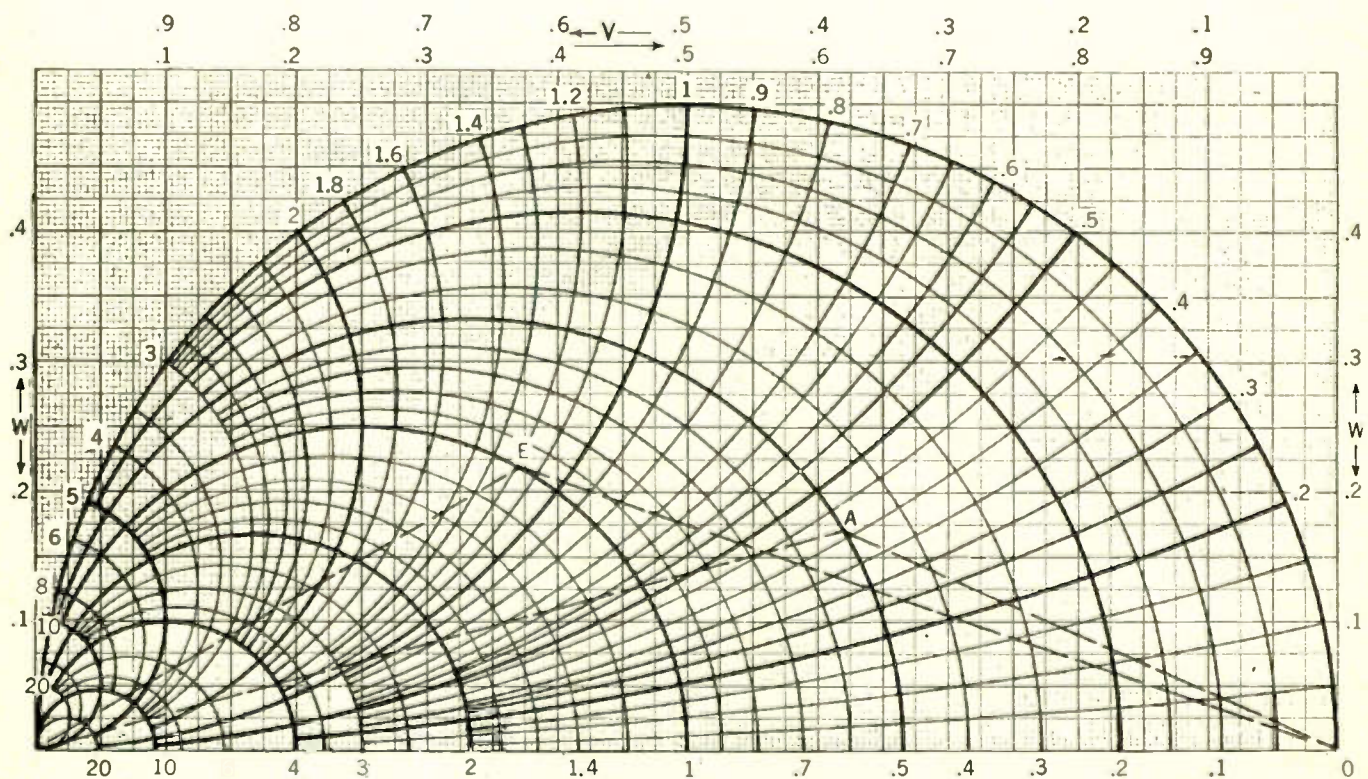

Fig. 1—Universal ac bridge voltage chart. Intersection of arcs representing ratio of bridge elements fixes value of voltage vectors

# UNBALANCED BRIDGE

diagrams to any convenient scale can be drawn and combined as in Fig. 2d, where OG represents the

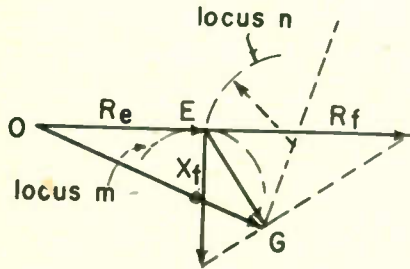

Fig. 2c—Impedance diagram of lower branch

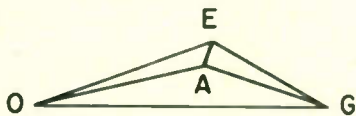

Fig. 2d—Combined voltage diagram of bridge

total applied voltage. Then the unbalance voltage available for operating the null indicator is represented by the vector AE.

As the frequency varies, the vectors representing  $X_b$  and  $X_r$  must also be varied. However, it can be shown that, with the applied voltage vector, OG, remaining constant, the point A moves in a semicircular locus, M, shown by the dashed arc in Fig. 2b, about a center on the line OG, as  $X_b$  varies.<sup>2</sup> In a similar manner, if the frequency, and therefore  $X_r$ , remains constant, but  $R_b$  is caused to vary, the point A moves in another arc, N, at right angles to the first arc.

Likewise for the lower branch, variation in the value of  $X_r$  only, causes the point E to move in a semicircular locus, m, as shown in Fig. 2c, about a center on the line OG. Variation in the value of  $R_r$  only, causes the point E to move in the semicircular locus, n.

Vector diagrams for any desired frequency similar to Fig. 2d can be drawn conveniently by the aid of the universal unbalanced ac bridge voltage chart of Fig. 1, which makes use of the semicircular loci shown above.

To use this chart the ratio of the various bridge elements are computed as follows: for the upper branch,  $R_b/R_a = M$ ,  $X_b/R_a = N$ , and for the lower branch,  $R_r/R_e =$

$m$ ,  $R_r/X_r = n$ . Values of M or m are represented by the arcs having their centers on the horizontal axis; values of N or n, by the arcs passing through the left hand origin and terminating on the circumference of the outer,  $M = O$ , arc.

For any given values of M and N the intersection of the corresponding arcs falls at a point designated by the rectangular coordinates,  $V_N$  and W. This value can be used in fixing the point A for drawing a vector diagram of bridge voltages, taking the driving voltage as unity. Arcs corresponding to the values of m and n are also located and their intersection fixes the coordinates of the point E, the horizontal coordinates being read in reverse as shown by the  $V_n$  values. Vertical coordinates, W, are read in the same way for either case.

As an example of the use of this chart, consider the Wien bridge of Fig. 2a with the following values:

$$R_a = 2,000 \text{ ohms, } R_b = R_c = R_r = 1,000 \text{ ohms, } C_b = C_r = .1 \text{ mf.}$$

At a frequency of 1,900 cycles the reactance values of  $X_b$  and  $X_r$  with the corresponding ratios, M, N, m, and n, are shown in table 2e.

Freq.	$X_b$	$M=R_b/R_a$	$N=X_b/R_a$	$A=V_N+jW$	
1900	$1837\omega$	.5	.418	$.62+j.17$	
1590	$1000\omega$	.5	.5	$.6+j.2$	
1200	$1325\omega$	.5	.664	$.56+j.245$	
	$X_r$	$m=R_e/R_r$	$n=R_e/X_r$	$E=V_n+jW$	Vector AE
1900	$837\omega$	1.	1.19	$.63+j.215$	.046
1590	$1000\omega$	1.	1.	$.6+j.2$	0 0
1200	$1325\omega$	1.	.755	$.56+j.165$	.08

Fig. 2e—Above values are an example of use of chart for Wien bridge

The point A corresponding to 1,900 cycles is located on the chart at the intersection of the curves  $M = .5$  and  $N = .418$ , as shown by the dashed lines. The base line represents the total applied bridge voltage considered as unity. This line, together with line to the point A, have been transferred to Fig. 2d to form the portion of the voltage diagram, OAG, representing the upper branch of the bridge. The point E' for the lower branch of

the bridge appears on the chart in the mirrored image of its true position E relative to point A, but this is taken care of by the coordinate figures  $V_n$  which run from right to left. In Fig. 2d the point E is shown in its correct position relative to A.

It is not necessary to draw the actual vector diagram, but the absolute value of the vector AE can be computed directly from its coordinates as for the hypotenuse of a right triangle, for 1,900 cycles,  $AE = \sqrt{(.63 - .62)^2 + (.215 - .17)^2} = .046$  of the applied bridge voltage. Table 2f also shows a zero unbalance voltage  $AE = 0$  at 1,590 cycles, the balance frequency. At a lower frequency, 1,200 cycles, the unbalance voltage is .08.

Unbalanced voltages in other types of bridges also can be solved by use of the chart of Fig. 1. In the Hay bridge, for inductance measurement, as shown in Fig. 3a, the upper branch is identical with the Wien bridge shown above. The voltage diagram for the lower branch is similar to that for the upper branch of Fig. 2a but reversed as shown in Fig. 3b. For constant values of  $R_c$  and  $R_r$  the

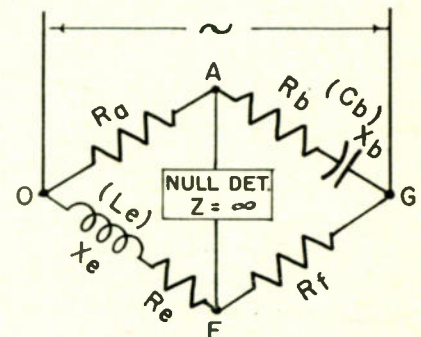

Fig. 3a—Circuit of Hay inductance bridge

2. Alan Hazeltine, "Current Loci in the General A. C. Network", A.I.E.E. Proc., pg. 325, March 1937.

point E moves in a circular locus the diameter of which,  $jG$ , equals  $R_t/(R_e+R_t)$ . For constant values of  $X_e$  and  $R_t$ , the point E moves in a circular locus the diameter of which is equal to  $R_t/X_e$ . On the chart this corresponds to values of  $m$  equal to  $R_e/R_t$  and  $n$  equal to  $X_e/R_t$ .

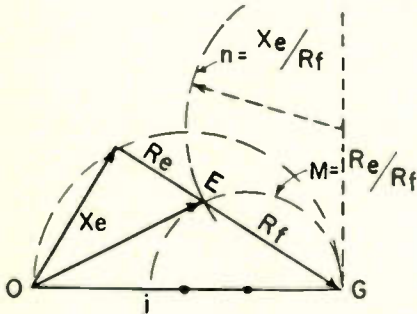

Fig. 3b—Impedance diagram of Hay bridge

As an example of the solution of the Hay bridge, take  $R_a = R_b = R_e = 1,590 \omega$ ,  $C_b = 1$  mf, and the inductance  $L_e$  under measurement equal to .253 henries, at balance at 1,000 cycles. In the table 3c it is shown that the unbalanced voltage AE is zero for these conditions. When the inductance is changed to .230 h. the voltage AE becomes .014.

$X_b$	$M=R_e/R_a$	$N=X_e/R_a$	
1590w	1.	1.	
$A=V_n+jW$	$L_e$	$X_e$	
$.4+j.2$	.253	1590w	
	.25	1445	
$m=R_e/R_t$	$n=X_e/R_t$	$E=V_n+jW$	AE
.5	.5	$.4+j.2$	0
.5	.454	$.59+j.19$	.014

Table 3c—Use of the chart for Hay bridge

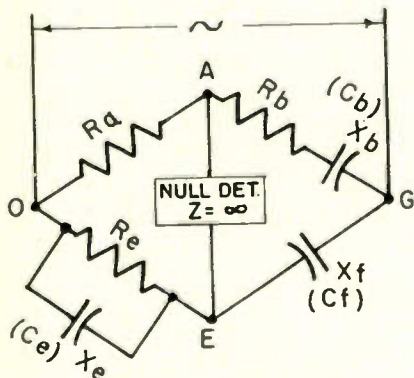

Fig. 4a—Circuit diagram of Schering bridge

The circuit arrangement of the Schering bridge, commonly used for dielectric measurements, is shown in Fig 4a. This diagram has been oriented so that the upper branch is the same as the upper branch

of the Wien bridge shown in Fig. 2a. The vector diagram of the lower branch is shown in Fig. 4b. When rotated through  $90^\circ$  as in Fig. 4c this diagram is seen to be similar to Fig. 2c for the lower half of the Wien bridge but reversed, corresponding on the chart to the values  $M = X_t/X_e$  and  $N = X_t/R_e$ .

As an example of the solution of the Schering bridge, the following values at balance are assumed:  $R_a = 3,180 \omega$ ,  $R_b = R_e = 1,590 \omega$ ,  $C_b = C_e = .1$  mf, and  $C_t = .2$  mf, frequency 1,000 cycles, where  $AE = 0$ . If  $C_e$  is changed to .11 mf the unbalanced voltage AE becomes .014.

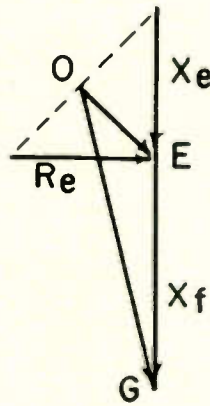

Fig. 4b—Vector diagram of Schering bridge

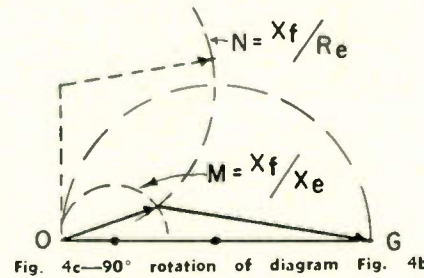

Fig. 4c— $90^\circ$  rotation of diagram Fig. 4b

$X_b$	$M=R_e/R_a$	$N=X_e/R_a$	
1590w	.5	5	
$A=V_n+jW$ <td><math>C_e</math> <td><math>X_e</math> <td></td> </td></td>	$C_e$ <td><math>X_e</math> <td></td> </td>	$X_e$ <td></td>	
$.6+j.2$	.1	1590w	
	.11	1440w	
$m=X_e/R_t$ <td><math>n=X_t/R_e</math> <td><math>E=V_n+jW</math> <td>AE</td> </td></td>	$n=X_t/R_e$ <td><math>E=V_n+jW</math> <td>AE</td> </td>	$E=V_n+jW$ <td>AE</td>	AE
.5	.5	$.6+j.2$	0
.55	.5	$.59+j.19$	.014

Table 4d—Use of chart for Schering bridge

The Owen bridge diagram, for inductance measurements, is shown in Fig. 5a. Its lower branch is the same as that of the Hay bridge shown in Fig. 3a. The vector diagram for its upper branch is shown in 5b. When rotated counter-

clockwise through  $90^\circ$  as in Fig. 5c this diagram is seen to be similar to the upper branch of the Wien bridge of Fig. 2b, but reversed. On the chart, then, the  $m$  and  $n$  values apply:  $m = X_a/X_b$  and  $n = R_a/X_b$ .

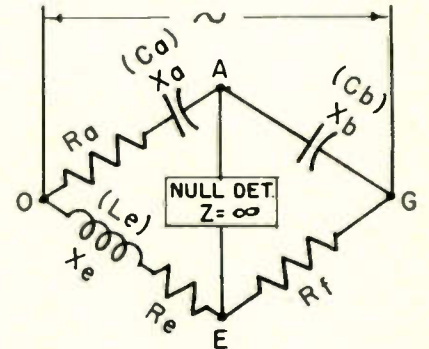

Fig. 5a—Circuit of Owen inductance bridge

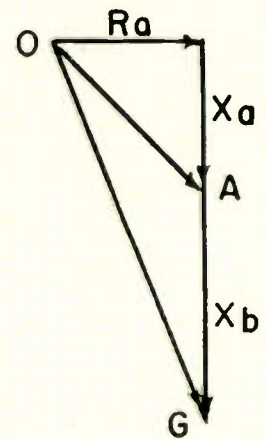

Fig. 5b—Impedance diagram of Owen bridge

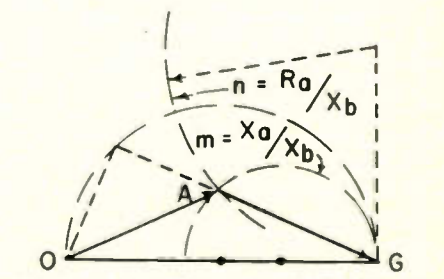

Fig. 5c— $90^\circ$  rotation of diagram Fig. 5b

$X_a$	$X_b$	$m=X_a/X_b$	
1590w	795w	2.	
$n=R_a/X_b$ <td><math>A=V_n+jW</math> <td><math>L_e</math> <td></td> </td></td>	$A=V_n+jW$ <td><math>L_e</math> <td></td> </td>	$L_e$ <td></td>	
2.	$.765+j.15$	.159h	
		.14	
$X_e$ <td><math>m=R_e/R_f</math> <td><math>n=X_e/R_f</math> <td></td> </td></td>	$m=R_e/R_f$ <td><math>n=X_e/R_f</math> <td></td> </td>	$n=X_e/R_f$ <td></td>	
1000w	2.	2.	
880w	2.	1.76	
$E=V_n+jW$ <td>AE</td> <td></td> <td></td>	AE		
$.765+j.15$	0		
$.75+j.145$	.016		

Table 5d—Use of the chart for Owen bridge

As an example of the solution of the Owen bridge the following val-  
(Continued on page 110)

# WATER ACTIVATED CELL

## Application of water starts action in new silver chloride-magnesium primary battery for emergency services

● When during the war, a serious need for light weight, small size, high powered batteries arose, the C. F. Burgess Laboratories, now Burgess Battery Co., Freeport, Ill., developed and put into production a silver chloride-magnesium, water-activated battery cell. As with other types, these cells may be assembled into either low or high voltage units. The main features of this cell are:

- (1)—Light weight and small size.
- (2)—Shipped and stored dry, since water only is used as electrolyte, (even sea water, since the purity is of secondary importance).
- (3)—It is maintained dry for indefinite shelf life under all conditions of temperature and humidity, since it is kept in a hermetically sealed container until used.
- (4)—When activated and placed in use it will operate at temperatures as low as  $-40^{\circ}$  F. without serious reduction of capacity, as well as higher than normal temperatures.
- (5)—It will give a constant voltage throughout the major portion of the time. This gives much more stable operation of equipment than that obtained by the conventional sloping discharge curve.

Technically, the battery consists of the silver chloride depolarizer and thin magnesium sheet (produced by an entirely new process) separated by highly absorbent paper, a construction not unlike that of a paper and foil capacitor. At the time of use, the battery is removed from its container and immersed in either ordinary tap water or sea water for activation.

After this immersion, it may be used either after removing it from the water and letting it stand in air, or during continued immersion (in the low voltage types) throughout the discharge. This eliminates the necessity of having an additional electrolyte chamber to carry electrolyte with the battery as with other types of reserve batteries.

The individual cell voltage under load averages around 1.5 volts. An example of size involved in normal rate discharge batteries follows:

- (1)—Type 4MC96 which is  $2\frac{3}{16}$  x

2 x 3 in. and weighs 260 grams when activated, has capacity equivalent to the normal 6 volt dry cell battery of the radio "A" variety, the latter being  $2\frac{5}{8}$  x  $2\frac{5}{8}$  x 4 in. and weighing 1.5 lb. (2)—A combination of a 3.2 volt

as a high discharge rate battery. The battery is essentially a reserve battery for "one shot" operation and at the present time is not designed for intermittent service. New applications, where light weight, minimum space, and high

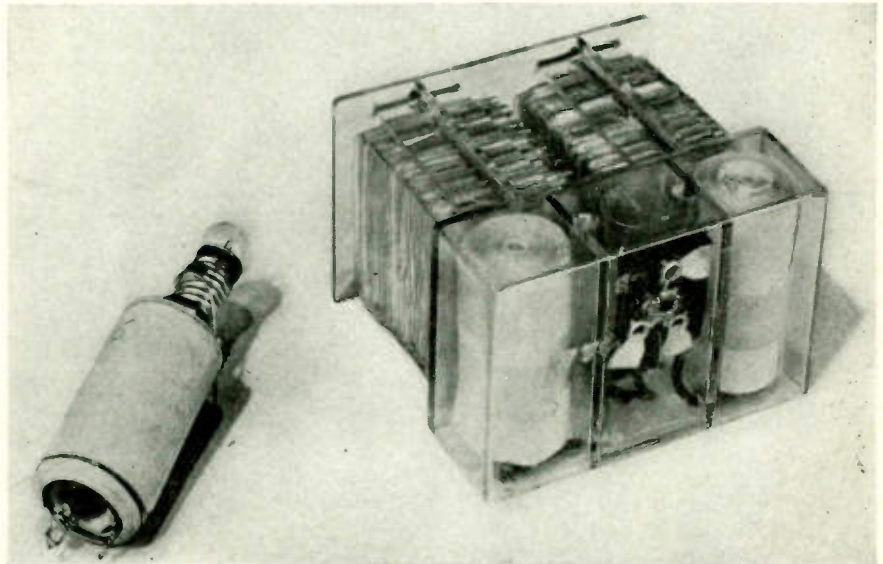

Above: (left) a signalling lamp wired permanently across 1.5 volt cell. Battery keeps indefinitely until wet. (Right) a combination 3.2 v-90 v radio reserve battery, item (2) in text, has load characteristics as shown in curves below.

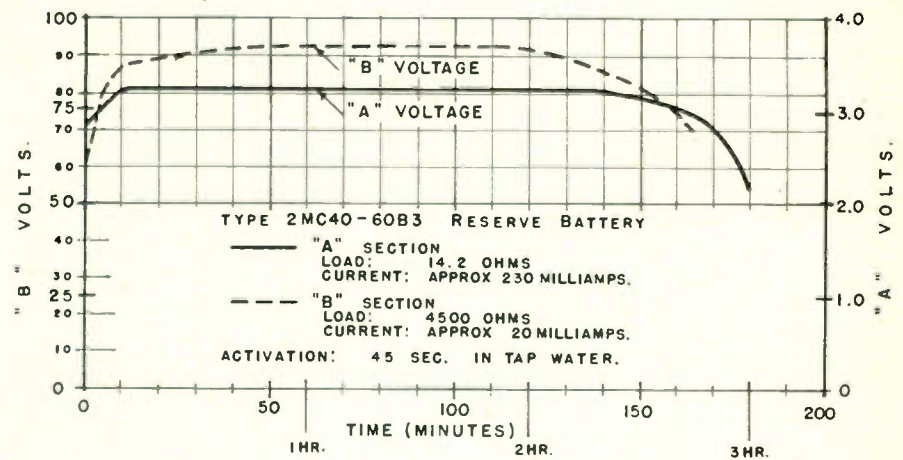

"A" and 90 volt "B" is  $2\frac{5}{8}$  x  $2\frac{13}{16}$  x  $1\frac{7}{8}$  in. and weighs 225 grams activated. This delivers 200 ma. "A" and 30 ma. "B" current for  $2\frac{1}{2}$  hours.

- (3)—A 3 volt unit  $2\frac{7}{8}$  in. diameter x  $3\frac{5}{8}$  in. long weighing 360 grams, activated, will deliver 38 amperes for 9 minutes to 2.2 end volts. This is an example of a type used

power are essential or where emergency units with indefinite shelf life prior to use are necessary factors, are appearing. In present designs, the output of these batteries is approximately 12 ampere-hours per pound, at extremely high rate discharges and 23 ampere hours per pound at normal and low discharge rates.

# UHF SIGNAL GENERATOR

Series of five interchangeable Klystron tubes, each covering a narrow band, provides frequencies from 2,600 to 10,300 mc

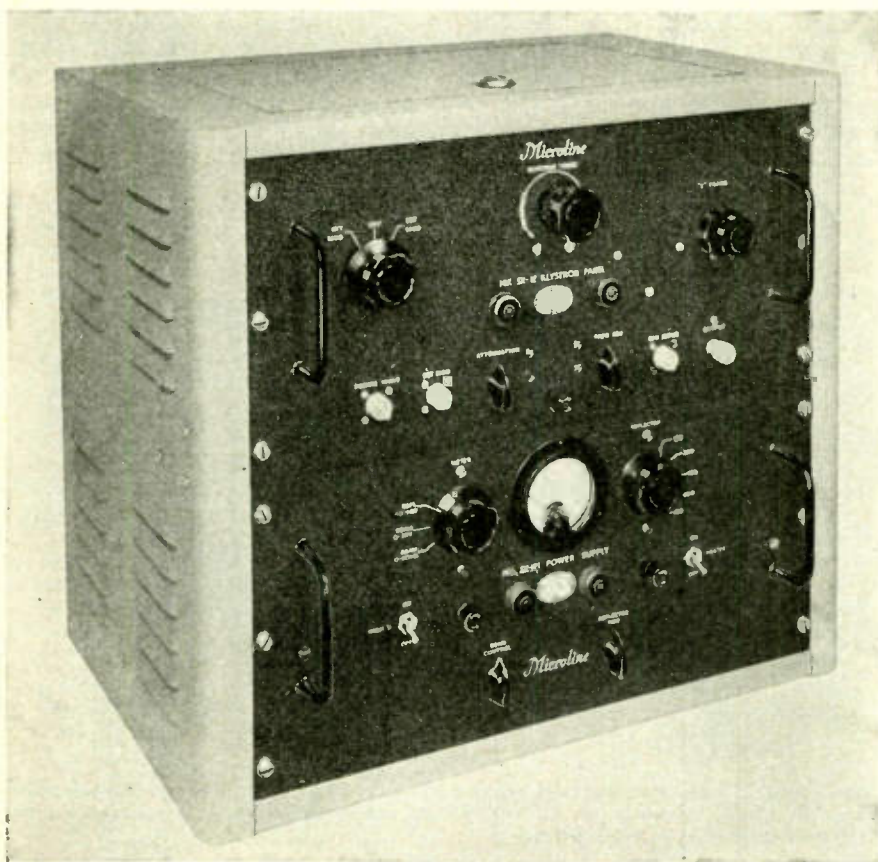

The Klystron signal source is a stable generator of micro-wave energy which supplies at least 200 milliwatts at all frequencies and up to 750 milliwatts at some frequencies

● Something new in the field of microwave equipment is the Mark SX-12 Klystron signal source which supplies microwave energy at any frequency from 2,600 mc to 10,300 mc. This is one of the first in a complete series of microwave measuring instruments now being manufactured and made available to the general market by the Sperry Gyroscope Co., Inc. It is a flexible and easy-to-operate instrument which satisfies a long-felt need for a stable, general purpose source of microwave energy which meets the requirements for use in laboratory measurements and production tests.

The signal source delivers at least 200 milliwatts at all frequencies and up to 750 milliwatts in certain frequency ranges. The output is stable and can be either frequency or amplitude modulated. A square-wave generator is built into the unit for

square pulse modulation. The square-wave modulator can be synchronized with an external source and its output is available for ex-

Functional block diagram of the signal generator showing circuits which supply power and modulation voltages to the interchangeable reflex Klystron oscillator

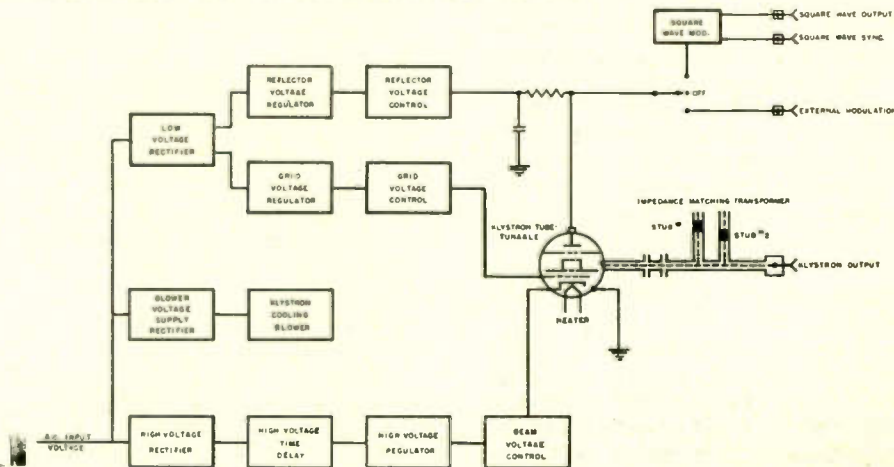

ternal use. The signal source can be voice modulated and therefore can be used as an experimental microwave communications transmitter.

The oscillator used to generate the microwave output is a reflex Klystron tube. A series of five Klystrons exist which are physically interchangeable to permit coverage of any frequency between 2,600 and 10,300 mc. Each tube is a complete oscillator in itself and can cover a band large enough for any single application. When another band of frequencies is desired, the Klystron can be changed readily by a simple plug-in operation.

The reflex Klystron is a perfectly stable oscillator which is well suited for use in a signal generator. It requires no external circuits other than modulation and dc power supply voltages. However, the frequency and amplitude of the Klystron output are direct functions of the electrode voltages. Because of this, an extremely well regulated, high-voltage power supply which is virtually free from ripple must be used if the Klystron output is not to contain spurious modulation components.

The power supply in the signal source exceeds this requirement through the use of an electronic regulator which has a feed-back amplifier. It delivers up to 1,250 volts with better than  $\pm 0.2$  volt

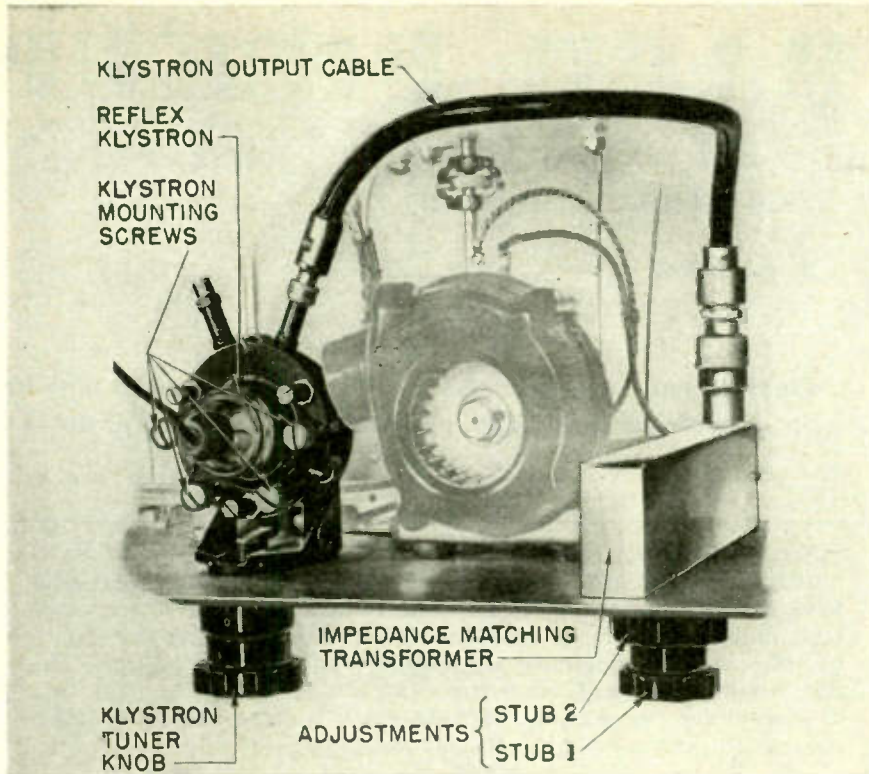

View looking into the top of the Klystron deck showing the convenient mounting of the reflex tube in its tuner and the output connection to the impedance matching transformer

regulation and less than 0.2 volt peak-to-peak ripple. This performance is maintained even when the line voltage is varied rapidly and repeatedly from 90 to 135 volts.

The electronic regulator provides a convenient means for controlling and varying the power voltages smoothly over a wide continuous range. The regulator delivers 0 to 750 volts negative and 0 to 1,250 volts positive, both continuously variable. The controls are so designed that small increments of voltage, and therefore of frequency also, can be easily obtained. The meter on the front panel measures beam voltage, reflector voltage, and beam current directly.

### Power supply

Such a regulated power supply can be put to many valuable uses other than operation of reflex Klystrons. As a "by product" of the signal source, a terminal strip is provided so that the power supply voltages can be used externally when the Klystron is not in operation. The separate voltages of the power supply are left ungrounded so they can be put together in any desired combination for external use. The output is suitable for operating cathode ray tubes, other Klystrons, and various high-voltage vacuum tubes which require stable dc voltages.

An important requirement in the applications of a Klystron is that of matching the tube impedance to the load. A bad impedance match between the generator and the line decreases the efficiency of the tube, "pulls" the frequency, and produces standing waves which can seriously

interfere with measurements being made. A tunable double-stub matching transformer is built into the signal source so that loads can be easily matched to the Klystron without using any external devices. The matching transformer is controlled directly from the front panel and will match to loads over the entire frequency band, 2,600 mc to 10,300 mc.

The square-wave modulation in the signal source generates undistorted square waves from 0 to 100 volts peak at any rate between 350 and 3,500 cycles. The rate of rise and fall of the square wave output is less than 0.1 microsecond over the entire range of the modulator.

### Measuring functions

In general, the signal source is useful wherever a low power source of microwave energy is required. It is especially useful in measuring:

1. Standing wave ratios in microwave transmission lines.
2. Impedance in microwave transmission lines.
3. Microwave receiver sensitivity.
4. Microwave frequency response and bandpass characteristics.
5. Experimental microwave communications systems.
6. Aligning and testing of microwave receivers.
7. Frequency modulated signal source for spectrum analyzers.
8. Test local oscillator.

Rear view of signal source showing adjustments and terminals (upper) power source (lower)

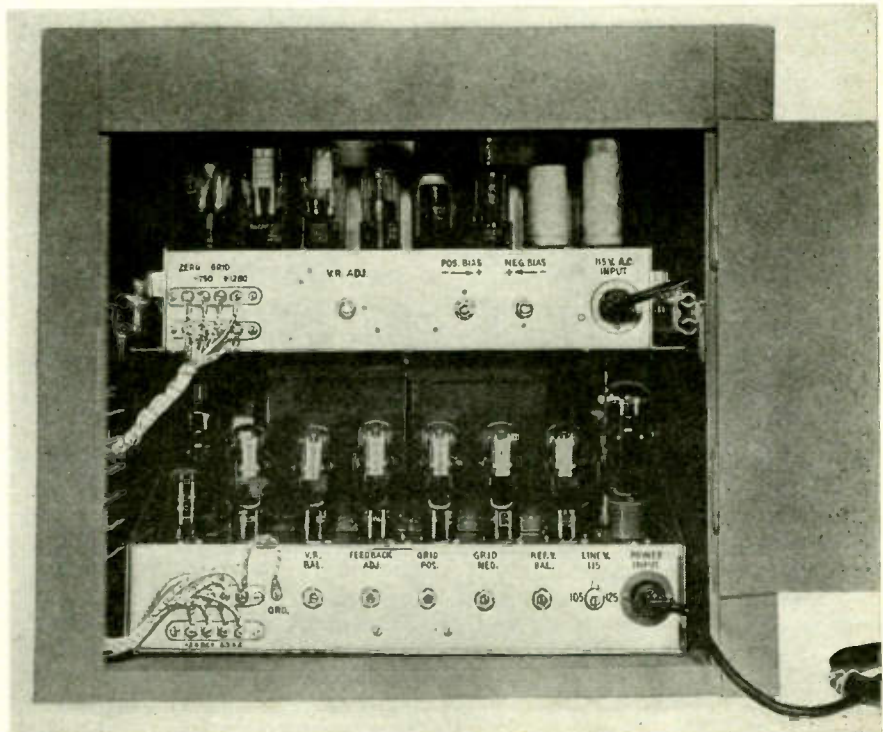

# PHONOGRAPH PICKUP

KENNETH J. GERMESHAUSEN,

M.I.T.\*

R. S. JOHN,

Pfanstiehl Chemical Co.†

## Resistance vs. strain characteristics of carbon results in a new wide-range reproducer of simple design

● This new pickup is based on the principle of the strain gage, a device that is used widely for the measurement of strain in mechanical systems. Strain gages measure strain, or change in dimensions, by the change in resistance of a resistive layer attached to the member being measured. Strain stretches or compresses the layer, changing its resistance accordingly. Various types of resistive layers have been used depending on the particular application. Usually they are composed of finely divided carbon, suspended in a carrier and having a plastic binder. The mixture is applied as a paint which when dried produces a thin, hard, coherent layer that is firmly bonded to the supporting member. For a given layer the resistance will depend on the relative proportions of carbon and binder, and on the fineness of the carbon powder. These factors are adjusted to produce a layer having the desired characteristics for a given application.

### Element design

The method of applying the strain gage principle to a phonograph pickup can best be explained by referring to Fig. 1. Basically, the pickup consists of a flexible cantilever beam rigidly attached to the tone arm at one end and driven at the other end by means of a stylus engaging the record grooves. The strain, or elongation and compression of the outer fibers of the beam, is proportional to the lateral displacement of the stylus, provided the tone arm has sufficient mass to be considered a rigid body. Along one surface of the beam, as indicated, is the thin resistive layer of carbon.

Lateral motion of the stylus pro-

\*Edgerton, GERMESHAUSEN and Grier, 77 Massachusetts Ave., Cambridge, Mass.

†Waukegan, Ill.

A great deal of effort has been put on the development of high-fidelity, light-weight phonograph pickups. The workers in this field have used crystal, electrodynamic, electromagnetic and capacity systems and have produced excellent results with each; but the system described here, it is believed, has definite advantages over others. The final result, perhaps, is no better than can be obtained by the best of each of the better known systems, but it is obtained with a simple rugged device capable of being easily manufactured.

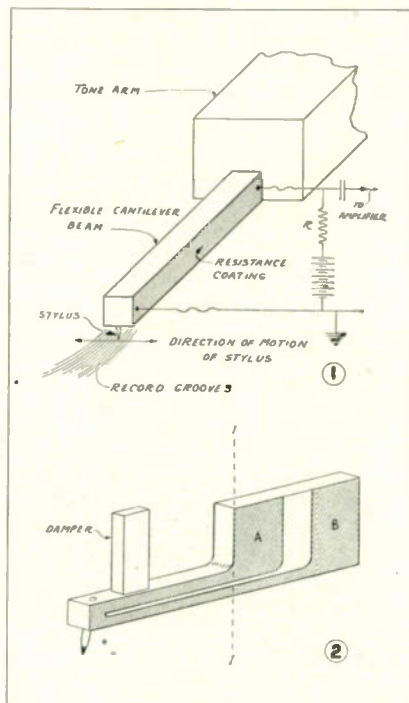

Fig. 1 (above)—Basic elements of pickup

Fig. 2 (below)—Actual form of carbon layer

duces a proportional change in the length of the carbon layer and a corresponding change in resistance of the layer. Changes in resistance may be converted to changes in voltage in a number of ways; a convenient method is to apply a voltage to the layer by means of a dc source and a series load resistor  $R$ , as shown in Fig. 1. With this arrangement a voltage is developed

across the load resistor  $R$  which is proportional to the lateral displacement of the stylus. It should be pointed out that vertical motion of the beam does not produce a change in resistance, since elongation or compression of the coating on the upper half of the beam is balanced by an opposite strain on the lower half, hence the average change in resistance is zero.

Simple as the above structure may seem, it meets the requirements of a quality reproducer. It possesses vertical compliance and is rigid with respect to motion along the record groove. By making the beam small, and of a material of low modulus of elasticity, it is possible to obtain very low mass and stiffness.

To a large extent the performance of the pickup will depend on the quality of the resistance layer, hence a great deal of experimental work has been done on the preparation and application of the carbon coating. Properly prepared layers are constant with respect to resistance and sensitivity to strain, and are completely free from the background noise or hiss usually associated with carbon devices.

The change in resistance with respect to strain is a linear relationship over a wide range of strain, considerably greater than is ever encountered in use. To prevent changes in resistance due to moisture absorption, or damage from mechanical abrasion, the carbon



# USING STRAIN GAGE

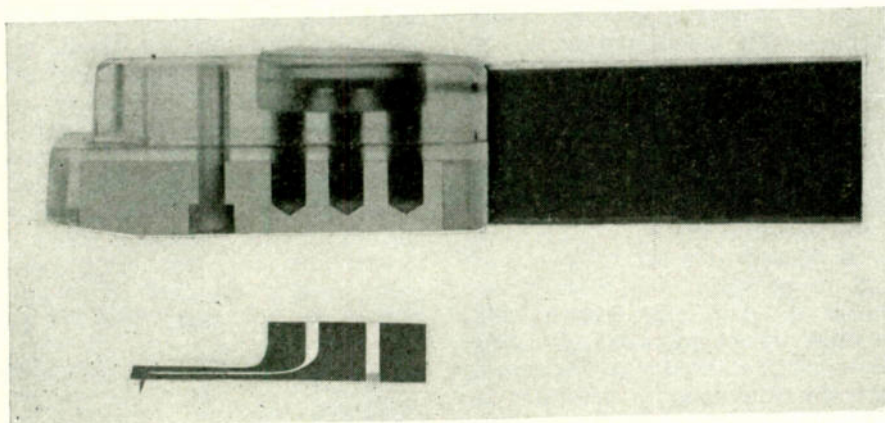

Fig. 4—Strain gage element removed from pickup head, showing position of three contact studs

layer is covered with a protective lacquer coating. This lacquer coating is so effective that water immersion does not appreciably affect the characteristics of the pickup.

Fig. 2 shows the form of the pickup as it is used in practice. Unplasticized, injection-molded polystyrene forms the base material of the unit. It is the only plastic found that combines a low modulus of elasticity with good dimensional stability. Other materials tried had a tendency to cold flow, causing the beam element to become bent upward after prolonged use.

The portion of the unit to the right of the line 1-1 is firmly clamped in a suitable cartridge attached to the end of the tone arm, the portion to the left of the line 1-1 is the flexible cantilever beam. Typical dimensions for the beam section are 0.0625 in. square by 0.5 in. long. A beam of these dimensions has a resonant frequency on the order of 4000 cycles per second, hence it is necessary to use some form of damping to prevent undesirable resonance peaks in the output. Since the mass and stiffness of the moving parts is very low, the amount of damping required also is low.

A damping member of rubber or one of the highly plasticized plastics can be cemented to the beam as shown in Fig. 2, with the upper end left free. However, it is not essential that the damper be cemented to the beam. An alternative method is to attach the damper to the cartridge, or holder for the pickup, and to allow the beam to bear lightly against it.

To avoid making a circuit connection to the free end of the beam

as in Fig. 1, the coating is carried out and back on the same side of the beam, connections to the two ends being made at A and B. These connections are readily made by means of pressure pads, against which the areas A and B bear when the pickup is clamped in its cartridge. A permanent stylus is used, since any device for clamping a re-

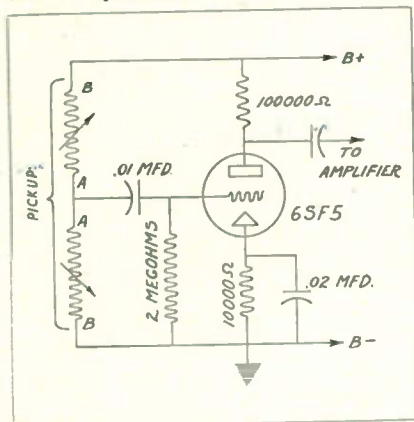
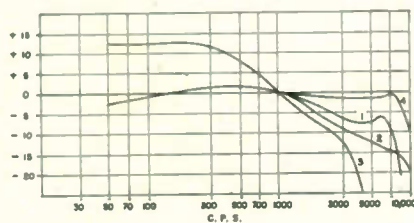

Fig. 3 (above)—Pickup preamplifier network

Fig. 5 (below)—Effect of damping adjustments



movable stylus would add materially to the mass of the moving parts. The stylus is attached to a small metal shank which in turn is cemented into the plastic beam.

The output voltage of the pickup can be increased somewhat, and the load resistor eliminated, by making

the pickup push-pull. This is accomplished by coating both sides of the beam in the same manner as shown in Fig. 2. Terminals A on both sides of the beam are connected together and become the output terminal, while the terminals B are connected across the dc power supply, as is shown in Fig. 3.

The resistance of the layers on opposite sides of the beam vary in equal and opposite directions, since any displacement of the stylus produces an elongation on one side of the beam and compression on the other. Any second harmonic distortion in the pickup will be eliminated by the push-pull connection; however, this type of distortion appears to be negligible.

Fig. 4 is a photograph of complete push-pull resistance pickup, and its cartridge or holder. It shows clearly the way in which the coating is carried out and back on the same side of the beam. The terminals B are brought out on the same side of the unit, so that all connections to the pickup can be made on one side. No damping element is shown, but in this model it is mounted in the cartridge and not cemented to the beam. When the pickup unit is placed in position the damper bears lightly against the upper side of the beam. Connections to the unit are made by three studs which bear against the respective connecting areas when the circuit is clamped in place.

## Method of compensation

Records usually are cut so that below a frequency of about 300 cycles per second the amplitude of the cut, for a given signal strength, is constant, while above this frequency the amplitude of the cut varies inversely with frequency. Since the output voltage of these pickups is proportional to amplitude over the entire frequency range, it is necessary to use some form of compensation when playing ordinary records.

A compensating system is shown in Fig. 3, where compensation is obtained by varying the inverse feed-back in the preamplifier stage. This arrangement results in a much smaller loss in voltage than the usual compensation networks, recommended for use with pickups

(Continued on page 118)

# TUBES ON THE JOB

## Raytheon Radarange Cooks with RF Heat

Electronic cooking is here. Raytheon Mfg. Co., 60 East 42nd St., New York, early last month demonstrated two production models of a new Radarange in which high

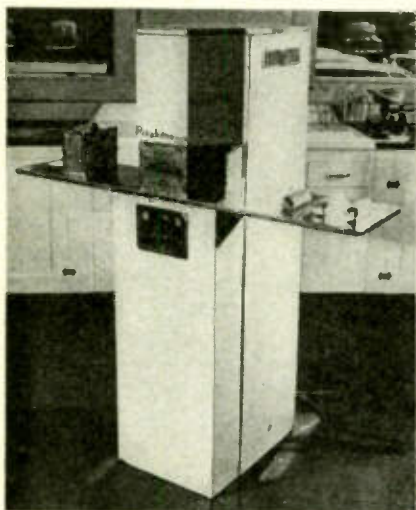

First electronic home cooker operates on vhf

frequency heat is generated with the aid of a magnetron tube. Of the two models, one is a sandwich size for the preparation of hamburger sandwiches, etc., and the other is intended for use aboard airplanes, railroads, ships, etc. This model is capable of handling a complete meal.

In appearance, the typical Radarange compares with the ordinary

home refrigerator, varying in size from a unit much smaller to one somewhat larger than a standard refrigerator. It consists essentially of a power supply, a magnetron unit and an applicator or horn through which energy from the tube is beamed and thereby concentrated into the food. This horn is so placed that the food may be put in an open oven directly beneath it. Two push buttons and a timer which automatically shuts the unit off when the food is cooked are the only controls necessary to operate the electronic range. The Radarange is rated at 5 kw consumption, is run from the 115 volt, 60 cycle lines and operates at a frequency of 3,000 megacycles.

## Carbon Black Weighing

A phototube assists in weighing carbon black at Lee Rubber and Tire Corp., Conshohocken, Pa. The scale has an additional pointer equipped with a black target, which covers a 15 lb area ahead of the indicator. A conveyor motor feeds the hopper until a lightbeam is intercepted by the target. This cuts the motor to half speed thereby eliminating excessive fluctuation.

## Production Checker

Mallory tropical dry batteries are electronically tested with a machine capable of checking electrical characteristics as well as physical dimensions in one inspection operation. Developed by Electric Eye

Equipment Co., Danville, Ill., the Hurlertron BVA-100 is based on photo-electric principles and is completely automatic; the operator merely places parts in a manual feeding chute. They are tested and selectively sorted at the rate of 78 pieces per minute. Voltage and current are the electrical characteristics checked. Voltage is compared with a standard to an accuracy of .001 volt. Current is



Dry batteries are fully checked by test unit

measured through a .1 ohm resistor. If the ingredients of the cell are improperly amalgamated, a bulge will appear at the bottom of the unit. This characteristic is also electronically checked and unsuitable units are rejected.

When front wheels of this Frazer car break a light beam during final testing at Willow Run plant, an electric eye controls raising of trap-door air scoop to dispose of poisonous monoxide fumes from tailpipe

Tires to be recapped are tested at Goodyear Tire & Rubber Co. for existence of ply separation using a supersonic tire tester. A defective tire decreases intensity of waves passing to microphone inside the tire

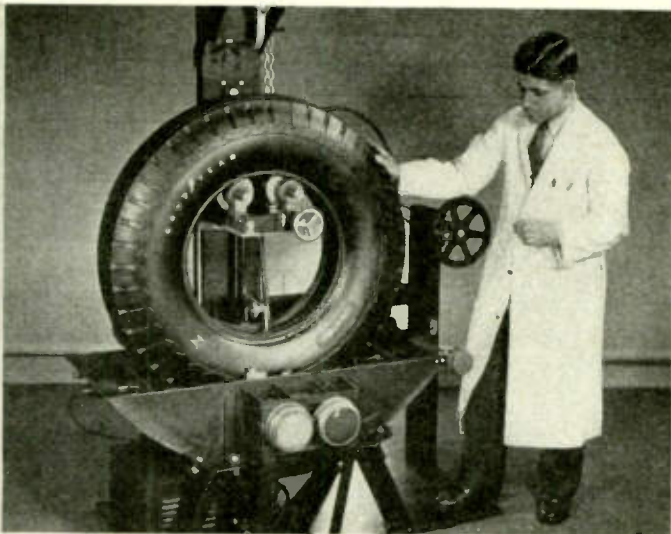
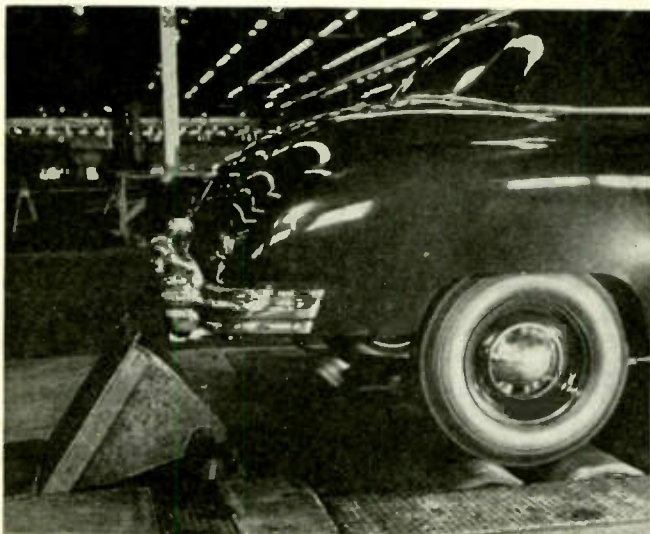



Metascope night sight produces its own power for detection of infra-red radiation

### Infrared Detector Uses Nuclear Reaction

One of the highly successful and until recently "top-secret" war-time developments was the "Metascope" night sight, a device used for the detection of infrared light. It is similar in operation to the now well-known "Sniperscope" and "Snooperscope" night-vision equipment. Chief advantages over such equipment are its small size, lightness and compactness, obtained by use of a self-contained power-source. The power-source consists of a small amount of radioactive material inside of a lead-sheathed compartment in the base of the metascope. When the control switch on the side of the scope is set in the "Charge" position, radioactive energy produced by a nuclear reaction in the material "charges" up a viewing screen and sensitizes it to infrared radiation. With the control switch in the "use" position, infrared light striking the screen produces a greenish-white glow, which may be viewed by means of a periscope-like mirror with attached infrared filter in the raised cover of the metascope. Due to its light weight the device was particularly suitable aboard planes for reading infrared signals from the ground during parachute landing operations. The navy used the device for reading infrared "blinker" signals. It was originally developed as a countermeasure against enemy use of infrared signalling systems. Electronic Laboratories, Inc., Indianapolis, Ind., is the manufacturer.

### Electronic Valve Testing

Valve motion study by electronic means has proven itself far superior in simplicity of operation to stroboscopic methods and high speed motion pictures at the Wilcox-Rich Division, Eaton Mfg. Co., Cleveland, Ohio. A velocity pick-up on the valve in conjunction with a DuMont type 208 oscillograph is

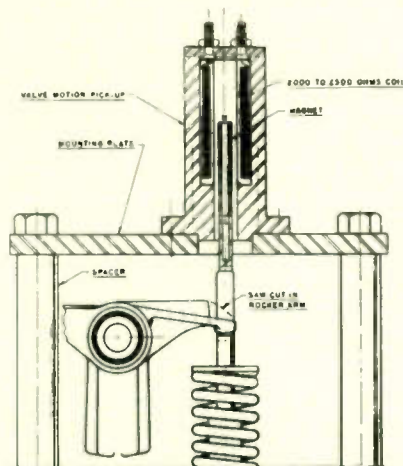

Sketch of velocity pickup mounted on valve

the only equipment required for detailed studies and diagrams of lift or displacement, velocity and acceleration.

The velocity pickup comprises an armature containing a small bar magnet, which is fastened to the valve tip and operates through a saw cut in the rocker arm. The magnet moves in a stationary coil of wire and generates a voltage directly proportional to the valve velocity.

The impulses from the coil are impressed on the terminals of the

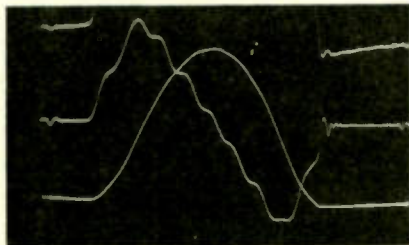

Typical velocity and lift diagrams on 'scope

oscillograph through an intervening circuit, which may be set for "Calibration", "Velocity", "Lift" and "Acceleration". For calibration the output of the pickup is measured at an engine speed where the maximum velocity is known. The calibration circuit is then adjusted for this output so as to permit the same setting of the oscillograph controls as at the outset of tests. A calibrated RC integrating circuit

is used for the determination of lift or displacement and a differentiating circuit for the acceleration diagram. Screen images are photographed with a 35mm camera and later enlarged for detailed study. According to the diagrams, valve motion is graded as good, fair or poor and necessary changes are then made on the basis of these tests. The electronic method also is used to determine wear of parts after accumulated mileage.

### Recording Thermal Expansion

An automatic recording dilatometer has been developed by the Electronics Div., Sylvania Electric Products Inc., 500 Fifth Ave., New York. The instrument embodies complete, automatic facilities for studying the thermal expansion and contraction of metallic, glass, ceramic and plastic specimens when subjected to a wide range



Automatic record of thermal expansion characteristics is obtained with dilatometer

of temperature cycling. A specimen chamber accommodates samples from 3 to 5 in. long which are then exposed to accurately controlled temperatures from below zero to as high as 1000° C., as indicated by separate thermocouples in both the furnace and specimen chamber. Temperature cycling is performed by an electronic furnace relay, controllable to an accuracy of 1° C, while a continuous chart record of dimensional changes vs. temperature is obtained, the overall accuracy of the system being about 0.2%. No attention is required during the 12 hr. recording cycle, though furnace and specimen temperatures, as well as specimen elongation, can be observed at any time during the cycle.

# SURVEY of WIDE READING

**Electronic news in the world's press. Review of engineering, scientific and industrial journals, here and abroad**

## Electron-Optical Method for Field Testing

M. von Ardenne (Physikalische Zeitschrift, Berlin, Vol. 45, pp. 312-313).

A method, analog to an established optical method, is suggested for locating disturbances or inhomogeneities in an electric or magnetic field. In this method a knife edge is inserted at the focal point of the lens to be tested which prevents half the electrons from reaching the screen.

The figure illustrates shadow images with the knife edge placed at the focal point: (A) small aperture to eliminate spherical aberration;



(B) large aperture illustrating effect of spherical aberration, perfect rotational field symmetry; (C) large aperture, rotational field symmetry disturbed by a small iron particle placed close to the outer edge of the air gap in the magnetic lens. If desired an image of the particle causing the field disturbance can be secured.

## Computing Intermodulation Products

A. Bloch (Wireless Engineer, London, August, 1946, pp. 227-230).

A method for the numerical calculation of the intermodulation product amplitudes from tube characteristics is set forth. In general, the value of the amplitude of a particular intermodulation product is found by means of tables and a series of equidistant ordinates ( $I_n$  in the sketch) of the tube characteristic, where the ordinate corresponding to the operating point is  $I_0$ .

The tables contain constants by which the equidistant ordinates have to be multiplied, the sum of these products being equal to the

desired intermodulation product amplitude. A separate table of constants for each product—such as sum of fundamentals, sum of each fundamental plus the first harmonic of the other fundamentals, etc.—is required, listing a series of values for various amplitudes of the original waves (these amplitudes are equal to unity and two, respectively, in the example illus-

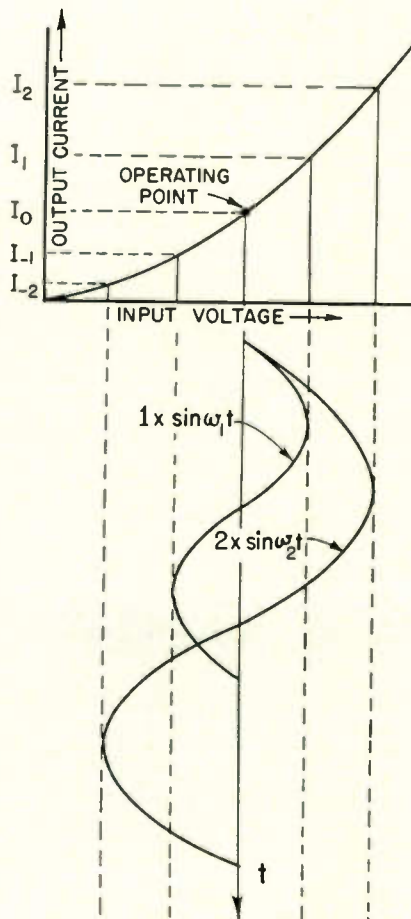

trated in the sketch). Amplitudes are measured in units which equal the potential difference between two neighboring ordinates.

The formulas for the tabulated constants are based on the formulas for the calculation of the harmonic output in the case of one input frequency presented in the I.R.E. Proc., Vol. 21, pp. 1439-1446, by D. C. Espley. Derivation of the

new tables from the tables permitting evaluation of the harmonics is described. Tables are included for the sum of the intermodulation products corresponding to the sum of the two frequencies for different amplitude values and of the sum of one fundamental frequency plus twice the other fundamental frequency for six different amplitude values. Other coefficients may be readily evaluated from the table for the computation of the harmonic content which is also available. More than two input frequencies may be handled by an extension of this method.

## UHF Wavemeter

J. Banner (Electronic Engineering, London, September, 1946).

Intended as a test instrument for radar equipment, a frequency meter for pulse-modulated waves covering the band from 155 to 255 megacycles has been designed for an accuracy better than 0.25 megacycles. The instrument operates, alternatively, as an oscillator to the same accuracy with the additional feature that radiation cannot be detected by the enemy. A short time stability better than 0.1 megacycle is achieved. The wavemeter design follows the lines of a conventional superheterodyne receiver and also incorporates a crystal monitor.

## Graphical Analyses of Nonlinear Circuits

A. Preisman (Quarterly of Applied Mathematics, Vol. III, No. 3, pp. 185 to 197).

Graphical methods for the solution of nonlinear circuits are explained. In particular, a diode in series with a resistor, a triode in series with a resistor, a balanced amplifier, and an inductance in series with a resistor are treated. Operation of a nonlinear resistance in series with an inductance is studied and operation of this circuit as a relaxation oscillator is made clear graphically.

## Study of Multipath Transmission

E. Hoelzler (Elektrotechnische Zeitschrift, Berlin, April 20, 1944, Vol. 65, Nos. 15/16, pp. 132 to 138).

Fading and change in tone quality in two sideband AM, one sideband AM, and FM short wave communication systems are studied and their performance compared. At single-sideband transmission there

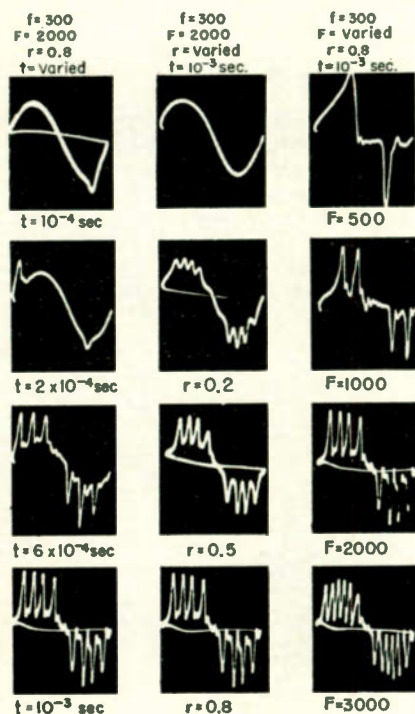

is no variation in intensity of the received signal, however, the tone quality may change; while at the two-sideband systems continuous changes in intensity and strong non-linear distortions are to be expected, the tone quality remains fairly constant. In frequency-modulation systems the arriving combined wave will have the medium frequency of the instantaneous frequencies of the two arriving wave trains, the difference frequency corresponding to the time delay. However, at certain intervals, a short large frequency excursion will take place, introducing considerable distortion.

These phenomena are discussed. An equivalent two-channel transmission system, simulating the two-way transmission through space, was set up to investigate the behavior of two simultaneously transmitted modulated waves and the influence of disturbing senders in the vicinity. The two-channel system was adapted for variation of the time delay,  $t$ , and for variation of the ratio,  $r$ , of the relative amplitudes of the two transmitted waves.

The figure shows the distortion of a frequency-modulated short wave obtained on the screen of an oscillograph which was connected to the experimental equipment. In the first row down the time delay,  $t$ , is varied, in the second row down the amplitude ratio,  $r$ , of the two transmitted waves is varied, and in the third row down the maximum deviation frequency,  $F$ , is varied, while the modulating frequency,  $f$ , is maintained constant throughout.

## Computation of Electron Lenses

H. Motz and Laura Klanfer (Proceedings of the Physical Society, London, January, 1946, pp. 30 to 41).

A complete numerical computation of electron-optical systems, without recourse to experiment, is described. The method is demonstrated with regard to a cylindrical electrostatic lens; the diameter ratio of the cylinders is 1.5, their potentials 200 volts and 1200 volts, respectively. Axially symmetrical magnetic focussing systems may also be solved.

The method involves subdividing the space considered into small squares by drawing a net, inserting the known potential values at the electrodes, and determining the value of each netpoint from the values of the neighboring points by a successive approximation formula based on Laplace's equation. At regions of large variations of the potential, for instance near sharp edges, the net must be adequately subdivided to give the required accuracy.

Electron paths may be computed once the potential field has been established. Two paraxial paths, determining focal length and principal planes, were calculated, as well as one non-paraxial path defining the spherical aberration for the special lens studied.

## Piezoelectric Recorder

J. Laurence Malcolm, University of Otago Medical School, Dunedin, New Zealand (Journal of Scientific Instruments, London, June, 1946).

A piezoelectric unit has been specially constructed for physiological recordings; an X- or AT-cut quartz crystal, approximately 25 x 25 x 2 mm, mounted between two Isolantite discs is used. Details of the crystal holder and the circuit diagram of the associated two-stage, resistance-capacitance coupled amplifier are given.

## Radar Principles

S. K. Haynes and W. J. Jackson (American Journal of Physics, Vol. 14, No. 3, May-June, 1946, pp. 143 to 164).

In a general article, the basic principles underlying the construction of a radar set—rather

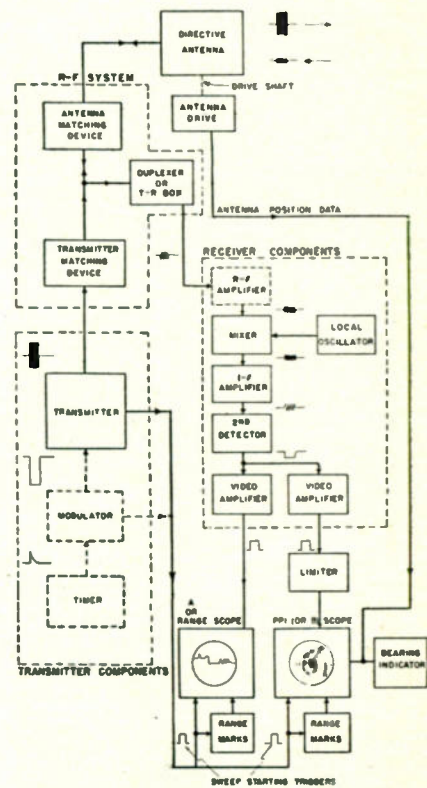

than details of a particular design—are explained. The various components illustrated in the above schematic and their functions are enumerated and several alternative circuits, capable of performing the desired operations and incorporated in certain models, are discussed.

## Inspection of Castings

T. E. Piper (Iron Age, May 27, 1946).

The fluoroscopic interpretation of casting irregularities as a supplement to radiographic inspection is discussed. Observations made with the equipment set up at Northrup Aircraft, Inc., is reported. Though less accurate—1/64 in. sensitivity as compared with 0.001 sensitivity of radiographic apparatus—fluoroscopic inspection may prove satisfactory in many instances.

## Decibel Meter for Broadcasting Stations

F. A. Peachey, S. D. Berry and C. Gunn-Russell (Wireless Engineer, London, July 1946)

Tone level for steady tones (rms values), peak volume for fluctuat-

(Continued on page 133)

# NEW PATENTS ISSUED

## FM Noise Squelching System

When the ratio of signal to noise magnitudes falls below a certain threshold value or "improvement threshold" the audio frequency output of the discriminator is essentially noise voltage; this will usually occur during tuning between stations or as a result of deep fading.

To eliminate the noise present at the output of an FM receiver in the absence of a modulated carrier, a locally-produced carrier current is introduced at a point prior to the limiter which effects suppression of the noise. The frequency of

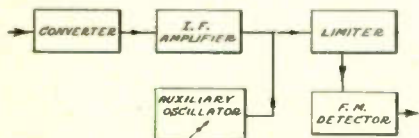

this locally generated oscillation is spaced from the edge of the received frequency band by a super-audible frequency, at least by 10 kc, to avoid audible beats.

For very deep amplitude modulation, the limiter output energy is amplitude modulated regardless of the degree of limiting. Noise will be the result of this condition. If there is equality between noise and signal peak amplitudes or if the noise amplitude exceeds the signal amplitude, complete cancellation of the signal by the noise may occur and the noise alone will be audible; however, the auxiliary carrier will suppress this noise. The locally produced carrier itself is suppressed, just like noise, when a strong enough desired carrier current is received. To secure complete squelching action, the input amplitude to the limiter should be great enough to secure limiting action; for this it is required that the auxiliary current amplitude minus the peak amplitude of the combined noise currents exceed the limiter level at all times. The auxiliary oscillator current amplitude is therefore preferably about twice the combined peak noise current amplitude; it is also considerably less than any desired signal amplitude so as not to produce disturbances.

S. W. Hansell, RCA, (F) August 11, 1943, (I) February 26, 1946, No. 2,395,737.

## Superregenerative Receiver

It is proposed to reduce distortion in a superregenerative receiver by negative feedback of the audio potential to the control grid of the regenerative radio-frequency amplifier tube. Automatic volume control action is secured.

R. C. Emerson, Bendix Aviation Corp., (F) February 14, 1944, (I) April 9, 1946, No. 2,398,214.

## Gas-Filled Tube

A specially constructed grid-controlled gas-filled tube is claimed which has a screen grid located in the region of greatest conductivity. In operation a negative potential is applied to this electrode which will then collect positive charges reducing its negative potential; it may serve as output electrode and has preferably no control over the discharge which is initiated by a positive pulse on the control grid.

The electrodes are concentric cylinders. Control and screen grid have apertures extending in the direction of the cylinder axis, the aperture of the screen grid being much wider so as not to hinder passage of the electrons. A pulse counting circuit based on the particular gas-discharge tube is described.

J. H. Cone and R. E. Numma, National Cash Register Co., (F) October 10, 1940, (I) April 23, 1946, No. 2,398,772.

## Exploding Torpedoes

The torpedo is exploded in the vicinity of the target by the electromotive force induced in coil 11 upon passage through a magnetic field of varying intensity or direc-

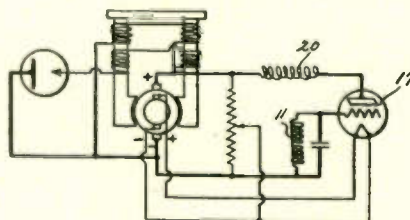

tion which field is provided by the presence of the ship in the earth's field. Coil 11 accommodates a large number of turns and has a highly permeable core. The induced electromotive force drives the grid of tube 17 more positive and plate current flows through solenoid 20 which actuates the torpedo explod-

ing mechanism. A water wheel rotates the generator which supplies plate and grid voltages for tube 17.

C. T. Minkler, (F) May 9, 1932, (I) April 2, 1946, No. 2,397,678.

## Locating Guns

A sound direction finding equipment, incorporating two microphones 11 and 12 and a recorder is designed to permit finding the direction in which one of several guns is located. By the present system it is possible to locate and distinguish guns firing at almost the

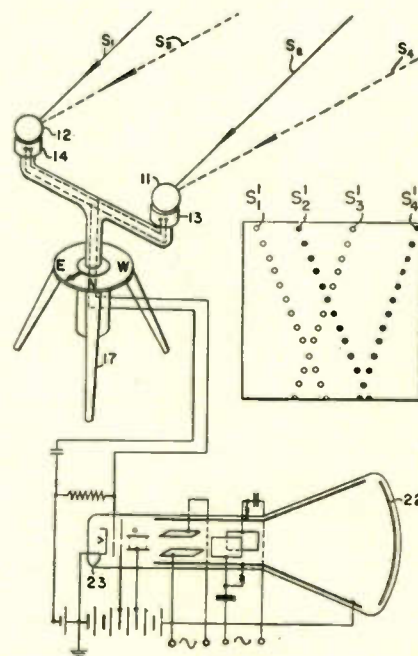

same rate which cannot be done by frequency-selective equipment.

The screen 22 is scanned in parallel lines at an adjustable rate. If the line repetition frequency is approximately an integral multiple of the recurrence frequency of the sound pulses emitted by the gun, a succession of spaced pairs of signal pulses arranged in parallel rows  $S'_1, S'_2$  (see inset drawing) will result, corresponding to the received signals  $S_1$  and  $S_2$ . The distance between two pulses of a pair on the screen corresponds to the phase difference of the received signals and therefore is related to the direction at which the sound originates.

Amplifier 13 has a considerably higher gain than amplifier 14 causing brighter spots on screen 22 of

(Continued on page 133)

# EVERY DE MORNAY-BUDD WAVE GUIDE is Electrically Tested, Calibrated and Tagged

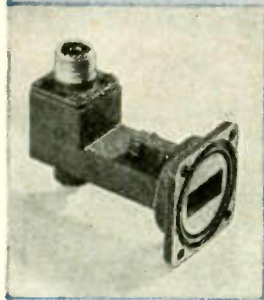

Crystal Mount DB-453



Rotating Joint DB-446



90° Elbow (H Plane) DB-433



Pressurizing Unit DB-452



Mitered Elbow (H Plane) DB-439



Uni-directional Broad Band Coupler DB-442

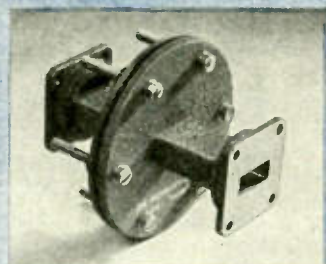

Bulkhead Flange DB-451



Uni-directional Narrow Band Coupler DB-440



90° Twist DB-435

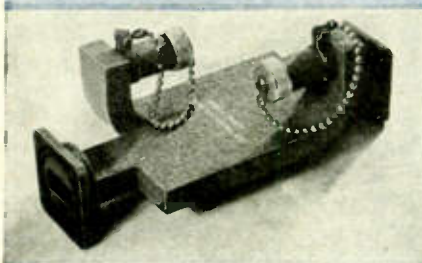

Bi-directional Narrow Band Coupler DB-441

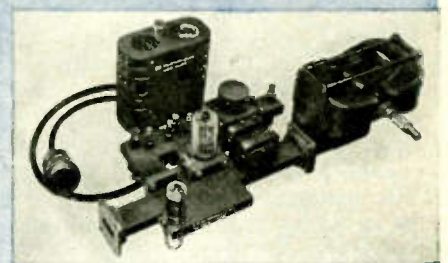
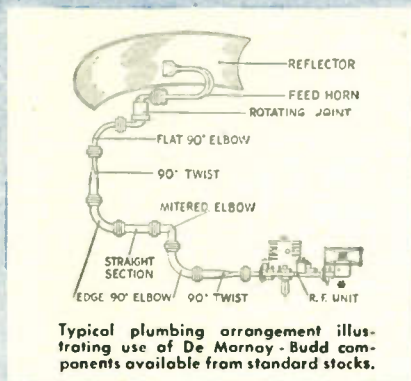

RF Radar Assembly DB-412

When you use any De Mornay-Budd wave guide assembly, you know exactly how each component will function electrically. You avoid possible losses in operating efficiency through impedance mismatches, or breakdown and arcing caused by a high standing wave ratio. (See chart below.)

De Mornay-Budd wave guides are manufactured from special precision tubing, and to the

most stringent mechanical specifications. Rigid inspection and quality control insure optimum performance.

**NOTE: Write for complete catalog of De Mornay-Budd Standard Components and Standard Bench Test Equipment. Be sure to have a copy in your reference files. Write for it today.**

The curve shows the manner in which the reflected power increases with an increase in the voltage standing wave ratio. The curve is calculated from the following equation:

$$\% \text{ Power Reflected} = \left( \frac{\left( \frac{V_{\max}}{V_{\min}} \right) - 1}{\left( \frac{V_{\max}}{V_{\min}} \right) + 1} \right)^2$$

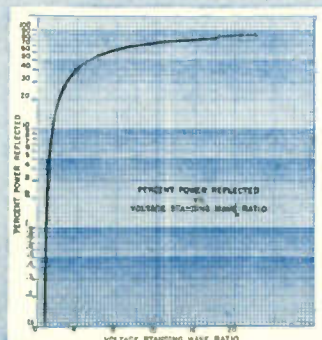

De Mornay-Budd, Inc., 475 Grand Concourse, New York 51, N. Y.

# WASHINGTON

★ ★ ★ Latest Electronic News Developments Summarized  
by Electronic Industries' Washington Bureau ★ ★ ★

**BATTLE OF TELEVISION**—Hearing before Federal Communications Commission this month on proposal of Columbia Broadcasting System for immediate adoption and authorization of commercial operation of color television stations in UHF frequencies will be most important milestone in Television's history. All the major companies, broadcasting and manufacturing—and the A.T. & T. because of relaying over coaxial cable and radio microwave relay—were slated to participate. But key testimony was projected as that of the Radio Technical Planning Board's Panel (Television) No. 6 which has been working on color television commercial standards all summer.

**HIGH FREQUENCY FOR COLOR**—CBS, while not wanting to discard black-and-white television broadcasting, is seeking to prove that color video is ready and to hold it up further would hinder progress of television as a "truly nationwide and competitive system". Band, 480-920 megacycles, now allocated for experimental video, is requested by CBS for commercial color television. FCC, which has endorsed monochrome video for immediate commercial operation because it is fully ready for the public, is asking CBS and its trio or so of manufacturer supporters to present full proof of their claims to counter the position of RCA, Philco, GE, and other companies that color video is still a long way off.

**PRICE DECONTROL**—Stimulus for radio manufacturing industry to maintain and increase present tempo of receiver production was augured during October by plans for all set manufacturers to launch price decontrol proceedings before the Price Decontrol Board of the Office of Price Administration early in November at the latest and with strong possibility of speedy decision by OPA Board. Ammunition in form of industry statistics and production costs and figures were gathered first by the parts manufacturers during mid-October and then were assembled into all-out industry story for presentation to OPA by set manufacturers, both in meetings in Washington and in Chicago Oct. 23. This is anticipated to mean Price Decontrol for the industry two months ahead of the previous schedule of the OPA.

**PROSPECT EXCELLENT**—With industry's record of set production which during the past three months has been greater than the prewar marks, and tubes and most other components at new highs for this year, the termination of price controls—with free competition and the law of supply and demand operating unfettered—is expected to result in substantial gains in output and sale of sets.

**U. S. ELECTRONICS MAY PROVIDE KEY**—Need for standardization of radio-communications-electronics facilities for overseas and global air travel was objective of Indianapolis CAA-Army-Navy-Coast Guard demonstration of latest American devices in aviation radio field during October, just before the Montreal Provisional Civil Aviation Organization (PICA) sessions which are being held in November to write the world "ticket" on flying communications-navigation standards.

**AVIATION COMMUNICATION EXPERTS GATHER**—More than 150 aviation communications experts from 37 foreign nations attended the Indianapolis demonstration, which was also the center of attention of the leading American government and industry officials in that field. Tests of equipment, in which U. S. devices will be stacked up against British apparatus demonstrated in London just prior to Indianapolis affair, were important in paving way for American manufacturers to sell their products in aviation radio-electronics not only in this country but throughout world.

**AMERICAN MANUFACTURERS STAGED NOTABLE EXHIBITS**—Eighteen leading U. S. radio manufacturers had equipment at the Indianapolis tests, the latter being semi-official as under the auspices of CAA, Army, Navy and Coast Guard. Leading Indianapolis Airport exhibits were: Raytheon's ground search radar, Minneapolis-Honeywell automatic electronic pilot, Bendix' airborne and ground radio-electronic devices, Federal Telecommunications Laboratories' "Navar" and "Navaglobe" systems of long-range radar navigation controls, Sperry Gyroscope's microwave instrument landing and automatic lander system, Radio Corporation of America's "Teleran" system of airport and airplane control, Gilfillan's ground control approach, Lear's airborne and ground radio equipment, General Electric's airborne radar, and devices for airplane safety and communications by Collins Radio, Aircraft Radio, Wilcox Electric and Radio Navigations Instrument Company. Aeronautical Radio's Airborne Instrument Laboratories also had a most significant array of its latest developments. Because of important displays, which are to be described in an article in later issue of ELECTRONIC INDUSTRIES, your Washington editor, who also observed them, wanted to mention the major participating manufacturers whose equipment is felt to be leading the world in performance.

National Press Building  
Washington, D. C.

ROLAND C. DAVIES  
Washington Editor



*for every control need*



*for every control need*



# TOMORROW'S RELAYS FOR DESIGNS OF TODAY

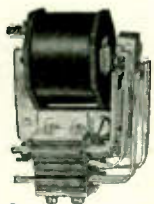

SERIES 40 A C  
LAMINATED RELAY

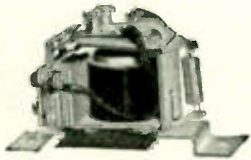

SERIES 150

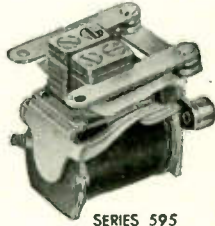

SERIES 595  
MIDGET RELAY

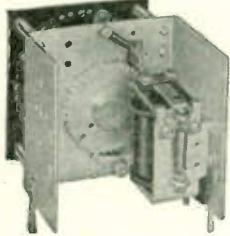

SERIES R STEPPER



SERIES 1-A  
SOLENOID

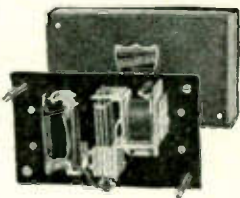

SERIES T-110  
TIME DELAY RELAY

Behind this view of typical Guardian Relays . . . designed for today and tomorrow . . . is a myriad of modern products that start, stop, count, time, see, hear, talk, fly, select, record . . . each controlled by Guardian Relays. Behind the scene at Guardian Electric, alert, experienced engineers are constantly thinking and planning ahead to benefit product designers in every branch of American industry.

Guardian Relays, specified by design engineers because of incredible responsiveness and dependability, operate day and night. Continuously. Unfailingly. Basic in type, the majority of Guardian Relays are adaptable to an almost endless number of variations. Where "specials" were formerly deemed necessary, variations of Guardian basic type relays have proved better qualified on performance—price—delivery. Yet, if a "special" unit or complete control assembly is needed, Guardian's expert engineering is at your command. Write for Bulletin TR-9.

**GUARDIAN  ELECTRIC**  
1622-M W. WALNUT STREET CHICAGO 12, ILLINOIS  
A COMPLETE LINE OF RELAYS SERVING AMERICAN INDUSTRY



*control need*



*for every*

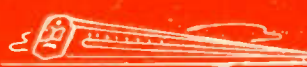

FELLER

# NEWS OF THE INDUSTRY

## Kellogg Enters HF Communications Field

Another large corporation is preparing to enter the field of high frequency radio transmission. Kellogg Switchboard and Supply Co., Chicago, has been granted a construction permit for a class 1 experimental station by FCC. Kellogg plans for the use of portable and portable-mobile stations using frequencies in the 30-40 mc band and also in the 152-158 mc band with 30 watts power and for A0, A1 and special FM and tone emission. Experimentation is to include a determination of the efficiency of various antenna designs under conditions of varying terrain and in areas that have been ordinarily difficult for VHF operations. Other experimental work will include a search for some means of correlating radio transmission and reception with the wire facilities of telephone companies.

## WNBT and WPTZ Exchange TV Programs

Television Station WNBT, which is the NBC outlet in New York, and WPTZ, the Philco station in Philadelphia, have agreed to exchange programs. Thus there is soon to be started the first regular two-way television relay service. The agreement will make it possible for NBC in New York to broadcast outstanding events originating in Philadelphia and likewise WPTZ will be able to give its Philadelphia audiences outstanding events originating in New York.

## NAB Draws Record

The National Association of Broadcasters' 24th Annual Convention held in Chicago, October 21-24, drew its largest attendance, among other things acquainted those who attended with the products of nearly fifty exhibitors who had spread their wares on several floors of the Palmer House. The following is a list of the companies who had exhibits.

Amperex Electronic Corp.; The Andrew Co.; Associated Program Service, Inc.; Audio Devices, Inc.; Capitol Records, Inc. (Transcription Division); Collins Radio Co.; The Daven Co.; Fairchild Camera and Instrument Corp.; Featured Radio Programs, Inc.; Federal Telephone and Radio Corp.; Gates Radio Co.; Harry S. Goodman Radio Productions; Frederick Hart & Co., Inc.; Kasper-Gordon, Inc.; Keystone Broadcasting

System, Inc.; The Langevin Co., Inc.; Lang-Worth Feature Programs, Inc.; C. P. MacGregor Electrical Transcriptions; Machlett Laboratories, Inc.; Magnecord, Inc.; NBC Radio-Recording Division; Neblett Radio Productions; Press Wireless, Inc.; Presto Recording Corp.; Program Buys; RCA Victor Division; Radio Engineering Laboratories, Inc.; Raytheon Mfg. Co.; Rek-O-Kut Co.; SESAC, Inc.; Standard Radio; Teleways Radio Productions, Inc.; Transcription Sales, Inc. United States Recording Co.; Universal Radio Productions of Hollywood, Inc.; Universal Recording Corp.; Western Electric Co.-Crawbar Electric Co.; Wincharger Corp.; World Broadcasting System, Inc.; Frederic W. Ziv Co.

## Promises Color TV With Still Filters

Electronic color television may be a step nearer. A west coast organization, styled Color Television, Inc., with headquarters in San Francisco, claims to have developed multi-colored video without the need for rotating filters. George Sleeper, who heads the company, claims a good job can be done with stationary filters, thus considerably simplifying technics. The company plans to make its patents, issued a year ago, generally available for licensing.

## Radio Reporters

Several newspapers are preparing to take advantage of radio communication for the collection of news. In Atlanta, Ga., the "Constitution" will equip a staff car with a radio transmitter to work in connection with the Bell System's civilian service. And in Washington, D. C., the "Evening Star" is preparing to equip its staff automobiles with two-way radiotelephone equipment.

## 20 Kw Transmitters Going to China

China is soon to have two new 20,000 kw telegraph transmitters. The equipment is being built by the Press Wireless Mfg. Corp., a subsidiary of Press Wireless, Inc., for the Central News Agency of China. The transmitters will be set up in Nanking, China, early next year and will be used mainly for radio telegraph, teleprinter and radiophoto operation in coordination with the Press Wireless International network. Frequency shift equipment will be incorporated in the design.

## Radio Equipment For More Taxicabs

Taxicabs are going more and more for radiotelephone communication facilities. Two more companies plan to use Galvin Motorola equipment; two have placed sizeable orders for Link equipment and a third will use equipment made by the Communications Co. of Coral Gables, Fla. The Galvin installations will be in Anchorage, Alaska, for the Yellow Cab Co., which will install a 50-watt fixed station and ten portable mobile units, and in Ottawa, Ill., where the 88 Cab Co., will install a fixed station and three portable mobile units.

The Link equipment is to be installed by the Libertyville, Ill., Cab

(Continued on page 133)

## Conventions and Meetings Ahead

American Welding Society—Annual Meeting, New York, N. Y., October 24. Atlantic City, November 17 to 22. (Miss M. M. Kelly, 29 West 39th St., New York, N. Y.)

NEMA Annual Meeting—Hotel Traymore, Atlantic City, New Jersey, October 28 to November 1, inc.

Radio Committee ASTM—Hotel Chalfant-Haddon Hall, Atlantic City, N. J., Oct. 30, 31, Nov. 1. Cathode Section A, Oct. 30 (Thomas H. Briggs, Superior Tube Co., Norristown, Pa.). Subcommittee of radio-tube industry, Oct. 31 (S. A. Standing, N. A. Philips Co., 100 E. 42nd St., New York City).

Rochester Meeting (Eng. Div. RMA, and IRE)—Hotel Sheraton, Rochester, N. Y., November 11-13.

The Acoustical Society of America—Convention, Stevens Hotel, Chicago, Nov. 14-15-16. (Wallace Waterfall, Sec'y. 64th Floor, 350 Fifth Ave., New York)

National Metal Congress & Exposition—Atlantic City, Nov. 18-22.

Association of American Railroads, Communications Section—Annual Convention, Hotel Statler, Detroit, November 19-21.

American Society for X-Ray and Electron Diffraction—Winter meeting University of Pittsburgh, Dec. 5, 6, 7. (Dr. S. S. Sidhu, University of Pittsburgh.) Joint Meeting with E.M.S.A.

Electron Microscope Society of America—Winter meeting, Mellon Institute of Industrial Research, Pittsburgh, Pa., December 5, 6, 7. (Dr. Earl A. Gulbransen, Westinghouse Research Laboratories, East Pittsburgh, Pa.) Joint meeting with A.S.X.R.E.D.

Electrical Engineering Exposition—71st Regiment Armory, New York, January 27 to 31, 1947.

7th International Heating and Ventilating Exposition—Lakeside Hall, Cleveland, Ohio, January 27-31 concurrently with the 53rd Annual Meeting of the American Society of Heating and Ventilating Engrs.

Institute of Radio Engineers—Annual Meeting (Commodore Hotel) and Show, (17th Regiment Armory) New York, March 8-7.

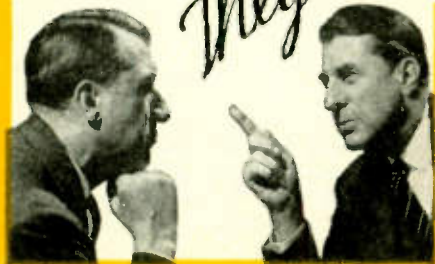

*They're talking about*



# HEINEMANN

## MAGNETIC CIRCUIT BREAKERS

*A Positive Protection for Expensive Apparatus*

### H. G. FISCHER & CO.

well-known manufacturers of dental X-ray apparatus, say in their descriptive folder, "The line switch is also a safety circuit breaker and is not only a guarantee of electrical and overload safety, but also prevents the line fuse from burning out."

Unfailing, instantaneous, magnetic action is the reason why manufacturers of intricate and delicate instruments depend upon HEINEMANN CIRCUIT BREAKERS for protection against the disastrous effects of short circuit or sudden dangerous overload. However, unnecessary tripping is avoided by means of a time-delay mechanism (a plunger which moves in a liquid-filled, hermetically-sealed tube) which allows passage of inrush current or harmless temporary overload.

Your equipment may require just such flexible yet positive protection. Find out just how the magnetic action of the HEINEMANN CIRCUIT BREAKER can be adapted to your needs.

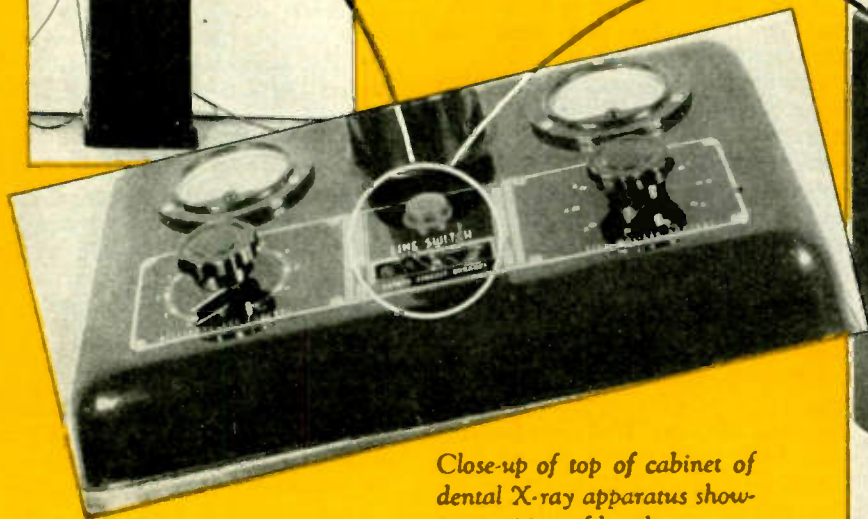
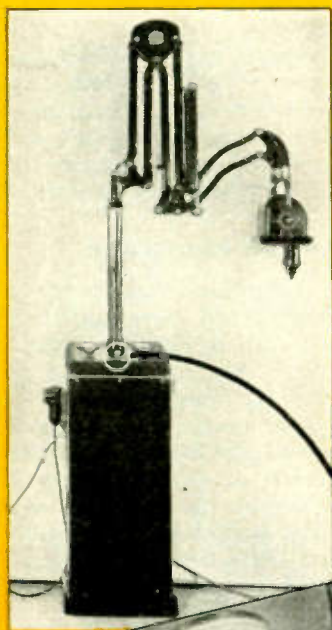

Close-up of top of cabinet of dental X-ray apparatus showing position of breaker.



Single Pole Auxiliary Breaker

# HEINEMANN CIRCUIT BREAKER CO.

Subsidiary of Heinemann Electric Co., Est. 1888

137 PLUM STREET

TRENTON, N. J.

# ★ TELEVISION TODAY ★

## New Developments in the Video Field

### CBS Shows Color-TV at 16 Ft.-Lamberts

A solution to one of the most important of the problems reported\* as confronting the developers of television in colors, has now been demonstrated by the engineers of CBS. In September, a live talent program in full brilliant colors was shown and latest details of the system released.

While progress in the pickup and transmission of colored slides and film was demonstrated earlier this year, those tests did not give any indication as to the capability of the proposed color system in avoiding color separation at the leading and trailing edges of a moving object. There was also some doubt regarding flicker if the brightness were increased to the level considered adequate for viewing in a room that is, let us say "cozily lighted."

CBS engineers, under Dr. P. C. Goldmark, have neatly passed these two hurdles in their continuing research. The modifications in the transmission system described (loc. cit.) can now be said to give a perfectly acceptable picture with a full and seemingly accurate range of color values, with enough brilliance (16 foot-lamberts) to give pleasing views without eyestrain or fatigue in a room adequately lighted for normal tasks.

No color separation was evidenced even in the close range pickup of two active boxers. The use of an orthicon tube in the camera, replacing the formerly used Dissector tube, reduced the need for intense lighting in the studio, with its consequent irritating heat.

A part of the increased brilliance is due to the new aluminized screen in the 10 in. dia. cathode ray tube (a Rauland product), which ap-

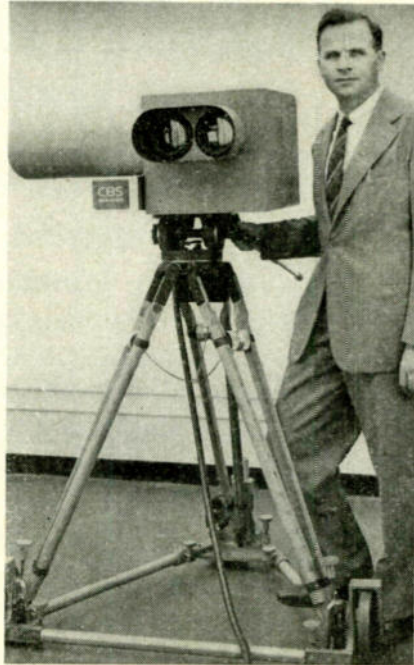

Dr. Peter C. Goldmark, CBS director of engineering-research and development, with the new live pick-up color television camera, using an orthicon tube

proximately doubled the brilliance even at anode voltages as low as 11.5 kv. This voltage is a convenient level but not the maximum limit for the tube.

Although the introduction of the color wheel causes a large (some 90%) loss of illumination, the psychological effect of "color" in showing small changes in picture tones and contrasts contributes much toward overcoming this handicap. As a result of these expedients, adequate illumination is obtained for a picture of this size (a 10 in. tube diameter enlarged to a 12 in. equivalent with a superimposed lens).

It was also revealed that parallel tests have been under way at CBS using an Image-orthicon tube for live pickup in color requiring even less (one tenth) of the light needed

by the present orthicon tube, for use with mobile pickup equipment which will be used for full color broadcasting of out-door sports and for a variety of sporting events at Madison Square Garden. This equipment is scheduled for operation by the end of 1946.

Based on these further experiments, CBS has now petitioned FCC to adopt standards for an authorized commercial operation of color-TV stations in the ultra-high frequencies, and to conduct a hearing at which CBS and others may testify.

The band from 480 to 920 mc, now assigned to experimental video, is requested by CBS. It has proposed dividing this band into channels 16 mc wide (as compared to the 6-mc. channels now used for B/W.

### Tele for Cleveland

It is promised that by next April, Cleveland will have its first television station. Scripps-Howard Radio, Inc., has contracted with the Allen B. DuMont Laboratories, Inc., for a complete video installation which will be in charge of the chief engineer, J. B. Epperson, who is now serving in a similar capacity for the Scripps-Howard radio stations. The new installation is to include a 5,000-watt video transmitter, a 2,500-watt aural transmitter, a three-camera studio chain, a dual film pickup chain, a three-camera Image Orthicon field pickup chain, a master control board, antenna and complete audio, light and test equipment.

### Tele for Schools

New York city's fathers have made provision for the use of television in public schools as an aid to teaching. The Board of Education has let it be known that all new schools built under the 1946 construction budget are to be wired for television. This will include 28 new buildings spread around the city's five boroughs. The plan is to equip each building with a special cable system and connect a single antenna with classrooms on each floor.

\*Title registered U.S. Patent Office.

#### SPECIFICATIONS OF NEW CBS COLOR-TV SYSTEM

	Preliminary test	Present tests
Complete pictures per second .....	20	24
Vertical scanning frequency .....	120	144
Horizontal scanning frequency .....	31,500	37,800
Picture "lines" .....	525	525
High-light brilliance .....	4 ft. lamberts	16 ft. lamberts
Anode voltage .....		11,500 volts
Color wheel speed .....	1,200 RPM	1,440 RPM
Bandwidth requirements increased approx. 20%		
Aural modulation arrangement—no change		

# When **POWER LINES** fail...

One-hundredth second after strike, automatic oscillographs start recording...

one-third second later, circuit breakers stop current flow...

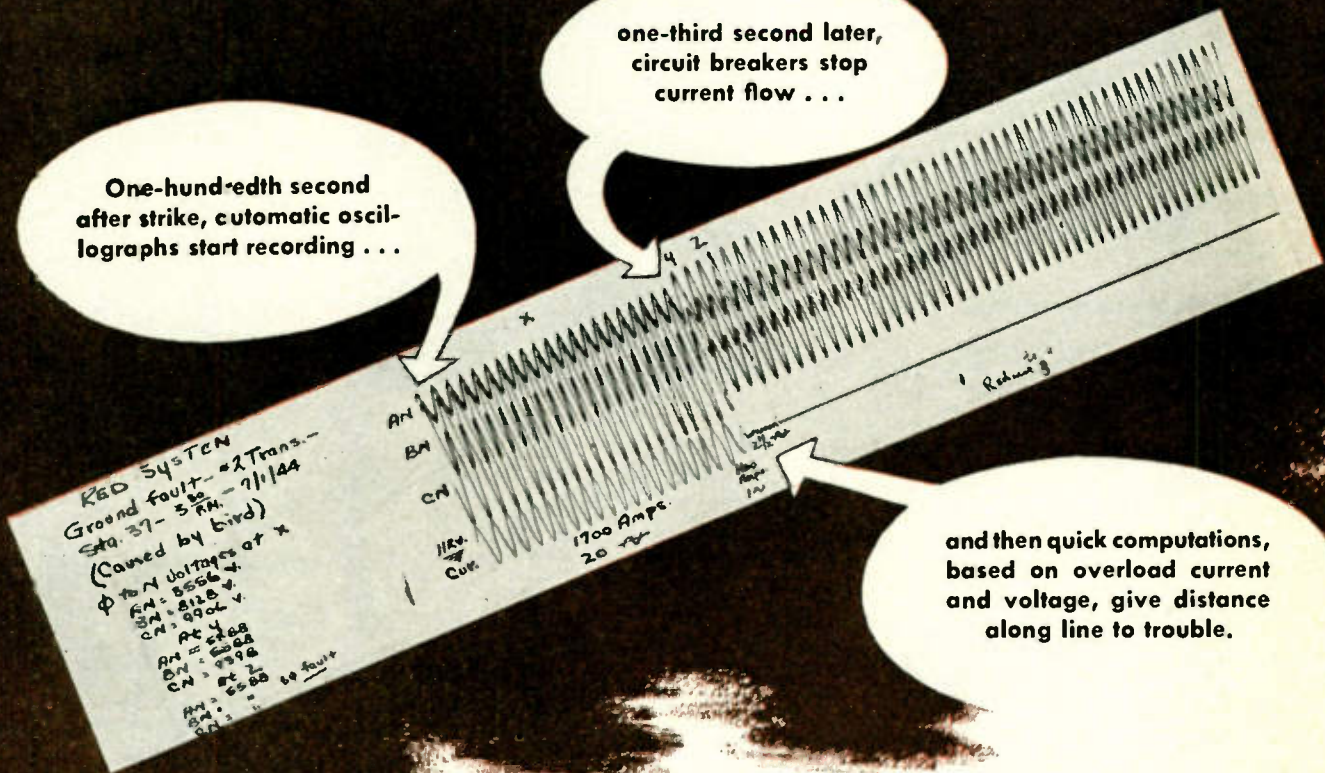

and then quick computations, based on overload current and voltage, give distance along line to trouble.

Oscillogram made on Kodak Recording Paper 697

WHEN WINDSTORMS damage power lines... when animals or birds "short" a circuit to ground... automatic oscillographs click into action and record the current and voltage changes. In less than one-half second it may be all over—the circuit breakers will have opened to stop the flow of current.

Tremendous speed of instrument response, of recording, is essential... and moving mirror oscillographs with photographic recording papers are more than equal to the task—because they can start operating in a hundredth of a second.

In service such as this, and in many other applications of oscillographs to studies of transient phenomena, the quality and dependability of photographic papers and films are factors which control the usefulness of trace data. There is a suitable Kodak paper or film for every type of oscillograph, and Kodak engineers will be glad to help with any work you may be doing with photographic instrument recording.

## Instrument Recording

...another important function of photography

**EASTMAN KODAK COMPANY**

Industrial Photographic Division, Rochester 4, N. Y.

**Kodak**

# ELECTRONIC PRODUCTS

Parts, components, materials the manufacturers offer



## Wide Band Oscillator

The Mega-Sweep oscillator provides carrier frequencies from 50 kc to 500 mc with a frequency sweep adjustable from 30 kc to 30 mc. The oscillator is suitable for production testing of television systems, radar systems, wide-band if amplifiers, etc. Output is approx. 0.1 volt at 50 ohms. The regulated power supply operates on 117 volts, 60 cycles, ac.—Kay Electric Co., 47 North Grove St., East Orange, N. J.—Electronic Industries

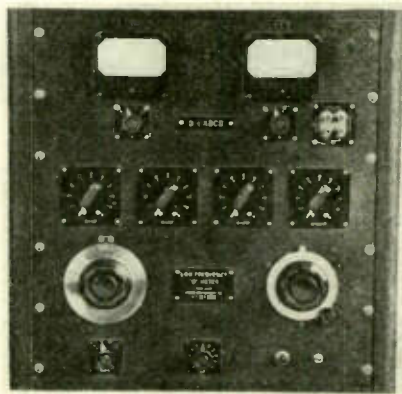

## "Q" Meter

No. 1030 Low Frequency "Q" meter consists of an RC type oscillator, a tuning capacitor, a vacuum tube voltmeter for measuring the voltage across the tuning capacitor and a variable impedance power amplifier. The test coil is resonated with the tuning capacitor, and the "Q" at resonance is measured directly by the VTVM. The oscillator is variable from 50 cycles to 50 kc. The "Q" of coils ranging from 15 to 500 can be measured with an accuracy of 6% from 50 to 50,000 cycles. The instrument operates on 95 to 130 volts, 50 to 60 cycles, ac and consumes 200 watts. Freed Transformer Co., Inc., 72 Spring St., New York.—Electronic Industries

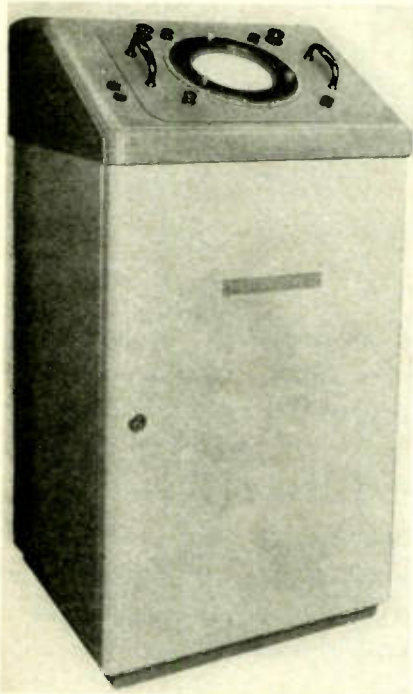

## Radar Equipment

Westinghouse marine radar equipment is designed to provide navigational aid and anticollision protection from 100 yards to 32 miles in any direction from a vessel. It is provided with a plan position indicator scope with range scales of 2, 8, and 32 nautical miles. The equipment consists of antenna and transmitter, preamplifier unit, and indicator console unit. Peak power output is over 15 kw at a repetition rate of 2000 cps and frequency of 9320-9430 mc. Operation is from 115 V., 60 cycles, ac, with a power consumption of 1000 watts at 85% power factor. Westinghouse Electric Corp., 306 Fourth Ave., Box 1017, Pittsburgh 30, Pa.—Electronic Industries

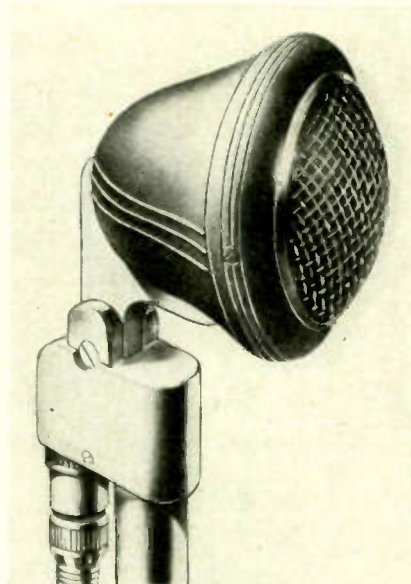

## Outdoor Microphone

A frequency response from 40 to 9,000 cycles  $\pm 4$  db at a level of  $-52$  db under extreme operating and climatic conditions is provided by the St. Louis outdoor microphone, which is a dynamic unit using an Alnico 5 magnet. The microphone is dust- and sandproof, fungus treated, and equipped with 15 ft. double conductor shielded cable. Output impedance is adjustable to low, 200, 500, or high impedance. St. Louis Microphone Co., 2726-29 Prentwood Blvd., St. Louis 17, Mo.—Electronic Industries

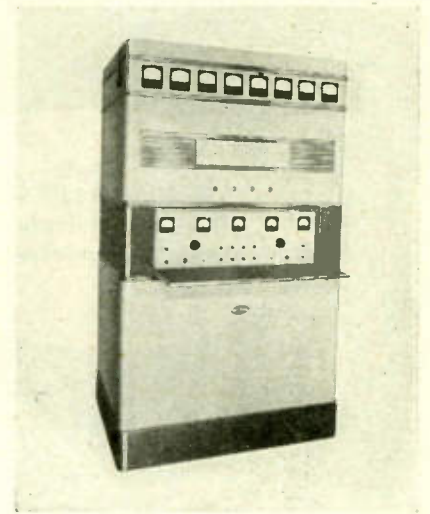

## Broadcast Transmitter

A new 1 kw AM transmitter with a frequency range from 530 to 1600 kc. The unit is triode-operated with a 6J5 crystal oscillator and push-pull 833A's in the output stage. Audio response range is from 30 to 10,000 cps with less than 2½% distortion for 95% modulation. Noise level is 60 db below 100% mod. The transmitter has a power consumption of 5 kw at 210/230 V., 3 wire, single phase, 50-60 cycle, ac. Raytheon Mfg. Co., Broadcast Equipment Div., 7517 N. Clark St., Chicago 26, Ill.—Electronic Industries

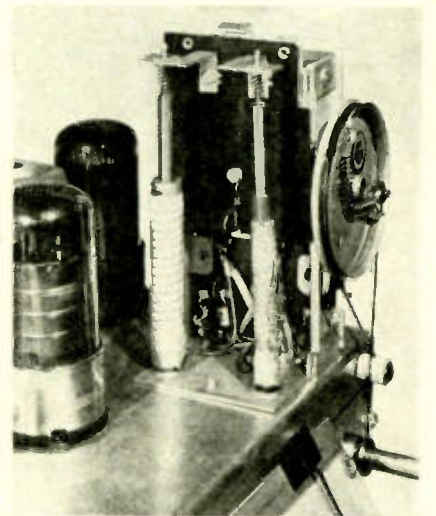

## Permeability Tuner

The E-L vario tuner is a permeability type radio tuner covering the broadcast band from 540 to 1620 kc. It consists of an rf unit and an oscillator section with an IF frequency of 455 kc. Maximum tracking error is 5 kc, the average being 2 kc. A Hi-Q loop antenna designed for use with the tuner also is available.—Electronic Laboratories, Inc., Indianapolis, Ind.—Electronic Industries

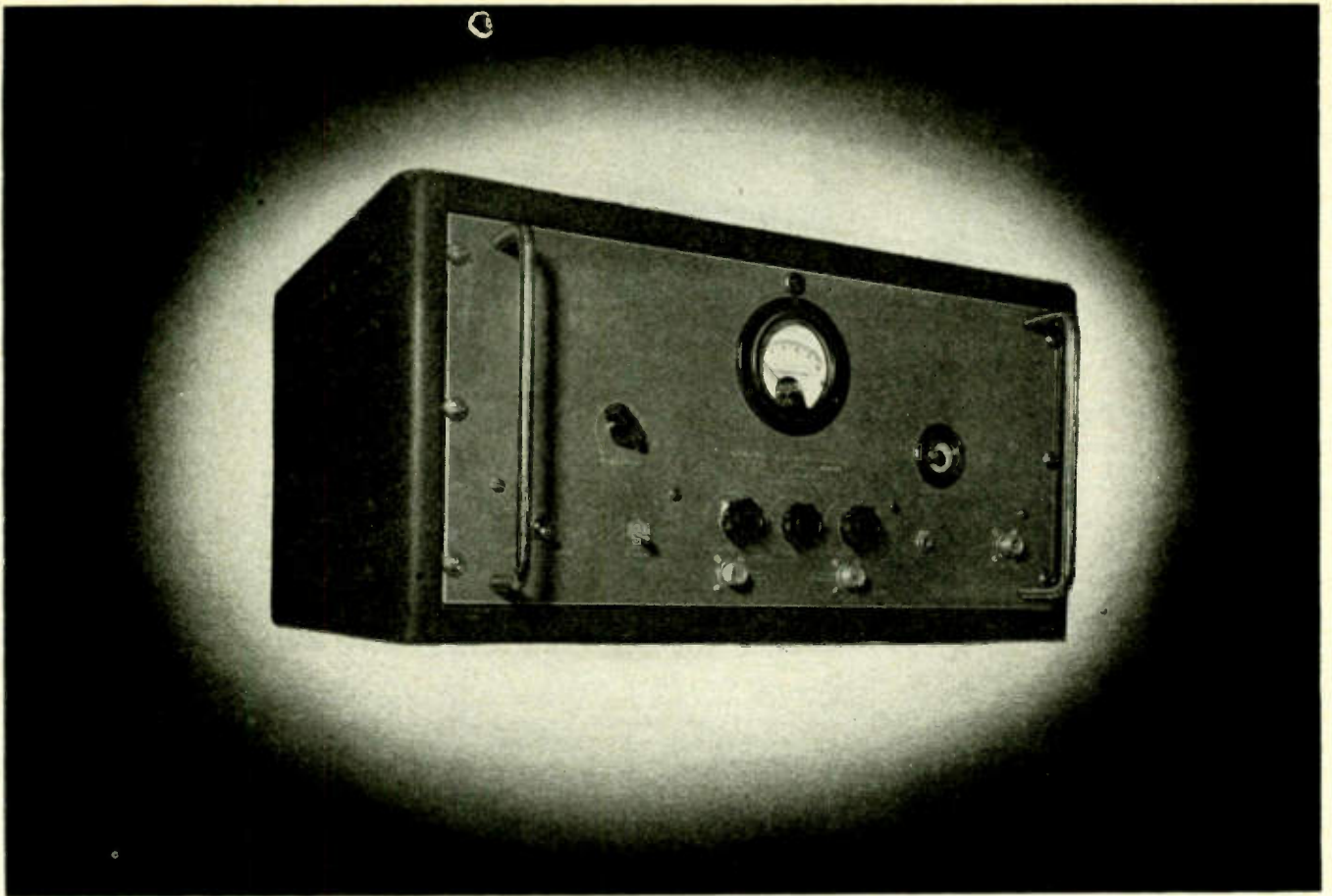

## LAVOIE C-200

### Harmonic Frequency Generator

Now you can obtain precision calibration up to and beyond 2000 megacycles of receivers and wavemeters at a fraction of the time previously required. Also, by means of a Beat Detector built into the instrument, you can calibrate oscillators and signal generators with equal ease.

The C-200 Harmonic Frequency Generator is a secondary frequency standard, designed especially for calibration work above 100 MC, with an accuracy of .02%. If greater accuracy is desired, the crystal may be supplied with temperature control.

The output voltage is supplied at a UG 58/U. 50 ohm connector with output coupling controls to obtain peak performance for a given harmonic. A milliammeter is incorporated in the instrument to facilitate easy adjustment of the output controls. The output voltage may be either unmodulated, or modulated with 400 C.P.S. internal oscillator. The calibrator provides output voltages every 10 MC, or every 40 MC. This selection is made by a switch on the front panel. The harmonic voltage is in the order of

thousands of microvolts for each harmonic with a value of approximately 50,000 microvolts at 100 MC's and 1500 microvolts at 1000 MC's.

Provision is made for the calibration of signal generators and oscillators by the incorporation of a beat frequency detector in the calibrator. The output of this beat frequency detector may be monitored, either aurally or visually with a tuning eye indicator.

To facilitate harmonic identification, frequency identifiers can be supplied for any harmonic frequency (multiple of 10 MC) between 100 and 1000 MC. The identifier is adjusted at our factory.

The C-200 Harmonic Frequency Generator can be used to calibrate signal generators, receivers, transmitters, wavemeters and oscillators. It provides a fast, accurate and easy method of calibrating in 10 or 40 MC steps.

This instrument is supplied with accessories needed for its operation, including tubes, 5 MC crystal, output coupling cable and instruction book.



Write for Illustrated  
Descriptive Folder

## Lavoie Laboratories

RADIO ENGINEERS AND MANUFACTURERS  
MORGANVILLE, N. J.

**Specialists in the Development and Manufacture of UHF Equipment**

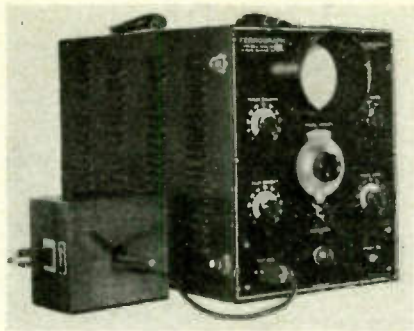

### Ferromagnetic Analyzer

Comparison of ferrous materials as to chemical analysis and heat treatment and their sorting with respect to hardness is facilitated by the Ferrograph. After establishing waveforms and phase angles of the hysteresis curve of standard samples, deviations from this standard on the production line are shown on the CR screen of the Ferrograph. The phase angle of the B-H curve provides a relation as to comparative hardness. The test sample is made the core of a test transformer, which is energized by a field with a frequency below 25 cps to obtain an effect from residual magnetism. The instrument operates on 110 V., 60 cycle, ac. Allen B. DuMont Labs., Inc., 2 Main Ave., Passaic, N. J.—Electronic Industries

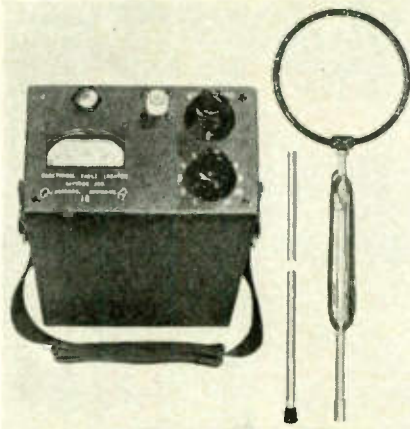

### Fault Locator

An electronic fault locator consisting of a detector circuit and a 12 in. diameter loop designed for use in the location of accidental grounds on overhead power distribution circuits has high sensitivity permitting following of rural lines by car at a distance of 100 yards or more. Power is fed to the defective line through a capacitor and the detector circuit is sharply tuned to one of the harmonics produced thereby, thus discriminating against signals from nearby circuits.—Raytron, Inc., Jackson, Mich.—Electronic Industries

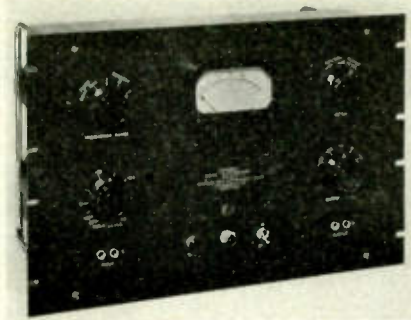

### Noise Suppressor

Type 910-A Dynamic Noise Suppressor, designed for use with commercial phonograph records by broadcasting stations, will maintain optimum signal-to-noise ratio by use of a special gate circuit, which instantaneously adjusts the width of the audio pass band with respect to noise and hf components present. Maximum suppression is 20 db for hf noise and 15 db for lf noise with a frequency range provided of 30 to 8,000 cycles for Vinylite records, and 30 to 5,000 cycles for old or noisy shellac records. Normal input and output level is from -30 to +10 VU with a total harmonic distortion of .8% at rated output. Technology Instrument Corp., Waltham, Mass.—Electronic Industries

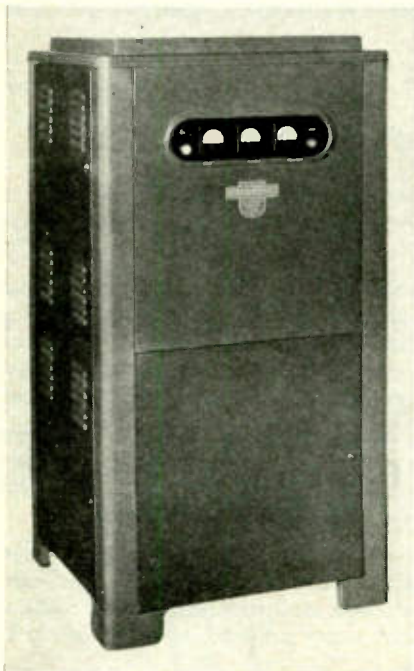

### Dielectric Heater

The Ther-Monic M-285C electronic heating generator is a dual-purpose unit suitable for induction and dielectric heating operations. Two oscillator sections are provided, an induction oscillator feeding into a rf output transformer, and a dielectric oscillator connected with the heating electrodes through coaxial cables. Full load output is approx. 5 kw at 375 kc for induction heating or at 20 mc for dielectric heating operations. The unit operates on 205-245 V., 60 cycle, single phase, and has an input of 12 kva at 90% power factor. Induction Heating Corp., 389 Lafayette St., New York 3, N. Y.—Electronic Industries



### Wire Recorder

The Peirce Model 55A wire recorder and reproducer will provide 66 minutes of continuous recording on 11,200 ft. of .004 in. diam. stainless steel wire. The recorder erases previous message automatically, when a new recording is being made and is provided with a timer, which may be set for any predetermined interval. Frequency response is within 3 db from 200 to 5000 cycles. Output matches a 10 ohm load. The instrument has a built-in 5 in. speaker and is for operation on 115 volts, 60 cycle, ac. Power consumption is 130 watts.—Bell & Howell Co., 7100 McCormick Road, Chicago 45, Ill.—Electronic Industries

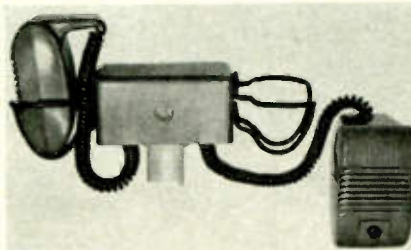

### Weatherproof Car Speaker

A weatherproof speaker unit for driver-in theatres, designed for accurate sound reproduction inside a car, includes a terminal box, speaker receptacle and a special coiled cable, which can be extended to 9 ft. length. An individual volume control is provided with each speaker.—Radio Corp. of America, RCA Victor Div., Camden, N. J.—Electronic Industries

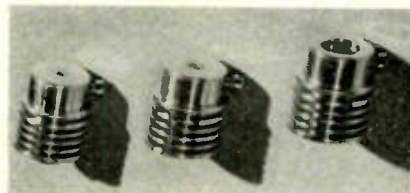

### Heat Dissipating Connectors

Used to make electrical connections to the plate and grid terminals of vacuum tubes, these heat dissipating connectors provide efficient heat transfer from the tube element and glass seal to the air. They are machined from dural rod, and aid in keeping seal temperatures at safe values. Eitel-McCullough, Inc. San Bruno, Calif.—Electronic Industries



### Resistance-Capacitance Bridge

Model 76 resistance-capacitance bridge covers resistance and capacitance readings in six overlapping ranges indicated on a 4 in. dial with a linear scale for both functions. Bridge balance is shown with CR-tube null indicator. The instrument measures capacitance from 100 mmfd to 200 mfd, resistance from 10 ohms to 200 meg-ohms, power factor from 0 to 50%, and provides a dc polarizing potential for leakage measurements from 0 to 600 volts dc, continuously variable. Aerovox Corp., New Bedford, Mass.—Electronic Industries



# NEW BEAM TETRODE by UNITED

**COMPACT • POWERFUL • DURABLE**  
with graphite, the real low temperature anode

DESIGNED for service longevity, UNITED type 5562 will prove to be a popular number on the VHF bands of the amateur, aeronautical, mobile, and emergency services. Conservatively rated at 175 watts input up to 120 megacycles. Authentic input ratings for higher frequencies will be announced after completion of further factory life tests.

Type 5562 has low drive characteristics—from 2 to 4.5 watts dependent upon plate input, frequency, and class of operation.

Type No.  
5562.  
(Actual Size)

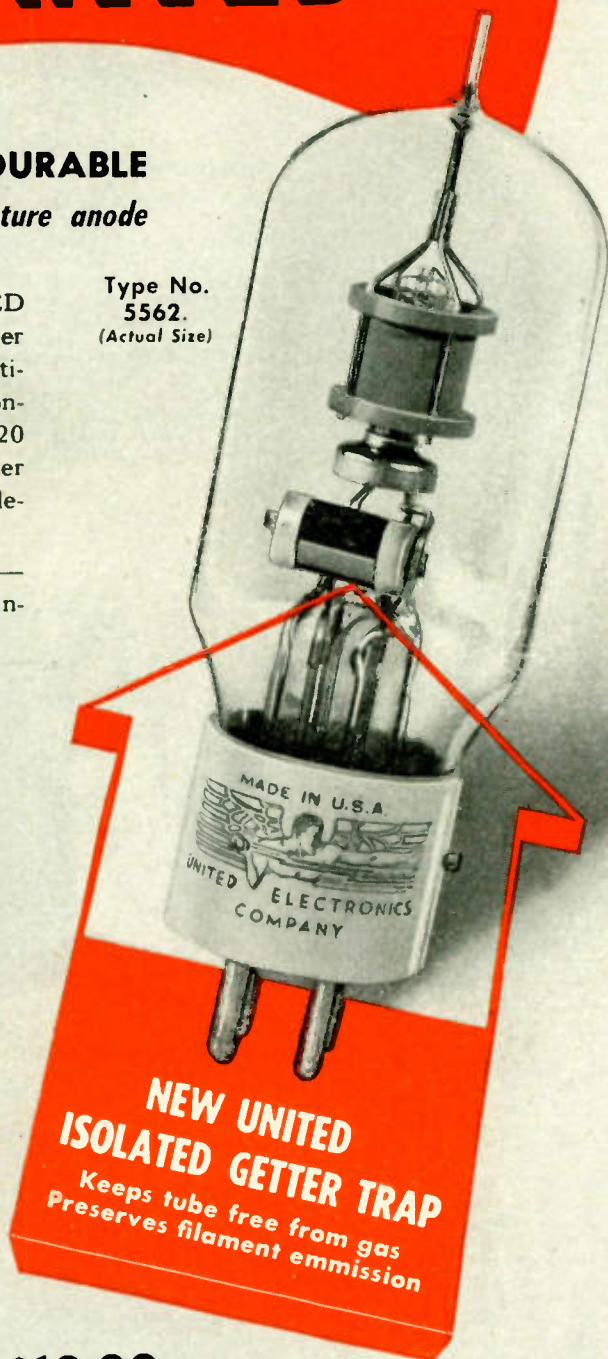

GENERAL CHARACTERISTICS		
Filament, 6.3 volts at 3.0 amps.		
Amplification factor	—	60
Transconductance	—	2500 micromhos
Direct Interelectrode capacitances		
Input to plate		.2 mmfds
Input		6.5 mmfds
Output		1.8 mmfds
MAXIMUM RATINGS	Class C Phone	Class C Telegraphy
D.C. Plate Voltage	1250	2000 volts
D.C. Grid Voltage (Grid # 1)	250	350 volts
D.C. Grid Voltage (Grid # 2)	350	400 volts
D.C. Plate Current	100	125 ma
D.C. Grid Current	20	20 ma
Plate Input	125	175 watts
Screen Input	8	8 watts
Plate Dissipation	35	45 watts

## UNITED

ELECTRONICS COMPANY

NEWARK, 2  NEW JERSEY

**\$10.00** ea.

Transmitting Tubes EXCLUSIVELY Since 1934

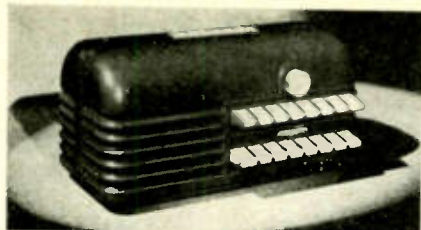

### Intercommunication Unit

A series of Belfone "Maestro" intercommunication systems with a number of novel features are in production. The case is molded in two sections of Durez bakelite, the keys being made of Lucite. When a key is depressed, the line is automatically tested and, if not busy, other stations are prevented from breaking in, thereby eliminating overheard or interrupted conversations. A stand-by unit allows only filaments to operate when the unit is not in use.—Bell Sound Systems, Inc., 1183 Essex Ave., Columbus, Ohio.—Electronic Industries



### Automatic Timer

The Promatic electronic timer provides full-or semi-automatic control of industrial processes under virtually any condition of temperature and humidity. Several timers may be used to control individually timed operations in predetermined sequence with self-recycling or manual recycling. Five timing periods, controlled by a plug-in type capacitor, are available in ranges of ½ sec. up to 60 secs. The unit can be supplied in 110 or 220 volt types, 60 cycles, ac, with relay contacts rated at 10 amps. General Control Co., 1200 Soldiers Field Rd., Boston 34, Mass.—Electronic Industries

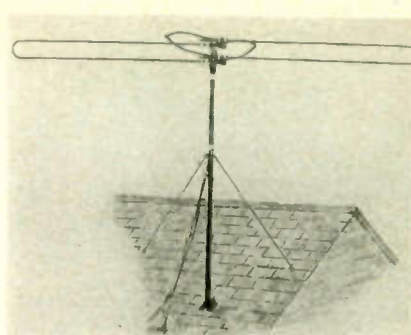

### Television Antenna

A television receiving antenna designed for use with RG 59/U coaxial cable or 72 ohm open wire line, balanced or unbalanced input, has a gain nearly equal to that of a standard dipole throughout 6 television channels from 44 to 88 mc and a gain greater than a dipole for the 7 channels from 174 to 216 mc. A reflector attachment provides unidirectivity for channels 2, 4, and 5 in the 44 to 88 mc band. The antenna is supplied complete with hardware and a broadband balancing transformer for the coaxial line. Dielectric Products Co., 125 Virginia Ave., Jersey City 5, N. J.—Electronic Industries

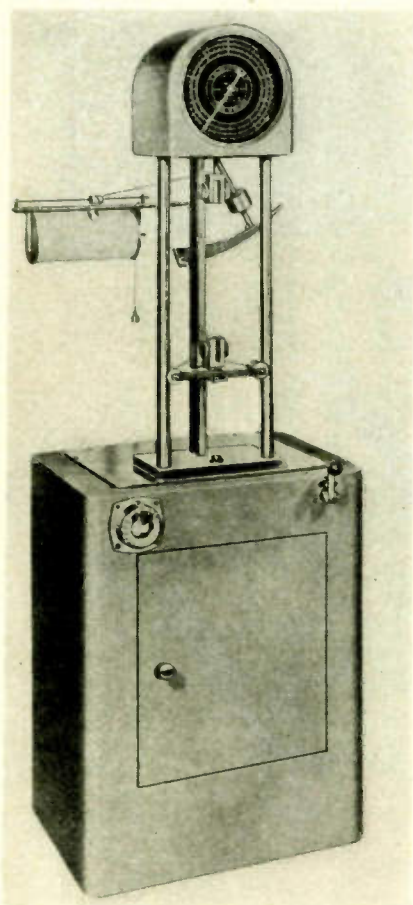

### Material Tester

A Multi-Low-Range Tester designed for physical testing of raw materials and finished products will perform strain, elongation, and—using special fixtures—compression and transverse tests on any material light enough to fall within range of four load scales varying from 0-10 to 0-100 lbs. In operation a specimen is placed on the pendulum arm of the tester, and loading is applied through a gear mechanism driven by a motor with stepless speed control up to 19 in. per minute travel. Elongation is measured in 1/50 in. divisions. Specimens up to ¼ in. thick by 1¼ in. wide can be tested. W. C. Dillon & Co., 5410 West Harrison St., Chicago 44, Ill.—Electronic Industries



### Add-a-Unit Amplifier

New in concept, Concord Multiamp amplifiers provide flexibility through the unique Add-A-Unit feature. From a single compact basic unit, the power output can be increased from two to nine times by simply plugging in additional, inexpensive power units. Additional output stages, to a total of six, can also be added without the need for additional cabinets or complicated connections. A phono-player, record changer, and output volume indicator also can be added in a matter of minutes. The compact, light-weight construction provides exceptional portability. Carrying cases are available which make a Multiamp amplifying system the ideal unit for every use demanding portability, with hum-free, distortion-free amplification; every degree of volume and tone, before audiences of 500 to 20,000. Concord Radio Corp., 901 W. Jackson Blvd., Chicago 7, Ill., and 265 Peachtree St., Atlanta 3, Ga.—Electronic Industries

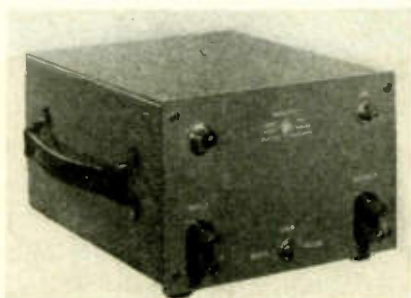

### General Purpose Amplifier

The hp-450A, a wide-band amplifier for general purpose or laboratory use, provides high stability at 40 db or 20 db gain. A resistance coupled circuit in conjunction with inverse feedback results in low phase shift and frequency response flat within ½ db between 10 and 1,000,000 cycles. Input impedance is 1 megohm, shunted by 15 mmfd. Output impedance is less than 150 ohms over the entire range. In conjunction with the 400A VTVM the amplifier increases the sensitivity 100 times.—Hewlett-Packard Co., Palo Alto, Cal.—Electronic Industries



### VHF Receiver

Designed for airline use the RV-1-B crystal controlled fixed frequency vhf receiver delivers an undistorted audio output of 1 watt in the frequency range of 100 to 162 mc with a signal to noise ratio of better than 2:1 for a 2 microvolt signal (30% mod.). The selectivity curve is more than 40 kc wide at 2 times down and less than 200 kc at 10,000 times down. A peak noise limiter and a "snap-action" circuit which opens the audio channel for carriers of 2 microvolts or more, are also incorporated.—Communications Div., Radio Receptor Co., 251 W. 19th St., New York 11.—Electronic Industries

# "Hey, You're Sitting On My Production Costs!"

I wrote a delighted manufacturer of electrical household appliances.

We grant you, a balance sheet is a strange place for an engineer to cool his heels. But this is just another way of showing you that "specialization" and "engineering flexibility" aren't merely words we throw around at Cornell-Dubilier; they carry weight... much weight! The fact that Cornell-Dubilier engineers were able to let loose 100% of their brain power and experience in designing capacitors

shown below is proof that Cornell-Dubilier's specialized capacitor knowledge can save you, as it has done for many other manufacturers, thousands of production dollars.

Perhaps we can help you with some special capacitor problem. Write us. Cornell-Dubilier Electric Corporation, South Plainfield, New Jersey. Five other plants in New Bedford, Providence, Worcester and Brookline.



MICA • DYKANOL • PAPER • ELECTROLYTIC

**CORNELL-DUBILIER**  
 world's largest manufacturer of  
**CAPACITORS**





## A FEW OF C-D's MADE-TO-ORDER CAPACITORS

**CAPACITOR #1.** Here is a capacitor designed specifically for automobile horn spark suppression. Fits into horn housing with minimum of assembly operations. Leads firmly, mechanically anchored to stand extreme vibration.

**CAPACITOR #2.** This capacitor was designed for high temperature application in equipment operating at 105° C. Unit is hermetically sealed and provided with glass, solder sealed terminals.

**CAPACITOR #3.** Built for operation with telephone relay and amplifier equipment. Construction makes for ease of assembly into parent apparatus and assures a life-time of trouble-free service.

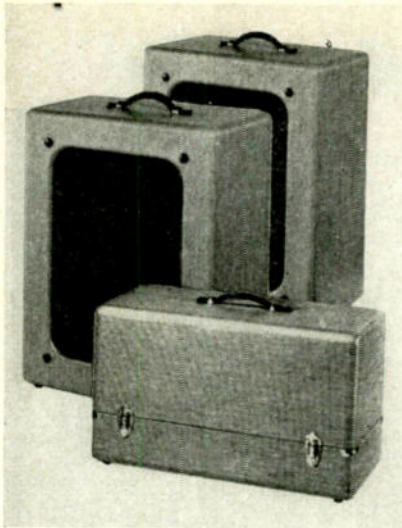
**CAPACITOR #4.** Tubular paper capacitor for bypass applications in radio receivers. This unit is encased in a metal tube which is then fully insulated with a cardboard sleeve. Meets all UL requirements for non-combustible case type capacitor.



### Portable Sound System

Model KX-30R12A portable sound system is one of a series of portable units ranging from 10 to 60 watts in output. The 3-case system includes a 30 watt amplifier with two 12 in. wide range, high efficiency loudspeakers, each supplied with 50 ft. of detachable cable. For quick conversion from high to low impedance, the unit is equipped with a socket for plug-in input transformers. Newcomb Audio Products Co., 2815 South Hill St., Los Angeles 7, Cal.—Electronic Industries

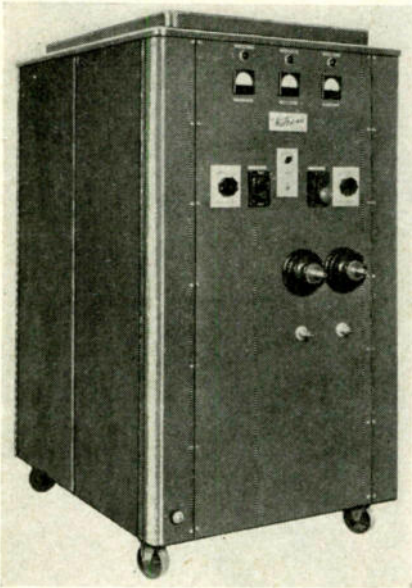

### Induction Heaters

Made with a rigid steel frame, this electronic high frequency generator is particularly adaptable for hardening and heat treating parts such as gears, tools, dies, gages, cams, bearings, shafts and rods. Designed for 20 kw available rf power output. Forty-five kva is the maximum demand, and the rf frequency ranges from 350 kc to 500 kc. Aluminum paneling reduces power loss, and a nitrogen filled tank condenser simplifies refilling. A blower for cooling forces filtered air into double wall between the oscillator and rectifier section, and air is directed to all heat producing parts by means of perforations. Door interlocks insure safety. Weltronic Co., 19500 West Eight Mile Rd., Detroit 19, Mich.—Electronic Industries

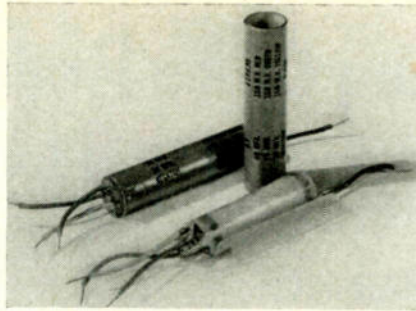

### Improved Electrolytics

Considerable increase in the life of Solar types DS, DT and DH, cardboard-tube dry electrolytic capacitors, has resulted from the introduction of a new plastic film wrap for the capacitor section before it is inserted in its cardboard housing. This plastic film replaces the Kraft paper liner formerly used as the standard internal wrap throughout the industry. The film keeps the electrolyte from drying out in high ambient operating temperatures, and also keeps external atmospheric moisture, which may contain many impurities, from being introduced into capacitors under the alternate heating and cooling experienced in normal radio usage. It also provides a barrier between the capacitor section and its external cardboard housing. Solar Mfg. Corp., 285 Madison Ave., New York 17, N. Y.—Electronic Industries

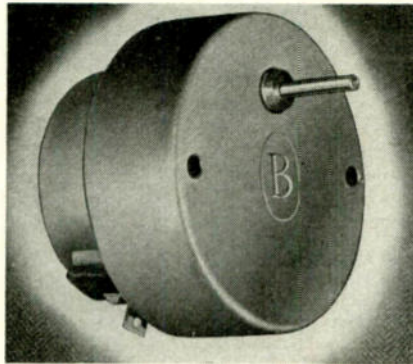

### Timing Motor

Especially compact, this new timing motor fits into a two in. circle. It has through holes for mounting, and easy to solder terminals. Initial production of the motor will be limited to one and five rpm speeds; other speeds available are 110, 220 and 24, all at 60 cycles.—A. W. Haydon Co., Dept. P, Waterbury, Conn.

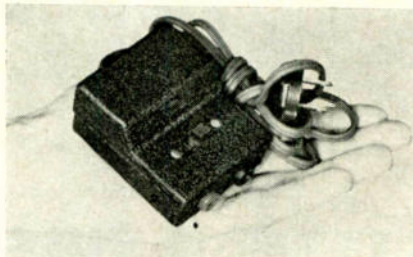

### Continuity Tester

The Meg-Lite pocket size indicator is an instrument for quick circuit checking for continuity and leakage resistance up to 200 megohms. Two sensitivity positions are provided for capacitor testing. The device operates on 115 V., ac or dc, and has negligible power consumption.—Robson-Burgess Mfg. Co., Omaha, Neb.—Electronic Industries



### Heavy Duty Appliance Switch

A miniature neon lamp, which serves as a warning glow light to indicate when the current is on, is one of the features of this heavy-duty double-pole, single-throw appliance switch. The switch is rugged; it will operate on electrical devices rated up to 2500 watts ac or dc, 125 or 250 volts, and carries the UL listing of 20 amperes at 125 volts. Trilmont Products Co., Philadelphia, Pa.—Electronic Industries

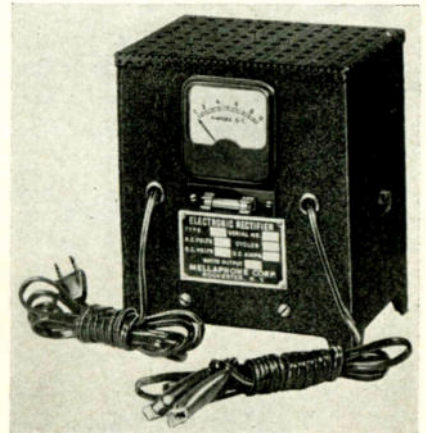

### Battery Charger

The SC-8 selenium battery charger for 6 volt storage batteries is rated at 8 amps—delivering an initial charge from 10 to 12 amps., which tapers to approximately 4 amps. at full charge. The unit will withstand an overload of 50%. It operates on 110 volts, 50-60 cycle, ac. Models operating on 220 volts also will be available.—Mellaphone Corp., Rochester 2, N. Y.—Electronic Industries

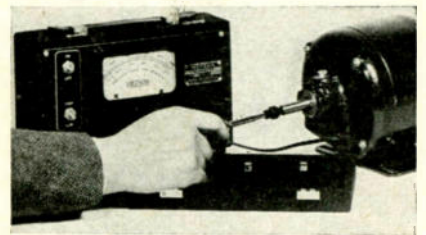

### Portable Tachometer

Adapted for overspeed trip-out testing of turbo-generators, production testing of electric motors, motor efficiency tests, and motor overload tests, this tachometer requiring only ¼ ounce-in. torque measures speeds at approximately the two synchronous speeds of 1800 and 3600 rpm. It is available in three models: 48A for speeds above synchronism, 48B for speeds below synchronism, and 48C with equal spread above and below synchronism. The head is a contact-making mechanism operated by the rotation of the spindle. This contact mechanism periodically charges a condenser through a dc milliammeter which indicates average current. Scales are linear to ¼ of 1%. No warmup period is required, and the instrument is stabilized against line voltage variations. Metron Instrument Co., 434 Lincoln St., Denver 9, Col.—Electronic Industries

# Coming in January

## ELECTRONIC INDUSTRIES will be Published in **TWO EDITIONS** **WITHOUT READER DUPLICATION**

GIVING EITHER **SELECTIVE OR COMPLETE**  
COVERAGE OF THE ELECTRONIC MARKETS

■ The electronic industries are twenty years ahead of where they were four years ago. Their products and ramifications are nearly endless. And with this accelerated evolution have come two widely divergent areas of reader-interest.

The men responsible for the technical development, manufacture and operation of tele-communications—radio and television, FM, point-to-point, microwave, radar, etc.—have little in common with the men in the metals, metal-working, textile, chemical, food and other industries who are interested in industrial electronic instrumentation and control. The two groups do not even speak the same professional language. For instance:

The men who comprise the tele-communications market are linked together in interests in the design, development, manufacture and operation of communications equipment.

The men in the industrial electronics field have a common interest in the design, manufacture and application of industrial electronic devices as a means of increasing productivity, upgrading quality or effecting better control.

No longer can one publication meet the editorial needs of both groups for adequate coverage of their particular problems. It is to fulfill this reader demand that this step is necessary *NOW* . . . when the men in both markets, more than ever before, need specific information.

Advertisers will use either or both of these editions for selective or complete coverage of the electronic markets *with the full guarantee of no duplication in readership* (except for a few hundred advertisers' copies). *And what's more*—it'll cost less to tell the advertising story to the readers of *both* magazines with approximately 300% greater effective circulation, than in over-all publications.



ELECTRONIC INDUSTRIES & INSTRUMENTATION Edition — A tabloid-size publication, 11" x 16", with uniform 1/9 page advertising space units, 3 1/4" x 4 1/4".

TELE-TECH Edition — A standard size publication, 8 1/4 x 11 1/4 overall, with 7 x 10 advertising pages.

1

### ELECTRONIC INDUSTRIES & INSTRUMENTATION EDITION

Designed to fit the needs of men throughout industry responsible for the application of electronic devices to processes, heat treating, measuring, detecting, indicating, controlling, etc.—All present industrial subscribers will be the nucleus of an expanded circulation of approximately 25,000.

2

### TELE-TECH EDITION

Editorially and specifically tailored to reach the men responsible for the development, manufacture and operation of tele-communications—radio, television, FM, microwave, point-to-point, radar, etc.—already a billion dollar industry. All present communications subscribers will be the nucleus of an expanded circulation of approximately 17,000.

CALDWELL - CLEMENTS, INC.  
480 LEXINGTON AVE., NEW YORK 17, N. Y.

**2 MARKETS - 2 MAGAZINES - A *Must* FOR 1947 - Ask for Details**



## at **ARNOLD** THERE IS NO CEILING ON QUALITY

We are not satisfied merely to offer you magnets which come up to the proposed R.M.A. standards . . . this is our minimum requirement. A quality floor below which we refuse to go.

Nor are we satisfied that ordinary production and inspection methods offer you adequate quality protection . . . we *individually test* each Arnold magnet in a loud speaker structure before shipment.

Another "*individual touch*" which has contributed to winning industry-wide customer acceptance for Arnold magnets is our established minimum standard of 4,500,000 BHmax for Alnico V material.

Over five million Arnold loud speaker magnets of the R.M.A. type have been produced since V-J Day under these quality safeguards. Continued adherence to them assures you of long-lived, dependable product performance.

*In the mass-production of magnets, the Arnold "individual touch" does make a difference. Let us give you the whole story.*

### **THE ARNOLD ENGINEERING COMPANY**

SUBSIDIARY OF ALLEGHENY LUDLUM STEEL CORPORATION

147 EAST ONTARIO STREET, CHICAGO 11, ILLINOIS

Specialists in the manufacture of ALNICO PERMANENT MAGNETS

## RECORDING STYLI

(Continued from page 67)

that a burnishing facet which tapers to a dimension of 0.25 mils at points corresponding to the groove top at a pitch of 100 lines per inch, will be progressively in excess of that measurement at 112, 120 and 136 lines per inch. The accompanying diagram (Fig. 6) illustrates the change in the functional portion of the sapphire with changes of pitch at a 70/30 ratio. Figs. 7 and 8 show the effects of a change in pitch upon the horns in the upper corner of two grooves cut by the same stylus.

Not until our studies had established these facts were we aware of the probable cause of certain types of trouble experienced by users of "regular"<sup>4</sup> styli in the past. Now it becomes clear that a complaint of grayness in the extreme upper portion of the groove probably indicates that the stylus was being used at a depth corresponding to a pitch of 96 or 100 lines to the inch whereas the burnish may have extended only to the point that would have been satisfactory for 112 lines per inch. Or "wire edges" may have been experienced because the burnishing facet tapered to the point corresponding to a 100 lines to the inch depth, while the stylus was being used to cut 136 lines per inch.

### *Stylus radius*

In manufacturing Master recording styli to very exact specifications, it has been found that there are limits in tolerances beyond which it is impractical to go. Fig. 9 illustrates 70° and 87° styli with radii properly tangent to the included angle. There is a greater arc of curvature in the 2 mil radius of a 70° stylus than in the 2 mil radius of an 87° stylus. Practical experience in dubbing a sapphire (i.e., establishing a burnishing facet upon it) has shown that the greater the arc in the radius, the greater the tendency for the curve to extend into the side wall area of the functional portion of the stylus.

The consensus seems to be that maintenance of straight side walls is more important than making the radius curvature match the curvature of an ideal drawing. For

4. There are two general types of recording styli currently in use (a) the "regular" stylus used for the majority of recordings and (b) the "master" recording stylus used by professionals and custom-made to their individual specifications.

**NEW!**

# WESTON Mutual Conductance Tubechecker and Circuit Analyzer

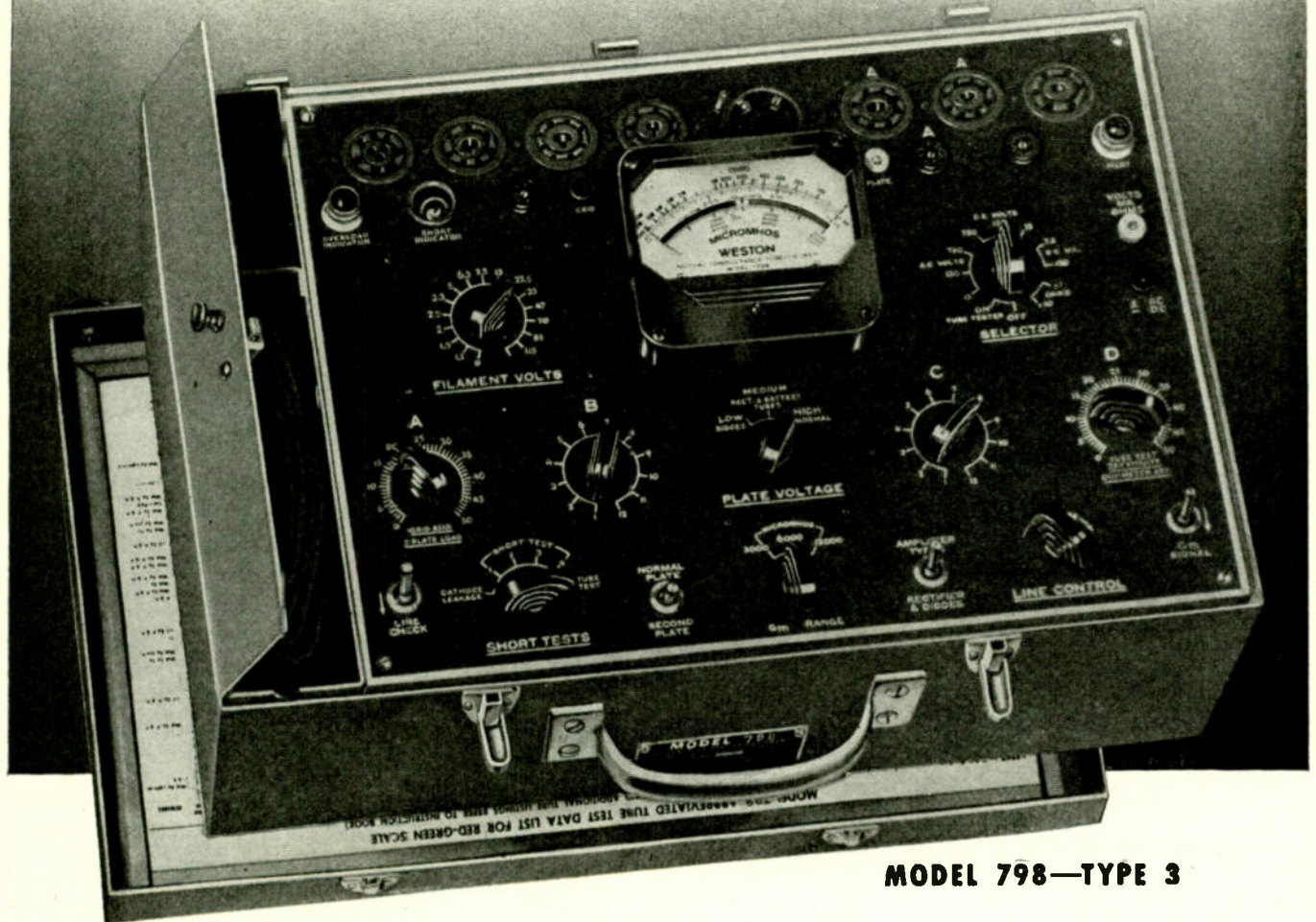

**MODEL 798—TYPE 3**

*Outstanding  
Features*

- ✓ Direct-reading mutual conductance tests, and "Good-Bad" indications.
- ✓ New patented high frequency tube testing circuit.
- ✓ AC-DC volt-ohm-milliamperage ranges.
- ✓ Tests 4, 5, 6, 7 prong octal, loctal, miniature, and acorn tubes... spare octal and miniature sockets.
- ✓ Hot neon leakage test between any two tube elements... neon short check.

- ✓ Adjustable plate, screen, grid bias, and signal voltages.
- ✓ Flexibility in switching simplifies testing present and future tubes.
- ✓ Durable heavy-gauge, light-weight aluminum case.

Model 798 combines broad utility, ruggedness, and dependable accuracy for maintenance of sound and electronic equipment. Detailed bulletin available. Weston Electrical Instrument Corporation, 666 Frelinghuysen Avenue, Newark 5, New Jersey.

# Weston Instruments

ALBANY • ATLANTA • BOSTON • BUFFALO • CHARLOTTE • CHICAGO • CINCINNATI • CLEVELAND • DALLAS • DENVER • DETROIT • JACKSONVILLE • KNOXVILLE • LOS ANGELES • MERIDEN • MINNEAPOLIS • NEWARK  
NEW ORLEANS • NEW YORK • PHILADELPHIA • PHOENIX • PITTSBURGH • ROCHESTER • SAN FRANCISCO • SEATTLE • ST LOUIS • SYRACUSE • IN CANADA, NORTHEARN ELECTRIC CO., LTD., POWERLITE DEVICES, LTD.

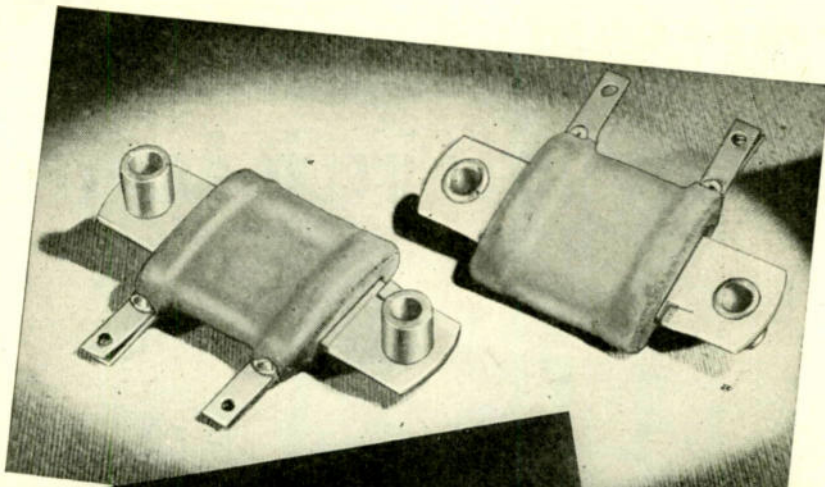

Top and bottom views of Type ZT stack-mounting Greenohms.

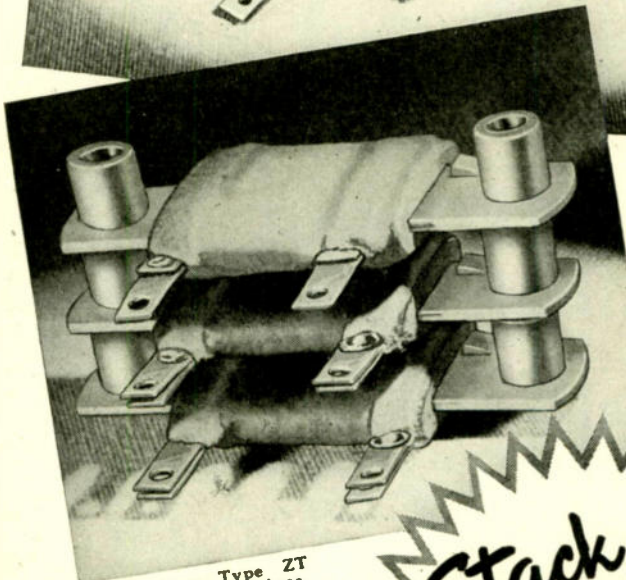

Bank of three Type ZT stack-mounting Greenohms.

Flattened ceramic tube supported by metal strip passing through it and taking the riveted mounting collars.



Clearance for No. 10 screw. 19/32" required for each stacked unit, with adequate air space between resistors.



Available in standard 30, 40, 55, 65 and 75 watt ratings. Resistance values of 10,000, 20,000, 35,000, 50,000 and 50,000 ohms, respectively.



These wire-wound resistors are coated with the famous Clarostat cold-setting inorganic Greenohm cement. Won't chip, flake or crack.

# Stack-mounting GREENOHMS

★ The flat-type Series ZT Greenohms are designed for handy stacking. Two or more units can be banked. Connected together or separately, as required. Can also be used individually with tall mounting collars keeping resistor clear of mounting surface. Adequate spacing for air circulation and maximum heat radiation. Just the thing for those compact, heavy-duty, trouble-free assemblies.

Interested? Write for Bulletin No. 113 describing these flat-type Greenohms and other types of power resistors. Also submit your resistance problem or requirements.

example, if the distance across the face of the sapphire from one point of tangency to the other is maintained, the actual arc of curvature connecting them is of secondary importance. In other words, such tolerances as must be taken had best be applied to the radius shape rather than to the included angle or the burnishing facet.

### Turntable speed

It has already been stated that styli should be designed with respect to depth of groove or pitch. Evidence also indicates that better performance may be obtained if they are also designed with reference to the linear groove speed (i.e. 78 or 33 1/3 RPM).

Recent studies have shown that styli intended for use at 33 1/3 RPM did not always function equally well at 78 RPM. The reasons for this is clear from the above discussion. The 78 RPM stylus, operating at a higher average linear groove speed is able to polish the groove adequately with a smaller burnishing facet. A dimension of 0.1 mil at the corner of the groove is satisfactory both from the viewpoint of adequately polishing the groove and of not enlarging the horns. At 33 1/3 RPM, on the other hand, a dimension of 0.25 mil is indicated for adequate groove polish. Furthermore, the size of the facet at the tip of the radius needs to be between 0.5 and 0.66 for 33 1/3 RPM and between 0.75 to 1.0 mils for 78 RPM in order to obtain a quiet groove.

In view of this, it is evident that the serious recording engineer should make use of Master recording styli that are designed for the specific application in hand.

### Groove inspection

Study of the foregoing data on the burnishing facet leads to a more understanding inspection of the groove under the recording machine microscope. Faint lines in the upper wall of the groove may be present because the burnishing facet is narrow at that point. But if the surface noise as measured remains at the usual low levels such lines should be considered of minor importance in comparison to the increased horns that probably would result from adding to the burnishing facet.

Our studies, as well as those of others, are extending into this field in an effort to determine the relative importance and actual effect of seeming faults observed under



**CLAROSTAT**

## Controls and Resistors

CLAROSTAT MFG. CO., Inc. · 285-7 N. 6th St., Brooklyn, N. Y.



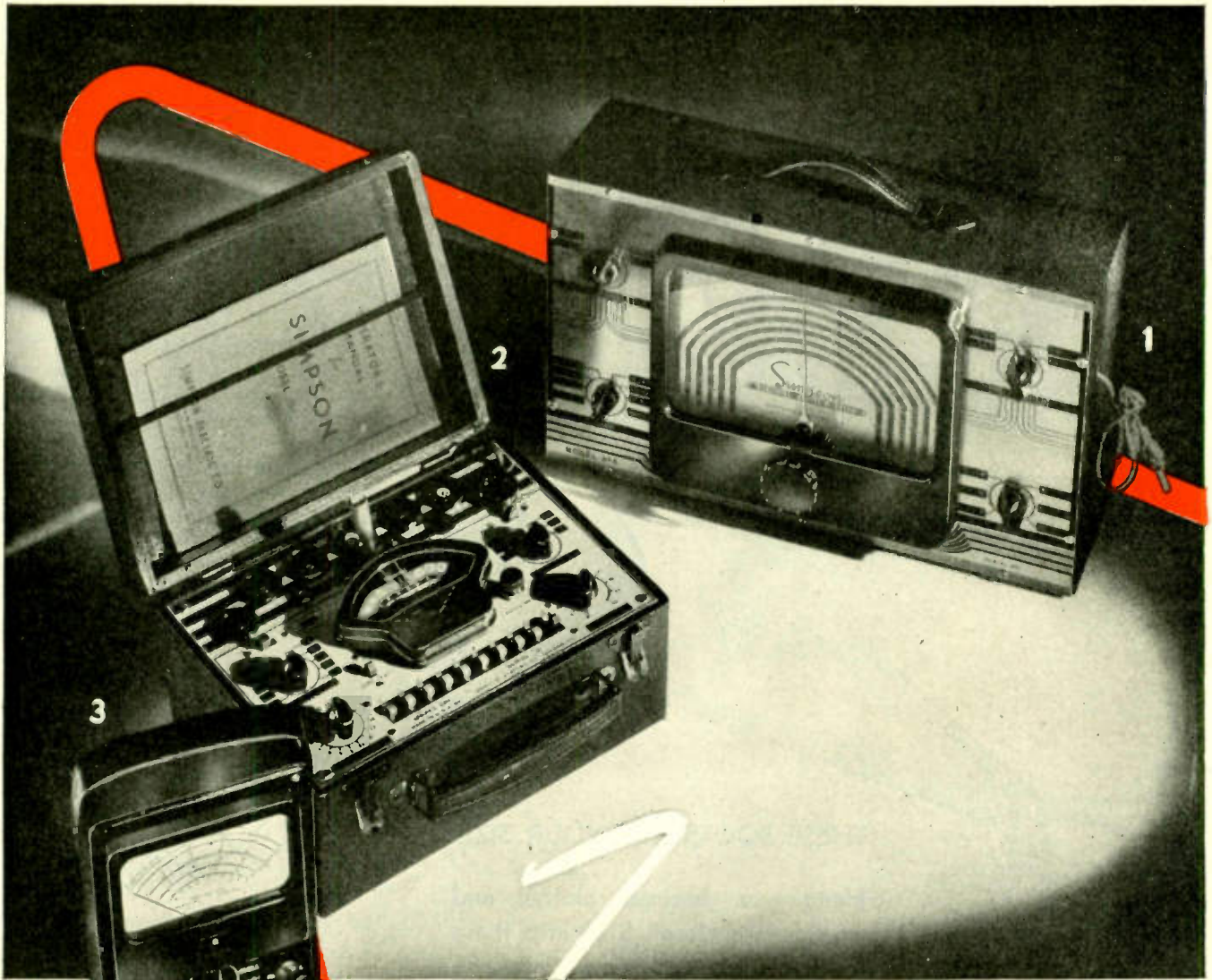

**Model 315 Signal Generator.**  
Designed down to the most minute detail for highest accuracy, greatest stability, minimum leakage, and good wave form .....\$67.35

**Model 305 Tube Tester.** Tests all tubes. Provides for filament voltages from .5 volts to and including 120 volts. Spare sockets for future tube developments....\$46.25

**Model 260 High Sensitivity Set Tester.** 20,000 ohms per volt. D.C. Voltage ranges to 5,000 volts A.C. and D.C. Resistance ranges to 20 megohms. Current ranges to 500 milliamperes.....\$38.95

## *This Simpson "Big 3"* **... gives servicemen a real profit-making set-up**

- The successful radio serviceman today must have the finest in test instruments for a very practical reason—that's his only hope of present and continued profits. To meet the tremendous volume of business available he must be able to "trouble-shoot" fast and *accurately* every time. Only thus can he correct trouble speedily, with satisfaction to the customers.

Simpson offers you, in three basic test instruments, the accuracy and advanced electronic engineering which have given Simpson the proudest name in the industry. They are tried-and-tested examples of the kind of instruments Simpson has always built. Their use will demonstrate that from Simpson alone can you expect "instruments that stay accurate" with construction and design that lead the field.

To dealer and to serviceman alike, Simpson offers today the assurance of continued profits that only quality can give. No Simpson instrument is ever marketed, or ever will be, unless its makers feel that, of its kind, nothing finer can be produced.

# Simpson

INSTRUMENTS THAT STAY ACCURATE

SIMPSON ELECTRIC COMPANY  
5200-5218 West Kinzie Street, Chicago 44



THIS SPACE RESERVED FOR YOU

THESE BOOTS ARE YOUR SIZE.

Hang your business clothes and worries in a closet. Step into these magic boots and wade into the surging freshness of a sylvan stream — leave your troubles to Macallen.

For wherever Mica is used, Macallen is the reliable and dependable source of supply that relieves you from all uncertainty. If you make motors or generators, switches, condensers or anything that requires Mica in any form — then Macallen will solve your problems for you. Because Macallen represents over half a century of working with Mica. Macallen has the vast resources, the wide technical knowledge and the physical equipment that is essential. Step into these boots — leave your troubles to Macallen.

When You Think of MICA, Think of MACALLEN

**THE MACALLEN COMPANY**

16 MACALLEN STREET—BOSTON 27  
 CHICAGO: 565 W. Washington Blvd. CLEVELAND: 2005 Leader Bldg

the microscope. At this writing we do know that it is possible to be misled by the microscope. "Lines" in the groove may be only reflections from its polished walls and can often be made to move or disappear by changing the angle of the groove illumination. Obviously, apparent faults of this nature are of no consequence and can be ignored.

**Ideal specifications**

A recording stylus with an 87° included angle and a radius of from 2.1 to 2.3 mils remained standard for many years and still is standard for vertical recording. While there are logical reasons for varying the size of the radius in lateral recording, the included angle of 87° ± 3° is preferred by the majority of the recording profession. It has certain advantages over the stylus with a 70° included

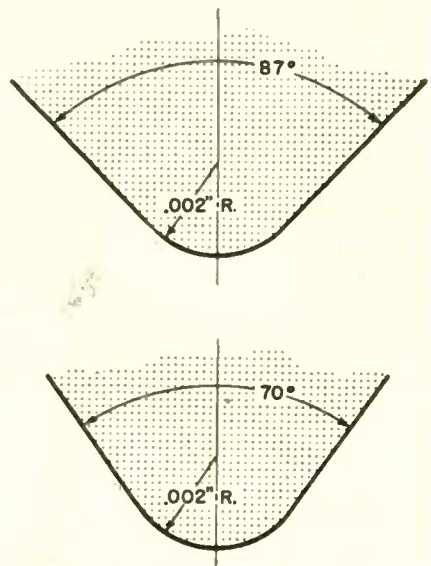

Fig. 9—Reference to a "radius" on a cutting stylus or playback stylus is confusing to many. Actually, in terms of styli, it refers to that portion of the circumference of a circle that is below the points where the circle is tangent to the included angle. Different angles will be tangent to a given circle at slightly different points. This results in greater or lesser degrees of arc below the point of tangency. This figure shows 70° and 87° included angles tangent to a 2.0 mil circle. There is more degree of arc in the 70° stylus because its point of tangency is above that of the 87° stylus

angle and a 2 mil radius which is now being used by some recording engineers.

Regular 70° styli are somewhat more difficult to manufacture than 87° styli. Not only is there likely to be a greater normal error in shape due to the increased amount of arc (as previously pointed out), but they tend to be noisier than 87° styli unless the burnishing

# Important FM news

for Broadcast Managers . . . Engineers . . . Listeners

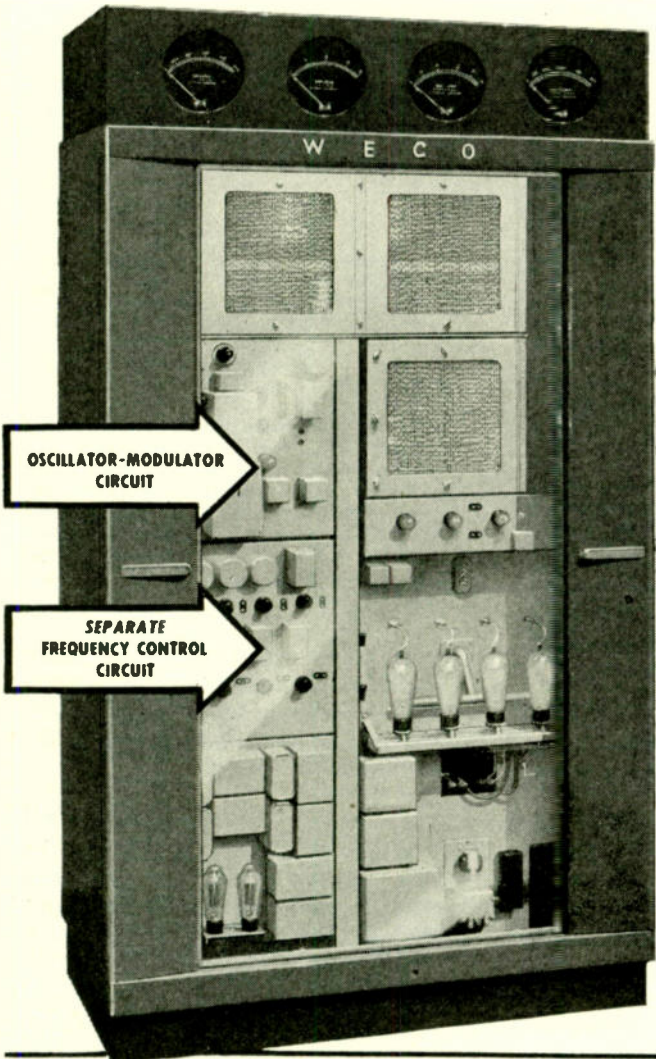

## Unexcelled Performance of Western Electric FM Transmitters

Audio Frequency Response	.....	±0.25 DB from 30 to 15,000 cycles
Harmonic distortion — for	±75 KC swing	Less than 0.5% from 30 to 15,000 cycles
— for	±100 KC swing	Less than 0.75% from 30 to 15,000 cycles
Intermodulation — for	±75 KC swing	Less than 0.5% for 80% 50 cycles and 20% 1000 cycles; less than 1.0% for 80% 50 cycles and 20% 7000 cycles
FM noise level	.....	65 DB below ±75 KC swing
AM noise level	.....	50 DB below 100% amplitude modulation
Carrier Frequency stability	.....	Less than 2000 cycles deviation (no crystal heater)

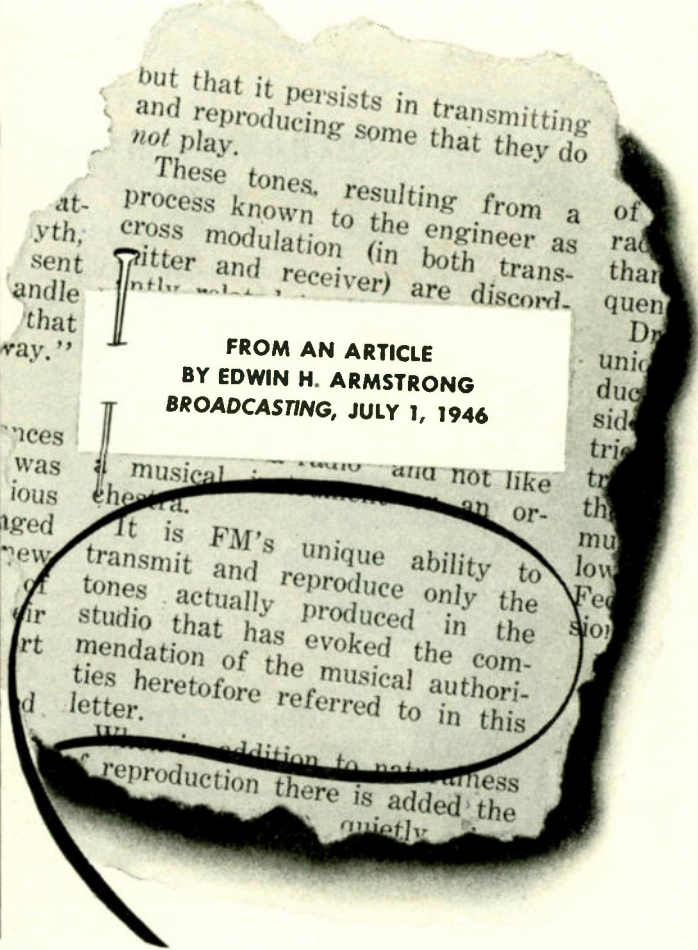

IT is low cross modulation (intermodulation), as Major Armstrong points out, which allows FM to reproduce only the notes actually played and thus achieve such naturalness of tone.

Western Electric's Synchronized FM transmitters are unique in FM broadcasting because of their *unusually low intermodulation products*—achieved by a complete separation of the oscillator-modulator circuit from the frequency control circuit.

For other important features of Western Electric's complete new line of FM transmitters, contact your nearest Graybar Broadcast Equipment Representative, or write to Graybar Electric Company, 420 Lexington Avenue, New York 17, N.Y.

**Western Electric**  
— QUALITY COUNTS —



# Colorful

## BEAUTY WITH ACCENT ON PERFORMANCE

### TURNER COLORTONE MICROPHONES

*New crystal and dynamic microphones  
in a choice of rich, gem-like colors*

Modern as tomorrow . . . packed with new performance features that give more accurate pick-up and higher fidelity reproduction of voice and music . . . Turner Colortone Microphones bring the beauty of matching color to microphone applications. Styled of rich, long lasting, shock resisting plastic in a choice of color finishes, they are especially adapted to orchestras, night spots, home recorders, and television studios. Green, orange, yellow and ivory models are now in production for limited delivery. Ask your dealer or write for details.

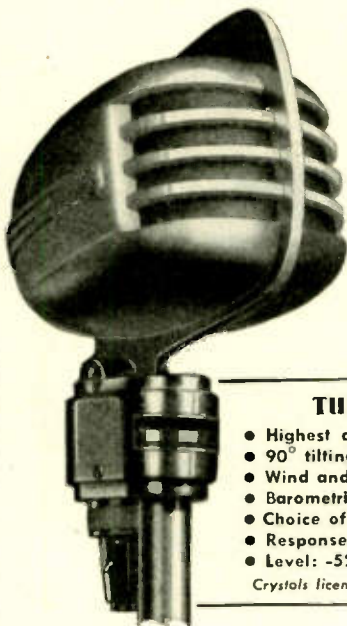

#### TURNER COLORTONE CRYSTAL

- Highest quality Metalseal, moisture proofed crystal.
- 90° tilting head. Semi or non-directional operation.
- Wind and blast proofed.
- Barometric compensator.
- Choice of color finishes.
- Response: Within  $\pm 5$ db from 50 cycles to 10,000 cycles.
- Level: -52db below one volt/dyne/sq.cm.
- Turner precision diaphragm.
- 20 ft. removable cable set.

*Crystals licensed under patents of the Brush Development Company*

#### TURNER COLORTONE DYNAMIC

- Heavy duty dynamic cartridge.
- Alnico V Magnet for increased sensitivity.
- Mu metal transformer shield eliminates possibility of extraneous pick-up.
- 90° tilting head. Semi or non-directional operation.
- Wind and blast proofed.
- Choice of color finishes.
- Turner precision diaphragm.
- 20 ft. removable cable set.
- Response: Within  $\pm 5$ db from 50 cycles to 10,000 cycles.
- Level: -54db below one volt/dyne/sq.cm.
- Impedances: 50, 250, 500 or high.

*Licensed under U. S. Patents of the American Telephone and Telegraph Company, and Western Electric Company, Incorporated.*

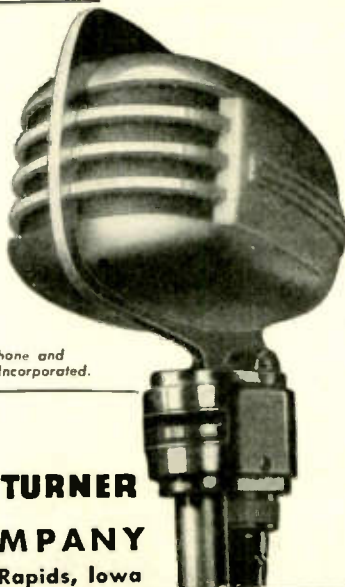

Microphones BY TURNER  
THE TURNER COMPANY

904 17th Street N. E. • Cedar Rapids, Iowa

TURN TO TURNER FOR THE FINEST IN ELECTRONIC EQUIPMENT

facet is increased to 0.75 to 1.0 mils. This, of course, exceeds the limitations imposed upon them as previously outlined. Moreover, 70° styli produce larger horns. An 83½° to 90° stylus, on the other hand, is equally quiet with a smaller burnishing facet and normally produces lesser horns.

In this connection it is well to

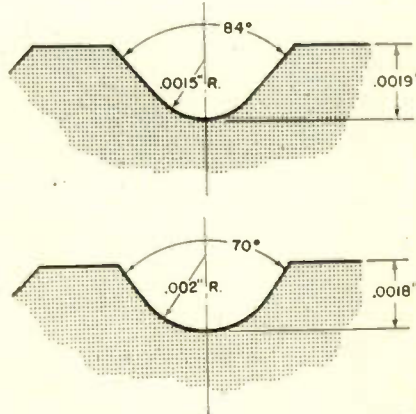

Fig. 10—Two grooves cut at a pitch of 150 lines/in. on a 70:30 ratio are shown. The groove cut with an 84° stylus, 1.5 mil radius, is slightly deeper than that cut by the 70° stylus with a 2.0 mil radius. Following this same line of reasoning, an 85° stylus with a radius of 0.5 mils can cut a pitch of 200 lines/in. with good tracing, if proper playback styli are used

note that a stylus with an included angle of approximately 85° and a radius of from 1.0 to 1.5 mils will cut just as deep a groove as a 70° 2 mil stylus (See Fig. 10).

#### Playback styli

While it is not the purpose of this paper to discuss playback styli, it seems proper to point out that if the functional portion of a cutting stylus is incredibly small,

Fig. 11 (top)—Actual photograph of a well shaped playback stylus in an "ideal" groove. The playback has a radius of 2.5 mils and included angle of 55°. The groove is 87° with a 2.0 mil radius cut at a pitch of 100 lines per inch. The included angle of playback serves as clearance

Fig. 12 (bottom)—Actual photograph of a poorly shaped playback intended to have a radius of 2.5 mils in the same groove as Fig. 11. Error in radius shape has resulted in poor contact and has the effect of reducing clearance

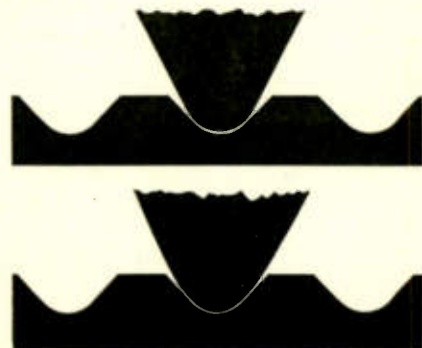

The world's largest plant devoted to the design and production of molded carbon-graphite-powdered metal specialties.

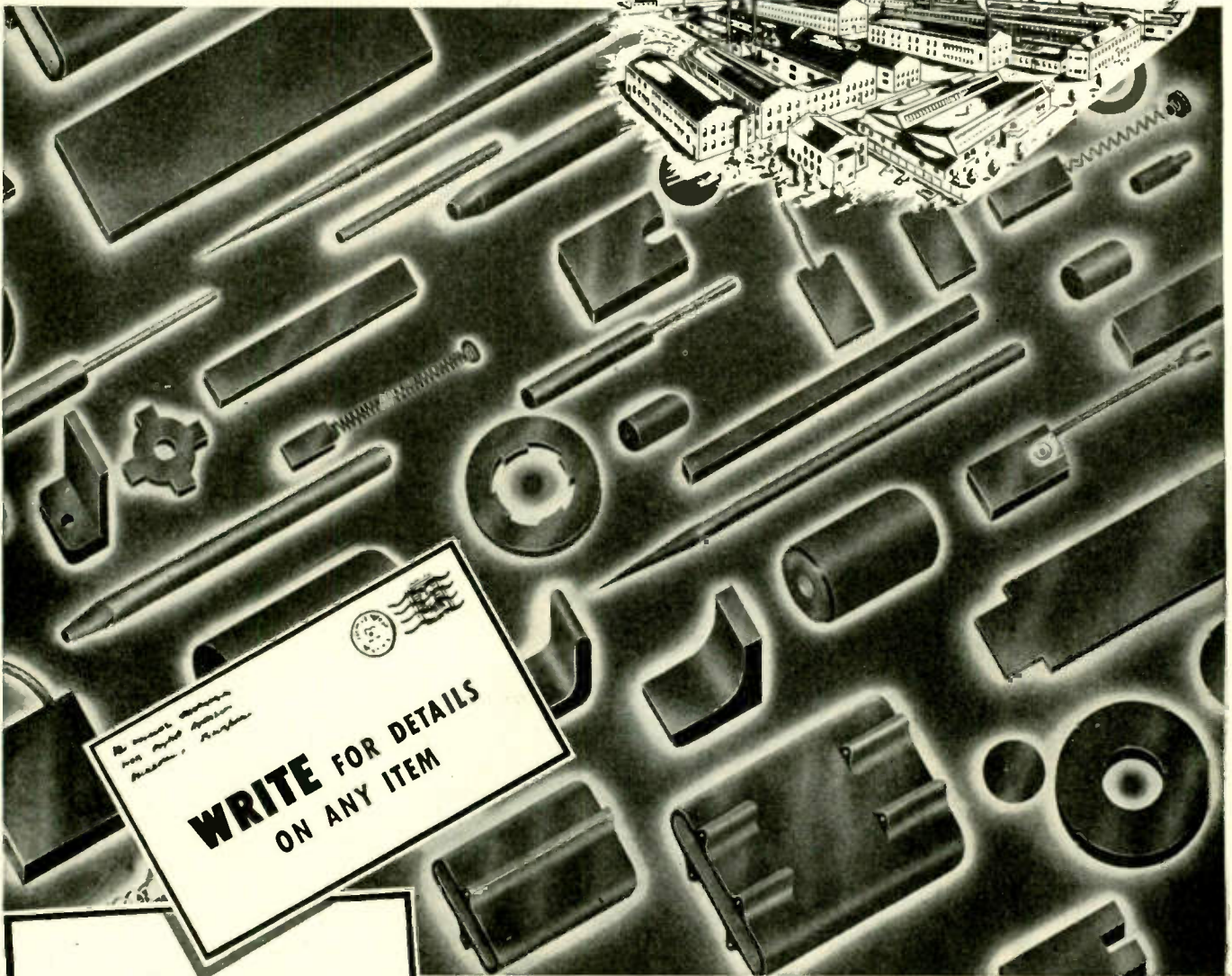

WRITE FOR DETAILS  
ON ANY ITEM

Rare Metal Contacts  
Brushes and Contacts  
(all carbon, graphite, metal  
and composition types)  
Anodes • Electrodes  
Bearings  
Welding and Brazing Products  
Carbon Pipe  
Chemical Carbons  
Power Tube Anodes  
Sintered Alnico II  
Flashlight Battery Carbons  
Packing, Piston and Seal Rings  
Rheostat Plates and Discs, etc.  
**Stackpole Electronic Products**  
Fixed and Variable Resistors  
Iron Cores  
Switches • Line, Slide,  
and Rotary Action

## CARBONS, GRAPHITES AND MOLDED METAL COMPOSITIONS



Here you see just a few of thousands of molded carbon, graphite, powdered metal and composition components manufactured by Stackpole. What you *don't* see is the tremendous background of engineering experience that goes into their production. And *that* makes a difference! It eliminates guesswork. It means that each particular product is made to conform EXACTLY to its own specific operating conditions. It means longer, more dependable service.

We can't sell our experience . . . you get that free. Yet it's the most valuable part of every Stackpole product you buy!

**STACKPOLE CARBON CO., ST. MARYS, PENNA.**

# STACKPOLE

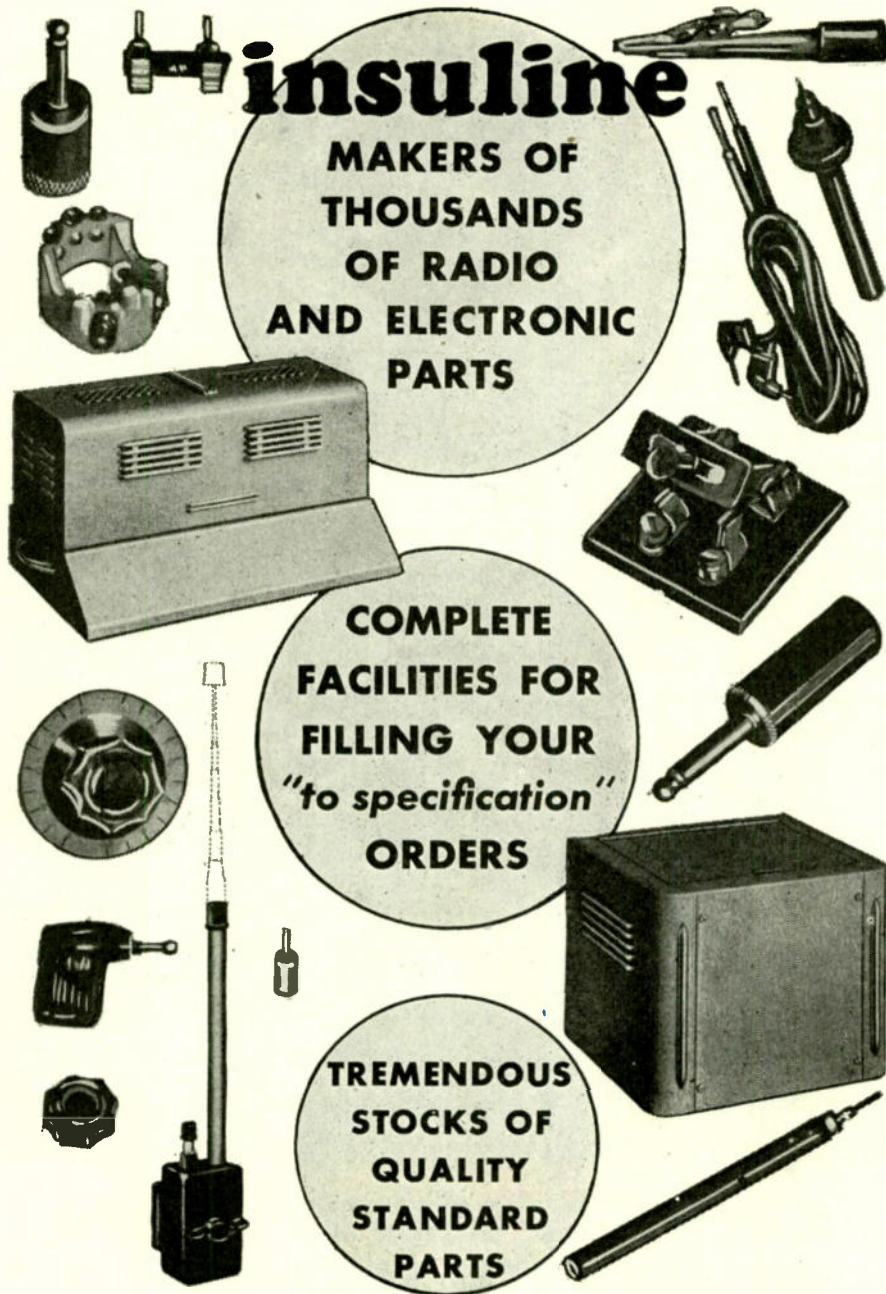

Insuline began to design, develop and produce quality radio parts for the industry a quarter of a century ago.

Today, Insuline produces one of the biggest lines of standard parts—everything from a small stamping to a giant transmitter cabinet—and occupies an enviable position as a to-your-specifications manufacturer.

You'll find quantity and quality, speed and precision, at Insuline. You'll find more complete details in Insuline's hot-off-the-press catalog. Write Dept. C-13, for your copy—now!

the functional portion of a playback stylus is even smaller. In fact, only the radial portion of the playback stylus is in contact with the groove and, therefore, the included angle is of little consequence except as clearance (See Fig. 11). On the other hand, any error in the contour of this radial portion greatly alters the fit of the stylus in the groove (Fig. 12).

A study of the various factors involved in both cutting and playback styli leads to the conclusion, from the viewpoint of the work mentioned herein, that an ideal combination of standard specifications would be as follows:

Cutting stylus .....  $85^\circ \pm 3^\circ$   
with a radius of 1.5 to 2.0 mils;  
Playback stylus .....  $45^\circ \pm 5^\circ$   
with a radius of from 2.3 to 2.5 mils.

The advantage of such combined specifications is as follows:

1—The normal error in regular cutting styli would be reduced to a minimum and the playback would, despite any error, ride the side walls.

2—Master cutting styli would be flexible to change of pitch, the same specification allowing either 96 or 150 lines per inch with proper playback tracking.

3—Any error in the contour of the playback would not result in excessively bad groove fit, except possibly at the 150 lines per inch pitch.

4—The same playback could be used for both vertical and lateral grooves.

5—Maximum low surface noise in the groove without exceeding the limitations imposed upon the burnishing facet would be assured.

#### Summary

The regular lacquer cutting stylus was originally developed for the sole purpose of cutting a quiet groove in plastic materials for direct playback. It is and always has been a remarkably fine tool for this purpose; and in addition has proved its general usefulness by cutting good originals although lacquer originals were an undreamed of possibility when instantaneous recording was initiated.

However, since it must be manufactured in large quantities, it can not be expected to meet the more exacting requirements outlined in this paper. The Master stylus is definitely indicated for critical originals or for experimental re-



# insuline

## Corporation of America

INSULINE BUILDING • LONG ISLAND CITY, N. Y.  
More than a quarter-century of Quality production





## ... Impromptu Discussions about Miniature Tubes



"It's a fact, John, those little TUNG-SOL Miniatures are actually doing a better job than the big tubes. Take radio frequency amplifiers for example. There's the TUNG-SOL 6BA6 for transformer and storage battery operated sets and the 12BA6 for series filament operation. It's only natural that you get greater rigidity with the shorter structure and the same grid cathode spacing . . . and to give you some idea of space saving, one of these little fellows occupies less than half the chassis area that a big tube requires. Think what this means in compact equipment like an auto set.

"With these

miniature amplifiers it's possible to obtain the correct bias by means of a cathode resistor of 68 ohms for normal operating current. If unbypassed this gives partial compensation for variations in input capacitance due to changes in automatic volume control voltage. Almost complete compensation can be obtained with a 100 ohm unbypassed cathode resistor. Under this condition the effective

transconductance is 2700 microhms. Excellent performance is obtained in the frequency modulation and television intermediate frequency bands. The stable gain figure of merit is about the same as for the large type tube while the broad band figure of merit is about 30% greater.

"I tell you, John, you should lay your tube problems before these TUNG-SOL Engineers. They'll help you select the miniature that'll be most efficient and they won't disclose your plans to others. You see they're tube manufacturers, not set builders."



# TUNG-SOL

*vibration-tested*

## ELECTRON TUBES

**TUNG-SOL LAMP WORKS INC., NEWARK 4, NEW JERSEY**  
Sales Offices: Atlanta • Chicago • Dallas • Denver • Detroit • Los Angeles • New York  
Also Manufacturers of Miniature Incandescent Lamps, All-Glass Sealed Beam Headlight Lamps and Current Intermittors

## WORK WELL TOGETHER



You've got a hard-working, unbeatable team in the Jackson Service Lab: the Dynamic Tube Tester Model 636, Test Oscillator Model 640, and the Condenser Tester Model 650-A—three fine instruments mounted on one panel for convenient use and good looks.

### JACKSON SERVICE LAB Model 808

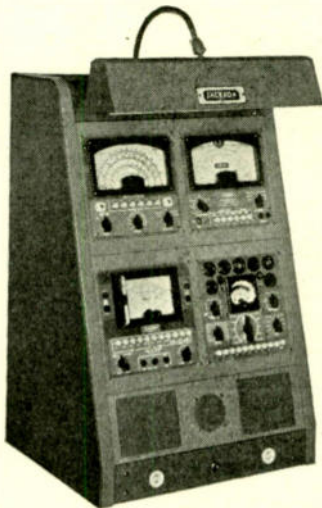

Angled front panel for visibility and attractive appearance.

Extra accessory panel machined for easy installation of any special test features you wish to add. A "custom-built" feature at no extra premium.

Two convenience outlets and master switch on front panel. Each lab completely wired ready for use. Also four A.C. outlets for installed instruments.

Interchangeable panels—Standard relay rack size panels, a feature originated by Jackson in the first service labs.

Fluorescent lighting (optional). Each unit has mounting provisions for the Jackson Fluorescent Lab Lamp.

Service Lab Rack finished in grey and morocco and supplied with trim strips.

Dimensions: 20" wide, 31 $\frac{3}{4}$ " high, 16 $\frac{1}{2}$ " deep.

Start today to equip your shop with modern Jackson instruments.

# JACKSON

*Fine Electrical Testing Instruments*

JACKSON ELECTRICAL INSTRUMENT COMPANY, DAYTON, OHIO

search where all factors need to be known and variables reduced to a minimum.

Improvements in discs, recording equipment and recording techniques together with this improved stylus now make recordings of higher quality possible. It is to be hoped that serious efforts to obtain both high fidelity recording and reproduction of sound will give the same critical attention to the playback stylus as it has to the cutting stylus.

### Acknowledgment

This opportunity is taken to express our appreciation for the cooperation of the many recording engineers and disc manufacturers who have contributed to the advance of our studies. The data given in this paper was in large part suggested or substantiated by their tests of experimental styli under actual recording conditions.

### BRIDGE CHART

(Continued from page 74)

ues are assumed for balance at 1,000 cycles:  $R_a = 1,590$  ohms,  $R_r = 500$  ohms,  $R_c = 1,000$  ohms,  $C_a = .1$  mf,  $C_b = .2$  mf, and  $L_c = .159$  h. If  $L_c$  is changed to .14 h., an unbalanced voltage AE appears equal to .016 as shown in the table 5d.

Several examples have been shown of methods applying the unbalanced bridge voltage chart for finding the voltage across the null detector, as well as other voltages in the various branches. By similar methods unbalanced voltages in other types of bridges, or due to variations of values in any of the branches of the bridges shown above, can be determined.

### REL Schedules FM Engineers Clinic

To assist engineers to better understand FM installations and engineering problems, a clinic has been arranged for the three days starting December 2 by Radio Engineering Labs, Inc., 35-54 36th Street, Long Island City. The program, to be presided over by Vice-President Frank A. Gunther, will consist of a review of FM theory and fundamentals, a study of FM progress up to and including present equipment as well as an examination of current operating techniques. Time also will be allowed for laboratory work and round table discussion.



# LOOK TO SEEBURG CHANGERS FOR TROUBLE-FREE OPERATION ... BETTER PERFORMANCE

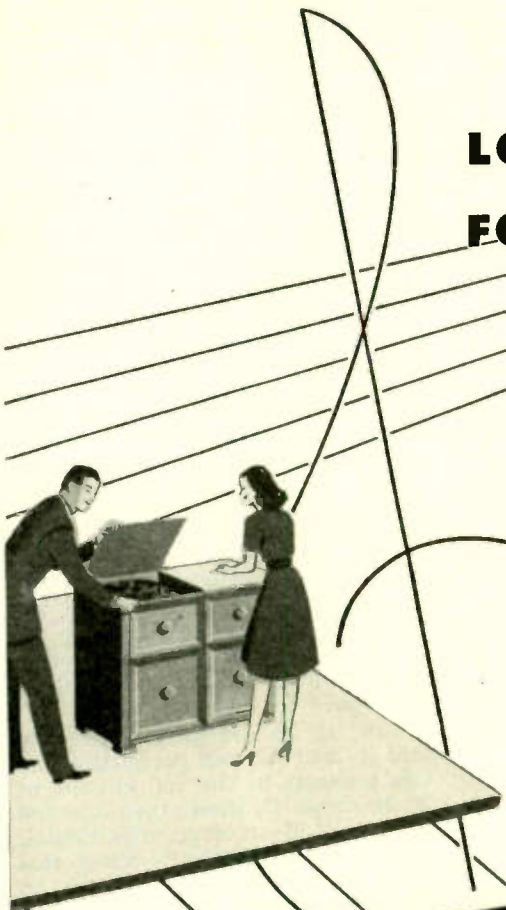

Phonograph manufacturers know that the success as well as the popularity of the instruments they manufacture depend in no small measure on the record changer they use. This is why so many of the leading producers of phonographs look to Seeburg for these mechanisms.

- The multiple posts of Seeburg changers hold records flat and prevent wear on spindle holes.
- The quiet mechanism moves records into place with minimum time between changes.
- The featherweight crystal pickup reproduces subtle harmonies and prevents wear on records.
- The strong, quiet motor brings the turntable up to speed and holds that speed constant.

These are some of the reasons why this latest line of Seeburg Record Changers continues to be the favorite with manufacturers and owners alike.



*The new Seeburg Wire Recorder — a brand-new development — permits perfect home recording of speeches, plays, radio programs. Single control knob simplifies operation.*

**RADIO MANUFACTURERS** — provision must be made in your circuits to accommodate the Seeburg Wire Recorder. We invite inquiries.

MINIMUM FRICTION  
SILENT  
LONG LIFE  
CONSTANT SPEED  
TROUBLE-FREE OPERATION

# Seeburg

RECORD CHANGERS ★ WIRE RECORDERS

J. P. SEEBURG CORPORATION  
1500 N. DAYTON ST. • CHICAGO, 22

**MEMO**  
 To Jim Davis, Engineer Lab  
 Are we interested in an  
 instrument that makes  
 Direct-Inking Recordings  
 from D.C. to 100 cycles  
 per second?  
 From Bob Neely

**MEMO**  
 To Bob Neely, Purchasing Dept.  
 Sure ave - get all the  
 details you can. That  
 range gives us almost  
 unlimited possibilities  
 for electrical impulse  
 measurements!  
 From Jim Davis

Brush Magnetic Oscillographs may be used for making detailed recordings of electrical impulses for an almost limitless number of applications. The Magnetic Pen Motor is capable of recording a D. C. signal. Used with the BL-905 amplifier, the frequency range is from .2 to 100 cycles per second. Recordings are direct, instantaneous, ink-on-paper graphs. Can be used for recording strains, pressures, vibrations, temperatures, light intensity and countless other phenomena. Write for detailed bulletin.

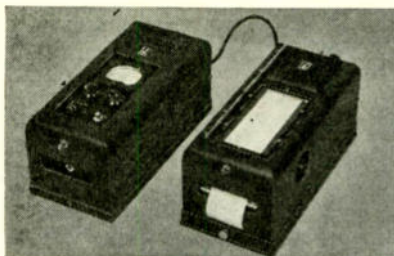

Brush Single-Channel Magnetic Oscillograph with amplifier. Especially suited for counting, temperature recording, surface analysis and similar applications.

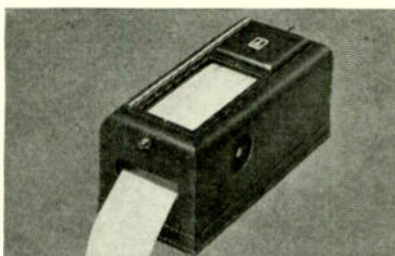

Brush Double-Channel Magnetic Oscillograph for use where two simultaneous recordings are desired - as in synchronizing problems.

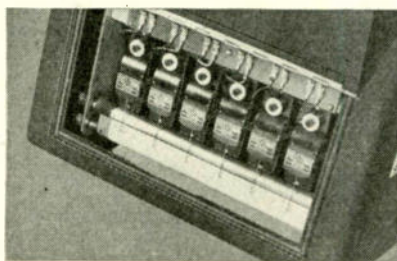

Brush Six-Channel Magnetic Oscillograph. Excellent for strain-gauge recordings and similar multiple applications.

## CARRIER FAILURE

(Continued from page 71)

air with a minimum of lost time. But the system used must be such that if further overloads continue at a rate endangering the equipment, the power must be held off. Two of the more popular of such 'reclosure circuits' will be described.

Fig. 11 shows a 'one-shot' type circuit which is used on the General Electric G-100A 100 kw international broadcast transmitter. In this circuit,  $K_1$  and  $K_2$  are the main rectifier start and run contactors, while  $K_3$  is the reclosure relay operating on dc from the copper oxide or selenium rectifier CR<sub>1</sub>. As shown, with  $K_2$  not energized,  $C_1$  is prevented from charging to appreciable voltage because of the shunt across it presented by the 'a' coil of reclosure relay  $K_3$ . After  $K_1$  has been energized for about 10 seconds,  $C_1$  has become charged to a voltage sufficient to close  $K_3$ .

Now, if an overload occurs,  $K_1$  and  $K_2$  will fall out permitting the two contacts in the coil circuits of  $K_3$  to close.  $C_1$  discharges into the 'a' coil of  $K_3$  momentarily closing it and permitting the 'b' coil to seal itself in. An auxiliary contact on  $K_3$  shorts across the rectifier 'On' button restoring the transmitter to operation. This permits  $C_1$  to again start charging and after 10 seconds to be ready for another reclosure. However, if another outage should occur in less than 10 seconds, the reclosure relay will not operate and it will be necessary to push the 'On' button to restore power. Note that the 'Off' button has an auxiliary contact which discharges  $C_1$  to prevent an undesired reclosure following a normal shutdown. Varying the resistance of  $R_1$  will determine the charging rate of  $C_1$  and permit changing the timing as desired.

### Multi-shot reclosure

Fig. 12 illustrates a circuit used in the General Electric Type BT-25A 50 kw Standard Broadcast Transmitter which permits two reclosures before locking out.  $K_3$ , the reclosure relay, is of the notching type with an electrical reset coil. This relay has two separate circuits, one of which has the sequence on notching of "closed—closed—closed—open", while the other has "open—closed—closed—open" for reset timing.

If an overload relay operates, the normally open contacts energize  $K_3$  permitting it to advance to its second position (also closed). A second overload will advance  $K_3$  to its third closed position, but a third overload will lock it out on the fourth position (Open). The purpose of the timing relay  $K_5$  is to reset  $K_3$  automatically after 10 sec-

# THE BRUSH DEVELOPMENT CO.

3405 PERKINS AVE. • CLEVELAND 14, OHIO

Canadian Representatives: A. C. Wickman, (Canada) Ltd.

P. O. Box 9, Station N. Toronto 14

# FROM ANY ANGLE...

## POWERSTAT TYPE 20

(VARIABLE TRANSFORMER)

### IS SUPERIOR

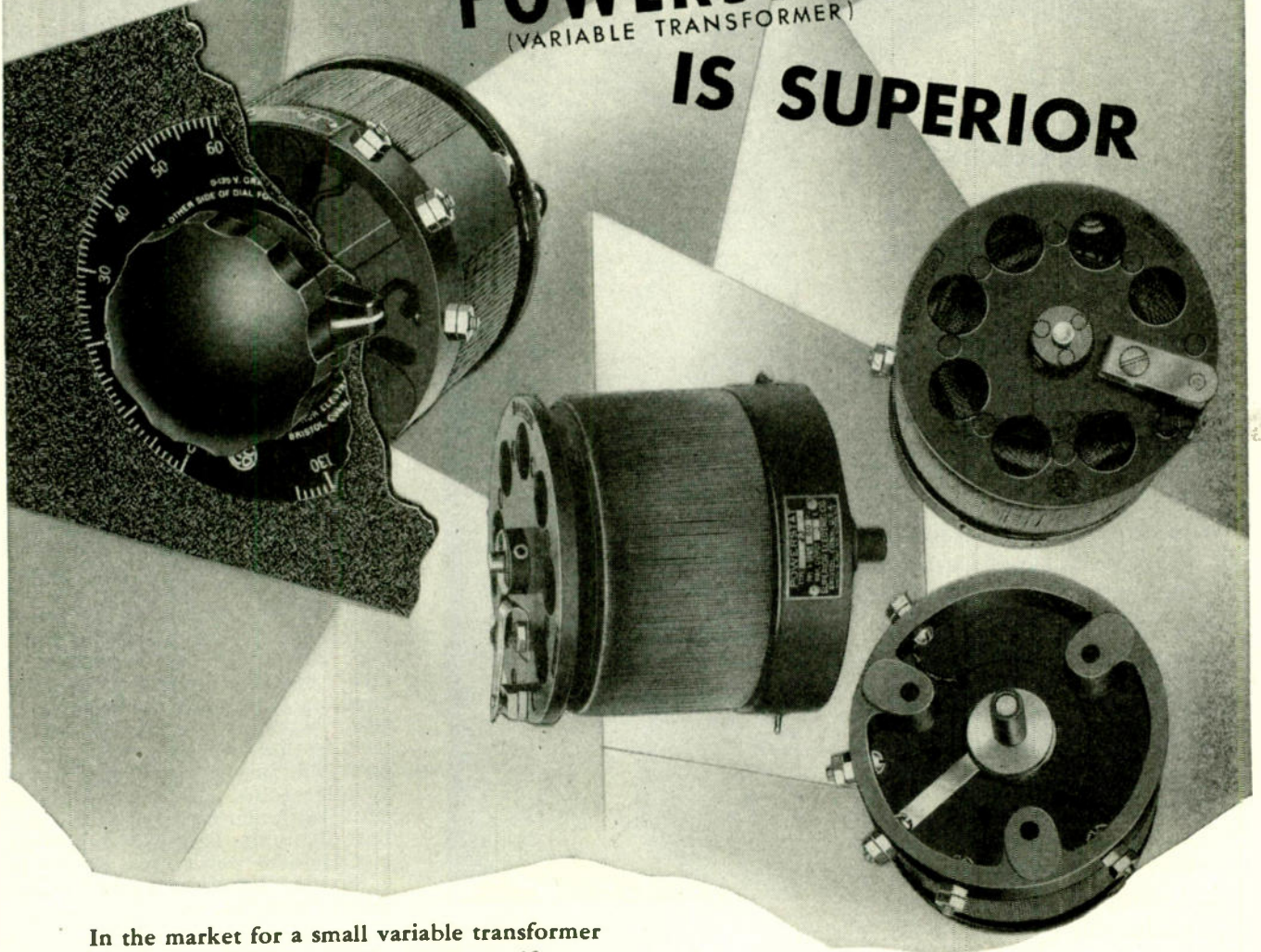

In the market for a small variable transformer of about  $\frac{1}{2}$  KVA capacity? To be more specific . . . INPUT — 115 volts, 50/60 cycles, 1 phase. OUTPUT — 0-135 volts or 0-115 volts, 3.0 amperes.

Take a look at POWERSTAT type 20.

Viewed from any angle it qualifies as a superior voltage controller.

**QUALITY ANGLE . . .** The mechanical construction is extremely rugged yet this POWERSTAT is unusually compact for the rating.

Mounting holes are located on a  $1\frac{1}{4}$  inch radius.

Excellent regulation, smooth control, high efficiency are only a few of its desirable electrical features.

**VERSATILITY ANGLE . . .** Type 20 can be connected to provide increasing voltage with either clockwise or counter-clockwise rotation. Terminals permit clip-lead or solder connections.

**COST ANGLE . . .** Highest valuation yet lowest price per rated ampere output of any similar type variable transformer.

Other angles regarding type 20 will be cheerfully discussed by SECO sales-engineers. . . *Consult us NOW!*

Send for Bulletin 150 I E

**THE SUPERIOR  ELECTRIC COMPANY**

771 LAUREL STREET

BRISTOL, CONNECTICUT, U. S. A.

## Astatic NYLON 1-J CRYSTAL PICKUP CARTRIDGE

- Improves performance with respect to needle life and frequency response.
- Improves tracking at low needle pressure and reduces record wear.
- Employs Nylon Chuck and matched, sapphire-tipped, knee-action, replaceable Nylon Needle.
- Assures phonograph manufacturer that the quality of reproduction remains **CONSTANT**, regardless of needle replacements . . . because the Nylon Needle is **MATCHED** to the cartridge and is the only needle that can be used with it.
- Assures phonograph owner of unalterable quality of reproduction.
- MANUFACTURERS** and **ENGINEERS** interested in improving the quality of phonograph reproduction and the **MAINTENANCE** of such quality during the life of the instrument, will find such possibilities in the use of Astatic's new Nylon 1-J Crystal Cartridge. A descriptive, informative and generously illustrated folder, including cartridge specifications, is now available. Write for it today.



The Magic of Nylon  
Now contributes to finer  
Reproduction of Phonograph  
Recordings

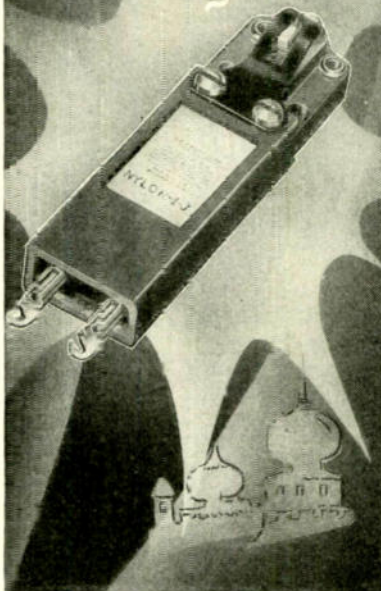

onds providing the fourth (lock-out) position has not been reached, so that overloads over a long period can not 'add up' on the reclosure relay. A reset pushbutton is provided which permits resetting  $K_3$  to position 1 at any time.

### Line voltage protection

Most modern transmitters use mercury vapor rectifier tubes. As these require a filament pre-heat time of about one minute before application of plate voltage, it is usual to include a time delay relay to hold off plate voltage until this time has elapsed. However, if a momentary line voltage dip occurs of magnitude to drop out the time delay relay it would be necessary in the absence of other circuits to wait until the relay again times out—even though the tubes did not cool enough to require the additional heat time. Fig. 13 shows a circuit which protects against this.  $K_1$  is the regular filament time delay relay—after 1 minute it closes permitting  $K_2$  to close— $K_3$  also closes completing the circuit for the plate contactor  $K_4$ . Now if a power failure occurs,  $K_1$  drops out at once but  $K_2$  requires 2 seconds to fall out. If the power is restored before  $K_2$  has dropped out,  $K_3$  is picked up at once and plate power can be applied. If more than 2 seconds have elapsed before power is restored,  $K_2$  will also have fallen out and it will be necessary to either wait 1 minute for  $K_1$  to again time out or to push the Emergency Start Button. Caution should be used in use of this button as insufficient timing could injure the rectifier tubes. A good rule is to wait approximately one and one-half times the length of time that the filament power was off (up to 1 minute) before using the Emergency Start Button.

### Antenna meter protection

Another piece of equipment vulnerable to lightning damage is the antenna ammeter. This is usually a thermocouple instrument located in the antenna lead above the terminating equipment. Due to the low resistance of the thermocouple it is not feasible to short it out. Removing it from the circuit is more satisfactory. A relay or a switch can be used for this purpose. Although it is desirable to use a make-before-break type, this is not absolutely necessary as the rf arc will carry over until the circuit is closed. Fig. 14 shows a simple circuit which has operated well for this purpose.

If a remote meter is used to give indication of antenna current, it usually will be found that the current transformer and thermocouple often used for this are subject to frequent burn-out. A diode rectifier

## PRODUCTIVE EMPTINESS...

**F**REE OF AIR . . . in a high vacuum so many of the familiar liquids and gases, so many heretofore "undistillable" substances react to various treatments in entirely new—often strange—but potentially useful ways. Despite the years of research and the solid accomplishments made to date, the field for new commercially valuable discoveries through high-vacuum technique remains virtually untouched.

The D.P.I. Glass Two-Stage Fractionating Pumps provide basic versatile tools for laboratory investigations in high vacuum. Beyond this important function, their economy and efficiency have furthered their wide industrial use in conjunction with trolley exhaust machines in the production of electronic tubes and parts.

GF-20A and GF-20W offer a choice of either an air- or water-cooled pump, capable of producing a vacuum of better than  $10^{-6}$  millimeters in a closed system of moderate size. Its controlled flow of oil through the three boilers makes this efficiency possible—without employing a cold trap.

If either your laboratory studies or your commercial processes involve high-vacuum technology, the D.P.I. Glass Two-Stage Fractionating Pump may be the tool you need to further your present and future work.

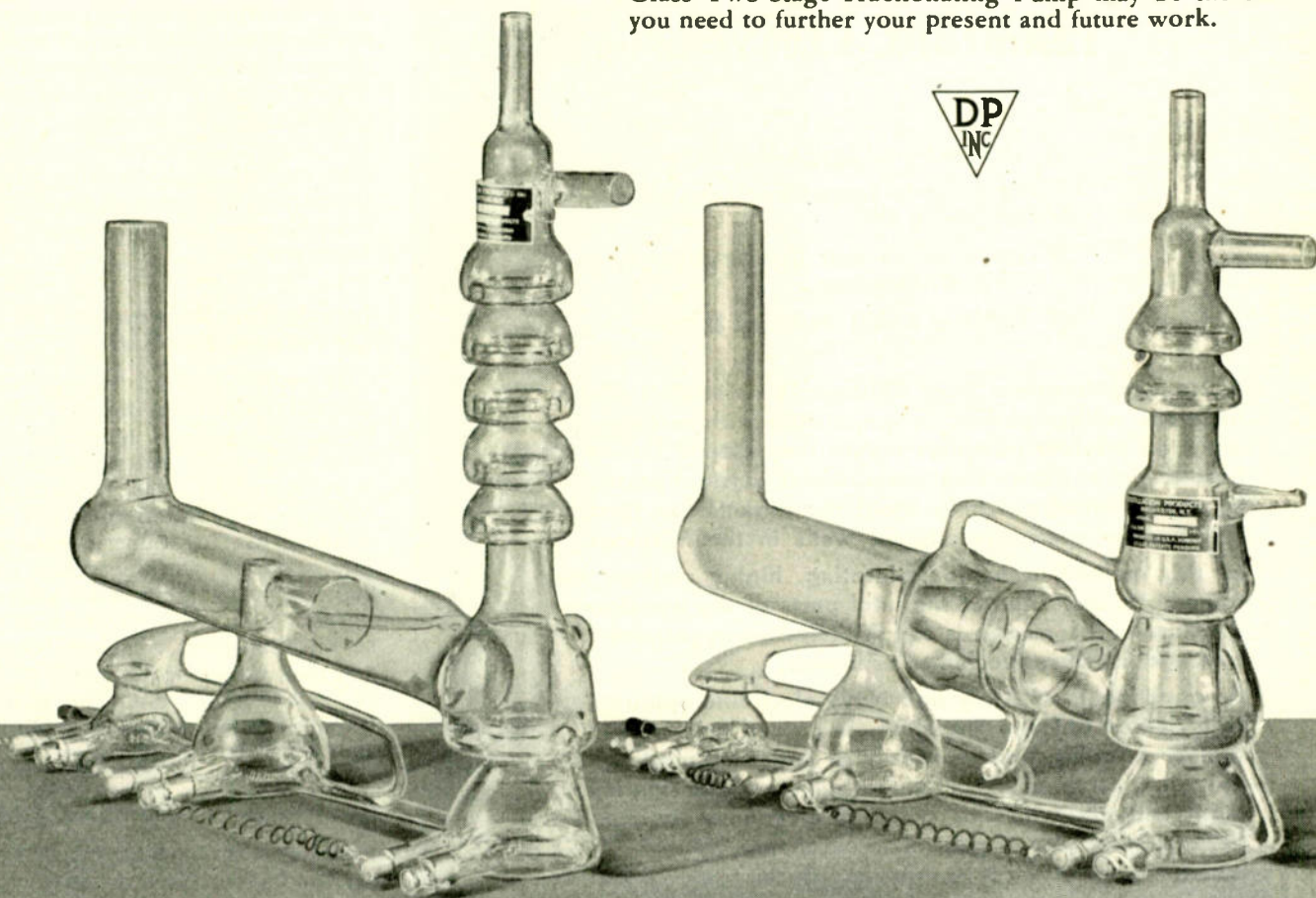

For complete details covering  
Type GF-20A and GF-20W, write—

**Vacuum Equipment Division**  
**DISTILLATION PRODUCTS, INC.**  
**Rochester 13, New York**

An Advertisement about **TRANSFORMER DESIGN**

... Directed to those who manufacture electronic equipment that must be **MOISTURE PROOF** and/or **FAILURE PROOF**

*Chicago  
Transformer's*

## HERMETICALLY-SEALED TERMINAL CONSTRUCTION

is . . .

- 1 Permanent Proof Against Moisture
- 2 Impervious to Temperature Changes in the Unit or Surrounding Air
- 3 Unaffected by Heat Transfer from Soldering of Terminal Connections
- 4 Cushioned Against Mechanical Shock

These qualities stem from Chicago Transformer's use of special neoprene rubber gaskets in conjunction with ceramic bushings to seal and insulate terminals where they extend through the steel base covers or drawn steel cases. Under constant pressure, imposed by the terminal assembly itself, the gaskets are forced into and retained by specially-designed wells in the bushings.

By this method, a non-deteriorating, highly resilient seal is obtained. Its protection of the vital parts of the transformer against moisture and corrosion is equally effective in extreme heat or cold and against corrosive fumes or liquids.

As components of Army and Navy electronic apparatus, Hermetically-Sealed Chicago Transformers gained an outstanding reputation for durability and dependability under the most severe wartime operating conditions. Today, this same basic design is available to manufacturers who are building electronic equipment to comparable standards of peacetime excellence.



**CHICAGO TRANSFORMER**

DIVISION OF ESSEX WIRE CORPORATION

3501 ADDISON STREET · CHICAGO, ILL.

coupled to antenna circuit will be found more trouble free and cheaper to replace.

That such measures have been successfully utilized is attested by the fact that some stations, even of 50 kw power, lose as little as 30 seconds during a broadcast year of 7000 hours. To achieve such a record, it is necessary to give careful attention to details, and it is hoped that the above brief description may prove helpful to station engineers.

### **See Television Use for Phosphor Telescope**

The Thirty-First annual meeting of the Optical Society of America held October 3, 4 and 5, 1946, at the Hotel Pennsylvania, New York, N. Y., discussed among other things a phosphor telescope developed for viewing regions of the sky in close vicinity to the sun that may find some application in television. Phosphors exhibiting after-glow and saturation effects are used. A further series of papers reported on a photoelectric method of preparing color printing plates in which an electronic calculator serves to solve the system of equations required for color correction. Characteristics of photomultiplier tubes were treated and a logarithmic photomultiplier tube circuit, useful because of the logarithmic response of the human eye and of photographic paper, was described.

### **Insulation Increases Cleveland Facilities**

By way of providing for considerably improved service to the trade, Insulation Manufacturers Corp. has greatly increased facilities at its Cleveland, Ohio, headquarters through occupation of its own building at 1231 Superior Avenue. The company manufactures a long line of insulating materials and will warehouse a complete stock at its new headquarters. Additional stocks are maintained in Chicago at 565 W. Washington Blvd., and also in Dayton, Detroit, Milwaukee, Minneapolis, and Peoria.

### **Barker & Williamson Add**

Barker & Williamson, Upper Darby, Pa., has acquired a new factory building in Bristol, Pa., which will be devoted exclusively to special development work and operated as a separate unit. The company's general offices will remain at 237 Fairfield Avenue, Upper Darby, where present manufacturing facilities are centered.

### **Diathermy-Industrial Allocations Proposed**

Federal Communications Commission has proposed that both medical and industrial electronic equipment be required to operate in either one of three specified bands. These are—13.6525-13.6675 mc. with a frequency tolerance of 7.5 kc.; 27.185-27.455 mc. with a frequency tolerance of 135 kc.; and 40.960-41.000 mc. with a frequency tolerance of 20 kc. Spurious and harmonic radiations on frequencies other than those specified must be suppressed so that such radiations do not exceed a strength of 25 microvolts per meter at a distance of 1000 feet or more from the equipment.

### **Marine Radio For N. Y. Central**

Supplementing its railroad radio communications equipment, the New York Central Railroad Co. will also use radiotelephone equipment for communication with its fleet of tugboats. The present plan is to establish a fixed station at Weehawken, N. J., to operate in conjunction with twenty-four mobile units to be installed in the company's tugboats operating from that railhead. General Railway Signal Equipment will be used.

### **Chicago Electronics Show For 1947**

Chicago is preparing already for a four-day national electronics equipment show which it is planned will be held during the week of May 11, 1947. Sponsors of the exposition are the National Electronic Distributors Assn., the Association of Electronic Parts and Equipment Manufacturers, the Sales Managers Club Eastern Division, and the Radio Manufacturers Assn. Show is to be held in Exhibition Hall.

### **Measurements Re-elects**

Officers of the Measurements Corp., Boonton, N. J., were re-elected at a recent stockholders' meeting. They are: John M. van Beuren, chairman of the board of directors; Harry W. Houck, president; and Jerry B. Minter, vice-president and chief engineer. The corporation was established in 1939 and manufactures a specialized line of radio frequency test equipment including standard signal generators, pulse and square wave generators, field strength meters, vacuum tube voltmeters and laboratory instruments.

# a new **CONANT** service



**For  
Rectifier  
Distributors...**

Unbalanced rectifier stock conditions are both annoying and costly. Now, however, you can avoid having surplus inventories on some items and "out of stock" entries on others with Conant's new Balanced Inventory Buying plan.

As a result of a study of instrument rectifier sales to test equipment manufacturers, Conant is now able to offer you 3 rectifier package assortments for balanced buying. Whatever your volume of business, one of these assortments will enable you to purchase instrument rectifiers with the assurance that your stock on hand will always be properly proportioned.

Prices of the new "packages" run from \$28.78 to \$120.48. Send a postcard today for full information about quantity and type of rectifiers in each unit. Reply will be prompt and include a FREE copy of the Conant Instrument Rectifier Replacement Guide... the handiest reference book available on replacements for most test equipment.

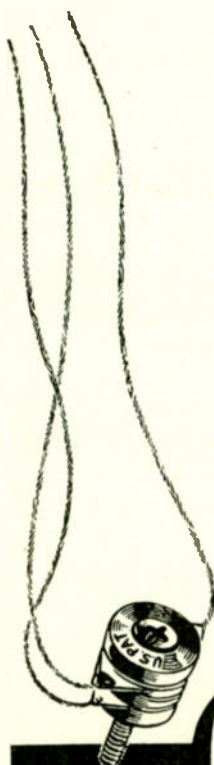

*Instrument Rectifiers*

**ELECTRICAL LABORATORIES**

6500 O STREET, LINCOLN 5, NEBRASKA, U. S. A.

20 Vesey St., New York 7, New York 518 City Bank Bldg., Kansas City 8, Mo. 1526 Ivy St., Denver, Colo.  
85 E. Goy St., Columbus, Ohio 1212 Camp St., Dallas 2, Texas 4214 Country Club Dr., Long Beach 7, Cal.  
600 S. Michigan Ave., Chicago 5, Ill. 378 Boulevard N. E., Atlanta, Ga. Export Div., 75 West St., New York 6, N. Y.  
1215 Harmon Pl., Minneapolis 3, Minn. 4018 Greer Ave., St. Louis, Mo. 50 Yarmouth Rd., Toronto, Canada

## PHONO PICK-UP

(Continued from page 79)

having amplitude response characteristics. The compensating network comprises the plate resistor of 100,000 ohms, and the cathode resistor 10,000 ohms, with its bypass condenser of .02 microfarad. The values of these components will depend upon the choice of tube in the preamplifier stage; for a 6SJ7, suitable values are 250,000 ohms, 25,000 ohms and a 0.01-microfarad bypass condenser.

The position of the damping element along the length of the needle can materially affect the frequency response, particularly at the high-frequency end. Advantage is taken of this property to secure the desired response characteristic. As is shown in Fig. 5, by the curves 1, 2 and 3, it is possible to secure a wide variation ranging from a rising response with a sharp cutoff at 7500 cycles to a falling characteristic with a cutoff at 4000 cycles. Between these two extremes it is possible to secure a response that is flat to 10,000 cycles within  $\pm 1$  db. An adjustment that has given very satisfactory results is represented by curve 2.

### Response characteristics

This response characteristic, in conjunction with the network shown in Fig. 3, produces the overall response shown as curve 4. There is a tendency on the part of some manufacturers to make pick-ups with a sharp cutoff at 3500 to 4000 cycles per second. Admittedly this reduces scratch to a low value, but at the same time it removes the higher tones essential to natural reproduction. With the newer records, particularly the plastic type, scratch is negligible even with good response characteristics to 8000 cycles per second. It would seem undesirable to penalize the purchaser of new equipment by a built-in limitation intended for the playing of old records when, by proper design, the enjoyment of new records can be made so much greater.

In addition to an excellent frequency response, distortion introduced by the pickup is very small. Attempts to measure distortion have met with little success, but extensive listening tests have indicated that this pickup is as good or better than the best of other types. These tests have included comparison with the highest quality pick-ups available, of both crystal and

# Hi-Q



## WIRE WOUND RESISTORS

- Soundly Engineered
- Quantity Produced
- Prompt Deliveries

Sturdy construction (as shown in the accompanying diagram) is but one characteristic of Hi-Q Wire Wound Resistors. The others are precision winding, wide range of types, sizes and ratings and quantity production. Standard units are available in capacities from 5 to 200 watts with outside dimensions of 5/16" x 1" to 1-1/8" x 12" and resistance values up to 100,000 ohms. Where required, special units are engineered to specific jobs.

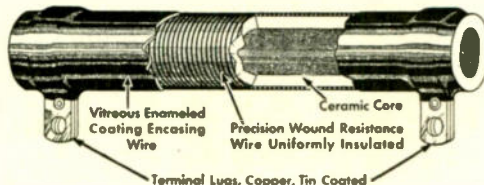

## OTHER Hi-Q COMPONENTS

### CERAMIC CAPACITORS

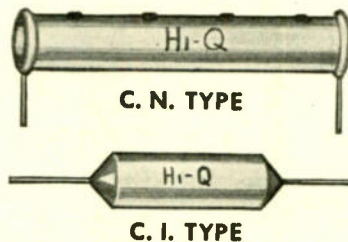

### CHOKE COILS



### STAND-OFF CONDENSERS

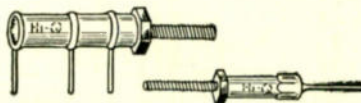

# Hi-Q

**ELECTRICAL REACTANCE**  
CORPORATION  
FRANKLINVILLE, N. Y.



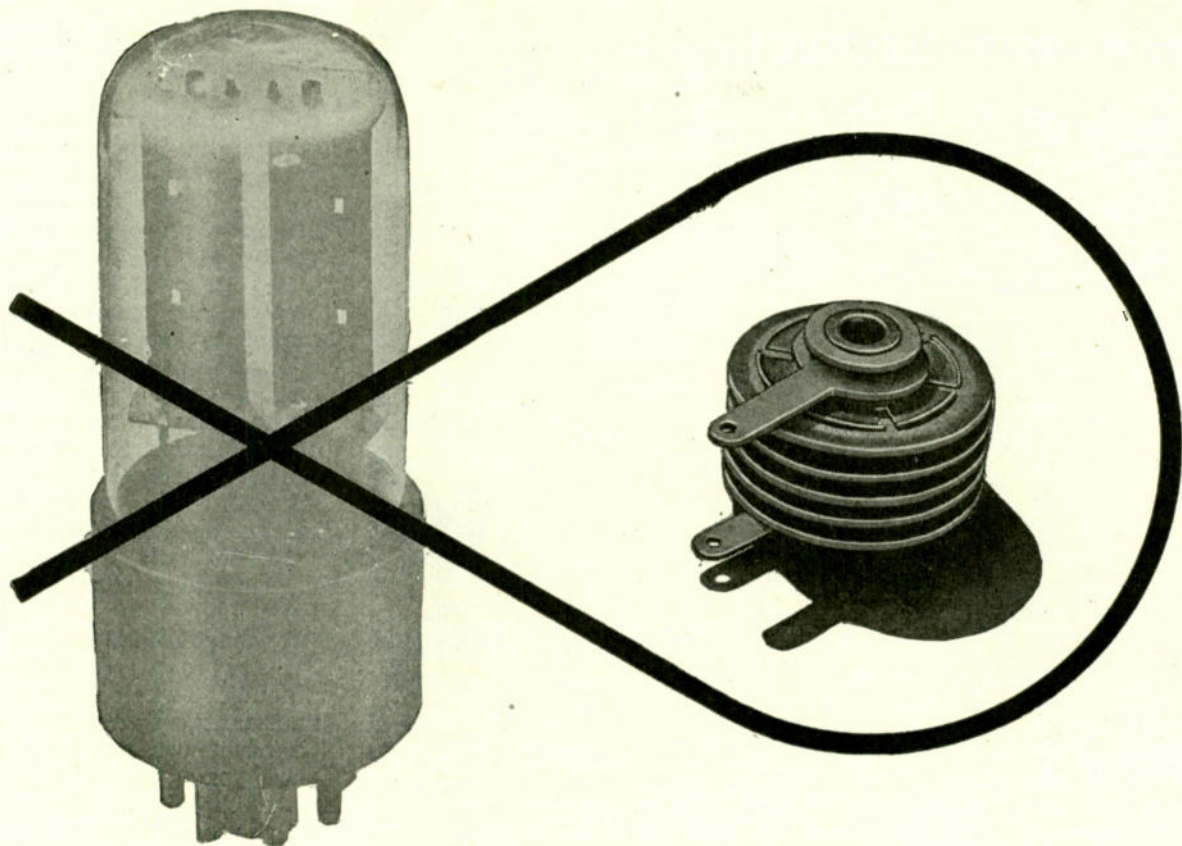

# SIMPLER — SMALLER — STRONGER NEW G-E SELENIUM RECTIFIER REPLACES TUBE IN PORTABLE RADIOS

This new selenium rectifier, *less than one inch long* and only one inch in diameter, offers builders of portable and car radios a new way to cut manufacturing costs and to build a better product.

You gain six ways when you incorporate it in your designs:

**Saves Space** — Can be mounted in places where a rectifier tube and socket won't fit. Radio cabinets can be made smaller when this new selenium rectifier is used.

**Cuts Installation Cost** — No socket or filament circuit is necessary. Only two soldering operations and a minimum of mounting hardware are required.

**Ample Current Capacity** — Designed to withstand safely the inverse peak voltages obtained when rectifying (half-wave) 110-125 volts, rms, and feeding into a capacitor as required in various radio circuits. Half-wave rectification of the a-c line is employed.

**Withstands Rough Usage** — Withstands rougher handling than the fragile tubes which it replaces. It won't break when dropped.

**Gives Instant Starting** — Eliminates usual warm-up period before radio starts. It runs cool, too, because of the absence of the heat-producing filament in the tube which it supplants.

**Longer Life** — Continuous tests have proved that this new selenium rectifier will outlast several 117-volt rectifier tubes — last the life of the product for which it is designed.

For information that will help you make efficient use of G-E selenium rectifiers in your designs, write for booklet *Two Steps Ahead*. Section A-23-11124, Appliance and Merchandise Department, General Electric Company, Bridgeport 2, Connecticut.

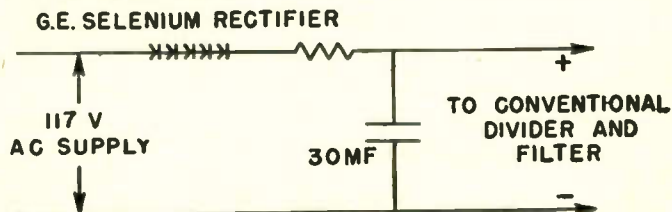

# GENERAL ELECTRIC

**The WEBSTER ELECTRIC Line  
of Cartridges Offers  
an Opportunity  
to Select—**

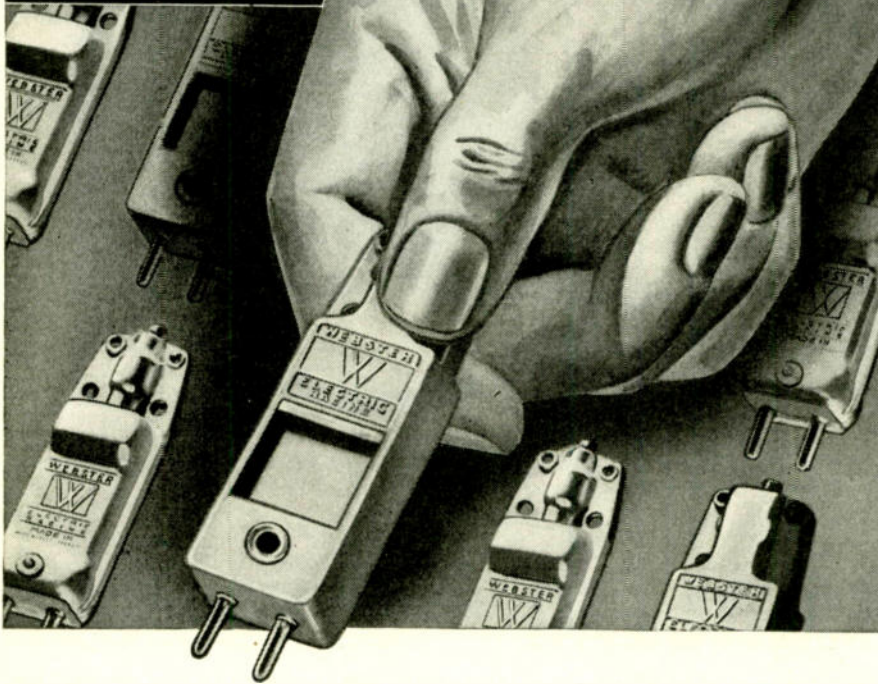

## The Correct Cartridge for

- WEIGHT
- RESPONSE CHARACTERISTICS
- VOLTAGE OUTPUT
- DIMENSIONS AND MOUNTINGS
- TYPE OF TERMINALS
- TYPE OF GROUND
- TRACKING PRESSURES

● WEBSTER ELECTRIC Company has not overlooked the requirements of the trade for a good high quality, long life cartridge. Experienced engineers have designed cartridges to include all necessary and important factors. Webster Electric cartridges have been widely used over a period

of years and proved their value for dependability so that you can select them with confidence for original equipment.

If you are not acquainted with the complete line, it will pay to write to Webster Electric Company, Racine, Wisconsin, for full information.

*(Licensed under patents of the Brush Development Company)*

**WEBSTER ELECTRIC**  
RACINE WISCONSIN



Established 1909

Export Dept. 13 E. 40th Street, New York (16), N. Y. Cable Address "ARLAB" New York City

**"Where Quality is a Responsibility and Fair Dealing an Obligation"**

electrodynamic types, under carefully controlled conditions and with the best obtainable sound system.

The resistance of the coating can be varied over wide limits, but experience has indicated that the best value is from 75,000 to 100,000 ohms per side. Since the output of the pickup is proportional to the applied voltage, it is desirable to have this voltage as high as possible; however, the maximum voltage is limited to about 100 volts by the allowable wattage dissipation in the pickup.

The output voltage is not sufficient to drive to full output the usual two-stage audio amplifier found in radio receivers, but a one-stage compensating preamplifier, as shown in Fig. 3, is adequate. Tests have indicated that the output voltage compares favorably with other light-weight, high-fidelity pickups. The need for a preamplifier may be a handicap where price is the most important consideration; however, the results obtained with the resistance pickup cannot be duplicated with heavy, stiff pickups having high voltage output.

There are many possible variations of the simple beam structure. By varying the shape of the beam, the frequency response characteristics may be made to meet almost any requirements. Experimental pickups have been made that have a velocity response instead of an amplitude response, and by proper design it is possible to make a self-compensating pickup. For quality work, however, the simple structure shown in Fig. 2 has proven to be the most satisfactory.

The extremely light weight and low stiffness of resistance pickups permit the use of very light tone arms, and low needle pressures of 2 to 3 grams, but for average use 20 to 30 grams pressure is preferable. Even at these pressures, record wear is negligible, there being no appreciable record deterioration in several hundred plays. One advantage of the light weight and low stiffness is the low level of needle talk. Resistance pickups may be used without any covering, or soundproofing, without annoying needle talk.

### **Stromberg in Erie**

Stromberg-Carlson is preparing to enlarge its manufacturing facilities through the establishment of a plant in Erie, Pa. The new factory will be used for the manufacture of table model radios and other products.

# Fahnestock Clips

## RADIO'S GREATEST CONVENIENCE

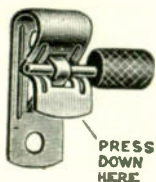

### FAHNESTOCK SPRING BINDING POST GRIPS THE WIRE BY THE ACTION OF A SPRING

No tools required to make the connection. Grips the wire with just the right pressure for good electrical contact. Simply press down, insert the wire and let go. Does not injure wire, hence connection can be made or opened as often as desired. Available in large variety of types and sizes to fit any radio purpose and any requirement as to position, space or method of attachment. You will find them in the better sets.

Positive contact; cannot jar loose. Brass or bronze — nonrusting.

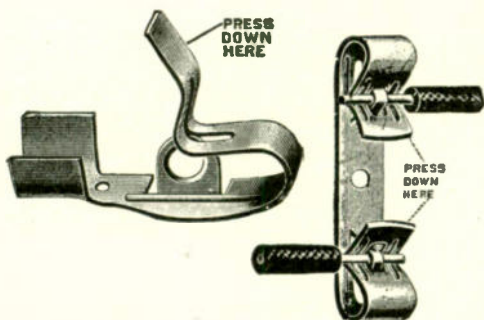

### FAHNESTOCK ELECTRIC COMPANY, Inc.

46-44 ELEVENTH STREET, LONG ISLAND CITY 1, N. Y.

Please send us at once, Descriptive Literature, Prices and Delivery Schedule on

### FAHNESTOCK CLIPS

For .....  
 Name .....  
 Address .....  
 City ..... State .....

## For Sale

# A COMPLETE RESISTOR PLANT

## MACHINERY AND MATERIALS

- All of the equipment necessary to manufacture wire wound power resistors.
- 2-year lease of 10,000 sq. ft. at a nominal rental.
- Good living and labor conditions.

### 20 WINDING MACHINES

1 DREVER CONTINUOUS ELECTRIC FURNACE—FOR V.E.

1 HEAVY-DUTY BOX TYPE FURNACE—FOR V.E.

3 FURNACES FOR DRYING CEMENT

LARGE STOCK OF TUBES, WIRE, HARDWARE, CEMENT, Etc.

Wire, phone or write

GROVES CORP.

CAPE GIRARDEAU, MISSOURI

# LOGARITHMIC AC VOLTMETER — WIDE BAND AMPLIFIER —

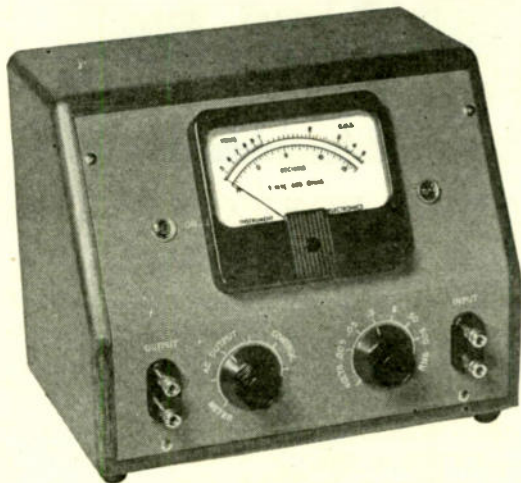

ADVANCED  
DESIGN  
GIVES YOU  
A SENSITIVITY  
AND FREQUENCY  
RESPONSE  
NEVER BEFORE  
OBTAINED

No other Voltmeter offers all these advantages:

- Range .0005 to 500 volts
- Frequency 5 CPS to 2.0 MC
- Logarithmic voltage scale
- Linear DB scale
- Input 2 Megohm 15 MMF
- Accuracy  $\pm 2\%$
- Stability  $\pm 1\%$  105 to 125 V.

Ideal for Audio, Supersonics, Lower Radio Frequency Spectrum. Measures Stage Gain, RF and IF Amplifiers on Broadcast Receivers.

Write for Complete Information

## INSTRUMENT ELECTRONICS

253-21 NORTHERN BLVD.

LITTLE NECK, L. I., N. Y.

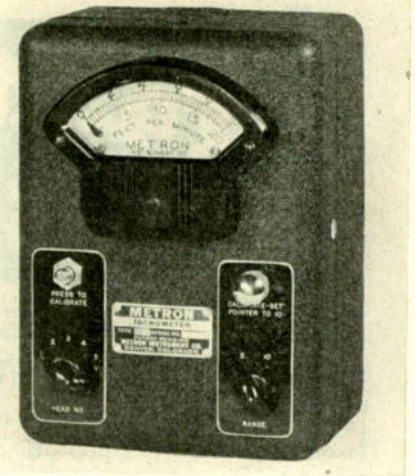

### Switchboard Tachometer

Particularly useful for measuring extrusion speeds in metal processing mills, these tachometers measure speeds as low as one revolution per minute or  $\frac{1}{4}$  foot per minute. They consist of a tachometer head and an indicator or recorder which may be mounted any distance from the head. The head is a simple contact-making mechanism, which is connected in series with a reactance and the indicator to a voltage source so that the current flowing through the indicator is directly proportional to the speed. Operating power is obtained from 110 volts 60 cycles, and the calibration is unaffected by changes in the line voltage. Accuracy of 1% of full scale is maintained even under adverse working conditions. Metron Instrument Co., 434 Lincoln St., Denver, Col.—Electronic Industries

## TOROIDAL COIL FILTERS

... are the answer  
to any network problem

- SHARP CUT-OFF
- LOW INSERTION LOSS
- HUM PROOF
- COMPACT
- HIGH STABILITY

Toroidal Coils

Inductance—1 MHY to 3 HYS  
Frequency—300 cy. to 30,000 cy.  
"Q"—55 at 1000 cy.; 150 at 3000 cy.

Ask to be put on mailing list for complete catalogue of coils and filters.

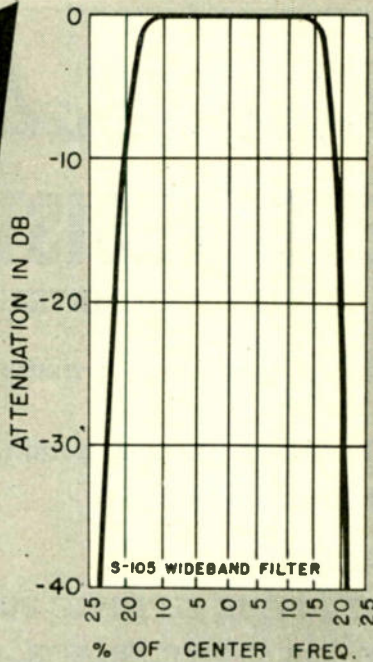

Actual measurements taken on  
Toroidal Coil Filter manufactured  
by Burnell & Co.

## Burnell & Co.

Designers and Manufacturers  
of Electronic Products

10-12 VAN CORTLANDT AVE. EAST, BRONX 58, N. Y., SEdwick 3-1593

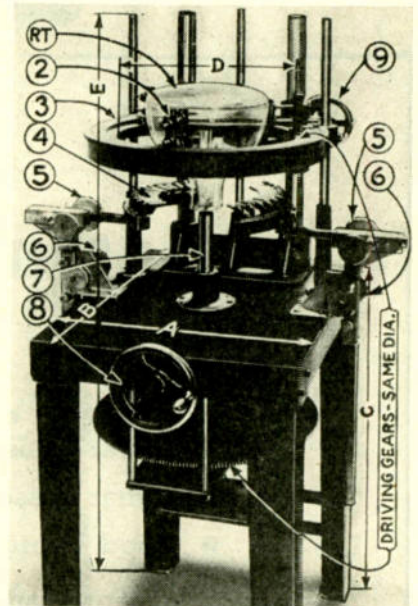

### Sealing Machine

Capable of sealing bulbs up to any height, this sealing machine can handle bulbs up to 24 in. in diameter, and the height adjustment is from 2 in. to 24 in. Machine is arranged to rotate at the rate of 75 to 120 rpm, but it can be varied to suit the job. It can also be adapted for butt sealing tubes of various wall thicknesses, 2 in. to 14 in. in diameter. The bulb holder has a horizontal adjustment, and is mounted on a rotating ring gear that is easily replaced to suit shape of bulb. Crossfires provide heat from several gases such as gas and air; gas, air and oxygen; oxygen and hydrogen, etc. Eisler Engineering Co., 740-770 S. 13th St., Newark, N. J.—Electronic Industries.

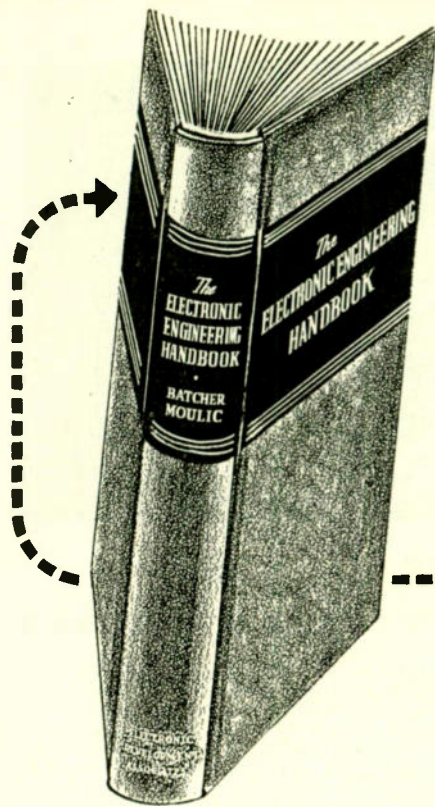

*Now Available*

## ELECTRONIC ENGINEERING HANDBOOK

**N**EW, original, authoritative, comprehensive—The *Electronic Engineering Handbook* is a working tool for every engineer interested in electronic developments and applications in the industrial or communication fields. Edited by Ralph R. Batcher, E. E., and William Moulic, the Handbook is written by some of the foremost men in their fields: men who have originated many of the techniques and applications they describe. Yet any engineer with a basic knowledge of electrical principles and simple circuits can understand and follow it with ease. You are invited to examine this outstanding Handbook in your own home or office.

**"The Most Complete Book on Electronic Tubes and their applications, I have ever seen."**

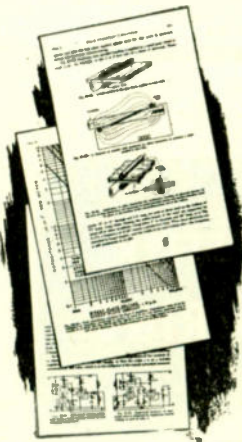

"An outstanding job . . . deserves to be classed with the best texts on the subject. The industrial and communications applications are unusually well balanced." "I was amazed at the amount of useful material contained in this volume. The pioneering sections on high frequency heating and industrial sound applications are extremely well prepared." These are just a few typical comments from engineers who have found, in its pages, authoritative answers to current questions about electronic applications. Beginning with fundamentals, the Handbook proceeds, logically, to detailed discussions. Every important circuit, each essential application that requires picturization is *illustrated*. There are more than 200 charts, diagrams, special drawings and photographs. Bound in limp blue leatherette, the Handbook opens flat for convenience in use. The partial contents give you some idea of its scope. Nothing short of the book itself, can prove its day-to-day worth to you. Read it. Study it. See for yourself why outstanding engineers call The **ELECTRONIC ENGINEERING HANDBOOK** "amazing", "priceless". If, after 5 days, you feel that the Handbook is not worth much more than its modest price of \$4.50, you may return it, without further obligation. But don't delay inspecting your copy. The present limited edition will go fast. Make sure of your copy by filling in and returning the coupon below *at once*.

**456 pages. More than 200 illustrations. Covers every important circuit and essential application.**

**CALDWELL-CLEMENTS, INC.**

**480 LEXINGTON AVENUE, NEW YORK 17, N. Y.**

### READ THESE PARTIAL CONTENTS

#### VACUUM TUBE FUNDAMENTALS:

Electronic Principles. Principles of Diodes. Principles of Multi-Element Tubes. Principles of Photo-electric Tubes. Cathode Ray Tubes. Special Purpose Tubes. Materials in Tube Construction. Vacuum Tubes as Circuit Elements.

#### ELECTRONIC CIRCUIT FUNDAMENTALS:

Principles of Rectification. Principles of Amplification. Low Frequency Amplifiers. High Frequency Amplifiers. Principles of Oscillators. Principles of Modulation. Principles of Detection. Cathode Ray Oscillographs. Relaxation Oscillators. Photo-electric Circuits. Electron Tube Circuit Application.

#### ELECTRONIC APPLICATIONS:

High Frequency Heating. Industrial Sound Systems.

#### VACUUM TUBE DATA:

Electronic Tube Data and Tables.

## MAIL THIS NO RISK COUPON TODAY

**Caldwell-Clements, Inc., 480 Lexington Avenue, New York 17, N. Y.**

Send me The **ELECTRONIC ENGINEERING HANDBOOK** for inspection. If I am not completely satisfied, I will return it to you within 5 days. Otherwise, I will remit \$4.50 in full payment.

( ) Payment enclosed. (Same money back guarantee.)

Name & Position .....

Company .....

Address .....

City ..... State ..... Zone .....

EL446

# FOR SALE

## PLANCOR 2189

### PUNXSUTAWNEY, PENNA.

This plancor was erected in 1944 for producing cylindrical carbon electrodes (up to size  $\frac{1}{2}$ " ) used in the construction of dry cell batteries.

It is reasonable to believe that this plant represents the most modern of its type, and could be a low unit cost producer of electrodes with near capacity production. The output would vary between 45 and 60 million electrodes a month, depending upon their size.

With certain additions and changes in this facility, it is quite possible that other carbon products could be produced—such as brushes for motors, contacts for electrical switch gear, electronic tube anodes, carbon discs, molds for casting, etc.

This plancor consists of land, building, machinery and equipment briefly described as follows:

**LAND:** Approximately  $10\frac{1}{2}$  acres.

**BUILDINGS:** *Finishing Building*—122' x 233'. One story. Structural steel framing. Sidewalls of concrete block and continuous steel sash. Precast gypsum roof slabs, built-up roofing. Area 28,600 sq. ft.

*Furnace Building*—12' x 233'. One story, with two supported floors at one end. Structural steel framing. Corrugated siding with continuous sidewall sash. Corrugated asbestos roof. Freight elevator to supported floors. Total area 34,060 sq. ft.

*Boiler House*—40' x 40'. One story. Cinder block walls. Gypsum plank roof.

**MACHINERY and EQUIPMENT:** Production equipment, machine tools, laboratory and testing equipment, furniture and fixtures. These include carbon furnaces, grinders and accessories, extrusion presses, mixers, rotary dryers, cutting tables, etc.—drill presses, lathe, shaper, milling machine, etc.—micrometers, testing sieves, platinum crucible, etc.—lockers, office furniture, calculator, etc.

The furnace building has two, 3-ton girder cranes and there are four hoists—of 1, 2 and  $3\frac{1}{2}$  ton capacities.

Complete utilities, including natural gas, are supplied by local companies. There are sidings from the B & O R. R. on the site. And the community provides an excellent labor market.

**CREDIT TERMS** for the purchase of this property may be arranged. And if you can qualify as a small business concern you may obtain *high priority* for its purchase through the Reconstruction Finance Corporation.

Information contained herein is not intended for use as a basis for negotiation. The War Assets Administration reserves the right to reject any or all proposals.



For detailed information about this offering of Government-owned surplus property, address:

## WAR ASSETS ADMINISTRATION

Office of Real Property Disposal  
1740 East 12th Street  
Cleveland, Ohio

742

# BARCOL

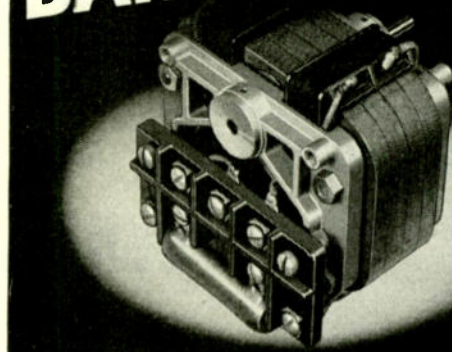

## NEW HEAVY-DUTY SMALL REVERSING MOTORS

- These shaded-pole type reversing motors are designed with a high starting torque for heavy duty service. The full load rating of the model shown is 1900 r.p.m., 0.15 lb. in. torque, 0.0045 h.p., drawing 55 watts at 115 volts, 60-cycle a.c. Starting torque is 0.22 lb. in. Reversal is accomplished by externally switching the shading coil circuit.
- These motors are ruggedly built with die-cast end plates, ball bearings,  $\frac{3}{16}$ " shaft, and precision construction throughout. Other sizes with larger output ratings are available. Send for data sheet.

**BARBER - COLMAN COMPANY**  
• ROCKFORD • ILLINOIS

## "TIP" FOR BETTER SOLDERING

Select the NEW G-E CALROD SOLDERING IRONS with the "non-freezing," easy-to-replace, calorized-copper tips. They simplify maintenance in your shop. General Electric Company, Schenectady 5, New York.



WRITE FOR BULLETIN  
GEA-4519.

**GENERAL ELECTRIC**

675-134

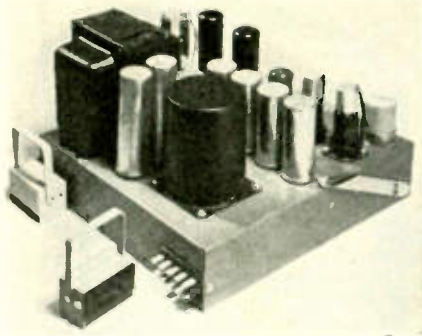

### Plug-In Amplifiers

A line of plug-in broadcast amplifiers equipped with standard type plugs permitting easy removal and exchange of complete units has been designed in combination with RCA-Type BR-2A shelf for mounting in a standard rack. A lever near the front of the amplifier permits ejection of the unit, automatically detaching it from the circuit connections. Special guide pins are provided for easy connection.—Radio Corp. of America, RCA Victor Div., Camden, N. J.—Electronic Industries

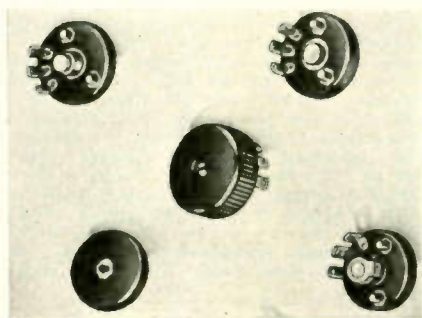

### Miniature Volume Attenuator

Model 1 Miniature Radiohm volume attenuator for hearing aids, pocket radio receivers, etc., will be available in ratings from 500 ohms to 5 megohms in six tapers. The units have three optional mounting locations and are provided with a dust shield and twin resistor contact. The shaft can be extended on the terminal side.—Centralab Div. of Globe Union, Inc., 900 E. Keefe Ave., Milwaukee 1, Wis.—Electronic Industries

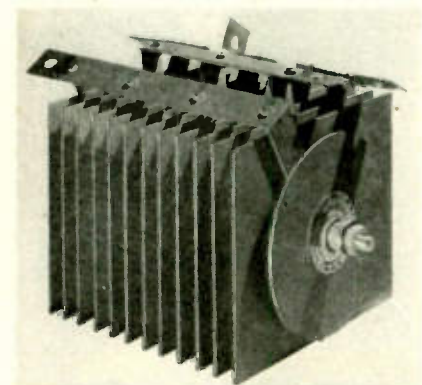

### Selenium Rectifier Plates

Developed for high current capacity, and adaptable for electro-plating and battery charging, these selenium rectifier plates measure 5 in. by 5 3/4 in. Built on aluminum, they are lightweight, and have maximum heat dissipating value. Radio Receptor Co., Inc., 251 West 19th St., New York 11, N. Y.—Electronic Industries

# A Good Name to Specify



**WHEN ORDERING RECORD CHANGERS AND SPEAKERS**



For every purpose—new installation or replacement—Crescent Speakers and Record Changers consistently deliver the finest performance. Designed and engineered to most exact standards. They are easy to install and because of their construction and adaptability they faithfully reproduce AM-FM and records with the utmost fidelity and true tone.

**CRESCENT SPEAKERS FEATURE:**  
Integral construction, not just an assembly of units. Standard sizes 4"—5"—6".

**CRESCENT RECORD CHANGERS FEATURE:**  
Quick pick-up, smooth, quiet operation and controlled speed. Plays 12—10" or 10—12" records

**UNCHALLENGED FOR QUALITY  
UNEQUALLED FOR PRICE**

**CRESCENT INDUSTRIES, INC.**  
4132-54 W. BELMONT AVENUE CHICAGO 41, ILLINOIS

## WANTED

Prominent Aircraft Company, Eastern United States, needs men with following qualifications:

Experienced engineers with Bachelor's, Master's, Doctor's degrees in Electrical Engineering, Physics, Mathematics. At least two years experience in design and development of radar and television systems, automatic computers, servomechanisms, target seekers, etc., required. Positions open for preliminary and detail design, research, and development of guided missiles under Army and Navy contracts.

Starting salary commensurate with experience. Address Box 1161

**ELECTRONIC INDUSTRIES**

480 Lexington Avenue

New York 17, N. Y.

Designed for



Application

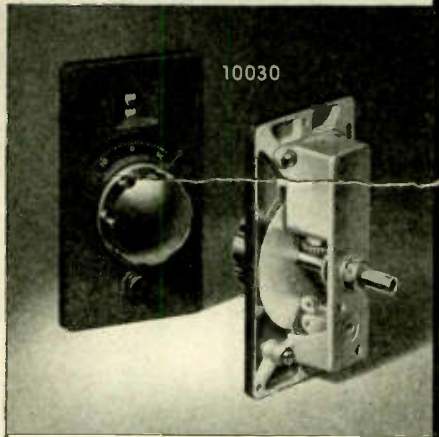

**The No. 10030  
INSTRUMENT DIAL**

An extremely sturdy instrument type indicator. Control shaft has 1 to 1 ratio. Veeber type counter is direct reading in 99 revolutions and vernier scale permits readings to 1 part in 100 of a single revolution. Has built-in dial lock and 1/4" drive shaft coupling. May be used with multi-revolution transmitter controls, etc. or through gear reduction mechanism for control of fractional revolution capacitors, etc. in receivers or laboratory instruments.

**JAMES MILLEN  
MFG. CO., INC.**

MAIN OFFICE AND FACTORY  
**MALDEN  
MASSACHUSETTS**

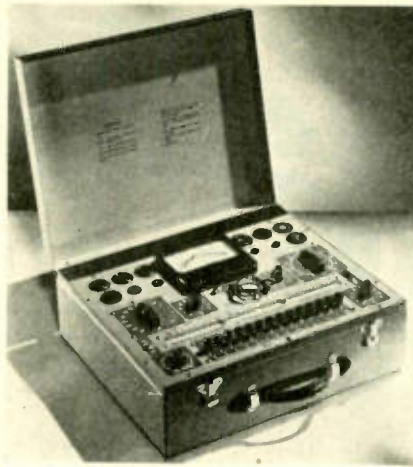

**Tube Testers**

Two tube testers, counter type 139 and portable type 140 provide dynamic tube checks with approx. 80% of the accuracy of commercial tube production equipment. Extra sockets and switch contacts for future tube types are included. Provisions are made for noise and short testing. The instruments are supplied for 105-125 volts, 50-60 cycle ac and are rated at 20 watts.—Radio Tube Div., Sylvania Electric Products Inc., 500 Fifth Ave., New York 18.—Electronic Industries

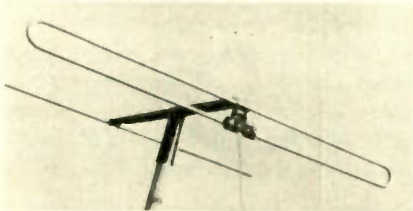

**FM Antenna**

The type 620 FM antenna kit contains all components necessary for the erection of a high efficiency folded dipole antenna operating in the 100 mc band. Standing wave ratio is less than 3 over the entire band. A reflector is included for unidirectional reception in areas of low signal strength.—Technical Appliance Corp., 4106 DeLong St., Flushing, N. Y.—Electronic Industries

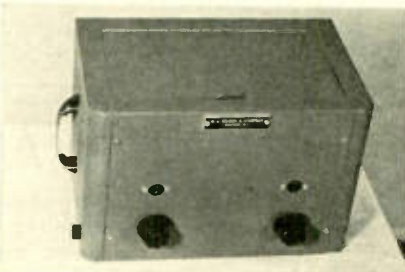

**Strain Gage Amplifier**

An amplifier particularly suitable for vibration studies provides an amplification of 25,000 from 1 to 30 cycles and is designed to couple directly to the plates of cr. oscilloscope. The amplifier has 6 tubes and includes a regulated power supply. In connection with a strain gage and oscilloscope, vibration amplitudes of .00001 in. are visually indicated. The unit operates on 115 V, 60 cycles, ac and consumes about 150 VA.—G. C. Wilson & Co., 2 N. Passaic Ave., Chatham, N. Y.—Electronic Industries



**Vacuum Tube Voltmeter**

The Freed No. 1040 vacuum tube type voltmeter is a midsize instrument covering .001 to 100 volts in five ranges with an accuracy of 2% on full scale. The instrument has an input impedance of 500,000 ohms and is suitable for a frequency range from 10 to 200,000 cycles. Changes with variation in supply voltage from 100 to 125 volts are 1% in effect. A logarithmic voltage scale and linear db scale, calibrated from 0 to 20 db, are provided. The unit operates on 100-125 volts, 50-60 cycles.—Freed Transformer Co., Inc., 72 Spring St., New York.—Electronic Industries

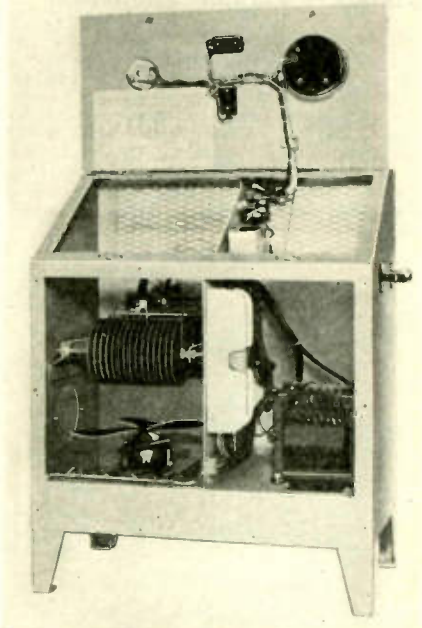

**Selenium Battery Charger**

A selenium charger designed to charge batteries of motorized hand trucks is for completely automatic service, the length of charge being regulated by the setting of a time clock. The chargers are available for operation on 110-115 V., 60 cycles; 220-230 v., 60 cycles; and for 110-115 V., 25 cycles, single phase, ac. Automatic Transportation Co., 149 W. 87 St., Chicago 20, Ill.—Electronic Industries





### Fathometer

A compact fathometer for fishing and pleasure craft based on the echo-sounding principle consists of a control unit, projectors and vibrapack power supply unit. The control unit contains a signal generator, echo amplifier, indicator and driving mechanism. Accurate depth measurements within a range of 400 ft. can be made at the rate of 360 soundings per minute.—Marine Div. of Raytheon Mfg. Co., Submarine Signal Co., Boston, Mass.—Electronic Industries

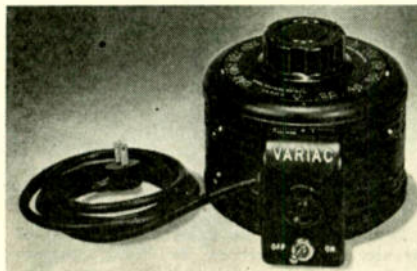

### Adjustable Autotransformer

The new type V-10 Variacs fill in the gap between the 5-ampere and 20-ampere adjustable autotransformers. The 115 volt models are rated at 10 amps. with a 15 ampere maximum, the output voltage being continuously variable from zero to 17% above line voltage. They are available in 6 models for 115 volt and 230 volt service.—General Radio Co., 275 Massachusetts Ave., Cambridge 39, Mass.—Electronic Industries

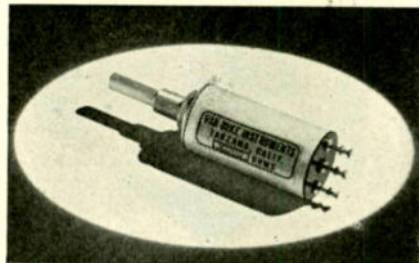

### Helical Potentiometer

A linear, wire wound resistor of the helical type designed for flight test and instrumentation work where weight and size are of importance has a resistance element consisting of a special alloy core over which a single layer of resistance wire is wound, bonded within an aluminum alloy housing. Five and ten turn units are available in resistance values up to 6000 ohms per turn and a power rating of 1.5 watts.—Van Dyke Instruments, P. O. Box 696, Tarzana, Cal.—Electronic Industries

## MANY FEATURES IN ONE INSTRUMENT

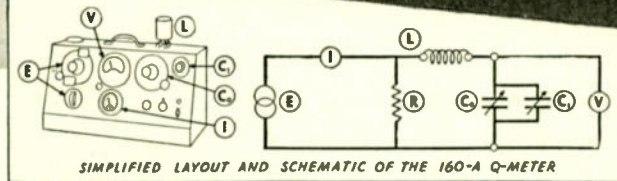
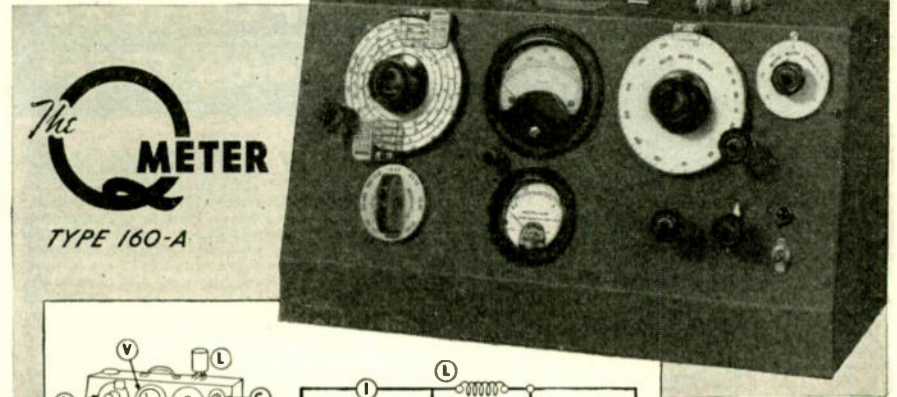

**THE BASIC METHOD OF MEASUREMENT EMPLOYED IN THE 160-A Q-METER**  
An R.F. oscillator (E) supplies a heavy current (I) to a low resistance load (R), which is accurately known. The calibrated voltage across the load resistance (R) is coupled to a series circuit consisting of the inductance under test (L) and a calibrated variable air capacitor (C<sub>0</sub>) having a vernier section (C<sub>1</sub>). When this series circuit is tuned to resonance by means of capacitor (C<sub>0</sub>+C<sub>1</sub>), the "Q" of (L) is indicated directly by the V.T. Voltmeter (V). Variations of this method are used to measure inductance, capacitance and resistance.  
**Oscillator Frequency Range:** 50 kc. to 75 mc. in 8 ranges. **Oscillator Frequency Accuracy:** ± 1%, 50 kc.—50 mc. **Q-Measurement Range:** Directly calibrated in Q, 20-250. **Multipplier extends Q range to 625.** **Capacitance Range:** Main section (C<sub>0</sub>) 30-450 mmf. Vernier section (C<sub>1</sub>) +3 mmf, zero, -3 mmf.

DESIGNERS AND MANUFACTURERS OF  
THE Q-METER  
QX CHECKER  
FREQUENCY MODULATED  
SIGNAL GENERATOR  
BEAT FREQUENCY GENERATOR  
AND OTHER  
DIRECT READING TEST INSTRUMENTS

## BOONTON RADIO

BOONTON · N · J · U · S · A ·

Corporation



FOR RADIO AND ELECTRONICS  
PARTS • SETS • EQUIPMENT

ask NEWARK they'll have it!

anywhere, you'll save time by phoning or wiring Newark Electric. Tremendous, up-to-the-minute stocks are maintained in all three stores.

IF YOUR NEEDS in radio or electronics parts, sets or equipment are available

COMPETENT TECHNICAL MEN handle your inquiries intelligently and promptly and can quote prices and delivery dates on specific merchandise. Orders shipped same day. When writing address Dept. P2.

★ Literature and full information on ANY manufacturer's products will be sent promptly on request. Wire or phone for quick action.

★ Our big bargain counters are loaded with new parts and unusual special equipment. Inquiring minds enjoy these displays.



N. Y. C. Stores: 115 W. 45th St. & 212 Fulton St.  
Offices & Warehouse: 242 W. 55th St., New York 19



NEWARK ELECTRIC COMPANY, INC. Dept. P2.

Please send informative literature on the following:

NAME: \_\_\_\_\_

ADDRESS: \_\_\_\_\_

CITY: \_\_\_\_\_

STATE: \_\_\_\_\_

P. A. Depts. in all stores. Set & Appl. Depts. in N. Y. C.

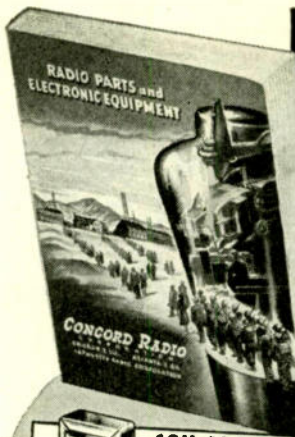

# RADIO PARTS SETS • AMPLIFIERS Concord Catalog FREE!

Revised! Up-to-the minute! Listing the newest, the latest and best in RADIO PARTS, RADIO SETS, AMPLIFIERS, AMATEUR GEAR, ELECTRONIC EQUIPMENT, SUPPLIES and ACCESSORIES! Hundreds of items for every Radio and Electronic need—Condensers, Resistors, Transformers, Tubes, Test Equipment, Tools and Repair, Replacement and Maintenance Parts of every kind. ••• All standard top quality, nationally famous makes, are fully represented in the great new Concord Catalog. Complete lines including new and hard-to-get parts and equipment at latest O.P.A. prices or lower. Thousands of items—and complete stocks ready for immediate shipment from CHICAGO or ATLANTA. Your copy of the new Concord Catalog is ready now—FREE! Mail the Coupon below.

**10H 40 MA. CHOKE**  
Extremely compact highly efficient choke well suited for auto radio receivers and AC/DC radios. Also excellent filter chokes for other receivers and amplifiers. 1 5/16" x 1 1/4" x 1 1/2" ins. Unshielded strap type mounting. **C1601 46¢**

**Midget Electrolytic**  
Midget dry electrolytic will handle any job requiring an electrolytic capacitor. Polarity clearly indicated. Bare wire leads. Easily replaces larger capacitors. Cap. Mfd 20-20. DC-WV 150. 1/4" x 2 inches **C3183 60¢**

**ROTARY SWITCH**  
Single gang, 6 pole, 3 position, shorting switch, 1 5/16" dia. with 1/4" shaft dia. Threaded bushing 1/2" long, 3/8" shaft. **SB3984 39¢**

**SEE . . . the first peacetime Concord line of modern Radio Sets and Radio Phonograph combinations—featuring a host of new, approved post-war developments . . . richer tone quality . . . super-selective tuning and reception . . . high fidelity . . . new modern design cabinets.**

**SEE . . . the thrilling new MULTIAMP Add-A-Unit Amplifiers, entirely new and revolutionary development in amplifier engineering. Sensational flexibility, power, fidelity, and economy, *exclusive with Concord!***

**CONCORD RADIO CORPORATION, Dept. J-116, 901 W. Jackson Blvd., Chicago 7, Illinois**  
Yes, rush FREE COPY of the comprehensive new Concord Radio Catalog.

NAME \_\_\_\_\_  
ADDRESS \_\_\_\_\_  
CITY \_\_\_\_\_ STATE \_\_\_\_\_

**CONCORD RADIO CORPORATION**  
LAFAYETTE RADIO CORPORATION  
**CHICAGO 7 ATLANTA 3**  
901 W. Jackson Blvd. 265 Peachtree Street

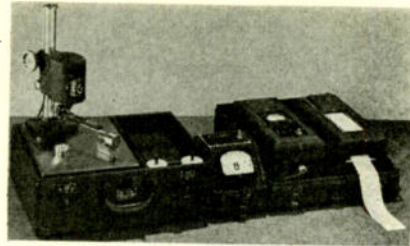

## Surface Analysis Equipment

Surface finishes from less than 1 to 5000 microinches roughness may be checked and recorded on a magnetic direct-inking oscillograph by means of the model BL-103 surface analyzer. The power-driven pickup is equipped with a diamond point and a meter is provided for constant visual checking of "RMS" surface roughness. The analyzer consists of a pickup arm, drive head, amplifier, magnetic oscillograph, surface plate, etc.—Brush Development Co., 3405 Perkins Ave., Cleveland 14, Ohio.—Electronic Industries

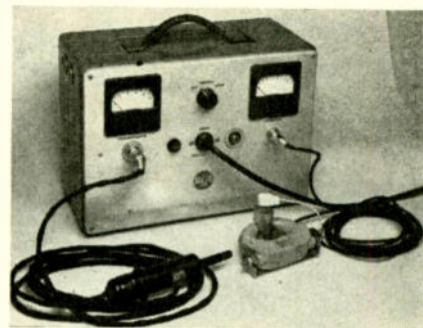

## Vacuum Gage

Type EMG vacuum gage, a component of the electron microscope, providing pressure measurements from 0.1 to 100 microns Hg., is now available separately. A thermocouple is used for higher pressure readings, while an ionization gage of the cold cathode type provides indication for very low pressures. The same meter control may be used with any number and combination of gages.—Radio Corp. of America, Victor Div., Camden, N. J.—Electronic Industries

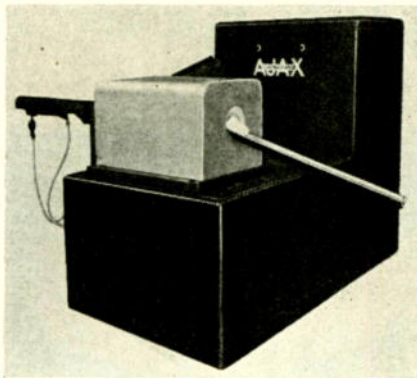

## Induction Heater

Designed for continuous automatic heating of steel slugs or forging blanks prior to forging operations, the Ajax-Northrup induction heater has a production rate of 350 slugs (3 3/4 in. dia.) per hour, each heated to about 2200° F. The unit is provided with an automatically timed pneumatic feeding device. The power source is a 200 kw motor-generator set, operating at 1000 cycles per second.—Ajax Electrothermic Corp., Ajax Park, Trenton 5, N. J.—Electronic Industries

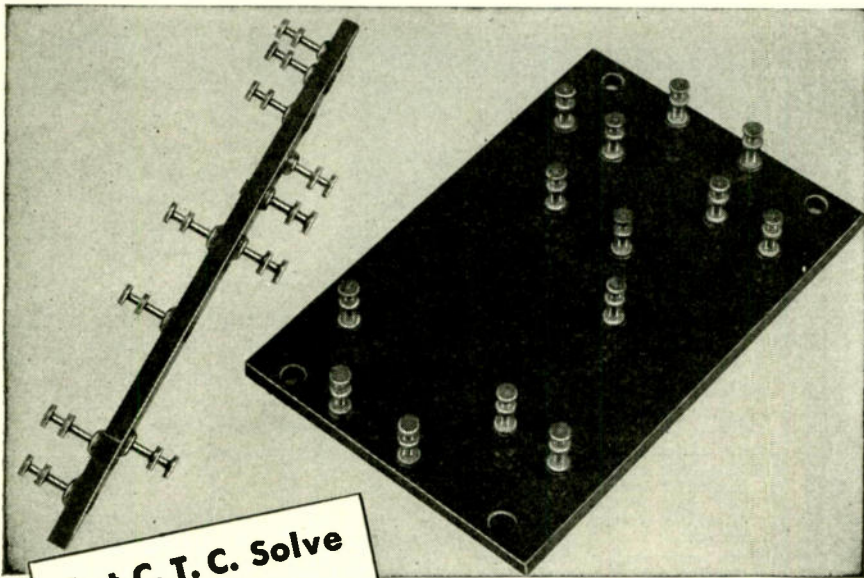

Let C. T. C. Solve Your **TERMINAL BOARD** Troubles

You'll save time and money if you order your Terminal Boards ready-made from C.T.C. Just send in complete specifications and in short order you'll receive perfectly cut and finished linen bakelite boards with quick soldering C.T.C. Lugs firmly anchored in exact position and ready to use.

Boards can be furnished with any type of C.T.C. Lug and in a variety of thicknesses.

Write for complete information or, better still, send us your specifications and let us show you just how inexpensively and quickly we can meet them.



**CAMBRIDGE THERMIONIC CORPORATION**

44 Concord Avenue • Cambridge 38, Mass.

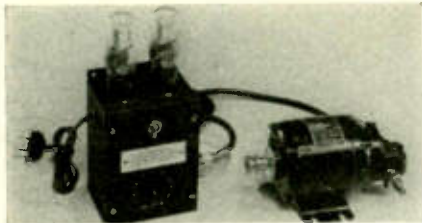

### Variable Speed Motor

To be operated on 110-120 volts, single phase, 60 cycle current, this variable speed motor and control incorporates a 1/50 hp shunt wound dc motor. Motor is operated on two half wave thyatron rectifiers with phase shift circuit. The geared head provides 18-1 reduction. Speed is varied by electronically changing voltage on armature and field. Gerald Heller Co., 625 S. Smallwood St., Baltimore 23, Md.—Electronic Industries

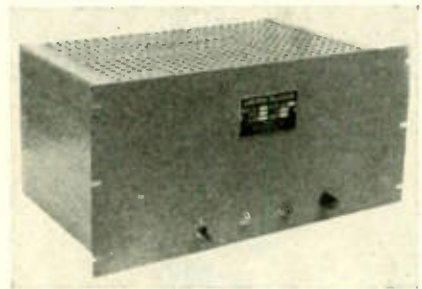

### DC Regulators

A series of dc voltage regulated power supply units designed to replace batteries and charging installations are available in 5, 10, and 15 ampere size at either 6 or 12 volts nominal output, adjustable plus or minus 10%. The units have a regulation of  $\pm 0.5\%$ , a ripple voltage of 1% rms max., and a load range of 50 to 100% of rated value. They are for operation on 100 to 125 volts, 60 cycles, ac. Sorensen & Co., Inc., 375 Fairfield Ave., Stamford, Conn.—Electronic Industries

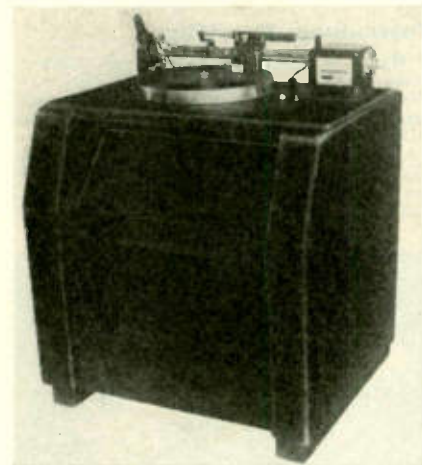

### Studio Recorder

The No. 523 studio recorder, designed for instantaneous or wax recordings, and for dubbing sound from disc to film, accommodates 18 in. flomed wax masters, acetate and thicker wax masters. The recorder is equipped with 33.3 rpm drive, No. 541 magnetic cutterhead, microscope and mount. The lead screw mechanism can be adjusted for any pitch from 80 to 160 lines, either in-out or out-in. Fairchild Camera and Instrument Corp., Jamaica, N. Y.—Electronic Industries

*Laboratory Standards*

# FM

## MODEL 78

### SIGNAL GENERATOR

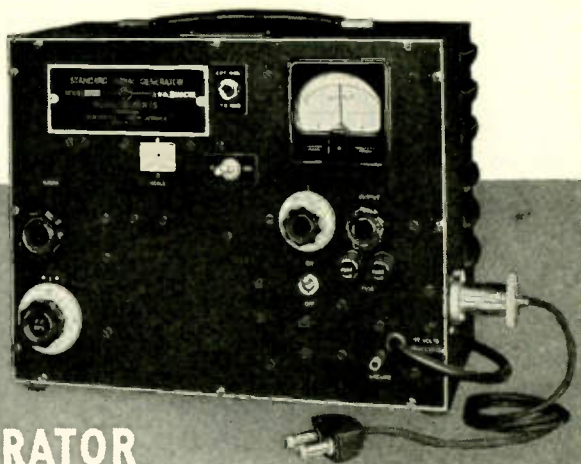

#### SPECIFICATIONS:

- CARRIER FREQUENCY RANGE:** 86 to 108 megacycles. Individually calibrated dial.
- OUTPUT SYSTEM:** 1 to 100,000 microvolts with negligible carrier leakage.
- OUTPUT IMPEDANCE:** Constant at 17 ohms.
- MODULATION:** 400 cycle internal audio oscillator. Deviation directly calibrated in two ranges: 0 to 30 kc. and 0 to 300 kc. Can be modulated from external audio source. Audio fidelity is flat within two db from d.c. to 15,000 cycles. Distortion is less than 1% at 75 kc. deviation.

PROMPT DELIVERY

**MANUFACTURERS OF**  
 Standard Signal Generators  
 Pulse Generators  
 FM Signal Generators  
 Square Wave Generators  
 Vacuum Tube Voltmeters  
 UHF Radio Noise & Field Strength Meters  
 Capacity Bridges  
 Megohm Meters  
 Phase Sequence Indicators  
 Television and FM Test Equipment

**MEASUREMENTS CORPORATION**  
 BOONTON NEW JERSEY

# ZOPHAR

## Waxes, Compounds and Emulsions



Materials for potting, dipping or impregnating all types of radio components or all kinds of electrical units. • Tropicalized fungus proofing waxes. • Waterproofing finishes for wire jackets. • Rubber finishes. • Inquiries and problems invited by our engineering and development laboratories.

Zophar Mills, Inc. has been known for its dependable service and uniformity of product since 1846.

# ZOPHAR MILLS, Inc.

ESTABLISHED 1846

117 26th STREET, BROOKLYN, 32 N. Y.

# Current Conversion WITH **ATR** QUALITY PRODUCTS



**ATR**  
"A"

## BATTERY ELIMINATORS

FOR CONVERTING A.C. TO D.C.  
New Models . . . designed for testing D.C. electrical apparatus on regular A.C. lines. Equipped with full-wave dry disc type rectifier, assuring noiseless, interference-free operation and extreme long life and reliability.

- Eliminates Storage Batteries and Battery Chargers.
- Operates the Equipment at Maximum Efficiency at All Times.
- Fully Automatic and Fool-Proof.

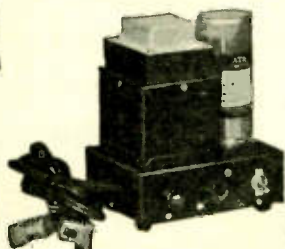

**ATR**

## LOW POWER INVERTERS

FOR INVERTING D.C. TO A.C.  
Another New ATR Model . . . designed for operating small A.C. motors, electric razors, and a host of other small A.C. devices from D.C. voltages sources.



**ATR**

## STANDARD AND HEAVY DUTY INVERTERS

FOR INVERTING D.C. TO A.C.  
Specially designed for operating A.C. radios, television sets, amplifiers, address systems, and radio test equipment from D.C. voltages in vehicles, ships, trains, planes, and in D.C. districts.

WRITE FOR NEW CATALOG—  
JUST OFF THE PRESS!

**AMERICAN TELEVISION & RADIO CO.**  
Quality Products Since 1931  
ST. PAUL 1, MINN. U.S.A.

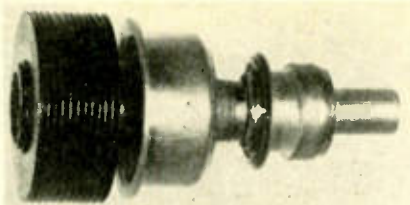

## Transmitting Triode

The Eimac 2C39 is a high-mu, forced-air cooled, external anode transmitting triode designed for service in the uhf range, or lower. Heater voltage is 6.3 volts at 1.1 amps., transconductance is 17,000 micromhos, amplification factor 100. As class C rf power amplifier a useful power output of 20 watts at 400 mc can be obtained.—Eitel-McCullough, Inc., San Bruno, Cal.—Electronic Industries

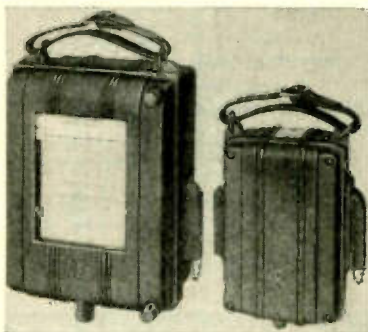

## Inkless Temperature Recorder

Instrument Div. of General Electric Co., Schenectady 5, N. Y., is offering an inkless temperature recorder designed for use with resistance temperature detectors. Type CF-2 consists of a portable recording instrument and external power supply. Resistance variations from 20 to 140°C are recorded on a 4 in. strip with a record length of from 8 days to two years possible on a single chart.—Electronic Industries

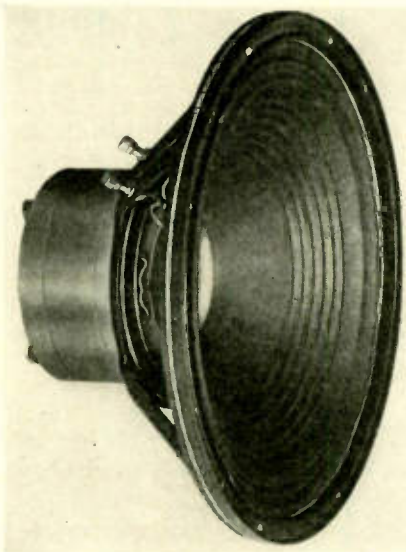

## High Fidelity Speaker

The model 600 Dia-Cone speaker is a permanent magnet reproducer using separate diaphragms for low and high frequencies. The high efficiency 12 in. unit is rated at 18 watts power output and has a voice coil impedance of 10 ohms. Weight of the speaker is 12 lbs.—Altec Lansing Corp., 250 W. 57th St., New York 19.—Electronic Industries

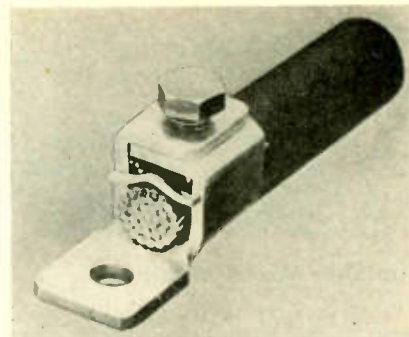

## Large Scrulug

Made to accommodate a range of wire and cable sizes from No. 4/0 wire to 500 mcm cable, this large solderless lug is the newest addition to the Scrulug series. It is quickly installed by tightening the clamping bolt which forces a pressure bar upon the cable. Designed to have the operating characteristics of the largest cable, it also accommodates a large range of wires and cables. Formed from pure copper, and brazed for mechanical strength. Burndy Engineering Co., Inc., 107 Bruckner Blvd., New York 54, N. Y.—Electronic Industries

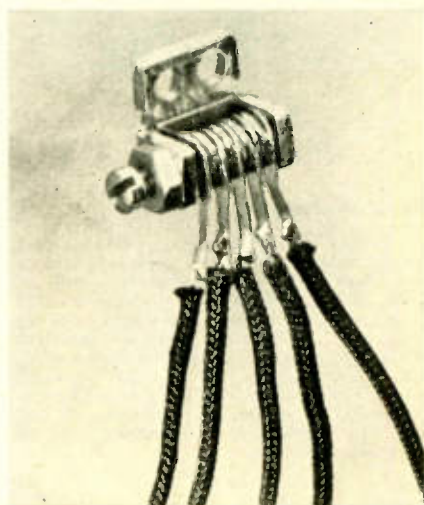

## Instrument Rectifier

Model CX2E4U is a universal replacement rectifier for instruments or for continuous operation in circuits at rated voltage and current rating. The 4-unit copper-oxide rectifier combination is rated from 6 to 12 volts ac and 3 to 5 ma dc, depending on its internal circuit connection.—Bradley Laboratories, Inc., New Haven 10, Conn.—Electronic Industries

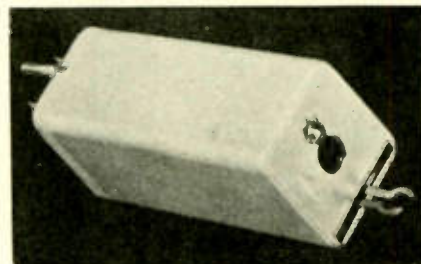

## IF Transformers

A set of IF transformers for use on AM and FM operate on 10.7 mc and can be used unchanged for the new fm band. Iron core tuning is used, the insulation being polystyrene. Tuning does not affect the bandwidth of 100 kc for the IFN model or 150 kc for the IFM model. The discriminator output is linear over 150 kc output.—National Co., Inc., Malden, Mass.—Electronic Industries

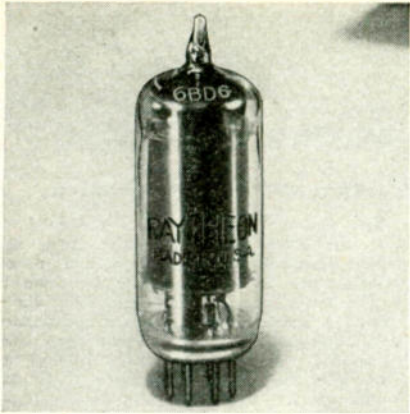

### Miniature Pentode

Type 6BD6 rf pentode is a miniature tube having the same high transconductance and remote cut-off characteristic as the standard octal type 6SK7. Where space saving is an important factor, the type 6BD6 offers a smaller diameter ( $\frac{3}{8}$  in.) than its octal counterpart, without sacrificing performance. A 12 volt version of the same tube, type 12BD6, is also available. Raytheon Mfg. Co., 60 E. 42nd St., New York 17, N. Y.—Electronic Industries

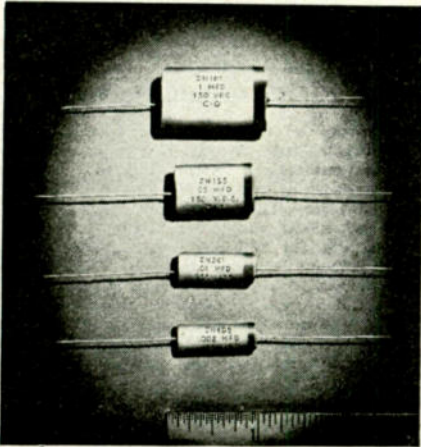

### Midget Capacitors

Type ZN capacitors are flat midget units designed for hearing aids, pocket radio receivers, etc. They are non-inductively wound with Kraft paper impregnated with halowax. Values range from .0001 mfd to 0.1 mfd with dc rated voltages varying from 150 volts to 600 volts.—Cornell-Dubilier Electric Corp., South Plainfield, N. J.—Electronic Industries

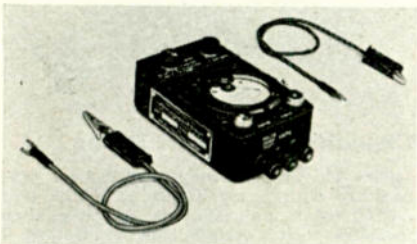

### Pocket Size Tester

An electrical tester for the aviation industry checks dc voltage from 0 to 30, current from 0 to 30 amps., resistance to 100 ohms, and continuity. A 3 volt internal battery and a 28 volt light for tracing of "live" circuits are provided.—Dept. BK, Airquipment Co., 2620 Ontario St., Burbank, Cal.—Electronic Industries

## Ingenious New Technical Methods

To Help You with Your Reconversion Problems

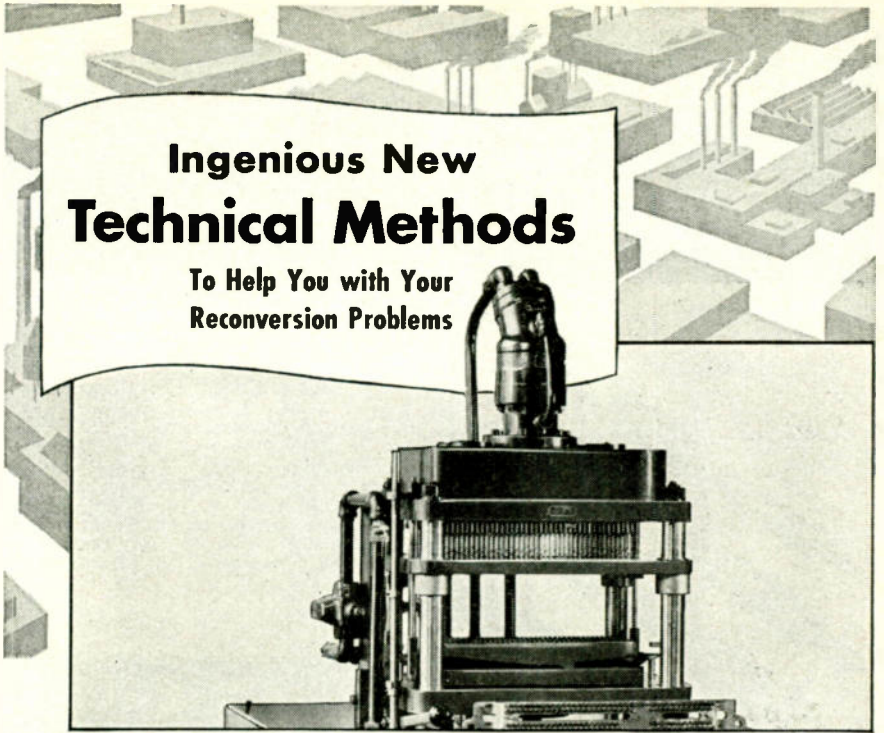

### 12,000 Holes per Hour! With New Gearless Multiple Spindle Drillhead!

The Zagar Gearless Drillhead can accommodate up to 400 drills in one head—drill up to 400 holes at one time! This revolutionary unit runs noiselessly and vibration-free on needle, tapered roller and precision ball bearings, and is lubricated by a patented automatic oiling system to insure trouble-free operation.

With this unit all holes are drilled at one pass, and valuable time is saved by the elimination of indexing and extra handling. It may be used on standard drill presses, or furnished as a complete hydraulic machine by the factory.

Another time saver, as well as a help on a tedious job, is chewing gum. The simple act of chewing seems to make the work go faster, easier—helping to relieve worker's fatigue—so that a better piece of work can be turned out with greater safety. Wrigley's Spearmint Gum may be used even when both hands are busy—right where the work is being produced.

You can get complete information from  
Zagar Tool, Inc.  
23881 Lakeland Blvd., Cleveland 17, Ohio

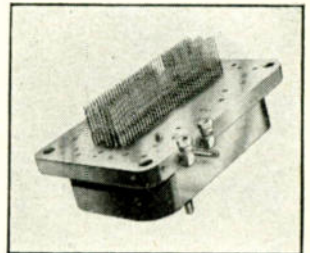

Zagar 220 Spindle Gearless Drillhead



AA-98

## SALES ENGINEERS WANTED

by large radio parts manufacturer

Will be trained for territorial office management-ships. Good appearance, pleasant personality and desire to learn overall sales and business management are essential, but none need apply who lack the prime requisite of practical broadcast receiver design engineering experience. In reply give historical background and salary requirement. Box 1063, Electronic Industries, 480 Lexington Ave., New York 17, N. Y.

# American Beauty

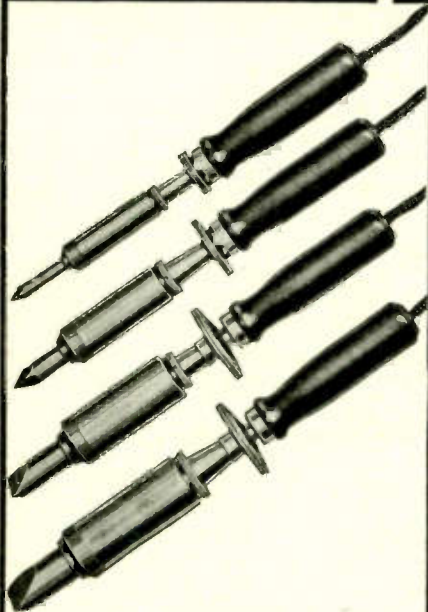

## ELECTRIC SOLDERING IRONS

are sturdily built for the hard usage of industrial service. Have plug type tips and are constructed on the unit system with each vital part, such as heating element, easily removable and replaceable. In 5 sizes, from 50 watts to 550 watts.

## TEMPERATURE REGULATING STAND

This is a thermostatically controlled device for the regulation of the temperature of an electric soldering iron. When placed on and connected to this stand, iron may be maintained at working temperature or through adjustment an bottom of stand at low or warm temperatures.



For descriptive literature write

111-1

**AMERICAN ELECTRICAL  
HEATER COMPANY**  
DETROIT 2, MICH., U. S. A.

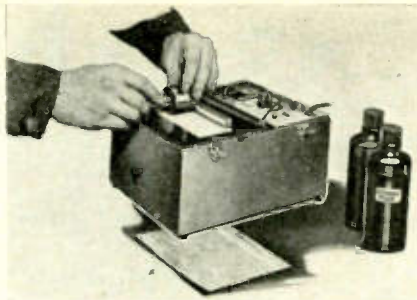

## Etching Device

The Ideal E-Z Mark etcher reproduces in 1 to 3 seconds on metal any mark or line appearing on a stencil film. It is adapted for production marking on round or flat surfaces, since several hundred reproductions may be made from one stencil. A rheostat controls the depth of marking. The device operates on 115 V., 50-60 cycle, ac, and is rated at 15 VA.—Ideal Industries, Inc., Sycamore, Ill.—Electronic Industries

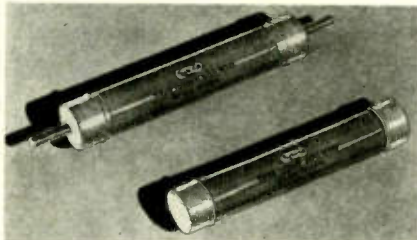

## Television Capacitors

A series of hermetically-sealed high voltage capacitors especially designed for use in rectified rf type power supplies for television receivers and other CR-tube applications are available in voltage ratings up to 30,000 KV wvdc and in capacitances up to 500 mmfd. They are housed in solder-sealed glass bushings and have mineral-oil impregnated, low power factor paper dielectric.—Solar Mfg. Corp., 285 Madison Ave., New York 17.—Electronic Industries

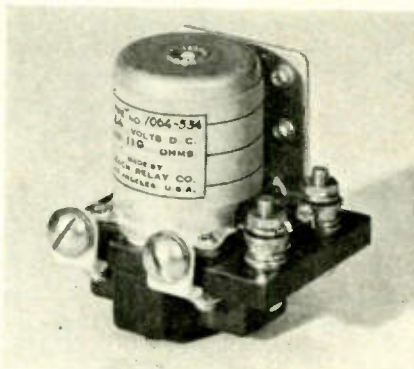

## Aircraft Relay

A lightweight dc, solenoid type relay designed for personal aircraft is capable of operating at altitudes up to 50,000 ft and at temperatures from  $-54^{\circ}\text{C}$  to  $+71^{\circ}\text{C}$ . The relay is protected against humidity, sand, dust, and salt spray and will withstand up to 10 G vibration and acceleration. SPST, double break normally open contacts are made of silver alloy and rated at 100 amps. at 12 v. dc or 75 amps. at 24 v. dc.—Leach Relay Co., 5915 Avalon Blvd., Los Angeles, Cal.—Electronic Industries

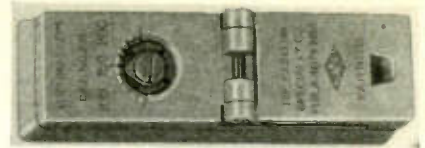

## Temperature Alarm Device

The Tesco Thermalarm is designed to give indication of high temperature and overload conditions of commercial power transformers by checking the temperature of the outer case. The device is a visual indicator of excessive temperature condition and facilitates detailed load surveys. It is adjustable over a range from  $100^{\circ}\text{F}$  to  $200^{\circ}\text{F}$ . The Eastern Specialty Co., 3617 North Eighth St., Philadelphia 40, Pa.—Electronic Industries

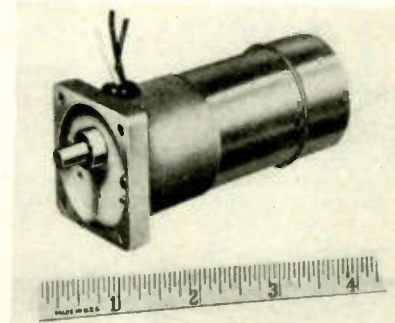

## Lightweight Rotary Actuator

Because of its extreme lightweight and small size, this midget rotary actuator is being used extensively in aircraft and other industries. Especially developed for post-war industry, the "G" motor is made in ac, dc and ac-dc types for a large range of voltages. Its small size, combined with a high output torque and rugged construction make it useful for valve operation for fuel and air systems, tuning motors for radios, remote controls, business machines, etc. Weighing 0.60 lb., it has been designed for loads ranging from 0.1 to 15 lb./in., and speeds from 2.5 to 375 rpm. Its motor is of the split series or single field type for intermittent duty, either reversible or continuous rotation. Lear, Inc., 110 Ionia Ave., N.W., Grand Rapids, Mich.

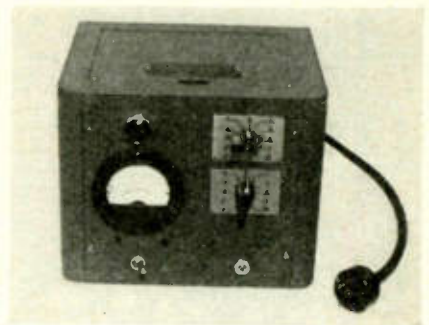

## Capacity Controlled Relay

The Thermocap Relay will control temperature with a sensitivity of better than  $.02^{\circ}\text{C}$  using an ordinary mercury thermometer with a single wire connection to the thermometer stem. A controlled load up to 2 kw may be plugged directly into the instrument which essentially consists of a resonant bridge, stabilized, electron coupled oscillator amplitude modulated by minute capacity changes under control. Control action may be obtained from manometers, flowmeters, rotameters or any instrument involving a change in level or position of a material. Niagara Electron Laboratories, Andover, New York.—Electronic Industries

## WIDE READING

(Continued from page 83)

ing modulation, and peak noise measurements may be carried out precisely with the instrument designed for broadcast station use.

The device incorporates a calibrated attenuator, a three stage resistance-capacitance coupled amplifier with adjustable negative feedback which feeds a rectifier connected to a dc meter. In operation the attenuator is adjusted until the meter pointer assumes a marked position; an accuracy of 0.25 db is assured. For greater accuracy, the rectifier is replaced by a non-linear Wheatstone bridge\* responsive to power rather than amplitude, its output is amplified, rectified and applied to a cathode-ray tuning indicator. The non-linear arm of the bridge is formed by a 6-volt metal filament lamp which reaches a resistance of 50 ohms at about 10mA for which value the bridge is balanced; the other bridge resistors being 50 ohms, 2000 ohms, and 2000 ohms, respectively. Balance of the bridge is obtained by adjustment of the attenuator for coarse regulation, and the negative feedback for fine regulation; 0.1 db may be read.

For peak volume readings, an additional diode rectifier following the three stage amplifier charges a capacitor in the grid circuit of a variable-mu pentode biased to operate on the logarithmic part of its characteristic. Its plate current is indicated by the dc meter. This arrangement, adjusted for high sensitivity, is also used for peak noise measurements.

\*For information on the performance of this type of bridge compare "Non-linear Bridge Circuits as Voltage Stabilizers", J. Inst. E. E., Part III, Jan. 1946, summarized in the Sept. Issue of Electronic Industries, p. 100.

## PATENTS

(Continued from page 84)

the cathode ray tube, as indicated by the full and empty circles in the inset drawing. Screen 22 retains the picture much longer than the duration of the signal. Signals  $S_3$  and  $S_4$ , associated with screen indication  $S'_3$  and  $S'_4$ , are caused by another gun positioned in a different direction from the apparatus.

To locate the gun emitting sounds  $S_1$  and  $S_2$ , microphones 11 and 12 are rotated around axle 17 until the two rows  $S_1$  and  $S_2$  coincide and merge into one row indicating that there is no phase difference in the received sound pulses, the direction in which the gun is placed is then at right angles to the line connecting the two microphones 11 and 12.

Signals from different guns would not exactly coincide so that one particular gun may be singled out for observation. From the results obtained from two direction finding apparatus, the distance of the gun may also be ascertained.

H. M. Lewis, Hazeltine Corp., (F) May 23, 1942, (I) April 2, 1946, No. 2,397,746.

## NEWS OF INDUSTRY

(Continued from page 88)

Co., with one fixed station and two portable mobile units. The other Link installation will be for the Lyndhurst, N. J., Cab Service which will have a fixed station and five portable mobile units.

Down in New Orleans, The Communications Co. of Coral Gables is to supply the Yellow Cab Co. with two fixed stations and a total of one hundred portable mobile units.

### Worner Enlarges

Worner Electronic Devices which heretofore has done business from Chicago has moved into a newly acquired and larger plant at Rankin, Illinois. The company manufactures industrial electronic equipment and intercommunication systems.

# MICRO-MIKER

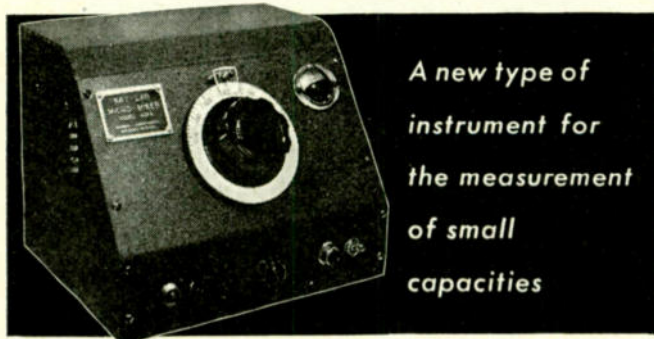

A new type of instrument for the measurement of small capacities

1. Measures capacities from 1 to 230 Micro-Micro-Farads by direct substitution.
2. This capacity is measured at the end of a shielded cable, thereby eliminating connection errors.
3. Wiring capacity in an amplifier may be measured without disconnecting the load resistor. Condensers as small as 1 MMF may be measured when shunted by a 1500 ohm resistor.

Write for Bulletin 4A

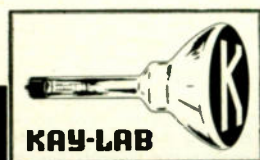

KAY-LAB

KALBFELL

LABORATORIES  
941 ROSECRANS STREET  
SAN DIEGO 6, CALIFORNIA

Manufacturers Representatives are invited to reply.

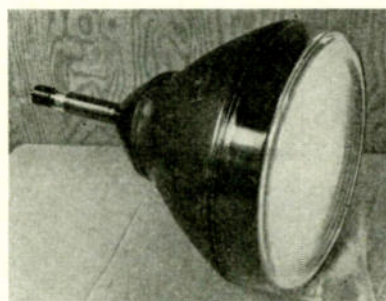

## NEW 15" TUBE for Television

High Vacuum, High Brilliance, Magnetic Focus & Deflection, Black & White Screen. Length 20 1/4". Face Plate approximately Flat. Operates anywhere from 8,000-15,000 Volts, best at 12,500 Volts. Write for full data. Also in production 12-inch magnetic tubes.

NO ION SPOTS — NO ION TRAP

ZETKA LABORATORIES, INC.

131 GETTY AVE., CLIFTON, NEW JERSEY

Affiliated with

UNITED STATES TELEVISION MFG. CORP.

# CUSTOM MADE COAXIAL CABLE and TUBING

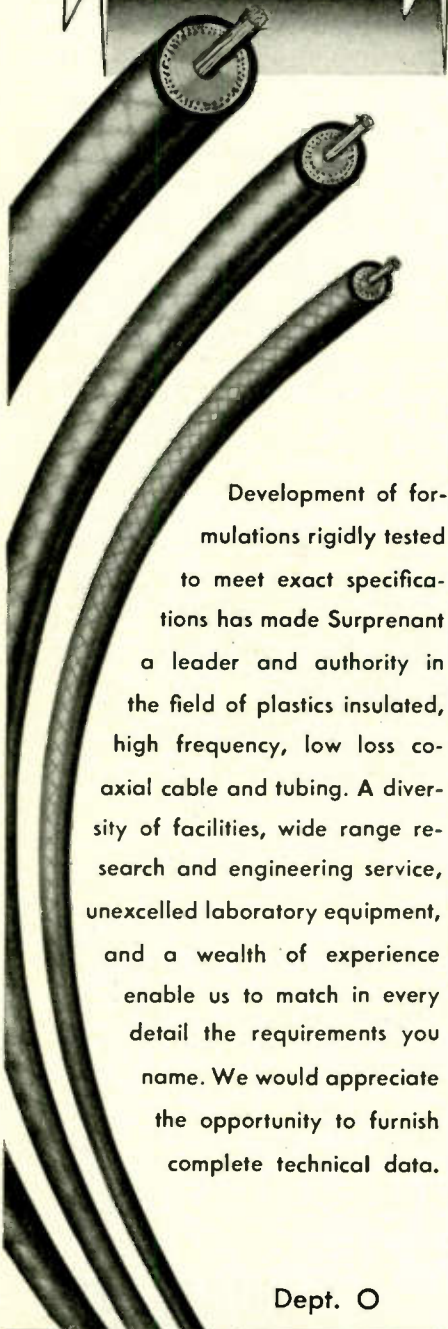

Development of formulations rigidly tested to meet exact specifications has made Surprenant a leader and authority in the field of plastics insulated, high frequency, low loss coaxial cable and tubing. A diversity of facilities, wide range research and engineering service, unexcelled laboratory equipment, and a wealth of experience enable us to match in every detail the requirements you name. We would appreciate the opportunity to furnish complete technical data.

Dept. O

**Surprenant**  
ELECTRICAL INSULATION CO.

199 Washington St. Boston 7, Mass.

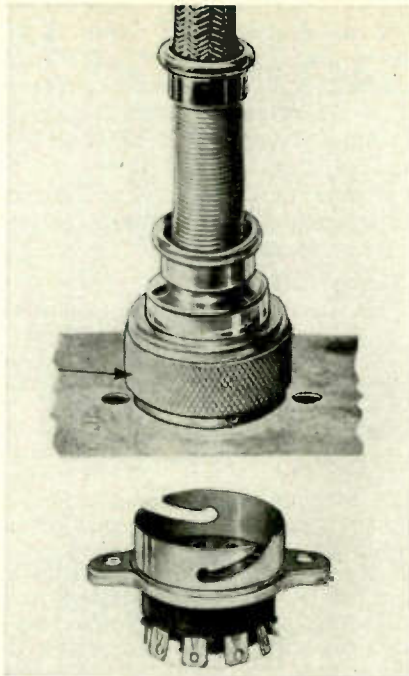

### Multi-wire Connectors

Designed for speedy operation, the two elements of these multi-wire connectors lock together by a knurled locking ring that engages slots in the opposite member. When the connector is locked, a rubber gasket exerts reverse pressure on the ring to make the assembly vibration proof, and to seal out moisture from the prongs. Shielding on the cable is brought inside the metal shell, and the wire soldered to the shield is brought back through a hole in the shell and soldered to provide strain relief. The cable is protected by a spring with a bell-mouthed ferrule. Comes in several combinations: female connector to male member mounted on the chassis, vice versa, or in connectors to attach to cables. Alden Products Co., 117 N. Main St., Brockton, Mass.—Electronic Industries

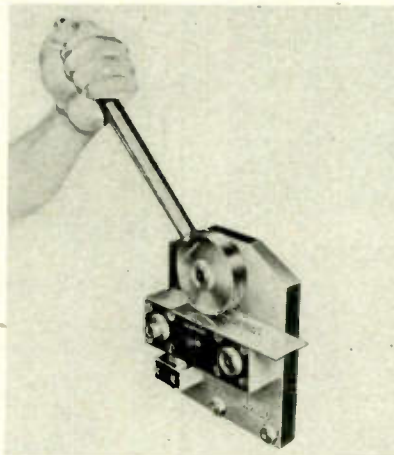

### Marking Machine

Useful for marking scales used on machines, for trade-marking, name and instruction marking, this hand operated bench type machine marks thirty or forty parts a minute. Machine is constructed from a heavy grey iron casting having a steel stud at the top to carry a sleeve bearing mounted roller marking die. Set up to mark flat parts, the machine will also mark round parts after a slight change in construction. Akromark Co., 7-15 Morrell St., Elizabeth, N. J.—Electronic Industries

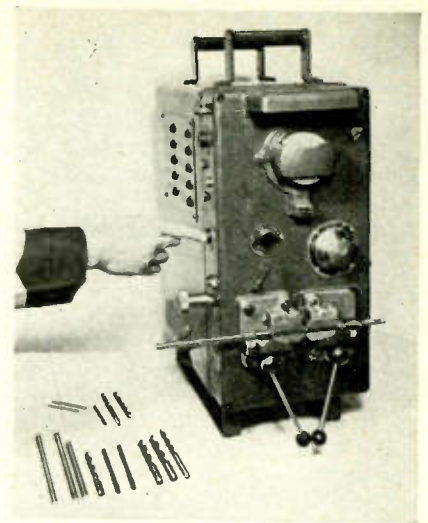

### Flash Butt Welder

Designed for production welding of bar and round stock up to 5/16 in. diameter, this flash butt welder is useful in repairing small tools, and joining band saw blades from 1/16 in. to 1 1/4 in. in width. It incorporates a built-in grinder for weld dressing, automatic motor controlled feed of material, and cam operated lever method of clamping. Welding is fully automatic; the complete cycle is controlled by a pushbutton switch. Designed for standard ac 220 volts single phase 50/60 cycle operation. DoAll Co., 1301 Washington Ave. South, Minneapolis, Minn.—Electronic Industries

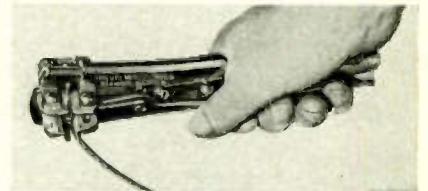

### Wire Stripper

Developed to meet the demand for a universal, flexible wire stripper in many types of electrical, construction and plant wiring work, this tool strips from No. 10 to No. 22 solid or stranded wires. It clamps the wire, cuts the insulation, and strips it in one operation. The lever or automatic feature prevents jamming of wires and strands. Pocket size; blades are renewable. Available in other sizes with a wire cutter blade on one side, but fewer stripping notches. Holub Industries, Inc., Sycamore, Ill.—Electronic Industries



### Interference Filter

The "Quietone" interference filter Type IF-54 is designed to eliminate noise energy created by fluorescent lamps and other machines and appliances. The capacitive inductive type filter provides high attenuation over a wide frequency range and is easy to install in a number of positions. The unit is hermetically sealed, wax filled, and rated at 2 amps., 120-220 volts, ac. Cornell-Dubilier Electric Corp., South Plainfield, N. J.—Electronic Industries



## MICROWAVE TEST EQUIPMENT

(Continued from page 54)

Dissipative attenuators produce their effect by introducing resistive elements in the waveguide or coaxial line so as to dissipate energy in the form of heat. In coaxial lines the loss may be introduced either in the form of series resistance or shunt conductance. Examples of the former are platinized glass rod and carbonized rod attenuators. Shunt conductance types consist of ordinary lossy cable or use poly-iron as a filler in the form of spacers between the inner and outer conductors. The spacers are tapered to match the load to the line.

### Attenuator types

A platinized glass attenuator is essentially a section of coaxial line in which the inner conductor is a length of glass tubing which has been coated with an extremely thin platinum film which is resistive and thereby produces attenuation. By controlling the thickness of the film during manufacture, various degrees of attenuation may be achieved.

Carbonized rod attenuators are similar except that the center conductor is a quartz rod which has a thin deposit of carbon.

Waveguide dissipative attenuators are either of the resistor-strip type, or of the sort in which the guide is filled completely or partially with a lossy material.

In the resistor strip type, a strip of bakelite or glass coated with resistive material is placed longitudinally in the guide, with the plane of the strip parallel to the short face, as shown schematically in Fig. 22.

When the guide is excited in the  $TE_1$  mode the electric field is parallel to the plane of the strip, currents flow in the resistive material, and energy is dissipated in the form of heat. The attenuation is a function of the surface resistivity of the strip. The lower the resistivity, the higher the attenuation (within limits) and the greater the mismatch.

Since the electric vector varies from a minimum to a maximum across the guide, the amount of attenuation with a given strip may be varied by moving the strip laterally across the guide. A variable attenuator for the 3 cm band using this scheme, is shown in Fig. 23.

*Compact Heater Holder by*  
**Crystalab**

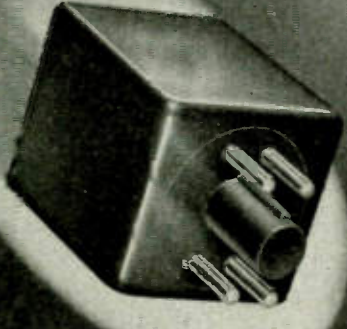

*Specialists in*  
*Special Crystals*

Especially suitable for applications for close frequency tolerance . . . VHF services — police, aircraft, railway communications, etc. . . . works on 6.3v at 1 amp. . . . temp control within  $\pm 3^\circ\text{C}$  . . . operates at  $60^\circ\text{C}$ . . . . frequency control of  $\pm .005\%$  . . . frequency range 3MC to 14MC . . . fits octal socket . . .

TYPICAL CRL — 30 FREQUENCY TEMPERATURE CURVE

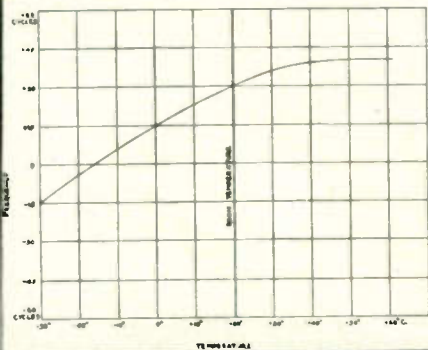

**CRYSTAL RESEARCH LABORATORIES INC.**  
29 FLYNN ST., HARTFORD, 3, CONN., PHONE 7-3215

*The* **FINEST MICROPHONES**  
*for P.A. and RECORDING!*



**AMPERITE VELOCITY MICROPHONE WITH PATENTED ACOUSTIC COMPENSATOR**



**New P. G. DYNAMIC WITH NEW SUPERIOR ELIPSOID PICK UP PATTERN!**



**AMPERITE KONTAK MIKES IDEAL FOR AMPLIFYING STRINGED INSTRUMENTS USED WITH ANY AMPLIFIER AND WITH RADIO SETS.**

ASK YOUR JOBBER . . . WRITE FOR FOLDER

**AMPERITE**

581 BROADWAY

NEW YORK



# MAGNETRONS! KLYSTRONS!



**MAGNETRONS!**  
Westinghouse type 2J32 (JAN) just released. This is the first large lot of MAGNETRONS to flow into the civilian market! The 2J32 is designed for 10 cm. operation. Brand New, packed in individual protective cartons. The 2J32 is listed at

\$200. OUR PRICE .....\$35.00



**KLYSTRON** oscillator tubes 2K25/723-ab, designed for 3 cm. operation. New. Packed individually. Listed at \$38.00

OUR PRICE .....\$7.75

## NEW CATHODE RAY TUBES!!

Made by North American Philips



Tube	Type	Approx. List	Your Cost
2AP1		6.75	3.75
3BP1		15.00	3.95
3FP7		27.00	3.35
5BP1		20.00	4.95
5BP4		27.00	5.95
5CP1		45.00	4.95
5CP7		48.00	6.00
5FP7		32.00	4.25
5JP2		48.00	13.50
5LP1		41.00	8.00

### HI POWER XMTR TUBES

837	2.80	1.50
872A	7.50	3.50
705A	22.50	7.50
241B-WE	85.00	50.00
861	155.00	95.00



Sangamo G-4 .004 mf 20kv (list \$110) .....\$25.50  
Sangamo G-3 .006 mf 10kv (list \$87.50) .....\$19.50



Dynamotor power supply PE-103  
Supplies 500 volts @ 160 mls from any 6 volt or 12 volt battery. ....\$12.95

**POWER SUPPLY** for LM-18 freq. meter.  
Output: 290v @ 20 ma; 13v @ 600 ma  
Input: 105-125v @ 60 cps; 260 ma; 27.6 W, with type 84 rectifier tube; shock mounted. Complete with input and output plugs \$14.75

**111-VOLT** plate transformer, made by American  
115v-60 cycle input. Secondary is 8200v-ct-700  
m.a. ....\$39.95  
6 HY. 700 M. A. CHOKE .....\$7.95

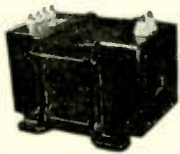

All merchandise guaranteed. Mail orders promptly filled. All prices F.O.B. New York City. Send Money Order or Check. Shipping charges sent C.O.D.

SEND FOR FLYER

**COMMUNICATIONS  
EQUIPMENT CO.**  
131B Liberty St., New York 7, N. Y.  
Telephone WH 4-7658

The resistivity strip is moved by the plunger which is moved by the eccentric cam when the shaft is rotated.

Another type of variable attenuator, using a resistor strip, is the "flap" type, shown in Fig. 24 which projects through a slit in the upper face of the guide. This type usually has a small range, generally from about zero to 10 db.

Resistor strip attenuators are matched in either by mechanically tapering the strip or by cutting notches in the ends of the strip. The notched sections act as matching transformers. By making the taper long enough, it is possible to get very low standing wave ratios.

### Standing wave ratio

In the steady state line condition where a line of characteristic impedance  $Z_0$  is connected between a load impedance  $Z$  and a generator of impedance  $Z_r$ , we can postulate two waves traveling on the line in opposite directions, one away from the generator toward the load (the incident wave) and one reflected from the load (reflected wave) traveling toward the generator. The voltage and current in the line at any point are simply the vector sum of the incident and reflected waves at that point.

If A represents the value of the incident current or voltage wave and B the respective reflected wave, we can find a point on the line where the vector sum is a maximum. Likewise, we can find a point where the vector sum is a minimum.

By measuring the standing wave ratio, which is the ratio of the maximum and minimum vector summations, and noting the position of the first minimum or maximum with respect to the load, it is possible to measure the impedance of the load.

Usually the reflected wave B represents a power loss and in order to minimize this loss it is desirable to keep the standing wave ratio small. Furthermore, most transmitter tubes used in the microwave region are very sensitive to load changes. Such changes cause the tube to change frequency and often output.

To measure the standing wave ratio a slotted section of transmission line is generally inserted between the signal generator and the load. In the slotted section a pickup probe is moved along the line in the electric field. Mounted in the probe is a detector which

supplies a dc, or audio frequency potential to an indicator.

The response of the detector-indicator combination is a measure of the field intensity at the probe. As the probe is moved along the line the meter gives an indication of the relative field strength of points in the section.

If the equipment under test is a transmission-type device, it will usually need to be terminated by a matched load.

A design of a 10 cm band coaxial slotted section for  $\frac{7}{8}$  in. line is shown in Fig. 25. The inner conductor of this unit is supported by a bead and by the inner conductor of the tuners which may be seen on the left-hand side of the slotted section. The other end, which is connected to the test piece, has no supports which might cause reflections.

Care must be taken during the construction of the equipment, and later when it is being used, to be sure that the inner conductor is well centered and that the probe projects into the slot the same distance over the entire length of travel. If these precautions are not taken, successive maxima and minima will have different values and an uncertainty will be introduced in computing standing wave ratios; that is, different ratios will be obtained by using different pairs of the maxima and minima.

Fig. 26 shows a waveguide slotted section used at 3 cm. The section is designed for use with a guide carrying the lowest modes. Fig. 27 illustrates a bench set-up for SWR measurements for 10 cm  $\frac{7}{8}$  in. coaxial line equipment. Fig. 28 illustrates a bench set-up for SWR measurements for 3 cm waveguide equipment.

## INSTRUMENT TRENDS

(Continued from page 55)

scientific instrument art is outside the scope of this short review, the continued exchange of instrumentation between laboratory and plant bears mention. What not long ago were strictly laboratory methods are now becoming production line procedures, largely because the skills of instrument designers have made scientific instruments rugged, simple, and reliable enough to withstand that service. Examples are the infra-red spectrometer for continuous analysis of gases and liquids, oxygen analyzers utilizing the magnetic properties of oxygen, etc.

Laboratories and pilot plants, on the other hand, are profiting from

greater investment in production instruments. Recorders and automatic controllers for numerous variables are in widespread laboratory service, frequently mounted on rolling stands for ready transfer from one job to another.

The requirements of pilot plants are being met by full plant-scale instrumentation, often with the aid of specially designed controlled valves to suit pilot plant flow rates. The pilot plant game has become so popular that it provides important and increasing business for manufacturers of its appurtenances.

Although the principles of radar do not yet promise to become important in industrial use, and although the needs for television to observe dangerous regions are as yet limited, these and other potential additions to instrument engineers' repertory may yet become useful realities.

### "TRON FAMILY"

(Continued from page 58)

type of electronic comparator. Sorts and counts according to size or a dimension. Manufactured by the Pollak Manufacturing Company, Arlington, N. J. Electrical Equipment, June, 1946, p. 13.

**Lumetron**—Trade name for a form of colorimeter manufactured by the Photovolt Corp. Elementary Engineering Electronics (Book) by A. W. Kramer, published by the Instruments Publishing Co., Pittsburgh, Pa., p. 276.

**Luxtron**—Trade name for a photoelectric cell (photo-voltaic type) made by Bradley Laboratories, Inc., New Haven, Conn. Electrical Equipment, April, 1946, p. 40, Item EE-308 (advertisement).

**Metron**—Metron Instrument Company, Denver, Colo. A manufacturer of tachometers and other measuring devices. Advertisement in Instruments, July, 1946, p. A16.

**Minitron**—A brand name used by RCA (probably about 1940) for their tubes in T-5½ bulbs.

**Motron**—Registered trademark for equipment manufactured by the W. C. Robinette Co., South Pasadena, Calif. It is a servo-mechanism. Instruments, Feb., 1946, p. 75.

**Musitron**—The Musitron Company, Chicago, Ill. Manufacturers of phonographs and sound equipment.

**Neutron**—Trade name for tubes made by Societe Anonyme des Lampes Neutron, Clichy (Seine),

A MUST IN EVERY LAB . . .

ON EVERY SERVICEMAN'S BENCH . . .

IN EVERY SERVICE KIT . . .

A pocket-size

# OSCILLOSCOPE

## The POCKETSCOPE

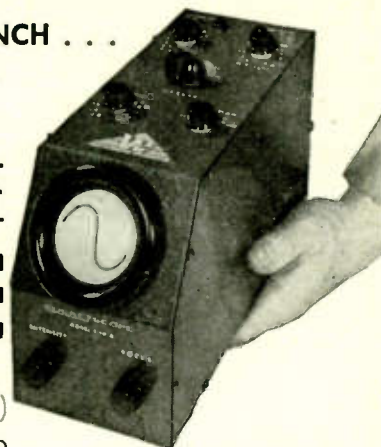

- So **SMALL** in size (4" x 6¾" x 10")
- So **LIGHT** in weight (5¾ lbs.)
- So **COMPLETE** in performance
- So **INEXPENSIVE** in price
- Plus **WIDE-ANGLE VISION**: on shelf, on floor, on bench
- Plus **RETRACTABLE LIGHT SHIELD**: for increased visibility.

A 2" "pocket-size" 'scope incorporating the cathode ray tube, vertical and horizontal amplifiers, linear time base oscillator, synchronization means and self-contained power supply.

FOR DELIVERY:

Contact your nearest jobber. If he doesn't have the POCKETSCOPE available, contact us direct.



**WATERMAN PRODUCTS CO.**

INCORPORATED

PHILADELPHIA 25, PENNSYLVANIA



for dimensional accuracy!

**METAL STAMPINGS**

**DKE**

Specialized DKE experience — over 20 years in the field — is now available for the production of stamped metal parts. All types of cups, sleeves, flanged shapes, intricate single pieces or fabricated components are included. High quality workmanship to exacting specifications — with any desired finish — is embodied in every job.

INQUIRIES INVITED

**THE ENGINEERING CO.**

DANIEL KONDAKJIAN  
271 WRIGHT ST., NEWARK, N. J.

*Plasticraft*  
**MACHINED PARTS**

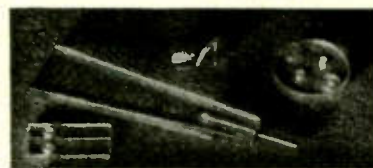

**LUCITE • VINYLITE • PLEXIGLASS  
POLYSTYRENE • ACETATE**

Complete facilities for machining, marking, finishing—plastic sheet, rod or tube—any size, shape or quantity.

Send us your prints for quotations.

**PLASTICRAFT  
PRODUCTS COMPANY**

BAKELITE & PLASTICS  
PARTS & SPECIALTIES

MANUFACTURED • FABRICATED  
PRINTED • HOT STAMPED • ENGRAVED

20 Hudson St., New York 13, N. Y.  
WOrth 2-1837

An entirely new vista in circuit conception and development now possible with Victoreen sub-miniature electrometer vacuum tubes.



*Actual Size*

Consider these factors for research . . . laboratory . . . production:

1. Low filament drain 10 milliamperes.
2. High input resistance 1016 ohms.
3. Versatility in instrumentation for chemical, oil, nuclear physics research, etc.
4. Ideal for electrometer applications.
5. Extreme portability—low battery drain.

Available As  
**DIODES**  
**TRIODES**  
**TETRODES**  
**PENTODES**



Actual size

Victoreen hi-megohm resistors are specially designed for the hard applications where stability with long life is required. Designed for laboratory use and fine instrumentation. Vacuum sealed in glass to cover a range of 100 to 10,000,000 megohms.

Write for technical data booklet on tubes and resistors.

**THE VICTOREEN INSTRUMENT CO.**

3800 PERKINS AVENUE  
 CLEVELAND 14, OHIO

France. Advertisement in *Le Vide*, May, 1946, p. VIII.

**Neutron**—A brand name for tubes made by a subsidiary of the Hygrade Lamp Co. prior to RCA licensing.

**Orgatron**—A musical instrument in which the vibrations of small wind-blown reeds are amplified from electrostatic pick-ups. A form of electronic organ marketed about 1935 by the Everett Piano Co. IRE Proceedings, Nov., 1936, p. 1458.

**Penetron**—Another name for a Mesotron. Electronics Dictionary, by Cooke and Marcus, 1945, p. 224.

**Phantastron**—A linear time delay circuit with control voltage. Developed for radar for blind bombing. Electronics, May, 1946, p. 142. In error, was spelled Phanastron in original reference.

**Phasitron**—A high-vacuum beam deflection tube used in producing frequency modulation from audio power in an FM transmitter. Electronic Industries, January, 1946, p. 78.

**Polytron**—One name suggested for a suspected particle made up of one or two electrons plus one or two positrons. Existence of particle suggested by Prof. J. A. Wheeler of Princeton. Science News Letter, November 24, 1945, p. 323.

**Resnatron**—A high-power UHF oscillator-amplifier tetrode.

**Selectron**—A trade name for a moulding compound made by the Pittsburgh Plate Glass Co. It is a polystyrene thermo setting material.

**Seletron**—Trade name for selenium rectifiers made by the Radio Receptor Co., Inc., New York, N. Y. Electronic Industries, February, 1946, p. 140.

**Servotron**—A trade name applied to an electronic variable speed motor drive made and sold by the Submarine Signal Co. Electrical Equipment, January, 1946, p. 1.

**Syntron**—A form of electric hammer for drilling concrete or stone. Diodes (tungars) rectify a 60-cycle supply and feed half waves through a solenoid winding. Elementary Engineering Electronics (Book) by A. W. Kramer, pub-

lished in 1945 by the Instruments Publishing Co., Pittsburgh, Pa., p. 53.

**Textron**—The name of a company and product in the textile field.

**Triotron**—A European trade name for tubes. Radio Tube Vademecum (Book) by P. H. Brans, published in 1945 by Algemeine En Technishe Boekhandel, Antwerp, Belgium.

**Victron**—A trade name for the electrical and mechanical products of the Victor Electric Products, Inc., Cincinnati, Ohio. Business Week, February 23, 1946, p. 44 (advertisement).

**Vectron**—Vectron Products Company, New York, N. Y. Manufacturers of industrial electronics equipment.

**Vibrotron**—A form of movable anode triode, the movement being transmitted through a thin metallic diaphragm. Electronic Industries, July, 1946, p. 77.

**Voltron\***—Trade name for an electrical insulating compound manufactured by the Industrial Synthetics Corporation, Irvington, N. J. Electronics Buyers' Guide, June 15, 1946, p. 123.

\*Trademark Reg. U. S. Patent Office.

## CONFERENCE PAPERS

(Continued from page 60)

for measuring displacement, strain, pressure and dimensional changes.

A plea was made for greater attention to the development of new and better primary elements that can more fully utilize our new electrical and electronic systems of detection and amplification. In this, as in most other fields of engineering development, there was considerable refinement in technics during the war years but apparently little improvement in basic methods.

### Standard terminology

An important discussion on the subject of automatic control terminology was touched off by a paper by J. G. Horn (Brown Instrument Co.), presenting illustrated explanations of the terms and definitions prepared by the Instruments and Regulators Div. committee on standard terminology of the ASME.

By the methods of illustration and analogy, all basic terms of industrial process control were explained. At a later session a number of control methods common to hydraulic and pneumatic systems were ingeniously demonstrat-

ed and their characteristics described in a paper by Atkins, Kowalski and Koenig (Eastman Kodak Co.). Common solutions to typical control problems were set up and demonstrated which indicated the advantage and faults of the usual controller actions. This demonstration, incidentally, gave proponents of electronic methods an opportunity to study the methods used in other systems.

#### Continuous process control

H. C. Frost, in his paper on "Some Consideration in the Control of Continuous Processes," presented a detailed, step-by-step exposition of a hypothetical chemical process in which the science of control instrumentation was applied so as to approximate the ideal "straight line" operation. The object was to produce completely automatic regulation and metering such that raw materials could be introduced into a continuous piping system at appropriate points, resulting in a continuous flow of finished product from the system.

An important point was made after the detailed discussion when Frost pointed out the necessity of skilled and intelligent maintenance supervision of such systems by an engineer having complete independence from operating personnel and company management and capable of carrying out a systematic program of preventive, rather than curative, maintenance. This is a point often stressed, but seldom applied as rigorously as such automatic systems demand.

#### Cohen to Make Industrial Controls

Taco West Corp. has been formed in Chicago and will manufacture and market automatic electronic control mechanisms and precision measurement devices for industrial furnaces, plastic moulding machines, and for combustion control, gas analysis, pyrometry, process control and allied fields. The company is headed by Theodore A. Cohen who will be its president and chief engineer. He was formerly vice-president and chief engineer of the Wheelco Instruments Co. Associated with him is Richard K. West who will be the company's secretary-treasurer. During the war he was affiliated with the Engineering Division of the Navy Bureau of Aeronautics. Prior to the war he was engineering representative for the Bakelite Corporation. Headquarters of the company are at 2620 South Park Avenue.

# ALLIED

for everything in **Electronics and Sound**

Equipment for Research  
Development • Maintenance

## 1946 Catalog FREE

**Largest Stocks • Complete Service  
From one Central Supply Service**

Leading industrial and engineering firms depend on the ALLIED Catalog as their Buying Guide for everything in radio, electronics and sound. Lists more than 10,000 quality items . . . radio and electronic parts, vacuum tubes, tools, test instruments, audio amplifiers, accessories . . . complete lines stocked by a single reliable source. Try ALLIED'S expert, specialized industrial service. Send for FREE Catalog now!

*Everything in Radio and Electronics*

**ALLIED RADIO CORP.**  
833 W. Jackson Blvd., Dept. 32-L-6 Chicago 7, Illinois

Send for  
*Your*  
**ALLIED  
CATALOG**



**SPECIAL VALUES**  
**ELECTRONIC & COMMUNICATION SUPPLIES**  
Immediate Delivery      Order Today

**PLATE TRANSFORMER**  
6200 Volt CT—700 Mils, 110 Volts 60 Cycles tapped. Primary 2KVA Amertran, Limited Quantity. \$39.95

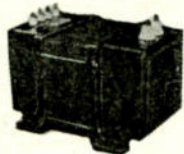

**A GOOD BUY**  
Full Wave selenium rectifier perfect for bias application—use your DC relays from an AC source—unit is very small and compact. Only requires 3" x 1/2" made by G. E.—.89 or 5 for \$4.00

**ADDITIONAL BARGAINS**  
Langevin Swinging Choke—9/60 henries 400/50 mils. DC resistance 72 Ohms....\$12.75  
G. E. Pyranol 2 mfd 4000 Volt filter No. 23F47 ..... 5.50  
G. E. Pyranol 4 mfd 2000 Volt filter 22F65 ..... 4.25  
C D Dycanol 2 mfd 2000 Volt..... 2.49  
Aerovox filter conds 6 mfd 1500 Volts 2.25  
1000 KC. Xtal precision AT cut mounted in standard holder ..... 4.95  
Adel Cable Clamps perfect for Coax RG8U, 11U, etc.....12 for 1.00

We carry a complete line of B & W Coils and Westline Xtals in stock. Send us your request or ask for catalog!

ALL PRICES F.O.B. OUR WAREHOUSE  
NEW YORK CITY, NEW YORK  
Export Cable Address  
MICROWAVE, N. Y.  
Write for our latest  
Bulletin 11E1



**NAGARA RADIO SUPPLY**  
160 Greenwich St., New York 6, N. Y.  
Bowling Green 9-7993

# GLASS INSTRUMENT BEARINGS

GLASS "V" BEARINGS  
made and set to your specification



We specialize in the manufacture and mounting of all types of sapphire jewel bearings.

We welcome your inquiries

**RICHARD H. BIRD & CO.**  
Incorporated  
Manufacturers of Jewel Bearings for thirty years

1 SPRUCE STREET  
WALTHAM, MASS.

## NEW INSTRUMENTS EXHIBITED

(Continued from page 61)

production is involved. This exhibit pointed out a possible future trend toward cooperation between various instrument manufacturers whose products are complementary rather than competitive. Sales and application engineering for all three companies was under the enthusiastic direction of John T. Fuhrman, Jr., 6736 McPherson Blvd., Pittsburgh, Pa.

### Balancing beam tube

A demonstration of illumination control (Askania Regulator Co., 1603 S. Michigan Ave., Chicago 16, Ill.) showed one of the many possible applications of a special cathode-ray tube in which signal output is governed by the type of deflection applied to an electron beam. Though developed several years ago, the applications of this device are still being explored.

### Metal sorter

An ingenious instrument for accurately comparing metal specimens against a standard sample was displayed and demonstrated (Control Equipment Co., 549 Brush-ton Ave., Pittsburgh, Pa.). Known as the "Metalsorter," this device uses the ancient but seldom applied tribo-electric effect. This phenomenon occurs when two materials are subjected to mutual friction by means of a variable-speed motor-driven specimen holder. If the two metals in contact are dis-

similar, a small electric charge is produced, on the order of 10 to 4,000 microvolts, and may be measured with a suitable high impedance micro-voltmeter. The result is an instrument that can separate metal pieces having a composition corresponding to the reference sample from a stockpile of dissimilar pieces, at a rate as high as 500 separations per hour. The device may be operated by unskilled personnel with as little as 15 minutes previous instruction.

### Process timing

A typical unit for controlling the time sequence and duration of various steps in an industrial process was shown by the Process Control Co. (2 East End Ave., New York 21, N. Y.). The unit demonstrated was developed for controlling the operation of a compression molding press, but should be adaptable to any process where a maximum of seven operations must be repeated in a definite sequence, with separate "on-off" timing of each step. The heart of the control unit is a special stepping switch having 18 cams, any one of which may be manually set to any of 24 positions. The closure of each switch triggers an electronic timing circuit which governs the "closed" period of the associated output circuit.

### Electrical computer

For rapid solution of any number of simultaneous linear equations up to twelve, this instrument

Process control electronic timer, showing 24 position stepping switch

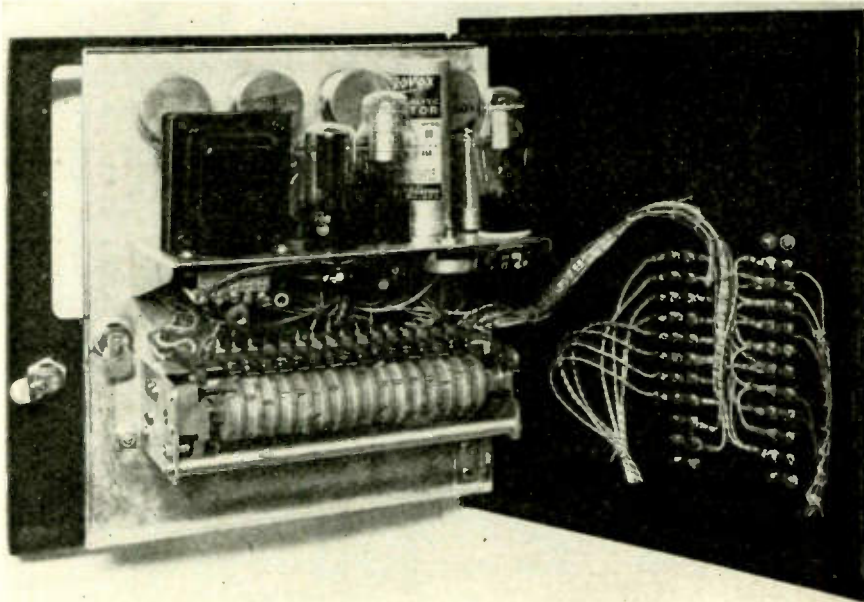

# New! B-W Lo-Stretch DIAL CORD



**NYLON—Most Stretch**



**SILK—Medium Stretch**



**B-W—Least Stretch**

### A BETTER Dial Cord\*

Accurate tests show that our new B-W Lo-Stretch Dial Cord has two-thirds less stretch than Nylon and about one-half the stretch of silk cords of similar diameters.

The constancy of this improved product is an important factor in accurate dial tuning where condenser units are cord driven.

Made in five standard diameters. Black only. 1,000-1,500 yard spools.

\*Write for Samples and Prices.

The  
**BEVIN-WILCOX**  
Line Company  
East Hampton, Conn.

was the subject of a paper on "Electronic Analog Computers," presented by C. E. Berry (Consolidated Engineering Corp., 1255 E. Green St., Pasadena, Calif.) during the session on computing. Variants of this basic instrument have been used for the integration of velocities, displacements, etc., and for solving stress-strain problems. Further application of such electrical analogies shows promise of becoming a common method for the prediction of various dynamic phenomena.

### Recording system

An entirely new approach to the problem of producing strip-chart records of various process variations has been made in the "Keinath" rotary stylus sweep balance recorder (Connecticut Telephone & Electric division of Great American Industries, Inc., Meriden, Conn.). This consists essentially of a facsimile type recorder in which a stylus moves longitudinally along a rotating drum carrying Teledeltos paper. A special RC circuit is arranged to produce a discharge at the instant when its residual charge (a function of time) equals the voltage across a



Electronic analog computer

measuring element (such as a thermocouple). The discharge is caused by closure of a relay and results in breakdown of the oxide surface of the Teledeltos paper.

The occurrence of successive dots on the paper is timed with respect to the process variation and drum rotation, producing a dotted curve as the stylus moves slowly along the chart length. A considerable advantage in response speed is thereby obtained, since the inertia of a directly positioned stylus is entirely eliminated. It is estimated that the curve produced will correspond within 0.2% to the amplitude of the input signal, an accuracy considerably greater than that of most primary measuring ele-

ments that will ordinarily be used to operate the recorder.

### Instrument scales

Methods and processes applicable to instrument manufacture were also the subject of several exhibits. One of these was the "Linotone Process" (Linotone Corp., div. of Mergenthaler Linotype Co., 563 W. 35th St., New York 1, N. Y.), developed by a division of the Mergenthaler Linotype Co. for the low-cost production of dials and scales on any type of surface contour of any material. The process will produce graduations and lettering of high precision, either engraved or surface applied. Instruments that were formerly hand calibrated may benefit from the greater mechanical precision of this method, especially where low-volume production does not justify the printing or stamping of scales by methods requiring expensive dies or plates.

### Versatile exhibit

A great variety of instruments, occupying five exhibit booths, was shown by the Apparatus Dept. and Electronics Dept. of the General Electric Co. A few samples from

LOOKING FOR TIME AND LABOR-SAVING IDEAS?

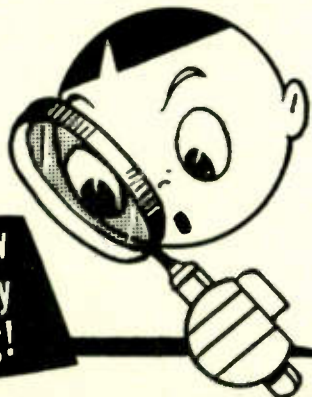

Get this new  
Free Ever Ready  
Label Catalog!

Page after page  
of practical ideas  
for the smoother,  
safer, simpler  
functioning of all  
departments from  
office-to-factory.

Have a copy on  
the desk of all  
your key men!

Write today for  
a FREE COPY.

**EVER READY** *Label* **CORP.**  
151 EAST 25th STREET NEW YORK 10, N. Y.



## Insulated WIRE and CABLE

Millions of feet of nearly every conceivable type on hand ready for immediate delivery. What are your requirements?

### COLEMAN CABLE & WIRE CORPORATION

4515 WEST ADDISON STREET

Chicago 41, Illinois

Tel.: Avenue 7173-4

### WANTED

### LOUDSPEAKER ENGINEER

Eastern Manufacturer has position open for man experienced in development, design and manufacture of radio loudspeakers. Please give details of education, experience and personal history. Salary open.

BOX 1164, ELECTRONIC INDUSTRIES  
480 Lexington Ave. New York City

POTENTIOMETERS  
 JACKS  
 RESISTORS  
 PHONE PLUGS  
 SWITCHES  
 SWITCH STACK ASSEMBLIES  
 "T" AND "L" PAD ATTENUATORS

# CARTER

## RADIO DIVISION

*"Twenty-five years of service to industry"*

CARTER RADIO DIVISION  
 PRECISION PARTS CO.  
 213 Institute Place  
 Chicago 10, Illinois  
 Write for full details  
 and catalogue today

## MORE HEAT PER POUND OF WIRE with **KANTHAL** RESISTANCE ALLOY\*

Kanthal Alloy A-1 allows continuous service temperature of 2462° F. with resistivity of 872 Ohms/C.M.F. at 68° F.

\*WIRE, RIBBON OR STRIP

The Kanthal Handbook, comprising 115 pages of complete technical reference material covering all data on the properties, fields of application, and design considerations of the Kanthal alloys, will be sent upon request to engineers writing on company letterheads.



THE C. O. JELLIFF MFG. CORP.  
 SOUTHPORT - CONN.

## JONES 400 SERIES PLUGS and SOCKETS

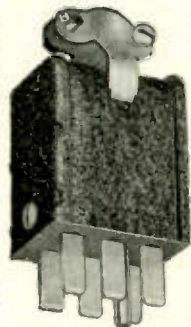

P-406-CCT

A medium size Plug and Socket that fulfills practically every requirement in the public address, radio and kindred fields. Socket contacts are of phosphor bronze, cadmium plated.

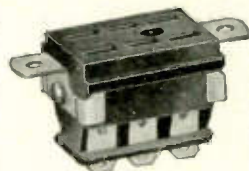

S-406-AB

Plug contacts are of hard brass, silver plated. Insulation is of molded Bakelite. All Plugs and Sockets are Polarized. Made in 2, 4, 6, 8, 10 and 12 contacts.

Caps are of steel with baked black crackle enamel. A quality item at popular prices. Send today for catalog No. 14 listing complete line of Jones Electrical Connecting Devices—Plugs, Sockets and Terminal Strips.

HOWARD B. JONES DIVISION  
 CINCH MFG. CORP.  
 2460 W. GEORGE ST. CHICAGO 18

this exhibit will illustrate the wide scope of this company's activities:

### Sheet fault detector

Pinholes or other flaws in various dielectric materials were counted by a system exploiting the electrical conductivity of such flaws as they pass between a metal electrode and a flexible contactor of conductive plastic. A scaling unit was connected to establish a "go-no-go" rate of inspection based on the permissible number of flaws in a given length of material. One form of this scaling unit is capable of counting impulses of only 0.05 microsecond width when separated by as little as 0.1 microsecond. This unit contains two channels, each of which delivers an output pulse after receiving ten input pulses. One channel can be used to count every tenth group of ten pulses delivered by the other channel and



Electronic decade scaling unit

several units may be cascaded to produce any number of decade counts up to 1,000, 10,000, or more.

### Electron diffraction

Chemical analysis of small specimens of many materials is performed by the phenomenon of x-ray diffraction, the analysis being observed from the characteristic pattern of concentric rings which differ according to the chemical and crystalline structure of each sample under test. Rings are displayed on a fluorescent screen and may be transferred to photographic plates by an automatic camera mechanism.

### Drafting machine

The fact that drafting room problems are of interest to most engineers was evidenced by the number of visitors who witnessed demonstrations of the new Pomeroy Stereograph, a machine for translating plan elevation drawings into perspective views (Pomeroy Stereograph Co., Inc., 1783 E. 11th St., Cleveland 14, Ohio). Basically a device for transferring points from a scale drawing in such a manner that the dimensional distortion due to perspective



is automatically provided, the Stereograph derives its name from the fact that it is the only equipment by which stereoscopic pairs of perspective drawings can be produced. The illusion of three-dimensional depth obtained by viewing such drawings through a stereoscope, or by polaroid projection, will no doubt encourage the use of this phenomenon for illustrating objects for which the correlation of all three dimensions in one view is desirable.

#### Popular electronics

Perhaps the most spectacular demonstrations of electronic applications were two devices exhibited by the Rowe Radio Research Laboratories (2422 N. Pulaski Rd., Chicago 39, Ill.). These were the "Tel-O-Buz" and the "Watchman's Protector". Since both were designed for general application and were not directly related to the instrument field, they aroused the interest of many non-engineers, including the visitors' wives. "Tel-O-Buz" is a simple acoustically operated relay, contained in a small stand, for notifying the telephone user when his party has been contacted. During a period of waiting, when no conversation is in progress, the telephone handset is hung on the desk stand while the caller attends to other business. Any conversation (or noise) in the telephone receiver will actuate the relay which sounds a buzzer, warning the caller to pick up his phone.

The "Watchman's Protector" consists of an extremely compact short-wave transmitter (about the size of two packages of cigarettes, end-to-end) which is strapped under the jacket of a watchman or guard. A camera-type flexible release cable may be carried in the pocket or other convenient location on the operator's person. Pressure of the release button touches off a code transmitter, energized by batteries and a spring motor previously wound by the operator. This enables the watchman to sound an alarm, in case of a holdup or other emergency, at any point within several hundred feet of the fixed receiver. The demonstration receiver was arranged to sound an alarm siren, light a signal lamp and print the watchman's individual code signal on Teledeltos tape. The receiver may also be connected by telephone line to some remote point, or a network of receivers used to relay the coded alarm for several miles.

# BURNDY HYLUGS

1000 per hour

With the Burndy pneumatic HY-PRESS Y10MCP illustrated, one operator attaches up to 1000 Hylugs per hour. Compare with your present production rate! Hylugs are one piece, pure copper construction. When indented to conductors the Burndy way they make permanent, low-resistance connections. Hylugs are stocked in all types and sizes for small wires. Indenting tools for large or small runs. Write for Hydent Catalog today.

**BURNDY ENGINEERING CO., Inc.,**  
107 Bruckner Blvd., New York 54, N. Y.  
In Canada: Canadian Line Materials, Ltd.,  
Toronto 13.



• The meeting of extraordinary applications—the designing and developing of new and specialized transformers—these are the day-by-day jobs Electronic Engineering is known for doing well.

**ELECTRONIC  
Engineering  
COMPANY  
INC.**

# Transformers

will meet your most exacting requirements, ordinary or unique—and the finest engineering talent and most complete electronic laboratories available are ready today to consult with and help you.

"SPECIALIZED  
*Transformer*  
ENGINEERS"

ELECTRONIC ENGINEERING COMPANY • 3223-9 WEST ARMITAGE AVE. • CHICAGO 47, ILLINOIS

# SPOT WELD the VANGTRONIC WAY in 1/500th to 1/1000th of ONE SECOND



- Vangtronic Self-Forging Stored Energy Spot Welder shown above is one of many used by The Foxboro Co., one of the largest instrument manufacturers.
- Welds are now being made which heretofore were practically impossible.
- This welder is desirable for small, precision parts, especially where dissimilar metals are utilized. . . . Welds without distortion, discoloration or change of crystallization structure.

Write for descriptive literature.

THE  
**VANGTRONIC**  
CORP.

87 WASHBURN STREET  
BRIDGEPORT 5, CONN.

## NEW BOOKS

### *Electrical Transmission in Steady State*

By Paul J. Selgin, Research Engineer, Farnsworth Television and Radio Corp., formerly Instructor, Polytechnic Institute of Brooklyn; First Edition Published by McGraw-Hill Book Co., Inc., New York, 1946. \$5.00, 427 pages.

This work aims primarily at strengthening the foundations for a superstructure of technological knowledge which the reader has acquired. It is a thorough overhaul of fundamental theory indicating time-saving methods of analysis and computation. When unfamiliar branches of mathematics have been called upon, they are adequately introduced.

The four-terminal network is introduced as a circuit element and questions on reflection at the terminals, of distortion in transmission lines and power flow are taken up. Problems involving impedance transformation and matching devices are also considered as is a brief review of electromagnetic theory, static fields and Maxwell's equations in their non-vectorial form. Coupling methods, the application of the four-pole theory to the vacuum tube and the flow of power through high-frequency amplifiers complete the book.

### *Polar Molecules*

By P. Debye, Ph.D., published by Dover Publications, New York, 1945, 172 pages, \$3.50.

Debye's article in 1912, basing the dielectric phenomena on the concept of polar molecules, has laid the foundation for the theory of dielectrics. It also initiated experimental research to establish the properties of these materials which since have become more and more important in their industrial applications. The book traces the history of this involved branch of modern science, showing the connection between the geometrical arrangement of the atoms in the molecules and their dielectric properties.

The process of scientific progress is described in a clear and concise manner by a man who became prominent by his contribution to the progress in this particularly intriguing branch. Coordination of experimental results with theory and the interaction of these two essential scientific methods will be readily appreciated by a study of

- SOFT SOLDER RINGS AND PREFORMS
- SILVER SOLDER RINGS
- COPPER BRAZING RINGS

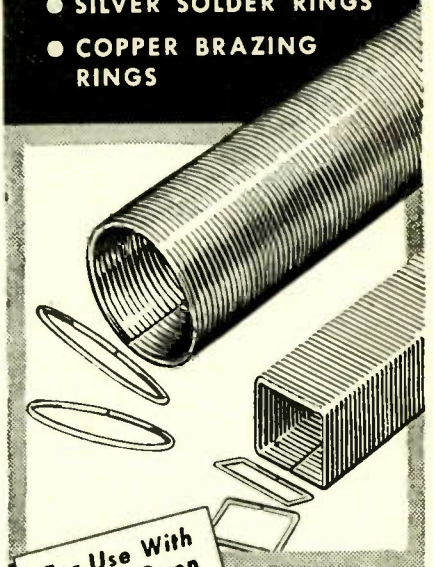

For Use With  
Flame, Oven  
or Induction  
Heating

Large range of wire sizes carried in stock for immediate fabrication into Rings and Preforms.

**ELECTRONIC SPECIALTIES  
MANUFACTURING COMPANY**  
123 North Main Street, Elkhart, Indiana



### HEYCO SOLDERING LUGS

Available in various sizes and shapes. These copper lugs are easy to apply. Samples free.

### HEYCO STRAIN RELIEFS

Three low-cost types. Prolong appliance life... Improve product performance... Act as grommet. Samples and literature.

HEYMAN MANUFACTURING CO.  
520 Michigan Ave. Kenilworth, N. J.

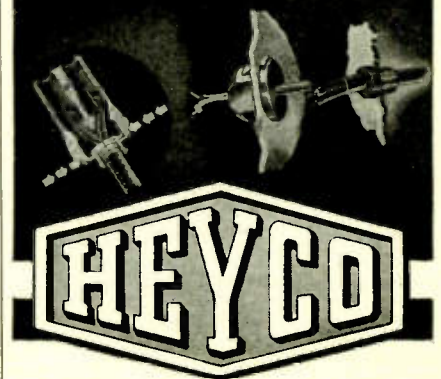

the text. Observing scientific development makes for dramatic reading, as compared with the conventional rather epic text book style of summarizing established facts.

The text may be considered compulsory for any original research project in the field; it also will prove of great interest to engineers seriously interested in the subject. Some knowledge of theoretical physics is required for an appreciation of the text.

### Higher Mathematics for Students of Chemistry and Physics

By J. W. Mellor. Published 1946. Dover Publications, New York 19. \$4.50, 641 pps.

This reprinted mathematical text (first ed. 1902) was written with the feeling that regular text books rather perplex than assist the chemical student who seeks a short road to knowledge of mathematics necessary to follow leading developments in physical or general chemistry. Therefore, a great many examples from physics and chemistry are included and many of the formal proofs of rules and principles have been omitted.

The book starts with differential calculus, analytical geometry, the integral calculus, and infinite series and their uses. It contains discussions of functions with singular properties, methods of solving numerical and differential equations, Fourier's theorem and ends with chapters on probability, determinants and the calculus of variations. Tables and formulas are included at the end. The exposition is clear and readable. It probably leans too much toward chemistry in its examples to be of maximum value to workers in the electronic field.

### The Electronic Engineering Master Index, 1935-1945

Edited by Frank A. Petraglia, published by the Macmillan Company, New York, 1946, 209 pages, \$6.00.

This subject index to electronic engineering periodicals covering the period from 1935 to 1945 is a special edition of Part II of the original Electronic Engineering Master Index which extended from 1925 to 1945 (reviewed in the January 1946 issue of Electronic Industries, page 128). The present compilation contains approximately 10,000 entries, each giving the full title of the article or text, author's name, periodical, date of issue.

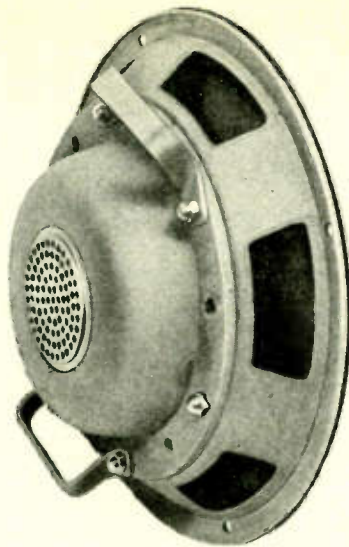

## Western Electric 728B LOUDSPEAKER

No fooling, the first time you hear music and speech delivered by the new 728B you'll find it hard to believe you're listening to reproduced sound! New design features, developed by Bell Laboratories, make the 728B ideal for studios where high quality reproduction from a single unit speaker is a "must." For full details—Graybar Electric Co., 420 Lexington Ave., New York 17, N. Y., or . . .

ASK YOUR LOCAL

# Graybar

BROADCAST REPRESENTATIVE

THERE'S A **DRAKE**  
**SOLDERING IRON**  
FOR EVERY TYPE OF  
ELECTRONIC WORK

From that mighty mite



the Drake No. 400 to the high speed production "honey"



the Drake No. 600-10 there is a high quality Drake Soldering Iron "just right" for the job.

Drake Heat Controls and the Drake "Magic Cup" Stand are important soldering aids.



SEE  
YOUR RADIO  
PARTS JOBBER

**DRAKE ELECTRIC WORKS, INC.**  
3656 LINCOLN AVE. CHICAGO, ILL.

HOPP *Plastic*  
**RADIO DIALS**

DIAL WINDOWS, NAME PLATES, GAUGES,  
CALCULATORS, SCALES, CHARTS, ETC.



PLASTIC RADIO DIALS have endless possibilities in design, size, shape and color combination. Attractive and durable, our radio dials, windows and scales are preferred by many leading Radio manufacturers.

Not only for dials, but for numerous other electronic and electrical applications, Laminated Plastics are preferable.

Consult with our artists and engineers regarding applications for your particular purpose. Or . . . send us your blue prints or samples for quotation.

**THE HOPP PRESS, INC.**  
460 W. 34th STREET, NEW YORK 1, N. Y.

ESTABLISHED 1893

# QUICK, EASY BENDING *with* DI-ACRO DIE-LESS DUPLICATING



## BENDS TUBES

The DI-ACRO System of Metal Duplicating without Dies eliminates loss of time needed for the preparation of dies.

STARTING DUO-BEND



## BENDS RODS

Speeds up experimental work . . . Steps up production . . . Duplicates metal parts to die tolerances of .001."

DUO-BEND UNDER WAY

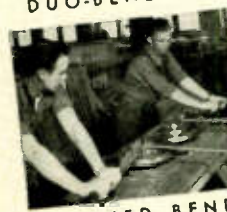

## BENDS STRIPS

Unskilled personnel is trained in a few hours to produce high hourly output. Mail coupon below for all the facts!

FINISHED BEND

All orders and inquiries receive speedy *W-J* EMERGENCY SERVICE. Write for descriptive literature, today. Use the convenient coupon below.

*Radio and Electronic Supplies*

**WALKER-JIMIESON, INC.**

Dept. D. 311 S. WESTERN AVE., CHICAGO 12

- Rush literature on DI-ACRO Die-less Duplicating.  
 Send *W-J* Electronic Catalog.

Individual.....

Company.....

Address.....

City.....State.....

## Medal for Merit for Stoll and Buckley

Two more distinguished members of the electronic industry have been given the nation's highest civilian award—the Medal for Merit. They are Clarence G. Stoll, president of Western Electric Co., and Oliver E. Buckley, president of Bell Telephone Laboratories. The awards, conferred by President Truman and presented by Major General Harry C. Ingles, Chief Signal Officer of the U. S. Army, are for "exceptionally meritorious conduct in the performance of outstanding services to the U. S.

## WEAF Becomes WNBC

It has been WEAF for a period of some twenty years. Starting about November 1, however, the National Broadcasting Company's outlet in New York is to have new call letters better defining its affiliation. Thus, WEAF becomes WNBC. Simultaneously, the frequency modulation station hereafter is to be known as WNBC-FM. Originally, WEAF was called WBAY. This was back in July 1922 when the station was launched by AT&T. WNBC will continue to broadcast at the 660 kc spot which was assigned to WEAF on Nov. 11, 1926.

## Wholesale Distributes Dormitzer Products

The Dormitzer Electric & Mfg. Corp., which was incorporated in June 1946 and represents a combination of the facilities and personnel of the Wholesale Radio Laboratories and the American Coil Co., both of Boston, has made Wholesale Radio Laboratories a division of the parent company to handle distribution and sales of its products. Dormitzer manufactures industrial X-ray units, transformers, amplifying systems and other electro-mechanical specialties. It does business from 782 Commonwealth Avenue, Boston.

## Electro-Voice Gets New Michigan Plant

After 19 years in South Bend, Ind., Electro-Voice, Inc., has moved 14 miles to Buchanan, Mich. Here, a modern factory has been acquired to permit the consolidation of manufacturing facilities of its three South Bend plants. The company has long been a manufacturer of microphones and is credited with having developed the differential principle which resulted in the lip microphone extensively used during the war for tanks, aircraft and landing barge service.

## NEW MODEL

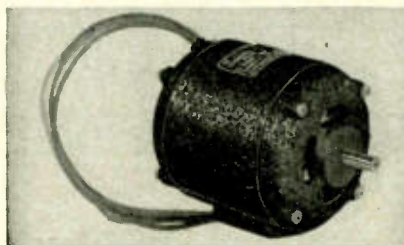

ELINCO TYPE ALP  
TYPICAL PERFORMANCE CURVE

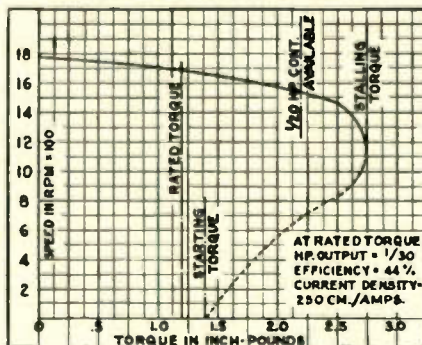

Type ALP-191; 110 volt 60 cye. single-phase Capacitor start & run; Motor Capacitor Value 4.25 Mfd. Curve 2235.

Elenco ALP Frame Motors are 3 3/8" x 4-5/16" capacitor start and run, two and four pole AC motors, internal fan cooled. Continuous duty rating—as induction motor to 1/30 h.p. at 1700 r.p.m.; as synchronous motor to 1/60 h.p. at 1800 r.p.m. Substantially higher ratings are available at speeds of 3400 and 3600 r.p.m. respectively. Also, higher rating for Intermittent duty.

ELECTRIC INDICATOR CO.  
STAMFORD, CONNECTICUT

**PREMAX**

Better Reception . . .



Tubular Verticals . . .

Fully adjustable, in 6 to 35-foot heights. In steel, aluminum, monel and stainless.

Elements . . .

Corulite Elements in corrosion-resistant steel. For building beam arrays.

Police Mobiles . . .

"Whip" type in steel, aluminum and stainless, complete with a wide variety of mountings. Ask your radio jobber for details.

**Premax Products**

Division Chisholm-Ryder Co., Inc.  
4712 Highland Ave., Highland Falls, N. Y.

## NEW BULLETINS

### Electrical Insulation Properties

An engineering treatise summarizing some of the published and available unpublished information on "Temperature-Resistance Characteristics of Electrical Insulation" has been prepared by the Engineering Staff of James G. Biddle Co., 1211 Arch St., Philadelphia 7, Pa. Technical publication 21T4 discusses in 16 pages subjects such as the "Composite nature of electrical insulation", "Temperature corrections for testing insulation resistance", etc. Graphic analyses are presented along with mathematical formulas, as well as temperature correction factors and simplified curves for their use.

### Capacitors

Catalog A 546 describes the "Amcon" line of dry electrolytic and paper dielectric capacitors manufactured by American Condenser Co., 4410 No. Ravenswood Ave., Chicago 40, Ill. Characteristics of

Type AHT hermetically sealed telephone condensers are given in the first part of the booklet. The second part is devoted to paper, tubular, dry electrolytic and midget paper electrolytic capacitors for applications in communications and industrial electronics.

### Electrical Connectors

The "Mechanical Principles of Gorilla Grip Electrical Connectors" are discussed in a 12 pg. booklet issued by National Electric Products Corp., Chamber of Commerce Bldg., Pittsburgh, Pa. The brochure is designed to assist engineers, jobbers, contractors and purchasing agents by presenting a factual analysis of the design and function of these connectors. Cut-away models and schematic drawings of connectors, available for sizes 2000 MCM to No. 2 stranded incl., are included.

### Induction Motor

The Louis Allis Co., Milwaukee 7, Wis., has released bulletin No. 720, covering the Type OG standard squirrel cage induction motor. The 8 pg. folder describes fully the construction, features and typical applications of this motor.

### Temperature Recorder

A new eight-page, two-color bulletin (GEA-4572) describes type CF-2 inkless temperature recorder recently developed by General Electric, Schenectady, N. Y. Various industrial applications for the new unit, such as recording temperatures in generators, transformers, ovens, air ducts, etc., are listed, along with complete specifications. Accessories, such as test resistor, and resistance-temperature detectors used with the unit, are pictured and described.

### Brass Cleaner

Enthone, Inc., 442 Elm St., New Haven, Conn., has issued a 4 pg. folder, describing a new alkali brass cleaner with high detergent ability, and no tarnishing action on copper, brass, bronze, nickel, silver, tin, and lead. The cleaner has a long operational life due to stable surface active materials and buffered alkali balance.

### Hydraulic Presses

Air-hydraulic presses having ram pressure controlled up to 5000 lbs. and adjustable stroke of 1/16 in. to 5 in., as well as adjustable ram

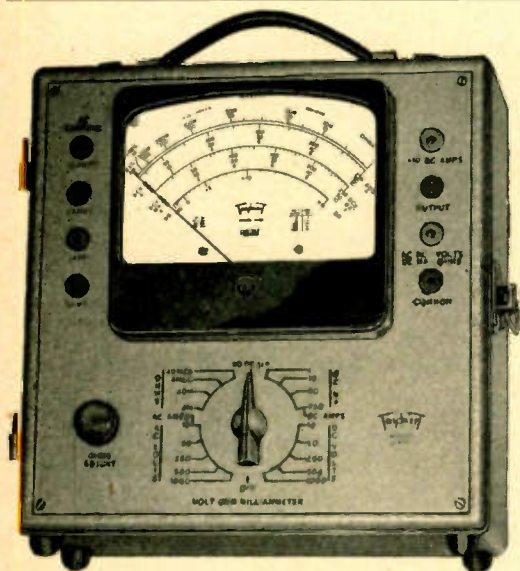

### NEW ENGINEERING • NEW DESIGN • NEW RANGES 50 RANGES

- Voltage: 5 D.C. 0-10-50-250-500-1000 at 25000 ohms per volt.
- 5 A.C. 0-10-50-250-500-1000 at 1000 ohms per volt.
- Current: 4 A.C. 0-.5-1-5-10 amp.
- 6 D.C. 0-50 microamperes — 0-1-10-50-250 milliamperes — 0-10 amperes.
- 4 Resistance 0-4000-40,000 ohms—4-40 megohms.
- 6 Decibel -10 to +15, +29, +43, +49, +55
- Output Condenser in series with A.C. volt ranges.

Model 2400 is similar but has D.C. volts Ranges at 5000 ohms per volt.

Write for complete description

### MODEL 2405

## Volt-Ohm-Milliammeter

25,000 OHMS PER VOLT D.C.



### SPECIFICATIONS

NEW "SQUARE LINE" metal case, attractive tan "hammered" baked-on enamel, brown trim.

- PLUG-IN RECTIFIER—replacement in case of overloading is as simple as changing radio tube.
- READABILITY—the most readable of all Volt-Ohm-Milliammeter scales —5.6 inches long at top arc.
- RED-DOT LIFETIME GUARANTEE on 6" instrument protects against defects in workmanship and material.

# Triplet

## ELECTRICAL INSTRUMENT CO.

BLUFFTON OHIO.

# COMPLETE TANK CIRCUIT *by*

## B&W

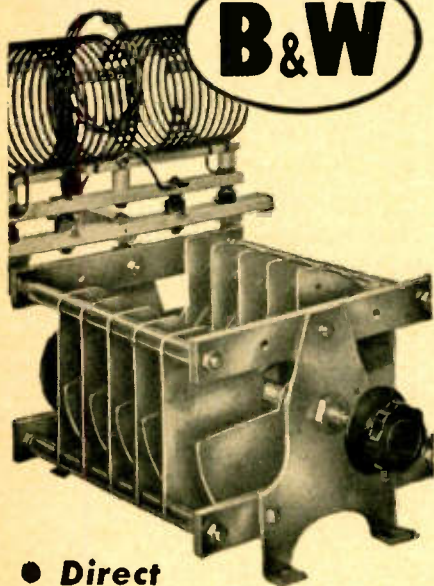

- **Direct Mounting of Coil**
- **Eliminates Wiring...**
- **Reduces Tuned Circuit Lead Lengths to an Absolute Minimum**

'Radically different' a few years ago, B & W Type CX Variable Capacitors with their perfect design symmetry are now standard in much of the finest transmitting equipment coming on the market.

Unique design resulting from split stator and butterfly rotor permits mounting famous B & W Inductor Coils directly on capacitors for an absolute maximum of efficiency.

Opposed stator sections provide desirable short R-F paths. Butterfly rotor construction permits grounding rotor at the center R-F voltage point with respect to stator. Built-in neutralizing capacitors can be mounted on end plate.

Standard types for powers of 500, 750 and 1,000 watts. Write for B & W Type CX Capacitor Catalog 75-C.

## BARKER & WILLIAMSON

**Inductor Coil Headquarters**

237 Fairfield Ave., Upper Darby, Pa.

speed, are described in an 8 pg. bulletin distributed by Air-Hydraulics, Inc., 401 Broadway, New York 13. The folder contains complete specifications for the presses which are widely used in riveting, forming, light broaching, stripping, heat sealing, and assembly operations.

### Automatic Controls

A complete line of controls for heating, air conditioning, refrigeration, and other applications is described and illustrated with line drawings and photographs in catalog No. 600-A issued by the Mercoid Corp., 4201 Belmont Ave., Chicago 41, Ill. Ranges and prices are listed. Control dimensions and conversion tables are included.

### STATEMENT OF THE OWNERSHIP, MANAGEMENT, CIRCULATION, ETC., REQUIRED BY THE ACTS OF CONGRESS OF AUGUST 24, 1912, AND MARCH 3, 1933

Of ELECTRONIC INDUSTRIES, published monthly at New York 17, N. Y., for Oct. 1, 1946, State of New York, N. Y., County of New York, N. Y.

Before me, a Notary Public in and for the State and county aforesaid, personally appeared Orestes H. Caldwell, who, having been duly sworn according to law, deposes and says that he is the Editor of ELECTRONIC INDUSTRIES and that the following is, to the best of his knowledge and belief, a true statement of the ownership, management (and if a daily paper, the circulation), etc., of the aforesaid publication for the date shown in the above caption, required by the Act of August 24, 1912, as amended by the Act of March 3, 1933, embodied in section 537, Postal Laws and Regulations, printed on the reverse of this form, to wit:

1. That the names and addresses of the publisher, editor, managing editor, and business managers are: Publisher, M. Clements, Rumson, N. J. Editor, Orestes H. Caldwell, Catrock Road and Bible St., Cos Cob, Conn. Managing Editor, Stanley P. McMinn, 92 Adams St., Garden City, L. I., N. Y. Business Manager, M. H. Newton, 583 W. 215th St., New York, N. Y.

2. That the owner is (if owned by a corporation, its name and address must be stated and also immediately thereunder the names and addresses of stockholders owning or holding one per cent or more of total amount of stock. If not owned by a corporation, the names and addresses of the individual owners must be given. If owned by a firm, company, or other unincorporated concern, its name and address, as well as those of each individual member, must be given.) Caldwell-Clements, Inc., 480 Lexington Avenue, New York 17, N. Y. M. Clements, O. H. Caldwell, Charles A. Petersen, Trustees, 480 Lexington Ave., N. Y. C. M. Clements, Trustee, Rumson, N. J. O. H. Caldwell, Trustee, Catrock Rd. and Bible St., Cos Cob, Conn. Charles A. Petersen, Trustee, 474 Senator St., Brooklyn, N. Y. Peter Kes, 111 Hamilton Rd., Ridgewood, N. J. McGraw-Hill Pub. Co., 330 W. 42nd St., New York, N. Y.

3. That the known bondholders, mortgagees, and other security holders owning or holding 1 per cent or more of total amount of bonds, mortgages, or other securities are: (If there are none, so state.) None.

4. That the two paragraphs next above, giving the names of the owners, stockholders and security holders, if any, contain not only the list of stockholders and security holders as they appear upon the books of the company but also, in cases where the stockholder or security holder appears upon the books of the company as trustee or in any other fiduciary relation, the name of the person or corporation for whom such trustee is acting, is given; also that the said two paragraphs contain statements embracing affiant's full knowledge and belief as to the circumstances and conditions under which stockholders and security holders who do not appear upon the books of the company as trustees, hold stock and securities in a capacity other than that of a bona fide owner; and this affiant has no reason to believe that any other person, association, or corporation has any interest direct or indirect in the said stock, bonds, or other securities than as so stated by him.

(Signed) Orestes H. Caldwell  
Sworn to and subscribed before me this 9th day of September, 1946.  
W. Kenneth Reynolds,  
Notary Public New York County,  
Notary Public N. Y. County Clerk's No. 95.  
Notary Public N. Y. County Register's No. 538-R-7.  
(My commission expires March 30, 1947.)

\*Represents minority stock interest which was purchase price for Radio & Television Retailing. Majority stock and control continue in hands of O. H. Caldwell and M. Clements.

## MODEL 81

# Termaline

## COAXIAL RESISTOR

A Wide Band Line Termination with Exceedingly low VSWR Characteristics.



The Model 81 Termaline is designed to serve as a matched load which dissipates all power applied to it. Featuring very low VSWR's, the Termaline is very useful in measurement work at VHF-UHF-SHF.

Frequency—Zero (dc) to 4000 mc. • Input Impedance—51.5 ohms • Power Capacity—50 watts continuous, higher powers for short periods • Fittings—AN Type UG-23 female coupling for RG-8, 9 and equivalent • Physical Dimensions—(Overall) 9 3/8" L x 5" H x 2 5/8" W. • Finish—Platinum gray with chrome trim. Collapsible handle.

### APPLICATION

1. As an impedance standard for accuracy and repeatability in VHF-UHF-SHF measurements.
2. General use as a non-reactive termination for r-f lines.
3. As a dummy load while tuning up transmitters.
4. In conjunction with the slotted line for measurement of VSWR, eliminates the usual necessity of matching transformers and tuning stubs.
5. Checking impedance in antenna to line match.

BIRD ELECTRONIC CORPORATION  
1800 EAST 38th STREET  
CLEVELAND 14, OHIO



## BIRD ELECTRONIC

Instrumentation for Coaxial Transmission

### Philips Moves Wire Production

The North American Philips Co., Inc., which has been manufacturing wire products in its Dobbs Ferry, N. Y., plant has moved the entire operation to its plant in Lewiston, Maine. A new addition approximately doubles the floor space and will facilitate specializing in the drawing, enamelling, and plating of wires of extremely fine size in practically all metals and alloys.

### Coin Operated Diathermy Machine

Designed to make diathermy available to the public, a new coin operated machine has been developed by the Coin Diathermy Corp., 612 Tenth Ave., New York, N. Y. The machine is fitted with two rubber pads that can be held in position by the patient, and a five minute treatment is provided for 25 cents.

Officers of the company include Stanley Arnold, president, and Harry Berger, vice-president. Arnold is also president of the Home Diathermy Corp.

### Color Code Guide

A RMA-JAN color code guide for radio and electronic type resistors provides three rotary discs for setting the code colors, the corresponding resistance values being brought into alignment automatically. Code color may be set to show resistance values or vice versa. The guide includes data covering resistance tolerance and a listing of RMA-JAN 10% resistance stock values. It is available at 10 cents from Allied Radio Corp., 833 West Jackson Blvd., Chicago 7, Ill.

### Dr. Coltman Authored Crossroads Article

Through an unfortunate typographical error the name of the author of the article "Telemetry for Project Crossroads" which appeared in the September issue of ELECTRONIC INDUSTRIES was misspelled. The author is Dr. John W. Coltman who is Section Manager of the X-Ray Section in the Electronic Department of the Westinghouse Electric Corp., East Pittsburgh, Pa.

### RETRACTABLE ANTENNA

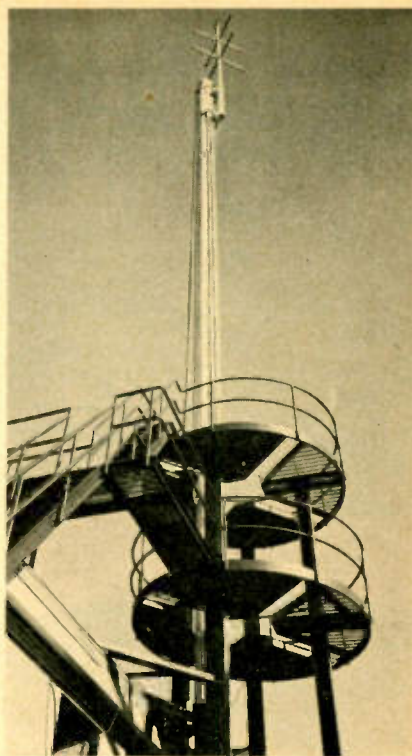

DuMont's Washington TV station antenna is retractable by winch for adjustment

#### INSULATED WIRE and CABLE . . .

Millions of feet of nearly every type on hand ready for immediate delivery. What do you need?

#### THORDARSON TRANSFORMERS . . .

115 V, 50-60 Cy Primary, 6 Volts at 10 Amps. Sec. Leads brought out on an engraved bakelite panel—Wt 5 lbs. Size 3 x 3 x 3 inches, with mounting brackets. Suitable for filament supply, battery charges, "A" supplies, pin-ball machines, juke boxes, bell-ringers, toys, etc.

6 to a carton — no less than 6 sold  
PRICE . . . . . Ea. \$1.50

Prices on larger quantities on request

#### AUDIO SALES COMPANY

11 WARREN STREET NEW YORK 7, N. Y.

#### TERMINALS

for  
ELECTRIC WIRES

#### SMALL METAL STAMPINGS

in accordance with your blueprints

#### PRECISION PARTS

from Modern Equipment

#### PATTON-MacGUYER CO.

17 VIRGINIA AVENUE PROVIDENCE 5, R. I.

# ESCO



## SPECIALLY DESIGNED

### MOTORS, GENERATORS AND OTHER ELECTRICAL POWER UNITS

Designed and produced to meet your specific requirements . . . not ordinary stock units. From blueprint to finished product . . . our years of engineering skill plus initiative and expert craftsmanship are your assurance of complete satisfaction.

### ELECTRIC SPECIALTY Co.

214 SOUTH STREET

STAMFORD, CONN.

## LINES WANTED

by a MANUFACTURERS REPRESENTATIVE with a  
SUCCESSFUL SALES BACKGROUND

12 years as Chicago Factory Representative of a large and well-known manufacturer, selling radio parts and assemblies for initial equipment to manufacturers; also replacement parts, ham, test and other equipment to JOBBERS.

21 years of selling and engineering experience in and near Chicago.

Established Chicago office with efficient salesmen.

Registered professional engineer—Senior member, Institute of Radio Engineers.

BOX 1061

#### ELECTRONIC INDUSTRIES

480 LEXINGTON AVENUE

NEW YORK 17, N. Y.

Smooth Running  
Smooth Selling

with

Smooth Power

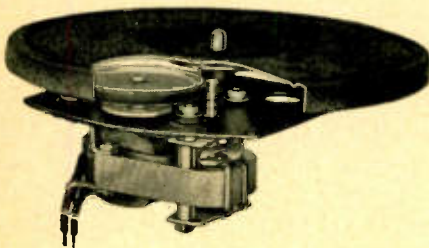

You'll build smoother performance into your phonographs, recorders and record-changers when you equip them with GI Smooth Power Motors.

Every unit in our wide line provides that combination of quick pick-up, unvarying speed and velvety operation which pleases customers and makes your selling job easier.

For smooth running and smooth selling, *standardize on Smooth Power Motors.*

**THE GENERAL INDUSTRIES co.**

Dept. ML

Elyria, Ohio

## PERSONNEL

Roy S. Laird has been elected chairman of the Association of Electronic Parts and Equipment Manufacturers, Chicago. He is vice-president and sales manager of Ohmite Mfg. Co., Chicago.

William F. Frankart has been appointed senior radio project engineer by Lear, Inc., Grand Rapids, Mich. He has been chief radio engineer for Precision Specialties, Inc., Los Angeles, and prior to that was employed by Air Associates, Inc., of California, as design engineer.



Wm. F. Frankart

Wm. W. Gilmore

William W. Gilmore, who has been executive vice-president of the Micro Switch Division of First Industrial Corp., Freeport, Ill., has been elected to the presidency of the Division. He takes the place of Walter B. Schulte, who has been the Division president since the formation of the Micro Switch Corp. in 1937.

Ray H. McLeod has joined the Cathodic Protection staff of the Dow Chemical Co. and will work out of the company's Chicago office. He was recently released from the Navy.

James R. Reed has been made manager of the commercial research department of the Allis-Chalmers Mfg. Co., Milwaukee. He has been connected with the company since 1941.

Jerome F. Fitzsimmons has been appointed supervisor in charge of research by the Allis-Chalmers Mfg. Co., Milwaukee. He joined the company in 1943.

Henry Lavin has been appointed field engineer for Kahn and Co., Hartford, Conn., electronic application engineers. He was recently discharged from the Navy as chief radio technician.

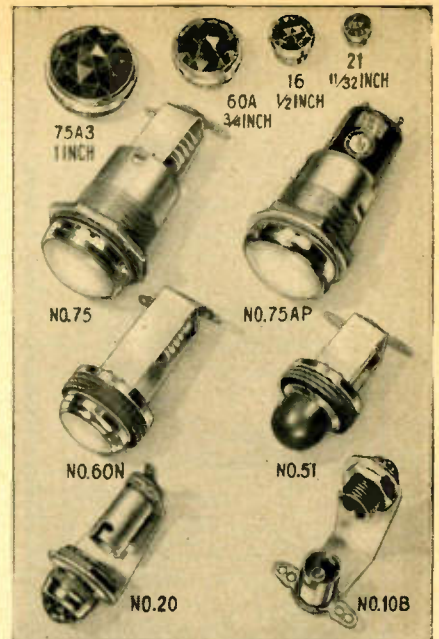

## WHAT TYPE OF Jewel Assembly DO YOU NEED?

No matter what type or size of Jewel Light Assembly you need, chances are we can produce it for you quickly, more satisfactorily, and at lower cost! Here, every facility is available for high speed quantity production . . . speedy, efficient, economical service. Drake patented features add greatly to the value and dependability of our products.

You'll like the friendly, intelligent cooperation of our engineers. Let them help you with signal or illumination problems. Suggestions, sketches, cost estimates or asking for our newest catalog incur no obligation.



**DRAKE MANUFACTURING CO.**

1713 W. HUBBARD ST., CHICAGO 22, ILL.



**Herbert C. Graves, Jr.**, has been appointed chief engineer by Gibson Electric Co., Pittsburgh. Previously he was engineering manager for I-T-E Circuit Breaker Co. During the war he served in the Electrical Design Section of the Bureau of Ships, Washington.

**Leo J. Healy** has been appointed national sales manager for the Electro Motive Mfg. Co., Inc., Willimantic, Conn. The company manufactures electrical and radio parts.

**Dr. Emery Meschter**, who has been connected with the Parlin Research Laboratory of E. I. du Pont de Nemours and Company, Inc., has been appointed laboratory director of the division's research laboratory in Towanda, Pa. The company makes X-ray and fluoroscopic screens and luminescent chemicals. His predecessor, **Dr. Frank E. Swindellis**, is being transferred from Towanda to the Parlin Laboratory and **Dr. J. Paul Weiss** will take over Dr. Meschter's work at Parlin.

**Charles Rinderle, Jr.**, has been elected treasurer and secretary of Eastern Air Devices, Inc., Brooklyn, N. Y. He was formerly connected with Bendix Aviation Corp. and its various divisions and subsidiaries.

**Commodore Jennings B. Dow**, USN, assistant chief for electronics, of the Bureau of Ships, retired from the Navy November 1, and will enter private business as a consulting engineer in the field of electronics. He will have offices in Washington. It was Commodore Dow who directed the Navy's huge communications-electronics equipment procurement program during the entire war. He will be succeeded in the Bureau of Ships by **Captain R. Hull**, USN, who has been deputy director since August, 1944.

**Dale Pollack**, Sc.D., has opened his own office specializing in FM development and research. Headquarters will be 352 Pequot avenue, New London, Conn. He was formerly vice-president for engineering of the Templetone Radio Mfg. Co., and a member of the technical staff of Bell Telephone Laboratories.

**Dr. A. E. Harrison** has resigned from the Sperry Gyroscope Research Laboratories to become associated with the Electrical Engineering Graduate School at Princeton University. He will handle UHF technics.

## Electrical Porcelain

A booklet on electrical porcelain, its history, uses, and adaptability for different types of insulation, has been published through the National Electrical Manufacturers Association, 155 E. 46th St., New York 17, by thirteen cooperating manufacturers. The back of the 20-page booklet lists applications and the average properties of three types of electrical porcelain.

## Motor Control

A brochure on adjustable inching "Pulsing Drive" has been issued by Yardeny Laboratories, Inc., 105 Chambers St., New York 7. The pulsing drive is a new, single knob switching control for electric motors providing incremental speed and rotational control. The device is based on an electrical pulse timing circuit with the duration of the pulses manually regulated.



*Unbelievable*  
**QUALITY**

"SPIRIT OF FREEDOM"  
5-GAITED CHAMPION GELDING  
MR. STANLEY JOHNSTON, OWNER

MISS SHIRLEY MOLOHAN  
WINNING MODEL  
"MISS PHOTO-FLASH OF 1946"

*... is the mark of a champion*

## OXFORD SPEAKERS

ARE BUILT ON THAT PRINCIPLE

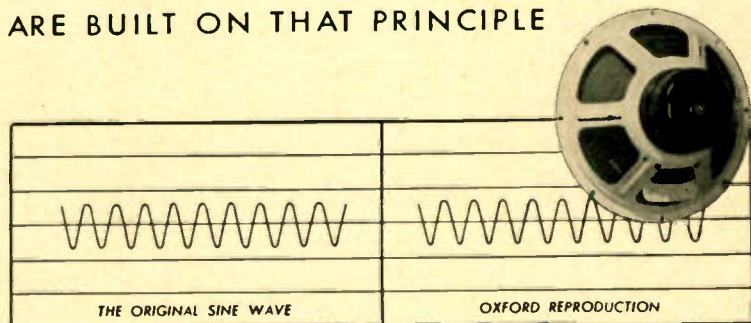

The accuracy and beauty of sound reproduction from a loudspeaker depends largely upon the excellence of the speaker design, the skill that goes into its construction, and the quality of its components. At OXFORD, none of these basic facts are overlooked. Each unit reflects the careful consideration which has gone into every step of its manufacture. Because of this, OXFORD SPEAKERS represent a precision-built instrument from which fine sound reproduction is the rule rather than the exception.

**OXFORD RADIO CORPORATION**  
3911 SOUTH MICHIGAN AVE., CHICAGO

## Scientists Measure Cosmic Showers

Technical details of the V-2 rocket experiments in New Mexico, recently conducted by the Army Ordnance Department that have been made public by the Applied Physics Laboratory of Johns Hopkins University reveal that electronic apparatus for the experiment, designed by the Applied Physics Laboratory and built by the Wilmotte Mfg. Co. of Washington, D. C., was successful in recording significant data on cosmic rays 100 miles above the earth's surface. The apparatus built consisted in part of two Geiger tube telescopes capable of counting radiations. These were mounted in the nose of the captured German V-2 rocket used for the experiment, and were of the same type used at the Bikini atom bomb test, with certain specialized features.

In addition to the telescopes, two units were built into the warhead containing circuits to identify the pulses and to separate or combine the cosmic ray impulses. One unit transmitted the impulses to an amplifier which put them in a form for mechanical recording within the rocket. This equipment has not yet been recovered. The second

unit sent the impulses through a separate circuit to amplify them before they were applied to the telemetering channels. It was

through this unit that the available data has been secured. Power to operate all of the electronic circuits was from batteries.

## THE MEN WHO DESIGN CANNON PLUGS



Engineering executives and designers of Cannon Electric Development Co., Los Angeles, gather around the chief engineer's desk. They are: Sam Arson, chief design engineer; Bruce Arnold, coordinating engineer; Edward J. Neifing, chief engineer, and D. Frank Jackson, assistant chief engineer

## WANTED

### 1 — RADIATION PHYSICIST

With background in measurement and detection of radiations and designing of associated instruments. Weight of background and interests should be in physical chemistry.

### 2 — X-RAY TUBE ENGINEER

Must have experience in actual tube design and production.

### 3 — TRANSMITTING TUBE ENGINEER

THESE THREE MEN will have stimulating work, laboratory freedom, full security and good salaries. Write in complete confidence. Or arrange for an immediate interview.

### AMPEREX ELECTRONIC CORPORATION

25 Washington Street, Brooklyn 1, New York  
Telephone: MAin 5-2050

## 18 YEARS IN RADIO

Latest developments in radio and electronic parts and devices, newest "Ham" gear, "Gadgets" to delight the experimenter, bargains in war surplus goods, all in new catalog for you.

**BA**

BURSTEIN-APPLEBEE CO.,  
1012 McGee, Kansas City 6, Mo.  
Send me FREE new B-A Catalog. EL. IND

I AM \_\_\_\_\_  
STATE CONNECTION IN INDUSTRY \_\_\_\_\_

NAME \_\_\_\_\_

ADDRESS \_\_\_\_\_

TOWN \_\_\_\_\_ STATE \_\_\_\_\_

BIG CATALOG FREE

# Kahle

## ENGINEERING COMPANY

### ELECTRON TUBE MACHINERY

All types, standard and special design.

Specialists in equipment and methods for the manufacture of:

RADIO TUBES	NEON TUBES
CATHODE RAY TUBES	PHOTO CELLS
FLUORESCENT LAMPS	X-RAY TUBES
INCANDESCENT LAMPS	GLASS PRODUCTS

On Production or Laboratory basis

1307-1315 SEVENTH ST., NORTH BERGEN, N. J., U. S. A.

# ELECTRONIC INDUSTRIES

Advertisers, November 1946

	Page
Adams & Westlake Company	10
Aerovox Corp.	35
Allied Radio Corp.	139
American Electrical Heater Co.	132
American Television & Radio Co.	130
American Time Products, Inc.	14
Amperex Electronix Corp.	152
Amperite	135
Andrew Co.	4
Arnold Engineering Co.	100
Astatic Corp.	114
Audio Sales Company	149
Barber-Colman Company	124
Barker & Williamson	148
Bell Telephone Laboratories	28
Bevin-Wilcox	140
Bird Electronic	148
Bird & Co., Richard H.	139
Boonton Radio Corp.	127
Brush Development Company	112
Burdny Engineering Co.	143
Burnell & Company	122
Burstein-Applebee Co.	152
Caldwell-Clements, Inc.	99, 123
Cambridge Thermionic Corp.	128
Carter Radio Division, Precision Parts Co.	142
Chicago Transformer, Div. Essex Wire Corp.	116
Clarostat Mfg. Co., Inc.	102
Coleman Cable & Wire Corp.	141
Collins Radio Company	37
Communications Equipment Co.	136
Conant Electrical Laboratories	117
Concord Radio Corporation	128
Cornell-Dubilier	97
Crescent Industries, Inc.	125
Crystal Research Labs., Inc.	135
Dalmo Victor	24
DeMornay-Budd, Inc.	85
Distillation Products, Inc.	115
Dolph Co., John C.	44
Drake Electric Works, Inc.	145
Drake Manufacturing Co.	150
Driver-Harris Co.	13
Dumont Laboratories, Inc., Allen B.	6, 27
Eastman Kodak Company	91
Eby, Inc., Hugh H.	40
Eisler Engineering Co.	154
Eitel-McCullough, Inc.	9
Electrical Reactance Corp.	118
Electric Indicator Co.	146
Electric Specialty Co.	144
Electronic Engineering Co.	143
Electronic Industries & Instrumentation	99
Electronic Specialties Mfg. Co.	149
Engineering Company	137
Ever Ready Label Corp.	141
Fahnestock Electric Company, Inc.	121
Federal Telephone and Radio Corp.	32
Formica Insulation Co.	26
General Electric Company, 5, 21, 38, 39, 119, 124	
General Industries Co.	150
General Plate Division	16
Graybar Electric Co.	145
Groves Corporation	121
Guardian Electric Mfg. Co.	87
Heinemann Circuit Breaker Co.	89
Hoyman Manufacturing Co.	144
Hopp Press, Inc.	145
Indiana Steel Products Co.	22
Instrument Electronics	122
Insulation Manufacturers Corp.	Cover 3

	Page
Insuline Corp. of America	108
International Machine Works	154
International Nickel Co., Inc.	30
Jackson Electrical Instrument Co.	110
Jelliff Mfg. Corp., C. O.	142
Jensen Manufacturing Co.	20
Johnson Co., E. F.	45
Jones, Howard, B., Div., Cinch Mfg. Corp.	142
Kahle Engineering Company	152
Kalbfell Laboratories	133
Karp Metal Products Co., Inc.	31
Keuffel & Esser Company	17
Lapp Insulator Company, Inc.	8
Lavoie Laboratories	93
Lord Manufacturing Company	41
Macallen Company	104
Machlett Laboratories, Inc.	25
Magnavox Company	46
Mallory & Co., Inc., P. R.	Cover 2
Measurements Corporation	129
Mephram Corporation, G. S.	154
Millen Mfg. Co., Inc., James	126
National Company, Inc.	12
Newark Electric Company, Inc.	127
Niagara Radio Supply	139
Ohmite Mfg. Company	33, 34
Oxford Radio Corp.	151
Patton-MacGuyer Co.	149
Plasticraft Products Co.	137
Plastic-Ware, Inc.	154
Premax Products	146
Radio Corp. of America	Cover 4
Rauland Corporation	36
Revere Copper & Brass, Inc.	7
Sangamo Electric Company	15
Seeburg Corp., J. P.	111
Selenium Corp. of America	29
Simpson Electric Company	103
Sperry Gyroscope Co., Inc.	2
Sprague Electric Company	23
Stackpole Carbon Company	107
Struthers-Dunn, Inc.	3
Stupakoff Ceramic & Mfg. Co.	42, 43
Superior Electric Company	113
Surprenant Electrical Insulation Co.	134
Sylvania Electric Products, Inc.	11, 19
TAB	153
Tele-Tech	99
Triplett Electrical Instrument Co.	147
Tung-Sol Lamp Works, Inc.	109
Turner Company	106
United Electronics Company	95
U. S. Television	133
Vangtronic Corp.	144
Victoreen Instrument Co.	138
Walker-Jimieson, Inc.	146
War Assets Administration	124
Ward Leonard Electric Co.	18
Waterman Products Co., Inc.	137
Webster Electric	120
Western Electric Co.	28, 105
Weston Instruments	101
Wrigley Co., Wm.	131
Zetka Laboratories, Inc.	133
Zophar Mills, Inc.	129

## "TAB"

That's A Buy

RCA 808 JAN-CRC New Gt'd Fil  
7.5V/4 Amp. Plate 1500V/200 Watts Rated  
140 Watts output each "UHF" (List \$7.75)  
"TAB" \$2.70 @; 2 for \$5.00  
9002 Jan. Caplats (1.25) \$1.25  
.70 @; 2 for  
UX sockets No. 224 (60c) .49  
@; 2 for  
9006 Jan (2.00) .99 @; 2 for \$1.90  
GE&Wst 807 JAN (LP \$2.75)  
1.35 @; 2 for .98  
6J5 Jan (1.10) .55 @; 2 for  
GE&Ray 955 JAN (LP \$2.85)  
.65 @; 2 for \$1.25  
VR150 Jan (2.80) .75 @; 2 for 1.30  
VT127A/100TS 2 for \$7.50  
872A Jan & sockets 2 for \$5.75



829/3E29 JAN BOXED Gtd with socket \$ 4.50  
5CP1 & Socket \$7.50; 3BP1 Socket. 3.95  
957 or 958A Acorn Tube & Socket. 1.25  
5.95  
WE 703A Tube UHF 20 Watt to 1000mc's 1.25  
RCA 956 JAN (LP5.00) & Socket. 1.95  
WE 717A Door Knob tube new (\$7.50) 9.90  
805/905-VT143 Jan & Socket \$6 Two for 14.00  
GE 845 new gtd & socket \$7.50 Two for 3.00  
RCA 6AC7 boxed new JAN, 4 for 6.95  
GE 446A/2C40 RCA Lighthouse tube (\$11)

PAN ADAPTOR BC1031A-3" SCOPE  
Used with any radio rcvr having IF 450 to 750KC,  
gives visual indication 100KC either side of  
freqs tuned. Complete with all tubes 115V 60 cys  
inpt "TAB" SPECIAL \$49.95

WE 307A RF. Pent (LP \$13) 5.95  
WE 339A RF. Pent (LP \$24) 6.95  
RCA 2V3G JAN H.V. C'Ray Rect 16500V. .75  
RX215 Raytheon FW 500V/15Amp (\$24) 7.95  
5BP1 or 5BP4 new gtd. JAN Boxed ea. 1.95  
2C26 JAN new UHF (\$5.00) Boxed 2.00  
6AG5 new Video Telev (\$2.80) 2 for 3.95  
GE vacuum condsr. 50 MMFD/16,000V 4.00  
6AK5 JAN new UHF min. (\$4) 4 for



Raytheon 866A  
filament trans-  
former 115V 60c  
pri, 2.5Vct 11A Sec  
and Two new RCA  
866A tubes \$5.90  
With Millen caps  
& sockets \$7.50  
Raytheon Trans-  
former only \$3.25  
Combination Two  
872A's KENYON  
NSNF, SOCKETS  
New gtd. \$12

Collins choke 6Hy/1.2 amp/12500wkg cased \$16.00  
Thermador S. C. Rated 3800VCT/6KW/2.7  
amps; Pri 200, 210, 220, 230, 240, V/50  
-40 60 cys new wgt. 325 lbs. 45.00  
Simpson 25 rd. 3 1/2" B'C DC one -MA 3.00  
Westinghouse 2mfd 12500WVDC oil Condsr. 75.00  
Westinghouse 1mfd 25000WVDC oil Condsr. 25.00  
GR 100 Q 2KW Variac 15N. Gtd. 25.00  
Weston 476 Sq3" B' Case 15VAC Gtd. (\$10) 4.25

Collins transformer mfgd Chicago Trans-  
former Co. Cased HMT'CLLY  
Sec 1100V CT/212ma, Pri 115 & 50/60  
cys. & Two 10 Hy/100 ohm/250ma  
GE Chokes \$ 7.95  
Raytheon cased 850VCT/110ma, 530VCT  
/21ma, 5V/3A, 5V/3A, 6.3V/1A,  
6.3V/3A, HV ins (\$28) @ 2.50  
Two for \$4.50; Five for \$10; 25 for 45.00

Auto Trans 115, 160, 170, 180V/1.95 \$ 2.95  
Choke hmt'clly cased 10HY/100 ma 98 @; 1.75  
2 for 7.95  
Kenyon 115V/60cypri, 5V/60A sec H.V. ins 3.95  
GE Transformers 115V/60cys inpt, 4000V/2-  
ma C'Ray Cased 3.95  
6.3&4V/10A, 6.5V/6A, 5V/3A, 5V/3A  
TRANSF in 230V, outpt 117, 112, 103, 93V  
/7AMP/50C 20.00  
1330VCT/170ma \$4.95; 6.3V/8 Amp. 1.65  
Choke GE 10 HY/250MA/100 ohm 1.95 @; 3.75  
2 for  
Kenyon 1140VCT/250ma 5V/3A, 2.5V/3A,  
6.3V/3A&6.3V/3A 5.95



EICOR DC Dynamotors new  
Gt'd Overseas packed-AB  
insp. Hi-eff. Inpt 12V/8A  
or 24V/4A, output 500V/  
50 ma. Input same output  
275V/110ma & 12V/3A.  
"TAB" SPECIAL EACH  
UNIT \$1.95 OR Both  
units (2) with filter \$3.49.  
Wgt. 9 lbs.; 73/4"L x 27/  
8"H x 4 1/4"W. U. S. Navy  
7 3/4 x 2 3/8. Conservatively  
rated. Can be 6V op.

\$2 Min. order FOB N.Y.C. Add Postage all orders and  
25% deposit. Whitehall 3-3557. Send for catalog 300.  
Specialists in International Export, School, College &  
Industrial trade. Buy thru "TAB" and save.

"TAB" Dept. D11  
SIX CHURCH STREET NEW YORK 6, N. Y.

## INJECTION MOLDING of all Thermoplastics

Dials • Knobs • Small Radio Housings  
Long Runs of Small Plastic Radio Parts a Specialty

ENGINEERING • MOLD DESIGN • MOLD CONSTRUCTION  
HAND MADE MODELS

Stock molds... large selection of stock molds requiring only inserts, saving you time and money.

Our completely modern fully equipped plant offers you quality, quantity and low cost production through the injection process.

Send blue print or sample for estimate... or, on request, we can produce a hand model and quote. Write, wire or phone

### PLASTIC-WARE, Inc.

Plastic Injection Molding from Idea to Finished Product

SINCE 1937

238 William St., New York 7, N. Y. BEckman 3-1122



## EISLER EQUIPMENT\*

complete and diversified for every phase  
of electronic manufacture!

**TRANSFORMERS** in all types—furnace, distribution, power, phase changing, air, oil, induction, water cooled, plate, filament and auto-transformers. Filter chokes and inter-phase reactors.



Transformers supplied from 1/4 to 300 KVA.

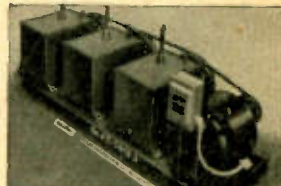

EISLER Compound Vacuum Pump.

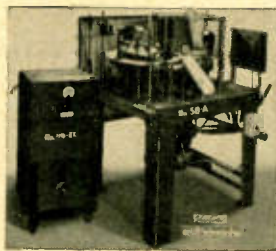

24 Head Radio Tube Exhausting Machine.

\*EISLER machines are in use and in production by 99% of all American radio tube and incandescent lamp manufacturers and throughout the world.

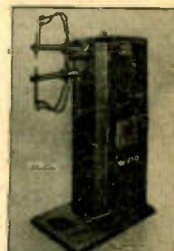

EISLER Spotwelders from 1/4 to 250 KVA.

CHAS. EISLER

### EISLER ENGINEERING CO.

778 South 13th Street

Newark 3, New Jersey

(Near Avon Avenue)

## BAACH-INTERNATIONAL

### EIGHT HEAD HOT-CUT FLARE MACHINE

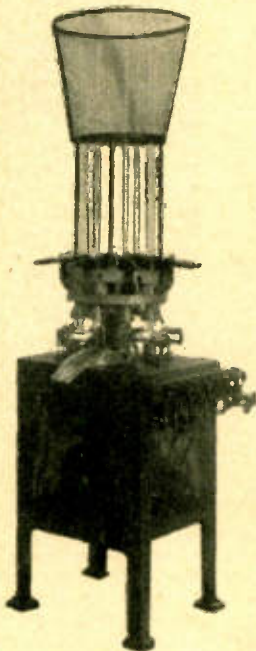

Automatic throughout.

Can be synchronized with automatic Stem machine.

Accommodates eight full lengths of glass tubing.

Cuts off and flares in one operation.

Production 1250 flares per hour.

Made in two sizes: *Miniature machine*, for miniature flares and fluorescent starters, and *Standard machine* for standard size lamps, fluorescent and radio tubes.

Range of *Standard Machine*:

Glass tubing	35 to 42 gauge
Length of flares	5 mm to 80 mm
Forms flares up to	47 mm diameter
Net weight	1500 pounds
Boxed	1700 pounds

### INTERNATIONAL MACHINE WORKS

Manufacturers of High Vacuum Pumps, Automatic Machinery for Incandescent Lamps, Electronic Tubes since 1916.

2027-46TH STREET, NORTH BERGEN, N. J., U.S.A.

Tel. UNion 3-7412. Cable Address "Intermach" North Bergen, N. J.

## magnetic iron powders

Uniformly high magnetic performance, exceptional Q and high permeability of the wide variety of Mephram magnetic iron powders (hydrogen reduced) suggest their use for high-frequency cores, core material, tele-communication and magnetic applications. Production is strictly controlled—prices are attractively low... Consult the Mephram Technical Staff—send for literature.

### G. S. MEPHAM CORPORATION

Established 1902 • East St. Louis, Illinois