

ELECTRONIC INDUSTRIES



1945
FEBRUARY
Caldwell-Clements, Inc.

Heart of This Heart Recorder is a **MALLORY** Precision Switch



Operating this electrocardiograph is sure and simple with the Mallory Circuit Selector Switch indicated by the large dial at upper left. Mallory also provides the Sanborn Company with other switches, jacks and electronic parts for other heart testing instruments and electronic equipment.

COMPACT, weighing only 23 pounds, the Cardiette is a modern portable electrocardiograph made by the Sanborn Company, Cambridge, Mass. Operation of this precise heart recorder is swift and simple with its "Instomatic" switch—a standard Mallory Circuit Selector Switch.

Standard Mallory precision switches have a number of *special* features, including: low-resistance, self-cleaning contacts; "hill-and-valley" index for smooth, positive switching action; heavy insulating sections; notched shafts for easy cutting to desired lengths.

Multi-gang, single gang and push button switches, variable and fixed resistors, volume controls, condensers, plugs and jacks—these and other Mallory Approved Precision Products meet the most exacting design requirements of electronic engineers building for industry and the professions, for assembly line and laboratory.

Write Mallory precision parts into *your* circuit diagrams and blueprints. It's a great convenience to specify *standard* electronic parts built for precision. They are available from your nearest Mallory Distributor or if you have a special design problem, consult our engineers.

P. R. MALLORY & CO., Inc., INDIANAPOLIS 6, INDIANA

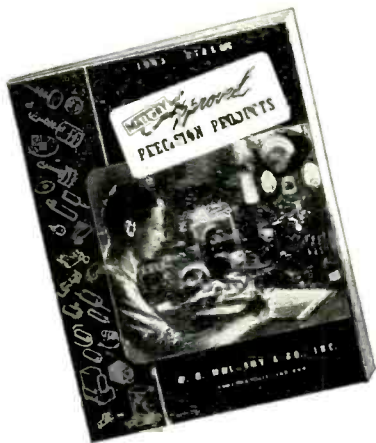

Time-saving information on electronic products is contained in this Mallory catalog. Ask your distributor for a free copy.



P. R. MALLORY & CO. Inc.
MALLORY

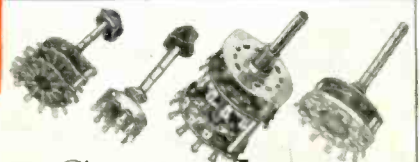
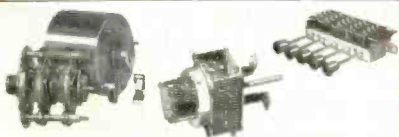

Industrial and Electronic Switches

ELECTRONIC INDUSTRIES

Including INDUSTRIAL ELECTRONICS

★ IN THIS ISSUE FEBRUARY, 1945 ★

FRONT COVER—WABC-FM Antenna	See Page 4
EDITORIAL	75
MEASURING KLYSTRON AMPLIFIER FEATURES—Coleman Dodd	76
PROPOSED ALLOCATIONS	80
ELECTRONIC TOOLS IN CHEMICAL RESEARCH—Robert H. Osborn and Lewis W. Beck	82
FABRICATING PLASTICS	86
WABC'S NEW TWO-BAY ANTENNA—Ogden Prestholdt	88
SHORT WAVE BC TECHNIC—H. G. Towlson	90
EASING MULTIPATH PROBLEMS	95
FACSIMILE EQUIPMENT COMMUNICATION UNITS—Roland C. Davies and Peter Lesser	96
FACTORY SHORT CUTS	100
ELECTRONIC USES IN INDUSTRY—W. C. White	102
OWI MOBILE RECORDER FOR DETACHED SERVICE	106
TUBES on the JOB	108
NAVY'S "TECH" SCHOOL	109
ROCK ISLAND RR RADIO	110
Association News	111
Survey of Wide Reading	112
What's New	114
Washington News	116
New Patents Issued	118
Television Today	120
Personnel	208
New Books	160, 213

ORESTES H. CALDWELL, Editor M. CLEMENTS, Publisher

EDITORIAL STAFF—Ralph R. Batcher, consulting editor; Stanley P. McMinn, managing editor; William Moulic, electronic theory and design; Gilbert Sonbergh, industrial applications; Josepha Zentner, Ph.D., patents and foreign reviews; H. L. M. Capron, engineering management relations; E. T. Bennett, editorial records; Charles Dreyer, art director; Carl Buhrer, circuit diagrams; Barbara Chasen, layout and production; Roland C. Davies, Washington editor.

READER SERVICE—J. Cosin, H. Mirtel; data research, H. Kulik.

CIRCULATION—B. V. Spinetta, circulation director; Subscriptions; list compilation: B. Gollub, M. Groening, B. Ruchalsky.

BUSINESS—M. H. Newton, business manager; John Samborn, eastern manager; Richard Fitzpatrick, western manager; O. H. Sutter, New England Manager; Lee Robinson, district manager; Ben Morris, research; N. McAllister, production manager; J. E. Cochran, make-up; E. P. Butler, E. Hekking; W. W. Swigert, credit manager; W. Kenneth Reynolds, D. Williams, E. Callahan.

CHICAGO MANAGER—R. Y. Fitzpatrick, 201 N. Wells Street. Tel. RAN 9225.

Electronic Industries, February, 1945. Vol. IV, No. 2. Regular price per copy 35 cents. Published monthly by Caldwell-Clements, Inc., 480 Lexington Avenue, New York, N. Y. M. Clements, President; Orestes H. Caldwell, Treasurer; M. B. Clements, Assistant Secretary. Subscriptions: United States and possessions, Mexico, Central and South American countries, \$3.00 for one year; \$5.00 for two years; \$6.50 for three years. Canada, \$3.30 per year; \$5.50 for two years; \$7.15 for three years. All other countries \$5.00 a year. Entered as Second Class Matter, September 20, 1943, at the Post Office at New York, N. Y., under the act of March 2, 1879. Copyright by Caldwell-Clements, Inc., 1945. Printed in U. S. A.

CALDWELL-CLEMENTS, INC.—TEL. PLAZA 3-1340—480 LEXINGTON AVENUE, NEW YORK 17, N. Y.



WHY

AMPEREX

WATER AND AIR COOLED TRANSMITTING AND RECTIFYING TUBES

An "Amperextra" greatly responsible for the high efficiency of Amperex tubes are our specially designed filaments. These filaments are correctly proportioned to take advantage of the full projected filament area. As a precaution against strain in processing, each filament is pre-formed and cleaned in vacuum before being mounted. This "Amperextra" is only one of many Amperex developments which, in total, make for longer operating life and greater economy.

NOTE! There are more than 100 different types of Amperex tubes for broadcasting, industrial and electro-medical applications. Many of our standard types are now available through leading radio equipment distributors.

AMPEREX ELECTRONIC CORPORATION

79 WASHINGTON STREET BROOKLYN 1, N. Y.
Export Division: 13 E. 40th St., New York 16, N. Y., Cables: "Arlob"

HELP KEEP THE CASUALTY LISTS DOWN... DONATE BLOOD TO THE RED CROSS

“Capacitors of Long Life”

is more than a slogan at

TOBE



Long Life is a Quality Built into
each and every Capacitor we make



SPECIFICATIONS OF JUST ONE TYPE OF THE MANY TOBE OIL-IMPREGNATED
AND OIL-FILLED PAPER CAPACITORS...

SPG-CAPACITORS

TYPE	SPG*
RATINGS	.05 to 2.0 mfd. 600 V.D.C. .05 mfd. to 1.0 mfd. 1,000 V.D.C.
STANDARD CAPACITANCE TOLERANCE	20%**
TEST VOLTAGE	Twice D. C. rating
GROUND TEST	2,500 Volts D. C.
OPERATING TEMPERATURE	-55° F to 185° F
SHUNT RESISTANCE	
	.05 to 0.1 mfd. 20,000 megohms .25 to 0.5 mfd. 12,000 megohms 1.0 mfd. 10,000 megohms 2.0 mfd. 5,000 megohms
POWER FACTOR	1,000 cycles—.002 to .005
CONTAINER SIZE	
Width	3/8", length 1-5/16", height 2 1/4"
MOUNTING HOLE CENTERS	1 1/2"

MIDGET SPG-CAPACITORS

TYPE	SPGM*
RATINGS	.05, .1 and 2 x .05 600 V.D.C. .05 and .1 1,000 V.D.C.
STANDARD CAPACITANCE TOLERANCE	20%**
GROUND TEST	2,500 V.D.C.
OPERATING TEMPERATURES	-55° F to 185° F
SHUNT RESISTANCE	20,000 megohms
POWER FACTOR	At 1,000 cycles—.0075
CONTAINER SIZE	
Width	3/8", length 1-5/16", height 1-11/64"
MOUNTING HOLE CENTERS	1 1/2"

*Data sheets showing complete code number for units having a specific capacitance value and voltage rating available on request. **Other tolerances available.

Illustrations show capacitors with terminals on bottoms.
Capacitors also available with terminals on top.



A SMALL PART IN VICTORY TODAY — A BIG PART IN INDUSTRY TOMORROW



When the Going Is Hardest . . .

MERIT TRANSFORMERS

are in the thick of the fight standing up to the most exacting demands and doing their part to maintain vital communications and operating controls.



MERIT COIL & TRANSFORMER CORP.

TELEPHONE

4427 North Clark St. Long Beach 6311 CHICAGO 40, ILL.

THE COVER

The illustration used on the cover this month is reproduced from a color photograph made especially for Electronic Industries by Columbia Broadcasting System photographers. It shows the new two-bay General Electric FM antenna which CBS recently completed atop a tall office building in mid Manhattan, and is now using. The radiator is mounted at the top of a 100-foot steel mast which has been erected on the office building roof 700 feet above street level. The building itself is 60 feet above sea level, making the height of the antenna 847 feet, the center of the radiating portion being 13 feet from the top of the tower. An article descriptive of the new installation appears on pages 88 and 89.

Electrical Industry Output Nine Billions

The electrical manufacturing industry's production index for 1944 topped by five per cent the all-time record output of '43—despite the fact that ten-month indices for all industries showed a one per cent decline, reports W. J. Donald, managing director of the National Electrical Manufacturers Association. Electrical manufacturers produced approximately nine billion dollars worth of products during 1944. The biggest gain in the electrical field was in signalling and communications equipment, attributed to the vastly stepped-up output of telephone equipment—particularly field and ship telephones—and signalling apparatus.

Frontier Jumper

"Television will be the most potent factor in the postwar world. It will be a great international frontier jumper, hurdling all barriers of language, and ripping off the sham and the farce of falsehood and insincerity. Television looks you straight in the eye—and deceit and lying are laid bare."—Samuel H. Cuff, General Manager WABD, before the Women's Press Club of New York.



"You mean you've never heard of electronics?"
—Colliers



Central stocks in 26 G-E warehouses mean quicker deliveries of tubes like this widely used ignitron

Warehouse supplies of G-E industrial tubes back up the stacks on the shelves of local G-E distributors — are maintained from Boston to Los Angeles, Minneapolis to New Orleans, enabling your plant to have electronic tubes when needed.



**IGNITRON FG-235-A
PRICE \$75**

G-E electronic tubes are marketed through the most extensive industrial tube sales and service organization in the country.

G-E district and local offices, G. E. Supply Corporation houses, and the branches of Graybar Electric Company represent 265 main distribution outlets. Behind these convenient local supply sources are 26 G-E warehouses in strategically placed cities from coast to coast.

G. E.'s purpose in building up these warehouse stocks, and also in keeping supplies of critical tubes on its distributors' shelves for quick delivery, is to help prevent factory

shutdowns due to local non-availability of electronic tubes. Your G-E tubes come from freshly checked stocks in your own or a nearby city, and you do not have the annoyance and delay of waiting for replacements. Further, the extensive G-E office, warehouse and distributor organization brings skilled technical consultation and aid to your plant doorstep.

Contact your nearby G-E office or distributor for prices, specifications, and performance charts on ignitrons, thyratrons, or other industrial type tubes. Or write direct *Electronics Department, General Electric, Schenectady 5, N. Y.*

A steel-jacketed, water-cooled, gas-filled triode with mercury-pool cathode, used both in welding control service and as a low-power current converter. Rugged, compact, easy to install, economical to operate. For welding control service, in which the FG-235-A finds its most popular application, the ratings are: maximum kva demand 1,200, with corresponding average anode current 75.6 amp—maximum average anode current 140 amp, with corresponding kva demand 400. (These ratings are for voltages of 600 rms and below.) Ignitor requirements are 200 v and 30 amp. Ask for full ratings, characteristics, and other data on Type FG-235-A and other tubes in the ignitron series, which will gladly be supplied.

Hear the G-E Radio programs: "The World Today" news, Monday through Friday, 6:45 p. m., EWT, CBS. "The G-E All-Girl Orchestra," Sunday 10 p. m., EWT, NBC. "The G-E House Party," Monday through Friday, 4 p. m., EWT, CBS.

Current Low Prices on G-E Electronic Tubes Are Due to Large Demand, which Has Made Possible Line Production Methods in the World's Most Modern Tube Factory

GENERAL  ELECTRIC

162 D3-8880



**"COIL? ALBION CAN SHIP YOU ALL
THE COILS YOU NEED."**

SUPER-QUALITY COILS AT REASONABLE PRICES

More and more every day, the industry is turning to Albion for fast, quality and quantity production of coils, chokes, and transformers. That's because here you benefit from the unbeatable combination of management "know how," skilled workmanship, streamlined facilities, and central location. Your requirements will be given prompt and thoughtful attention.

**ALBION
COIL COMPANY**

ALBION, ILLINOIS

R. F. AND TRANSMITTING COILS AND CHOKES;
I. F. TRANSFORMERS

ELECTRONIC INDUSTRIES • February, 1945



When the guns
are racked . . .

When the shooting is over and the great civilian demands can again be met, Jefferson Transformers will be ready.

Under the stimulus of war production, still greater developments in manufacturing technique and quality control have been effected to insure you Transformers to meet your most exacting requirements.

When the guns are racked, we'll be ready to serve you. JEFFERSON ELECTRIC COMPANY, Bellwood (Suburb of Chicago), Illinois. *In Canada:* Canadian Jefferson Electric Co., Ltd., 384 Pape Avenue, Toronto, Ontario.

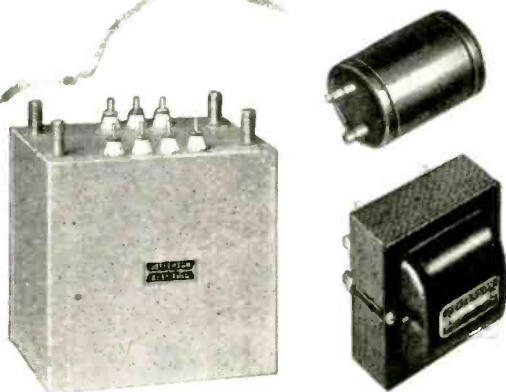

T R A N S F O R M E R S

MAGNAVOX IS ALSO HEADQUARTERS FOR SOLENOIDS

THIS is the youngest of the Magnavox family, but like the other members is on top of the heap.

Did you know: That every solenoid used by any branch of the armed forces—firing all automatic weapons from .30 calibre machine guns to 105 m. m. cannon—was developed by Magnavox?

- That Magnavox has been providing every type of solenoid—fifty different models?
- That the production of solenoids by Magnavox during the war has been greater than that of all other manufacturers combined?
- At present we can only consider inquiries for quan-

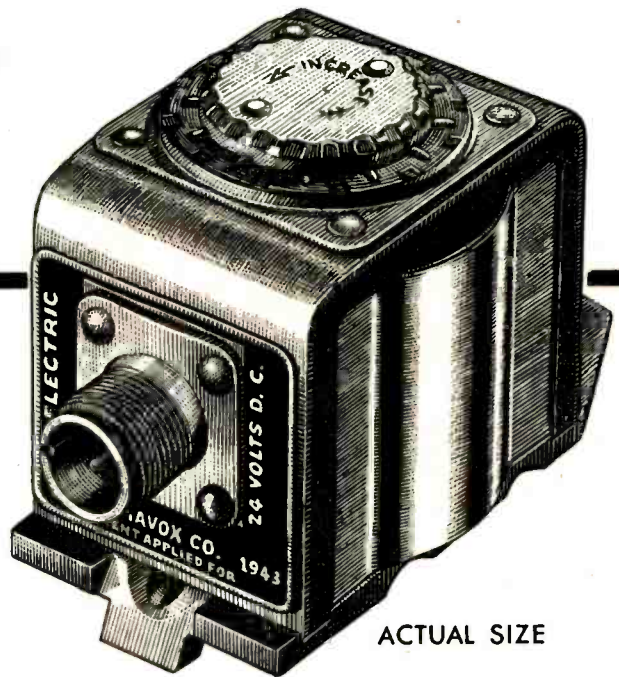

ACTUAL SIZE

tity production, but that situation will change. If you have any solenoid problems, we suggest that you consult our technical department. Their skills are at your service, plus the outstanding facilities of our completely modern six-acre plant.



The Magnavox Company, Special Devices Division, Fort Wayne 4, Indiana.

Magnavox
has served the radio industry 33 years

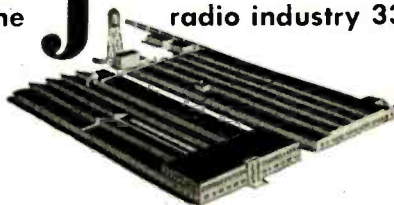

SPEAKERS • CAPACITORS • SOLENOIDS • ELECTRONIC EQUIPMENT

ELECTRONIC INDUSTRIES • February, 1945

An IRC Adapter You'll Want to Adopt

CONNECTOR #50.394-1
U. S. SIGNAL CORPS #M-359
NAVY PART #CI-49192



U. S. ARMY-NAVY RIGHT ANGLE PLUG

HERE'S an UHF elbow adapter that will prove to be your answer to many a coaxial cable problem. Engineered and tested to surpass the rigid Army-Navy specifications for this type unit, it will find many applications where a change in cable direction is desirable. • The die-cast zinc housing, as well as all other metal parts, is heavily silver plated. Contact parts, both pin and socket, are made of special spring-brass and engineered so as to insure positive, vibration-free contact. Insulation is polystyrene. • Plug is designed to take the following cables: Army-Navy types RG-7/U, RG-8/U, RG-9/U, RG-10/U, RG-11/U, RG-12/U, RG-13/U, RG-63/U, RG-65/U.



For engineering data, write today for Bulletin No. 4



CONNECTOR DIVISION OF
INTERNATIONAL RESISTANCE CO.

DEPT. B-2, 401 N. BROAD STREET, PHILADELPHIA 8, PA.

new directions in radio . . .



hallicrafters

*New directions
in radio will
be charted by
Hallicrafters*

As radio development moves onward and upward, Hallicrafters engineers are setting the pace, pushing back the horizons in the exciting fields of very high frequency, ultra high frequency, and super high frequency development work. The range of the Model S-37 illustrated here covers higher frequencies than any other continuous tuning commercial type receiver. It is becoming a prime instrument of experiment and research in marking out the new directions that all radio will take.



hallicrafters RADIO

Buy a War Bond Today!

THE HALLICRAFTERS CO., MANUFACTURERS OF RADIO AND ELECTRONIC EQUIPMENT, CHICAGO 16, U. S. A.



CHECK on this "QUICK-CHECK" Feature of the Solar Capacitor Analyzer . . .



THE SOLAR MODEL CE Capacitor Examiner speedily locates common defects in capacitors without disconnecting condensers—often eliminating further tests. This saving of time and labor is accomplished by the unique Solar "QUICK-CHECK" feature.

In this *single* instrument are combined the simplest, most convenient methods for examining the true condition of every capacitor in ordinary use . . . shorts, opens, intermittents, high R.F. impedance and high power factor.

Catalog IN-1 illustrates and describes features of all models. Send for your copy today.



Solar Mfg. Co.

ANOTHER HELPFUL SOLAR SERVICE

SOLAR CAPACITOR SALES CORP.
285 Madison Avenue, New York 17, N. Y.

Please send me a copy of Catalog IN-1 on Solar CAPACITOR ANALYZERS.

Name

Title

Company Name

Street Address

City State

SEND THIS COUPON IN—TODAY

7756



CONTROL FOR

Giants

RELAYS are vital in the control of many parts and functions of our new giant planes. Automatic flying, communication, navigation and actual combat equipment all depend in varying degree on the satisfactory operation of relays.

Allied relays are designed to assure troublefree service under the most adverse conditions resulting from terrific temperature changes, altitude and excessive vibration. Whether the requirements are for power application or extreme sensitivity where the relay must operate under almost negligible power, Allied design meets the severest tests.

Allied has been foremost in engineering and design of relays for special applications. If your product requires electrical control we recommend that you specify .. Allied



ALLIED CONTROL COMPANY, INC.

2 EAST END AVENUE (AT 79th STREET) • NEW YORK 21, N. Y.

FACTORIES: NEW YORK CITY • PLANTSVILLE, CONN. • CHICAGO, ILL.

14 MICRO SWITCHES

Control 12 Accurate Operations of this Stokes Molding Press Every 33 Seconds

Timing, limiting and safety operations of this Stokes Automatic molding press, which can perform a complete cycle in as little as 33 seconds, are accurately controlled by 14 Micro Switches:

The F. J. Stokes Machine Company of Philadelphia, Pa., turned to Micro Switch as the control components of this accurate molding machine because their small size, precise operating characteristics, long life and dependability most exactly met their requirements.

Experience of the F. J. Stokes Machine Company with Micro Switches is typical of the many uses design engineers are finding for this small, sensitive, durable, snap-action switch.

Design engineers who are planning products for the highly competitive post-war markets should be thoroughly familiar with Micro Switches and the many advantages they have to offer. We will be glad to send you as many Micro Switch Handbook-Catalogs as you may be able to use. Write for them today.

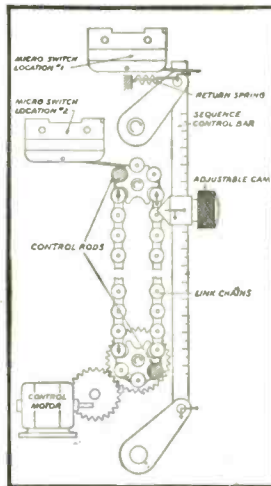

Nine Plastic Enclosed Micro Switches are used in the sequence and timer control. Eight of them are actuated by adjustable cams set along the sequence control bars. The ninth shuts off the control motor and starts the timer which determines the curing operation of the mold.

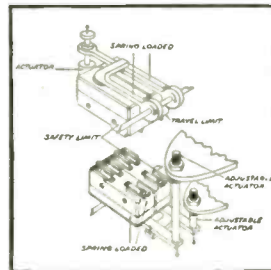

Four Plastic Enclosed Micro Switches are used—two as travel limits and two as safety limits for the press ram. The travel limits are operated by adjustable push rod actuators to stop the press ram at the correct extremes of movement. The safety limits operate only to stop the press if the others should not be set correctly.

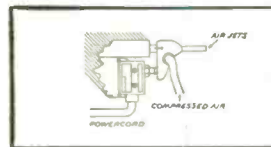

One Die Cast Enclosed Micro Switch is used on the air and mechanical mold cleaner. It is actuated by a push rod and operates the six air jets which blow a sheet of air through the mold to blow off the molded part.

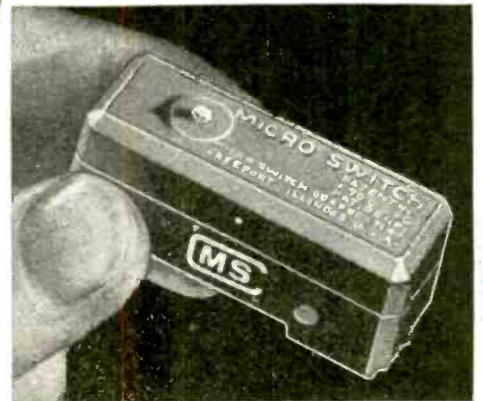
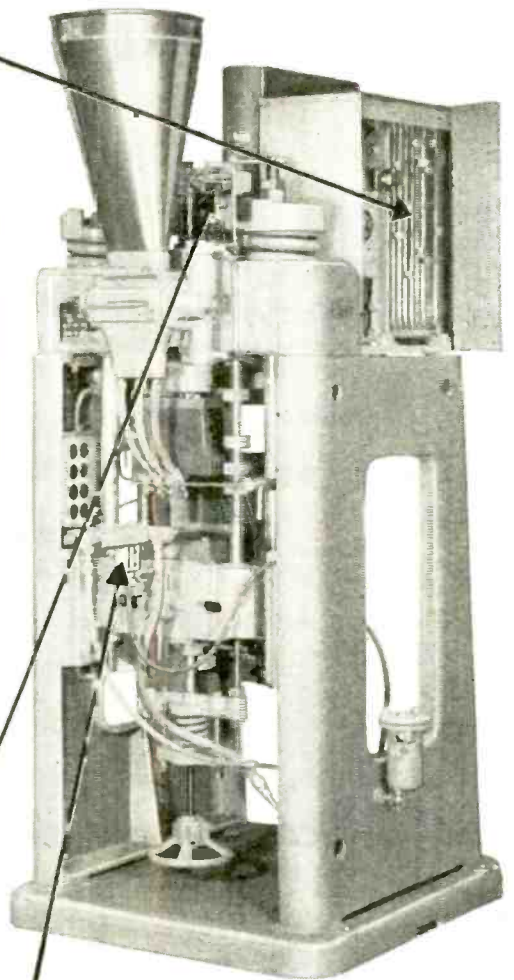

Handbook-Catalog No. 60 gives complete details on electrical characteristics, housings, and actuators.

Handbook-Catalog No. 71 gives complete information on Micro Switch for use in aircraft equipment.



Two stars have been added to our "E" Flag as further recognition to the men and women of Micro Switch for maintaining our war production standards.

MICRO **MS** **MARK**
TRADE **SWITCH**

A DIVISION OF FIRST INDUSTRIAL CORPORATION

FREEMONT, ILL., U.S.A., Sales Offices in New York, Chicago, Cleveland, Los Angeles, Boston, Dallas, Portland, (Ore.)

The basic Micro Switch is a thumb-size, feather-light, plastic enclosed, precision, snap-acting switch. Underwriters' listed and rated at 1200 V.A. at 125 to 460 volts a-c. Capacity on d-c depends on load characteristics. Accurate reproducibility of performance is maintained over millions of operations. Basic switches of different characteristics are combined with various actuators and metal housings to meet a wide range of requirements.

Let's all back the attack—Buy extra War Bonds

© 1945



...COLLABORATION

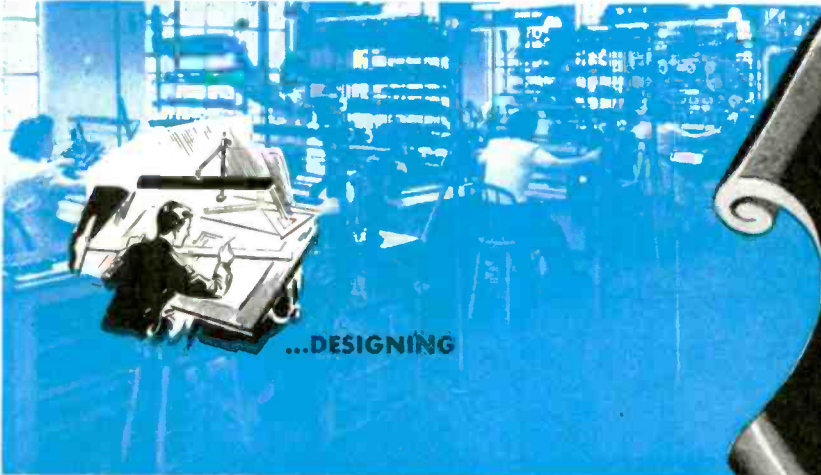

...DESIGNING



...TESTING

N·Y·T

..facilities to
meet critical
transformer
requirements
economically



The transformer illustrated is typical of the many immersion-proof designs conceived by N-Y-T. These compact components represent achievements in compactness and immunity to operating hazards.

With current deadline and delivery factors steadily being overshadowed by sharpened-pencil cost considerations, fluctuations in price structure will be in evidence. Adjustment for post-war necessities will, in all probability, be on a downward trend without sacrifice of quality or reliability.

From its inception, N-Y-T has 'majored' in the design of transformers, chokes, filters and solenoids, custom-engineered to meet specific requirements. Aside from meeting

exacting requirements, all phases of production—collaboration, design, and manufacture—were 'in line' relative to cost.

This same policy—currently adhered to—is credited with numerous solutions in vital military design problems. Manufacturers projecting peacetime plans should keep in mind the record of N-Y-T in accomplishing 'impossibilities' . . . economically.



NEW YORK TRANSFORMER CO.

22-26 WAVERLY PLACE

NEW YORK 3, N. Y.

Crystal Blanks TO YOUR SPECIFICATIONS

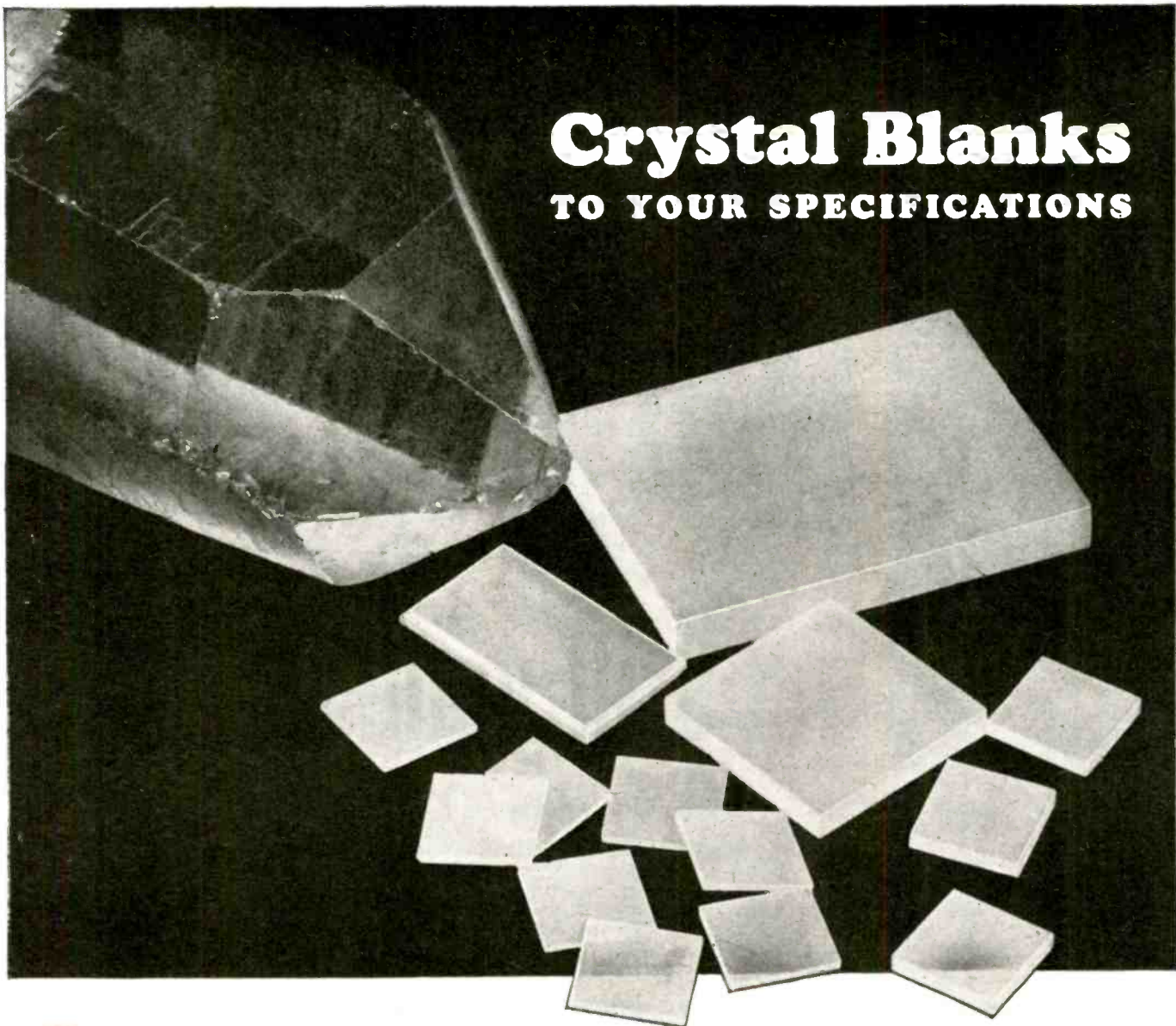

Crystal Products Company can supply Quartz Crystal blanks in any of the three stages of manufacture: (1) "rough-sawed" blanks, (2) "semi-finished" blanks, and (3) "electrically finished" blanks.

"Rough-sawed" blanks are cut to the specified angles and roughly sawed to dimensions.

"Semi-finished" blanks are blanks which have been brought to approximate dimensions by machine lapping, allowance being made for final hand finishing.

"Electrically-finished" blanks are finished by hand to the frequency desired and electrically tested.

All crystal blanks are cut to specifications from selected Brazilian quartz and guaranteed free from all impurities such as optical twinning, electrical twinning, bubbles, fractures, scratches, mineral inclusions, and other mechanical and electrical imperfections. Dimensions, temperature coefficients, and frequencies are guaranteed within specifications listed. **Send us your holders for replacement of crystal blanks to exact specifications.**

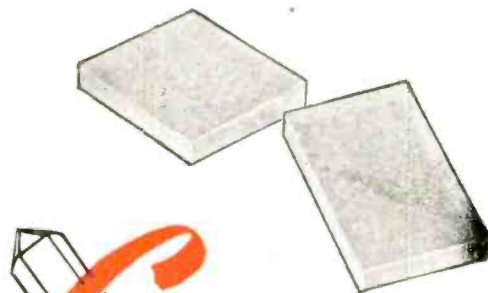

Crystal
PRODUCTS COMPANY

1519 McGee Street, Kansas City, Mo.
Producers of Approved Precision Crystals
for Radio Frequency Control



2044 A.D.

Still young at 99..

It is really worthwhile to use a *permanent* tracing paper, for you never can tell when an old drawing may have to be consulted or reproduced. In many drafting room files there are drawings on ALBANENE that are years old, but are still in perfect condition, and should stay that way for 99 years or more. Protect your designs, your inventions, your business itself—use ALBANENE!

ALBANENE Tracing Paper is treated with Albanite, a crystal-clear, unaltering synthetic developed by the K & E Laboratories. So far as the most severe tests show, it should last almost forever. The paper itself is 100% white rag stock. The Albanite not only makes it ageless but extra transparent. And because ALBANENE stays white, it gives strong, contrasting prints. It's fine to work on too, with pencil or ink—keeps clean and takes erasures well. Comes in rolls, sheets, and pads. Write on your letterhead for sample sheet.

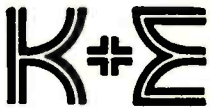

Drafting, Reproduction, Surveying
Equipment and Materials
Slide Rules, Measuring Tapes



Albanene

REG. U. S. PAT. OFF.

KEUFFEL & ESSER CO.

EST. 1867

NEW YORK • HOBOKEN, N. J.

CHICAGO • DETROIT • ST. LOUIS • SAN FRANCISCO • LOS ANGELES • MONTREAL

ELECTRONIC INDUSTRIES • February, 1945

Variable Resistors of

UNIFORM QUALITY

Ever since it was founded in 1896, the Chicago Telephone Supply Company has taken special pride in the exceptional uniformity of their products. Once specifications have been agreed upon for an order, every C.T.S. resistor delivered on that order will be right—and they will be right on time.

Such results—in a plant producing millions of units each year—can be achieved only by engineers and workmen who combine the highest degree of skill with true craftsmen's pride in their work.

*Manufacturers of Quality
Electro-Mechanical
Components Since 1896*

SWITCHES, TELEPHONE GENERATORS, RINGERS
VARIABLE RESISTORS, PLUGS AND JACKS

REPRESENTATIVES

R. W. Farris
406 West Thirty-fourth Street
Kansas City 2, Missouri
Phone: Logan 7495

Frank A. Emmet Co.
2837 West Pico Boulevard
Los Angeles 6, California
Phone: Rochester 9111

BRANCH OFFICES

S. J. Hutchinson, Jr.
401 North Broad Street
Philadelphia 8, Pennsylvania
Phone: Walnut 5369

IN CANADA

C. C. Meredith & Co.
Streetsville, Ontario



CHICAGO TELEPHONE SUPPLY
Company

ELKHART • INDIANA

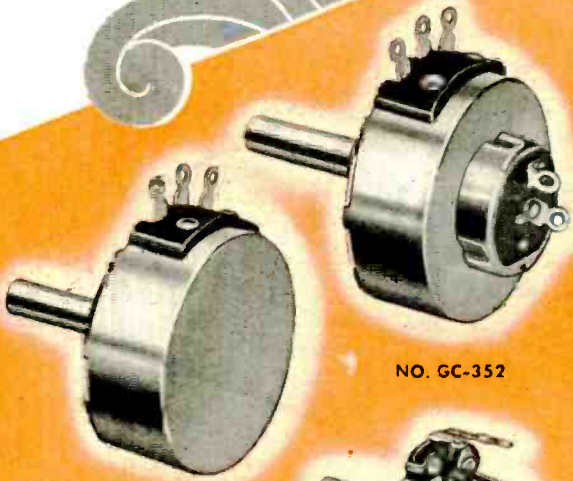

NO. GC-352

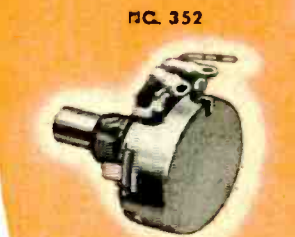

NO. 352



NO. GC-45



NO. 45

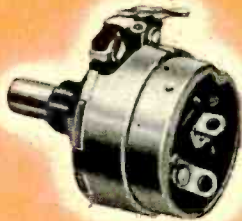

NO. AC-35



NO. 35



NO GC-252



NO. 252



NO. GC-25



NO. 25

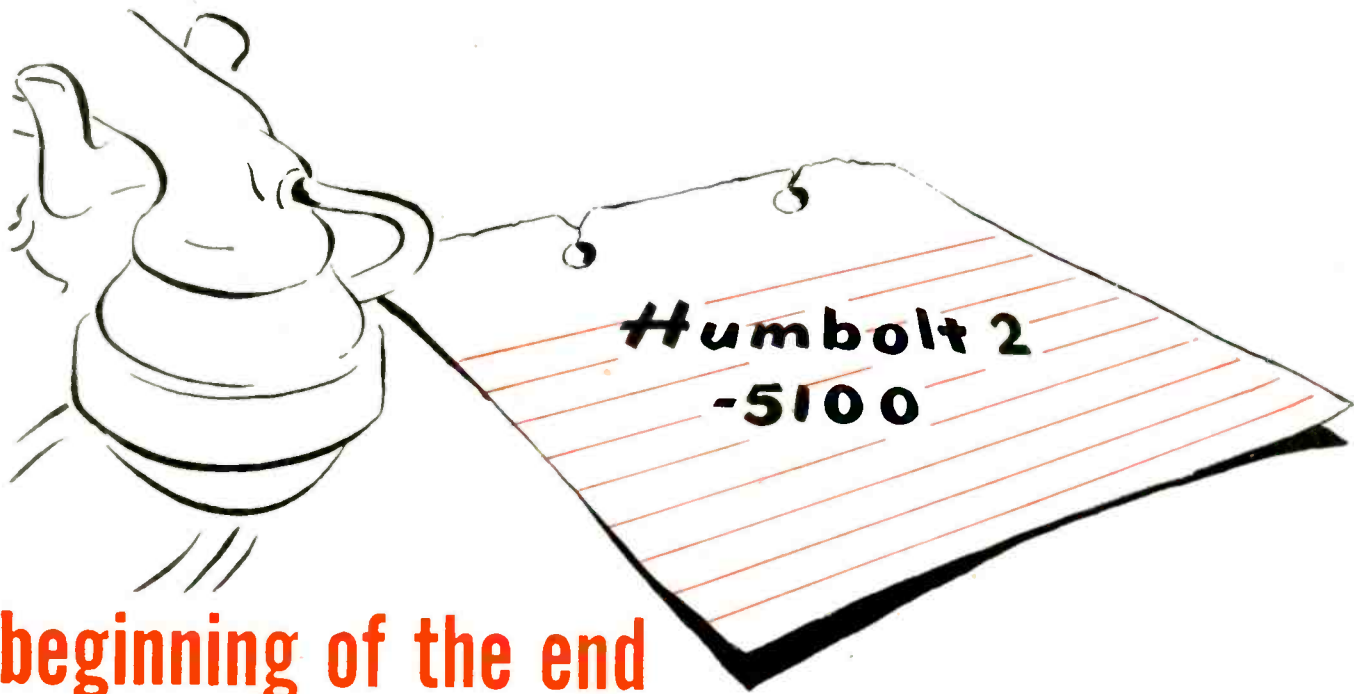

beginning of the end for product headaches

In a brief telephone call you can arrange for a meeting to discuss Foote, Pierson contract manufacturing service. By making it, you may be taking the first step in ending a troublesome production headache.

For, without obligation on your part, a frank face-to-face conversation with Foote, Pierson technical men may provide an answer you're looking for . . . may show you how to get—*economically*—the extra product or the extra component you need.

Even before you talk things over, keep in mind these facts about Foote, Pierson & Co. It has been in contract manufacturing most of its 48 years in business. It has machines and tools and the manpower and technicians to lick tough present day schedules. Top to bottom, its personnel brings to your problems ingenuity, skill and a sense of loyal responsibility.

F-P service can start as far back as planning, engineering and design. It can include metal-forming and fabricating operations. It can extend to plating and finishing a product or a product's component. It can follow through all the way from assembling, inspecting and packaging to the shipment by rail, water or air freight from the company's uniquely favorable location in Newark, which includes storage warehouse facilities.

Why not 'phone HUMBolt 2-5100 now and make an appointment?



"like adding a wing
to your plant"

FOOTE • PIERSON & Co. INC

MANUFACTURERS OF PRECISION INSTRUMENTS SINCE 1896

75 Hudson Street



Newark 4, N. J.

Ⓜ 7168

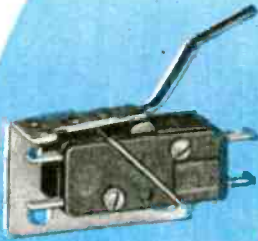

A leaf actuator makes this Switchette into a tiny limit switch.

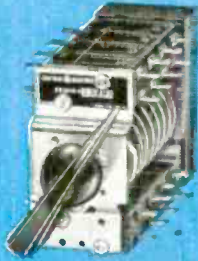

Selector switches made up of Switchettes provide compact, sequence circuit control.

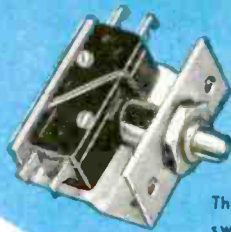

This small but sturdy limit switch has widespread application. The Switchette is actuated by a plunger.



In this compact multicircuit switch, Switchettes save space and weight.

The G-E Switchette

KEY TO COMPACT DESIGN

YOU can use Switchettes to control several circuits from a single location. They can be actuated by cams in selector switches, or by a bellows or lever in limit switches. Whichever way you use them, G-E Switchettes help you save space and make your equipment more compact.

Note the dimensions: $1\frac{1}{4}$ by $\frac{1}{2}$ by $\frac{1}{2}$ inch. Yet the Switchette handles up to 10 amperes at 24 volts d-c (230 volts a-c), and is sturdy enough to withstand millions of mechanical operations.

Its small size, its lightning-fast snap action, and its ability to resist high physical shock and vibration make it ideal for built-in applications on electric control equipment

that has to "take it." Best of all, because of its unusual double-break contact structure, it simplifies the solution of many tricky circuit-control problems.

Don't handicap your important designs

Your plans for a smaller, lighter, or more compact equipment need not be stymied by the lack of a suitable make-and-break contact mechanism. More than 200 modifications of the Switchette are ready to meet your needs. In addition, we have a variety of limit switches, transfer and selector switches, push-button stations, thermostats and timers built around the Switchette. Perhaps you can use some of these

ready-made devices to advantage.

Send for a catalog

If you don't already have a copy of our Switchette catalog, mail the coupon below. If none of the forms listed in the catalog meet your needs, our engineers will be glad to work with you to adapt them. *General Electric Co., Schenectady 5, New York.*

General Electric Company, Section B676-142
Schenectady 5, New York

Please send me Bulletin GEA-3818, which gives detailed information on Switchettes.

NAME.....

COMPANY.....

ADDRESS.....

GENERAL ELECTRIC



IMPERVIOUS TO HEAT, WATER AND FUNGI GROWTH

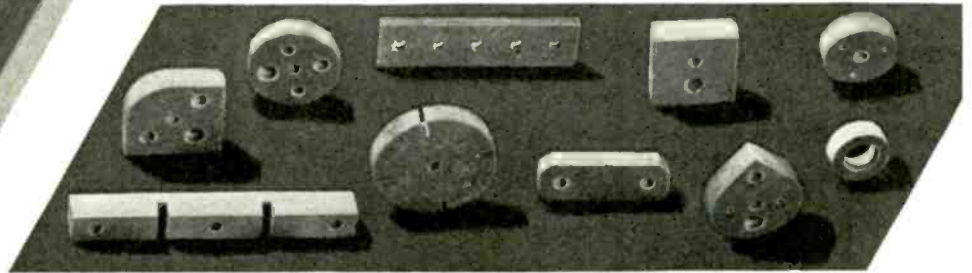
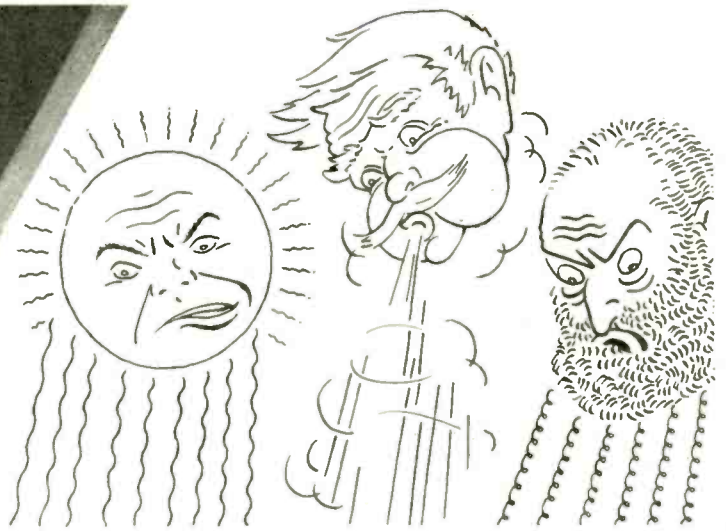

PEMQUE is a high frequency Glass Bonded Mica insulating material produced exclusively by the INTERNATIONAL PRODUCTS CORPORATION. By a new PYRO-WELDING process, we have developed in PEMQUE a product that is moisture proof—heat proof and impervious to fungi growth.

Because of its extreme density PEMQUE can be machined to very close tolerances. Its "service life" is practically unlimited.

We are in a position to supply sheet stock in quantities and the most intricate sizes and forms in the shortest possible time.

Write us for more detailed information

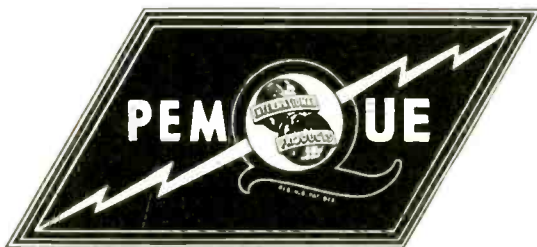

INTERNATIONAL PRODUCTS CORPORATION

2554 GREENMOUNT AVENUE
BALTIMORE 18, MARYLAND

QUOTATIONS CHEERFULLY SUBMITTED ON REQUEST

PROPERTIES

ELECTRICAL	
Dielectric Constant	7.21
Power Factor	.002-.003
(At one Megacycle)	
(After 48 hours in distilled water at room temperature)	
Arc Resistance (Current and time to form conducting path)	
Milliamperes Average	45
Seconds Average	427
PHYSICAL	
Water Absorption	.009
Coefficient of Linear Expansion	
Per Degree C	10 x 10-6
Density—lbs. per cubic inch	.100
Specific Gravity	2.83
Color	Gray
Surface	(Hard-Smooth)
Porosity—After 6 hours in dye at 10,000 psi there was no visible penetration into the sample.	
MECHANICAL	
Tensile Strength—	
lbs. per sq. in.	8,500-10,000
Compressive Strength—	
lbs. per sq. in.	35,000-45,000
Flexure	17,000-18,500
Impact Strength (IZ0d)	
Energy absorbed ft. lbs.	
Per inch—Width (Aver.)	0.437
Per inch—Square (Aver.)	2.25
Pemque will not soften until it reaches a temperature of 800° to 900° F. It has, however, a permanent expansion as shown on the following table:	
Permanent Expansion 15-Min. Cycle	
750 F.	.05%
850 F.	.29%
950 F.	1.75%

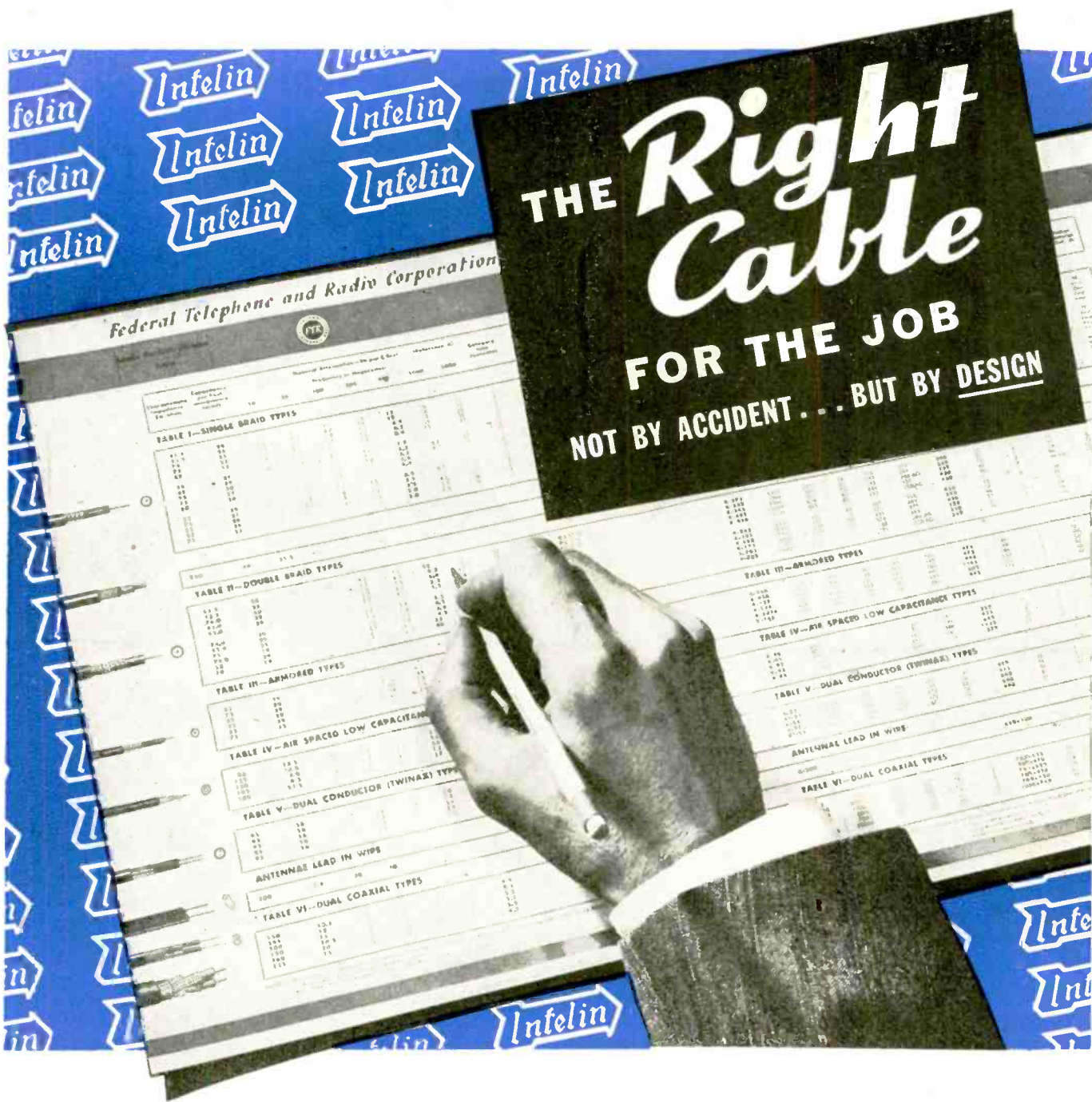

To assist the equipment designer Federal offers comprehensive data on high frequency cables.

This technical information sheet provides the design-engineer with pertinent electrical and physical characteristics...including impedance, capacitance, attenuation, diameter, materials, and weight... for Federal's wide variety of high-frequency cables.

Single and double braid, armored, dual con-

ductor and dual coaxial, air-spaced, low capacitance lines, and antenna lead-in wire... there's a right type for your job, backed by the built-in superiority that's a tradition with Federal.

Special developments in flexible low-loss cables by Federal have resulted in superior cables for all types of transmission. For a better job, see Federal first.

Write for your cable information sheet today.



Federal Telephone and Radio Corporation

Newark 1, N. J.



Electronics

HAS US WOOLZY...

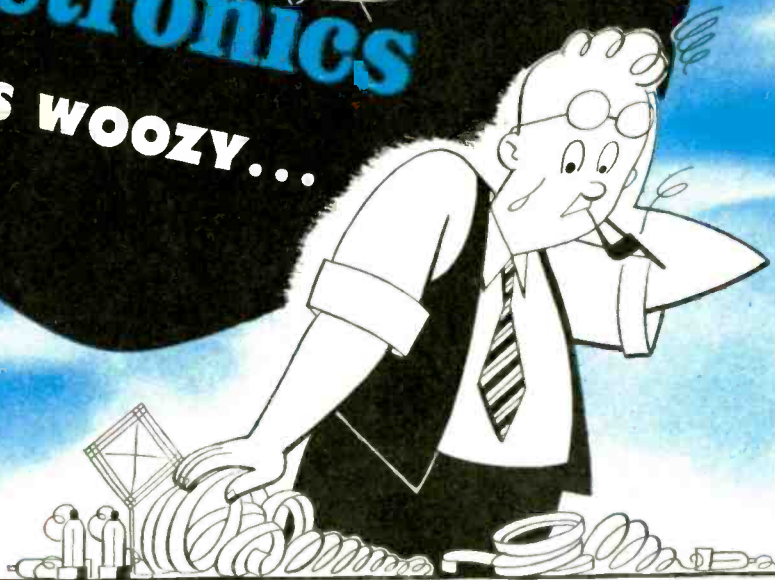

BUT WE DO KNOW ALUMINUM

As a designer, builder or user of electronic or electrical equipment, you know what you want a material to accomplish there. Up to that point, frankly, we probably can't help much. But name the requirements and we'll send some real men into the game. They *know* aluminum.

Is there a corrosion problem, a question of weight or strength? Alcoa engineers have a wealth of data on which to base their alloy recommendations. Must it have peculiar electrical properties? Aluminum is nonmagnetic,

you know, and an excellent conductor of electricity.

Are parts to be sand-cast, permanent mold or die-cast? Could they be produced better as extruded shapes, forged or formed from sheet? Alcoa's manufacturing divisions offer complete fabricating services, so they play no favorites. Alcoa advice is based on what's most economical for you.

For this service, write ALUMINUM COMPANY OF AMERICA, 1921 Gulf Building, Pittsburgh 19, Pennsylvania.



He has a wealth of information



Alcoa gives you your choice

ALCOA FIRST IN ALUMINUM



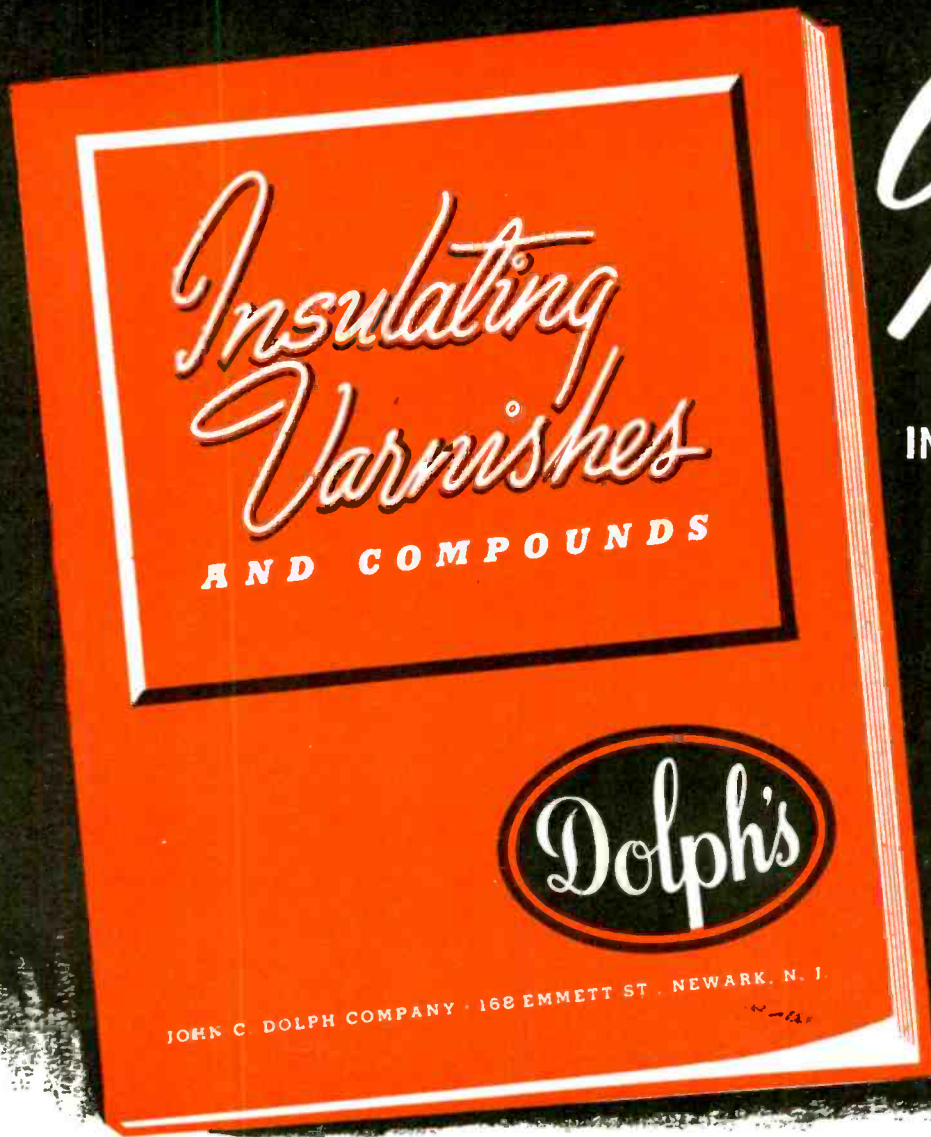

New

**THIS 56 PAGE
INFORMATIVE BOOKLET**

To those interested in insulating varnish, this booklet presents an informative and worthwhile approach to their insulation problems. A valuable, ready reference!

- ✓ **Product Information**
- ✓ **Reference Tables**
- ✓ **Production Control**
- ✓ **Research**
- ✓ **Testing Procedure**
- ✓ **Application Methods**
- ✓ **Solvent Chart**

- ✓ **History of Insulating Varnish**
- ✓ **Illustrations**
- ✓ **Complete Index**

SEND FOR YOUR FREE COPY TO-DAY

Just pin the coupon to your Company letterhead and return it to us.

Firm _____

Name _____

Address _____

City _____ State _____

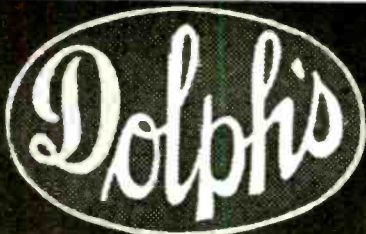

JOHN C. DOLPH COMPANY

Insulating Varnish Specialists

173C Emmet Street, Newark, New Jersey

"Have you seen this dope on Bridgeport?"

"Yes. That's the company that's going to get our coil business after the war. Right now they're turning out search coils and variometers for the army by the carload."

HERE'S MORE DOPE ON BRIDGEPORT:



After V-Day, the same personnel that meet the most exacting military specifications and the same capacity that enables Bridgeport to produce search coils and variometers in the quantities necessary for our Armed Forces will be your assurance of quality and service.



Bridgeport's central location, right near the center of population, gives you fast, trunk line service to any point in America. Write to us TODAY to insure early postwar delivery of R. F. coils and ohokes, I. F. transformers and transmitting coils and chokes.

BRIDGEPORT

MANUFACTURING COMPANY
Bridgeport, Illinois

R. F. Coils • R. F. Chokes • I. F. Transformers
Transmitting Coils • Transmitting Chokes

War Babies are Children of Destiny!



E-E Engineering nurtures them —

Disparaging connotations to the contrary new inventions—the war-babies of today—are destined to be the production giants of tomorrow! New processes born of adversity—electronically controlled resistance welding and electronic induction heating, typify this trend. The growth of these industrial embryos depends, in the last analysis, on the development of efficient applicable components essential to the particular job in hand. E-E Grid controlled Rectifiers are such components.

Specifically designed to supply constant voltage under widely varying load conditions, these tubes meet, completely, the rigorous requirements of industrial applications. By a simple, inexpensive circuit adaption they also provide a continuously variable source of power of unusual flexibility, ideally suited to electronic heating. Further—the use of these tubes, in appropriate circuits, effects considerable reduction in hum with accompanying lower filter cost.

For complete technical information, write for the new E-E Data Book today. No obligation is incurred.

ELECTRONIC ENTERPRISES, INC.



GENERAL OFFICES: 65-67 SEVENTH AVENUE, NEWARK, 4, N. J.
EXPORT DIVISION: 25 WARREN STREET, NEW YORK, 7, NEW YORK

CABLE ADDRESS: SIMONTRICE NEWYORK

THESE PLASTIC PILLS

can kill tubes *Fast!*

...unless the tubes are specially designed

Faster and more uniform heating of preforms is now being achieved with electronic heating. For this unusual function the Scientific Electric Company of Garfield, N. J. builds High Frequency Vacuum Tube Generators distinguished for their rugged, compact construction and advanced engineering design.

The heart of these units is a tough proving ground for tube stamina. Every plastic preform requires a specific power and frequency combination. The resulting variations of load and frequency encountered greatly shortens the life of the *average* tubes built to *ordinary* standards. Only specially designed tubes can stand the "gaff."

Scientific Electric Engineers approve the installation of United Mercury Power Rectifiers and Heavy Duty Oscillators in all S.E. Dielectric Heaters. Underlying this preference for United Tubes is their sterling workmanship—unusual physical ruggedness and inherent stability under changing loads and frequencies.

Be guided by Engineers who have pioneered in Electronic Heating since 1921. Standardize on tubes by UNITED. Get the facts about these better rectifiers and oscillators today. Write for technical data and tube interchange information.

UNITED

ELECTRONICS COMPANY

NEWARK, 2



New Jersey

Transmitting Tubes EXCLUSIVELY Since 1934



949H

KU-23

973



◀ For sustained efficiency and economical operation Scientific Electric High Frequency Heaters depend on Tubes by UNITED

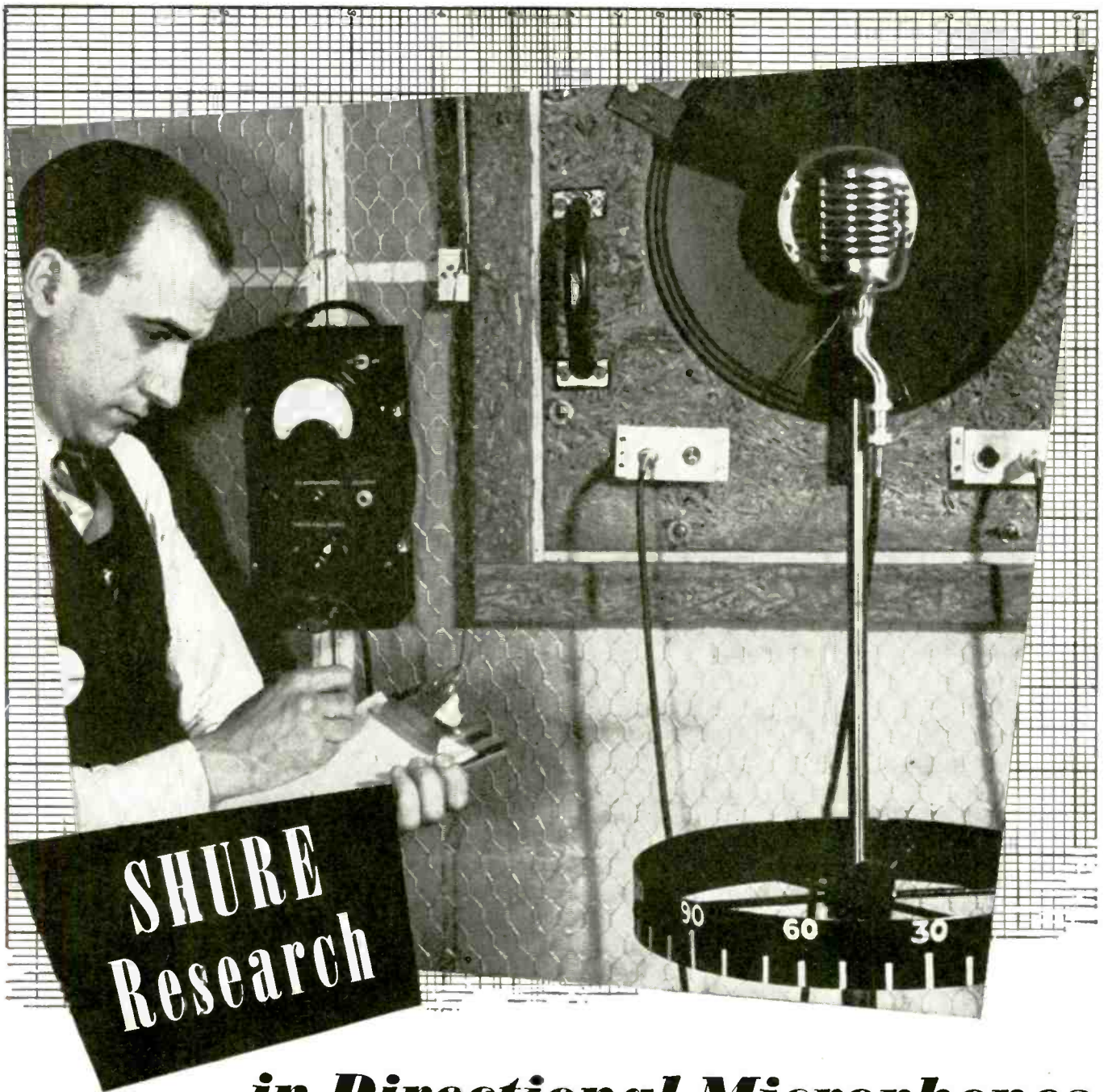

**SHURE
Research**

... in Directional Microphones

It is not enough to design a Microphone that merely converts sound waves into electrical impulses. A Microphone, to be truly useful in modern broadcasting, should be discriminating enough to accept wanted sounds — and reject unwanted sounds. Shure Research was the first to develop a single unit uni-directional Microphone, both crystal and dynamic.

Shure Research is the reason why practically every major broadcasting station uses the Shure 556 Unidyne. Shure Research is your assurance of postwar microphone superiority.

SHURE BROTHERS, 225 West Huron Street, Chicago
Designers and Manufacturers of Microphones and Acoustic Devices



KEN-RAD

MAKES ALL ELECTRON TUBES

essential for airborne equipment

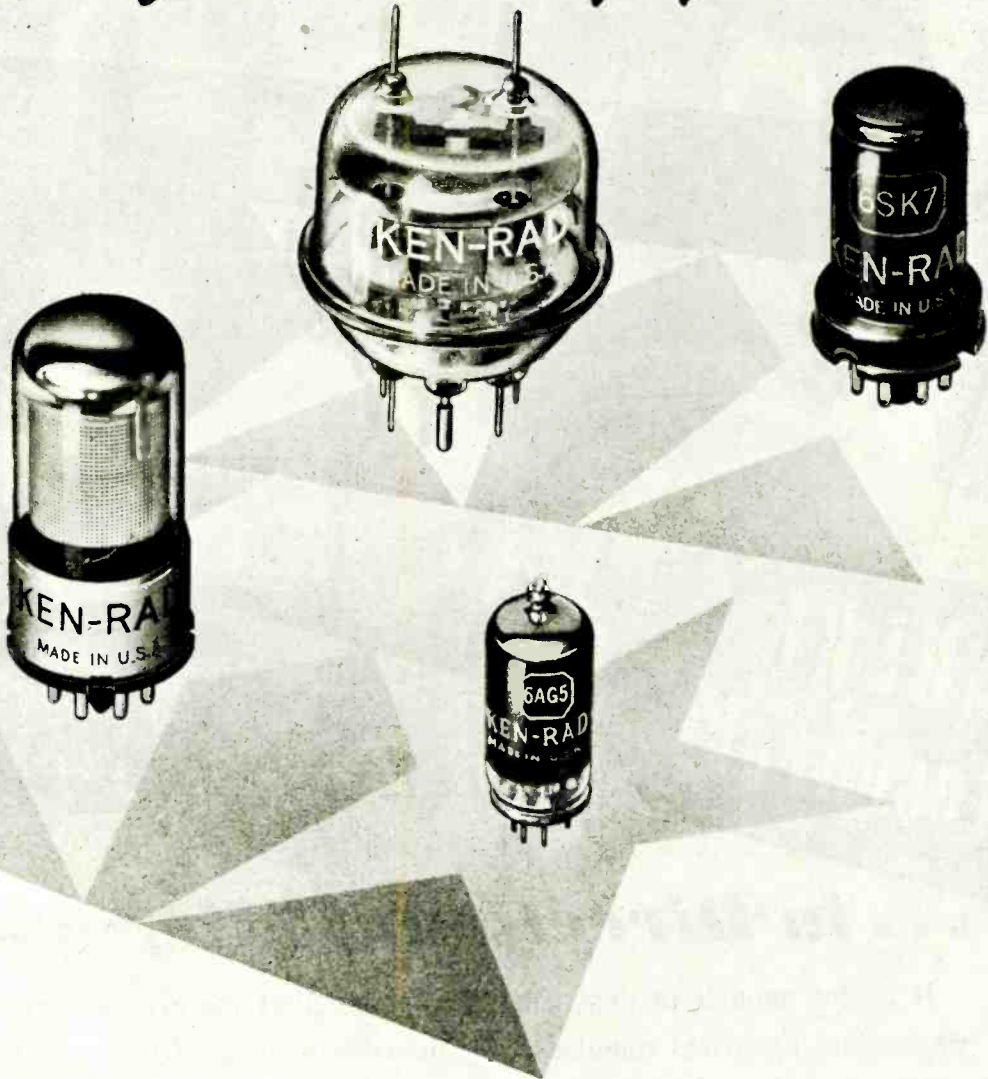

All electron tube types essential for airborne equipment are manufactured by

Ken-Rad They assure dependable long life in all critical apparatus

• Write for your copy of
"Essential Characteristics"
the most complete digest of
tube information available

KEN-RAD

AVIATION DIVISION

OWENSBORO · KENTUCKY

EXPORTS 15 MOORE STREET NEW YORK

TRANSMITTING TUBES

CATHODE RAY TUBES

SPECIAL PURPOSE TUBES

RECEIVING TUBES

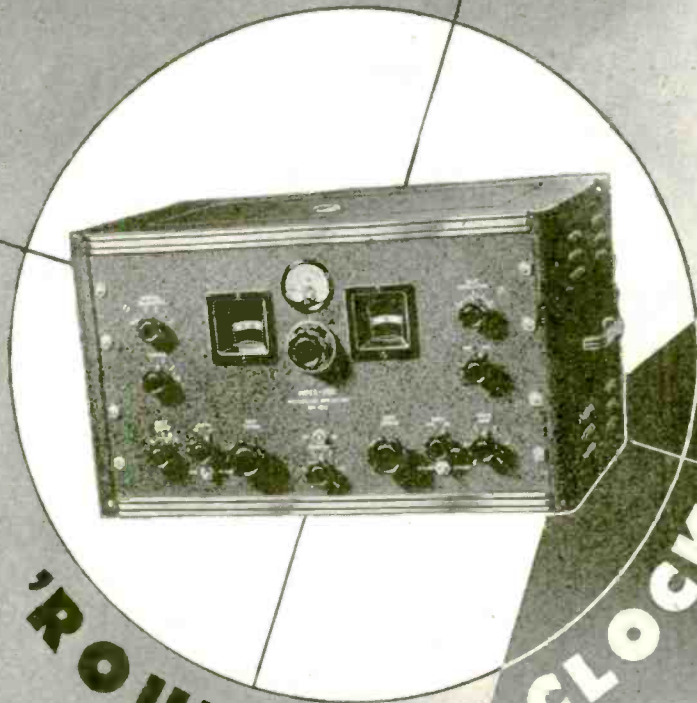

'ROUND THE CLOCK WITH SUPER-PRO



For twenty-four hours of every day
"Super-Pro" receivers are assisting
the "Round the Clock" bombing of
the enemy.... In war and in peace
"Super-Pro" leads the field.



THE HAMMARLUND MFG. CO., INC., 460 W. 34TH ST., N.Y.C.
MANUFACTURERS OF PRECISION COMMUNICATIONS EQUIPMENT



OUR prewar work was building Steel-Age Office Furniture. As part of our war effort we went into the production of electronic equipment.

It proved to be a fortunate choice. With all due modesty, we can honestly say, "We've done a good job." At least that's what the firms we produce for have been kind enough to say.

Electronics has grown on us. We like it. We want to stay in it, in addition to our office furniture work.

We think we can continue to produce work of

outstanding quality at reasonable costs. Want us to prove it? Send us your specifications.

BUY WAR BONDS



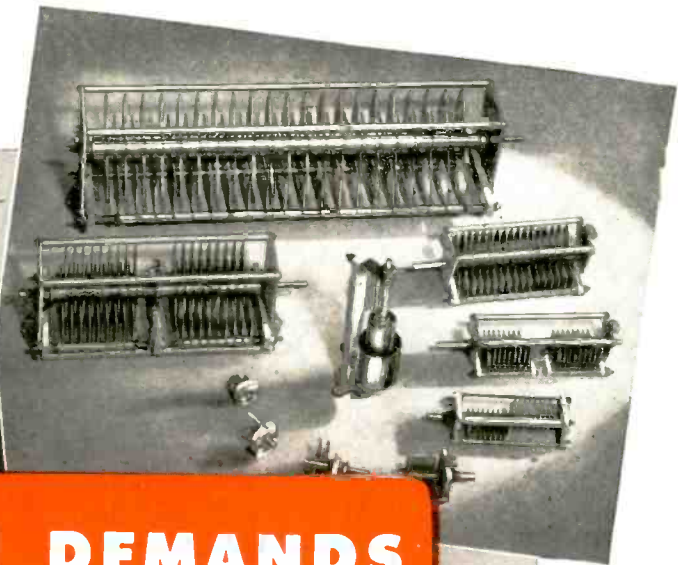

GEARED TO WAR DEMANDS

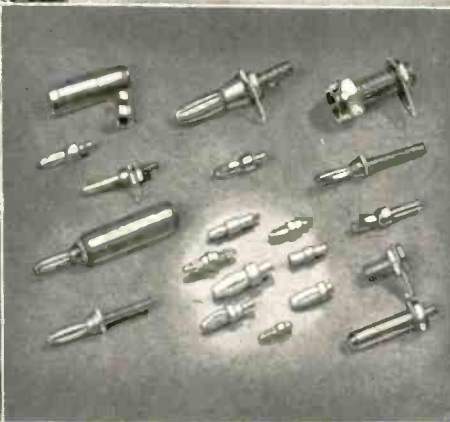
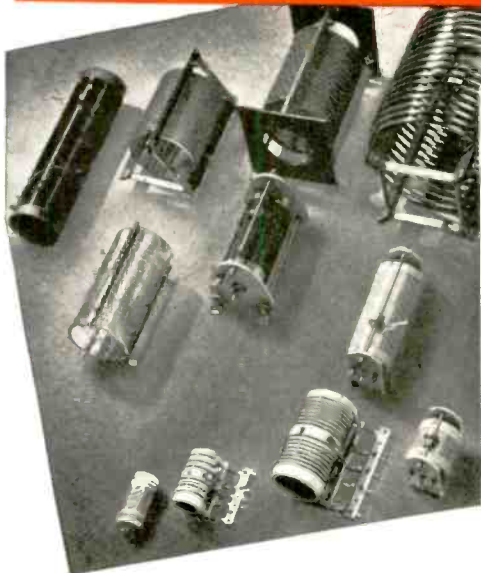

Johnson production facilities are flexible - -
 10 or 10,000 - - standard specifications or
 special - - repeat items or new - - any plating
 - - any metal or alloy - - any insulation. If it's
 metal or insulation or a combination of both,
 try Johnson first.

Ask for Catalog 968 (O)

SPECIALISTS IN

- Fixed and Variable Condensers
- Porcelain and Steatite Insulators
- Plugs, Jacks, Clips and Connectors
- Fixed and Variable Inductors
- Radio Frequency Chokes
- Flexible and Rigid Insulated Couplings
- Antenna Systems and Equipment
- Mycalex Machining and Parts
- Special Insulated Assemblies
- Broadcast Station Equipment



JOHNSON

a famous name in Radio



Plugs

FOR VICTORY

Remler is equipped for the mass production of many types of radio and electronic devices from humble plugs and connectors to complete sound amplifying and transmitting systems. Ingenious production techniques contribute to Remler precision, reduce costs and speed up deliveries. • The Axis is on the run and final Victory is in sight. Let us help you finish the job.

Wire or telephone if we can be of assistance

REMLER COMPANY, LTD. • 2101 Bryant St. • San Francisco, 10, Calif.

70 Types PLUGS & CONNECTORS

SIGNAL CORPS • NAVY SPECIFICATIONS

Types :		P L			
50-A	61	74	114	150	
54	62	76	119	159	
55	63	77	120	160	
56	64	104	124	291-A	
58	65	108	125	354	
59	67	109	127		
60	68	112	149		

PLP		PLQ		PLS	
56	65	56	65	56	64
59	67	59	67	59	65
60	74	60	74	60	74
61	76	61	76	61	76
62	77	62	77	62	77
63	104	63	104	63	104
64		64			

NAF

1136-T

No. 212938-1

Other Designs to Order

REMLER

SINCE 1918

Announcing & Communication Equipment

SMOOTH COMMUTATION!

A.C. VOLTAGE CONTROL with TH 2½A TRANSTAT

Brush Arm Assembly

One piece die casting permits good heat dissipation, provides a simple means of replacing the brush and protects the commutator against contact with brush holder if brush should break or loosen.

Core and Coil Impregnated FOR Long Service

Each turn of vinyl acetal insulated wire is PERMANENTLY anchored by impregnation of whole core and coil with phenolic resin, followed by baking.

Broad Commutating Surface

Ground from parallel wires on outer periphery of coil, forms long even segments with solid insulation necessary to avoid shorted turns. Greater contact area results in a lower operating temperature. Smooth, mirror-like finish provides a practically frictionless brush track.

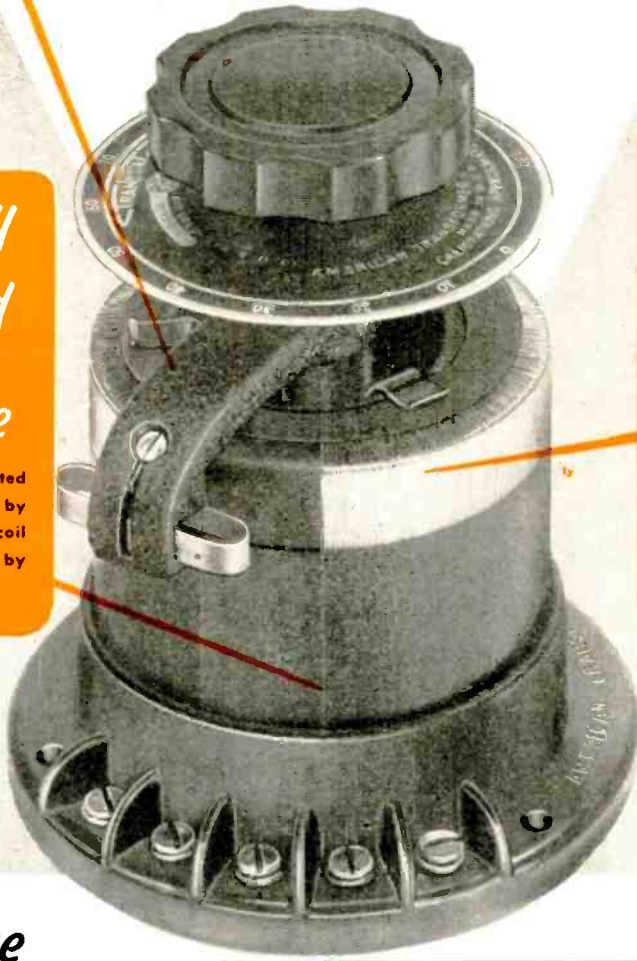

Write

FOR THIS
NEW FOLDER!

Complete description, including construction details, performance curves, wiring diagrams, ratings, electrical data and applications covered. Ask for Bulletin No. 171-01.

AMERICAN TRANSFORMER COMPANY
178 Emmet Street, Newark 5, N. J.

ELECTRONIC INDUSTRIES • February, 1945

AMERTRAN

MANUFACTURING SINCE 1901 AT NEWARK, N. J.

Pioneer Manufacturers of Transformers, Reactors and
Rectifiers for Electronics and Power Transmission





This is the **APPROVED**
MINIATURE
TUBE SOCKET
 THAT MEETS
ARMY-NAVY SPECIFICATION
JAN-S-28

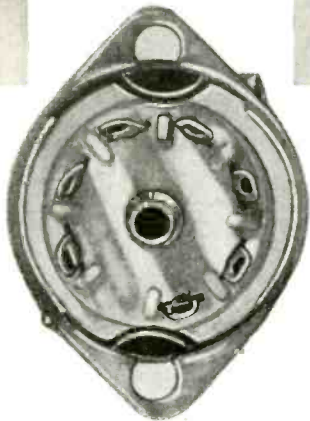

TWO TYPES OF SOCKET

Navy Grade G Steatite
 and General Purpose Type
 with Mica Filled Plastic

WRITE TODAY
FOR SAMPLES AND PRICES

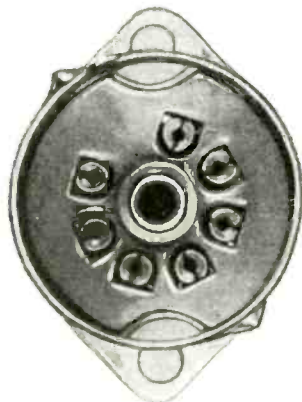

Photographs
 Twice Size

HUGH H.
EBY
 INCORPORATED
 18 W. CHELTEN AVE.
 PHILADELPHIA 44, PA.

MINIATURE TUBE SHIELDS

QUICK REFERENCE CHART

Tube Type No.	Description	EBY Tube Shield Catalog No.	Height
1A3	H-F Diode	7797	1 3/4"
1L4	R-F Amplifier Pentode	7797	1 3/4"
1R5	Pentagrid Converter	7797	1 3/4"
1S4	Power Amplifier Pentode	7797	1 3/4"
1S5	Diode-Pentode	7797	1 3/4"
1T4	Super-Control R-F Amplifier Pentode	7797	1 3/4"
2D21	Thyratron (Gas-Tetrode)	7797	1 3/4"
3A4	Power Amplifier Pentode	7797	1 3/4"
3A5	H-F Twin Triode	7797	1 3/4"
3Q4	Power Amplifier Pentode	7797	1 3/4"
3S4	Power Amplifier Pentode	7797	1 3/4"
6AG5	R-F Amplifier Pentode	7797	1 3/4"
6AK6	Power Amplifier Pentode	7797	1 3/4"
6AL5	Twin Diode	7798	1 3/8"
6AQ6	Duplex-Diode High-Mu Triode	7797	1 3/4"
6C4	H-F Power Triode	7797	1 3/4"
6J4	U-H-F Amplifier Triode	7797	1 3/4"
6J6	Twin Triode	7797	1 3/4"
9001	Detector Amplifier Pentode	7798	1 3/8"
9002	Detector Amplifier Triode	7798	1 3/8"
9003	Super-Control R-F Amplifier Pentode	7798	1 3/8"
9006	U-H-F Diode	7798	1 3/8"

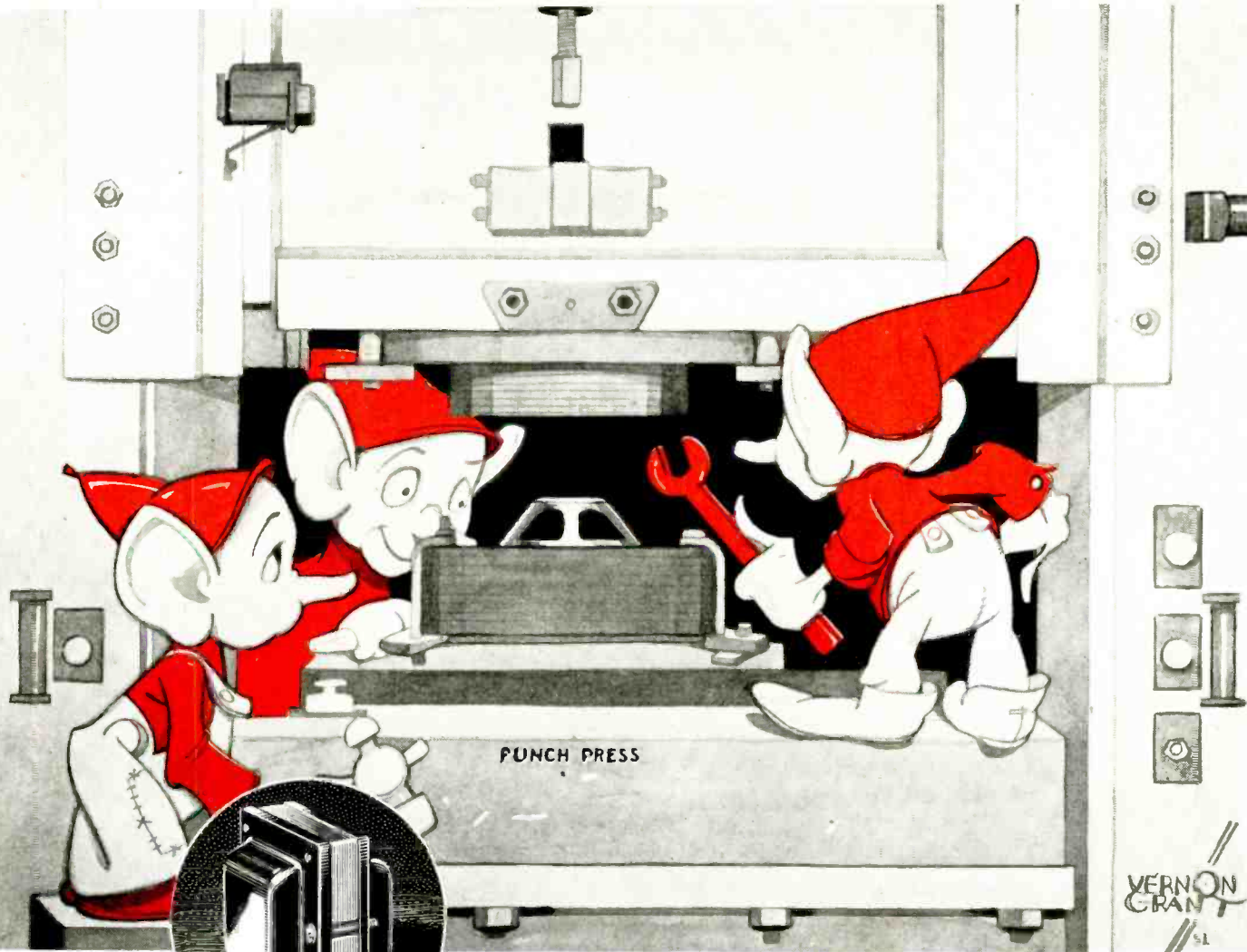

This speaks for itself: Utah is its own transformer supplier for speakers, vibrators, wire recorders, et cetera.

UTAH'S COMPREHENSIVE PROCESS

... GUARANTEES PERFORMANCE!

Sure, this is a punch press . . . and Utalins* know that a punch press is a pretty important piece of equipment in Utah's modern plant. They guide it in an important step in the precision manufacture of Utah's products and see 'way beyond . . . to the finished products in action.

The honest pride they feel in their part is the knowledge that Utah's process makes superior quality inevitable . . . eliminates the possibility of error. Utah's plant is entirely self-contained. Every phase of manufacture, from buying raw materials to final delivery of inspection-tested pieces is under Utah's own exacting supervision. Constantly, painstakingly, Utah controls, inspects,

rejects and supervises every step of the way.

Yes, heavy machines are made to produce with the precision of delicate instruments in Utah's comprehensively controlled process. And the result is Utah performance . . . accepted internationally as the absolute standard of quality.

*Utah Radio Products Co., 820 Orleans St., Chicago 10, Ill.
Utah Products (Canada) Ltd., 300 Chambly Rd., Longueuil, Montreal (23) P. Q.*



*Utalins Utah's helpers



MAXIMUM CAPACITANCE at minimum cost...

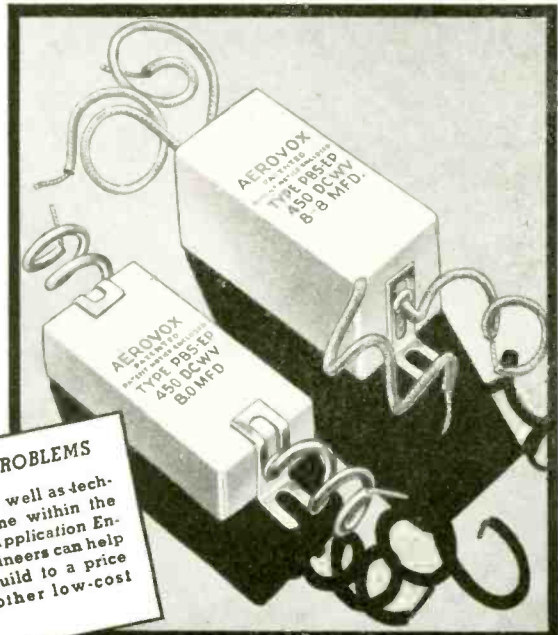
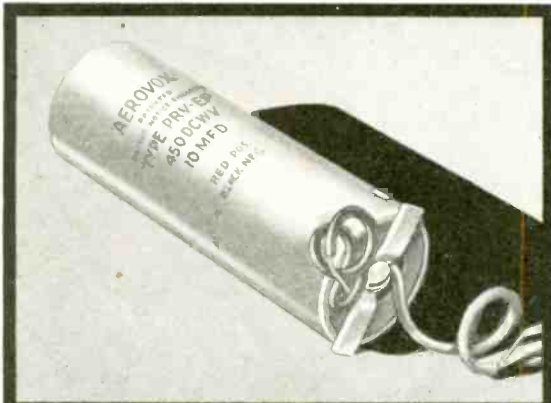

SUBMIT YOUR PROBLEMS
Your cost figures, as well as technical problems, come within the scope of Aerovox Application Engineering. Our engineers can help you design and build to a price with these and other low-cost types. Write us.

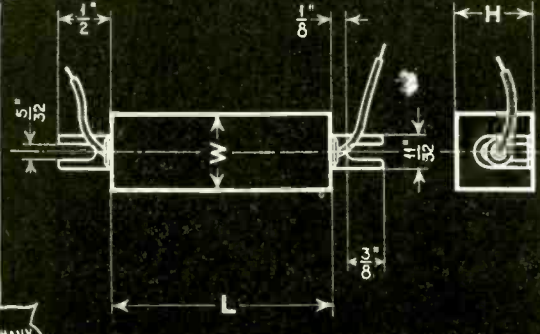
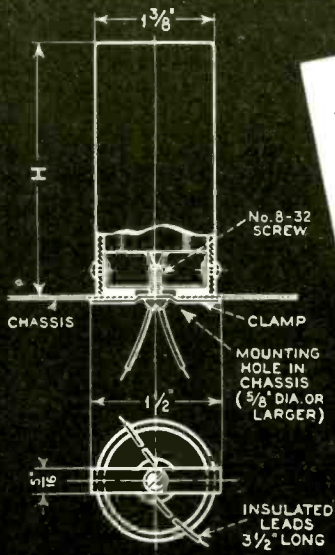

CLAMP-MOUNTING ELECTROLYTICS

● **PRICE** with inbuilt Aerovox Quality—that's the prime objective of the ingenious Type PRV one-hole-mounting paper-cased electrolytic. • Wax sealed. Impregnated cardboard-tube container. Suitable for commercial and other applications where extreme operating conditions are not encountered and metal-can types are not essential. • Note ingenious clamp and center-screw mounting means. This type can take the place of various other vertical-mounting electrolytics such as twist-prong, spade-lug, screw-base, etc. • Normally with etched foil. Also available in plain foil. High-purity aluminum elements throughout. Positive and negative lead for each section. 450 and 600 v. D.C.W. 4 to 40 mfd.; 8-8 to 20-20 mfd. 1-3/8" dia.; 3 to 4-3/4" high.

CARDBOARD-CASE ELECTROLYTICS

● **PRICE** with inbuilt Aerovox Quality—that's the prime objective of this popular Type PBS rectangular cardboard-case dry electrolytic. • Sections housed in sturdy cardboard containers. Patented Aerovox Adjustimount or swivel metal flange permits mounting flatwise or on narrow side according to space limitations. Also, PBS units may be stacked and held together by overlapping metal flange and soldering securely. • Normally with etched foil. Plain foil also available. High-purity aluminum elements throughout. Made in single and multiple sections. Separate sections with positive and negative leads for each section. • 450 and 600 v. D.C.W. 4 to 16 mfd.; 8-8, 8-16 and 8-8-8 mfd. Dimensions: L, 2-7/16 to 3-3/16"; W, 3/4 to 1-1/2"; H, 1/2 to 1-7/16". A good general-purpose electrolytic for normal service.



Capacitors

INDIVIDUALLY TESTED

AEROVOX CORPORATION, NEW BEDFORD, MASS., U. S. A.

SALES OFFICES IN ALL PRINCIPAL CITIES

Export: 13 E. 40 St., NEW YORK 16, N. Y. • Cable: 'ARLAB' • In Canada: AEROVOX CANADA LTD., HAMILTON, ONT.

SPARE PARTS BOXES

...in every needed size!

...for every needed use!

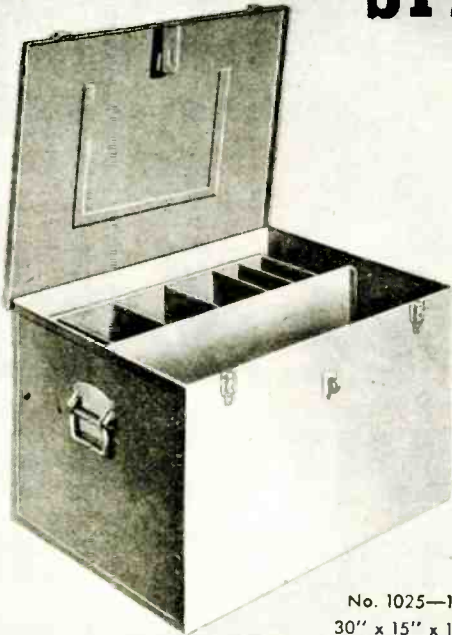

No. 1025-14
30" x 15" x 12"
(Partitions not included)

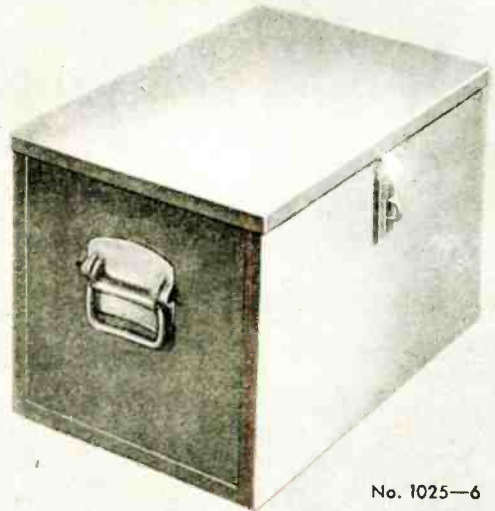

No. 1025-6
18" x 9" x 9"

24 STOCK SIZES

As per specification 42 B 9 (Int) for shipboard use, Electrical and Mechanical. Navy grey finish. Immediate Delivery.

— WRITE FOR PRICE LIST —

Number	Length	Width	Height	Number	Length	Width	Height
1025-1	12	6	6	1025-13	18	18	12
1025-2	12	9	6	1025-15	24	15	12
1025-3	12	12	6	1025-16	24	15	15
1025-4	12	9	9	1025-17	24	18	12
1025-5	18	9	6	1025-18	24	18	15
1025-6	18	9	9	1025-19	24	18	18
1025-7	18	12	9	1025-20	24	12	9
1025-8	18	6	6	1025-23	30	15	9
1025-9	18	15	9	1025-14	30	15	12
1025-10	18	12	6	1025-22	36	12	9
1025-11	18	15	12	1025-21	42	9	9
1025-12	18	12	12	1025-24	42	12	9

COLE

STEEL EQUIPMENT COMPANY

349 Broadway, New York 13, New York • Factory: Brooklyn, New York

COLE STEEL OFFICE EQUIPMENT
will again be available after the war

Centralab



Lever Action SWITCHES

THESSE low-capacity space-saving switches are used singly and in groups.

In shops and laboratories, by experimenters and by manufacturers these Centralab switches are becoming increasingly popular.

They are particularly adapted to broadcasting, receiving, public address, test instruments and individual uses.

These Centralab switches are available in ten different combinations including positive and spring return action types with either shorting or non-shorting contacts.

Be sure to specify "CENTRALAB" when ordering Lever Action Switches.



Centralab

Division of GLOBE-UNION INC., Milwaukee

PRODUCERS of Variable Resistors; Selector Switches; Ceramic Capacitors, Fixed and Variable; Steatite Insulators and Silver Mica Capacitors.

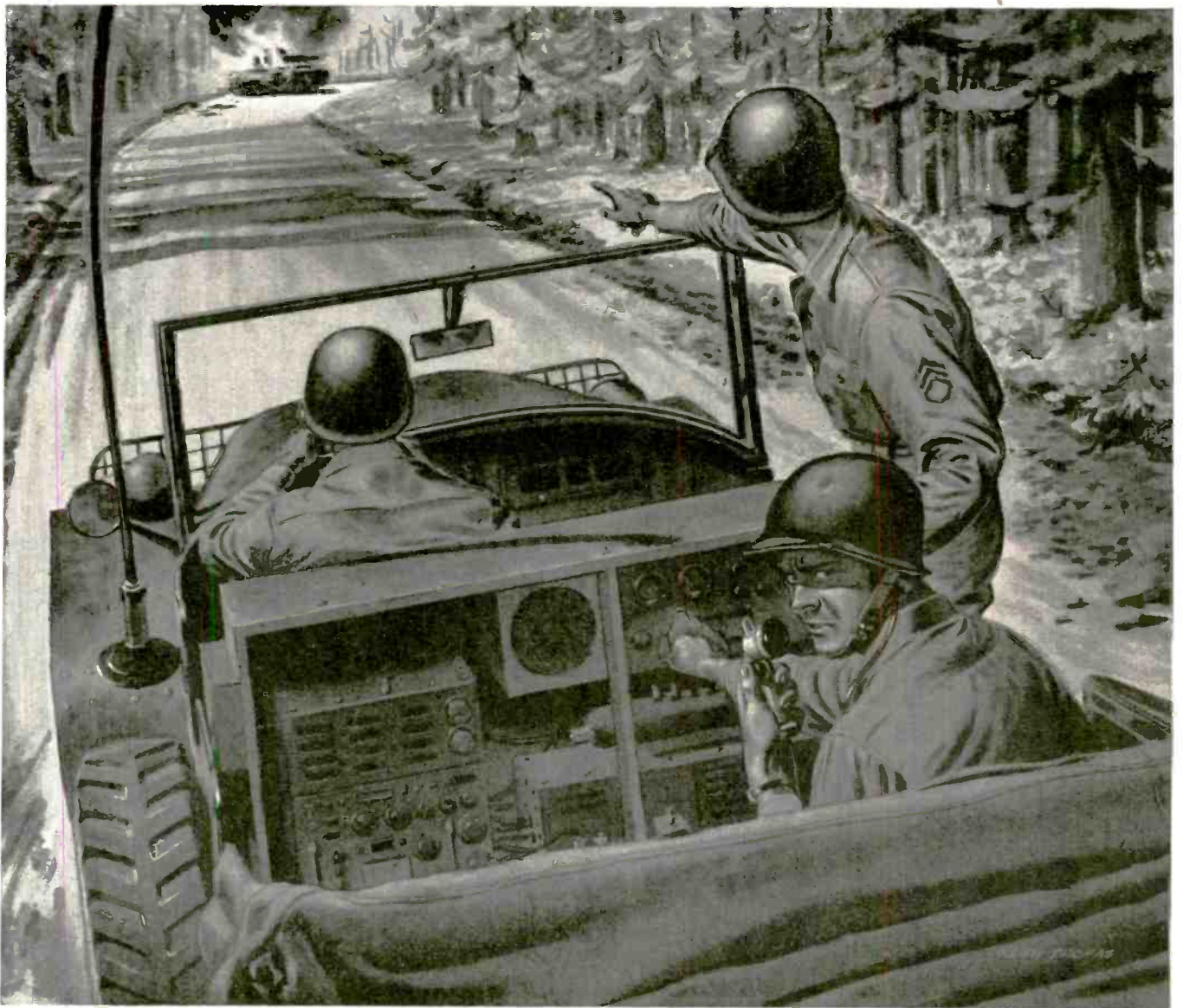

History of Communications. Number Thirteen of a Series

MILITARY RADIO COMMUNICATIONS

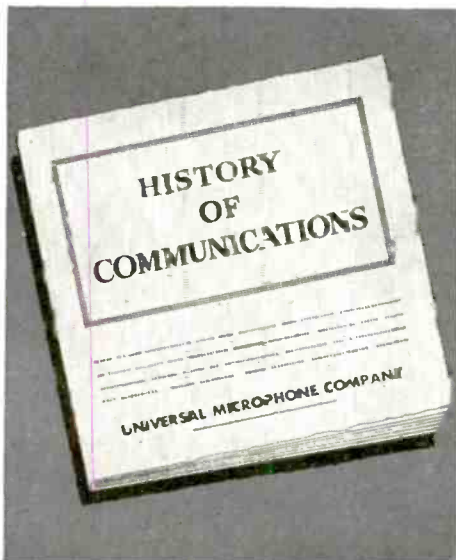

Today the allied military radio equipments represent the "tops" in engineering design. Progress from the spark transmitter of World War I to present-day equipment is, indeed, a far cry. Taking up where they left off December 7, 1941, Universal Engineers, with their added experience with precision military equipment, shall produce for the public, electronic devices not of fantastic design — but of proven utility and quality.

After Victory is ours, radio amateurs, affectionately known as "hams," will be back after their experience with military radio equipment with an even greater desire to operate their own "rigs." It will be then that Universal will again have Microphones and recording components available on dealers' shelves.

< *FREE—History of Communications Picture Portfolio. Contains over a dozen pictures suitable for office, den, or hobby room. Write for your "Portfolio" today.*



UNIVERSAL MICROPHONE COMPANY

INGLEWOOD, CALIFORNIA



HOW EXCELLENCE IS

DEXTEROUS FINGERS Several million pieces of mica are punched out daily by a battery of sixty-five mica punch presses at the Sangamo plant. To meet this large production schedule, and at the same time conserve strategic mica, operators are trained to obtain the maximum number of punched films from each mica lamination.

THE UTILIZATION of accurate, modern, and efficient production methods in the manufacture of Sangamo Mica Capacitors begins with MICA SPLITTING and MICA GAUGING. Next comes the important process of MICA PUNCHING—described on these pages.

SANGAMO ELECTRIC

ESTABLISHED 1898 . . . MICA CAPACITORS . . .

BUILT INTO . . .



Sangamo

MICA CAPACITORS



Mica Punching



The great number of case sizes in which Sangamo Mica Capacitors are manufactured necessitates a large variety of sizes and shapes of mica films. Mica, as produced in nature, has no semblance of uniformity, consequently it must be fabricated to the desired size and shape. Mica is a hard brittle material requiring the use of specially designed dies to insure a finished film with sharp, clean edges and free from fractures.

Thus, only by maintaining constant vigilance in each of the manufacturing processes, is it possible to produce a capacitor capable of giving long and dependable service under the severe operating conditions encountered by modern electronic equipments.



COMPANY **SPRINGFIELD ILLINOIS**

. . . WATT HOUR METERS . . . TIME SWITCHES . . .

RELAYS THAT "Click" ON THE JOB!

SIMPLE, DEPENDABLE, POSITIVE ACTION

You can depend on silent Adlake plunger-type Relays to "make good" on every kind of equipment into which you design these modern, hermetically sealed mercury relays for timing, load and control circuits. May we co-operate with your designers by suggesting the type of Adlake Relays best adapted to your product?

Adlake Relays have snap action that stays "snappy." The contact mechanism is hermetically sealed in an armored glass or metal cylinder. No dirt, dust, or moisture can enter . . . there is no danger of oxidation.

The liquid metal mercury contact is instantaneous, positive in action, silent, chatter-free, and cannot burn, pit or stick. No other relays are as simple, rugged and dependable.

Write for bulletin.

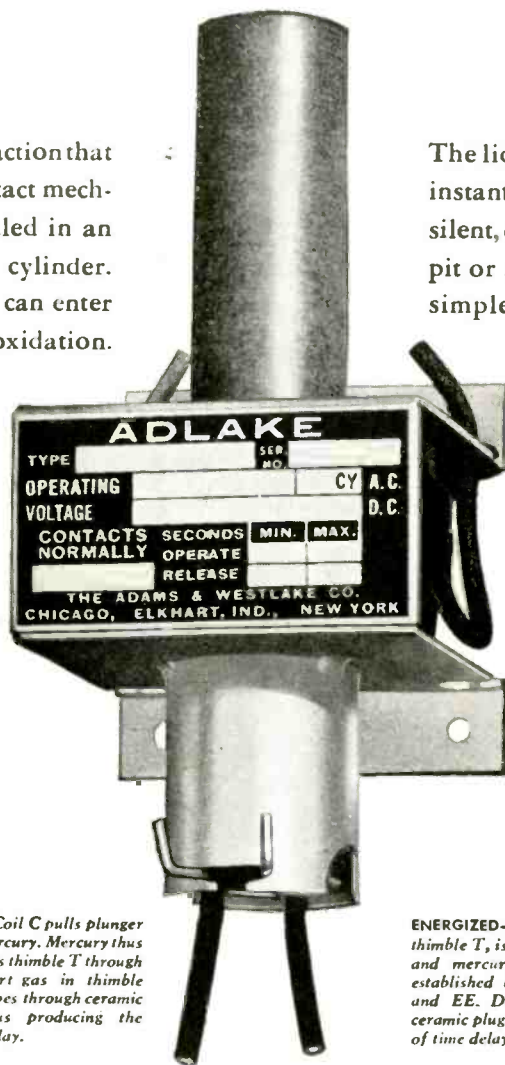

Adlake Model 1040 . . . for panel mounting . . . available with either quick or time delay action, normally open or closed.

Quick acting relays are available with contact ratings up to 50 amperes A.C. with proportional D.C. ratings.

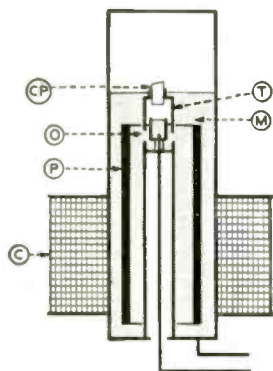

ENERGIZED—Coil C pulls plunger P down into mercury. Mercury thus displaced enters thimble T through orifice O. Inert gas in thimble gradually escapes through ceramic plug CP—thus producing the desired time delay.

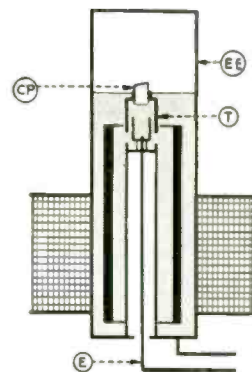

ENERGIZED—Mercury now fills thimble T, is completely leveled off and mercury-to-mercury contact established between electrodes E and EE. Degree of porosity of ceramic plug CP determines length of time delay.



THE ADAMS & WESTLAKE COMPANY

ESTABLISHED IN 1857

ELKHART, INDIANA

NEW YORK · CHICAGO

MANUFACTURERS OF ADLAKE HERMETICALLY SEALED MERCURY RELAYS FOR TIMING, LOAD AND CONTROL CIRCUITS

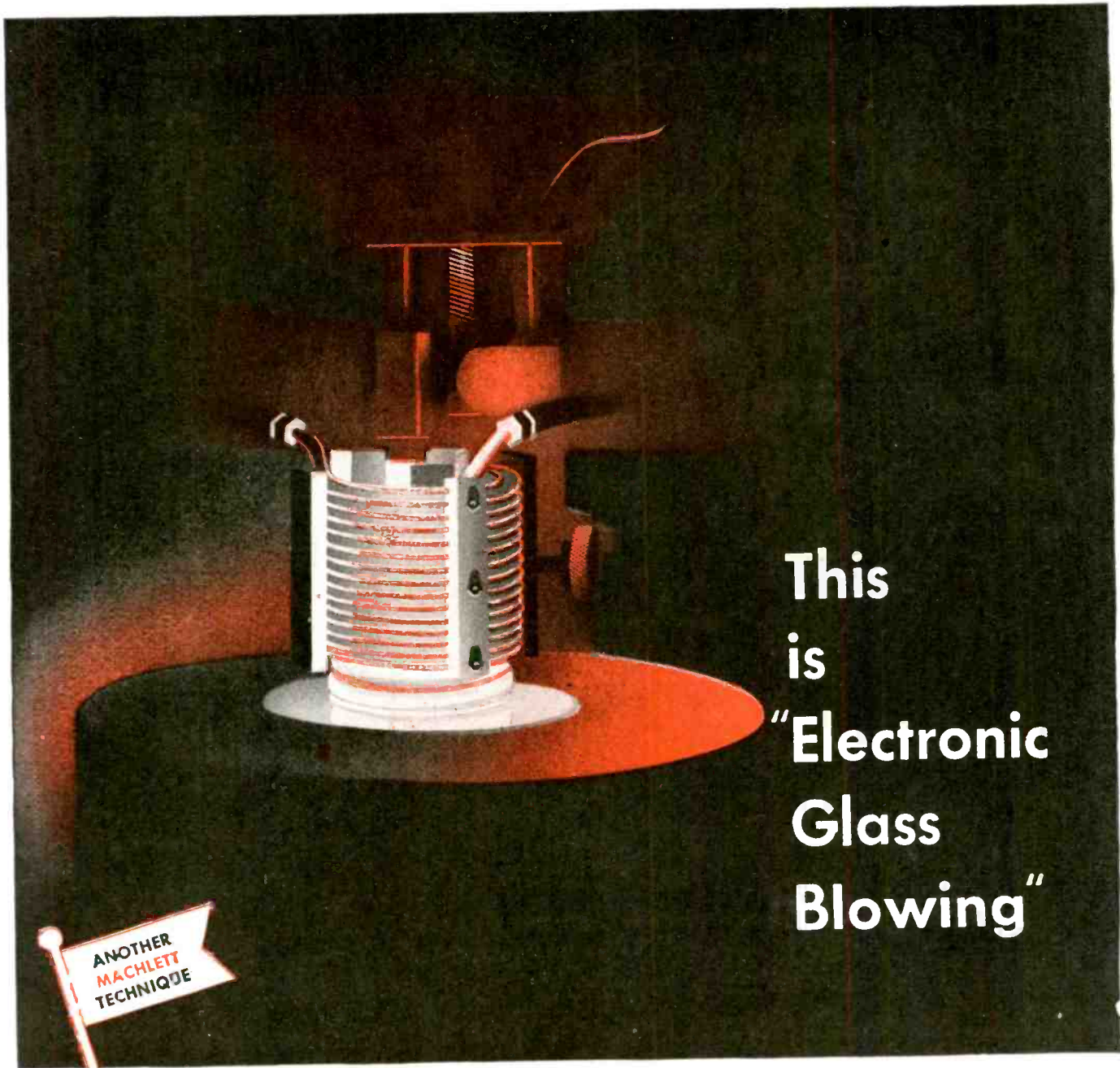

This is "Electronic Glass Blowing"

**ANOTHER
MACHLETT
TECHNIQUE**

A group of scientists recently designed a vacuum tube of great potential usefulness. It required a long, air-tight column made with a large number of alternate rings of glass and metal, and conventional methods of glass-blowing offered no promise whatever. When asked what could be done, Machlett cast aside precedent, as it often does, and devised a way of producing the "impossible" column.

Here it is. On top of a ring of glass is placed a ring of one of the special alloys that have the property of fusing with glass. Another glass ring goes on top of this. A high-frequency induction coil is lowered over this sandwich, heat-

ing the metal so hot that the glass is softened to exactly the right degree for formation of a perfect fused joint, when supplemented by other glass-working techniques. Another sandwich on top of the first is treated in the same manner, and so the column grows, ring by ring.

Induction heating often makes the impossible practical; this is an example of that, and of Machlett's willingness to tackle baffling problems. If you have a vacuum tube problem see Machlett. And remember that skills of the type exemplified here make possible the tube shown above . . . Machlett Laboratories, Inc., Springdale, Connecticut.

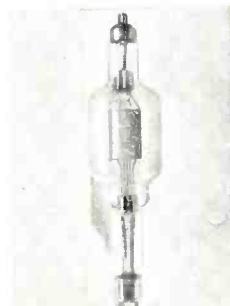

ML-100, high-voltage industrial rectifier.

MACHLETT

APPLIES TO RADIO ITS 46 YEARS
OF X RAY TUBE EXPERIENCE

TYPE 648—Heavy duty dual power pack with parallel output. 300 volts at 200 ma. from 6 volt battery

TYPE 650—Standard: 200 volts at 50 ma. Optional: 200 volts at 75 ma. This type available for 6, 12, or 32 volt operation. Has built-in filter. Notice simplicity of construction.

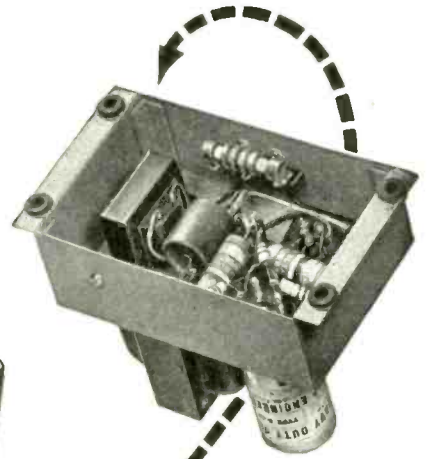
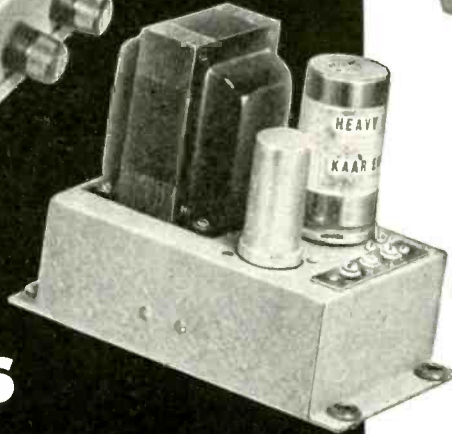
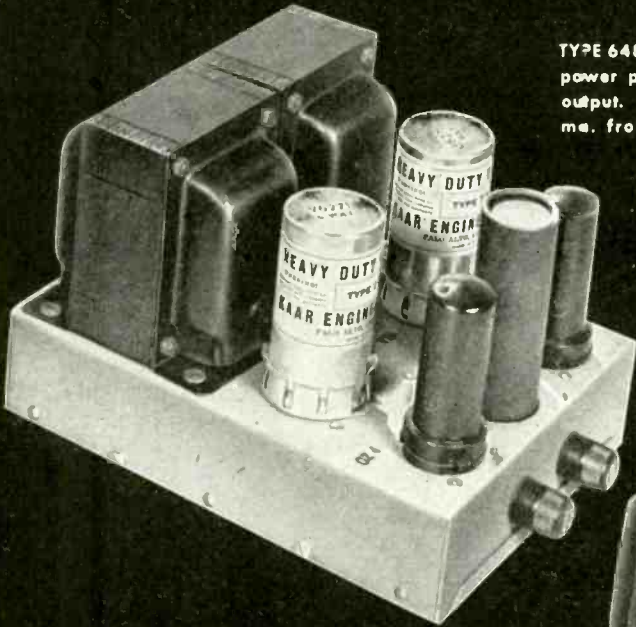

KAAR POWER PACKS

Engineered for
✓ SIMPLICITY
✓ EFFICIENCY
✓ DEPENDABILITY

Use this West Coast source for vibrator power packs

TYPE 649—Provides 240 volts at 50 ma. Available at other standard ratings, and for operation from 6 or 12 volt batteries. Type 647, not illustrated, provides 240 volts at 75 ma.

Kaar Engineering Company offers prompt delivery of standard and special types of vibrator power packs for operation from 6, 12, or 32 volt sources. In addition, laboratory facilities are available for a variety of power

packs designed to your own specifications.

Take advantage of this convenient West Coast source of exceptionally efficient low-drain packs, designed for simplicity and dependability.

KAAR
ENGINEERING CO.
PALO ALTO, CALIFORNIA



Export Agents: **FRAZAR & HANSEN**
301 Clay Street • San Francisco 11, Calif.

MOBILE RECEIVERS—Crystal controlled superheterodynes for medium and high frequencies. Easy to service.

CRYSTALS—Low-drift quartz plates. Fundamental and harmonic types available in various holders.

TRANSMITTERS—Mobile, marine, and central station transmitters for medium and high frequencies. Instant heating, quickly serviced.

MICROPHONES—Type 4-C single button carbon. Superb voice quality, high output, moisture proof.

CONDENSERS—Many types of small variable air condensers available for tank circuit and antenna tuning.

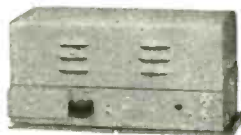



STACKPOLE

CONTINUOUSLY ADJUSTABLE CARBON RHEOSTATS (CARBON PILES)

Under impetus of war requirements demanding resistance adjustments for more critical, more precise, smoother, and more dependable control than is possible with conventional variable resistance units, Stackpole engineering has developed the Continuously Adjustable Carbon Rheostat formed of carbon disc piles to a high degree of efficiency. Simply by changing the pressure applied to the pile, every possible resistance value within its range is available without opening the electrical circuit in which it is connected. The pressure to vary the resistance to the most critical adjustment may be applied electrically, mechanically, centrifugally or hydraulically. Uses range from both generator and line voltage regulator applications to remarkable speed control through governed field current on motors. Many other projects incorporating the Carbon Pile Resistor are now in the development stage.

Stackpole regularly supplies Carbon Piles in practically any length pile and diameter required. Resistance ranges have been materially expanded and a greater degree of resistance variation may now be obtained in a pile of a given size. Careful engineering control of manufacture assures a high degree of uniformity on a quantity production basis. Write for bulletin giving complete data.

STACKPOLE CARBON COMPANY
St. Marys, Pa.

CARBON DISCS FOR OTHER APPLICATIONS

Other Stackpole types include carbon discs for electric brakes for trucks, speed governors— or wherever a little power must control a lot of power with utmost precision, smoothness, and dependability.

OTHER STACKPOLE PRODUCTS

BRUSHES - CONTACTS (All carbon, graphite, metal, and composition types)

WELDING CARBON PRODUCTS

PACKING, PISTON, and SEAL RINGS

IRON CORES

VOLTAGE REGULATOR DISCS

POWER TUBE ANODES, etc.

RARE METAL CONTACTS

BATTERY CARBONS

KARP

SPARE PARTS BOXES

Made-to-order at no extra cost

For the many years that sheet steel has been designated for spare parts boxes, Karp has been a major national supplier. Vast experiences, coupled with unusual production facilities, permit us to lay out and design boxes to individual order . . . at no extra cost. Each is built in accordance with U. S. Navy specifications. Tightly welded seams are vermin-proof. Special corrosion resisting paint is applied. Partitions, fittings, supports and trays are added as the case demands. Sizes range from 12" x 6" x 6" (and smaller where special existing conditions require) to boxes of sufficient length to house long motor shafts. *Rapid deliveries, too.*

Artisans in sheet metal, Karp craftsmen produce a varied line of products . . . from a chassis small enough to be handled by two fingers to a heavy rack which requires a crane to lift. We save you time, cost and manpower. A Karp engineer will gladly consult with you.

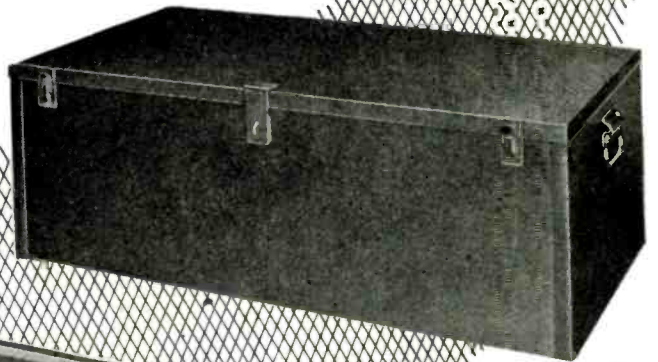
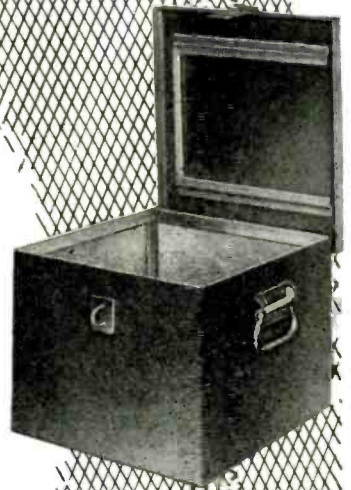

ARTISANS
IN
SHEET
METAL

KARP METAL PRODUCTS CO., INC.

126 30th STREET • BROOKLYN 32, N. Y.

CABINETS
CHASSIS
RACKS
PANELS

HELP SHORTEN THE WAR . . . BUY MORE WAR BONDS

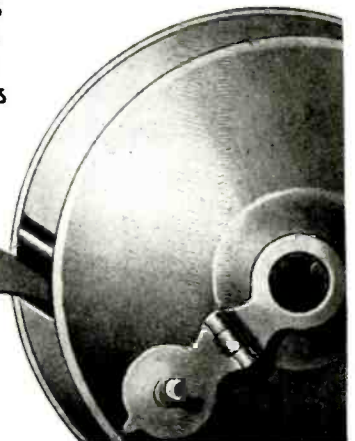

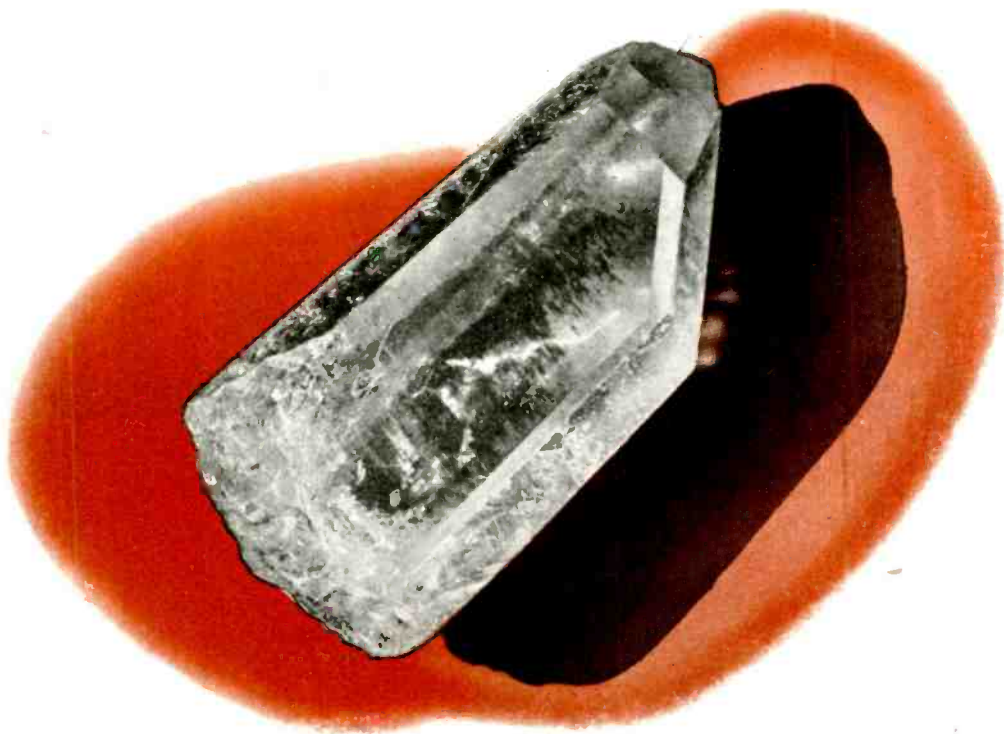

Here all similarity ends...

from this point on, it's craftsmanship!

In one important respect there is a striking similarity between the millions of Bliley crystals which we now produce and the mere handful of custom made units that constituted our annual production when radio was still young.

In these early days of radio, when each quartz crystal was painstakingly cut and ground by hand, a tradition was born. It was a tradition of craftsmanship that has grown with the years—a tradition that Bliley engineers have successfully translated into the more intricate techniques of volume production.

Etched crystals are an outstanding discovery and development of Bliley research engineers. This technique, by means of which crystals are finished to frequency by acid action rather than abrasive action, was an established part of Bliley production long before Pearl Harbor. It has since proven to be an essential element in the manufacture of crystals that have the dependable characteristics necessary for military communication in global warfare.

We have been called upon to solve

some knotty problems. But that is nothing new at Bliley. It has been our habit to parallel new developments in radio with the right crystal for each application.

Things will be different soon. Peacetime projects will again come first. But our engineers and craftsmen will be ready, as always, with the right answer to your requirements. Don't fail to include Bliley crystals in the component specifications for your peacetime equipment.

Do more than before...

buy extra War Bonds



A new star has been added

Bliley
CRYSTALS

BLILEY ELECTRIC COMPANY
ELECTRONIC INDUSTRIES • February, 1945

UNION STATION BUILDING • ERIE, PENN.

Hermetically Sealed TRANSFORMERS

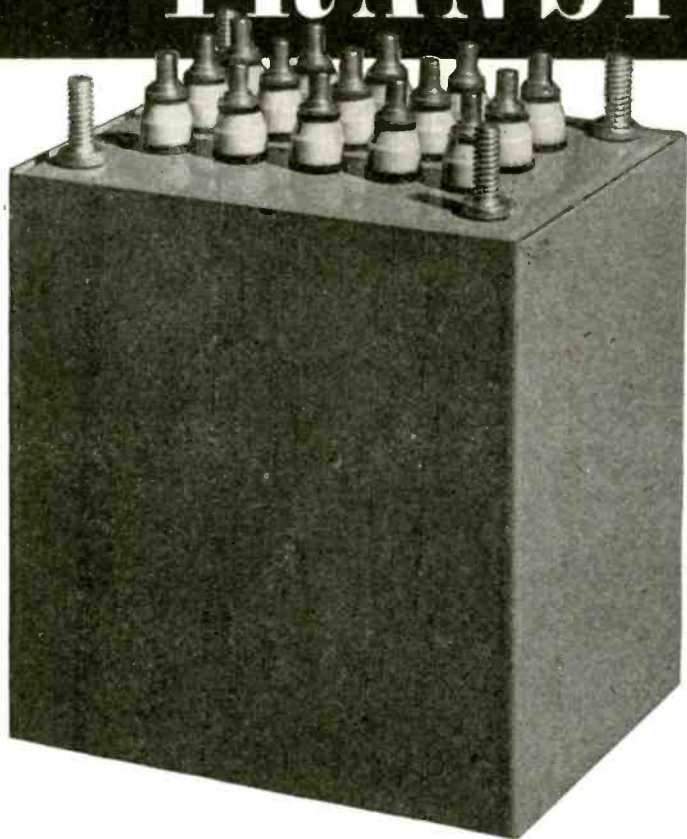

Illustrated at left is a Langevin Hermi-Lock hermetically sealed transformer. Case must be destroyed before interior of unit can be reached. Hermi-Lock provides extensive safety factor for combat use.

The failure of a hermetically sealed transformer is largely due to the fact that solder is depended upon for a mechanical union as well as the hermetic seal. Solder having a low tensile strength is readily fractured by thermal action, vibration or shock, and the seal broken; with failure a probability.

LANGEVIN hermetically sealed transformers employ the unique *Hermi-Lock construction which provides a positive mechanical union between body, cover and bottom, the solder being simply the sealing agent. The result is a dependable unit with little chance of failure under simultaneously adverse conditions.

Your inquiry for transformers of all types up to 5 KVA are solicited.

* Trade Mark Registered



-50°C AMBIENT



+65°C AMBIENT

The Langevin Company

INCORPORATED

SOUND REINFORCEMENT AND REPRODUCTION ENGINEERING

NEW YORK

37 W. 65 St., 23

SAN FRANCISCO

1050 Howard St., 3

LOS ANGELES

1000 N. Seward St., 38

The name

LORD

On Mountings and other BONDED RUBBER Products Assures the Ultimate in Vibration Control



Every genuine Lord vibration mounting has the name "LORD" molded into the rubber section, as a means of ready identification, and as a guarantee to the user that he is receiving Lord quality.

Lord has had the best part of a generation of scientific research and experiment in the field of vibration. Lord processes and features, many of which are patented, have proven, in practically every field of industry, that they provide the highest degree of vibration isolation efficiency. Lord Mountings are bonded, rubber to metal, in a union that can't fail because the bond is as strong as the rubber. In every Lord Mounting, the size, the shape and composition of the rubber is accurately determined by the requirements of the job. In the process of manufacture, the rubber is put under no stress or tension, compression or torque, and is ready to give its full strength and resiliency to combatting the forces of vibration.

Included in this famous line of products are plate and tube form mountings, flexible couplings, engine suspensions, meter mountings and diaphragms. Special bonded-rubber products of every conceivable shape and size are produced to specification. All bear the name "LORD".

If you have a vibration problem, or a mechanical design problem involving the use of functional rubber, it may best be solved by means of rubber-bonded-to-metal. Call in a Lord Vibration Engineer, or write for literature on the subject. There is no obligation.

Do More Than Before—Buy EXTRA War Bonds

IT TAKES BONDED RUBBER *In Shear* TO ABSORB VIBRATION

LORD MANUFACTURING COMPANY
ERIE, PENNSYLVANIA

SALES REPRESENTATIVES
NEW YORK - 280 MADISON AVE.
CHICAGO - 520 N. MICHIGAN AVE.
DETROIT - 7310 WOODWARD AVE.
BURBANK, CAL. - 245 E. OLIVE AVE.
CANADIAN REPRESENTATIVE
RAILWAY & POWER ENGINEERING CORP., LTD.
TORONTO, CANADA

Originators of Shear Type Bonded Rubber Mountings

Get flexible lighting for each employee... each job... with **DAZOR** *Floating* LAMPS



MORE PRODUCTION

Both machine and hand operations go faster, more smoothly, with controlled localized lighting. Dazor *Floating* Lamps help employees improve and maintain efficiency.



HIGHER ACCURACY

Adequate lighting aids precision, reduces errors, conserves materials by cutting down spoilage. Dazor high intensity illumination is just right for inspection tasks.

GREATER SAFETY

By lighting dark areas and danger points, eliminating reflected glare, reducing eye-strain and fatigue, Dazor *Floating* Lamps help to check accidents at the source.



LOWER COSTS

Dazor *Floating* Lamps deliver productive, economical light. Option of fluorescent or incandescent lamps and 4 base types provides a correct fit for each installation.

Employees differ... and jobs differ... in their lighting needs. That, in a nutshell, is the reason for the Dazor *Floating* Lamp—the first lamp with complete lighting *flexibility* at the point of work. The operator's finger-tip touch *floats* the Dazor Lamp to the exact position desired, where it *stays put* without fastening. An enclosed balancing mechanism holds the lamp arm at the place chosen... firmly... automatically.

At the left are typical advantages of Dazor illumination on machine tools, assembly lines, inspection benches and drafting boards. To gauge these economies fully, get details from your experienced and cooperative Dazor-appointed distributor. If you'd like this 16-page descriptive booklet, ask for Booklet "E"; we'll send it promptly. Dazor Manufacturing Co., 4463 Duncan Ave., St. Louis 10, Mo.



CHOICE OF 4 BASES

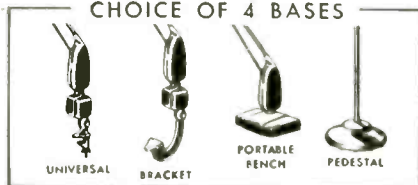

Call your electrical wholesale supplier or write us for the names of our distributors in your locality.

DAZOR *Floating* LAMPS

FLUORESCENT and INCANDESCENT

HARVEY
OF CAMBRIDGE

REGULATED POWER SUPPLIES

for use with **CONSTANT FREQUENCY OSCILLATORS**
AMPLIFIERS • PULSE GENERATORS • MEASUREMENT EQUIPMENT

500 to
1000
VOLTS

The HARVEY Regulated Power Supply 206 PA

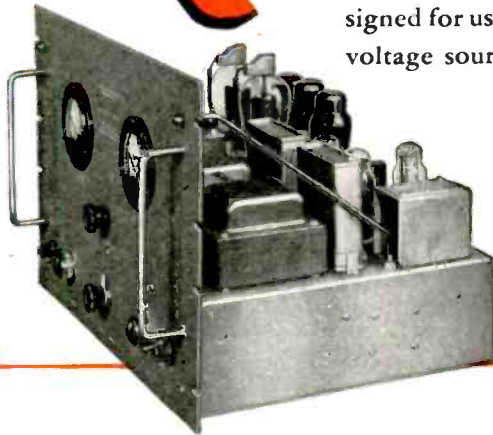

This new HARVEY OF CAMBRIDGE development is designed for use with equipment requiring a constant D.C. voltage source in the 500-1000 volt range. It operates in two ranges—500 to 700 at $\frac{1}{4}$ of an ampere; 700 to 1000 volts at .2 of an ampere. The voltage change caused by current change is less than one per cent in both ranges. Write for complete specifications.

The HARVEY Regulated Power Supply 106 PA

performs smoothly and dependably in the lower voltages. It has a D.C. output variable from between 200 to 300 volts that is regulated to within one per cent. It operates on 115 volts, 50-60 cycles A.C., introduced by a convenient two-prong male plug. For complete information, write for bulletin.

200 to
300
VOLTS



HARVEY
OF CAMBRIDGE

HARVEY RADIO LABORATORIES, INC.

441 CONCORD AVENUE • CAMBRIDGE 38, MASSACHUSETTS

THERMEX meets the demand for high frequency equipment for pre-heating of plastic preforms. Preforms are placed on this drawer which slides into unit shown below.



THERMEX MODEL 2-P

Of course it uses Eimac tubes

This compact Thermex unit measures 28 inches by 28 inches, stands 47 inches high, and weighs only 614 pounds. It is a practical and flexible piece of equipment with built-in heating cabinet and removable 12 inch by 15 inch drawer-electrode.

Being completely automatic, there is nothing to do but plug this Thermex in and load and unload the preform drawer. No dials, no tuning, not even a button to push. Closing the preform drawer all the way in, turns on the high frequency power and timer. At the end of the prescribed time, which may be anywhere from 5 to 10 seconds up to 2 minutes, the red indicating light goes out, the operator removes the tray and unloads the preforms into the mold cavities.

The Thermex Model No. 2-P, which is illustrated, operates at a frequency of 25 to 30 megacycles using 230 volt 60 cycle single phase current. It has an output in excess of 3400 BTUs per hour, and it uses a pair of Eimac 450-TH tubes. The use of electronic heating has increased production for many plastic manufacturers who

have been leaders in utilizing the science of electronics.

The Thermex Division of the Girdler Corporation of Louisville, Ky., is a leader in supplying equipment for this and other industrial applications. It's natural that Eimac tubes are used, since these tubes are first choice of leading electronic engineers throughout the world.

Follow the leaders to

Eimac
REG. U. S. PAT. OFF.
TUBES

EITEL-McCULLOUGH, Inc.

985 San Mateo Avenue, San Bruno, California

Plants located at: San Bruno, California and Salt Lake City, Utah
Export Agents: Frazer & Hansen, 301 Clay St., San Francisco 11, California, U. S. A.

Eimac has received 7 ARMY-NAVY "E" AWARDS for production efficiency • San Bruno 5, Salt Lake City 2

Greater Accuracy Over Longer Periods

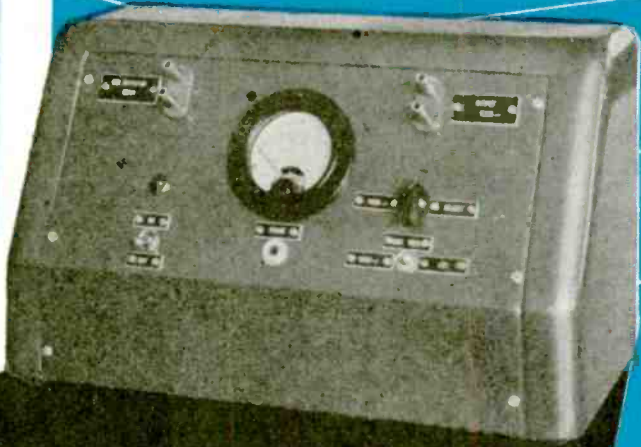
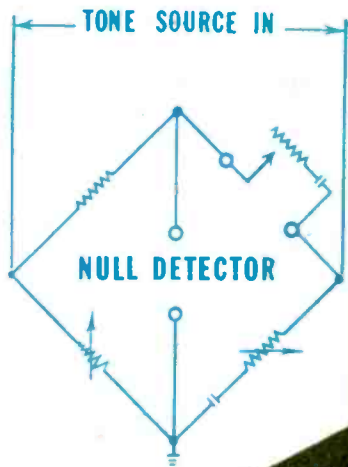

SHERRON NULL DETECTOR

The Sherron Null Detector is a necessary adjunct to all A. C. Bridge measurements, such as, A. C. resistance, impedance, capacity and others, and is used to indicate rapidly and accurately when that bridge is at balance or null point.

The standard Sherron Null Detector is designed to give an appreciable deflection with an input voltage of .01 volts. However, increased sensitivity can be readily obtained to any desired degree.

The Null Detector is so designed that while an input voltage of .01 volts will cause an appreciable deflection of the indicating meter, 32 volts across the input will not cause the meter to swing off scale.

The substitution of a Cathode Ray Tube in place of a meter moves the test equipment upward from quantitative to qualitative.

Use of the Cathode Ray Tube permits the engineer or operator to note immediately and correct any distortion of wave shape, any displacement of phase or extraneous noise that may cause error.

All Null Detectors are equipped with a 1000 cycle tone source of sufficient level to operate any of the standard bridges, and a filter circuit resonated to that frequency to insure only that frequency activating the indicating meter.



Inasmuch as most of the standard bridges may be used at frequencies other than 1000 cycles per second, switching arrangements are provided to disconnect both the internal tone source and filter circuit.

By means of a conventional jack, a head set may be inserted to ascertain audibly if the meter is indicating the bridge frequency or any extraneous noises.

*Sherron
Electronics*

SHERRON ELECTRONICS COMPANY

Division of Sherron Metallic Corporation

1201 Flushing Ave., Brooklyn 6, N. Y.

"Where the Ideal is the Standard, Sherron Units are Standard Equipment"

Whitaker Can Wire It



Let us help you by producing your wiring requirements. We have the experience and the facilities to engineer and manufacture cable products for you, or we can take your blueprints and turn out jobs to your specifications . . . Whitaker has been making cable assemblies and other cable products since 1920. In addition to our SPECIAL CABLE and CABLE ASSEMBLY service, Whitaker also offers a quality line of standard cable products . . . Catalog on request . . . Your inquiries are solicited.

WHITAKER CABLE CORPORATION

General Offices: 1311 Burlington Avenue, Kansas City 16, Missouri
Factories: Kansas City, Mo. • St. Joseph, Mo. • Philadelphia • Oakland

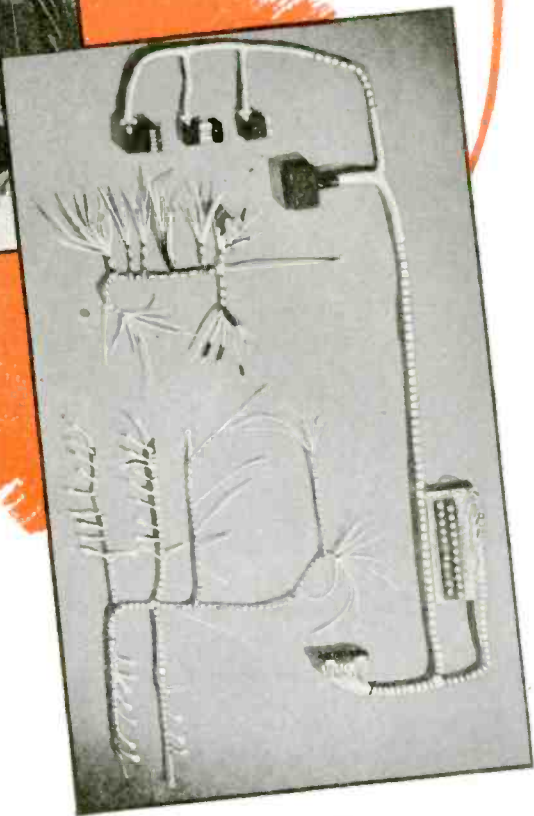
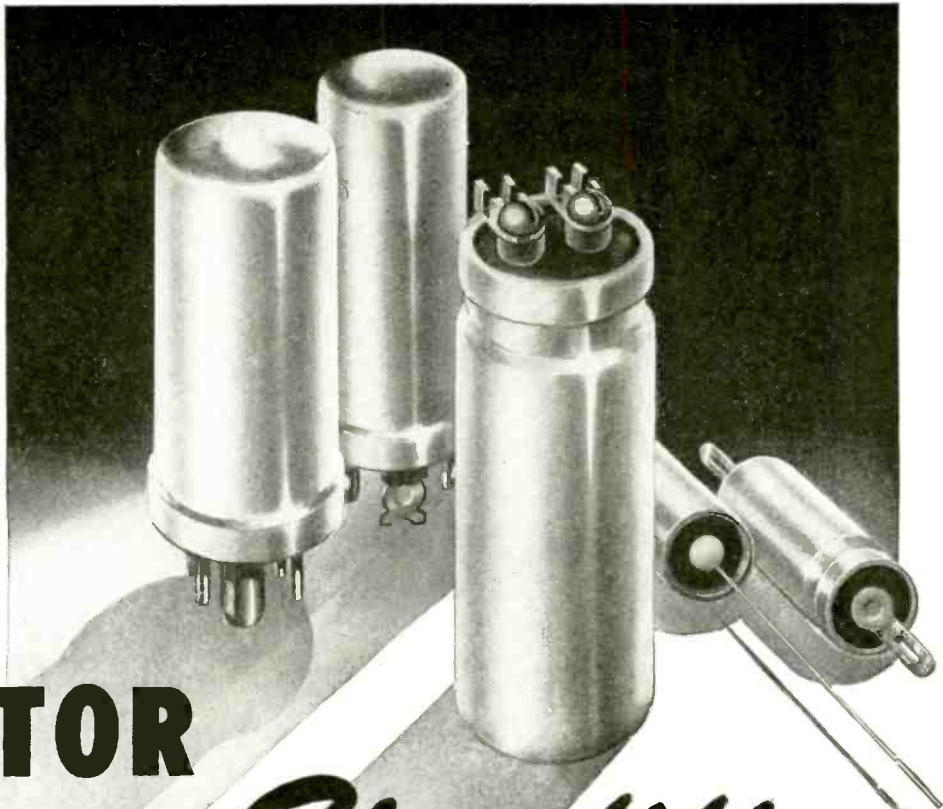

Illustration above shows an example of one of many complicated jobs recently produced in volume by Whitaker.

IF YOUR PRODUCTION NEEDS include:
★ WIRING HARNESES ★ CABLE ASSEMBLIES
★ BONDING JUMPERS ★ CABLE or TERMINALS
--you'll find **WHITAKER**
is a dependable source



CAPACITOR SELECTION

Simplified

Probably no type of Electrical-Electronic component affords a greater variety of selection for a given application than capacitors. Probably no component is more susceptible to design changes to accommodate given conditions. Moreover, nowhere has engineering been moving faster in developing new types, improving old types and, in general, changing past conceptions of Capacitor usage.

That's why proper Capacitor selection is no casual matter—and this, in turn, is why we make the following recommendation to Capacitor users:

Write today for a supply of Sprague Capacitor Sample Request Forms. Then, as Capacitor applications arise, send full data to Sprague engineers on these forms. Let Sprague consider all factors involved—both in the light of long, specialized experience, and of the latest Capacitor developments or adaptations which Sprague engineering may have to offer.

It takes no longer to buy Capacitors on this basis. Such service makes them cost no more—and it frequently means important savings, increased efficiency on your production line, and greater dependability for your product.

SPRAGUE ELECTRIC COMPANY, North Adams, Mass.
(Formerly Sprague Specialties Co.)

SPRAGUE CAPACITOR TYPES

Dry Electrolytics Paper—Mica
Power Factor Correction
High Voltage Networks
Vitamin Q Capacitors
Radio Noise Suppression
Filters, etc., etc.

SPRAGUE RESISTOR TYPES

*Koolohm Wire-Wound Power
Hermetically-sealed Wire Wounds
Bobbin Types
Voltage Divider Sections
Precision Meter Multipliers, etc.

*T. Ms. Reg. U. S. Pat. Off.



SPRAGUE

CAPACITORS — *KOOLOHM RESISTORS

Gammatron **MATCHED PERFORMANCE**

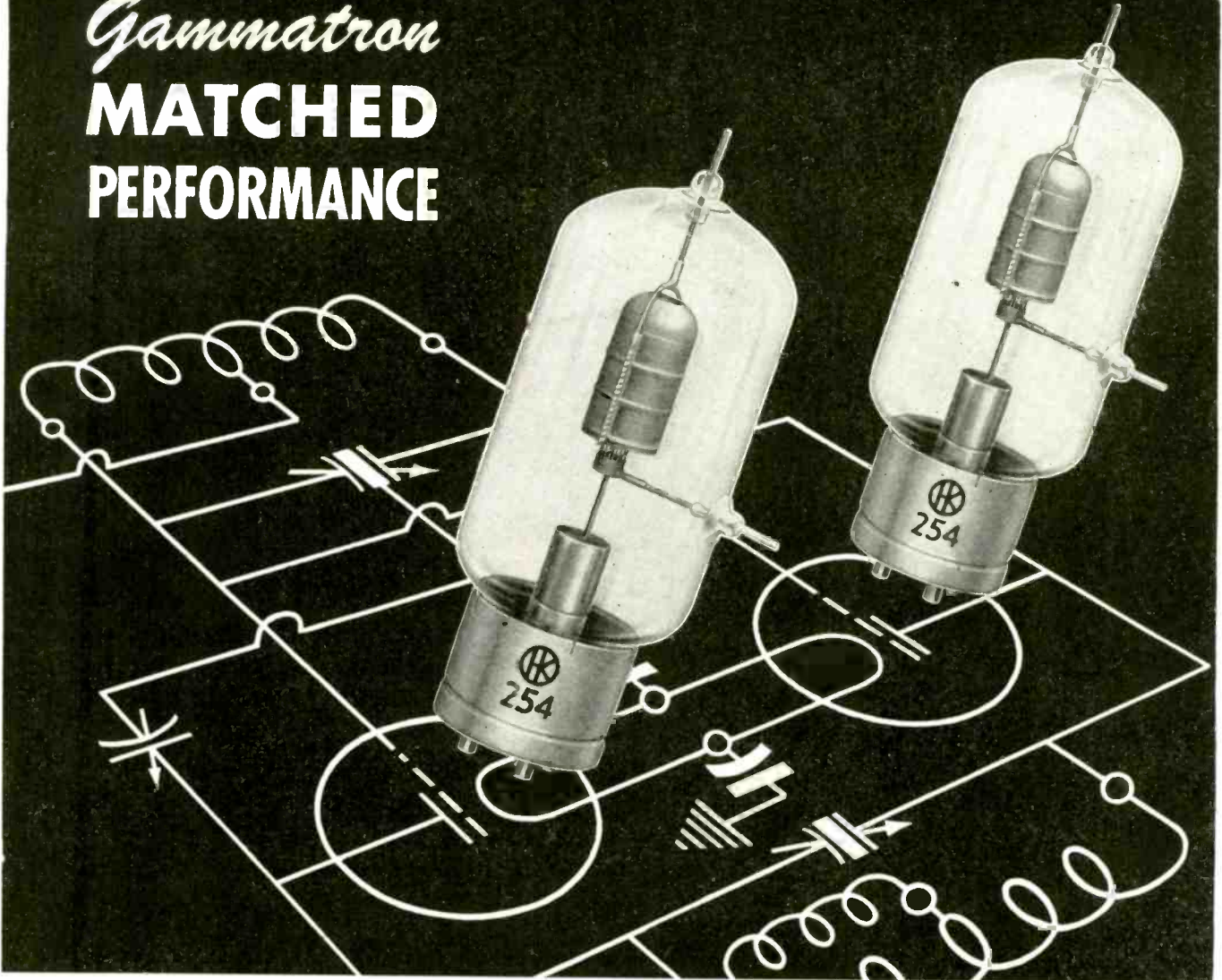

Gammatron **UNIFORMITY MEANS LONGER TUBE LIFE**

Heintz and Kaufman engineers have continually developed closer electrical and physical tolerances for Gammatron tubes over the past 16 years, knowing that matched characteristics result in better operation and longer tube life.

Today the importance of tube uniformity, especially in the very high frequencies, is widely recognized; and many of the peacetime standards we have established for Gammatrons are now contained in the wartime specifications for all tubes of the Gammatron type... When you design a transmitter around a pair—or even a dozen—Gammatrons, you will get the full benefit of our years of experience in pioneering constantly higher standards of transmitting tube performance.

HEINTZ AND KAUFMAN LTD.
SOUTH SAN FRANCISCO • CALIFORNIA

Gammatron Tubes

H K-254 Matched CHARACTERISTICS

MAXIMUM RATINGS

Power Output	500 Watts
Plate Dissipation	100 Watts
Amplification Factor	25
DC Plate Voltage	4000 Volts
DC Plate Current	225 M. A.
DC Grid Current	40 M. A.
Max. Frequency	175 Mc

INTER-ELECTRODE CAP. :

C grid-plate	3.6 uuf
C grid-filament	3.3 uuf
C plate-filament	1.0 uuf
Filament Voltage	5 Volts
Filament Current	7.5 Amps.



**KEEP IT UP
BUY WAR BONDS**

Announcing Two Highly Developed Collins Autotune* Transmitters



Collins 16F-9—Nominal power output: 300 watts phone; 500 watts CW. Frequency range: 2 to 18 mc. Ten quick-shift frequencies.

Collins 231D-13—Nominal power output: 3000 watts phone; 5000 watts CW. Frequency range: 2 to 18 mc. Ten quick-shift frequencies.

IN DESIGN and construction, these transmitters reflect intense engineering endeavor and hard won experience in meeting the requirements of war. The most advanced laboratory refinements are combined with military ruggedness on a production-line basis!

The lessons learned since Pearl Harbor have increased the already high reset accuracy and dependability of the Collins Autotune. Any one of ten frequencies is reliably, precisely available at the flip of a dial, from a remote point. The standard models are crystal controlled, and special models are available with tunable master oscillator control.

The physical size of these transmitters has been increased, and components specially Collins re-designed, to increase safety factors throughout.

The renowned Collins pi network matches into a wide variety of single wire or vertical antennas. The 231D-13 also matches into a 600 ohm balanced transmission line from 4 to 18 mc.

Frequency-shift keying is available, making it possible to use these transmitters in printing telegraph circuits.

We will welcome inquiries and an opportunity to make recommendations for your particular application. Collins Radio Company, Cedar Rapids, Iowa.

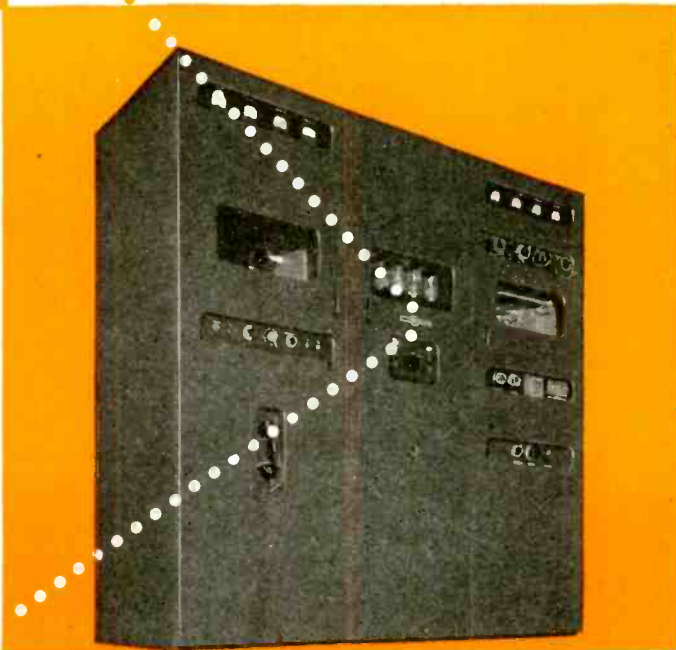

*The Collins Autotune is a repositioning mechanism which quick-shifts all tuning controls simultaneously and with extreme precision to any one of a number of pre-selected frequencies. Patents issued and pending in the U. S. A. and other countries.

• IN RADIO COMMUNICATIONS, IT'S ...

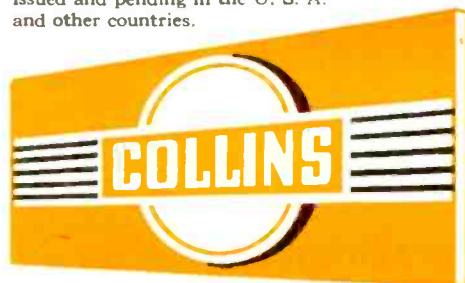

CONTROLS FOR POSTWAR PRODUCTS

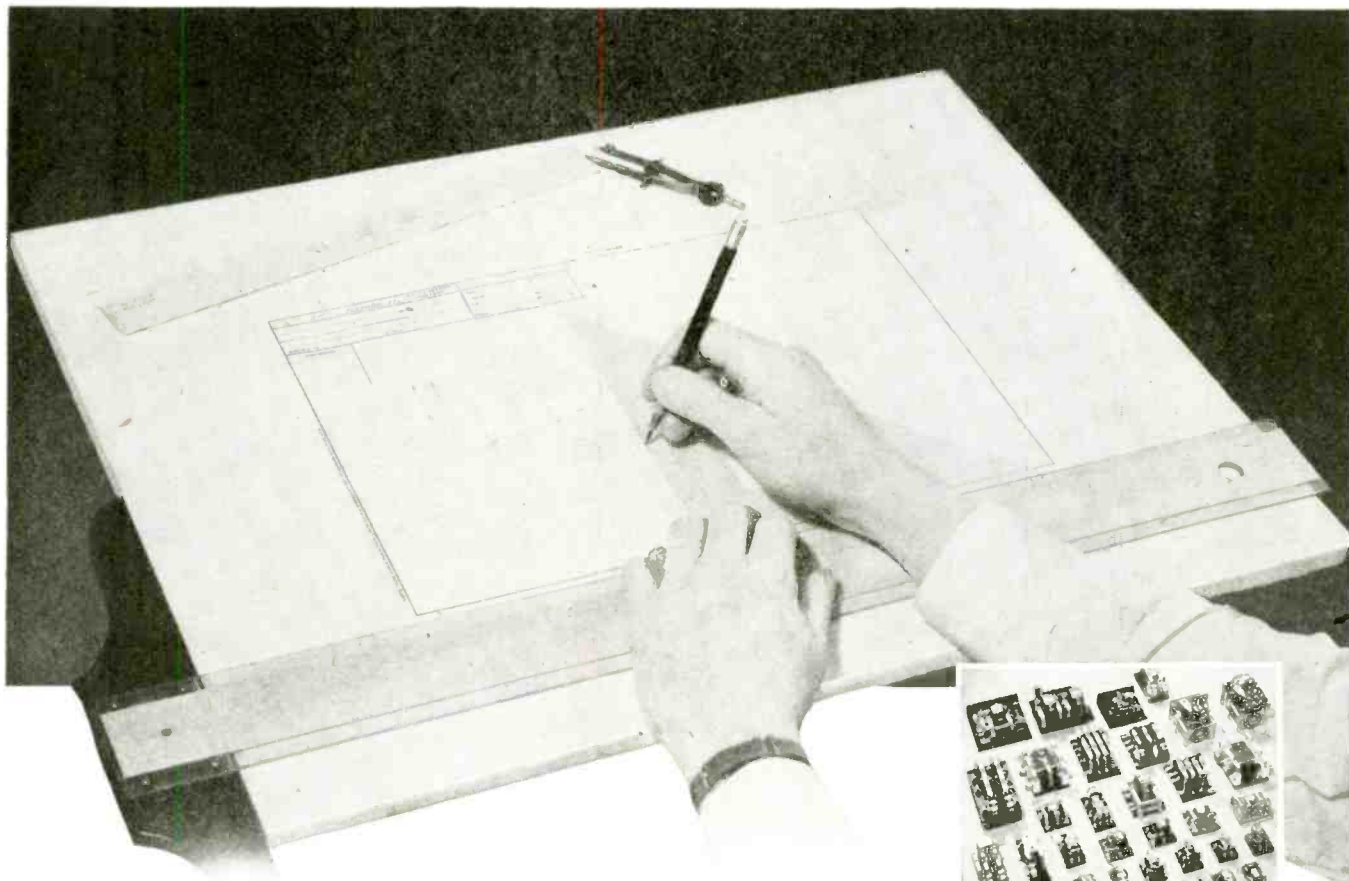

With the rush to catch the earliest possible markets with postwar products, it is important that they be designed with units that can be procured without undue delay. Manufacturers of equipment requiring electric controls will find Ward Leonard Relays, Resistors and Rheostats readily available without "time-out" for redesigning. Facilities at Ward Leonard used to produce products for war purposes required little or no conversion. To serve postwar markets, they will likewise require a minimum of reconversion. Make your selection from the Ward Leonard Line. Let us send you bulletins describing controls of interest to you.

WARD LEONARD

RELAYS • RESISTORS • RHEOSTATS



Electric control  devices since 1892.

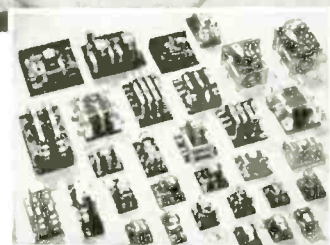

RELAYS for light, intermediate and heavy duty, sensitive, transfer, time delay, antenna changeover, break-in and latch-in operation.



RESISTORS that withstand heat, moisture, vibration and other adverse conditions. Wide range of types, ratings, terminals and enclosures.

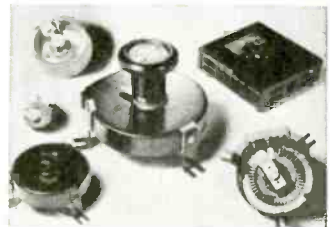

RHEOSTATS that include the widest range of sizes, types and current ratings from the tiny ring types for radio to huge industrial assemblies.

WARD LEONARD ELECTRIC COMPANY • 61 SOUTH ST. • MOUNT VERNON, N. Y.

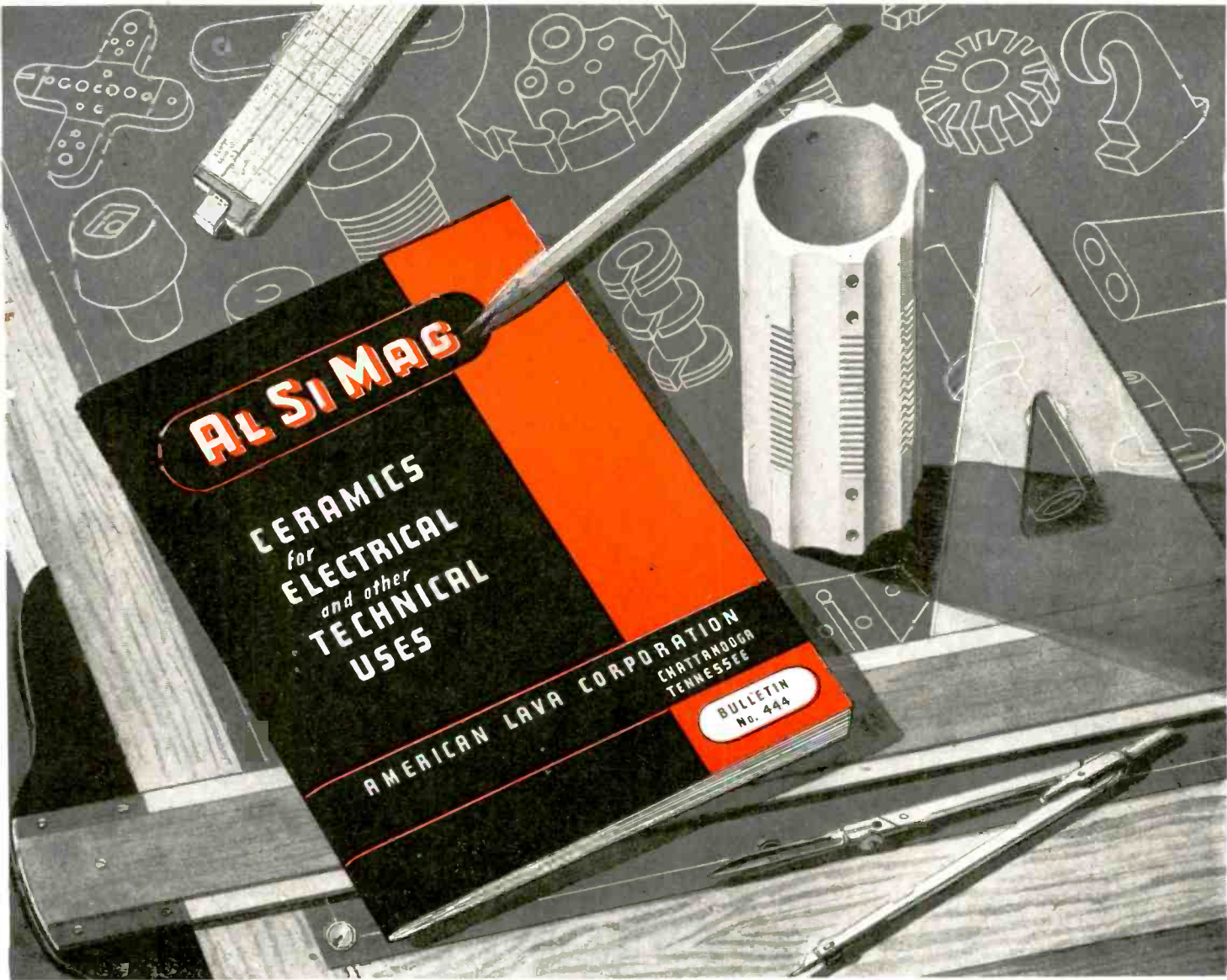

ANNOUNCING BULLETIN NO. 444

... JUST OFF THE PRESS

BULLETIN No. 444 will prove a valuable tool in the hands of Engineers, Designers and Research Men. It is also a helpful, informative guide for Purchasing Agents.

ALSiMAG Ceramic Insulator bodies, each with its particular physical and electrical characteristics, are concisely described and the uses indicated.

Typical designs taken from a roster of more than 25,000 distinct items are splendidly illustrated—in groups of

applications covering electrical, electronic, industrial heating, chemical, automotive and other fields. Property charts and other technical data, together with practical information on manufacturing processes, are included.

Here is valuable, authentic information... the latest work on Ceramic insulators... in concise, easy-to-use form. If you have not received your complimentary copy of Bulletin No. 444, please write for it today.



ALCI has been awarded for the first time the Army-Navy "E" Award for "continued excellence in quantity and quality of essential war production."

AMERICAN LAVA CORPORATION
CHATTANOOGA 5, TENNESSEE

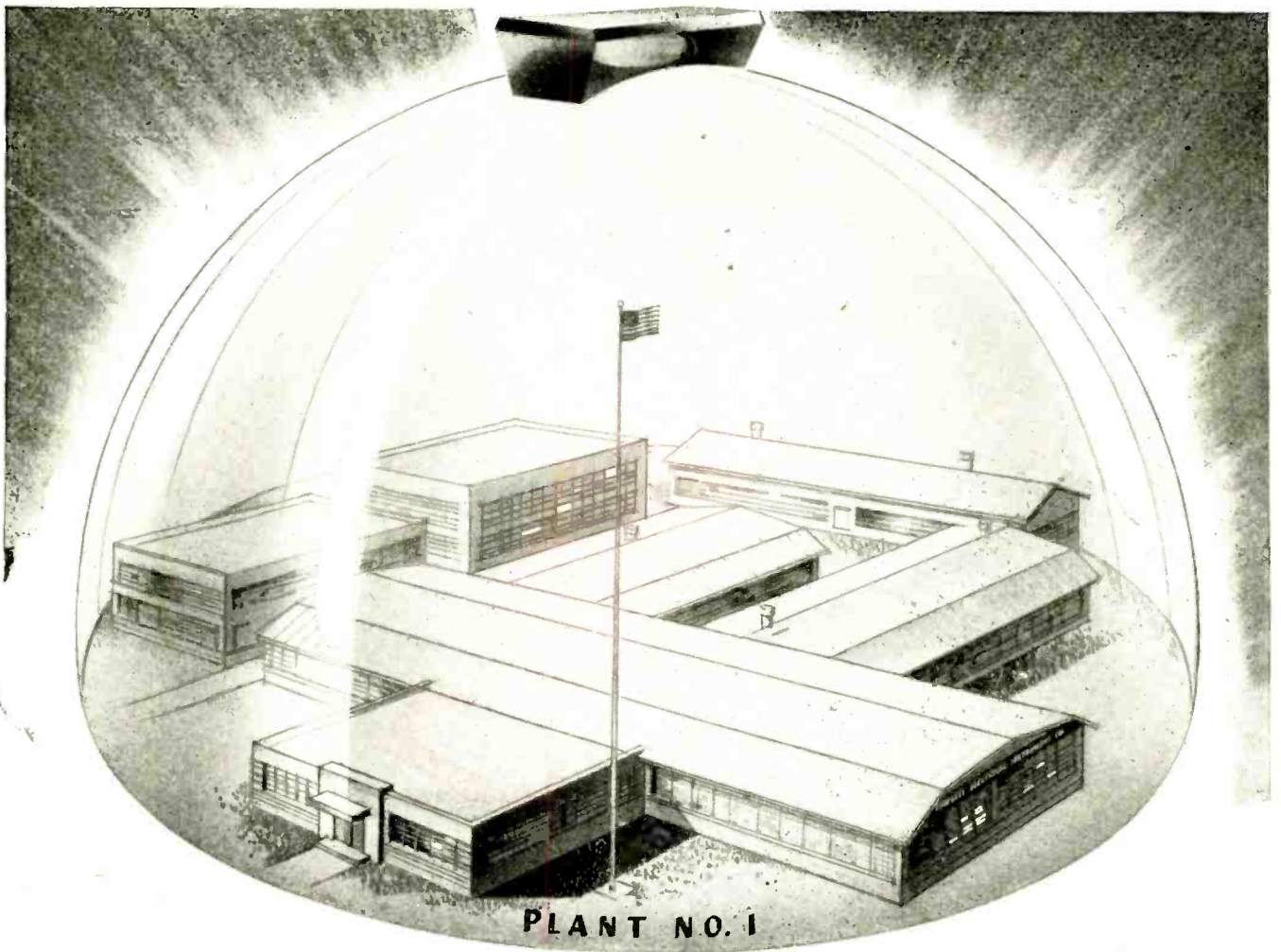

" DUSTLESSTOWN, OHIO "

● It's the little things that loom biggest in the manufacture of delicate electrical measuring instruments. Little things like specks of dust or breath condensation can play havoc with accuracy. That's why Triplett Instruments are made in spotless manufacturing departments; why the air is washed clean, de-humidified and

temperature-controlled; why every step in their mass production is protected. As a result Triplett Instruments perform better, last longer and render greater service value.

Extra Care in our work puts Extra Value in your Triplett Instrument.



Triplett

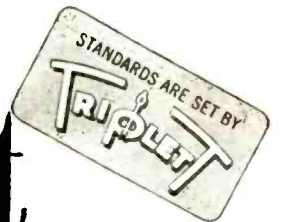

ELECTRICAL INSTRUMENT CO. BLUFFTON, OHIO

ELECTRONIC INDUSTRIES ● February, 1945

Plenty of Protection *against...*

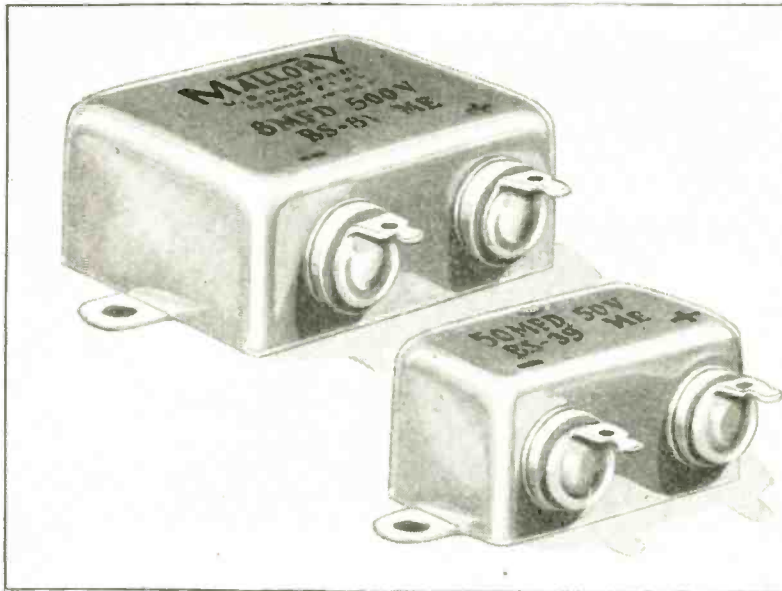

**EXTREME
VIBRATION**

**HIGH
HUMIDITY**

**EXTREME
TEMPERATURES**

**CORROSIVE
FUMES**

MALLORY "BS" CAPACITORS

HERE'S the "toughy" among dry electrolytic capacitors. Mallory "BS" Capacitors have proved their ruggedness in the severest service all over the world.

These "bathtub" capacitors are built with an inner container of aluminum to protect the unit itself, and an outer case made of plated steel, hermetically sealed. This double protection is proof against severe vibration, corrosive fumes and high humidity. In actual service tests, "BS" capacitors operate over a temperature range from -40° C. to 85° C. The impedance at -40° C. at 120

cycles is well within operational limits.

Type "BS" is a standard Mallory capacitor and is available from stock in ratings from 10 mfd. at 25 volts to 8 mfd. at 500 volts. Surge voltage ratings are from 40 to 700. Terminals are located at side for convenient mounting.

To obtain complete specifications, get a copy of the Mallory catalog from your nearest Mallory Distributor or write direct. We'll gladly provide special engineering help on your unusual applications.



P. R. MALLORY & CO., Inc., INDIANAPOLIS 6, INDIANA

P. R. MALLORY & CO. Inc.
MALLORY
Electrolytic,
Film and Paper
CAPACITORS

RAYTHEON VOLTAGE STABILIZERS

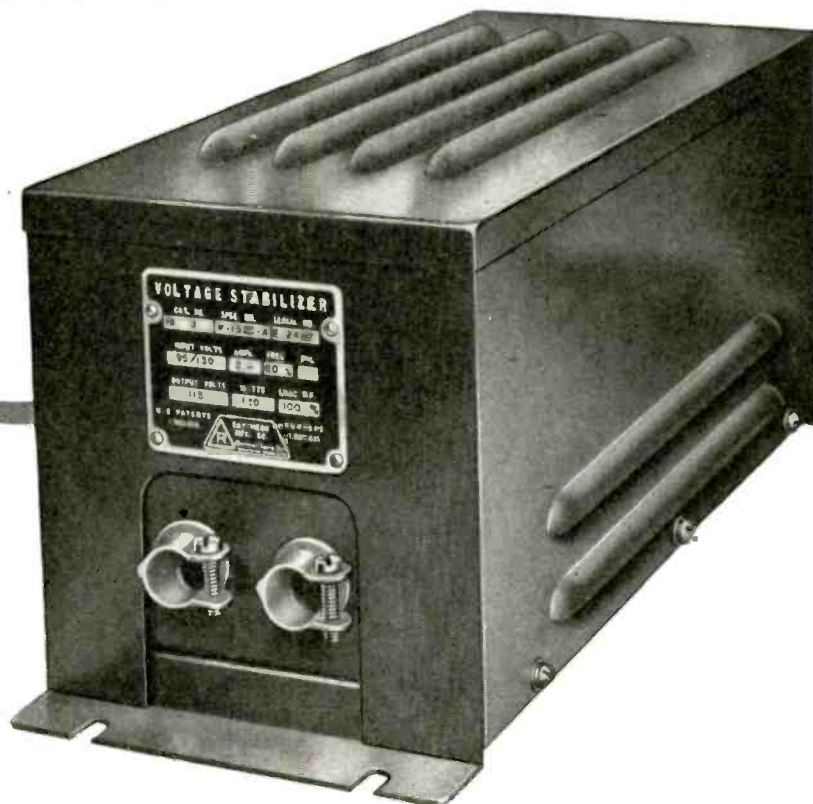

CONTROL VARYING LINE VOLTAGES

TO 115 VOLTS $\pm \frac{1}{2}\%$

Ordinary A.C. line voltages as taken from supply mains often vary as much as from 95 to 130 volts. This impairs the precision operation of electrical equipment.

A Raytheon Voltage Stabilizer, built into new products or incorporated into equipment already in use, overcomes the disadvantage of fluctuating voltages by providing an accurately controlled source of power to $\pm \frac{1}{2}\%$.

Here's what a Raytheon Stabilizer does—stabilizes varying input voltage from 95 to 130 volts to 115 volts $\pm \frac{1}{2}\%$ within 2 cycles.

Raytheon Voltage Stabilizers are entirely automatic. They require no adjustments or repeated maintenance. No moving parts assure long life. Write for bulletin DL 48-537.

EFFECT OF VARIABLE FREQUENCY

Since partial resonance is a requisite design feature, these devices are sensitive to frequency changes. The output voltage will vary in the same direction and 1.4 times the percentage change in frequency, over a range of 5% of the normal frequency.

Stabilization, however, will be within $\pm \frac{1}{2}\%$ at the output voltage which is established by the frequency.

TYPE VR 2
INPUT VS OUTPUT VOLTAGE
FOR VARIOUS FREQUENCIES

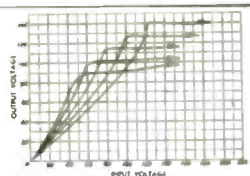

Tune in the Raytheon radio program: "MEET YOUR NAVY," every Saturday night on the Blue Network. Consult your local newspaper  for time and station



RAYTHEON
MANUFACTURING COMPANY

Electrical Equipment Division

190 WILLOW STREET, WALTHAM, MASS.

Devoted to research and manufacture of complete electronic equipment; receiving, transmitting and hearing aid tubes; transformers; and voltage stabilizers.

The coveted Army-Navy "E," for Excellence in the manufacture of war equipment and tubes, flies over all four Raytheon Plants where over 16,000 men and women are producing for VICTORY.

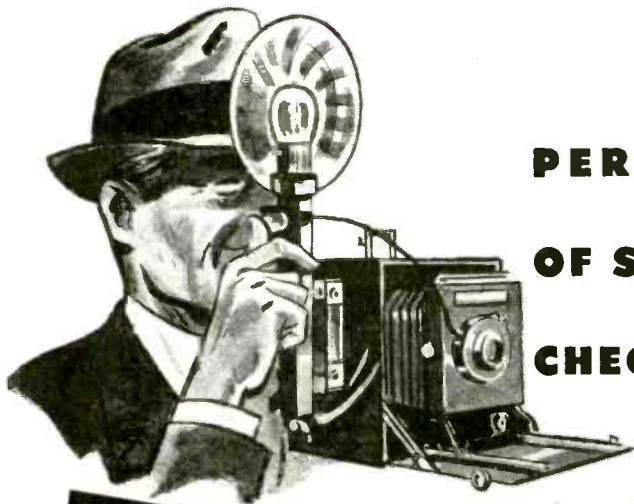

**PERFECT EXPOSURE BECAUSE
OF SHUTTERS AND FLASH-BULBS
CHECKED BY **Du MONT****

Oscillography

▶ Testing of photographic shutters; measurements of flash-bulb characteristics; calibration of lens diaphragm openings; comparison of transmission factor of lenses; opacity and density measurements—such are typical applications of versatile *DuMont Oscillography* to still better photography.

Typical of this technique is the precise checking of shutter speeds. Fig. 1 shows an oscillogram obtained with arrangement in Fig. 2. Light intensity passing through shutter is directly plotted as a function of time.

When shutter opens, light from neon lamp falls on photo-cell. Both cell and neon lamp operate on D.C. Output from photo-cell directly, or D.C. amplified if necessary, is applied to vertical deflection plates of cathode-ray tube. A timing wave modulates the cathode-ray beam, so that plot appears as dotted line. The distance between two adjacent dots being determined by the period of the timing wave.

Typically *DuMont Oscillography*. No doubt there is an equally important application in your laboratory, on your production line, or out in the field. Submit your problem for our suggestions and engineering help.

This oscillogram discloses the elapsed time for the opening shutter, the full opening, and the closing shutter, calibrated in time elements of 1/1000ths of a second.

Fig. 3 discloses the characteristics of a flash-bulb again in terms of 1/1000ths of a second. Equipment used is shown in Fig. 4. A relay, delayed for about 1/30th second, starts the flash after the start of the single sweep.

This flash-bulb checkup determines: (1) Time elapsing between closing of battery contact and start of flash; (2) Duration of flash itself; (3) Measurement of peak luminous output; and (4) Determination of total light output (by integration).

▶ Write for Literature

© ALLEN B. DUMONT LABORATORIES, INC.

DUMONT

Precision Electronics & Television

ALLEN B. DUMONT LABORATORIES, INC., PASSAIC, NEW JERSEY • CABLE ADDRESS: WESPEXLIN, NEW YORK

Cook Relays are "Extra-Ordinary" in ENGINEERING and CRAFTSMANSHIP

The Cook Type 113 Relay Is an Example of Outstanding Relay Manufacture

The Cook Type 113 relay, as illustrated, is an example of how every energy is exerted to see that each and every phase of manufacture is the best that modern science and engineering can produce. From the original development and engineering stage, through the specification of the best and highest grades of materials, the precision manufacture of all parts, the careful assembly, the rigid testing of the completed relay, every step along the way is an operation in which Cook craftsmen take pride, with the knowledge that on their efforts depend the continuance of the Cook reputation for the production of "extra-ordinary" relays.

Nothing is left to chance with a Cook relay, each part is a carefully engineered item, all materials must pass the inspection of our metallurgical laboratory, there is no "wishful thinking" that some stock-bin part is "good enough". . . It's this close attention to detail that makes Cook relays "extra-ordinary."

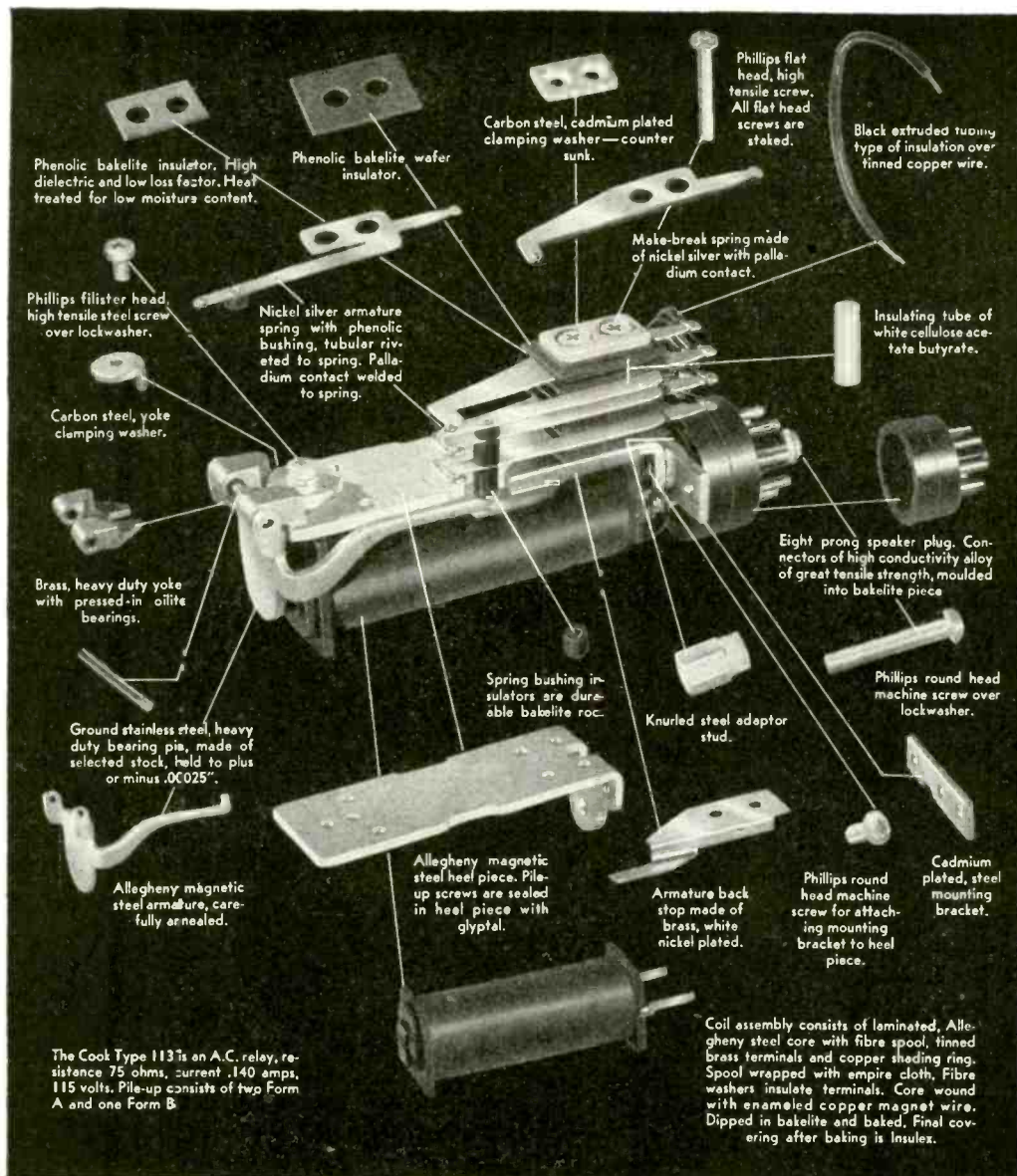

Whether your requirements are for a standard type relay or a special type relay for an unusual application, you can rely on Cook engineering and craftsmanship to give you those "plus features" of performance and dependability. Cook's engineering staff is at your service to assist you with your relay problems. A staff of field engineers, located in various key cities through the United States and Canada is also available to you. Why not call on one of these experts when you desire a better relay for your finest equipment?



2700 SOUTHPORT AVENUE
CHICAGO 14, ILLINOIS



GLASS ENDURES

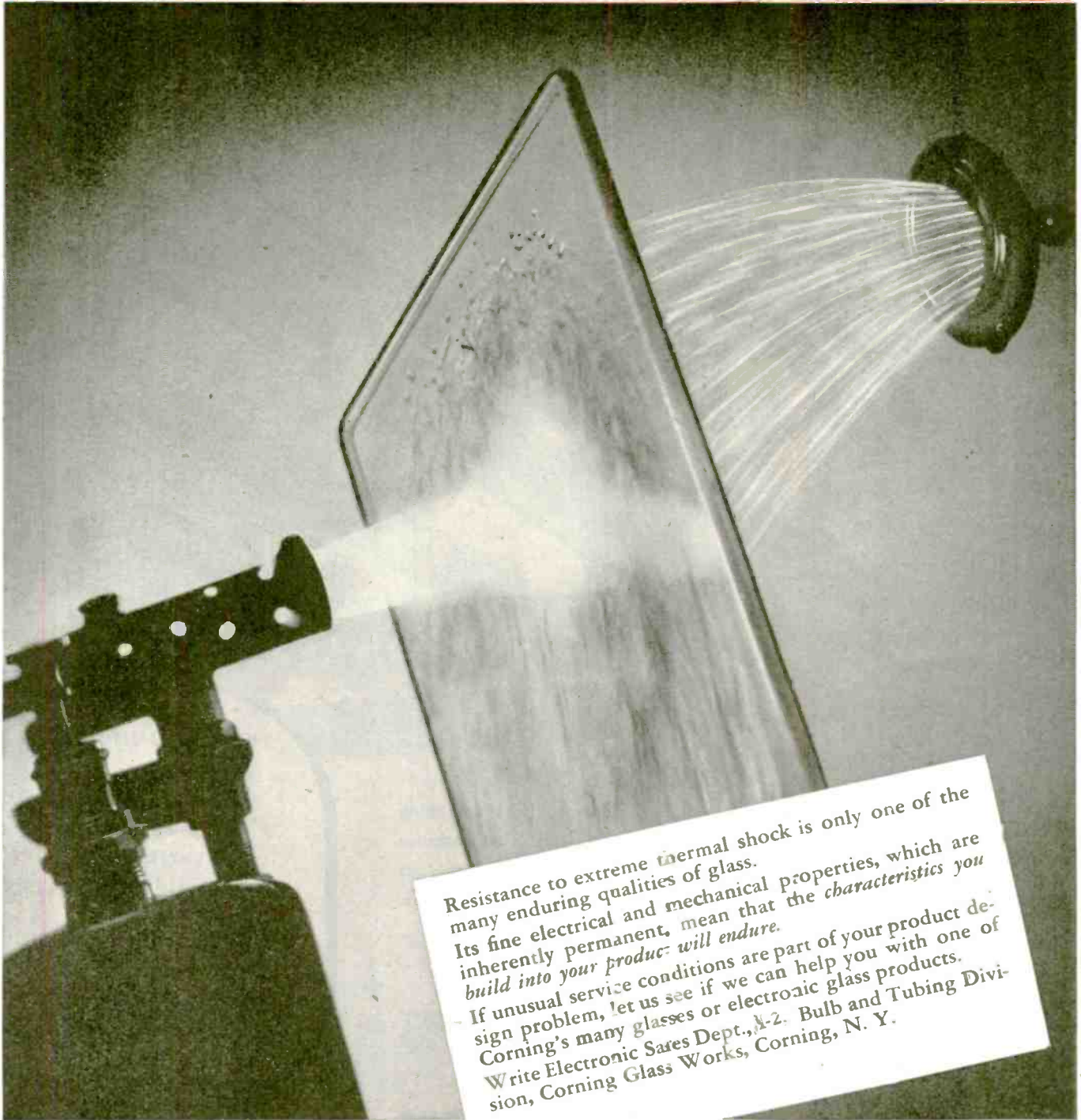

Resistance to extreme thermal shock is only one of the many enduring qualities of glass. Its fine electrical and mechanical properties, which are inherently permanent, mean that the characteristics you build into your product will endure. If unusual service conditions are part of your product design problem, let us see if we can help you with one of Corning's many glasses or electronic glass products. Write Electronic Sales Dept., 4-2, Bulb and Tubing Division, Corning Glass Works, Corning, N. Y.

CORNING
— means —
Research in Glass

Electronic Glassware



“PYREX”, “VYCOR” and “CORNING” are registered trade-marks and indicate manufacture by Corning Glass Works, Corning, N. Y.

OHMITE RESISTORS

Many Types and Sizes
Assure the Right Resistor
for Each Control Job

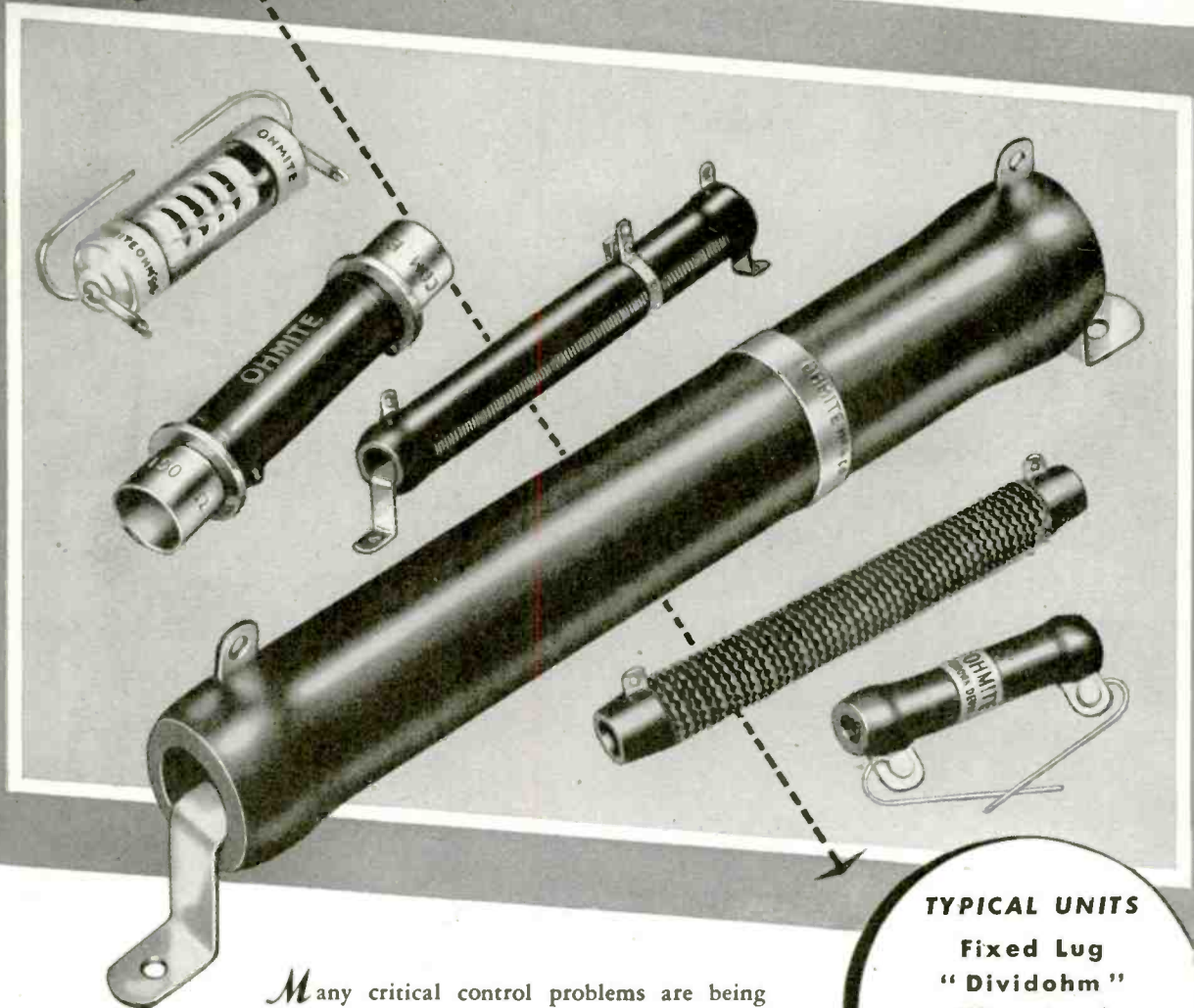

Many critical control problems are being readily and successfully solved with Ohmite Resistors. That's because the extensive range of Ohmite types and sizes makes possible an almost endless variety of regular or special units to meet each need best.

Ohmite core sizes range from 2½" diameter by 20" long to ⅝" diameter by 1" long. Wide selection of stock units are available.

These rugged resistors have proved their worth under toughest operating conditions, in every field of action. Ohmite engineers are glad to help on today's and tomorrow's control problems.

OHMITE MANUFACTURING COMPANY
4984 Flournoy Street Chicago 44, U.S.A.

- TYPICAL UNITS**
- Fixed Lug
 - "Dividohm"
 - Wire Lead
 - "Corrib"
 - Ferrule
 - Edison Base
 - Precision
 - Bracket
 - Non-Inductive
 - Tapped
 - Cartridge
 - Strip

Send for Catalog and Engineering Manual No. 40
Write on company letterhead for this complete, helpful guide on resistors, rheostats, tap switches.
Address OHMITE, 4984 Flournoy, Chicago 44.



Be Right with **OHMITE**
RHEOSTATS • RESISTORS • TAP SWITCHES

THE ION SPOT



A Television Problem Solved by Philco Research!

THE ION SPOT... that dull, brownish blur that develops in the center of a television picture tube after a few hours of use... was one of television's most baffling problems. Caused by the bombardment of negative ions on the fluorescent screen, the Ion Spot creates a serious blemish in the television picture.

Today, thanks to Philco research, the problem of the Ion Spot has been solved. Philco television engineers invented an electron gun with an *Ion Trap* that deflects these harmful ions before they can reach the screen. Thus

Philco research makes possible a clear television picture, *unmarred by the Ion Spot.*

This successful solution of a television problem is an example of how Philco research contributes to the advance of electronic science. Currently, Philco scientists and engineers are concentrating on the electronic miracles of modern warfare. After the war, look to Philco for continued leadership in making electronics a better servant of both industry and consumer.

PHILCO

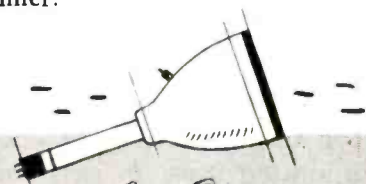

*Famous for Quality
the World Over*

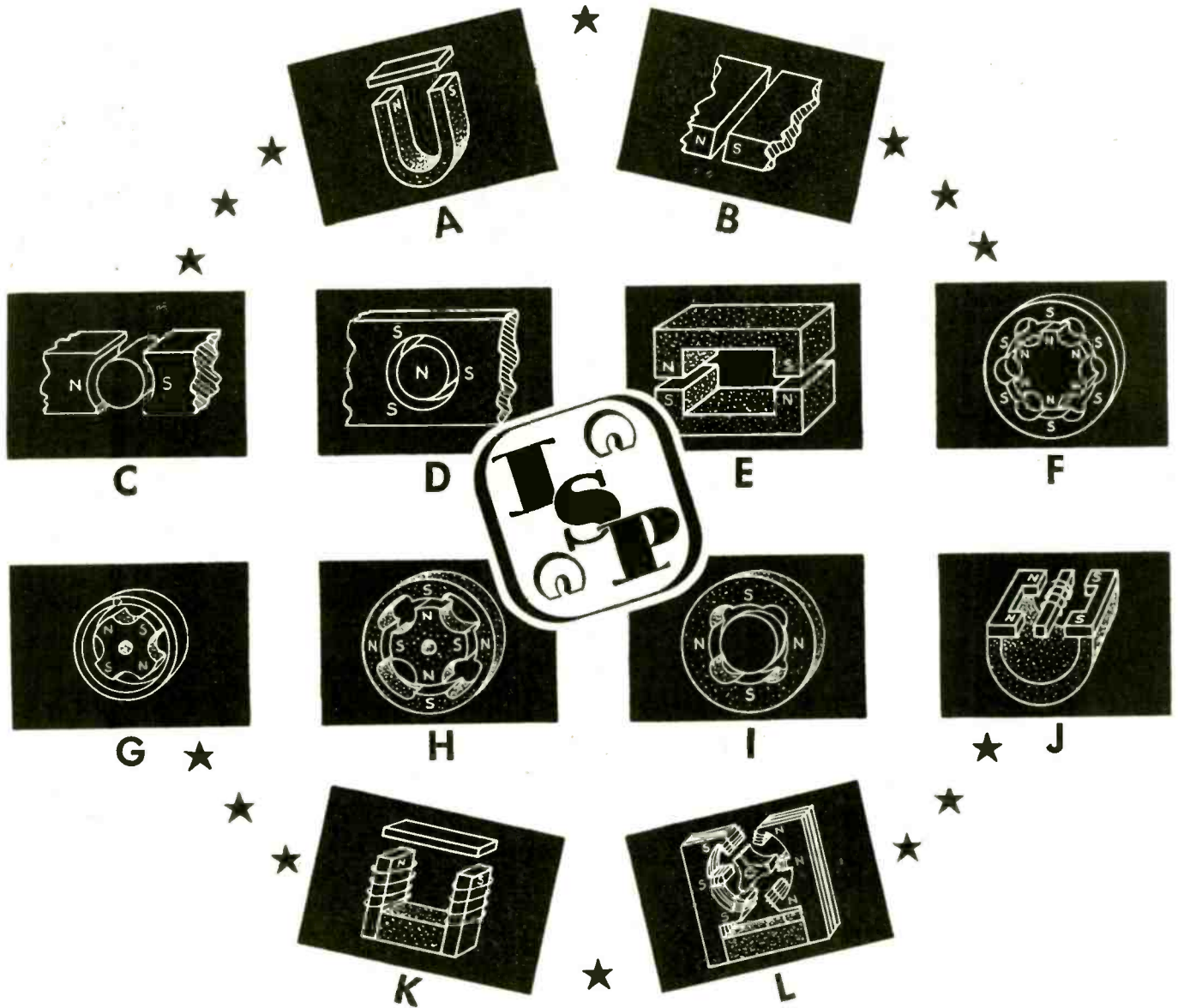

Basic Types of Air Gaps

The space required for a magnetic field is known as an "air gap." Most of the fundamental types of air gaps are illustrated above—from the familiar form shown in "A," which is simply a permanent magnet with an armature adjacent to the poles of the magnet, to the inductor type alternator such as type "L."

The basic forms of permanent magnets and their associated air gaps are subject to infinite variations. They are used in a rapidly growing number of applications... potentially, there are unlimited uses for permanent magnets as yet undiscovered.

In specializing in permanent magnets since 1910, we have discovered and engineered many advances in magnetic technology with the result that this company is now the largest in the

country manufacturing permanent magnets exclusively.

If you are making products which might function better through the employment of magnetic energy, our engineers will be pleased to consult with you. Write for complete information. Ask for a copy of "Permanent Magnets Have Four Major Jobs."

★ THE INDIANA STEEL PRODUCTS COMPANY ★

6 NORTH MICHIGAN AVENUE • CHICAGO 2, ILLINOIS



Specialists in Permanent Magnets Since 1910

COPYRIGHT 1945, THE INDIANA STEEL PRODUCTS COMPANY

ELECTRONIC INDUSTRIES • February, 1945

ANNOUNCING!

4 NEW LARGE SIZES CREATIVE GROMMETS



Send for this free sample card containing 8 standard sizes of grommets

SEVEN SPECIAL ADVANTAGES

1. All edges are chamfered.
2. All holes are concentric.
3. They can't "pop out" of chassis.
4. They are matte finished.
5. Fine thread assures snug fit.
6. All threads are clean and lubricated.
7. All collars are geared.

The new larger sizes range up to $\frac{1}{2}$ " inside diameter. Like the smaller sizes, they are 100% phenolic plastic, and will not "pop out" when you pack wires through them snugly. This sure, speedy assembly is why they cost less in the long run.

CREATIVE GROMMETS ARE IN STOCK AT:

Allied Radio Corporation
833 W. Jackson Boulevard
Chicago 7, Ill.
Tel. HAYmarket 6800

Harrison Radio Corporation
12 West Broadway
New York 7, N. Y.
Tel. WOrth 2-6276

Lew Bonn Company
1211 LaSalle
Minneapolis 4, Minn.
Tel. Main 5313

Radio Specialties Company
1956 So. Figueroa Street
Los Angeles 7, Calif.
Tel. PRespect 7271

Seattle Radio Supply, Inc.
2117 Second Avenue
Seattle 1, Washington
Tel. Seneca 2345

For special size Grommets in quantity or Creative's custom work without molds, contact factory or the following direct factory representatives:

MR. BRUCE CUMMING
201 N. Wells Street
Chicago 6, Ill.
Tel. ANdover 5837

MR. VERN T. RUPP
1150 West Olympic Blvd.
Los Angeles 15, Calif.
Tel. PRespect 9516



PLASTICS CORP.

968 KENT AVE, BROOKLYN 5, NEW YORK

RAYTHEON 6AK5

for Broad-Band Amplifiers

in the high and ultra-high frequency regions

For several years Raytheon has been producing for the government a miniature pentode tube so compact and so outstanding in performance that it should be carefully considered by engineers designing future FM, television and amateur equipment.

Interelectrode spacings and element size have been so greatly reduced that the 6AK5 combines the desirable features of low input and output capacitance with high transconductance, reduced lead inductances and lower transit time losses.

It is obvious that "split-hair precision" is required to manufacture the 6AK5, for the distance between the control grid and the cathode is .0035 in.—and the grid is wound with tungsten wire whose diameter is a fraction of that of a human hair.

The 6AK5 is just one example of Raytheon's outstanding ability to build fine tubes for important military use—ability that will be equally evident in the postwar products of the radio and electronics industry.

Specifications of 6AK5

Maximum Diameter		3/4 inches
Maximum Seated Height		1 1/4 inches
Filament Voltage	6.3	6.3 volts
Filament Current	0.175	0.175 amperes
Plate Voltage	180	120 volts
Screen Voltage	120	120 volts
Control Grid Bias	-2	-2 volts
Plate Current	7.7	7.5 ma
Screen Current	2.4	2.5 ma
Transconductance	5100	5000 umhos
Control Grid to Plate Capacitance*		0.01 μpf
Input Capacitance*		4.0 μpf
Output Capacitance*		2.8 μpf

*Using RMA Miniature Shield

All Four Divisions
Have Been Awarded
Army-Navy "E"
with Stars



RAYTHEON

RADIO RECEIVING TUBE DIVISION
Newton, Mass. • Los Angeles • New York • Chicago • Atlanta

Listen to
"MEET YOUR NAVY"
Every Saturday Night
ENTIRE BLUE NETWORK
Coast-to-Coast
181 Stations

DEVOTED TO RESEARCH AND THE MANUFACTURE OF TUBES AND EQUIPMENT FOR THE NEW ERA OF ELECTRONICS

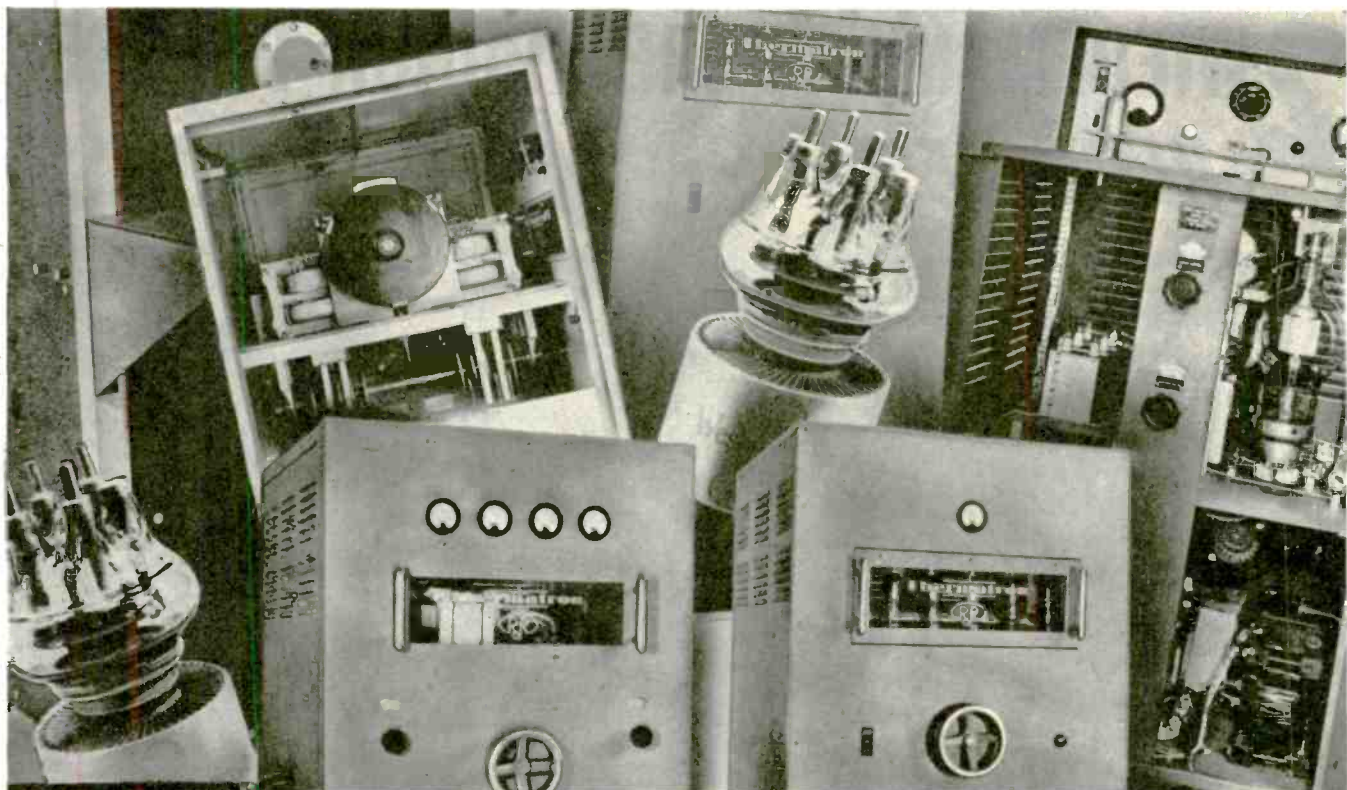

MORE HEAT—FASTER—PER DOLLAR

Thermatron

ELECTRONIC HIGH FREQUENCY HEATERS

THERMATRON internal heat generation, designed and perfected by *Radio Receptor* engineers, opens up new vistas for the processing of many diversified types of materials, including ...

**Plastics
Drugs and Chemicals
Wood Products
Paper**

**Ceramics
Food Products
Textiles
Rubber**

... and enables them to be used for purposes hitherto undreamed of. **THERMATRON** equipment heats, sterilizes, dehydrates, roasts, evaporates, melts and bonds—faster, better, cheaper. **PRODUCTION TIME OF HOURS REDUCED TO A FEW MOMENTS.** Where formerly there were imperfections in the run of a job, now every run is more nearly perfect because output and quality can better be controlled. **THERMATRON** increases profits by reducing costs.

There is a **THERMATRON** electric high frequency heater for every need. Standard sizes from 500 watts to 30 kilowatts output. Units of special sizes and frequencies built to order.

WE ADVISE... INSTALL... SERVICE

Radio Receptor engineers supervise **THERMATRON** installation without charge. Field engineers make periodic check-ups, and emergency service is available on a nation-wide basis. Advice and consultation on present or projected applications freely available.

Write for our new brochure to Dept. 1-2

Thermatron Division

RADIO RECEPTOR COMPANY, INC.

251 WEST 19th STREET

NEW YORK 11, N. Y.

SINCE 1922 IN RADIO AND ELECTRONICS



2 WIEDEMANN TURRET PUNCH PRESSES REPLACE 14 MACHINES!

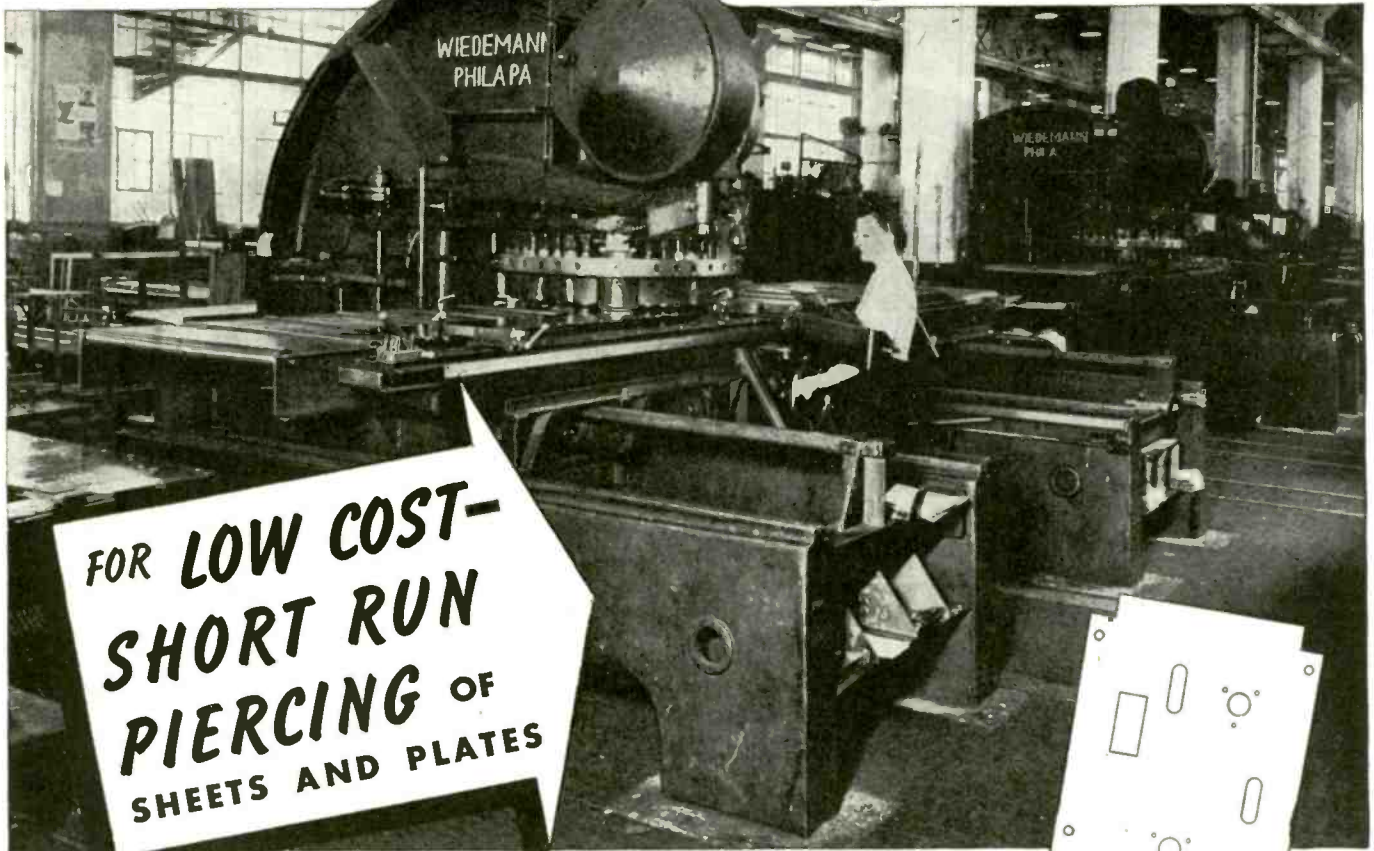

**FOR LOW COST-
SHORT RUN
PIERCING OF
SHEETS AND PLATES**

REDUCED AVERAGE PIERCING TIME ON *SHORT RUN* WORK APPROX. 90%

The two Wiedemann R-7's illustrated are in a line of four which have set new production standards for piercing sheets and plates in the plant of a large manufacturer of electrical equipment.

The R-7 permits 1 person to handle large sheets and plates . . . gauging arrangement positions work by direct reading Handwheels . . . Punch and Die required is positioned by operator through motor controlled turret . . . dimensions are taken from the drawing or from a chart . . . no layout required.

The R-7 Turret Punch Press is unsurpassed in efficiency—if you have sufficient volume of short run* piercing, louvre and similar work to keep the R-7 operating 40 hours a week, the machine will pay for itself in two years or less.

Full details on the R-7 will be sent upon request. In addition, information will be sent gladly on smaller and lighter turret punch presses for handling lighter gauges and smaller material. The same basic economy is inherent in all machines. Write today

WIEDEMANN MACHINE COMPANY

1833 SEDGLEY AVENUE, PHILADELPHIA 32, PA.

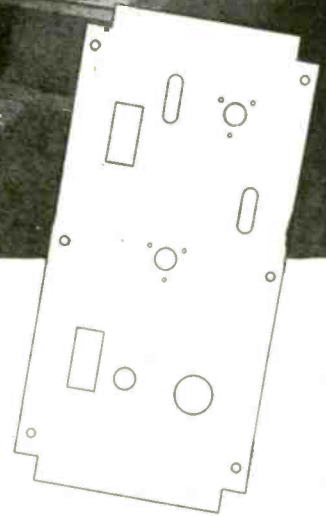

THE JOB:*

48" x 96" mild steel.
24 openings pierced requiring 6 different shapes and diameters.
Old method. 2 hours and 10 minutes.
Wiedemann Method. 12.57 minutes.
(Time includes loading and unloading of material in machine.)
Layout work done directly in the machine and is also included in above time.
Three similar pieces were produced in the same time.

* In general, if the number of pieces does not warrant making a piercing die to do the piercing operation in a single purpose machine, then the job can be most quickly and economically handled on a Wiedemann Turret Punch Press.

WIEDEMANN TURRET PUNCH PRESSES & GAUGE TABLES

So little

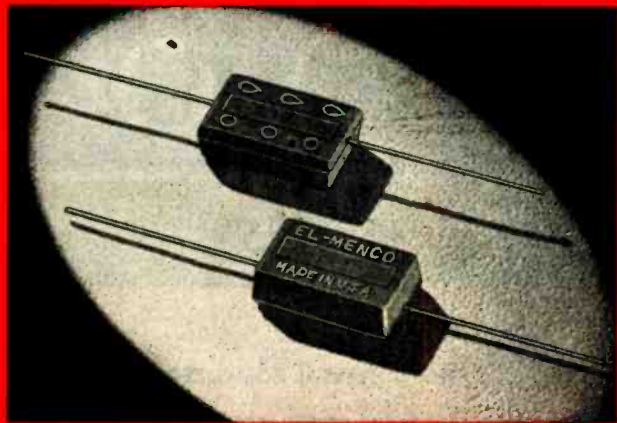

but they mean so much to so many

Small, unseen, Electro Motive Capacitors — in countless numbers — are contributing to the certainty of our battle communications systems.

Upon the continuously reliable performance of these systems the lives of our fighting men depend. They *must not* fail.

Electro Motive is proud of the part its products are playing now — looks forward to the day

when the same products will be helping to bring comfort and entertainment to the men they are now helping to protect.

Electronic Equipment Manufacturers: Write — on company letterhead for new Capacitor Catalogue.

**THE ELECTRO MOTIVE MFG. CO.
Willimantic, Connecticut**



El-Menco

**MOLDED MICA — MICA TRIMMER
CAPACITORS**

EQUALIZERS

by



3AX . . . THE UNIVERSAL EQUALIZER FOR BROADCAST AND RECORDING SERVICE. PROVIDES ADJUSTABLE EQUALIZATION AT 25, 50, OR 100 CYCLES FOR LOW END, AND AT 4000, 6000, 8000, OR 10,000 CYCLES AT HIGH END. CALIBRATED CONTROLS READ DIRECTLY IN DB EQUALIZATION AND FREQUENCY SETTING. THE INSERTION LOSS EFFECTED BY THE EQUALIZER IS COMPENSATED THROUGH SPECIAL COMPENSATING PADS, SO THAT IT IS CONSTANT REGARDLESS OF SETTING. RAPID CHANGE IN TONE COLOR CAN BE OBTAINED WITH NEGLIGIBLE CHANGE IN VOLUME.

4C . . . AN IDEAL SOUND EFFECTS FILTER FOR BROADCAST AND RECORDING SERVICE. LOW PASS FILTER FREQUENCIES OF 100, 250, 500, 1000, 2000, 3000, 4000, AND 5000 CYCLES ARE PROVIDED. IDENTICAL HIGH PASS FILTER FREQUENCIES ARE PROVIDED. THIS UNIT EMPLOYS NOISELESS SWITCHING, AND A SUFFICIENTLY WIDE RANGE OF FREQUENCIES TO TAKE CARE OF ANY TYPE OF TONE COLOR REQUIRED.

MAY WE COOPERATE WITH YOU ON DESIGN SAVINGS FOR YOUR APPLICATION . . . WAR OR POSTWAR?



United Transformer Co.

150 VARICK STREET

NEW YORK 13, N. Y.

EXPORT DIVISION: 13 EAST 40th STREET, NEW YORK 16, N. Y., CABLES: "ARLAB"

ELECTRONIC INDUSTRIES

Including INDUSTRIAL ELECTRONICS

O. H. CALDWELL, EDITOR ★ M. CLEMENTS, PUBLISHER ★ 480 LEXINGTON AVE., NEW YORK (17), N. Y.

X-Rays in Industry

Wartime processing and inspection have advanced industrial radiography a great many years. Foremost of these developments is the "packaged unit" X-ray equipment—safe and simple to operate. Development and application of super-power X-ray tubes of practical size and weight, make the inspection of heavy, thick steel sections rapid and thus less costly. Such apparatus fits in with our mass-production ideas. Undoubtedly, most of the food, cars, trains, planes, and many other devices in our daily lives will soon be featured as "tested and approved by X-rays."

"Printing" Circuits in Conducting Ink

Some eight years ago, when prices of small radio sets were being pared to all-time lows, we jokingly proposed, as a next step, that circuits be simply printed in conducting ink on an insulating cardboard chassis. Thus at a couple of strokes of a printing press all circuits and wiring would be complete. Then the cardboard could be punched with holes to receive the prongs of tubes, condensers, cross-overs and other units. And now we learn that a low-priced radio-set line for postwar production is actually being planned with its wiring assembly simplified by "printing the circuits" all at one fell swoop, saving many minutes on the assembly line!

One Tele Set Cancels Five BC Listeners!

The courageous position of those broadcasters who seek to go ahead with television immediately postwar (rather than delay it as long as possible) deserves the admiration of both engineers and the public. For television, even "as is," already offers an actual menace to broadcasting's evening programs. Recent experience in the New York area indicates that each tele set going into use completely withdraws five listeners from the 8-10:30 p.m. broadcast audience, the

choice hours of the broadcast day. What inroads future tele may make on existing established broadcast equities can be readily surmised. Some broadcasters will meet this problem by mastering the new video agency; others by seeking to put off the evil day of competitive home entertainment during broadcasting's prize evening hours.

Radio Signalling in Emergencies

Recent terrible train wrecks point the need for radio-electronic signalling and communication in place of the old-fashioned signals. For years radio men have been trying to pound home the fact that radio-controlled technics will be of great value to the railroad and automotive industries, particularly in supplementing existing traffic signals of visual type which, in effect, can "speak" only several words, such as "stop," "go" and "caution." These signals cannot convey the detailed information which is required in emergencies. And, when visibility is obscured, they cannot effectively perform their functions.

By the addition of radio circuits full information may be transmitted by voice signals into the interior of mobile units regardless of weather conditions.

Electrified Snow— a Minor Menace!

Now even the beautiful snow takes its place as a menace to home television—along with automobile ignition and diathermy. A recent Connecticut snowstorm riddled our own video screen with flashes of light (like heavy truck ignition) all one evening, as each little snowflake hitting the dipole imparted its electrostatic charge. Result—an electronic "snowstorm" across the cathode screen (indoors as well as out), shattering the picture.

Since winter is the peak season for television entertainment as well as snowstorms, it will be well to see that future home dipoles are insulated or heavy-lacquered.

For the IRE BUILDING Fund, \$500,000

is the amount the five-billion-dollar radio-electronic industry is being asked to donate—or about \$1 for each \$10,000 of business done by the industry in 1944.

Plans are to spend \$200,000 to purchase the new IRE building to be located in New York City, plus \$100,000 to remodel and furnish it, and then invest the remaining \$200,000 for the building's maintenance. See page 206.

MEASURING KLYSTRON

by **COLEMAN DODD**

Project Engineer, Research Laboratories,
Sperry Gyroscope Co., Garden City, N. Y.

Oscillographic testing methods for determining power input and output characteristics of oscillators and amplifiers

● Articles on the theory and operation of two resonator Klystron* tube amplifiers and oscillators have appeared in a number of publications.† The main purpose here is to present some material on the operating characteristics of the Sperry Klystron tube used as an amplifier and as an oscillator.

The most evident ways in which a Klystron tube amplifier differs from a conventional triode amplifier are:

- 1—the electrons are accelerated to full velocity before being modulated,
- 2—the electron beam is velocity modulated, instead of being density modulated,
- 3—the electron bunching process is used to convert this velocity modulated electron beam into a density modulated electron beam, and,
- 4—the input and output circuits are resonant cavities which are an integral part of the tube.

The sectional view of the Klystron tube in Fig. 1 shows the electron gun at the base end of the tube. The beam voltage, or acceleration

voltage, is applied between the cathode and the metal shell of the tube. This means that the electrons from the cathode are accelerated to the full beam potential by the time they go through the first grid. The electron beam is velocity modulated by the RF field which can be developed across the input gap. This velocity modulated beam is converted to a conduction current modulated electron beam as it proceeds down the practically field free drift space.

The opposing RF field across the output gap extracts power from the radio frequency component of the conduction current, and this RF power can be delivered to an external load by means of the coaxial lines and coupling loops which are an integral part of the output resonant cavity. The tube is an amplifier when the power delivered to the external load is greater than the drive power.

Equivalent circuit

The equivalent circuit of the Klystron tube used as an amplifier can be represented as shown in Fig. 2. An external source of the proper frequency is shown supplying the drive power to the input resonator through one of its coaxial terminals. The other coaxial terminal of the input cavity is open circuited. This drive power develops the voltage E_1 across the input resonant circuit. This signal causes a current i_2 to flow in the output circuit and develops a voltage E_2 across the output resonant circuit. The load is connected to one of the coaxial terminals coupled to the output circuit and the other terminal is open circuited.

The simplified theory of the operation of a two cavity Klystron tube amplifier shows that the relation between the bunching parameter (x) and the current (i_2) in the output resonant circuit is as shown in Fig. 3. Since "x" is directly proportional to E_1 , according to the equation shown in Fig. 4, the curve of i_2 vs. E_1 will be of the same general form as Fig. 3. The drive power is proportional to E_1^2 and the power output is proportional to i_2^2 according to the usual relations between

*Registered trade name, Sperry Corp.
†Klystron Characteristics—Electronic Industries, June 1944; Klystron Oscillators—Electronics, Nov., 1944.

Fig. 1—Sectioned view of Klystron showing cavities, tuning system and coaxial input and output loops at right. Evacuated metal cavities have flexible ends permitting tuning

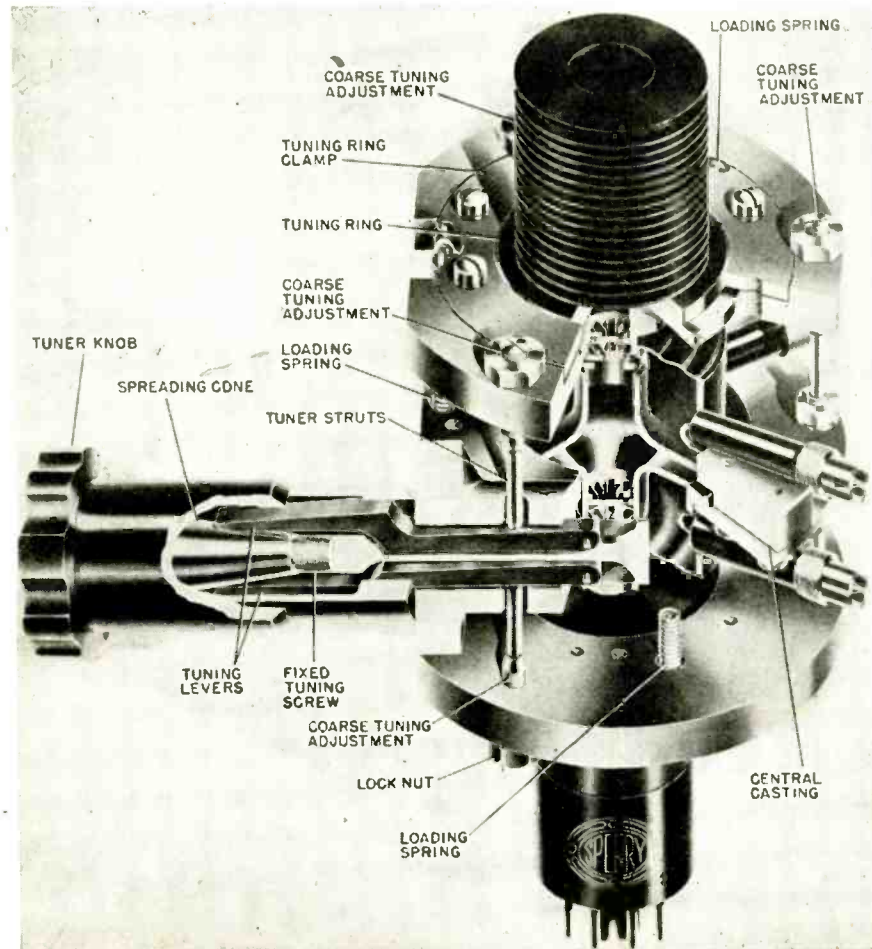

AMPLIFIER FEATURES

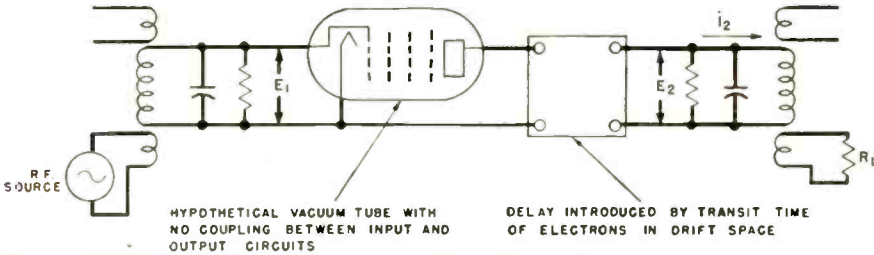

Fig. 2—Equivalent circuit for a Klystron amplifier using a well screened tube. E_1 and E_2 correspond to buncher and catcher signal voltages respectively

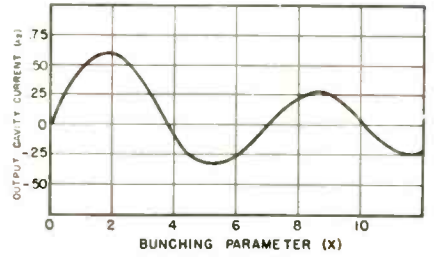

Fig. 3—Output cavity current as a function of voltage and frequency given in Fig. 4

power, voltage and current. This means that by squaring the values along both coordinates of Fig. 3 we can obtain a curve as shown in Fig. 5 which is the theoretical shape of the power output versus drive power curve for a two cavity Klystron tube amplifier.

A typical characteristic curve for the tube for comparison with this theoretical curve is shown in Fig. 6. For ease of comparison the theoretical curve is shown as a dotted line in this same illustration. The theoretical curve was matched with the typical curve at the first peak of the power output characteristic.

The practical conclusions to be drawn from this Klystron tube amplifier characteristic are:

- 1—the power output does not reach a saturation value as the drive power is increased, but reaches an optimum value, then decreases,
- 2—with excessive overdrive the power output will pass through several maxima and minima,
- 3—the power gain is about 2.5 times as great at low drive powers as it is at the maximum power output, and
- 4—the part of the characteristic

Fig. 5—Theoretical power output vs. power input relation obtained by squaring values on curve in Fig. 3

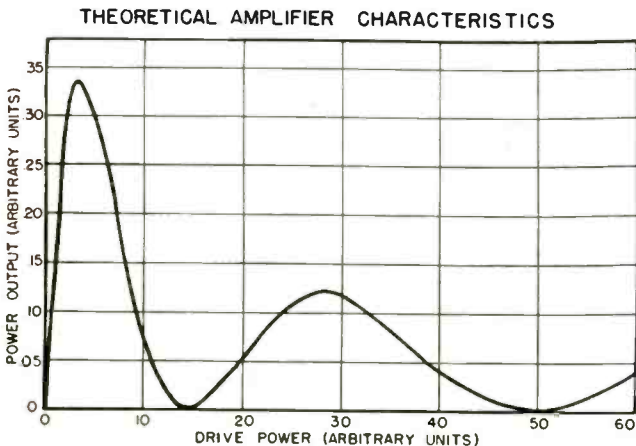

$$X = \sqrt{\frac{m}{8e}} \frac{\omega_1 s E_1}{E_0^{3/2}} = \pi N \frac{E_1}{E_0}$$

- m = MASS OF THE ELECTRON
- e = CHARGE OF THE ELECTRON
- ω_1 = $2\pi f_1$ = RADIAN FREQUENCY OF THE INPUT TO THE BUNCHER
- s = LENGTH OF DRIFT SPACE
- E_1 = PEAK R.F. VOLTAGE AT THE BUNCHER RESONATOR GRIDS
- E_0 = ACCELERATION VOLTAGE OF THE BEAM
- N = NUMBER OF CYCLES WHICH OCCUR DURING TRANSIT BETWEEN BUNCHER AND CATCHER

Fig. 4—Bunching parameter (X) equation. See plot of X in Fig. 3

beyond the first maximum is not normally used.

This overdriven characteristic of a Klystron tube amplifier may be shown by an experimental set-up as in the block diagram of Fig. 7.

In the discussion so far it has been assumed that the beam voltage was held constant at some unspecified value. If the beam voltage is changed to some other fixed value the general shape of the P. vs. drive power curve will not be changed and there will be no marked change in the operating efficiency of the tube. This char-

Fig. 6—Comparison of theoretical and actual power input vs. power output curves for constant acceleration voltage E_0

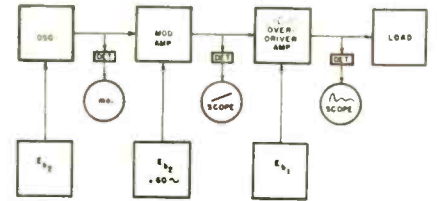
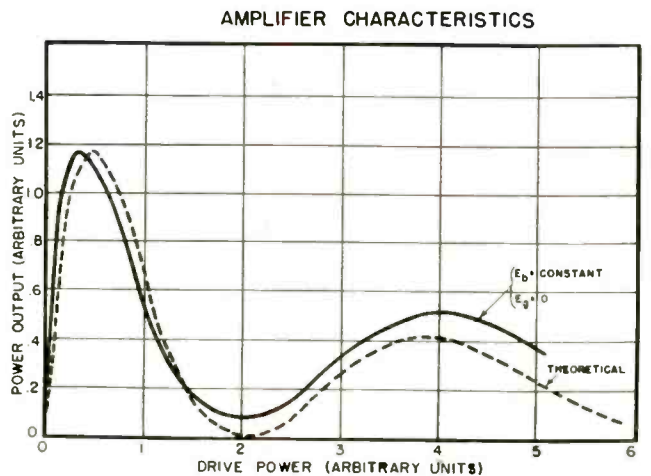

Fig. 7—Equipment block diagram to give curve shown in Fig. 6

acteristic is shown for several beam voltages in Fig. 8. These curves make it evident that although the peak power output is obtained with less drive power at the lower beam voltages the amount of power obtained is almost directly proportional to the beam power input. Actually the power output and the efficiency does increase slightly as the beam voltage is increased.

Modulated amplifier

The block diagram in Fig. 7 indicated the use of a Klystron tube as a modulated amplifier to vary the drive power supplied to the overdriven amplifier. In this case the drive power input to the tube is held constant and the beam voltage is varied. The general shape

AMPLIFIER CHARACTERISTICS

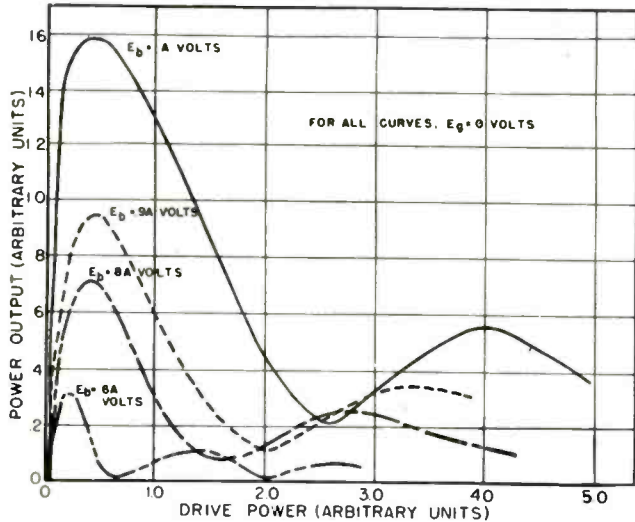

Fig. 8—Typical input-output power curves for various relative values of direct beam acceleration voltage

AVERAGE CHARACTERISTICS

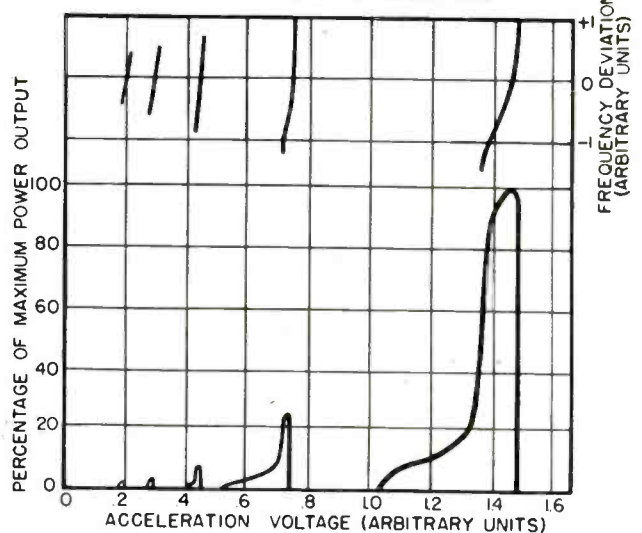

Fig. 11—Power output and frequency deviation characteristics of oscillator for range of acceleration voltages

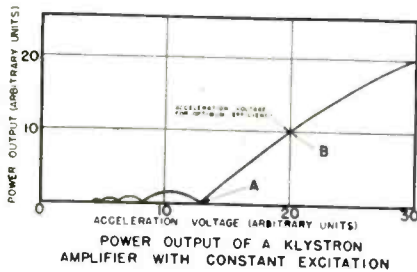

Fig. 9—Power output relationship with acceleration voltage

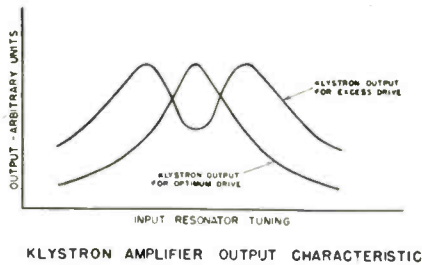

Fig. 10—Buncher tuning characteristic for optimum and over-driven conditions

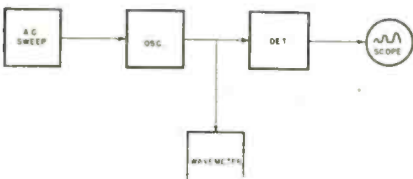

Fig. 12—Block diagram for demonstration of characteristic in Fig 11

of the power output characteristic obtained for this case is shown in Fig. 9. In the portion of the characteristic between points A and B the power output is practically a linear function of the acceleration voltage over this range.

One other variable of a Klystron

tube amplifier which must be taken into account is the tuning of the input and output cavities with respect to the frequency of the drive source. If the amplifier is not overdriven the power output will follow the form of a normal resonance curve as either cavity is tuned through resonance, while the other cavity is at resonance. When the Klystron tube amplifier is overdriven the tuning of the output cavity will still give a normal resonance curve, but the tuning of the input resonator is tuned is a direct indication of the amount of overdriving and is one of the best tests for this condition.

Power output

The power output of a Klystron tube amplifier also varies in a rather complicated manner as the load is varied. This discussion has been limited to cases where the tube feeds into a matched load. If the characteristics of the load are not known the use of an adjustable matching transformer between the tube and the load is recommended. This transformer should be adjusted until a low standing wave ratio in the output line is obtained.

The block diagram shown in Fig. 7 showed the use of the Klystron as an oscillator to generate an RF signal which was supplied to the modulated amplifier. Some of the characteristics of this oscillator will now be discussed.

Since any amplifier can be made to oscillate if sufficient energy from the output circuit is fed back to the input circuit in the proper phase,

the Klystron can be expected to oscillate if the proper type of feedback line is connected between the output and input cavities.

Since the operation of an oscillator depends upon the existence of the proper phase, energy transfer, and frequency relations between the output and input circuits, it is logical to expect that the factors which affect these items will influence the operation of the oscillator. In a two cavity Klystron tube oscillator some of these items are:

- 1—the phase relations between the resonator fields and the bunched electron beam,
- 2—the beam voltage, since it determines the transit time between the input and output gaps,
- 3—the length of the feedback line in electrical degrees,
- 4—the relative tuning of the two cavities, and,
- 5—the degree of coupling between the two resonators.

The first item in this list is practically self adjusting if the other variables are close to some correct combination. The effect of the beam voltage can be examined by adjusting the combination of variables to obtain optimum output at some frequency and then observing the variations in frequency and power output as the beam voltage is changed from its optimum value. It can be seen that the frequency of oscillation changed in order to maintain the correct phase relations around the whole circuit from input to output and back to the input circuit again.

This shift in frequency to compensate for a change in transit time has limits and the tube stops oscillating if the beam voltage is varied

beyond these limits. If the beam voltage is swept throughout its full range several beam voltage regions will be found where the conditions required to produce oscillations are fulfilled, as shown in Fig. 11. The block diagram of the equipment used to obtain this characteristic is shown in Fig. 12.

This dynamic method of observing all of the modes of a Klystron tube oscillator simultaneously provides a convenient method of investigating the effects of the use of an absorption type wavemeter. This wavemeter can be used to investigate the variation in frequency over the various modes. As the wavemeter is tuned through the operating frequency range of the oscillator a small notch will move across the pattern observed on the oscilloscope screen. The frequency deviation data shown at the top portion of Fig. 11 was obtained by this general method.

Frequency deviation

These frequency deviation curves show that the total frequency deviation between the half power points on the modes increases as the operating voltage increases, but the modulation voltage required increases at even a greater rate. In order to conserve on modulation power the lowest operating voltage that will give adequate band width and power output should be used.

As the length of the feedback line is varied the shape of the modes change and some lengths of feedback line will be found which stop the oscillations. As the length of the feedback line is varied from that required to produce optimum output, the frequency of the oscilla-

tions will change in order to maintain the correct phase relations completely around the circuit. When the frequency which satisfies the phase requirements for oscillation deviates too far from the frequency to which the resonant cavities are tuned the oscillations will cease. Changing the tuning of one of the resonant cavities as the length of the feedback line is varied makes it possible to keep the tube oscillating over a wider frequency range.

Possible adjustments

The high frequency side of a mode can be emphasized by detuning the input cavity towards a lower frequency. Similarly the low frequency portion of a mode can be emphasized by detuning the input cavity towards a higher frequency. Some of the possible adjustments are shown in Figs. 13 and 14. This last condition is interesting because it gives the widest bandwidth consistent with good output and a minimum of amplitude modulation. A comparison of Fig. 11 with Fig. 14 shows that the bandwidth can be increased by about five times if a 50 per cent decrease in power output can be tolerated.

The practical significance of these characteristics is that it is possible to use the Klystron tube, or any similar type, as either an amplifier or an oscillator. The two cavity Klystron tube can be used either as a low level or as a high level power amplifier. In order to obtain optimum output or efficiency the drive, load, and tuning of a Klystron tube amplifier must be carefully adjusted. A beam voltage is chosen which will make it possible to obtain the desired output.

When a two resonator Klystron tube is used as an oscillator a choice of narrow band peak output, or a wide band type of operation at a lower power output, is possible. Although intelligent care must be exercised in the use of these tubes, results can be obtained with them which are even more difficult to attain by other methods.

Observing output

The dynamic method of observing the output characteristics of a Klystron is a great aid in the initial adjustment of the tube. It is also a convenient method to use when the effects of different variables are being investigated. Minor trimming adjustments are usually all that are required to get the tube to work at a static operating condition after it has been adjusted using the dynamic method. The value of such a method will be apparent to anyone who has tuned up a multiple resonator Klystron without an external signal source, or without modulating the beam voltage. It can be seen that this procedure is of great assistance in the use of Klystron tubes and for the investigation of their characteristics.

Bibliography

- Harrison, A. E., "Klystron Technical Manual," Sperry Gyroscope Company, Inc., Great Neck, N. Y., 1944
- Brainerd, J. G., "Ultra-High Frequency Techniques," D. Van Nostrand Company, Inc., 1942
- Sarbacher, R. I. and Edson, W. A., "Hyper and Ultrahigh Frequency Engineering," John Wiley & Sons, Inc., 1943
- Moulic, W. E., "Klystron Characteristics," Electronic Industries, Vol. III, No. 6, p. 90-93, June 1944
- Harrison, A. E., "Klystron Oscillators," Electronics, Vol. 17, No. 11, p. 100-107, November 1944

Fig. 13—Effect of tuning and feedback loop adjustments on power output and frequency deviation vs. acceleration voltage

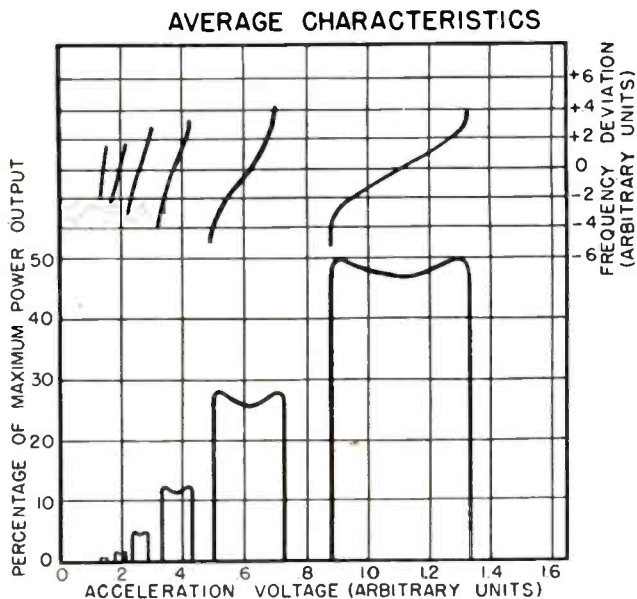
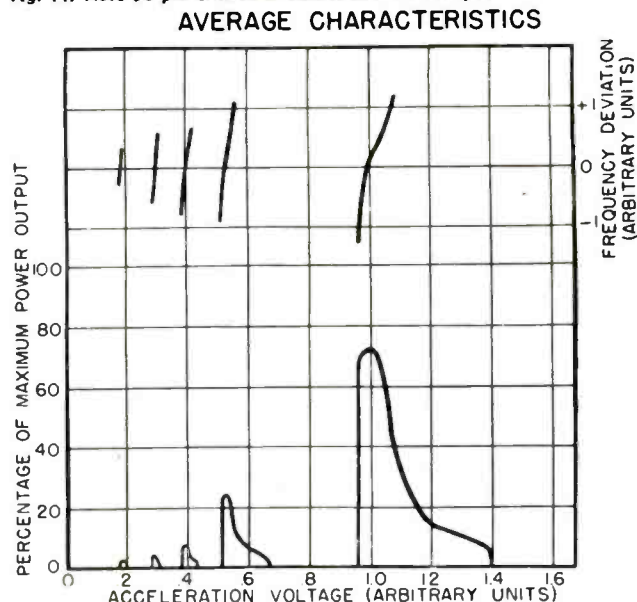
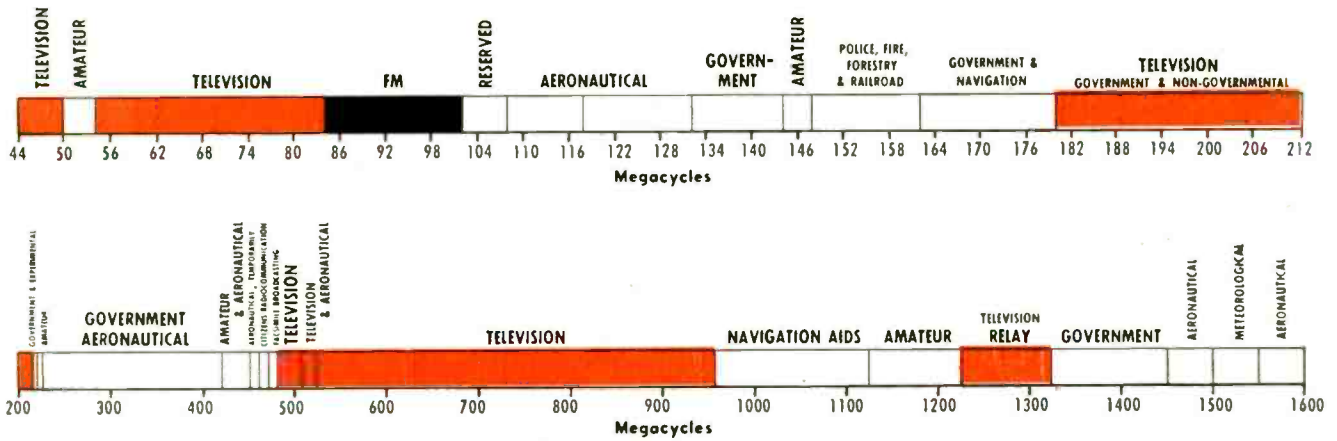

Fig. 14—Good FM characteristic with minimum of AM. Compare with Fig. 11. Note 50 per cent reduction in available output





Federal Communications Commission's proposed allocation of the radio spectrum between 44 KC and 1600 MC. Remainder of the spectrum running up to 30 MC includes four amateur bands (2500-2700, 5200-5750, 10000-105000, 21000-22000), government and experimental

PROPOSED ALLOCATIONS

FCC Report, not final, moves FM "upstairs," leaves television substantially as is—Adds new services

● Unless the Federal Communications Commission has a change of heart following oral and written arguments to be presented beginning February 14, it is FM that is "going upstairs"—a little way but far enough to obsolete all existing receivers—and not television as has several times been suggested during ex-commissioner Fly's tenure of office.

In a Report which otherwise agrees substantially with recommendations of the Radio Technical Planning Board, the Commission has tentatively allocated that part of the radio spectrum lying between 25 kilocycles and 30 megacycles. The report, however, is not final. Briefs may be filed by any of the great many witnesses heard by FCC during the many weeks of hearings and oral arguments will be listened to beginning February 14. A final report then will be issued.

In the meantime, this preliminary report, which runs to 265 closely typewritten pages, would do these things if finally followed as written:

- 1—Move FM from 42-50 to 84-102 mc
- 2—Increase FM channels from 40 to 90
- 3—Leave television between 44 and 216 mc
- 4—Reduce television channels from 18 to 12
- 5—Provide channels for railroads
- 6—Provide civilian "Walkie-talkie" channels

Most radical proposal concerns FM. The suggested shift would be

made, states the report, purely for engineering reasons, "on the grounds that skywave interference in the lower region would be severe enough to impair the utility of FM to such an extent that its full development might be retarded." The report does not judge to be serious the fact that some 500,000 existing FM sets in the hands of listeners would be rendered obsolete, suggesting that they would have become partially obsolete anyway if the recommendations of the FM industry to widen the band had been followed. The cost of remodelling FM transmitters will not be substantial the report points out, and besides they will not be required to move upward until new receivers capable of tuning the new wavelengths are generally available.

90 channels for FM

FM at present has 35 commercial and 5 non-commercial channels, and this amount of space is judged inadequate. It is proposed, therefore to increase the number of assigned channels to 90, of which 70, beginning at 88 mc and continuing to 102 mc would be for regular commercial service, with the remaining 20, between 84 and 88 mc for non-commercial educational purposes.

To provide room for possible FM expansion, the band between 102 and 108 mc has been reserved, though it is pointed out that the 6 mc held back may be considered for other services as well as for FM.

Insofar as television is concerned,

the recommended change is relatively slight; at least video service is not to be sent "upstairs." In fact there are still to be 12 channels below 216 mc, as there are at present. Channels No. 13 to No. 18, located between 230 and 294 mc would be dropped, with the explanation that "no additional frequencies can be assigned to television between 225 and 300 mc because all these frequencies are required for government services."

However, to permit the development of a system for color pictures and higher definition monochrome pictures through the use of wider channels, it is proposed to allot space for experimental purposes between 480 and 920 mc. Explaining the reason for the changes it has proposed, the Commission states:

"The Commission does not believe that broadcast service to the public through the use of a 6 mc channel with the improvements now available over pre-war developments should be abandoned and commercial television held in abeyance until a wide channel system in the ultra high frequencies can be developed and proven. The time which may elapse before a system can be developed to operate on wider channels in these ultra high frequencies is indefinite and primarily dependent upon the resourcefulness of the industry in solving the technical problems that will be encountered." Hence, commercial television is permitted to remain roughly where it is in the lower part of the spectrum.

Two new services appear among the allocations. The first of these is railroads, the other is what FCC describes as "Citizens Radio-communications Service." During a September week FCC conducted hearings concerning the use of radio facilities for railroads and as a result has become convinced that such facilities would contribute to the safety of life and property and be of universal benefit to the public. In consequence, a substantial block of frequencies has been set aside for railroad use.

Civilian "Walkie-Talkies"

The success of the "walkie-talkie" on the battlefield and the possibilities for its varied uses in peacetime have induced the Commission to allocate the band from 460 to 470 mc for a new radio service. Small portable radios can be used, for example, to establish a physicians' calling service, for communication to and from trucks and tractors operating in and around large plants, on farms and ranches, on board harbor and river craft, in mountain and swamp areas. Sportsmen and explorers can use them to maintain contact with camps. Department stores, dairies, laundries and other business organizations can use the service to communicate with their delivery vehicles.

Common carrier operation will not be permitted and no charge can be made for messages. Only the minimum requirements of the Communications Act plus a few minimum traffic rules will be set up. No technical knowledge will be required.

Increased channels are allotted for forestry and conservation radio systems; for electric, gas and water companies, for buses, streetcars, trucks and highway maintenance departments; for oil companies drilling in inaccessible areas, for the location of oil by seismograph recording, for motion picture crews out on location and for press associations and newspapers reporting events at places where regular facilities are not available.

Provision is made for a Rural Telephone Service to furnish a radio-telephone link for isolated communities, farmers, ranchers, miners and others who cannot be or are not served by wire line facilities. The Commission does not set aside specific frequencies for this service but will permit it to share the band of frequencies allocated to television, most of which will be concentrated in urban areas.

Three bands are assigned for industrial and medical radio equipment to prevent interference with other radio services.

SPECTRUM DIVISION PROPOSED BY FCC

MC	
25-28	Fixed and mobile
28-30	Amateur
30-40	Fixed and mobile, except aeronautical
40-42	Fixed and mobile
42-44	Fixed and mobile, except aeronautical; temporarily FM
44-50	Television
50-54	Amateur
54-60	Television
60-84	Television
84-102	FM
102-108	Reserved
108-118	Aeronautical
118-132	Aeronautical
132-144	Government
144-148	Amateur
148-152	Government
152-156	Police
156-162	Railroad
162-180	Government and navigation
180-216	Television, government and non-governmental
216-220	Government
220-225	Amateur
225-420	Government
420-450	Amateurs and aeronautical
450-460	Aeronautical, temporarily
460-470	Citizens' radiocommunication service
470-480	Facsimile broadcasting
480-508	Television
508-524	Television, aeronautical
524-960	Television
960-1125	Navigation aids
1125-1225	Amateur
1225-1325	Television relay
1325-1450	Government
1450-1500	Aeronautical
1500-1550	Meteorological
1550-1650	Aeronautical
1650-1900	Government
1900-30,000	Government, amateur and experimental

The allocation plan boosts the number of channels allotted to amateurs, pointing out that this service is one of the oldest in radio and its development closely parallels that of the entire radio art. The Amateur service is a vast training school and constitutes a

Shelling Didn't Stop This "Walkie Talkie"

Sergeant Herbert O. Taylor of Richmond, Virginia, headquarters communications chief with the veteran 135th Regiment of the 34th "Red Bull" Infantry Division tells how one SCR 300 Motorola "Walkie Talkie" survived two shellings by German artillery on the Fifth Army front in Italy. The set was put out of commission once but was quickly repaired and the second time the shrapnel ripped the case but did not stop the equipment from func-

tioning. "We received this particular set just before we went to the Anzio beachhead," Sergeant Taylor said. "It's the best type radio we've used. On the Anzio beachhead we could operate with it from two to three miles over what was supposed to be the maximum. This set was used in the offensive against Rome, Leghorn and the southern part of Pisa as well as the fighting on the Gothic Line. It has given a remarkable performance."

Police frequencies

Criminals of the future will find the way of the transgressor harder as the police build up radio communication networks with the greatly-increased number of frequencies allotted by this allocation. The number of channels in the 30 to 44 mc band is increased from 29 to 56. In addition a band from 152 to 156 mc was assigned. With suitable equipment likely to be available in the near future, the Commission has provided channels which will make possible facsimile networks for transmitting photographs and fingerprints from one police department to another and to the FBI in Washington.

Channels are provided for much wider use of radio by fire departments which hitherto have largely depended on an outgrown arrangement of sharing police radio systems. Ninety-two cities of over 100,000 population have indicated their intention of using radio for fire service.

Coincident with the publication of the FCC report (Docket No. 6651), the Interdepartment Radio Advisory Committee, issued a proposal modifying the proposal which was issued on June 15 last in the light of recommendations in the FCC report. The new IRAC report represents coordination between its original suggested allocations for government services and the recommendations made by FCC.

It is hoped and expected that hearings which are to start on Feb. 14 can be concluded in time for further consideration by FCC and that it may be possible to make public a final report with allocations in the 25KC to 30MC portion of the spectrum definitely set probably by the middle of March.

ELECTRONIC TOOLS IN

by ROBERT H. OSBORN

and

LEWIS W. BECK

Hercules Experiment Station,
Hercules Powder Co.,
Wilmington, Del.

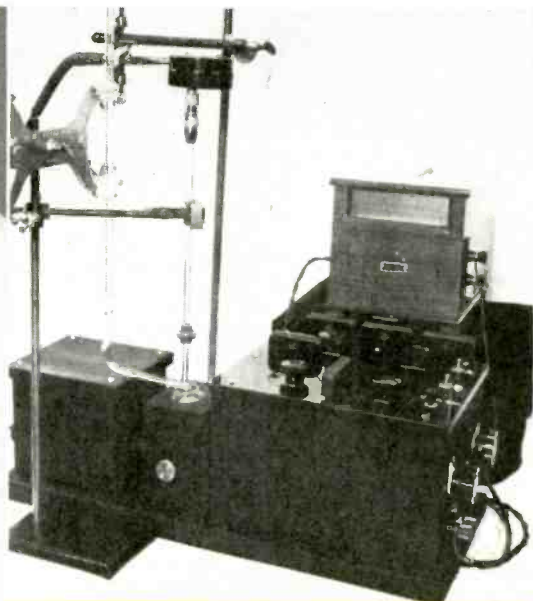
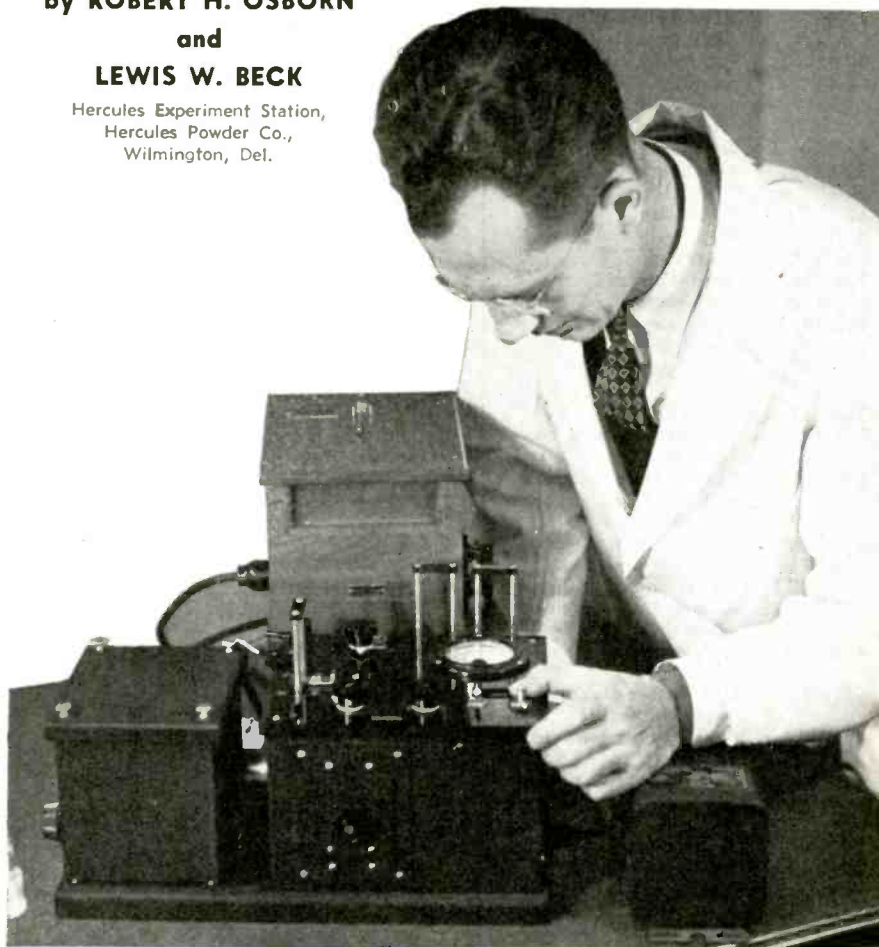

Instruments for qualitative inspection, and control open

Fig. 1—(a) (left) the Hercules photoelectric color grader. (b) above, a photoelectric titration unit, a modification of the color grader. Both units made by Hercules technicians

• The use of electronic controls and instruments to aid chemical research has increased by leaps and bounds during the last decade. Powerful physical tools, most of which employ electronic devices, have been applied to many chemical processes formerly investigated or controlled by time-consuming classical procedures. Early equipment was generally designed and built by the chemists themselves, less frequently by physicists and engineers. But not until electrical manufacturers applied their engineering experience and skill to laboratory instrumentation were rapid strides made in the design of rugged, easy-to-use equipment. Even now, however, considerable pioneering is being done in instrumentation by chemical laboratory workers.

The accompanying photographs of typical apparatus used in the Research Laboratories of Hercules Powder Company, near Wilmington, show the scope of electronic applications to chemical problems in a large industrial laboratory.

Most of this equipment has been developed and manufactured by instrument companies, but some of the pictured apparatus was devised by laboratory personnel because suitable commercial units were not readily available at the time they were needed.

Time and labor saved

Electronic instruments are often used in a chemical laboratory either to do jobs that can be done only very laboriously or inaccurately by other means, or to do things that cannot be done by ordinary chemical or simple physical means. Among the instruments which save time and labor are spectrophotometers, color-graders, the mass spectrometer, polarographs, and electronically controlled distillation columns. Instruments which give us information that cannot, in general, be gained in other ways are the electron microscope and x-ray diffraction units.

The General Electric recording spectrophotometer automati-

cally draws a curve of spectral transmission or reflection as a function of wavelength over the range from 400-700 millimicrons. It is used by Hercules primarily for color measurements and specifications of many products produced by the company or produced by other companies from Hercules products. Among those on which the instrument is successfully used are cellulose derivatives, plastics, and natural and synthetic resins. It is also used to perform careful colorimetric analyses.

This spectrophotometer is a null instrument, i.e., it automatically and continuously adjusts the intensity of one of two identical monochromatic light beams so that it remains equal in intensity to the transmitted or reflected portion of the other beam as their wavelength is continuously changed. This continuous adjustment is effected by means of a photocell-amplifier combination, the output of which supplies a small-reversing motor, which in turn drives the intensity adjustment mechanism. The same

CHEMICAL RESEARCH

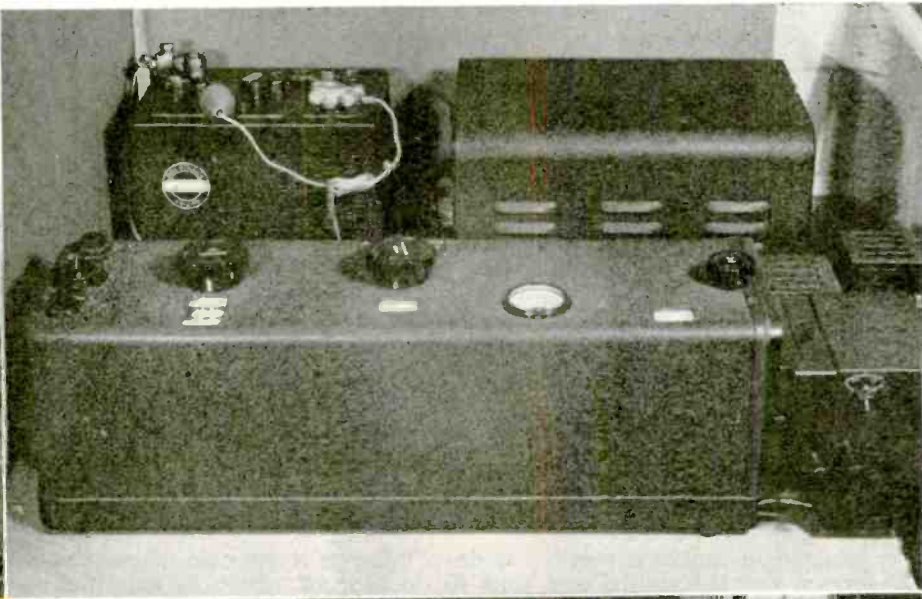
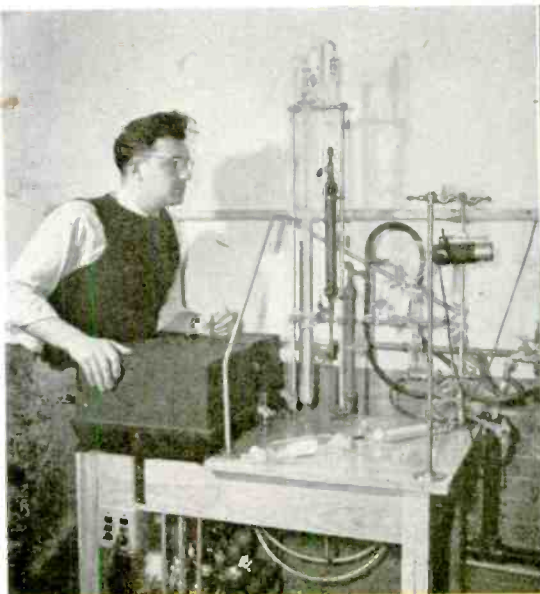

**and quantitative analysis,
new vistas in chemistry**

Fig. 2—(above) Beckman routine infrared spectrophotometer

Fig. 3—(extreme right above) closeup of Beckman ultraviolet spectrophotometer

Fig. 4—At right, Leeds and Northrup recording microphotometer

motor drives a pen which graphs the per cent of light reflected or transmitted at each wavelength.

Color grading

Figure 1a shows a photoelectric photometer designed by Hercules physicists for the rapid routine color grading of natural and synthetic resins, plastics, and cellulose derivatives. It consists of an incandescent lamp, sample drawer, pairs of colored light filters, a photocell, and electrical equipment for measuring the ratio of the intensities of light of two different colors transmitted by the sample. The use of two colors minimizes the effect of varying sample brightness. Instruments of this type are being used both in the research laboratory and in plant control laboratories. A modification of this photometer is employed with suitable indicators in the titration of dark-colored solutions (Figure 1b).

The Beckman infrared spectrophotometer (Figure 2) is a standard instrument for routine chemi-

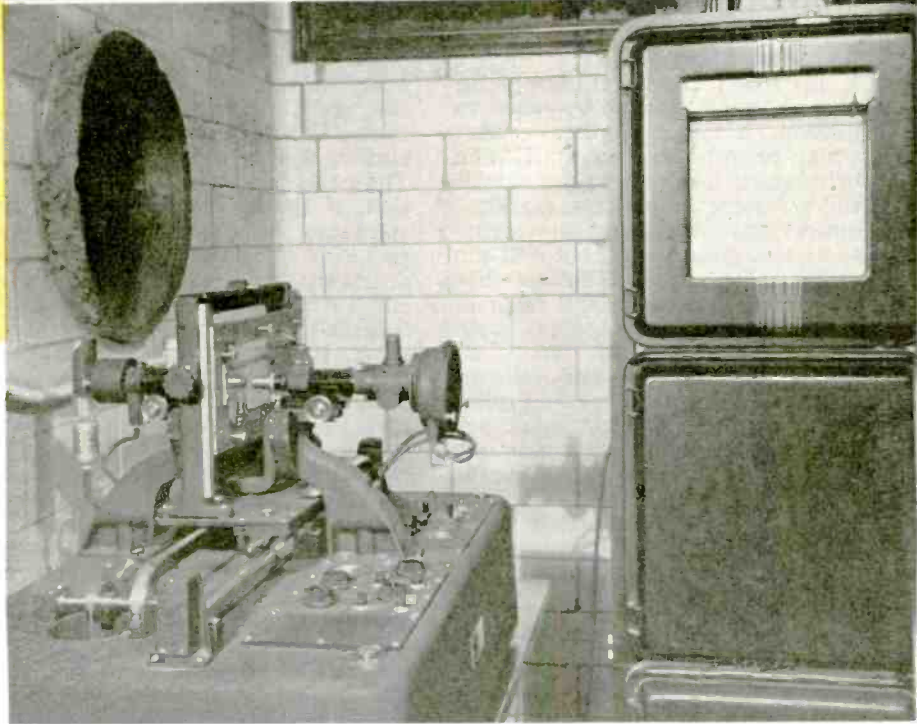

cal analyses. It is especially well adapted to the analysis of hydrocarbon gases and other organic compounds having low boiling points. When used with special adapters, liquid mixtures also may be analyzed. This instrument is also used for determining the presence of functional groups, double and triple bonds, and other molecular structural features. It has been of considerable value to Hercules in the analysis of mixtures of terpene hydrocarbons.

Infrared radiation from a Nernst glower is passed through a cell con-

taining the sample to be analyzed, and is then spread out into a spectrum by a rock-salt prism. The prism is rotated so that the spectrum moves across a fixed slit. This allows narrow spectral bands to fall on a vacuum thermocouple whose response is measured by a low-resistance, high-sensitivity galvanometer. The electronic application comes into play when the operator wishes to increase the instrument's resolving power; then this galvanometer is attached to a photoelectric amplifier feeding into another galvanometer. This ar-



Fig. 5—Westinghouse mass spectrometer

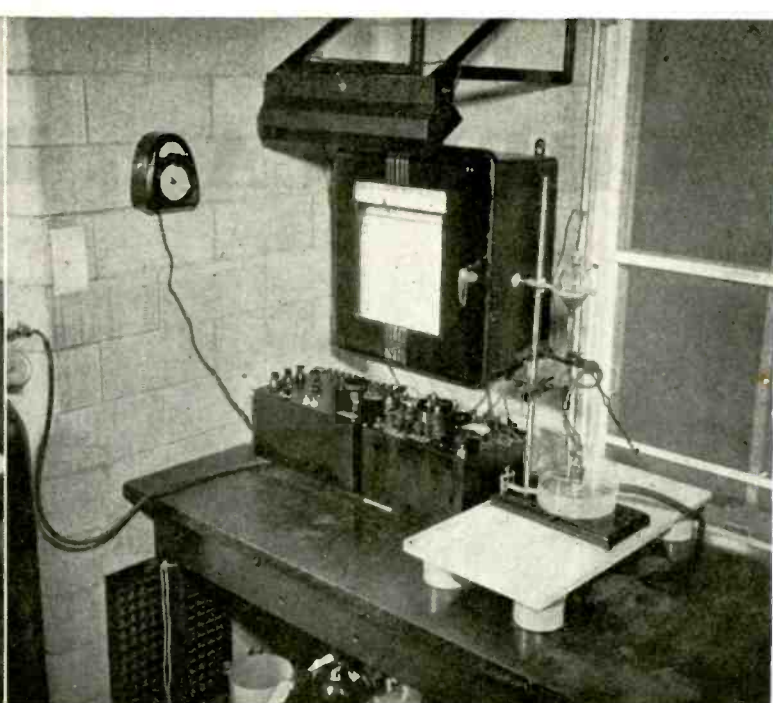

Fig. 6—Electro-chemograph made by Leeds and Northrup

range makes it possible to decrease the slit widths and thus to increase resolving power.

The Beckman ultraviolet spectrophotometer (Figure 3) consists of a hydrogen discharge lamp furnishing continuous ultraviolet radiation, a quartz optical system which provides an essentially monochromatic beam, means of varying the wavelength of the radiation, a quartz cell containing the sample to be analyzed, and a photocell-amplifier-indicator combination which receives the radiation and measures its intensity after it has passed through the sample. From the absorption curves, the chemist obtains both qualitative and quantitative information on small percentages of organic impurities having aromatic rings, conjugated double bonds, or other resonating structures. It is especially useful in the quantitative determination of certain classes of resin acids and terpenes.

Materials analysis

The emission spectrograph is one of the more common physical instruments used for chemical analyses. The spectrograph itself is an optical instrument, but the various methods of creating a spectrum (arc and spark excitation) embody electronics in its broader aspects. Electronic instruments have, however, greatly facilitated and extended the usefulness of the spectrograph. At the Hercules experiment station a Leeds and Northrup recording microphotometer (Figure 4) is used to measure the densities of the various lines on spectrographic plates. In this instrument a narrow slit of light is focused on the spectrum line to be measured. The transmitted beam

falls on a vacuum phototube, the output of which is amplified and applied to a high-speed recorder. The spectrum plate is mounted on a carriage moving synchronously with the paper roll on the recorder. The microphotometer record is a series of sharply peaked curves, one for each spectrum line. The height of each peak is a function of the optical density of the spectrum line it represents. The positions of the peaks tell the chemist what elements were present in the sample and the peak heights enable him to compute concentrations.

The spectrograph, with its associated equipment, is used to maintain high standards of purity in all types of Hercules products.

The Westinghouse mass spectrometer (Figure 5) is a comparatively new analytical tool for gas analyses. Briefly, the instrument makes use of the different masses and charges of ions for separating and counting them. An electron gun shoots a stream of electrons through a chamber containing a gas sample at low pressure. The molecules of the gas are thus dissociated into ionized fragments. The ions are accelerated by means of a voltage applied between two electrodes. They pass through a small opening in the lower electrode and then into an intense magnetic field which is directed at right angles to the motion of the ions. This magnetic field deflects the course of the ions into circular paths, the radius of curvature of each path being directly proportional to the mass and inversely proportional to the charge of the corresponding ion. As a result, the ions are spread out into a "mass spectrum."

This spectrum may be moved across a fixed slit by varying the accelerating voltage. In this manner, ions with a given mass-charge ratio may be selected for counting by electrical means. Under a given accelerating voltage the selected ions pass through the slit into a counting chamber where the rate of charge-accumulation is measured by means of a thermionic amplifier, potentiometer, and sensitive galvanometer.

By investigating the entire mass spectrum a pattern of maxima is obtained. Since each pure compound has, in general, a unique pattern, the constituents of a mixture may be deduced from the composite pattern. A mixture of gases which would be very difficult or impossible to analyze by ordinary chemical means may thus be rapidly analyzed by the mass spectrometer.

Metals determination

Hercules also uses Leeds and Northrup electro-chemographs (a form of polarograph) for the determination of electro-reducible metals such as copper, lead, zinc, and nickel, and organic compounds such as quinones, aldehydes, and unsaturated acids, as shown in Figure 6. Low concentrations in the neighborhood of 10^{-6} to 10^{-2} moles per liter are detectable. Analyses may be run in a few minutes on as little as 5 millimeters of solution.

In this apparatus, ions having characteristically different reduction potentials diffuse to a dropping mercury electrode and produce a current which is amplified and applied to a Micromax recorder. The potential applied to the solution is increased continuously by means of a motor-driven slide wire which

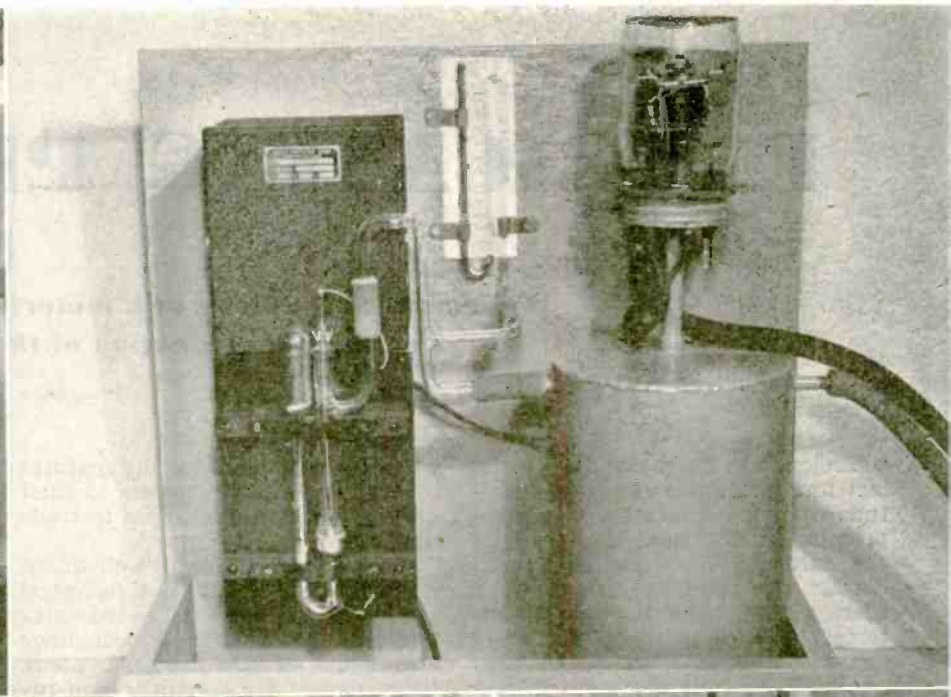
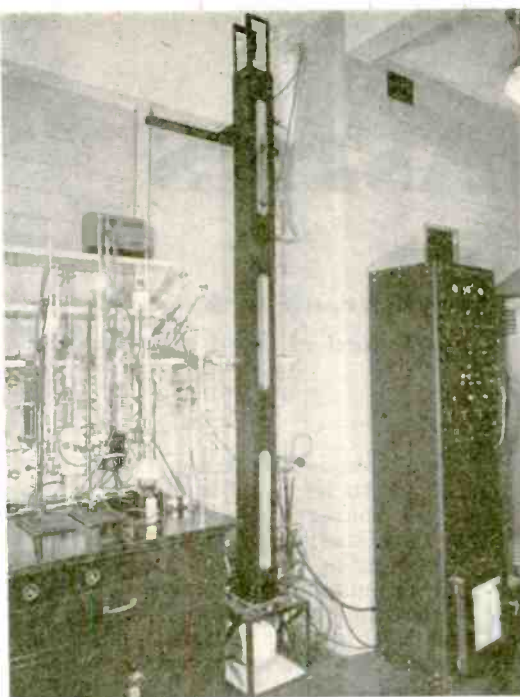

Fig. 7—(a) (above) laboratory distillation columns. (b) at right above, an electronic pressure regulator

operates in synchronism with the recorder chart mechanism. The record thus shows the magnitudes of the currents and the reduction potentials corresponding to each ion present in the solution. The values of these currents are proportional to the concentrations of the corresponding ions. This analytical tool is applicable to a large variety of Hercules products.

Electronic relays

Distillation apparatus is widely used for purification and analysis of volatile organic substances. Figure 7a shows a typical laboratory setup. Electronic relays of conventional design may be used on such distillation columns to operate pressure regulators, to control column throughput, and to regulate jacket temperatures. Figure 7b is a typical pressure regulator which may also be used to control throughput by regulating the heat input to the still-pot through a back pressure manometer. Such distillation equipment has made possible the preparation of terpenes and terpene derivatives, the purities of which are much higher than those attainable a few years ago.

The versatile x-ray diffraction equipment at Hercules is used for the qualitative and quantitative analysis of crystalline materials, the determination of particle sizes in the submicroscopic range, the determination of phase relations in alloys, studies of fiber structure, and the elucidation of ultimate molecular structure. Research on explosives, resin acids, and cellulose derivatives has benefited from the use of x-ray techniques.

Figure 8a is a General Electric

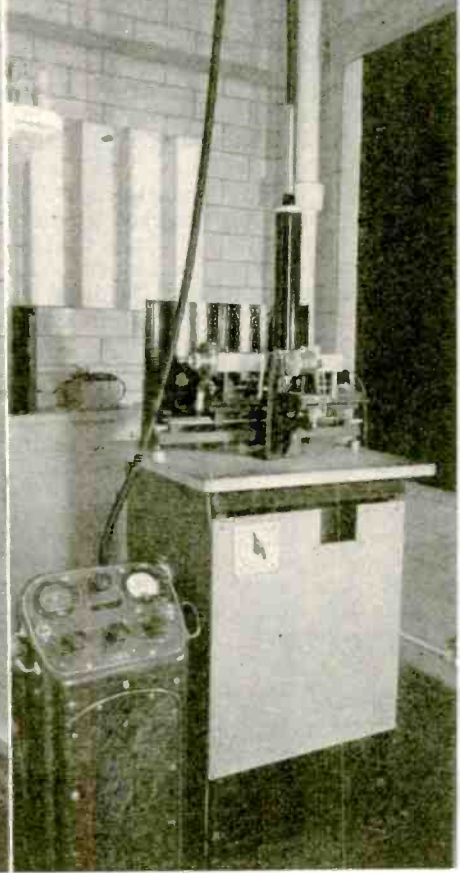
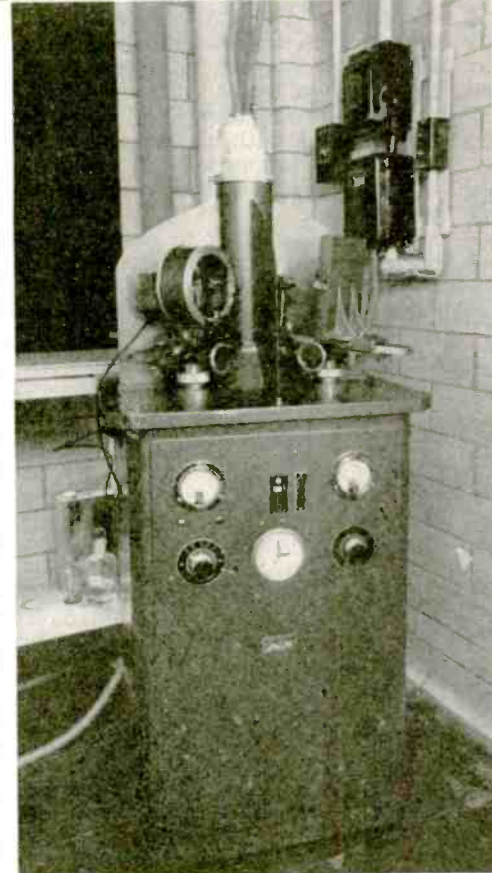

Fig. 8—(a) at left, a G-E X-ray diffraction unit. (b) at right is a Hercules-built unit with Picker tube and equi-inclination Weissenberg goniometer

XRD unit employed primarily for obtaining powder diffraction pictures used in chemical analyses of crystalline materials. Laue photographs for crystal structure determinations and back-reflection pictures used in alloy phase studies may also be obtained on this unit.

Figure 8b shows a unit assembled from a Picker x-ray tube, control equipment, and an equi-inclination Weissenberg goniometer built by the Charles Supper Company. This

apparatus is used in the Hercules Laboratory for obtaining rotation and Weissenberg photographs and for determining crystalline and molecular structures.

The RCA electron microscope operates on the principle that a beam of electrons moving under an applied potential of several thousand volts behaves like a light beam of only a few hundredths of an Angstrom unit in wavelength. In

(Continued on page 142)

FABRICATING PLASTICS

New uses of plastics as a material for electronic components require careful evaluation of their published characteristics

● Progress in research during the last four years has shown a multitude of new contributions of great promise in the peacetime arts of the future. When the equipment details and circuits can be told there will be much to report of interest to all engineers. It is not generally realized, however, that extraordinary developments have occurred in the field of materials that will become available for all types of components. Many radio components of widely different types will have certain parts made of plastic material of some kind or another.

The words "electronics" and "plastics" both indicate glamorous and expanding industries that have no well-defined boundaries. Both fields include many categories, some of which are the commonplace items well known over several decades, and others, are so new that their complete characteristics and importance have hardly been evaluated. To the informed engineer, the advertising statement that "We use electronics" to do such and such a job, unqualified as to how the vacuum tubes are used, brings on a smile, as does the unqualified use of the word "plastics" without further description to members of that industry.

Many forms

The question—"but just what is electronics," so frequently sprung on the unwary, has become a catchphrase since the inclusion of so many activities in this field have made its boundaries rather indefinite. Equally so, the subject of plastics has come to embrace so many new compounds and products that it is difficult to determine just what-is-what there also. This is rather unfortunate because the public may come to blame all troubles encountered in their use of specific items on plastics in general.

Actually, plastics is just as general a term as is the word "metals" and no one ever attributes a single set of characteristics to all metals. While thus the public at first is apt to evaluate all plastics by the results of their experience with a single material, it is expected that advertising will ultimately help in this

problem by publicizing the features of each material, either as to their chemical designation or as to trade names.

Since relatively few are chemists, it may be regretted that technical names of plastics are so complex and many are difficult to pronounce and memorize. On the other hand, trade names are generally non-indicative of the form of material, and as their number increases greatly each year it would seem that the policy of early radio receiver manufacturers of tagging each model with a name, coined from a combination of pseudo-scientific terms is to be repeated in plastics.

There are getting to be as many basic groups in the plastic field as there are kinds of metals, (without considering variations in composition and the use of different heat treatments, plasticizers, inhibitors, etc.)

Varied characteristics

There is no one perfect material from an electronic component designer's standpoint. It would seem that the important characteristics, that he is interested in, are not always measured under a standard procedure, so that published data from different sources cannot be compared directly.

It is hoped therefore that the characteristics of all types of plastics ultimately will succumb to the orderly eye of the scientist, so that the guide-book to plastics of the future will enable one to select materials for any purpose and from any producer, with confidence that full adherence to some standard procedure was made while determining the listed values.

Until this can take place, it is up to sales representatives to interpret an engineer's needs and give proper advice as to what to specify. For many materials we can give engineers a tip: If the normal listed plastics don't meet your needs, ask for what you want and somewhere in the plastic field you are likely to get it. Many characteristics have controllable limits, and if the need is great enough a variation in the manufacturing or the subsequent handling technic may bring about the desired improvement.

Several somewhat disconcerting effects are to be noted with many materials that are used as dielectrics: Both their power factor and the dielectric constants change over wide limits as the temperature is varied, the former over a range of some 20:1 and the latter in some cases over a range of 2:1 or more. Besides this, both values change with the applied frequency. These effects handicap such materials in any applications where frequency (and gain) stabilized circuits are present. It happens that these conditions occur mainly in the heat-softening classes (thermoplastics) and are infrequent in heat-hardening (thermosetting) materials.

Theoretical investigations have begun to throw light on these anomalies in thermoplastic materials and once a correlation between the dielectric properties and chemical polar groupings is reached more definite characteristics will be forthcoming. In the thermosetting materials, dielectric properties may vary with frequency also, but the effect is dependent largely on the type of filler included. It is indeed fortunate that one of the best materials of the plastics group for dielectric uses at radio frequencies, polystyrene, also shows little or no variation with frequency or with temperature through the useful range.

Design factors

An engineer will have few new rules to learn in laying out component designs, but must keep in mind certain factors that have been ignored when ceramics and metals are used. Some of the best insulating materials in the newer multi-megacycle ranges are types of plastic. However, where improvements are found in the matter of shattering, care must be taken to avoid undue stresses which would exaggerate the tendency to cold-flow. Where constancy as to size and to temperature is important, there is a possibility that the use of powdered "fillers" such as mica or quartz added to basic materials, such as polystyrene, might find still wider use.

In addition to the commonly known applications it is evident that many new effects have been

	Processing Adaptability						Optical Properties	Specific Gravity	Thermal Characteristics				Electrical Characteristics						Moisture Absorption	Typical Form or Application	
	Thermosetting	Thermoplastic	Compression Moulding	Injection Moulding	Sheet (Laminated)	Film			For Extrusion	Specific Heat	Heat Resistivity Max. Safe Temperature (Fahr.) (depends on filler used)	Burning Rate	Expansion Parts/Million per Degree Fahr.	Percent Power Factor			Dielectric Constant				
														At Power Frequencies	At Audio Frequencies	At Radio Frequencies	At Power Frequencies	At Audio Frequencies			At Radio Frequencies
Aniline Formaldehyde	✓	✓	✓	✓	✓	✓	TL	1.25	.4	185	low	20-30	0.2	0.4	0.6	3.7	3.7	3.8	low	Radio components	
Casein	✓	✓	✓	✓	✓	✓	TL-O	1.35	160	very slow	25-35	5.-6.	5.-6.	5.-6.	6.5	6.5	6.5	high	Non-electrical uses	
Cellulose Acetate Butyrate	✓	✓	✓	✓	✓	✓	TL-O	1.18	.33	150-190	slow	60-90	1.-5.	1.-6.	1.-5.	3.6-6.0	3.5-6.2	3.-6.	high	Wire insulation	
Cellulose Acetate (High Acetyl)	✓	✓	✓	✓	✓	✓	T-O/C	1.4	.34	160-170	slow	1.6-3.	1.8-6.	4.4-6.	3.5-5.	3.8-4.6	med.	Films and sheets	
Cellulose Acetate	✓	✓	✓	✓	✓	✓	T-O/C	1.5	.35	140-180	slow	45-90	1.5-7.	1.-5.	3.-6.5	3.2-6.2	3.5-6.4	3.-5.	high	Films and sheets	
Cellulose Nitrate	✓	✓	✓	✓	✓	✓	T-O/C	1.3-1.6	.35	140	fast	65-90	6.-14.	9.5	7.5-9.7	7.0-9.	6.-15.	6.-15.	med.	Celluloid	
Ethyl Cellulose	✓	✓	✓	✓	✓	✓	T-O/C	1.12	.39	140	slow	55-75	1.-2.	.8-1.5	.1 to 2.	3.-3.8	3.-3.8	3.2-3.7	med.	Low temp. flexibility	
Fibre	✓	✓	✓	✓	✓	✓	O/C	1.1-1.3	340	slow	12.5	5.0	5.0	6.	5.5	5.-6.5	5.-7.	high	Inexpensive insulation	
Lignin	✓	✓	✓	✓	✓	✓	O	1.4	.38	176	slow	11-13	3.5-4.0	4.4	high	Sheet laminate	
Melamine Formaldehyde	✓	✓	✓	✓	✓	✓	TL-O	1.5	215	nil	10-25	5.-17.	6.-11.5	med.	Molded parts in color	
Methyl Methacrylate	✓	✓	✓	✓	✓	✓	T	1.18	.35	180	slow	36-52	3.6	3.0	2.8	3.6	3.0	2.8	low	Lucite, Plexiglass	
Polyamide Resins	✓	✓	✓	✓	✓	✓	TL-O	1.06-1.19	.55	400	very slow	55	1.5	1.5	2.2	3.2	3.3	3.6	high	Nylon	
Organic Polysulfide	✓	✓	✓	✓	✓	✓	O	1.54	.4-.45	160	slow	50.	7.5	Thokol
Phenol-Formaldehyde	✓	✓	✓	✓	✓	✓	TL-O	1.30	.35	250	slow	13-30	2.0	2.5-6.	1.5-4.	5.-6.	4-5	4-5	med. to low	Bakelite	
Phenol-Furfural	✓	✓	✓	✓	✓	✓	O	1.3	.35	250	nil	10-12	8.-14.	7.-20.	3.5-10.	4.-8.	4.-8.	4.-8.	med. to low	General purpose	
Polyethylene	✓	✓	✓	✓	✓	✓	TL-O	.92	.53	180	slow	59	.02	.02	.03-.06	2.25	2.25	2.29	very low	Low loss dielectric	
Polyisobutylene	✓	✓	✓	✓	✓	✓03-.05	.03-.05	0.4-0.6	2.2-2.3	2.2-2.3	2.2-2.3	Rubberlike material	
Polystyrene	✓	✓	✓	✓	✓	✓	T	1.06	140	slow	30-45	.01-.02	.01-.02	.02-.04	2.6	2.6	2.6	very low	Outstanding RF insulator	
Polyvinyl Acetal	✓	✓	✓	✓	✓	✓	O	1.25	170	very slow	40	5.-7.	5.-7.	2.-3.	3.6	3.3	3.0	low	Formex (etc.)	
Polyvinyl Alcohol	✓	✓	✓	✓	✓	✓	T/O	1.25	slow	poor	poor	poor	high	Interlayer cement	
Polyvinyl Butyral	✓	✓	✓	✓	✓	✓	T	1.1-1.2	110	medium	200	.7	.7	.7	3.6	3.5	3.3	med.	
Polyvinyl Chloride Resins	✓	✓	✓	✓	✓	✓	TL	1.2-1.6	.42	150	nil	17	3.-12	4.	6.	5.-12.	5.5	3.5-10.	med.	Cable insulation	
Hard Rubber	✓	✓	✓	✓	✓	✓	O	1.2-1.8	.34	140	medium	45	3.-9.	3.-8.	2.5 to 7	3.0	3.0	3.0	low	Early type of insulation	
Shellac	✓	✓	✓	✓	✓	✓	O/C	1.2-2	150	high	2.0	5.	3.-5.	3.5-5.5	3.-5.	high	Inexpensive molding	
Urea-Formaldehyde	✓	✓	✓	✓	✓	✓	TL-O/C	1.48	.40	170	low	14-16	3.9	4.0	3.2	7.0	6.5	6.3	high	Excellent wearing properties	
Vinyl Chloride Acetates	✓	✓	✓	✓	✓	✓	T-O/C	1.35	.24	150	slow	38	.8	3.0	1.-2.	3.2	3.2	3.1	low	Cable insulation	
Vinylidene Chloride Resins	✓	✓	✓	✓	✓	✓	T-O/C	1.7	.32	145	nil	87	3.-8.	3.-15.	3.-5.	3.-5.	3.-5.	3.-5.	low	Tubing	

NOTES—1. Optical Properties; (T) transparent; (TL) translucent; (O) opaque; (C) color range available. When more than one symbol appears, a complete range through the values stated is available. 2. The data evaluated in this chart is approximate, owing to differences in preparation, plasticizers used, and (in no small degree) to differences in measuring technic used in various plants. The latter is particularly true regarding electrical characteristics. The moisture absorption comparison is made according to the following absorption rates during a 24-hour immersion: high, over 2%; med., 0.5% to 2%; low .01% to 0.5%; very low, under .01%.

developed that will prove of interest to radio designers, such as: heat-tempered wood, impregnated with thermosetting materials. Radio cabinets would then retain their beauty throughout the life of the set.

Decorative laminates, will provide

many innovations on the home radio cabinet. They will enable simplification of the panels for all commercial receivers such as those needed for aircraft installations.

Plastic foam, for sound insulation can be used, for reducing cabinet resonance effects and main-

taining the high fidelity tones so easily produced in modern electronic circuits.

Optical mirrors and lenses having large apertures, are needed for the television set of the future, to-

(Continued on page 132)

WABC's NEW TWO-BAY

by **OGDEN PRESTHOLDT**

General Engineering Dept., Columbia Broadcasting System

847-ft. mid-Manhattan radiator provides considerably improved service in metropolitan and suburban areas

● Since November 22, 1944, WABC-FM, the Columbia Broadcasting System FM station in New York, has been giving the FM audience in the New York area improved service through the use of a new antenna. This antenna, located atop the 500 Fifth Avenue building, consists of a General Electric two-bay circular antenna having a field gain of 1.29. The center of the radiating portion is 847 feet above sea level. This height consists of a 100-ft. tower

on top of a 700-ft. building at a ground elevation of 60 ft. The center of the radiating portion is 13 ft. below the top of the pole. The three kw transmitter operating on 46.7 mc is on the top floor of the building. Figure 4 is a map showing the location of 1 mv/m and 50 uv/m contours using the new and the old circular antennas.

The old antenna (Fig. 3) erected just prior to the war, was intended to serve for a few months until the

permanent antenna was delivered. The war prevented delivery of the ordered antenna so that the temporary one has served to date. As may be seen from the picture this antenna, a one-bay turnstile, is badly shielded to the north by the water tank penthouse and its effectiveness in that direction should be considerably reduced (measurements discussed later bear this out). The predicted locations of the 1 mv/m and 50 uv/m contours for

Fig. 1—Worm's-eye view of the new structure which mounts a General Electric two-bay circular antenna atop a 100-ft. tower erected on the roof of an office building 700 ft. above street

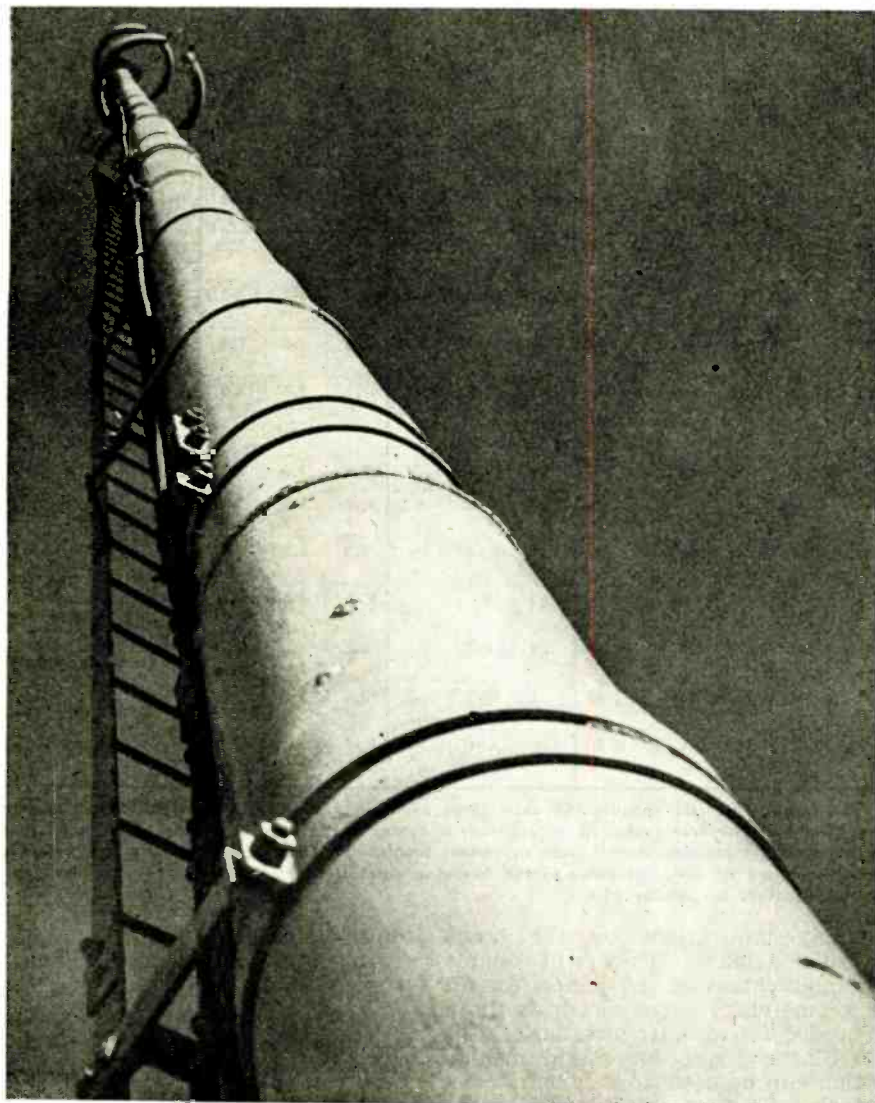
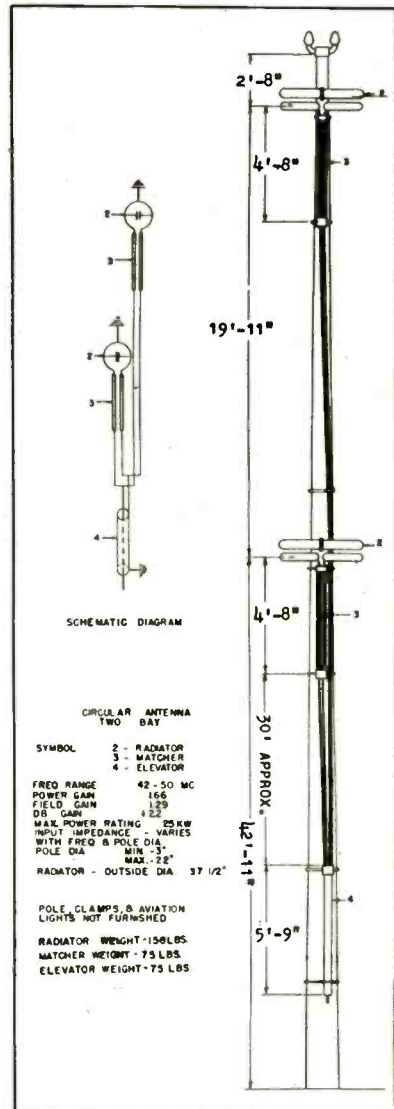

Fig. 2—Schematic diagram giving engineering constructional details of the new antenna



ANTENNA

this antenna are shown in Fig. 4.

The circular antenna consists of a folded dipole which has been shortened and formed into a circle. Capacitance has been added between the shortened ends. Adjustment of the capacitance varies the resonant frequency so that antenna may be used at any frequency in the FM band. The radiation resistance of the antenna is a function of frequency and of the diameter of the supporting pole.

At the WABC-FM frequency and on the diameter pole used, the radiation resistance of each bay is in the order of 33 ohms and each unit is a balanced load. A pair of $\frac{7}{8}$ in. coaxial cables is used to feed each bay and this transmission line has an impedance of 132 ohms for the pair. Thus the quarter wave matching section required should have an impedance of 66 ohms. This section consists of four quarter wave sections of $\frac{7}{8}$ in., two being used in parallel for each side of balanced line.

Measuring standing waves

The elevator section used in the installation converts the balanced coaxial line to a single $2\frac{5}{8}$ in. coaxial line which is the feed from the transmitter. A fair match is obtained at the junction between the elevator and the feed lines to the individual bays, since the impedance of the two lines when paralleled is 66 ohms and the impedance of the $2\frac{5}{8}$ in. line is 74 ohms.

Provisions were made in the in-



Fig. 3—The old antenna, erected just before the war and used since, was a simple, single bay radiator

Fig. 4—Contour map showing calculated and measured field strengths for old antenna, and in red, for the new



stallation for measuring the standing wave conditions on the transmission lines so the progress in tuning could be easily determined. In the lines to each bay from the elevator, a section was built so that the voltage could be measured at one foot intervals for eight feet. This section is near the base of the pole so that an engineer can have access to them during the tuning operation.

Just below the elevator a section was built so that the voltage could be measured at three points, an eighth wave length apart, and the impedance at some point on the lines so the progress in tuning could be easily determined.* One other section for voltage measurements and this is in the transmitter room near the final amplifier.

In building these sections for voltage measurements on the lines it was necessary to drill holes in the line for a probe. Since the line was exposed to weather it is operated under gas pressure. Brass buttons, drilled and tapped so that the holes could be sealed with screws for normal operation, were made and sweated over the holes in the line. This made it possible to measure voltages on the line at any time and still have a simple

(Continued on page 152)

*See IRE Proceedings, June, 1944, P. J. Kilbler

SHORT WAVE BC TECHNIC

By H. G. TOWLSON

General Electric Co., Schenectady, N. Y.

Engineering details of the General Electric transmitting installations on the East and West Coasts totalling 275 kw

● The General Electric international broadcast transmitters are at two sites. The South Schenectady station, (Fig. 1) is located about 5 miles from the city of Schenectady, N. Y. Here in one building are located the three international transmitters, WGEO (100,000 watts), WGEA (50,000 watts), and WGEX (25,000 watts). At the same location are also the 50,000 watt standard broadcast transmitter WGY, a complete auxiliary transmitter, and the 5,000 watt New York State police transmitter WPGC. Primary power is received at 13,200 volts, and can be fed to the station from two directions from any of several sources, assuring continuous operation. The other site, located near San Francisco, is particularly well suited for transmission to the Far East, Alaska, Mexico and South America.

New 100 kw transmitter

The KGEX transmitter recently installed by the Office of War Information, (Fig. 3) at the West Coast site is one of the new 100 kw General Electric Type G-100-A models. It incorporates many features which assure peak efficiency and reliability. The vertical sliding doors are closed in the operating condition. The large 240 degree scale meters are easy to read from the operator's desk and the glow of the tubes can be observed through translucent windows. The vertical doors are opened in the tune-up position giving ready access to various adjustments, automatic tuning controls, etc.

The simplified block diagram (Fig. 2) of the essential electrical circuits shows that for high overall efficiency and freedom from critical adjustments, Class B high-level modulation and Class C rf amplifier operation are used. For reliability, all tubes are conservatively operated. Use of audio feedback assures fidelity of transmission.

The GL-880 tube (Fig. 4) made possible the attainment of 100 kw power at high frequencies. Despite its small size, this tube is capable of an anode dissipation of 20 kw and of an output of 30 kw as a Class C plate-modulated amplifier. Due

to the unique "folded anode" construction, this tube, with an overall height including glass and connection pins, of less than 12 in., has a power capability such as would require tube structures of twice the length with conventional type construction. This feature, resulting in short internal leads, is particularly emphasized as it makes possible an amplifier design which is stable and trouble-free, especially important when the equipment must be operated on many different frequencies.

Four GL-880's are operated in push-pull parallel in the power amplifier (Fig. 5). This assembly is exceptionally clean and accessible, an ample aisle going around the assembly within the cubicle. The inner cylinders of the concentric plate-tuning capacitors are raised and lowered by a motor-driven carriage to pre-set positions. The neutralizing capacitors also have concentric cylinders, the inner cylinder being arranged to telescope for tuning adjustment. This form of construction has many important advantages:

1—Due to its compactness, circuit elements are kept lumped—an important consideration in obtaining good operation. 2—The lead inductance between tube anode, tank

capacity, and tank inductance is practically nil. This is especially important at the higher frequencies as any appreciable inductance can produce spurious parasitic circuits. 3—The use of concentric cylinders approaches an ideal design from the standpoints of maximum capacity and maximum flashover strength for a given size and spacing. The movable cylinders will unmesh completely giving a high ratio of maximum-to-minimum capacity. 4—The smooth, highly polished outer surfaces of the assembly give freedom from corona and flashovers which could readily occur with modulation peaks producing voltages to 40,000. Efficiency of this amplifier is exceptionally high, averaging about 74 per cent over the frequency range.

The exciter output stage (Fig. 6) uses push-pull GL-889 tubes. These tubes, while capable of several times the 4 kw required of them, are physically small and sturdy and are specially designed for high frequency use. Their conservative operation makes it possible to use considerably reduced filament voltage with appreciable increase in tube life.

Low power rf stages include a GL-807 crystal oscillator, a GL-807

Fig. 1—General view of the General Electric broadcasting transmitter installation at South Schenectady showing part of the antenna arrays. Here are located five high power transmitters

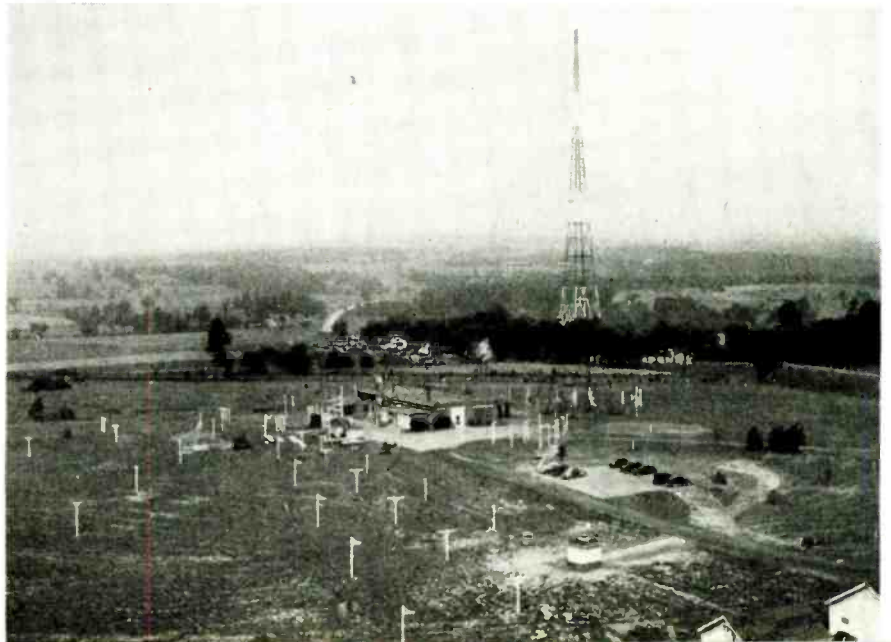

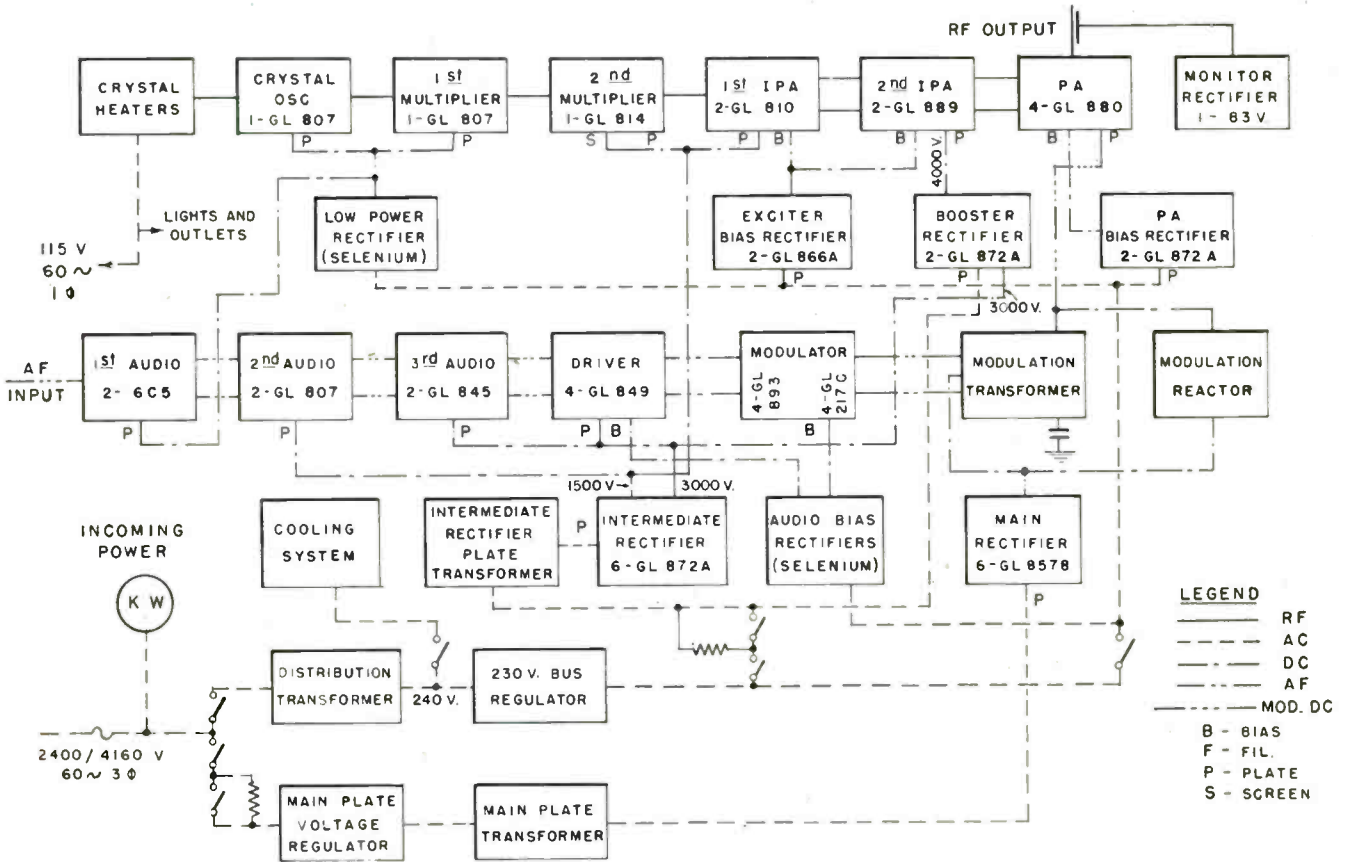

Fig. 2—Simplified block diagram showing arrangement of the tubes in the KGEX 100 KW transmitter recently installed on the West Coast

doubler or tripler, a GL-814 doubler, and push-pull GL-810's. All crystals are of low frequency temperature coefficient and are mounted in the new G-31 individual heat control units.

The complete accessibility of each component in the modulator cubicle (Fig. 7) is apparent. Attention is also called to the use of semi-flexible, transparent, plastic tubing for water connections to the jackets. Some of the advantages of this tubing are: 1—Chemically inert and impervious to acids and alkalis. 2—Being semi-flexible, it can be formed as desired. It is not as sus-

ceptible to accidental breakage as is porcelain. 3—Being transparent, the condition of electrolytic targets can be readily checked without their removal.

The tubes used in the modulator are GL-893's. These tubes are particularly well adapted to this service due to their moderate driving power requirements, use of three-phase filaments to give low residual hum, and their comparative freedom from grid emission effects.

In the audio circuit (Fig. 8) four GL-849 tubes operate in push-pull parallel Class A prime, cathode-coupled to the modulator grids. Pre-

ceding this stage are three push-pull Class A stages using GE-6C5's, GL-807's, and GL-845's. Metallic rectifiers are used as sources of bias for the modulator and driver tubes.

Sub-station equipment includes: automatic plate voltage regulator; automatic filament and main bus regulator; main rectifier plate transformer; distribution transformer; modulation transformer; modulation reactor; weatherproof cubicles containing air-contactors, resistors, etc.

An important feature of this apparatus is the use of non-inflammable Pyranol throughout. This

Fig. 3—This general view of KGEX transmitter shows how the vertical sliding doors are raised providing complete safety for the operating personnel while the equipment is on the air

Fig. 4—The GE Type GL-880 Tube which made possible high power at high frequencies

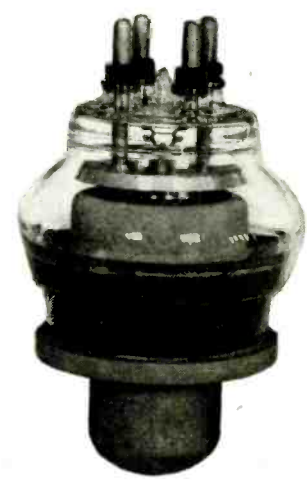
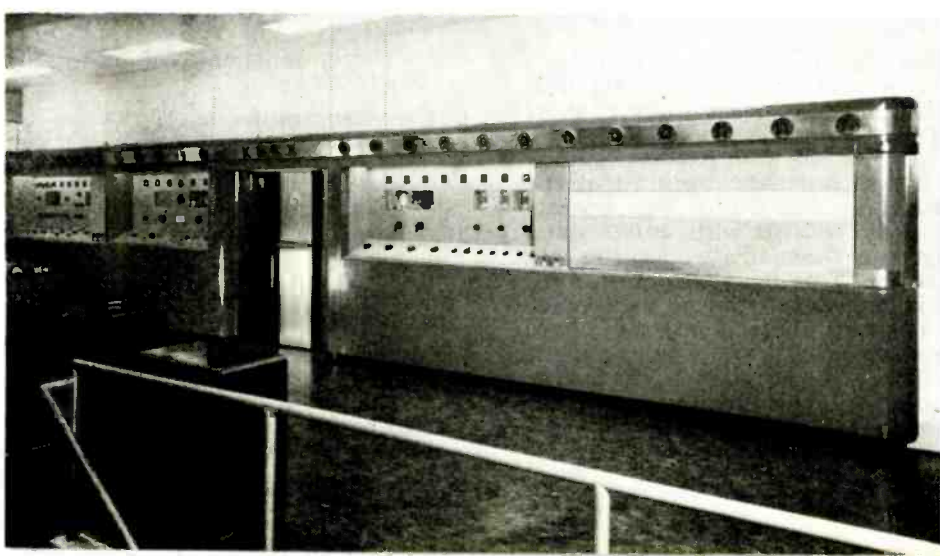

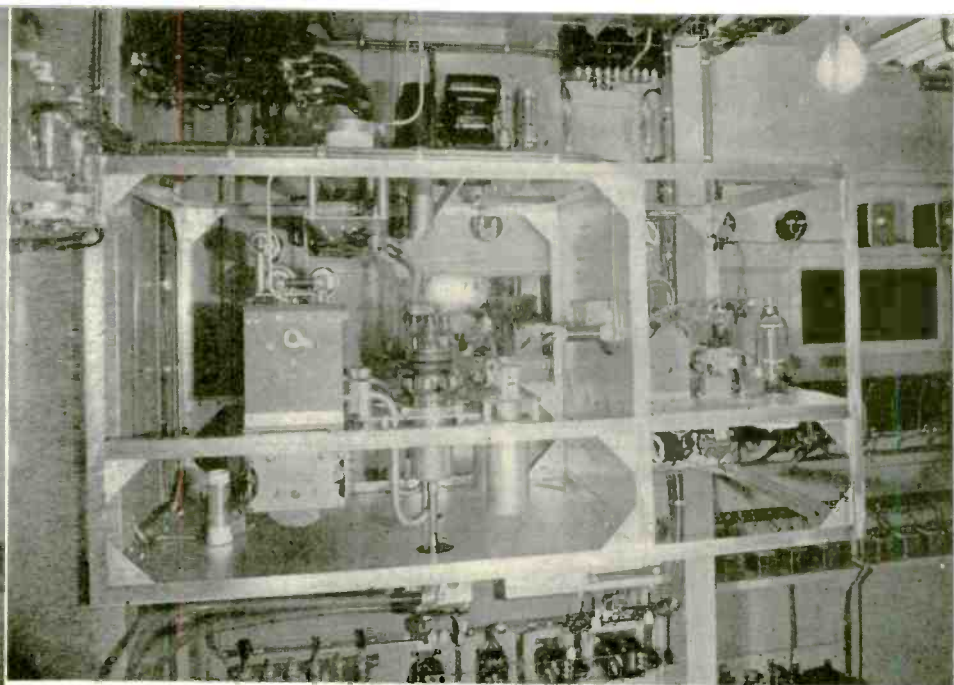
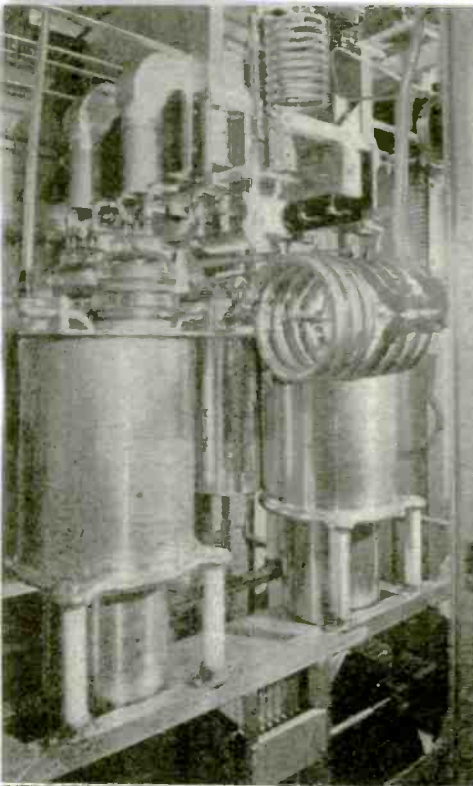

Fig. 5 (Left)—Massive construction of the 100 KW International broadcast transmitter, KGEX.
 Fig. 6 (Above)—The exciter cubicle of the transmitter showing first and second PA stages

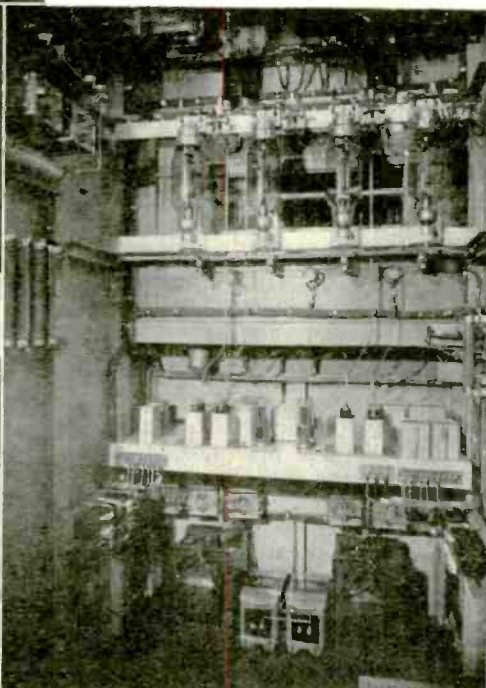
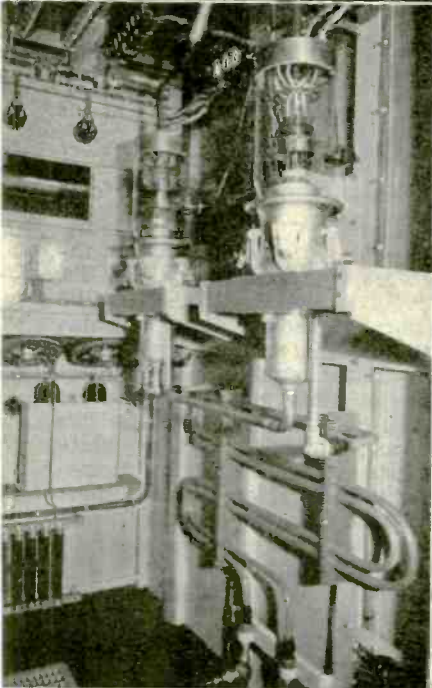

Fig. 7 (Left)—Modulator cubicle of KGEX showing use of plastic tubing for water-cooling connections. Fig. 8 (Right)—View through the rear door showing a portion of the audio equipment

equipment can be placed indoors or outdoors without special vaults and without the fire hazard ever present when the older oil-filled units are used.

Additional features of the transmitter include: 1—All cubicles are pressurized with filtered air. 2—Automatic voltage regulators, besides holding the voltages at the proper operating values, bring the filament bus up from zero on start-up. In addition each tube is provided with its individual control. 3—Centralized supervisory control indicates at a glance the status of all circuits. 4—Complete safety to

personnel is provided by both electrical and mechanical interlocks. 5—Automatic reclosure for short duration outages.

The 50,000 watt KGEI transmitter was originally installed at the San Francisco World's Fair, operating as W6XBE with 20,000 watts power. When this transmitter was moved to its new location in 1941, the necessary changes were made to convert the equipment to 50,000 watts power.

Two GL-880's are used in the power amplifier stage, modulated by two GL-893's operating Class B. Two GL-833-A tubes provide ample

excitation to the rf amplifier stage, and two GL-849's operating Class A prime drive the modulators. The transmitter incorporates many of the modern features discussed above under the KGEX heading.

The main short-wave transmitter room at the South Schenectady plant houses the 100,000 watt WGEO transmitter and the 50,000 watt WGEA. The tube arrangement of WGEO is nearly identical with that of KGEX. In fact, WGEO was the experimental model in which many of the KGEX circuits and components were "proving-ground tested." This transmitter was installed in 1942, but its hour-meter already indicates 18,000 hours of operation. Both the mechanical and electrical details follow closely those described for KGEX.

Transmitter performance

The following table indicates the performance as measured on WGEO and is typical of that of the other transmitters (the 50 and 25 kw transmitters being rated at full power to 22,000 kc).

- Carrier-freq. range at 100 kw—6,000-16,000 kc
- Carrier-freq. range at 90 kw—16,000-18,000 kc
- Power amplifier efficiency (at 15,000 kc)—74 per cent
- Modulation capability—100 per cent
- Audio frequency response—1,000 cps reference—plus 1 db
- Harmonic distortion (to 50 per cent modulation)—less than 3 per cent
- to 85 per cent modulation—less than 4 per cent

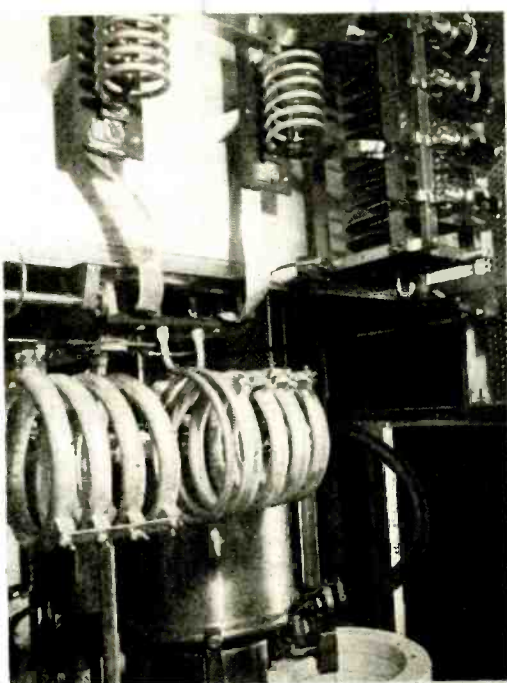

Fig. 10—Water-cooled plate tank and method of varying output coupling of WGEA transmitter

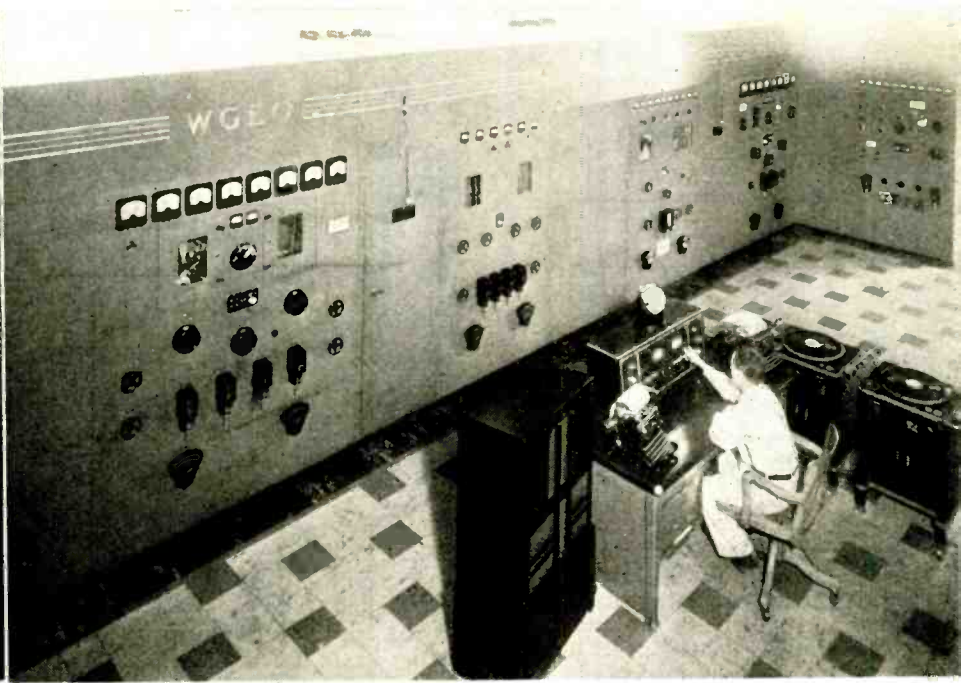

Fig. 9—General view of the main short wave transmitter room at the South Schenectady station with the 100 KW transmitter WGE0 at the left and WGEA, rated at 50 KW output, at the right

Carrier noise level (below 100 per cent modulation—minus 52 db

WGEA transmitter was installed during the summer of 1941 and its hour-meter now indicates 25,000 hours of transmission.

Two GL-880's are again used in the power amplifier with two GL-893's as modulators. Construction is similar to that of the other transmitters. Fig. 10 is a view of the power amplifier showing the tank circuit, variable coupling to the transmission line, and network for impedance matching and harmonic attenuation. Attention is called to the simple effective method of changing the coil inductance when changing frequency bands. Due to the fact that the tube cooling water

also flows through the tank coil, a comparatively small shorting strap is adequate.

WGEX is the newest call letter being signed at the South Schenectady station and was installed for the Office of War Information in April, 1944. An interesting fact about this transmitter is that it was war-time constructed, using a minimum of new materials. The power amplifier, for example, employs much of the original 2XAD transmitter, the modulation equipment is largely from the original W6XBE transmitter, and other parts have seen service in other transmitters. This transmitter is, nevertheless, a thoroughly modern unit developing 25,000 watts in any of the international bands.

The South Schenectady station presents an impressive sight with its eleven directive antennas, 625 ft. vertical radiator for WGY, and the 300 ft. cage antenna for WPGC. Fig. 11 shows the layout of the various antennas. The three rhombic antennas, I, J, K, are located on adjacent leased land.

The arrays are arranged roughly in a circle so that they do not shoot through each other. This feature is important as early tests, made with continuous recording of field intensity at a European receiving site, demonstrates that as much as 10 db drop could readily occur due to another array in front of the transmitter. At first it may appear that the principle is neglected in the

Fig. 11—Map of the extensive antenna arrangement at South Schenectady. Directivity and beaming of various units given in appended table

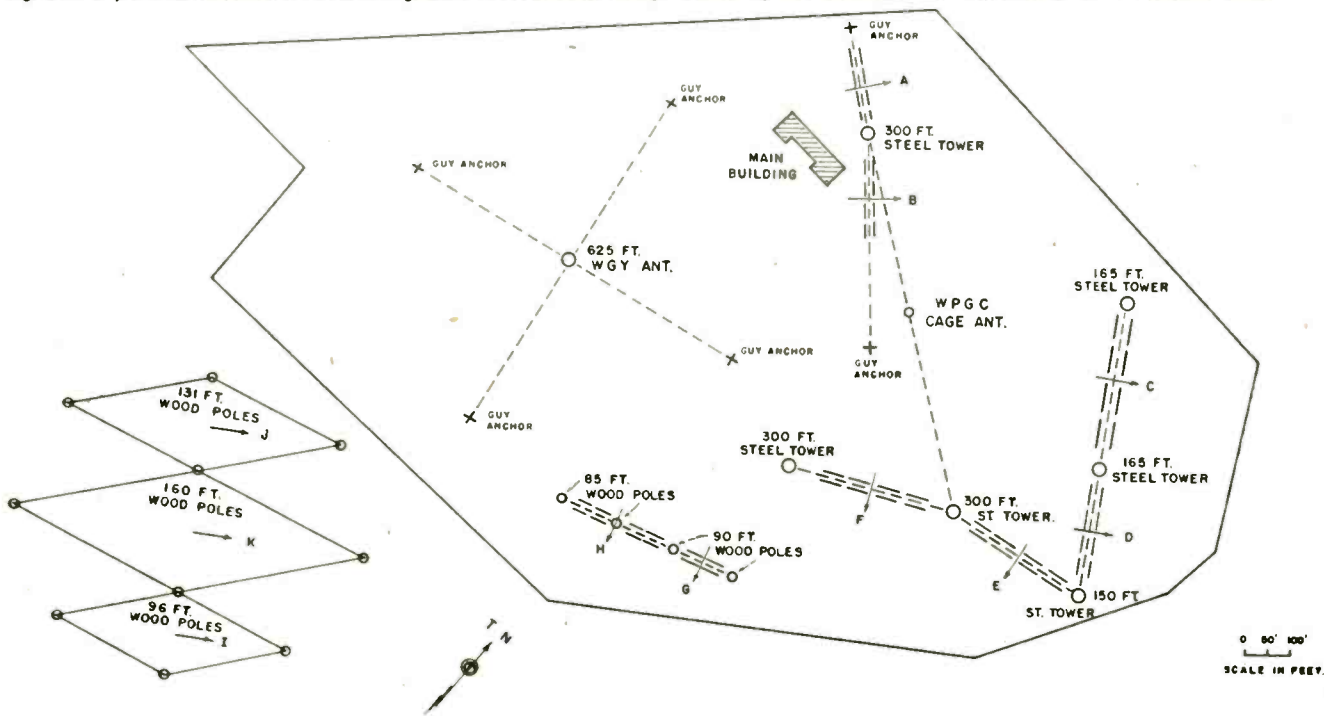

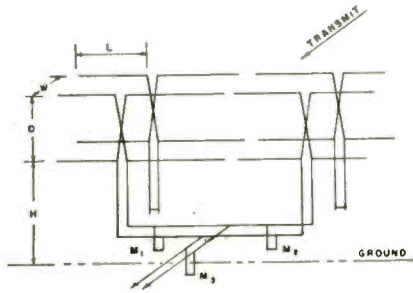

Fig. 12—Schematic of Type A antenna: L, 0.5 wavelength; W, 0.21 wavelength; D, 0.5 wavelength; H, wavelength desired; $M_{1,2,3}$ tuning stubs

case of the J and K rhombics. However, the distances involved are great enough so that, at the vertical angles in which we are interested, the rhombics "shoot over" the interfering structures.

Most of the towers and poles are used to support more than one antenna. In the case of Antenna A and B, support is from a 300 ft. tower and a guy wire attached from the tower to an anchorage.

The type A array (see appended table) is the original Alexanderson panel antenna which was developed by Dr. E. F. W. Alexanderson. It was found ideal for international broadcasting and after 16 years still has great popularity and is widely used in either the original or a modified form. This array has four co-linear, horizontal half-wave elements with a similar section stacked one-half wave above, all elements being excited in phase. A similar curtain is suspended .21 wavelength to the rear and is parasitically excited as a reflector. The height of the lowest element should be one wavelength wherever possible. The pattern of radiation from this array is very clean and free from parasitic lobes of large magnitude; the width of the beam is 36 degrees

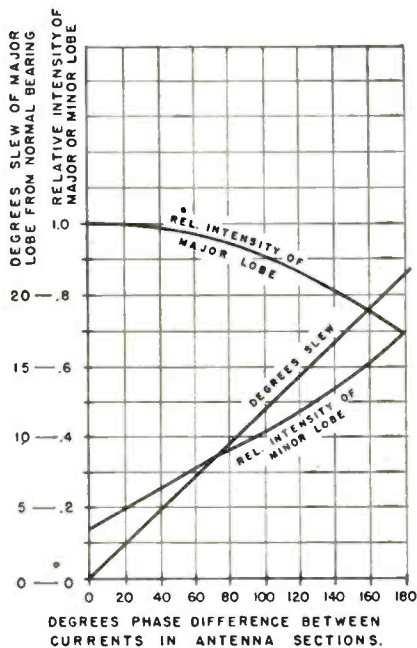

Fig. 13—Curve showing relationship between degrees of electrical phase difference and degrees of slewing of beam from the normal

at the point of 6 db below peak intensity. Gain is 11.5 db over a half wave element. This type of antenna lends itself readily to both reversing and slewing. Fig. 12 shows the schematic diagram of the fundamental array itself.

It will be noted that the driven portion of the array is fed in two sections. The vertical feeder for each section is tuned by the shorted, grounded (for lightning protection) stubs M_1 and M_2 to present a 550 ohm resistive impedance (the surge impedance of the line). The impedance seen at any point between M_1 and M_2 is, then, 275 ohms, and stub M_3 is required to correct the 2 to 1 mismatch which would occur on the main transmission line

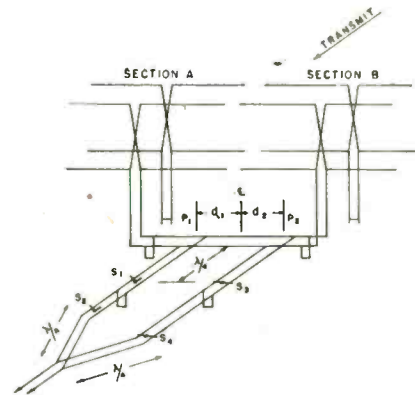

Fig. 14—Schematic diagram showing method of slewing beam between two or more bearings

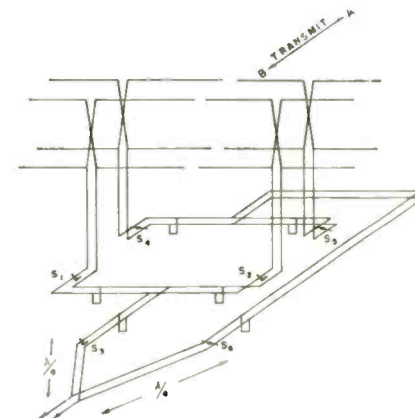

Fig. 15—Schematic diagram showing method of reversing direction of the type A antenna

when connected. If the point of attachment of the main line is made at the center of the system, the two sections will be fed in phase and the beam direction will be normal to the axis of the antenna.

If the point of attachment is made at other than the midpoint the phase of the current in one section will lag that in the other

(Continued on page 132)

GENERAL ELECTRIC INTERNATIONAL BROADCAST STATION ANTENNA FACILITIES

Ant. No.	Freq. mc	Area Served	Bearing	db Gain	Ant. Type	Vert. angle of max. int.	Beam width (to 6db down)	Supporting Towers, ft.
Stations KGEI-KGEX								
A	15.2	SA & Asia	126° & 306°	11.5	A	10°	36°	125 steel
B	7.2	SA & Asia	126° & 306°	10.25	D	19°	45°	125 steel
C	11.7	Asia	306°	11.5	A	18°	36°	105 steel
D	9.5	Asia	306°	11.5	A	17°	36°	125 steel
E	15.3	Pacific	269½°	14.5	E	10°	21°	96 wood
F	11.8	SA	105°	14.8	E	10°	21°	131 wood
G	9.5	SA & Asia	115° & 295°	15	E	10°	20.5°	160 wood
Stations WGEA, WGEO, WGEX								
A	15.3	Europe	32°-40°-50°	11.5	A	13°	36°	300 steel
B	11.8	Europe	40°-50°	11.5	A	12°	36°	300 steel
C	6.19	Europe & Aust.	44°-249°	11.5	A	18°	36°	150 steel
D	9.5	Europe & Aust.	55°-250°	11.5	A	15°	36°	150 steel
E	7	S.A.	160°	11.5	A	18°	36°	150 steel
F	9.5	S.A.	162°	14.5	B	8°	36°	300 steel
G	15.3	S.A.	170°	11.5	A	17°	36°	85 wood
H	11.8	S.A.	160°	12.5	C	18°	25°	85 wood
I	15.3	Europe	60°	14.5	E	10°	21°	96 wood
J	11.8	Europe	60°	14.8	E	10°	21°	131 wood
K	9.5	Europe	60°	15	E	10°	20.5°	160 wood



A tower of such a height erected on the Palisades, New Jersey side of the Hudson River, might appear as shown and permit a fair degree of vertical angle discrimination for many sections of Manhattan, where the reception angle can be directed above the surrounding walls

Easing Multipath Problems

● In metropolitan New York, television has received as thorough a workout as anywhere in the world. There the needs were discovered and improvements worked out for the continued upgrading of quality. There, some of the original television enthusiasts have seen all picture quality levels from 30 lines upward. However, the upper limit of quality now depends on the observers' good luck in being located in a ghost-free position.

Within a range of say five mile radius from the midtown section it is common experience to be able to get any one of the several programs with only a minor amount of multiple path distortion, and with a lot of patience in setting up an antenna it is possible for one to pick out which of these stations he can receive well, but it is nearly hopeless, except by elaborate multiple antenna means, to get them all.

Ghosts persistent

All viewers are acquainted with the appearance of these multiple images—double "reflections" of the same picture a little ways left or right away from the main image. Many do not realize that multiple reception over substantially identical path lengths can reduce the quality or the effectiveness of the number of lines used to what would be received with half the lines, or less, even though no actual ghosts might be in evidence.

There are about 580 picture elements per line in the present system, so the spot jumps from one picture spot to another in about one-tenth microsecond. An alternate path only 100 feet longer will fill in and destroy the contrast that would have existed between adja-

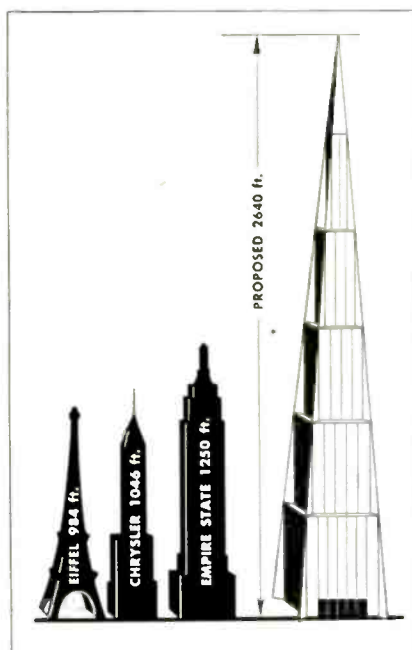

Indicating high tower possibilities, this design was proposed in 1939 for the N. Y. World's Fair. From a base 400 ft. square, it rises about 500 ft. to the first setback, providing ample space for many uses besides housing television systems. Each setback is 50 ft. in depth. Courtesy Wm. Van Alen, architect, and Ralph W. Squire, engineer

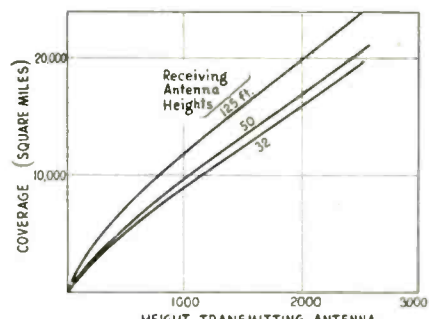

Coverage is closely proportional to height

cent points, since the second signal arrives one picture element away.

The ease with which signals at these frequencies bounce around is astonishing. They are as energetic in this regard as are light waves—and the whole science of vision is based on light being reflected from all materials into the eye.

"Just put up a directional antenna." This sounds nice and simple until a service man is called in to figure how to direct toward three (and there will soon be more) stations at once and still avoid ghost signals coming from all sides. However, there are no known methods of avoiding such interference in other ways except by this method of directivity. Here the results depend entirely on the sharpness of the reception angle.

Directivity a solution

This introduces the one greatest need of the television system for anticipating and alleviating to the greatest possible extent the problems that will confront the many thousands of potential television set purchasers when sets are available: getting single path reception with a low cost antenna; and in many places even getting good reception at all, no matter what the cost. The following suggestion is made:

Based on the metropolitan New York area: Immediate steps should be taken to work out a plan for erecting a single television tower to serve as many transmitters as can to join in the cooperation. A tower, with say a 2,000 foot elevation erected above the Palisades, would accomplish the following direct results:

1. Give all receivers a single point

(Continued on page 140)

FACSIMILE EQUIPMENT

by ROLAND C. DAVIES* and PETER LESSER

Picture and printing transmission and receiving components in use by Signal Corps for radio and wire lines

● "Yanks Enter German Town", the caption reads. In fine print below the picture, the credit line says "Associated Press Photo, via Signal Corps Radiotelephoto". How that picture is reproduced on the front page of the daily newspaper is the story of how the U. S. Army uses facsimile equipment in order to speed up not only press photographs, but, more important, reconnaissance pictures, maps, charts, and other graphic materials so vital in this second World War.

Before American doughboys entered that German town, their commander had to know what was going on inside the enemy lines: where the foe was concentrated; whether enemy reinforcements and supplies were moving up to help; were they tanks? Artillery? Transportation? Foot soldiers? Upon the answers to those questions, depended the American plan of attack, choice of weapons, intensity of artillery preparation.

The fact that he did get his troops into the town meant that the Yank commander did have the answers and quite possibly, those answers were supplied by aerial reconnaissance, the results of which were transmitted to him by facsimile.

During the past year and a half, facsimile transmission has increased tremendously in the armed forces. Through these equipments have flowed a wealth of informa-

War has been the catalyst for the speeding up of many inventions in many fields of science. Facsimile transmission, also, has partaken of this acceleration. It has come a long way from the first conception by the English physicist, Alexander Bain, in 1842. It has come a long way from the first FM transmission performed commercially by Press Wireless Inc. which supplied units for the sending of pictures to the Byrd Expedition in Antarctica in the 1920's.

tion from front lines back to rear areas and from rear areas to front lines. They have influenced battles from North Africa onward.

During the early days of the Normandy invasion, maps, charts, and aerial photographs flashed from General Eisenhower's headquarters in England to General Bradley's command post in France over a cross-channel facsimile radio circuit. Pilots of the 9th Air Force swooped over Rommel's lines taking pictures of enemy fortifications and rail lines, and plotting on maps of the area their observations of movements on roads, tank parks, artillery positions, etc. Back at their English bases, film was developed, maps correlated, and within minutes they were on the air for the guidance of ground units battling the Hun.

On the other side of the world,

in China, help has been given U. S. instructors in the training of Chinese troops by the use of facsimile equipment that links half a dozen major Chinese cities over a land telegraph line. Telegraphy in China has always been a problem, for the Chinese alphabet contains thousands of characters, each one of which had to be translated into a number for telegraphic transmission. More than 9,000 numbers comprised the code. Upon receipt, the numbers had to be recoded into the original Chinese character before the message could be delivered. Now through the use of Western Union Telefax machines, Chinese messages are sped over telegraph lines via facsimile and are reproduced at the receiving stations as written.

As is all communication by electrical means, the procurement and issuance, maintenance and, in most part, operation of facsimile equipment is the responsibility of the Signal Corps.

Facsimile principles

Radiotelephoto circuits are operated by the Army Communications Service of the Signal Corps between Washington and fixed stations in overseas theaters for the transmission of official news photographs. Facsimile equipments used by combat Signal men in the field—between Armies, or from Army to Corps, or even from Corps to Divi-

*Electronic Industries Washington Bureau

Left, components of U.S. Army facsimile equipment RC-120, with light-tight cover flipped left. Right, converter CV-2/TX for use with facsimile transceiver FX-1

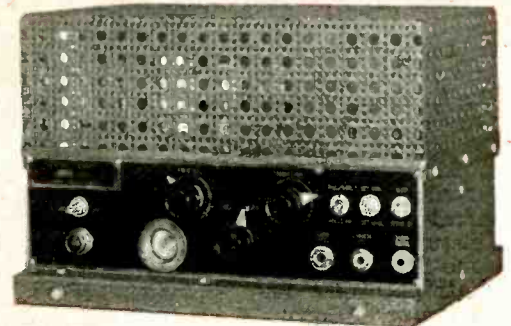

COMMUNICATION UNITS

sion—are for the shorter circuits. The light, portable apparatus pioneered and developed by the Signal Corps with the cooperation of civilian experts is a far cry from the bulky, intricate devices of the early days of commercial telephoto service.

The principles of facsimile transmission remain the same, however. A photograph, for example, is clamped to a drum which revolves at about 100 rpm. The transmitter and receiver are synchronized, and a tiny beam of light, 1/100th of an inch square, scans the drum laterally, at a speed of about one inch per minute. The beam is reflected to a photo cell by means of lens arrangements and an oscillating mirror. Acted upon by the beam of light, the photo cell generates electrical impulses (1,800 cycles) which vary in amplitude with the intensity of the light, which in itself is varied by the black, white and gray of the picture.

Radio transmission

Received at the other end of a telephone line, the incoming signal is applied to a modulator, controlling the swing of the mirror, which varies the intensity of the light striking photographic film. As the light beam scans the film on the drum at the receiving end—100 lines to the inch—the original picture is thus reproduced so faithfully as to be almost indiscernible from the original.

Transmission by radio, however, necessitates additional procedures. This is due to interference, fading, static, and other atmospheric disturbances which cause distortion, and which is more acute in facsimile transmission than in ordinary voice transmission. To overcome these effects, the signal is convert-

ed from a fixed frequency amplitude modulation to a constant amplitude with a varying frequency, which controls the variable frequency oscillator output.

In order to receive this signal, it must be inverted back to amplitude modulation. The received signal is first amplified and then sent through a pair of push-pull limiter tubes, which restrict the effect of selective fading to minus 65 decibels. After this filtering, the signal is again amplified and passed through a discriminator. This output, now pulsating direct current, is fed to the plates of a control tube. Output of a fixed frequency oscillator (1,800 cycles) is applied to the grid of the control tube to provide the picture carrier

and the resultant output may be applied directly to standard telephoto equipment.

Wire telephoto

Wire telephoto came into being after months of experimentation to adapt commercial equipment to military use. The need for such a service had long been apparent to the Signal Corps. It was translated into reality by Brigadier General Frank E. Stoner, present chief of the Army Communications Service. The first station was set up in a broom closet in the old Munitions Building in Washington. Other stations soon followed until there were stations that covered the United



AAF PHOTO 5 SEPTEMBER 1944. A B-24 LIBERATOR OF THE 15TH AAF COMES OFF THE TAP AT THE ORA RAILYARDS IN NORTHERN ITALY AFTER IT DROPPED ITS LOAD OF BOMBS THAT HELPED TO DESTROY 34 UNITS AND BLOCK ALL TRACKS ON SEPTEMBER 4. SIG CORPS. AD10 TELEPHOTO FROM ITALY 8-255

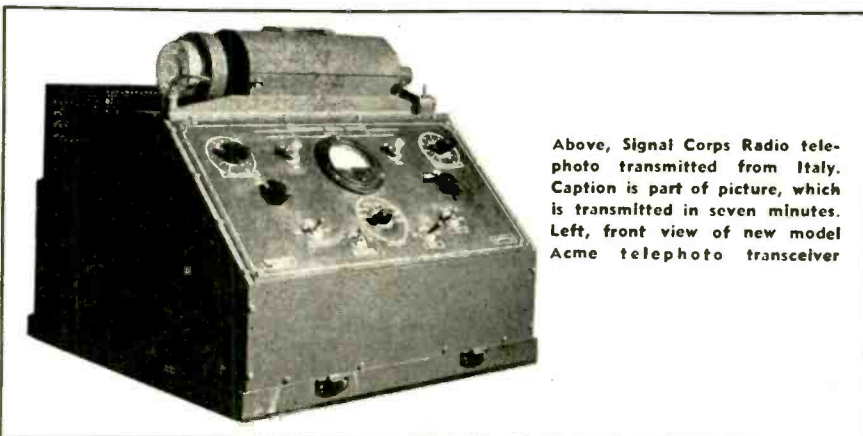

Above, Signal Corps Radio telephoto transmitted from Italy. Caption is part of picture, which is transmitted in seven minutes. Left, front view of new model Acme telephoto transceiver

States. Operationally, this circuit played its part in the anti-submarine campaign during the Battle of the Atlantic in 1942 and early 1943, when maps and charts were quickly and accurately transmitted among the various stations of the Navy and Army Air Forces.

The equipment was a modification of the equipment used by Acme News Pictures, Inc. It operates from a 100- to 125-volt, 50- to 60-cycle single phase source. This equipment, improved since then so that today it is one unit, is still in use on that circuit, and in the overseas radio-telephoto circuit that

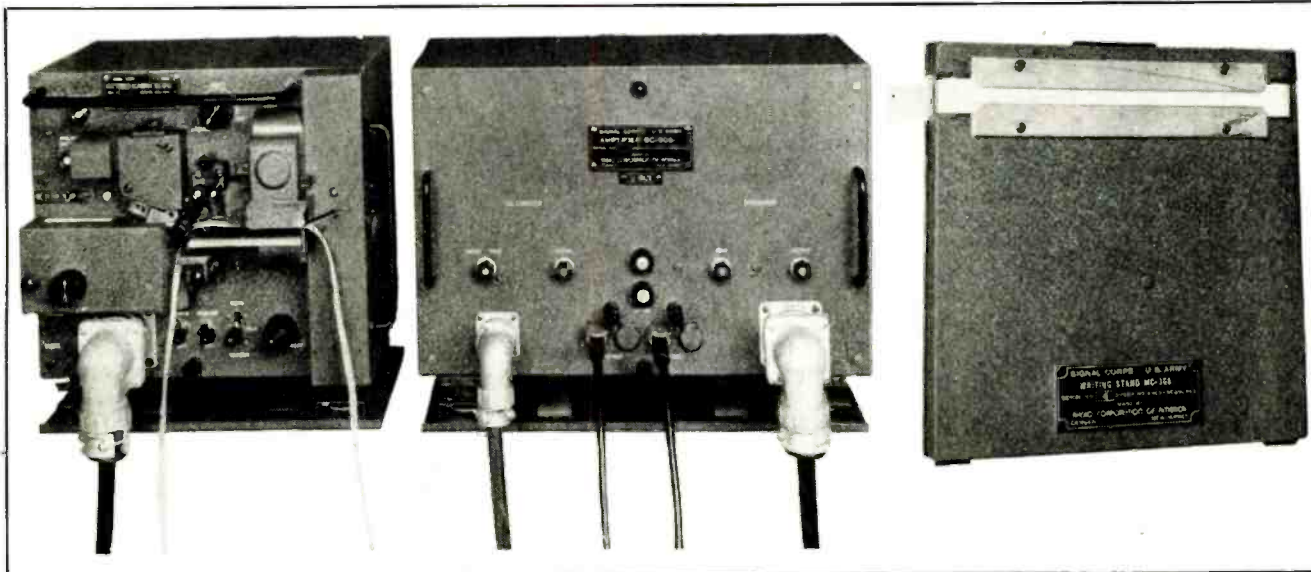

Tape facsimile equipment such as RC-58, shown here set up for operation, is used extensively for written communication. Left, the

recorder-scanner unit which operates at 12 volts. Right, the writing stand, used for hand lettered messages or over-size typewriter

began operation in February of 1943. The first overseas station was installed in Algiers and the first picture that came over was that of the capture of Gafsa by American troops during the Tunisian campaign. Other stations entered the net as the Allies moved forward. Today there are radio-telephoto stations at Brisbane in Australia, Port Moresby and Hollandia in New Guinea, London, Honolulu, Caserta in Italy, the Burma-India theater, and Paris.

When the invasion of France took place June 6, 1944, more than 50 photographs flashed across the ocean the first day. For the first week of the attack on Fortress Europe, more than 600 pictures were transmitted.

Carrier shift

For the transmission of pictures where voice radio facilities are unavailable, the Army Communications Service uses specially developed equipment employing the carrier shift method. Radio transmitters and receivers normally used for cw transmission are utilized. The radio carrier is radiated continuously at constant amplitude, and its frequency is varied in direct proportion with the change in picture tone or gray scale. The highest carrier frequency corresponds to picture black and the lowest frequency, to picture white.

A suitable frequency shifter or exciter is used with the radio transmitter in place of the crystal oscillator normally employed on cw radio transmission. The frequency shifter is operated by the amplitude modulated audio frequency output from the telephoto transmitter. On the receiving end of the radio circuit, a regular communica-

tion type radio receiver, equipped with stable conversion and beat oscillators, is used to receive the facsimile signal and produce an audio tone output varying in frequency in accordance with the transmitted signal. This tone output is fed into a limiter amplifier and an inverter which changes the audio FM signal to an AM signal suitable for operation of the facsimile receiver.

The principal advantage of this method of transmission is the elimination of the effect of fading, except for the most severe, through the use of the current limiter. Another advantage is the use of existing equipment with a minimum of modifications.

The facsimile equipments used by U. S. combat troops are three. They are the RC-120, the AN/TXC-1, and the RC-58. Oldest of the three is the RC-120, a modification of the set used by Times World-Wide Pictures.* It is composed of a recorder-scanner and a power supply. The recorder-scanner weighs about 60 lbs., and the power supply, about 50 lbs. The power supply uses 100 to 130 volts, 50 to 65 cycle, alternating current. In an emergency it can be operated from a 6-volt storage battery. The RC-120 transmits and receives page-size copy, maximum 7 x 7 $\frac{3}{8}$ in., in about seven minutes. It is used for transmission of photographs and maps.

Early in 1944, a modification of the "120" was brought out. This set, known as the AN/TXC-1, handles large size copy, 12 x 17 $\frac{1}{2}$ in., in twenty minutes. This enabled the Army Signal Corps to transmit by facsimile the larger military maps and AAF synoptic weather charts so necessary in modern warfare.

Reception is accomplished by

* Electronic Industries, November 1943.

either of two processes: the use of chemically sensitized paper, discolored by modulated current passing from a stylus through the paper to the revolving drum; or photographically, in which a modulated spot of light is directed onto photographic film or paper carried by the revolving drum. In the latter case the Signal Corps has furnished troops with a portable darkroom in the shape of a bag with sleeves through which the operator can insert his hands to manipulate the receiver and through which he can remove the recorded film or print from the drum. A small cylindrical tank is also included within the bag into which the film or print can be placed for protection from light.

Photographic process

The first models of the RC-120 had the decibel meter on the panel of the recorder-scanner. For use when the bag covered the machine, there was a second meter with two long leads which passed through an opening in the bag. More recent models contain only one meter, on leads, installed so that it can be used either with or without the bag.

The photographic process produces a facsimile that is higher in fidelity than that produced by the electrothermal process. In addition, copies can be made of the received copy and relay of the photograph is possible without loss in fidelity. However, the electrothermal process has its advantages: it is quicker, since no developing technics are necessary, and where definition is not too important—as in combat intelligence—it has its place. Maps and charts are good subjects for this type of reproduction, and are being utilized

widely on fighting fronts today.

Both the RC-120 and the AN/TXC-1 were designed for wire transmission; however, satisfactory results have been obtained over FM circuits and short AM circuits. Longer AM circuits have resulted, as has been explained, in distorted pictures due to fading, interference, etc.

To overcome this distortion, and to make these facsimile equipments function over the many long-distance AM radio communication circuits which the Army uses, a converter has been developed that overcomes the effects of static, fading, and other interference. This converter is the CV-2/TX. It weighs about 30 lbs. and uses a 50 to 70-cycle, 100 to 130 volt ac power supply. Normal drain is about 50 watts. A 6-volt battery can also be used, the dc current drain then being about 6.5 amperes.

The principle of the converter is the changing of the AM signal from the scanning portion of the recorder-scanner into an FM signal which is transmitted. The recorder section of the recorder-scanner then changes these impulses back into an AM signal and from then on the procedure follows the normal principles of facsimile reception.

Tape facsimile

In the spring of 1944, the need for tape facsimile equipment was seen for use in tanks and other armored vehicles of the Army where a high degree of ambient noise existed. Voice circuits were proving too difficult, and cw, in a bouncing, jouncing iron monster, was out of the question.

The RC-58 is tape facsimile equipment. Operating over FM circuits—tank and armored vehicle radio sets are all FM in the Army—fading, interference, and static offer no problem. This set consists of a recorder-scanner, an amplifier and a writing stand. It operates from a 12-volt dc source. Also possible is 24-volt operation, but some connection alterations are necessary. A rectifier permits operation from a 115-volt, 60-cycle source.

Using the writing stand, which contains a roll of three-quarter inch tape and a guide, messages are lettered in large characters. Large typewritten characters are also usable, but the standard typewriter letter size is too small for satisfactory reproduction. The tape is fed through the recorder-scanner automatically at a speed of 50 in. (about 42 words) a minute. Transmission and reception are similar to the other equipments mentioned above.

(Continued on page 170)



These three photographs, transmitted by U.S. Signal Corps Telephoto from Australia, London and Italy, illustrate the fidelity with which modern facsimile equipment duplicates the detail in the original picture. Received pictures measure about 7 x 9 in., take seven minutes in transmission



UNITED STATES ARMY AIR FORCES PHOTO ITALY 16 OCT 1944. BELOW THE FORMATION OF B-24 LIBERATORS OF THE 15TH AIR FORCE IS THE TARGET, INSTALLATIONS IN THE VIENNA AREA, ATTACKED BY HEAVY BOMBERS ON OCTOBER 13. SIC CORPS TELEPHOTO FROM ITALY

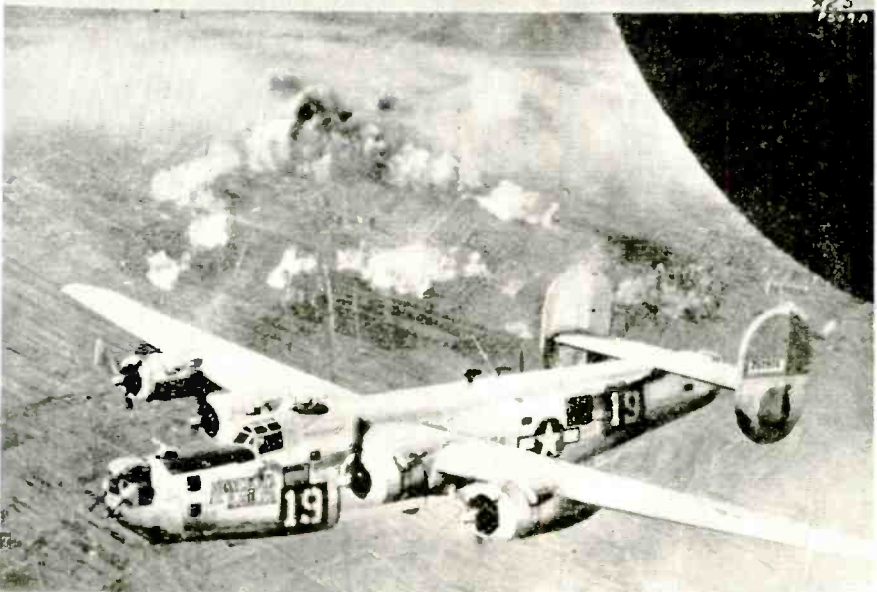

FACTORY SHORT CUTS

1—EMERGENCY COIL REPAIRS are effected in field by Signal Corps with hand-drill and spool rewind gadget in foreground. Here a switchboard drop coil is unwound until break is found and soldered, then rewound by drill

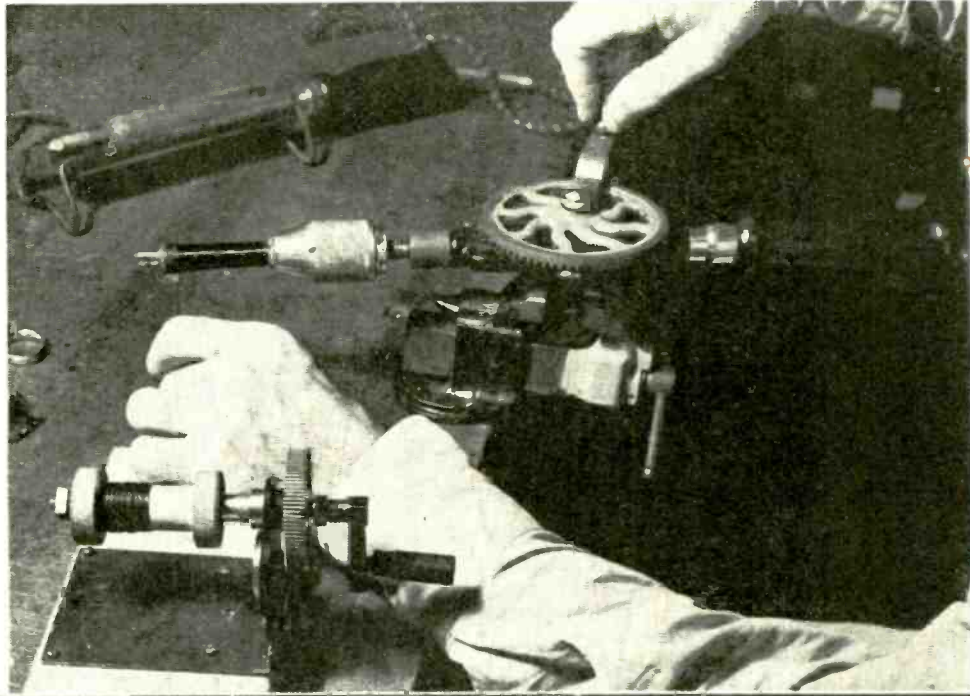

2—PIGTAIL TRIMMER for large scale production saves time at a Westinghouse plant. Top face of cut off die ranges from 1/2-in. to 1 1/2-in. depth. Shear runs continuously while operator feeds in resistors or capacitors

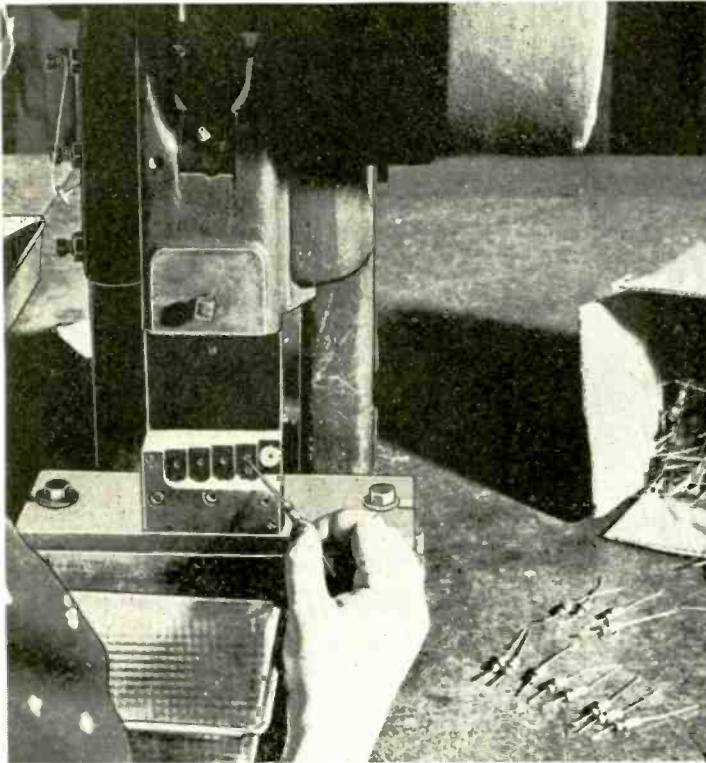

3—SMALL PARTS are prime-coated at Oklahoma City plant of Douglas Aircraft Company with this ingenious gadget. Funnel with a hinged screen lid is attached to conventional spray gun. The gun is "loaded" with handful of small parts. Operator shakes the unit gently and admits air, then trigger is pulled rest of the way to admit paint to the nozzle. Finally, trigger is eased off again, admitting only air, which dries the parts and prevents their sticking together. Idea paid off at a 500 per cent saving on labor and materials over former methods



4—SPRING PACKAGING of large tubes, developed by Eitel-McCullough, Inc., San Bruno, Calif., has been approved by Signal Corps as the "spec" standard for certain tube types. Interlocked stainless steel springs, suspended in galvanized X-frame fit diagonally in a corrugated box. Stands seven times the spec's 3-foot fall

5—WATER PURIFIER (at far right) yields 8-10 gals. mineral-free water per hour with average salts content of two parts per million. Called Filt-R-Stil, the equipment uses replaceable cartridges of melamine-derived ion-exchange resins, and is manufactured in three sizes by American Cyanamid and Chemical Corp., N.Y.C.

6—BLIND RIVETS of new design replace conventional fastenings and save time. Made in two types, hollow and self-plugging, the blind rivets have either brazier or countersunk heads. Special rivet guns insert rivets, pull up the built-in plug which spreads the head, and break the plug into two pieces which drop free. Developed by Cherry Rivet Co., 231 Winston Street, Los Angeles, Calif.

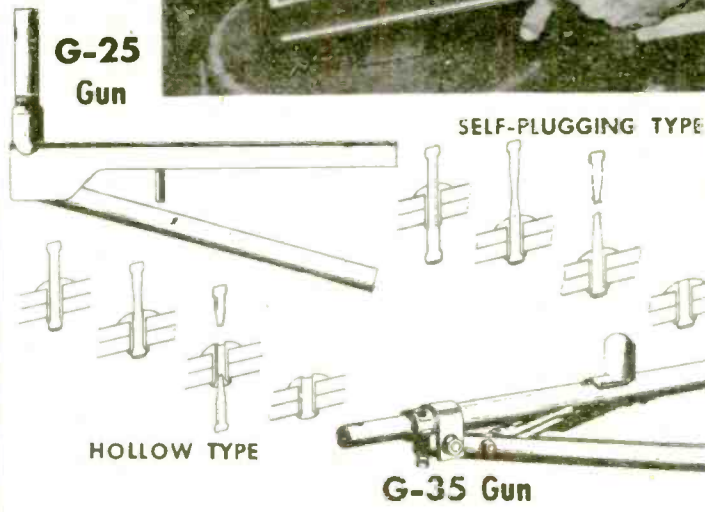
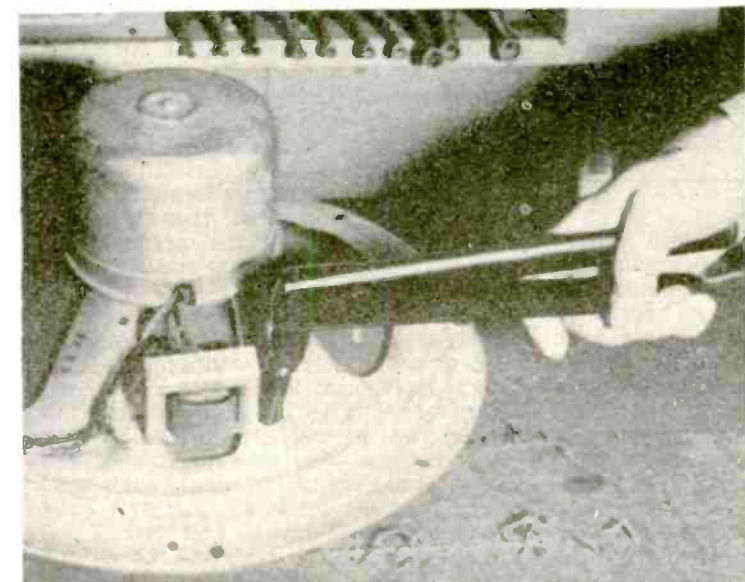
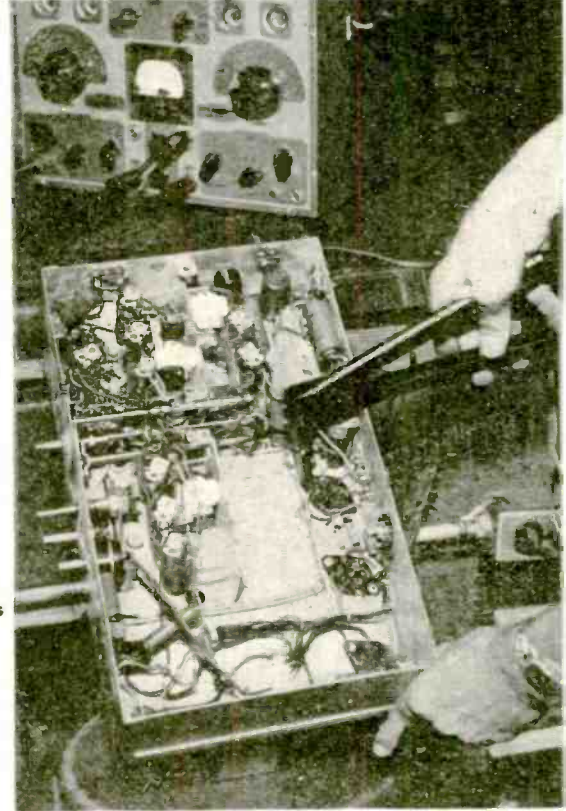
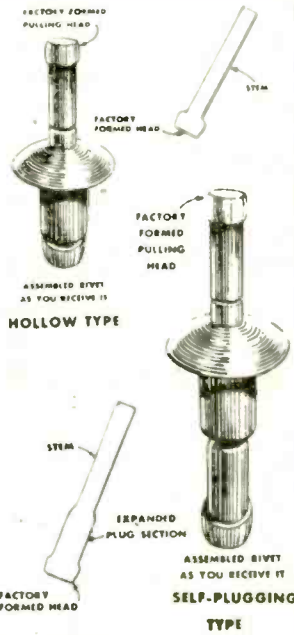
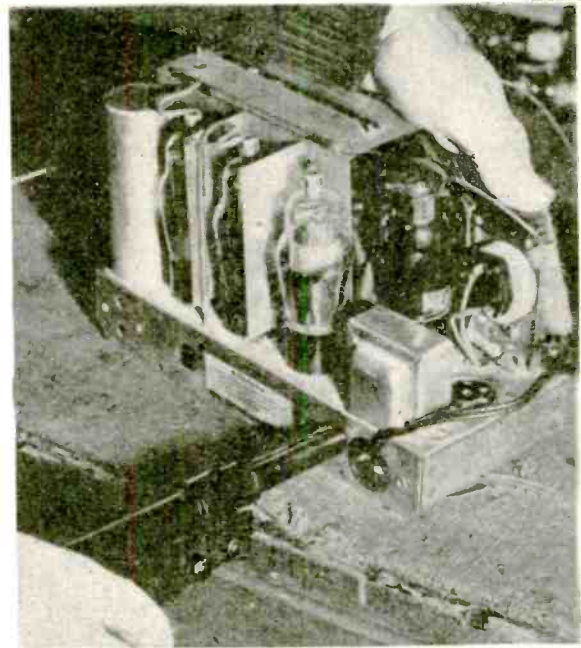
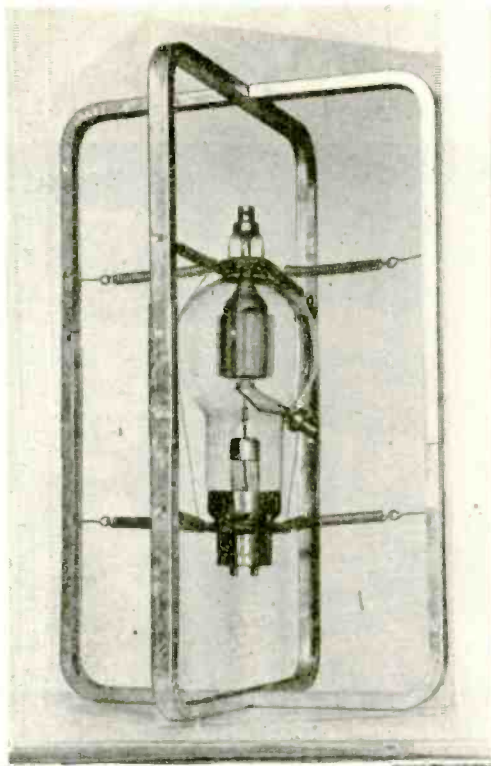

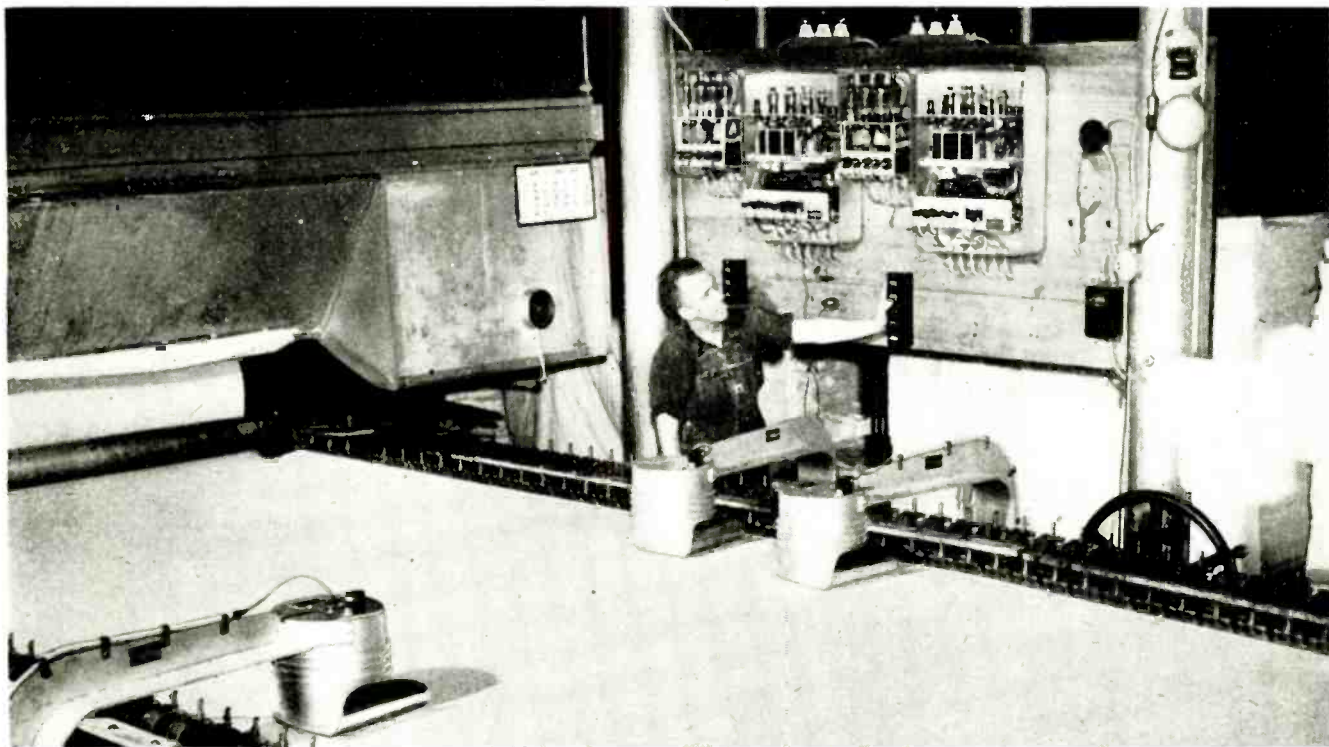

Electronic control equipment for weft straightening as used in the textile industries. The main control is in the background with operator ready to start the mechanism manually. Tenter, with scanning mechanism in place appears in the foreground

WHERE TO FIND SPECIAL INFORMATION ON

Electronic Uses in Industry

by W. C. WHITE

Electronic Laboratory
General Electric Company, Schenectady, N. Y.

● The following list of references supplements those published in the June, 1943, and February, 1944, issues of "Electronic Industries." This list has been prepared by the author from the many hundreds of articles published during 1944 as probably being of greatest interest to readers. Articles on electron tubes and electronic applications were more numerous during 1944 in comparison with 1943 and this is reflected in the greater number tabulated here for 1944.

A special effort has been made to cross index thoroughly so that information on some specific application of electronics can be readily found. Also trade names and coined names of electron tubes or electronic devices have been included in the index wherever possible so that when a strange name is encountered in this field its significance may be determined.

No attempt has been made to include publications in the field of

SUBJECT INDEX

To assist in locating references to specific subjects, a complete Subject Index has been included with this compilation and may be found on page 184.—Editor

radio communication and entertainment, unless the application was industrial in nature such as, for example, railway operation. References in trade journals have been favored as reflecting the viewpoints of a particular industry or type of business and, therefore, probably using terms and describing methods characteristic of that business. In selecting these references, particular attention has been paid to ones that are more than merely descriptive; that is, ones having diagrams, specific de-

scription of components employed and including engineering aids to application. Preference has also been given to references which include a bibliography so that further study of a particular subject is facilitated. The number of references included under such headings have been weighted to some extent according to current interest. For example, high-frequency dielectric heating and measurement technic are at the present time very active electronic applications.

Some references on subjects closely related to electronic devices, such as sensitive relays and super-sonics, have been included. A few references that appeared in 1943 or earlier have been added to the list either because they were published too late to include in last year's compilation or because they were subsequently brought to the attention of the author and deserve a place in this reference.

Aircraft Operation Applications

1. Electronic Pilot. "Flying," May, 1944; v. 34, pp. 48-49, 158, 160.
2. Fluorescent Lighting of Aircraft Instruments. A. D. Dirksen. "Elec. Engng.," July, 1944; v. 63, p. 247.
3. Aircraft Vibration Analyzer. F. G. Marble. "Electronics," October, 1944; v. 17, p. 98.
4. Gaseous-Discharge Lamps for Airplane Lighting Service. E. W. Beggs. "AIEE Transac.," October, 1944; v. 63, p. 760.
5. A Cathode-Ray Universal Flight Attitude Instrument. F. Postlethwalte. "Electronic Engng.," November, 1944; v. 17, p. 229.
6. Application of Electronics to Flight Control. W. H. Gille and R. J. Kutzler. "AIEE Transac.," November, 1944; v. 63, p. 849.
7. A Continuous-Control Servo System. J. T. McNaney. "Electronics," December, 1944; v. 17, p. 118.
8. Electric Control in Automatic Pilots. C. M. Young, E. E. Lynch and E. R. Boynton. "AIEE Transac.," December, 1944; v. 63, p. 939.

Amplifiers

9. D-C Amplifier Design Technique. E. L. Ginzton. "Electronics," March, 1944; p. 98.
10. A Stable Direct-Coupled Amplifier. G. Robert Mezger. "Electronics," July, 1944; v. 17, p. 106.
11. An Analysis of a Direct-Current Galvanometer Amplifier. D. I. Lawson. "Electronic Engng.," August, 1944; v. 17, p. 114.
12. Triggered Electronic Control Circuits. M. H. Shamos. "Radio-Electronic Engng.," October, 1944; v. 3, p. 22.

Carrier-Current Applications

13. Application of Carrier to Power Lines. F. M. Rives. December, 1943, Supplement to "Elec. Engng., Transac. Section,"; p. 835.
14. Industry Uses of Carrier Current. G. G. Langdon. "Electronic Industries," January, 1944; p. 82.
15. Railroad Traffic Control With Carrier Current. H. W. Richards. "Electronic Industries," February, 1944; v. 3, pp. 114-115, 190, 192, 194, 196.
16. Electronic Communication for Trains. William S. Halstead. "Electronics," August, 1944; v. 17, pp. 102-107, 262, etc.
17. Train Telephone Communication. W. R. Triem. "Ry. Age," Feb. 12, 1944; v. 116, pp. 352-355.
18. Versatile Power Line Carrier System. H. W. Lensner and J. B. Singel. "AIEE Transac.," March, 1944; v. 63, p. 129.
19. Train Telephone Communication. W. R. Triem. "Ry. Mech. Engr.," March, 1944; v. 118, pp. 134-137.
20. Carrier Current System Helps Run "Pennsy." R. R. Gilbert Sonbergh. "Electronic Industries," April 1, 1944; v. 3, p. 96.
21. Carrier Channels Releasing Much-Needed Capacity. G. A. Grimm. "Elec. Wld.," April 29, 1944; v. 121, pp. 1588-1590.
22. Carrier Systems for Radio and Wire Lines. L. G. Erickson and F. W. Lynch. "Electronic Industries," June, 1944; v. 3, p. 96.
23. Carrier Communication to Crane Cabs. M. L. Snedaker. "Electronics," August, 1944; v. 17, p. 112.
24. New Carrier Relaying System. T. R. Halman, S. L. Goldsborough, H. W. Lensner and A. F. Drompp. "AIEE Transac.," August, 1944; v. 63, p. 568.
25. Carrier Telegraph Systems. F. B. Bramhall. "Elec. Engng.," August, 1944; v. 63, p. 283.
26. Power-Line Carrier-Current Communications. P. R. Crooker. "Radio-Electronic Engineering," November, 1944; v. 3, p. 13.
27. FM Carrier Telephony for 230 KV Lines. "Electronics," December, 1944; v. 17, p. 105.

Control Applications

General and Miscellaneous

28. Electronics in Industry. "Westinghouse Engr.," November, 1943; v. 3, pp. 106-110.

29. Designing Electronic Control Devices. W. D. Cockrell. "Mach. Design," January, 1944; v. 16, pp. 140-144.
30. Circuits of Electronic Controls. G. M. Chute. "Elec. Cont.," February, 1944; v. 43, pp. 96, 98, 100, 102.
31. Electronic Turbo Supercharger Control System. W. H. Gille and H. T. Sparrow. "Aero Digest," March 15, 1944; v. 44, pp. 110, 112, 115-116, etc.
32. Electronic Control Maintenance. R. H. Schaaf. "Radio-Electronic Engng.," April, 1944; v. 2, pp. 13-15, 39.
33. Photoelectric Industrial Controls. Harold J. Hague. "Electronics," April, 1944; v. 17, pp. 114-117.
34. Application of Electronic Control. E. H. Vedder. "Asme Transac.," May, 1944; v. 66, pp. 259-264.
35. Theory and Design of Electronic-Control Apparatus. W. D. Cockrell. "Asme Transac.," May, 1944; v. 66, pp. 249-258.
36. Electronic Regulation of Industrial Processes. S. L. Burgwin. "Instruments," June, 1944; v. 17, pp. 328-330, 369.
37. Grid Control of Gas-Filled Tubes. W. D. Cockrell. "Electronics," June, 1944; v. 17, pp. 124-128.
38. Deflection Beam Tube. Paul Glass. "Electronic Industries," August, 1944; v. 3, p. 90.
39. Electronic Controls in Industry. B. R. Cannon. "Radio-Electronic Engineering," August, 1944; v. 3, p. 3.
40. Installing, Maintaining and Servicing Photoelectric Relays — I. E. B. McDowell.

"Elec. Cont.," Sept., 1944; v. 43, pp. 126, 128, 130, 132.

41. Phototube Control of Fluid Flow. Robert C. McNickle. "Electronics," September, 1944; v. 17, pp. 110-113.

Furnaces, Heating

42. Electronic Control for Resistance Furnaces. Harold J. Hague. "Steel," August 14, 1944; v. 115, pp. 106, 108, 152, etc.
43. Flame-Failure Control of Industrial Furnaces. "Electronics," September, 1944; v. 17, p. 152.
44. Laboratory Oven Temperature Control. W. B. Ritchie Agnew. "Electronics," October, 1944; v. 17, p. 108.

In Specific Manufacturing Operations

45. Holding Tension With the Amplidyne. H. W. Poole. "Blast Fur. & St. Pl.," December, 1943; v. 31, pp. 1379-1380.
46. Electronic Control of Gas-Cutting Machines. "Electronics," December, 1943; v. 16, pp. 172, 174, 176, etc.
47. Electronic Control of Gas-Cutting Machines. R. D. McComb. "Weid. Jour.," January, 1944; v. 23, pp. 11-15.
48. Electronics — An Important Aid in the Processing of Steel. Carl J. Madsen. "Steel Processing," January, 1944; v. 30, pp. 25-28.
49. Accurate Sorting of Colored Objects. Leland L. Antes. "Electronics," June, 1944; v. 17, p. 114.
50. Photoelectric Control of Manufacturing Operations. D. Fidelman. "Radio - Elec.

Checking a Thy-mo-trol drive applied to a wire speed control capstan in a wire enameling system. Vacuum tube voltmeter and cathode ray oscilloscope are used in checking circuits

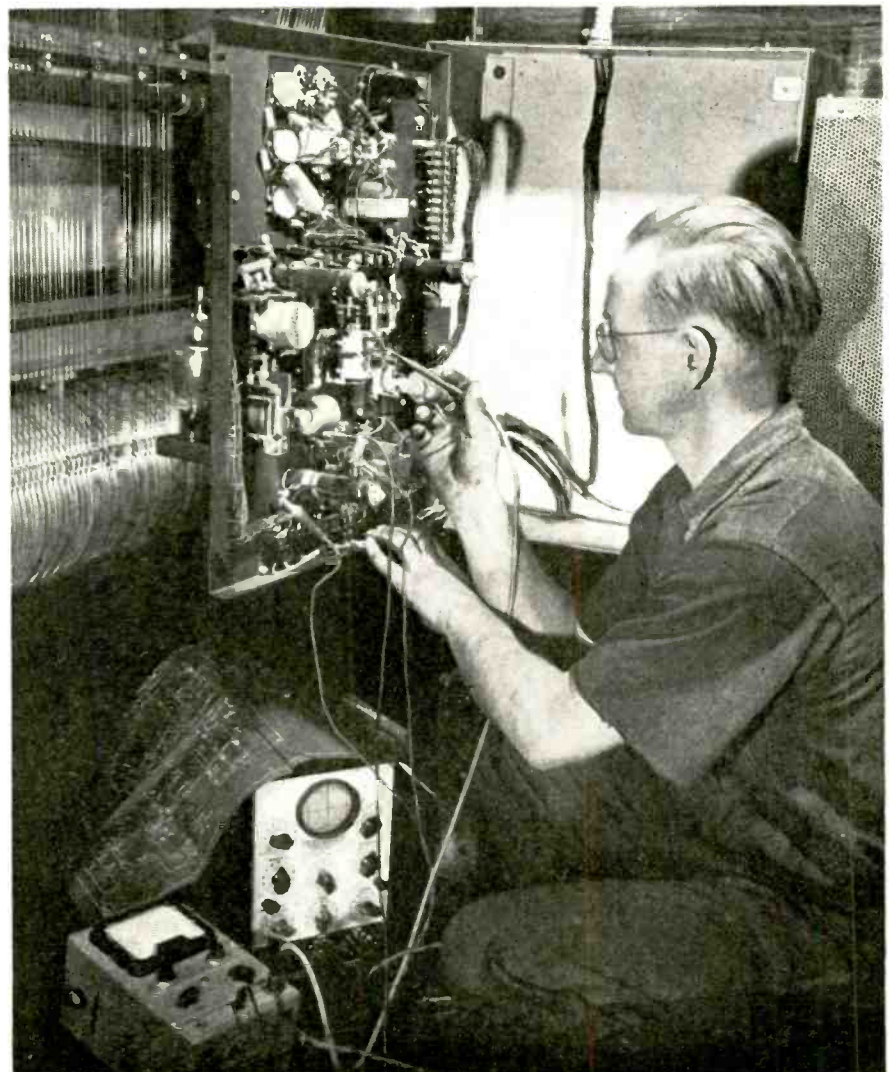

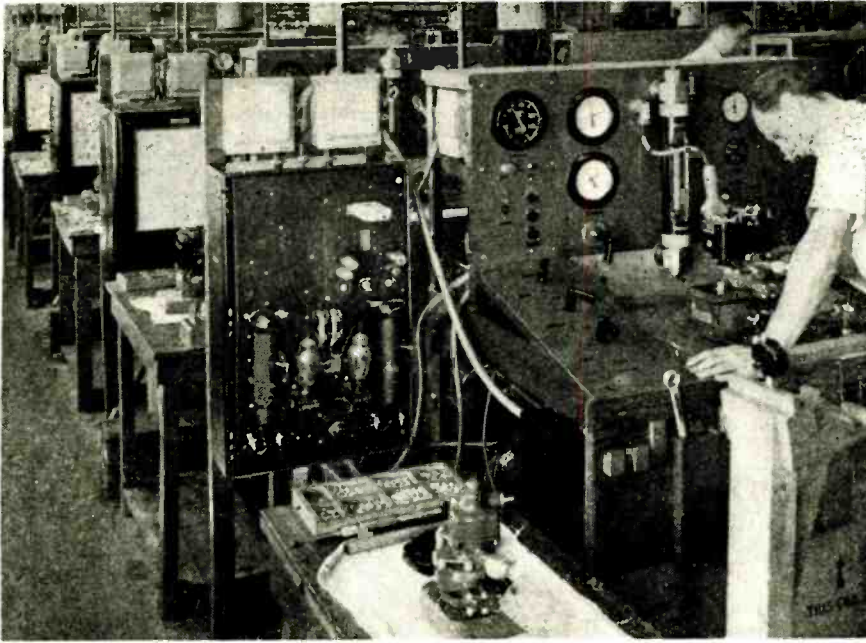

Thy-mo-trol drive used to maintain dc driving motor speed constant regardless of varying load in a set-up designed for the rapid and efficient testing of governors on airplane propellers

tronic Engineering," December, 1944; v. 3, p. 3.

51. Electronic Magnetizer. H. J. Hague. "Electronic Industries," December, 1944; v. 3, p. 96.

Motors

52. Electronic Control of D-C Motors. K. P. Puchlowski. December, 1943, "Supplement to Elec. Engng., Transac. Section," p. 870.
53. All-Electric Versus Electronic Speed Control Systems. J. W. Picking. "Prod. Engng.," September, 1944; v. 15, pp. 586-589.
54. Amplidyne System of Control. E. F. W. Alexanderson, M. A. Edwards and K. K. Bowman. "Proc. IRE," September, 1944; v. 32, pp. 513-520.
55. Electronic Autopilot Circuits. Willis H. Gille and H. T. Sparrow. "Electronics," October, 1944; v. 17, p. 110.

Welding

56. High-Frequency Welding. "Electronic Industries," November, 1943; v. 2, pp. 101, 226.
57. Ignitron Control for Seam-Welding Machines. "Engng.," December 10, 1943; v. 156, pp. 476-480.
58. Resistance Welding. John D. Goodell. "Radio - Electronic Engng.," November, 1944; v. 3, p. 10.

Electron Tube Applications—

General and Miscellaneous

59. Electronics and Post-War Industry. A. C. Montieth. "Edison Elec. Inst. Bul.," November, 1943; v. 11, pp. 337-340.
60. Recovery of Valuable Materials by Electrostatic Separation. Herbert Banks Johnson. "Chem. & Met. Engng.," November, 1943; v. 50, pp. 130-133.
61. Electronics at Work in Industry—I. E. W. Morris. "Elec. West," December, 1943; v. 91, pp. 47-48.
62. The Future of Industrial Electronics. W. J. Noble. "Industry Record," December, 1943; p. 286.
63. Dust-Dipoles-Dielectrics. J. O. Goodell and C. P. McCord. "Radionics," December, 1943; p. 6.
64. Possible Applications of Ultrasonics. A. Behr. "Metal Ind." (Lond.), December 31, 1943; v. 63, p. 422.
65. The Electron Tube; Genie, Gremlin or Jeep? W. D. Cockrell. "Heat., Piping & Air Cond.," January, 1944; v. 16, pp. 16-19.
66. Basic Electronic Circuits and Tubes. C. B.

Stadum. "Prod. Engng.," January, 1944; v. 15, pp. 52-56.

67. Basic Electronic Circuits for Industrial Functions. C. B. Stadum. "Prod. Engng.," February, 1944; v. 15, pp. 92-96.
68. Application of Supersonics. John D. Goodell. "Radio-Electronic Engng.," February, 1944; v. 2, p. 14.
69. Electrostatic Fields. G. W. Birdsell. "Steel," February 7, 1944; pp. 128-129, 168-169.
70. Industrial Applications of Electronics—No. 1. A. G. Turnbull. "Elec. News & Engng.," March 1, 1944; v. 53, pp. 45-48.
71. Some Possibilities of the Electronic Home of the Future. "Electronic Industries," March, 1944; v. 3, p. 268.
72. Powered by Electrons. "Power," April, 1944; v. 88, pp. 215-238.
73. Fundamentals of Industrial Electronics. G. M. Chute. "Steel," April 3, 1944; v. 114, pp. 112-113, 148, etc.
74. Electronics in Industry. C. J. Madsen. "Iron & St. Engr.," July, 1944; v. 21, pp. 76-79.
75. Automatic Map Tracer for Land Navigation. D. J. Faustman. "Electronics," November, 1944; v. 17, p. 94.

Fault, Flaw, Object Detectors, Alarms

76. Electronic Sorting and Testing. "Iron Age," November 4, 1943; v. 152, pp. 57-58.
77. Electronic Testing Method. David Gross. "Steel," December 20, 1943; v. 113, pp. 82-83, 127-129.
78. The Cyclograph. P. E. Cavanagh and E. R. Mann. "Radio-Electronic Engng.," January, 1944; v. 2, p. 14.
79. Electronic Tube Flow Detector. "Radio-Electronic Engng.," January, 1944; v. 2, p. 26.
80. Power Line Fault Locator. W. H. Blankmeyer. "Electronics," January, 1944; v. 17, p. 166.
81. PE Tube Gas Detection. "Electronic Industries," March, 1944; v. 3, pp. 108-109.
82. Electronic Detection of Pinholes. Harold J. Hague. "Steel," March 20, 1944; v. 114, pp. 108, 110.
83. An Electronic Baby Alarm. J. S. Worthington. "Electronic Engng.," April, 1944; p. 476.
84. Crack Detection in Large Metal Castings by Supersonic Waves. Messrs. Behr and Shrayber. "Jour. Applied Physics," May, 1944; v. 15, p. 457.
85. Supersonic Inspection Methods. B. A. Andrews. "Electronics," May, 1944; p. 122.

86. Detecting Fire at Sea. "Electronics," July, 1944; v. 17, p. 125.
87. Fluorescence Aids Mining. H. T. Plumb. "Elec. Engng.," July, 1944 v. 63, p. 243.
88. Uses Limited Signal Current in Thyratron Fault Locator. Lawrence E. Kline. "Elec. Wld.," September 2, 1944; v. 122, pp. 66-68.
89. Electronic Protective Systems. Maxwell H. A. Lindsay. "Elec. Engng.," October, 1944; v. 63, p. 367.
90. Two-Million Volt X-Ray Tube. "Electronic Industries," November, 1944; v. 3, p. 79.
91. Location of Line Faults. M. A. Honnell. "Electronics," November, 1944; v. 17, p. 110.
92. Electronic Life Detector. Leslie W. Orton. "Radio News," November, 1944; v. 32, p. 70.

High-Frequency Heating

General and Miscellaneous

93. Theory and Practice of Industrial Electronic Heating. J. P. Jordan. "General Electric Review," December, 1943; v. 46, pp. 675-683.
94. Operating Experience With HF Heating. Henderson C. Gillespie. "Electronic Industries," February, 1944; v. 3, pp. 80-83, 158, etc.
95. High-Frequency Heating. R. R. Baker and C. J. Madsen. "Paper Trade Jour.," August 24, 1944.
96. Electronic Heating Design Chart. C. V. Fields. "Electronics," April, 1944; v. 17, pp. 143-144, 395-396.

Dielectric—General and Miscellaneous

97. Electronic Heating of Nonconductors. G. C. Nonken. "Paper Trade Jour.," February 24, 1944; p. 23.
98. Electronic Dehydration of Foods. V. W. Sherman. "Electronics," February, 1944; v. 17, pp. 94-97.
99. Electronic Cooking and Sterilization of Foods. "Electronics," July, 1944; v. 17, p. 150.
100. Electronic Vulcanizing of Tires for Army Trucks. "Electronics," August, 1944; v. 17, p. 148.
101. Dielectric Heating of Tire Cord Sets Twist. "Electronics," September, 1944; v. 17, p. 148.

Dielectric—Plastics

102. High-Frequency Heating for Plastics; an Explanation of Its Principles and Uses. "British Plastics," November, 1943; v. 15, pp. 322-326.
103. High-Frequency Heating of Plastics. John Dale Morrison. "Radionics," December, 1943; v. 1, pp. 3-5, 30-31.
104. R-F Heating of Plastics. Eugene Mittelmänn. "Radio-Electronic Engng.," May, 1944; v. 2, pp. 3-6, 35.
105. Progress in Heatronic Molding. V. E. Meharg and A. P. Mazzucchelli. "Modern Plastics," June, 1944; v. 21, pp. 108-113, 160, 162.
106. Short Waves and Transfer Molding. J. P. Moran and G. P. Bohrer. "Modern Plastics," June, 1944; v. 21, pp. 116-118, 166, 168.
107. Electronic Heating of Plastic Preforms. "Electronics," August, 1944; v. 17, p. 146.
108. Automatic Tuning System for Preheating Plastics. R. W. Gilbert. "Electronics," December, 1944; v. 17, p. 115.

Dielectric—Wood Products

109. Heat-Conduction Problems in Presses Used for Gluing of Wood. George H. Brown. "Proc. IRE," October, 1943; v. 31, pp. 537-548.
110. Radio-Frequency Heating Applied to Wood Gluing. R. A. Bierwirth and Cyril N. Hoyer. "Proc. IRE," October, 1943; v. 31, pp. 529-537.
111. Radio-Frequency Gun for Spot-Gluing Wood. John P. Taylor. "Electronics," November, 1943; v. 16, pp. 106-111, 310.
112. R-F Heating Sets Glue in Laminated Aircraft Spars. J. P. Taylor. "Electronics," January, 1944; v. 17, p. 96.
113. R-F Heating of Aircraft Spars and Gas Tanks. "Electronics," February, 1944; v. 17, pp. 150, 152, 154, 156, 158.

- 114. Electronic Processing of Plastic Bonded Molded Plywood. "Aero. Digest," February 15, 1944; v. 44, pp. 104, 106, 108, etc.
- 115. R-F Heating for Fabricating Wood Aircraft. J. P. Taylor. "Electronics," March, 1944; v. 17, p. 108.
- 116. Fabricating Wood Aircraft "Skins." John P. Taylor. "Electronics," April, 1944; v. 17, pp. 102-107, 391-392.
- 117. Plywood and Plastics. W. Nichols. "Flight," April 6, 1944; v. 45, pp. 371-374.
- 118. Radio-Frequency Technology in Wood Application. G. F. Russell and J. W. Mann. "ASME Transac.," August, 1944; v. 66, pp. 563-567.

Induction—Electromagnetic

- 119. H-F Electrothermics in the Technology of Light Metals. B. J. Brajnikoff. "Lt. Metals," December, 1943; v. 6, pp. 615-618, 620-621.
- 120. Coil Design for Successful Induction Heating. Frank W. Curtis. "Am. Mach.," December 9, 1943; v. 87, pp. 83-86.
- 121. Developing an Induction Heating Machine. William Tuerck, Jr. "Mach. Design," January, 1944; v. 16, pp. 137-139, 194.
- 122. High-Speed Soldering With Radio-Frequency Power. J. P. Taylor. "Electronics," February, 1944; v. 17, p. 114.
- 123. Electronic Heating. R. A. Whiteman. "Radio - Electronic Engng.," February, 1944; v. 2, p. 6.
- 124. Electronic Tin Fusion. H. C. Humphrey. "Proc. IRE," February, 1944; p. 61.
- 125. Industrial Applications of Induction and Dielectric Heating. Charles A. Scarlott. "Elec. News & Engng.," March 1, 1944; v. 53, pp. 40-42, 48.
- 126. Induction Heating Serves to speed Production. M. P. Vore. "Prod. Engng.," March, 1944; v. 15, pp. 182-184.
- 127. Electronic Heat Dries Paint Coatings "Ind. Fin.," April, 1944; v. 20, pp. 36, 38, 40, 42.
- 128. Coupling Methods for Induction Heating. Wesley M. Roberds. "Electronic Industries," April, 1944; v. 3, pp. 80-83, 174, etc.
- 129. Case Studies of Typical Induction Heating Jobs. "Electronic Industries," May, 1944; v. 3, p. 110.
- 130. If You Are Designing An Induction Heating Product. Charles R. Underhill. "Elec. Mfg.," June, 1944; v. 33, pp. 94-96, 196, etc.
- 131. Megacycle Induction Heat for Thin Cases. V. W. Sherman. "Metals & Alloys," June, 1944; v. 19, pp. 1409-1414.
- 132. High-Frequency Induction Heating. G. E. Shaad. "Iron & St. Engr.," June, 1944; v. 21, pp. 66-73, 88.
- 133. Heating of Nonmagnetic Electric Conductors by Magnetic Induction Longitudinal Flux. R. M. Baker. "Elec. Engng.," June, 1944; v. 63, p. 273.
- 134. H-F Heating Oscillators. W. C. Rudd. "Electronic Industries," July, 1944; v. 3, pp. 96-97, 202, 204.
- 135. Surface Hardening of Metals. H. C. Gillespie. "Electronics," July, 1944, v. 17, p. 102.
- 136. Induction Hardening of A. P. Shot. Thomas E. Lloyd. "Iron Age," July 6, 1944; v. 154, pp. 58-60.
- 137. High-Frequency Generators for Fusion of Tin Plate. H. G. Frostick. "Steel," July 31, 1944; v. 115, pp. 90-92, 94.
- 138. Efficiency of Induction Heating Coils. George H. Brown. "Electronics," August, 1944; v. 17, pp. 124-129, 382-385.
- 139. Design of Electronic Heaters for Induction Heating. J. P. Jordan. "Proc. IRE," August, 1944; v. 32, pp. 449-452.
- 140. Practical Aspects of Induction Heating. Wesley M. Roberds. "Iron Age," August 24, 1944; v. 154, pp. 50-55.
- 141. High-Frequency Induction Heating. H. E. Somes. "Edison Elec. Inst. Bul.," September, 1944, v. 12, pp. 285-288.
- 142. Some Peculiarities of Heating Steel by Induction. G. I. Babat. "Jour. Applied Physics," December, 1944; v. 15, p. 835.

Measurements, Recorders, Instruments, Testing

General and Miscellaneous

- 143. Ionization Gage. "Rev. Sci. Instr.," December, 1943; p. 377.
- 144. Electronic Instrumentation in the Textile Industry. S. T. Herr. "Instruments," January, 1944; p. 50.
- 145. A Pirani Vacuum Gage (For Much Lower Pressures Than Usual: Its Usefulness: Point of Inflection Found to Occur in Calibration Curves for Tungsten Filaments). Mukerji. "Sci. & Culture" (Calcutta), January, 1944; v. 9, pp. 303-304.
- 146. Process Control Methods for Industrial Uses. Ralph R. Batcher. "Electronic Industries," February, 1944; v. 3, pp. 110-111, 172, 174, 176.
- 147. Process Control Methods for Industrial Uses. R. R. Batcher. "Electronic Industries," April, 1944; v. 3, p. 94.
- 148. Discharge Tube as a Pressure Gage. J. Yarwood. "Electronic Engng.," April, 1944; v. 16, pp. 461-463.
- 149. Photoelectric Dimension Gage. A. Edelman. "Electronic Industries," May, 1944; v. 3, p. 96.
- 150. Measuring Distance With Reflected Waves. Ernst Norman. "Electronics," July, 1944; v. 17, p. 198.
- 151. Measurement of High Vacuums. H. H. Zielinski. "Electronics," July, 1944; v. 17, p. 112.
- 152. Fish Talk. "Electronics," August, 1944; v. 17, p. 115.
- 153. Magnetic Inspection of Bolts and Castings. "Electronics," September, 1944; v. 17, p. 150.
- 154. Precision Leveling. Paul Bennett. "Electronic Industries," October, 1944; v. 3, p. 92.
- 155. Earthquake Recorder. "Electronic Industries," October, 1944; v. 3, p. 98.

- 156. Weather and War Above the Clouds. W. R. Thickstun and M. L. Blanc. "Radio News," November, 1944; v. 32, p. 25.
- 157. Differentiating and Integrating Circuits. James G. Clark. "Electronics," November, 1944; v. 17, p. 138.
- 158. Electronics in Instrumentation. H. D. Middel. "General Electric Review," November, 1944; v. 47, p. 9.

Cathode-Ray Oscilloscope Operation

- 159. Some Unusual Applications of the Cathode-Ray Oscillograph. G. N. Patchett. "Electronic Engng.," Part 1—October, 1943, p. 195; Part 2—February, 1944; p. 378.
- 160. Industrial Applications of the Oscilloscope. Guy Dexter. "Radio News," November, 1943; v. 30, pp. 40-41, 66, 69.
- 161. Photography of Cathode-Ray Tube Traces. N. Hendry. "Electronic Engng.," January, 1944; v. 16, pp. 324-326.
- 162. Photographing Patterns on Cathode-Ray Tubes. Rudolph Feldt. "Electronics," February, 1944; v. 17, pp. 130-137, 262, etc.
- 163. Wide-Band Oscilloscope. E. H. Bartelink. "Electronics," February, 1944; v. 17, pp. 122-125.
- 164. Recording of High-Speed Transient Phenomena by the Hot-Cathode, Glass Bulb, Cathode-Ray Oscillograph. W. Nethercot. "Electronic Engng.," February, 1944; v. 16, pp. 369-371.
- 165. Some Unusual Applications of the Double Beam Cathode-Ray Oscillograph. G. N. Patchett. "Electronic Engng.," April, 1944; v. 16, pp. 467-468, 470.
- 166. Cathode-Ray Tube Traces. Part 1. Hilary Moss. "Electronic Engng.," June, 1944; p. 21.
- 167. Cathode-Ray Tube Traces. Part 2. Hilary Moss. "Electronic Engng.," July, 1944, p. 65.

(Continued on page 172)

(General Subject Index Appears on page 184)

Scanning head installed on Republic Steel Corp. 40-in. electrolytic cleaning and shearing line for tin plate for the detection and automatic marking of defects resulting from pin holes

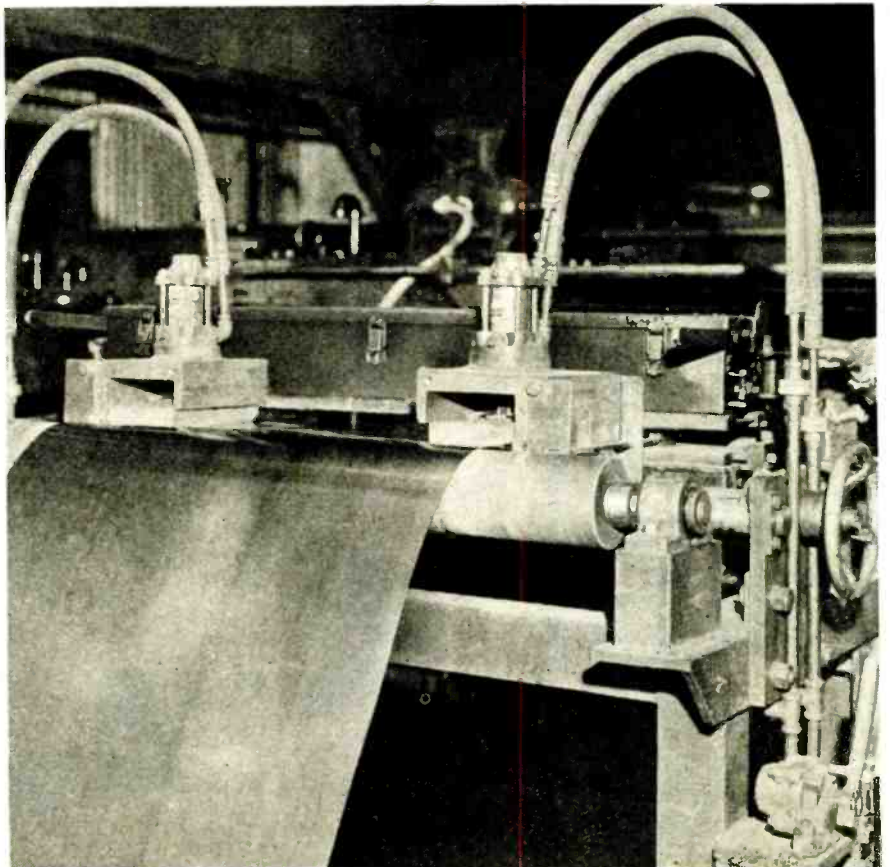

OWI MOBILE RECORDER

Ruggedly built, air-conditioned truck contains complete equipment for record cutting remote from ac supply lines

● Engineers and technicians of the Office of War Information in New York have designed, and recently completed construction of a mobile recording studio that is serving a wide variety of purposes in providing recorded material useful in the international short-wave broad-

casting of the organization. The equipment, which may be operated from available 110-volt 60-cycle lines, or from its own gasoline engine-driven 1-kw generating plant, is mounted in a considerably rebuilt GMC 1½-ton high speed delivery truck.

the orthacoustic type providing high fidelity recording, flat from 50 to 10,000 cycles.

There are a number of unusual features of the truck itself. It has been equipped with special shock absorbers for better protection of the equipment, and has a heavy steel floor and sidewall plates to serve as a firm foundation for lathes, the console, parts cabinets and the like. The body has been insulated with a 2 in. thickness of spun glass, contains a gasoline heating system, and a ventilating system. All equipment is on Korfund vibration mounts bolted to steel plates.

Dubbing facilities

For recording there are two RCA 73AX lathes equipped with automatic equalizers and a vacuum system for thread removal. They are equipped with RCA universal playback arms used for testing and dubbing. The lathe motors and cutting heads are controllable from the console so that complete dual recording, or such mixing as may be required, can be handled by one operator.

Principal purpose of the equipment is to put on 16-inch discs much material that would otherwise be inaccessible but is nevertheless highly desirable for broadcast. The truck is taken to various Army camps, for example, for interview service, and for the recording of band concerts, musical shows, etc. Two types of records are cut — masters which are processed and pressed for shipment abroad, and acetate discs which are broadcast from OWI facilities in New York. The equipment is all of

The lathes are mounted in a unique fashion. The Lord mounts which hold them are fastened to heavy wood cases which normally carry 300 blank 16 in. discs thus providing considerable stabilizing weight which helps to damp out vibration. The wooden cases in turn

Looking in from the wide door at the back reveals the modified 25A WE console which provides complete remote control facilities as well as a phantom phone line and control over the RCA 73AX lathes just back of the driver's seat. Microphone stands are carried at right



AC and mike line connections are plugged into enclosed switchboard at rear of the truck which is completely air conditioned and ventilated



FOR DETACHED SERVICE



This close-up view was made through the windshield and shows arrangement of the two RCA recording lathes, with the operator in normal position seated at the console controls. Right, below, is a view showing the insulated well holding the 1 kw motor-generator set

are carried in Korfund mounts bolted to the steel floor.

The console is a Western Electric 25A that has been modified for this particular service. The two channels have been separated so that either may be used alone (in case of trouble in one, for example) or both can be used at once. The equipment handles four microphones and two telephone lines. It has a remote mixing turret and phantom 'phone line so that there is complete communication between the truck and remote operators at all times and proper mixing can be effected from any distance. The remote mixer is an RCA model OP5 and is mounted in a removable unit in the compartment appearing above the motor generator set.

Two amplifiers are carried in this same cabinet. They are Langevin model 101A units of 50-watt capacity and have been modified with orthacoustic feedback compensation and complete metering facilities. The cabinet also provides a sponge rubber protected compartment for storing the microphones, cutting heads, spare tubes and other delicate parts. The mikes are two RCA model 44BX and two model 77, all of the ribbon type, and two

model 88, the standard dynamic type.

The motor generator plant consists of a Pioneer 1-kw 110-volt 60-cycle generator direct connected to a Wisconsin gasoline engine. The unit is carried on Korfund mounts in a double rockwool insulated steel case mounted below the floor at the rear and provided with forced air ventilation. The engine is equipped with a Maxim silencer and noise reduction has been so effective that it is possible to record 10 feet from the truck without interference.

The gasoline engine is started and stopped by push button control through relays which operate to connect the three heavy duty Willard batteries to the generator and cause it to function as a motor to start the engine. Thereafter operation is entirely automatic, voltage and frequency being indicated on meters mounted in the panel that serves as the door to the bus bar and relay compartment. For operation from available service lines, up to 2000 ft. of cable, carried on reels, can be plugged into a miniature switchboard covered by a steel door at the rear on the right side. The same switchboard also contains receptacles for the microphone and 'phone line plugs.

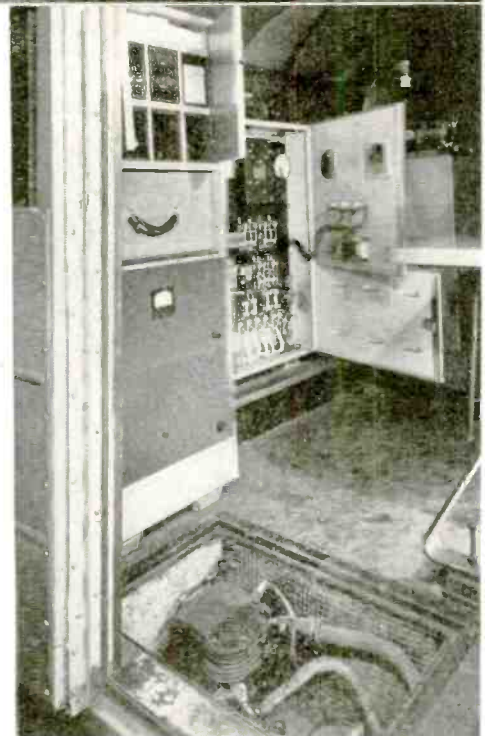

The whole vehicle has been quite ruggedly built. All internal wiring is in conduit sealed with Glyptol, and all doors have been made waterproof so that the truck can operate under any and all weather conditions.

TUBES ON THE JOB

X-Raying Rocket Fuel

Rocket fuel is extruded in solid form. Any voids in the rocket sticks mean loss of range, uneven propulsion of the shell, and other faulty operation. Special x-ray equipments are being used to detect those voids.

The x-ray sets themselves are not unusual, being virtually standard Westinghouse 220-kv factory inspection-type sets. But the hazardous nature of the product required they be provided with an unusual enclosure. This is a lead-lined chamber equipped with a sensitive temperature indicator and photoelectric tube that turns on a veritable flood of water from nozzles should a jet stick start to burn. The chamber is provided with lead diaphragms that blow outward on any sudden build-up of internal pressure. The operator positions about the x-ray chambers were chosen to permit unrestricted escape through the emergency exit doors of the building should an accident occur.

The x-ray inspection of the rocket fuel is essentially automatic. Small carriages with the stick lying directly on x-ray plates are passed into the chamber through a door on

one side. The lead-lined doors close automatically, the exposures are made, and the door on the opposite side opens automatically for the removal of the carriage.

P-E Controlled Lens Coating

Greater transparency for the lenses of eyeglasses, cameras, television projectors, field glasses, telescopes, microscopes and other instruments after the war will result from electronically controlled lens coating processes now in use to increase the efficiency of optical elements in Army and Navy devices.

Apparatus developed by RCA has been used for the past two and one-half years to produce monomolecular coatings of special chemical films which increase the transparency of the glass by reducing its tendency to reflect light. A photoelectric reflection meter controls the critical thickness of the films, and another electronic device measures the vacuum, which has a bearing on their hardness.

The low reflection coatings consist generally of a single layer of magnesium fluoride which is de-

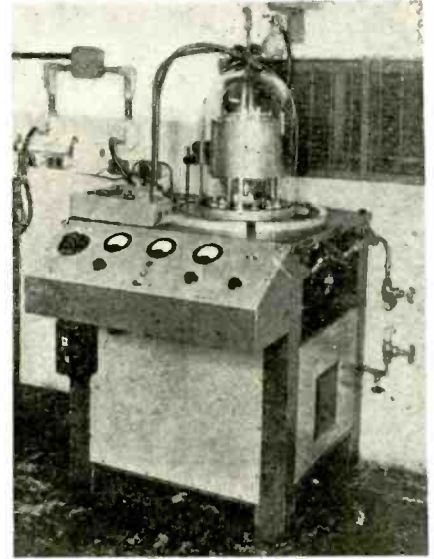

Complete set-up for evaporating monomolecular coatings onto lenses, using electronic vacuum gage and photoelectric determination of spectral reflection minima

posited on each surface of the lens that comes in contact with the air. This film is applied by evaporating chemically pure magnesium fluoride powder in a vacuum bell jar, so as to bring the magnesium fluoride vapor in contact with the lens surfaces under low pressure conditions. A baking operation is then carried out within the jar by means of radiant heaters.

A conventional electron multiplier tube in a photoelectric circuit is used to measure the diminishing amount of reflected light from the lens, thus enabling the operator to stop the coating operation exactly when the proper thickness of film—about five-millionths of an inch—has been attained.

Wright Field Adopts Electronic Tire Repairing

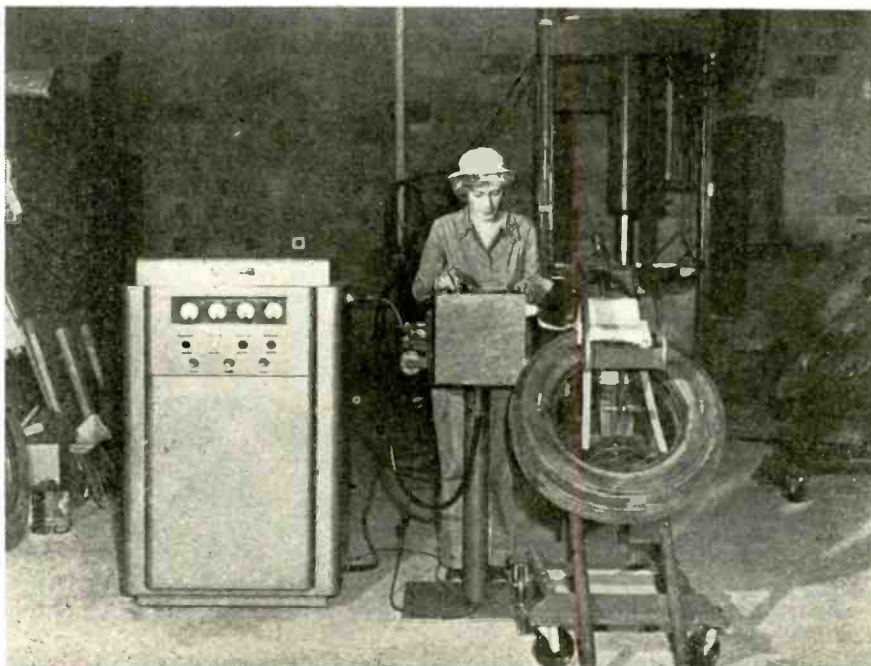

WAC Corporal Arvella Nelcey, with the Air Technical Service Command at Wright Field helps to extend the life of damaged truck tires by electronic heating methods. Many kinds of vulcanizing can be done in a fraction of the time required by conventional steam installations. The electronic heater that supplies high frequency energy for the vulcanizer, was developed especially for the purpose by the research and engineering laboratories of North American Philips Co., Inc., of New York

Color Standardization

Substantial progress in the scientific work of the Research Associate, established by the Textile Color Card Association of the United States at the National Bureau of Standards, has been reported.

The report states that the scientific program of accurate color identification and standardization includes the measurement by the photoelectric recording spectrophotometer of the curves of each of the 216 colors contained in the association's ninth edition of its standard color card. When the data have been assembled, it will be printed in booklet form and placed at the disposal of the Government and industry.

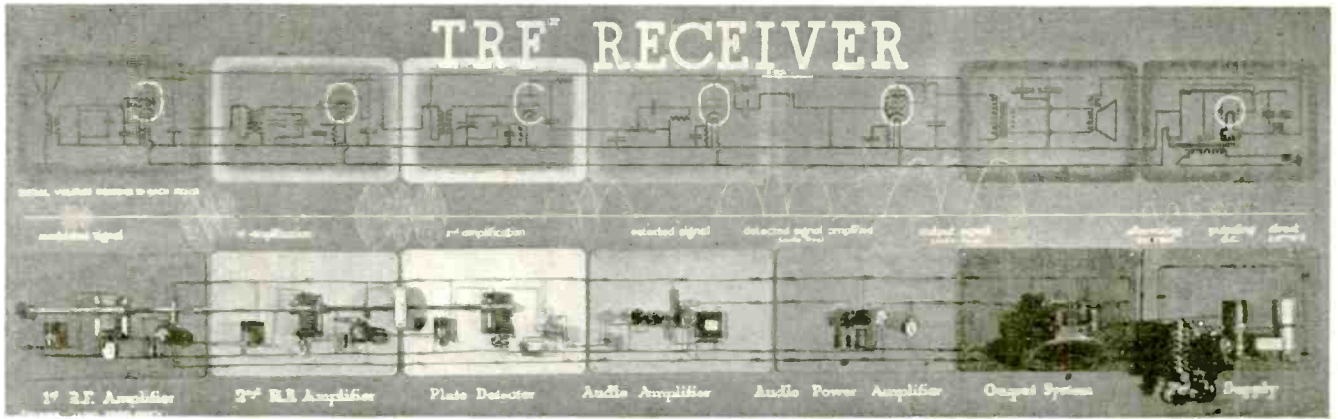

NAVY'S "TECH" SCHOOL

Working from 5 AM to 11 PM six days a week for 10 months trainees receive equivalent of a technical college course

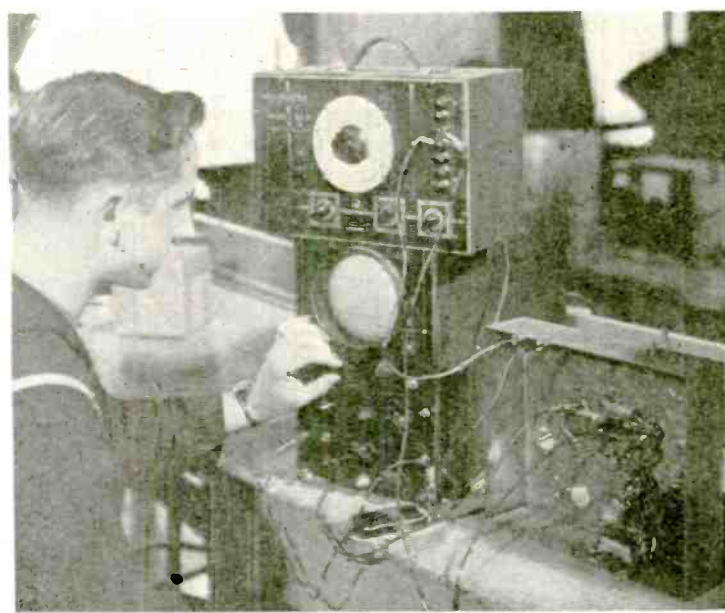

Radio Chicago, largest of Naval Training Schools, intensively trains inexperienced personnel to become experts in the operation and maintenance of any and all radio and radar equipment used by the Navy afloat or ashore at home or abroad. These are some of the instruction labs and shops

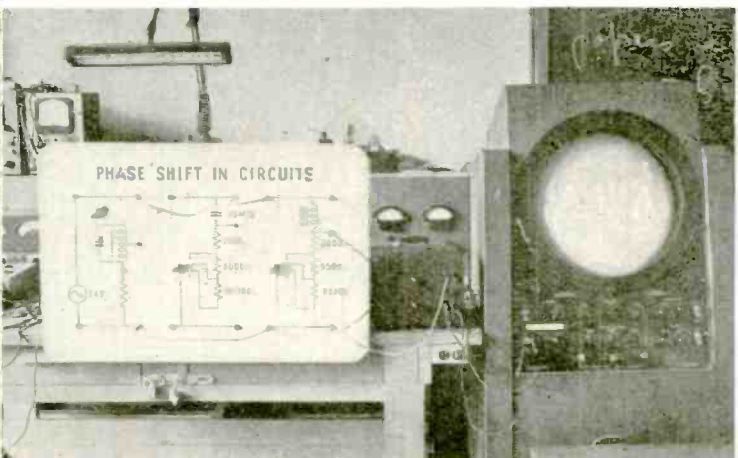

→
 One of two emergency FM transmitter-receiver units used to bridge gaps which may occur in the railroad telephone lines due to storms, etc. Receiver and transmitter are on different frequencies, inversely matched to frequencies at other end of gap. The equipment may be set up and left in automatic operation providing a two way radio link until the defective section of telephone line is restored. A recent snowstorm left a 30 mile gap in the lines, but use of the emergency units provided contact indistinguishable from that of the wire circuits. Power is obtained from gasoline driven generator or any handy 110 volt ac line



Central control station at base of 90-ft. tower which carries coaxial antenna. This Motorola unit has facilities for remote control, including a line equalizer to correct frequency distortion of telephone lines. On top shelf, 50 watt multiple crystal controlled transmitter at left, receiver at right.

ROCK ISLAND RR RADIO

Highlights of two way, 30-40 mc Motorola FM in Blue Island Yards of Rock Island Lines at Chicago

Middle shelf contains remote relay and equalizer →

▼ Remote control unit at Blue Island Yard being used to issue instructions to engineer in moving locomotive 20 miles away via central control transmitter. Unit is basically an audio amplifier with relaying to switch function from microphone amplifier when transmitting to loud speaker amplifier when receiving. When handset is returned to hook at left, loudspeaker is left in circuit for calls. Handset has "push to talk" button which controls all switching automatically

Engineer in cab of Diesel locomotive. Fifty watt transmitter and receiver visible at lower right. Coordinating lights at top of cab glow white to indicate that a message is on the air, green to indicate that the system is clear, and red to show engineer he should give his reply. Six foot quarter wave whip antenna is on locomotive forward of cab

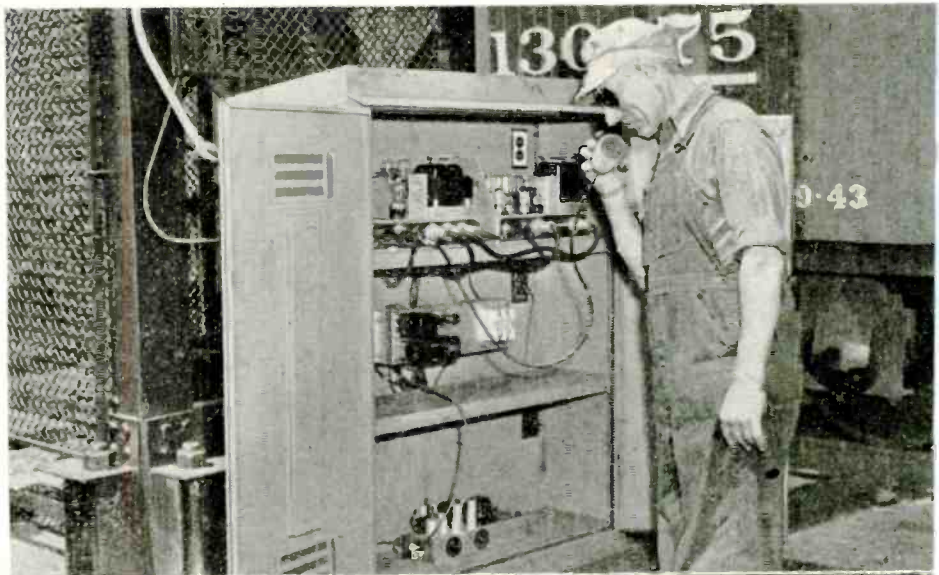

ASSOCIATION NEWS

Postwar Radio Workers Down 39.8%

In one of the first postwar employment surveys made by a large industry, Radio Manufacturers Association reveals that its members expect to employ about 68.6 per cent more people than were employed before Pearl Harbor. Although the industry has expanded its war dollar volume by 1300 per cent, the huge pent up demand for radio will result in a drop of only 39.8 per cent with return to peacetime production. The RMA survey, covering 202 companies representing 64.9 per cent of the industry, shows that these companies expect to employ 145,266 persons during the first postwar year of production, as compared with 86,173 during 1940, and 241,286 in the July-September period of 1944. It is expected that 28.5 per cent of present industry employes will be forced to seek employment in other fields due to cut-backs and the return of former employes now in the armed forces. Probably 23.6 per cent of the men and 27.9 per cent of the women now employed will not seek radio industry work for various reasons after the war. The 145,266 persons who will be needed, postwar, will include 85,799 women.

Calamaras NEDA Ex-Sec.

Effective with the new year, the executive office of National Electronic Distributors Association, located at 2240 LaSalle-Wasker Building, 221 North LaSalle St., Chicago, is to be in charge of Executive Secretary Louis B. Calamaras. Office of Secretary George D. Barbey remains at the Ganster Building, Reading, Pa.

Hiter RMA Director

F. A. Hiter, senior vice-president of the Stewart-Warner Corp., Chicago, has been elected a director of the Radio Manufacturers Association. He takes the place left vacant by the resignation of L. L. Kelsey, formerly with Stewart-Warner, but now with Belmont Radio Corp., Chicago.

RMA Directors Cancel Mid-Winter Conference

Radio Manufacturers Association has called off all its various meetings scheduled for middle of February at the Roosevelt in New York

except a meeting of the Board of Directors, February 21. Abandonment of the "Mid-Winter Conference" is out of deference to requests of the Office of War Mobilization for voluntary reduction in travel and attendance at trade shows and conferences. It appears likely, too, that the proposed trade show scheduled for next June in Chicago, also will be cancelled despite the fact that RMA directors had made the show contingent upon defeat of Germany by April 1. It is probable that the annual RMA "War Production Conference" and annual membership meeting scheduled for June in Chicago will be held, but on a reduced scale.

Conventions and Meetings Ahead

American Physical Society (Dr. Karl K. Darrow, Secretary, Columbia University, New York); Meeting of the Metropolitan Section of New York, February 24, New York.

American Society for Testing Materials (260 S. Broad St., Philadelphia, Pa.); Spring Meeting on Corrosion Prevention, February 28, Hotel William Penn, Pittsburgh, Pa.

Electrochemical Society (Colin G. Fink, Columbia University, New York); Spring Convention, April 12-14, Hotel Claridge, Atlantic City.

Optical Society of America (A. C. Hardy, Massachusetts Institute of Technology); April 12-14, Cleveland, Ohio.

American Institute of Electrical Engineers (H. H. Henline, 29 West 39th Street, New York); North Eastern District Meeting, April 25-26, 1945, Buffalo, N. Y.; Summer Technical Meeting, June 25-29, Detroit, Mich.

Society for Experimental Stress Analysis (W. M. Murray, President; Central Square Station, Cambridge 39, Mass., Post Office Box 168); 1945 Spring Meeting, May, Buffalo, N. Y.

American Society for Measurement and Control (L. Susany, c/o Carnegie Institute, 4400 Forbes Street, Pittsburgh); "Instrumentation for Tomorrow" Exhibit and Conference, September 17-21, William Penn Hotel, Pittsburgh.

Engineers Honor Dunn and Jewett

Dr. Gano Dunn, president of the J. G. White Engineering Corp. and president of Cooper Union, and Dr. Frank B. Jewett, chairman of the National Defense Research Committee, who has just retired as vice-president of A. T. and T., were made honorary members of the New York Electrical Society, Inc., at the 598th meeting of the society, January 10th. Both Dr. Dunn and Dr. Jewett, who are two of the most eminent men in the engineering profession, have been past presidents of the American Institute of Electrical Engineers and past presidents of the National Research Council.

'44 RMA Directory Issued

The membership list and trade directory of the Radio Manufacturers Association has appeared in its 1944 form and as indicating the growth of the organization the new booklet contains some 20 pages more than its predecessor and represents a peak record of 227 member companies. As usual the Directory gives complete data on personnel and products of all member companies. The book is being distributed widely by Executive Vice-President Bond Geddes from association headquarters at 1317 F St. NW, Washington.

MIT-Philco Course in Practical Electronics

Philco Corp. and Massachusetts Institute of Technology will cooperate in providing a professional course in electronics. A selected group of students in the department of electrical engineering at MIT will spend alternate terms at the Institute and at Philco plants, thus combining practical operating technics with "book learning." Plant experience and theoretical training will be integrated. Similar courses have been conducted for more than 25 years in conjunction with General Electric, AT&T, Boston Edison Co., Boston Elevated Railroad and the General Radio Co.

FMBI Moves

FM Broadcasters, Inc., celebrates the new year by occupying new offices. Enlarged quarters are at 1730 Eye St., NW, Washington (6) D. C.

SURVEY of WIDE READING

Electronic news in the world's press. Review of engineering, scientific and industrial journals, here and abroad

Pulse-Time Modulation

E. M. Deloraine and E. Labin (*Electrical Communication*, Vol. 22, No. 2)

Pulse-time modulation consists essentially in the transmission of signals by pulses of constant amplitude and duration, the instantaneous signal amplitude being translated into variation of the time intervals between successive pulses; the rate of this variation then corresponds to the instantaneous frequency of the signal. Short pulses of constant shape, triangles in the ideal case, are used.

With this type of modulation the signal-to-noise ratio improves as the bandwidth is increased, as is also true for frequency modulation but not for amplitude modulation. The required bandwidth is determined by the steepness of the pulses. Repeaters may be added without increasing distortion. The method is recommended for multi-channel radio and coaxial cable transmission systems, uhf broadcasting, and television sound channels.

Remanence of Magnetostriction

M. Kornetzki (*Annalen der Physik*, Leipzig, Vol. 43, No. 1, 1943)

The article contains a study of magnetostriction in polycrystalline, long, thin iron and nickel wires. Particularly, magnetostrictive remanence is investigated, which refers to the change in length compared to the initial condition, upon removal of the magnetic field which caused the change in length.

As will be seen from the table, considerable magnetostrictive remanence was observed on long, thin, soft iron and nickel wires. Hard substances, as exemplified by the hard-drawn nickel wire, theoretic-

ally are expected to have only a small magnetostrictive remanence, which conclusion agrees well with the experiments.

Theory of magnetostriction and its relation to the magnetic properties are treated and explained by processes within the structure of the material. The amount of the magnetostrictive remanence in combination with the magnetic behavior of the material and its change in resistivity under the influence of a magnetic field permit deductions as to the processes within the material which are responsible for these phenomena.

Ground Absorption for Dipole Antennas

A. Sommerfeld and F. Renner (*Annalen der Physik*, Berlin, Vol. 41, No. 1, summarized in *Bulletin des Schweizer Elektrotechnischen Vereines*, No. 8, 1944)

The energy radiated by a dipole antenna is computed for finite ground conductivity. At infinite ground conductivity, all energy is reflected, but at finite conductivity some is lost by absorption. The amount lost depends on the height h of the antenna above ground and on k_1 and k_2 which are defined by the following equations:

$$k_1^2 = \frac{\omega^2}{c^2}, \quad \zeta = 2 h k_1 = 4 \pi \frac{h}{\lambda},$$

$$k_2^2 = \frac{\epsilon \omega^2 + 4 \pi i \sigma \omega}{c^2}, \quad i = \sqrt{-1},$$

$$\sqrt{-k_2^2} = |k_2| e^{i\vartheta}, \quad -\frac{\pi}{2} < \vartheta < 0,$$

where ϵ and σ are the dielectric constant and conductivity of the ground, respectively.

Starting from the differential equation for Hertz' vector, the field components and Poynting's vector for the radiated energy den-

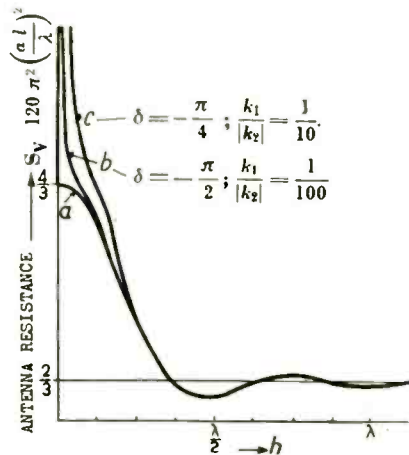

Resistance of vertical antenna as function of distance from ground. (Ordinate scale is calibrated in values of S_v)

sity are derived. The terms in the expression for the radiated energy, which represent the absorption of the ground, are simplified by as-

(Continued on page 164)

Transformation of Electromagnetic Waves

E. M. Studenkov (*Journal of Physics*, Moscow, Vol. VII, No. 6)

In a wave guide, two opposite sides of which are rectangles and the other two sides of which are trapezoids, excited at its large end, standing waves of the H_{01} type may arise. Theoretically, wave length and field intensity increase towards the small end of the guide. Experiments were carried out with a 32 cm wave and good agreement with the expected behavior was observed. The wave guide was 150 cm long, 20 cm wide, and had an angle of flare of 5.5 deg.

When the shape of the cross-section of a hollow wave guide varies, and in the case when it is bent, the

(Continued on page 162)

Material	Treatment	Sample No.	Permeability	Intensity of Magnetization in CGS Units			Relative Change in Length x 10 ⁶			Relative Change in Resistivity x 10 ⁶		
				Saturation I_s	Residual I_r	I_r/I_s	Saturation L_s	Residual L_r	L_r/L_s	Saturation R_s	Residual R_r	R_r/R_s
Electrolytic Iron	Soft (3h in H ₂ at 850°C)	1	320	1690	1240	0.73	-8.1	3.0	0.37	2.7	0.15	0.06
		2	320	1660	1220	0.74	-6.5	3.6	0.55	3.0	0.17	0.057
Electrolytic Nickel	Soft (3h in H ₂ at 900°C)	1	310	500	360	0.72	-35	-13	0.37	24.5	10.5	0.43
		2	310	0.73	-37	-15	0.40	23.0	9.4	0.41
Electrolytic Nickel	Hard	1	14	469	190	0.38	-32	1.5	0.05	19.5	1	0.05
		2	14

*they said
it couldn't
be done . . .*



and again . . .
**THEY SAID
IT COULDN'T
BE DONE . . .**



Hytron's telescoping of receiving tubes to BANTAM GT size was at first considered impracticable. Development of the BANTAM JR. was another impossibility to be proved possible. This first sub-miniature was a tiny tube whose diameter was about that of your little finger — and it was a pentode at that! As a production tube it just didn't seem to make sense.

Encouraged by hearing-aid manufacturers eager to gain the additional sensitivity of the vacuum tube, Hytron sweated it out for two long years. Operators were trained to assemble the minute parts under

magnifying glasses. A simple reversal of the conventional stem made baseless tubes possible. Problems of obtaining suitable vacuum with such small bulbs, were licked.

Finally in 1938, Hytron introduced the first successful sub-miniature. Tiny but rugged despite a hair-like filament and a diminutive mount structure, its low current drain and compactness made the BANTAM JR. a natural for all kinds of portable equipment, hearing aids, and military electronic devices. After the war, watch for even smaller and better Hytron sub-miniatures.



OLDEST EXCLUSIVE MANUFACTURER OF RADIO RECEIVING TUBES

HYTRON
CORPORATION ELECTRONIC AND RADIO TUBES

SALEM AND NEWBURYPORT, MASS.



BUY ANOTHER WAR BOND

WHAT'S NEW

Devices, products and materials the manufacturers offer

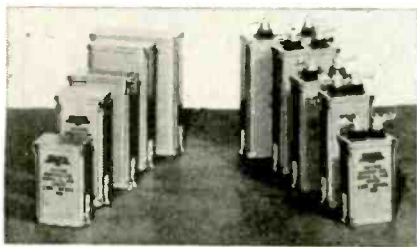

Vibration Mounting

The new M type brackets have been specially developed by Industrial Condenser Corp., 3243 N. California Ave., Chicago, to withstand the most severe vibration conditions encountered by all branches of the armed forces. Designed to permit the mounting of oil capacitors in either vertical or inverted position, they are readily adapted to any industrial application.

Comparison Bridge

The Freed comparison bridge measures resistors, capacitors and inductors by comparison with a standard. The constants are selected so that such components can be measured if they fall within a range extending up to 10 per cent variation from that of the standard used for comparison. The range can be extended to 20 per cent. The bridge is self-contained, operates from 105-125 v 60 cycle ac. The instrument con-

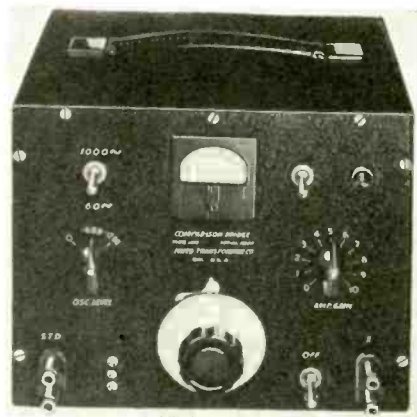

sists of one ac bridge feedback oscillator and vacuum tube voltmeter. A rectifier type voltmeter in conjunction with a calibrated dial indicates the percentage difference between the unknown and the standard. The bridge is supplied with three frequencies: 60, 1000 and 10,000 cycles. It can be used with capacitors from 25 mmf to 20 mf, inductors 5 microhenries to 500 henries, resistors from 10 ohms to 5 megohms. Manufacturer is the Freed Transformer Co., 72 Spring St., New York.

Wire Stripper

A new two-motor wire stripper for cleaning cotton and enamel, silk and enamel, string asbestos and other light insulation from round, flat or rectangular wire, of any length, solid or stranded, has been developed by Ideal Commutator Dresser Co., 5194 Park Ave., Sycamore, Ill. The tool is especially suited for cleaning fine Litz, Formex and Formvar wire and for fiber glass insulation. Two wire cleaning brushes are positively driven; a separate motor-driven dust collector removes strippings.

Power Tube

A new, compact power tube (7-5303) first in a series especially designed for industrial use in high-frequency heating equipment, has been developed by the Federal Telephone and Radio Corp., Newark, N. J.

The tube is supplied with 6 in. flexible copper leads permanently secured to the tube terminals. Rated at 3500 watts input, the tube operates at full ratings at frequencies up to 50 megacycles. Maximum ratings are: dc plate voltage 3500, dc plate current 1.0 ampere, plate dissipation 1200 watts. The filament current is 27.5 amperes at 11 volts. Overall height of the tube is approximately

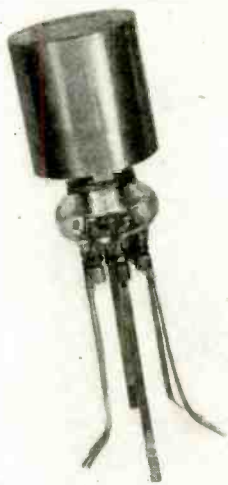

7 in. with a maximum diameter of 3 1/2 in. The F-5303 model is designed for forced-air cooling, but can be supplied for water cooling in model F-5302.

Signal Generator

The new signal generator offered by Radio City Products Co., 127 West 26th St., New York, has a range from 95 kilocycles to 100 megacycles. Fundamental frequencies are continuously variable from 95 kc to 25 mc in 5 bands. Calibration is accurate to 2 per cent band up to the broadcast band and within 3 per cent for high frequency bands. The instrument has a planetary drive condenser with direct reading calibration. Output can be modulated or unmodulated. Self-contained modulation is either 400 cycles or 1,000 cycles sine wave which modulates carrier. Either is available for external use. Protective features are: automatic shorting of all coils not in use; individual shielding of rf circuits, coil assembly and attenuator; overall steel case, chassis and panel. The five step ladder attenuator is used for controlling output.

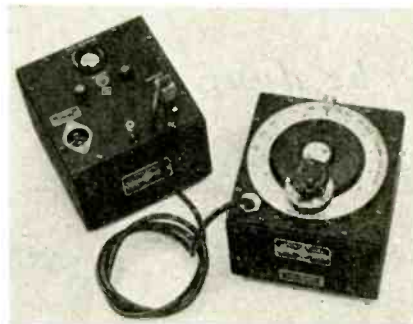

UHF Oscillator

The Type 857-A UHF oscillator manufactured by General Radio Co., 275 Massachusetts Ave., Cambridge 39, Mass., covers a frequency range of 100 to 500 megacycles. Designed for use as a power source for laboratory measurements, its maximum output is 1/2 watt or better over the entire frequency range. The frequency-determining element in this oscillator is a "butterfly," a new type of high-frequency tuned circuit in which inductance and capacitance are varied simultaneously with a single control and no electrical contact to the moving element is necessary. The dial reads directly in frequency with an accuracy of ± 1 per cent. A slow-motion drive is provided. The output circuit is inductively coupled to the oscillator and the output is controlled by varying the coupling. The output terminal is a coaxial jack. Type 857-P1 power supply, supplied with the oscillator, furnishes filament and plate power and operates from a 115- or 230-volt ac line, 42 to 60 cycles. An electron-ray tube is used to indicate oscillation.

Indicating Light

The De Luxe No. 659 D/E indicating light is a shallow-depth unit the overall depth behind the front of the panel to the extreme end and of the insulation barrier being 1 in. It is for single-hole mounting in a 1 1/8 in. diameter hole in panels up to

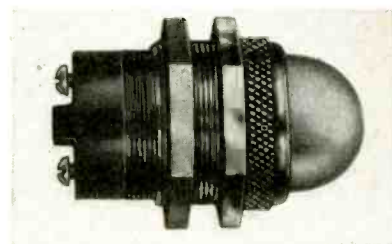

1/4 in. thickness. The screw type lens-cap, which contains the heavy walled glass lens, is removed from the front of the panel and allows for installation and removal of the lamp bulb. As the lamp bulb protrudes well into the cup of the lens, brilliant visibility is effected from all forward angles. The candelabra screw base molded bakelite socket is for use with the S6-120 volt tungsten lamp or the T4 1/2 Neon glow lamp. A 1/4 in. square insulation barrier separates the two 6/23 terminal screws which go directly to the two sides of the lamp contacting members providing a direct-line electrical contact, without the use of solder or a "press-fit" assembly. The maker is H. R. Kirkland Co., Morristown, N. J.

(Continued on page 194)

Precision Calibration Up to 2000 Mc's

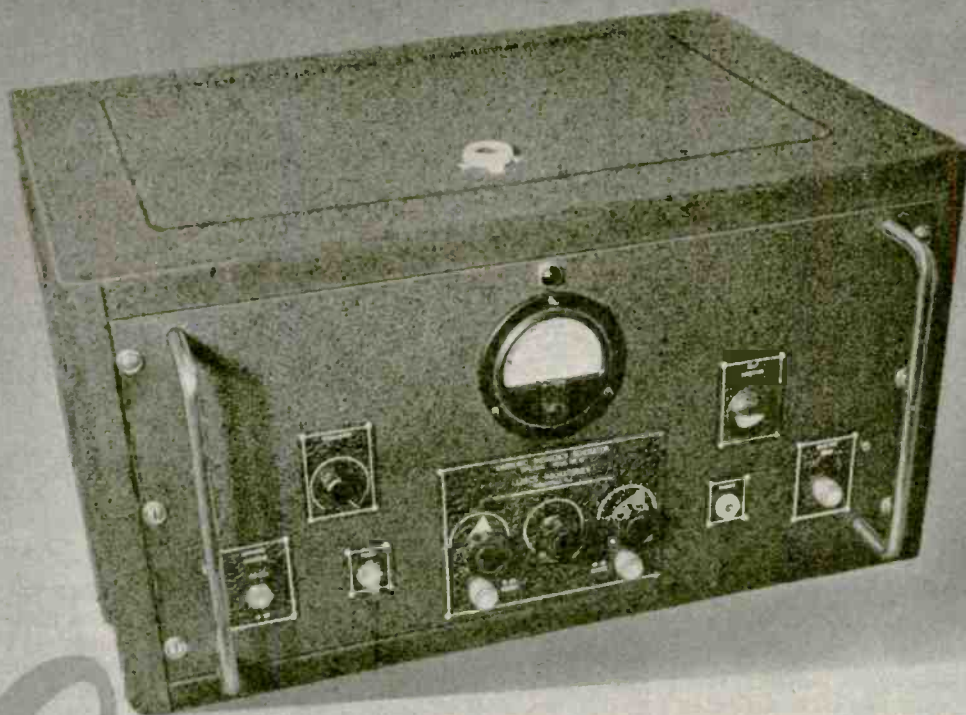

Larvick

HARMONIC FREQUENCY GENERATOR

A big step forward in the **FAST, EASY, ACCURATE** calibration of **RECEIVERS** and **WAVEMETERS**. Suitable also for the calibration of **OSCILLATORS** and **SIGNAL GENERATORS** by means of a Beat Detector built into the instrument.

OUTPUT VOLTAGES in multiples of 10 or

40 megacycles are provided with **CRYSTAL-CONTROLLED** accuracy. Selects 10 or 40 megacycle series by means of a front panel switch. Identifies any **ONE** of these harmonics by means of a **Frequency Identifier*** which provides high attenuation of all voltages except that of frequency to be identified.



* Specify frequency of Identifier wanted.

Larvick Laboratories

RADIO ENGINEERS AND MANUFACTURERS
MORGANVILLE, N. J.

**Specialists in The Development of UHF Equipment
and in The Manufacture of UHF Antennas**

WASHINGTON

★ ★ ★ ★ Latest Electronic News Developments Summarized ★ ★ ★ ★
by Electronic Industries' Washington Bureau

SMALL COMPANIES TO PARTICIPATE IN SURPLUS DISPOSAL—The electronic-radio industry's planning with the government agencies in charge of military surplus disposal is felt to have lived up to the aims of Attorney General Biddle that small companies should have just as much chance as large concerns in the surplus program. The Defense Supplies Corporation, as the agency of the Surplus War Property Board in charge of electronic-communications programs, revealed that about 60 per cent of the companies which have already accepted the government contract to act as agents in the disposal of the surpluses are small companies.

165 MANUFACTURERS HAVE SIGNED UP—To date, around 125 component manufacturers and over 40 end-equipment companies have accepted the DSC contract. The Surplus War Property Board hopes that by the completion of the program the number of component manufacturers will total about 200 and the end-equipment companies will aggregate around 150. The DSC from the beginning of the disposal program had the goal of enrolling the entire industry to act as agents in the disposition of the military surpluses.

OUR INDUSTRY'S MAGNIFICENT JOB—Because it has been filling the bill with great efficiency, the electronic-radio manufacturing industry is receiving deserved "pats on the back" from the Signal Corps leadership as represented by Major General William H. Harrison, from the Navy through Captain Jennings B. Dow and from the War Production Board in statements by Operations Vice Chairman Hiland G. Batcheller and Radio-Radar Division Director Chatten and Acting Director Ray Ellis.

TWO HUNDRED FIFTY MILLION MONTHLY—Even though the sights are fixed at very high levels, the industry is producing at the rate of \$225,000,000 a month at present and is expected to reach the peak of \$250,000,000 a month in March (equivalent to nearly one year's output before the war.) General Harrison in his address awarding the Army-Navy "E" to a major battery producer epitomized the views of the military services when he said the achievements in production and deliveries represented "excellent response to the needs of the services, long hours, meeting of unreasonable demands" and teamwork between management and labor.

ONLY ARMY UNIT TO FULFILL DELIVERIES—When the German offensive commenced its drive with its destructive effects on U. S. and British Army electronic-radio facilities, the U. S. Army Signal Corps rose to the emergency and loaded approximately 50 freight cars with replacement apparatus and equipment immediately. The supplies were rushed to the European theatre—much of it was flown across the Atlantic and large quantities went by the fastest ocean convoy routes.

NOW IT'S NAVY ELECTRONICS DIVISION—Because electronic devices in the fields of naval communication, navigation, ordnance and gunnery tactics and in the general battle efficiency of the Navy's air-

planes and surface ships, the Navy Department has changed the name of its Radio Division in the Bureau of Ships to **ELECTRONICS DIVISION**. Captain Jennings B. Dow, that exceptionally able Navy officer who has headed the former Radio Division since Pearl Harbor and during the days of preparedness, has been appointed Director of Electronics. The Electronics Division counts among its personnel of 1,200 officers, enlisted men and civilians some of the foremost electronic engineers and authorities in the United States.

NAVY EQUIPMENT BEST AMONG ALLIES—Through the careful and comprehensive planning of this division of the Navy and as the result of the full collaboration of the research organizations of government and industry, the electronic, radio, radar and sonar equipment which has been produced for the Navy has proved definitely superior to that of the Axis forces and, as every one in the industry knows, has provided the "edge" contributing to the American victories. Captain Dow stated recently that the accelerated research in the electronic field has advanced the art by at least ten years.

FLEXIBILITY HAS CONQUERED BOTTLENECKS—Ever since the WPB established the Radio and Radar Division, that agency has been noted for its ability to concentrate its staff and efforts speedily on bottlenecks as they have arisen. With this flexibility the Division has in every case speedily conquered. Best illustrations of these results are found in the facts that the industry with which the Division is working has achieved production miracles and even in the present climactic situation has been able to overcome critical labor and materials problems. The Division's man-hour survey of sampling end-product plants and tube plants had proved satisfactory by the end of January and is expected to even off the production load throughout the entire industry through the ascertainment of the man-hour capacity of the respective plants.

MISCELLANY—Louis J. Chatten was resuming the end of January the directorship of the WPB Radio and Radar Division after his recent operation; Acting Director Ray C. Ellis went back to General Motors after having achieved a fine record of accomplishment. . . . The Army Air Forces are tentatively slated to take over procurement of airborne radar and radio equipment from the Signal Corps April 1. . . . New plant facilities for the production of military receiving tubes have been authorized; this will relieve the pressure on the plants which had been participating in the output of civilian home receiver replacement tubes so that probably the quota of the latter deliveries will be maintained; the tube labor situation has been improved with a better classification by WMC for referrals in employment of workers in tube plants. . . . The German offensive brought about a resumption of the equipment "freeze" mandate which has been in existence since shortly after Pearl Harbor.

National Press Building
Washington, D. C.

ROLAND C. DAVIES
Washington Editor

relays

FOR OVERLOAD PROTECTION IN ELECTRIC SHOCK TREATMENTS

Series L Overload Relay

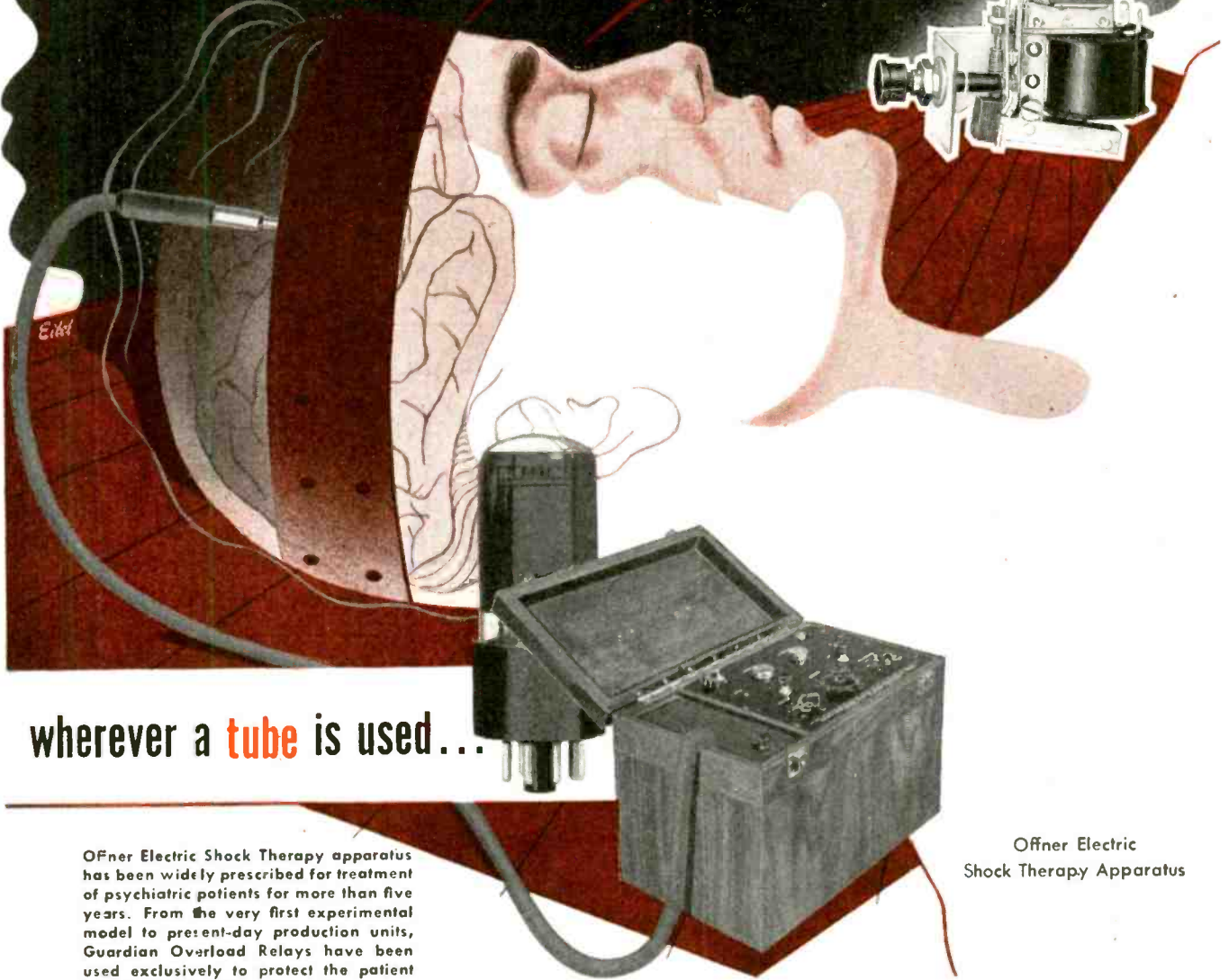

wherever a **tube** is used...

Offner Electric Shock Therapy apparatus has been widely prescribed for treatment of psychiatric patients for more than five years. From the very first experimental model to present-day production units, Guardian Overload Relays have been used exclusively to protect the patient from dangerous current surges.

Offner Electric
Shock Therapy Apparatus

Relays BY GUARDIAN

In certain types of mental disorders it is possible to shock patients back to normal by passing an electric current through brain tissues. Naturally the patient must be protected against the possibility of excessive current surges. Such protection must be positive—dependable. In providing this protection, Guardian Series L Overload Relays have established a perfect record for safe, dependable performance in hundreds of thousands of known treatments.

The Series L Overload Relay provides accurate protection against surges and overloads. Standard coils

attract on 150, 250, 500, or 750 milliamperes; coils for operation on other current values are available on specification.

The large, oversize contacts used on this relay can take severe overloads without damage. They are rated for 1500 watts on 110 volt non-inductive A.C. and in A.C. primary circuits of any inductive power supply delivering up to and including 1 kilowatt. Contacts lock open and cannot be reset until overload is removed. For further information, write for Series L bulletin.

Consult Guardian whenever a tube is used—however—Relays by Guardian are NOT limited to tube applications, but may be used wherever automatic control is desired for making, breaking, or changing the characteristics of electrical circuits.

GUARDIAN ELECTRIC

1622-B W. WALNUT STREET

CHICAGO 12, ILLINOIS

A COMPLETE LINE OF RELAYS SERVING AMERICAN WAR INDUSTRY

HIGH-SPEED PRODUCTION TESTING . . .

NEW PATENTS ISSUED

Loop Antenna Circuit

A permeability-tuned autotransformer L_1, L_2 couples the loop antenna 1 to the input stage. Due to shunting the loop inductance across the portion L_1 of the tuning coil L_1, L_2 of the input circuit to the radio frequency amplifier tube T, serious mistracking occurs between this first

tunable circuit and the other identical tunable circuits of the receiver.

The invention provides an auxiliary coil L_3 to improve the tracking. Coil L_3 is wound over the autotransformer and is serially connected with coils L_1 and L_2 in such a manner as to provide negative mutual inductance, i.e., in bucking relation.

W. F. Sands, RCA, (F) December 30, 1942, (I) October 3, 1944, No. 2,359,684.

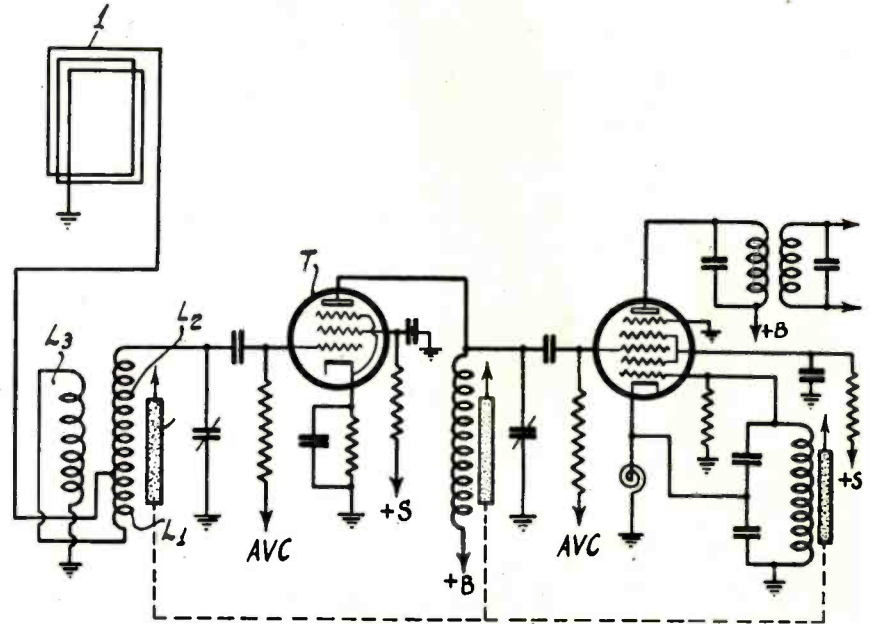

Directional Antenna

Secondary maxima in the radiation pattern of a directional sheet antenna are suppressed by arranging several aerials 11, 12, 13, 14 below one another and staggered with respect to one another in the horizontal direction. By appropriate staggering any desired distribution of current in the antenna surface is obtainable. Anten-

nas 11, 12, 13, 14 may be cylindrical parabola reflectors or sheet radiators made up of dipoles. The diagram shows the improvement in the horizontal characteristic obtained by the vertical staggering.

E. Gerhard, Alien Property Custodian, (F) April 17, 1941, (I) July 25, 1944, No. 2,354,254.

(Continued on page 122)

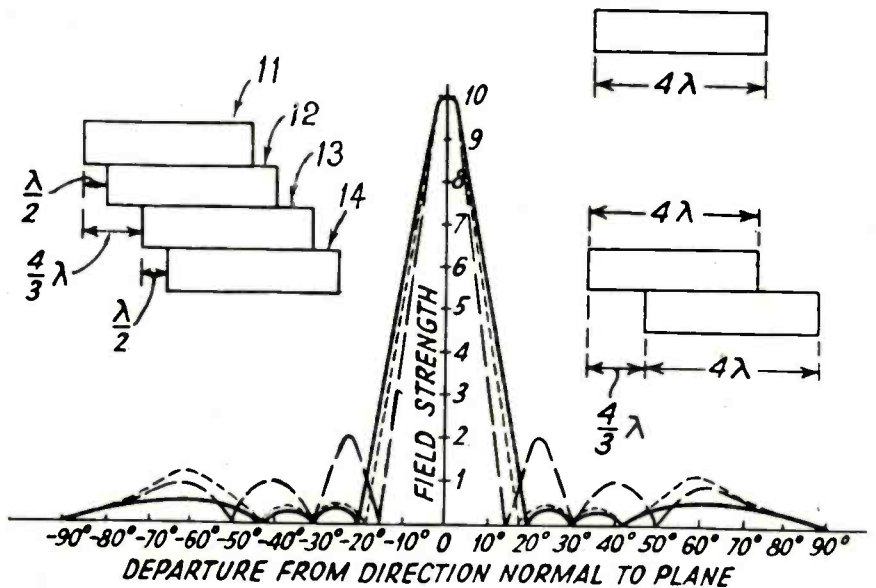

Dashed line gives directional pattern of unstaggered antenna. Dotted line gives directional pattern of two staggered antennas. Full line gives directional pattern of four staggered antennas

Capacitance
Limit Bridge

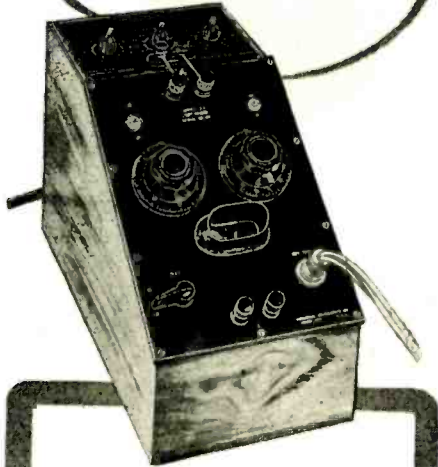

- Normally supplied with Model DK-2AA Decade Capacitor—.001 mfd. steps from .001 to 1.11 mfd.
- Modified Wheatstone Bridge. High and Low limit dials. Uses two "magic eyes" for indicators.
- Self-incorporated switch-operated relays provide for speed test operation, on panel or in test fixture.
- Guaranteed accuracy of plus/minus 1% of standard. Independent of line-voltage fluctuations and tube characteristics.
- Instantaneous indication. Testing speeds up to 1000 condensers hourly.
- Operates from standard 115 V. A.C. Line. 15" x 8" 10" h.

• Model LB-1 Capacitance and Impedance Limit Bridge is designed for high-speed production testing, for conformance with tolerance specs. A companion instrument to Type LB Resistance Limit Bridge. Features are negligible setup time, great flexibility, wide range, accuracy, high speed, extreme ruggedness, moderate cost.

• Bulletin on request . . .

Industrial

PLANT and OFFICES:

17 POLLOCK AVENUE

JERSEY CITY 5, N. J.

Instruments

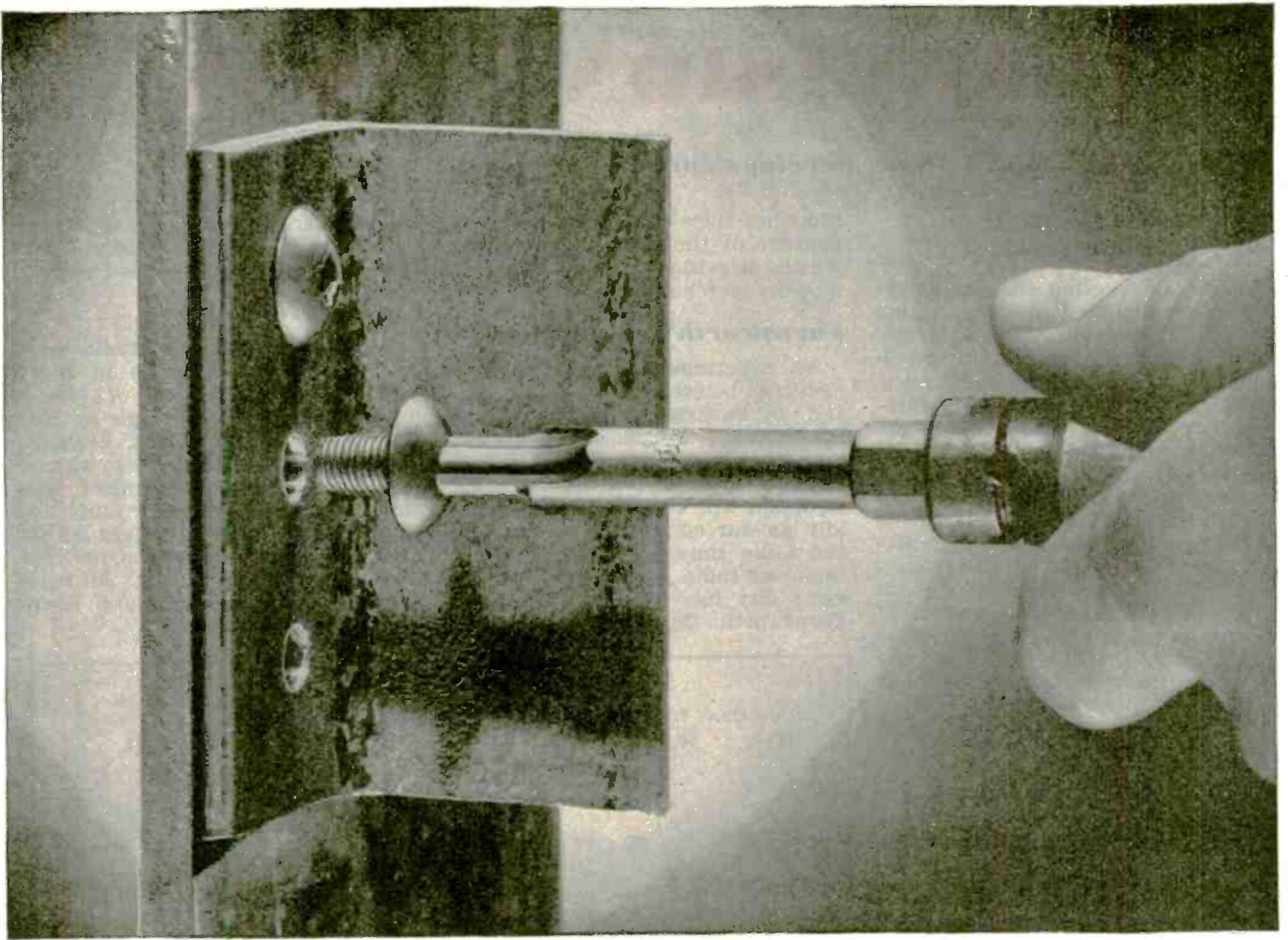

There Is No Tougher Test in assembly than the driving of thread-forming screws; especially where the thickness of the metal equals or exceeds the diameter of the screw. This is the critical spot where CLUTCH HEAD'S special features, of *both screw and driver*, challenge point by point comparison... for lower cost, efficiency, speed, and safety.

- ✓ Rugged Type "A" Bit construction for longer uninterrupted service and longer total life, plus simplified reconditioning, means fractional tool maintenance and assembling costs.
- ✓ Automatic dead-center entry with the Center Pivot for the speed and certainty of *straight* driving.
- ✓ Square instead of "tapered" engagement... a *straight-sided* driver contacting *straight-walled* Clutch recess... eliminates ride-out and reduces end pressure to a minimum.
- ✓ Positive engagement for definite torque drive; no chewed-up heads; no hazard of slippage to injure manpower or damage materials.
- ✓ The CLUTCH HEAD Lock-On which carries screw and bit as a unit for fast one-motion driving.
- ✓ And... an ordinary type screwdriver will service CLUTCH HEADS.

You are invited to make your own test of these and other exclusive advantages by asking us to mail



you package assortment of CLUTCH HEAD Screws, sample TYPE "A" Bit and fully illustrated brochure.



UNITED SCREW AND BOLT CORPORATION
CHICAGO 8 CLEVELAND 2 NEW YORK 7

★ TELEVISION TODAY* ★

New Developments in the Video Field

1945 Tests for RCA 5 kw-300 mc Tele

Radio in meeting the challenges of war, performed services in 1944 believed impossible in 1940, Brigadier General David Sarnoff, president of the Radio Corp. of America, pointed out in a year-end statement reviewing the progress of radio during the past year. He described, as an example, a 300 megacycle television transmitter which he said is the first of its kind developed to use five kilowatts of power for television broadcasting. Its development came about primarily through the creation of a special electronic tube and associated circuits. The full use of the new transmitter, General Sarnoff explained, must await the end of the war. Engineers, caged in a great wire mesh at RCA Laboratories, are studying the transmitter's performance and perfecting it for the future, with field tests scheduled early in 1945 in the New York area.

Television Conventions

Conventions of tomorrow may well be handled by television circuits, according to J. R. Poppele, president of the Television Broadcasters Association, Inc., who addressed hundreds of retailers from all sections of the country attending the annual convention of the National Retail Dry Goods Association at the Hotel Pennsylvania, New York, early last month.

"Conventions have become a wartime casualty," Poppele declared. "If sufficient coaxial cable and radio relay circuits as well as television transmitting and receiving equipment were now available for a national service, the convention ban might work no hardship on organizations who annually conduct their business through national conclaves."

He pointed out that in the future, "large screen television equipment could be installed in public auditoriums in each city where Association members are located. Thus, the entire convention program," he stated, "could be conducted in New York City while members 'sit in' on the activities in their own home towns."

Poppele outlined the many uses which department stores and retailers can make of television. He said his association with merchants during the past 23 years has convinced

him that they will readily take advantage of the great opportunities which television can provide for modern merchandising.

Farnsworth Tele License

An experimental television station is to be erected in Fort Wayne, Ind., by Farnsworth Television and Radio Corp., a license to proceed with the work having been issued by FCC late in December. Construction will be completed as rapidly as war conditions permit. At the same time purchase of Westinghouse radio station WGL in the same city has been completed by Farnsworth. An application is now

before FCC for a license to operate an FM transmitter in addition to the newly acquired standard outlet.

Studios Available

A complete television studio setup has become available in New York through purchase of Manhattan Odd Fellows Temple at 105 East 105th St. by Diesel Electric Co., 2 Park Ave., New York, which plans to lease the premises for video. The building contains 14 studios with a ceiling height of 22 feet and one large studio, 80 x 90 feet with a 32-foot ceiling. All studios are air conditioned and have soundproofed walls.

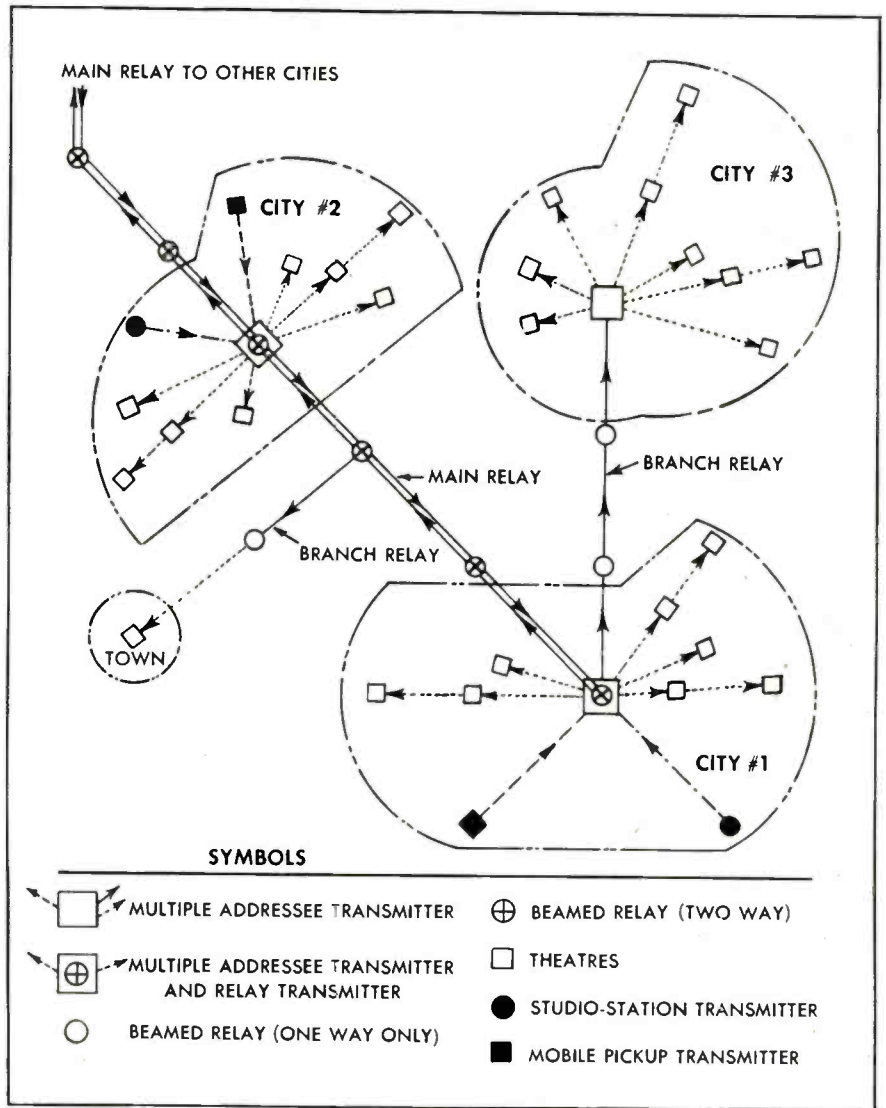

Preview of postwar plans for theater television. To put system into immediate nationwide operation, the Society of Motion Picture Engineers has asked FCC for 1,500 megacycles of the spectrum in 20 mc cleared channels as follows: 8 contiguous channels from 600 to 760 mc, 7 from 860 to 1000, 15 from 1900 to 2200, 15 from 3900 to 4200, and 30 from 5700 to 6300. "Ultimate" theater tele requirements will demand many additional frequencies between 6300 mc and "tens of thousands" of megacycles for diversified programs in high definition full color

*Title registered U. S. Patent Office.

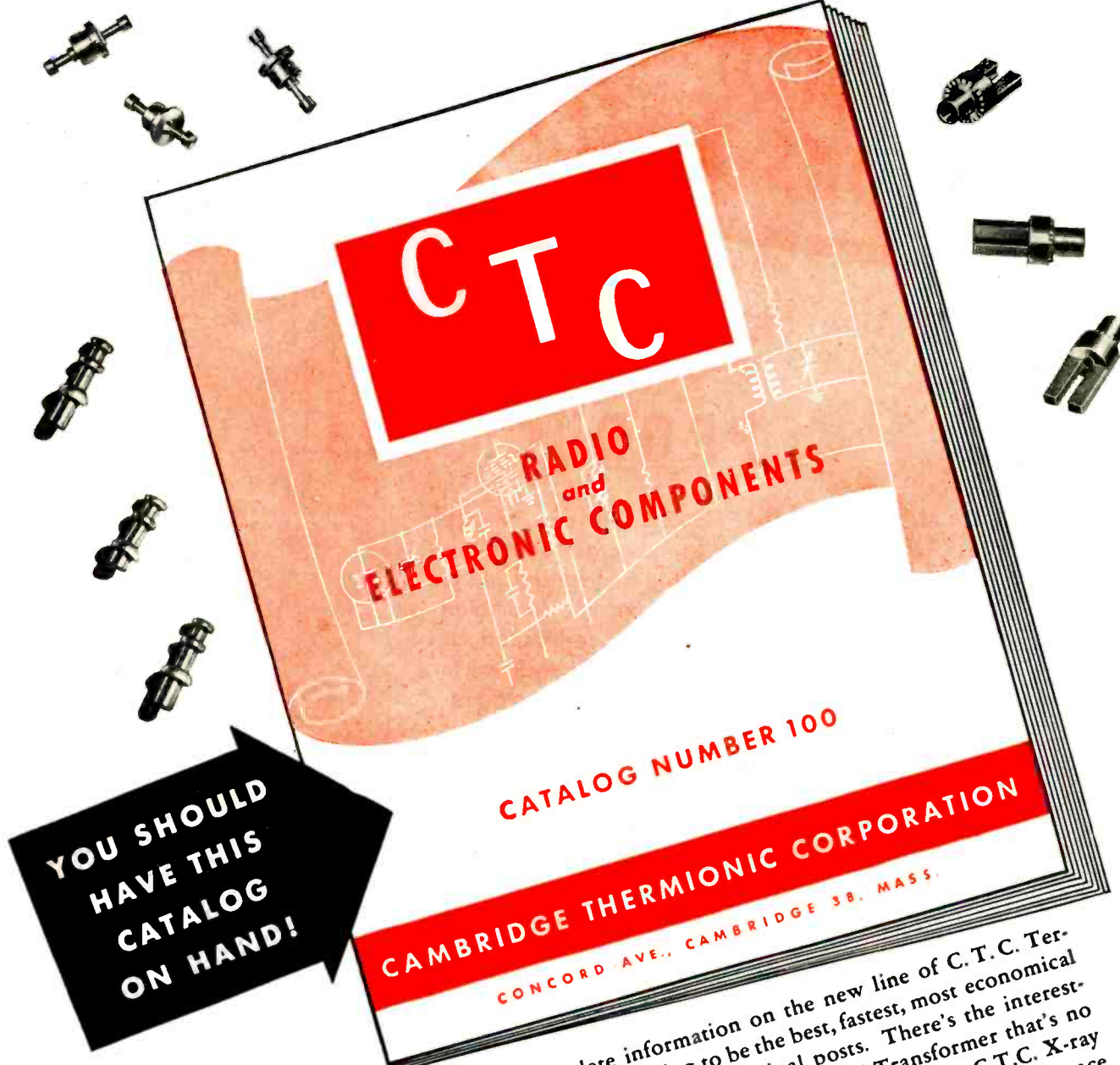

**YOU SHOULD
HAVE THIS
CATALOG
ON HAND!**

CATALOG NUMBER 100
CAMBRIDGE THERMIONIC CORPORATION
CONCORD AVE., CAMBRIDGE 38, MASS.

It contains complete information on the new line of C. T. C. Terminal Lugs that are proving to be the best, fastest, most economical route to firm, swift soldering terminal posts. There's the interesting facts about an Ultra-High Frequency I-F Transformer that's no bigger than your thumb and complete information on C.T.C. X-ray Oriented Crystals which are setting new standards of performance and long life.

You may find the information in the Catalog very useful to you in connection with present or projected components. Write for it today. Ask for C.T.C. Catalog Number 100. No obligation, of course.

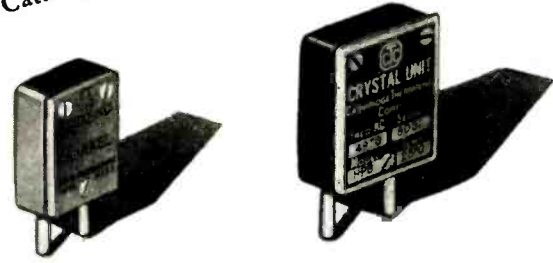

CAMBRIDGE THERMIONIC CORPORATION
441 CONCORD AVENUE • CAMBRIDGE 38, MASSACHUSETTS

LAMINATED PRECIOUS METALS

for POSTWAR PRODUCTS

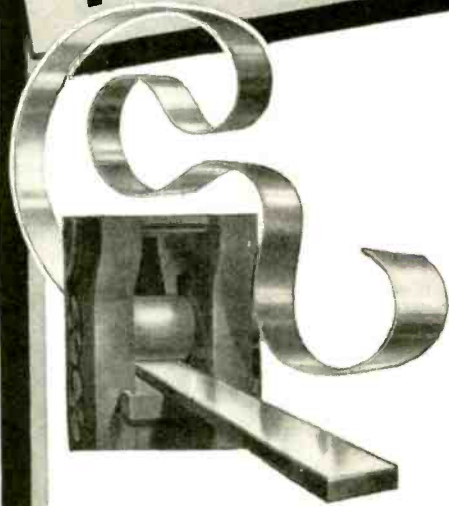

For over half a century the Makepeace organization has pioneered and specialized in the development of laminated metals. Our early products were almost entirely used in

the jewelry, pen and pencil and optical trades, where painstaking care in manufacture, maintenance of close tolerances and fine finishes were prime essentials.

Wartime needs have greatly broadened and enlarged our field of operations. We have enjoyed steady expansion . . . continuously added to our production facilities with the most modern equipment . . . perfected and advanced our manufacturing methods. Such precision work as aviation instruments, radio and radar equipment, fire control instrument parts, collector rings and assemblies, bears witness to the scope of our operations.

Postwar . . . the variety of uses to which laminated metals can be put by industry . . . the variety and type of future applications . . . is limited only by the creative genius of the engineer and product designer. To help meet these coming needs, we are maintaining a staff of thoroughly experienced metallurgists, chemists, designers and consultants, a fully equipped research and testing laboratory, and a splendidly equipped tool room. These are at your service . . . ready to assist your own designers to the full extent of their facilities.

YOUR INQUIRIES ARE CORDIALLY INVITED



Makepeace PRODUCTS

SHEETS • WIRE • TUBING • SOLDERS
FABRICATED PARTS AND ASSEMBLIES

D. E. MAKEPEACE COMPANY

Main Office and Plant, ATTLEBORO, MASS.

New York Office, 30 Church St.

NEW PATENTS

Temperature Indicator

Resistor 1, having a constant temperature coefficient, is inserted in the plate of pentode 5, which provides a constant current through the resistor 1. The voltage across the resistor will then be proportional to the temperature of the medium 2. This voltage is measured by the meter 17 in the cathode lead of voltmeter tube 15 operating on the linear portion of its characteristic. Consequently, the temperature scale of meter 17 will be linear.

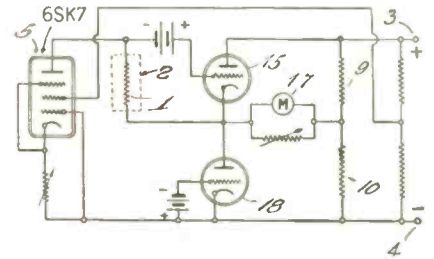

To adjust the zero reading of the instrument, the current drawn by the triode 15 in the absence of a controlling voltage at resistor 1 is counteracted in the meter 17 by the constant current supplied by triode 18. The arrangement may be considered as a balanced bridge circuit, with tubes 15 and 18 forming two arms and resistances 9 and 10 the other two arms connected in series across the source at terminals 3 and 4.

In a commercial embodiment, pentode 5 is replaced by two pentodes connected in parallel and each triode 15 and 18 is replaced by two triodes connected in parallel so that a greater current carrying capacity and ruggedness is obtained. Two standard resistances are incorporated in the circuit which can be switched into the grid circuit of tube 15 for calibration purposes.

J. W. Smith, Collins Radio Co., (F) May 19, 1941, (I) October 3, 1944, No. 2,359,334.

Reducing Noise in Recorders

Rectifier 19 is introduced in a conventional noise reduction circuit to provide a short discharge time for capacitor 20 for rapid increases of the signal level as well as good filtering properties. The output of the noise reduction circuit may be used to control a shutter in a variable-area system

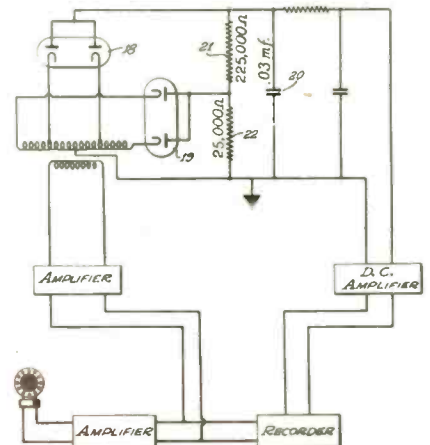

or the light intensity in a variable-intensity system. The circuit acts as an averaging type of rectifier having a high resistance input to the filter, slow timing, and consequently, good filtering.

For constant, decreasing, and slowly increasing signal levels, rectifier 19 provides the controlling current while rectifier 18 will be inoperative due to the negative potential across capacitor 20.

(Continued on page 126)

WHAT THE WELL DRESSED TUBES ARE WEARING

MYKROY
PERFECTED MICA CERAMIC INSULATION

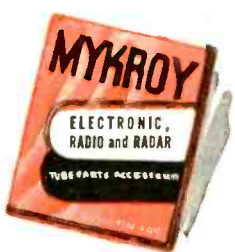

In their design considerations leading Tube Manufacturers are now specifying MYKROY because it provides the ideal combination of essential insulation characteristics . . . low-loss — dimensional stability — high strength and heat resistance.

Through advanced engineering ideas utilizing improved materials and better techniques, modern radio tubes achieve a high degree of efficiency. Complete vacuums within the tubes provide the perfect low-loss inter-electrode insulation; externally, however, insulation of lower dielectric properties is often used, considerably reducing tube efficiency.

The external leaks that occur at plate, grid, filament, tube base and socket terminals due to poor insulation, seriously reduce power output. To reduce these external power losses to a negligible minimum, you can now obtain tube accessories and parts made of MYKROY . . . the perfected mica ceramic insulation.

Write for full information today. Ask for your copy of the MYKROY Bulletin #104 — containing the scientific facts about this vastly improved Radio Tube Insulator.

MECHANICAL PROPERTIES*

MODULUS OF RUPTURE	18000-21000psi
HARDNESS	Mohs Scale 3-4 BHN, BHN 500 K9 Load, 63-74
IMPACT STRENGTH	ASTM Charpy .34-.41 ft. lbs.
COMPRESSION STRENGTH	42000 psi
SPECIFIC GRAVITY	2.75-3.8
THERMAL EXPANSION	.000006 per Degree Fahr.
APPEARANCE	Brownish Grey to Light Tan

ELECTRICAL PROPERTIES*

DIELECTRIC CONSTANT	6.5-7
DIELECTRIC STRENGTH (1/8")	.630 Volts per Mil
POWER FACTOR	.001-.002 (Meets AWS L-4)

*THESE VALUES COVER THE VARIOUS GRADES OF MYKROY

GRADE 8. Best for low loss requirements.
 GRADE 38. Best for low loss combined with high mechanical strength.
 GRADE 51. Best for molding applications.

Special formulas compounded for special requirements.

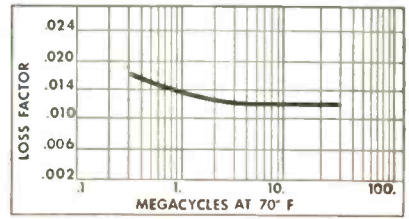

Based on Power Factor Measurements made by Boonton Radio Corp. on standard Mykroy stock.

MADE EXCLUSIVELY BY

ELECTRONIC MECHANICS INC.

70 CLIFTON BLVD., CLIFTON, N. J.
 CHICAGO 47; 1917 N. Springfield Ave., Tel. Albany 4310
 EXPORT OFFICE: 89 Broad Street, New York 4, New York

MYKROY IS SUPPLIED IN SHEETS AND RODS, — MACHINED OR MOLDED TO SPECIFICATIONS

AM

Western

Why Western Electric equipment leads the way!

1. Western Electric products are designed by Bell Telephone Laboratories—world's largest organization devoted exclusively to research and development in all phases of electrical communication.
2. Since 1869, Western Electric has been the leading maker of communications apparatus. Today this company is the nation's largest producer of electronic and communications equipment.
3. The outstanding quality of Western Electric equipment is being proved daily on land, at sea, in the air, under every extreme of climate. No other company has supplied so much equipment of so many different kinds for military communications.

There can be no question that both AM and FM are slated for important jobs in the world of tomorrow—in broadcasting, aviation, mobile and marine radio. And Western Electric will offer you the finest equipment of each type—backed by 76 years of leadership in making communications apparatus for almost every purpose.



BROADCASTING



AVIATION RADIO



MOBILE RADIO



MARINE RADIO

Western Electric has specialized

or FM

Electric equipment leads the way!

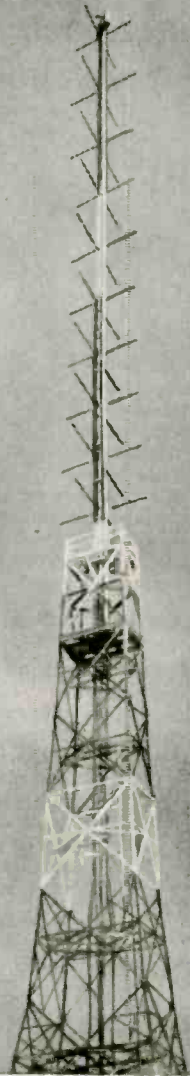

As a result of intensified wartime research at Bell Telephone Laboratories, of improved manufacturing techniques and increased production facilities at Western Electric, many new things are now being produced which will have peacetime applications.

In the years of progress that lie ahead for radio, count on Western Electric to lead the way!



*Buy all the War Bonds you can
... and keep all you buy!*



TELEVISION



SOUND SYSTEMS



ACOUSTIC INSTRUMENTS



COMPONENT PARTS

knowledge in all of these fields

Do You Require Research or NEW Developments in

ELECTRICAL or ELECTRONIC INSTRUMENTS



These are specialized services in which Associated Research, Inc., is pre-eminent. Experienced engineers, technicians, and craftsmen are immediately available to the power field, electrical and electronic industries, and scientific groups. Also a modernly equipped plant and all facilities. Send your problems to us for prompt attention.

This Organization Has Pioneered Many New Units

Meeting *unusual* calls is an outstanding part of our service. The Voltammeter illustrated below is only one example. Readings of both voltage and amperage on open scales, is provided in one compact instrument. Originally built on special order of a large manufacturer, it has come into wide demand.



Voltammeter Model 601

Shows 8 ampere ranges between 0 and 500 amperes, enabling operator to read continuously and accurately from .2 to 500 amperes. Three voltage ranges reading to 600 volts AC. Light, portable in strong metal case.

Products of Associated Research, Inc.

VIBROTEST, insulation resistance tester, (many models); HYPOT, all purpose insulation breakdown tester; DONUT CURRENT TRANSFORMERS; PHASE SEQUENCE INDICATORS; KEELER POLYGRAPH lie detector, etc.

Reconditioning Service

We maintain one of the largest shops for recalibration, repairing and reconditioning of instruments. Save time and money by sending them to us. Power analysis and load investigations by competent engineers. Manufacturers of the Keeler Polygraph (Lie Detector).

Engineering Service Representatives in all Principal Cities.

Phone, wire or write



221-B So. Green St., Chicago 7, Illinois
Telephone: STAt 5076

NEW PATENTS ISSUED - Continued from page 122

During rapid signal level increases, however, the circuit acts as a condenser input, peak reading circuit which provides fast opening. Rectifier 18 becomes effective because the voltage applied to it is larger than that across capacitor 20, the charging rate of capacitor 20 by rectifier 19 being delayed by resistor 21. The result is a fast adaptation to rapid increases in signal level preventing clipping of peaks. For best filtering the voltage impressed on the rectifier 19 should be about 57 per cent higher than the voltage impressed upon rectifier 18.

R. L. Haynes, RCA, (F) December 31, 1942, (I) October 10, 1944, No. 2,359,989.

Color Television System

It is intended to provide a color television system that permits considerable detail in image reproduction without requiring an excessive band width. The improvement is based on the property of the human eye to distinguish more details in a blue picture as compared with a red one.

As indicated in the diagram, red, green and blue picture signals are radiated in alternating succession. However, the different color signals are transmitted in variable detail in accordance with the particular delineation requirements, red having the lowest, green a higher one, and blue the highest delineatory capability. Therefore, in the color television system sug-

Voltmeter

The vacuum bridge voltmeter may be used for alternating voltages as shown and for direct voltages if the resistor 23 and the meter M are replaced by the rectifier-meter combination shown inside the dotted lines. Diode 29 and resistor 32 serve to balance out the emission current of tube 27.

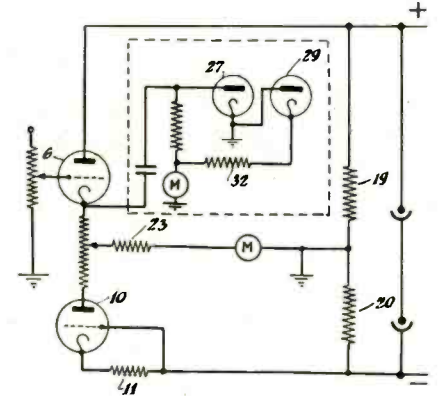

In the bridge circuit, tube 6 corresponds to the unknown arm, tube 10 to the standard arm, and resistors 19 and 20 to the ratio arms. The cathodes of tubes 6 and 10 should be heated from the same source

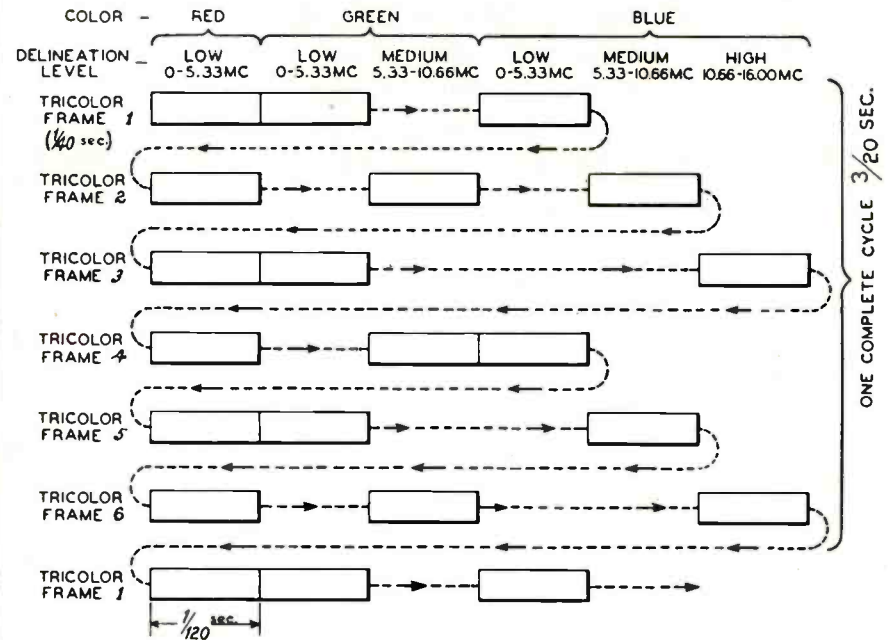

Time-frequency scheme in color television

gested, only low frequencies for the red component are provided while higher frequencies are included in the green and blue picture signals. These higher frequencies are alternately transmitted with the low frequency signals, as will be seen from the diagram, where the successive rectangles represent the color and frequency sent. The higher frequency ranges are heterodyned down to cover the lowest frequency range, i.e., 0-5.33 mc, and at the receiver will be reconverted to the original range. Switching means at the transmitter to subdivide the different color signals into the designated frequency ranges are described.

A. N. Goldsmith, (F) October 31, 1942, (I) October 3, 1944, No. 2,359,637.

so that effects caused by variations in the heater supply voltage cancel out. The bias resistor 11 is so dimensioned that the operating characteristics of tubes 6 and 10 are nearly the same.

J. R. Banker, Allen B. Du Mont Laboratories, (F) April 24, 1943, (I) August 29, 1944, No. 2,356,733.

Correction

Through an unfortunate oversight the name of Mr. Henry C. Dalrymple was omitted as one of the inventors of U.S. patent No. 2,358,148, summarized on page 134 and 136 of the January issue of Electronic Industries.

Four steps ahead in Crystal Manufacture

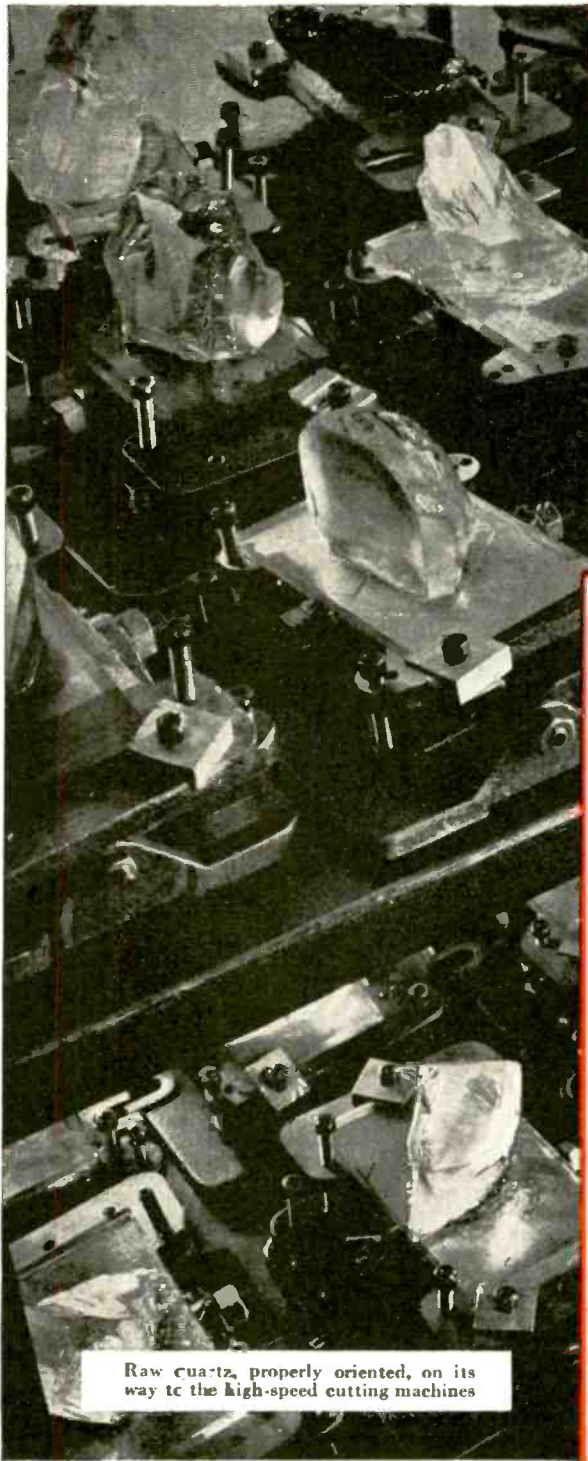

Raw quartz, properly oriented, on its way to the high-speed cutting machines

NORTH AMERICAN PHILIPS research and engineering have contributed to four developments that have advanced the art of crystal processing. Each has solved at least one problem in the mass production of quartz oscillator plates to meet the rigid demands of war equipment.

• **Q-Lap:** An exclusive North American Philips development, this high-speed machine automatically grinds crystal blanks parallel to close tolerances, ready for further production operations.

• **Utilization of Unfaced Quartz:** By developing in 1913 a method of utilizing unfaced quartz, previously very difficult and costly to use, North American Philips materially increased the available supply of quartz in the nation's limited war-time stock pile.

• **X-Ray Quartz Analysis Apparatus:** First practical, commercial device specifically designed for accurate mass production of quartz crystals. It provides the best known method of measuring the precise angles required.

• **Automatic Testing of Crystals:** North American Philips is the only crystal manufacturer, to our knowledge, which has developed special test units which test temperature activity and frequency automatically and at high speed.

These four steps ahead in precision crystal processing further mark the progress of an organization with a background of over a half century in research, development and manufacture in the electrical field. Today, North American Philips is one of the leading producers of quartz crystals for military communications equipment. Tomorrow, our production of crystals will be available for peacetime radio and electronic equipment. In these fields precise frequency control and selection at low cost will be important factors.

We would be glad to send you a copy of an interesting booklet on, "How Quartz Crystals Are Manufactured." Just fill in the coupon and mail today.

OTHER PRODUCTS: Amplifier, Transmitting, Rectifier and Cathode Ray Tubes; Searchray (Industrial X-ray) Apparatus, X-ray Diffraction Apparatus; Medical X-ray Equipment, Tubes and Accessories; Tungsten and Molybdenum Products; Fine Wire; Diamond Dies. *When in New York, be sure to visit our Industrial Electronics Showroom.*

 Send today for this Quartz booklet!

Norelco ELECTRONIC PRODUCTS by
NORTH AMERICAN PHILIPS COMPANY, INC.

Dept. D-2, 100 East 42nd Street, New York 17, N. Y.
Factories in Dobbs Ferry, N. Y.; Mount Vernon, N. Y. (Metalix Div.); Lewiston, Me. (Elmet Div.)

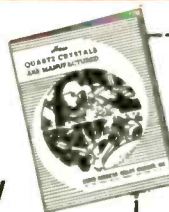

North American Philips Co., Inc.
100 East 42nd Street, New York 17, N. Y.

Gentlemen:

Kindly mail booklet, "How Quartz Crystals are Manufactured" to:

Name _____

Title _____

Company _____

Address _____

Dept. D-2

Which Terminal for Your *Hermetic Sealing* Problem?

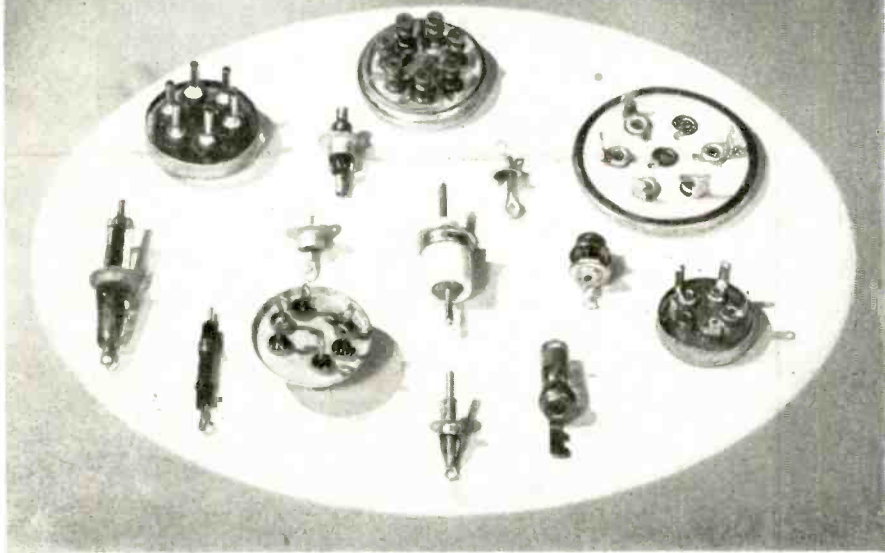

⊗ To correctly seal transformers and filters it is highly important to select the right terminal for each particular design. Relationships between electrical and mechanical requirements, space limitations and overall specifications are all important in the achievement of good performance — every factor must be given careful and detailed consideration.

Here at ADC, we use many types of terminals for hermetic sealing — making a point to use each where best suited. It takes a little more effort to produce final designs this way, but after all, knowing they're right for the jobs they have to do is what counts most with us and with you.

SEND FOR LATEST CATALOG!



Audio Development Co.

2833 13th Ave. S., Minneapolis 7, Minn.

NEW PATENTS

Converting Electron Microscopes

An additional unit can be inserted to convert a conventional electron microscope into a scanning microscope. The unit includes electron beam deflection electrodes, auxiliary focusing electrodes, an apertured fluorescent screen, an apertured shield an auxiliary specimen chamber and a phototube or electron multiplier connected to a recorder. The unit is interposed between the microscope electron projection lens and the microscope recording film or viewing screen.

J. Hillier, RCA, (F) May 30, 1942, (I) July 25, 1944, No. 2,354,263.

Welding System

Capacitors 5, 6, 7 are in succession discharged through the primary of welding transformer 3. Tubes 29 and 43, arranged in the discharge paths of the associated capacitor, are fired at the time of maximum current of the previous tube by circuits including rectifiers 38 and 50, supplying firing potential to igniters 33 and 47.

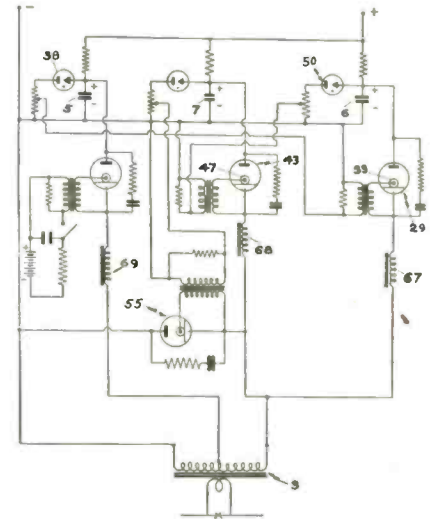

The firing of the next tube tends to apply an inverse voltage across the previous tube at a time when its gaseous atmosphere is substantially ionized. This inverse voltage will cause the ions in the tubes to be hurled against the anode which may cause sputtering of the anode or flashback.

To avoid the application of this high inverse voltage to the anodes of the tubes while they are still ionized, saturable reactors 67, 78, and 69 are inserted in the cathode leads of tubes 29, 43, and 15, respectively. These reactors will prevent rapid increase of current through the tubes upon firing, while being of little influence later on. Tube 55 is inserted to make the welding current impulse decline exponentially.

J. W. Dawson, Raytheon Manufacturing Co., (F) March 25, 1942, (I) August 15, 1944, No. 2,355,633.

Hearing Aid Amplifier

The circuit is designed to prevent oscillations due to the self-biasing resistor 25 in the battery circuit without the use of a large by-pass capacitor across this resistor. To accomplish this aim, a decoupling resistor 40, small by-pass capacitor 41, screen-dropping resistor 5, and by-pass capacitor 8 are provided. The capacity of capacitor 8 is such that the portion of the voltage in the plate circuit of tube 3 resulting from the feedback voltage at the screen grid 4 due to resistor 25, is greater

*Seaworthy!...
and IRC-Worthy*



GRADE 1 — CLASS 1 RESISTORS

Exhaustively tested for dependable performance and sound construction, IRC's Type GRW **GRADE 1—CLASS 1 RESISTORS** are now available. Only after every requirement of Army-Navy specification Jan-R-26 had been met or surpassed would our Engineering Department approve this product for the applications for which it is designed.

Resistant to salt water immersion following thermal shock, they are capable of continuous efficient operation at a total temperature of 275° C. (ambient plus rise).

Made in 7 standard sizes with power ratings from 15 to 140 watts and resistance ranges of from 0.1 to 46000 ohms, the GRW's are enclosed in special heat-treated glass for optimum strength. Non-corrosive ferrules are hermetically sealed to the tube with pure lead. Nickel alloy leads pass through the centering devices and are welded to the outer ferrule cups. All resistors are *space wound*.

These IRC **GRADE 1—CLASS 1's** are engineered to "take it" far beyond normal requirements and can stand transverse loads as high as 100 pounds without failure or damage of any kind.

INTERNATIONAL RESISTANCE CO.

DEPT. 2-B

401 NORTH BROAD STREET, PHILADELPHIA 8, PA.



Write today for special Engineering Bulletin containing dimension drawings, temperature rise and de-rating curves as well as other technical data.

IRC makes more types of resistance units, in more shapes, for more applications than any other manufacturer in the world.



AN 3155
Rheostat

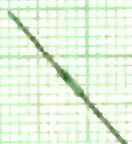

BTR—1/4 watt
Insulated Resistor



BTA—1 watt
Insulated Resistor



Grade 1—Class 1
Resistors

COMING... COMING... COMING...

MOTOR DATA No. 124

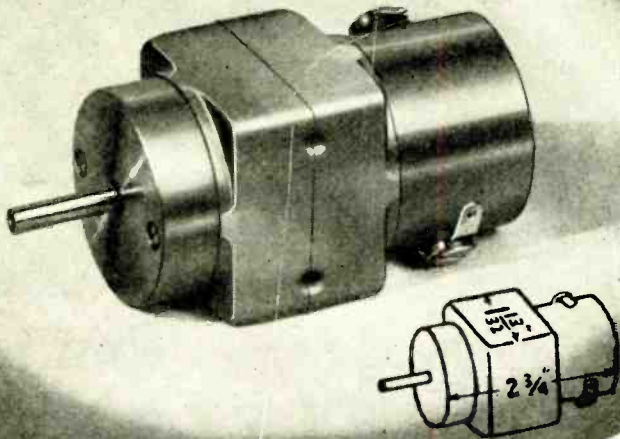

PM MOTOR Torque 3.5 in. oz. at 4500 RPM

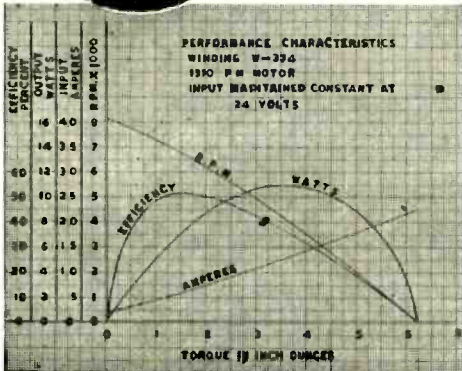

PM MOTOR - 1310

Watts Output Int. (max.)	11
Torque at 7000 RPM (in.oz.)	1
Torque at 4500 RPM (in.oz.)	3.5
Lock Torque (in.oz.)	6
Volts Input (min.)	5
Volts Input (max.)	32
Temperature Rise Int.	50°C
Weight	11 oz.
Shaft Diameter (max.)	.250"
Length less Shaft	2 3/4"
Overall Diameter	1 13/32"

Unique in design and construction, this permanent magnet field motor has been selected for many applications having critical space and weight factors. Wound as a shunt motor, its output characteristics are adaptable for a wide variety of power requirements.

FEATURES

ELECTRICAL

- Alnico field magnets
- No field losses
- Low starting current
- Reversible with change of polarity
- Low RF interference
- Armature windings varnish impregnated and baked

MECHANICAL

- Completely enclosed
- Mounting in any position
- Aluminum end brackets
- Laminated pole pieces
- Stainless steel shaft
- Rotation on ball bearings
- Commutator mica insulated

NEW PATENTS

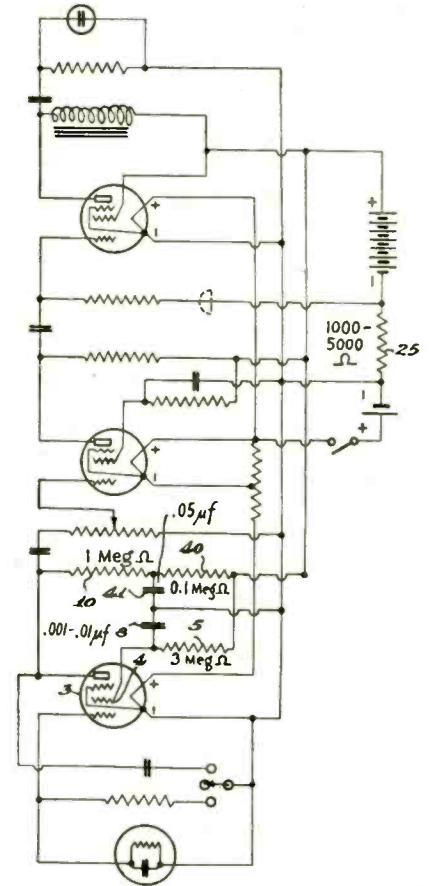

than the feedback voltage reaching the plate of tube 3 through plate coupling resistor 10. Consequently the plate feedback voltage is suppressed and does not produce oscillations in the amplifier.

S. F. Lybarger, E. A. Myers & Sons, (F) March 15, 1943, (I) April 4, 1944, No. 2,345,761.

Cathode-Ray Ignition Analyzer

Two cathode-ray tubes and associated circuits are used to analyze the spark plug ignition of internal combustion engines. Signals from all spark plugs operating from one magneto can be viewed at one time on one cathode-ray tube, and any spark plug which appears abnormal can be selected and shown on an enlarged scale on the other cathode-ray tube. At the same time its signal can be intensified on the first tube for certainty of identification when it is being examined on the large scale tube. The circuit is described and claimed in detail.

P. S. Christaldi, Allen B. Du Mont Laboratories, (F) September 29, 1942, (I) August 8, 1944, No. 2,355,363.

Army-Navy "E" Awards

Burke Electric Co., Erie, Pa.

C. P. Clare & Co., 4719 W. Sunnyside, Chicago, Ill.

Commercial Radio-Sound Corp., 570 Lexington Ave., New York 22, N. Y.

The Hallicrafters Co., 2611 S. Indiana Ave., Chicago 16, Ill. (fourth star added)

EICOR INC. 1501 W. Congress St., Chicago, U. S. A.

DYNAMOTORS • D. C. MOTORS • POWER PLANTS • CONVERTERS

Export: Ad Auriema, 89 Broad St., New York, U. S. A. Cable: Auriema, New York

WE'VE TURNED THEM OUT

by the
MILLIONS

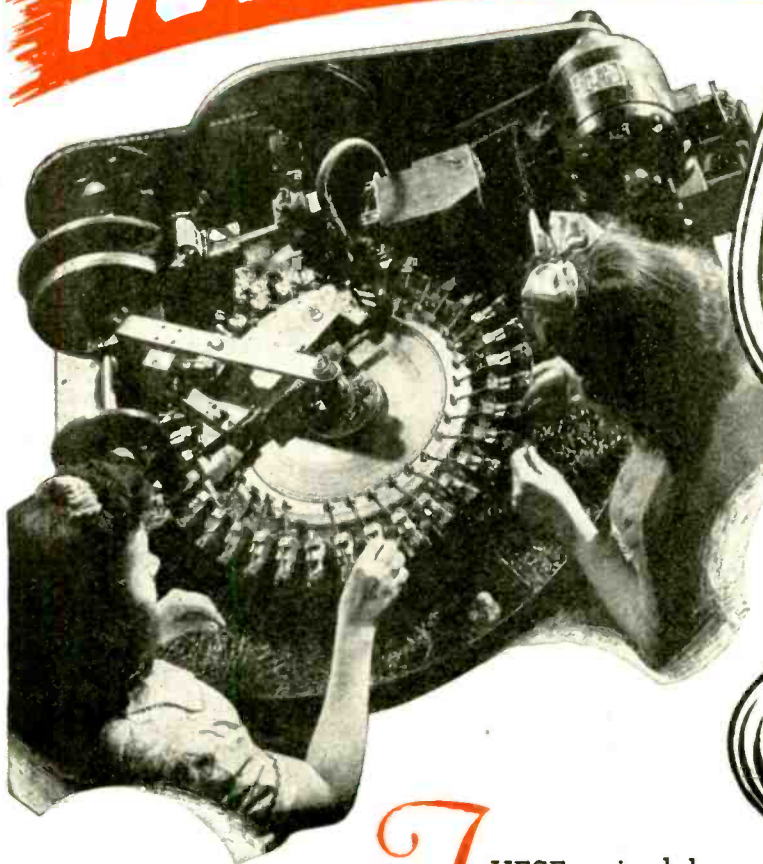

THESE swivel loops are essential to certain devastating projectiles. Here at Accurate, special forming and testing equipment were designed and built to produce them in the vast quantities needed, and to the rigid specifications required.

Perhaps you will never need a swivel loop for your product. But, whether it's swivel loops, special wireforms or springs, Accurate experience and ability is at your service. Your products of tomorrow, as well as of today, are our interest. We want to help you produce them better, faster, for less.

WIRE FORMS
SPRINGS
STAMPINGS



Send for your copy of the new Accurate Spring Handbook. It's full of data and formulae which you will find useful. No obligation, of course.

ACCURATE SPRING MFG. CO., 3808 W. Lake St., Chicago 24, Ill.



THERMOSTATIC METAL TYPE DELAY RELAYS PROVIDE DELAYS RANGING FROM 1 TO 120 SECONDS

Other important features include:—

1. Compensated for ambient temperature changes from -40° to 110°F .
2. Contact ratings up to 115V-10a AC.
3. Hermetically sealed — not affected by altitude, moisture or other climate changes . . . Explosion-proof.
4. Octal radio base for easy replacement.
5. Compact, light, rugged, inexpensive.
6. Circuits available: SPST Normally Open; SPST Normally Closed.

WHAT'S YOUR PROBLEM? Send for "Special Problem Sheet" and Descriptive Bulletin.

AMPERITE CO. 561 BROADWAY
NEW YORK 12, N. Y.

In Canada: Atlas Radio Corp., Ltd.
560 King St. W., Toronto

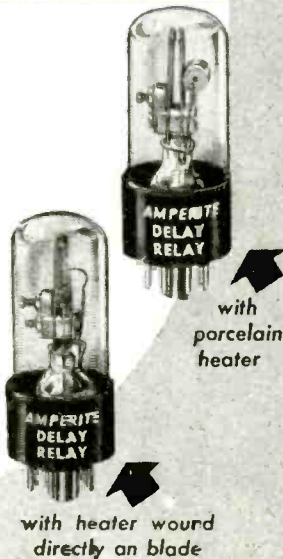

FABRICATING PLASTICS

(Continued from page 87)

gether with plastic screens upon which the pictures are to be projected. This is an extremely timely research project.

Use of metal-plated plastics will become increasingly important in many fabricated components. Conversely, hot sprayed synthetic rubber covering for metal parts is another useful item. One particular need will be light weight containers for storage batteries for portable radios, hearing aids and the like. The science of electronics deals with radio tubes. Some day plastics may be developed capable of being used as the envelope for tubes, withstanding the heat without affecting the vacuum.

Polystyrene films for use in radio capacitors may supplant wax impregnated paper with improved efficiency and supplement mica types.

SW-BC TECHNIC

(Continued from page 94)

and the beam will slew in the direction of that section with the lagging phase. The amount of slewing is proportional to the phase difference between the two sections as shown in Fig. 13. It is apparent that the amount of slewing should not exceed about 15 deg. in either direction as there is a transfer of power from the major to a minor lobe on a different bearing.

Beam Shifting

A novel arrangement is used on the A and B antennas for shifting between two or more bearings. This method is diagrammed in Fig. 14. For example, if we wish to transmit on the bearing determined by the location of P_1 , we operate with switches S_1 and S_2 open and all others closed. Note that the closed switches in all cases become part of quarter-wave shorted sections of transmission line which accept no power and have negligible effect on the lines.

A similar arrangement is used with the C and D antennas for reversing and this is shown in Fig. 15. To transmit in the direction AB, we open switches S_1, S_2, S_3 and close S_4, S_5, S_6 . To transmit from B to A, the order is reversed. $M_{1,2,3,4,5,6}$ are tuning stubs. $S_1, S_2, S_3, S_4, S_5, S_6$ are located at the proper points for optimum reflector operation. Note that with this arrangement it is not necessary to compromise tuning to obtain the reversible feature, each direction being fully and independently adjustable for peak performance.

The type of switch used for reversing and slewing the antennas is manually operated, although it could be readily arranged for remote "push-button" control.

The type B antenna array consists essentially of two type A arrays

BACK THE INVASION—BUY MORE BONDS NOW!

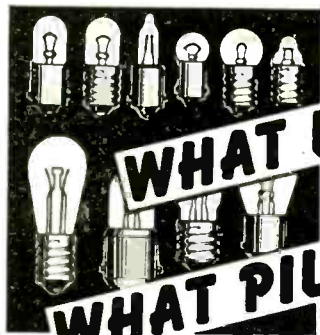

WHAT LAMP? WHAT PILOT LIGHT?

ANSWERS TO BOTH QUESTIONS
WAITING FOR YOU AT DIALCO

Let us solve your problem with a complete unit — fitted with the proper G.E. or Westinghouse Lamp. We manufacture the most extensive line of Pilot Lights . . . Special emphasis on Neon applications. Write for Catalog today.

YOU CAN DEPEND ON DELIVERIES
WHEN YOU DEAL WITH THE

World's Largest
Manufacturers
of Pilot Lights



DIAL LIGHT CO. of America, Inc.

900 BROADWAY • NEW YORK 3, N. Y.
Telephone: ALgonquin 4-5180-1-2-3

BACK THE INVASION—BUY MORE BONDS NOW!



A MICA MINE

IN A LABORATORY

War shortages crop up in strange materials. Mica, for instance. Once seen principally in the windows of stoves, and in small boys' pockets, it is now used extensively as electrical insulation. In some war products, it is virtually indispensable: capacitors for radio, spark-plugs for airplane engines, insulators in electronic tubes.

With demand mounting, manufacturers were desperate. A four-man

technical mission flew to London to help ration the world's supply between the United States and Great Britain. The shortage was serious.

The War Production Board, convinced that much mica was classified too low when judged by appearance alone, asked Bell Telephone Laboratories to develop a new method of electrical tests. The Laboratories were able to do this quickly and successfully

because of their basic knowledge and experience in this field.

The new tests were made available to manufacturers in this country and abroad—the supply of usable mica was increased 60% — and a difficult situation relieved.

Skill to do this and other war jobs is at hand in Bell Laboratories because, year after year, the Laboratories have been at work for the Bell System.

BELL TELEPHONE LABORATORIES



Exploring and inventing, devising and perfecting for our Armed Forces at war and for continued improvements and economies in telephone service.



**HIGH
VOLUMETRIC
EFFICIENCY**

KINNEY

High Vacuum

PUMPS

The exceptional performance of Kinney Compound Dry Vacuum Pumps is making headlines in the electronic industry. Year after year, they maintain extremely low absolute pressures down to 0.5 micron—reliable, low pressures which save production time, cut the percentage of tube rejections and reduce production costs.

Send today for Bulletin 18.



Model CVD Compound Dry Vacuum Pump



**KINNEY
MANUFACTURING
COMPANY**

3595 WASHINGTON STREET
BOSTON 30, MASS.

Branch Offices: New York, Chicago, Philadelphia, Los Angeles, San Francisco

We also manufacture single stage vacuum pumps, vacuum tight valves, liquid pumps, clutches and bituminous distributors.

**LOW
ABSOLUTE
PRESSURES**
0.5 MICRON OR BETTER

stacked vertically. The horizontal pattern remains the same but the gain is increased approximately 3 db due to suppression of the higher angle radiation. The major vertical lobe peaks at an angle of about 9 degrees to the ground. This type is by far our favorite array.

The type C array is similar to the type A except for a one-half wave separation between the two sections for mechanical reasons only.

The type D antenna is similar to the type A with the exception that only three co-linear elements are used instead of four, the method of feed being modified accordingly. This type array is used where space does not permit erection of the longer A array or where a broader (45 deg. instead of 36 deg.) beam is desired.

The type E array is of the rhombic type. This is of the three-wire type using a stainless steel dissipation line for termination. Although this array is inherently less efficient than are the other arrays, it has the advantage of being operable with good effectiveness on several bands. Although this antenna cannot be slewed as can the panels, it can be readily made reversible.

With powers on modulation peak of 400 kw and especially at the higher frequencies, the selection of the proper type of transmission line is of great importance. Low impedance lines of the unbalanced type

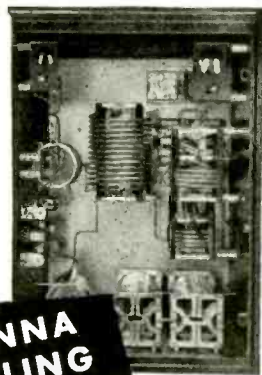

**ANTENNA
COUPLING
EQUIPMENT**

If it's an antenna problem, Johnson Engineers can give you the answer. Don't waste power. Johnson antenna coupling units insure a perfect match and maximum power transfer. Housed in weather-proof cabinets, they provide an inner door with glass window for observing meter, thereby protecting observer from high voltage.

Other Johnson products include phasing equipment, concentric line, tower lighting chokes, sampling transformers, inductors, condensers, insulators and similar items. Write for more information and prices.

JOHNSON
a famous name in Radio



E. F. Johnson Co. Waseca, Minn
ELECTRONIC INDUSTRIES • February, 1945

LET US DEMONSTRATE WHAT ELECTRONIC HEATING can do for YOU

PROOF BY TRIAL . . . that's our motto. Before you invest in electronic heating equipment you should be shown how any process requiring heat can be done *better, faster and more economically* for you with a Scientific Electric unit.

Our engineers will gladly—*without obligation*—make a study of the heating process under consideration. They will then make recommendations supported by practical demonstrations on the S.E. heater best suited for the job.

This procedure will enable you to figure accurately the economies that will result; also permit you to estimate the time required to pay for the equipment out of resultant savings.

You can submit your heating problems to us with the assurance that absolute secrecy will be observed, if so desired. Investigate the advantages of applying electronic heating in your manufacturing operations **NOW**. Consult with us at your earliest opportunity.

*Write for free copy of
The ABC of Electronic Heating*

**Manufacturers of
Vacuum Tube and Spark Gap Converters Since 1921**

Scientific Electric

DIVISION OF "S" CORRUGATED QUENCHED GAP COMPANY

119 MONROE ST.  GARFIELD, N. J.

ELECTRONIC INDUSTRIES • February, 1945



3 KW DIELECTRIC HEATER
Dielectric Heating Units priced from **\$1500.**
(3 KW complete)

5 KW INDUCTION HEATER
Induction Heating Units priced from **\$1285.**
(for 5 KW complete with 1 work coil)

Scientific Electric Electronic Heaters are made in the following range of power; 3—5—7½—8—10—12½—15—18—25—40—60—80—100—250 KW. — and range of frequency up to 300 Megacycles depending on power required.

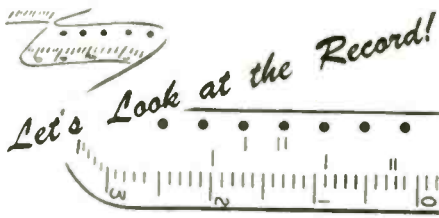

AUTHENTIC - UNASSAILABLE IN LABOR RELATIONS

- ✓ gathers elemental time quickly and accurately.
- ✓ Saves time because fewer observations are necessary.
- ✓ No need to combine elements—every motion recorded at the instant of occurrence.
- ✓ increases confidence between management and labor.

THE NEW MARSTO-CHRON

MODERNIZES TIME STUDIES

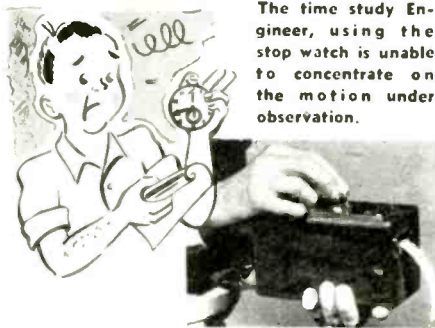

The time study Engineer, using the stop watch is unable to concentrate on the motion under observation.

FAST ACCURATE CONVENIENT

No watch to read . . . nothing to write down . . . time values accurate to .0025 minutes can be read directly, easily and accurately. Postwar competition will demand greater individual operating efficiency based on new methods and more comprehensive time studies. Now is the time to get set.

Write today . . . learn how the Marsto-Chron time study method will give you more efficient production.

BAY PRODUCTS CORP.
171 CAMDEN ST.
BOSTON 18, MASS.

do not lend themselves well to feeding balanced loads as presented by these antennas, and a balanced line is therefore indicated. A type of construction that has worked out very well consists of two No. 4 conductors in parallel, held to a $\frac{3}{4}$ in. spacing by small brass clips at about 10 ft. intervals. Separation between lines is 21 in. to give 550 ohm impedance. The purpose of the double-conductor construction is to give the electrical effect of a single conductor of large diameter to reduce the voltage gradient at the surface to a safe value. Failure to use sufficiently large conductor size would result in breakdown.

For the same reason, it is important that support insulators be used which have some form of corona shield to distribute the electric forces. The insulator used is of $\frac{3}{4}$ in. diameter Mycalex with an overall length of $13\frac{3}{4}$ in. Each end is fitted with a corona ring $2\frac{3}{4}$ in. in diameter. The conductors are firmly connected to the insulator by brass clips. The insulators are sus-

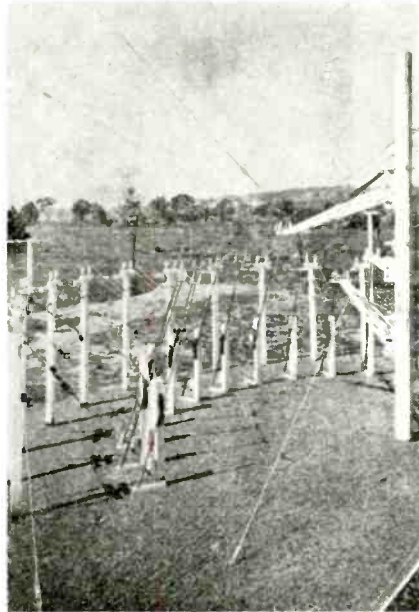

Fig. 16—Antenna switching arrangement at So. Schenectady.

pending by angle brackets which permit some lengthwise movement but prevent side sway. These insulators are the same type as used in the antenna construction.

As the number of transmitters, antennas and operating frequencies grew and the transmitters' powers increased, the problems of transmission line switching became more difficult. With transmitters of moderate power and with comparatively few transmission lines a simple bus system with knife switches had been adequate. This was definitely not the answer to our problem, however, where it was desired to: 1—Switch to any one of three transmitters any of twelve transmission lines in any combination.

(Continued on page 138)

for Parts

Ten thousand different radio and electronic parts immediately available on priorities.

for Service

Trained expeditors select and ship, same day your order is received.

for Experience

Known since 1922 for the high character of our policies and practices—as jobbers, wholesalers and manufacturers.

CONTACT

Radio Wire Television Inc.

100 SIXTH AVE., DEPT. N-2, NEW YORK 13, N. Y.
BOSTON, MASS. • NEWARK, N. J.

WORLD'S LARGEST
RADIO SUPPLY HOUSE

Originators and
Peacetime Marketers
of the celebrated

Lafayette Radio

Write today for our bargain flyers
and special bulletins.



Microscopic enlargement
approximately 10 power



Science on the Production Line

Commonly you think of the microscope as a scientific laboratory instrument. But at National Union, these days, you will find it even more extensively used, as a *production* machine, insuring microscopic precision step by step through many processes of manufacture.

With the aid of microscopes, National Union workers accurately check almost invisibly small parts. They *see* to it that welds are sound, clearances are exact and the structure is mechanically perfect. In the photograph above for example, a N. U. 6AG5 miniature tube mount, no higher than your thumb nail is enlarged approximately 10 times, to permit minute examination of important structural factors. Enlargements up to

500 times—making a hair on your head look as tall as a tree—are just as readily obtained, when needed. Moreover, this tube, assembled from 31 individual parts, must pass 40 individual inspections, in addition to thorough examination under the microscope.

Here, again, is one of those unusual techniques developed by National Union engineers to make tube manufacture a more exact science. Such infinite care makes certain that every electronic tube which carries the National Union name will deliver a uniformly high level of performance with long service life. *Count on National Union.*

NATIONAL UNION RADIO CORPORATION, NEWARK, N. J.
Factories: Newark and Maplewood, N. J.; Lansdale and Robesonia, Pa.



NATIONAL UNION

RADIO AND ELECTRONIC TUBES

Transmitting, Cathode Ray, Receiving, Special Purpose Tubes • Condensers • Volume Controls • Photo Electric Cells • Panel Lamps • Flashlight Bulbs

RADIO SPEAKERS *for all applications*

Recently expanded production facilities combined with complete engineering "know-how" enable Consolidated Radio Products Co. to supply the finest radio speakers available. Speakers can be furnished in the following ranges:

Dynamic Speakers from 2 inches to 18 inches
Permanent Magnet Speakers from 2 inches to 18 inches
Headsets

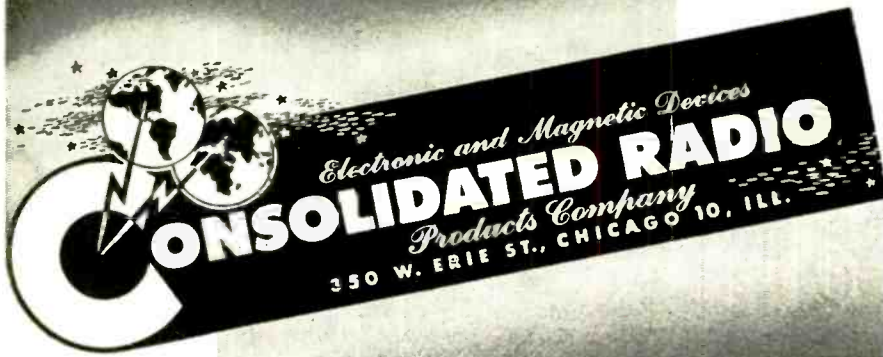

Small and Medium TRANSFORMERS

Consolidated Radio is also a nationally known manufacturer of small and medium transformers including Pulse Transformers, Solenoid and Search Coils.

Engineering service is available to design transformers and speakers for special applications, or to your specifications.



(Continued from page 136)
with provision for future increase of this number. 2—Introduce no irregularity in the line sufficient to cause reflections and necessitate re-tuning when changing antennas on the same frequency. 3—Maintain a high degree of reliability, simplicity, and freedom from flashovers.

The system based on these requirements (Fig. 16) was installed at the South Schenectady plant for the Office of War Information. Three booms can be rotated about a common axis. One boom feeds from the WGEO transmitter, one from WGEA, and one from WGEX. To shift it is merely necessary to rotate the boom to the desired antenna and make the connection by means of a pole carrying a hook-switch.

This system has proved highly successful. A similar one is used at the Belmont station, although there only two booms are required.

Fifteen for Essex

As part of the Essex Wire Corporation's 15th Anniversary, a three-day sales meeting in Fort Wayne, Ind., drew together 85 representatives from all over the country. Sessions were held at the Chamber of Commerce building and covered all phases of the manufacture and sale of products supplied by Essex and the Paranite Wire and Cable Division.

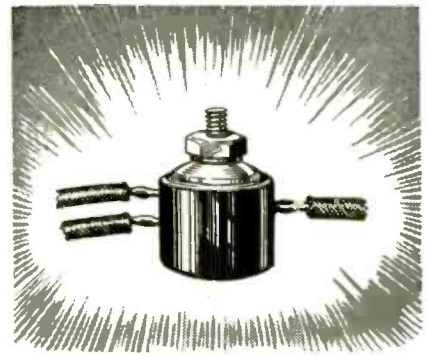

ELECTROX RECTIFIERS

• All kinds of rectifiers for all purposes . . . any capacity. Suppliers of Electrox Rectifiers to leading instrument and test-set makers since 1930.



Write for illustrated
Bulletin 446.

SCHAUER MACHINE COMPANY
2057 READING RD., CINCINNATI 2, OHIO

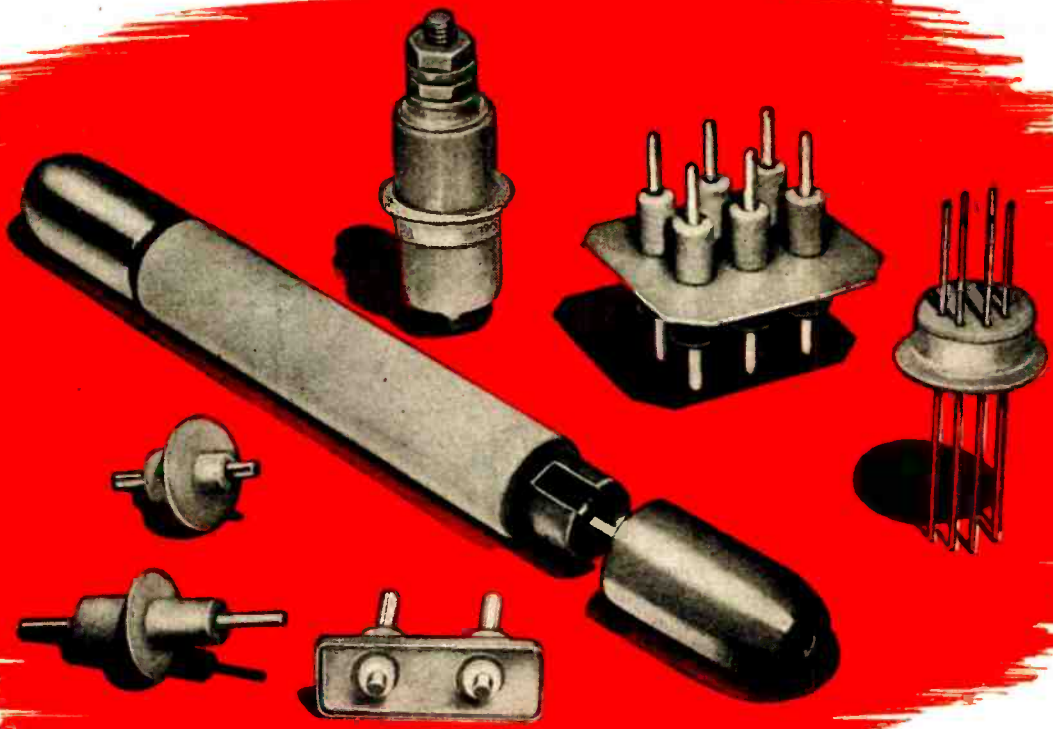

STEATITE AND STEEL PERMANENTLY BONDED TOGETHER

● SEALEX Bushings developed by General Ceramics and Steatite Corporation are the answer to the problem of hermetically sealing all types of communication equipment.

SEALEX Bushings will contain air at 50 pounds per square inch after a thermal change test of 25 cycles from -65°C to $+125^{\circ}\text{C}$.

Available in single terminal and multiple terminal designs for high and low voltage requirements.

Contact General Ceramics and Steatite Corporation for help in solving your hermetic sealing problems.

SALES REPRESENTATIVES

H. W. GEBHARD
737 No. Michigan Ave., Chicago, Illinois
J. J. PERLMUTH & ASSOCIATES
942 Maple Avenue, Los Angeles, Calif.
MICA COMPANY OF CANADA LTD.
P. O. Box 189, Hull, Quebec

General Ceramics
AND STEATITE CORP.



KEASBEY
NEW JERSEY



In 1942 the average use of paper per issue of **ELECTRONIC INDUSTRIES** was

7.3 TONS



In 1944 the average use of paper per issue of **ELECTRONIC INDUSTRIES** was

5.3 TONS



WE CAN PUBLISH ONLY 65% of ADVERTISING OFFERED US!

The drastic need for paper rationing has resulted in publishers using considerably less paper than they consumed in 1942. With a paper quota inadequate for **ELECTRONIC INDUSTRIES**, we are forced to sharply limit our advertising.

Under the operation of paper rationing rules, publishers are allowed a gross tonnage to cover all their magazines, and may allocate whatever they wish to individual ones, still keeping within their quota.

Caldwell-Clements, Inc., has no weaker publications from which to shift paper in order to meet competitive situations. With two strong magazines and a growing demand for space in both, the absence of a secondary medium to draw upon has made our curtailment of advertising space necessary. However, there has been no impairment of editorial service or circulation.

Comparisons of advertising volume now are more or less meaningless. Since paper rationing prevents our handling more than 65% of advertising available to us, a comparison does not show the true strength or position.

CALDWELL-CLEMENTS, INC.
480 Lexington Ave., New York 17, N. Y.

ELECTRONIC INDUSTRIES

Also Publishers of RADIO & TELEVISION RETAILING

MULTIPATH PROBLEMS

(Continued from page 95)

- to aim at.
2. Avoid reflection surfaces of the Palisades rocks.
 3. Be high enough to give some chance for elevated directivity at the receiver to shoot over surrounding roof structures. This upward tilt would be quite effective in Manhattan where multiple path difficulties are greatest.
 4. Increase the coverage to roughly double the present. If the effective height is roughly doubled, the area covered is also doubled.
- Towers of this nature are unusual but entirely practicable. In fact, a 2,500-foot tower was designed some years ago for use at the New York World's Fair but never built. Whether or not the structure is designed to handle a sightseeing "load" as well is a matter of cost economics.

From a technical standpoint, many separate antenna arrays could be installed with little difference in their effective heights. Or else a single antenna broadened to cover the whole television spectrum range could be designed with necessary filters and fed with coaxial cables from the ground or a lower level. A third method would place a single broadband power amplifier at the top, fed by dc vertical cables and modulated by coaxial down leads of suitable construction. These methods are all technical possibilities and the various phases of the plan will be discussed in these columns by experts in those fields.

There are many side issues that would need consideration, such as a flying hazard. From one viewpoint, a beacon having a chance of giving above-the-clouds visual guidance would have many advantages when needed. As an in-the-clouds collision hazard, the application of modern radio services, wherein a signal emitted in the neighborhood to operate one of the numerous radio receivers with which the planes are to be equipped, would give ample warning.

As to the cost, it would be large, but might be distributed among several stations possibly on the leased service plan.

The development of the necessary wide band phone cables has progressed so that there is no handicap in transmitting signal bands of any width necessary for future quality and color services.

There can be no forced requirements that a station must utilize this universal transmitting point. If several stations did cooperate, it would give the set owner and the installation man something to point to with best assurance of good results. Signals coming from other directions would have to be just as satisfactory as those from the master tower, or they would remain unheard.—R.R.B.

Operating Notes on

INDUSTRIAL ELECTRONICS

by Arthur G. Mohaupt, B. A., M. S.

NOTHING ELSE LIKE IT! DOWN-TO-EARTH INFORMATION FOR THE PRACTICAL ELECTRONIC TECHNICIAN

A practical, useable **ELECTRONIC MANUAL**. A valuable aid to foremen, superintendents, engineers, electrical contractors, electricians—to everyone interested in Electronic Control devices. Packed with practical data on Thyratrons, Ignitrons, Electronic Lighting, Induction and Dielectric Heating; Photo Tubes, Photo Control devices, Relays and Timers, Resistance Welding Control, Electronic Motor Control, etc. Replete with charts, diagrams and timely data on the functions, installation, operation and maintenance of Electronic Control devices. **SEND FOR YOUR COPY TODAY!**

De FOREST'S TRAINING, INC., 2531 North Ashland Ave., Chicago 14, Ill.
I am enclosing \$10.00 for Arthur G. Mohaupt's "OPERATING NOTES ON INDUSTRIAL ELECTRONICS." If not satisfied, I will return book in 5 days for full refund.

Name.....
Address.....
City..... State..... BEI-1

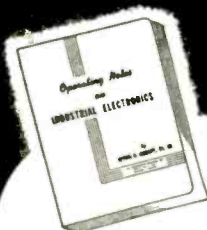

A valuable digest of 12 lectures given to engineers and practical electronic technicians from over 50 leading manufacturing concerns. Many helpful charts and diagrams.

J. F. MACENULTY, President
Pressed Steel Car Company, Inc.

"As manufacturers of transportation equipment we are constantly alert for the new developments that mean advancement and progress. We look for factors of efficiency, safety and comfort, and any development that provides these factors is a definite step forward. It would seem that..."



"VIBRATOR POWER SUPPLIES MAKE A VITAL CONTRIBUTION TO PROGRESS"

Mr. MacEnulty, Vibrator Power Supplies are truly contributing not only to the transportation industry but to many other industries as well. Wherever direct current must be changed in voltage, or to alternating current, for fluorescent lighting or other applications they have proved their advantages. They offer efficiency, versatility and economy in current conversion; and as they are now serving the armed forces with dependability, so in the electronic and electrical era of tomorrow, they will benefit many fields: Transit, railroad, aviation, marine, radio, electronic and electrical, and will have many individual applications within those fields for power outputs of up to 1000 watts.

Electronic Laboratories are pioneers in the field of vibrator conversion of current, and have developed many exclusive advantages in the heavy and light-duty power supply field. For radio telephone, aircraft radio, fluorescent lighting and electrical appliance operation and other specialized applications, Vibrator Power Supplies are the superior type of current conversion unit. . . . Consult with E-L engineers concerning your power supply problem.

E-L STANDARD POWER SUPPLY MODEL S-1050

Model S-1050 is a typical military model Vibrator Power Supply which may easily be adapted for peacetime mobile radio transmitters. Input voltage: 12 or 24 volts DC. Output voltage: 475 volts DC at 200 MA, 8 volts DC at 4.5 MA. Dimensions: $9\frac{1}{2} \times 8\frac{3}{4} \times 13\frac{13}{16}$ inches. Weight: 52 pounds.

Write for further information of this and other models.



Electronic

LABORATORIES INC.

INDIANAPOLIS

VIBRATOR POWER SUPPLIES FOR LIGHTING, COMMUNICATIONS, AND ELECTRIC MOTOR OPERATION • ELECTRIC, ELECTRONIC AND OTHER EQUIPMENT

Dependable Power..

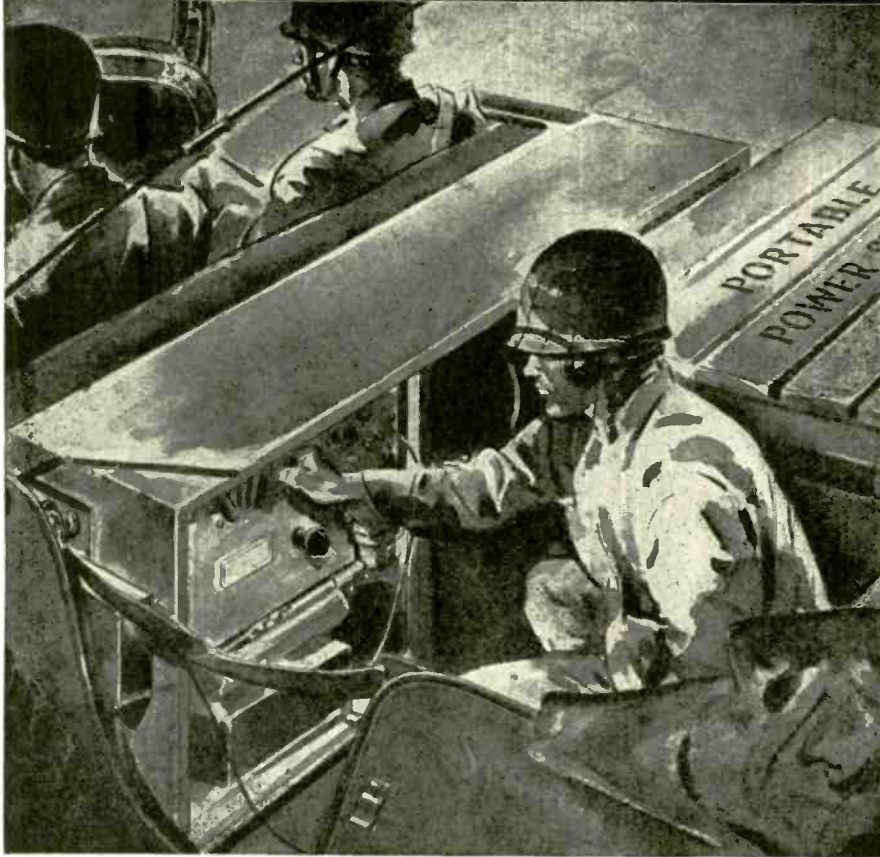

Probably the most important single factor in modern warfare is complete, dependable communications. Dependable communications require a dependable power supply. Pincor is proud of its part in furnishing portable gasoline-driven and other electrical power supply units to the fighting front as well as to the home front.

Look to Pincor for your postwar needs in power plants, motors, converters and battery chargers.

DYNAMOTORS . . . CONVERTERS
GENERATORS . . . D C MOTORS
POWER PLANTS...GEN-E-MOTORS

BUY WAR BONDS!

PINCOR
Products

**PIONEER
GEN-E-MOTOR
CORPORATION**
5841-49 DICKENS AVENUE
CHICAGO 39, ILLINOIS

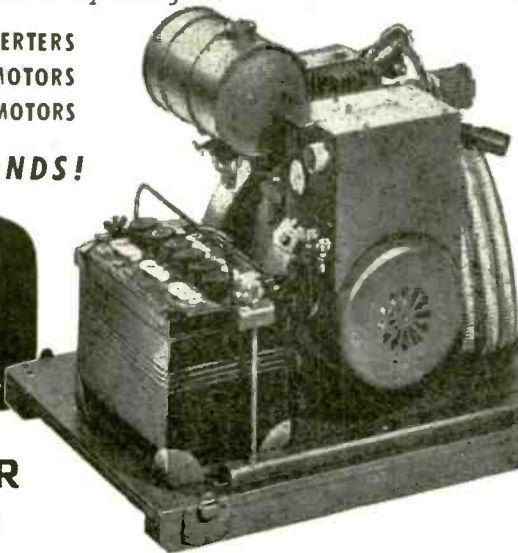

EXPORT ADDRESS: 25 WARREN STREET, NEW YORK 7, U. S. A. • CABLE ADDRESS: SIMONTRICE, NEW YORK

ELECTRONIC TOOLS IN RESEARCH

(Continued from page 85)

a proper optical system in which focusing is accomplished by electromagnetic lenses, this electron beam permits much higher resolution than that obtained in microscopes using light (approximately 4000 to 7000 Angstroms in wavelength). Consequently, higher useful magnifications (up to 100,000 diameters) are obtainable with the electronic instrument. To hold the voltages applied to the electron beam and to the electromagnetic lenses stable to less than 0.1 per cent complex vacuum tube circuits are required.

The electron microscope has proved valuable in studying the size, shape, and structure of particles in the range of sizes between 50 and 50,000 Angstrom units. This is essentially the realm of colloids and includes most pigments, fibers, bacteria, and viruses. By the use of a replica technique (see *Electronic Industries*, Oct., 1943), surface structures of solid objects can also be studied with the electron microscope.

By means of a special attachment, electron diffraction patterns of crystalline specimens may be obtained. These patterns may be used for analysis in the same man-

(Continued on page 148)

JONES BARRIER STRIPS

**SOLVE MOST TERMINAL
PROBLEMS**



No. 151

A compact, sturdy terminal strip with Bakelite Barriers that provide maximum metal to metal spacing and prevent direct shorts from frayed wires at terminals.

6 SIZES

cover every requirement. From 1/4" wide and 13/32" high with 5-40 screws to 2 1/2" wide and 1 1/8" high with 1/4"-28 screws.

Jones Barrier Strips will improve as well as simplify your electrical intra-connecting problems. Write today for catalog and prices.

HOWARD B. JONES COMPANY
2460 WEST GEORGE STREET
CHICAGO, 18 ILLINOIS

Introducing "Control Gaging"—A New Technique

EXPERIENCE spot-lighted the necessity for gaging at the machine by which the operators themselves could quickly detect any tendency towards "out-of-control" running.

Setting go-no-go gages at the specified tolerance was ineffective. Studies resulted in development of a simple technique which we have called "control gaging."

This new technique, now used by Hunter on all control-charted operations, has proved very efficient. On short-run, close-tolerance jobs, where control charting cannot be effectively applied, control gaging obtains a degree of control comparable with long-run control-charted jobs.

In control gaging, the setting of the gages is determined by a simple mathematical analysis of samples from the machine. While running, the operator draws 5 pieces produced in suc-

cession, passes them through the control gage, and notes the number of failures at both limits. If, for example, over 2 pieces fail at the high limit the machine is running to the high side. A combination of low and high failures exceeding 3 pieces indicates the range has increased.

Suppose a machine is producing parts with a tolerance of $\pm .003$ ". Now assume the machine setting shifts so that production is running $+ .004$ " $- .002$ ". The machine operator has only one chance in 44 of detecting the shift using conventional gage limits. Control gages, however, would definitely show the machine was off center through an increase in number of gage failures (beyond the 2 high max.) to 26% of the lots checked. The ratio of efficiency is at least 10/1 in favor of the control gage method.

THIS PROBLEM posed in the last paragraph above is illustrated by the models below. The heights of the bars show the relative frequencies with which control gage limits are exceeded. Note the strong positive shift in these frequencies with off-center running. Control gage setting for sample size

$5 = \bar{X}' \pm .577 \bar{R}$. If you are not already acquainted with statistical methods for quality control we recommend that you promptly obtain copies of ASA Bulletins Z1.1-1941, Z1.2-1942 and Z1.3-1942 from the American Standards Association, 29 West 39th Street, New York, N. Y.

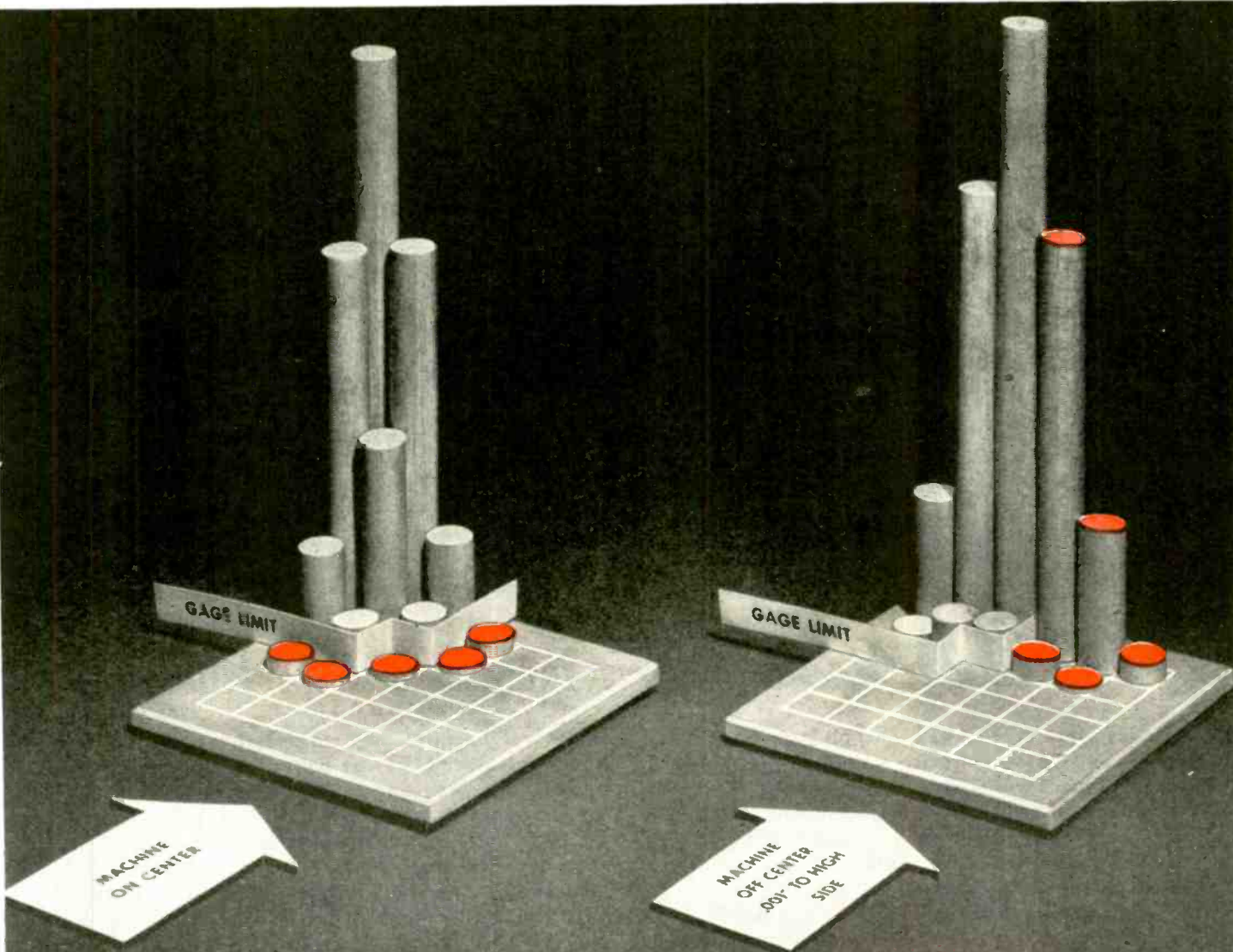

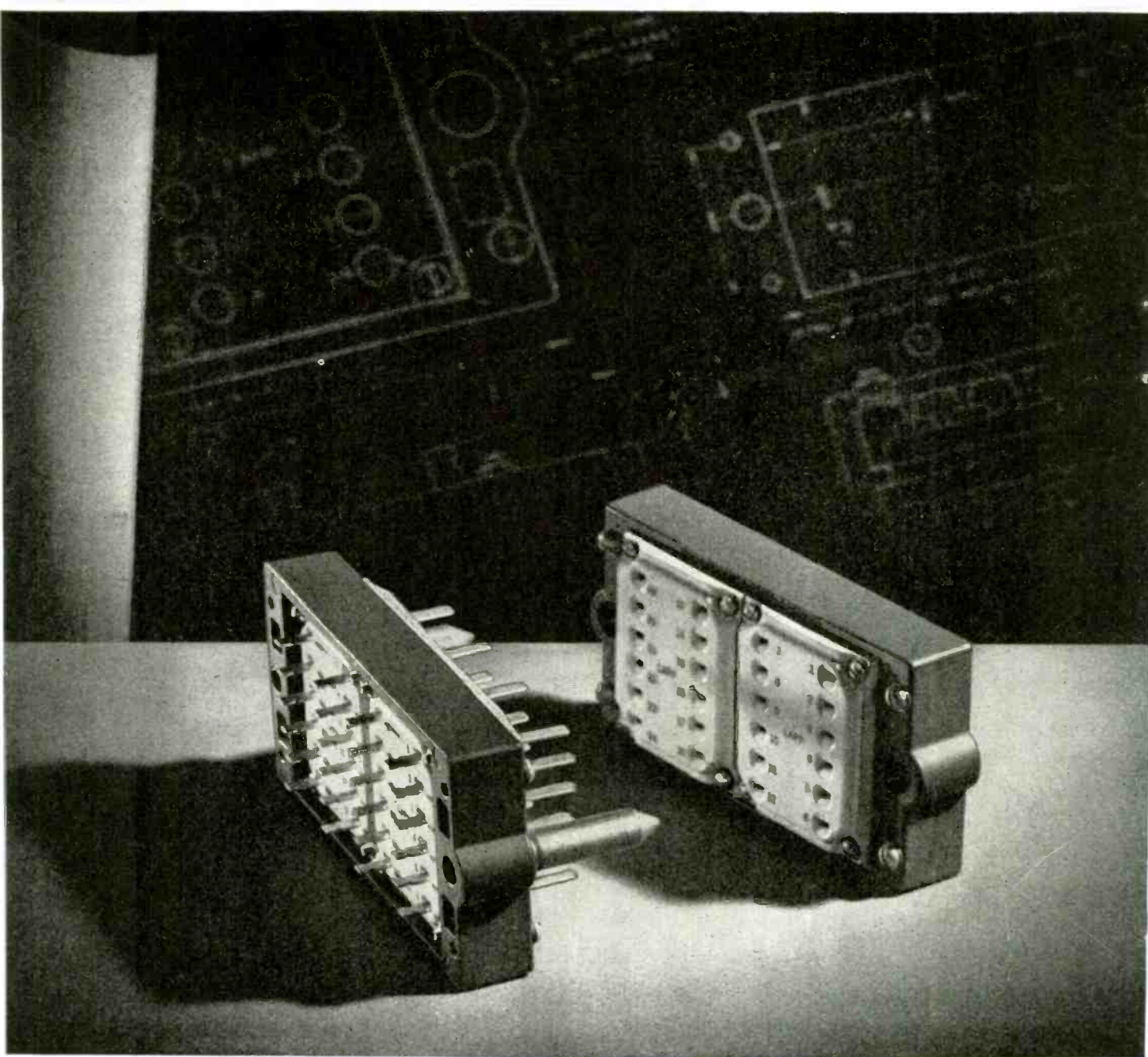

An Electronic Part ... ENGINEERED TO A SPECIFIC NEED

This is a special-purpose electronic part. It is a plug-receptacle assembly for use with rack-panel type of mounting. Twenty-four silver-plated phosphor-bronze contacts are provided, each male and female contact full floating between steatite plates. Heavy guide pins and matching holes in the frame assure perfect alignment.

We don't know that your product has any need for such a part as this. We do know, however, that this part is most exactly suited to its special requirement, just as are hundreds upon hundreds of other parts which have been created through Lapp engineering and Lapp production facilities directed to the solution of specific problems.

With a broad basic knowledge of ceramics—their capabilities and their limitations—Lapp has been able to simplify and to improve many types of elec-

tronic equipment through engineering and production of sub-assemblies that make most efficient use of porcelain or steatite and associated metal parts.

There may be a way you can improve performance, cut costs and cut production time through use of Lapp-designed and Lapp-built sub-assemblies. We'd like to discuss your specific requirements with you.

Lapp Insulator Co., Inc., LeRoy, N. Y.



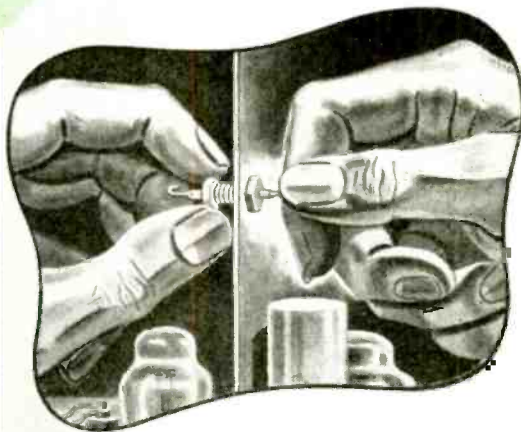
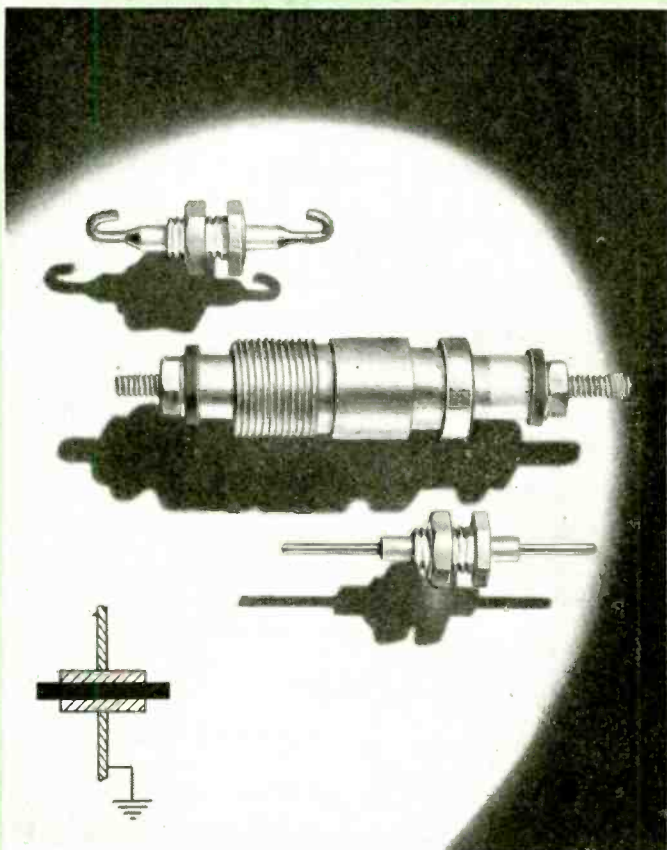

ERIE Feed-Thru CERAMICONS

REG. U. S. PAT. OFF.

For By-passing R. F. Currents to Ground

Erie Feed-Thru Ceramicons are sturdy, compact ceramic condensers of a rigid mounting type that perform the function of bypassing high frequency currents to ground through the shortest possible path. As shown in the illustration, lead inductance is practically eliminated, since the lead inductance is in series with the transmission line rather than in the path to ground.

Small sizes are made in capacities from 5 MMF through 75 MMF, and can be furnished with either straight or hooked wire leads, as shown in the photograph above. The

larger size, Erie Part No. SP-110 represents a special design for high voltage applications, and is available in capacities from 20 MMF through 250 MMF.

The Erie Resistor Engineering Department is working on several other developments for high voltage, high altitude, and pressurized feed-thru applications.

ERIE PART No.	MIN. CAP. MMF.	MAX. CAP. MMF.	WORKING VOLTAGE D. C. SEA LEVEL		OVERALL LENGTH
			50,000 FT.		
357-000 (Hooked wire)	5	75	1,000	375	1-1/16"
SP-114 (Straight wire)	5	75	1,000	375	1-1/4"
SP-110	20	250	2,000	750	2-3/8"



Electronics Division

ERIE RESISTOR CORP., ERIE, PA.

LONDON, ENGLAND • • TORONTO, CANADA

The "PASSWORD"

to reliable Control
or Protection

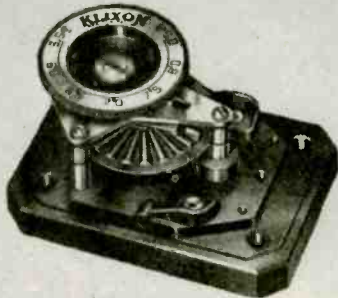
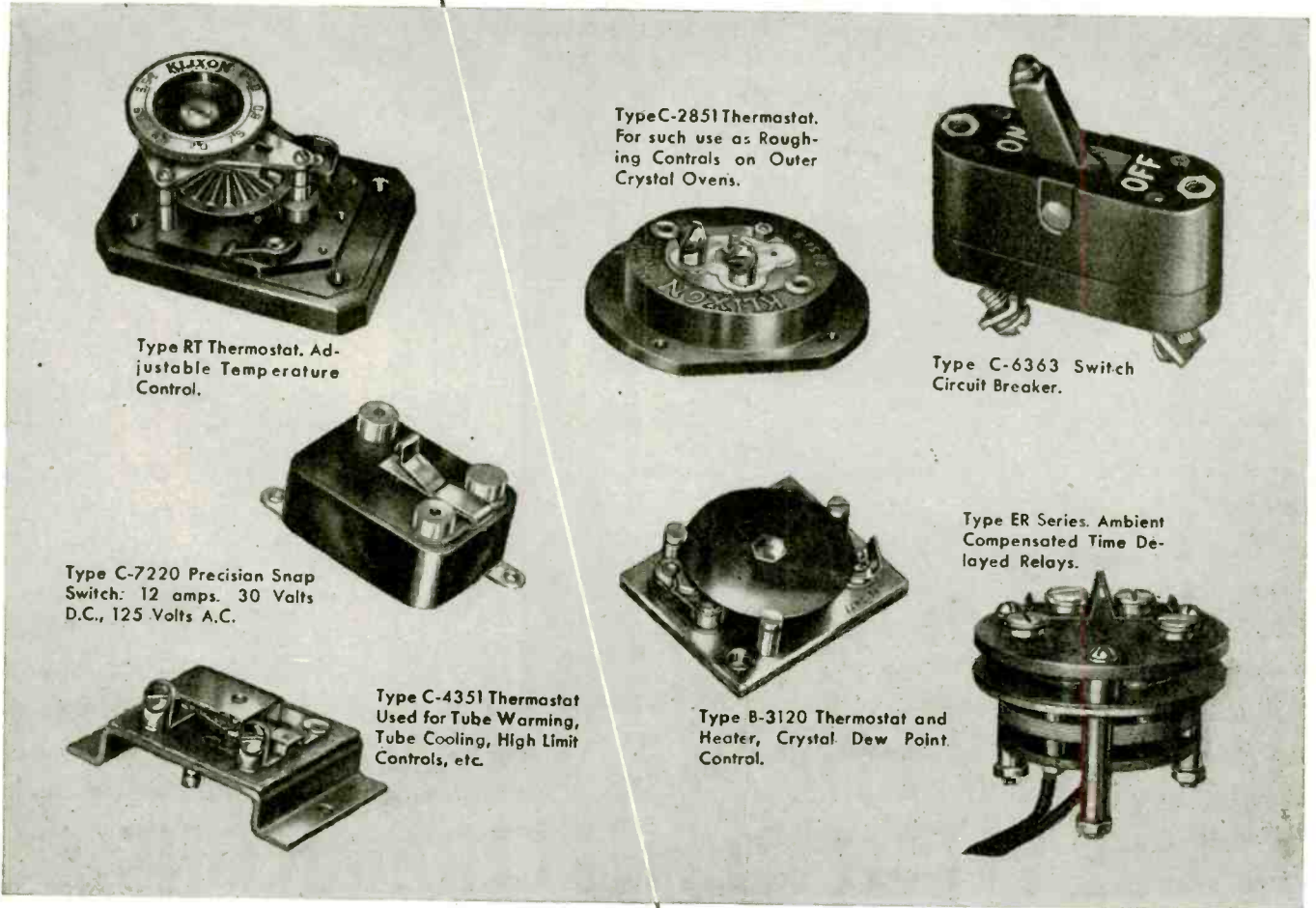

Type RT Thermostat. Adjustable Temperature Control.



Type C-2851 Thermostat. For such use as Roughing Controls on Outer Crystal Ovens.

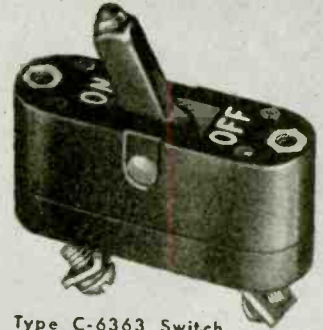

Type C-6363 Switch Circuit Breaker.

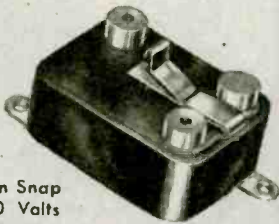

Type C-7220 Precision Snap Switch: 12 amps. 30 Volts D.C., 125 Volts A.C.

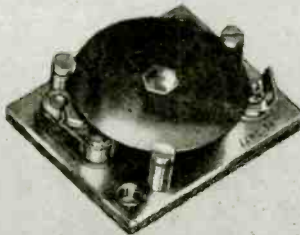

Type B-3120 Thermostat and Heater, Crystal Dew Point Control.

Type ER Series. Ambient Compensated Time Delayed Relays.

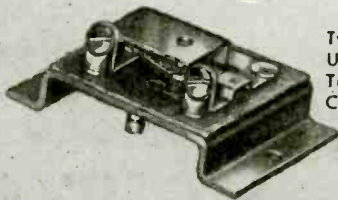

Type C-4351 Thermostat Used for Tube Warming, Tube Cooling, High Limit Controls, etc.

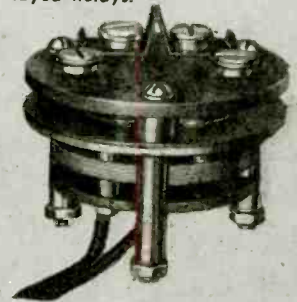

"KLIXON"

SNAP-ACTING CONTROLS

Only Klixon snap-acting controls give you the enormous advantage of simplicity of operation. Actuated by the simple scientifically calibrated Spencer thermostatic disc . . . Klixon controls have no complicated operating mechanisms . . . nothing to wear out or get out of adjustment. That's why they always provide accurate, reliable control or protection no matter where they are used.

Small, compact, light in weight, Klixon controls "snap open" to a quick, clean break or "snap close" to a solid make, no matter how often they operate. Their accurate, dependable performance is unaffected by shock, motion, vibration or altitude.

If you have a control problem, such as motor

or transformer overheat protection, electrical circuit overload protection, thermal time delays, or temperature control for radio equipment, investigate Klixon snap-acting controls. They are available in a wide range of standard types. Write for complete information.



SPENCER THERMOSTAT COMPANY, ATTLEBORO, MASS.

Recent Progress

HAS MADE AVAILABLE TO FORMICA:

- *Better Fibre Bases Such as Glass*
- *Better Resins*
- *Better Production Methods*
- *Better and More Accurate Test Information*

FORMICA'S service to the electrical engineer and the electrical manufacturer, under the pressure of war research, has improved more rapidly during the past few years than usual.

New fibre bases such as glass have made possible high frequency insulation of excellent quality—comparable for many purposes to ceramics—which can be readily machined—which is easily workable in production.

New resins such as melomine have intensified the useful qualities of many Formica grades.

Infra-red treating machines, electronic heat for curing thick sections, new types of tube rolling machines, are features of newly developed equipment that make possible better quality in greater volume.

A large investment in the most modern testing equipment has enabled the Formica laboratory to give more accurate, detailed and valuable answers to the engineer's questions regarding the exact physical and chemical characteristics of the material.

Why not make use of this exceptional equipment for service? Send in your inquiries.



THE FORMICA INSULATION CO. • 4647 SPRING GROVE AVE. • CINCINNATI 32, OHIO

Oil Type EC CAPACITRONS

... Ready to Meet Your Requirements!

Up to 10 MFD. Capacity

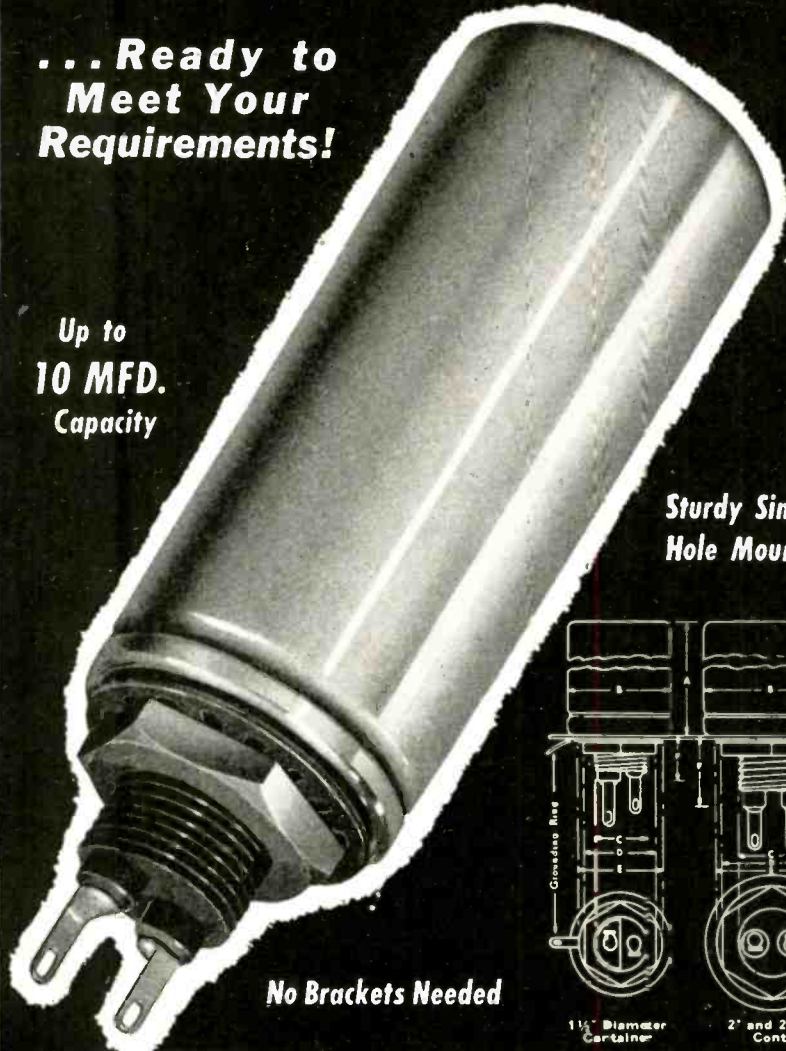

Sturdy Single Hole Mounting

No Brackets Needed

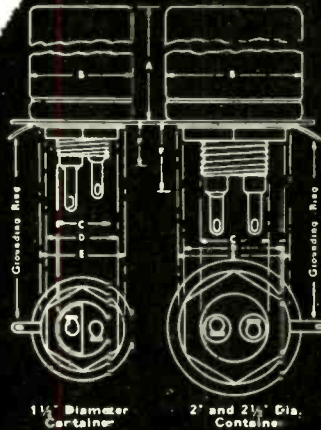

Catalog Number	Capacity in Mfd.	Working Voltage D.C.	DIMENSIONS IN INCHES					
			A	B	C	D	E	F
6EC200	2.0	600	2 3/4	1 1/2	3/4 x .6thd	1	1 1/4	3/8
6EC300	3.0	600	4 1/2	1 1/2	3/4 x .6thd	1	1 1/4	3/8
6EC400	4.0	600	4 1/2	1 1/2	3/4 x .6thd	1	1 1/4	3/8
6EC600	6.0	600	4	2	1 x .4thd	1 1/8	1 3/8	1
6EC800	8.0	600	4 1/2	2	1 x 1/4thd	1 1/8	1 3/8	1
6EC1000	10.0	600	4	2 1/2	1 x 1/4thd	1 1/8	1 3/8	1
10EC100	1.0	1000	2 3/4	1 1/2	3/4 x .6thd	1	1 1/4	3/8
10EC200	2.0	1000	4 1/2	1 1/2	3/4 x .6thd	1	1 1/4	3/8
10EC400	4.0	1000	4	2	1 x 1/4thd	1 1/8	1 3/8	1
10EC600	6.0	1000	4	2 1/2	1 x 1/4thd	1 1/8	1 3/8	1
10EC800	8.0	1000	4 1/2	2 1/2	1 x 1/4thd	1 1/8	1 3/8	1
1SEC50	.5	1500	2 3/4	1 1/2	3/4 x 1/6thd	1	1 3/8	3/8
1SEC100	1.0	1500	4 1/2	1 1/2	3/4 x 1/6thd	1	1 3/8	3/8
1SEC200	2.0	1500	4	2	1 x 1/4thd	1 1/8	1 3/8	1
1SEC400	4.0	1500	4 1/2	2 1/2	1 x 1/4thd	1 1/8	1 3/8	1

All of the Above A.W.S. Army-Navy Submersion Proof Units Available in Production Quantities for Prompt Delivery. Write, Wire or Telephone — Now!

The CAPACITRON Company

849 North Kedzie Ave.,
Chicago 51, Illinois
Telephone VAN Buren 3322

OUR NEW HOME - America's Most Modern Capacitor Manufacturing Plant

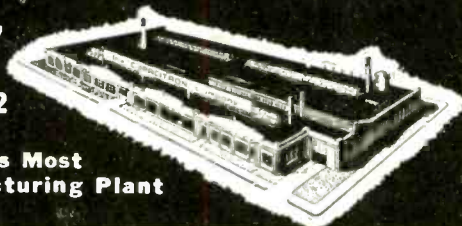

(Continued from page 142)

ner as those obtained with x-rays. At the Hercules Experiment Station, the electron microscope has found its greatest application in the study of cellulose and its derivatives.

In addition to the apparatus shown in the photographs, electronic instruments for measuring pH, apparatus for the determination of the dielectric properties of plastic materials, dielectric heating equipment, and electronic temperature controls of various types are widely used.

Vibration Amplitudes

Writing of electron microscopes in the December issue of General Electric Review, Igor B. Bensen emphasizes the need for revising vibration elimination standards. Vibration of, say, 0.00001 in. in amplitude is present in walls and floors of almost any industrial building, he points out. Yet, if the sample inside the microscope were allowed that much movement, at 10,000 times magnification, it would register on the screen as 0.1 in. A design engineer, he adds, usually is satisfied if a unit as a whole vibrates less than 0.001 in., but if the sample vibrated that much in the microscope its amplitude would become about 10 in. when fully magnified.

HAVE YOU A PROBLEM

for Electronic Specialists?

At your service are a group of highly-trained, precision workmen specializing in production of varied electronic testing equipment, sub-assemblies, and other small quantity production. Their valuable experience and thorough knowledge of electronics may be just the answer you're looking for.

Also at your service are our complete metalworking facilities for making screw machine products and small parts.

We are prepared to give immediate attention and prompt deliveries on all orders. For further information, write or wire . . .

Springfield SOUND CO.

Electronics Division

12 CASS STREET, SPRINGFIELD 4, MASS.

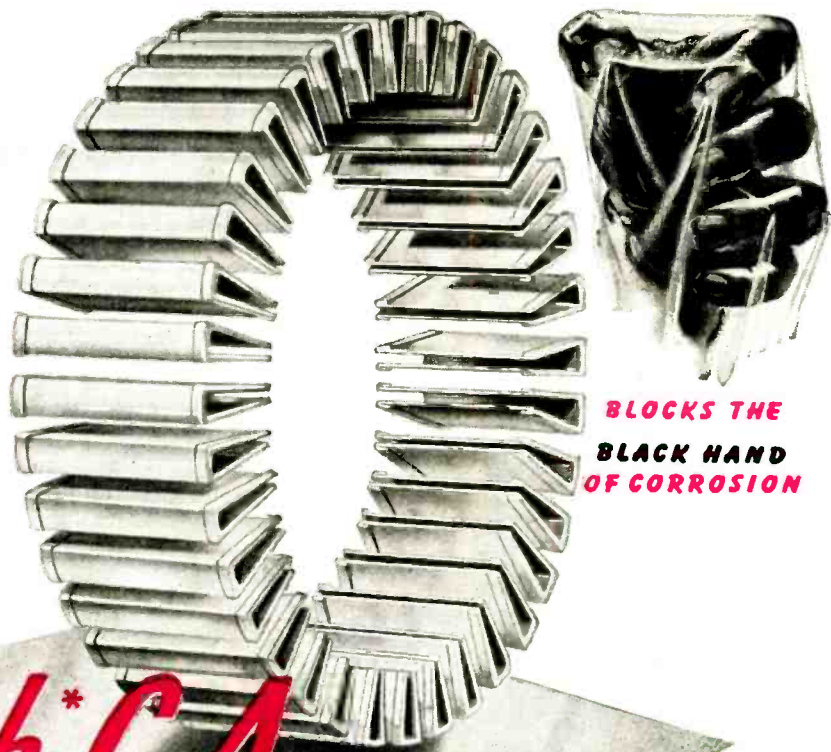

**BLOCKS THE
BLACK HAND
OF CORROSION**

Lumarith* C.A.

GIVES FREE-AIR PROTECTION TO ELECTRICAL EQUIPMENT

ORDINARY INSULATION paper—laminated both sides with Lumarith Transparent Foil—will increase the life of your electrical equipment. Lumarith Foil is a cellulose acetate base plastic with dielectric strength that remains high, even when subject to excessive humidity and temperature. Its smooth, shiny surface eases winding operations in small or hard-to-reach spaces. Lumarith is tough and flexible. As in slot insulation illustrated above, it can be folded or creased without cracking—without losing dielectric strength.

Electrical equipment insulated with Lumarith is free of corrosion hazards that threaten with other types of insulation. Lumarith is resistant to electrolytic action. It does not combine with moisture and current to give corrosion a breeding ground.

Write for names of laminators using Lumarith Foil, and ask for Electrical Booklet about Lumarith plastics in the electrical field. Celanese Plastics Corporation, a division of Celanese Corporation of America, 180 Madison Avenue, New York 16, N. Y.



**A-78 MAT FINISH
PREVENTS WIRE SLIPPAGE**

... gives more visibility to foil ... increases elongation ... does not require talc or other lubricants.

Celanese Yarns and Fabrics offer the same qualities of high dielectric strength and corrosion resistance as Lumarith Plastics. For data, address Celanese Corporation of America, 180 Madison Ave., New York 16, N. Y.

A Celanese Plastic*

*Reg. U. S. Pat. Off.

RCA's New 170-A

Audio Chanalyst

Tests Everything
from Microphones
to Multiple Speakers



THE new 170-A Audio Chanalyst is a combination testing unit which includes the famous Voltohmyst circuit, a new diode flat through the audio range, a B.F.O. signal source, a gain calibrated amplifier, and speaker and line output connections.

The various channels of the RCA Type 170-A can be used independently or in unison to check

all common defects in audio amplifiers and sound systems. Polarity indication and a.c. can be determined instantly with the new electronic indicator, without danger of overload!

A pamphlet containing full description and specifications of the 170-A Audio Chanalyst will be sent gladly, on request.

Please use this coupon ↘

BUY MORE WAR BONDS



Test & Measuring Equipment, Dept. 97-87B
Radio Corp. of America, Camden, N. J.

Please send the bulletin describing the new RCA 170-A Audio Chanalyst to:

Name

Position

Company

Street City.....

RADIO CORPORATION OF AMERICA

RCA VICTOR DIVISION • CAMDEN, N. J.

In Canada:

RCA VICTOR COMPANY, LTD., MONTREAL

Faradon Condensers for Industrial Oscillators

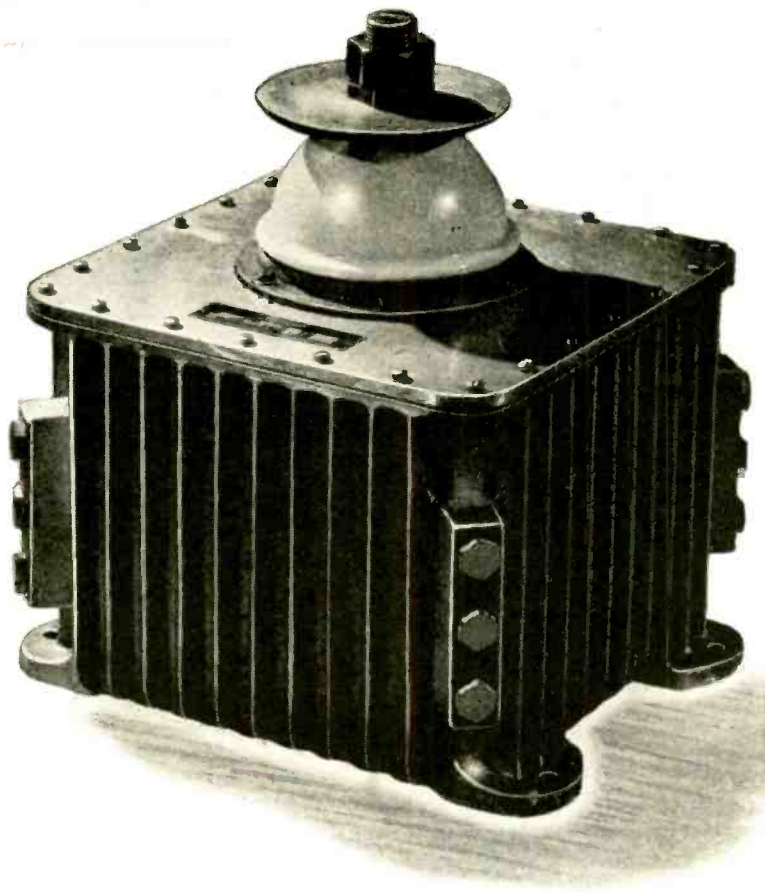

Faradon Power Condenser used in Industrial Oscillators

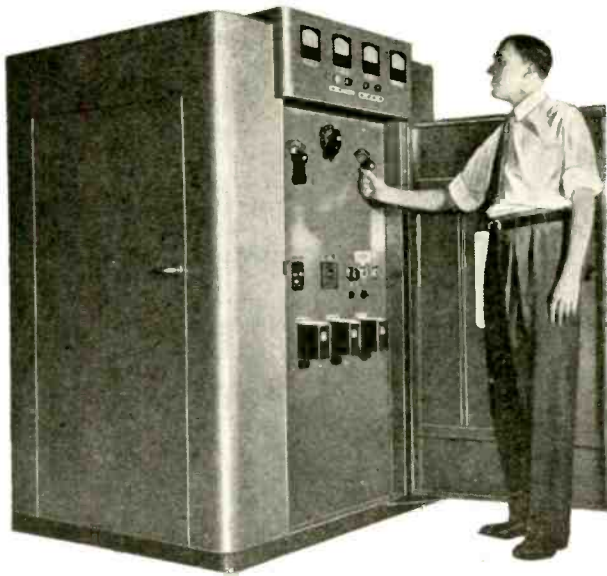

*RCA 15,000-Watt Electronic
Generator for electronic heating*

For 25 years Faradon Condensers have been used in outstanding communication and broadcasting equipment built by RCA and other well-known manufacturers.

Today these condensers are finding new uses in electronic power generators, which are serving industry in many ways.

The reliability of Faradon Condensers, the wide range of sizes available, and the facility with which they can be adapted to design requirements, makes them a natural choice for all such applications.

For information on Faradon Condensers, for any purpose, write to Engineering Products Department, RCA Victor Division, Camden, N. J.



BUY MORE WAR BONDS

RADIO CORPORATION OF AMERICA

RCA VICTOR DIVISION • CAMDEN, N. J.

In Canada, RCA VICTOR COMPANY LIMITED, Montreal

More
Examples of
ACME ENGINEERED
TRANSFORMERS

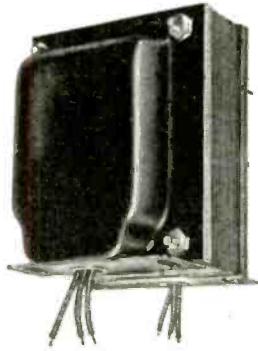

AUDIO TRANSFORMERS

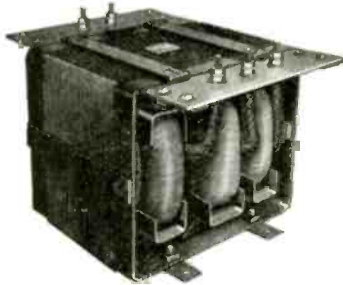

**HIGH LEAKAGE REACTANCE
 FILAMENT TRANSFORMERS**

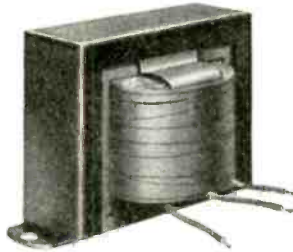

**INTERSTAGE
 TRANSFORMERS**

THE ACME ELECTRIC & MANUFACTURING CO. • CUBA, N. Y. • CLYDE, N. Y.

Acme ACME Electric

ELECTRICAL

Time Controlling Instruments

Their correct application . . .
 use, design and functioning.

If you use one or a million such instruments—our specialized engineers, backed with our special equipment, are anxious to work with you to make that instrument "forgettable" forever.

Write us, telling us what
 you use Timing Devices for
 or what you have to be
 Time Controlled (electrically),
 and we will gladly lay be-
 fore you, FREE, instructive
 and helpful data.



TYPE TD1

The R.W. CRAMER COMPANY Inc.
CENTERBROOK CONNECTICUT

WABC'S ANTENNA

(Continued from page 89)

way to make the line air tight. A vacuum tube voltmeter with a special probe was used for making the voltage measurements.

The adjustment of the antenna was carried out in the following order. First each bay was adjusted separately. They were then combined and adjusted as a pair, and finally the transmission line was matched to the transmitter. A steeplejack was available to climb the pole and make the necessary adjustment on the condensers. With the top bay alone operating at low power the standing wave condition on the pair of 7/8 in. lines feeding it was determined. The steeplejack then made an appropriate change in condenser setting in the top bay. The standing wave was again investigated and the process repeated until a satisfactory adjustment was obtained. The lower bay was adjusted in the same manner. The two bays were then both connected and minor adjustments made to insure correct operation of the pair.

The final adjustment of the antenna left a standing wave ratio of about 1.7 on all transmission lines. This was considered satisfactory since there was a more than adequate safety factor in the size of all transmission lines and the measurements indicated that the power was dividing equally between bays and that the bays were operating in phase.

The proposed field intensity measurements on the new antenna have not been completed. However, sufficient progress has been made so that a comparison can be had with the old antenna and with the predictions for the new antenna. The measurements that have been made include two complete radials with the new antenna, one complete radial with the old antenna and three partial radials with the old antenna.

The measurements made on the old antenna agree with the predictions except in the directions shielded by the water tank penthouse. To the west and southwest the calculated distances to the 1 mv/m contour were 17.5 miles and 18.9 miles respectively. The measurements indicate that these distances actually were 17 miles and 18.5 miles. However, to the northwest and northeast the distances to 1 mv/m contour were calculated to be 17.6 miles and 18 miles respectively. Here the measurements indicate that those distances are 9 miles and 11 miles. In the northeast direction 50 uv/m contour was located at 38 miles by the measurements while the calculations indicated it should have been at about 50 miles.

(Continued on page 156)



A NEW JUNGLE FIGHTER

Moves Up...

TROPICALIZED Q-MAX A-27, H. F. LACQUER Protects Communication Equipment Against FUNGI

Tropical fungus and mold does not respect the finest workmanship and performance which can be built into communication and electrical equipment. Ruthless as any Jap, it attacks unprotected surfaces and swiftly deteriorates vital communications such as walkie-talkie, handy-talkie, radar, power plants, signal detector apparatus and scores of other electrical devices that "move up" with our armed forces and contribute to victory. But they can "move up", jungle-proofed against this insidious enemy, if you use Tropicalized Q-Max A-27, H. F. Lacquer.

The tropicalizing of this effective dielectric coating material was a wartime achievement of our chemists who sought and found an ideal fungicide that would combine well with the lacquer, and yet retain its good electrical characteristics and its high corrosion resistance.

To fungus-proof components of your communication equipment destined for the tropics and shut out harmful moisture, play safe by using this tropicalized lacquer. Dip or brush on during your assembly operations—you'll find it not only coats the surface, but also provides a protective surface *around* the coated area. Specify and look for the word *Tropicalized* on the factory-mixed Q-Max fungicidal lacquer.

Coaxial Transmission Line and Fittings
Sterling Switches
Auto-Dryaire
Antenna and Radiating Systems
Tropicalized Q-Max A-27, H.F. Lacquer

Communication

PRODUCTS  COMPANY, Inc.

FACTORY & OFFICES: 346 BERGEN AVENUE
JERSEY CITY, NEW JERSEY

Q-MAX CHEMICAL DIVISION



"Judged by
the company
you keep"



● **LEADING PHONOGRAPH-RADIO COMBINATION
MANUFACTURERS HAVE USED
DEPENDABLE SEEBURG RECORD CHANGERS**

● **LEADING PHONOGRAPH-RADIO COMBINATION
MANUFACTURERS CAN DEPEND
UPON SEEBURG RECORD CHANGERS**

After Victory!

BUY WAR BONDS

Awarded to the J. P. Seeburg Corporation for outstanding production of war materials in each of its four plants



J. P. SEEBURG CORPORATION · CHICAGO

Seeburg

TINE MUSICAL INSTRUMENTS SINCE 1902

A MODERN TOOL FOR MODERN INDUSTRY

-MEGATHERM *ELECTRONIC HEAT

Here is high-speed uniform heat—precision controlled and directed—offering tremendous possibilities for new products and new processes . . . for faster, more efficient production . . .

That's Megatherm—high-frequency electronic heating at its best—a modern tool with uses as broad as industry itself.

In the processing of plastics, foods, drugs, candy, paper, textiles, wood products, and in printing, book-binding . . . in the surface hardening of metals, brazing, soldering, and annealing . . . to mention only a few of an endless number of possible applications.

Megatherm is available in a range of compact, efficient models—powers from 3 kilowatts to 100 kilowatts. One of these models is right for your work.

Now, while you are planning for the future, is the time to get the story on Megatherm—learn how it will speed your production—cut your costs—make new designs—new products and new materials possible. Write for data.



Federal Telephone and Radio Corporation

*Reg. U. S. Pat. Office

INDUSTRIAL ELECTRONICS DIVISION



Newark 1, N. J.

Pioneers Yesterday
Pioneers Tomorrow

TURNER Microphones

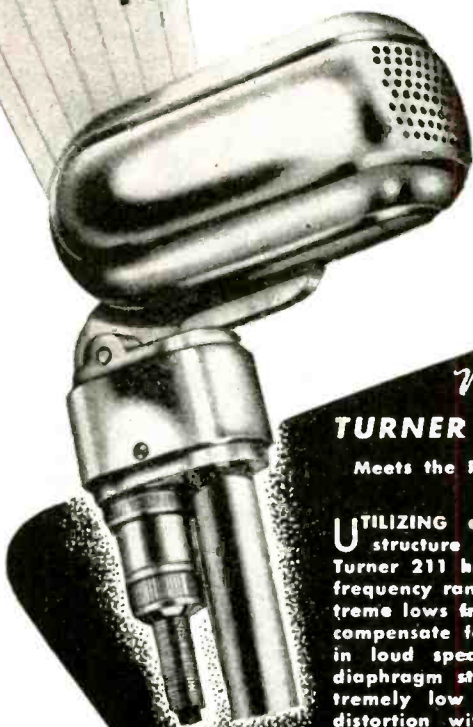

New

TURNER 211 Dynamic

Meets the Requirements of FM

UTILIZING a new type magnet structure and acoustic network, Turner 211 has extended the high frequency range and raised the extreme lows from 2 to 4 decibels to compensate for overall deficiencies in loud speaker systems. Unique diaphragm structure results in extremely low harmonic and phase distortion without sacrificing high output level. A sensitive unit for extra intelligible sound transmission, Turner 211 has wide application in military and industrial areas, as well as for P.A. systems and broadcast studios, including FM. Write for specifications.

(TURNER 211)

Free

Write for Free Turner Microphone Catalog giving complete information on all Turner Microphones.



Crystals licensed under patents of the Brush Development Co.



9X-D



22X-D



999

The

TURNER Company

CEDAR RAPIDS, IOWA

With the new antenna the measurements agreed quite well with the calculations. In a northwesterly direction the calculated and measured distances to the 1 mv/m contour were 24.5 miles and 22.5 miles, and for the 50 uv/m contour the distances were both 59 miles. In the northwestern direction the terrain is more rugged and the field intensity drops off more rapidly than would be expected from prediction by the FCC method. The distances in this direction to the 1 mv/m contour are 23 miles, calculated, and 19 miles, measured. An examination of the topographic profile in this direction shows numerous valleys where the field is reduced so that average field intensity for any sector a few miles long would be materially lowered. Also a large valley which starts 39 miles from the transmitter is sufficiently shaded from the transmitter so that very little energy is diffracted into it.

An examination of the topographic profiles in other directions indicates that the contours would be located approximately as calculated except for the northern direction.

Wanted ENGINEERS

Radio

*Electrical

Electronic

*Mechanical

Metallurgical

*Factory Planning

Materials Handling

Manufacturing Planning

Work in connection with the manufacture of a wide variety of new and advanced types of communications equipment and special electronic products.

Apply (or write), giving full qualifications, to:

R.L.D., EMPLOYMENT DEPT.

Western Electric Co.

100 CENTRAL AV., KEARNY, N. J.

*Also: C.A.L.

Locust St., Haverhill, Mass.

Applicants must comply with WMC regulations

COPPER
SULPHIDE



SELENIUM

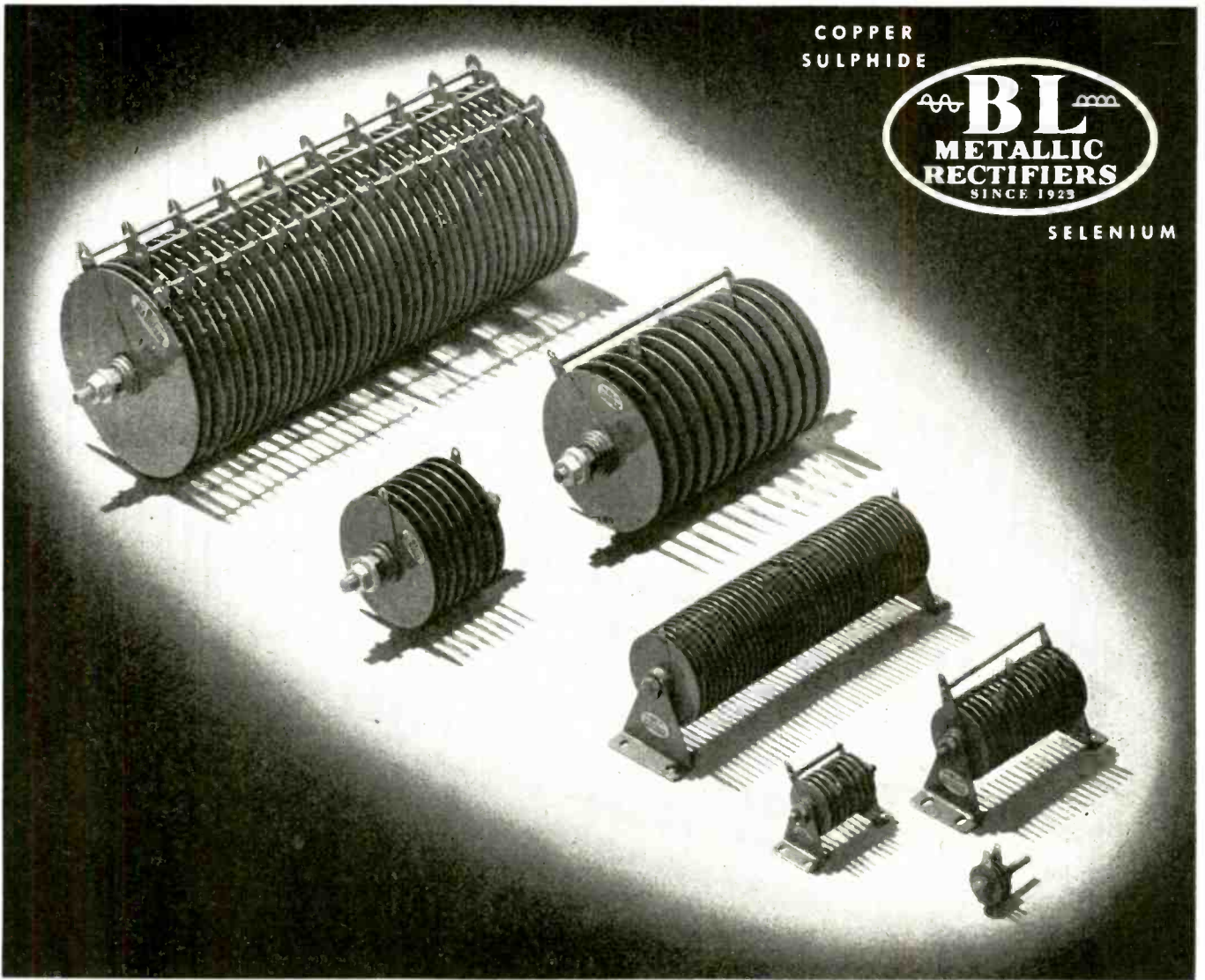

B-L METALLIC RECTIFIERS from Milliwatts to Kilowatts

If you have an A. C.-D. C. conversion problem, let B-L engineers help you. We have successfully produced many appliances formerly thought impractical.

B-L Metallic Rectifiers have been favorably known to the electrical industry for

many years. They are reliable, efficient, designed to get *your* job done right!

No matter what rectifier applications you are considering, B-L will be glad to work with you. Selenium and Copper Sulphide Rectifiers for all needs are available.

*Write today for Bulletin R-41b giving full details about B-L Selenium Rectifiers.
Bulletin R-38b for full details about B-L Copper Sulphide Rectifiers.*

COPPER
SULPHIDE



SELENIUM

THE BENWOOD LINZE COMPANY

1815 Locust Street • • • St. Louis 3, Mo.

DESIGNERS AND MANUFACTURERS OF COPPER SULPHIDE AND SELENIUM RECTIFIERS,
BATTERY CHARGERS, AND D.C. POWER SUPPLIES FOR PRACTICALLY EVERY REQUIREMENT.

**SEALED AGAINST
THE ELEMENTS...**

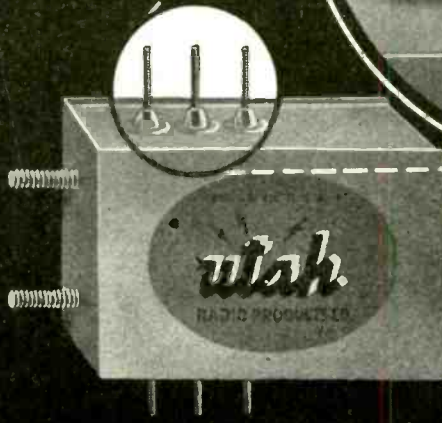
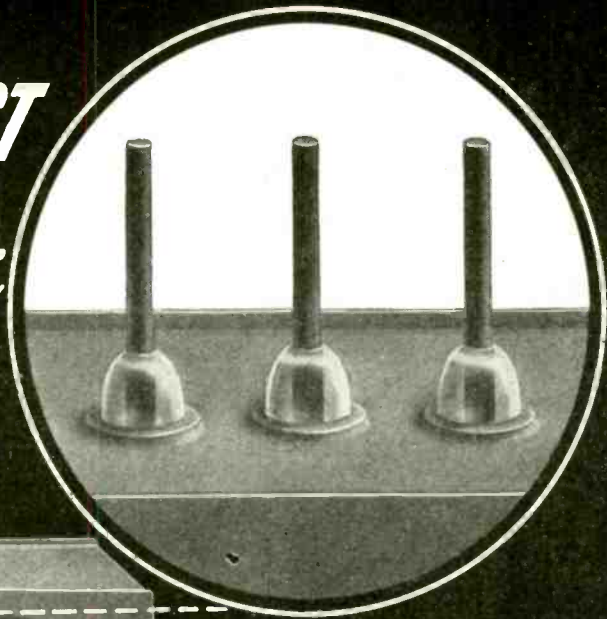

...with **STUPAKOFF**
Metal-Glass Terminals

The hermetically sealed transformer illustrated functions properly under the most adverse conditions. Stupakoff metal-glass terminals, soldered, welded or brazed to the container, protect against humidity, fungi and other elemental hazards. Ideal working conditions are sealed in—detrimental conditions are sealed out.

Stupakoff metal-to-glass sealed terminals are made possible by the metal, Kovar—a cobalt, nickel iron alloy which forms a chemical bond with glass through a heating process, in which the oxide of Kovar is dissolved into the glass. Kovar matches the expansion of thermal shock resistant

glass and forms a permanently vacuum and pressure tight seal.

Stupakoff manufactures Kovar-glass terminals with single or multiple, solid or hollow electrodes. For those equipped to do their own glass working, Kovar is supplied as sheet, rod, wire, or tubing; or fabricated into cups, eyelets or special shapes.

Write Stupakoff today for assistance in engineering Kovar-glass terminals to your product.

**KOVAR*Glass
Seals for**

**ELECTRONIC TUBES
TRANSFORMERS
RESISTORS
CAPACITORS
CONDENSERS
VIBRATORS
SWITCHES
RELAYS
INSTRUMENTS
GAUGES
METERS
RECEIVERS
TRANSMITTERS**

DO MORE THAN BEFORE—BUY EXTRA WAR BONDS

*TRADE MARK 337962 REGISTERED IN U. S. PATENT OFFICE



STUPAKOFF CERAMIC AND MANUFACTURING CO., LATROBE, PA.

Products for the World of Electronics

**PUT THIS
TUBE
TO WORK**



without kid gloves

Good news for designers of welding and motor controls, timing circuits, and voltage regulating devices:

This stream-lined Westinghouse Thyatron WL-672 has everything you need in a grid-controlled mercury vapor rectifier. Look at its sturdy industrial size base, slotted to give greater creepage distance . . . oversize anode-support and dome-type construction hold every part rigidly in its exact position, for unwavering performance . . . extra large high-current-capacity pins and cap that won't get hot and burn off . . . totally enclosed arc stream for better control.

Designers and users of electronic equipment know that all these features add up to Perfect Performance of every WL-672 during a long trouble-free life. Such performance is typical of every tube marked

"Westinghouse." It's the result of Westinghouse engineering, complete quality control over all the raw materials, and precision control over the many steps in the making of tubes.

No electronic equipment is better than its tubes and no tubes are better than Westinghouse tubes.

For complete information on any Westinghouse Thyatron, as well as Ignitrons, Phanotrons, Pilotrons, Kenotrons, and Phototubes, write to your nearest Westinghouse District Office or to Westinghouse Electric & Manufacturing Co., Lamp Division, Bloomfield, N. J.

Westinghouse

PLANTS IN 25 CITIES OFFICES EVERYWHERE

Quality Controlled Electronic Tubes



BEAT FREQUENCY GENERATOR

Type 140-A

*A dependable
test instrument*

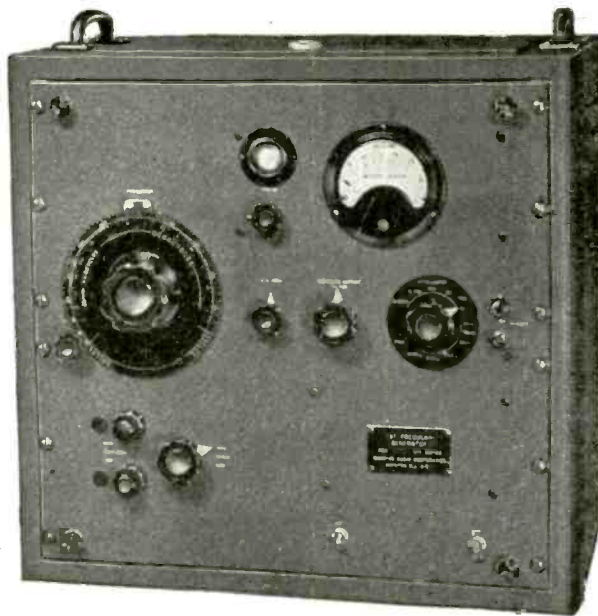

An accurate signal source capable of supplying a wide range of frequencies and voltages.

Frequency Range 20 C.P.S. to 5 MC.
Output Voltage 1 mv to 32 volts.
Power Output 1 watt.



BOONTON RADIO
BOONTON, N. J. *Corporation*



DESIGNERS AND MANUFACTURERS OF THE "Q" METER . . . OX-CHECKER . . . FREQUENCY MODULATED SIGNAL GENERATOR . . . BEAT FREQUENCY GENERATOR . . . AND OTHER DIRECT READING TEST INSTRUMENTS

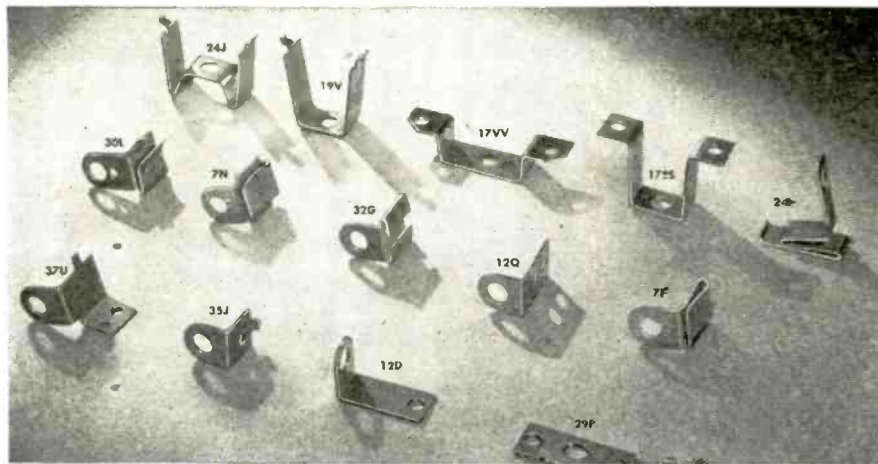

**WHAT BRACKET
DO YOU NEED?**

Drake Mounting Brackets are designed and built in every conceivable shape to bring lamp filaments into desired positions. There are now over 950 different kinds available! This big variety is sufficient to cover practically every requirement. However, should a new application call for a special design, our skilled socket and jewel assembly engineers will quickly design a bracket for the specific need. Our literature does not describe this full line of brackets. If you'll send us a sketch we'll gladly submit a sample of closest stock design. Please write us about your needs.



Socket and Jewel Light Assemblies

DRAKE MANUFACTURING CO.

1713 WEST HUBBARD ST., CHICAGO 22, U.S.A.

NEW BOOKS

Technic of Electrotherapy

By S. L. Osborne, Assistant Professor, Department of Physical Therapy, Northwestern University Medical School, Chicago, and H. J. Holmquest, Lecturer in Applied Physics at the same institution, and Research Engineer for the General Electric X-Ray Corp. Published by Charles C. Thomas, Springfield, Ill., XII + 760 pages, 240 figures and 72 tables, \$7.50.

This book covers in a thorough manner the use of electrical currents in therapeutic applications, including direct currents, low and high frequencies. It will prove an excellent guide in giving physicians the essential physical foundation upon which this art is based, and the physiological effects that influence its operation. The book is scientifically accurate and gives rational approach to technics that have too often been based on "rule of thumb" knowledge gleaned from equipment salesmen and casual reports. The book will also provide a source of information for engineers as to present day developments, that will enable them to keep in touch with this rapidly growing art. The sections on high frequency therapy and the generating of artificial fevers are of particular interest.

(See also page 213)

BIRD & CO. GLASS INSTRUMENT BEARINGS

GLASS "V" BEARINGS
made to your specifications



We welcome your inquiries

RICHARD H. BIRD

Manufacturers of Jewel Bearings
for thirty years

23 MOODY STREET
WALTHAM, MASS.



MEC-RAD

MANUFACTURERS OF MECHANICAL-ELECTRICAL
COMPONENTS FOR RADIONICS

TRAVELING WITH YOU ON THE STRAIGHT ROAD OF POST-WAR PLANNING

The period after the war may well become known as the "Electronic Era". In the development of the many ingenious post-war products, there will be a need for specialized engineering of precise and intricate high frequency components. This is our field. Our organization, with years of experience designing and making such products is at present devoting its manufacturing facilities 100% to war work. These unusual facilities will soon be available for the peacetime needs of our industry, and our engineering "know-how" is at your service now to help you with your post-war planning.



MEC-RAD

DIVISION-BLACK INDUSTRIES

1400 EAST 222ND STREET ☆ CLEVELAND 17, OHIO

Meet...



the Conant

family of instrument rectifiers

It's a distinguished family, this Conant clan of instrument rectifiers. They have taken all the mystery out of the rectifier business.

Over ninety per cent of all rectifier requirements are served by 12 types—4 basic assemblies in 3 series. These 3 series are the three members of the Conant family shown above. Special types, however, can be developed as needed, and you'll find Conant ready to cooperate.

Conant rectifiers are available from stock for immediate delivery on priorities of AA5 or higher. MRO, CMP, V3 or MILITARY END USE classifications are recognized.

If you have no priority: File form WPB 547 for your stock requirements. You'll be glad to know this Conant family of rectifiers. They're doing a great wartime job.



Instrument Rectifiers

ELECTRICAL LABORATORIES

6500 O STREET, LINCOLN 5, NEBRASKA, U. S. A.

20 Vesey St., New York 7, New York
85 E. Gay St., Columbus, Ohio
600 S. Michigan Ave., Chicago 5, Ill.
1215 Harmon Pl., Minneapolis 3, Minn.

2017 Grand Ave., Kansas City, Mo.
7935 Eustis St., Dallas 18, Texas
4018 Greer Ave., St. Louis, Mo.
1526 Ivy St., Denver, Colo.

4214 Country Club Dr., Long Beach 7, Cal.
4205 N.E. 22nd Ave., Portland 11, Ore.
Caixa Postal 930, Sao Paulo, Brazil
50 Yarmouth Rd., Toronto, Canada

WIDE READING

Transformation of Electromagnetic Waves

(Continued from page 112)

type of the progressive wave suffers certain changes, which are the more considerable, the sharper the bend. These conditions suggested a method to transform waves of one type into those of another type by using horns having perpendicular branches. Experiments on these lines were carried out with waves from 8 to 11 cm generated by low-capacity magnetrons (1-2W).

By creating a standing E_0 -wave in a circular guide having a perpendicular branch located exactly at the place of the loop in the axial field of the E_0 -wave, an H_1 -wave was obtained in the branch which was polarized perpendicularly to the plane containing the axes of both guides. The guide diameters were so chosen that the wavelength in the branch was twice the diameter of the main guide. Proper location of the loop of the E_0 -wave was secured by means of an adjustable stub in the main guide. The lengths of the standing waves were measured and the electric field in the cross-section of both guides investigated. The inverse transformation, i.e., the transformation of an H_1 -

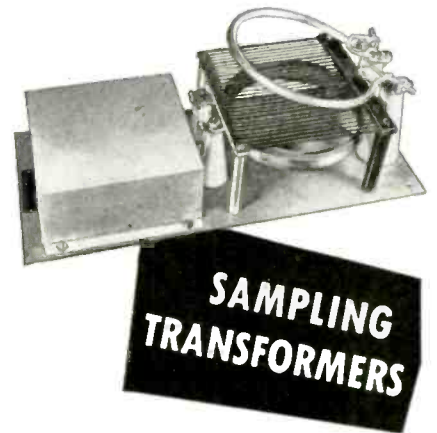

SAMPLING TRANSFORMERS

One model is available for phase monitoring with directional antenna systems. Easy to install and adjust. Results are more constant and installation and maintenance much simpler than with other sampling methods.

Another model is widely used for remote metering, giving antenna current at the antenna instead of at the transmitter. Write today for more information and prices.

JOHNSON
a famous name in Radio

E. F. Johnson Co. Waseca, Minn

ELECTRONIC INDUSTRIES • February, 1945

WIDE READING

wave into an E_0 -wave is also possible. In both instances, pure transformed waves were excited, no other waves than those intended being present.

H_0 -waves can be transformed into H_1 -waves by the same method. Since direct excitation of H_0 -waves is difficult, an E_0 -wave was excited in the main guide which was then transformed into an H_0 -wave by a wire transformer, and an H_1 -wave was generated in a branch of the main guide located beyond the wire transformer. The H_1 -waves were polarized in the plane containing the axes of both guides; they were of pure wave form when the axis of the branch guide coincided with the loops of the electric field in the main guide.

By using a cross-shaped branch instead of a T-shaped one, and by introducing an additional regulating stub into one section of the branch to increase the intensity of the transformed waves, the transformation conditions in the experiments described were facilitated.

Transformation of the H_1 -waves into H_0 -waves was attempted because of the great practical interest. An H_1 -wave was excited in the circular main guide, which was polarized in the plane parallel to the axes of both guides. The diameter of the branch guide was greater than that of the main guide. A ring-shaped conductor was placed at the branching-off point with its plane perpendicular to the branch axes, and its radius equal to 0.48 of the branch guide radius (this corresponds to the position of the electric field maximum of the H_0 -wave in the branch). The H_1 -wave induces a current in the ring-shaped conductor, which in turn excites an H_0 -wave in the branch. Under these conditions an H_0 -wave of sufficient intensity was generated in the branch, the purity of which could be improved by a volume filter.

A 1,000-g Centrifuge

R. M. Pease (Bell Laboratories Record, December, 1944)

To study the effects of accelerations, a 1,000-g centrifuge, providing 1,000 times the earth's gravitational acceleration, has been built. Two parallel steel rods are clamped at their midpoint and rotated by the adjustable-speed, dc driving motor. Fastened between the rods at their outer ends is a heavy steel plate to which is secured a mounting for the object under test. The machine and accessory equipment are described in detail.

With the test object in place, this machine may be driven at the speed necessary to give the desired acceleration. After stopping the

FAST, RELIABLE SOURCE FOR

Leading Makes of

INDUSTRIAL ELECTRONIC INSTRUMENTS



For Measurement,
Inspection,
Testing and Control

TUBE TESTERS
OSCILLOSCOPES
CAPACITY DECADES
RESISTANCE DECADES
WHEATSTONE BRIDGES
RESISTANCE LIMIT BRIDGES
WERNER CAPACITY BRIDGES
SIGNAL GENERATORS
PANEL METERS
VACUUM TUBE VOLTMETERS
VOLT-OHM-MILLIAMMETERS

Helpful
BUYING
GUIDE
Available
on Request
Write for it!

Allied's concentration of leading makes *under one roof* means you can obtain the type of instrument you want . . . *in the shortest time possible*. This specialized service to industry, government, and research laboratories

simplifies procurement . . . increases efficiency . . . saves hours, days, and effort. Such well known makes as RCA, Dumont, G.E., Industrial Instruments, Hickok, Radio City, Triplett and others. Many on hand for immediate delivery.

EVERYTHING IN ELECTRONICS AND RADIO

It's faster, simpler to get all your electronic and radio supplies from this one central source. We carry the largest and most complete stocks of parts and equipment under one roof . . . ready for immediate shipment. Besides, our procurement experts are in constant contact with all leading manufacturers to speed supplies.

*Save time and work . . . Call Allied First!
Write, Wire or Phone Haymarket 6800*

ALLIED RADIO

C O R P O R A T I O N

833 W. Jackson Blvd. Dept. 32-B-5 Chicago 7, Illinois

SUPPLIERS OF ELECTRONIC PARTS AND EQUIPMENT TO INDUSTRIAL AMERICA

Electronic Tubes, Rectifiers, Power Supplies, Intercommunicating Systems, Sound Systems, Photo-Cell Equipment, Batteries, Chargers, Converters, Generators, Supplies for Resistance Welders, Fuses, Test Instruments, Meters, Broadcast Station Equipment, Relays, Condensers, Capacitors, Resistors, Rheostats, Transformers, Switches, Coaxial Cable, Wire, Soldering Irons, Microphones, Speakers, Technical Books, etc.

WILEY Books



in COMMUNICATIONS-ELECTRONICS

Post-war plans in your field are being made now. Now is the time, then, to step up your knowledge. Be ready for new ideas. Look over the important titles listed below. Then make your selection and order from the coupon today.

FIELDS AND WAVES IN MODERN RADIO

By Simon Ramo and John R. Whinnery

503 Pages \$5.00

Authoritative data on high-frequency circuits, skin effect, shielding problems, problems of wave transmission and reflection, transmission lines and wave guides, cavity resonators, and antennas and other radiating systems—with a rigorous account of the technique of applying field and wave theory to the solution of modern radio problems.

HOW TO PASS RADIO LICENSE EXAMINATIONS—Second Edition

By CHARLES E. DREW

320 Pages \$3.00

This revised edition of a well-known book offers recent material for amateur radio operators, radiotelephone and telegraph operators, whether in the broadcasting, marine, aeronautical, or any other field of transmission or reception.

RADIO RECEIVER DESIGN—Part I

By K. R. STURLEY

435 Pages \$4.50

Communications engineers will want to own this book, which covers radio frequency amplification and detection. A detailed study, stage by stage, beginning with the aerial and going as far as the detector.

TIME PASSES—(Scanning Generators)

By O. S. PUCKLE

204 Pages \$2.75

Covers the subject from both the design and the development points of view; assembles more time bases circuits than have heretofore been available in one volume.

THE TECHNIQUE OF RADIO DESIGN

By E. E. ZEPLER

312 Pages \$3.50

Thoroughly practical, this treatment of radio design deals with the day-to-day problems of the radio engineer, both in the development and in the testing of radio receiving apparatus of all types.

APPLIED ELECTRONICS

By the Electrical Engineering Staff, Massachusetts Institute of Technology

772 Pages \$6.50

Provides a thorough understanding of the characteristics, ratings, and applicability of electronic devices. Gives a working knowledge of the physical phenomena involved in electronic conduction, plus its applications common to various branches of engineering.

HYPER AND ULTRA-HIGH FREQUENCY ENGINEERING

By ROBERT I. SARBACHER and WILLIAM A. EDSON

644 Pages \$5.50

A practical treatment of an important new branch of communications engineering, requiring no special advanced knowledge. Of value to the beginner, as well as those having some familiarity with the subject.

GUIDE TO CATHODE RAY PATTERNS

By MERWYN BLY

30 Pages \$1.50

Important for technicians and laboratory workers. This book summarizes briefly by means of sketches and captions the cathode-ray pattern types encountered in the usual course of laboratory and test bench work.

FUNDAMENTALS OF ELECTRIC WAVES

By HUGH H. SKILLING

186 Pages \$2.75

Discusses the principles of wave action as applied to engineering practice, with particular emphasis on the basic ideas of Maxwell's equations and repeated use in simple examples; also on physical concepts and mathematical rigor.

PRINCIPLES OF ELECTRONICS

By ROYCE G. KLOEFFLER

175 Pages \$2.50

Tells, clearly and simply, the story of electron theory and the operation of the electron tube. Beginning with the discovery of the electron and the forces of attraction and repulsion of charged particles, the entire action taking place in electronic devices is carefully explained.

HIGH FREQUENCY THERMIONIC TUBES

By A. F. HARVEY

244 Pages \$3.00

Gives the details of these important new tubes and describes the experimental work that has been done with them. Presents a thoroughly comprehensive account of the properties of thermionic tubes at very high frequencies and their relation to those of the associated electric circuits.

WIDE READING

machine, the effect on the apparatus under investigation may be determined. To observe the effects of the acceleration on the object as the speed of the machine is increased, a stroboscopic neon lamp is mounted to illuminate the object for a few millionths of a second every time the arm is horizontal.

Ground Absorption for Dipole Antennas

(Continued from page 112)

suming k_1^2 to be much smaller than k_2^2 , meaning that the ground conductivity, though not infinite, is quite considerable. Then the antenna resistances for horizontal and vertical dipole antennas (indicated by the subscripts H and V, respectively) are equal to:

$$120 \pi^2 \left(\frac{a l}{\lambda}\right)^2 S_H = -\frac{k_1}{|k_2|} \frac{2}{\zeta^2} \left[\zeta \cos(\zeta - \theta) - \sin(\zeta - \theta) \right]$$

$$120 \pi^2 \left(\frac{a l}{\lambda}\right)^2 S_V = S_H + \frac{2 k_1}{|k_2|} \left[\sin \theta \text{Ci}(\zeta) - \cos \theta \left(\text{Si}(\zeta) - \frac{\pi}{2} \right) \right]$$

$$\text{Si}(\zeta) = \int_0^{\zeta} \frac{\sin x}{x} dx$$

$$\text{Ci}(\zeta) = -\int_0^{\zeta} \frac{1 - \cos x}{x} dx + C + \log \zeta$$

where a is the form factor for the antenna current distribution in the antenna and l is the length of the antenna.

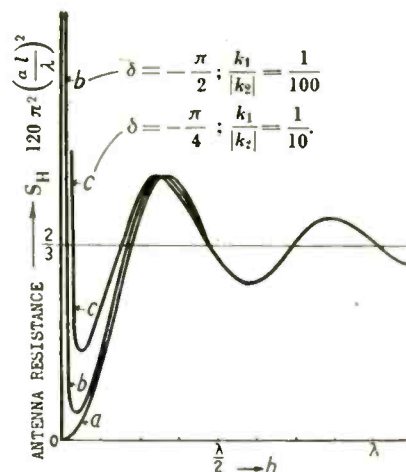

Resistance of horizontal antenna as function of distance from ground. (Ordinate scale is calibrated in values of S_H)

In the figures, curves "a" represent the antenna resistances for infinite ground conductivity, curves "b" and "c" showing the effects of finite conductivity noticeable only for small h , i.e., for antennas mounted close to the ground as compared with the wavelength.

(Continued on page 166)

ON APPROVAL COUPON

JOHN WILEY & SONS, INC.
440 Fourth Avenue, New York 16, N. Y.

Please send me on ten days' approval the books I have checked in this advertisement (or I am attaching to this coupon a separate list of the books desired). At the end of that time, if I decide to keep the books, I will remit indicated price plus postage; otherwise I will return the books postpaid.

NAME.....
ADDRESS.....
CITY AND STATE.....
EMPLOYED BY.....

EI-2-45

6 blades hardened
every **10** seconds

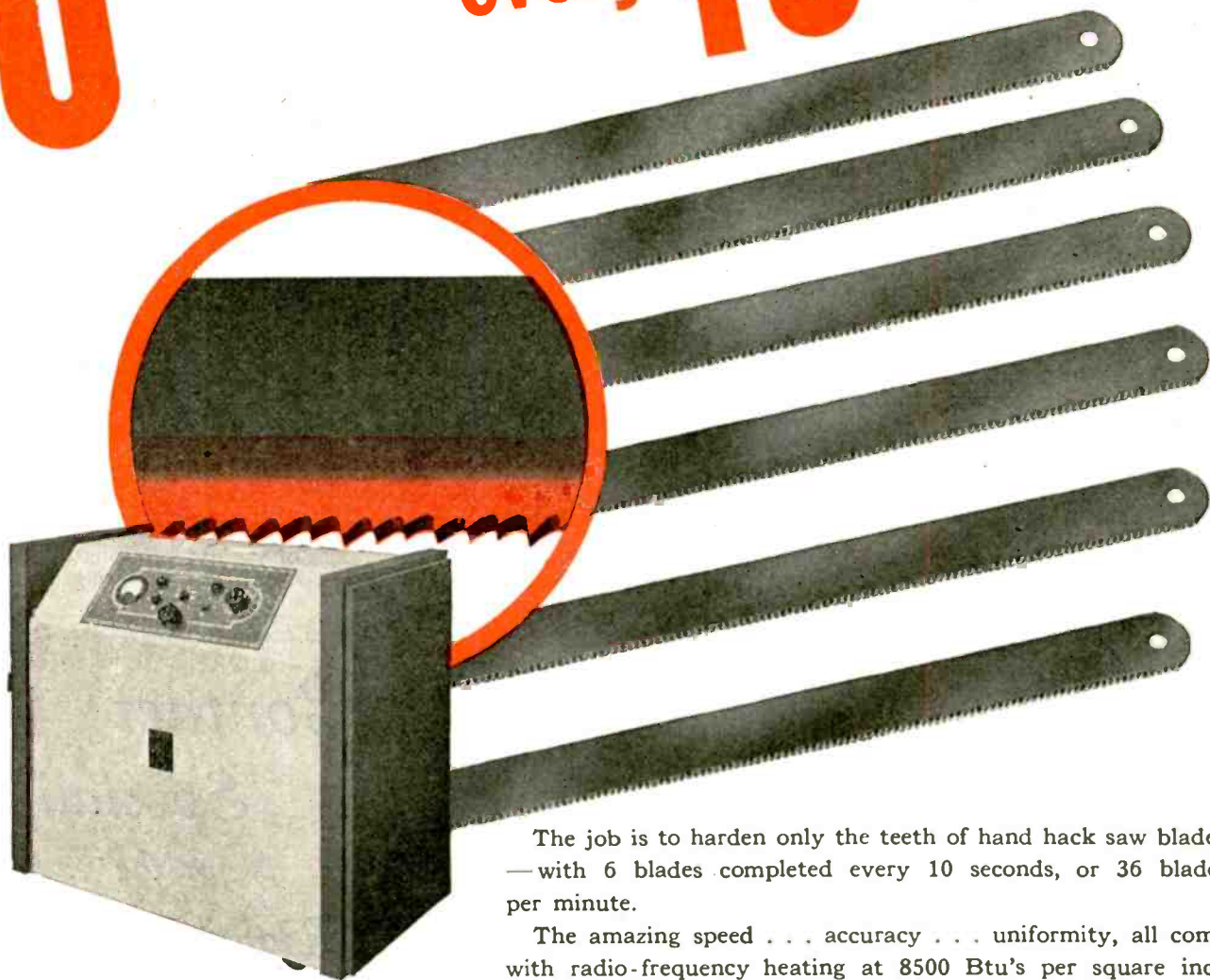

10 KW RADIO-FREQUENCY GENERATOR

This unit has many applications. Its "table top" work surface eliminates the need for small tables, and all controls are centralized on the sloping panel. Large sturdy casters provide speedy mobility.

The job is to harden only the teeth of hand hack saw blades — with 6 blades completed every 10 seconds, or 36 blades per minute.

The amazing speed . . . accuracy . . . uniformity, all come with radio-frequency heating at 8500 Btu's per square inch per minute. Compare this with the old method, at 5 Btu's per square inch per minute.

Similar high speeds are possible in every metal heating job—annealing, hardening, brazing, sintering, forging and soldering. And the heating is so simple that it's a "push button" job for unskilled help.

Another great advantage comes with Westinghouse design . . . a single shielded cabinet contains generating equipment and controls, easy to install and maintain . . . requiring a minimum of space.

Westinghouse Radio-Frequency Generators for induction or dielectric heating are available in eight different standard sizes up to 200 kw, with a range of frequencies for all but the most unusual needs. For added information, write for Descriptive Data 85-800. Or, for aid on any specific application, ask a Westinghouse engineer to call. Write Westinghouse Electric & Manufacturing Co., P.O. Box 868, Pittsburgh 30, Pa. J-08098



Westinghouse
PLANTS IN 25 CITIES . . . OFFICES EVERYWHERE

Electronics at Work

PORTABLE POWER PROBLEMS

THIS MONTH—COMMERCIAL SOLVENTS CORPORATION PENICILLIN TEST

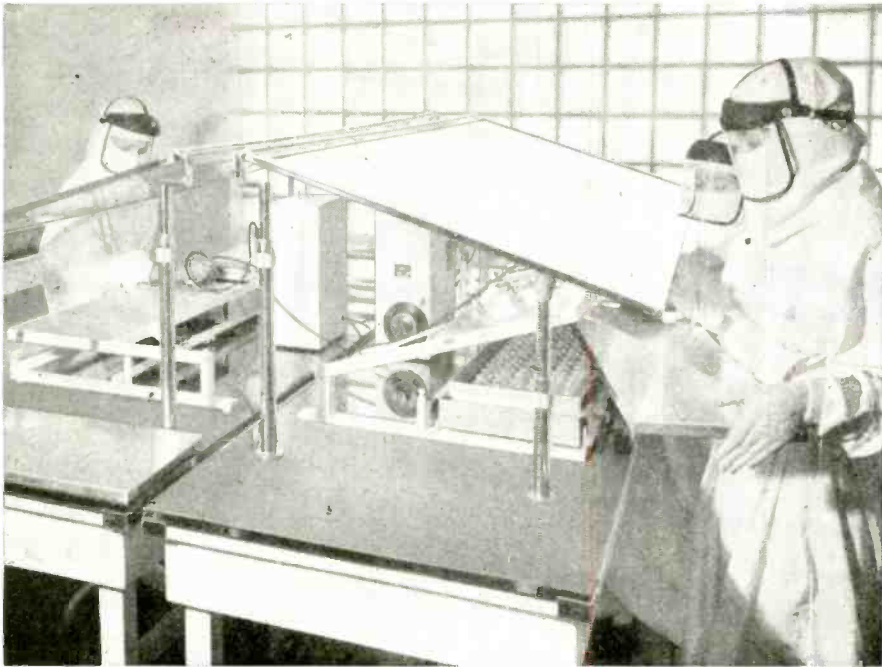

LIFE-SAVING PENICILLIN salt solution is carefully tested by *battery-powered* pH meters before it is placed in vials by white-clad technicians at the modern Commercial Solvents Corporation plant. Throughout the entire manufacturing process, rigid pH checks against excess acidity and alkalinity must be maintained while the penicillin is in solution.



FOUR pH METERS, powered by Burgess Industrial Batteries, are employed by Commercial Solvents Corporation on a 24-hour a day basis to assure necessary, uniform product control. Burgess Industrial Batteries are built to meet specific requirements of test and control instruments. Whatever *your* portable power problem may be, Burgess engineers are equipped to find the answer. Write us today about your needs, or request free, 80-page Engineering Manual on dry batteries. Dept. 16. *Burgess Battery Company, Freeport, Ill.*



BURGESS BATTERIES



THINK TWICE BEFORE YOU TRAVEL!

Famous for the WORLD'S MOST COMPLETE LINE of dry batteries

WIDE READING

Liquid Film Modulates Light In Television System

T. M. C. Lance (Electronic Engineering, London, December, 1944)

The principle followed is based on the point to point deformation of the surface 1 of a liquid film which is about 0.1 mm. thick and spread on glass plate 2. Modulated electron beam 8, produced by electron gun 6, is focused and deflected by systems 7 and 9 to scan and charge the surface 1 of the liquid. These charges produce electrostatic forces which effect the desired deformations 22 of the previously smooth liquid surface 1.

The light from an arc lamp 16 passes through the system of lenses 3 which serves to focus the light rays formed by the slits between the lower bars 4 exactly onto the upper bars 5, provided the film surface is smooth. All light rays—a few of which are indicated by dotted lines 23—are consequently intercepted by the upper bars 5, no light appearing on the screen 21.

These conditions are, however, considerably altered as soon as the liquid surface 1 is deformed, as all light rays—some are indicated by lines 24—traversing the oblique sides of the indentations 22 are deflected and therefore pass between

*Contact
Specialists
for the
Right Connector*

Terminals—Lugs:—
Solder—Compression
—Solderless Types.

Standard Government
Electrical Parts.

ATLAS PRODUCTS
CORPORATION

30 ROCKEFELLER PLAZA
NEW YORK, U. S. A.



WIDE READING

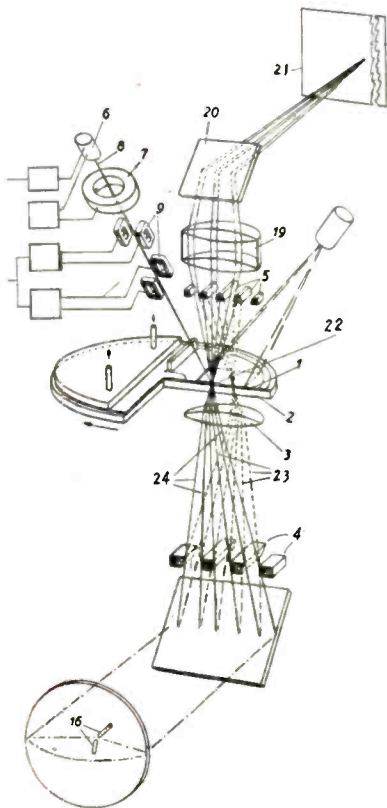

Liquid-Film Television System

the upper bars 5. These light rays are projected through an optical system 19 onto a mirror 20 and form a bright spot on the screen 21. The intensity of the transmitted light is proportional to the deformation and, consequently, depends on the modulation of electron beam 8.

Waves in Tubes Filled With Two Dielectrics

L. Pincherle (Physical Review, September, 1944)

The propagation of electromagnetic waves is investigated first in a rectangular tube half-filled longi-

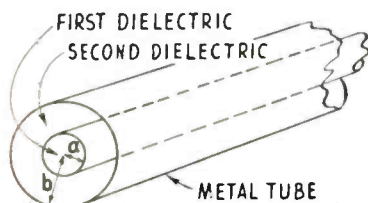
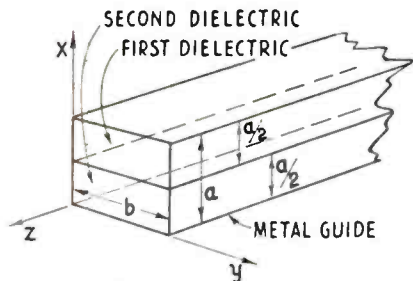

Two-Dielectric Wave Guides

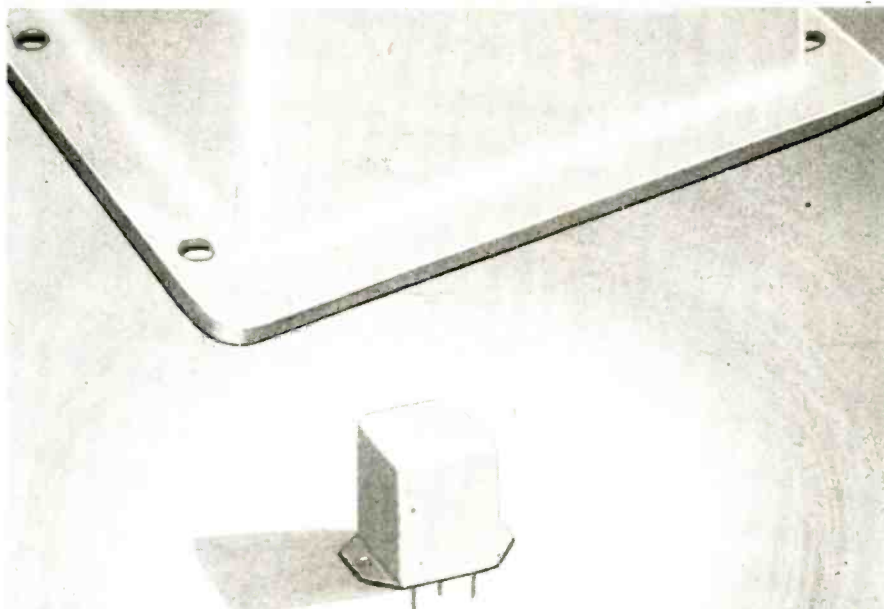

Superiority

IN A MIDGET!

Permoflux Transformer Efficiency Conserves Vital Space and Weight!

The urgent requirement for light weight war communications equipment was the challenge that led Permoflux to develop these miracle coupling devices. From the original need of just a few small transformer types combining high performance standards has come acceptance and demand for many. The value of these achievements will mean much to improve the operation of postwar radio and electronic products. Permoflux engineers welcome consultation on all sound design problems.

BUY WAR BONDS FOR VICTORY!

TRADE MARK
PERMOFLUX

PERMOFLUX CORPORATION
4900 WEST GRAND AVE., CHICAGO 39, ILL.

PLASTIC PARTS

Large or small quantities. Produced to your specifications. Precision machining, stamping and forming all plastics. No molds required. Send your blueprint, or write for bulletin.

PRINTLOID, Inc.

93 Mercer Street

New York 12, N. Y.



WIDE READING

gradually with one dielectric, the other half being filled with another dielectric, as shown in the figure. Solving Maxwell's equations for the conventional boundary condition in a rectangular tube and the additional conditions at the separating surface of the two dielectrics, leads to the conclusion that (with the exception of the H_z-wave) a simple E or H-wave can not be propagated in this type of guide, but the waves in the tube must be linear combination of E and H-waves. However, these waves have either no E_z or no H_z component, x being the direction at right angles to the plane separating the two dielectric materials. For high frequencies, the waves are confined to the medium of higher dielectric constant.

The propagation of electromagnetic waves is also studied in a cylindrical dielectric guide of radius a, surrounded by a coaxial metal tube of a radius b larger than a, as shown in the figure. The waves are again linear combinations of E and H-waves. The case of axial symmetry is considered, in which they are simple E and H waves. For E_z a critical wavelength exists, depending only on the dimensions of the inner dielectric and on the dielectric constants, below which the system behaves more or less as a dielectric guide in free space, and above which as an ordinary hollow tube. For H_z this critical wavelength depends also on the ratio b/a. The case in which the external medium has a higher dielectric constant is also briefly investigated.

Polythene as Dielectric

E. G. Williams (Post Office Electrical Engineers' Journal, London, July, 1944)

Polythene is the generic name given to solid polymeres of ethylene, which are prepared under high pressure. The chemical formula of this recently developed thermoplastic is . . . CH₂-CH₂-CH₂-CH₂ . . . , the chains being of variable length but of the order of 1,000 units long. Polythene is recommended for submarine telephone cables, high frequency coaxial feeders, cable terminations, plugs, sockets, etc.

The electric properties at 20 deg. C. are: dielectric constant 2.3 at all frequencies, power factor 0.0003 at all frequencies, breakdown voltage 1,000 volts/mil on a specimen 20 mils thick, volume resistivity 10¹⁷ ohm/cm, and surface resistivity 10¹⁴ ohm.

The mechanical properties are: density 0.93, tensile strength 1,500 lbs./sq.in., elongation of break 100-450 per cent, modulus of elasticity 1,500 lbs./sq.in., impact strength 50 ft.lbs./sq.in., hardness, marked by

IT'S DRY!

— and so is your equipment when it's been pressurized with an **ANDREW DRY AIR PUMP**

● Dry Air Pumps provide simple, inexpensive source of dehydrated air for your pressurized electronic products. You can avoid component failure due to humidity by enclosing the entire apparatus in an air tight chamber and maintaining dry air pressure.

FOR DETAILED INFORMATION
WRITE FOR BULLETIN No. 30

For air-borne equipment, too! Condenser plates will not spark over at high altitudes if the apparatus is pressurized with dry air, because then moisture condensation is no longer a problem.

ANDREW CO.

363 East 75th Street
Chicago 19, Illinois



Type 876-A

When you reveal
your post-war line

**BE SURE IT'S
POWERED BY**

RAY-O-VAC



»RAY-O-VAC

. . . If your V-Day products will require dry batteries, be sure to include Ray-O-Vac in your plans. The know-how that has solved so many portable power problems for the armed forces can be of great value to you. Ray-O-Vac engineers are at your service. Write Dept. I-A.

RAY-O-VAC COMPANY, MADISON, WISCONSIN
OTHER FACTORIES AT CLINTON, MASS., LANCASTER, O., SIOUX CITY, IA., FOND DU LAC, WIS., MILWAUKEE, WIS



Transformers

Consult our Engineers . . .

Into the Stancor units of today are assembled only those engineering improvements which grueling field and combat service have stamped with unconditional approval . . .

May we suggest that in your projected plans, you consider Stancor . . . Our engineers, while largely assigned to the war effort, may be available to discuss the adaptability of Stancor transformers to your current and future needs . . . Your inquiry will receive our best attention within the limits, of course, of the imperative demands upon all of us.

STANDARD TRANSFORMER CORPORATION, 3500 NORTH HALSTED ST., CHICAGO 22, ILLINOIS

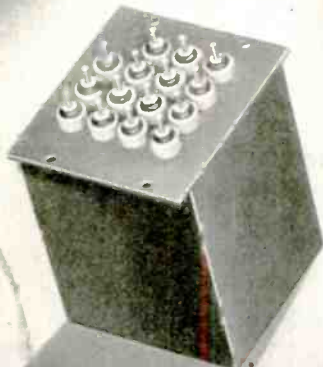

finger nail, softening point (ball and ring), 110 deg. C, melt viscosity at 190 deg. C, 3,500 poises, linear thermal expansion at 20 deg. C is .02 per cent per deg. C, and thermal conductivity 0.0007 cal/sec./cm/deg. C.

Polythene is highly resistant to most chemicals. Above 75 deg. C it will dissolve fairly readily in all hydrocarbon and chlorinated solvents.

Magnetic Measurements on Iron Powder

T. H. Oddie (*Journal of Scientific Instruments*, London, September, 1944)

The materials to be investigated, carbonyl iron powder type E (designated powder E) and hydrogen reduced iron powder type 14B (designated powder H) were molded into cores; phenolic resin was added. A bridge circuit was used to measure the apparent resistance and inductance of coils wound on these cores. Preparation of the cores and coils, testing of the coils and evaluation of the tests are described in detail.

In the table on p. 171, a, c, e are the hysteresis, residual, and eddy current loss coefficients, respectively. They are defined by the equation:

$$R = \mu Lf (aB + c + ef),$$

where R in ohm is the equivalent resistance due to magnetic loss in the core, μ is the permeability of the core, L the inductance of the tested coil, f the frequency, and B the flux density in gauss.

FACSIMILE EQUIP.

(Continued from page 99)

The RC-58, however, transmits only black and white. The scanning portion of the amplifier picks up the impulses that have come from the photo cell and converts them into two frequencies, one for black and the other for white. The recorder section of the amplifier picks up the incoming signal, screens out extraneous frequencies, and amplifies only the two frequencies sent by the transmitter.

The printing is done by a printer unit which is energized by one frequency (for black) and is not energized by the second frequency (for white). Transmission by wire is also possible with the RC-58.

Because of possible voltage variations in motor vehicles, perfect synchronization is not always possible and the message being received has a tendency to "drift" and might leave gaps in the content of the message. In order to ensure that the entire message is recorded, the RC-58 prints double lines, so that one line is always on the tape.

Summary of properties calculated from measurements for iron powder type E

Volume fraction of Iron	Iron content by weight in %	Core density g./cm. ³	Loss coefficients			Permeability at frequencies of		
			10 ⁵ a	10 ⁵ c	10 ⁵ e	0-100kc	01-66mc	16-40mc
0.05	25	1.56	—	—	—	1.56	1.41	1.37
0.1	44	1.77	—	—	—	2.15	1.92	1.77
0.15	54	2.17	—	—	1.04	2.72	2.49	2.32
0.2	62	2.52	—	—	0.88	3.33	3.08	2.96
0.25	69	2.83	—	—	0.76	4.1	3.82	3.66
0.3	75	3.12	14	20	0.68	4.8	4.6	4.5
0.35	80	3.41	9	17	0.62	5.8	5.4	5.3
0.4	84.3	3.70	7	14	0.58	6.9	6.3	6.0
0.45	87.6	4.00	4.5	12	0.54	8.3	7.3	6.7
0.5	90.7	4.30	3.2	10	0.52	9.8	8.4	7.2
0.55	93.3	4.60	2.7	8	0.51*	11.7	9.8	7.7
0.6	95.2	4.92	1.6	7	0.50*	14.0	11.2	8.3
0.65	96.7	5.24	1.2	6	0.49*	16.5	13.0	—
0.7	97.9	5.58	0.8	5	—	19.5	—	—
0.75	98.6	5.94	0.6	4	—	23.2	—	—

Summary of properties calculated from measurements for iron powder type H

Volume fraction of Iron	Iron content by weight in %	Core density g./cm. ³	Loss coefficients			Permeability at frequencies of	
			10 ⁵ a	10 ⁵ c	10 ⁵ e	0-100 kc	6.6-40 mc
0.05	25	1.56	—	—	—	1.67	1.41
0.1	44	1.77	—	—	—	2.33	1.92
0.15	54	2.17	—	—	2.2	3.00	2.54
0.2	61	2.56	—	—	2.0	3.73	3.26
0.25	68	2.87	—	—	1.8	4.6	4.1
0.3	73	3.21	—	—	1.7	5.5	4.9
0.35	78	3.50	80	100	1.6	6.7	5.8
0.4	82.4	3.79	55	80	1.5	8.1	6.7
0.45	86.3	4.06	38	67	1.5	9.8	7.8
0.5	89.2	4.37	26	55	1.4	11.8	9.0
0.55	91.4	4.69	18	46	1.4	14.2	10.4
0.6	93.1	5.03	12	38	1.35	17.1	12.1
0.65	94.8	5.35	8.5	32	1.3	20.6	14.0
0.7	96.3	5.67	5.8	26	1.3*	25.0	16.3
0.75	97.4	6.01	4.0	22	1.25*	30.1	—

* These values extrapolated—not obtained with the method of particle insulation used.

METAL STAMPINGS

IN SMALL LOTS

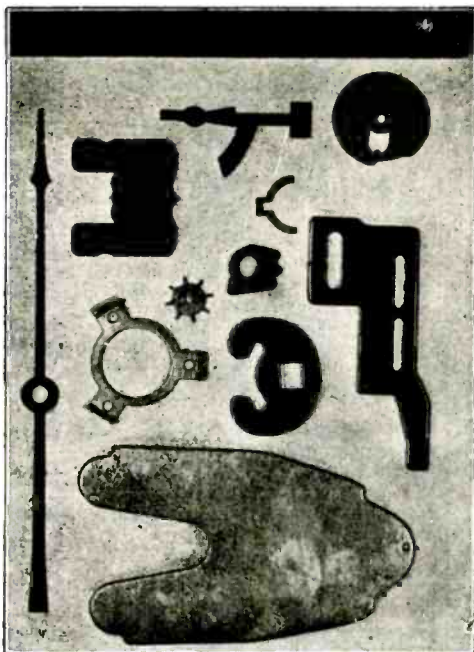

If you need a limited number of DIE CUT metal stampings, it will pay you to try DAYTON ROGERS metal stamping service.

**NO QUANTITY TOO SMALL
NO PART TOO INTRICATE**

With twenty-three years' experience in this specialized service of our finger tips, we can produce all your small lot metal stamping requirements with greater ACCURACY and ECONOMY.

A quotation will convince you.

Write for illustrated booklet No. 176-5.

DAYTON ROGERS MANUFACTURING CO.

2835 12th Ave. So.

Minneapolis, Minn.

This is
IMPORTANT
to **5**
MANUFACTURERS

WE will purchase one or more equipment or component manufacturing businesses in these fields

RADIO
TELEPHONE
TELEGRAPH
TELEVISION
WIRE PHOTO
SOUND on FILM

OR we will purchase only a particular Department. In either case we will assume responsibility for servicing equipment now in use.

All answers will be held confidential.

Please Reply to BOX A-27

ELECTRONIC INDUSTRIES
480 Lexington Avenue, New York 17, N. Y.

(The publisher is authorized to furnish our name if written request is made on your company letterhead.)

SERVICE
THROUGH THE
YEARS!

1935
1937
1939
1941
1943
1945

★
America's
MOST COMPLETE
Source of Supply

for

RADIO PARTS
RADIO TUBES
INDUSTRIAL
ELECTRONIC EQUIPMENT
AMPLIFIERS
SOUND SYSTEMS
TEST INSTRUMENTS
COMMUNICATIONS and
BROADCAST APPARATUS
AIRCRAFT and
MARINE EQUIPMENT
F/M—television—A/M

★

OVER 10,000 ITEMS!
AT YOUR FINGERTIPS!

PURCHASING AGENTS!
ENGINEERS!

Send for this
FREE 800 PAGE CATALOG!

Write today on your company letterhead for this massive 800 page Buying Guide containing everything in radio-electronics. Complete listings of all standard nationally known products in one handy, bound volume! Sent free on request by addressing Box FE.



This Book
Can Help Answer
Your Procurement
Problems!

★

★ **FOR PROMPT SERVICE** ★
Telephone BARclay 7-1840

BUY THAT EXTRA BOND NOW
and SAVE AN EXTRA LIFE!

SUPPLIERS TO

Industrial Manufacturers • Research
Laboratories • Schools • Colleges
Government Agencies • Railroads
Public Utilities • Broadcast Stations
Hospitals • Shipyards • Police Depts., etc.

SUN RADIO
& ELECTRONICS CO.
212 Fulton Street, New York 7, N. Y.

ELECTRONIC USES IN INDUSTRY

(Continued from page 105)

168. Cathode-Ray Tube Traces. Part 3. Hilary Moss. "Electronic Engng.," August, 1944; p. 109.
169. Cathode-Ray Tube Traces. Part 4. Hilary Moss. "Electronic Engng.," September, 1944; p. 153.
170. High-Speed Time Bases. W. A. Stewart. "Electronic Industries," August, 1944; v. 3, p. 112.
171. Beam Blanking Circuit for Oscilloscopes. Walter Richter. "Electronics," September, 1944; v. 17, pp. 128-130.
172. Oscilloscope for Pulse Studies. Horace P. Atwood, Jr., and Robert P. Owen. "Electronics," December, 1944; v. 17, p. 110.

Chemical and Metallurgical Field Application

173. Metallurgical Analysis. "Electronic Industries," November, 1943; v. 2, pp. 86-87, 238, 240.
174. New Method of Sorting Steels. R. J. Brown and J. Bridle. "Engr.," December 3, 1943; v. 176, pp. 442-444.
175. An Improved Laboratory Polariscopes of Simple Design. John Gallup. "The Bulletin of the American Ceramic Society," January 15, 1944; v. 23.
176. Polarographic Analysis. A. C. Walker. "Electronic Industries," March, 1944; v. 3, p. 120.
177. Tubes in Metallurgical Research. E. V. Potter. "Electronic Industries," April, 1944; v. 3, p. 113. (Part 1)
178. Tubes in Metallurgy. E. V. Potter. "Electronic Industries," May, 1944; v. 3, p. 115. (Part 2)
179. Electronic Devices Aid Metallurgical Research. E. V. Potter. "Elec. Engng.," May, 1944; v. 63, pp. 175-185.
180. Colorimetry. Albert A. Shurkus. "Radio News," June, 1944; v. 31, p. 25.
181. Densitometry. Albert A. Shurkus. "Radio-Electronic Engng.," August, 1944; v. 3, p. 7.
182. Automatic Control of Stills. R. E. Schrader and E. J. Wood. "Electronics," September, 1944; v. 17, p. 98.
183. Microanalysis by Means of Electrons. James Hillier and R. F. Baker. "Jour. App. Physics," September, 1944; v. 15, pp. 663-675.
184. Electronics in Petroleum Plants. F. P. Hochgesang and C. H. Schlesman. "Electronics," September, 1944; v. 17, pp. 116-121, 308, etc.
185. Rapid Gas Analysis for Vapor Control. "Electronics," September, 1944; v. 17, p. 148.
186. Electronic Indicator for Oil Refining Plant. "Electronics," November, 1944; v. 17, p. 144.

Counting, Timing

187. A Photoelectrically Operated Stop-Watch. R. J. Wey. "Electronic Engng.," January, 1944; p. 334.
188. Electronic Timer for Microsecond Intervals. Paul B. Welsz. "Electronics," April, 1944; v. 17, pp. 108-112.
189. A-C Electronic Timer. G. M. Chute. "Distribution," April, 1944; v. 6, pp. 10-12.
190. Electronics Enables Timing by Cycles in Place of Seconds. "Elec. Mfg.," June, 1944; v. 33, pp. 110-113, 180, etc.
191. A Four-Tube Counter Decade. John T. Potter. "Electronics," June, 1944; v. 17, p. 110.
192. Cold-Cathode Timing Devices. A. H. Myles. "Electronic Industries," July, 1944; v. 3, p. 98.
193. New Type of Counter for Ionizing Particles. C. B. A. McCusker. "Jour. Sci. Instr.," July, 1944; v. 21, pp. 120-122.
194. Electronic Timer. W. H. Bergman. "Elec. News & Engng.," August 1, 1944; v. 53, pp. 39-40, 43-45.
195. Electronic Counter and Tachometer. E. G. Downie. "General Electric Review," November, 1944; v. 47, p. 50.
196. Measuring Arc Duration. J. S. Quill.

CONCORD
SERVICE
is
unsurpassed

SO SAY LEADERS OF
Industry • Wartime Agencies
Laboratories • Schools

RADIO AND ELECTRONIC
PARTS AND
EQUIPMENT

Tens of thousands of enthusiastic customers are proof of Concord leadership. We can supply you with anything from a single capacitor to complex laboratory installations. Two strategically-located Concord stores—Chicago and Atlanta—are geared for speedy action.

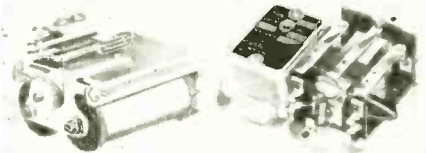

SENSITIVE RELAY . . .

Fully adjustable sensitive relay with 2000 ohm coil. Ideal for plate circuit or photocell applications. Minimum pull-in current only 2.5 milliamperes. SPDT Contacts.

MA10-C113
Your cost, each . . . \$4.75

THERMAL TIME DELAY RELAY . . .

Leach Type 1054T with 375 ohm 24 volt DC coil. Delay adjustable from 20 seconds to 1 minute. 1/2" fine silver DPST contacts; normally open, will handle 50 amps at 12 volts DC, or 25 amps at 24 volts DC, or 6 amps at 110 volts AC.

MA10-C121
Your cost, each . . . \$3.35



FREE! Special 16-page Supplement of "hard-to-find" and urgently needed parts and equipment. All items are ready for immediate delivery . . . but are, naturally, subject to prior sale.



MAIL THIS COUPON

CONCORD RADIO CORPORATION

901 W. Jackson Blvd., Chicago 7, Ill., Dept. J-25

Please rush me the 16-page "Special Supplement" published by the CONCORD RADIO CORPORATION.

NAME _____

ADDRESS _____

CITY _____

STATE _____

CONCORD RADIO CORPORATION
Lafayette Radio Corporation

901 W. Jackson Blvd.
CHICAGO 7, ILL.

265 Peachtree Street
ATLANTA 3, GA.

SUPERIORity in TUBING

is the Result of

Intensive Specialization

(IN SIZES $\frac{5}{8}$ " AND UNDER IN MANY METALS)

SUPERIOR

SUPERIOR TUBE COMPANY, NORRISTOWN, PENNSYLVANIA



THE BIG NAME IN
**SMALL
TUBING**

FOR EVERY SMALL TUBING APPLICATION FROM $\frac{5}{8}$ " OD DOWN

SUPERIOR  Seamless in various analyses. WELDRAWN  Welded and drawn Stainless, "Monel" and "Inconel"

SEAMLESS and Patented LOCKSEAM Cathode Sleeves

"Nothing but the Truth"

by
ALEXANDER McQUEEN
Famous Radio Feature
Commentator

*A Monarch
Fact Story!*

HOW THE FIRST "FOOT" MEASUREMENT WAS STARTED!

Just four hundred years ago, Charles V of Austria, Holy Roman Emperor, in seeking a standard of measurement for his domain, adopted the following procedure: To the doors of the church one morning he dispatched a trustworthy member of his court with instructions to detain the first 16 men who emerged from the house of worship. These 16 stalwarts were directed to stand just back of each other so that the toes of the left foot of every second man touched the heel of his neighbor in front. The total measurement of the 16 feet thus lined up was then divided by 16 and the result was declared to be "one foot"



... and that's "NOTHING BUT THE TRUTH"

... BUT TODAY

For the exacting measurements and calibrations which are desirable in every phase of radio and electronic work, engineers and production experts insist upon

MONARCH

TESTING • MEASURING • CALIBRATING EQUIPMENT

... and that's "nothing but the truth"



2014 N. MAJOR AVE. • CHICAGO 39, ILL.

- "General Electric Review," November, 1944; v. 47, p. 22.
197. Electronic Timing Circuits. M. H. Shamos. "Radio-Electronic Engng.," November, 1944; v. 3, p. 16.

Electrical Quantities

198. Electronic Voltmeter for High Voltages. W. Ehrenberg and H. Hirsch. "Jour. Sci. Instr.," October, 1943; v. 20, pp. 161-163.
199. Photoelectric Potentiometer Recorder. D. F. Hang. "General Electric Review," November, 1943, v. 46, pp. 623-625.
200. Electronic Phase-Angle Meter. E. H. Schulz and J. N. Van Scoyoc. "Radionics," November, 1943, v. 1, pp. 22-24.
201. Electronic Switch. Rufus P. Turner. "Radio News," December, 1943, v. 30, pp. 28-29, 70, 72.
202. Synchronism Indicator for Electric Power Systems. K. C. Cook. "Electronics," February, 1944, v. 17, p. 110.
203. Vectorscope Shows Phase Angles of E, I and Fluxes. Lawrence G. Betz. "Elec. Wld.," February 19, 1944, v. 121, pp. 667-668.
204. Voltage-Measuring and Control Equipment for Electrostatic Generators. A. O. Hanson. "Rev. Sci. Instr.," March, 1944, v. 15, p. 57.
205. Simple C-R Tube Voltmeter. "Electronics," April, 1944, v. 17, pp. 234, 236, 238, etc.
206. Surge Type Insulation Tester Reflects Electronic Progress. N. Rohats. "Elec. Mfg.," April, 1944, p. 97.
207. Wow Meter. C. R. Miner. "General Electric Review," April, 1944, v. 47, p. 31.
208. Application of the "Memmoscope" to Rectifier Study. W. E. Pakala and Victor Wouk. "Proc. IRE," June, 1944, v. 32, pp. 336-338.
209. High-Potential Vacuum-Tube Voltmeter. Paul B. Weisz. "Proc. IRE," June, 1944, v. 32, p. 338.
210. Frequency Range Extension. "Electronic Industries," August, 1944, v. 3, p. 117.
211. Direct-Reading Capacity Meter. Rufus P.

SKILL
that saves you
TIME • MONEY
WORRY!

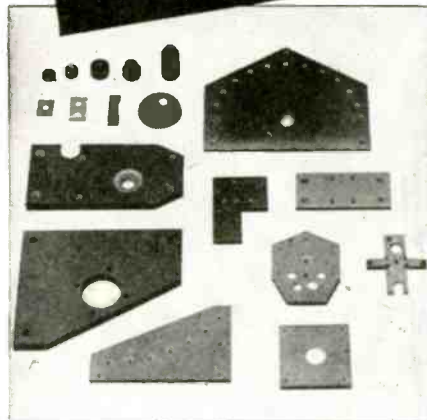

FABRICATING
GLASS BONDED MICA

**COLONIAL
KOLONITE COMPANY**
2212 W. ARMITAGE AVE., CHICAGO, ILL.

Announcing

A MINIATURE OSCILLOGRAPH

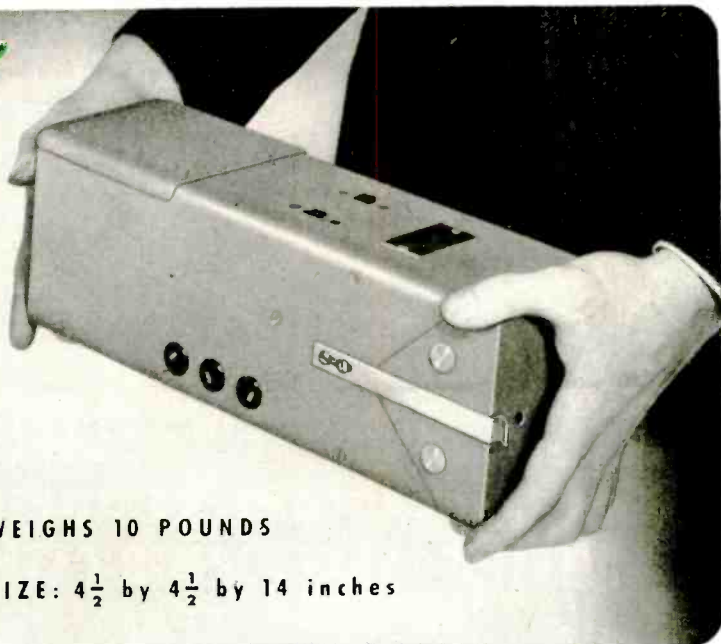

WEIGHS 10 POUNDS

SIZE: $4\frac{1}{2}$ by $4\frac{1}{2}$ by 14 inches

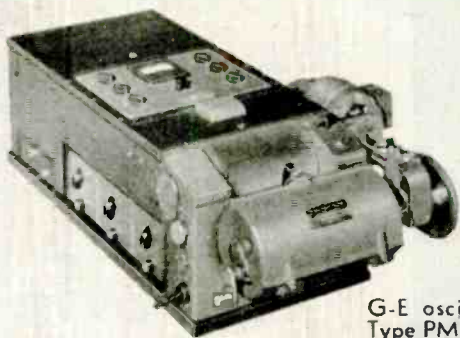

G-E oscillograph, Type PM-10, set up for tests with magazine film holder, driving head, and a-c motor unit

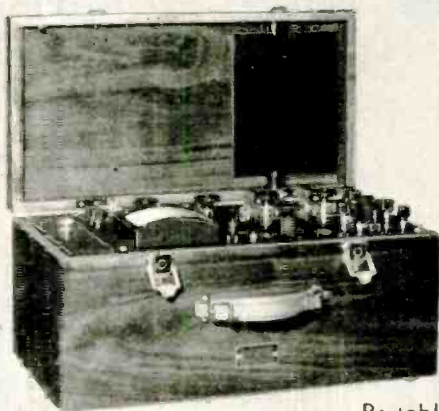

Portable oscillograph, Type PM-12, for general use where only two elements are required

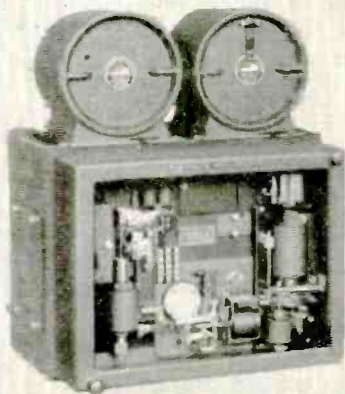

Automatic oscillograph, Type PM-13. Starts recording one-quarter cycle after disturbance occurs

THIS 6-ELEMENT OSCILLOGRAPH was developed for use where light weight and small size are essential. It's easily portable, to obtain "on the spot" photographic records of the characteristics or the performance of many machines and devices. Records simultaneous variations of six rapidly changing phenomena. Type PM-17; net price, \$850 up. Write today for leaflet GEA-4331.

IF SMALL SIZE IS NOT ESSENTIAL, HERE ARE OTHER G-E OSCILLOGRAPHS

TYPE PM-10—Records 6 to 12 phenomena simultaneously. A large, multi-element, general-purpose oscillograph for a wide field of application. Includes simultaneous viewing with recording. Net price, \$3160 up.

TYPE PM-12—Anyone can operate it. For work in the field, in the laboratory, or in the classroom. For either visual indications or taking oscillograms of current and voltage waves. Originally developed for school use, industry has found this 2-element portable especially valuable for observing or recording welding current. Net price, \$665.

TYPE PM-13—Entirely automatic. Can take as many as 100 oscillograms of transients and surges without attention. Particularly useful for determining the sequence of relay and breaker operation and the effect on system stability. Net price, \$2125.

Our nearest office will be glad to help you select the right oscillograph for your specific requirements. *General Electric Company, Schenectady 5, N. Y.*

BUY WAR BONDS AND KEEP THEM

GENERAL ELECTRIC



602-32-6290

*Clip
the
Coupon*

PEERLESS Electrical Products Co.
6920 McKinley Ave., Los Angeles 1, Calif.

Please mail new 20-page catalog No. 431 to:

Name _____
Firm _____
Position _____
Street _____
City _____ State _____

FOR YOUR COPY OF THE NEW PEERLESS TRANSFORMER CATALOG

Contains latest information and prices on the complete line of Peerless transformers, windings and reactors.



PEERLESS

ELECTRICAL PRODUCTS CO.

6920 McKinley Avenue, Los Angeles 1, California

*Why depend
on say-so or guessing?
FOR ABSOLUTE ACCURACY
get TIME TOTALIZERS!*



FOR an exact record of machine hours the Industrial Time Totalizer provides distinct advantages over written or personal checks. This visible Totalizer will give a record up to 10,000 hours. On equipment of pre-determined life expectancy the Totalizer, by showing the hours in use, visibly signals when replacement ought to be made. Whether your product is now made for the war effort or to compete in postwar markets the application of Industrial Time Totalizers is worth your immediate attention.

INDUSTRIAL TIMER CORPORATION

110 EDISON PLACE



NEWARK, NEW JERSEY

SOME TYPICAL APPLICATIONS

Conveyors
Diesel Generators
Drill Presses
Molding Machines
Oil Burners
Punch Presses
Refrigerators
Radio Transmitters
Welding Machines
Vacuum Tube Devices
and many other types of machines

- Turner. "Radio News," September, 1944, v. 32, pp. 40-42, 87-88, 90.
212. No Rotating Standard in Stroboscopic Calibration. E. E. Stevens. "Elec. Wid.," October 14, 1944, v. 122, pp. 94-95.
 213. Testing Selenium Rectifier Cells. W. E. Schwanhauser. "General Electric Review," November, 1944, v. 47, p. 53.
 214. Testing Insulation. H. C. Anderson. "General Electric Review," November, 1944, v. 47, p. 38.
 215. Analysis of High-Frequency Ignitron Circuits. A. W. Robinson, Jr. "AIEE Transac.," December, 1944, v. 63, p. 916.
 216. Measuring Potentials In Growing Things. Harlan T. Stetson. "Electronic Industries," December, 1944, v. 3, p. 82.

Electron Microscope, Diffraction Camera, Mass Spectrometer

217. Mass Spectrometer Aids Research. John A. Hipple. "Electronics," November, 1943, v. 16, pp. 120-124.
218. Mass Spectrometer for Gas Analysis. John A. Hipple and H. E. Dralle. "Westinghouse Engr.," November, 1943, v. 3, pp. 127-130.
219. Compact High Resolving Power Electron Microscope. V. K. Zworykin and James Hillier. "Jour. App. Physics," December, 1943, v. 14, pp. 658-673.
220. Magnification Calibration of the Electron Microscope. Ernest F. Fullam. "Jour. App. Physics," December, 1943, v. 14, pp. 677-683.
221. Electron Diffraction Analysis of Surface Films. Earl A. Gulbransen. "Electronics," January, 1944, v. 17, pp. 126-128.
222. The New Microscopes. R. E. Seidel and M. Elizabeth Winter. "Franklin Inst. Jour.," February, 1944, v. 237, pp. 103-130.
223. Spectrographic Analysis in the Manufacture of Radio Tubes. S. L. Parsons. "Proc. IRE," March, 1944, v. 32, pp. 130-135.
224. Mass Spectrometer—New Industrial Tool. Clifford E. Berry. "Electronic Industries," June, 1944, v. 3, p. 94.
225. Spectrophotometry. A. Shurkus. "Radio-Electronic Engng.," June, 1944, v. 2, p. 16.
226. Light Spectra Analysis. C. A. Valle. "Electronic Industries" June, 1944, v. 3, p. 114.
227. Electronic Microscopy. James Hillier and V. K. Zworykin. "Elec. News & Engng.," September 1, 1944, v. 53, pp. 41-42, 44, etc.
228. Electron Microscope for Metals. Robert G. Picard and Perry C. Smith. "Metals & Alloys," September, 1944, v. 20, pp. 636-641.
229. Reducing Electrical Interference from Spectrographic Spark Source. E. W. Landen. "Jour. Opt. Soc. America," September, 1944, p. 532.
230. Electron Microscope: Its Applications in Metallurgy. V. K. Zworykin. "Metal Ind." (Lond.), October 22, 1943, v. 63, pp. 258-260.
231. Electron Diffraction Patterns of Copper-Gold Alloy. F. E. Haworth. "Bell Labs. Record," November, 1944, v. 22, p. 596.
232. Electron Microscopy. I. B. Bensen. "General Electric Review," December, 1944, v. 47, p. 6.

Light, Illumination, Heat, Sound

233. A Photoelectric Cell Very Sensitive to the Extreme Ultra-Violet. J. Mattler. "Comptes Rendus" (Paris), 2nd/30th August, 1943, v. 217, pp. 143-145.
234. New Magnetic Wire Recorder. Marvin Camras. "Radionics," November, 1943, v. 1, pp. 3-5, 38-39.
235. Engineering Details of Magnetic Wire Recorder. D. W. Pugsley. "Electronic Industries," January, 1944, v. 3, pp. 116-118, 206, 210, 212.
236. High-Speed Photolight. S. L. Bellingier. "General Electric Review," March, 1944, p. 31.
237. Electronic Control for Constant Illumination. John K. Hilliard. "Electronics," March, 1944, v. 17, pp. 180, 184, 188, etc.

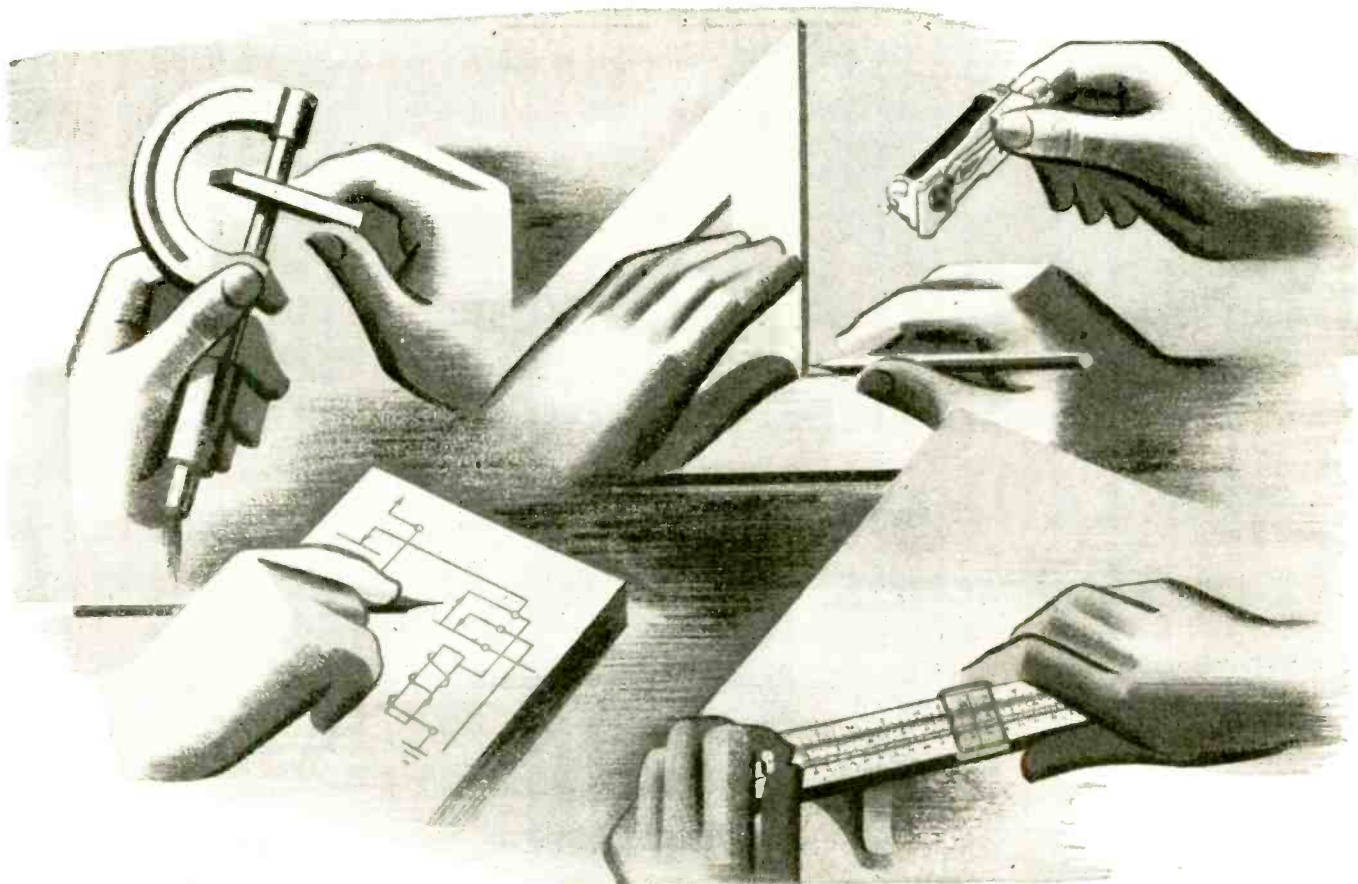

Your New Product may need the Magic of Electrical Control

TAKE another look at that new product your designers are planning. It may be that Automatic Electric control devices can make it function better—at lower cost. It's worth checking into.

To help designers perfect new developments—or improve old ones—Automatic Electric offers this unique three-point service:

1. Technical advice by experienced field engineers, who know the "how" and "why" of control technique.
2. A complete range of relays, stepping switches, and other control units—time-proved products readily adapted to your needs.
3. A design and manufacturing service for complete engineered assemblies.

Ask our field engineer for a copy of our catalog of control devices. He will be glad to show you how they can serve you.

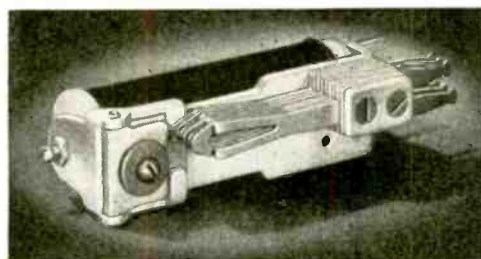

Here are jobs that can be done easier and better with Automatic Electric control devices:

Automatic Selection and Switching of Circuits • Time, Temperature and Sequence Control • Counting and Totalizing • Inspection and Sorting Operations • All Types of Electrical and Electronic Control.

Relays
AND OTHER CONTROL DEVICES
by **AUTOMATIC ELECTRIC**



AUTOMATIC ELECTRIC SALES CORPORATION
1033 West Van Buren Street • Chicago 7, Illinois

In Canada: Automatic Electric
(Canada) Limited, Toronto

PARTS AND ASSEMBLIES FOR EVERY ELECTRICAL CONTROL NEED



**Faster, more
efficient operation**

with CANNON D.C. SOLENOIDS

With Cannon Electric D.C. Solenoids you get automatic, trigger-action. Solenoid pull is positive. Cannon Solenoids may be operated without damage to a maximum temperature of approximately 150 degrees C.

A wide selection of Cannon Solenoids are built for various combinations of voltages, pull, armature travel, duty cycle, etc. to suit design requirements. Nominal voltages are 12 and 24; others by special order. Eight types have "holding" features.

As a reliable means of controlling or operating various devices, they are used for retarding magnetos in starting engines, operating hydraulic valves and mechanical clutches, firing machine guns, arming and releasing bombs, dropping auxiliary fuel tanks, locking retracting gears, film-winding mechanisms for shutter control on special cameras. These are only a few of the possible applications. *Let us know your needs.*

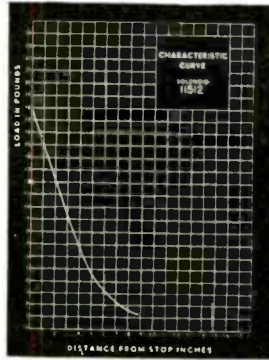

Response characteristic charts like the above (test at 28 volts) together with wiring diagrams are found in Solenoid Bulletin.

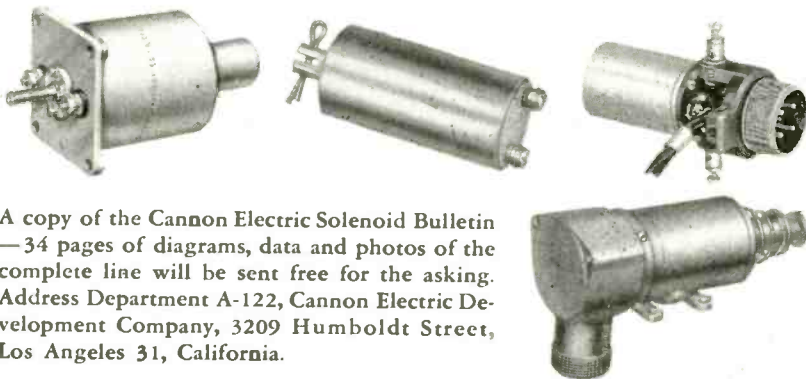

A copy of the Cannon Electric Solenoid Bulletin — 34 pages of diagrams, data and photos of the complete line will be sent free for the asking. Address Department A-122, Cannon Electric Development Company, 3209 Humboldt Street, Los Angeles 31, California.

Also manufacturers of Electrical Connectors

CANNON ELECTRIC

Cannon Electric Development Company
3209 Humboldt St., Los Angeles 31, Calif.

Canadian Factory and Engineering Office:
Cannon Electric Company, Limited, Toronto

REPRESENTATIVES IN PRINCIPAL CITIES — CONSULT YOUR LOCAL TELEPHONE BOOK



238. The "Kodatron" Speedlamp. G. A. Jones. "Electronic Engng.," June, 1944, v. 17, pp. 16-18.
239. Studying Thermal Behavior of Houses. John G. Linvill and John J. Hess, Jr. "Electronics," June, 1944, v. 17, p. 117.
240. Electronic Thermometer. Paul G. Weiller and Irving H. Blatz. "Electronics," July, 1944, v. 17, p. 138.
241. Magnetic Recording; A Simple Exposition of the Principles Involved. G. L. Ashman. "Wireless Wld.," August, 1944, v. 50, pp. 226-228.
242. Industrial Temperature Instruments Employing Electronic Methods and Devices. C. O. Fairchild. "Instruments," August, 1944, v. 17, pp. 468-472, 496.
243. The Multiplier Photo-Cell. A. Sommer. "Electronic Engng.," September, 1944, v. 17, p. 164.
244. The Mechanism of Supersonic Frequencies as Applied to Magnetic Recording. Hershel Toomim and David Wildfeuer. "Proc. IRE," November, 1944, v. 32, p. 664.

Mechanical Applications

245. C-R Tube in Mechanical Testing. E. Cattanes. "Electronic Engng.," December, 1943, v. 16, pp. 277-280, 295.
246. Electrodynamic. "Rev. Sci. Instr.," February, 1944; p. 49.
247. Process Control Methods for Industrial Uses. R. R. Batcher. "Electronic Industries," March, 1944; v. 3, p. 118.
248. An Automatic Vibration Analyzer. F. G. Marble. "Bell Labs. Record," April, 1944; p. 376.
249. Electric Gaging Methods for Strain, Movement, Pressure and Vibration. H. C. Roberts. "Instruments," May, 1944; p. 260.
250. Electronic Vibration Tester. Forrest Dorman. "Radio-Electronic Engng.," June, 1944; v. 2, pp. 3-6, 45-46.
251. An Electronic Tachometer, Accelerometer and Vibrometer. "Electronics," June, 1944, v. 17, p. 100.
252. Test-Set for Strain Gages. E. H. Heine-mann. "Electronics," July, 1944; v. 17, p. 146.



**TEST INSULATION
THE MODERN WAY**

... WITH A
MODEL B-5

MEGOHMER NEW BATTERY-VIBRATOR TYPE

No more tiresome cranking of a hand-driven generator. Entirely self-contained. Steady test potential of 500 volts D.C. available at the touch of a switch. Direct reading in insulation resistance. Various new models and ranges.

Write or phone for Bulletin 430

HERMAN H.
Sticht
COMPANY, INC.
27 PARK PLACE
NEW YORK, N. Y.

I'D LIKE TO SEE
ABOUT SOME SMALL
MOTORS

DO YOU
KNOW WE MAKE
MOLDED PLASTICS,
TOO?

GENERAL
INDUSTRIES
CO.

THIS conversation might easily occur at our reception desk because here under one roof and management we produce both small motors and molded plastics in large quantities for use in widely different products.

YES, YOU CAN BUY **BOTH**
AT GENERAL INDUSTRIES



Take small motors. We've built *Smooth Power* units for many years for our own line of velvety operating recorders, record-changers and turntables. We supply standard or designed-to-order *Smooth Power* drives and assemblies for automotive devices, controls and other small electric products. Our customers include leading manufacturers in a wide range of industries.



Now about molded plastic parts. We have the equipment for small and large work in any quantities. Our engineers, mold makers and machine operators have the combined "know-how" to deliver better plastic parts quicker and at prices in line with our established high quality. If you visit our factory (and you'll be welcome) you'll be amazed at the diversity of our work and at the length and quality of our customer list.

THE

GI GENERAL
INDUSTRIES
COMPANY

ELYRIA, OHIO



Yes, you can buy both small motors and molded plastics for your postwar products from General Industries. We suggest a general discussion now, to be followed by details when our war work has been finished. It will be appreciated if you will address the specific division . . . *motors* or *molded plastics*.

NEW OBJECTIVES QUICKLY GAINED

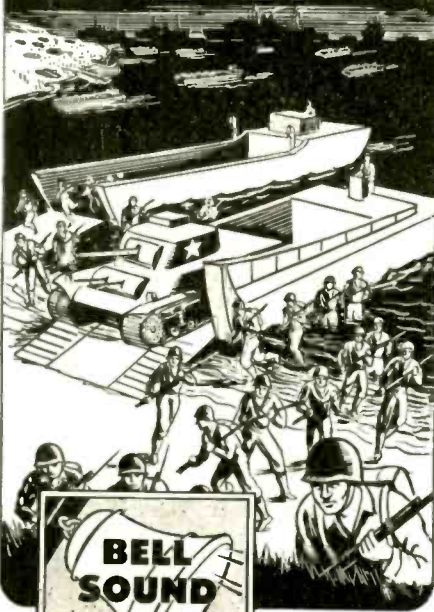

BELL SOUND SYSTEMS

Like a trained attack force striking swiftly and surely at new objectives, Bell Sound Systems forged ahead with fast action in taking over wartime needs for electronic equipment. As pioneers in the development of improved systems for inter-communication, amplifying, recording, and other purposes, BELL has always adhered to a policy of progressive experiment and research. This habit of looking and thinking ahead gives BELL engineers a head start on new requirements. Because still further knowledge of how electronics can serve a peacetime world is being gained from this wartime production, you can look to BELL Sound Systems, Inc. for leadership after Victory.

BELL VOICE-PAGING EQUIPMENT!

For efficient vocal-paging and plant-wide broadcasting of announcements, signals, recorded music—the first, complete system of standard units designed for industrial needs. Quick, easy expansion or rearrangement; adjustable to any variety of noise levels; standard units combine to fill needs of any type or extent. Write!



BELL SOUND SYSTEMS
Incorporated
1185 ESSEX AVE., COLUMBUS 3, OHIO
Export Off., 4900 Euclid Ave., Cleveland 3, Ohio

253. Measurement of Static and Dynamic Pressures. C. E. Grinstead, R. N. Frawley, F. W. Chapman and H. F. Schultz. "Electronic Industries," August, 1944; v. 3, p. 84.
254. Cathode-Ray Oscillograph As an Engine Indicator—Construction of Integrator and Degree Marker. P. H. Schweitzer and Franz Veith. "Instruments," September, 1944; v. 17, pp. 526-527, 560, 562.
255. Measurement of Static and Dynamic Pressures. C. E. Grinstead, R. N. Frawley, F. W. Chapman and H. F. Schultz. "Electronic Industries," September, 1944; v. 3, p. 104.
256. Speed of Retraction of Rubber. R. B. Stambaugh, Margaret Rohner and S. D. Gehman. "Jour. App. Physics," November, 1944; v. 15, p. 740.

Medical, Psychological

Therapeutic, Germicidal, Sterilization

257. Dosimetry and Local Distribution of Energy in the Electric High Frequency Field. K. S. Lion. "Jour. App. Physics," October, 1943; v. 14, pp. 545-551.
258. Electronic Stimulator for Use in General Physiology. Roland H. Thorp and Donald Robinson. "Electronic Engng.," October, 1943; v. 16, pp. 188-190.
259. Medical Shock Machine. Paul Traugott. "Electronics," November, 1943; v. 16, pp. 166, 170, 172, 174.
260. Energy Absorption in Biological Media. W. D. Oliphant. "Electronic Engng.," January, 1944; p. 338.
261. Effect of High-Frequency Fields on Micro-Organisms. Hugh Fleming. "Electrical Engng.," January, 1944; v. 63, pp. 18-21.
262. Electronics in the Study of Head Injuries. C. Sheer and J. G. Lynn. "Electronics," January, 1944; v. 17, p. 112.
263. High-Frequency Bug Eliminator. "Electronic Industries," March, 1944; p. 122.
264. A Simple Variable "Square Wave" Stimulator for Biological Work. A. E. Riltchle. "Jour. Sci. Instr.," April, 1944; p. 64.
265. Medical Electronic Practice and Research. John D. Goodell. "Electronics," April, 1944; v. 17, pp. 96-101, 356, 358.
266. Statistical Trends Among Hearing Aid Users; A Study of 10,000 Case Records. Einar Strommen. "Acoustical Soc. of Am. Jour.," April, 1944, v. 15, pp. 211-222.
267. A Chronaxie Meter and Electronic Stimulator. Brian Denny. "Electrical Engng.," June, 1944; v. 63, p. 26.
268. Electrical Hearing Aids. T. S. Littler. "Jour. Institution of Elec. Engrs.," June, 1944; v. 91, Part 3, No. 14, p. 67.
269. Slow Action Recording. H. S. Remnick. "Electronic Industries," July, 1944; v. 3, p. 102.
270. Photoelectric Plethysomograph. W. E. Wilson. "Electronics," July, 1944; v. 17, p. 116.
271. A Generator of Damped Microwaves. Angelo Montani. "Electronics," September, 1944; v. 17, p. 114.
272. Fundamentals of Hearing-Aid Design. W. D. Penn. "AIEE Transac.," October, 1944; v. 63, p. 744.

Miscellaneous

273. Electronics of the Fluorescent Lamp. M. A. Townsend. "Electrical Engng.," August, 1942; v. 61, p. 607.
274. Saturable-Core Reactor Now Smaller, More Capable. E. C. Wentz. "Westinghouse Engr.," November, 1943; v. 3, pp. 115-117.
275. The Cyclotron. M. Stanley Livingston. "Jour. App. Physics," Part 1—January, 1944; v. 15, pp. 2-19; Part 2—February, 1944; v. 15, pp. 128-147.
276. Mercury Switches and Relays Offer Specialized Performance. "Elec. Mfg.," January, 1944; v. 33, pp. 90-93, 172, etc.



For LONG RANGE and HIGH NOISE LEVELS

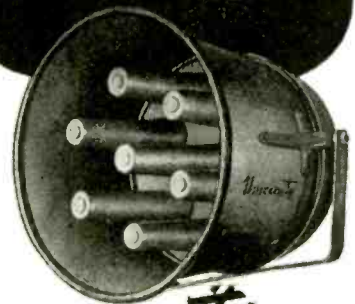

University SUPER-POWER SOUND PROJECTORS

The UNIVERSITY Model AA-7, 250 watt projector, illustrated, is powered with 7 type PAH driver units which may be connected for impedance of 2 to 100 ohms. Frequency response is 250 to 5000 cycles, and dispersion angle 90° with intelligible voice projection range up to 2 miles.

The AA-7 is reflexed for compactness and completely immune to severest continuous exposure in any climate. Diameter only 23", height 21", weight 100 lbs. The exclusive "U" bracket mounting feature permits rapid mounting and orientation. All UNIVERSITY speakers are free of acoustical or mechanical resonance, and embody rugged shockproof construction.

Special designs handling 400 watts of audio will be available for post-war civilian applications. At present, specifications can only be supplied to government agencies or firms so engaged. A letter will bring prompt, complete data.



UNIVERSITY LABORATORIES
225 VARICK STREET
NEW YORK 14, N. Y.

BH NON-FRAYING FIBERGLAS SLEEVING

ENDS
"WIRE THREADING"
WORRIES



**BH EXTRA FLEXIBLE
FIBERGLAS SLEEVING**

2 WAYS BETTER



THIS



NOT THIS

NON-FRAYING

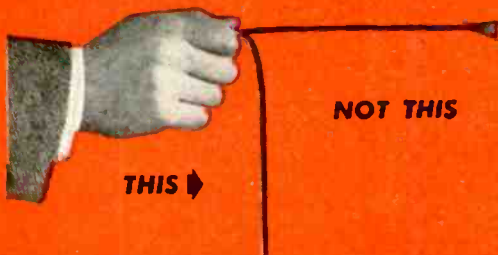

NOT THIS

THIS

NON-STIFFENING

INSERTING bare wire in rough sleeving that frays out on the ends is time- and patience-consuming. The job is much simpler and less irksome when you use BH *Extra Flexible* Fiberglas Sleeving, the non-fraying, smooth bore insulation that takes fine-stranded wires without a hitch.

Special-processed BH Sleeving is *permanently* flexible and non-fraying. It won't harden and crack with age, and it won't burn. In addition, it has all the other desirable electrical and physical features of inorganic Fiberglas.

If you're looking for an easy-working, long-lasting insulation, why not try BH *Extra Flexible* Fiberglas Sleeving? It's available in all standard colors and sizes from No. 20 to $\frac{5}{8}$ ", inclusive. Write for samples today!

**BH SPECIAL TREATED FIBERGLAS SLEEVING
CUTS CLEAN, DEFIES HEAT**

Here's another high quality BH Fiberglas Sleeving. No saturant is used in the exclusive BH process, yet the sleeving will not fray when cut and withstands heat up to 1200°F. Made in natural color only—all standard sizes. Try it!



SLOW-BURNING IMPREGNATED MAGNETO TUBING • SLOW-BURNING FLEXIBLE
VARNISHED TUBING • SATURATED AND NON-SATURATED SLEEVING

BENTLEY, HARRIS MANUFACTURING CO.

Dept. I Conshohocken, Penna.

SHEET METAL FABRICATION

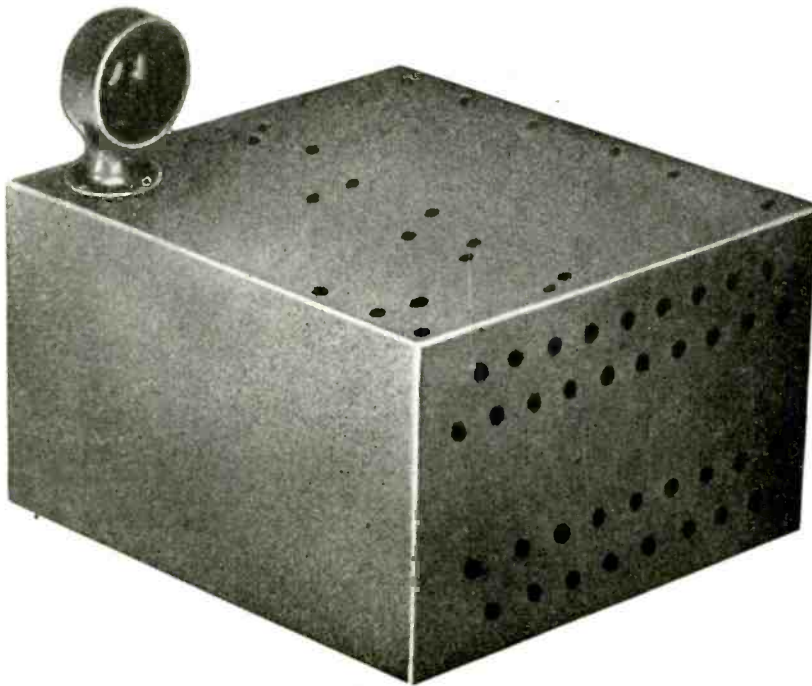

"Cole Steel Equipment" specializes in tough sheet metal assignments as well as boxes, chassis, and instrument housings. Whether your blueprints call for extreme precision or gauge limits, we're geared to design, fabricate and finish exactly to specifications. Whatever your problem, let us help you.

COLE STEEL OFFICE EQUIPMENT

will again be available
after the war

COLE

STEEL EQUIPMENT COMPANY

349 Broadway, New York 13, New York • Factory: Brooklyn, New York

277. Vibrator Converters, Wartime Improved, Offer Highly Flexible Power Sources. "Elec. Mfg.," February, 1944; v. 33, pp. 90-93, 174, etc.
278. Multiwinding Motors for Electronic Uses. Edward M. Glaser. "Electronic Industries," March, 1944; v. 3, pp. 104-105, 382, etc.
279. Supersonic Fundamentals. V. J. Young. "Electronics," March, 1944; v. 17, pp. 122-125, 204, etc.
280. Electrophotography. Nicholas Langer. "Radio-Electronic Engng.," July, 1944; v. 3, pp. 22-23, 40-41.
281. Behavior of Resistors at Radio Frequencies. R. G. Anthes. "Electronic Industries," September, 1944; v. 3, pp. 86-88.
282. VHF Ignition Noise. Gilbert Sonbergh. "Electronic Industries," November, 1944; v. 3, p. 94.
283. Relays in Industrial Tube Circuits—Part 1. Ulrich R. Furst. "Electronics," December, 1944; v. 17, p. 134.
284. Clipping, Blanking and Discriminating Circuits. M. H. Shamos. "Radio-Electronic Engng.," December, 1944; v. 3, p. 7.

Musical Instruments (Electronic)

285. Radionic Musical Instruments. Nicholas Langer. "Radionics," December, 1943; v. 1, pp. 19-24, 37.
286. Mechano-Photo Musical Instruments. Nicholas Langer. Radionics Section of "Radio News," January, 1944; p. 16.
287. Electronic Musical Instruments. Nicholas Langer. "Radio-Electronic Engng.," February, 1944; p. 19.
288. Music in an Industrial Plant. F. Ritter Shumway. "Exec. Service Bul.," April, 1944; v. 22, pp. 3-4.
289. The Future of Electronic Music. S. K. Lewer. "Electronic Engng.," June, 1944; p. 32.
290. Problems in Electronic Organ Design. S. K. Lewer. "Electronic Engng.," September, 1944; v. 17, p. 149.

Rugged!



Capacitors

Dependability is a MUST. The rugged, durable Illinois Capacitors give you maximum satisfaction under the severest of operating conditions. When looking for "tough" condensers that can be relied upon, choose "ILLINOIS."

**ILLINOIS CONDENSER
COMPANY**

1160 NORTH HOWE STREET
CHICAGO 10, ILLINOIS

Plug-in RESISTORS AND BALLASTS



★ Troubled by fluctuating line voltage? Just include a Clarostat Automatic Line Voltage Regulator in your assembly—or as an accessory plugged in between connecting cord and outlet. At 110 volts the resistance is low. Voltage drop is negligible. But as line voltage increases, the resistance builds up so as to maintain uniform and safe voltage to your assembly.

Clarostat also makes voltage-dropping resistors, such as for adapting 110-volt equipment to 220-volt power lines. Made either for built-in applications, or as convenient plug-in accessories.



★ Submit your resistance or control problems to us for engineering collaboration and quotations.



CLAROSTAT MFG. CO., Inc. • 285-7 N. 6th St., Brooklyn, N. Y.

ELECTRONIC INDUSTRIES February 1945

Oscillators

291. Oscillator Fundamentals. J. P. Jordan. "Electronic Industries," April, 1944; v. 3, p. 105.
292. Flip-Flop Circuits. S. E. M. Susskind. "Electronic Industries," November, 1943; v. 2, pp. 78-79, 236, 238.
293. Stability in High-Frequency Oscillators. R. A. Heising. "Proc. IRE," November, 1943; v. 31, pp. 595-600.
294. Wide-Range Electronic Generator. Eugene Mittelman and others. "Electronics," December, 1943; v. 16, pp. 132-134, 322.
295. The Basis of Microwave Generation. V. J. Young. "Radio," December, 1943; p. 21.
296. Pulse Generation. J. M. A. Lenihan. "Electronic Engng.," March, 1944; p. 408.
297. RC Oscillator Performance. J. H. Newitt. "Electronics," March, 1944; v. 17, pp. 126-129, 252, etc.
298. The Generation of Decemetric Waves With Diodes. J. Menke. Abstracted in "Wireless Engr.," October, 1944; p. 490 (No. 3132).
299. Characteristics of the Transitron Oscillator. Cleo Brunetti. "Communications," June, 1944; v. 24, pp. 40-42, 44, etc.
300. Klystron Characteristics. William E. Moulie. "Electronic Industries," June, 1944; v. 3, pp. 90-93, 150, 154, etc.
301. New Valve-Oscillator Circuit. F. Butler. "Wireless Engr.," July, 1944; v. 21, p. 317.
302. A Resistance-Capacity Oscillator. S. S. West. "Electronic Engng.," August, 1944; v. 17, p. 118.
303. Klystron Oscillators. A. E. Harrison. "Electronics," November, 1944; v. 17, p. 100.
304. Theory of the Multivibrator. H. W. Webb and G. E. Becker. "Jour. App. Physics," December, 1944; v. 15, p. 825.

Radio in Industry

305. Historical Notes on the Determination of Distance by Timed Radio Waves. C. D. Tuska. "Franklin Inst. Jour.," January, 1944; v. 237, pp. 1-20.
306. Radio for Railroads. William S. Halstead. "Electronics," April, 1944; v. 17, pp. 92-95, 210, 214.
307. Radio Communications for Railroads. Ernest A. Dahl. "Radio - Electronic Engng.," July, 1944; v. 3, p. 3.
308. Microwaves for Postwar Railroads. Samuel Freedman. "Radio News," July, 1944; v. 32, p. 21.
309. Developments in Train Communication. "Ry. Mech. Engr.," August, 1944; v. 118, pp. 378-381.
310. Circuit Diagram Symbols Are Standardized. "Electronic Industries," August, 1944; v. 3, p. 200.
311. Transport Communications for Railways. J. A. Curtis. "Radio News," September, 1944; v. 32, p. 32.
312. Transport Communications for Highways. J. A. Curtis. "Radio News," September, 1944; v. 32, p. 37.
313. End to End Communications for Trains. Ernest A. Dahl. "Radio News," October, 1944; v. 32, pp. 29-31, 112-114.
314. Low Voltage Receiver. Joseph Lorch. "Electronic Industries," December, 1944; v. 3, p. 86.

Rectifiers, Converters, Frequency Changers

315. Special Frequency Changers. C. E. Atkins. "Radionics," December, 1943; v. 1, pp. 9-11, 28.
316. Electronically Controlled Dry-Disk Rectifier. A. Rosenstein and H. N. Barnett. "Electrical Engng.," January, 1944; v. 63, p. 21.
317. Power Rectifiers. Emil J. Remscheid. "General Electric Review," March, 1944; v. 47, pp. 25-28.
318. Behavior Factors of Rectifier-Driven D-C Motors. Victor Siegfried. "AIEE Transac.," July, 1944; v. 63, p. 530.



SM Fractional H. P. Motors
for radio, communications,
aircraft and many commercial
applications.

Whenever you need concentrated power — maximum power per ounce of weight and per inch of space—specify SM Fractional H.P. Motors. You'll get a unit engineered and precision built to your exact specifications, a long-life motor of dependable performance. From 1/10th to 1/200th H.P. Speeds from 3,000 to 20,000 R.P.M. Voltage from 6 to 220 AC-DC. Thousands have been engineered and built for signal corps and military aircraft use. Plant facilities for large volume production. What are your requirements?

Small Motors, Inc.

Dept. 51

1308 ELSTON AVE., CHICAGO 22, ILL.

Manufacturers of special small universal, fractional H. P. motors, dynamotors, shaded pole motors, heater motors, generators.

Design • Engineering • Production



New ATLAS Little GIANT Model DR-12

Versatile is the word for Atlas Sound's latest creation, the DR-12 Little Giant (Bell diameter 7 in. Overall length 7 1/2 in.) Its construction gives equally gratifying service when used for marine application, factory, police and other communications . . . a design that has proven itself more than equal to War's rigorous demands.



Write for detailed description

Complete Atlas Sound Catalog on request.

ATLAS SOUND

CORPORATION

1445 39th Street

Brooklyn, N. Y.

WOKMAR

Manufacturers of
RADIO, ELECTRICAL AND
ELECTRONIC COMPONENTS

ELECTRONIC PRODUCTS MFG. CORP.
DEXTER, MICHIGAN

319. Controlled Rectifier Circuits. P. T. Chin and E. E. Moyer. "AIEE Transac.," July, 1944; v. 63, p. 501.
320. Electronic Power Converters. E. F. W. Alexanderson and E. L. Phillipi. "General Electric Review," September, 1944; v. 47, p. 41.
321. Filter Design for Grid-Controlled Rectifiers. Harold A. Thomas. "Electronics," September, 1944; v. 17, pp. 142-145.
322. Pentode Ignitrons. H. C. Steiner, J. L. Zehner and H. E. Zuvers. "AIEE Transac.," October, 1944; v. 63, p. 693.
323. Operation of Rectifiers Under Unbalanced Conditions. E. F. Christensen and M. M. Morack. "General Electric Review," October, 1944; v. 47, pp. 32-37.

Regulators, Exciters, Stabilizers

324. New Electronic Stabilizer and Regulator for D-C Voltages. Arvon Glynne. "IEEE Jour.," Pt. 2, June, 1944; v. '91, pp. 174-177.
325. Electronic Regulator. J. E. Reilly and C. E. Valentine. "AIEE Transac.," August, 1944; v. 63, p. 601.
326. Electronically-Regulated Power Supplies. M. S. Kay. "Radio News," November, 1944; v. 32, p. 38.

INDEX

A

Accelerometer	251
Aircraft Wood Gluing	112-116 Incl.
Alarm, Furnace Flame	43
Alarms, Protective	89
Amplidyne for Winding Control.....	45
Amplidyne System of Control.....	54
Amplifier (DC)	9-11 Incl.
Amplifier, Wideband	172
Analysis, Metallurgical.....	173, 177, 178, 179
Analysis, Spectrographic	223, 225, 226, 229
Analysis, Vibration	3, 248, 249, 250, 251
Anesthesia, Electrical	265
Anti-Hunt Circuit	36
Applications in Industry (Control).....	59, 61, 62, 65, 66, 67, 70, 72, 73, 74
Arcback Testing	208
Arc-Duration Measurement	196
Audio-Frequency Measurement	210
Auto Pilot (Aviation)	1, 5, 6, 8, 55
Auto Pilot Circuit	55

B

Baby Alarm	83
Bacteriological Applications.....	260, 261, 271
Balancing Machine	246
Beam Tube, Deflection	38
Biological Applications	260, 265, 269
Blanking Circuits	171, 284
Blocking Oscillator Time Base	170
Boiling Flask Control	182
Bolt Inspection	153
Brain Current Recording	262, 265
Brazing, H-F	122
Bug Eliminator	263
Burglar Alarms	89

C

Cable Fault Locator	80, 88, 91
Calibration, Watthour Meter	212
Capacity Meter	211
Cardboard Heating	95, 97
Carrier for Cranes	23
Carrier on Power Lines.....	13, 14, 18, 21, 26, 27
Case Hardening	123, 129, 131, 133, 135, 136, 140
Castings, Inspection	84, 85, 90, 153
Cathode Follower DC Amplifier	9
Cathode-Ray Control Tube	38
Cathode-Ray Tube Time Base	170
Cathode-Ray Tube Traces	166 thru 169
Cathode-Ray Tube Use	159 thru 172
Chronaxie Meter	267
Circuit Symbols	310
Circuits for Control	30, 35, 37
Clipping Circuits	284
Coil Design, H-F Heating.....	120, 128, 133, 134, 138, 140
Colored Object Sorting	49, 159
Colorimetry	177, 180
Contactors, Ignitron	30, 34
Control, Servo (Aircraft)	7

when silence is golden*



C-D capacitors are precision products.

Every operation in their processing is subject to careful checking and re-checking. Specialists in capacitor manufacture dictate the proper tests, the value of the tests and their sequence in the manufacturing process.

Such precise attention to detail brings its reward in the reputation C-D capacitors have for quality and performance. We are maintaining that reputation . . .

PROOF: *More engineers choose C-D than any other make.*

Today our special skills are focussed on the capacitor problems of the nation and of industry. Our enormously enlarged facilities may be able to help you. Cornell-Dubilier Electric Corporation, South Plainfield, N. J. Other plants: New Bedford, Brookline, Worcester, Mass., and Providence, R. I.

*This reliable bridge balancing test for checking capacity and power factor is one of the many, many tests used at C-D during the course of production. If the bridge is not in balance, capacity of unit being checked is off, and a hum is heard by tester. When capacity is correct she hears no signal.

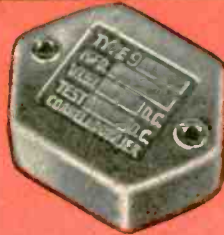

HERE'S A FAMOUS C-D MICA CAPACITOR — THE TYPE 9 FOR R. F., BY-PASS, GRID AND PLATE BLOCKING IN LOW POWER TRANSMITTERS AND AMPLIFIERS.

Special impregnation resists changes in capacity with high insulation resistance.

No magnetic material reduces losses at all frequencies.

Moulded in Bakelite for greater mechanical strength and better insulation.

Short, heavy terminals for minimum r.f. and contact resistance. Typical of C-D's precision engineering.

CORNELL - DUBILIER
CAPACITORS 1910  1945

MICA • DYKANOL • PAPER • WET AND DRY ELECTROLYTICS

DO YOU MAKE:

RADIO, SOUND AND COMMUNICATIONS EQUIPMENT?

Loud Speakers	Sound-powered	Vibration Pick-ups
Headsets	Telephones	Polarized Relays
Microphones	Telephone Ringers	Generators
Hearing Aids	Voltage Regulators	Meters
Electrical Musical Instruments	Phonograph Cutting Heads	Magnetron Fields
	Phonograph Pick-ups	

AUTOMOTIVE AND AVIATION EQUIPMENT?

Magnetos	Voltage Regulators	Generators
Tachometers	Motors	Magnetic Oil Filters
Compasses	Speedometers	

INSTRUMENTS?

Ammeters	Oscillographs	Light Meters
Voltmeters	Flux Meters	Cardiograph
Galvanometers	Watt-hour Meters	Recorders
Seismographs	Flow Meters	Vibration Pick-ups

MISCELLANEOUS PRODUCTS?

Magnetic Separators	Arc Blow-out Magnets	Clocks
Magnetic Chucks	Temperature and Pressure	Toys and Novelties
Magnetic Conveyors	Control Equipment	Coin Separators
Magnetic Clutches	Circuit Breakers	for Vending
Magnetic Damping Devices	Limit Switches	Equipment
	Holding Magnets	



IF YOU make any of the above products, it will pay you to find out how *better permanent magnets* can improve efficiency and reduce costs. Put your design, development or production problems up to The Arnold Engineering Company. Arnold engineers have been of great assistance to many manufacturers and are at your service to advise exactly what Alnico

permanent magnet will solve your particular problem.

NEW! Get your copy of this valuable, up-to-the-minute manual on the design, production and application of modern Alnico permanent magnets. Write us, on your company letterhead, today.

THE ARNOLD ENGINEERING COMPANY

147 EAST ONTARIO STREET, CHICAGO 11, ILLINOIS

Specialists in the manufacture of ALNICO PERMANENT MAGNETS

Controlled Rectifiers	316, 319, 321
Conveyor Belt Sorting	49
Cooking, H-F	99
Counters	191, 193, 195
Coupling Coils for H-F Heating	120, 128, 133, 134, 138, 140
Crack in Metal Detection	76, 77, 78, 79, 84, 85, 90
Crane Cab Carrier	23
Cycle Interval Timing	190
Cyclograph	76, 77, 78, 173
Cyclotron	275

D

DC Amplifier	9, 10, 11
Deaf, Aids to the	266, 268, 272
Decade Counter	191
Deflection Beam Tube	38
Dehydration of Foods	98, 99
Densitometry	177, 181
Design of Phototube Controls	29, 33, 35, 37
Detection, Gas or Smoke	81, 86
Diagnosis, Head Injuries	262
Differentiating Circuits	157, 159
Dimension Gage	149
Dimension Testing	76, 77, 78, 85
Direct Coupled Amplifier	10
Discriminating Circuits	284
Distance Measurement	150, 305
Dosimetry for H-F Field	257
Double-Beam Oscillograph	165
Double-Trace Oscillograph	201
Dry-Disk Rectifier Control	316
Drying Paint	127
Drying Paper	95
Duramold	114
Dust Precipitation	60, 63, 69

E

Earthquake Recorder	155
Electric Shock Generator	257, 265, 271
Electrodynoscope	246
Electron Diffraction Instruments	221, 228, 231
Electron Microscope	219, 220, 222, 227, 228, 230, 232
Electronic Heating Principles	93, 95, 97, 123, 125, 139, 141
Electronics, Elementary	65, 72
Electrophotography	280

PLASTIC NAME PLATES

SCALES, GAUGES,
CALCULATORS,
CHARTS,
DIALS,
ETC.

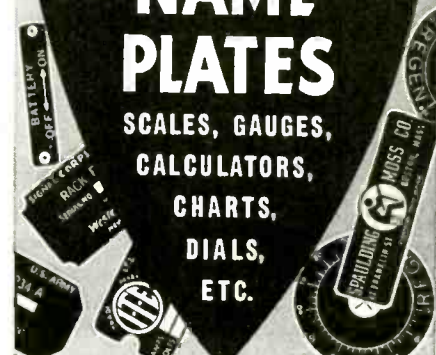

- Impervious to moisture, grease, oils, acids, alkalis.
- Printing guaranteed not to wash or rub off.
- Non-inflammable, non-corrosive plastic.
- Printed and laminated vinylite and cellulose acetate.

SAMPLES AND ESTIMATES GLADLY SUPPLIED ON REQUEST
WRITE DEPARTMENT E. 1.

THE HOPP PRESS, INC.

PRINTING - FABRICATING - FORMING

460 W. 34th STREET, N. Y. C.

ESTABLISHED 1893

Electrostatic Generator Voltage Measurement	204
Electrostatic Separation	60, 63, 69
Electrothermics of Light Metals	119
Elementary Electronics	65, 72
Engine Indicator	253, 254, 255

F

Faint Sound Detectors	92
Fault Locator, Line	80, 88, 91
Filter for Rectifiers	321
Fire Alarms	86
Fish Sound Detection	152
Flame Cutting Control	46, 47
Flame Failure Alarm	43
Flaw in Metals, Testing.....	76, 77, 78, 79, 82, 84, 85, 90
Flight Attitude Instrument	5, 6
Flip-Flop Circuits	292
Flocculating Apparatus	178
Flow Control	41
Fluid Flow Control	41
Fluorescence of Minerals	87
Fluorescent Lamp, Electronics of	273
Fluorescent Lighting, Aircraft	2, 4
FM Carrier Current	27
Food Dehydration	98, 99
Frequency (Audio) Measurement	210
Frequency Changers	315, 320
Furnace Control	42, 177
Furnace Flame Alarm	43

G

Gage for Dimensions	149
Gaging	249, 252, 253
Gallay Gluing Process	117
Galvanometer Amplifier	11
Gas Analysis	185
Gas Analysis, Spectrometer	217, 218, 224
Gas Cutting Control	46, 47
Gas Detection	81, 86
Gas Engine Indicator	253-255 Incl.
Gas Tank Fabrication	113
Glow Discharge Gage	148
Glue Heating	109-118 Incl.
Grid Control of Tubes	37
Growing Plant Potentials	216
Gyroscope Testing	251

H

Hardening of A. P. Shot	136
Hardness Testing	85
Hearing Aid Technique	266, 268, 272
Heat Treating Control	36, 42, 44
Heating Characteristics of Houses.....	239
Heatronic Molding	105
High-Frequency Heating Charts	94, 96
High-Frequency Heating Control	108
High-Frequency Heating, Stria Effect.....	142
High-Frequency Heating Theory.....	93, 95, 96, 139, 142
High-Speed Photography	236, 238
High-Vacuum Gage	143, 145, 148, 151
Highway Communication	312
Home Appliances	71
House Thermal Tests	239
Hydrometallurgy	179

I

Identifying Petroleum Products	184
Ignition Circuit Analysis	215
Ignition Circuit, H-F	215, 282
Ignition Noise, H-F	282
Ignition Contactor	30, 34, 57
Ignitron Control	57
Ignitrons	322
Ignitron Temperature	317
Illumination Control	237
Induction Heating Theory.....	93, 95, 123, 133, 139, 142
Industrial Applications, General	28, 29, 30, 32, 34, 35, 39, 59, 61, 62, 65, 66, 67, 70, 72, 73, 74
Industrial Plant Music	288
Industrial Use of Oscilloscope	159, 160
Installing Photoelectric Relays	40
Instrumentation by Electronics	158
Instruments, Temperature	242
Insulation Testing	206, 214
Integrating Circuits	157, 159
Interference from Spectrograph	229
Interval Timer, Microsecond.....	188
Ionization Gage	143, 151
Ionization Particle Counter	193

J

Jigs for High-Frequency Wood Heating.....	115
---	-----

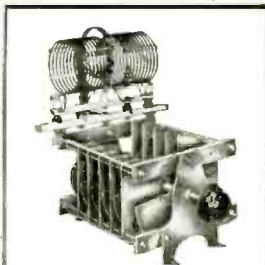
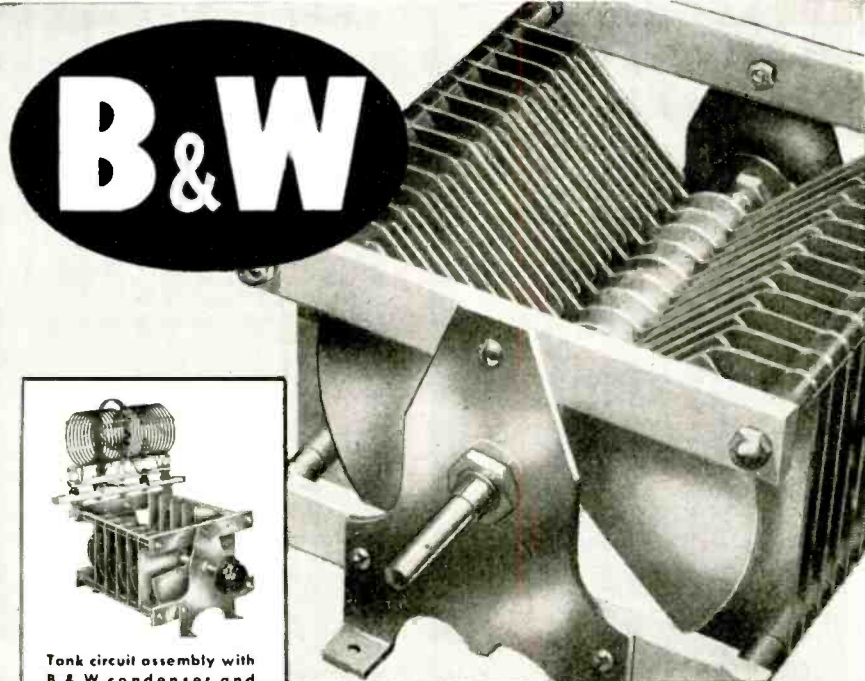

Tank circuit assembly with B & W condenser and integrally-mounted coil.

REALLY BETTER . . . BECAUSE THEY'RE REALLY DIFFERENT

It pays to plan ahead for real, honest-to-goodness variable condenser efficiency for your product! Because they are half the length of conventional dual units, and because they are designed for built-in neutralization, B & W Type CX Heavy Duty Variable Con-

densers sometimes call for slight changes in the physical design of the product in which they are incorporated—but what a whale of a difference their perfect electrical design symmetry makes in its performance! Write for Variable Condenser Catalog 75-C.



Miniature R-F INDUCTORS

B & W Miniductors in diameters from 1/2" to 1 1/4" are the answer to countless engineering calls for rugged, finely made little coils for all sorts of r-f applications. We can supply them with any type of mounting, in any length, in any winding pitch from 4 to 44 t.p.i., and with either fixed or variable internal or external coupling links, and a large variety of other special features. Q is amazingly high. Write for Miniductor Catalog 78-C.

Write for FREE SAMPLE

BARKER & WILLIAMSON

Dept. EL-25, 235 Fairfield Ave., Upper Darby, Pa.

Exclusive Export Representatives: Lindeteves, Inc., 10 Rockefeller Plaza, New York, N.Y., U.S.A.

TECHNICAL NOTES

Excerpts from New Home Study Lessons Being Prepared under the Direction of the CREI Director of Engineering Texts

Circuit Equivalents

The February issue of the CREI NEWS contains Number Five in a series of articles on the subject, "CIRCUIT EQUIVALENTS." Part 5 discusses an interesting application of the equivalent tee network to the problem of a television series peaking circuit. By means of the equivalent tee network, one can clearly see how to arrange the series peaking network so as to obtain optimum results from the plate and grid capacities of the two tubes involved.

The response for this series of articles on "Circuit Equivalents" as they appear in our magazine has been very enthusiastic. Each of these articles is complete in itself—so, send now for the current issue. A new technical article appears each month and each is of interest to professional radiomen in applying this material to their daily activities, or for filing in a scrap book for future and permanent reference.

If you have not, as yet, requested being placed on our mailing list, do so now by asking for the February issue. The CREI NEWS is published each month and is sent free to those who ask to be placed on our mailing list. Of course, you incur no obligation.

The subject of "Circuit Equivalents" is but one of many that are being constantly revised and added to CREI lessons by A. Preisman, Director of Engineering Texts, under the personal supervision of CREI President, E. H. Rietzke. CREI home study courses are of college calibre for the professional engineer and technician who recognizes CREI training as a proved program for personal advancement in the field of Radio - Electronics. Complete details of the home study courses sent on request.

Ask for 36-page booklet.

CAPITOL RADIO

Engineering Institute

E. H. RIETZKE, President

Home Study Courses in Practical Radio-Electronics Engineering for Professional Self-Improvement

Dept. EI-2, 3224—16th St., N. W. WASHINGTON 10, D. C.

Contractors to the U. S. Navy—U. S. Coast Guard—Canadian Broadcasting Corp.—Producers of Well-trained Technical Radiomen for Industry.

K

Kiln Output Sorting	49
Klystron	295, 300, 303
Kodatron	238
Kraft Paper Heating	95, 97

L

Laboratory Oven Control	44
Lamps, Aircraft	2, 4
Land Travel Tracer	75
Leveling	154
Light Metal Electrothermics	119
Lighting, Aircraft	2, 4
Limit Indicator	252
Line Fault Locator	80, 88, 91
Low-Pressure Gages	143, 145, 148, 151
Low-Voltage Receiver	314

M

Magnetic Inspection	153
Magnetic Wire Recorder234, 235, 241,	244
Magnetizer	51
Maintenance of Controls	32, 40
Map Tracer	75
Marine Fire Alarm	86
Mass Spectrograph	217, 218, 224
Measurements, General	158
Measuring Distances	150, 305
Mechanical Testing	245
Memnoscope	208
Mercury Switches	276
Metal Testing..76, 77, 78, 79, 82, 84, 85,	90
Meteorological Devices	156
Microanalysis	183
Microscope, Electron	219, 220, 222, 227, 228, 230, 232
Microsecond Interval Timer	188
Microwave Generators	271, 295, 298, 303
Microwave Generators, Therapeutic	271
Mineral Identification	87
Mining Aids	87
Moist-o-graph	144
Moisture in Textiles	144
Motor Control	52, 53, 54, 55, 318
Motors, Rectifier Operated	318
Mot-o-trol	52
Movement Measurement	247, 249, 252
Multiplier Phototube	243
Multivibrator Application	210
Multivibrator Theory	304
Muscle Movement Recording	269
Music for Factorles	288
Musical Instruments, Electronic 285, 286,	289, 290

N

Network Fault Locator	88
Noise Detector	83, 92
Noise, Ignition	282
Novachord	287

O

Odograph	75
Oil Refining Applications	184, 186
Ore Dressing	179
Organ, Electronic	287, 289, 290
Oscillator, Engineering Fundamentals	291
Oscillators	See Main Heading
Oscillograph, Double-Beam	165
Oscillograph, Double-Trace	201
Oscillograph Traces Illustrated166-169	Incl.
Oscilloscope, Blanking Circuit	171, 172
Oscilloscope Time Bases	170
Oscilloscope, Wideband	163
Oven Control	44

P

Paint Drying	127
Paint Spraying Control	69
Paperboard Heating and Drying	95, 97
Paper Heating and Drying	95, 97
Particle Counter	193
Pentode, Ignitron	322
Petroleum Plant Applications	184, 186
Phase Angle Measurement	200, 202, 203
Phase Shifting Circuits	37
Phonograph Turn-Table Testing	207
Photoelectric Relay Controls29, 30, 33,	34, 35, 40, 41, 50
Photoelectric Relay Installation	40
Photographing Cathode-Ray Traces 161,	162, 164
Photography, Electronic	280
Photography, High-Speed	236, 238

HARVEY

has for

Immediate Delivery

- American War Standard Meters in all different ranges—microammeters, milliammeters, ammeters, voltmeters, db. meters, portable instruments, etc.

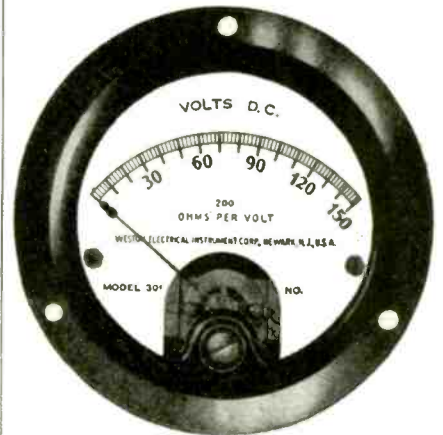

Illustrated is the Weston Model 301, just one example of the wide variety of famous make meters available at HARVEY'S.

- Mica Capacitors with 2%, 5%, 10%, or 20% tolerance to American War Standards. Also in stock are oil and electrolytic condensers.

- Precision carbon or wire wound resistors.

- 10 and 50-watt ceramic sockets.

... and hundreds of other critical radio and electronic components.

HARVEY is the complete radio and electronic supplier. Locating hard-to-find parts is but one of our many plus-services. We are prepared to answer your technical questions ... to advise you about priorities. Fast deliveries to any point in the United States.

Don't forget...

HARVEY also carries distinguished AUDAK equipment... cutters, jewel points, and pick-ups preferred by broadcasting stations and recording studios.



This merchandise available with suitable priority. Write, phone: LONgacre 3-1800

HARVEY RADIO COMPANY

103 WEST 43rd ST., NEW YORK 18, N. Y.

WILCO Now EQUIPPED

for large scale production of

JACKETED WIRE

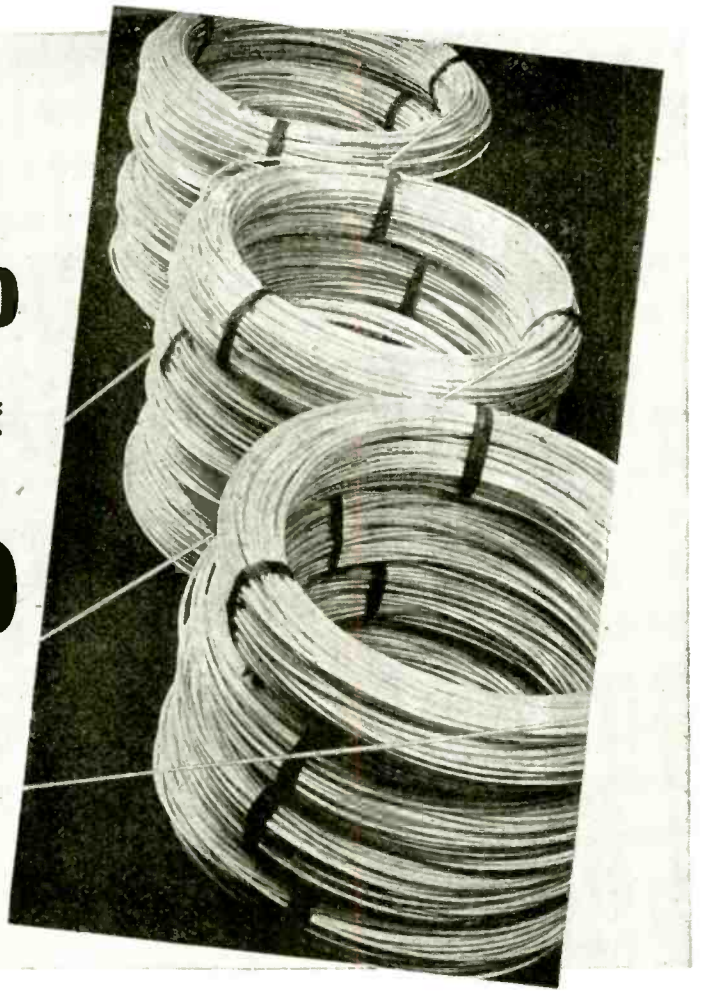

WILCO wire, tubing and other products are used in various electronic applications for the Army and Navy. In response to the wartime demand for these various products, the H. A. Wilson Company has enlarged its plant, increased its manufacturing facilities, added essential new equipment and developed new products and techniques. Both present and future customers will find these new WILCO developments of great advantage.

The H. A. Wilson Company manufactures and is interested in receiving inquiries regarding the following typical products—

WILCO JACKETED WIRE

Silver (Fine, Sterling or Coin)
Silver Jacketed Copper
Silver Jacketed Invar
Silver Jacketed Brass
Silver Jacketed Steel
Gold Jacketed Silver (Fine, Sterling, Coin)
Gold Jacketed Brass or Bronze
Copper Jacketed Monel
Nickel Jacketed Copper

WILCO JACKETED TUBING

Silver Tubing (Fine, Sterling or Coin)
Gold Tubing (any Color or Karat)
Silver Jacketed Brass or Bronze (one or both sides)
Gold Jacketed Silver (one or both sides)
Gold Jacketed Brass or Bronze (one or both sides)

WILCO STRIP MATERIAL

Silver (Fine, Sterling or Coin) on Brass or Bronze (Inlay or Overlay)
Gold on Silver (any Karat on Fine, Sterling or Coin)
Gold on Brass or Bronze

Other WILCO products include *Electrical Contacts—*

Silver, Platinum, Tungsten, Alloys, Powder Metal. *Thermostatic Bimetal* (High and Low Temperature with new high temperature deflection rates.) *Precious Metal Collector Rings—*For Rotating controls. *Silver Clad Steel. Rolled Gold Plate. Special Materials.*

Let us analyze your problems.

THE H. A. WILSON COMPANY

105 Chestnut Street, Newark 5, N. J.

Branches: Detroit • Chicago



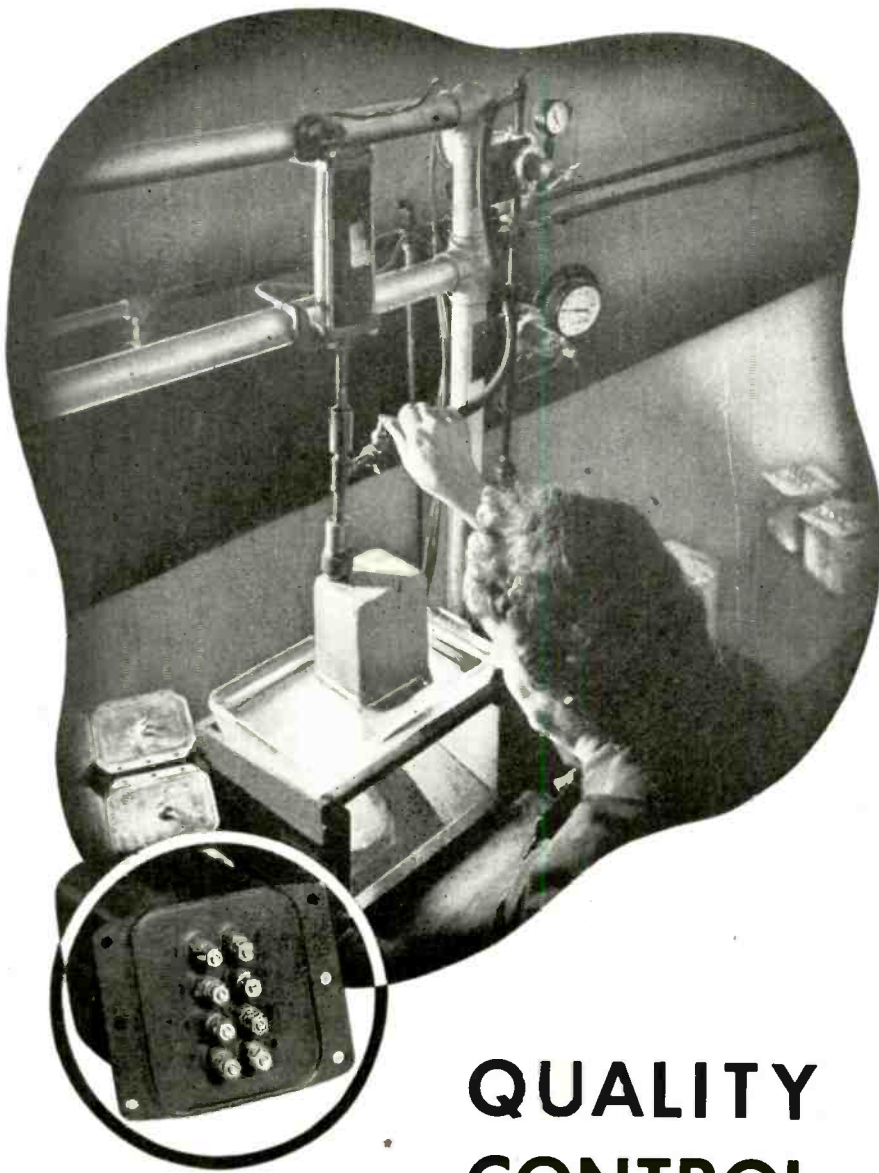

QUALITY CONTROL

The Pressure Test

One of the many tests developed for quality control at Chicago Transformer subjects the case-seam and bushing seals of all Hermetically-Sealed transformers to air-pressure prior to compound filling. This procedure, along with numerous other tests, detects any weakness in bushings and seams at an early stage of production and insures perfect sealing of every unit.

CHICAGO TRANSFORMER

DIVISION OF ESSEX WIRE CORPORATION

3501 WEST ADDISON STREET

CHICAGO, 18



Phototube, Multiplier Type	243
Phototube, Ultraviolet	233
Pick-Up Devices	245
Pilot, Electronic (Aviation)1, 5, 6, 7, 8	
Pin-Hole Detector	82
Pirani Gage	145
Plant Potential Measure	216
Plastic Heating Frequency Control.....	108
Plastics Heating	See Main Heading
Plethysmograph	270
Plywood Fabrication	114, 116, 117, 118
Polarographic Analysis	176
Polaroscope	175
Position Indicating Motors	278
Positioning Servo (Aircraft)	7
Postwar Electronics	59, 62, 71
Potentiometer Recorder	199
Powder Precipitator	60, 63, 69
Power Converters	320
Power Line Carrier13, 14, 18, 21, 26, 27	
Power Line Fault Locator	80, 88, 91
Power Supply, Regulated	326
Precipitation	60, 63, 69
Precision Leveling	154
Preform Heating, Plastics	107, 108
Preheating of Plastics	102-108 Incl.
Pressure Measurement 247, 249, 252, 253, 255	
Process Control	146, 147, 158
Prospecting, Aid to	87
Protective Systems	89
Pulse Generator	296
Pulse Measurement	172
Pulse Method of Testing	91
Pyrometallurgy	179

R

Radio Sonde	156
Railroad Use of Radio306, 307, 308, 309, 311, 313	
Railway Use of Carrier15, 16, 17, 19, 20	
Recorder, Wire Magnetic234, 235, 241, 244	
Rectifier Arcback	208
Rectifier Control	316, 319, 321, 326
Rectifier Operation, Unbalanced	323
Rectifier Temperature	317
Rectifier Testing, Selenium	213
Reeling Control	45
Refinery Applications	184, 186
Regulated Power Supply	326
Regulators	36, 324, 325

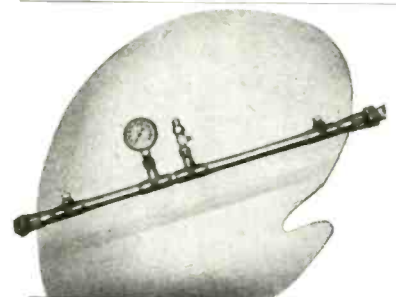

COPPER TUBING CONCENTRIC LINE

Standard stock sizes include 5/16", 1/2", 3/8", 1-3/8" and 2-3/8". Other sizes can be manufactured on special order. Johnson concentric line is accurately designed for uniform impedance and manufacturing methods insure accurate diameters of both outer and inner conductors and maintenance of spacing ratios within close limits. Insulation is Alsimag 196, conductors are pure copper, and special manufacturing techniques at joints insure lower losses.

Complete lines of fittings, gauges, valves, expansion joints, and gas equipment are also available. Write today for recommendations and prices.

JOHNSON

a famous name in Radio



E. F. Johnson Co. Waseca, Minn

ELECTRONIC INDUSTRIES • February, 1945

10XBX

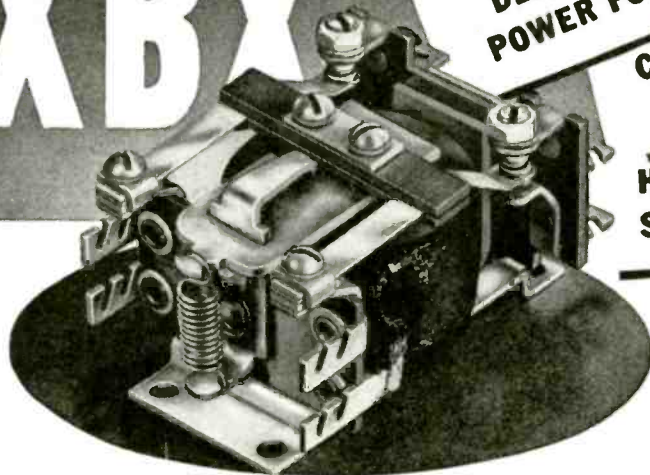

**DELIVERS A LOT OF
POWER FOR ITS SIZE**

**COVERS A WIDE RANGE
OF APPLICATIONS**

**HIGHLY RESISTANT TO
SHOCK AND VIBRATION**

... A GOOD RELAY TO KNOW!

If any Relay type ever deserved the name "All-Purpose" it is Type 10XBX of the Struthers-Dunn 10-frame series. While new and special types come and go, this popular 2P. D.T. relay continues in heavy favor with leading users to whom its extreme versatility on a wide range of applications holds strong appeal. From audio frequency circuits to motor control circuits; from naval battle announcing stations where shock resistance is important, to aircraft use where vibration is a big factor, 10XBX relays are performing competently and well.

These relays are light, small, and

sturdy. Highly electrically efficient, they deliver a lot of power for their size. Contact pressures up to 50 grams are available. Bakelite insulation is supplied for power circuit applications, and ceramic insulation for radio-frequency use. A-C coils to 115v, 60 cycles; or d-c coils to 115v are available. Contacts may be in any desired combination up to and including 3 pole, double throw. All 10XBX relays withstand 10G vibration and are highly resistant to shock. Other relays of the 10-frame series are available in either single or three pole contact arrangements.

STRUTHERS-DUNN, Inc., 1321 ARCH ST., PHILADELPHIA 7, PA.

*WRITE for the big Struthers-Dunn 48-page
Catalog and Relay Engineering Data Book.*

STRUTHERS-DUNN

5,312 RELAY TYPES

DISTRICT ENGINEERING OFFICES: ATLANTA • BALTIMORE • BOSTON • BUFFALO • CHICAGO • CINCINNATI • CLEVELAND
DALLAS • DENVER • DETROIT • HARTFORD • INDIANAPOLIS • LOS ANGELES • MINNEAPOLIS • MONTREAL
NEW YORK • PITTSBURGH • ST. LOUIS • SAN FRANCISCO • SEATTLE • SYRACUSE • TORONTO • WASHINGTON

**Specially Recommended
for Heavy Vibration**

Gothard

**No. 1203
PILOT
LIGHT**

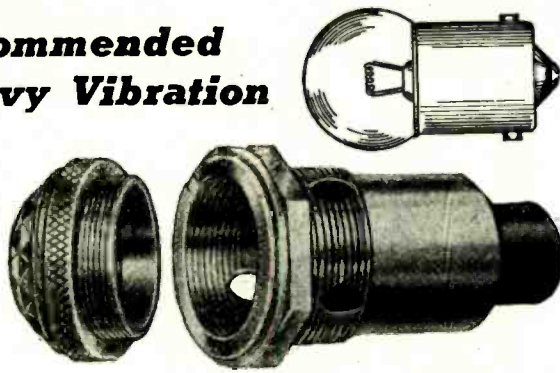

Every design detail of this Gothard Light counteracts troublesome vibration. Jewel holder is threaded into body of light and is unscrewed to permit lamp change from front of panel. Bayonet type lamps are used—accommodating a range from 6 to 24 volt ratings. The No. 1203 requires only a 1" mounting hole and mounts on panels up to 3/8" thick. Metal parts are all brass, except hex. nut. Heavy plated. Available with

plain, faceted or frosted jewels—in colors: red, green, amber, blue, opal or clear as specified. Request your copy of the Gothard catalog for data on the complete line of Gothard Lights.

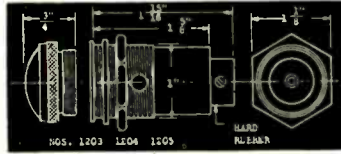

LOOK TO THE LEADER FOR LEADERSHIP.

Gothard **MANUFACTURING COMPANY**
1315 NORTH NINTH STREET SPRINGFIELD, ILLINOIS
EXPORT DIVISION—25 Warren Street, New York 7, N. Y.
CABLES—Simontrice, New York

Specialists

- ... in Assembly and sub-assembly of Precision Electronic Products
- Complete Facilities for Production and Testing of Audio Equipment
- Consult us with your Production Assembling Problems

RADELL
CORPORATION

6323-27 GUILFORD AVENUE, INDIANAPOLIS 5, INDIANA.

Relaying System, Carrier	18, 24
Relays for Tube Circuits	276, 283
Resin Bonding of Wood	109-118 Incl.
Resistance-Capacity Oscillator	297, 302
Resistance Furnace Control	42
Resistance Welding Control	56-58 Incl.
Resistors at High Frequency	281
Retraction of Rubber, Testing	256
Reverberation Measurements	159
Revolution Counter	195
Rotameter Application	41
Rubber, Testing	256

S

Saturable Core Reactor	274, 316
Seam Welding Control	57
Seismographic Recorder	155
Selenium Rectifier Testing	213
Separation, Electrostatic	60, 63, 69
Servicing of Control	32, 40
Servo Amplifier	55
Sheet Metal Hole Detector	82
Ship Fire Alarm	86
Shock Generators (Electrical)	257, 265, 271
Slow Action Recording	269
Smoke Detectors	86, 177
Soldering	122
Solovox	287
Sonic, Radio	156
Sonic Flocculating Apparatus	178
Sorting Colored Objects	49
Sorting Metals	76, 77, 78, 174
Sound Detector	83, 92
Sound Measurement	159
Spectrographic Analysis	223, 225, 226, 229
Spectrophotometry	225
Speed Balancing	246
Speed Control	52-54 Incl.
Speed Measurement	159, 195, 164, 170
Spray Control (Paint)	69
Spot Gluing	111
Square Wave Generator	264, 292
Square Wave Stimulator	264
Stability, High-Frequency Oscillator	293
Stabilizer for DC	324
Steel Heating Peculiarities	142
Steel Processing Applications	46-48 Incl.
Steel Strip Hole Detector	82
Sterilization of Foods	99, 263
Sterilizer, Packaged Cereals	263
Still Control	182
Stimulator, Physiological	258, 259, 264, 265, 267
Stop Watch, Photoelectric	187
Strain Gages	247, 249, 252, 255
Stria Effect, H-F Heating	142
Strip Winding Control	45
Stroboscopes	177, 203, 212
Supercharger Control	31
Supersonics	64, 68, 85, 244, 279
Supersonic Testing	64, 68, 85
Surface Hardening	123, 129, 131, 133, 135, 136, 140
Surge Type Tester	206
Sweep Circuit	172, 292
Switch, Electronic Oscilloscope	201
Symbols	310
Synchronism Indicator	202

T

Tachometer	195, 251
Telegraph Systems, Carrier	25
Temperature Control	36, 42, 44, 240, 242
Tension Control	45
Textile Moisture Constant	144
Therapy, H-F	257, 271
Thermometer, Electronic	240
Thickness Gage	147
Time Base Oscillator	170
Time Delay Relay	30
Timer, Microsecond	188
Timers	187, 188, 189, 190, 192, 194, 197
Tin Fusion	124, 137
Tire Cord Setting	101
Tire Heating	100, 101
Tocco Process	136
Traffic Control, Railroad	15, 16, 20
Train Communication, Carrier	17, 19, 20
Train Communication, Radio	306, 307, 308, 309, 311, 313
Transfer Molding	106
Transient Recording	164, 170, 171, 172
Transitron Oscillator	299
Transmission Line Fault Locator	80, 88, 91
Tree Potentials	216
Trigger Circuits	12
Tripoli Powder Precipitation	63
Turbo Supercharge Control	31

DeJUR DESIGN EFFICIENCY...

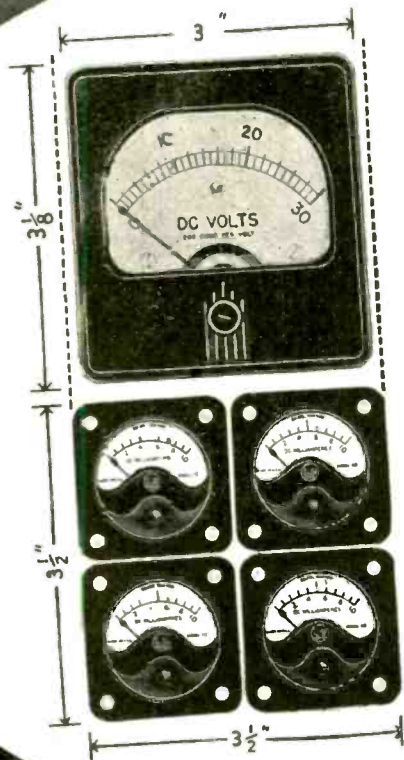

DeJUR ELECTRICAL INSTRUMENTS

Conservation of space and materials while, at the same time, maintaining efficiency is demonstrated in the DeJur 1 1/2-inch Model 112 Meter. Four of these meters, as shown in the photograph, take no more room than one DeJur 3 1/2-inch Model 312 Meter. Yet, the 112, measuring only 1 3/4 inches square and 25/32-inch deep is capable of doing a man-sized job in many applications where space is at a premium. Using basically the same carefully designed components as our larger instruments, this meter is built with fine watch precision. Available in standard ranges.

DeJUR RHEOSTAT-POTENTIOMETERS

The manufacturing scope of DeJur is exhibited in the wide range of our rheostat-potentiometer line. There are models for electronic devices, radio transmitters, dynamic voltage control, portable power amplifiers, mixing panels, spot welding, motor control, etc. Mechanically and electrically engineered to the precise requirements of the industry. Available in standard, multiple or ganged units, and units with special resistance values and tolerances. Designed for efficient service under all operating conditions.

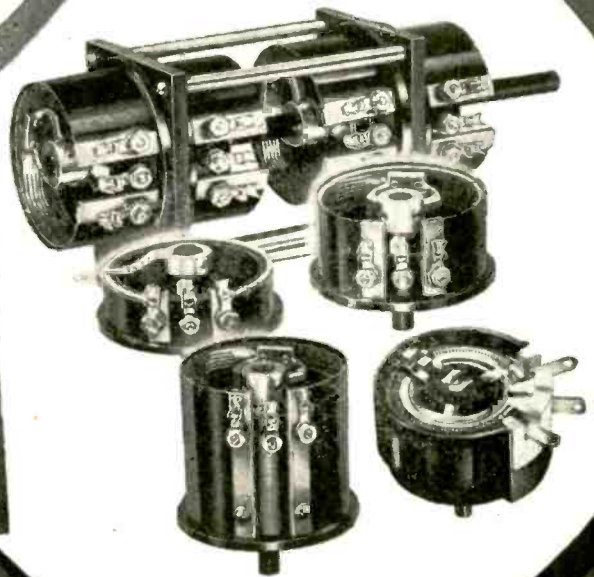

We are equipped to work with you on special models, of all DeJur products, for present or postwar applications. Write for the latest DeJur catalog.

BUY • AND • HOLD • MORE • WAR • BONDS

DeJur-Amsco Corporation

GENERAL OFFICE: NORTHERN BLVD. AT 45th ST., LONG ISLAND CITY 1, N. Y.



Proved Performance IN VHF

Customized for Airlines Airport Traffic Control and Public Safety

COMCO engineers have pioneered in the development of VHF equipment . . . designed for ease of installation and maintenance . . . ruggedly constructed to withstand varied climatic conditions and long service . . . proved performance in commercial use . . . adopted for military service. We can supply equipment on priority NOW and are accepting non-priority orders for post-war delivery. Write for complete details.

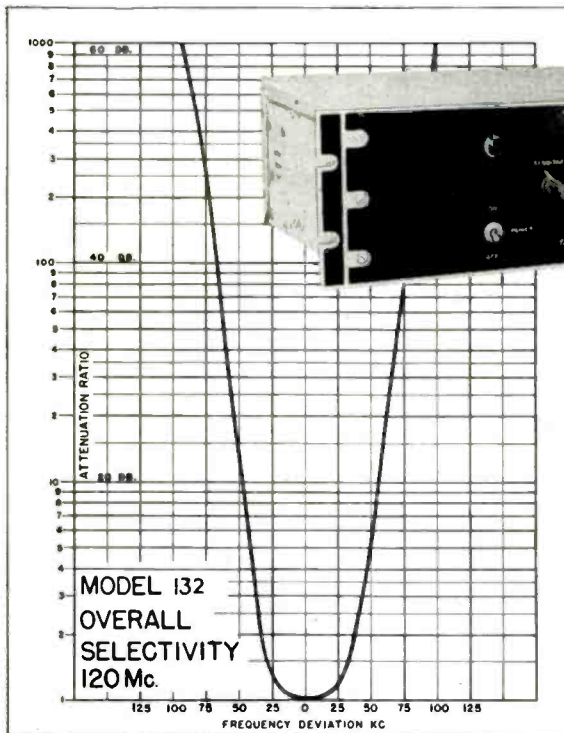

VHF COMCO RECEIVER MODEL 132

- Frequency Range:**
100 to 156 Mc.
- Image Ratio:**
100 to 1 (40 db.) at 156-128 Mc.
300 to 1 (50 db.) at 128-100 Mc.
- A.V.C. Action:**
Constant within 3 db. from 100 microvolts to 100,000 microvolts.
- Sensitivity:**
7.5 microvolts 30% modulated for 6 mw. output.
- Signal-to-Noise:**
13 db. at 7 microvolts. Input 30% modulated.
- Antenna Input Impedance:**
50 ohms for co-axial line.
- Audio Output:**
Maximum undistorted. 0.5 watt into 500-600 ohms —balanced output. Audio response within 6 db. from 100 to 3000 cycles.
- Power Source:**
110-120 volts, 60 cycles A.C., 75 watts.



VHF COMCO TRANSMITTER MODEL 170

50 watts . . . frequency range 100 to 150 Mc. . . . Width 23"; Depth 18"; Height 48" . . . self-contained unit.

MANUFACTURERS
OF RADIO AND
ELECTRONIC
EQUIPMENT

COMCO

CUSTOMIZED ELECTRONICS

COMMUNICATIONS
COMPANY, INC.
CORAL GABLES
34, FLORIDA

U

Ultrasonics	64, 68
Ultraviolet Phototube	233
Universal Amplifier (AC and DC)	10
Utilities Use of Carrier13, 14, 18, 21, 24, 25, 26, 27	

V

Vacuum Gage	143, 145, 148, 151
Vapor Control	185
Vectorscope	203
Vegetable Potentials	216
Velocity-Modulation Oscillator295, 300, 303	
Vibration Analyzer	3, 248, 249, 250, 251
Vibration Analyzer (Aircraft)	3
Vibrator Converters	277
Voltmeters	198, 204, 205, 209
Vulcanizing	100

W

Water-Flow Control	41
Water-Level Control	182
Watt-Hour Meter Calibration	212
Wave Form Measurement	172
Weather Devices	156
Welding, H-F	56
Wideband Amplifier	172
Winding Tension Control	45
Winding Tester	206
Wire Recorder, Magnetic234, 235, 241, 244	
Wire Tension Control	45
Wood Gluing Theory	109, 110, 118
Wow Meter	207

X

X-Ray, Industrial Use	90
-----------------------------	----

WHAT'S NEW

(Continued from page 114)

Circuit Breaker

The Heinemann Circuit Breaker Co., 137 Plum St., Trenton, N. J., has in production an improved single pole circuit breaker for 240 volt ac and 125 dc, 50 ampere maximum. It may be front connected or rear



connected. This breaker has instantaneous trip or a selection of three time delays. Overall dimensions are 5 1/4 in. long by 2-11/16 in. high, and 1 1/2 in. wide.

Vacuum Gage

An improved type Tru-Vac vacuum gage (of the Pirani type) for accurate high vacuum measurement is now available. The gage gives instantaneous and continuous reading within a range of 0 to 3,000 microns. It indicates the presence of water and other vapors, takes note of vacuum changes as they occur and is adaptable to any high vacuum pump or system. It is direct-reading and the state of the vacuum may be noted at any time. These dc operated gages require only one or two No. 2 dry cells and may be installed in rubber, sealed to hard or soft glass systems, or coupled to one half inch standard pipe connections. Manufactured by the Continental Electric Co., Geneva, Ill.

Electro-Voice MODEL 205-S

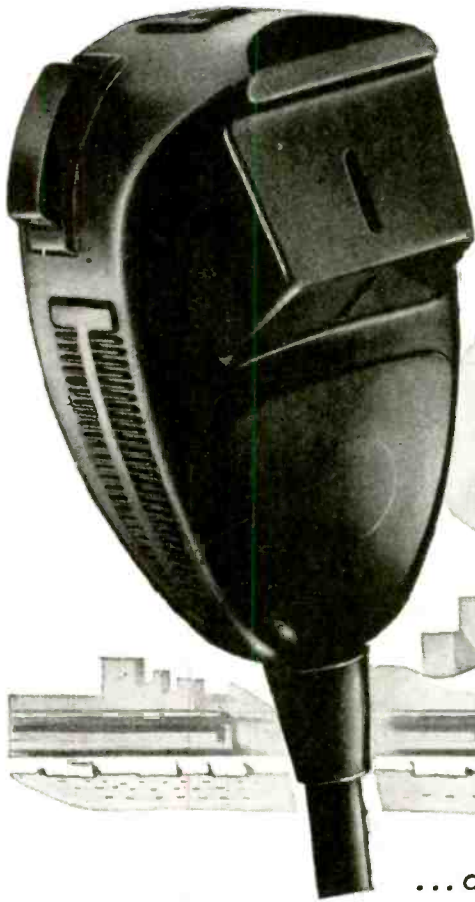

For
RAILROAD
MARINE
AIRCRAFT
POLICE
EMERGENCY
INDUSTRIAL CALL SYSTEMS
in NOISY LOCATIONS
... and many other applications

... a single button, hand-held, carbon DIFFERENTIAL microphone, designed for maximum intelligibility under extreme noise

Ambient noise is fed into dual apertures, shown in photograph, in correct phase relationship to provide almost complete cancellation of the entire noise spectrum. Speech that originates close to one of these apertures is faithfully reproduced. Articulation percentage is at least 97% under quiet conditions, and 88% under a 115 db noise field. The Model 205-S is unusually versatile . . . can be used, indoors or outdoors, for all speech transmission in any noisy, windy, wet or extremely hot or cold location.

Because the 205-S is a noise-cancelling microphone, it must be used in a manner different from any other type. The microphone should be held so that the lip-rest will touch lightly against the upper lip. This brings the mouth and instrument into the correct position for proper transmission. As with all Electro-Voice microphones, the Model 205-S is guaranteed to be free from defect in material and workmanship — for life.

SPECIFICATIONS OF THE MODEL 205-S

OUTPUT LEVEL: Power rating: 27 db below 6 milliwatts for 10 bar pressure. Voltage rating: 10 db above .001 volt/bar, open circuit. Voltage developed by normal speech (100 bars): .32 volt.

FREQUENCY RESPONSE: substantially flat from 100-4000 c.p.s.

ARTICULATION: at least 97% articulation under quiet conditions; 88% under 115 db of ambient noise.

AVERAGE BACKGROUND NOISE REDUCTION: 20 db and higher, depending on distance from noise source.

WEIGHT: less than eight ounces.

INPUT: standard single button input is required.

CURRENT: 10-50 milliamperes button current.

HOUSING: molded, high impact phenolic housing; minimum wall thickness, 5/32", vinylite carbon retainer.

TEMPERATURE RANGE: from -40° to +185°F.

PRESS-TO-TALK SWITCH: available with or without hold-down lock. Double pole double throw contacts provide an optional wide assortment of switch circuits.

STANDARD SWITCH CIRCUIT: provides closing of button circuit and relay simultaneously.

THERMAL NOISE: less than 1 millivolt with 50 milliamperes through button.

STURDY CONSTRUCTION: capable of withstanding impact of more than 10,000 6" drops to hard surface.

POSITIONAL RESPONSE: plus or minus of 5 db of horizontal.

CONDUCTOR CABLE: 5 feet of two conductor and shielded cable, overall synthetic rubber jacketed.

Model 205-S,
List Price...\$25.00

Model 205-SL,
with switch lock,
List Price...\$26.50

Electro-Voice MICROPHONES

ELECTRO-VOICE CORPORATION • 1239 SOUTH BEND AVENUE • SOUTH BEND 24, INDIANA
Export Division: 13 East 40th Street, New York 16, N. Y., U. S. A. Cables: Arlab



BLOWERS for Electronic Equipment

Easy-to-install . . . compact . . . quiet-running . . . economical . . . these are the features which make Pilot Blowers ideal for the important job of air circulation and ventilation in Radio Equipment. Available in standard models to move from 15 to 100 C.F.M. Write for Bulletin 507.

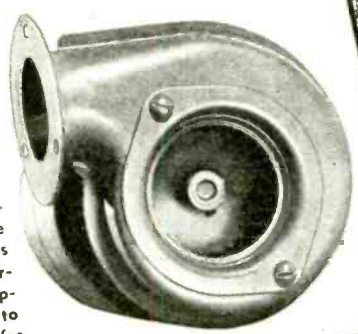

SHADED POLE F. H. P. MOTORS

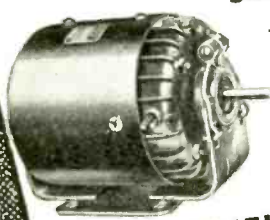

Tell us what your requirements are and we will send you "fact sheets" giving complete specifications on these dependable, efficient, low-cost Motors. For continuous or intermittent duty with H.P. ratings ranging from 1/15 to 1/500 H.P. and from 1550 to 3400 R.P.M. Plain round or with base or resilient mounting . . . open or enclosed cases.

F. A. SMITH MANUFACTURING CO., INC.
901 DAVIS ST., ROCHESTER 2, N. Y. 

SHADED POLE MOTORS *Pilot* CENTRIFUGAL BLOWERS

Get this

READY REFERENCE MANUAL ON GROVES wire wound RESISTORS

This comprehensive Manual, just issued, can save you time in selecting resistors to meet your requirements. Derating curves enable you to pick proper operating temperatures. Types are listed in complete detail. Contains up-to-date engineering data on applications. Write for copy. No obligation implied.

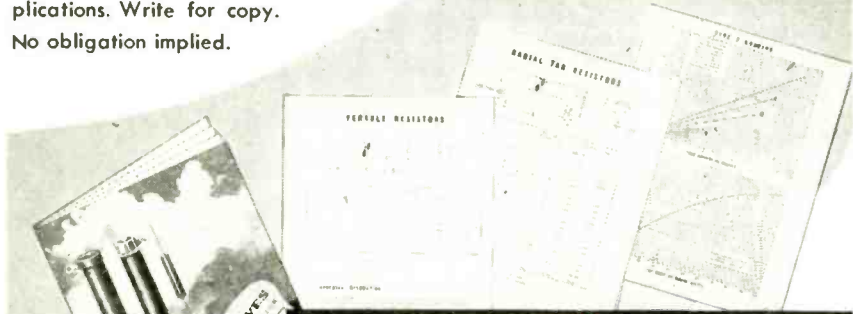

GROVES CORPORATION
CAPE GIRARDEAU MISSOURI

WHAT'S NEW

Magnetic Fluxmeter

The Model 256 Hickok fluxmeter utilizes an electronic circuit so connected to an indicating meter that when the exploring inductor is placed in a magnetic field the indication of the meter will be in proportion to that field. This model is designed to operate from 105-120 volts ac, 50 cycle circuit. Built-in voltage regulation is provided so that the indication is independent of normal line voltage fluctuations. Magnetic flux measurements can be compared within plus or minus 3 per cent. Higher accuracy can be obtained by calibrating the instrument with a known gauss standard and using it

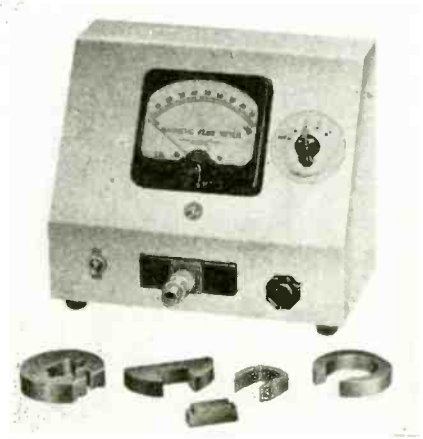

shortly afterwards. One four position sensitivity control serves the dual-purpose of turning the instrument off and also selects the three sensitivity positions. The balance control is used to pre-set the meter at zero. Accessories include a seven-foot power cord to connect the ac source of power and one standard exploring inductor that can be used to measure air gaps 1/2 in. or larger, or bar or disk type magnets. Maker is Hickok Electrical Instrument Co., 10523 Dupont Ave., Cleveland 8, O.

Facsimile Unit

A newly refined model Duplex facsimile unit has been designed by Finch Telecommunications, Inc., Passaic, N. J., and is engineered to transmit and receive simultaneously either by radio or over telephone lines. The equipment measures 15 x 9 x 14 in., weighs 25 lbs. and operates from the 110 v lines from its own power supply. It will transmit and receive copy on paper 8 1/2 x 7 in. on 7 x 2 1/2 in. identical cylinders which hold the copy and the dry electro-sensitive recording paper. Scanning is at the rate of 8 sq. in. per minute, 100 lines to the inch.





WHY WE LIKE TO "ROLL OUR OWN"

THE production of high-efficiency electrical and electronic equipment demands close control over the manufacture of most of the parts which go into it.

To be certain of accurate control over component parts, Connecticut Telephone and Electric Division manufactures an unusually high percentage of them in its own plant. For instance, we produce our own magnets, wind our own coils. Stampings and screw

machine products are turned out to our own standards, in our own shops.

These facilities for complete fabrication of the more essential elements of a piece of electrical or electronic equipment are as important to our customers as to us—they result in a better product at a "better" price . . . also assurance of our ability to keep delivery promises.

MAGNETS have a great deal to do with the efficiency of many types of electrical apparatus. Specially developed alloys treated in our own electric furnaces permit close control over the performance of C. T. & E. products.



CONNECTICUT TELEPHONE & ELECTRIC DIVISION
GREAT AMERICAN INDUSTRIES, INC. • MERIDEN, CONN.

TELEPHONIC SYSTEMS • SIGNALLING EQUIPMENT • ELECTRONIC DEVICES • ELECTRICAL EQUIPMENT
HOSPITAL AND SCHOOL COMMUNICATIONS AND SIGNALLING SYSTEMS • IGNITION SYSTEMS

SIGMA SENSITIVE RELAYS

ASSURE *Positive* CONTROL

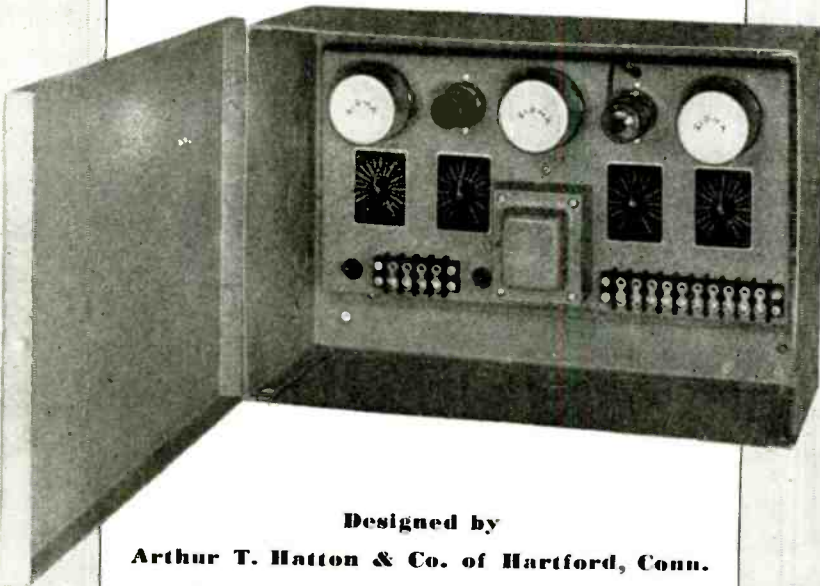

Designed by

Arthur T. Hatton & Co. of Hartford, Conn.

This Electronic Motor Controller employs Sigma Relays in pre-adjusted timing circuits.

Applied to a stationary motor, it provides reliable control from an overhead crane . . . by way of a beam of light.

Many similar installations are successfully operating today . . . have you a problem which requires positive control?

Perhaps Sigma Relays will help you solve a difficult control problem.

Sigma Instruments, Inc.
Sensitive RELAYS
70 CEYLON ST., BOSTON 21, MASS.

WHAT'S NEW

Portable Kilovoltmeter

Latest addition to the Shallcross line of high voltage measuring equipment is the Type 772 portable 2-scale dc kilo-voltmeter. Its scales cover 0-2 kv and 0-20 kv. The unit is compactly assembled in a portable oak cabinet with carrying handle, making it well suited for a wide variety of uses. Maker is Shallcross Mfg. Co., Jackson & Pusey Avenues, Collingdale, Pa.

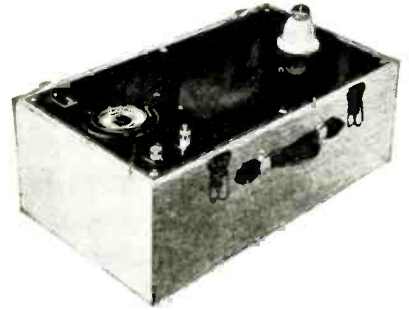

Nut Cover Plates

These new Speed Nut cover plates were first designed for patching bullet holes in airplanes. Easily and quickly attached from one side by sliding one end of the Speed Nut into the hole, centering the cover plate over the hole and tightening the screw. The turned-down tab on the cover plate prevents the Speed Nut from turning while the screw is tightened. Made of SAE 1060 steel, heat treated, Parkerized and coated with zinc

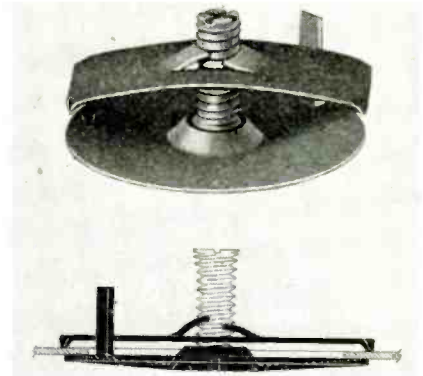

chromate primer. Three sizes available to fit a wide range of panel thicknesses and to cover holes $2\frac{3}{32}$, $1\frac{1}{8}$ and $1\frac{1}{16}$ diameter. Manufactured by Tinnerman Products, Inc., 2111 Fulton Rd., Cleveland 13, Ohio.

Mobile Rectifier

Developed especially for making magnetic particle inspection of steel propellor shafts, this new mobile rectifier unit has a continuous capacity of 1500 amperes dc with the



output voltage adjustable in 8 steps from 1 to 6. The rectifier is a fan-cooled selenium unit. Input is 3 phase 440 volt 25 cycles. Manufacturer is W. Green Electric Co., 130 Cedar St., New York, N. Y.

SUCCESSFUL DESIGN FOR PLASTICS DEPENDS UPON THE CORRECT APPLICATION OF SOUND DESIGN PRINCIPLES. A NEW TWENTY-FOUR PAGE DESIGN BULLETIN HAS BEEN PREPARED BY THE PLASTICS DIVISIONS OF THE GENERAL ELECTRIC COMPANY AND INCLUDES A LISTING OF MATERIALS, DESIGN CONSIDERATIONS AND MOLDING PROCESSES. FOR YOUR COPY WRITE TODAY TO SECTION T-49, ONE PLASTICS AVENUE, PITTSFIELD, MASS.

Hear the General Electric radio programs: "The G-E All Girl Orchestra" Sunday 10 P.M. EWT, NBC. "The World Today" news every weekday 6:45 P.M. EWT, CBS.

Buy War Bonds

CALL A G-E PLASTICS TECHNICIAN FOR SOUND ADVICE

GENERAL  ELECTRIC

PD-49

Designed for

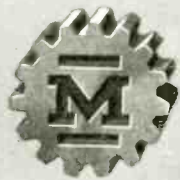

Application



No. 33991
Voltage Regulator
Tube Socket

Sturdy, compact with dependable contacts. Another in the series of Millen "Designed for Application" components for modern circuits. For use with miniature neon type dual contact bayonet base voltage regulator tubes such as Radiotron No. 991.

JAMES MILLEN
MFG. CO., INC.

MAIN OFFICE AND FACTORY
MALDEN
MASSACHUSETTS



Smaller Four-Band Radio Compass Set

A new type of four-band, 28-volt operated automatic radio compass receiver has been developed by Fairchild Camera and Instrument Corp. for the military forces. Use of the normal 28-volt storage battery for power permits elimination of dynamotor and filter equipment by substitution of a high-altitude type vibrator. The new set, operating in the 100-200 kc (for foreign navigational aids) 200-410, 410-850 and 850-1750 kc bands, is 28 per cent smaller than its predecessor, which covered only the three higher frequency bands, and 21 per cent lighter. It operates at a saving of 27 per cent in power consumption, as compared with the older model which was operated from a 115 volt 400 cycle supply, requires no external ac voltages.

Wire Recorder Licenses to Five

Five more companies have been added to the roster of those that have been licensed by Armour Research Foundation to manufacture magnetic wire recorders. These are the E. H. Scott Radio Laboratories, Inc., and J. P. Seeburg Corp., both in Chicago; The Lewyt Corp., Brooklyn, N. Y., Radiotechnic Laboratory, Evanston, Ill., Boosey & Hawkes, Ltd., London, England.

Collins in Flight Research

As a part of its expanding program of research, development and manufacture of airborne radio communication and navigation equipment for the Armed Services, and for post-war commercial and private buyers, the Collins Radio Co., Cedar Rapids, Iowa, has acquired an airplane and is letting contracts for the construction of a hangar and laboratories at the Cedar Rapids municipal airport. These facilities will be used for flight testing and proving new and advanced designs of radio equipment by actual installation and use in aircraft, and for service to customers. A staff of about forty scientists, engineers and laboratory assistants will conduct special research and development work in the laboratories adjacent to the hangar. This represents an expansion of the staff of the company's Engineering Design Division, most of which will still be housed in the main Collins plant.

Bittan Adds Nevins

Bittan-Nevins Co., is the new name of the D. R. Bittan Sales Co., 53 Park Place, New York, manufacturers representatives. The change signifies the admission of Irvin Nevins to partnership in the firm.

PRECISION PARTS

PUTTING THE HEX ON TRAIN-WRECKS

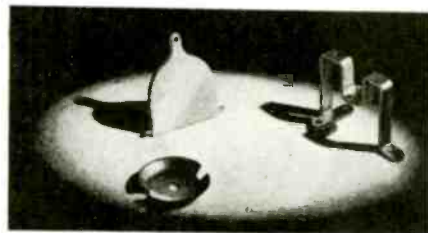

As the modern flier roars down the tracks, the way-stations at regular intervals along the line report its progress back to the dispatcher. He, in turn, can talk to any of the way-stations with the flip of a key, and bring the train to a quick stop if necessary.

These small metal pieces are a part of the modern train-dispatching communications equipment. Involving accurate stamping, tapping, and machining, they are typical of Ace facilities for fast, dependable production on small parts and assemblies.

Here you will find the ability and equipment that have earned an outstanding record in war-production. Here men and machines have turned-out parts calling for tolerances finer than the thickness of a human hair—and have done it on a mass-production basis. If you are looking for a future source of supply for small, accurate parts involving stamping, machining, heat-treating, grinding, and assembling, call on Ace today. Send sample, sketch, or blueprint for quotations.



Send for Ace Booklet Fine Precision which includes description of heat-treating facilities.



ACE MANUFACTURING CORPORATION
for Precision Parts



1239 E. ERIE AVE., PHILADELPHIA 24, PA.
ELECTRONIC INDUSTRIES • February, 1945

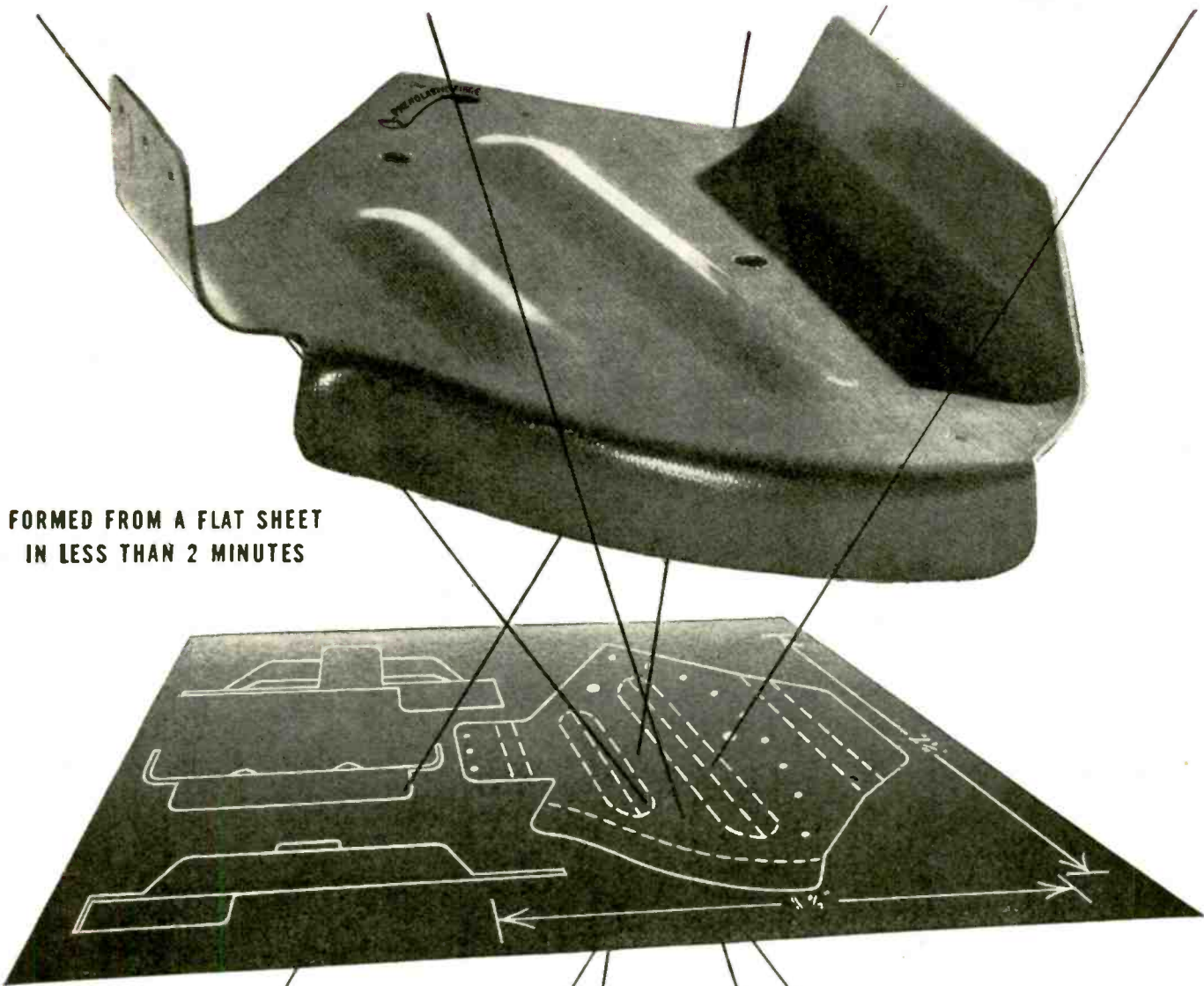

FORMED FROM A FLAT SHEET
IN LESS THAN 2 MINUTES

TAYLOR PHENOLASTIC FIBRE

THE METHOD by which ordinary sheets of fully-cured Phenol Fibre are re-heated and formed into various shapes is a new development to which users of Laminated Plastics are turning with ever-increasing interest. Now, Taylor engineers, working in the new Taylor Research Laboratory, have developed a *special* fibre which forms *better* and *easier* than standard grades of Phenol Fibre. This new development is called *Taylor Phenolastic Fibre*—a Phenol Fibre with special, elastic qualities. This new product has many advantages. Unlike metal, Phenolastic Fibre is not reduced in section at the maximum point of draw. Shapes involving compound curves and comparatively deep draws are easily made with no sacrifice in the strength of the material. Send us the facts about your product and our engineers will gladly tell you whether it can be made easier or better or more economically with Taylor Phenolastic Fibre.

TAYLOR FIBRE COMPANY

LAMINATED PLASTICS: PHENOL FIBRE · VULCANIZED FIBRE · Sheets, Rods, Tubes, and Fabricated Parts
NORRISTOWN, PENNSYLVANIA · OFFICES IN PRINCIPAL CITIES · PACIFIC COAST HEADQUARTERS: 544 S. SAN PEDRO ST., LOS ANGELES



Craftsmanship by

PAR-METAL

- CABINETS
- CHASSIS
- PANELS
- RACKS

When skill of a high degree becomes habitual, and shows up in the smallest detail — that's *Craftsmanship!*

Having specialized for many years, Par-Metal has this habit of *Craftsmanship* — expressed throughout the entire line, which ranges from small chassis to housings for huge transmitters.

To get a picture of what Par-Metal can do now (and the post-war possibilities) write for a copy of Catalogue No. 41-A.

PAR-METAL PRODUCTS CORPORATION
 32-62—49th STREET . . . LONG ISLAND CITY, N. Y.

Export Dept.
 100 Varick St., N. Y. C.

Enemy Radiosondes

German and Japanese radiosondes give fewer readings than those developed by America and therefore are less accurate. They are well built and well designed, and are smaller in size and lighter in weight than American instruments. The Germans have two types of radiosondes in general use. The first has wet and dry bulb mercury in glass thermometers for measuring temperature and relative humidity, and a mercury filled glass manometer for the determination of pressure. These glass tubes have metallic coils on the outside distributed through the operating length of the mercury columns within the glass tubes. Two transmitters are used, and two radio frequencies and two antennas are required. It is probable that constant tracking of the signals at the ground station is required to operate this set.

The Germans also use chronometric radiosondes that have bimetallic elements to measure temperature, and hair hygrometers to measure humidity. Temperature contacts are made twice a minute, humidity contacts once a minute.

The Japanese use radiosondes very similar to the German. Pressure is determined in much the same way as in the chronometric instrument of the Germans; however, there are only seven contacts. The Jap radiosondes have the same defect as the German, that they must operate on two radio frequencies, requiring two transmitters, two antennas, and constant tracking at the ground station.

The American radiosonde operates with one transmitter. The carrier frequency is audio modulated and variation in audio modulation can be translated into meteorological data. The signal is received and graphically recorded on a chart. The number of contacts can be counted and the pressure read. Then the elevation is determined. Some American radiosondes have 80 contacts; others 95.

The foreign instruments use vibrators and transformers to obtain desired voltages and alternating currents. American instruments use batteries with the correct plate voltage and tap only certain components of the battery for the correct filament voltages.

Aircraft Accessories Now Aeron Corp.

Aeron Mfg. Corp., is the new corporate style of the Aircraft Accessories Corp., 60 East 42nd St., New York. The company has done business under the older name since 1937 when the organization came into being as a West Coast distributor of aircraft parts and accessories. Two years later an electronics division was started in Kansas City and

DUMONT CAPACITORS

FOR DEPENDABLE RADIO REPAIRS

SOLE ONLY THROUGH
EXCLUSIVE JOBBER
TERRITORIES

DUMONT ELECTRIC CO.
 34 HJBERT ST. NEW YORK, N. Y.

NOTICE: Sales Representatives, Some Territories Open.

SYLVANIA NEWS

ELECTRONIC EQUIPMENT EDITION

FEBRUARY

Published in the Interests of Better Sight and Sound

1945

Type 1AB5 Used as Mixer, RF Amplifier At 50Mc. and Above

Sylvania Electric's 1AB5 tube is a filament type pentode for use as a mixer or RF amplifier in circuits requiring a tube of greater mutual conductance than the 1LN5.

The 1AB5 is especially designed for operation at frequencies of 50Mc. and

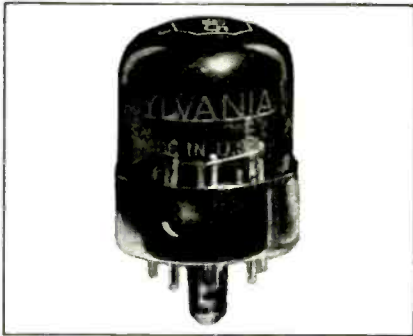

higher. Its combination of characteristics results in higher effective input resistance at these frequencies.

The tube has an 8-pin base of the Lock-In type, and a Short T-9 bulb. It is designed to operate on a filament voltage of 1.2. Full technical data are available from Sylvania Electric.

DID YOU KNOW...

That new long, small diameter fluorescent lamps soon to be placed in production at Sylvania Electric will be of the instant starting type? Using no starters, they will need less maintenance.

★ ★ ★

That the taking of tube characteristics by photographing an oscilloscopic trace permits the measurement of tube performance which could not otherwise be obtained? This is the method used in the Sylvania Laboratories.

Set-Owners Place FM First in Sylvania Survey of Radio Sets

91% of Consumers Interviewed Say They Want This Feature in Postwar Receivers

Preliminary reports of the nationwide survey being conducted by Sylvania Electric indicate a high degree of interest in frequency modulation. Of the thousands of set-owners who have been personally interviewed, 91% have indicated their desire to have FM incorporated in their postwar receivers.

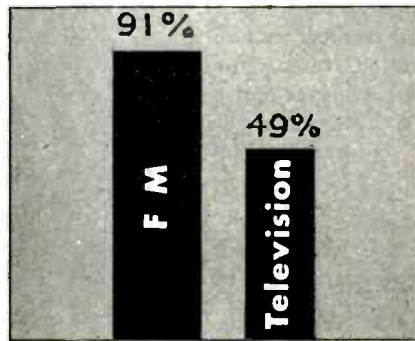

Graph shows percentages of set-owners stating that they want FM and television in their postwar sets.

SYLVESTER SURVEY



"Would you be willing to go as high as \$300 to have FM and television included in your radio set?"

70% said that they were willing to pay an additional sum in order to get this feature.

Television, while also a subject of considerable interest, ranked behind FM in the tabulation of survey results. 49% of those interviewed stated that they wanted television reception after the war. The same percentage indicated their willingness to pay extra for it.

INFLUENCE OF COST

As a guide to set manufacturers in their postwar planning, the Sylvania survey is also eliciting information on the amounts which consumers would be willing to pay in order to have FM and television. The results of this phase of the survey will be published in subsequent issues of SYLVANIA NEWS.

SURVEY CONTINUES

While the analysis of the results of personal interviews is going on, Sylvania Electric is continuing its survey, and broadening its scope, through the medium of a series of questionnaire-type advertisements appearing in leading national magazines.

The purpose of these advertisements is to gather additional information on consumer preferences and interest, not only in various types of radio and television receivers, but also in the possibility of using electronic devices in their homes.

SYLVANIA ELECTRIC

SYLVANIA ELECTRIC PRODUCTS INC., Radio Division, Emporium, Pa.

MAKERS OF RADIO TUBES; CATHODE RAY TUBES; ELECTRONIC DEVICES; FLUORESCENT LAMPS, FIXTURES, ACCESSORIES; INCANDESCENT LAMPS
ELECTRONIC INDUSTRIES • February, 1945

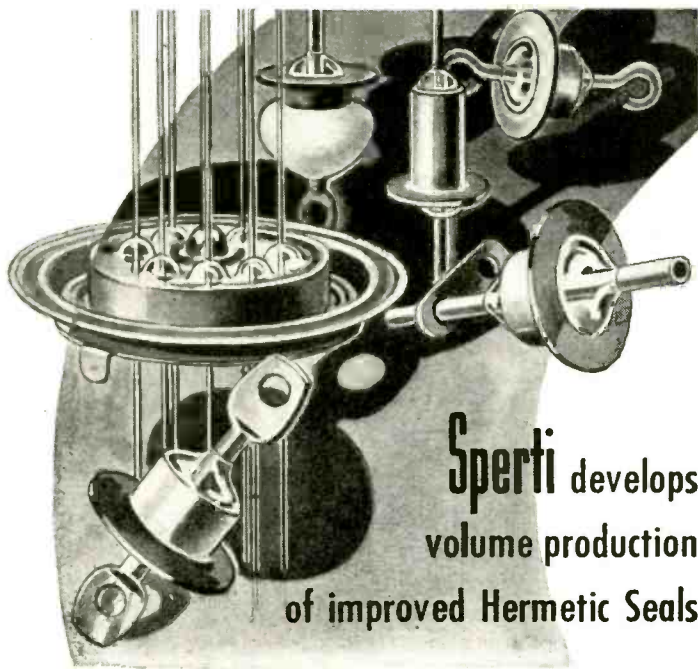

**Sperti develops
volume production
of improved Hermetic Seals**

**Conforming to Army-Navy requirements
for critical field conditions**

Transformers, condensers, relays, vibrators and various component parts can now be protected against heat and tropical humidity, salt spray, sand infiltration, fumes, fungus attack and other varied conditions that cause sensitive equipment to fail under critical conditions.

In the laboratories beyond Sperti, Inc., techniques have been discovered which permit volume production of improved Hermetic Seals at low cost, safeguarded by unique inspection methods.

Principal features of the improved Sperti Hermetic Seal are:

1. Small, occupies little space, one piece, no other hardware needed, simple and easy to attach. (Soldering temperature not critical.)
2. Vacuum tight hermetic bond, hydrogen pressure tested for leaks.
3. Resistant to corrosion.
4. High flash-over voltage. Does not carbonize.
5. Insulation resistance, 30,000 megohms, minimum, after Navy immersion test.
6. Thermal operating range—70° C. to 200° C. Will withstand sudden temperature changes as great as 140° C.

Wire or phone for information, today. Give as complete details as possible so that samples and recommendations may be sent promptly.



Sperti

INCORPORATED



RESEARCH, DEVELOPMENT, MANUFACTURING, CINCINNATI, OHIO

soon expanded into a large producer of radio equipment. The company long ago dropped its accessories franchises, now devotes itself (both divisions) entirely to manufacturing.

Airborne Radar

Radar devices will play a spectacular part in the projected naval fighter planes which will operate at speeds upward of 700 miles an hour—as fast as sound—Rear Admiral De Witt C. Ramsey, Chief of the Navy's Bureau of Aeronautics, informed the House Naval Affairs Committee recently.

Admiral Ramsey declared that in the present war the "most spectacular of all developments" had been the numerous adaptations of radar and other electronic devices to military aircraft. Such devices have been particularly useful for night fighters.

"Electronic weapons of all sorts have played a decisive part in the prosecution of the present war," Admiral Ramsey emphasized, "and the application of new and improved devices is expected to increase still further our future margin of superiority over the enemy.

"In the field of radar," he added, "many devices still held secret for military purposes have been engineered, produced and made available to training activities and to the fleet for operational use."

El-Menco
MOLDED
MICA
CAPACITORS



IMMEDIATE DELIVERY

ALL SIGNAL CORP ORDERS BEARING INSPECTION AT SOURCE; INSPECTED ON PREMISES & SHIPPED IMMEDIATELY

All R.M.A. or A.S.A. color coded

A complete stock is ready for immediate shipment of quantities, ranging from 500 to 5,000 of each capacity in regular MICA CAPACITORS in 5%, 10% and 20% tolerance and silvered MICA CAPACITORS in 2%, 5% and 10% tolerances.

Write for price sheets and complete information

Territory open for JOBBERS

SEND FOR OUR SPECIAL INITIAL ORDER OFFER



ALBERT ROTHENSTEIN
National Distributor
135 LIBERTY ST. New York 6, N.Y.

One Hundred Hudson's Bay Trading Posts Rely on P. R. MALLORY & CO. INC. MALLORY Vibrapacks*

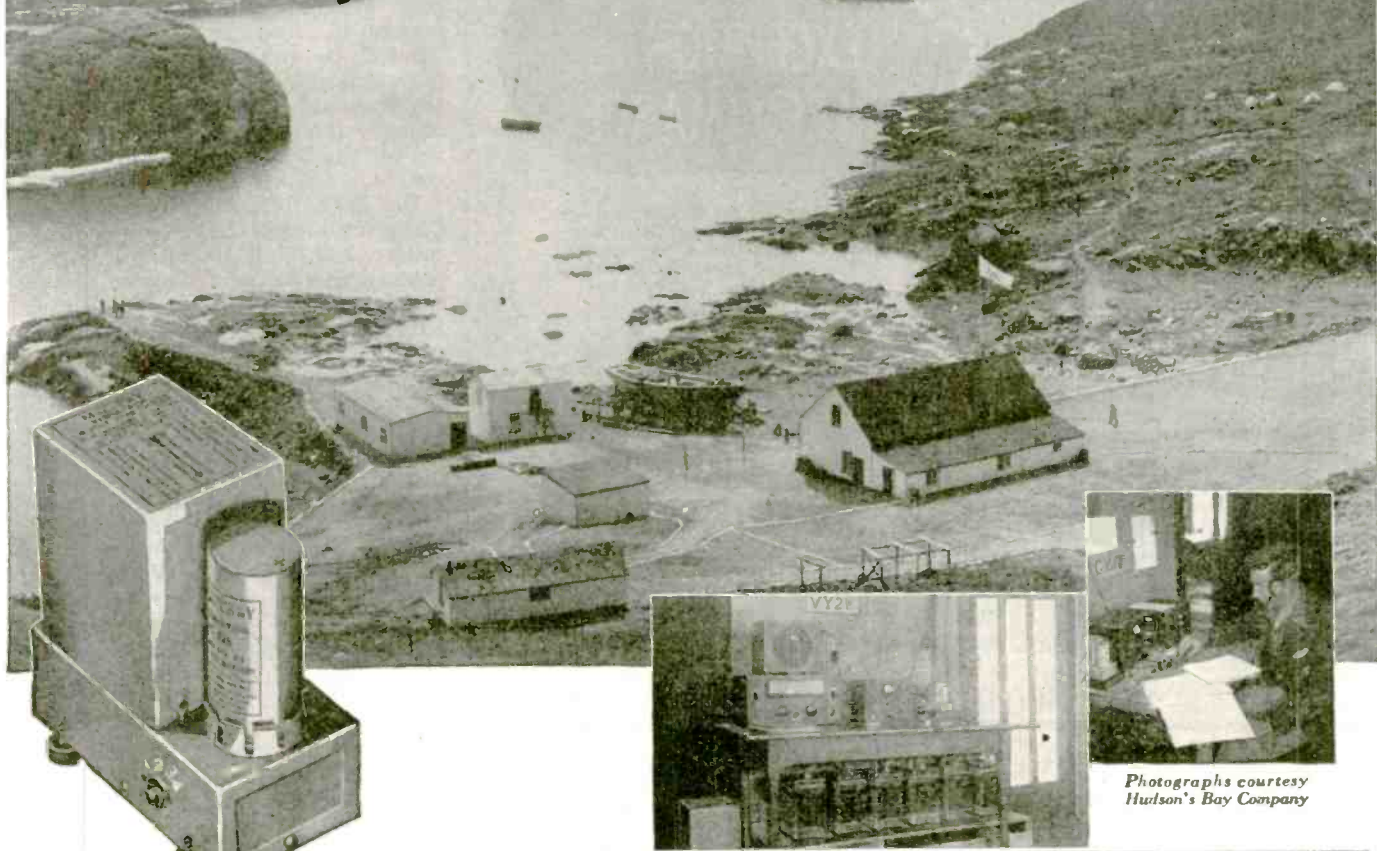

Photographs courtesy Hudson's Bay Company

A NETWORK of 100 low-power short wave radio stations at fur trading posts of the famous Hudson's Bay Company provides communications over a vast northland area—more than 1,000,000 square miles. Power for all these isolated radio stations is supplied by wind-driven generators and storage batteries. High voltage plate power for each of the 100 receivers and transmitters is obtained by conversion from the low voltage battery DC, using Mallory Vibrapacks.

According to an official of the Hudson's Bay Company:

"We are very enthusiastic about the Mallory Vibrapacks, and we have been using them in our Fur Trade radio set-up for the last seven years. They have proven to be more than satisfactory at all Company radio stations where a reliable power supply is a 'must', because these trading posts rely largely on their radio for communication with the outside."

F. R. MALLORY & CO., Inc., INDIANAPOLIS 6, INDIANA

Features of Mallory Standard Vibrapacks

- Nominal input voltages of 6, 12 and 32 volts DC.
- Nominal output voltages from 125 to 400.
- Models available with switch for four output voltages in approximate 25-volt steps.
- All standard Vibrapacks are equipped with Mallory Hermetically-Sealed Vibrators for top performance in extremes of atmospheric pressure or humidity.
- Heavy-Duty models with 60-watt capacity.
- You can easily obtain Mallory Vibrators and Vibrapacks from your nearest Mallory Distributor. Ask him for a free catalog, or write us today.
- Inquiries are invited from manufacturers for Vibrators and Vibrapacks for use in original equipment.



*Reg. U. S. Pat. Off. for vibrator power supplies.



MALLORY

VIBRATORS and VIBRATOR POWER SUPPLIES

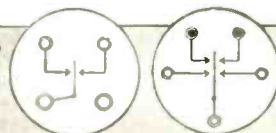
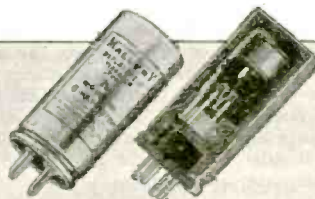

2nd AWARD
for
EXCEPTIONAL PERFORMANCE

ARMY
NAVY

48-page Catalogue describes Insuline's vast line of Radio-Electronic Products.

8-page Brochure presents Insuline's organization and manufacturing facilities.

Write for Catalogues describing our extensive line of Radio-Electronic Products.

INSULINE
CORPORATION OF AMERICA
INSULINE BUILDING • LONG ISLAND CITY, N.Y.

HEADQUARTERS FOR RADIO-ELECTRONIC PRODUCTS

IRE to Raise \$500,000 for Building

With its present quarters cramped for space, the Institute of Radio Engineers is setting out to provide a new headquarters building in New York City. About \$200,000 will be needed for the structure, plus \$100,000 to recondition and furnish it. Another \$200,000 will be funded to provide carrying and maintenance expenses in excess of the present outlay for headquarters offices. Thus \$500,000 is the sum set for the IRE Building Fund project.

Dr. B. E. Shackelford and I. S. Coggeshall head the general committee. Dr. W. R. G. Baker is chairman of the Initial Gifts Committee which is raising the necessary funds through donations from large corporate and individual givers.

With \$500,000 in hand, an alternative plan might permit IRE advantageously to join with other engineering societies or scientific bodies in securing appropriate quarters. At all events it is proposed that the IRE shall have a new headquarters suited to its functional needs, of a dignity in keeping with its prestige, and large enough for its prospective requirements over a long period of years.

Meanwhile Internal Revenue authorities have ruled that contributions to the IRE are deductible in arriving at taxable net income. Payments may be made quarterly throughout 1945 and early 1946.

Carrier System Best For Wire Communications

The extent to which carrier communications facilities are being used in the war probably will not be revealed for some time. However, the Signal Corps reports that spiral-four cable and carrier systems have proven the most satisfactory for wire communications in combat areas. Installation requires fewer man-hours and communication is "solid" for 150 miles with spiral-four laid on the ground or used as aerial cable. Burled, spiral-four is effective up to 400 miles.

Hydrogen Annealing For Coast Maker

A hydrogen annealing plant has been installed by Peerless Electrical Products Co., Inc., Los Angeles manufacturer of transformers, windings, and reactors. It is the first of its type to be installed by a transformer manufacturer in the West, and is in line with the trend toward very wide range audio transformers using high permeability nickel alloy laminations and shields. The annealing plant consists of a 25 kilowatt electric annealing furnace with automatic heat control and complete machinery for the drying and purifying of hydrogen gas used in the process.

LECTROHM } WIRE WOUND ADJUSTABLE } VITREOUS ENAMELLED RESISTORS

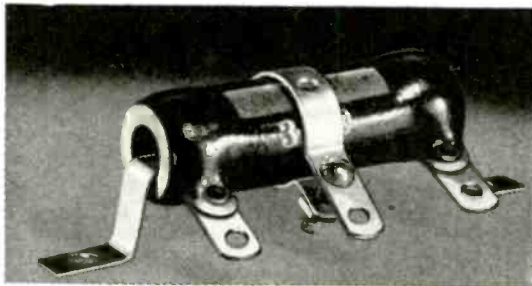

Experience Built
under personalized supervision

Lectrohm adjustable Resistors are a precision product. Resistance wire is silver soldered to the solder lugs by special process, assuring perfect electrical bond always. A thoro vitreous enamel coating completely embeds the accurately spaced winding, terminals and silver soldered connections—producing a solid, integral unit. These Resistors are used as voltage dividers, or potentiometers and can be equipped with several adjustable bands. Capacities 10 watt to 200 watt. Request complete information.

LECTROHM
INCORPORATED

5139 West 25th Street, Cicero 50, Illinois

Adaptability in CERAMICS

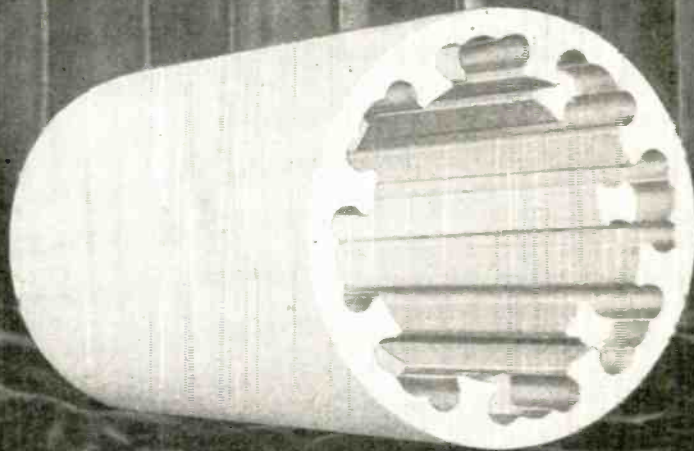

COIL FORM FOR INTERNAL WINDING by **STUPAKOFF**

Permanently strong and stable both mechanically and electrically, ceramics are versatile materials capable of intricate design. Competent engineering enables dimensional tolerances to be held to a minimum.

The internally wound coil form illustrated is engineered and produced by Stupakoff for a specific application. Resistance to thermal shock and mechanical strength are specifications

embodied in this one-piece extruded insulator. Slotted, longitudinal winding holes expose the heating element and allow heat to be directed instantaneously to the center of the coil.

Specialists in the field of electrical insulation, Stupakoff engineers are trained to find *specific* solutions for *your* insulation problems. Contact Stupakoff today—two generations of dependability in the ceramic field justify this choice.



STUPAKOFF CERAMIC AND MANUFACTURING CO., LATROBE, PA.

Ceramics for the World of Electronics

**PEACE
TIME ...**



(Freight conductor, talking from caboose):—
"Charlie, we drop four cars from the rear at
Pikeville, and pick up three from the Saw
Hill siding to hook on in front."
(Engineer, replying):—"O. K., Joe. We'll
take on water; we're ahead of the card."

In the railroading of tomorrow, express freight trains will be one of the many public services that will depend on co-ordination and speed which in turn will depend on perfect communications — which will depend on perfect crystals.

Valpey Crystals, unseen, unobtrusive, will be the vital servants of this type of communication. Precision-ground by crystal craftsmen, they can be depended upon for perfect service whether in the arctic or the tropics.

**WAR
TIME ...**



In planning your peacetime products, be sure to consult Valpey. Our laboratory and our engineers are ready to help you with any problem of design or performance.

Write for information on "CRYSTONICS."

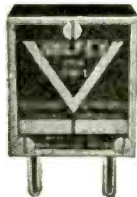

CM-1
A design for normal
frequency control
applications.



NEW XLS
Special new low fre-
quency unit... vital
in the newer fields
of electronics.



CBC-0
Where utmost in
stability requires
constant tempera-
ture control in com-
mercial installations.

VALPEY
Crystal Corp.
CRAFTSMANSHIP IN CRYSTALS SINCE 1931
HOLLISTON, MASSACHUSETTS

PERSONNEL

Dr. W. D. Coolidge, General Electric vice-president and director of the G-E Research Laboratory since 1932 retired, first of the year, and **Dr. C. G. Suits**, who has been Dr. Coolidge's assistant, has been made a vice-president and henceforth will have charge of the labs. Dr. Coolidge has had a long and distinguished career in the electronic industry. He is the holder of some 83 patents and has been partly responsible for hundreds of others, his best known achievement being the development of a radically new type of X-ray tube which has practically superseded all other types.



Dr. C. G. Suits Dr. W. D. Coolidge

William E. Cairnes has been appointed chief engineer and **Gus Wallin** assistant chief engineer of the home radio division of the Galvin Mfg. Corp., Chicago, Ill.

David C. Prince, vice-president of General Electric will take charge of the company's general engineering laboratory, the activities of which will be broadened to include the requirements of the entire company. Mr. Prince's service with G-E has been continuous except for five years beginning in 1914 which he spent with the Illinois Public Utilities Commission and as an officer in World War I. He was for several years associated with Dr. E. F. W. Alexanderson, world famous radio pioneer, was a member of the research laboratory staff and subsequently became research engineer on switchgears and manager of commercial engineering.



David C. Prince who assumes charge of GE Co's. general engineering laboratory.

ELECTRICAL OR RADIO ENGINEER WANTED

Should have general experience in Electrical or Radio Measurements. Graduate engineer (radio or electrical) from recognized engineering school desirable. Long-established radio-electrical components manufacturer in New England, doing war work at present. Postwar future for right man. Give detailed outline of experience, etc., salary requirements. Box 2549, Electronic Industries, 480 Lexington Avenue, New York 17, New York.

Kahle

ENGINEERING COMPANY

ELECTRON TUBE MACHINERY

All types, standard and special design.

Specialists in equipment and methods for the manufacture of:

RADIO TUBES	NEON TUBES
CATHODE RAY TUBES	PHOTO CELLS
FLUORESCENT LAMPS	X-RAY TUBES
INCANDESCENT LAMPS	GLASS PRODUCTS

On Production or Laboratory basis

1307-1315 SEVENTH ST., NORTH BERGEN, N. J., U. S. A.



PRECISION & SPEED!

GASKETS AND WASHERS

TO BLUE PRINT
SPECIFICATIONS

in all
MATERIALS

NATIONAL GASKET & WASHER MFG. CO.
122 EAST 25th STREET NEW YORK 10, N. Y.

OPPORTUNITIES in Present and Postwar Work

Senior and Junior graduate Engineers with one or more years radio experience wanted by an expanding manufacturing division of an established Communication Company. Also, Engineers with practical experience for radio communication plant installation and test in foreign countries. Phone, call or write stating experience, education, present salary, etc., to:

PRESS WIRELESS, INC.
HICKSVILLE, L. I.

ATT: S. A. BARONE, CHIEF MFG. ENGR.

RELAYS by KURMAN

Twenty-five years' experience in solving all types of Relay Problems. Complete facilities for Designing, Engineering, Manufacturing. Specialists in producing Relays of exceptional power and sensitivity for Aircraft, Intercommunications Systems, Electronic Devices. Exclusive Kurman features provide greater dependability, longer life, more precise performance.

Send data for quotations.

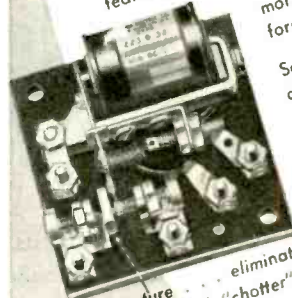

New Feature eliminates "bounce" and "chatter"

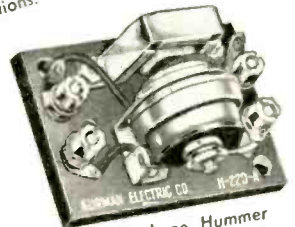

Microphone Hummer

KURMAN ELECTRIC CO.

35-18 37th STREET • LONG ISLAND CITY 1, N. Y.



MacRae's DOES A GREAT JOB • MacRae's
MacRae's DOES A GREAT JOB • MacRae's
MacRae's DOES A GREAT JOB • MacRae's
MacRae's DOES A GREAT JOB • MacRae's
MacRae's DOES A GREAT JOB • MacRae's



For advertising and book rates consult your agency or write
MacRae's Blue Book

A DIRECTORY OF AMERICAN INDUSTRY
19 E. HURON STREET CHICAGO 11, ILL.

The name to remember
in **ANTENNAS**
for every radio purpose

EST.

BRACH

1906



Since the beginning of radio broadcasts 25 years ago, BRACH Antennas for Home and Automobile have been the acknowledged pace-setters in their field.

Today  Antennas

are doing their part for victory
on land, on sea, and in the air

And when peace comes . . .

BRACH Puratone* ANTENNAS, tested and perfected to meet Army and Navy standards, will again resume their established leadership for Home and Auto Radios, Television, Marine, F.M. and other services.

*Reg. Patent Trade Mark

L. S. BRACH MFG. CORP.

World's Oldest and Largest Manufacturers of Radio Antennas and Accessories
55-65 DICKERSON STREET • NEWARK N. J.

Permanent Magnets

All Shapes, Sizes and Alloys. Alnico magnets cast or sintered under G. E. license. Chrome, Tungsten and Cobalt magnets stamped, formed or cast.

THOMAS & SKINNER

STEEL PRODUCTS CO. • INDIANAPOLIS, IND.

42 YEARS' EXPERIENCE

Donald B. Sinclair has been appointed assistant chief engineer of the General Radio Co., Cambridge, Mass. He will be in charge of circuit development; was for several years research assistant and associate at Massachusetts Institute of Technology.

Arthur Rhino has been elected a vice-president of Federal Telephone and Radio Corp., Newark, N. J. He will be in charge of the corporation's public relations department.

Myles V. Barasch has become associated with the Sherron Electronics Co. division of Sherron Metallic Corp., Brooklyn, N. Y., as chief engineer. He was formerly employed as staff engineer for the Tremont Electric Co., New York; also for the Todd Shipyard Co., Inc., as engineer in charge of installation of radar, radio and sonar equipment.

Max E. Markell, for the past four years chief of the vacuum tube section of the U. S. Signal Corps at Camp Evans, has joined RCA's tube and equipment organization as a specialist on industrial tube applications. He will work under the direction of L. S. Thees, manager of RCA's equipment tube section, Harrison, N. J.

Roy S. Kercher has been made chief electrical engineer for Grayhill of Chicago, La Grange, Ill. For the past two and a half years, he has been associated with the Furnas Electric Co.

A. J. Monack has been elected vice-president in charge of engineering of the Mycalex Corp. of America. He has been chief engineer of the company since February of 1942. He has also served with the Radio Corp. of America and the Western Electric Co., and was a member of the staff of the Ceramic Engineering Department of the University of Illinois.



A. J. Monack, just elected vice-president in charge of engineering for Mycalex Corp.

ELECTRONIC INDUSTRIES • February, 1945

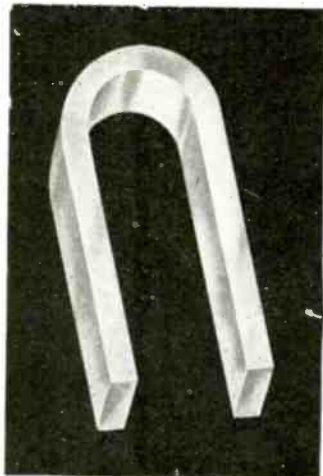

Do You See Your Spring Here?

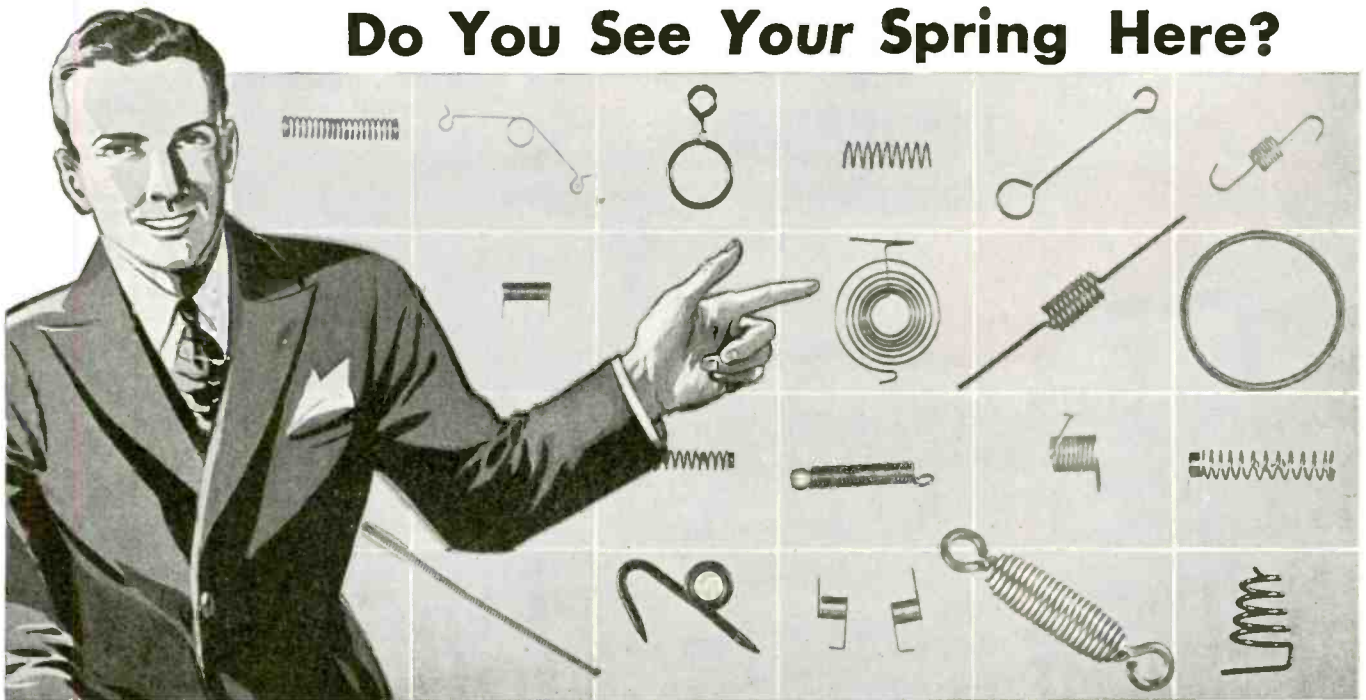

We specialize in fitting the spring to the need! If the spring for your postwar product is not pictured above, describe how and where it will be used and our engineers will suggest the right design for the job. This holds good also for your present products. The performance of many an existing appliance or machine could be materially improved merely by supplanting old springs with new ones "engineered" into the design. Peck Springs are made up to 1/8" wire size. Let's get together.

Peck THE PECK SPRING CO., 10 WELLS ST., PLAINVILLE, CONN. SPRINGS & SCREW MACHINE PRODUCTS

STAINLESS STEEL FASTENING DEVICES

IN STOCK!

Prompt Delivery of both Specials and Standard Items

We Stock:

- Cap Screws
- Machine Screws
- Bolts
- Washers
- Nuts
- Wood Screws
- Taper Pins
- Pipe Fittings
- Rivets
- Cotter Pins
- Wing Nuts
- Etc.

When you need non-corrosive fastening devices, write or phone Allmetal first. Chances are we have them IN STOCK ready for shipment. We can take care of your special work, too, as we have equipment for tapping, drilling, reaming, turning, slotting, etc. We also have complete centerless grinding facilities. Let us estimate on your requirements. Write us today.

Send for FREE CATALOG



This new, 83-page catalog helps you pick the correct size and type of non-corrosive fastening device for any particular job. Includes stock sizes, typical specials, engineering data, etc. Make request on company letterhead, please.

Write to DEPARTMENT D

ALLMETAL SCREW PRODUCTS CO.
80 Grand Street New York 13, N. Y.

ESICO

REG. U. S. PAT. OFF.

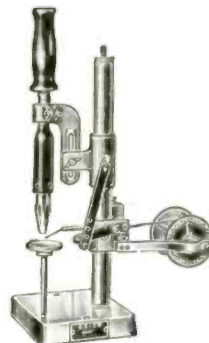

SPOT SOLDERING MACHINE
designed for treadle operation for advancement of iron and solder, leaving operator's hands free for handling of product.



SOLDERING IRONS

are widely used in industrial plants throughout the country. They are designed to withstand the strain of continuous service required of factory tools.

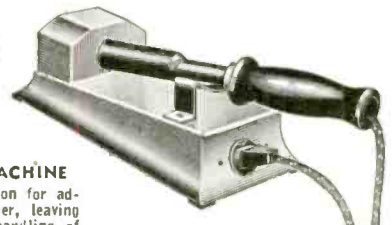

SOLDERING IRON TEMPERATURE CONTROLS
prevent overheating of soldering irons between soldering operations. Irons do not deteriorate when being used. The idle period causes oxidation and shortens life.

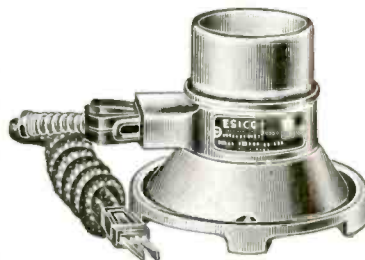

SOLDER POTS
ruggedly constructed pots of various sizes designed for continuous operation and so constructed that they are easily and quickly serviced, should elements have to be replaced.

Write for Catalog

ELECTRIC SOLDERING IRON CO., INC.
2144 WEST ELM STREET, DEEP RIVER, CONN.



for
14TH INNING
dependability



Twenty years of KNOW HOW helps to give each MICAMOLD component that extra-inning stamina that means so much now!

**CERAMIC · MOLDED MICA · POTTED MICA
MOLDED PAPER · OIL-FILLED
DRY ELECTROLYTIC**

CAPACITORS

MICAMOLD Radio Corporation
115 Knickerbocker Ave., Brooklyn 6, N. Y.

Elinco
A.C.

DRAG-CUP
INDUCTION
GENERATORS

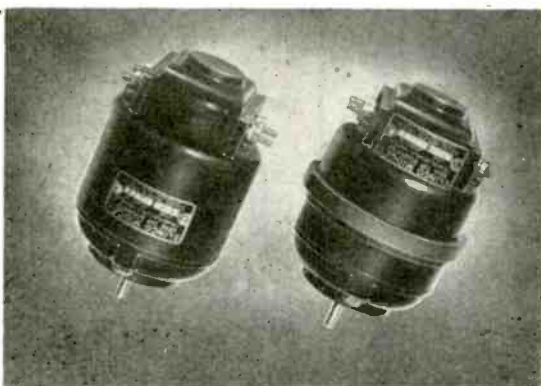

BOTH BASE AND FRAME MOUNTED MODELS

New "Elinco" Drag-Cup Induction Generators are of die-cast aluminum alloy housing anodized in accordance with Army and Navy specifications, and furnished with baked black synthetic enamel.

OPERATION:

Generators consist of laminated stator wound two phase, stationary steel pole, and aluminum cup on shaft rotating between stator and pole. With voltage applied to one of two stator phase terminals, rotation of shaft and cup induces voltage at other terminal, voltage lineal with speed. Torque required for rotation approx. 25 grains at 1" radius. Far increased voltage where linearity is not important, copper cup may be used.

SPECIFICATIONS:

Type 68: Applied voltage 115 v. 60 c. AC, generated voltage with resistive load 100,000 ohms varies from 0.15 v. max. with cup stationary, to 1.20 v. min. at 1,000 RPM, and to increase at uniform rate up to 6,000 RPM.

Type 101: Generates from 0.15 v. max. with cup stationary to 3.65 v. min. at 980 RPM, and 20.0 v. at 5,600 RPM.

MODELS CAN BE VARIED TO MEET SPECIAL REQUIREMENTS

Electric Indicator Co. 112 PARKER AVE.
STAMFORD, CONNECTICUT

Wilbur N. Nelson has joined the Andrew Co., Chicago, as mechanical design engineer to develop coaxial transmission lines for military purposes. For the past eight years he has been with Western Electric.

M. Robert Saslaw, who has been laboratory director for the Federal Telephone and Radio Corp., Newark, N. J., has left that organization. He has set up his own offices at 347 Madison Ave., New York.

Murray G. Crosby, of Riverhead, Long Island, for twenty years a research engineer for the Communications Division of RCA Laboratories, has joined the research and development staff of Press Wireless, Inc., as a consultant. He will make his headquarters at the Little Neck laboratories where he will be associated with P. D. Zurian, Director of Press Wireless research and development.

Col. George C. Hale, who has been with the Army Air Force since 1942 as communications equipment officer, has joined Emerson Radio & Phonograph Corp. as director of the special products division. He was formerly with Philco Corp. in its Detroit and Philadelphia offices and has also been with Transitone Auto Radio Corp., Jewett Radio & Phonograph Corp. and Black & Decker Electric Tool Corp.

**DIALS
PANELS**
and
PLATES

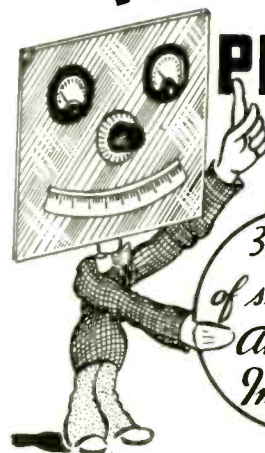

35 years
of service to
American
Industry

DIALS · PANELS · PLATES
made to your precise engineering specifications in etched metals and finishes.

PREMIER
METAL ETCHING CO.
21-03 44th AVE.
LONG ISLAND CITY, NEW YORK

Kenneth McLeod has joined the engineering staff of National Union Radio Corp. to take charge of electronic quality control. Mr. McLeod has a broad experience in the radio industry, having been responsible for transmitter installation at WBR-Y, Waterbury, Conn.; WAIM, Anderson, S. C., and WELR, New Haven, Conn. Other technical assignments since his graduation from Connecticut State College, include development engineering for WDRC, Hartford, Conn., construction of FM transmitter W65H, research in the Johns-Hopkins Applied Physics Laboratory, Silver Spring, Md., and secret war development work at the Columbia University Laboratory, Alhambra, Col.

Frank N. Townsend has been appointed export manager for its electronic components division by Stackpole Carbon Co., St. Marys, Pa. He will make headquarters at 254 West 31st St., New York, prior to the war was in charge of Stackpole sales in Europe with offices in Paris.

Arden Levre has been named vice-president and director of engineering of Division One (Alemite, instruments and radio); **Fred R. Cross**, advertising manager and **George W. Oehlsen, Jr.**, assistant director of engineering of the Stewart-Warner Corp., Chicago.

Roger M. Wise who joined the original Sylvania Products Co., in 1929 as chief engineer, and latterly has been director of engineering of the present Sylvania Electric Products, Inc., has been elevated to the post of vice-president in charge of engineering.



Roger M. Wise, now vice president in charge of engineering at Sylvania

Modern Operational Mathematics in Engineering

By Ruel V. Churchill, Professor of Mathematics, University of Michigan, published by the McGraw-Hill Book Co., Inc., New York, 1944, 306 pages, \$3.50.

The text is an excellent treatment of the theory and application of operational mathematics which in many instances reduces rather involved differential equations to simple algebraic equations. The extensive table of transforms in the appendix should prove useful in converting to the algebraic equation and in the inverse process after its solution has been found.

The operational properties of the Laplace transform are derived and stated as theorems for ready use in the solution of problems. Most of the text treats the application of this operational method to differential equations in engineering and physics, with emphasis on boundary value problems of partial differential equations. The last chapter deals with Fourier transforms and their applications.

A year of college physics would seem to furnish a sufficient background for the physical and engineering problems treated; very little previous knowledge of ordinary differential equations is needed.

RADIO ENGINEERS CIRCUIT AND MECHANICAL DESIGNERS

Radio Manufacturer seeks the services of qualified engineers for development work. Extensive experience required in design of electronic equipment, including receivers, chassis, dial mechanisms, remote control. Engineering degree desirable but not essential. Excellent post-war opportunities. Please submit resume.

PHILHARMONIC RADIO CORPORATION
528 East 72nd Street
New York 21, New York

ENGINEERS WANTED

ACOUSTIC EXPERIMENTAL ENGINEER

Graduate Engineer with Laboratory and design experience. To design microphones and other electro-acoustical devices.

ELECTRO-MECHANICAL DESIGN ENGINEER

Graduate Engineer to design Electro-Magnetic Devices, such as phonograph pickups, etc. Write, giving phone number, education, experience and salary desired.

Well established Southern California concern.
Box 1540, Electronic Industries
480 Lexington Ave., New York 17, New York

Talk About PRODUCTION Without DIES!



4,000 Parts Per Day
with DI-ACRO Bender

"Enclosed are pictures taken in our plant which prove the DI-ACRO Bender will do a real production job. We are making 4,000 completed parts per day which is competitive to most Power Presses." (Name on request.)

Here is an example of "DIE-LESS DUPLICATING" typical of a great variety of formed parts readily made with DI-ACRO Precision Machines, — Benders, Brakes, Shears. Picture below shows an acute right angle bend and photograph above shows the finished part formed to die precision. Women operating DI-ACRO UNITS maintain a high out-put on production work.



DI-ACRO is pronounced "DIE-ACK-RO" →

Send
for
Catalog



O'NEIL-IRWIN MFG. CO.

348 EIGHTH AVENUE SOUTH • MINNEAPOLIS 15, MINNESOTA

dependable
durable
efficient

American Beauty

ELECTRIC SOLDERING IRONS

Preferred by those who measure the value of a tool by the service it renders. Soldering irons are made in 5 sizes and for low as well as standard voltage.



TEMPERATURE REGULATING STAND

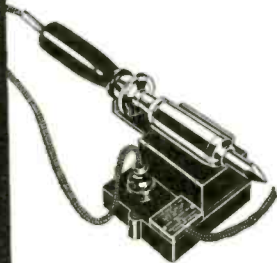

A thermostatically controlled stand for regulating the temperature of an electric soldering iron when at rest. The thermostat is adjustable for various heats.

Write for Catalog Sheets.

AMERICAN ELECTRICAL
HEATER COMPANY
DETROIT, MICHIGAN

B-42 101AE

EISLER'S

General Glass Working
Equipment

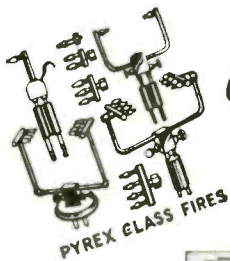

PYREX GLASS FIRES

manufacturing RADIO, CATHODE RAY,
ELECTRONIC and FLUORESCENT TUBES,
ELECTRONICS LABORATORY UNITS.

WELDERS, TRANS-
FORMERS FROM
1/4 TO 500 KVA.



Glass Cutter



Ampule Machine



Tipless Stem Mach.



Sealing Machine

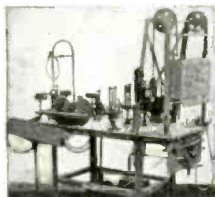

Electronics Laboratory Unit



Flare Machine

CHAS. EISLER
EISLER ENGINEERING CO.
778-SO. 13th ST. Near AVON AVE. NEWARK, 3 N. J.

MORE RF KILOWATT HOURS PER DOLLAR WITH

F & O TRANSMITTING TUBES

Inquiries Invited—Let us explain how Savings are effected and the F & O greater guarantee.

FREELAND & OLSCHNER PRODUCTS, INC.

611 BARONNE STREET NEW ORLEANS 13, LA.
Raymond 4756

High Power Tube Specialists Exclusively
(1/4 to 100 KW)

NATION-WIDE MAIL
ORDER DISTRIBUTORS
SINCE 1928



RADIO AND ELECTRONIC
DEVICES For Trade... Industry... Vocational
... Communication... Public Utility and Ex-
perimental Applications

BURSTEIN-APPLEBEE CO.

1012-14 McGee St. Kansas City 6, Missouri

Continuously
Since 1930

PRECISION GROUND

Crystals
BY
HIPOWER

AIRCRAFT
MARINE • BROADCAST
POLICE • COMMERCIAL • AMATEUR

HIPOWER CRYSTAL COMPANY

Sales Division—205 W. Wacker Drive, Chicago 6
Factory—2033 Charleston St., Chicago 47, Ill.

TERMINALS

for

ELECTRIC WIRES

SMALL METAL STAMPINGS

in accordance with your blueprints

PRECISION PARTS

from Modern Equipment

PATTON-MacGUYER CO.

17 VIRGINIA AVENUE
PROVIDENCE 5, R. I.

ELECTRONIC INDUSTRIES

Advertisers—February, 1945

Page	Page	Page
Accurate Spring Mfg. Co. 131	DuMont Laboratories, Inc., 63	National Gasket & Washer Mfg. Co. 209
Ace Mfg. Corp. 200	Allen B. 34	National Union Research Laboratories 137
Acme Electric & Mfg. Co. 152	Eby, Inc., Hugh H. 34	New York Transformer Co. 14
Adams & Westlake Co. 42	Eicor, Inc. 130	North American Philips Co., Inc. 127
Aerovox Corp. 36	Eisler Engineering Co. 214	Ohmite Mfg. Co. 66
Albion Coil Co. 6	Eitel-McCullough, Inc. 52	O'Neil-Irwin Mfg. Co. 213
Alliance Mfg. Co. 216	Electric Indicator Co. 212	Par-Metal Products Corp. 202
Allied Control Co., Inc. 12	Electric Soldering Iron Co., Inc. 211	Patton-MacGuyer Co. 214
Allied Radio Corp. 163	Electro Motive Mfg. Co. 73	Peck Spring Co. 211
Allmetal Screw Products Co. 211	Electronic Enterprises, Inc. 25	Peerless Electrical Products Co. 176
Altec Lansing Corp. 215	Electronic Laboratories, Inc. 141	Permoflux Corp. 167
Aluminum Co. of America. 22	Electronic Mechanics, Inc. 123	Philco Corp. 67
American Electrical Heater Co. 214	Electronic Products Mfg. Corp. 184	Philharmonic Radio Corp. 213
American Lava Corp. 59	Electro-Voice Corp. 195	Pioneer Gen-E-Motor Corp. 142
American Transformer Co. 33	Eric Resistor Corp. 145	Premier Metal Etching Co. 212
Amperex Electronic Corp. 2	Federal Telephone & Radio Corp. 21, 155	Press Wireless, Inc. 209
Amperite Co. 132	Foote-Pierson & Co., Inc. 18	Printloid, Inc. 168
Andrew Co. 168	Formica Insulation Co. 147	Radell Corp. 192
Arnold Engineering Co. 186	Freeland & Olschner Products Inc. 214	Radio Corporation of America: RCA Victor Division. 150, 151, Cover 4
Associated Research Corp. 126	General Ceramics & Steatite Corp. 139	Radio Receptor Co., Inc. 71
Atlas Products Corp. 166	General Electric Co. 5, 19, 175, 199	Radio Specialties Corp. 216
Atlas Sound Corp. 184	General Industries Co. 179	Radio Wire Television, Inc. 136
Audio Development Co. 128	Gothard Mfg. Co. 192	Ray-O-Vac Co. 169
Automatic Electric Sales Corp. 177	Groves Corp. 196	Raytheon Mfg. Co. 62, 70
Barker & Williamson 187	Guardian Electric Mfg. Co. 117	Remler Co., Ltd. 32
Bay Products Corp. 136	Hallicrafters Co. 10	Rogers Mfg. Co., Dayton 171
Bell Sound Systems, Inc. 180	Hammarlund Mfg. Co., Inc. 29	Rothenstein, Albert 204
Bell Telephone Laboratories. 133	Harvey Radio Co. 188	Sangamo Electric Co. 40, 41
Bentley, Harris Mfg. Co. 181	Harvey Radio Laboratories, Inc. 51	Schauer Machine Co. 138
Benwood Linze Co. 157	Heintz & Kaufman, Ltd. 56	"S" Corrugated Quenched Gap Co. 135
Bird & Co., Richard H. 160	Hipower Crystal Co. 214	Seeburg Corp., J. P. 154
Bliley Electric Co. 47	Hopp Press, Inc. 186	Sherron Electronics Co. 53
Boonton Radio Corp. 160	Hunter Pressed Steel Co. 143	Siure Brothers 27
Brach Mfg. Corp., L. S. 210	Hytron Corp. 113	Sigma Instruments, Inc. 198
Bridgeport Mfg. Co. 24	Illinois Condenser Co. 182	Small Motors, Inc. 183
Burgess Battery Co. 166	Indiana Steel Products Co. 68	Smith Mfg. Co., Inc., F. A. 196
Burstein-Applebee Co. 214	Industrial Instruments, Inc. 118	Solar Capacitor Sales Corp. 11
Cambridge Thermionic Corp. 121	Industrial Timer Corp. 176	Spencer Thermostat Co. 146
Cannon Electric Development Co. 178	Insuline Corp. of America. 206	Sperli, Inc. 204
Capacitron Co. 148	International Products Corp. 20	Sprague Electric Co. 55
Capital Radio Engineering Institute 188	International Resistance Co. 129	Springfield Sound Co. 148
Celanese Corp. of America. 149	Jefferson Electric Co. 7	Stankpole Carbon Co. 45
Centralab 38	Johnson Co., E. F. 31, 134	Standard Transformer Corp. 170
Chicago Telephone Supply Co. 17	Jones Co., Howard B. 142	Sticht Co., Inc., Herman H. 178
Chicago Transformer Div., of Essex Wire Corp. 190	Kaar Engineering Co. 44	Struthers-Dunn, Inc. 191
Clarostat Mfg. Co., Inc. 183	Kahle Engineering Co. 209	Stupakoff Ceramic & Mfg. Co. 158, 207
Cole Steel Equipment Co. 37, 182	Karp Metal Products Co., Inc. 46	Sun Radio & Electronics Co. 172
Collins Radio Co. 57	Ken-Rad Tube & Lamp Co. 28	Superior Tube Co. 175
Colonial Kolonite Co. 174	Keuffel & Esser Co. 16	Sylvania Electric Products, Inc. 203
Communications Co., Inc. 194	Kinney Mfg. Co. 134	Taylor Fibre Co. 201
Communication Products Co., Inc. 153	Kurman Electric Co. 209	Thomas & Skinner Steel Products Co. 210
Conant Electrical Laboratories 162	Langevin Co. 48	Triplet Electrical Instrument Co. 60
Concord Radio Corp. 172	Lapp Insulator Co., Inc. 144	Turner Co. 156
Connecticut Telephone & Electric 197	Lavore Laboratories 115	United Electronics Co. 26
Connector Div., of International Resistance Co. 9	Lectrohm, Inc. 206	United Screw & Bolt Corp. 119
Consolidated Radio Products Co. 138	Lord Mfg. Co. 49	United Transformer Co. 74
Cook Electric Co. 64	Machlett Laboratories, Inc. 43	Universal Microphone Co. 39
Cornell-Dubilier Electric Corp. 185	MacRae's Blue Book 209	University Laboratories 180
Corning Glass Works. 65	Magnavox Co. 8	Utah Radio Products Co. 35
Corry-Jamestown Mfg. Corp. 30	Makepeace Co., D. E. 122	Valpey Crystal Corp. 208
Cramer Co., Inc., R. W. 152	Mallory & Co., Inc., P. R. Cover 2, 61, 205	Walker-Jimieson, Inc. 216
Creative Plastics Corp. 69	Mec-Rad Division—Black Industries 161	Ward Leonard Electric Co. 58
Crystal Products Co. 15	Merit Coil & Transformer Corp. 4	Western Electric Co. 124, 125, 156
Daven Co. Cover 3	Micamold Radio Corp. 212	Westinghouse Electric & Mfg. Co. 159, 165
Dazor Mfg. Co. 50	Micro Switch Corp. 13	Whitaker Cable Corp. 54
DeForest's Training, Inc. 140	Millen Mfg. Co., Inc., James 200	Wiedemann Machine Co. 72
De Jur-Amsco Corp. 193	Monarch Mfg. Co. 174	Wiley & Sons, Inc., John. 164
Deuschmann Corp., Tobe. 3		Wilson Co., H. A. 189
Dial Light Co. of America, Inc. 132		
Dolph Co., John C. 23		
Drake Mfg. Co. 160		
Dumont Electric Co. 202		

THE HORN
OF
Plenty

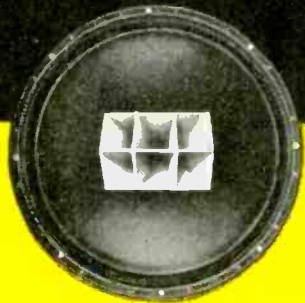

(MODERN VERSION)

Plenty of high frequency
Sound reproduction, up to
15,000 cycles plus... plenty
of bass response, down to
40 cycles... plenty of hori-
zontal distribution, 60 de-
grees... plenty of vertical
distribution, 40 degrees...
plenty of quality... plenty
of EVERYTHING a modern
post-war America wants in
quality sound reproduction.
You enjoy them all in the Al-
tec Lansing Duplex Speaker.

SEND FOR BULLETINS

ALTEC

LANSING CORPORATION

1210 TAFT BLDG., HOLLYWOOD 28, CALIF.

While every precaution is taken to insure accuracy, we cannot guarantee against the possibility of an occasional change or omission in the preparation of this index.

GET THIS FREE

Emergency Service BUYER'S GUIDE!



A MODERN Reference Book and Buyer's Guide is ready NOW! It represents an important contribution to the field of Industrial Electronics. Between its attractive covers you'll find pertinent information and data on the most advanced types of electronic instruments, devices and tools. Here are descriptions of products such as industrial X-Ray Machines, an Electronic Comparator, Test Equipment including Signal Generators, Tube Testers, and Multitester, Die-Less Duplicating Tools, Plastic Sectional Wiring Systems, Photo-Electric Devices, and others that have never been catalogued before. Industrial engineers and purchasing agents are invited to send for a free copy today!

FILL IN AND MAIL TO YOUR NEAREST DISTRIBUTOR!

WALKER-JIMIESON, INC.

311 S. Western Avenue, CANal 2525, CHICAGO 12

RADIO SPECIALTIES CORP.

20th & Figueroa, Phone Prospect 7271, LOS ANGELES 7

GENTLEMEN: Please send me a free copy of your Reference Book & Buyer's Guide.

NAME _____

COMPANY _____

CITY _____ ZONE _____ STATE _____

1,001 USES

Condensed Power for Years of Service

VERSATILITY and dependability were paramount when *Alliance* designed these efficient motors—*Multum in Parvo!* . . . They are ideal for operating fans, movie projectors, light home appliances, toys, switches, motion displays, control systems and many other applications . . . providing economical condensed power for years of service.

Alliance Precision

Our long established standards of precision manufacturing from highest grade materials are strictly adhered to in these models to insure long life without breakdowns.

EFFICIENT

Both the new Model "K" Motor and the Model "MS" are the shaded pole induction type—the last word in efficient small motor design. They can be produced in all standard voltages and frequencies with actual measured power outputs ranging upwards to 1/100 H. P. . . Alliance motors also can be furnished, in quantity, with variations to adapt them to specific applications.

DEPENDABLE

Both these models uphold the *Alliance* reputation for all 'round dependability. In the busy post-war period, there will be many "spots" where these Miniature Power Plants will fit requirements . . . Write now for further information.

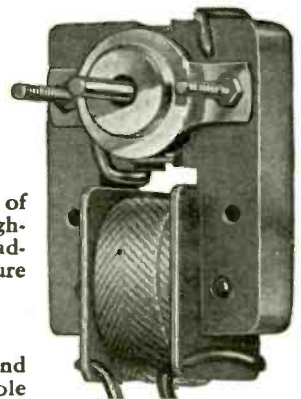

Model "MS"—Full Size Motor Measures 1 3/4" x 2 3/8"

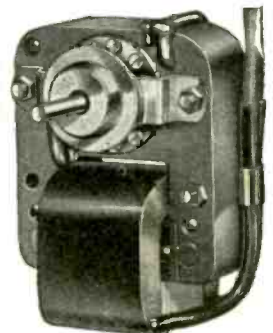

New Model "K"—Full Size Motor Measures 2 1/2" x 2 3/8" x 3 1/4"



Remember Alliance!
—YOUR ALLY IN WAR AS IN PEACE

ALLIANCE MANUFACTURING CO.

ALLIANCE . OHIO

DAVEN

ATTENUATION NETWORKS

Series 690

DAVEN Series 690 Attenuation Networks comprise 20 models, designed for general laboratory and production testing at audio frequency levels. DAVEN plug-in type Fixed Attenuators are employed for matching source and load impedances with the base impedance of the network. A high degree of flexibility is thus achieved with an absence of mis-match, reflection loss and switching noises.

MODEL VARIATIONS

- 2 MOUNTINGS: Portable and Rack Type
- 3 BASE IMPEDANCES: 500, 600 and 135 ohms
- 2 CIRCUITS: "T" and Balanced "H"
- 2 RANGES: 0-110DB, steps of 1DB (2 dials)
0-111DB, steps of 0.1DB (3 dials)

*Balanced "H" type may be used as an unbalanced network of one-half the base impedance.

OTHER SPECIFICATIONS

ACCURACY: Resistors calibrated within $\pm 1\%$

PLUS-IN PADS: Octal tube base, panel mounting, in wide range of impedances and losses.

FREQUENCY RANGE: 0-17,000 c.p.s.; at higher frequencies, slight reduction in accuracy.

OPERATION LEVEL: +20DB (0.6w) maximum input.

SIZE: 2 dial portable: 5"x10"x5"; 3 dial portable: 6"x11 1/2"x5"; rack: 3 1/2"x19".

Daven Attenuation Standards, types 740 and 742 (resistor accuracy $\pm 1/2\%$), are designed for applications requiring greater accuracy. See your DAVEN Catalog or write for details.

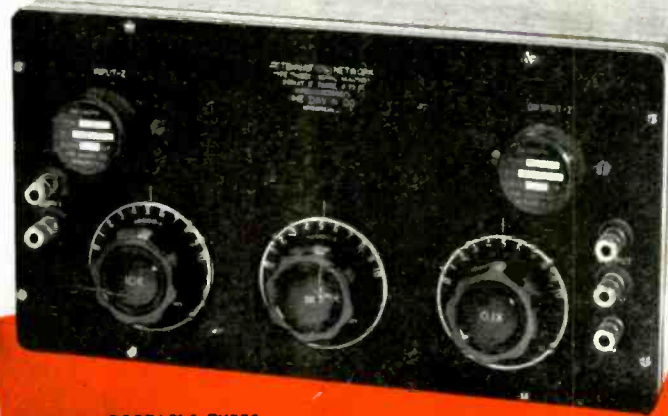

PORTABLE TYPES

"T"	BAL. "H"	DB RANGE	BASE Z
T-690-A	H-690-B	0-110	500
T-690-C	H-690-D	0-110	600
T-692	H-692	0-111	500
T-693	H-693	0-111	600
T-694	H-694	0-111	135

RACK TYPES

"T"	BAL. "H"	DB RANGE	BASE Z
T-690-AR	H-690-BR	0-110	500
T-690-CR	H-690-DR	0-110	600
T-692-R	H-692-R	0-111	500
T-693-R	H-693-R	0-111	600
T-694-R	H-694-R	0-111	135



THE **DAVEN** COMPANY
191 CENTRAL AVENUE
NEWARK 4, NEW JERSEY

YOU CAN MAKE NO GREATER PERSONAL CONTRIBUTION TO THE WAR EFFORT THAN TO DONATE A PINT OF YOUR BLOOD TO THE RED CROSS

HOW TO SELECT PHOTOTUBES

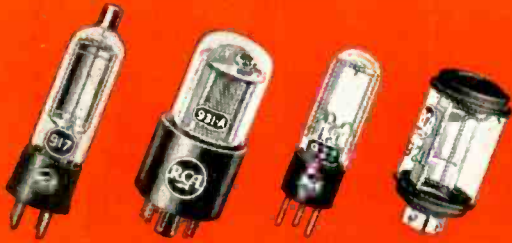

PHOTOTUBES have found such a wide variety of applications that many types have been developed to meet special needs. The complete RCA line includes both gas-filled and high-vacuum phototubes, with various spectral responses and a variety of sizes and shapes. And for applications requiring extreme sensitivity, RCA supplies multiplier phototubes.

A phototube acts as a light-actuated electric valve. (It does not convert light energy to electrical energy, but acts only as a control device.) The current passed is in proportion to incident light. Some phototubes are "high-vacuum" types; some are filled with an inert gas (such as argon) to increase current-carrying capacity.

A multiplier phototube contains additional electrodes (dynodes) which emit secondary electrons and thus greatly increase sensitivity and output current as compared to 2-electrode phototubes.

Color Sensitivity: The cathode coating material and the envelope glass determine color sensitivity. RCA phototubes fall into five "color groups":

Use	Tube Types	Maximum Color Sensitivity
With incandescent lamps	High vacuum: 925, Gas-filled: 868, 920, 924, 927*, 928	Red and infra-red
With incandescent lamps—and for infra-red application	High vacuum: 917, 919, 922*, Gas-filled: 918, 921*, 923, 930*	Similar to above, but sensitivity extended further into infra-red
With light source for colorimetry application	High-vacuum: 926	Blue light. Approximates the human eye
With daylight, carbon-arc, or mercury-vapor light source	High-vacuum: 929*, 934, Multipliers: 931-A*, IP21	Blue light. Very sensitive to incandescent light at a color temperature above 2700° K.
For ultra-violet measurement	High-vacuum: 935, IP28	Same as above, but special glass envelope permits high ultra-violet sensitivity

*An RCA Preferred Type Tube

Color response curves are available on all RCA phototubes.

Vacuum- or Gas- or Multiplier-Type? Several important factors to be considered in selecting the general type of phototube for a service are given in the following table. Specific values should be considered in selecting the actual tube type.

Characteristic	High-Vacuum type	Gas-filled type	Multiplier type
Sensitivity	Low	Medium	Very high
Current Output	Low	Medium	Very high
Amplification factor	1	Up to 10	Up to 1,000,000
Relative signal-to-noise ratio (Including amplifier stage)	Low	Intermediate	High
Anode Volts	Up to 500	Not over 90	Up to 1250
Distortion (audio)	Negligible	Appreciable in some cases	Negligible
Frequency Range	Limited largely by circuit	Limited by tube performance	Limited largely by circuit

Gas-filled phototubes are, at present, extensively used for sound-on-film reproduction and for relay work. Vacuum-types are widely used where high sensitivity is needed; for precision measurement where stability of calibration is essential; and for high-speed work.

Sensitivity: The sensitivity of a phototube may vary according to whether the light change is abrupt or continuous. *Static sensitivity* is the ratio of anode direct current to constant light flux. *Dynamic sensitivity* is the ratio of the variation of anode current to the variation of light input. The sensitivity of gas-filled phototubes drops off as light-source frequency increases.

Optical Systems: The use of phototubes usually involves some sort of optical system. The fundamentals of optics must be carefully considered in the successful application of phototubes.

Mechanical Features: As illustrated at left, several types of tubes are available. Size, vibration, directional requirements, etc., all may influence the choice of one of the many RCA phototubes.

Phototube Life: Phototubes are inherently sturdy, long-lived tubes and when operated under recommended conditions, give extended reliable service.

Application Hints: Here are a few general suggestions on applying phototubes:

1. In relay and measurement circuits where tubes must respond to very small amounts of light, avoid leakage currents outside tube. Keep tube terminals and sockets clean. Erratic leakage currents will affect results.
2. In amplifiers where low leakage is important, select top cap types such as 917, 919, or 935.
3. Shield phototube and leads to amplifier or relay tubes when amplifier gain or phototube load resistance is high.
4. Where high-frequency response is important keep phototube leads short to minimize capacitance shunting of output.
5. For constant calibration of high-precision vacuum phototube devices, keep anode voltage at or below 20 volts. Keep incident light spread over wide cathode area.
6. Design or circuit constants should be based on tests with the equipment operating over the expected range of line-voltage variation.
7. RCA voltage-regulator tubes can improve phototube circuit performance.
8. Anode characteristic curves on phototubes can be used to predict performance under given operating conditions.

What Phototube Do You Need?

Due to space limitations, the suggestions presented here are brief and in a condensed, summary form. If you have a specific application problem or wish to discuss your phototube requirements with us, write to RCA, Commercial Engineering Section, Dept. 62-27J, Harrison, N. J. For further published information on RCA Phototubes and how to use them, send the coupon at left.



Send for this valuable data

Free to electronics engineers: "RCA Phototube Booklet," complete with 11 typical circuit diagrams, curves, tables, and clearly written text. Address: RCA, Commercial Engineering Section, Dept. 62-27J, Harrison, N. J.

FREE!



Please send free phototube data to:

Name

Company

Address

City State

RADIO CORPORATION OF AMERICA

RCA VICTOR DIVISION • CAMDEN, N. J.

The Magic Brain of all electronic equipment is a Tube and the fountain-head of modern Tube development is RCA.