

ELECTRONIC INDUSTRIES



- ★ Measurement of Static and Dynamic Pressures
- ★ Cathode Coupling Circuits ★ Sound on Film
- ★ OWI's Master Control ★ Production Short Cuts

AUGUST 1944

Calwell-Clements, Inc.

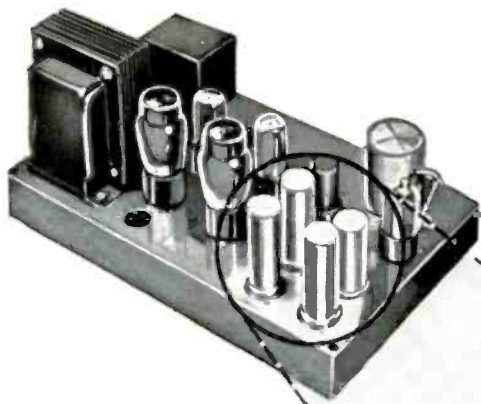

STANDARD for Top Chassis Mounting MALLORY FP* Capacitors

*Trademark Registered



*The Harder They Fight, the More
They Need—Buy War Bonds*

MALLORY FP CAPACITORS embrace so many features, and are ideally suited to so many types of service, that they have largely outmoded the ridiculous array of "specials" in use prior to their introduction. This standardization has made possible appreciable savings in time and money, in addition to improved performance.

The patented "twisted ear" mounting of FP Capacitors rules out the necessity of extra clamps, washers, nuts or screws; no other parts are required for mounting. The greatly reduced size of the capacitor carries its own obvious advantages, without any sacrifice of electrical characteristics. Special internal cartridge design assures minimum coupling with only occasional need of extra circuit isolation. And FP Capacitors are low in price—widespread acceptance has made that possible.

Specifications and complete test data on FP and other Mallory capacitors are contained in the latest Mallory Catalog. Send for a copy today. See your Mallory distributor.

P. R. MALLORY & CO., Inc., INDIANAPOLIS 6, INDIANA

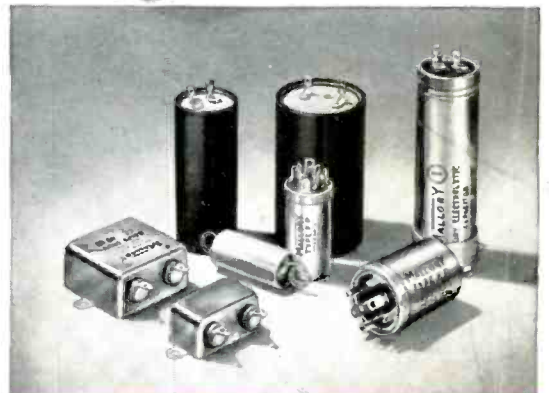

P. R. MALLORY & CO. Inc.
MALLORY
ELECTROLYTIC,
FILM AND PAPER
CAPACITORS

ELECTRONIC INDUSTRIES

Including INDUSTRIAL ELECTRONICS

★ IN THIS ISSUE AUGUST, 1944 ★

EDITORIAL	83
MEASUREMENT of STATIC and DYNAMIC PRESSURES—C. E. Grinstead, R. N. Frawley, F. W. Chapman, H. F. Schultz	84
CONTINUOUS PRODUCTION of LARGE POWER TUBES	88
DEFLECTION BEAM TUBE—Paul Glass	90
OWI's NEW YORK MASTER CONTROL	94
RECORDING SOUND on FILM—Gilbert Sonbergh	98
MAINTAINING MILITARY RADIO COMMUNICATIONS—Roland Davies	102
PRODUCTION SHORT CUTS	104
USING CATHODE COUPLING—W. Muller	106
FLEXIBLE STUDIO CONSOLE—Philip C. Erhorn	108
PRODUCTION of CATHODE RAY TUBES	110
HIGH SPEED TIME BASES—William A. Stewart	112
BRIDGE-CONTROLLED OSCILLATOR DESIGN—William H. Bussey	114
THE ENGINEER as EXECUTIVE—Raymond M. Wilmotte	116
FREQUENCY RANGE EXTENSION	117
TUBES on the JOB	113
DIRECT READING FREQ METER—R. D. Hickock, Jr.	120
What's New	122
Survey of Wide Reading	124
Washington News	126
Association News	128
Television Today	130
New Books	152
New Bulletins	156
New Patents Issued	164

ORESTES H. CALDWELL, Editor M. CLEMENTS, Publisher

EDITORIAL STAFF—Ralph R. Batcher, consulting editor; Stanley P. McMinn, managing editor; William Moulle, electronic theory and design; Gilbert Sonbergh, industrial applications; Josepha Zentner, Ph.D., patents and foreign reviews; H. L. M. Capron, engineering management relations; E. T. Bennett, editorial records; Charles Dreyer, art director; Carl Buhrer, circuit diagrams; Barbara Chasen, layout and production; Roland C. Davies, Washington editor.

READER SERVICE—L. D. Chesson, H. Mirtel; data research, H. Kulik.

CIRCULATION—B. V. Spinetta, circulation director; Subscriptions; list compilation: B. Gollub, M. Groening, B. Ruchaisky, A. Warsaw.

BUSINESS—M. H. Newton, business manager; John Samborn, eastern manager; Richard Fitzpatrick, western manager; O. H. Sutter, New England manager; Lee Robinson, district manager; N. McAllister, production manager; Estelle Coven, make-up; E. P. Butler, E. Hekking, M. Fitzgerald; W. W. Swigert, credit manager; M. Feldman, D. Cali.

CHICAGO MANAGER—R. Y. Fitzpatrick, 201 N. Wells Street. Tel. RAN 9225.

Electronic Industries, August, 1944, Vol. III, No. 8. Regular price per copy 35 cents. Published monthly by Caldwell-Clements, Inc., 480 Lexington Avenue, New York, N. Y. M. Clements, President; Orestes H. Caldwell, Treasurer; M. B. Clements, Assistant Secretary. Subscriptions: United States and possessions, Mexico, Central and South American countries, \$3.00 for one year; \$5.00 for two years; \$6.50 for three years. Canada, \$3.30 per year; \$5.50 for two years; \$7.15 for three years. All other countries \$5.00 a year. Entered as Second Class Matter, September 20, 1943, at the Post Office at New York, N. Y., under the act of March 2, 1879. Copyright by Caldwell-Clements, Inc., 1944. Printed in U. S. A.

CALDWELL-CLEMENTS, INC. — TEL. PLAZA 3-1340—480 LEXINGTON AVENUE, NEW YORK 17, N. Y.

Why AMPEREX

WATER and AIR COOLED TRANSMITTING AND RECTIFYING TUBES

Even for small Amperex tubes, extraordinary processing temperatures are specified by our engineers. To achieve these, we employ high frequency induction heating with high power water cooled tube generators. This "Amperextra" drives the occluded gases from the tube elements, after which they are pumped out in an operation for which specific and unique equipment was devised in our own tool shop. A better Amperex tube is the result . . . as substantiated by operating economy and an increased number of working hours per tube.



AMPEREX ELECTRONIC CORPORATION

79 WASHINGTON STREET
EXPORT DIVISION: 13 EAST 40th STREET, NEW YORK 16, N. Y., CABLES: "ARLAB"

BROOKLYN 1, N. Y.

SHARE YOUR BLOOD WITH A WOUNDED SOLDIER . . . VISIT YOUR BLOOD BANK TODAY

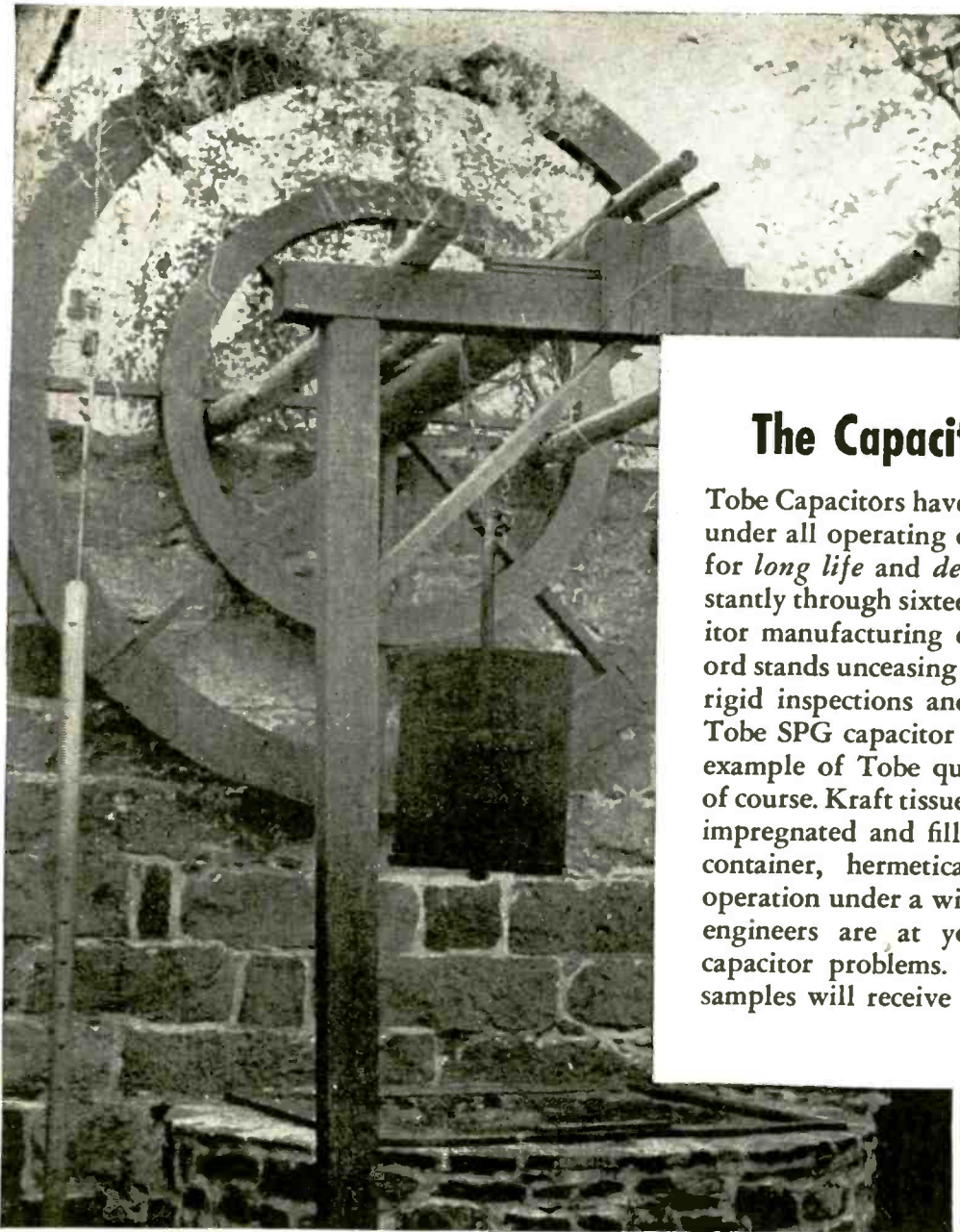

Old Mining Shaft at Newgate Prison in Granby, Conn. The Granby Mines, perhaps the most historic in America, are over 225 years old.

The Capacity to "TAKE IT!"

Tobe Capacitors have proved they can "take it"—under all operating conditions. Their reputation for *long life* and *dependability* has grown constantly through sixteen years of specialized capacitor manufacturing experience. Behind this record stands unceasing Tobe research, frequent and rigid inspections and *conservative ratings*. The Tobe SPG capacitor illustrated below is a good example of Tobe quality. Top grade materials, of course. Kraft tissue, aluminum foil. Mineral oil impregnated and filled, in a streamlined drawn container, hermetically sealed. Designed for operation under a wide temperature range. Tobe engineers are at your ready disposal in all capacitor problems. Inquiries and requests for samples will receive prompt attention.

SPECIFICATIONS

SPG-CAPACITORS

TYPE	SPG*
RATINGS05 to 2.0 mfd. 600 V. D. C.
	.05 mfd. to 1.0 mfd. 1,000 V. D. C.
STANDARD CAPACITANCE TOLERANCE	20%**
TEST VOLTAGE	Twice D. C. rating
GROUND TEST	2,500 Volts D. C.
OPERATING TEMPERATURE	-55° F to 185° F
SHUNT RESISTANCE	
	.05 to 0.1 mfd. 20,000 megohms
	.25 to 0.5 mfd. 12,000 megohms
	1.0 mfd. 10,000 megohms
	2.0 mfd. 5,000 megohms
POWER FACTOR 1,000 cycles—	.002 to .005
CONTAINER SIZE	
	Width $\frac{3}{8}$ ", length $1\frac{5}{16}$ ", height $2\frac{1}{4}$ "
MOUNTING HOLE CENTERS	1 $\frac{1}{2}$ "

MIDGET SPG-CAPACITORS

TYPE	SPGM*
RATINGS05, .1 and
	2 x .05 600 V. D. C.
	.05 and .1 1,000 V. D. C.
STANDARD CAPACITANCE TOLERANCE	20%**
GROUND TEST	2,500 V. D. C.
OPERATING TEMPERATURES	-55° F to 185° F
SHUNT RESISTANCE	20,000 megohms
POWER FACTOR	At 1,000 cycles—.0075
CONTAINER SIZE	
	Width $\frac{3}{8}$ ", length $1\frac{5}{16}$ ", height $1\frac{1}{4}$ "
MOUNTING HOLE CENTERS	1 $\frac{1}{2}$ "



MIDGET SPG CAPACITOR



SPG CAPACITOR

*Data sheets showing complete code number for units having a specific capacitance value and voltage rating available on request. **Other tolerances available.

Illustrations show capacitors with terminals on bottom. Capacitors also available with terminals on top.

A small part in victory today... A BIG PART IN INDUSTRY TOMORROW



THE COVER

High Speed Automatic Tube Testing

The kodachrome shows an automatic tube test unit designed and built by Eitel-McCullough, Inc. to facilitate the testing of some of the characteristics of eighteen different types of Eimac transmitting tubes. By means of a single selector switch on the control panel, test conditions for any particular tube type are set up. Each tube then goes through the following test sequence while passing around the machine on a rotating circular table: filament on; full plate dissipation for two minutes; regulated plate voltage applied for 20 seconds, during which the grid bias is automatically adjusted to give the plate current required by the test specification; filament off; tube cooled by air blast. The test requires eight minutes.

While each tube is on the regulated plate supply section, the grid bias and negative grid current ("gas" current) are metered and recorded by the control operator. High plate voltages up to 15 kv and a high bias voltage also are available following the grid bias and current test point to allow high-voltage cut-off tests on certain types. The unit tests 150 tubes per hour, and requires only one operator to record the various voltage and current values while another operator inserts and removes the tubes.

★ ★

"What, No Pressure Cookers?"

Wartime shortages and the scarcity of consumer goods reared its head at The Daven Co., Newark, N. J., manufacturers of potentiometers and attenuators. Proof that Daven "pots" are nationally known came in the form of a strange written request from a non-priority source, to wit:

"Gentlemen:

I've heard that you made or carried aluminum pots. I expect to get married soon, and I can't seem to find any more aluminum pots or pans. If by any chance you may have any in stock, I would appreciate it very much if you could let me know what you have and the price of them. Thank you."

★ ★

On the wall of Edison's laboratory in Orange, N. J., hung this framed quotation from Sir Joshua Reynolds: "There is no expedient to which a man will not resort to avoid the labor of real thinking."

ELECTRONIC INDUSTRIES • August, 1944



FATIGUE TESTS dependent on **THORDARSON** AMPLIFIERS

Four of the Thordarson 2500 Watt Amplifiers are used in the laboratories of the Curtiss Wright Corporation-Propeller Division. Fatigue analysis of Aircraft components demands continuous 24-hour a day operation. Thordarson amplifiers serve continuously in these unusual tests, demonstrating their ability to "stand the gaff" under the most exacting conditions.

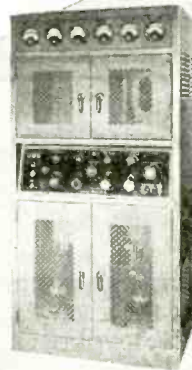

FATIGUE AMPLIFIER
POWER OUTPUT—2500 watts,
less than 5% distortion, continuous duty.
FREQUENCY RESPONSE—
Within ± 2 db 35 to 1500 C.P.S.
(Other frequency response available on special order).
GAIN—80 db.
OUTPUT IMPEDANCES—5, 7.5, 10, 15, 20, 30, 50, 75, 100, 125, 250 and 500 ohms
(Rotary switch selection).



THORDARSON

TRANSFORMER DIVISION
THORDARSON ELECTRIC MFG. CO.
500 W. HURON ST., CHICAGO, ILL.

Transformer Specialists Since 1895
ORIGINATORS OF TRU-FIDELITY AMPLIFIERS

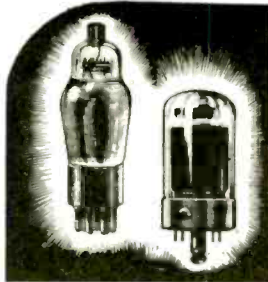

◀ STANDARD TYPE RECEIVING TUBES

SYLVANIA "LOCK-IN" RECEIVING TUBES

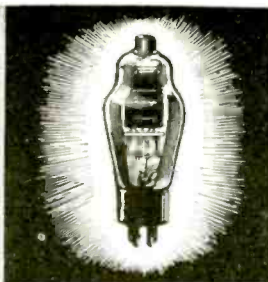

TRANSMITTING TUBES

MINIATURE RADIO RECEIVING TUBES

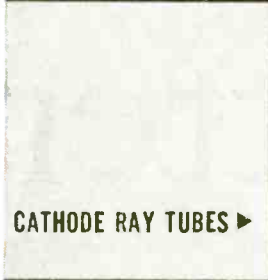

CATHODE RAY TUBES ▶



MINIATURE SIZE GAS VOLTAGE REGULATOR TUBES

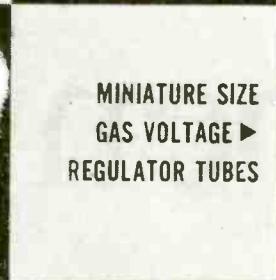

STANDARD SIZE GAS VOLTAGE REGULATOR TUBES



◀ STROBOTRONS

FACSIMILE RECORDING TUBES

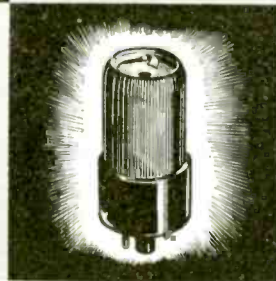

PIRANI TUBES ▶

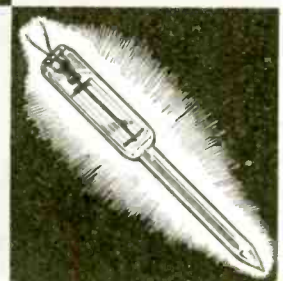

ELECTRON TUBES in Search of an Inventor

Whether the inventor is an individual or the research laboratory of a great corporation, Sylvania offers a wide variety of electron tubes. A few of them are shown here, together with components—as a sample of our manufacture to one standard—the highest anywhere known. There are many more, some of which are on the restricted list. For information about Sylvania electron and radio tubes, write Sylvania Electric Products Inc., 500 Fifth Avenue, New York 18, N. Y.

One Standard — The Highest Anywhere Known



SYLVANIA

 ELECTRIC PRODUCTS INC.

500 FIFTH AVENUE, NEW YORK 18, N. Y.

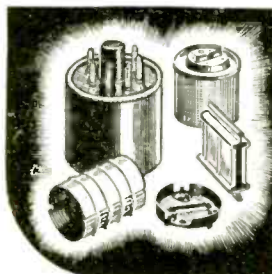

THERMOCOUPLE TUBES ▶

◀ RADIO TUBE PARTS

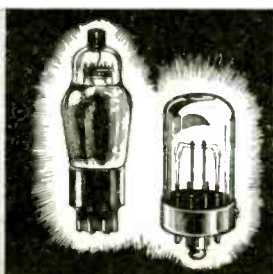

◀ POWER MEASUREMENT TUBES

WELDS AND LEADS ▶

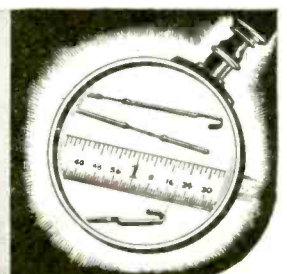



An Open Letter
to Executives
of the
Radio Industry





When you find time to consider post war problems, give a thought to what can be accomplished *now* by better industry standardization of components.

Prior to this war, the variety of tubes, resistors, condensers, coils and hardware was limited only by the desires or fancies of hundreds of engineers and by the ability of parts makers to tool and tool and tool. Possibly this haphazard procedure was a necessary adjunct to pioneering and growth.

The automotive industry experienced similar confusion in its early days, but with the advent of stability there also came standardization—of spark plugs, tire sizes, bumper heights, fan belts, sealed beam headlights, etc. Or maybe cooperative standardization helped to bring about industry stability.

Today—while post war radio sets are still in the making—is the time for top radio executives to insist that engineering and commercial departments work with the proper Committees of the Radio Manufacturers' Association to establish industry standards. If it is not done now, the next opportunity may be years away.

Here is an example of what can be accomplished. In one class of component, namely dry electrolytic condensers, there were more than 500 different types, ratings or sizes used as filters in the various radio sets made in a pre-war year. Chief Engineers appear to agree that between 30 to 40 standard units will meet all filtering requirements in 95% of the chassis built.

Should something like 40 electrolytics be adopted as standard type filters, the manufacturers of these condensers can produce in larger quantities and in more fully mechanized departments, furnishing a more uniform product at lower cost. It is probable that metal encased units—with their longer life—can be made so economically that inferior cardboard enclosures can be eliminated as standards. Some production can be maintained in "off-season." Set manufacturers' and service department inventories can be kept lower than heretofore. The public obviously will benefit by cost reduction in both sets and service charges.

Although condensers are used as an example, similar benefits and economies will accrue to the industry and the public by elimination of unnecessary types of other components.

This standardization is a matter which is vital to our industry's growth. If you believe in it, do something about it. Write or confer with the Chairman of the R. M. A. Parts Division, or contact the heads of the various special R. M. A. Committees on components. Only concerted industry effort will bring results. There is great need for leadership. Yours is solicited.

Ordered and paid for by a Capacitor Manufacturer, who, for the sake of industry cooperation, prefers to remain anonymous.



HERE'S ONE JOB Dielectric Heating CANNOT DO...

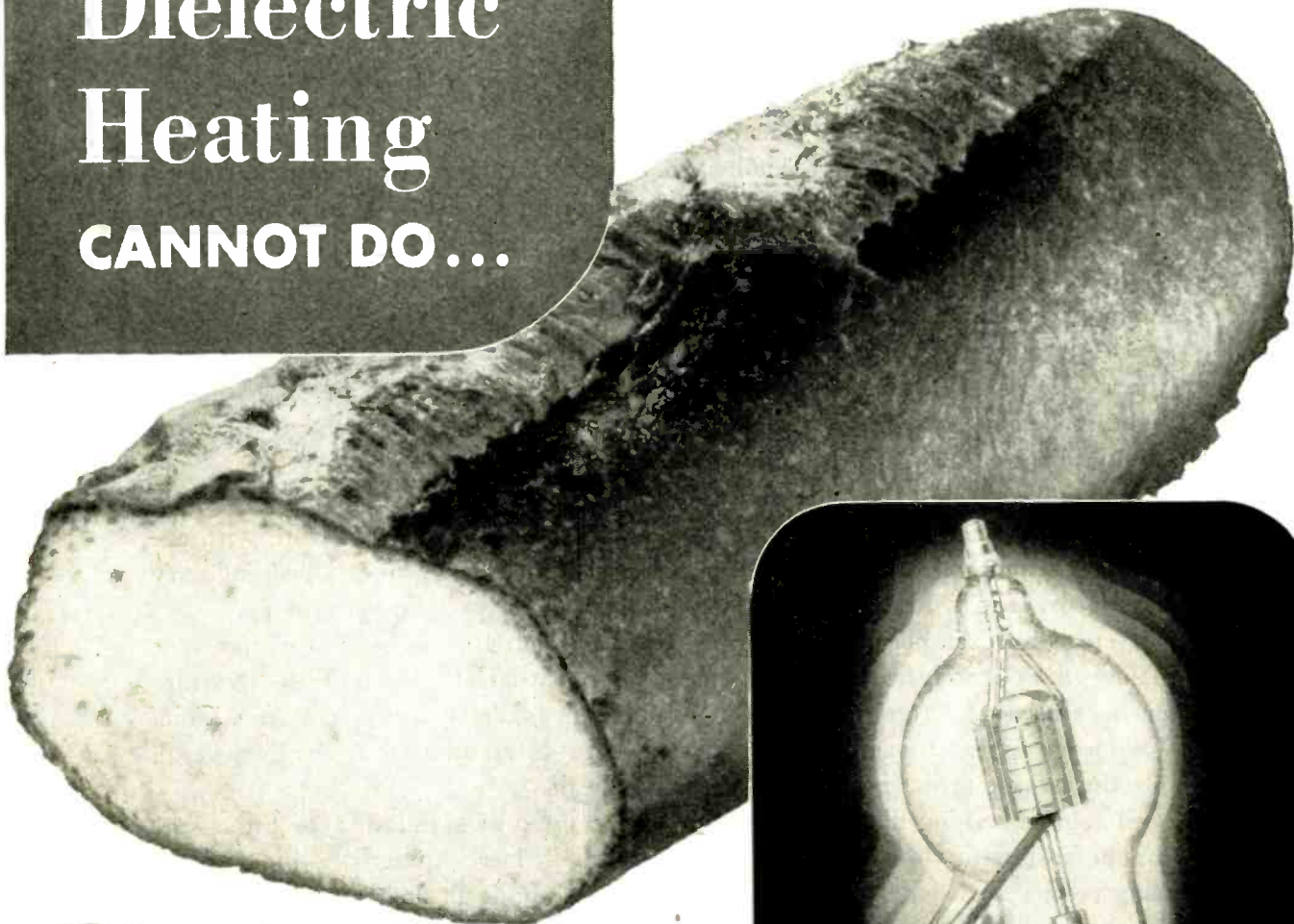

When bread dough is placed between two metal plates carrying high-frequency power generated by vacuum tubes, a crust swiftly forms in the center of the loaf... not on the outside!

This clearly illustrates how dielectric heating differs from all other methods of applying heat. *It is the only means of heating a non-conducting material from the inside out.* For although the material is heated uniformly, surface radiation allows the exterior to remain cooler than the interior.

In heating or drying such materials as paper, textiles, wood, plastics, powders and ceramics the "inside out" characteristic of dielectric heating has numerous advantages. Investigate this process now for war and post-war applications on your production lines. We will gladly refer you to sources of additional information.

HEINTZ AND KAUFMAN LTD.
SOUTH SAN FRANCISCO · CALIFORNIA

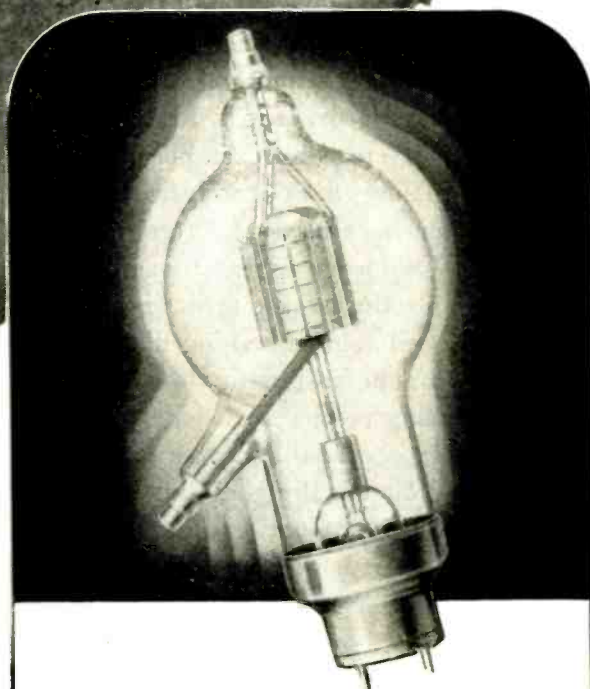

HK-1054... For electronic heating applications a pair of these Gammatron tubes in an oscillator circuit will generate approximately 5KW of power at frequencies up to 15,000,000 cycles a second. These Gammatrons are air-cooled, compact, efficient, and are engineered by Heintz and Kaufman for remarkably long operating life.

IT'S TIME TO BUY ANOTHER WAR BOND



Gammatron Tubes

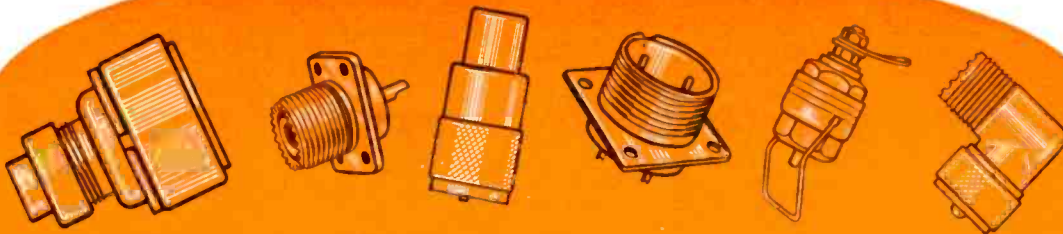

A Good Firm to Connect With For Your Postwar Needs in:

CONNECTORS—such as coaxial cable connectors, multiple contact connectors, cable plugs **AND RELATED UNITS** and such other small components to which our experience, manufacturing facilities and volume production in this field can be applied.

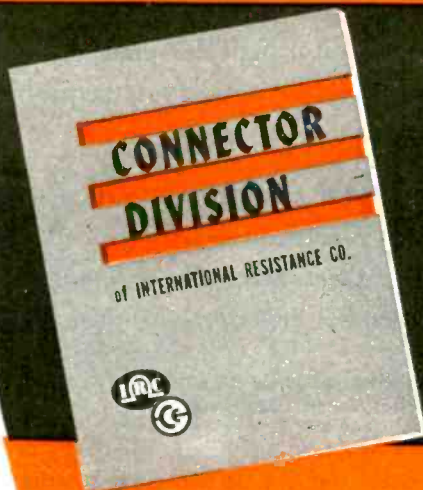

Write for Your Copy of our Catalog

Illustrated and described in this catalog are the types of connectors we are now producing. . . . A member of our Engineering Staff is available for consultation on other types of connectors for industrial use.



*CONNECTOR DIVISION OF
INTERNATIONAL RESISTANCE CO.

401 N. BROAD ST., PHILADELPHIA 8, PA.

*FORMERLY CONNECTOR CORPORATION

GENERAL ELECTRIC

announces the appointment of

GRAYBAR

and **GENERAL**

IN ADDITION TO G-E DISTRICT

as national distributors of General Electric

General Electric announces the formation of a national network of electronic-tube distributorships.

Three well-known national electrical sales and service organizations: the Graybar Electric Company, the General Electric Supply Corporation, and all G-E district and local apparatus offices.

Each of these national distributors will carry a diversified stock of electronic tubes as soon as priority regulations per-

mit. Now available is a weekly stock and delivery estimate schedule that will tell you when your electronic-tube order will be delivered.

Each distributor will be glad to obtain engineering information on request for any electronic-tube problem.

We urge you to take full advantage of this improved electronic-tube service. *Tube Division, Electronics Department, General Electric, Schenectady, New York.*

• Tune in General Electric's "The World Today" and hear the news from the men who see it happen, every evening except Sunday at 8:45 E.W.T. over CBS network. On Sunday evening listen to the G-E "All Girl Orchestra" at 10 E.W.T. over NBC.

THERE IS A G-E ELECTRONIC TUBE FOR EVERY PURPOSE



PHANOTRON —
for high-frequency
electronic heating



PHOTOTUBE —
for counting,
sorting, grading



THYRATRON —
for industrial
equipment control



IGNITRON — for
resistance welding
and converting
a-c to d-c



PLIOTRON —
for induction and
dielectric heating



PENTODE —
a general-purpose
amplifier

ELECTRIC COMPANY ELECTRIC SUPPLY CORP.

AND LOCAL APPARATUS OFFICES

electronic tubes for industrial applications

**HERE'S WHAT THIS NEW NATIONAL DISTRIBUTION
MEANS TO YOU AS AN ELECTRONIC-TUBE PURCHASER:**

There are now over 265 distributing houses ready to serve you with dependable G-E electronic tubes for industrial applications.

Two regional electronic-tube warehouses have been established for the purpose of speeding up deliveries—one at Chicago for the central region; one at San Francisco for the western region (opening in the immediate future).

Eight emergency electronic-tube depots have been established to provide you with 24-hour electronic-tube replacements on critical types for vital war production processes. These are located in:

CHICAGO	LOS ANGELES
CLEVELAND	PHILADELPHIA
DALLAS	SCHENECTADY
DETROIT	SEATTLE

• Consult the telephone directory for the address of your nearest Graybar Electric Company, G-E Supply Corporation, or General Electric office.

ELECTRONICS DEPARTMENT

GENERAL  ELECTRIC

162-C8-8852

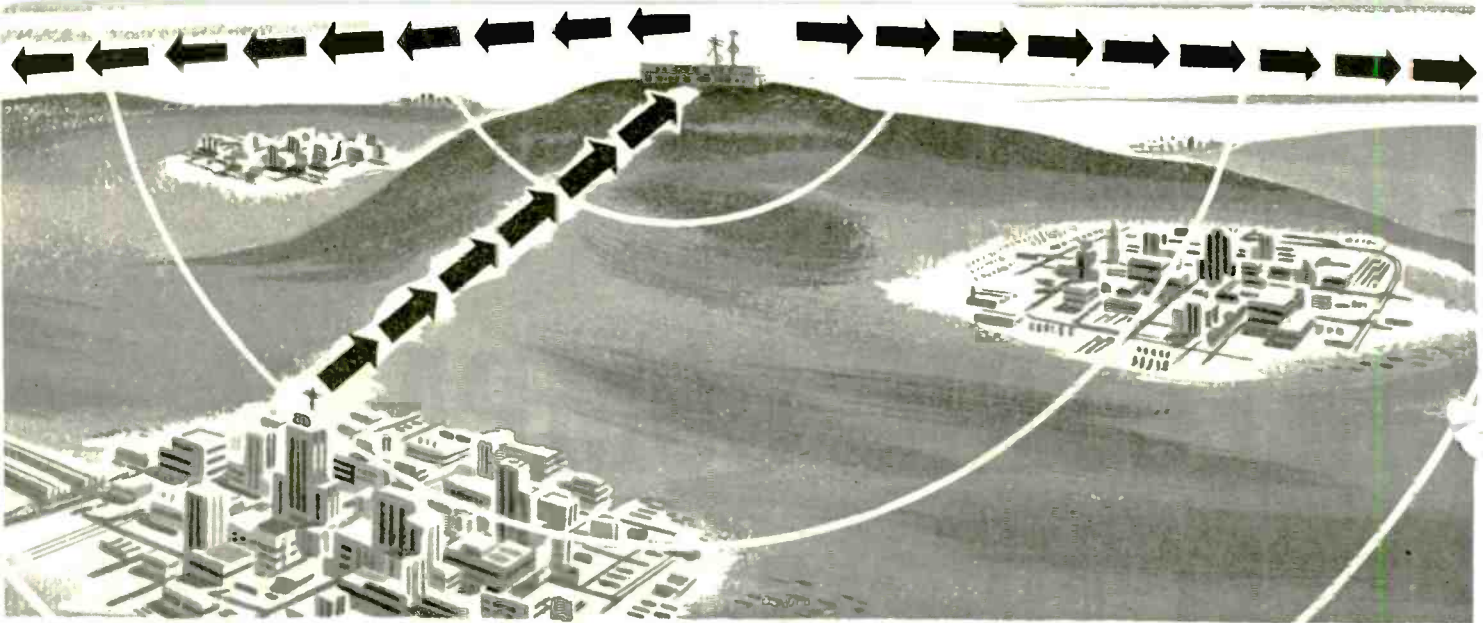

Locate your transmitter for maximum coverage

Locate your studio for maximum convenience

Bridge the gap without wires

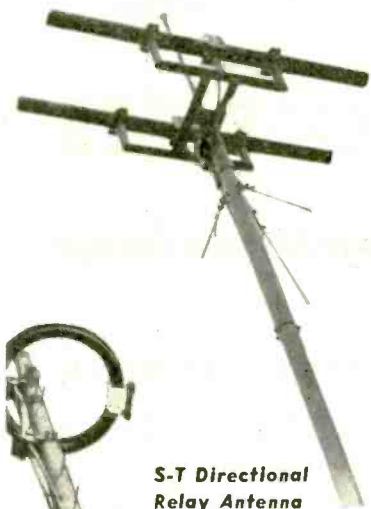

S-T Directional Relay Antenna



FM Broadcast Antenna

160-C9

• Tune in General Electric's "The World Today" and hear the news from the men who see it happen, every evening except Sunday at 6:45 E.W.T. over CBS network. On Sunday evening listen to the G-E "All Girl Orchestra" at 10 E.W.T. over NBC.

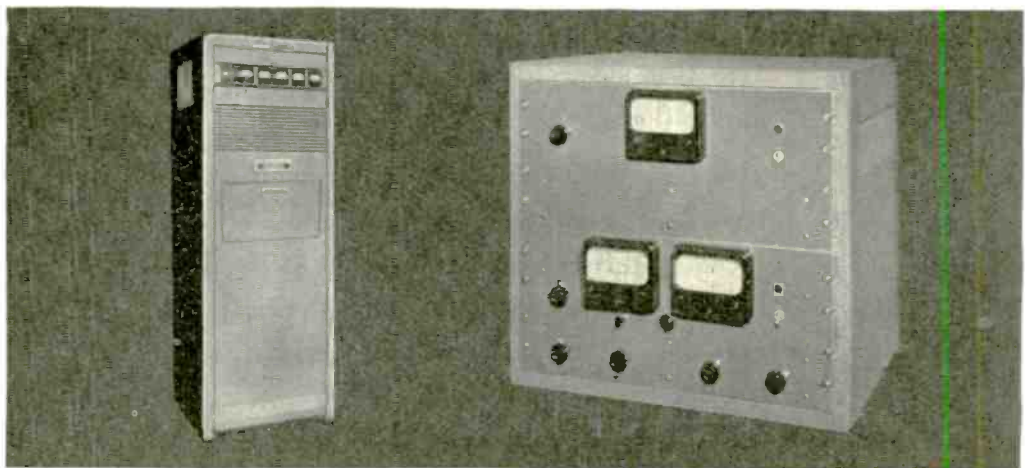

S-T Relay Transmitter (25-watt)

Station Monitor and Converter

STATION AND STUDIO EQUIPMENT • TRANSMITTERS • ELECTRONIC

GENERAL  ELECTRIC

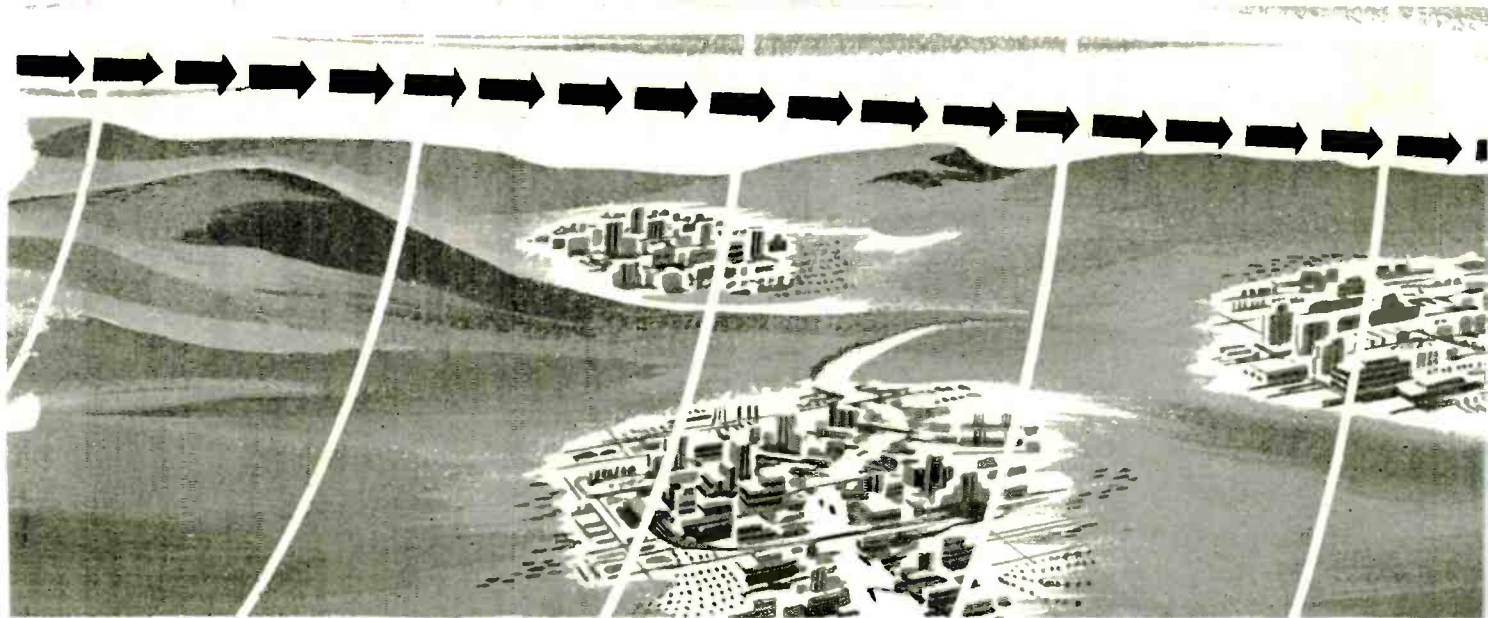

THROUGH proved performance in the six already established relay systems, G-E S-T (studio-to-transmitter) relay equipment offers a practical method by which you can reliably and economically relay your FM programs from studio to transmitter.

Extremely high fidelity, low noise level and a virtual absence of distortion are additional advantages of this exclusive G-E equipment. Completely dependable, too! Rain, sleet, floods or windstorms have no effect on this unique system "without wires." Distance is not a problem, for G-E S-T equipment is now reliably functioning up to airline distances of as much as 110 miles.

The G-E S-T relay transmitter is of the economical low-power rating of 25 watts. The G-E directional S-T relay antenna beams the signals to a receiving antenna of the same type at your G-E broadcast transmitter location. The total power gain of this system is 100. Thence, with full fidelity and further power gain, the programs go out over your service area through the easily tuned G-E circular broadcast antenna. . . . G-E S-T equipment is low in initial cost and economical to operate. Write for details, and information. Our engineers will be glad to discuss your problems with you. Section 3-D, Electronics Department, General Electric, Schenectady, N. Y.



NEW G-E DEVELOPMENT

The G-E disk-seal tube, an ultra-modern transmitting type, makes possible radio relaying of FM and television programs at very high frequencies. It will be used in post-war studio-to-transmitter and network relays.

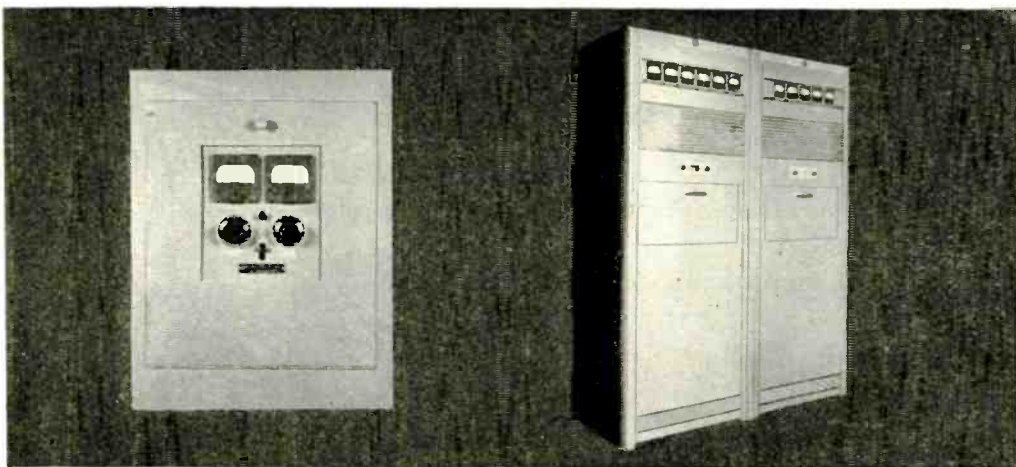

S-T Receiver

FM Broadcast Transmitter (1000-watt. Others 250-watt to 50-lw)

TUBES • ANTENNAS • RECEIVERS

FM—television—AM

See G.E. for all three!

50 FM STATIONS ARE ON THE AIR—157 APPLICATIONS ARE PENDING

Now is the time to plan your FM station. The "G-E Equipment Reservation Plan" enables you to obtain a post-war priority and early delivery on equipment. Send for it and descriptive literature on FM—today.

TORQUE

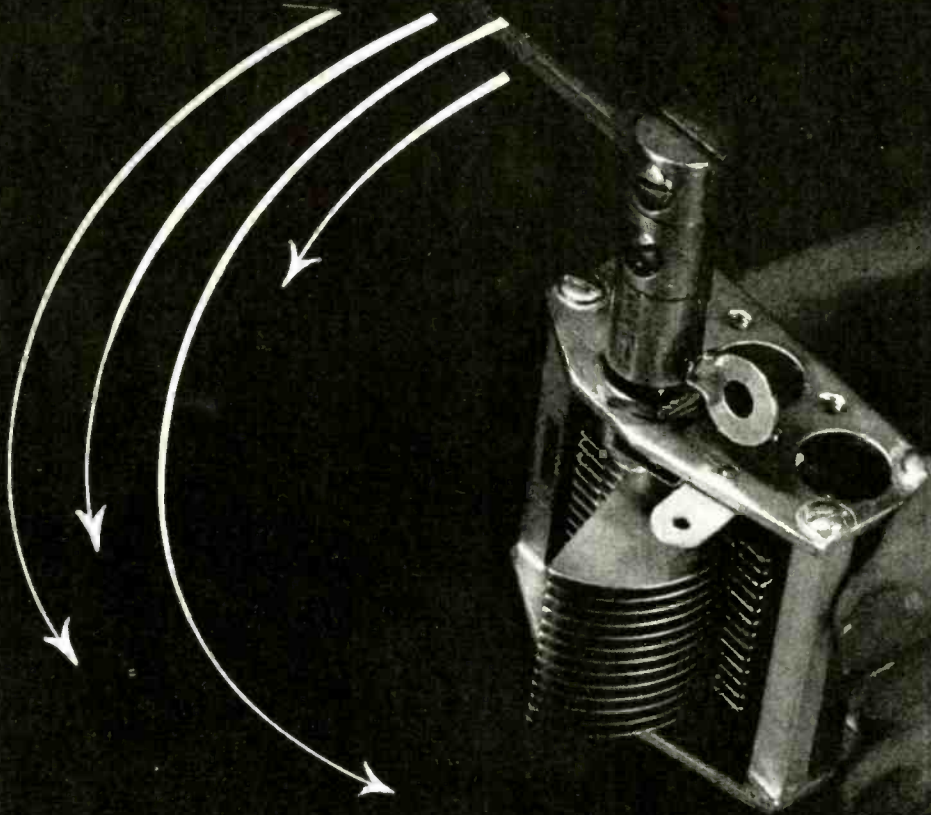

Hammarlund precision variable capacitors have just the right amount of **TORQUE**, to permit smooth and accurate adjustment. You don't have to fight rough and jumpy action when you tune with Hammarlund variables.



ESTABLISHED 1910

HAMMARLUND

THE HAMMARLUND MFG. CO., INC., 460 W. 34TH ST., N. Y. C.
MANUFACTURERS OF PRECISION COMMUNICATIONS EQUIPMENT



M-R

Friction and Sealing Tapes

M-R FASTHOLD FRICTION TAPE

Double Coated With Rubbery Compounds . . . Tensile Strength more than 44 pounds . . . Adhesive Strength more than 50 Pounds

In the manufacture of FASTHOLD FRICTION TAPE the best procurable cotton sheeting (long staple 56/60) is first dried to eliminate moisture . . . then the fabric is thoroughly impregnated with a filler coat of insulating, waterproofing and preserving compound . . . after several days of drying a second coat, exceptionally heavy in rubber content, is forced through the fabric by means of enormous rollers . . . then follows another period of drying out before cutting and wrapping in tin foil for protection.

The materials used and the precision and control exercised in the manufacture of FASTHOLD FRICTION TAPE enables it to meet all known electrical tests and requirements . . . and to Guarantee it against Unraveling or Drying Out.

FASTHOLD FRICTION TAPE is New York warehouse stocked in widths of $\frac{3}{8}$ — $\frac{1}{2}$ — $\frac{3}{4}$ —1— $1\frac{1}{2}$ and 2 inches.

M-R ANHYDROUS SEALING TAPE

IMPROVES WITH AGE AND SERVICE

25.58% Cotton Sheeting
74.42% M-R Insulating Compounds

Weatherproof . . . Waterproof . . .
Acid, Alkali, Oilproof . . . Permanently Flexible . . . Will not Vulcanize or Dry Out . . . Tensile Strength 30 Pounds . . . Dielectric 1,000 volts

ANHYDROUS SEALING TAPE contains nothing which will injure fabrics or metals. It is made of the best procurable cotton sheeting and special M-R Bituminous Compounds. A wrapping of ANHYDROUS TAPE gradually becomes one solid mass (glass hard on the outside and soft inside) that excludes air, moisture, vapors, etc. It can be used to great advantage under conditions which disintegrate ordinary tapes; inside work where acids or alkali fumes or spray prevail; outside for cable joint insulation in conduits, transformer connections, extreme high or low temperatures, etc.; mines and damp places where atmospheric conditions and constant friction demand maximum wearing qualities.

A joint, properly taped with ANHYDROUS, is absolutely waterproof even after complete submergence for many weeks.

ANHYDROUS SEALING TAPES are New York warehouse stocked in widths of $\frac{3}{4}$ and $1\frac{1}{2}$ inches . . . other sizes are available, as ordered.

FREE FOR THE ASKING

valuable aids, are the M-R Guide Book of Electrical Insulation . . . the Wall Chart with reference tables, electrical symbols, allowable capacities of conductors, dielectric averages, thicknesses of insulating materials and tap drill sizes . . . and the M-R Wax and Compound Guide Book . . . they are full of valuable information . . . write for them on your letterhead.

Write today for samples of M-R Friction and Sealing Tapes . . . also your Free Card of Varnished Tubing with samples ranging from size 0 to 20 to fit wires from .032 to .325 inches . . . other

MITCHELL-RAND
for
55 YEARS
THE ELECTRICAL
INSULATION
HEADQUARTERS

MITCHELL-RAND INSULATION COMPANY, INC.

51 MURRAY STREET

CORtlandt 7-9264

NEW YORK 7, N. Y.

EST. 1889

Fiberglas Varnished Tape and Cloth
Insulating Papers and Twines
Cable Filling and Pothead Compounds
Friction Tape and Splice
Transformer Compounds

A PARTIAL LIST OF M-R PRODUCTS
Fiberglas Braided Sleeving
Cotton Tapes, Webbing and Sleevings
Impregnated Varnish Tubing
Insulating Varnishes of all types

Fiberglas Saturated Sleeving and Varnished Tubing
Asbestos Sleeving and Tape
Extruded Plastic Tubing
Varnished Cambric Cloth and Tape
Mica Plate, Tape, Paper, Cloth and Tubing

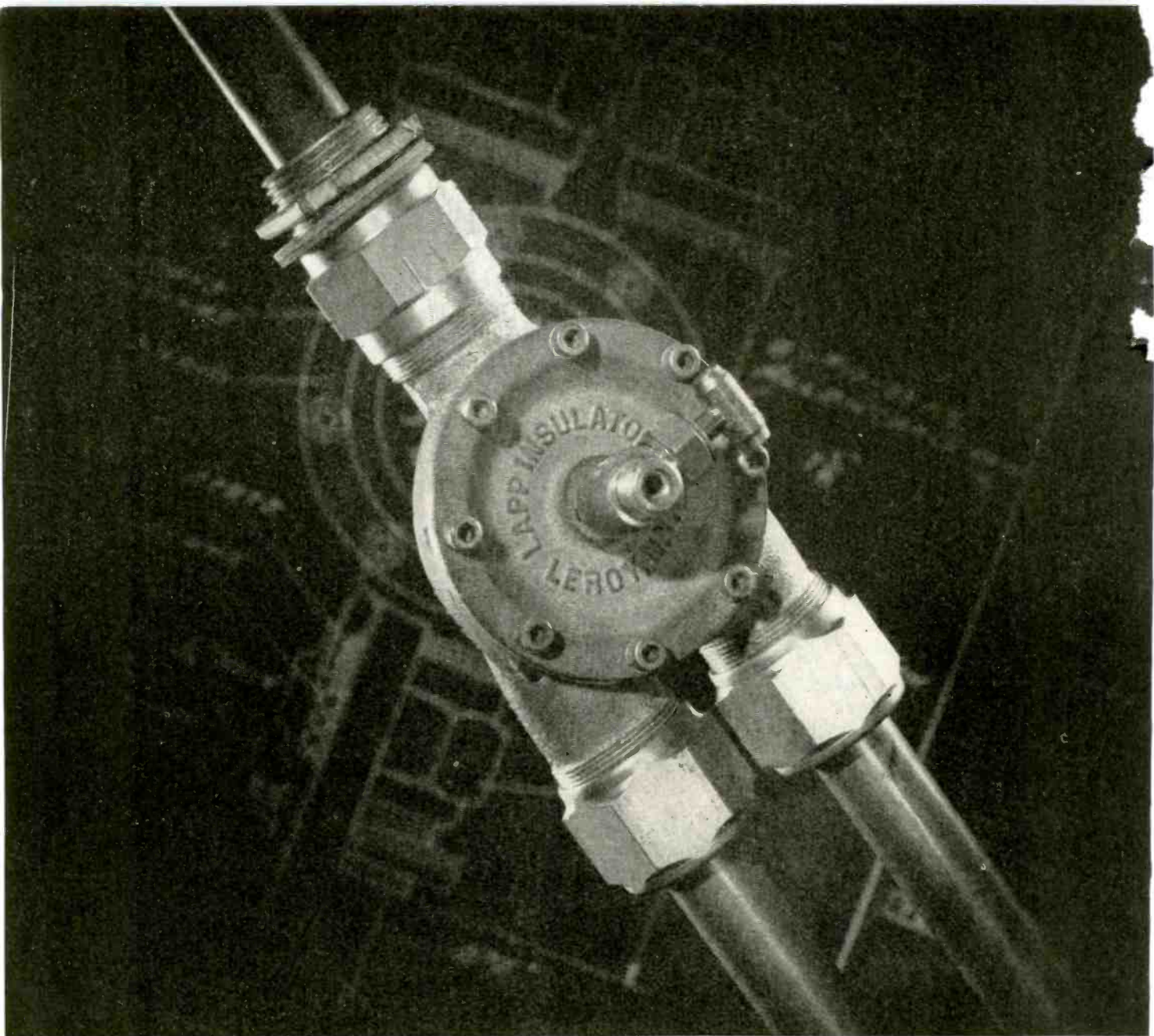

Electronic Parts: ENGINEERING AND PRODUCTION

The gadget above is a junction box for a co-axial gas-filled transmission line. It is one of a series of coupling units, end seals and other fittings for high-frequency transmission—designed and built by Lapp.

To this type of construction, Lapp brings several innovations and improvements. For example, such a line from Lapp parts is genuinely leak-proof. Every gasket is under spring loading, so there's no leakage created by vibration or thermal change.

Whether or not you're interested in gas-filled transmission lines, you ought to know about Lapp. Here is an organization of engineers and manufacturers with broad basic knowledge of ceramics and their application. With experience in hundreds upon hundreds of special-purpose electronic parts, we have been able countless times to improve performance, or reduce costs, or cut production time through

the application of our specialized skills to design and manufacture of parts involving porcelain or steatite and associated metal parts.

For quick and efficient assistance on a war production subcontract—or for the competitive advantage Lapp-designed and Lapp-built parts will give to you in the postwar battle—an inquiry to Lapp now may pay you dividends. *Lapp Insulator Co., Inc., LeRoy, N. Y.*

Lapp



W. J. HALLIGAN, President
Hallicrafters Radio . . .

Mr. Halligan says, "Those of us who are building radio communications equipment in this war anticipate a tremendous demand in the future for radios and radio telephones for plane to ground, ship to shore use, and many other applications."



"COMMUNICATIONS EQUIPMENT IS ONLY AS GOOD AS ITS POWER SUPPLY"

"Radio equipment needs an efficient, reliable power supply," continues Mr. Halligan, "And for that reason, the radio industry is constantly on the alert for new and better power supplies and devices for adapting current for radio use. Such power supplies and such devices are of inestimable value to the communications equipment manufacturer."

Electronic Laboratories has vibrator power supplies for use wherever current must be changed in voltage, frequency or type, or will engineer one to fit specific space, weight and voltage requirements. E-L Vibrator Power Supplies offer many advantages for all current conversion requirements up to 1500 watts as a result of development in circuits and design pioneered and perfected by Electronic Laboratories. E-L Power Supplies are definitely more efficient, and give substantially longer service life. In addition, they are highly versatile, permitting multiple inputs and outputs, any needed wave-form, great flexibility in shape and size, and a high degree of voltage regulation when needed. They are economical in price and require almost no attention or maintenance. Their dependability is being demonstrated everyday on the fighting fronts. E-L engineers offer consultation on power supply problems.

E-L STANDARD POWER SUPPLY MODEL 307

For the operation of standard 110 volt AC equipment, such as radios and small motors, from a 6 volt battery. Characteristics: Input voltage, 6 v. DC; Output voltage, 115 v. AC; Output power, 100 watts; Output frequency, 60 cycles.

Dimensions: 7½x8¼x10¼ in. Weight: 23½ pounds.



Write for further information of this and other models of the extensive E-L line.

Electronic

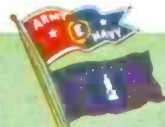

LABORATORIES INC.
INDIANAPOLIS



THE SPHERE OF ELECTRONICS



The sphere of electronics is increasing constantly . . . it now encompasses practically all industries. Electronic devices are being applied to do old jobs quicker and more efficiently, and to accomplish tasks heretofore considered impossible.

At I. C. E. new methods of solving radio-electronics problems are being developed . . . and these developments will be ready to serve you when the peace is won. The time is coming when I. C. E. can help put your post-war blue-prints into action. One of the precision-engineered tubes ready now is the I. C. E. 257B . . . Beam Pentode transmitter tube . . . 75 watt plate dissipation . . . 200 watt output and 0.1 watt driving power. Send your inquiries now.

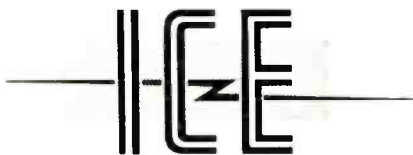

ELECTRONIC TUBES

INDUSTRIAL & COMMERCIAL ELECTRONICS

BELMONT, CALIFORNIA

CHARLETON MOORE

NEW LETTER CONTEST for SERVICEMEN!

ELEVEN 1st PRIZE WINNERS IN 5 MONTHS IN CONTEST No. 1!

Yes sir, guys, the hundreds of letters received were so swell that *double* first prize winners had to be awarded each of the first four months and there were *triple* first prize winners the fifth and last month . . .

SO—HERE WE GO AGAIN!

Get in on this NEW letter contest—write and tell us your *first hand* experiences with *all* types of Radio Communications equipment built by Hallicrafters including the famous SCR-299!

RULES FOR THE CONTEST

Hallicrafters will give \$100.00 for the best letter received during each of the five months of April, May, June, July and August. (Deadline: Received by midnight, the last day of each month.) . . . For every serious letter received Hallicrafters will send \$1.00 so even if you do not win a big prize your time will not be in vain. . . . Your letter will become the property of Hallicrafters and they will have the right to reproduce it in a Hallicrafters advertisement. Write as many letters as you wish. V-mail letters will do. . . . Military regulations prohibit the publication of winners' names and photos at present . . . monthly winners will be notified immediately upon judging.



BUY A WAR BOND TODAY!

hallicrafters RADIO

MEC-RAD

MANUFACTURERS OF MECHANICAL-ELECTRICAL COMPONENTS FOR RADIONICS

Although Mec-Rad is a new name in the field, our organization has a wide background of experience in designing and producing intricate mechanical-electrical components for radionics. Today we are 100% on war production, manufacturing high-frequency precision parts for the radionic equipment of our armed forces. After the war our specialized engineering "know-how" and plant facilities will be available for the development and manufacture of similar peace-time products for the electronic industries.



MEC-RAD

DIVISION-BLACK INDUSTRIES

1400 EAST 222ND STREET ☆ CLEVELAND 17, OHIO

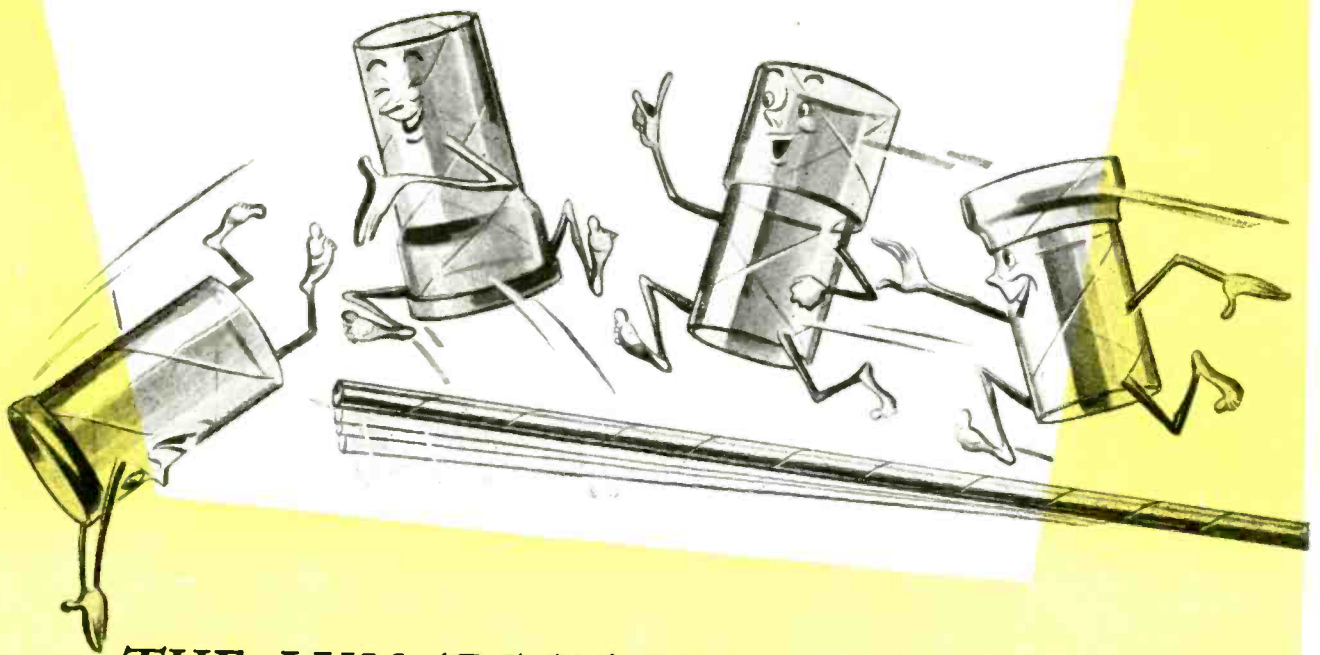

THE LUMARITH* SODA STRAW

was just a SPRINGBOARD . . .

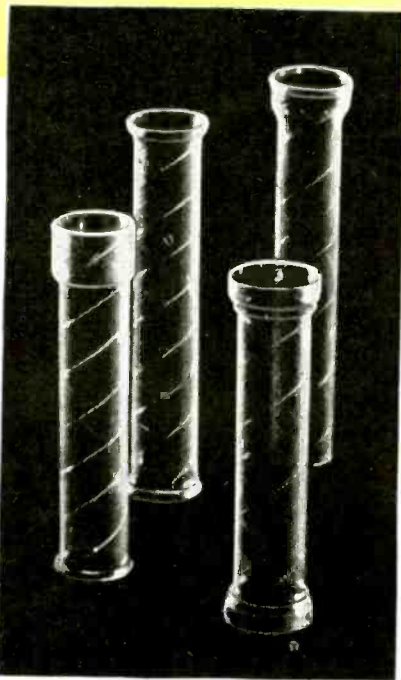

Note these new electrical uses for spirally-wound LUMARITH!

You'll find the old Lumarith soda straw idea doing business all over the war-front these days—precision grommets, for one thing, of spirally-wound Lumarith, and doing a real job. Spirally-wound units are also serving in aircraft hydraulic controls, on small motors, in lamps, push button tuning coils, coil forms and as "spaghetti."

These transparent Lumarith parts are efficient performers wherever light weight, toughness, good insulating qualities are important, plus Lumarith's well-known resistance to the "black hand" of corrosion.

Fabricators producing spirally-wound

tubing of Lumarith offer a range of lengths, diameters and wall thicknesses, suitable to many types of applications in the electrical field. What new uses can you visualize in your products?

You'll also want to be posted on the excellent insulating qualities and corrosion-resistance of Lumarith foils, films and molding materials. Send for "Lumarith for the Electrical Industry," a comprehensive booklet. *Celanese Celluloid Corporation, The First Name in Plastics*, a division of the Celanese Corporation of America, 180 Madison Avenue, New York 16. *Reg. U. S. Pat. Off.

An outstanding development, by one fabricator, is the spirally-wound grommet of Lumarith—supplied with one end spun. After the grommet is in place, the other end is spun on standard drill press equipment, making a tight-fitting, permanent installation. The Lumarith won't crack or come out despite climatic changes.

LUMARITH*

A Celanese Plastic*

**YOU'VE
SEEN
THESE
BEFORE**



1919

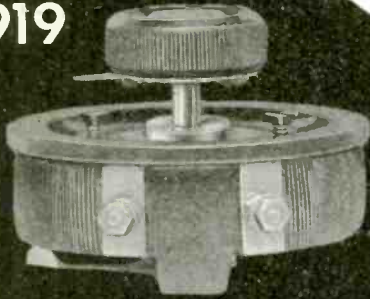

1923

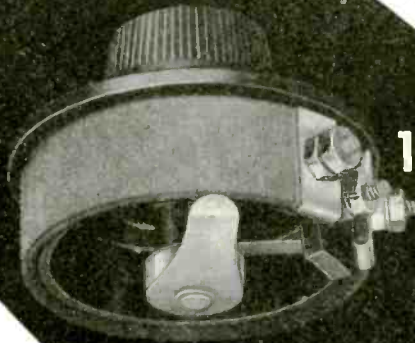

1934

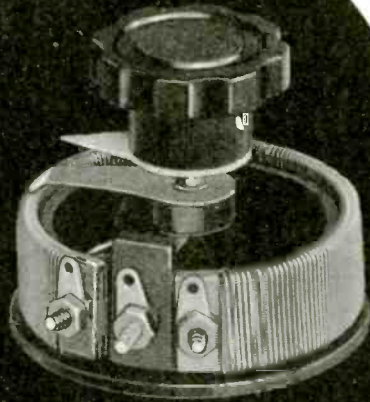

NOW

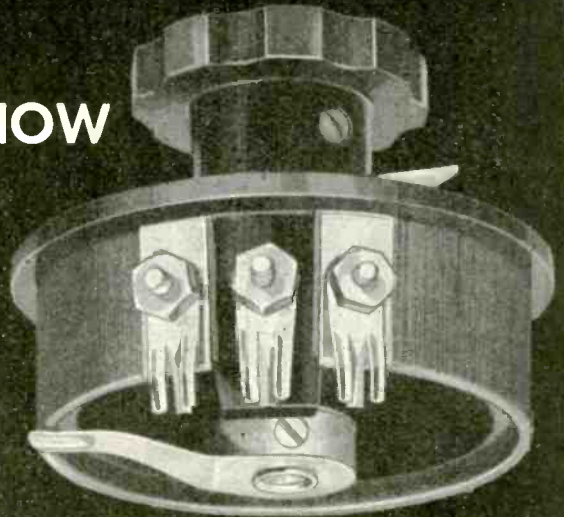

NO hasty development or Chinese copy of the units of some other manufacturer, the popular Types 214-314 Rheostats have been made by us for many years. The Type 214 was first brought out in its present general form in 1919. As materials improved . . . better wire . . . better insulation . . . more accurate winding methods . . . better mechanical design of molded form, winding cards and contact arms . . . the Type 214 gradually reached its present stage. They are being turned out just as quickly and in just as large volume as we are able. After the war we may have some radical improvements in our entire rheostat line. In the meantime when ordering rheostats that look like G-R, why not *buy* G-R, if our present delivery schedules meet your requirements.



GENERAL RADIO COMPANY

Cambridge 39, Massachusetts
NEW YORK CHICAGO LOS ANGELES

GOLD makes Electrons Behave

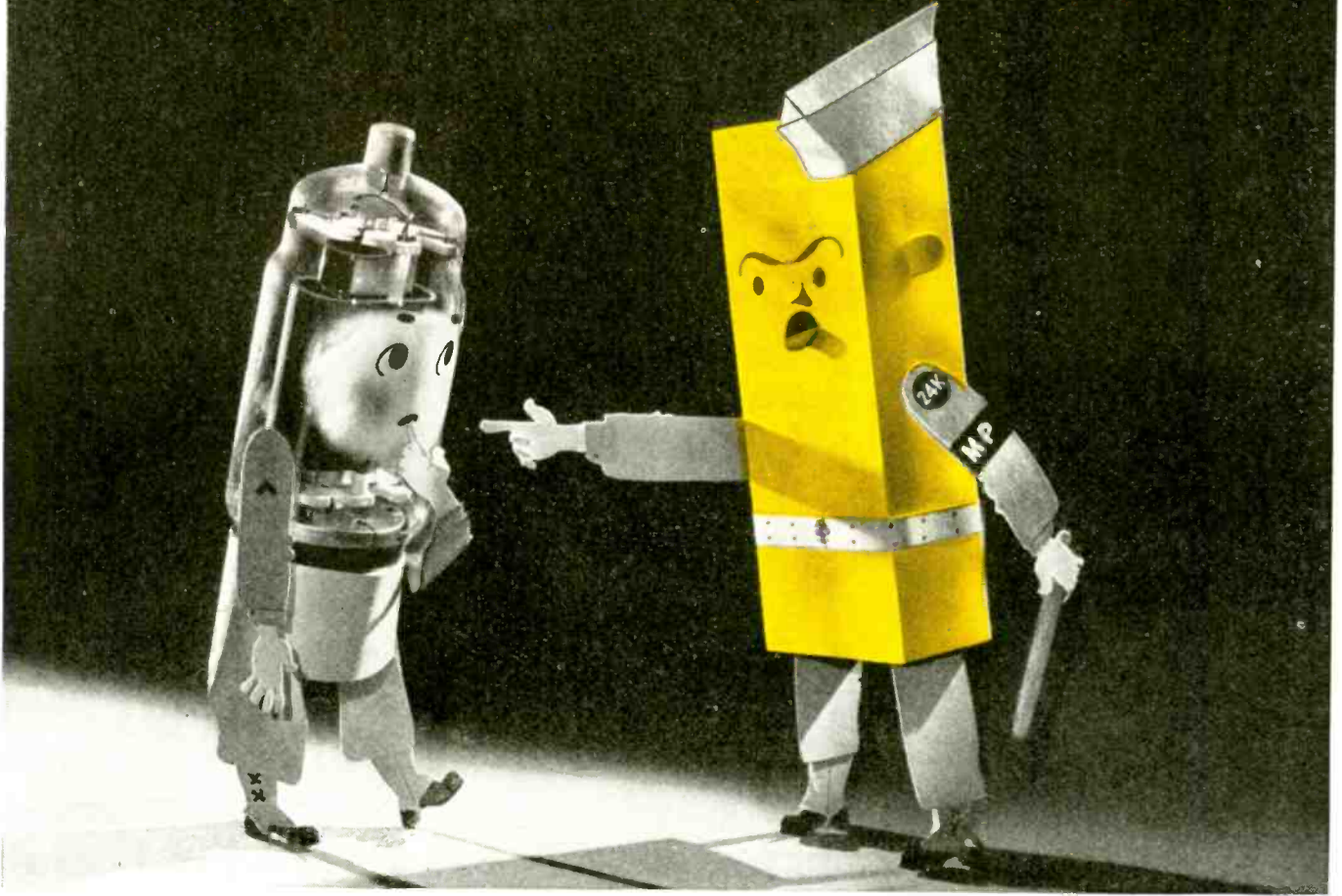

It was a great day for radio communication when National Union engineers developed the technique of gold plating certain tube parts. For by this ingenious means they measurably extended the life of power tubes.

The object, here, was not to make power tubes structurally stronger—or even more durable. Already these tubes were sound enough mechanically to do a bang-up job. What the N. U. process of gold plating did, was to make the electrons behave. N. U. engineers demonstrated that by gold-plating the grid wire, they automatically eliminated a very disturbing factor in power tube performance, known as

grid emission. The source of this undesirable primary emission was imprisoned within the gold. No longer could it interfere with the planned and controlled electron flow within the tube. Result—power tubes of a higher performance level and longer life.

Thanks to the greatly expanded electronic research program at National Union Laboratories, many such improved tubes with wide application in America's homes and industries will be available at the war's end. *Count on National Union.*

NATIONAL UNION RADIO CORPORATION, NEWARK, N. J.
Factories: Newark and Maplewood, N. J.; Lansdale and Robeson, Pa.



NATIONAL UNION

RADIO AND ELECTRONIC TUBES

Transmitting, Cathode Ray, Receiving, Special Purpose Tubes • Condensers • Volume Controls • Photo Electronic Cells • Panel Lamps • Flashlight Bulbs

W K B N

Youngstown, Ohio

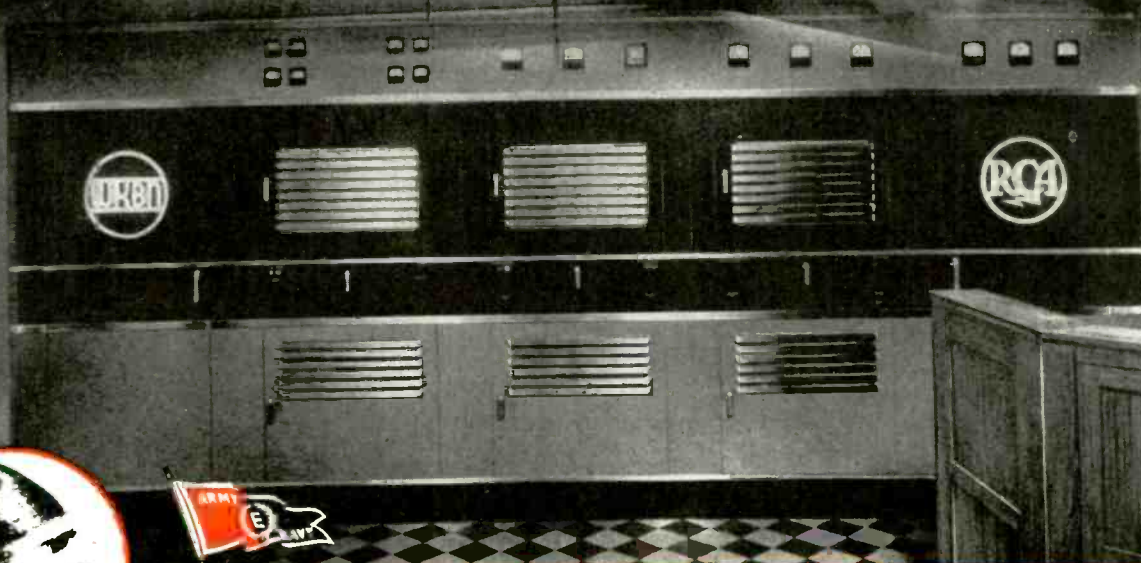

E. F. JOHNSON CO.

Waseca, Minnesota

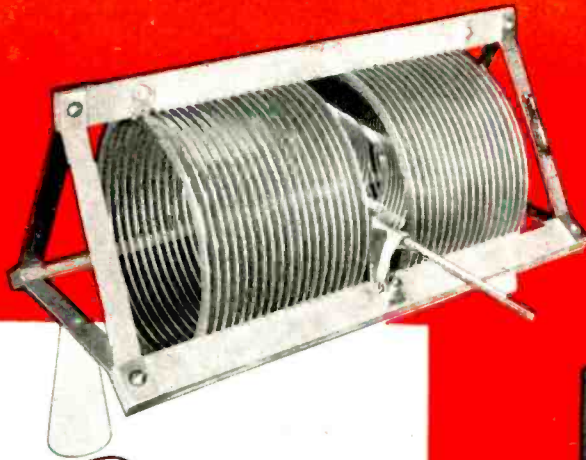

JOHNSON *Broadcast Components*

Widely used by discriminating broadcast engineers. Typical is the Phasing Equipment installation by WKBN, Youngstown, Ohio. Variable air condensers, fixed air condensers, gas pressure condensers (for higher voltages), inductors (all kinds), chokes, remote motor driven tuning controls and other components.

Send your specifications or problems for Johnson suggestions and prices -- no obligation.

Ask for Catalog 9680

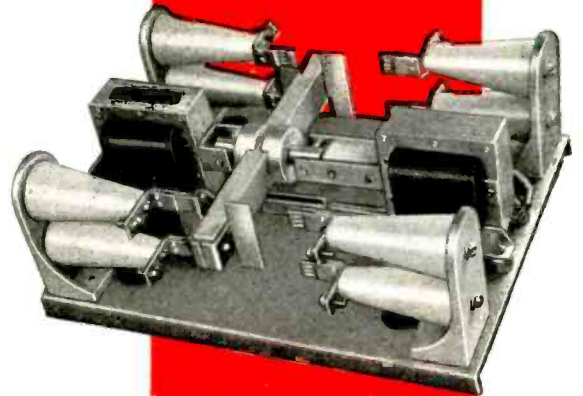

JOHNSON

a famous name in Radio

E. F. JOHNSON COMPANY • WASECA • MINNESOTA

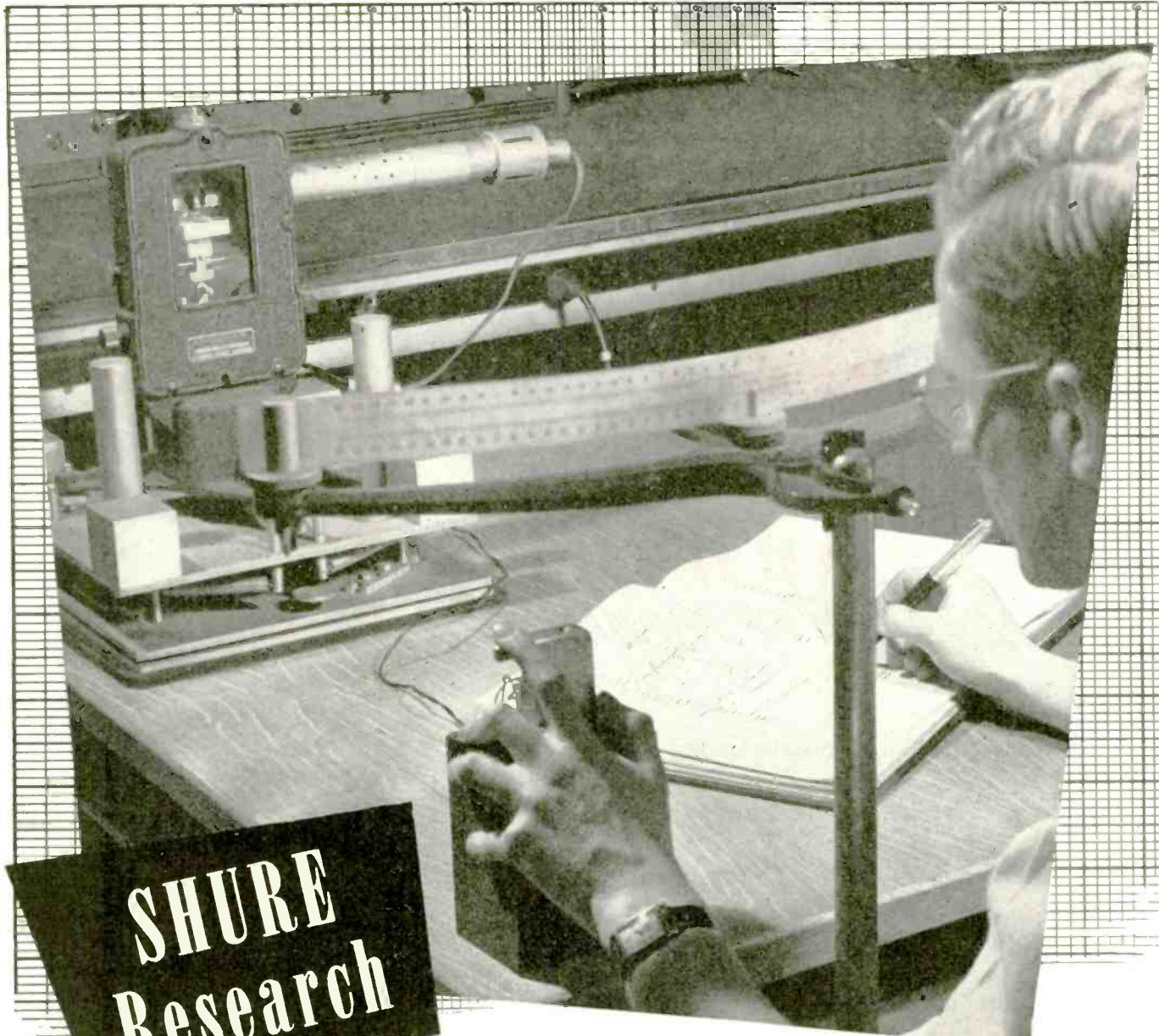

**SHURE
Research**

... in Headphones

It is logical that engineers, long trained in designing microphones for transmitting the human voice, should be especially familiar with the techniques of voice reception.

Headphone design, therefore, is a natural province of Shure engineers.

The Shure headphone employs a unique moving armature design which combines light weight[†] with sensitivity, simplicity and reliability.

In headphones, as well as microphones, you may continue to look to Shure for leadership.

SHURE BROTHERS, 225 West Huron Street, Chicago
Designers and Manufacturers of Microphones and Acoustic Devices



PANORAMIC

SHOWS
A WIDE
BAND OF
FREQUENCIES
ALL
AT ONCE

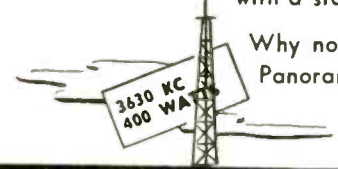
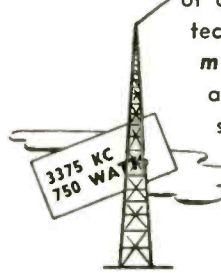
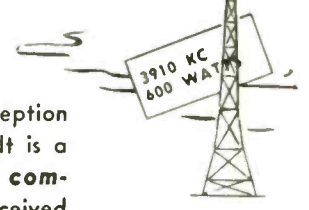
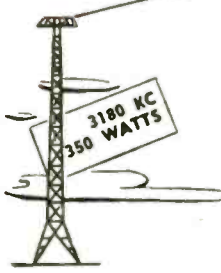
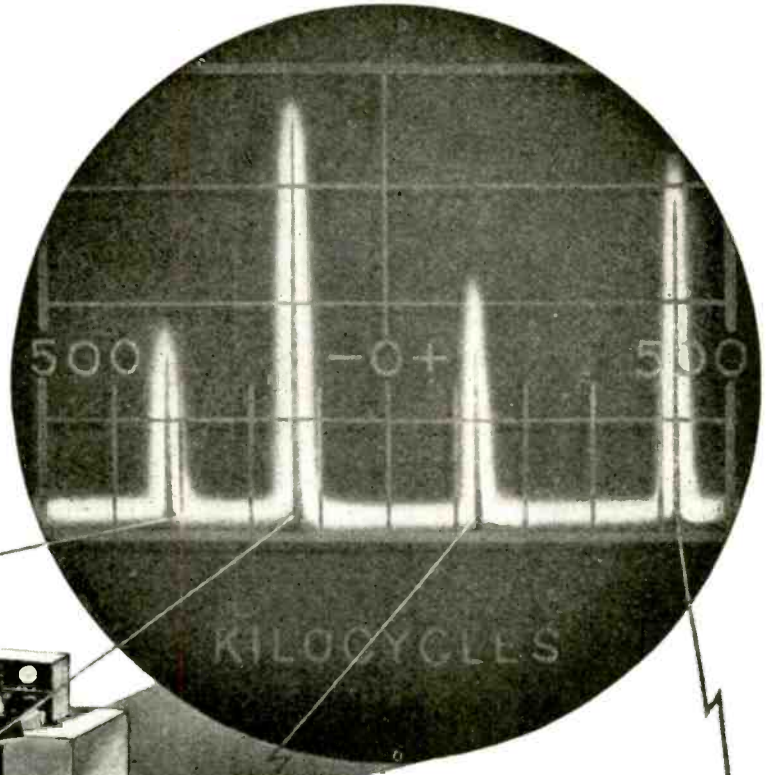

Panoramic reception is defined as the **SIMULTANEOUS VISUAL** reception of a multiplicity of radio signals over a broad band of frequencies. It is a technique that literally allows you to see what you are missing. In **communications**, for example, while ordinarily only one station may be received at one time, with Panoramc reception, the presence and characteristics — signal strength, frequency stability, modulation, etc. — of a number of stations may be seen concurrently.

In other applications, as well, Panoramc reception permits you to see what you're missing. In **direction finding**, signals too weak to give an aural indication can be made to give a satisfactory bearing with its use. In **transmission**, field strength and frequency of transmitter can be accurately compared with a standard signal. And in **production**, Panoramc reception may be utilized to compare components with a standard.

Why not let one of our engineers explain to you the principle of Panoramc technique, and how it may be used to your advantage.

PANORAMIC  **RADIO CORPORATION**
242-250 WEST 55TH ST. New York 19, N.Y.

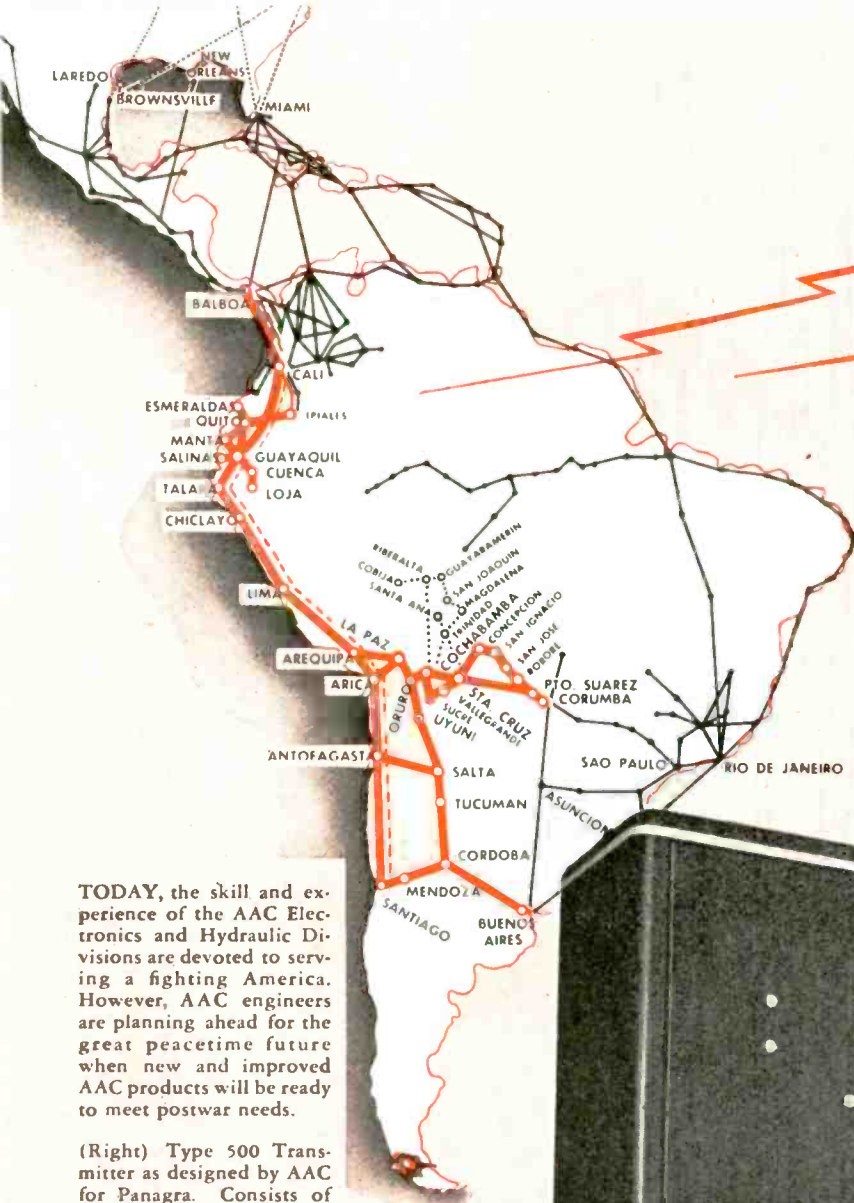

★ **ALONG THE PANAGRA ROUTE** is located AAC transmitting equipment at approximately 30 different points in Colombia, Ecuador, Peru, Chile, Bolivia and Argentina—forming the nucleus of the radio navigation and communications system.

Panagra is today primarily devoting its personnel and facilities to maintenance of aerial lifelines between the Americas, across which are speeding men, mail and materials vital to the success of the democratic war efforts.

TODAY, the skill and experience of the AAC Electronics and Hydraulic Divisions are devoted to serving a fighting America. However, AAC engineers are planning ahead for the great peacetime future when new and improved AAC products will be ready to meet postwar needs.

(Right) Type 500 Transmitter as designed by AAC for Panagra. Consists of multi-channel transmitting equipment, 1,000 watts each channel. Two channels may be operated simultaneously. Telephone and telegraph transmission. Frequency range 250-550 KC and 1500-12000 KC.

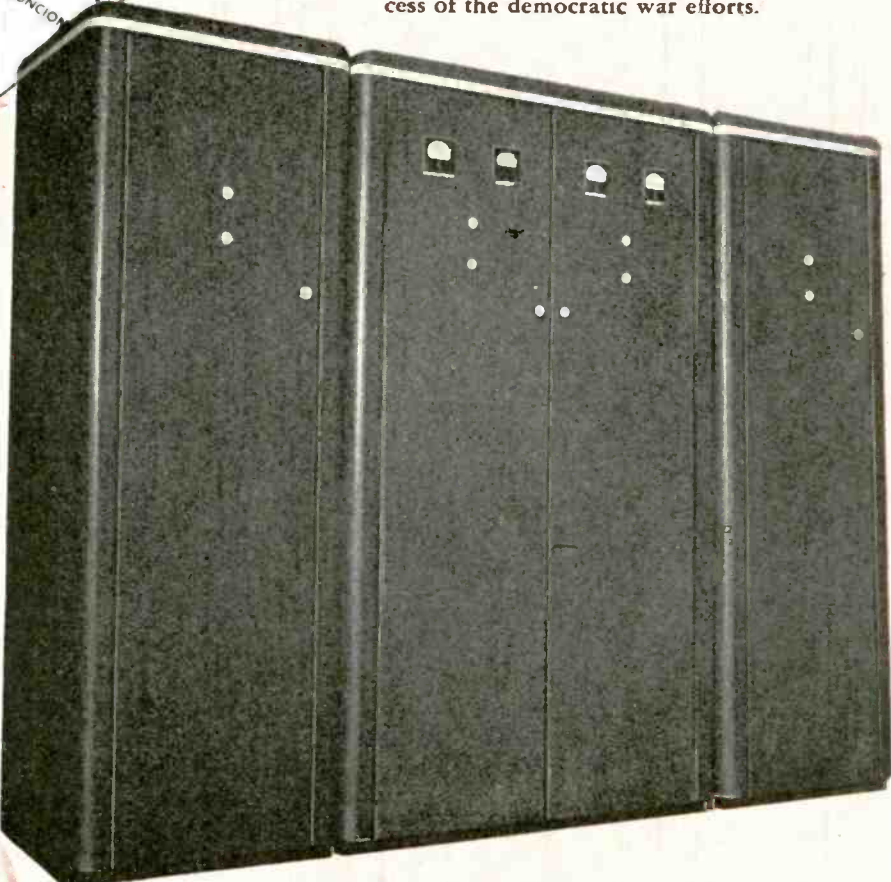

Products

Randolph C. Weber PRESIDENT

AIRCRAFT

Manufacturers of **PRECISION**
Burbank, Calif. Kansas

TRANSMITTERS AND OTHER COMMUNICATIONS EQUIPMENT

for

Dependable Operation Of Airlines And Various Communication Services

★ Today, AAC transmitters and other AAC communications equipment play a vital part in dependable operation of warplanes on the fighting fronts, as well as airlines serving the war-busy Americans on the home fronts.

AAC Electronics Division has won distinctive leadership as one of the country's large producers of radio transmitting and receiving equipment. One outstanding example of AAC communications engineering is the equipment designed and built to meet the specified needs of Pan American-Grace Airways, Inc. Consisting of a multi-channel 1,000 watt transmitter, this equipment is used by Panagra for radio homing and communication purposes. It represents one of a complete line of transmitting equipment for use by airlines or services having similar communication needs.

At the present time practically all AAC facilities are devoted to war production. However, your inquiries are welcomed now for commercial equipment which can be supplied in limited quantities if adequate priority ratings are available.

AAC products in transport planes, cargo carriers, troop ships, bombers . . . airport traffic net, police or other services where communications are crucial, can be depended upon as expertly engineered and built to the most efficient performance standards.

Products of **ELECTRONICS DIVISION**
TRANSMITTERS • AIRCRAFT & TANK ANTENNAS • QUARTZ CRYSTALS • RADIO TEST EQUIPMENT

(Below) Panagra airliner delivers important cargo of mail and passengers.



ACCESSORIES CORPORATION

AIRCRAFT EQUIPMENT • HYDRAULICS • ELECTRONICS

City, Kans.

New York, N. Y.

Cable Address: AACPRO

INVASION BY... TELEPHONE



According to War Department records, rehabilitation of 49,176 wire miles of communications was accomplished by the Signal Corps in Sicily alone.

The magazine, "Steel", comments on the fact that wire communication remains basic in this zone. It enjoys the advantage of a degree of security not enjoyed by other mediums. The editor of "Steel" points out that the demand for wire field communications will continue to be heavy until the wars in both major zones are won.

Imagine the demand for field telephone equipment with the whole continent of Europe under invasion, and Pacific operations constantly expanding!

The men and women of Connecticut Telephone & Electric Division, commended personally by War Manpower Commissioner McNutt for their splendid record in turning out field telephones and other basic communications equipment, realize their ever-increasing responsibilities. They are determined to fulfill this obligation to our armed forces and those of our allies.

CONNECTICUT TELEPHONE & ELECTRIC ★ DIVISION ★

GREAT AMERICAN INDUSTRIES, INC.

MERIDEN



CONN.

G. A. I. divisions are producing for the war effort: Military Trucks, Fire Apparatus, Communications and Electronic Equipment, Aircraft Ignition Components, Cellular Rubber Products.



WHERE TOMORROW MEETS TODAY

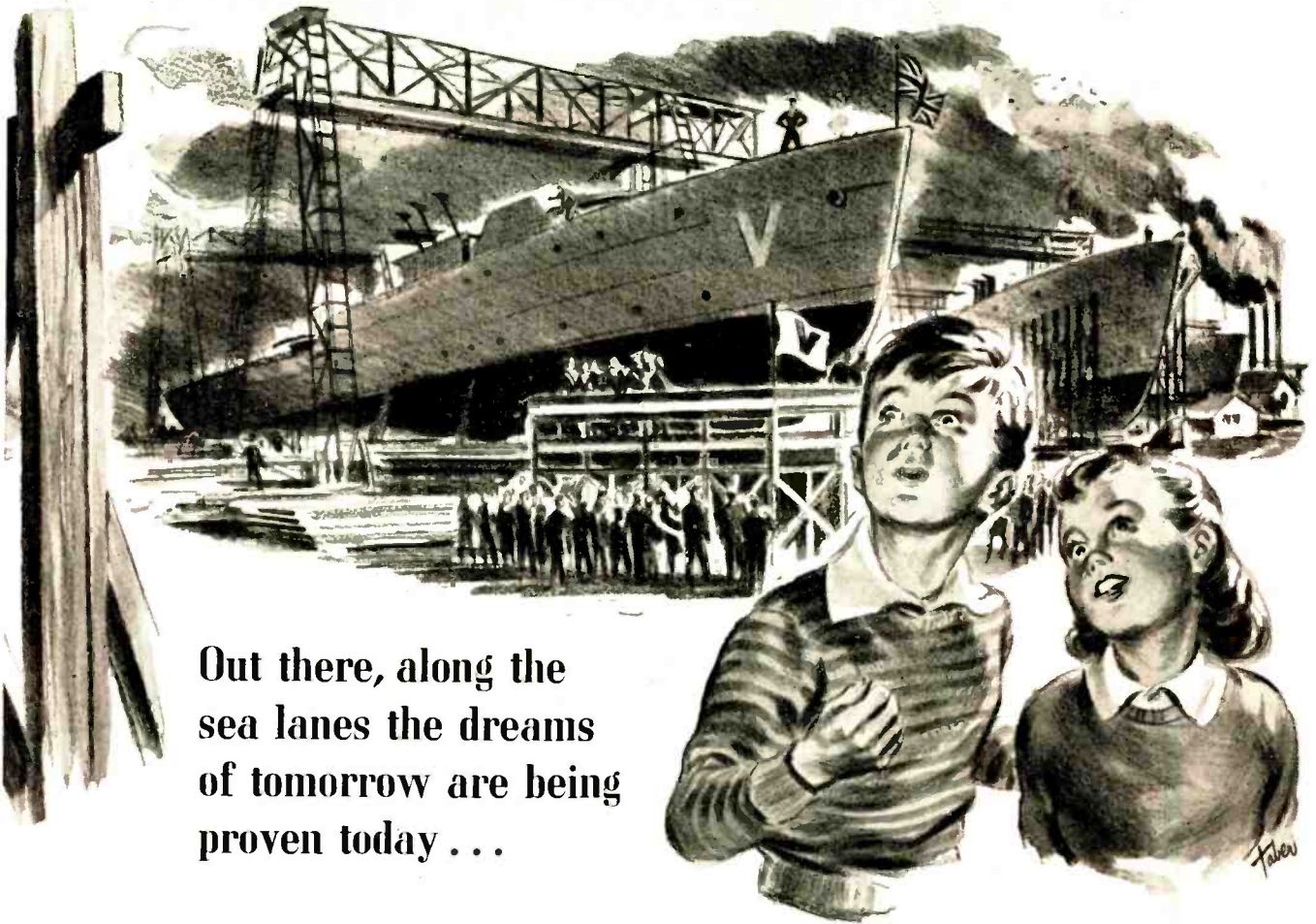

Out there, along the sea lanes the dreams of tomorrow are being proven today . . .

CORVETTES "turn on a dime"—destroyers race at abnormal speed—that's the navy of today! Mastery of the sea depends on new and ever-improved equipment.

Today on our fighting ships, many pieces of electrical apparatus are designed and produced by Small Electric Motors (Canada) Limited. At the moment we are devoting all our efforts to turning out material of an advanced scientific nature. Research, engineering and inventive genius work hand in hand to produce equipment that normally would be much longer in developing.

In the days to come you may wish to benefit by this "know-how." These experiments and achievements in technical war contributions will be reflected and recognized in the electrical world of tomorrow. Small Electric Motors plan with confidence a noteworthy role in the post-war era.

**DESIGNERS
AND MANUFACTURERS
Of All Types of Precision
Electrical Apparatus
Including:**

*D.C. & A.C. Motors for
Specialized Purposes
Aircraft Generators
Aircraft Engine Starters
Alternators
Motor Generators
Electric Pumps
Motors with Governors
Gyros, etc.*

SMALL  **Electric Motors**
(CANADA) LIMITED

LEASIDE - TORONTO - CANADA
ELECTRONIC INDUSTRIES • August, 1944

SHERRON TELEVISION TEST EQUIPMENT

Key to Quality Control at All 3 Points

AT POINT OF

MANUFACTURE

AT POINT OF

TRANSMISSION

AT POINT OF

FIELD SERVICE

Sherron Test Equipment qualifies as indispensable to manufacturers of television transmitting and receiving apparatus . . . and operators of television stations. With this equipment on the job, no error can creep in undetected. No flaw can slip by unnoticed. Every characteristic of quality is accounted for—all along the line . . . In their automatic, all-seeing, all-knowing alertness, Sherron Test Units are invaluable in forestalling operational breakdowns in television efficiency . . . at point of manufacture . . . at point of transmission . . . at point of field service.



**Sherron
Electronics**

**LABORATORY • DESIGN • DEVELOPMENT
MANUFACTURING . . .** The full-scoped facilities and specialized skills of Sherron Electronics are available to manufacturers of television equipment and operators of television stations.

SHERRON METALLIC CORP.

1201 FLUSHING AVENUE

BROOKLYN 6, N. Y.

"WHERE THE IDEAL IS THE STANDARD, SHERRON TEST UNITS ARE STANDARD EQUIPMENT"

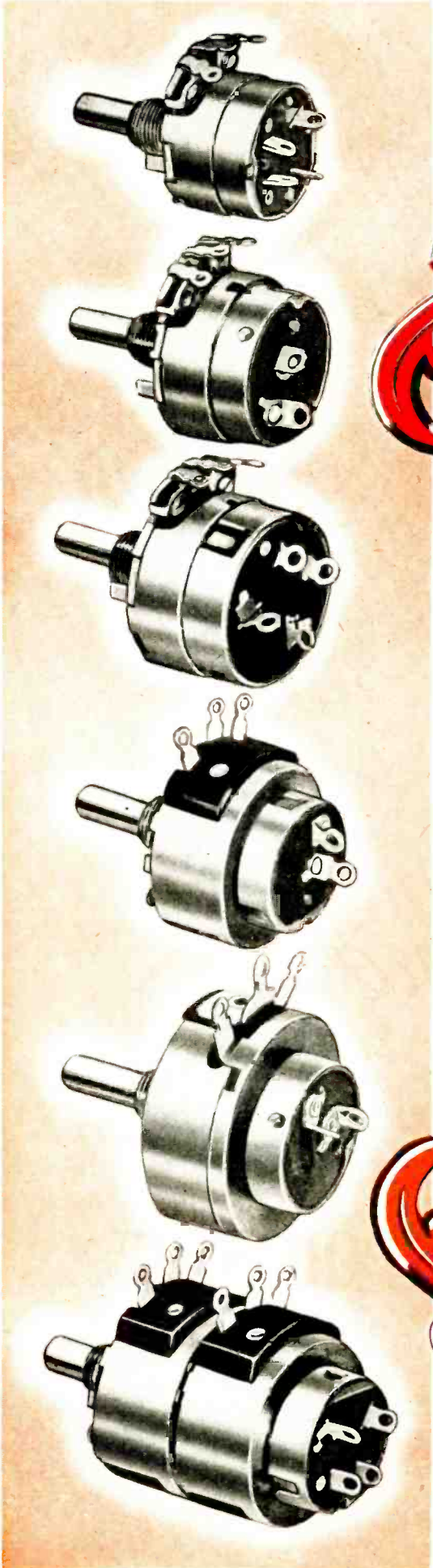

Intensive research, creative engineering and precision mass production are the factors diligently followed in the development and manufacture of Chicago Telephone Supply Company variable resistors, both wire wound and carbon.

*Manufacturers of Quality
Electro-Mechanical Components Since 1896*

VARIABLE RESISTORS, PLUGS, SWITCHES,
JACKS, TELEPHONE GENERATORS, RINGERS

REPRESENTATIVES
R. W. Farris
2600 Grand Avenue
Kansas City 8, Missouri
Phone: Victory 3070

Frank A. Emmet Co.
2837 West Pico Boulevard
Los Angeles 6, California

BRANCH OFFICES
S. J. Hutchinsan, Jr.
401 North Broad Street
Philadelphia 8, Pennsylvania
Phone: Walnut 5369

IN CANADA
C. C. Meredith & Co.
Streetsville, Ontario



CHICAGO TELEPHONE SUPPLY
Company

ELKHART • INDIANA





Daniel Szantay

Mr. Szantay and three associates, founded The Sinko Tool & Mfg. Co. 25 years ago. With his guidance, the business has grown and prospered. An expert tool designer, he was also a pioneer in molding thermoplastics. Today as the owner of the company, Mr. Szantay continues to supervise the management of the business.

SINKO TOOL AND MFG. CO. ANNOUNCES THAT
ITS CORPORATE NAME HAS BEEN CHANGED TO
SANTAY CORPORATION
NO CHANGE IN THE ACTIVITIES OR MANAGEMENT
OF THE CORPORATION WILL BE EFFECTED
CHICAGO 24, ILLINOIS
351 NORTH CRAWFORD AVENUE

Announcing

the change in name of one of America's leading manufacturers of Injection Molded Plastic parts and products. The Sinko Tool & Manufacturing Company will hereafter be known as **SANTAY CORPORATION**. For many months, 100% of our facilities have been operating three shifts a day, producing intricate Thermoplastic Parts and Electro-Mechanical Assemblies for the Army and Navy. Invaluable knowledge and experience has been gained, which is bound to be reflected in the products we make in the future. Post-war planners are invited to consult with our master craftsmen on the simplest or most involved metal or thermoplastic part or product.

SANTAY CORPORATION

FORMERLY SINKO TOOL & MANUFACTURING CO.

351-359 NORTH CRAWFORD AVENUE • CHICAGO 24, ILLINOIS

INJECTION MOLDING AND METAL STAMPING • ELECTRO-MECHANICAL ASSEMBLIES

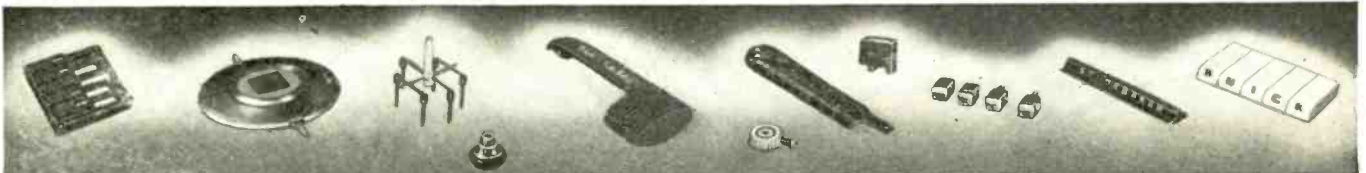



Franklin's \$64 Question Gave Electricity a Job

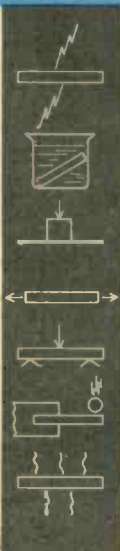

HIGH DIELECTRIC STRENGTH

LOW MOISTURE ABSORPTION
CORROSION RESISTANCE

COMPRESSIVE STRENGTH

TENSILE STRENGTH

FLEXURAL STRENGTH

IMPACT STRENGTH

STABLE OVER A
WIDE TEMPERATURE RANGE

Many More Properties—Combined

LIGHTNING streaked through ages, feared but unchallenged. Then to Benjamin Franklin it flashed the answer to a question that unlocked the future of electricity.

Technical plastics, Synthane for example, have already answered many \$1 to \$64 questions for people who make things. And may for you. The question, of course, should come before the answer—for only you know,

as *you* do, what your requirements are. If whatever you are working on suggests a material of excellent electrical insulating characteristics, resistance to corrosion, mechanical strength, stability at usual temperatures, easy machineability, or a variety of other inter-related properties, our type of technical plastics may readily be indicated. Our latchstring is always out to any inquiry.

Synthane Corporation, Oaks, Penna.

SYNTHANE TECHNICAL PLASTICS

SHEETS - RODS - TUBES - FABRICATED PARTS

SYNTHANE

MOLDED - LAMINATED - MOLDED - MACERATED

Plan your present and future products with Synthane Technical Plastics

A comparison of SYNTHANE TECHNICAL PLASTICS with certain metals, debunking a popular notion that plastics being "magic" can be used indiscriminately

IT IS CHARACTERISTICALLY HUMAN to back a winner . . . to ascribe precipitately to vitamins or sulfa drugs or plastics more powers and claims than sober research can keep up with. Plastics have their possibilities . . . and their limitations. Good design is the reward of knowing both.

Plastics are doing many jobs that metals used to do, especially since certain critical metal shortages have cropped up. But, basically, plastics are not substitute materials. Correctly applied, they should and do stand solely on their own merits.

INTERESTING COMPARISONS TO PROVE the point can be made between our type of plastics—Synthane—and certain metals. Synthane is made by applying heat and pressure to paper or fabric impregnated with thermo-setting resins. It is non-metallic, a fact which should at once suggest uses fundamentally different from those of metals. Actually, Synthane is an excellent electrical insulator, and so you find it in hundreds of radio and electrical products and applications, not in place of metal, but to insulate metal. That does not imply Synthane cannot replace metal. As a matter of fact, Synthane has taken over for metals in pulleys, bearings, panels, structural members, scales, dials. The reasons can usually be traced to one or a combination of the many properties of Synthane technical plastics.

ONE OF THE PRINCIPAL REASONS at present is light weight. Synthane has a specific gravity ranging from 1.20 to 1.70, about half that of aluminum, less than magnesium. So in many unstressed parts for aircraft Synthane is a logical consideration.

SYNTHANE LAMINATED PLASTICS GENERALLY have lower mechanical strength than metals for a given cross section. For example, an approximate comparison might read like this:

	Tensile Strength (p.s.i.) ultimate	Compressive Strength (p.s.i.)
Alloyed Aluminum	16,000-60,000	9,000- 47,000 (y)
Brass	40,000-80,000	28,000-126,000 (u)
Cast Iron	16,000-45,000	80,000-200,000 (u)
Synthane	8,000-12,000	30,000- 50,000 (u)

(y—yield strength
u—ultimate strength)

IT IS IMPORTANT, HOWEVER, TO REMEMBER that on a weight basis, Synthane may be stronger though redesign of a part for plastics may be necessary.

HARDNESS IS A PROPERTY in which another interesting comparison of Synthane with metals can be made. Brinell hardness, tested with 500 Kg. load, 10 mm ball, shows approximately these values: Alloyed aluminum 45-110, Brass 95-150, magnesium (drawn annealed) 29, annealed cast iron 77, Synthane 24-40.

BEHAVIOR UNDER TEMPERATURE CONDITIONS is characteristic of Synthane's non-metallic composition. For instance, whereas the thermal conductivity of aluminum alloys may range from .20 to .54 calories per second per square centimeter per centimeter of thickness per degree C., Synthane's thermal conductivity is about .0005 to .0008. The coefficient of thermal expansion of Synthane is about .0000140 inches per inch per degree F., approximately the same as alloyed aluminum, slightly more than pure aluminum, copper, brass.

CORROSION RESISTANCE IS A SUBJECT of such complications as to temperature, degree of concentration, and type of agent that any comparison with metals would necessarily be lengthy. Synthane does resist corrosion from water, many acids, oils, and salts, and to a greater or lesser extent than metals depending on the metal with which it is compared and the corrosion conditions. Synthane is extensively used as a corrosion resistant material.

APART FROM ITS PHYSICAL, CHEMICAL, electrical and chemical properties, Synthane may be easily and quickly machined by ordinary shop methods, a point which may occasionally influence selection when other factors are the same. And, just as metals are cast for economy in large quantities, so Synthane is available in two molded forms, molded-laminated and molded-macerated, for economy of duplication.

OBVIOUSLY, IN CERTAIN CASES there can be no question of whether to use Synthane plastics or a metal such as when the material must be an electrical conductor or an electrical insulator. In other cases, weight or strength may decide, or corrosion resistance, resilience, hardness, machinability. Or as often happens, the decision may rest upon the extent to which the material required meets many combined specifications. Synthane technical plastics are usually more desired for their combination of properties than for any one specific property for which another specific material or metal may be the only logical answer.

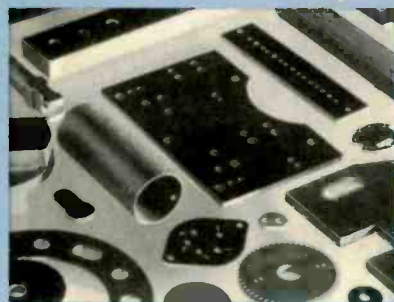
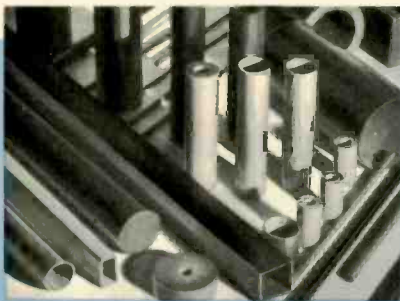

SYNTHANE

PLAN YOUR PRESENT AND FUTURE PRODUCTS WITH SYNTHANE TECHNICAL PLASTICS · SHEETS · RODS · TUBES · FABRICATED PARTS · MOLDED-LAMINATED · MOLOED-MACERATED

SYNTHANE CORPORATION, OAKS, PENNA.

REPRESENTATIVES IN ALL PRINCIPAL CITIES

Don't Handicap Important Designs

for Lack of a SMALL Electric Switch

3 basic contact arrangements



single-circuit, normally open



single-circuit, normally closed



double-circuit; one normally open and one normally closed

And many special forms. For example:



three-point structure



single-break, normally open



single-break, double-throw

THE G-E SWITCHETTE IS ONLY THIS BIG

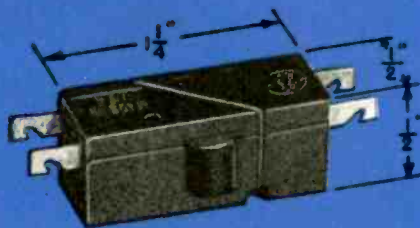

(This one is
ACTUAL SIZE)

WHEREVER you need a tiny contact mechanism in ratings up to 10 amperes at 24 volts d-c—an enclosed, self-contained unit that's light and compact, yet can withstand thousands of operations—there's a G-E Switchette to do the job.

This tiny switch weighs only 9 grams, and is suitable for use at altitudes up to 50,000 feet and in ambient temperatures from 200 F to -70 F. It's corrosion-proof—meets 50-hour salt-spray tests. It's vibration-resistant. The contacts will not chatter when subjected to mechanical frequencies of 5 to 55 cycles per second at 1/32-inch maximum amplitude (1/16-inch total travel), or to a linear acceleration of 25 g in any direction.

Two terminal arrangements are available—out the ends of the case as shown above, or out the top through the cover. This makes for easy mounting in any position.

More than 200 design modifications of the G-E Switchette are available to provide for a wide variety of electrical and mechanical arrangements.

SHIPMENT FROM STOCK

Some forms are now available from warehouse stocks in substantial quantities, to give you quick delivery for your important war jobs.

For your copy of our new catalog (GEA-3818B) which gives dimensions, ratings, and ordering directions for both standard and modified Switchettes, call our local office. *General Electric Co., Schenectady 5, New York.*



SWITCHETTES

BUY WAR BONDS

GENERAL ELECTRIC

876-140-8940



War Gem Today

WHAT WILL THE QUARTZ CRYSTAL DO TOMORROW?

The fabled princes of Hindustan or the wealthy Nizam of Hyderabad never owned a gem more valuable.

The quartz crystal is doing more than rubies or emeralds to protect our way of life against the aggressor.

Cut into tiny wafers the quartz crystal is performing with merit wherever fixed radio frequencies are a "must".

Federal is mass producing frequency control crystals for military use. How many difficult jobs they are doing is a war secret. But their versatility is unlimited.

Even now—in the great FTR research laboratories—men are finding new uses for

quartz crystals—pointing the way to widespread industrial and civilian use after the war is won.

Not alone in communications—but in such widespread applications as precision timing and measuring devices, television, supersonics, pressure gauges, filters, generators, induction heating devices and automatic control equipment, crystals will find new uses... a war gem will become a peacetime servant.



Megatherm, Federal's pioneering induction and dielectric heating equipment, is giving outstanding production line performance in the metals, plastics, food, textile and other industries.

To achieve mass production Federal has installed new machinery and new methods to speed crystals on their way to war—and will continue to be a leader in crystal production. Now is the time to get to know Federal.

Federal Telephone and Radio Corporation

**AN I.T.E.T.
ASSOCIATE**

Newark 7, N. J.

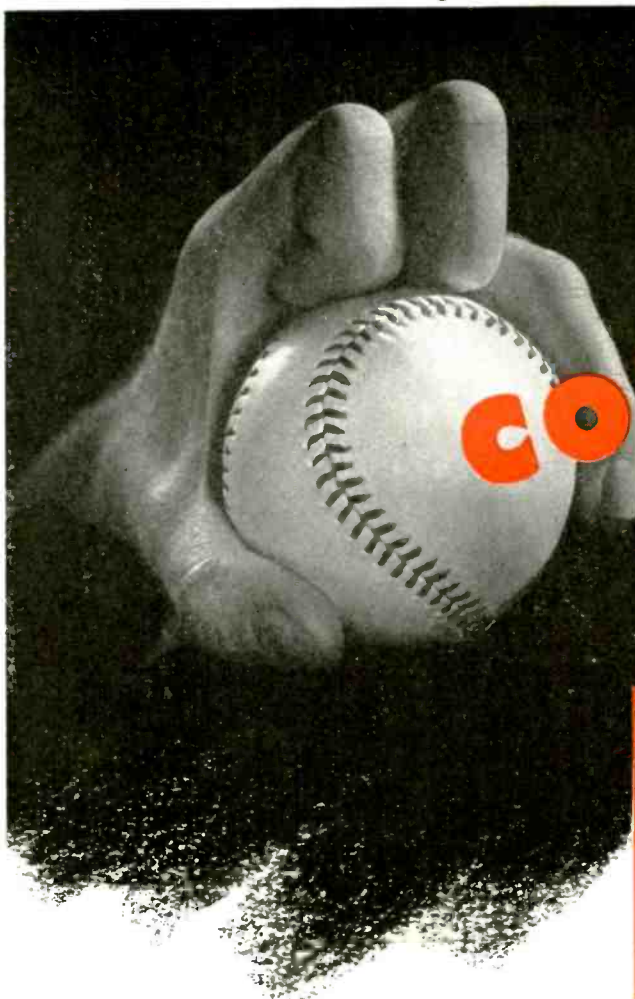

CONTROL . . .



Unique research, engineering, tool design and production skills combine, not only to build control devices that fulfill the most exacting requirements, but also to build special purpose devices for which no specifications exist. Our list of customers, the most exacting in government, aviation and manufacturing, attest to these skills.

Manufacturers of
Control Devices
and Components . . . for
Electric, Electronic and
Mechanical Applications



EASTERN AIR DEVICES, INC.

585 Dean Street • Brooklyn 17, N. Y.

An Affiliate of THE FRED GOAT CO., INC., Est. 1893

AN OUTSTANDING DESIGN!
1/50 H.P. CAPACITOR MOTOR
TYPE J-70

SEVEN weeks from inquiry to delivery . . . 3 weeks to engineer final sample . . . 4 weeks to production.

60 Cycles, 115 Volts • Single Phase-3400 R.P.M. • Low temperature rise • High efficiency: Diameter $3\frac{5}{16}$ ", Overall length $3\frac{1}{8}$ ", Shaft diameter $\frac{5}{16}$ ", Weight 3 lbs. Applications are for driving blowers in high ambient temperatures and for powering small control devices of all types.

We Invite Inquiry

This motor can be supplied to deliver $1/25$ H.P., can be wound for 2 or 3 phase and also furnished for 400 cycle applications at higher speeds and H.P.

COLE STEEL OFFICE EQUIPMENT

will again be available after the war



Fabricating Products in

SHEET METAL

Tough assignments are part of our day's work. Whatever the product — instrument housings, boxes, chassis — we are geared to design, fabricate and finish.

The Plant Behind Your Plant

Our huge plant and entire organization are devoted 100% to war production. Many firms have found it advantageous to sub-contract to us part of their work. Whatever your problem, let us help you. Send for brochure, "THE PLANT BEHIND YOUR PLANT".

COLE

STEEL EQUIPMENT COMPANY

349 Broadway, New York 13, N. Y.

Factory: Brooklyn, New York

MOVING COIL ASSEMBLY OF THE DE JUR METER

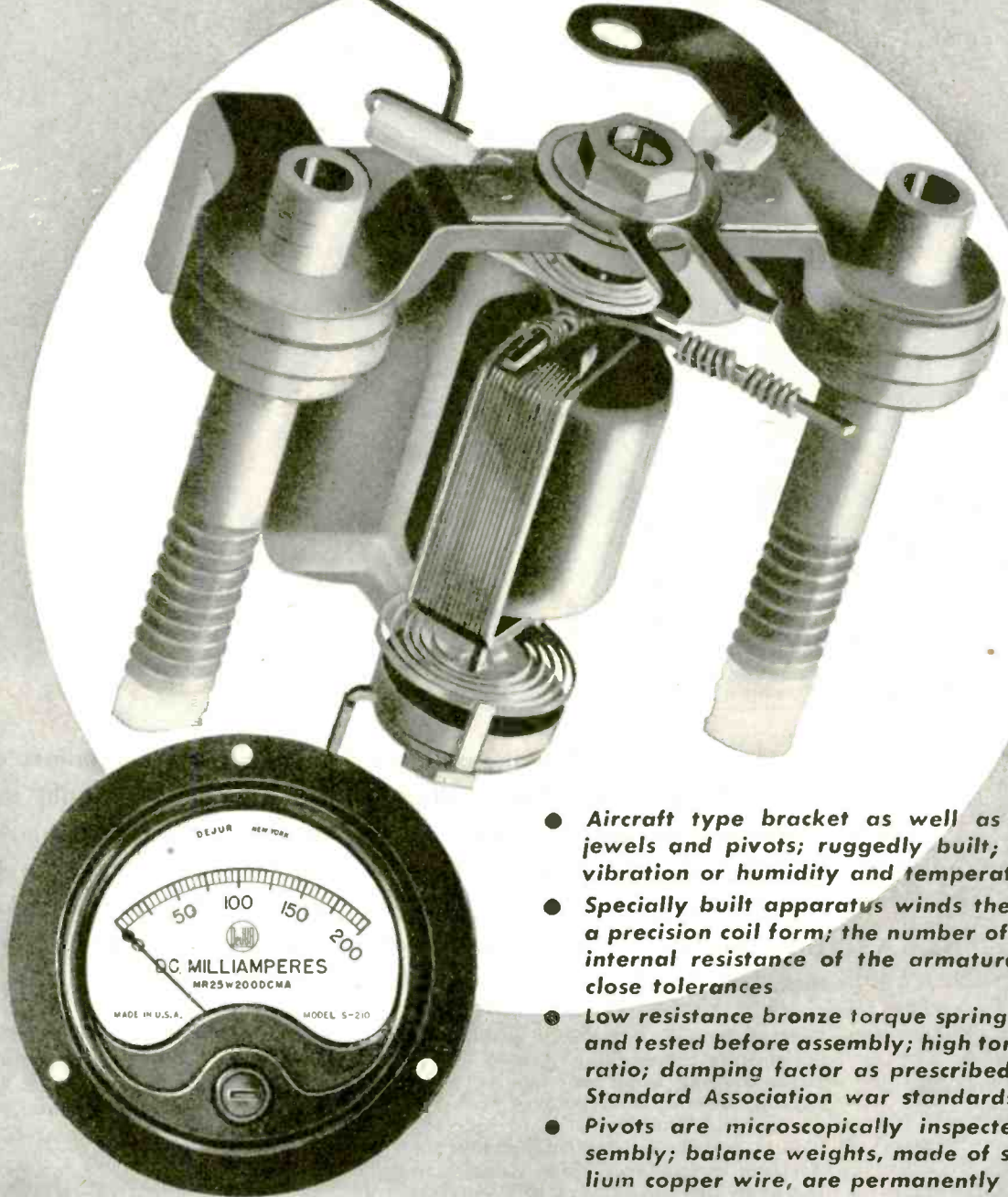

- Aircraft type bracket as well as aircraft type jewels and pivots; ruggedly built; unaffected by vibration or humidity and temperature extremes
- Specially built apparatus winds the armature on a precision coil form; the number of turns and the internal resistance of the armature are held to close tolerances
- Low resistance bronze torque springs are adjusted and tested before assembly; high torque to weight ratio; damping factor as prescribed by American Standard Association war standards
- Pivots are microscopically inspected before assembly; balance weights, made of selected beryllium copper wire, are permanently fixed in place
- DeJur Meters are characterized by their ruggedness, close tolerances, and highest quality materials

YOUR BLOOD IS URGENTLY NEEDED ON THE ROAD TO BERLIN . . . DONATE A PINT TO THE RED CROSS TODAY



DeJur-Amsco Corporation

MANUFACTURERS OF DE JUR METERS, RHEOSTATS, POTENTIOMETERS AND OTHER PRECISION ELECTRONIC COMPONENTS
SHELTON, CONNECTICUT



NEW YORK PLANT: 99 Hudson Street, New York 13, N. Y. • CANADIAN SALES OFFICE: 560 King Street West, Toronto

You are looking at
the first and only
Floating **LAMP**

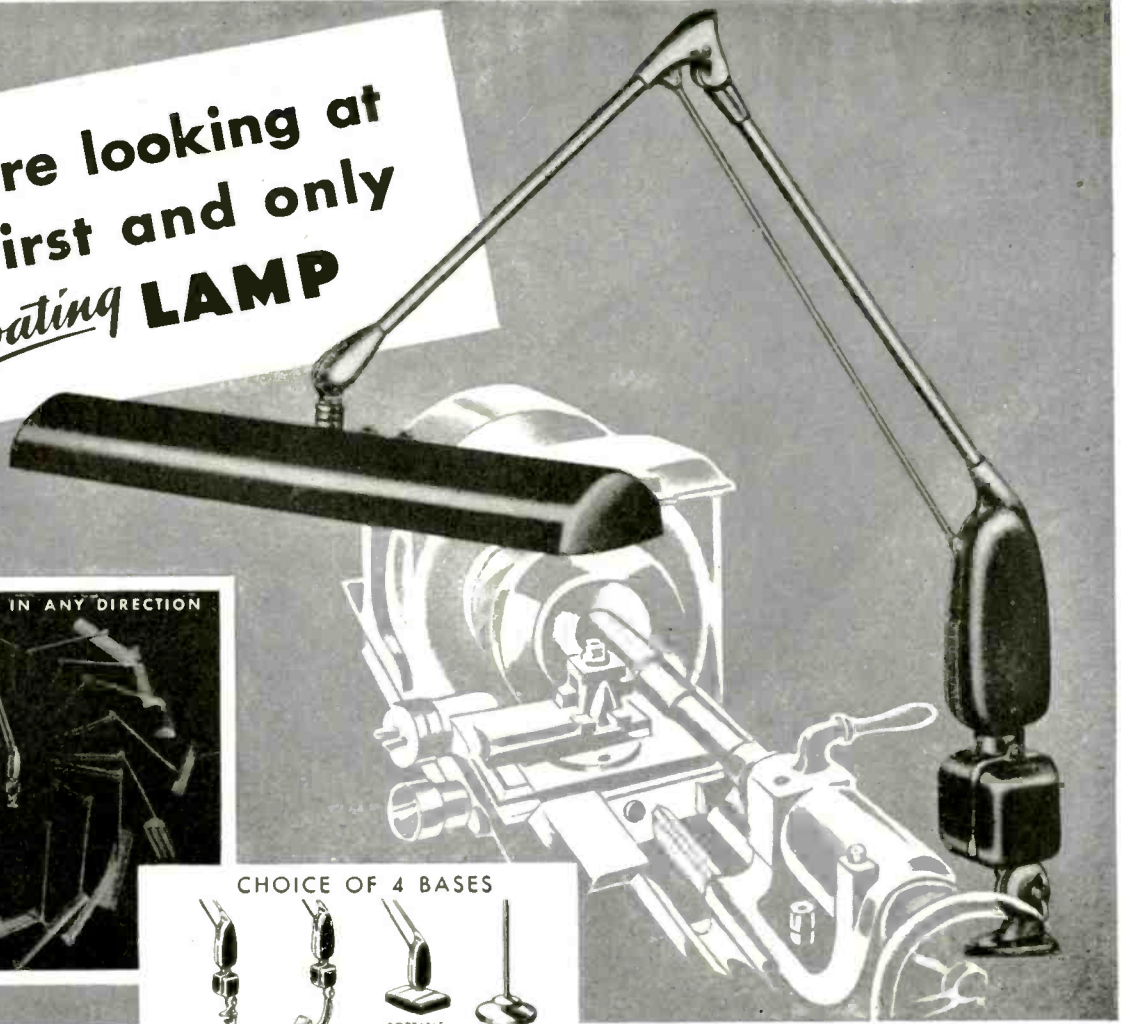

CHOICE OF 4 BASES

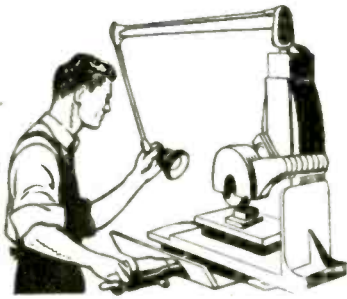
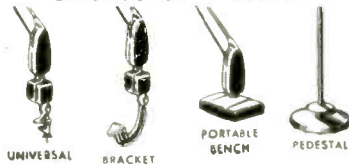

MACHINE TOOLS



ASSEMBLY LINES



INSPECTION BENCHES



DRAFTING BOARDS

FLOATING is the only word to describe the effortless action of the Dazor Lamp. For a slight touch will *float* this light exactly where it's needed, as easily as a man can move his arm. And it *stays put* without locking. Raise, lower, push, pull or turn the Dazor Floating Lamp—it remains firmly and automatically held in position. Thus *localized* lighting acquires new efficiency . . . increasing production, improving accuracy and safety, lowering costs.

Each job presents a separate problem of illuminating the working area. With the Dazor Floating Lamp an employee gets lighting *flexibility* at the point of work. He can control intensity . . . avoid reflected glare . . . curtail eye-strain, fatigue and error. A single spring force acting through an ingenious linkage and arm parallelogram balances the lamp arm in any desired position. Both Fluorescent and Incandescent Dazor Lamps are available; 4 bases cover every type of machine fastening and portable plant use.

In thousands of industrial and governmental operations, economical Dazor Floating Lamps are contributing to high productive capacity. They are distributed by electrical wholesalers, selected for ability to serve. Call your electrical wholesale supplier or write us for the names of our distributors in your locality. Upon request for Booklet "E" we will also send a 16-page Illustrated Catalog describing Dazor models, features, applications.



Dazor Manufacturing Co. • 4463 Duncan Ave., St. Louis 10, Mo.

DAZOR *Floating* LAMPS

FLUORESCENT and INCANDESCENT

ELECTRONIC INDUSTRIES • August, 1944

FIRSTS in Ceramic Condenser Design

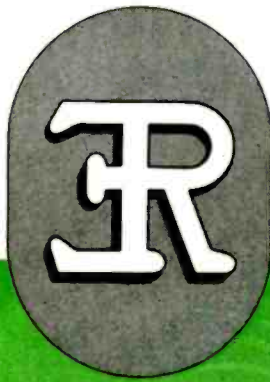

by *Erie Resistor*

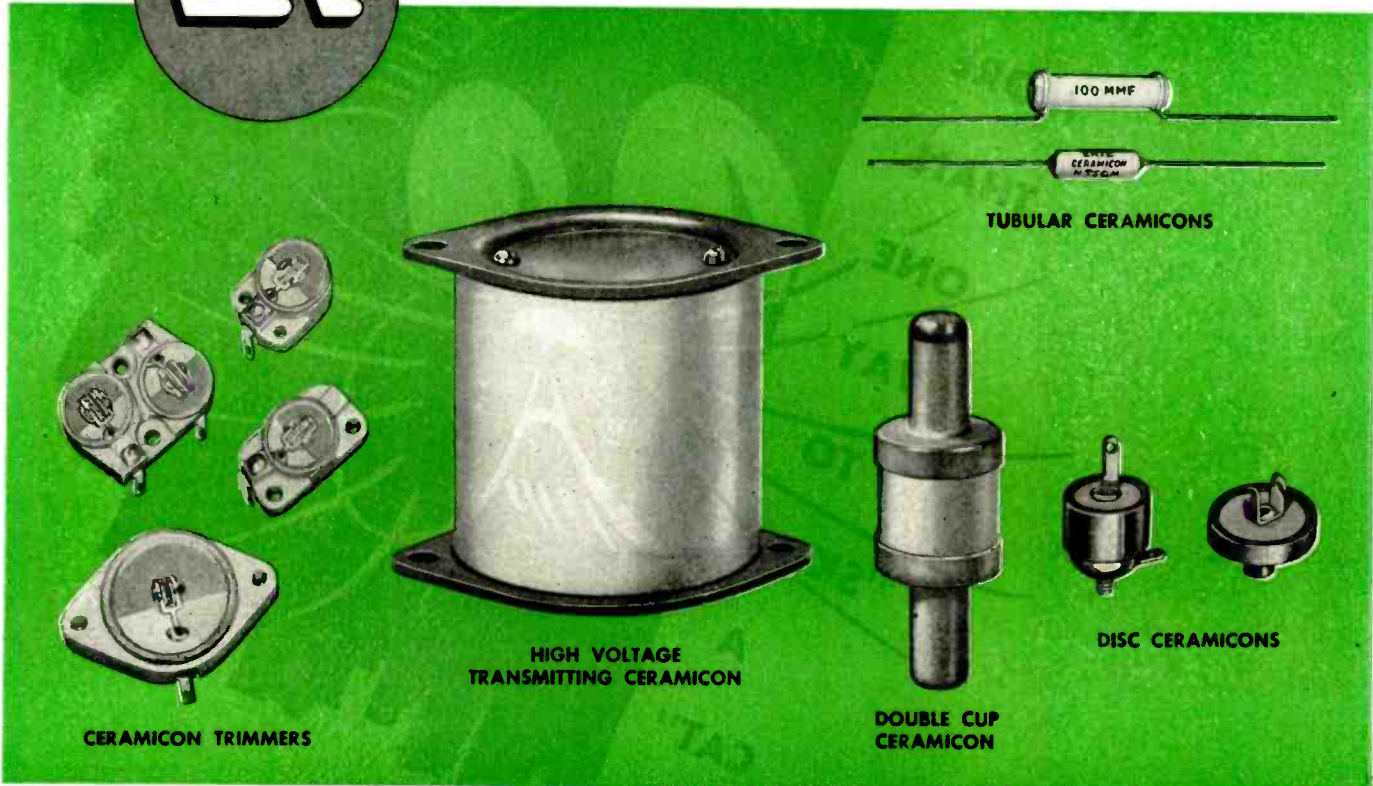

HERE are illustrated five types of ceramic condensers that are playing a vital part in today's wartime electronic apparatus and that will greatly effect the functioning of future electronics. Each is built around a basic design first created by Erie Resistor.

The first silver-ceramic condenser made in this country was an insulated tubular unit designed and produced by Erie Resistor over seven years ago. These popular temperature-compensating Ceramicon's have fully proved themselves under severe wartime conditions. A few years later Erie Ceramicon Trimmers gave the U. S. radio industry an entirely new type of padder with hitherto unobtainable characteristics.

For obtaining relative high capacities in compact, low-loss units

for high frequency applications, Erie Resistor engineers originated disc-type Ceramicon's.

The original Erie double-cup design for high voltage applications has overcome many problems that formerly limited the expansion of ceramic condensers for high voltage, high KVA applications.

Large, high voltage transmitting condensers are now a reality with the characteristic stability of silvered ceramic construction, thanks to another pioneering Erie Resistor Ceramicon design.

We believe that existing Erie Ceramicon's, and other Erie Ceramicon designs to come from our development laboratory in the future will play an important part in the progress of the electronic industry.



Back The Attack—With War Bonds

ERIE RESISTOR CORP., ERIE, PA. LONDON, ENGLAND · TORONTO, CANADA.

Sure-

THERE'S

MORE

THAN

ONE

WAY

TO

"SKIN

A

CAT"

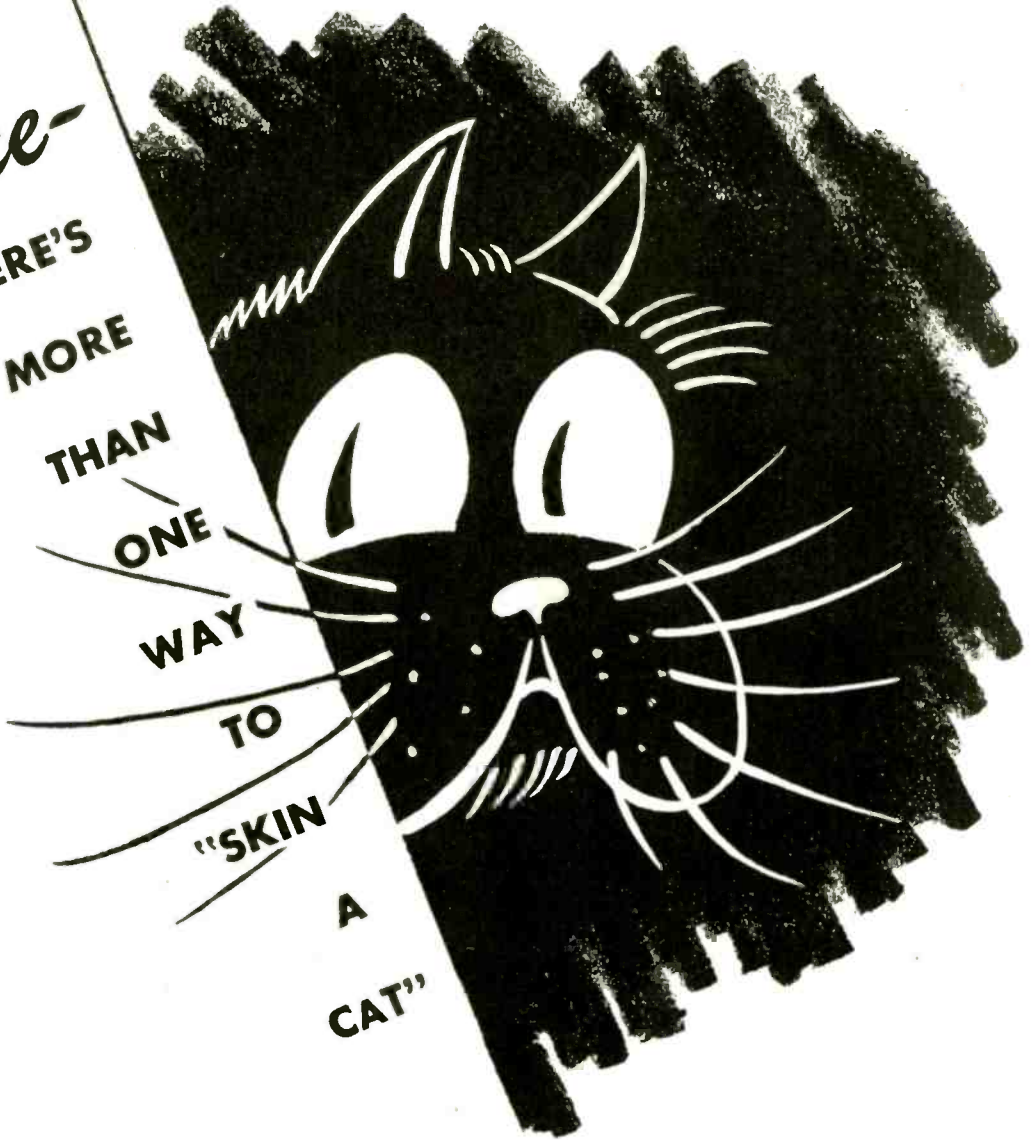

... and there's more than one way to locate a source of supply for chassis, mounting assemblies, panels, transformer housings or cabinets.

... but there's always a BEST way! Might we venture to say THAT way is to send your specifications to Corry-Jamestown?

We work in steel, stainless steel and aluminum ... for many firms in the electronic industry ... meeting rigid Army and Navy specifications in a right smart manner.

No reason why we can't do the same for you. Best way to start the ball rolling is—write us today.

Steel Age

CORRY - JAMESTOWN

MANUFACTURING CORPORATION ★ CORRY, PENNA.

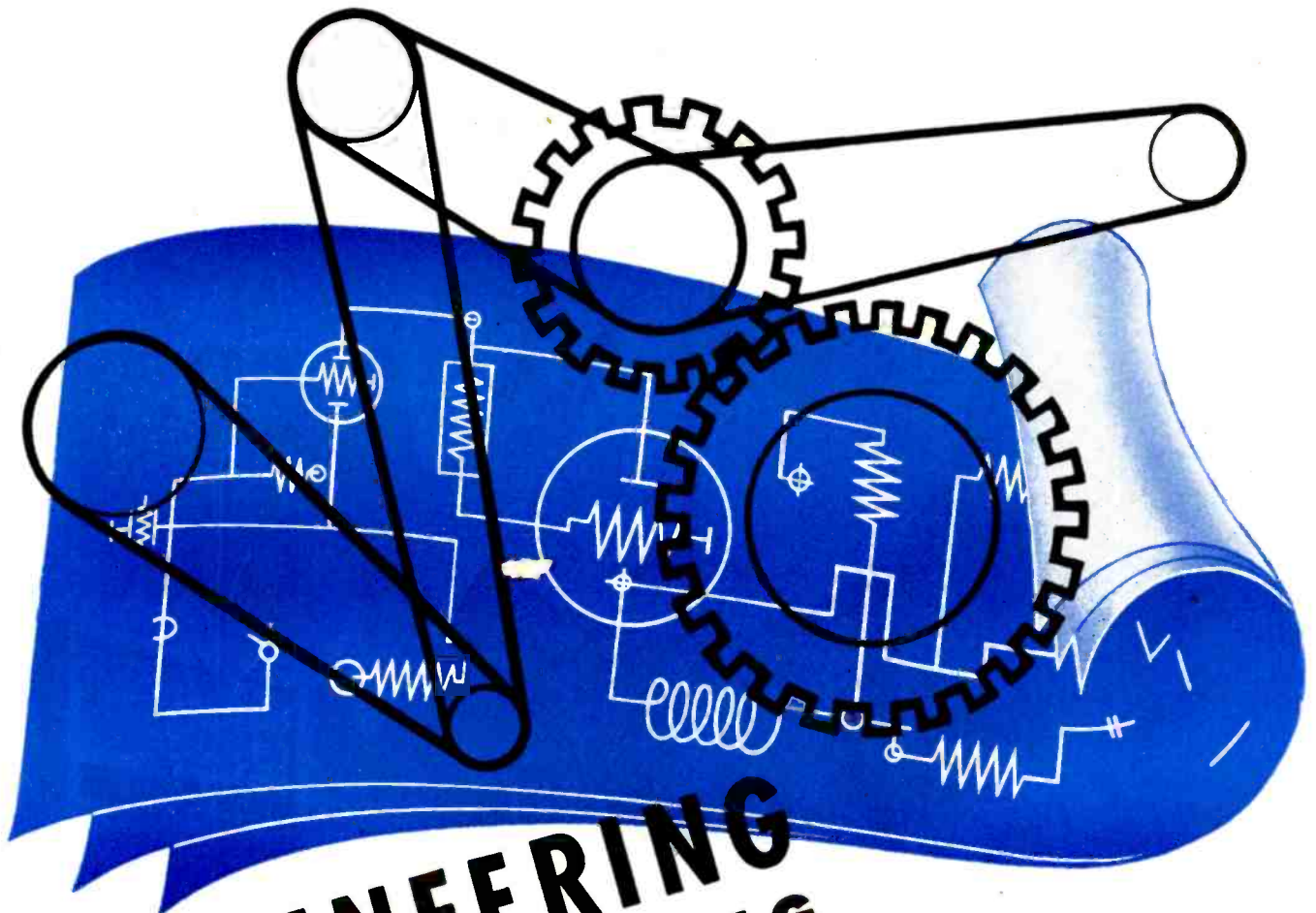

ENGINEERING AND PRODUCING

DOOLITTLE engineers are still designing and producing radio equipment for the *Naval Aircraft Factory* and the *Bureau of Aeronautics*.

Before the war began "Specialized Communications Equipment" by DOOLITTLE was a consistent aid to aviation, broadcast and police radio engineers. . . . Come tomorrow, our pre-war and war-born experience will be translated into many new benefits for a world of peacetime communications. . . . *Look Ahead with DOOLITTLE!*



Doolittle **RADIO, INC.**

Builders of Precision Radio Communications Equipment
7421 South Loomis Boulevard, Chicago 36, Illinois

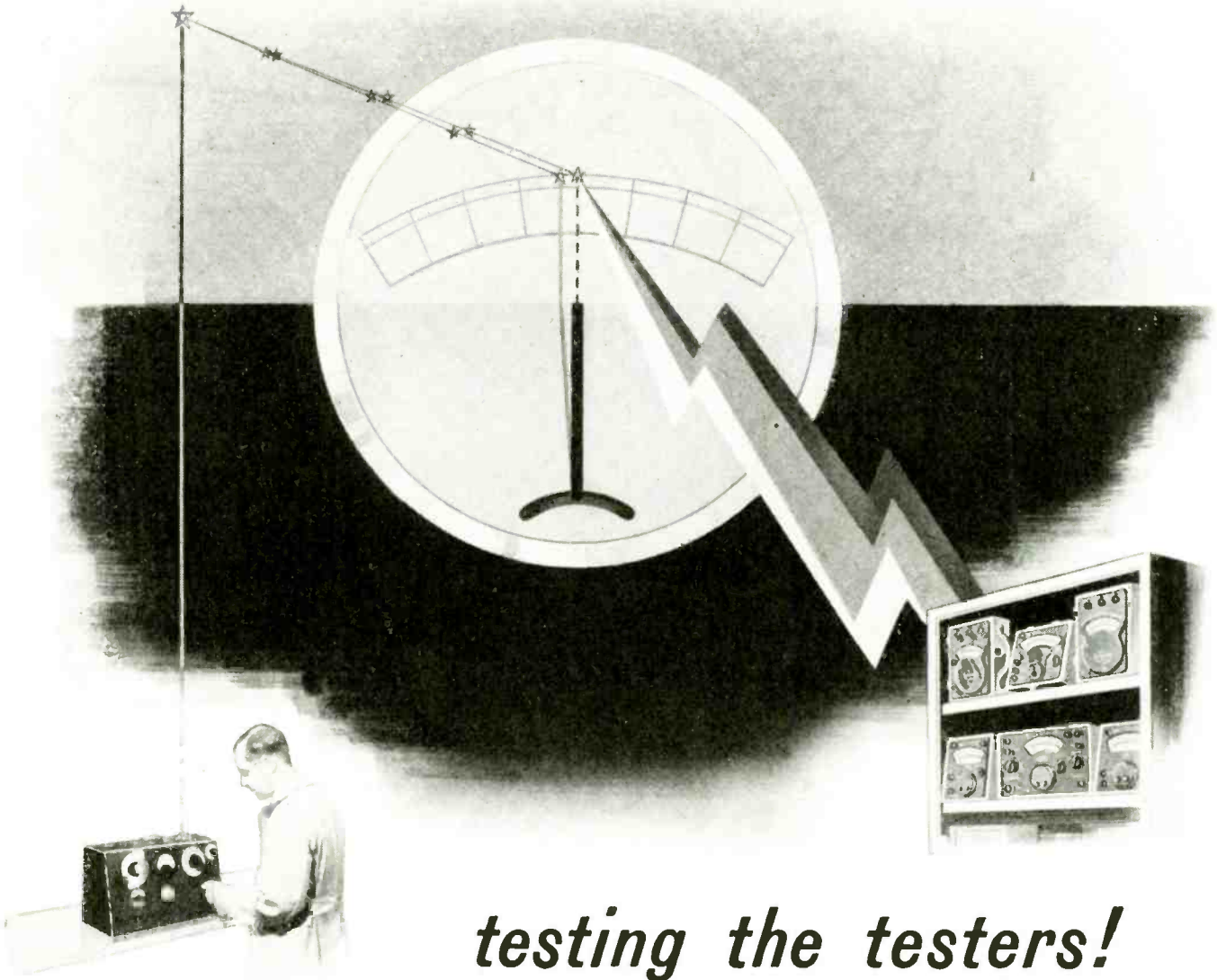

testing the testers!

Tests are meaningless unless the testing equipment is accurate. Utah's "bureau of standards" is kept under guard to assure absolute accuracy . . . these special testing devices, used to check the testing equipment on the line, are operated only by specially trained men and are never allowed to reach full-scale reading.

Because of this testing of testing equipment, the results of Utah's com-

plete testing laboratory can always be relied upon—failures due to inadequate, inaccurate testing are avoided.

These comprehensive testing techniques which have been developed by Utah engineers are playing an important part in the adaptation of the many new

radio and electronic ideas to military needs today—and will play an equally vital part in meeting commercial requirements tomorrow.

★ ★ ★

Every Product Made for the Trade, by Utah, Is Thoroughly Tested and Approved



Keyed to "tomorrow's" demands: Utah transformers, speakers, vibrators, vitreous enamel resistors, wirewound controls, plugs, jacks, switches and small electric motors.



Utah Radio Products Company, 850 Orleans Street, Chicago 10, Ill.





How would you lubricate bearings in a vacuum?

ANOTHER
MACHLETT
TECHNIQUE

This is a cross-section of the Machlett Dynamax X-ray tube. The ball bearings support the anode, which rotates at 3000 r.p.m., and reaches a temperature of 1000° F. The entire structure is in a vacuum of about 10^{-6} mm. of mercury, or a billionth of an atmosphere.

Conventional lubricants cannot be used, because they would destroy the vacuum and the tube. Machlett's scientific studies showed that a very thin film of certain metals can act as lubricant. Pure silver was found most advantageous. An almost molecular-thin film of it is deposited upon the balls in a vacuum, by a unique method.

So successful was this technique that Machlett, five years ago, guaranteed its Dynamax rotating anode tube for

10,000 exposures. Today it outlasts conventional stationary anode tubes. Some amazing records have been made with it, the best to date being 272,610 exposures, at the Army Examining and Induction Station, Pittsburgh, Pa.

This tube has a focal spot so small as to produce exceedingly sharp pictures, and an X-ray beam so intense as to make possible exposures as short as 1/60th sec. It was the solution of the lubrication problem that added reliability to these advantages. Machlett employs many other advanced techniques in the manufacture of its various types of high-vacuum tubes for medical, scientific and industrial purposes . . . Machlett Laboratories, Inc., Springdale, Connecticut.

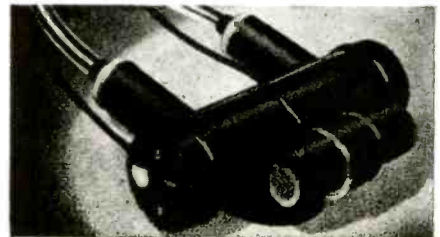

This is the Machlett Dynamax Rotating Anode tube, 100 kilovolts, 50 kilowatts, as supplied in an oil-filled, shockproof housing with air circulator and vapor-proof cable terminals.

MACHLETT

RAY TUBES SINCE 1898

TODAY THEIR LARGEST MAKER



**MANUFACTURING • DESIGNING
ENGINEERING TO ORDER
ELECTRONIC EQUIPMENT
RADIO TRANSMITTERS
RADIO RECEIVERS
TESTING EQUIPMENT
HIGH & ULTRA HIGH
FREQUENCY UNITS
AMPLIFIERS**

STANDARD PRODUCTION

of
**AIRCRAFT • MARINE
POLICE • MOBILE
OR BASE RADIO
EQUIPMENT**

REX BASSETT
INCORPORATED
FORT LAUDERDALE, FLORIDA.

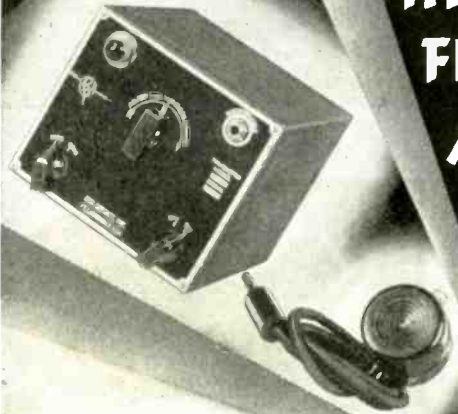

NOW A
New
"TH" TRANSTAT

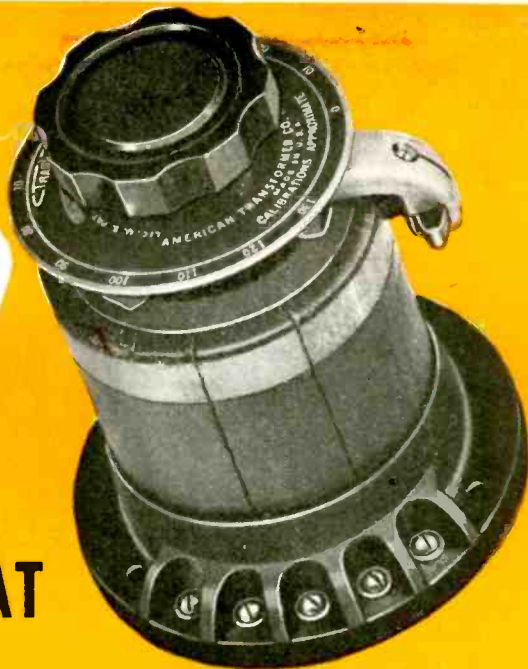

SMALLER
AND
LIGHTER
THAN EVER
BEFORE!

NOMINAL LOAD 300 VA, 50/60 CYCLES,
115 VOLTS INPUT, 0 TO 115 VOLTS
OUTPUT

MAXIMUM LOAD 340 VA, 50/60 CYCLES,
115 VOLTS INPUT, 0 TO 130 VOLTS
OUTPUT

MAXIMUM BRUSH CURRENT 2.6 AMPERES

With this new model, many smaller communications and industrial applications can have Transtat's smooth control, high efficiency and ruggedness. An ideal component, this transformer-type a.c. voltage regulator is but one-half the size and less than one-half the weight of the smallest previous TH Transtat.

UNIFORM—Interchangeable Bakelite Bases

In addition to the well-known Bakelite closeness of tolerance, these bases have insulating barriers between terminals to prevent shorting of leads.

FLEXIBLE—New Brush Assembly Facilitates Mounting Changes

The unique brush arm shaft mechanism provides ease of change from table mounting to back of panel mounting or ganging. Die cast brush arm permits quick brush changes, improves heat dissipation and has generous brush contact area. Other features include extra wire insulation and impregnation of core and coil with special synthetic phenolic varnish. For complete details write for bulletin.

AMERICAN TRANSFORMER COMPANY, 178 Emmet St., Newark 5, N. J.

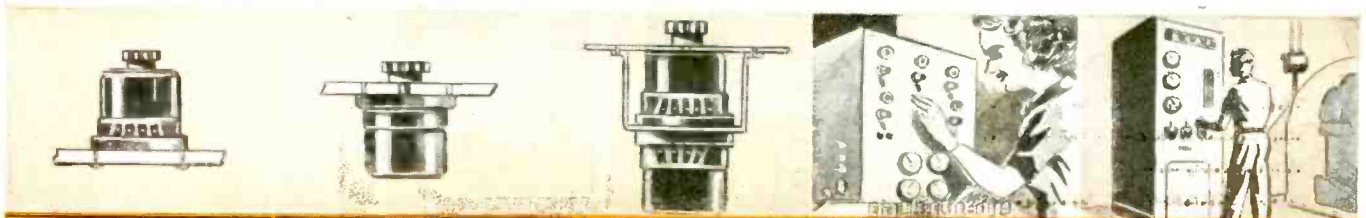

Clockwise rotation of hand-wheel increases the voltage when table-mounted unit is connected as shown below.

For back of panel mounting, connect Transtat as shown and reverse shaft to provide voltage increase on clockwise movement.

Many circuits are possible when the new Transtat is ganged for polyphase or simultaneous single phase control.

For fuse testing, spot welding, soldering, etc., an adjustable voltage can be furnished as shown.

For rectifier plate supply, and other h.v. applications, the new Transtat may be connected thus.

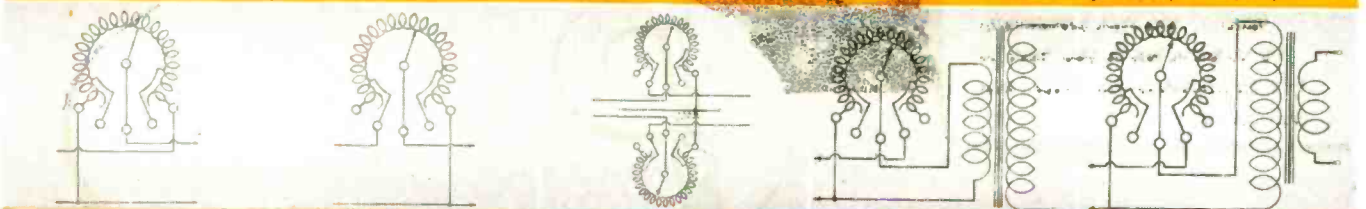

Pioneer Manufacturers
of Transformers, Reactors
and Rectifiers for Electronics
and Power Transmission

AMERTRAN

MANUFACTURING SINCE 1901 AT NEWARK, N. J.



Plastic

NAME AND INSTRUCTION PLATES

FR.33

MANUFACTURERS RECOMMENDATIONS

OCTANE RATING OF GASOLINE	68 MIN.
MOTOR OIL, WINTER, S. A. E.	10
" " SUMMER, S. A. E.	30
CRANK CASE CAPACITY	7 QTS.
TRANSMISSION, TRANSFER CASE,	
FRONT AXLE DECLUTCH & PILLOWBLOCK	
OIL, WINTER, S. A. E.	80
" " SUMMER, S. A. E.	90
TRANSMISSION CAPACITY	4.5 QTS.
TRANSFER CASE	4 PTS.
FRONT AXLE DECLUTCH	5 PT.
PILLOWBLOCK CAPACITY	5 PT.
TIRE INFLATION	60+ FRONT
" "	50+ REAR
BATTERY	12 VOLTS

TRANSMISSION SHIFT PATTERN

FRONT

TRANSFER CASE LEVER DOWN FOR HIGH RATIO. UP FOR LOW

FRONT AXLE DECLUTCH LEVER DOWN TO DISENGAGE AXLE. UP TO ENGAGE

USE LOW TRANSFER RATIO ONLY AFTER COMPLETELY ENGAGING FRONT AXLE

2-13 CHAIN LOCKER A-302E

CARRIER RING SUPPLY

2-47-1 CREWS MESSING & BERTHING A-205L

01-58 RADIO ROOM A-101ACEL

FR.78

18 TO 23 INCL

LANDING GEAR

NOSE ELEVATOR TAB

ENGRAVED
EMBOSSSED
LITHOGRAPHED
PRINTED
HOT PRESSED

from
LAMINATED PHENOLICS
WHITE CORE-BLACK SURFACE
COLORED SURFACES
MELAMINE
LUCITE
PLEXIGLASS
and other Plastic materials as specified

War is a proving ground for many things. Take Plastic Name and Instruction Plates for instance. Because of their clean-cut legibility and durability under severe usage, these plates are proving their worth in scores of applications including many types of combat equipment.

As specialists in specification fabrication, we have acquired the knack of producing these plates in quantity . . . producing them better . . . faster . . . and more economically!

Let us prove this to you. Send us the specifications for your next requirements.

Specification Fabricators of
GLASS BONDED MICA, PHENOL FIBRE,
VULCANIZED FIBRE, RUBBER, ASBESTOS,
CORK, CORPRENE AND OTHER MATERIALS



114 N. FITZHUGH ST., ROCHESTER 4, N. Y.

Branch Offices: NEW YORK: 420 LEXINGTON AVE., DETROIT: 14319 STRATHMOOR AVE.
PHILADELPHIA: 6710 HOLLIS ST., CHICAGO: 4317 RAVENSWOOD AVE.

Centralab

CERAMIC TRIMMERS

Here are trimmer capacitors of compact size . . . full capacity range obtained with 180° rotation, and equal stability . . . maintained at any position from minimum to maximum.

Centralab Ceramic Trimmers are stable under vibration without any special locking device, due to the light weight rotor that is always in balance and under constant heavy spring pressure. Send for Centralab's revised Form 695 which describes the various styles in current production with data on capacity ranges, breakdown, leakage resistance, tracking, temperature coefficient, power factor and humidity characteristics.

CENTRALAB'S CERAMIC TRIMMERS are easily adjusted by means of a screw driver.

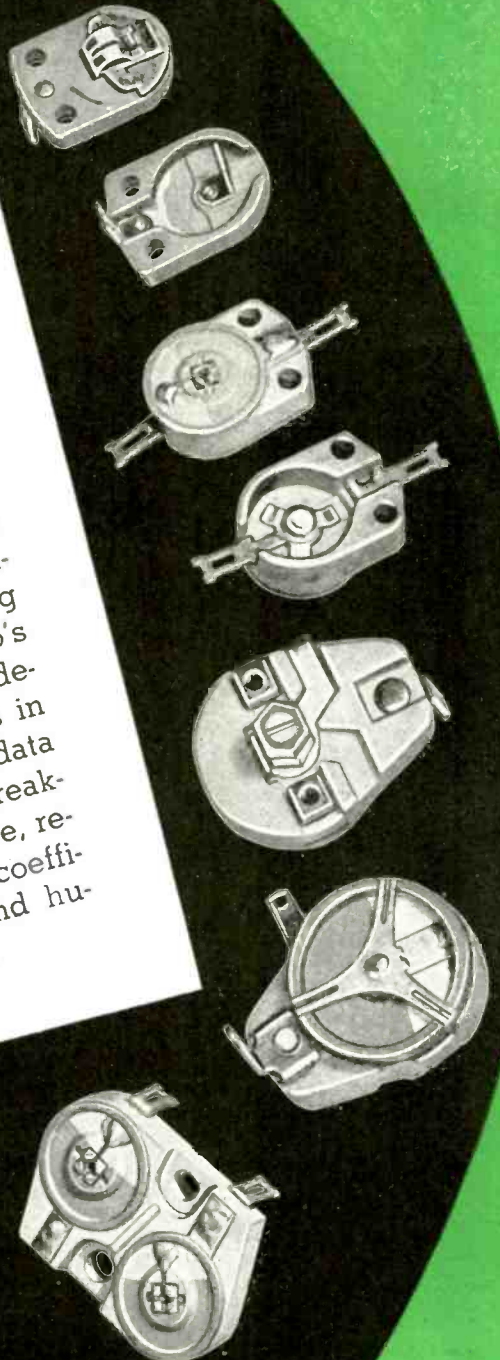

Centralab

Division of GLOBE-UNION INC., Milwaukee

Producers of Variable Resistors • Selector Switches • Ceramic Capacitors, Fixed and Variable • Steatite Insulators.

Many complex glass structures go into a modern vacuum tube

In vacuum tubes many complicated shapes, large and small, must be made within very close tolerances. Eimac's know-how of handling glass is just one reason why electronic engineers throughout the world submit their special problems to Eimac with complete confidence in Eimac's ability to do a superior job.



Forming special quartz part at 1800° Centigrade

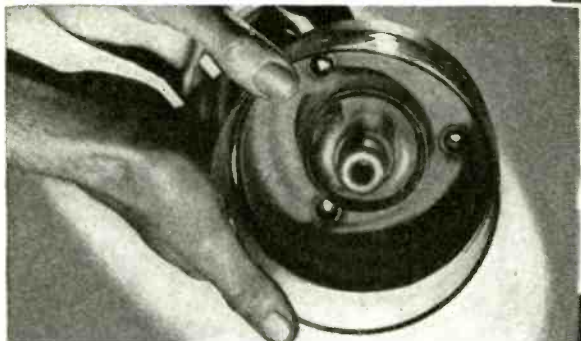

There are four complicated glass to metal seals in this vacuum tube part

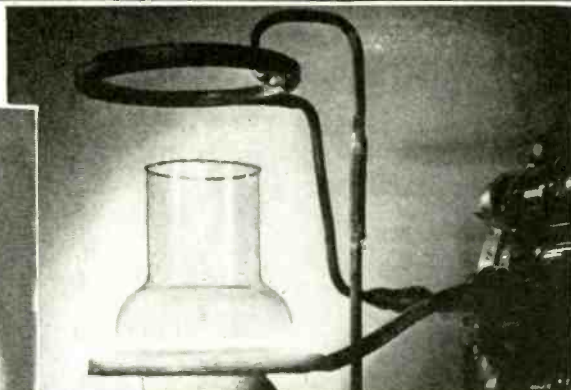

The use of R. F. heat in making glass to metal seals simplifies and speeds many such sealing operations



Making very large glass seals requires expert handling. Two 17" glass cylinders are being joined

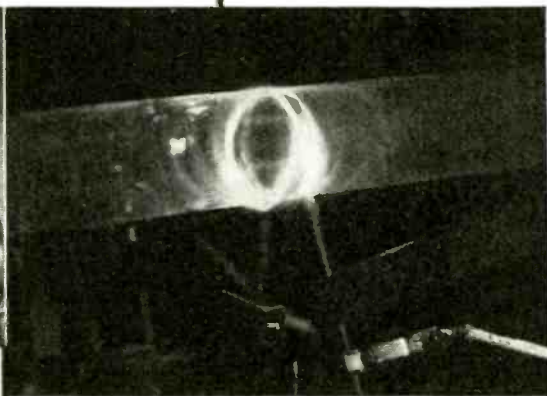

Heavy glass tubing is accurately and rapidly sealed with a Radio Frequency Arc



Electronic Telesis — a sixty-four page, completely illustrated handbook has been designed especially to assist you in explaining the fundamentals of Electronics to laymen. Send for your copy today.

Follow the leaders to

Eimac
REG. U. S. PAT. OFF.
TUBES

EITEL-McCULLOUGH, INC., 872 San Mateo Avenue, SAN BRUNO, CALIFORNIA

Plants located at: San Bruno, California and Salt Lake City, Utah

Export Agents: Frazar & Hansen,

San Francisco 11, California, U. S. A.

... AIR COMMUNICATIONS

Guardian of Tomorrow's World of Flight...

A great new era of air transportation is on the way... and AIR COMMUNICATIONS, Inc. is proud to have a part in helping to bring it ever nearer.

Already new electronic communication developments have brought new safety and increased striking power to our warplanes—enabling them to fly true to their target, and return to base through the densest fogs, storms and darkness.

Tomorrow, still more amazing air communications will form and mark the highways of the skies, for private planes as well as for the great coast-to-coast and trans-oceanic airliners—will make air travel *positive* day or night, in storm or fair weather.

While AIR COMMUNICATIONS, Inc. continues to produce precision built products for the war effort, our engineers are busy developing new and improved devices for the great post-war "Air Age"—to safeguard tomorrow's world of flight. In the peacetime future this war-tested organization will design, engineer and build *everything for the safety, economy and convenience of flying.*

Cooperative Engineering Available—let us help you solve your engineering problems of the future.

AIR COMMUNICATIONS, INC.

KANSAS CITY 8, MISSOURI

Designing, Engineering and Building for Victory...and for the Future



Battle Talk

is our business!



Every move our fighters make on land, at sea or in the air is based on communications. Men depend not only for their orders but for their very lives on radio and telephone and many other communications devices. In every battle, on every front including the home front, you'll find apparatus made by Western Electric—the nation's largest producer of electronic and communications equipment for war.

Buy all the War Bonds you can—and keep all the War Bonds you buy!



75TH ANNIVERSARY

Western Electric

ARSENAL OF COMMUNICATIONS EQUIPMENT



MORE small and medium
TRANSFORMERS
AVAILABLE

because production facilities have been
expanded **AGAIN**

More rapid delivery is now possible because an additional expansion of production facilities has made possible the increased manufacture of Consolidated's well-known small and medium transformers. These transformer types include Pulse Transformers, Power Transformers, Solenoid Coils and Search Coils. Other products include Range Filters and Headsets.

Consolidated engineers will also design transformers for special applications or will build to your specifications.



 *Electronic and Magnetic Devices*
CONSOLIDATED RADIO
Products Company
350 W. ERIE ST., CHICAGO 10, ILL.

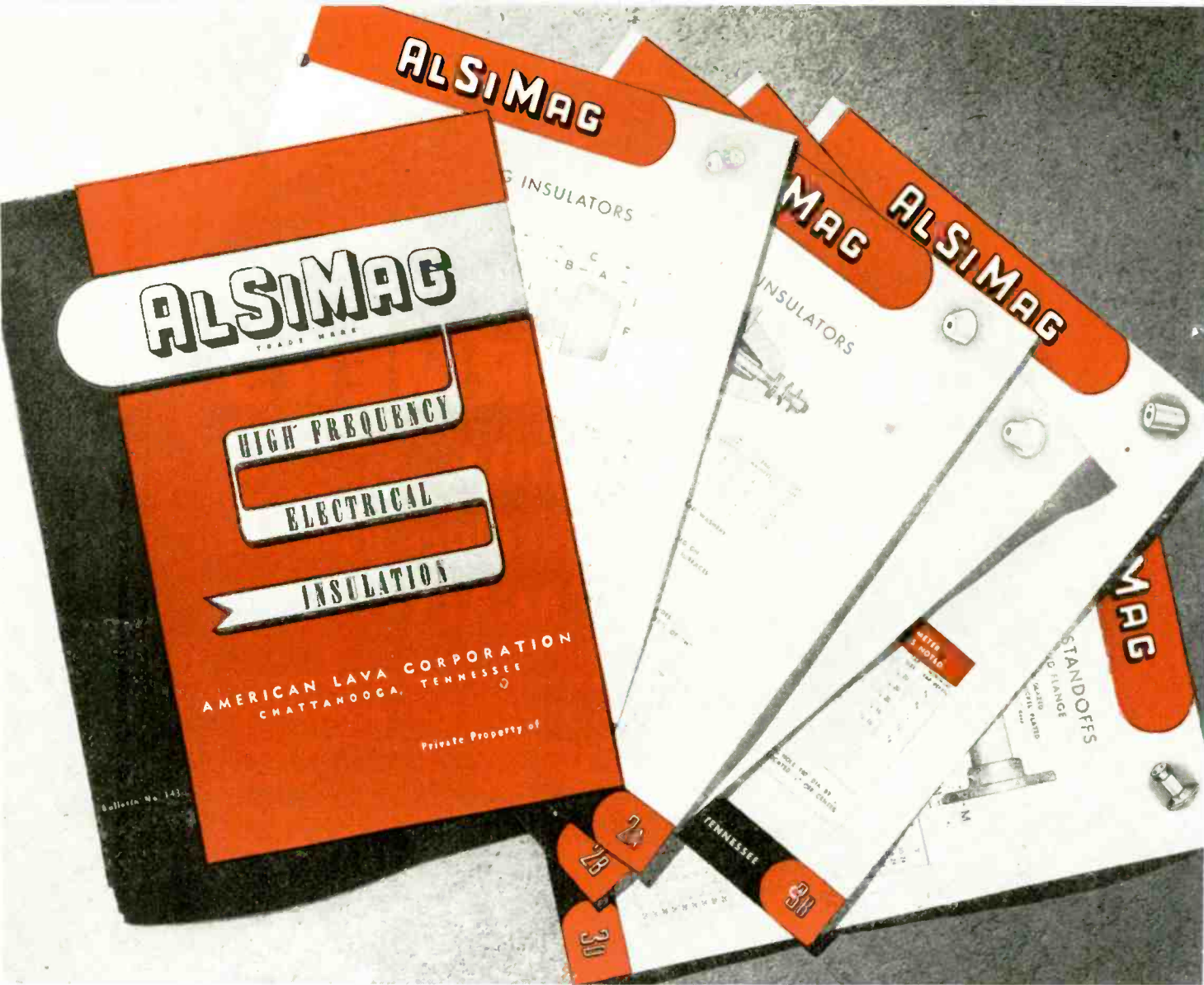

ANNOUNCING BULLETIN NO. 143

Every engineer in the electronic field will appreciate the concise method in which the Electrical and Mechanical properties together with the design and dimensions of ALSiMAG High Frequency Insulators have been arranged and tabulated for easy and quick reference in new Bulletin No. 143.

The ALSiMAG insulators described are those most commonly used in high frequency applications. *Deliveries can now be made within a reasonable period.*

AMERICAN LAVA CORPORATION

Chattanooga 5, Tennessee

Note: When requesting copies please include name and position of others in your organization to whom we should send Bulletin No. 143 so that you may retain your own copy.

The insulators described in Bulletin No. 143 represent only a small portion of our output. Specially made insulators to customer's specifications are our principal products. Our Engineering Staff will be glad to cooperate on your designs.

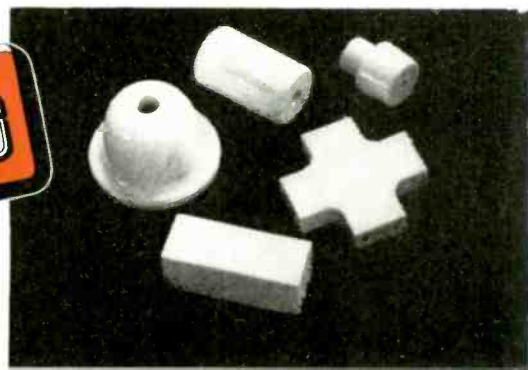



not just a task force

but Full Capacity Production at G. I.

All in all, industry did, and is still doing, a grand job — has rolled up a stupendous record of accomplishment in the past four years. But, looking back, we can see errors of procedure which made the going tough in spots, obstacles that retarded progress. These conditions were due to confusion and lack of experience in the drastic conversion from civilian to war production. Our industry can

well profit by these mistakes as we make the transition back to peacetime activity.

We at G. I., anticipating WPB's recent Go-Ahead signal, have readied definite plans — plans which will enable us to swing into capacity execution of post-war assignments the instant our facilities are no longer wholly required for the supplying of military equipment.

GENERAL INSTRUMENT CORP.

829 NEWARK AVENUE, ELIZABETH 3, N. J.



OUR WARTIME JOB has been the volume output of variable condensers, many with circuit applications never before possible, wired assemblies, automatic tuning mechanisms, etc.



OUR PEACETIME JOB will be to produce such precision instruments, featuring new designs, innovations and improvements, for civilian use in the fields of electronics and communications equipments.

3 REASONS WHY...

SPERTI HERMETIC SEALS ARE SPECIFIED ON EQUIPMENT DESIGNED FOR TOUGH MILITARY CONDITIONS

1

FUSED INTO ONE PIECE. Glass-to-metal vacuum tight hermetic bond, resistant to shock and corrosion.

2

EFFECTIVELY SEALS out dust, humidity, and fungus from transformers, relays, vibrators and other sensitive component parts.

3

WIDE THERMAL OPERATING RANGE AND HIGH INSULATION LEAKAGE RESISTANCE.

Thermal operating range, -70°C. to 200°C.
Insulation leakage resistance, 30,000 megohms, minimum, after Navy immersion test.

SOLDERING TEMPERATURE NOT CRITICAL. Simple, easy to attach by means of high frequency, oven-soldering or standard soldering iron.

Now in Volume production

WRITE, WIRE OR PHONE TODAY FOR INFORMATION!

Sperti

INCORPORATED

ELECTRONIC DIVISION, DEPT. (E1-3)
RESEARCH · DEVELOPMENT · MANUFACTURING · CINCINNATI 12, OH IO

40 pages of new,
up-to-the-minute

facts

FOR
**COMMUNICATIONS
ENGINEERS**

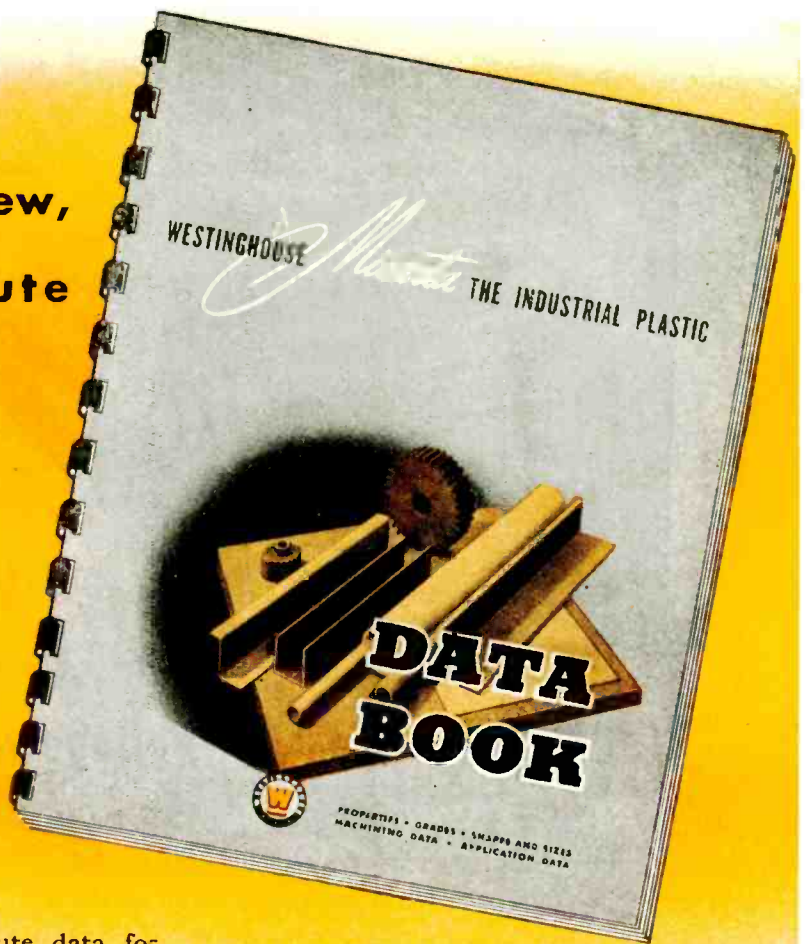

Here's new and up-to-the-minute data for designers of communications and electronics equipment in concise, easy-to-use form.

Forty pages of property tables, performance curves and design suggestions provide working data for selecting the proper grade of Micarta for any communications application. Data covers both laminated, molded, and formed Micarta. Grades include those designed for severest wear and high dielectric strength. Micarta terminal blocks, commutators, bases, coil forms, switch spacers and tube sockets, are now standard in the industry. In these successful applications, you may find the basis for an improved design.

Reserve your copy of the new Micarta Data Book today. Write Westinghouse Electric & Mfg. Co., East Pittsburgh, Pa., Dept. 7-N. J-06354-1B

GET THIS HELPFUL DATA:

Grades of Micarta—their characteristics . . . corresponding Army and Navy types.

Properties of Micarta—electrical . . . mechanical . . . chemical . . . how they compare with other materials.

Designing Help—machining data . . . how to apply directional loads . . . molded and formed Micarta design suggestions.

Forms Available—standard shapes and sizes . . . plates, rods, tubes, angles, channels, zees.



PLANTS IN 25 CITIES . . .



OFFICES EVERYWHERE



CASED MODEL



RAYTHEON Voltage Stabilizers

Accurately Control Fluctuating

Voltage to $\pm \frac{1}{2}\%$

Raytheon Voltage Stabilizers are available for incorporation in your product or equipment for almost any type of service. There are three designs —cased, uncased and endbell models—to meet

your installation requirements. All Raytheon Stabilizers deliver controlled output voltage to $\pm \frac{1}{2}\%$ over their full rating. Write, outlining your needs —Raytheon Engineers will make recommendations.

Raytheon Voltage Stabilizers Give You These Outstanding Advantages . . .

- Hold constant varying A. C. input voltage to $\pm \frac{1}{2}\%$.
- Stabilize at any load within their ratings.
- Quick action . . . stabilizes within 2 cycles . . . variations cannot be observed on an ordinary volt meter.
- Wide A. C. input voltage limits . . . 95 to 135 volts.
- Entirely automatic . . . no moving parts . . . requires no maintenance . . . connect it and forget it.



Endbell Model

The coveted Army-Navy "E", for Excellence in the manufacture of war equipment and tubes, flies over all four Raytheon Plants where 12,000 men and women are producing for VICTORY.



RAYTHEON MANUFACTURING
Company

190 WILLOW ST WALTHAM, MASS.

non-destructive

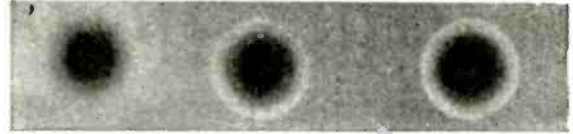

checking

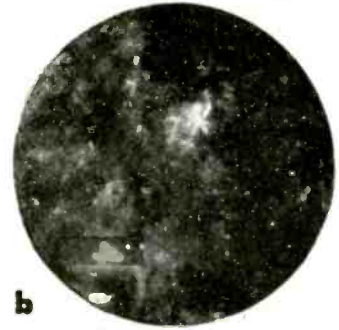

**b
and control**

*low voltage
X-ray*

tool of many uses . . . in many fields

This newly designed Picker Series "50" Low Voltage X-Ray Unit is a tool of many uses in many fields . . . light metals, plastics, textiles, fibres, plywood . . . to name only a few. It provides accurate controls on spot welds, routinely and non-destructively, through periodic radiographic checks of operation procedures (as in example "A"). A typical example of its utility in the field of plastics is evident in the radiograph "B" above, where density variations would indicate the need for revisions in manufacturing technique.

Don't imagine that such X-Ray check-and-control operations require large space and cumbersome installations. On the contrary, this new Picker Series "50" X-Ray Unit, designed for just such work, is clean-lined, simple, compact and efficient . . . capable of all kinds of low voltage long wavelength radiography from 5 KVP to 50 KVP. There is definitely a place for this machine in your plant. Your local Picker representative will be glad to discuss with you its amazing utility and manifold applications. Or send for Picker Bulletin 1444 which gives complete details.

**PICKER 50 KV
INDUSTRIAL X-RAY UNIT**

*special line-focus tube, water-cooled, end-grounded
low absorption beryllium window
continuous operation throughout entire range
safe electrically; safe against primary as well as secondary radiation*



sets the pace in X-ray

PICKER X-RAY CORPORATION • NEW YORK, N. Y.
WAITE M'FG DIVISION • CLEVELAND, OHIO

PIONEERING IN THE HIGH-VOLTAGE ELECTRICAL FIELD

Victors in the Race with Time



1860

The Pony Express carried the mail from Missouri to California in the record breaking time of 10 days. In those days there was no faster and reliable means of transportation than that of a trusted messenger on a fast horse.

1944

Today a soldier with his Handy-Talkie radio transmitter receiver can start the news of a battle and of victory around the world in a split second. Effortless, 2-way communication is within the reach of everyone!



Sentinel

Though thousands of miles lie between the battle-fronts throughout the world, the forces of the widely separated United Nations are welded into a single victorious fighting unit through modern radio communications.

Sentinel Radio is proud to be playing an effective part in developing and producing this supremely important war communications equipment. Six Sentinel plants are translating the blueprints of Sentinel engineers into victory-winning equipment.

These wartime experiences will result in vastly improved new Sentinel products which will help Sentinel dealers translate postwar prospects into profitable sales.

SENTINEL RADIO CORPORATION

2020 Ridge Avenue, Evanston, Ill.

ELECTRONIC INDUSTRIES • August, 1944

Quality
Radio Since
1920

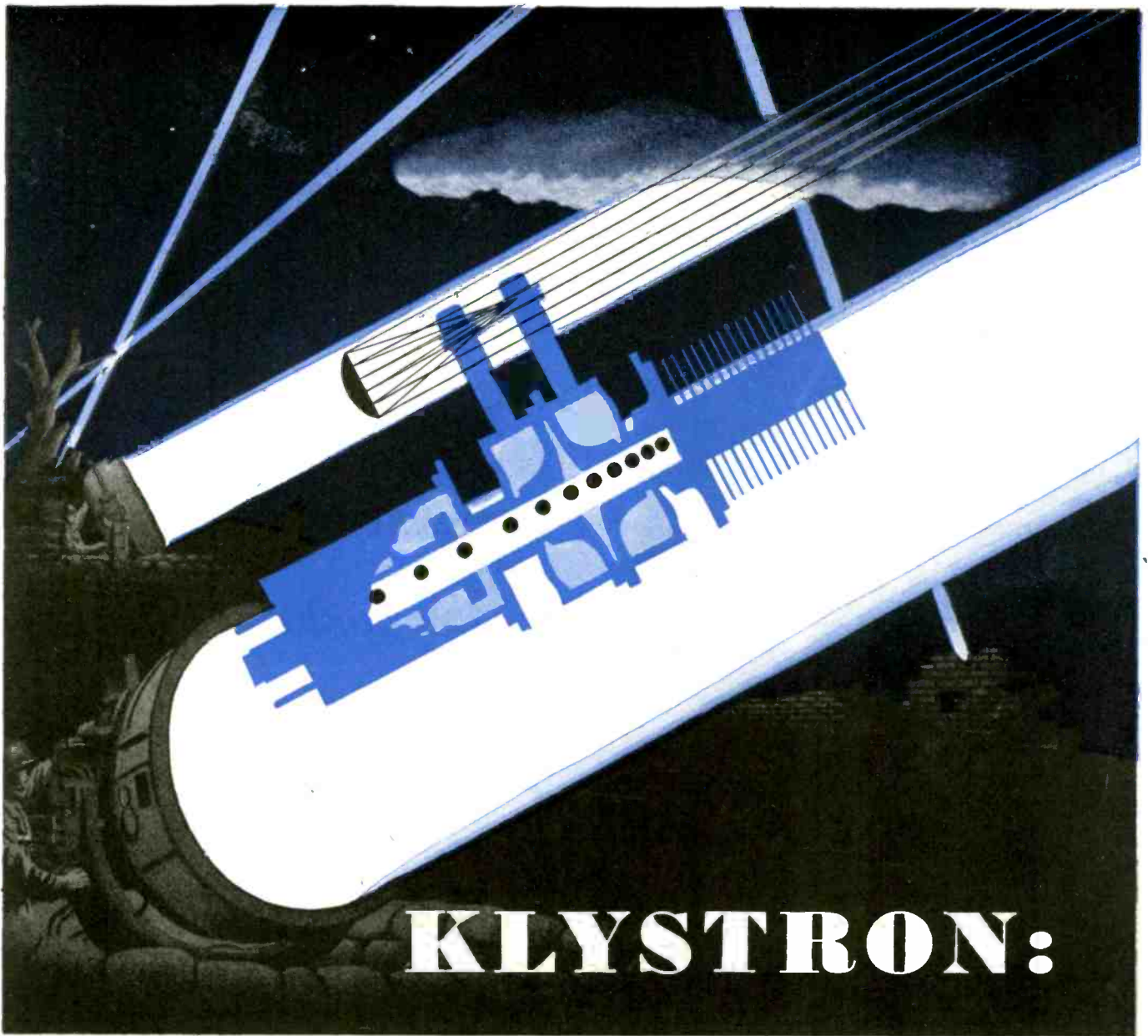

A pencil of energy beamed like light

IF YOU'LL imagine an *invisible* search-light beam, you'll have a good picture of how Klystron-generated radio waves can be directed into a narrow "pencil" of energy.

► This direction is accomplished by suitable reflectors. The beam of ultra-high-frequency waves travels

in a straight line, and it can pierce fog, smoke, and clouds which would stop a light beam.

Sperry-developed Klystron tubes are used in many equipments now serving our Armed Forces. Later, *Klystronics* will open the door to the development of many ingenious peacetime devices.

► Klystrons are now being produced in quantities, and certain types are available.

The name "KLYSTRON" is a registered trade-mark of the Sperry Gyroscope Company, Inc. Like many other Sperry devices, Klystrons are also being made during the emergency by other companies.

Sperry Gyroscope Company
INC.

GREAT NECK, N. Y. • DIVISION OF THE SPERRY CORPORATION

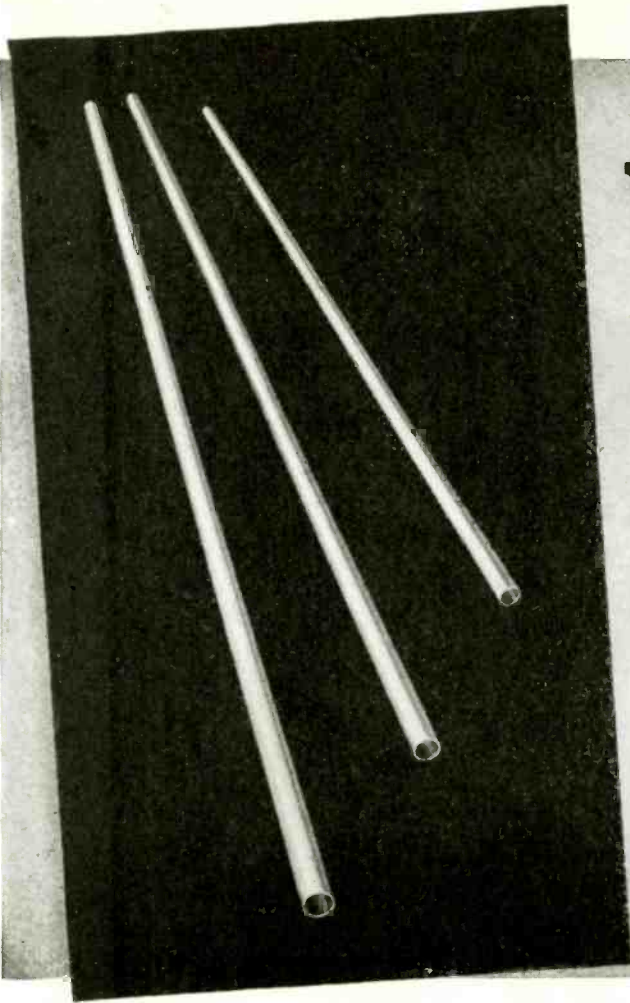

WILCO ANNOUNCES

Larger Plant

New Equipment

Increased Facilities

for producing

TUBING

The demand for Wilco tubing, wire and other products used in various electronic applications for the Army and Navy has caused the H. A. Wilson Company to increase its manufacturing facilities and develop new products and techniques. Both present and future customers will find these new Wilco developments of great advantage.

The H. A. Wilson Company manufactures and is interested in receiving inquiries regarding the following products—

WILCO RADIO TUBING

Silver Tubing (Fine, Coin, Sterling)
Gold Tubing (any karat)
Gold on silver (on one or both sides)
Gold on bronze (on one or both sides)
Silver on copper (on one or both sides)
Tubing made to order from special materials or any combination of materials.

WILCO RADIO WIRE

Silver (Fine, Coin, Sterling)
Silver-jacketed Invar
Silver-jacketed Brass and Bronze
Silver-jacketed Copper
Gold Wire
Gold on silver
Gold-jacketed Bronze and Brass
Any other type of jacketed wire desired

Let us analyze your problems. Write

THE H. A. WILSON COMPANY

105 Chestnut Street, Newark 5, N. J.

Branches: Detroit • Chicago

UNITED TRANSFORMER COMPANY

150 VARICK STREET



NEW YORK 13, N. Y.

S.F. BOWSER & COMPANY, INC.

BOWSER

Liquids Control Specialists

MOBILE REFRIGERATION DIVISION
NEW YORK OFFICE COMMERCIAL BLDG
189 EAST 42ND STREET

COPPER WIRE PRODUCTS
LIMITED

Manufacturers of Transformers, Janssen Speakers, Coil Windings

NEW YORK TRANSFORMER CO

26 WAVERLY PLACE



NEW YORK 3, N. Y.

GRANITEY 7-3077



AUDIO DEVELOPMENT COMPANY

DUgent 786

Manufacturers of
COMMUNICATION EQUIPMENT
2833 Thirteenth Avenue South
MINNEAPOLIS, MINNESOTA

AUTOMATIC AND REMOTE CONTROL EQUIPMENT

CONTROL CORPORATION

600 STINSON BOULEVARD MINNEAPOLIS 14, MINNESOTA

TELEPHONES:
804
1,808



Federal Telephone and Radio Corporation

RESEARCH LABORATORIES
67 BRAD STREET
NEW YORK 4, N. Y.
TELEPHONE BOWLING GREEN 9-3800

THE ROLA COMPANY INC.

TELEPHONE
FRONTVIEW 4242

Makers of the Finest in Sound Reproducing and Electronic Equipment

2530 SUPERIOR AVENUE
CLEVELAND 14, OHIO, U. S. A.



Meet our 9 best salesmen for Pyrex Metallized Bushings

WE could never pay these "salesmen" what they're worth! For it's companies like these who have discovered for you all the savings that Pyrex metallized bushings can bring. This unique method features a metallized layer that solders easily yet gives you a positive seal against leakage of oil, water, or air. With fewer parts and operations you save time and money on assembly. Best of all, Corning type metallizing can be applied to a wide range of glasses offering extreme resistance to thermal, mechanical, or electrical shock as needed.

This new metallizing method is just one of many ways Corning Research in Glass can help you. Let us send you full details of hermetic metallizing on glass plus a new booklet, "There Will Be More Glass Parts in Post-war Electrical Products." Write Electronic Sales Department I-8, Bulb and Tubing Division, Corning Glass Works, Corning, N. Y.

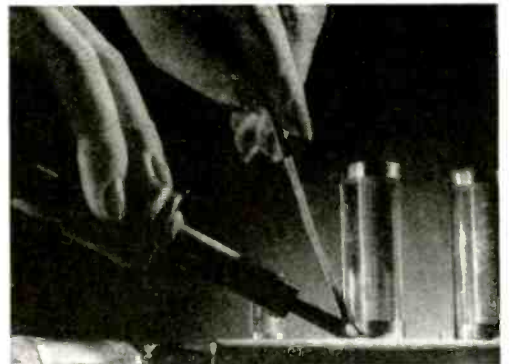

SOLDERING METAL TO GLASS is one of the things they said "couldn't be done". . . but many companies are now doing it every day. With Corning's method the base for the solder becomes part of the glass itself, providing a permanent hermetic seal.

CORNING
— means —
Research in Glass

Electronic Glassware



"PYREX" and "CORNING" are registered trade-marks of Corning Glass Works

Sound Engineering



Final test—Remler marine amplified sound transmitting equipment.

REMLER IS EQUIPPED with facilities for the mass production of complete announcing and amplified sound transmitting equipment; radio; plugs and connectors. Skilled technicians and vigilant inspectors check and re-check final products to meet rigid specifications. The facilities of this organization backed by twenty-five years of experience in the manufacture of electronic products and plastics, is at your disposal for further assignments.

REMLER COMPANY, LTD. • 2101 Bryant St. • San Francisco, 10, Calif.



PLUGS & CONNECTORS

Signal Corps - Navy Specifications

Types:		PL			NAF	
50-A	61	74	114	150		
54	62	76	119	159		
55	63	77	120	160		1136-1
56	64	104	124	291-A		
58	65	108	125	354		No.
59	67	109	127			212938-1
60	68	112	149			

PLP		PLQ		PLS	
56	65	56	65	56	64
59	67	59	67	59	65
60	74	60	74	60	74
61	76	61	76	61	76
62	77	62	77	62	77
63	104	63	104	63	104
64		64			

OTHER DESIGNS TO ORDER

REMLER

SINCE 1918

Announcing & Communication Equipment

NINE SEALED METAL-CLAD MICRO SWITCHES

used by REHNBERG-JACOBSON MANUFACTURING COMPANY
to control operation of this automatic drilling and reaming machine

Rehnberg-Jacobson Company of Rockford, Illinois, use nine sealed metal-clad Micro Switches at strategic points to control the operation of their Automatic Drilling and Reaming Machine. This machine drills and reams 20 holes in sequence in the reduction gear pinion carrier for an aircraft engine. The Type RN Micro Switches used are sealed against the entrance of oil, dirt, and chips.

The piece is held in a fixture mounted on a standard Rehnberg 20" automatic index unit which is controlled by an 11-step program wheel. On the first step, the reamers rest; on the last step, the drills rest. There are four horizontally-mounted heads, two for drills and two for reamers, paired alike to drill two holes and ream two holes simultaneously.

The five metal-clad Micro Switches, shown on the front of the machine, control the electrical circuit. The two innermost switches of the left hand group control the program of the drilling and reaming units. The third switch of the group, directly in front, terminates the machine cycle after all drilling and reaming operations have been completed. The lower right hand switch stops the automatic index motor after each index cycle is completed. The upper right hand switch permits the machine cycle to be started only at the proper position of the indexed table.

The four Micro Switches mounted above each of the four units of the machine electrically interlock the machine in such a way that should either the drills or the reamers fail to retract from the work, the automatic index table will not index and break the tools.

Rehnberg-Jacobson Company's use of Micro Switches for this important operation is typical of the many uses which design engineers are finding for this tiny, accurate, snap-action electric switch. They find that, more than any other, it meets modern needs for a switch to control substantial amounts of power yet operate in small space.

Thousands of special housings, actuators and electrical characteristics... more than 2700... are available to meet almost every design problem. Send for Micro Switch Handbook-Catalog No. 60 today for full particulars. If your design is for aircraft, send for Handbook-Catalog No. 70 also.

"Uses Unlimited"—a dramatic talking motion picture of Micro Switches, in color, is available to industrial groups, training classes, schools and colleges, through Y.M.C.A. Motion Picture Bureau, New York, Chicago, San Francisco. Size: 16 mm. Length: 40 minutes. Write us for details.



Let's All Back the Attack—
Buy EXTRA War Bonds

The trademark MICRO SWITCH is our property and identifies switches made by Micro Switch Corporation

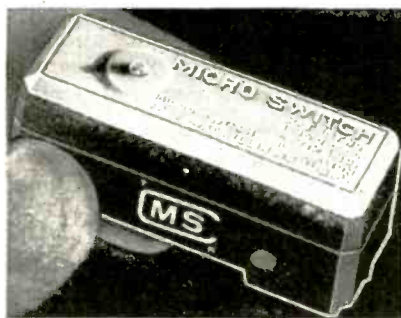
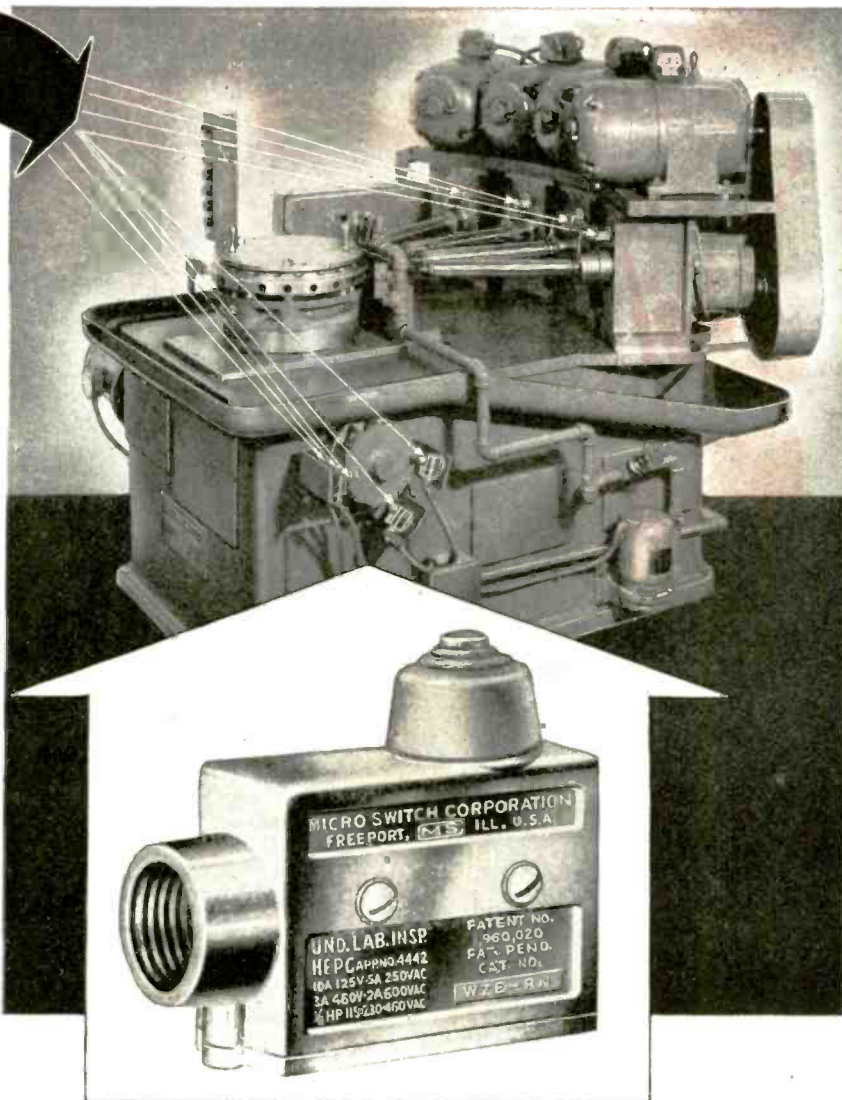

The basic Micro Switch is a thumb-size, feather-light, plastic enclosed, precision, snap-action switch, Underwriters' listed and rated at 1200 V.A. at 125 to 460 volts a-c. Capacity on d-c depends on load characteristics. Accurate repeat performance is experienced over millions of operations. Wide variety of basic switches and actuators meets requirements varying from high vibration resistance to sensitivity of operating force and motion as low as 2/1000 ounce-inches. Many types of metal housings are available.

Micro Switch Corporation, Freeport, Ill.

Branches: 43 E. Ohio St., Chicago (11) • 4900 Euclid Ave., Cleveland (3)
11 Park Pl., New York City (7) • 1709 W. 8th St., Los Angeles (14)
Sales & Engineering Offices: Boston • Hartford • Portland, Ore. • Dallas, Tex.

MICRO  SWITCH

Made Only By Micro Switch Corporation . . . Freeport, Illinois, U. S. A.

© 1944

TRIGNITROL

..for greater efficiency in welding!

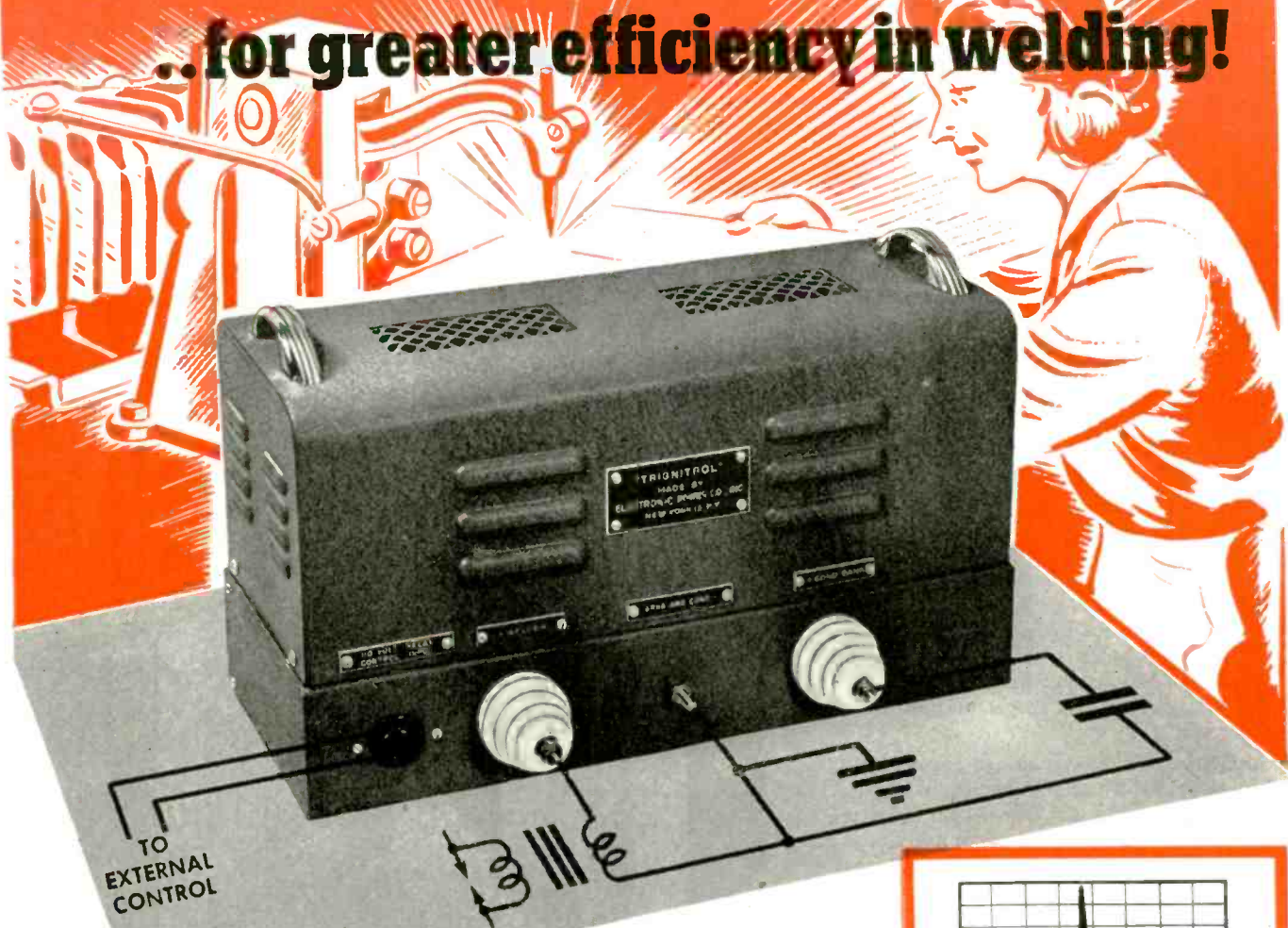

- COMPLETE, READY FOR USE
- NO MECHANICAL PARTS
- BETTER, FASTER WELDS

The TRIGNITROL is a silent, positive acting, economical electronic switch. Designed to supersede mechanical switching on Capacitor Welders, it instantly and completely discharges the condenser bank through the welding transformer. This instantaneous peaked discharge welds with minimum damage to metal grain structure and no burning of surrounding metal. Further, the total capacitance required is substantially reduced.

For unfailing action, the TRIGNITROL utilizes the TRIGNITRON, a new mercury pool conduction tube, fired capacitively by a low

power trigger circuit. The control circuit must be reopened before the TRIGNITROL will recycle but speed of operation is only limited by the condenser recharging interval. The TRIGNITRON is immune to flashback and oscillatory discharges—expensive preventative circuits are not required.

Self contained, attractively housed, only four simple connections are required for immediate installation. Power supply is standard 110 or 220 volt, 60 cycle A.C. Prompt delivery is assured on rated orders—quotations on request.

This device and the TRIGNITRON used therein are licensed for exclusive use in welding equipment under the U. S. Pat. 2,287,541. Other pats. pending.

ELECTRONIC
19 WEST 44th STREET



POWER CO.,
NEW YORK 18, NEW YORK



INSTANTANEOUS PEAK
POWER TO THE WELDER

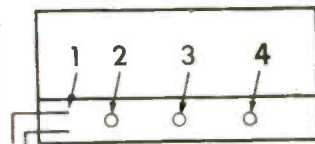

APPLICABILITY PLUS
ONLY FOUR CONNECTIONS

COMPACT
PORTABILITY



A New G-E COMPONENT

LECTROFILM CAPACITORS

Their high dielectric strength assures dependability

Lectrofilm* capacitors are excellent for radio-frequency blocking and by-pass applications where "Q" and temperature coefficient are not critical. Many thousands have been proved in G-E radio equipment now in use on every battle front. Among their outstanding features are the following:

Wide operational margin insures dependability—note the high ratio of d-c test voltage to d-c working voltage shown in table.

Dependable operation over a wide range of ambient temperatures—from minus 55 C to plus 85 C.

Mechanically interchangeable with mica capacitors of the same ratings built to American War Standards (C-75.3—1942) in case sizes CM 60, 65, and 70.

Dense, strong, and moisture-resistant cases made of a distinctive-green, low-loss plastic. The case-60 type is molded under high pressure and high temperature; the case-65 and case-70 types are potted with a special G-E compound, selected for its moisture resistance and stability at high temperature. Lectrofilm capacitors will pass the above American War Standards thermal-cycle tests without difficulty.

For information on "Q," temperature coefficient, and r-f current-carrying capacity, ask for Bulletin GEA-4295. General Electric Company, Schenectady 5, N. Y.

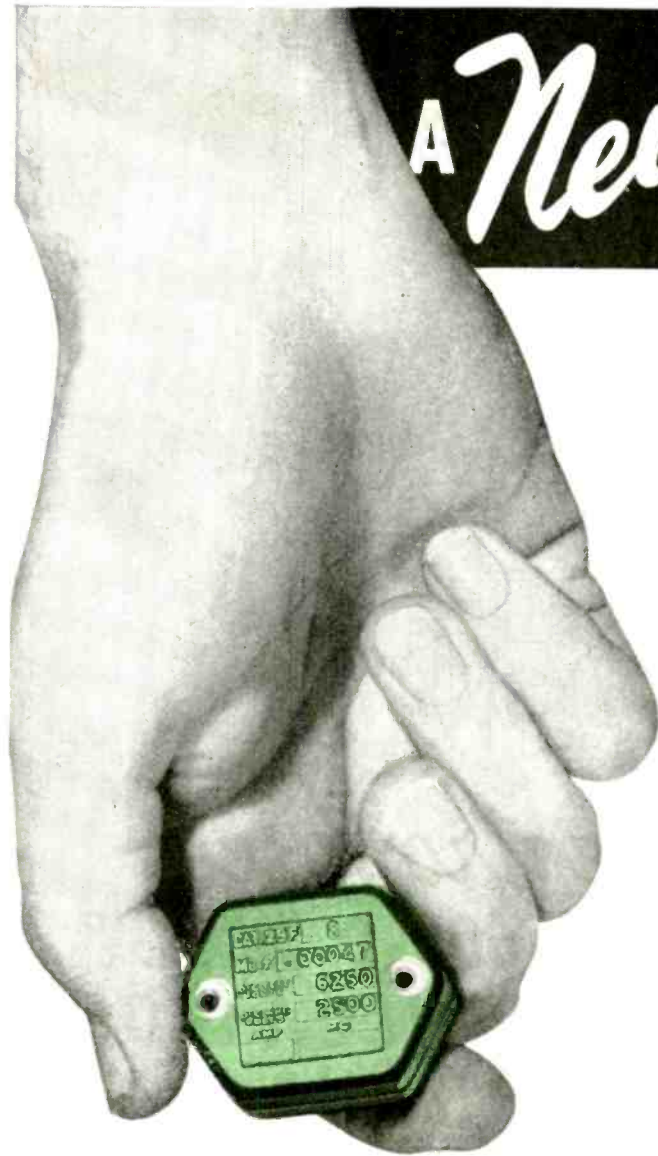

RATINGS CURRENTLY AVAILABLE IN CASE-60 TYPE SHOWN ABOVE

Micromicrofarads †	D-c Working Voltage	D-c Test Voltage	Cat. No.
100	2500	6250	29F21
150	2500	6250	29F22
220	2500	6250	29F23
330	2500	6250	29F24
470	2500	6250	29F8
680	2500	6250	29F9
1000	2500	6250	29F10
1500	2500	6250	29F11
2200	2500	6250	29F12
3300	2500	6250	29F13
4700	2500	6250	29F16
6800	1200	3000	29F25
10000	1200	3000	29F26

†Capacitance tolerance ± 10 per cent. Capacitance temperature coefficient approximately 700 parts per million per degree C, as measured at 1000 cycles over a temperature range of minus 40 C to plus 86 C.

*Lectrofilm is General Electric's new synthetic dielectric made from materials that are available in the United States.

Illustration shows case 65 or 70 type. Bulletin GEA-4295 lists ratings available

Buy all the BONDS you can
—and keep all you buy



GENERAL ELECTRIC

407-78-6700



NEW!
Electro-Voice
Model 600-D HAND-HELD
MOVING COIL
**COMMUNICATION
MICROPHONE**
(REPLACING MODEL 600-C)

FOR MOBILE RADIO TRANSMITTERS AND SOUND EQUIPMENT

- Resistant to high humidity, wide temperature ranges, mechanical shock and vibration
- Frequency curve scientifically designed for highest articulation through interference and background noise
- The new Electro-Voice Model 600-D is available in high or low impedance output
- Lightweight, can be held for long periods without fatigue
- Shock-proof, high impact molded phenolic case
- Press-to-talk switch (switch-lock optional) for relay operation, with choice of switching circuits

To the growing list of Electro-Voice developments, we now add the Model 600-D which may be adapted to a number of essential civilian applications. Built to rigid wartime specifications, it reflects the painstaking care of the Electro-Voice design laboratory. Electro-Voice Microphones serve you better . . . for longer periods of time.

If your present limited quantity needs can be filled by any of our Standard Model Microphones, with or without minor modifications, please contact your nearest radio parts distributor.

**PAPER PACKS A WAR PUNCH . . .
..... SAVE EVERY SCRAP**

ELECTRO-VOICE MANUFACTURING CO., INC. • 1239 SOUTH BEND AVENUE • SOUTH BEND, INDIANA
Export Division: 13 East 40th Street, New York 16, N. Y. — U. S. A. Cables: ARLAB

Obvious Quality

VISUAL

Clean cut mechanical nicety literally radiates from these UNITED mercury rectifiers. It is only natural that their eye appeal impresses the exacting minds of so many government and commercial users.

TEST

The physical ruggedness and sterling workmanship in these tubes reveal the kind of care and precision that has entered into the electrical phases of their design. They are criterions, rather than ordinary conformers to the constantly stiffening Army and Navy test specifications—both mechanical and electrical.

SERVICE RECORDS

Representative service records maintained over a period of 10 years by large users prove an average of many thousands of hours satisfactory operating life.

THERE IS NO SPECULATION IN CHOOSING UNITED
MERCURY RECTIFIERS

UNITED

MERCURY RECTIFIERS



UNITED ELECTRONICS COMPANY • NEWARK 2, N. J.

Transmitting tubes exclusively since 1934



The UNITED types illustrated will interchange with and replace other type tubes as follows:

USE UNITED TYPE	957	to replace	9G-17
" " "	972-A	" "	872-A
" " "	LX-973	" "	
" " "	973 (Not illustrated)	873	

The Trend is to

MYKROY
PERFECTED MICA CERAMIC INSULATION

Now used *Exclusively* for Ceramic Insulation
in **FERRIS INSTRUMENTS**

Ferris Instruments, world famous signal generators, set the standard for the entire electronic industry by maintaining accuracy to within 0.01 percent. Insulation specifications for an instrument of Ferris' perfection are consequently of the highest order.

4 REASONS WHY FERRIS ENGINEERS SELECTED MYKROY

- (1) Despite wide temperature swing, the insulation must unflinchingly maintain low loss factor.
- (2) No change in dielectric constant can be tolerated.
- (3) Physical stability must be assured to prevent changes in inductances and capacitances.
- (4) The ceramic must have great mechanical stability to carry safely the load of rugged Ferris construction.

For these most exacting insulation specifications MYKROY "fills the bill" dependably.

Ferris engineers are particularly satisfied with MYKROY because it can be machined to closest tolerances permitting them to make spot changes in structural design rapidly and easily in their own shop. Though your own H-F designs may not embrace such critical standards, it is wise to use MYKROY for dependably high results.

(Illustrated) 20-250 Megacycle Ferris Standard Signal Generator

SEND FOR YOUR FREE COPY OF THE MYKROY ENGINEERS MANUAL containing the newest facts about the improved insulation. A request on your letter-head will bring your copy by return mail.

MYKROY IS SUPPLIED IN SHEETS AND RODS . . . MACHINED OR MOLDED TO SPECIFICATIONS

MADE EXCLUSIVELY BY **ELECTRONIC MECHANICS INC.** 70 CLIFTON BOULEVARD • CLIFTON, NEW JERSEY
Chicago 47: 1917 NO. SPRINGFIELD AVENUE . . TEL. Albany 4310
Export Office: 89 Broad Street, New York 4, N. Y.

AMPHENOL -

FRIEND OF YESTERDAY'S "HAMS"...

*... Now
Radar
Radio
Experts*



Back in the days when thousands of home basements sheltered embryo radio research laboratories, "Amphenol," stamped on a plug, socket or knob, meant a "good job." The "hams" learned the value of quality the *hard* way, and after the first disappointments saved their dimes and quarters to buy the better job identified by "Amphenol."

Now these "hams" are grown-up sergeants, emsigns, lieutenants, captains. They are communications officers, radio technicians, members of the secret radar fraternity, or concerned in some of the other wartime uses of electronics. Many of them are getting to foreign countries in person instead of by airwave. But wherever they are, "Amphenol" is with them—on cables, on wiring assemblies, connectors, sockets. To them Amphenol quality today has a new meaning, a more important personal dependability, in the electrical and electronics equipment they use in battle.

They will bring home their battle experience to the new radio sets, television, frequency modulation, the electronic and electrical developments to follow V-Day. Quality parts will be made by an equally war-seasoned and broadened Amphenol—a leader wherever electronic and electrical equipment are used.

Depend upon

AMPHENOL

Quality

CONNECTORS
FITTINGS
CONDUIT
CABLE
RADIO
PARTS
SYNTHETICS
AMERICAN PHENOLIC CORPORATION
1630 S. 54th Avenue, Chicago 50, Illinois

Standard of Excellence

Bliley Crystal Units are doing a great wartime job. Increased engineering knowledge, expanded facilities, and improved production techniques have emerged from this effort. This wartime experience will be reflected in peacetime application.

Bliley Crystals will again take their rightful place with their pre-war record of dependability, accuracy and user acceptance. Not counting applications covered by wartime secrecy necessities, there will be Bliley Precision-made Crystals for diathermy, ultrasonic generators, pressure gauges, carrier-current communications systems, radio frequency filters, and precision interval timers. And, of course, in greater quantities than ever before, frequency controlling crystal units for all radio communication necessities, F. M. or A. M., fixed, portable, mobile or air borne. As always, Bliley Engineers are ready to extend their assistance to you . . . call on them freely.

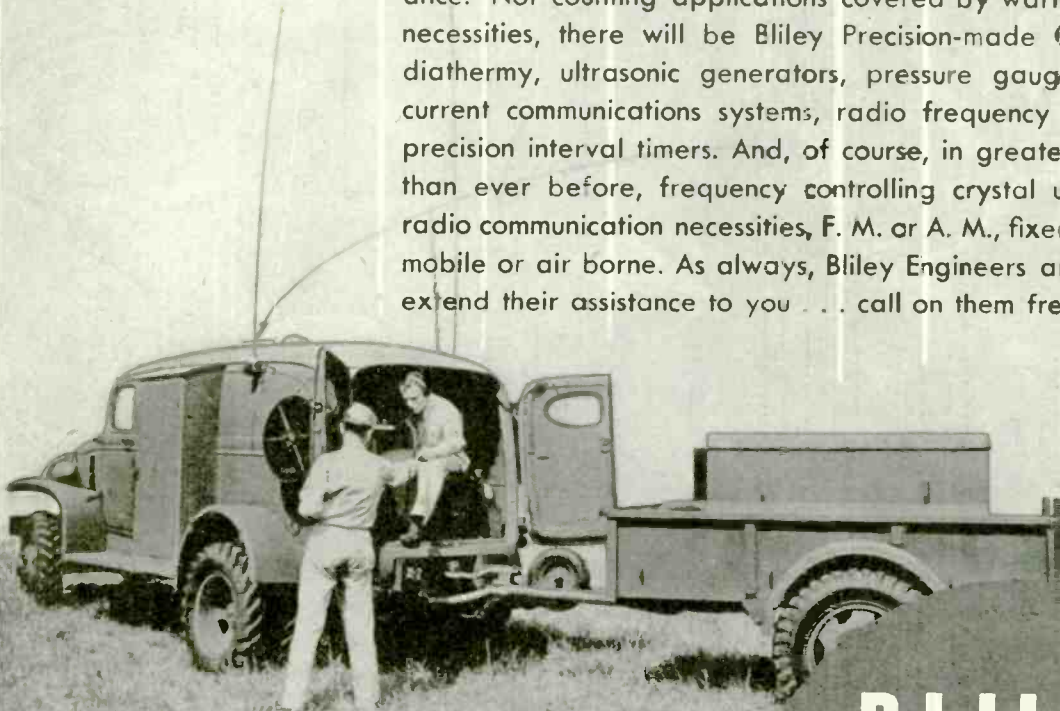

OFFICIAL SIGMA CORPS PHOTO
SCR-299 MOBILE RADIO STATION

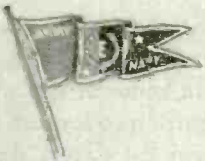

**BLILEY
CRYSTALS**
Accurate
Dependable

BLILEY ELECTRIC COMPANY . . . ERIE, PA.



Bliley Crystals





ARE YOU MOVING FORWARD WITH HIM ?

It's been mighty tough going every inch of the way for him . . . trudging over the burning sands of African deserts . . . sloughing through the steaming jungles of the South Pacific . . . crawling over the jagged rocks of Italy . . . and now, cutting a blood-paved path to Paris!

When he comes back, he will expect to find a better world waiting for him than the one he left to go out and fight for . . . and he has a right to expect it!

That's why it is our sacred obligation to plan for him and his future now. We must be ready to convert to peacetime production . . . ready to start building that better world . . . a world in which there will be a well-deserved place for him.



★ BUY MORE THAN BEFORE . . . BONDS



MAGUIRE INDUSTRIES, INC.

ELECTRONICS
division

No industry can afford to overlook Electronics when planning new production methods . . . for in Electronics will be found the key to the streamlining of many processes by automatic "magic eye" controls.

GREENWICH • STAMFORD • BRIDGEPORT • NEW MILFORD • NEW YORK

ELECTRONIC INDUSTRIES • August, 1944

**IN THIS "SPOT" - I'M
GLAD THEY'RE TUNG-SOL**

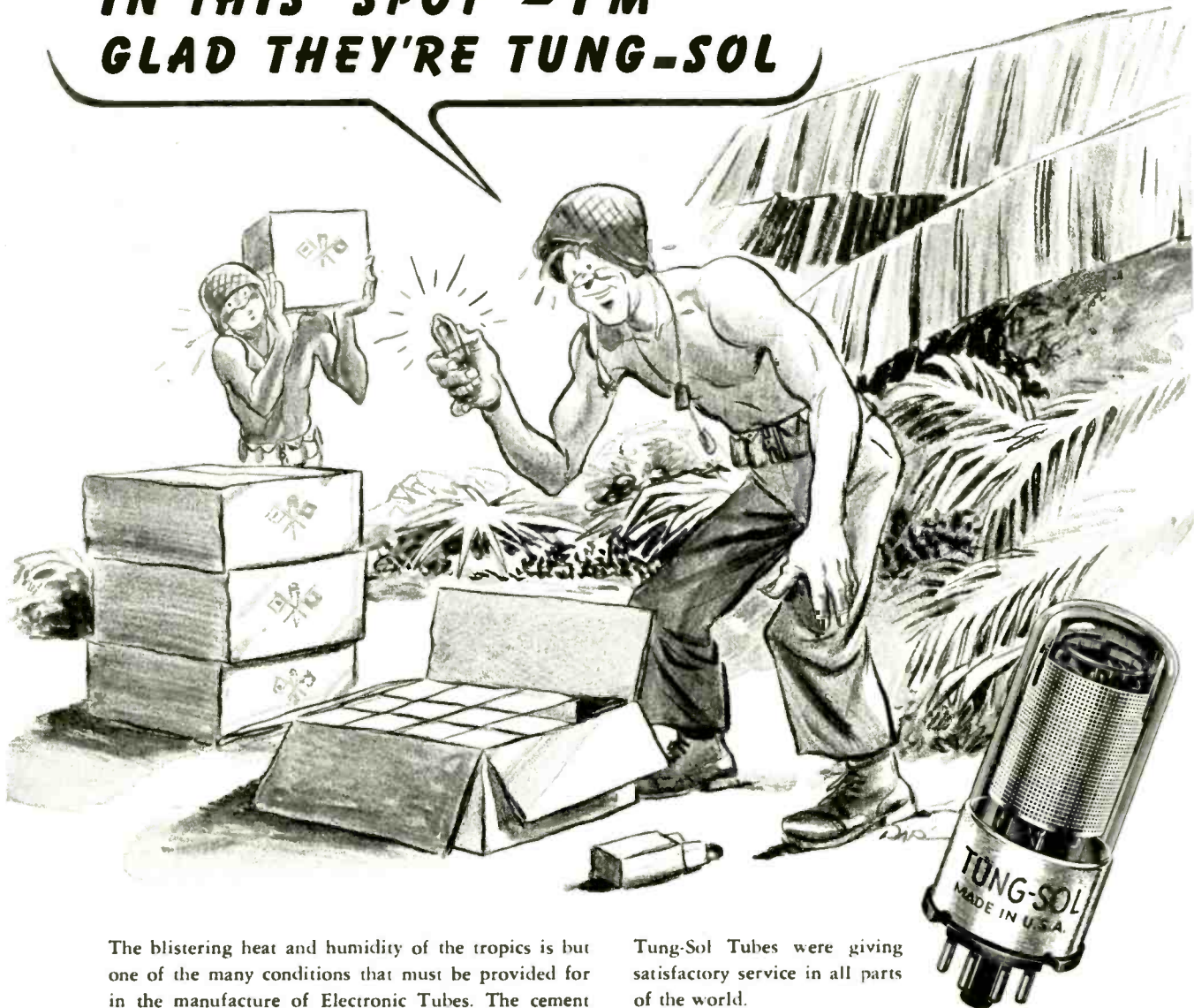

The blistering heat and humidity of the tropics is but one of the many conditions that must be provided for in the manufacture of Electronic Tubes. The cement used to secure the bases to the glass must not loosen under the high temperatures and humidity. This is why the Army and Navy insist on a rigid "tortion-test" of all bases and top caps.

A tough test . . . sure it's tough . . .

The importance of the resistance of the cement, to heat and humidity, has always been recognized by Tung-Sol quality control engineers. Before the war,

Tung-Sol Tubes were giving satisfactory service in all parts of the world.

Many new types of tubes for sending, receiving and amplifying have been developed that will be available to civilians. War has proved the dependability and efficiency of TUNG-SOL Electronic Tubes. While present facilities are now devoted entirely to war work, our engineers are interested in your plans for post-war products that will use Electronic Tubes.

THE "TORTION-TEST" FOR SECURITY OF BASES

The tube is subjected to tropic-like heat and humidity for 18 hours, then room temperature for one hour. It is then inserted in a swivel base with a weighted arm. The tube must withstand this terrific twisting strain without the base becoming loose from the glass.

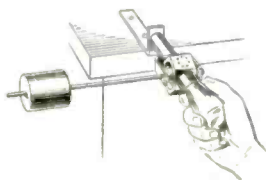

TUNG-SOL
vibration-tested
ELECTRONIC TUBES



TUNG-SOL LAMP WORKS INC., NEWARK 4, NEW JERSEY

ALSO MANUFACTURERS OF MINIATURE INCANDESCENT LAMPS, ALL-GLASS SEALED BEAM HEADLIGHT LAMPS AND CURRENT INTERMITTORS

WE CAN'T BUY 'EM — SO WE BUILD 'EM

Cannon Quality Control requires tools and dies of exceptionally close tolerances. So to meet our standards we make our own.

That's doing it the hard way but it's worth it. For now we have a tool and die manufacturing plant second to none in precision, accuracy and general excellence of product.

It's an organization of skilled tool makers, none with less than seven years experience. These expert craftsmen work with the best equipment and the finest materials. It is a big plant with a capacity many times our ordinary needs. But this production margin means better tools, more efficient machines, replacements long before exhaustion and thus, of course, connectors we're proud to identify with the Cannon trade mark.

CANNON ELECTRIC

Cannon Electric Development Co., Los Angeles 31, Calif.

Canadian Factory and Engineering Office: Cannon Electric Co., Ltd., Toronto

Representatives in principal cities — Consult your local telephone book

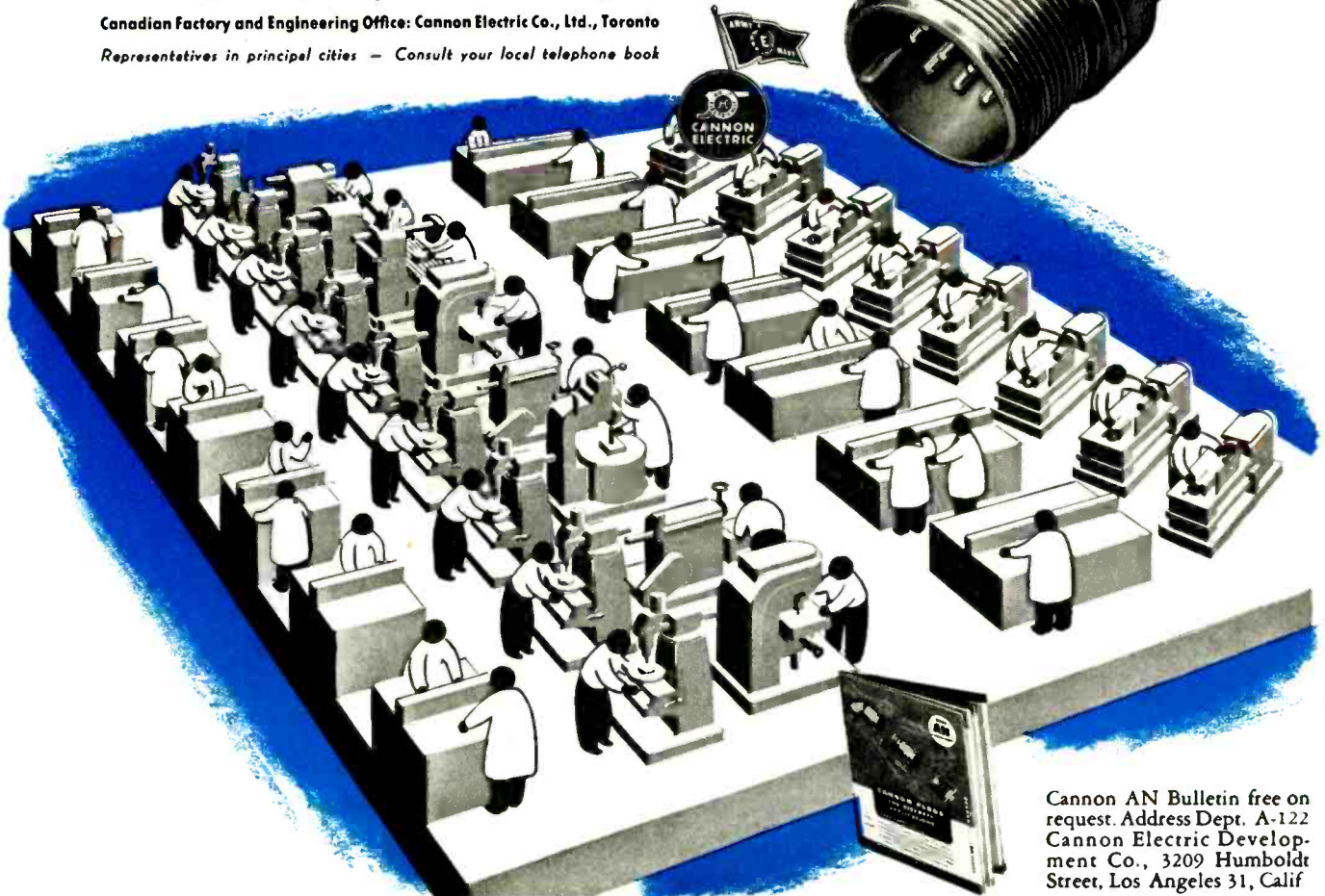

Cannon AN Bulletin free on request. Address Dept. A-122 Cannon Electric Development Co., 3209 Humboldt Street, Los Angeles 31, Calif

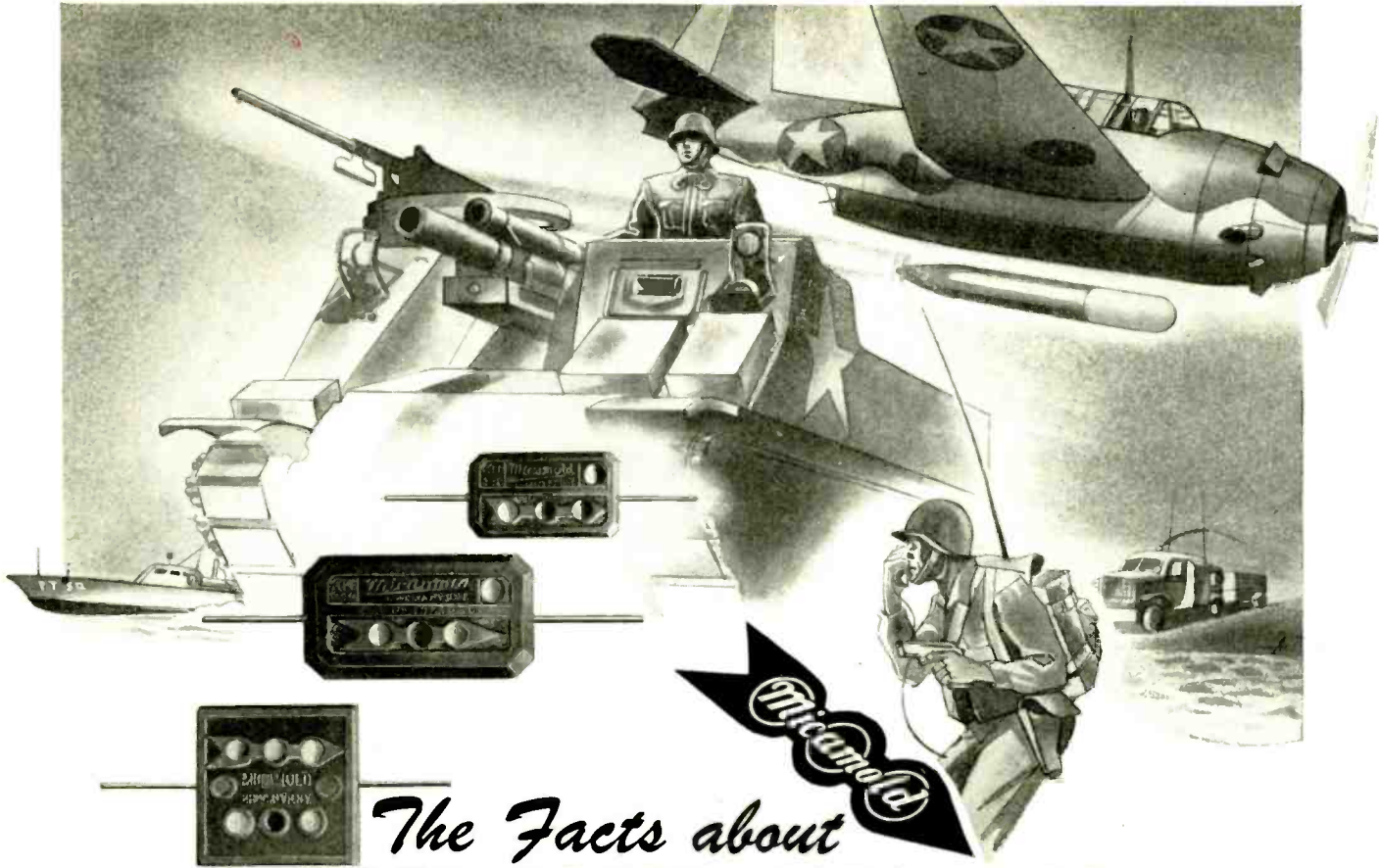

The Facts about MOLDED PAPER CAPACITORS

MOLDED PAPER VERSUS MICA CAPACITORS

—wartime equipment has definitely proven the ability of Micamold Molded Paper Capacitors to function satisfactorily in by-pass, coupling and filter applications above .001 mfd. As strategic mica is scarce, Micamold Molded Paper Capacitors not only fill the breach but materially assist in maintaining the flow of equipment to the Armed Services.

MOLDED VERSUS METAL HOUSED PAPER CAPACITORS

—here again Micamold Molded Paper Capacitors serve as adequate alternates for capacities of .25 mfd. or less. As compared to metal encased paper capacitor the plastic molded types save space, weight and cost.

IN BOTH CASES

—considerable economies in time, labor and materials have resulted. Manufacturers who utilize Micamold Molded Paper Capacitors instead of mica and metal housed paper types can effect substantial savings in their own production.

Manufacturing facilities have been further increased . . . prompt deliveries of large production quantities.

IF YOU HAVE A CONDENSER DESIGN PROBLEM, CALL ON MICAMOLD . . .

we design and build molded paper and mica, oil and electrolytic capacitors for all radionic and electrical applications. We will be glad to cooperate with you on any project . . . for war or postwar assignments.

NO LET-UP AND
NO LET-DOWN . . .
KEEP BUYING MORE
WAR BONDS

MICAMOLD RADIO CORPORATION
1087 FLUSHING AVENUE
BROOKLYN 6, N. Y.

There's no ONE-MAN-BAND in Electronic Heating

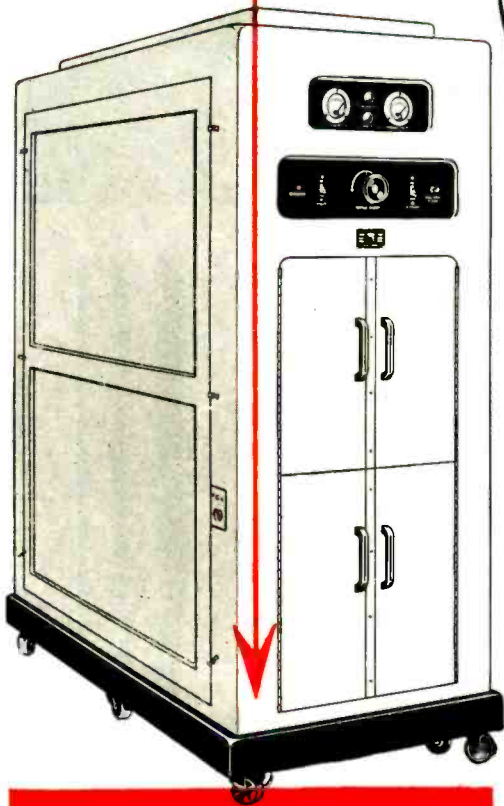

Although it is possible to construct an electronic heater that will generate a great range of high frequency currents, it will not perform *all* heating jobs efficiently and it would be very costly in use.

Virtually every application of electronic heating requires a specific **FREQUENCY AND POWER** combination. Therefore, to realize the maximum advantages of this improved heating method, *each installation should be designed and built for its particular application.* For example: when a heating operation can best be done at 5 kw and 22 megacycles it would be *wasteful and inefficient* to use a machine that delivers 20 kw at 500 kc.

Many first-time users of electronic heating are induced to buy "misfits" when they try to find an all-purpose machine. Our extensive line of equipment offers you the broadest range of power and frequency combinations at *prices lower* than other makes of comparable quality.

Investigate the production economies and advanced engineering designs offered by our greater variety of units . . . each one time-tested for high efficiency.

Before you buy write to us for detailed information

Scientific Electric



DIVISION OF "S" CORRUGATED QUENCHED GAP COMPANY
119 Monroe Street Garfield, New Jersey

Manufacturers of Vacuum Tube and Spark Gap Converters since 1921

Our equipment offers you a selection of frequencies up to 300 megacycles — and the following power range, with stepless control from zero to full load:

3 Kw
5 Kw
7½ Kw
10 Kw
12½ Kw
15 Kw
18 Kw
25 Kw
40 Kw
100 Kw



New Bit Life in 60 Seconds

AGAIN, and AGAIN, and AGAIN this one-minute operation will restore the CLUTCH HEAD Type "A" Bit to its original efficiency. Contrast the elimination of cost and delay attained by this simple application of the end surface to a grinding wheel . . . as against the expense and bother of "back-to-the-factory" shipment of bits for reconditioning. Consider also, the rugged structure of this Type "A" Bit . . . a factor that enables it to deliver a *longer uninterrupted spell of service* on the Line between reconditioning grindings. The definitely longer total life of CLUTCH HEAD Type "A" Drivers is an economy item that has a direct bearing on final production costs.

CLUTCH HEAD offers seven major features that contribute to faster, safer, and lower-cost production and service. You may examine and test these features right at your own desk. Ask us to *mail* you sample of this Type "A" Bit along with package assortment of CLUTCH HEAD Screws and illustrated Brochure. You will discover why CLUTCH HEAD is The Screw That Sells Itself.

This is the *only* modern screw that may be operated with the ordinary type screw-driver; even with a piece of flattened steel rod in emergency . . . so important in simplifying field problems in war and peacetime service.



Note the straight-walled Clutch matched by the straight sides of the Driver. No tapered entry to create ride-out tendency. No end pressure required. This means elimination of fatigue factor for sustained high production.



UNITED SCREW AND BOLT CORPORATION
CHICAGO CLEVELAND NEW YORK

CORNELL-DUBILIER pioneers its designs on the drafting board of experience



Through the years, Cornell-Dubilier has keyed its design to the needs and requirements of the radio and electronic industries.

When the accelerated demands of war came, C-D was prepared with the experience, the skills and the equipment needed. For 34 years C-D research engineers have been active partners with equipment manufacturers. To supply their requirements, C-D has expanded from one plant in 1940 to six plants today.

The tremendous increase in production has not affected the high quality of C-D Capacitors. Their inherent stamina has been battle-tested in countless war applications. The finest materials, the same care thru every step of construction, produces the dependability which makes C-D's the

choice of 4 out of 5 engineers. Consult us in the design stages of your product, we will gladly contribute our knowledge and experience. Cornell-Dubilier Electric Corporation, South Plainfield, N. J.

C-D HIGH POWER TRANSMITTER TYPE 59

For use as grid, plate blocking, coupling, tank and by-pass applications in high power transmitters. Low-loss, glazed ceramic cylindrical case. Can be mounted in any position. Series or parallel combinations obtained by bolting terminal ends together. Send for details.

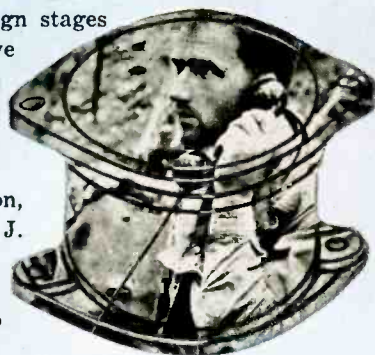

Cornell-Dubilier Capacitors



MICA • DYKANOL • PAPER • WET AND DRY ELECTROLYTICS
WORLD'S LARGEST MANUFACTURER OF CAPACITORS



**POWER SUPPLY
COMPONENTS
FOR WAR**

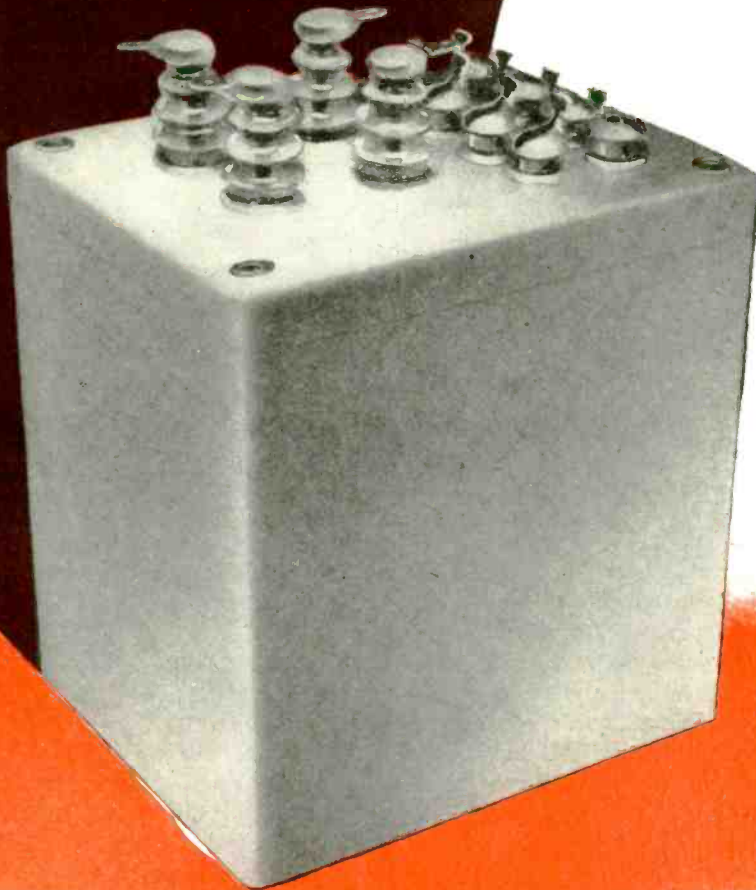

The complex power supplies of war apparatus require components of maximum dependability. The unit illustrated is a typical power transformer for cathode ray application. In addition to the tapped primary, this unit provides a low voltage filament winding . . . a 5,000 volt anode supply winding . . . and a filament winding insulated for 15,000 volts peak inverse.

For hermetic sealing this unit employs an all metal enclosure . . . glass seal terminals . . . sealing compound which neither cracks nor flows from -55°C to $+130^{\circ}\text{C}$.

May we cooperate with you on design savings for your applications...war or postwar?

United Transformer Co.

150 VARICK STREET

NEW YORK 13, N. Y.

EXPORT DIVISION: 13 EAST 40th STREET, NEW YORK 16, N. Y. CABLES: "ARLAB"

ELECTRONIC INDUSTRIES

Including INDUSTRIAL ELECTRONICS

O. H. CALDWELL, EDITOR ★ M. CLEMENTS, PUBLISHER ★ 480 LEXINGTON AVE., NEW YORK (17), N. Y.

Aluminum Available Soon

Aluminum is now ready for release from its wartime priorities, since military demands for the light metal have reached the mere replacement stage. This freeing of aluminum opens up an important material for radio and electronic manufacturing. Also it may be expected that aluminum will serve as a test pattern for the release of other critical materials, as rapidly as war needs slacken.

Simplification, Standardization

With millions of civilian radios soon to be manufactured, a golden opportunity now presents itself for an industry-wide program of simplification and standardization of the radio parts and components entering into initial equipment. Where, pre-war, hundreds of different types and models were demanded,—postwar, a dozen might serve better and more economically. Wartime standardization has shown the way. Now RMA should put civilian-parts simplification on a sound and permanent peacetime basis.

Would Cut Costs; Level Production

When special components and parts are demanded by the radio-set designer, the parts maker must put each order through as a special job. This is costly, and often best quality cannot be attained on such short runs. But standard parts of a simplified line can be produced during off-seasons for stock, making for lowest-possible unit prices. Such standard units also eliminate end-of-season surpluses and waste. And for jobber and repairman they reduce future inventories.

RR Communications Still Early American!

That recent derailment of the "Chief" in the southwest was a bad enough wreck to begin with, but for an uneasy few minutes it looked as if recent railroad history might repeat itself. Another crack passenger train was due, possibly to plow disastrously into the derailed cars.

We'd like to be able to report that the crew of the wrecked train signaled the oncoming flyer by radio, but such was not the case. According to the newspapers the frantic Indians and others aboard the "Chief" instead made a primitive signal pyre of oil-soaked mattresses. It was successful in stopping the second train, but we're sure there's a solemn moral here somewhere—for FCC, ODT and the 30 railroad applicants for communication channels.

Television "Lines" Not Everything!

In every art the merits of certain factors have come to be judged by rule-of-thumb grading. Oriental rugs, Panama hats, leaf tobacco, a person's optimum weight, and even the weather, are all frequently evaluated by one single factor. This is usually better than a blind-folded guess, but is not conclusive to say the least. The television battle, being fought out in the press and by appeals to non-technical laymen, is being judged solely on the number of lines in a television picture frame.

Other Video Factors

Since real quality can be obscured by many other effects, such as the prevalence of hum, noise effects, multiple images, contrast, halation, aspect ratio, background illumination, and many psychological effects that vary with each viewer, it is refreshing to look back on a report by prominent television experts (Aug. 1940 Proc. IRE, pages 343 to 350) showing experimentally the satisfactory picture quality to be obtained from even 441-line pictures, when these other and so-called incidental effects are missing.

Dip in the Research Curve

Research, which has been tremendously accelerated because of new technics required for the military, probably will have to slow down for the want of new blood. Colleges have been stripped of students. The brain crop is going to be short. True, we shall have a small army of more or less technically trained men coming back from the wars, but they, too often, have been trained to follow orders—and blueprints—rather than to think. Perhaps the researchers have enough projects in progress to allow a safe coast over the dip in the curve of original work.

Punch Paragraph for Sales Talk

A manufacturer of electronic combustion controls and safeguards against explosions, makes a very impressive comparison between mechanical and electronic devices, by analogy:

After you start an average 50-car freight train, 13 seconds elapse before the caboose is set in motion. But a word telephoned from New York is heard 1/67 of a second later in San Francisco.

In selling electronic equipment, one of the strongest cards in your deck is the vacuum tube's split-second obedience.

MEASUREMENT OF STATIC

by C. E. GRINSTEAD, R. N. FRAWLEY,
F. W. CHAPMAN and H. F. SCHULTZ

Research Laboratories Division, General Motors Corp.

Improved type capacitor indicator for determining engine pressures has many industrial possibilities

● The important requirements of an ideal engine pressure indicator and its associated amplifying and recording equipment are:

1. It must give a linear and undistorted response to any instantaneous pressure encountered in an engine.
2. Its natural frequency must be well above any frequencies to be measured.
3. It must have an accurate predetermined calibration that will not be affected by temperature, time, fatigue, or external forces such as vibration, or shock.
4. It must be insensitive to all forces except the pressures applied to the diaphragm, that is, it must not pick up engine vibrations. This means that the moving element must have low mass.
5. It must be capable of indicating an atmospheric or any other desired pressure datum line.
6. It must be small in physical structure in order that it may be easily installed in modern engines.
7. It must be reasonably simple to operate.
8. It must be capable of recording pressures during a single engine explosion.

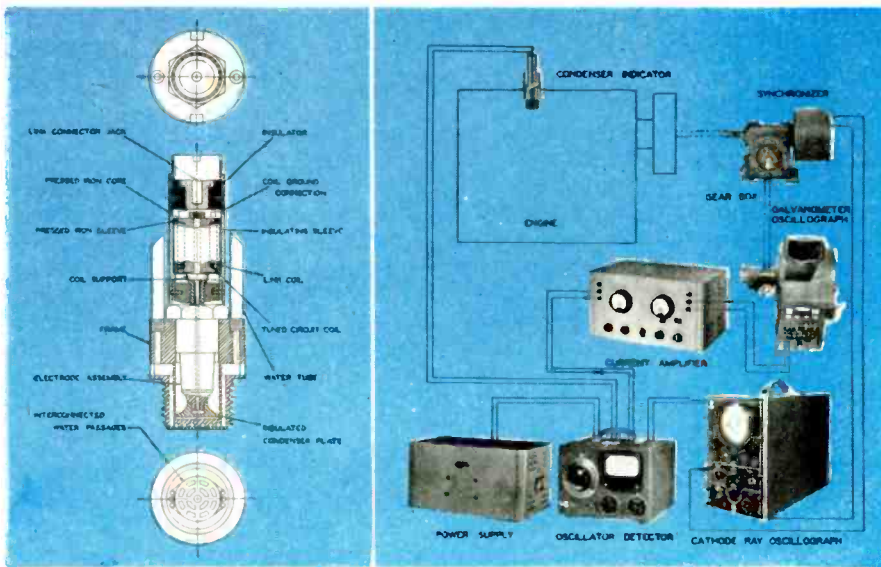
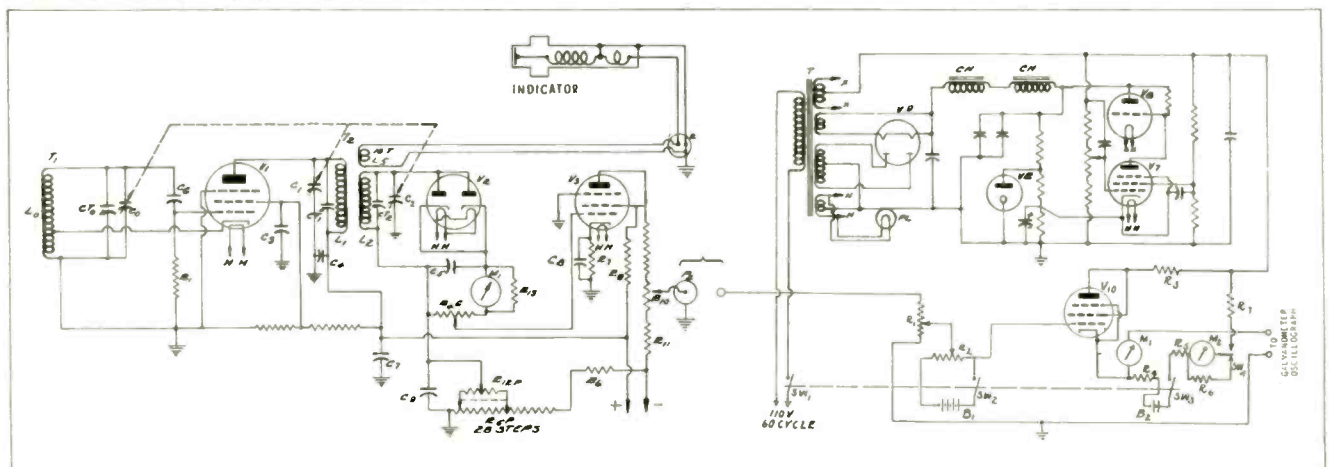

Fig. 1—Common form of capacitance variation pressure indicator. Fig. 2 (Right)—Complete pressure recording system

Fig. 3—Capacitance-variation converter and potential amplifier (left) with pressure-actuated C_v and L_v-L_1 mounted in indicator. Current amplifier circuit used with associated recording oscillograph (right)



and DYNAMIC PRESSURES

which is easily serviced, has a high natural frequency, and is relatively insensitive to shock and vibration. No mechanical linkage is required between the pressure diaphragm and the electrically sensitive element.

Some of the limitations of such equipment were overcome by using a resonance circuit in conjunction with the capacity-variation type of indicator developed in the General Motors Research Laboratories, one form of which is shown in Fig. 1. One limitation found with earlier equipment was that the capacitance of the connecting cable was in parallel with the capacitance of the pressure indicator itself, and so the effectiveness of the latter was obscured by changes in cable capacitance such as might be produced by vibration, etc.

To minimize this difficulty, it was necessary to use low-capacitance cable in short lengths only. This limitation required that part of the electrical equipment be mounted near the indicator which in some applications was inconvenient, if not impossible. To provide for remote location of the electrical equipment, an improved electrical circuit has been developed which utilizes low impedance link coupling between the indicator and the electrical equipment. Cable lengths up to 100 ft. have been used satisfactorily.

Figs. 2 and 3 show the general arrangement and the circuit of the equipment. The indicator illustrated has been drawn in its elementary form for simplicity. The capacitance formed by the diaphragm and the insulated electrode is altered by the pressure on the diaphragm.

The operation is based on the response of a tuned circuit L_2C_2 to a constant frequency as modified by changes in the absorption caused by the resonance conditions in a third circuit L_3C_3 linked to it. In this circuit a coil, L_3 (Fig. 3) has been built as an integral part of the indicator assembly. The coil, L_3 , is connected in parallel with the indicator capacitance, C_3 , to form a tuned circuit with a resonance frequency of approximately 600 kc. The tuned circuit, L_3C_3 , is close-coupled to the tuned circuit L_2C_2 by means of the link coils L_4 and L_5 which are connected together by means of a low impedance (approximately 70 ohms) untuned cable. Changes in cable capacitance, such as produced by vibration, are negligible when reflected into the high

impedance tuned circuit. Therefore, long cables can be used satisfactorily between the indicator and the electronic units.

In the interests of simplicity of design and rigidity of construction, no provision has been made for changing the resonant frequency of the circuit L_3C_3 . Therefore, it is necessary to tune the oscillator and detector circuits simultaneously to the resonant frequency of the indicator with ganged capacitors.

The tuning characteristic of the link coupled circuit is shown in Fig. 4. The operating range is the linear section midway between the maximum and minimum readings obtained.

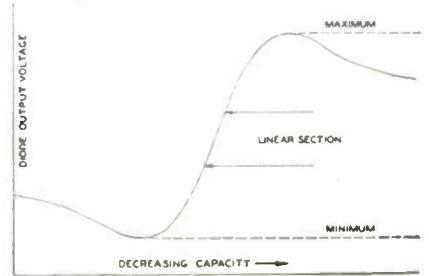

Fig. 4—Characteristic curve showing conversion of capacitance variations into potential changes

The cutaway view of the latest type of indicator Fig. 1, shows that it consists of four principal parts: (1) a water-cooled frame and dia-

Fig. 5—Calibration curves of typical pressure units with commonly-used diaphragm thicknesses

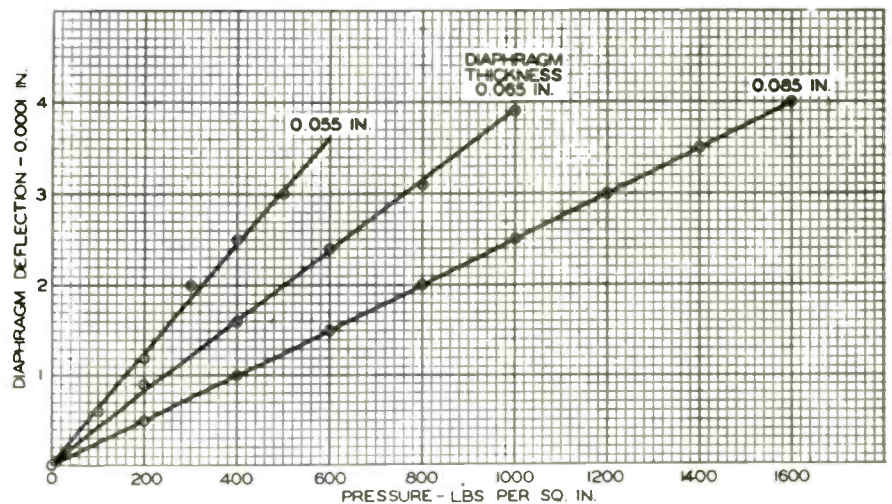
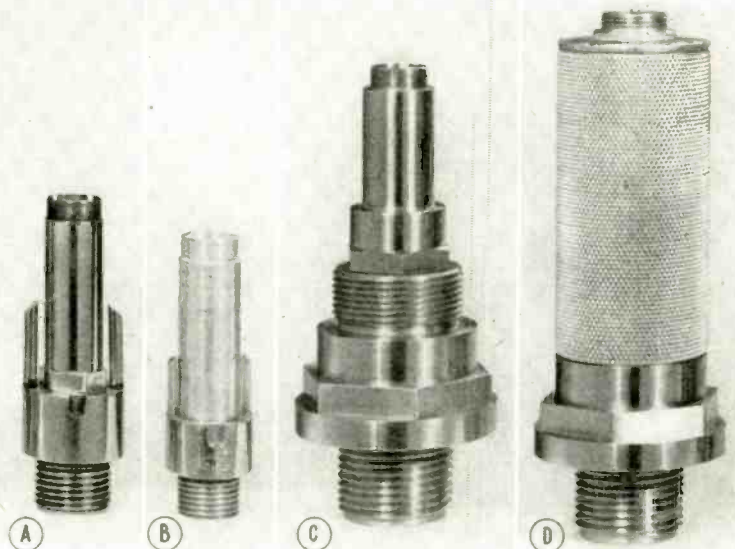

Fig. 6—Representative types of capacitive converters. Water-cooled indicator of high pressure type for standard (18 mm.) threads (A), 14 mm. threads (B), one inch threads (C) and (D), the latter showing the protective sleeve



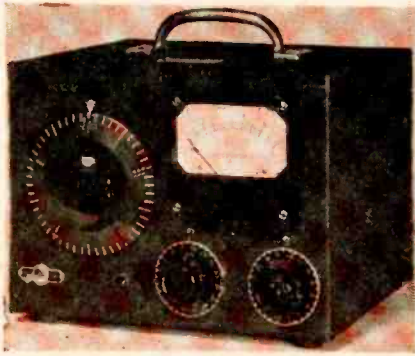

Fig. 7—Oscillator-detector equipment

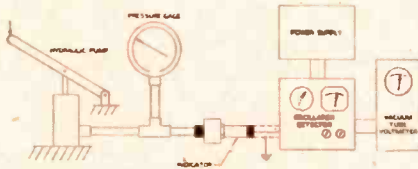

Fig. 8—(Center) Calibration system for static pressure characteristics. Fig. 9—Balanced diaphragm unit for high pressure studies

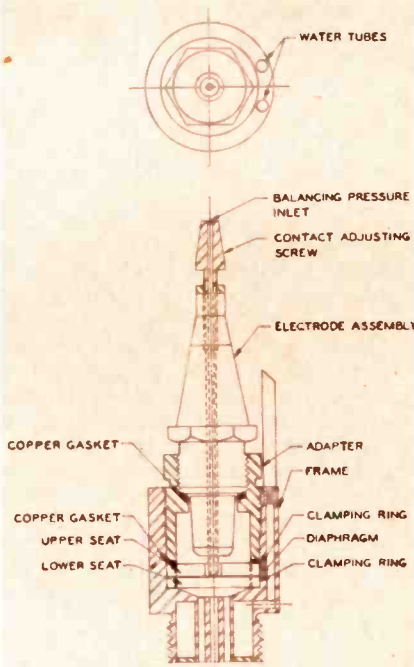
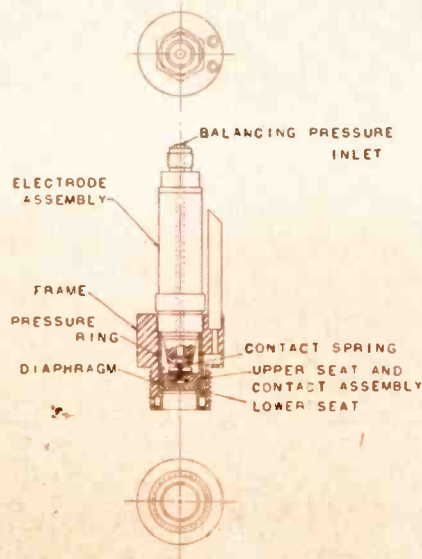
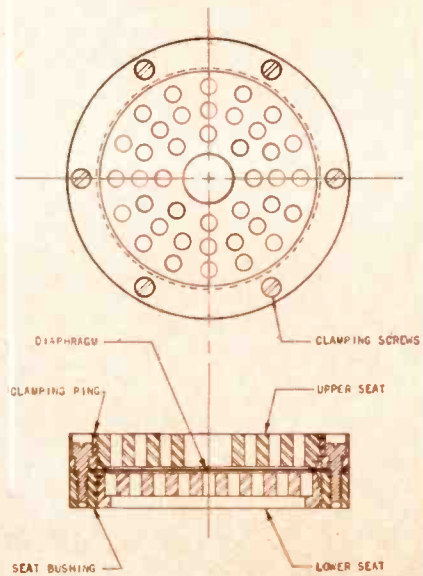

Fig. 10—(Above) Water-cooled balanced diaphragm unit for lower pressures, with enlarged view of diaphragm assembly, Fig. 11 (below)



phragm, (2) an insulated fixed plate and electrode assembly, (3) a coil assembly, and (4) an electrode shield and cable connector. The frame and diaphragm form an integral unit which is machined from a solid piece of Invar steel. Invar is used to minimize the effect of temperature changes in the diaphragm. Water cooling keeps the temperature of the indicator within the range where the low thermal coefficient of Invar is realized.

The water cooling of the diaphragm is an important design feature. After passing through the frame, the water flows through a series of interconnected concentric grooves machined on the bottom

side of the heavy diaphragm which is sealed by a thin disk, copper-brazed in place. This construction makes the thin sealing disk an integral part of the heavy diaphragm, and thus eliminates any mechanical joints or linkages. The diaphragm is also extremely sturdy.

In order to minimize extraneous capacitance changes in the indicator assembly and the oscillator detector unit, it is desirable to have a large capacitance change in the pressure sensitive portion of the indicator. Since the capacitance between parallel plates varies as an inverse function of spacing, it is necessary to select a diaphragm thickness so that its movement is limited to approximately 15 percent

of the initial air gap in order to obtain approximately linear response. Considering the natural frequency of the diaphragm, its elastic properties and limited diameter, a maximum diaphragm movement of 0.0003 in. was chosen. An air gap of approximately 0.003 in. was selected to obtain adequate initial capacitance, sensitivity, and linearity. The initial capacitance and sensitivity of the indicator is further improved by the use of a 0.0015 mica separator between the plates. This mica also prevents shorting of the plates by minute dust or metallic particles.

Since it is desirable to limit the movement of the diaphragm to approximately 0.0003 in., its thickness is determined by the peak pressure to be measured. The curves in Fig. 5 have been obtained by plotting diaphragm deflection of the water-cooled 18-mm. indicator, versus pressure in lb. per sq. in. applied to the indicator diaphragm. A suitable diaphragm thickness for any given pressure measurement may be selected by reference to this chart. For example, with peak pressures of 800 lb. per sq. in., a diaphragm thickness of 0.065 in. should be used.

The indicator shown in Fig. 1, has a standard 18-mm. sparkplug thread. The fixed plate diameter is held to 0.415 in. in order to clear the root diameter of the 7/16 in. tapped hole in the frame. Spacing between the 0.415 in. diameter insulated plate and the 7/16 in. bore provides sufficient clearance to assure small electrical capacitance between the periphery of fixed plate and the frame. Fig. 6(A) is a picture of an assembled 18-mm. indicator.

A 14-mm. indicator, shown in Fig. 6(B), has been developed for applications where extreme compactness is necessary. However, this unit is not as rugged or as serviceable as the 18-mm. indicator. A larger indicator with a 1 in. diameter thread measures pressures up to 15,000 lb. per sq. in., Fig. 6(C), with a protective sleeve around the electrode assembly, as in 6(D).

The oscillator-detector unit is housed in a cast aluminum case to provide rigid construction, as in Fig. 7. Tube V₁, in Fig. 3 and its associated circuits, form an electron-coupled high-frequency oscillator, with relatively high output and inherent stability. The rectifier or diode-detector tube V₂, connected as a half-wave rectifier, is coupled to the oscillator through transformer T₂. The rectified current flowing through the diode load resistor R₁₀, read on the milliammeter is an indication of the voltage output across R₁₀.

The circuits C₀T₁L₀, C₁T₁L₁ and

$C_2C_{T_2}L_2$ are all tuned to the same frequency. The tuned circuit $C_2C_{T_2}L_2$ is coupled to the indicator by means of the close coupled link coils L_4 and L_5 , which are interconnected with a low impedance cable. The output voltage developed across R_{10} is balanced by a negative potential source through R_{5P} and R_{12P} to zero, thereby permitting direct-coupled amplification by means of V_3 . This amplifier tube V_3 is primarily used to obtain a low-impedance output source to minimize high-frequency losses in interconnecting cables to cathode ray or mechanical oscillographs.

In order to observe or record the output of the oscillator-detector unit under dynamic conditions, the output must be amplified to operate either a cathode ray or a galvanometer oscillograph as in Fig. 2. Since the voltage output of the oscillator-detector is large (10 volts) the use of a cathode ray oscillograph is quite simple, as no external amplifiers are needed besides the one contained in the instrument. A gain of 50 in the internal amplifier of the oscillograph is sufficient.

Calibration

The really important feature of direct-coupled amplification is the fact that it permits a static calibration of the indicator as in Fig. 8 and the measurement of low frequency pressure changes. The overall frequency response of the equipment has been built to be linear from 0 to 10,000 cycles per second.

Various methods have been developed for calibrating a single-card indicator. These methods, in general, can be classified as follows:

1. Static calibration, which consists of applying a known steady pressure to the diaphragm of the indicator and recording the oscillograph deflection.
2. Dynamic calibration, which consists of applying a known dynamic pressure to the indicator diaphragm with a compressor or rotating valve, and recording the oscillograph deflection.
3. Calibration in the engine under firing conditions by a supplementary* instrument to indicate a point in the pressure cycle cor-

responding to a known balancing pressure.

The disadvantage of the first two methods of calibrating is chiefly their failure to simulate actual engine conditions in regard to temperature. After calibrating in a suitable device, the indicator must be transferred to the engine. This transfer may introduce another source of error in the calibration because of the probability that the forces on the indicator frame in the calibrator will not be duplicated when the indicator is sealed in the engine.

For calibrating under engine firing conditions, two types of balanced pressure indicators are suitable: (1) the balanced valve and (2) the balanced diaphragm. After considering the characteristics of these two indicators, the balanced diaphragm was chosen as the more suitable. All balanced diaphragm indicators are similar to, or are modifications of, the indicator developed by the Bureau of Standards.

Balanced diaphragm indicators, in general, can be divided into two groups, namely, high- and low-pressure types. Fig. 9 shows the high-pressure balanced-diaphragm indicator designed and built in the General Motors Research Laboratories. The diaphragm of the high-pressure indicator must be heavy enough (0.002-0.007 in.) to withstand the pressure encountered in the combustion chamber of an engine. The pressure necessary to move the diaphragm away from the contact (one to three pounds) usually is small, compared with cylinder pressures.

For use in manifolds of engines where maximum pressures are one to ten pounds, it has been necessary to build indicators with extremely thin diaphragms (0.0005 in.) in order to decrease the differential pressure necessary to open the contact. A specially designed indicator had to be built for use with these thin diaphragms to prevent wrinkling, buckling, twisting, sticking and diaphragm rupture and is shown in Fig. 10. Here the seat and diaphragm are assembled as a separate unit, Fig. 11, before installation in the indicator frame.

A thin diaphragm, 0.0005 in., is placed between the two clamping rings and held in place by six countersunk screws. This method of clamping prevents twisting of the diaphragm. The diaphragm is then stretched by screwing the bottom seat in place. The upper seat is then screwed against the top of the diaphragm, forming a seal where the bottom stretching seat makes contact with the diaphragm. Both the upper and lower seats contain many small holes for passage of the gas to the diaphragm. The clearance between the upper and lower seats is very small (0.002 in.) in order to limit the maximum movement of the diaphragm. After assembly, the insulated adjustable electrode is lowered until it makes contact with the diaphragm. Caution should be exercised when making this adjustment to avoid rupture of the thin diaphragm.

Fig. 12 shows two low-pressure calibrated cards taken in the manifold of an engine. These cards clearly show the ability of the balanced diaphragm to follow low-pressure waves. Fig. 13 is a calibrated high-pressure combustion-chamber record taken on an aircraft engine running at 2,600 rpm.

This type of indicator and its associated electrical equipment is not limited to pressure measurements. The technic and equipment developed for measuring pressure can be applied to studying the amplitude and wave form of small deflections of moving bodies.

From a paper delivered before the Detroit Section, Society of Automotive Engineers.

Fig. 13—(Below) Typical record of aircraft engine cylinder pressure

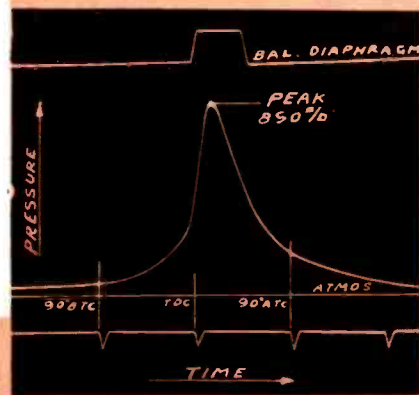
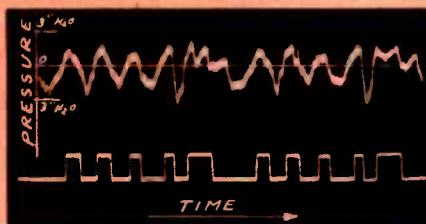
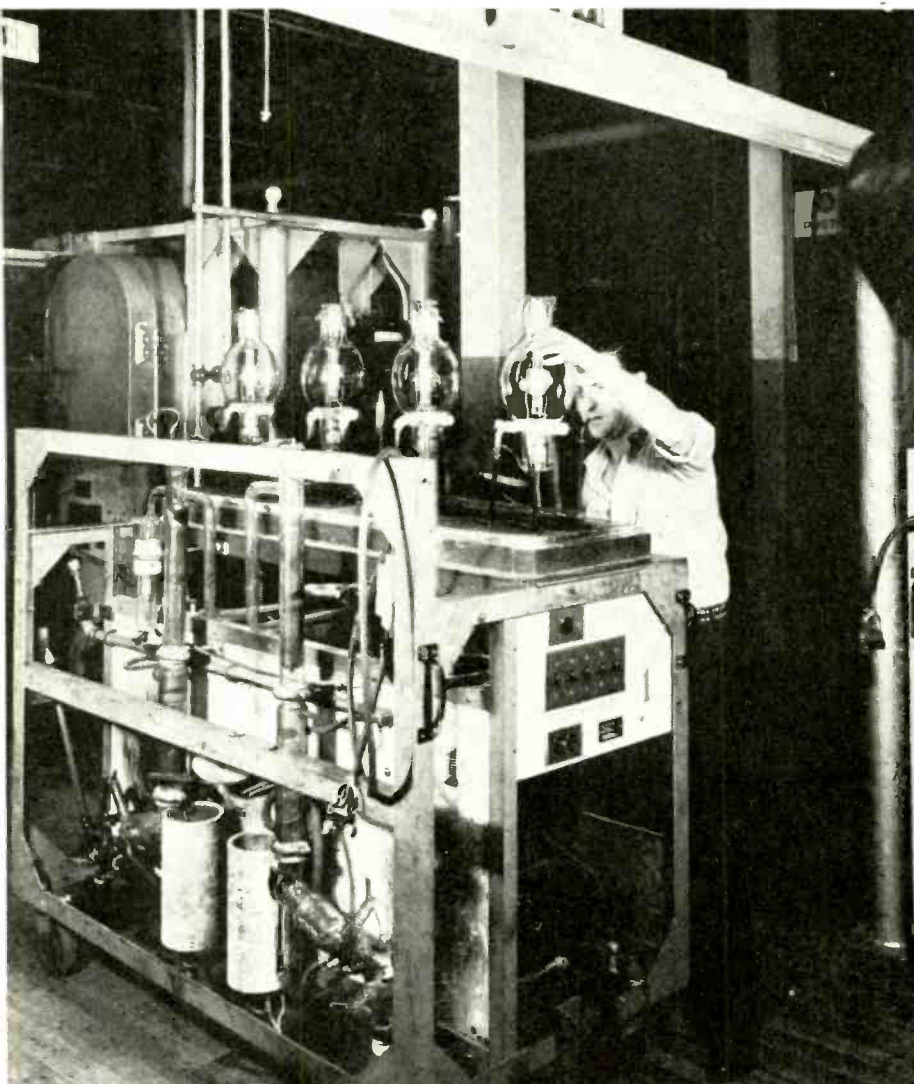

Fig. 12—(Below) Two manifold pressure oscillograms, with marker points established by balanced diaphragm unit.



*The auxiliary pressure indicator described utilizes the principle that a diaphragm that separates two chambers bulges out in the direction of the space with lowest pressure. In this calibration a known and constant air pressure keeps the diaphragm against or away from a fixed contact until the cylinder pressure just exceeds its value, whereupon a high impedance electrical circuit is altered so as to produce a surge that is superimposed on the regular indicator diagram, or otherwise utilized to establish the pressure at a known reference level on those diagrams.—Editor.

CONTINUOUS PRODUCTION



● Large electronic tubes, such as X-ray and powerful transmitter tubes, must be carefully "out-gassed" during the exhaust process.

With the conventional arrangement, the equipment required for any two of the operations remains idle while the third operation is in progress. A new procedure developed by Machlett Laboratories and put into use in their Norwalk, Conn. plant, approximately triples the production capacity of such equipment by eliminating these idle periods for various components.

This procedure is to arrange a production line along which are located a series of five stations. At the first station, a set of four or more tubes are sealed onto the vacuum pumping equipment, which is mounted on a dolly. This dolly travels along a track and is connected to a power supply trolley, so that the tubes are being continually exhausted. It moves to the second station where the tubes enter a baking oven and remain for the required baking period. Moving next to the third station the high-frequency treatment is applied, and at station No. 4, the high-voltage processing takes place.

1—Tubes are sealed on manifold of high-vacuum pumping system on movable dolly

2—Dolly is wheeled to second station where tubes enter oven for baking process

3—HF bombarder station where internal parts are processed by induction heating

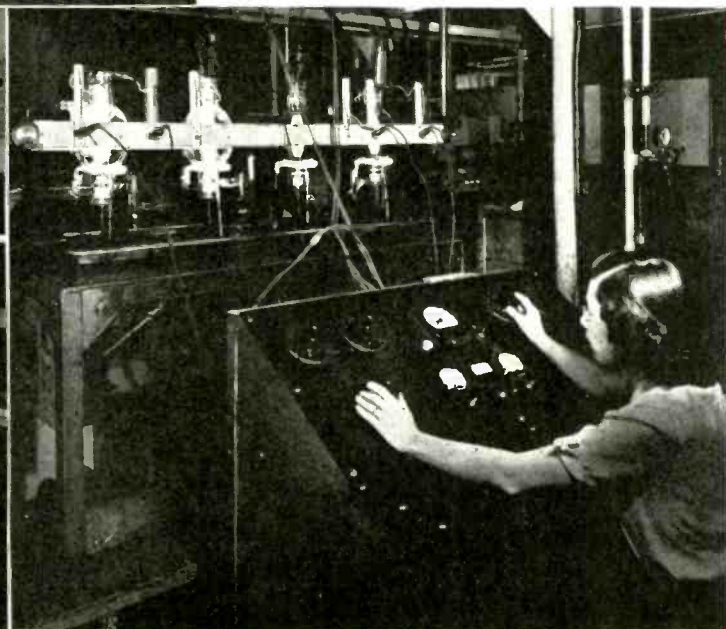
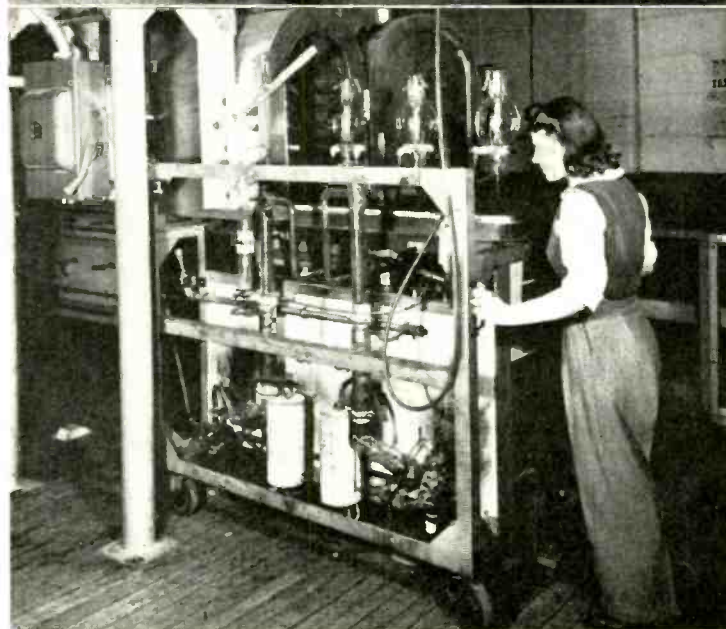

of LARGE POWER TUBES



4—The dolly with its tubes has been moved into lead-protected cabinet for high voltage bombardment. It is then advanced to next station

5—Upon completion of high voltage processing which can be inspected through lead glass, dolly is removed and tubes are sealed off

In this arrangement for the continuous production line manufacture of power vacuum tubes, dollies carrying four tubes each are moved along a track, stopping at each of four stations for the time necessary to complete an operation. They are sealed off at the last position in line

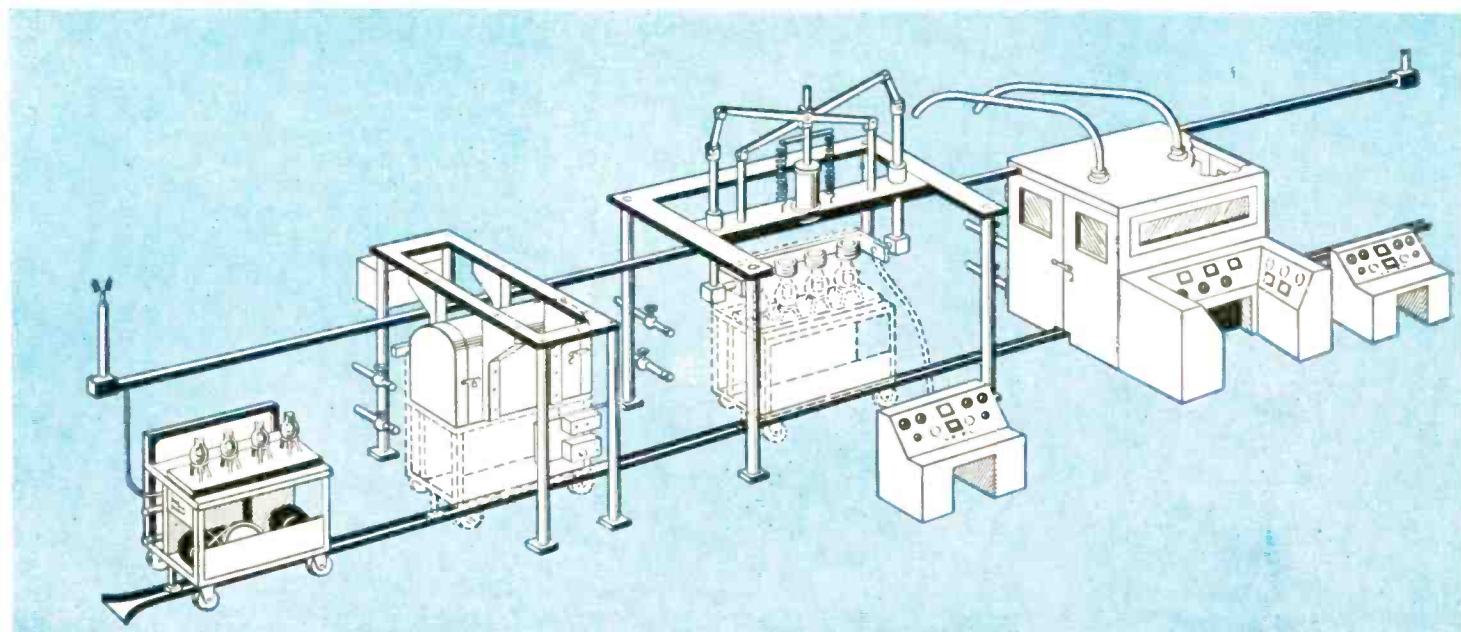

DEFLECTION BEAM TUBE

by PAUL GLASS

Research Engineer, Askania Regulator Co.
Consulting Engineer, Electronbeam, Ltd.

**Useful in direct current negative feedback circuits
and for great variety of industrial applications**

● Cathode ray tubes have gained great importance in recent years and are familiar to every worker in the wide field of electronics. They have been developed to a high degree of perfection and have found their principal prewar applications in cathode ray oscillographs and in television apparatus. The term cathode ray tube almost seems to imply applications of a kind where a fine beam of electrons is focused upon a fluorescent screen in order to produce a visible trace or image of the applied signals.

Another type of electron beam tube, however, has been known for many years in which no fluorescent screen is used^{1, 2, 3}. In these tubes the screen is replaced by one or more target electrodes whose object it is to intercept a varying amount of beam electrons whenever the beam is deflected from its normal position in accordance with an applied signal.

In Fig. 1 a simple deflection beam tube and its circuit are shown. The electron gun structure and the deflection system do not differ from the conventional design. The glass envelope is cylindrical, and carries a target electrode T near the end where the screen usually is mounted. The target is connected to a suitable tap on the voltage supply through load resistor R.

The signal voltage is applied to a pair of deflection plates D₁ while an initial adjusting voltage may be applied to the pair D₂ in order to

center the beam with respect to the target. For zero signal the beam may be in position B₁ where it just misses the target. In this position no electrons are collected by the target and the target current I is zero.

As soon as a signal voltage of suitable polarity is applied to plates D₁ the beam will be moved along the path a . . . a in an upward direction, and a target current will flow. The current increases with increasing signal voltage and reaches its maximum value when the beam arrives in position B₂. The curve of the target current as a function of applied signal voltage is determined by the configuration and electron density distribution of spot B and will in general have a shape as shown in Fig. 2.

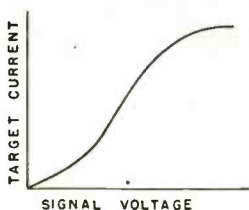

Fig. 2—Target current-signal voltage characteristic of deflection beam tube

center the beam with respect to the target. For zero signal the beam may be in position B₁ where it just misses the target and the target current I is zero. As soon as a signal voltage of suitable polarity is applied to plates D₁ the beam will be moved along the path a . . . a in an upward direction, and a target current will flow. The current increases with increasing signal voltage and reaches its maximum value when the beam arrives in position B₂. The curve of the target current as a function of applied signal voltage is determined by the configuration and electron density distribution of spot B and will in general have a shape as shown in Fig. 2.

A two-target beam tube and its characteristic are shown in Fig. 3. Zero output voltage is obtained when an equal number of electrons is collected by each target while the maximum output voltage is reached when one or the other target intercepts the entire beam. The overlapping target arrangement, also shown in Fig. 3, has certain advantages as compared

with mounting the targets in one plane.

Beam deflection can be accomplished by electrostatic or magnetic fields according to the well-known relations:

$D = \text{const} \times e \times L$ for electrostatic deflection

$D = \text{const} \times Ni \times L$ for electromagnetic deflection where

D = beam deflection in target plane

e = deflection voltage

Ni = ampere turns of deflection coil

L = length of path from deflecting field to target.

A glance at these equations reveals that control of the deflection beam tube can be obtained by changing e, i, or L. Since the electromagnetic field may be replaced by any other magnetic field (for example that of a permanent magnet) the following three control methods immediately are available:

- 1—Voltage applied to deflection plates
- 2—Current applied to deflection coils
- 3—Displacement applied to movable magnetic field of constant intensity.

Tubes of this kind have been used for a variety of applications in alternating current circuits^{4, 5}. Their use in direct current amplifier circuits, however, is subject to the usual limitations, as long as the performance is governed by characteristics of the type shown in Figs. 2 or 3. These characteristics depend entirely on beam intensity and geometry in the target plane and are subject to change whenever one of the many contributing factors changes.

The situation becomes radically different, however, when according to Ziebolz⁶ a secondary deflection system, which is connected in a negative feedback circuit, is applied in addition to the primary deflection means.

While application of negative feedback in ac amplifiers is common practice, negative feedback in dc amplifiers presents a number of

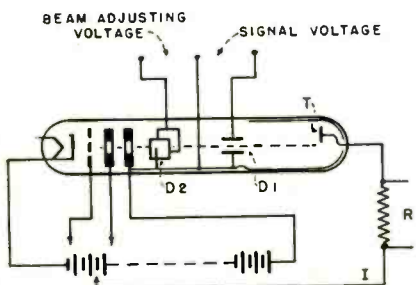
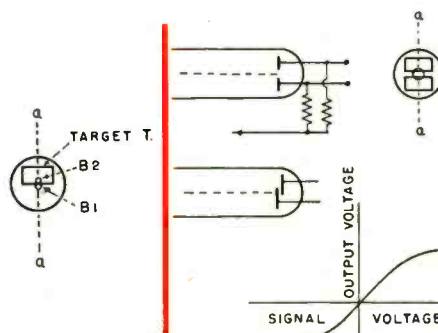

Fig. 1—(Left) Simple deflection beam tube and circuit. When signal voltages are applied beam is displaced along line a . . . a. B₁ and B₂ indicate beam positions for zero and maximum signal. Fig. 3—(Right) Two-target deflection beam tube and its characteristic



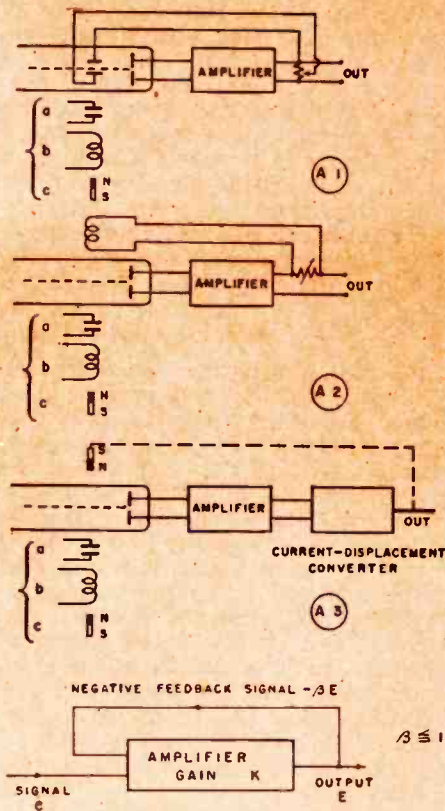

Fig. 4—(Above left) Deflection beam tube circuits with voltage feedback, (A1), current feedback, (A2), displacement feedback, (A3). In each case three types of input circuits are available: voltage input, (a), current input, (b), displacement input, (c). Fig. 5—(Left) Basic negative feedback circuit. Fig. 7—(Right) Calculated characteristics of basic circuit with nominal gain $K = 100$ when gain is varied

problems, since grids inserted in the electron path between cathode and anode control the intensity of the electron flow. The control grid, therefore, is a member of the grid and plate circuits at the same time, and both circuits have the cathode as common point.

In a one-stage amplifier negative feedback is not difficult. Frequently, however, the output level of the last stage differs from the input level of the first stage and prohibits a conductive feedback connection between output and input. Considerable work has been done to overcome this difficulty but, basically, simple and flexible negative feedback circuits, so readily available in ac amplifier design, are not possible in dc amplifiers using conventional tubes.

A different type of tube is required in which the interconnection between input and output circuits is eliminated. The deflection beam tube is such a tube. In it, control is effected by deflecting an electron beam of constant intensity with control members which are arranged adjacent to but not inserted in the electron path. Negative feedback, therefore, becomes a simple matter, and opens up a wide field of circuit solutions.

In order to review the possibilities

a number of basic feedback circuits are shown in Fig. 4. The choice of three different input circuits is indicated schematically by the symbols for

electrostatic deflection—(plates)—a
 electromagnetic deflection—(coil)—b
 movable magnetic field—(magnet)—c

The output of the beam tube is generally shown to be connected to an amplifier which, however, may not be required in certain applications. From the circuit output a feedback connection is made to a secondary deflection system which again may be any one of the three types listed above.

In circuit A1 an amplifier with voltage output is provided. A part of the output voltage, according to the adjustment of an output potentiometer, is fed back to a pair of secondary deflection plates in order to produce a deflecting field opposing the primary beam deflection. In circuit A2 a current output is provided. Part of the output current as determined by ad-

justment of the output series resistor, is fed back to a secondary coil system again counteracting the effect of the input signal.

Circuit A3 is basically different from A1 and A2 inasmuch as a mechanical displacement is required as the output quantity of the circuit. This can be obtained by connecting the amplifier to a device which converts current or voltage into mechanical displacement. A simple example of a current-displacement converter is a solenoid. The feedback connection consists here of a mechanical link between the movable output member and the feedback magnet. The connection is such that movement of the feedback magnet tends to oppose the deflection produced by the primary deflection system.

The following Table I lists the nine circuit problems involved and their solution as given in Fig. 4.

CIRCUIT PROBLEM		SOLUTION
No.	Input Signal	Output Desired
1	Voltage	Voltage
2	Current	Voltage
3	Displacement	Voltage
4	Voltage	Current
5	Current	Current
6	Displacement	Current
7	Voltage	Displacement
8	Current	Displacement
9	Displacement	Displacement

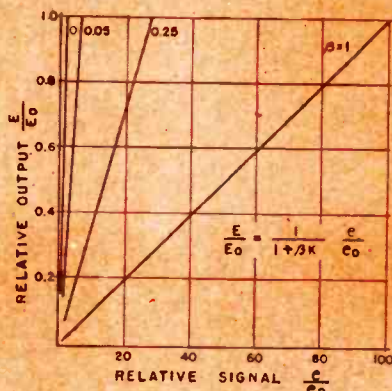
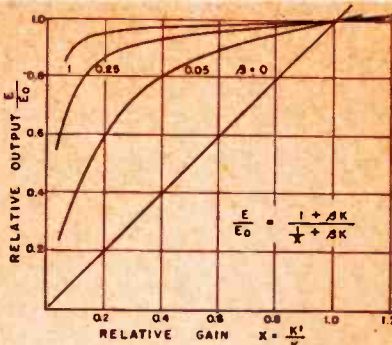

Fig. 6—Calculated characteristics of basic circuit with gain $K = 100$ when signal is varied



Before discussing the merits of the nine basic circuits in practical applications a short review of their performance characteristics may be appropriate. Since all circuits are of the negative feedback type it will be sufficient to refer to the basic circuit shown in Fig. 5.

Using the notations of a voltage amplifier, the amplifier has applied to its input the voltage $e - \beta E$ and produces the output voltage

$$E = K(e - \beta E)$$

Hence

$$E = \frac{K}{1 + \beta K} e$$

which is the basic equation of

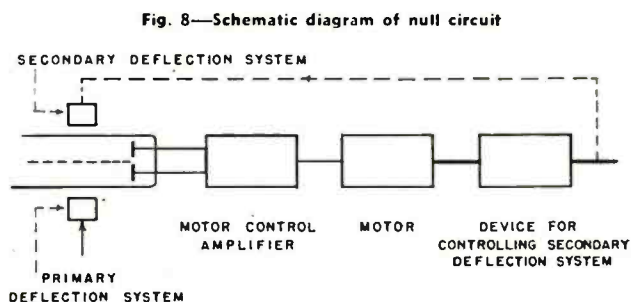

Fig. 8—Schematic diagram of null circuit

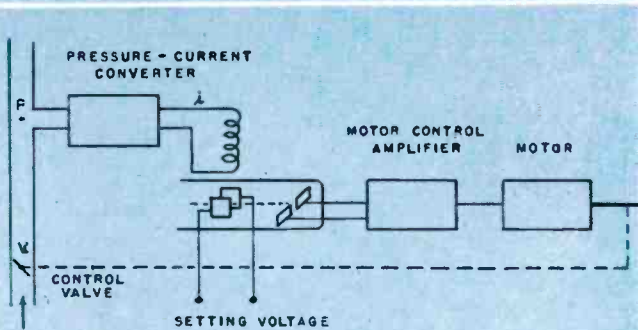
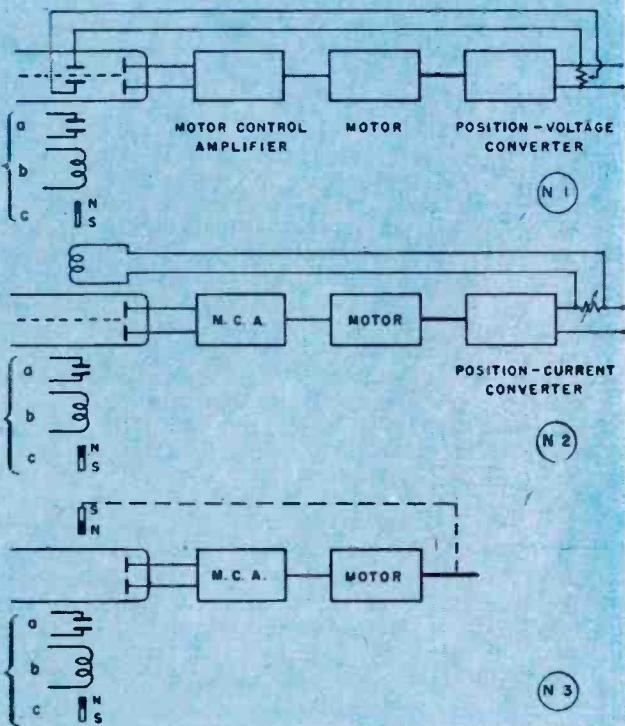

Fig. 9—(Above) Null circuits with deflection beam tube. Counterbalancing force produced by voltage, (N1), current, (N2), displacement, (N3). Three types of input circuits are again available. Fig. 10—Application of deflection beam tube in automatic pressure control system

negative feedback amplifiers. Obviously the output voltage will approach

$$E = \frac{1}{\beta} e$$

when the term βK becomes large compared with 1.

Considering that β is constant, this simple review leads to the following remarkable features of the circuit:

- 1—The output is directly proportional to the applied signal;
- 2—The output is practically independent of the characteristic (K) of the amplifier;
- 3—The effective amplification is reduced by the factor $1/(1 + \beta K)$ as the price paid for obtaining the advantages of (1) and (2).

In order to check these characteristics in actual applications, two tests have proved valuable and their outcome can be predicted from the above analysis. In test 1

the output is measured as a function of the applied signal for different adjustments of the feedback ratio β . Sample curves are readily obtained from the basic equation when we define the maximum output $E_o = K e_o$. The resultant expression for the relative output and a number of curves for a gain $K = 100$ are shown in Fig. 6. The results of test 1 indicate the degree of linearity obtained and the reduction of effective amplification.

In the second test the amplifier gain is changed below and above its nominal value K and the output is measured as a function of the relative gain

$$x = K'/K$$

for different values of β . For the purpose of easy comparison the signal is readjusted for every value of β so that for $K' = K$ the output is always equal to E_o . In Fig. 7 the final expression for the relative output and sample curves for $K = 100$ are shown.

The curves of Fig. 7 demonstrate strikingly the advantages of the circuit. As an example, when the amplifier gain drops by

50 per cent the output will drop only by 1 per cent, when a feedback ratio $\beta = 1$ is used. Consequently, any change of characteristics due to aging or replacement of tubes or parts and any change in supply voltages will have but a negligible influence on the performance of the circuit.

The result of actual tests performed on one of the basic circuits will be found in Figs. 13 and 14.

Circuit applications

Some applications of the basic circuits (Fig. 4) will now be discussed keeping in mind that the results of the last paragraph apply in all cases.

Circuits A1 and A2 are direct-current voltage and current amplifiers of great stability and flexibility. The combination of beam tube and additional amplifier makes it possible to derive the overall gain from both devices at any desired ratio. In limit cases where the amplifier provides most of the amplification the beam tube may simply be considered as a stabilizing device for the associated amplifier.

The amplifier itself may be of conventional design but no special precautions with regard to its characteristics are required since it is included in the feedback loop. The output stage of the amplifier may be designed for any particular load condition. Considering, in addition, that three different primary deflection systems are available, a few of the applications are as follows:

Circuits A1a and A2a can be used as static dc voltmeters with voltage or current output. If a source of constant potential is connected to the output, circuits are obtained which furnish constant dc output voltage or current independent of fluctuating supply voltages or changing tube characteristics.

Circuits A1c and A2c may also serve as sources of constant voltage

Fig. 11—Experimental deflection beam tubes

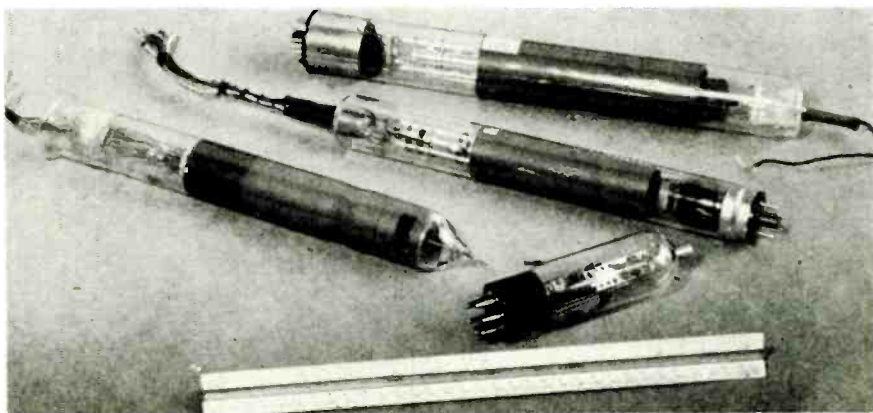

or current output when the external magnet is fixed in its position relative to the tube. In other applications, the magnets may be moved according to a given time function. If a synchronous motor drive is used a periodically changing voltage or current may be obtained whose wave form and frequency may be varied within wide limits. It would not be difficult, for instance, to obtain an alternating current of perfect sine wave shape and of very low frequency, say one cycle per hour or one cycle per day.

Circuit A2b receives a small dc input current and furnishes a large dc output current with complete separation between input and output circuits. It may be termed a "dc transformer". The ratio between the two currents will be extremely stable.

Circuits A1c and A2c may be used for remote position indication where voltmeters or ammeters at the remote end indicate the position of a transmitter to which the magnet is attached. If the transmitter is a float indicating a liquid level, the device becomes a liquid level meter with remote indication. An interesting application is found in remotely indicating the movement of an object in a completely enclosed space without having any connection from the inside to the outside.

Circuits A3a and A3b permit controlling the position of the secondary magnet by a remotely located source of signal voltage or current. Circuit A3c, finally, constitutes a position transmission system where the secondary magnet reproduces the movement of the primary magnet. Referring again to the case of the movement within an enclosed space it is possible to obtain a corresponding movement on the outside without any connection.

The nine basic circuits, described so far, are negative feedback cir-

cuits. This implies that the secondary deflecting force is always slightly smaller than the primary deflecting force. The resultant small differential force deflects the beam from its zero position and thus produces the output value. Zero output is obtained only when the primary and secondary deflecting forces are also zero.

The deflection beam tube lends itself admirably to another group of basic circuits in which use of the null principle is made. In this type of circuit the beam must always return to its zero position thereby indicating complete equality of primary and secondary deflecting forces.

As shown in Fig. 8, the beam tube output is connected to a motor control amplifier which energizes a reversible motor. The motor in turn operates a device which controls the secondary deflection system. As long as the two deflection forces are of equal size the beam assumes its null position which results in zero output of the beam tube. In this case, the motor control amplifier does not receive any signal and the motor does not operate. The motor position, however, and the condition of the secondary deflection system directly indicate the value of the primary signal.

Whenever the balance between the opposing deflection forces is disturbed the electron beam will be deflected towards one or the other target and thus create an output voltage of a certain polarity. The motor will then be energized to run in a certain direction and thereby change the condition of the secondary deflection system until the beam has resumed its null position.

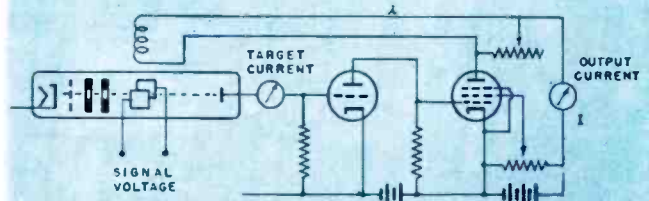

Fig. 12—Schematic diagram for laboratory model of basic circuit A2a with single-target deflection beam tube

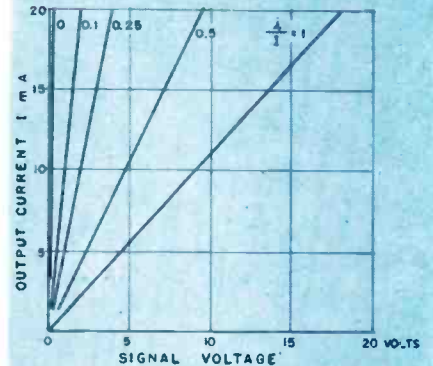

Fig. 13—Measured characteristics of circuit A2a; signal voltage varied

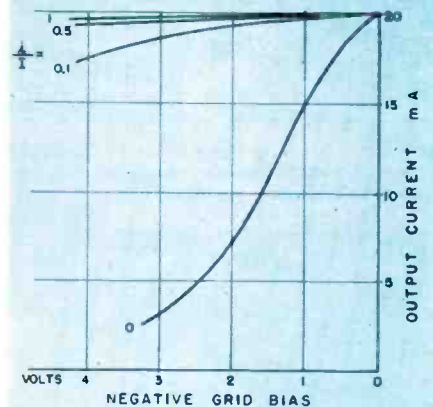

Fig. 14—Measured characteristics of circuit A2a; beam intensity varied

The new position of the motor and the newly established condition of the secondary deflection system indicate the new value of the input signal. The motor position and the secondary deflection system may be calibrated directly in terms of the unknown input signal.

A review of null circuits is contained in Fig. 9 and Table II. In circuit N1 the motor operates a position-voltage converter, for instance a potentiometer, which produces at the secondary pair of deflection plates a voltage proportional to the motor position. In circuit N2 a position-current converter and an electro-magnetic secondary deflection system are used. In circuit N3 the motor directly positions a secondary magnetic field.

(Continued on page 202)

Fig. 15—Experimental model of position control circuit based on null circuit N3a

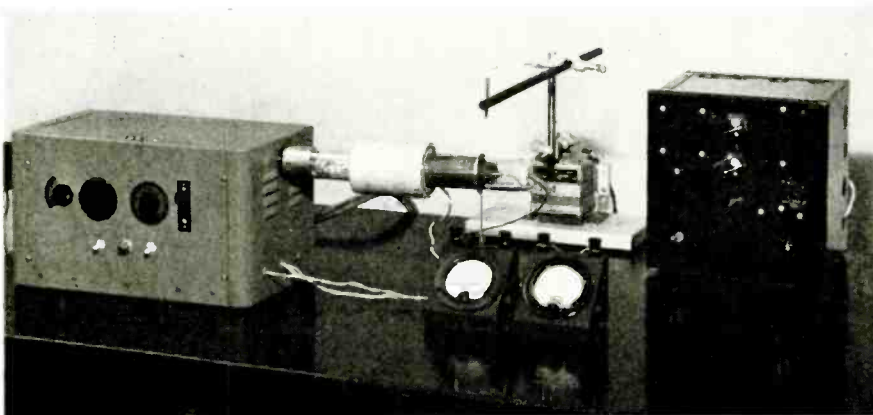

OWI's NEW YORK

(See also *Electronic Industries* for Oct., 1943)



There are 20 sections in the Master Control unit each capable of taking programs from 60 incoming points and transmitting to 20 out-going channels. Unit operates entirely on pre-set basis with each section inter-

locked and protected by "mistake" circuit and alarm, preventing operator from pre-setting more than one program on same channel. Individual channels can be added or dropped without affecting remaining set-up. Re-

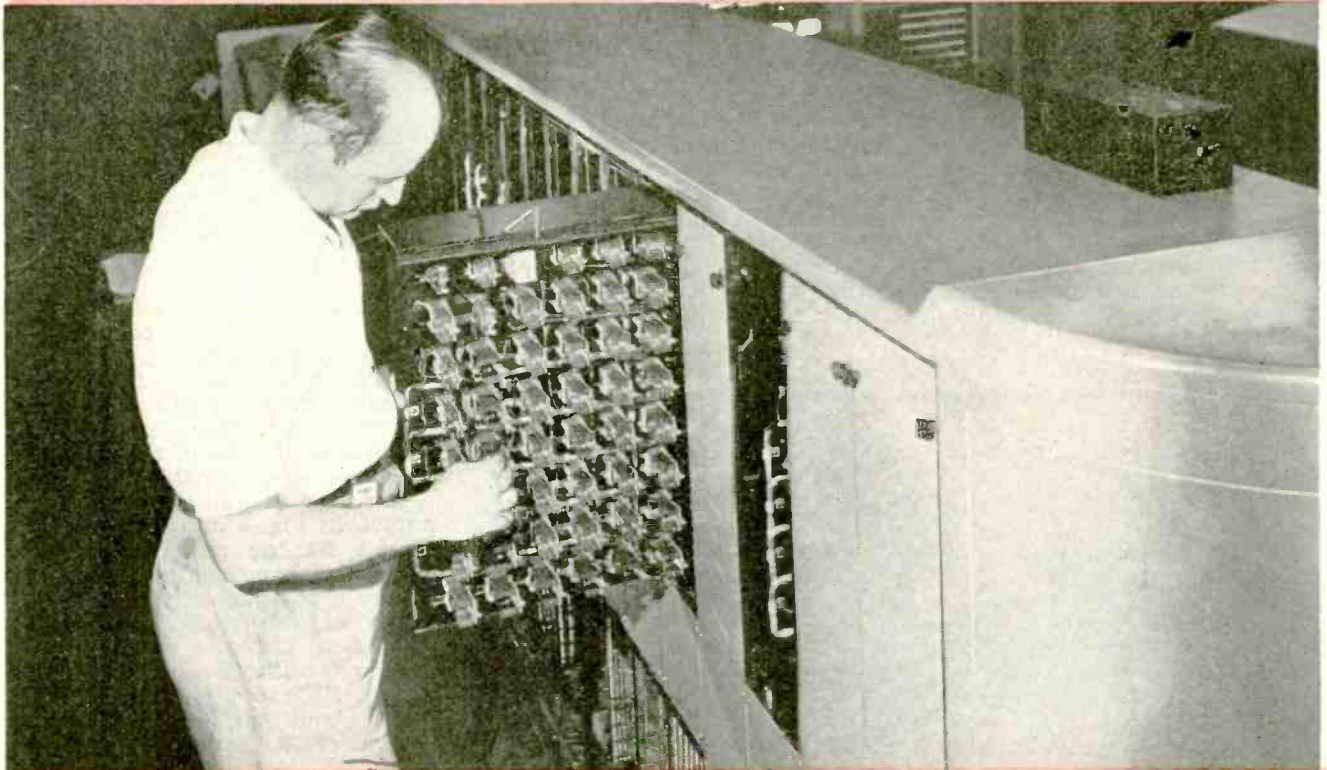

nes, or all, simultaneously. Panel in corner continuously indicates studios in use. Above is shown how the 960 relays are mounted in racks which slide like drawers so that equipment can be serviced. Each chan-

nel in master control is completely interlocked so that there can be no possibility of cross channel feeding. Patch cords in upper photo were for temporary use during construction operations and are no longer used.

MASTER CONTROL

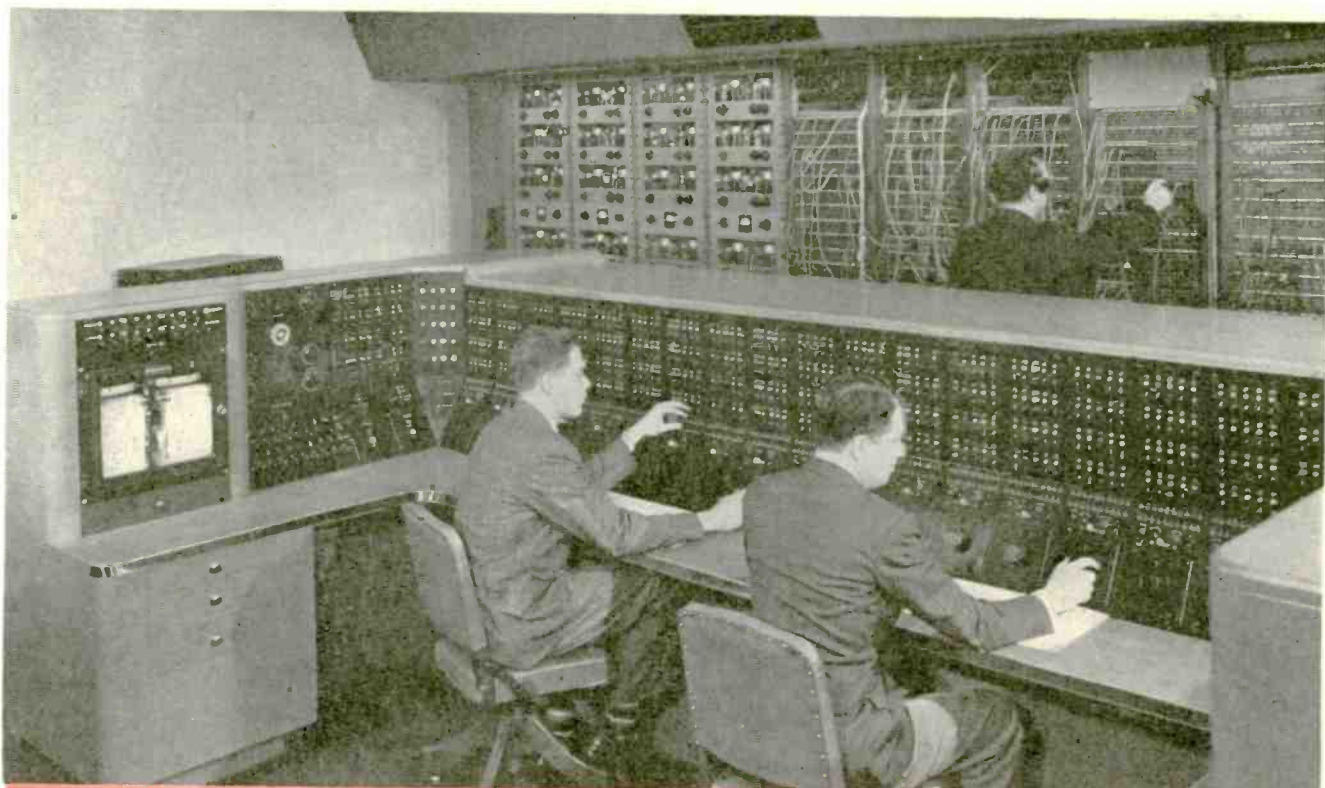

Recording volume indicators (left) may be switched to any channel and continuously record modulation percentage. To right of them is monitoring panel enabling operator to monitor the 2C studios, the 4C transmission

lines and 2D receiving lines. Below them are emergency studio release controls and right of them studio break channel section enabling operator to pre-set and announcer to break, any combination of transmitting chan-

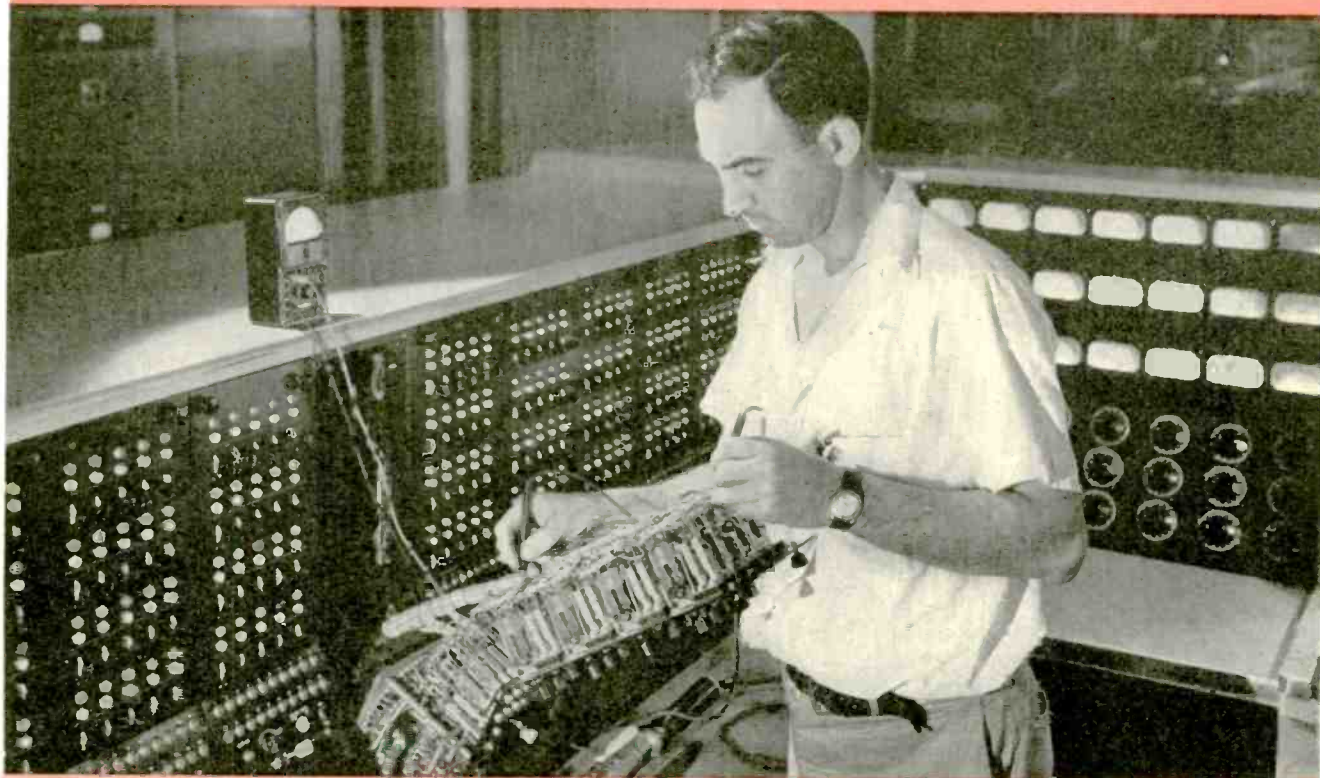

Each of the 20 sections in Master Control is complete in itself, may be tipped forward for maintenance. Behind technician is bank of 21 volume indicating meters which are ganged to selector relays allowing opera-

tor by push button to monitor three groups of lines of 21 each. Corner panel in upper left view contains 100 indicating lights continuously showing condition of 20 long line circuits, whether incoming or outgoing.

(Over)

OWI's NEW YORK

(See also two previous pages)

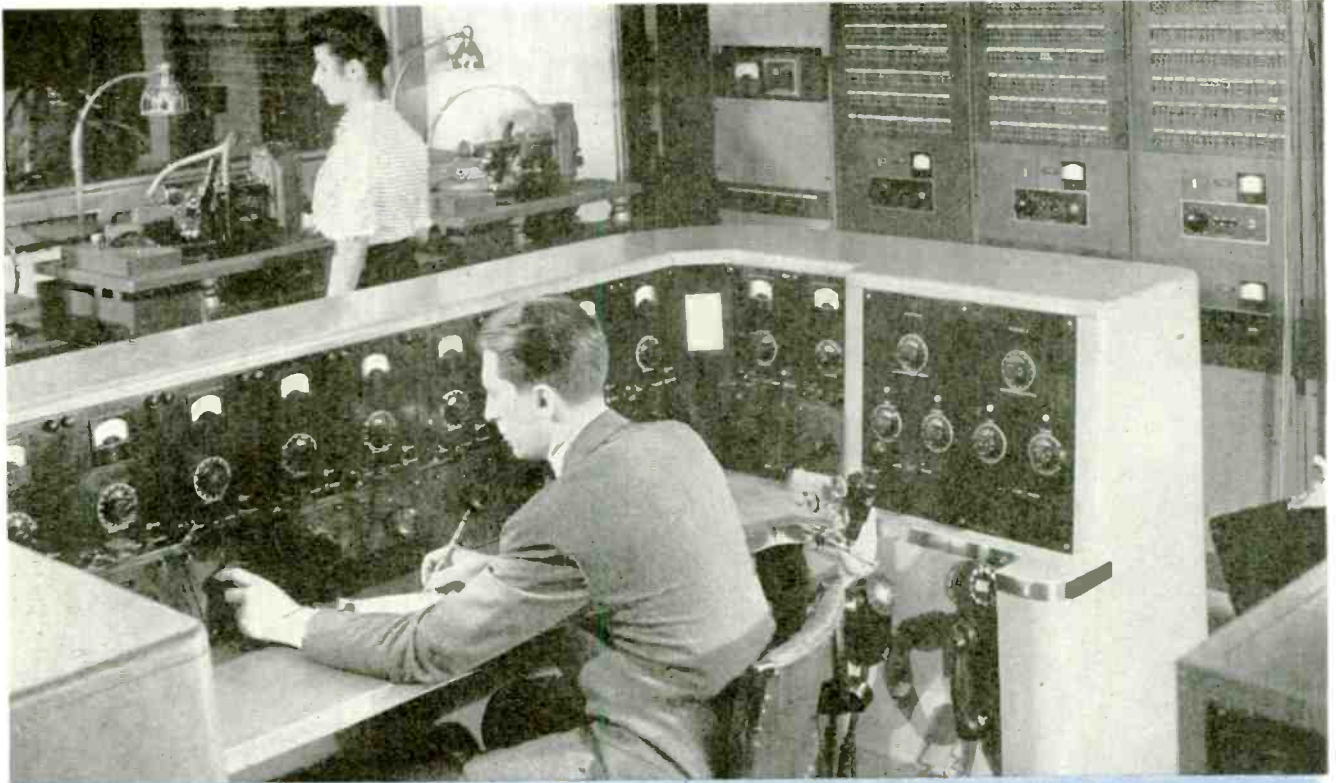

All programs going through Master Central appear automatically on this Recording Console. Supervisor can pre-set to any channel and assign recording paths. Any of 14 lines can be assigned to any channel or when

necessary all 14 can be put on one channel for multiple recordings. Microscope at right of operator is for continuous examination of recording sapphires of which some 3000 a year are used. Upper panel at left cen-



In this 14-bay bank of Western Electric amplifiers there is an individual amplifier for each of the 14 RCA precision lathes used for recording programs which may be fed on the line through Master Central or used

for making pressings for shipment abroad. The complete amplifying equipment, only part of which is shown, includes a total of 46 amplifiers of various types including models 105, 118 and 1087, all Western Electric

MASTER CONTROL

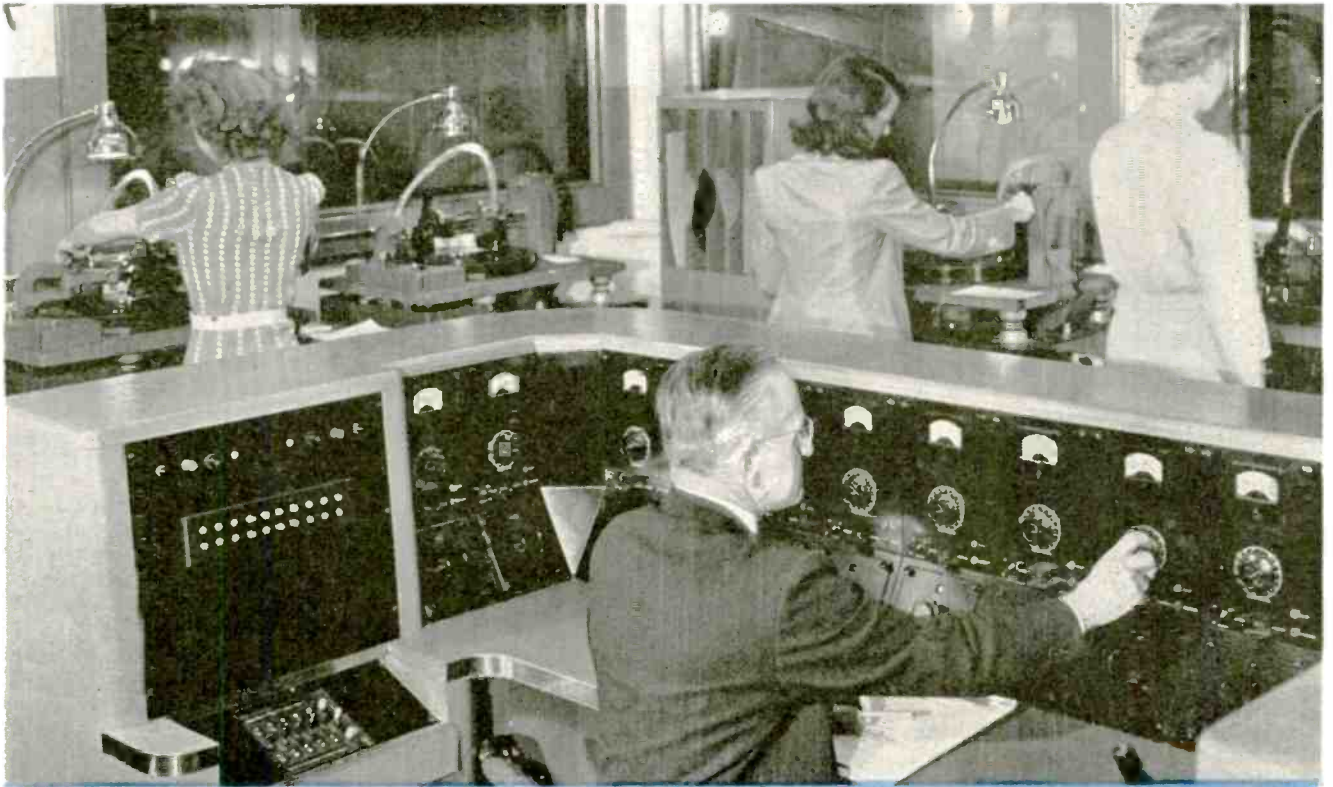

ains indicating lights for 20 Memovox machines which automatically record every transmission. Below it is telephone recording installation for transferring incoming phone calls to individual phones at the

lathes. Memovox machines start and stop automatically each time a section is put in operation or knocked down. Below are some of the 46 Western Electric amplifiers used to drive the cutting heads on the lathes

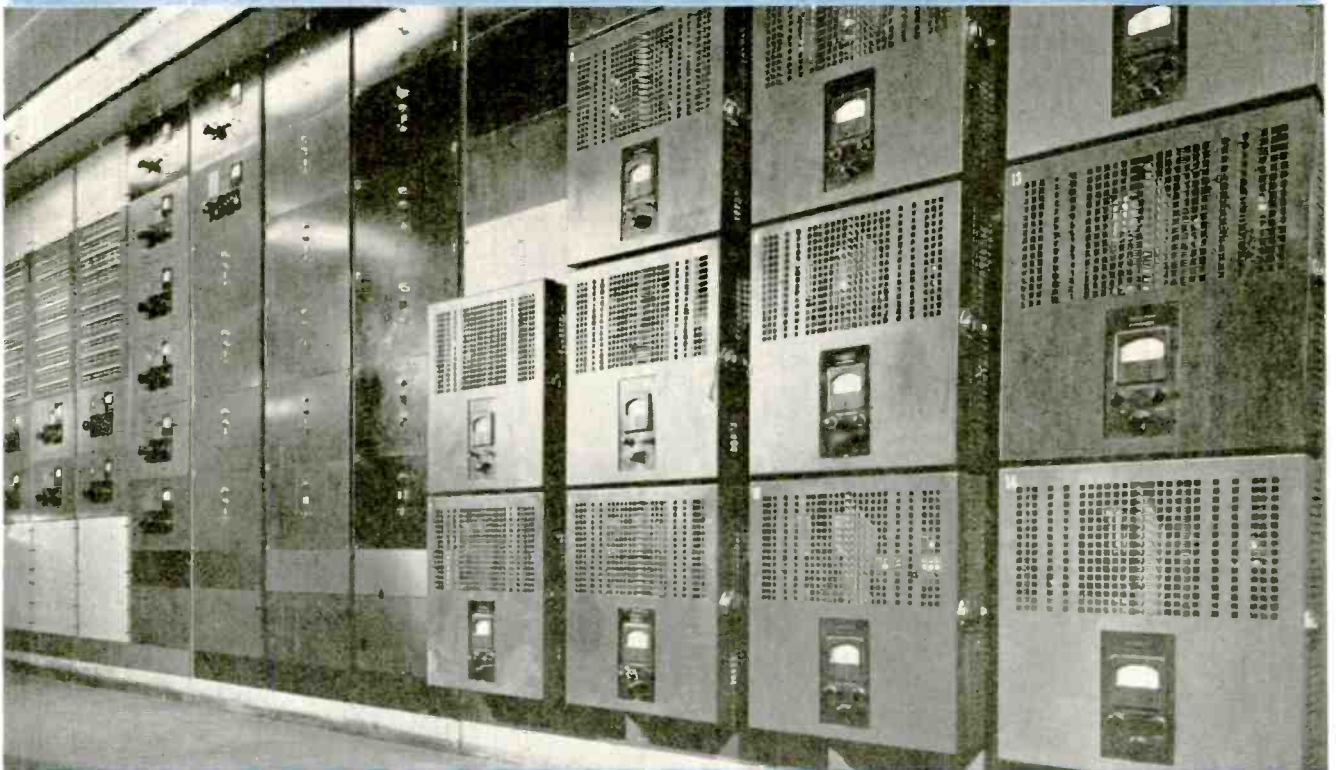

Recording lathes are automatically interlocked into channels and the interlock is indicated by panel lights. When fed from studios, the pre-set and go ahead lights operate on separate panels making the recording operator

completely separate from the on air operator. Entire Master Control unit, which has been under construction more than a year and has just been put in operation was installed under supervision of Chief Engineer George Herrick

RECORDING SOUND ON

by **GILBERT SONBERGH**

Associate Editor

Factors in the selection or design of equipment for recording and reproducing television motion picture sound

● The commercial sound motion picture is less than two decades old, although the idea itself dates back nearly half a century. Motion picture sound track was recorded in 1900, although satisfactory reproduction of its record was not possible until the later development of electronic amplification. Today, the technic of simultaneously recording motion pictures and their accompanying sound has reached a high state of perfection, thanks largely to the vacuum tube. With the advent of large scale television, the sound motion picture will have ample opportunity to repay its debt to the science of electronics.

It seems inevitable that the expansion of television ultimately will result in greatly increased use of sound motion picture recording. News events* worth telecasting are more likely to occur during the day than at night, but they must be shown during the evening hours for widest audience coverage. Events occurring simultaneously at different locations must be separated in time for presentation via the television transmitter. In live dramatic presentations, television studio limitations can be overcome by interspersing previously filmed shots made outdoors or under other conditions not feasible on the stage. In short, the commercial success of home television may greatly extend the production and utilization of picture and sound-on-film recording equipment. Certain deviations from established technics may be desirable for optimum television results.

In general, the ideal of motion picture sound recording is to reproduce rather better than faithfully the sounds fed into the microphone. There are several good reasons why it is not sufficient merely to reproduce the original. First, the conventional commercial recording system is monaural, or without perspective. Humans with two good ears and related mental processes are able to single out a sound to

which they desire to listen, differentiating it from background noise and other sounds partly because of minute phase differences resulting from the time-difference in the arrival of the desired sound at each ear. This, obviously, the single-channel recording system cannot do.

Second, reverberation time of the auditorium (or living room, in which the film is to be reproduced) is just as much a factor in the final result as is reverberation time in the studio where the recording was made, the final effect being the sum of the two.

Third, the volume range of the reproduced sound must be less than that encountered in nature, because of equipment limitations as well as audience comfort. Fourth, raising the average volume level of the reproduced human voice, which must be done in theaters or large rooms, introduces effective amplitude/frequency distortion, making the reproduction boomy or un-

natural. When voices are raised in real life, the energy distribution center shifts to the higher sound frequencies.

Fifth, sound to accompany pictures allows no play of the listener's imagination, as in radio broadcasting, but must "match the picture" at all times. An outdoor shot, for example, must sound like the outdoors, even if it has been photographed inside studio walls. These and other limitations will be taken up in more detail in the following.

In brief, a motion picture sound recording system includes a microphone, an amplifier, an optical system to provide a recording light in the form of a concentrated, thin, rectangular beam or slit, a light modulating device to vary the amplitude or intensity of the beam, and an accurate mechanical system to impart uniform motion to the film recording stock, providing the linear time-base required.

To this equipment may be added

Professional quality 16 millimeter motion picture equipment, manufactured by J. A. Maurer, Inc., New York City. From lower left up: power supply, amplifier, and recorder. Recorder and camera (insert) are driven by synchronous motors at 24 frame-per-second speed. Two-man crew needed

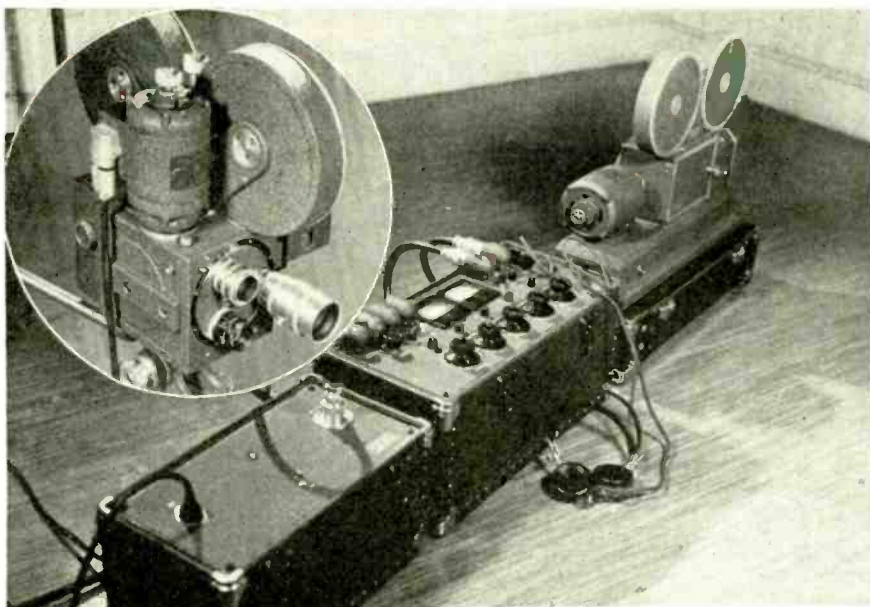

*The Republican National Convention in Chicago, middle of June, was handled in this way, motion pictures being flown to New York for transmission from WNBT and other stations.—Editor.

FILM

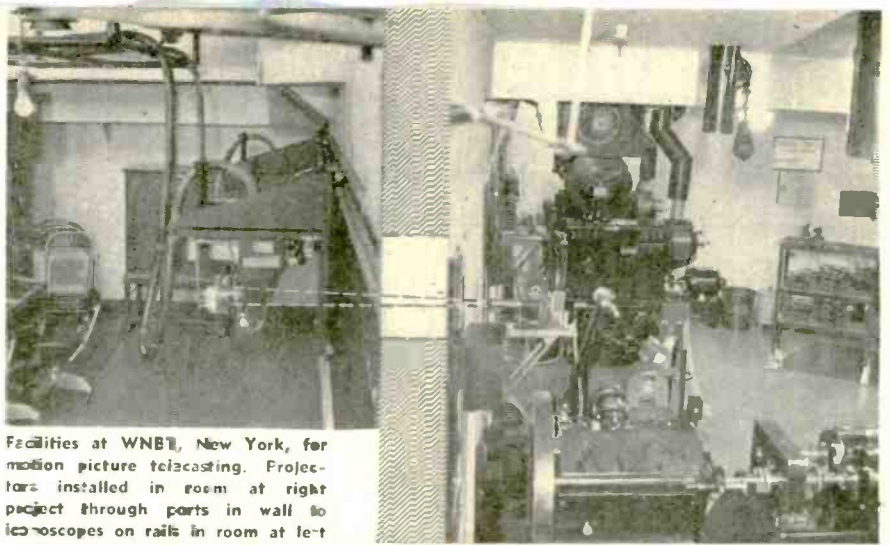

Facilities at WNBT, New York, for motion picture telecasting. Projectors installed in room at right project through parts in wall to microscopes on rails in room at left

various equalizers and filters to correct for inherent deficiencies in various parts of the system or to introduce intentional amplitude/frequency distortion to achieve certain effects. Facilities for mixing the output of several microphones or preamplifiers may be provided. The main amplifier usually incorporates some form of AVC or volume compression to simplify the work of the sound-recorderist "riding the gain" and avoid overloading the amplifier or light-valve, overexposing the film itself in variable density recording, or "clipping" high-amplitude wave peaks on a variable area track.

Sound track types

The simplest form of variable area sound track is an oscillogram of the amplifier output with the area to one side of the trace dark and the area to the other side transparent. Such a track is produced by a mirror-galvanometer as the light-modulator, varying the height or length of the illumination of the slit under which the unexposed film passes.

The simplest form of variable density sound track consists of transverse striations or variations in density corresponding in opacity to the instantaneous values of the amplifier output. Such a track may be recorded either by a gas-discharge lamp in which the light output varies with the impressed voltage, or by a light-valve which varies the width of the recording slit above or below a mean value corresponding to the ac axis of the sound wave.

The gas-discharge device is no longer used because of the limited light output, lack of linearity, and poor dynamic response at the higher audio frequencies. A conventional Wente type light-valve consists of two thin duralumin ribbons in a magnetic field. Passing the signal currents through the two in opposite directions causes the separation to increase or decrease from the mean spacing, admitting more or less light to the film. Many variations of these simple sound

Positive prints of representative sound tracks. 1-A is simple variable area track, made by deflecting wedge-shaped light-beam across slit. 1-B and other variable area tracks are produced by changing shape of light source image with masks, as shown under each track. Arrow under 1-A shows direction of beam deflection from mean (no signal) position, as well as direction (either way) of film travel under slit. The push-pull tracks require two beams, deflected as a unit. Cases of push-pull tracks are exactly analogous to classes of push-pull v-t amplifier operation, having to do with the proportion of the cycle during which each of the two reproducing phototubes receives light and passes current. Track 2-A is conventional density track produced by ribbon-type light valve, to which auxiliary shutter-type noise reduction has been added in 2-B. Class A pp density only is shown, as other classes are similar in appearance. Both types of light-modulators are described in accompanying text. Sound tracks from ERPI chart

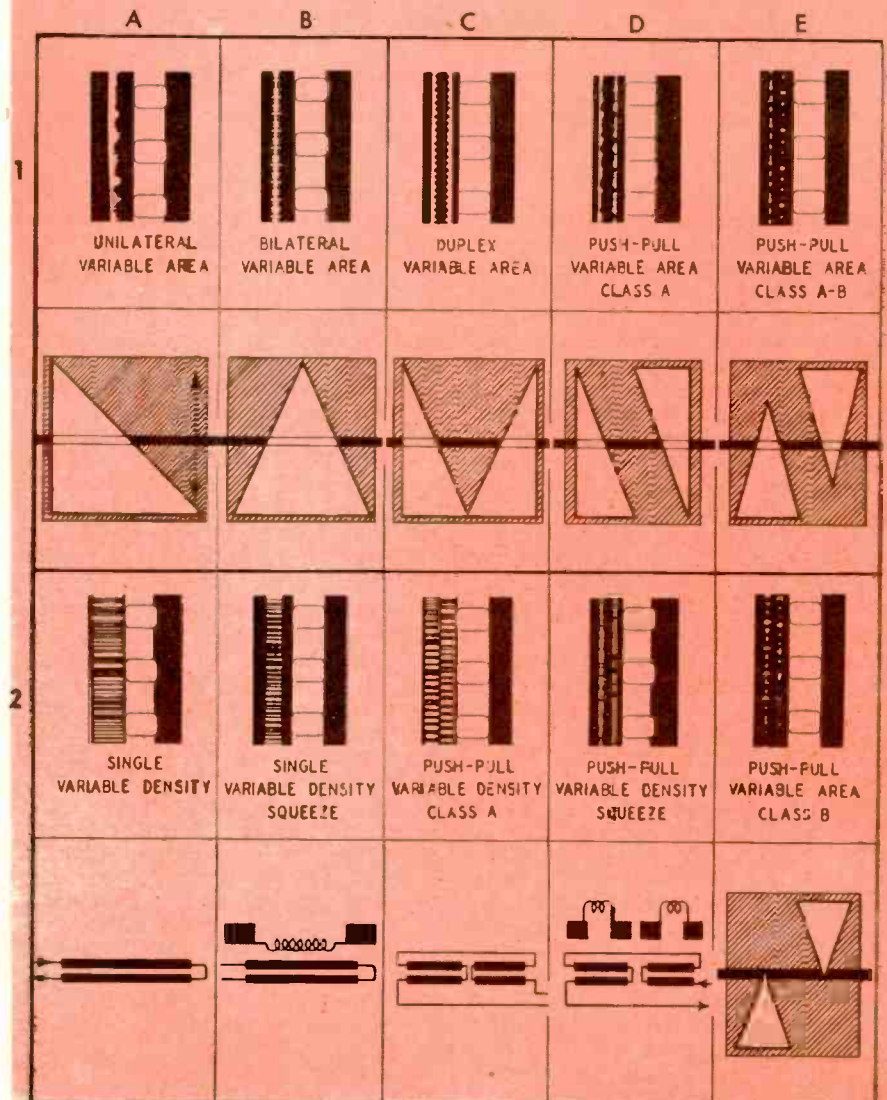

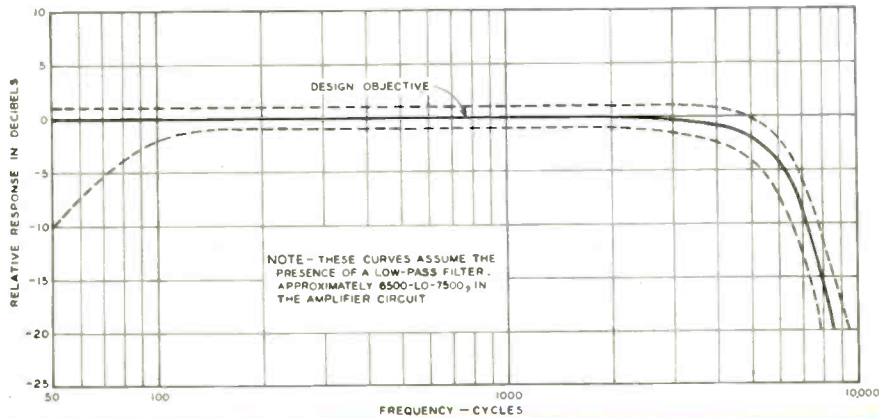

Proposed American War Standard for 16 mm. projector response. Hi cutoff is to reduce dirt-noise

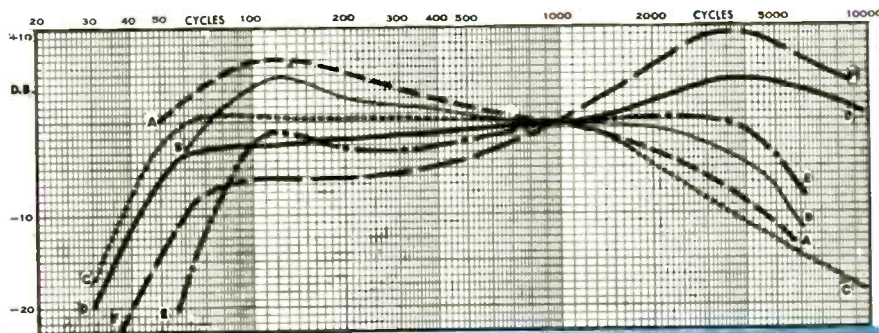

Typical pre-war 16 mm. projector performance (Victor Animatophone). Curve D, amplifier alone, tone control normal; C, low; E, high. Curves B and E indicate overall response, at normal and high tone control settings, to frequency film whose inherent characteristic is given in curve A

tracks are possible. A few representative types are illustrated.

Much has been written about the relative merits and demerits of the two types of sound records. The Hollywood studios are perhaps equally divided between variable density and variable area. Producers of commercial or industrial films favor variable area. The best possible area recording compared with the best possible density recording probably would yield identical results, but relatively it is easier to secure a good variable area track.

The H&D curve of a photographic emulsion is a record of the material's opacity plotted against exposure time, under given conditions of development. Such a curve is quite analogous to the anode-current vs. light-flux curve of a phototube or the plate characteristic curve of a vacuum tube. At the toe of the curve as well as at the shoulder, a change in exposure fails to bring about a corresponding increase in opacity sufficient to maintain a linear relationship.

As with single-ended vacuum tube amplifier operation, the variable density sound record's density variations, including positive and negative peaks, must be kept on the straight-line portion of the curve if audio distortion is to be avoided. This requires stringent correlation

between exposure and development technics in variable density recording and an absolute accuracy in both. Variable area, while not automatic, merely requires a clean white and a good black, for average quality work. It is much less critical with regard to placement on the H&D curve. In the early days of television sound motion picture photography, there is danger that there may be much hasty photography and little cooperation between recordists and film processing laboratories, which conditions definitely indicate the desirability of variable area.

Comparing present-day, improved 16 millimeter picture definition with that of the television process, the latter will probably for some time be the limiting factor on picture quality. Thus, if strict economy should be a factor, 16 millimeter might be used exclusively. On this substandard film size the status of the art of variable area recording is considerably better than that of variable density. Whether the recording be on 16 or 35 mm. film, a possibility worth considering is that of shooting at 30 frames per second instead of 24, improving sound track quality and the smoothness of pictorial motion as well.

Since the motion of film must be intermittent for picture making or

projection and uniform for sound recording or reproduction, the sound record is always placed a convenient distance ahead of the corresponding picture on the film. This inherent requirement imposes restrictions on the cutting, splicing, and editing of finished sound film because there is no practical way physically to separate the sound track from the adjacent frames of pictures.

To escape this limitation, most sound motion picture work utilizes the double system, in which pictures and sound are recorded simultaneously on two lengths of film running in synchronism through the camera and through the sound recorder. Driving the two units are synchronous motors, selsyn motors or, for field work, a dc interlock type. Another advantage of the double system is that additional sound effects, music or narration may conveniently be added to the original record before it is combined with the picture record in the final print for projection.

The single system has the inherent advantage of simplicity; both records are made simultaneously on the same film in the same camera-recorder, a compact, combined unit. Such equipment is more portable. It has enjoyed considerable use in the newsreel field, where what is often wanted is a truthful record of what took place visually and audibly, without later editing or rearranging. The fact that the sound is wedded to the picture is not a disadvantage under such conditions. Single system must make some compromise between picture and sound track quality, since no one photographic emulsion is ideally suited to both types of records. However, satisfactory results for newsreel-type work can be obtained. It is quite possible that the single system technic would be ideally suited to wide scale news event recording for later television release.

It is safe to say that much of the commercial sound-on-film recording being done today is of poor quality. The modern Hollywood product is generally reliable—it is the non-theatrical type of film, usually released in 16 mm., that often offends. Such prints may be imperfect reductions of older Hollywood products or they may be direct 16 mm. work poorly recorded due to faulty equipment or personnel. Film making in the field, whether originals be 35 or 16 mm., is the type of work which television broadcasters will have to learn. Many variables which have been successfully "tied down" in the film studios still plague the efforts of the non-theatrical film producer, but much of the difficulty is a re-

sult of the misapprehension that expensive recording equipment is foolproof.

Factors affecting final sound quality in the projection print may be divided roughly into four categories: Mechanical and optical perfection of the recording unit; quality of the electronic equipment and associated elements such as microphones and mirror-galvanometer or light valve; the film, exposure, processing combination; and the human element in maintenance and operation of the total equipment. If re-recording is employed, these same factors apply to that process as well.

Mechanical problems

Two major problems in recording equipment design and maintenance are the achieving of uniform film motion and a narrow, sharply focused, and correctly orientated recording light beam. Non-uniform film motion may be divided under three major categories: Slow speed-variations resulting in frequency modulation of the recorded sound audible as "wows"; sprocket-tooth flutter, faster speed-variations; and gear-tooth clash, frequency modulation at higher frequencies.

Good mechanical design minimizes all film motion problems. Sprocket-tooth design attempts to compensate for the inevitable varying degrees of film shrinkage and consequent non-uniform spacing of perforations. Good design and long "running in" procedures reduce gear-meshing and other mechanical troubles. In spite of all such precautions, however, it is impossible to secure sufficiently uniform film flow without mechanically isolating that point in the film path where the recording exposure is made. Usual practice involves passing the film around a rotating recording drum which is part of a flywheel driven through a filter. This filter may be mechanical (springs), hydraulic (oil-drive) or magnetic (lines of force provide the coupling). Each method is capable of good results. Tests of a given piece of equipment for film speed variations are best made with the cathode ray oscillograph and a constant frequency test film.

If an original sound recording is played back on a so-called film-phonograph for the addition of musical score or to "dub in" speech or sound effects not present when the shot was filmed, all of the reproducing and recording units employed must likewise be free of film motion irregularities which would cause any of the various types of frequency modulation of the combined sound track.

Sound recording on film approaches theoretical perfection only as the recording light beam is re-

duced to a mathematical line having no width. Since the beam must have finite width to provide light for exposure, certain distortion products are inevitably introduced, particularly at the higher frequencies, where the dimensional width of the beam becomes appreciable in terms of the linear distance the film stock travels during one cycle of the frequency being recorded. This is true both for variable area and variable density. In variable density recording, moreover, since the wanted signal causes varying exposure by increasing or decreasing the mean or no-signal width of the beam, high frequency sound signals are further distorted with increasing amplitude because of too great widening of the beam on that side of the signal's ac axis calling for more light and exposure.

A satisfactory compromise between the requirements of frequency response and recording light efficiency, using presently available recording emulsions, is .0005-in. slit-width for variable density and .0002-in for variable area

on 35 mm. A still further downward revision of these figures is necessary to secure comparable results in 16 millimeter, due to the reduced linear speed of the film. A high quality direct 16 mm. variable area recorder may use a light beam only slightly wider than one ten-thousandth inch. These slit widths are achieved by optical reduction of the actual physical slit or mask image.

Sharpness of the beam at the film surface, or clear demarcation between the area of light and the areas of no light, is a prime requisite of the optical system, since any light scattering would effectively increase the slit width. Accurate focus and precise azimuth orientation at 90 deg. to the direction of film travel are other requirements. Any adjustments, of course, must be made under a suitable microscope. Certain types of recording units, adjusted during manufacture and sealed, require no field servicing under conditions of normal operation. Highest quality is ob-

(Continued on page 190)

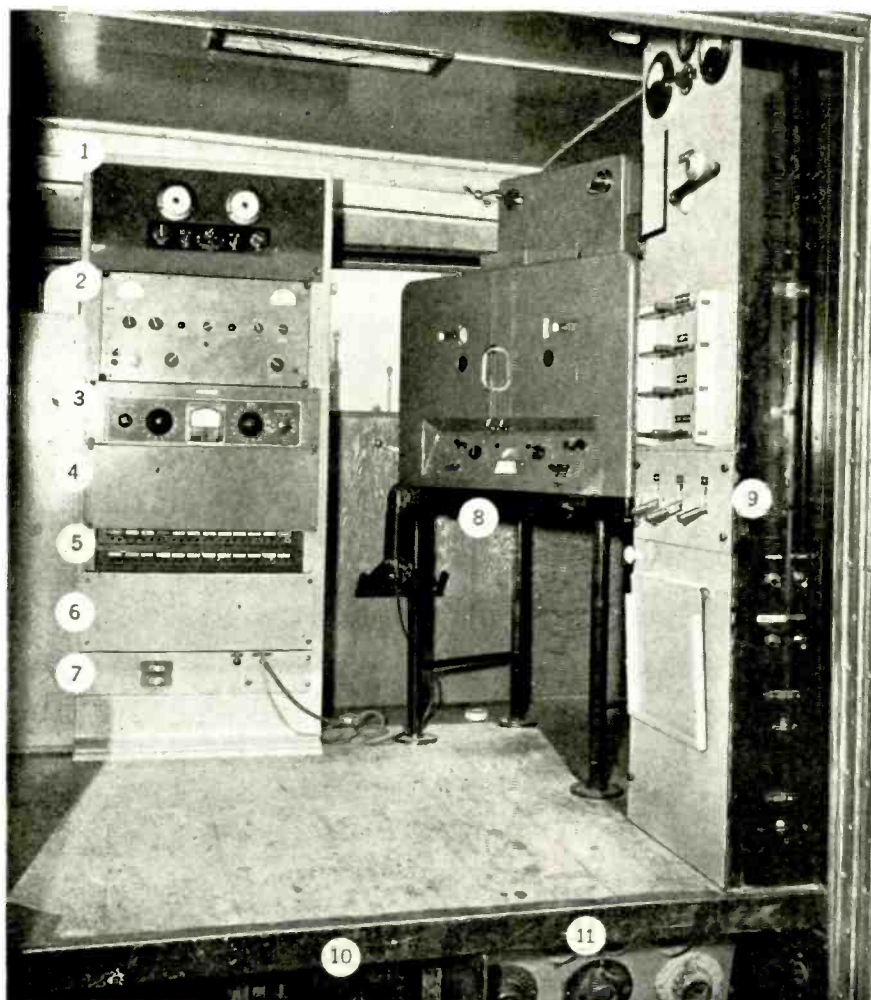

Inside of 20th Century Fox mobile recording truck, a 35 mm. push-pull system. Elements are: 1—noise reduction equipment, 2—recorder control panel, 3—limit amplifier controls, 4—limit amplifier, 5—jack field, 6—filter and monitoring amplifier, 7—telephone equipment, 8—35 mm. recorder or film machine, 9—motor control panel, 10—rectifiers, 11—power input. P₂—amplifier not shown. Push-pull track, after editing, etc., is recorded as single-ended for distribution

MAINTAINING MILITARY

by **ROLAND C. DAVIES**

Electronic Industries Washington Bureau

Laying out, equipping and servicing radio highways of the sky regularly flown by Army Air Transport Command

● The building of the "Radio Highways of the Sky" along which the huge planes of the Army Air Transport Command and the military bombers for the United Nations have been traveling safely over jungles and mountains, through storms, fogs and darkness, has been performed by specialists of the U. S. Army Signal Corps. After these radio stations are installed—and they have been built by the hundreds in 52 foreign countries of the globe—the Signal Corps turns them over to the Army Air Forces for operation and then the radio guidance of flying falls upon the Army Airways Communications System, although the Signal Corps plant and engineering experts are always ready on call for major maintenance and repair jobs.

The Plant Engineering Agency, one of the units of the Army Communications Service of the Signal Corps, and a sister group, the Communications Engineering Branch, have worked hand-in-glove on the assignment of engineering, procuring and installing equipment for the Army Airways Communications and Weather Systems outside the continental limits of the United States. Other segments of the Signal Corps have also assisted the AACCS—which deserves a tremendous amount of credit for the notable achievements of aviation radio communications in every part of the world during this war—among these is the Signal Corps Security Agency which has the responsibility of safeguarding military communications and recogni-

tion codes for the air forces of the United Nations.

The Signal Corps specialists who have placed in operation the radio equipment that has enabled the many thousands of military planes to shuttle across oceans and continents carrying men and materiel to the fighting fronts, oddly, have been trained on the rolling fairways of one of Philadelphia's swank golf courses, the Brookline Country Club. Instead of golf enthusiasts, Philadelphians have seen during the war young men in Army fatigue uniforms learning one of the most specialized of military trades. These specialists erect poles and string transmission lines; construct antenna towers and radio equipment; assemble transmitters, receivers, power plants and weather stations and then tear them down again. They keep on repeating the process until they are skilled enough to install the apparatus under any conditions in any part of the world.

This is how the Signal Corps Plant Engineering Agency swings into action for a new airways radio and weather station:

A decision is made to extend an Air Transport Command route, necessitating communications and weather recording facilities at a new airfield. Regional and Sector control officers of Plant Engineering Agency and the Army Airways Communications System collaborate on the plans, which vary according to the geographical, climatic and tactical conditions.

Typical installation

One set of the plans is sent to Plant's headquarters, where men swing into action swiftly—for virtually every request bears an "urgent" tag. Plant engineers the equipment, procures it from commercial manufacturers, ships it to the scene, and sends out a team of from five to twelve men to install it.

But it is not so simple as it sounds. A typical installation requires an airdrome control tower,



Inside a training plane radio and navigation officers learn to use the complex equipment that keeps the pilot on the beam and insures the safety of the crew on every sort of mission

RADIO COMMUNICATIONS

an operations room, a transmitter and receiver plant, a radio range, a homing transmitter, a meteorological station and power units. The equipment includes radio transmitters varying between 25 watts and 40 kilowatts in power; radio-sonde and other weather recording apparatus; high-speed tape radio apparatus; direction finders, and range beacons. An installation may have as many as five huge antenna towers.

Insure air safety

Without these facilities there would be chaos; the planes could not fly the routes with any degree of dependability. Each airfield must be in communication both with the planes and with other fields and headquarters, to control the flights and exchange weather data. The planes must be guided by navigational aids from the ground—the radio beams, homing devices and direction finders. For instance, the beam literally lays down a definite path for the pilot to follow; as long as the "on course" signal is heard, he knows the beam will lead him through the safest passes and clear him of the dangerous peaks. So the planes fly, aided by well over a half-million miles of radio and wire circuits.

In order to install the apparatus that makes the air routes dependable and safe, Plant's engineers and technicians must fly those routes before they become safe. The installation teams have had their quota of adventurous moments and have been under fire. One such moment came in an emergency call to Plant Engineering to install a duplex radioteletype channel to aid in the flying over the Himalaya Mountains. An eleven-man installation team set out in a transport plane for the China end of the route, a snow storm was encountered and, even though the plane crew threw out tools and artillery shells, the men had to bail out, but ten men finally made their way back through the jungle to civilization. They then continued their job to install the communications channel in China even though they frequently had to dodge Japanese bombs being dropped on the air field.

The Signal Corps units, always working against time, frequently have had to labor 14 to 18 hours daily in broiling heat or sub-zero cold and in several cases, men have worked through heavy tropical

rainstorms without rest up to 36 hours. Time and again, to meet deadlines, the specialists have improvised equipment on the spot, have raided aircraft junk yards, have borrowed material and equipment from various services and have borrowed and purchased materials from foreign commercial concerns.

Occasionally, engineering must be done in the field to meet conditions never before encountered. Unusually violent and frequent electrical storms, bitterly cold temperatures and—in the high northern latitudes

Glider "Radio Base"

A wrecked glider was used as a radio control station by Col. John Alison for the landing of gliders on the "Broadway" air strip after the "Piccadilly" field has been obstructed by the Japs—this was part of the sensational feats of the First Air Commando Force—the AAF's glider organization—which carried Allied troops over the Japanese lines in Northern Burma last month to carve air bases out of the jungles, it has been revealed by the War Department.

—the Aurora Borealis, have played havoc with communications and have required ingenious on-the-scene innovations. As a result, Plant Engineering's equipment and methods are frequently ahead of the text books. Back in the Philadelphia headquarters, engineers are constantly revamping apparatus; for example, they have pretty well drawn the teeth of the Aurora Borealis through the use of selected radio frequencies and the design of special directional antennas and equipment.

At the same time, the Signal Corps experts are always hard at work developing short cuts and new streamlined methods that save time, personnel and materials. For wire communications Plant Engineering produced "packaged carriers," an innovation in which the best features of thousands of items of equipment were combined into compact units which were sent into the field with instruction pamphlets, for quick installation by non-technical men. Similarly, individual engineering for standard radio installations was reduced greatly by the provision of kits containing transmitters, receivers, antennae and other materials necessary for particular needs.



Hundreds of Army Airways communications towers have been installed in the United States and in 52 foreign countries by specialists of the US Army Signal Corps to guide army planes

PRODUCTION SHORT CUTS



4 Tubing cutter, devised at Argus, Inc., Ann Arbor, Mich., cuts insulating tubing into preset lengths at rate of 6,000 pieces per hour. Older, foot-powered equipment cut up to 4,000 pieces per hour with heavy toll of operators. The unit (shown here with guards removed) is powered by a solenoid and actuated by a microswitch. Air blast disposes of the cut pieces

5 Electronic sorting and inspection table replaced needle micrometer hand operation at General Electric in sizing tiny contact assemblies. Operator slides assemblies down incline. If top of assembly touches first overhead contact it is oversize, and electronic relay acts to eject it into first chute. Second contact point is set at standard height less tolerance. Upon contact, assembly is kicked down chute for "correct" size. Undersize units miss both points

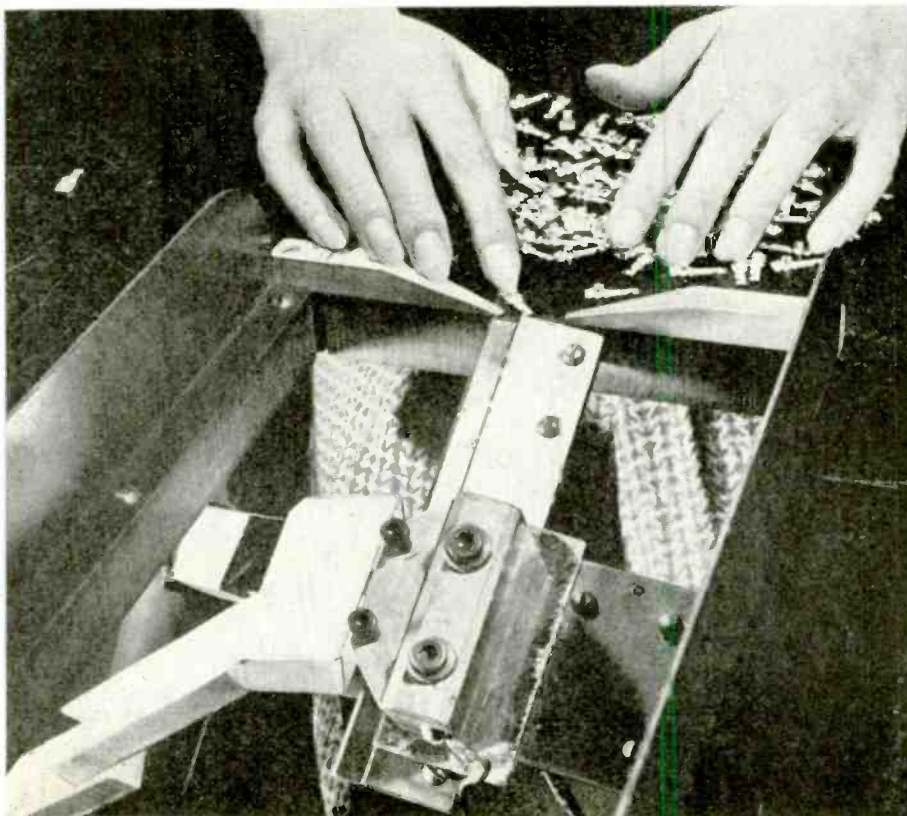

Ideas to speed production, inspection, and testing of war radio-electronic gear

1 Dramatizing Humdrum Jobs

It can be very monotonous for a worker to repeat, day after day, some simple operation on a subcontracted job like punching out chassis stock for radio equipment. Many plants have learned the value of organizing exhibitions of the finished equipment ready for war communications duty. The workers making vital components otherwise might never know what the finished gadget looked like and could hardly be blamed for losing interest.

The latest such exhibition was arranged for employes of North American Metal Products Co., Chicago, prewar makers of metal stampings for cookie cutters and toys. The Signal Corps supplied two walkie-talkies, field telephones, and several larger transmitters and receivers. One unit of each type was assembled, the other broken up to show the parts of local manufacture. Signal Corps motion pictures and refreshments combined to make the Saturday afternoon a highly successful gathering from the morale standpoint.

2 Bucket Brigade—Water-Cooled Factory Girls

Sore need by Signal Corps for mine detectors brought sore arms and wrists to gals at International Detrola Corp., Detroit, Mich., in all night rush-order panic. Special train awaited the detectors, to give you an idea of the urgency. Anyway, the story is that those sore wrists succumbed to a quarter-hourly plunge in buckets of cold water!

3 Saved: 10,000 nickel nickels

Another example of an unnecessary operation and its successful elimination: Girl at a tube plant discovered that welding of tungsten top leads to platinum-plated grid side rods could just as well be done without using the conventional nickel flux. Result: saving of many hours' time and about \$500 worth of nickel annually.

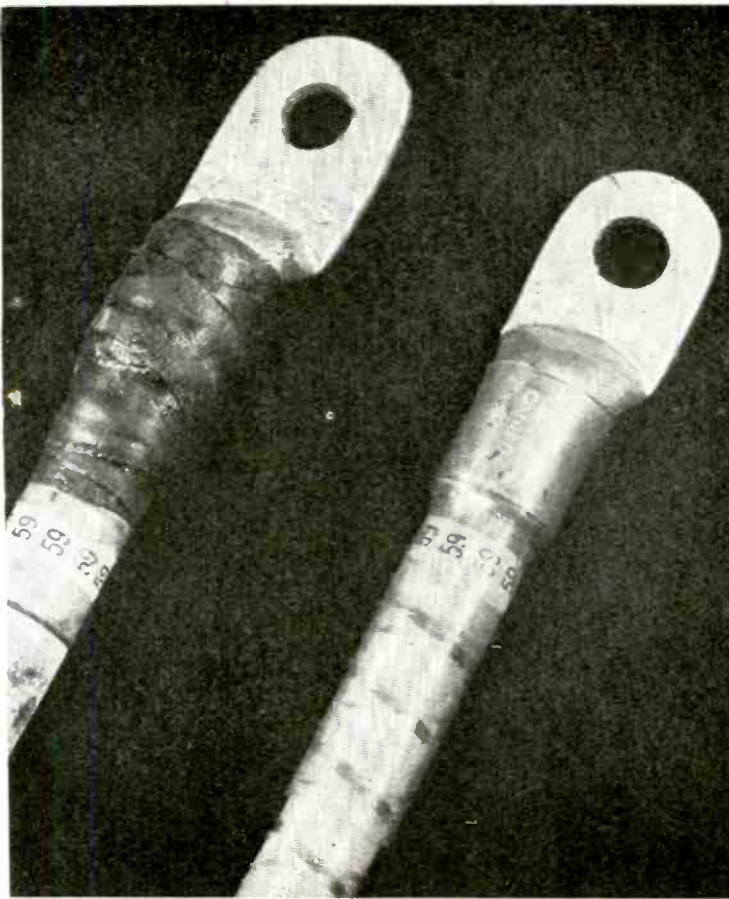

6 Transparent plastic tubing now covers cable terminals at Northrup Aircraft, Inc., Hawthorne, Calif., instead of rubber tape. Result is neater, quicker job allowing final assembly inspectors to check soldering without removing tape. Photo shows old and new methods. The plastic tubing is expanded over terminal by special beveled-end air hose nozzle

8 Rotary drop test unit at Tung Sol, Newark, N. J., is useful research tool and production quality test instrument. Graduated hexagonal boxes rotate on common shaft. If normal breakdown of a certain tube type occurs in Drum No. 5, it is henceforth known as "bogie drum" for that type. All production must then pass tests up to No. 6

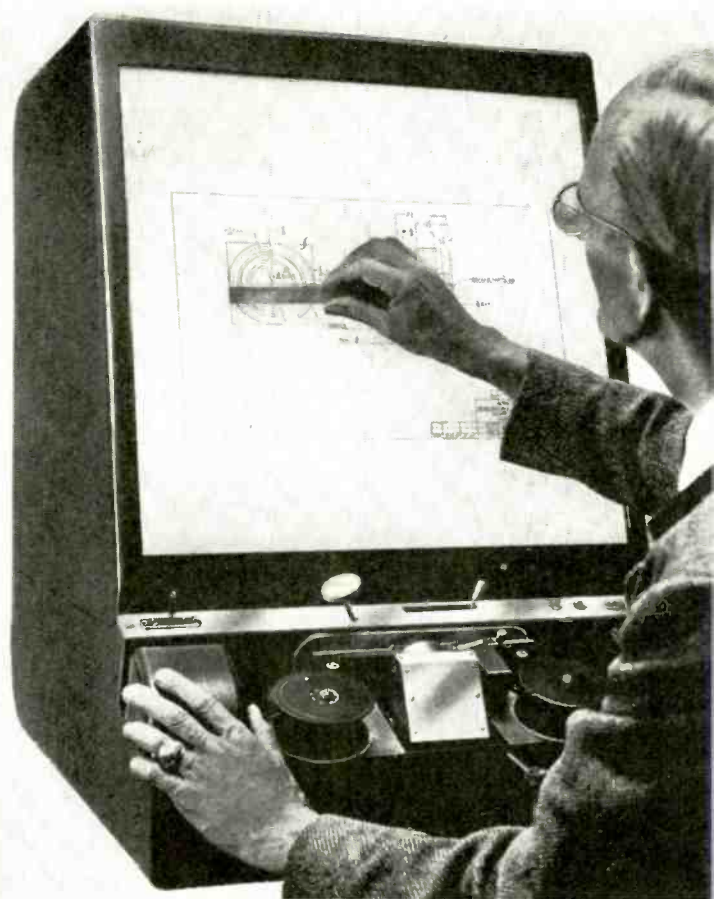

7 V-Mail technic on the home front renders service to industry in preserving records, drawings, and plans. Equipment manufactured by Microcopy Corp., Burbank, Calif., saves time, money and space in storing records, as well as providing "document insurance" in cases where originals are removed. New technic allows copying pencil drawings

9 Two operations formerly separately performed can frequently be combined into one, at great savings of man and machine time. Photo shows \$50 bond winner at Farnsworth Television and Radio Corporation's Marion, Indiana, plant. Girl operator demonstrates special punch and die set to form and cut wire in a single operation



USING CATHODE COUPLING

by W. MULLER

Useful applications of cathode follower systems at low and high frequencies. Basic circuit characteristics

● Among the large variety of tube circuits that are daily employed to carry out all sorts of jobs the "cathode follower circuit" seems to be sort of a stepchild among the greater part of electronic workers. In general while a few radio engineers and laboratory men seem to have recognized the value of cathode follower circuits and their applications, many others never have become fully aware of their features. The cathode follower is a most useful circuit in these times when parts are at a premium.

Primarily a cathode follower is nothing else but a circuit using a grid-controlled vacuum tube (any type) where the signal impressed on the grid is picked up across the cathode-to-ground impedance instead of from plate to ground as is customary (see Fig. 1). Its features which are advantageous include the matching of loads to a tube in a manner not possible with other connections: First: Easier matching to low impedance circuits. Second: Phase shift is largely eliminated. Third: Frequency distortion and discrimination are reduced to a minimum. Fourth: It can be used at all audio and radio (including ultra-high) frequencies. Perhaps there are

some other advantages, but the aforementioned are the most obvious.

The disadvantages are as follows: First: No voltage amplification results. That is, the theoretical energy transfer is unity, but in practice is slightly less (usually about 90 per cent of input signal). Second: The tube selected must be able to handle maximum signal at input, which in some applications might be almost any level. Third:

The output signal is in phase with input signal, which might be objectionable in some cases. Fourth: Since there is no gain, but a slight loss, this might mean that additional amplification would be required. Certain other disadvantages are not listed since they have little bearing on the following.

Referring back to the first advantage, namely easier matching of loads at low impedances, assume the conditions in Fig. 2. where a

Conventional pre-amplifier and power amplifier system using transformers in Fig. 2. In Fig. 3, a cathode follower stage replaces low impedance output transformer for emergency service

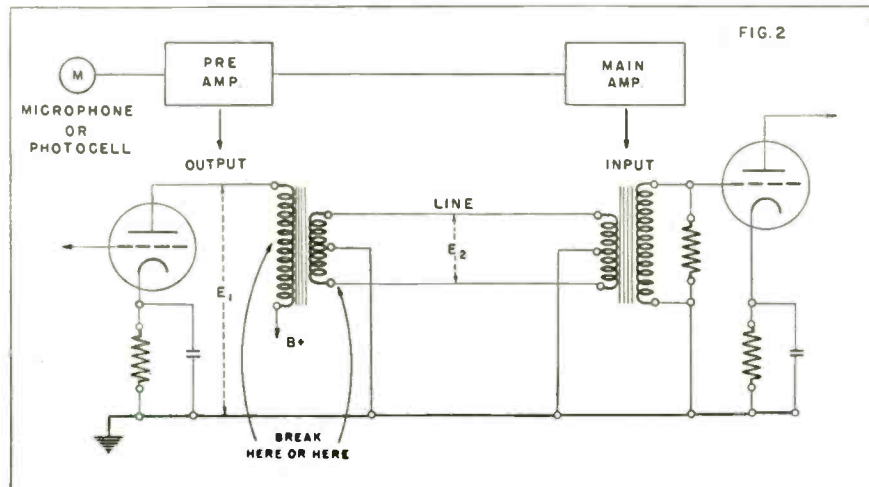
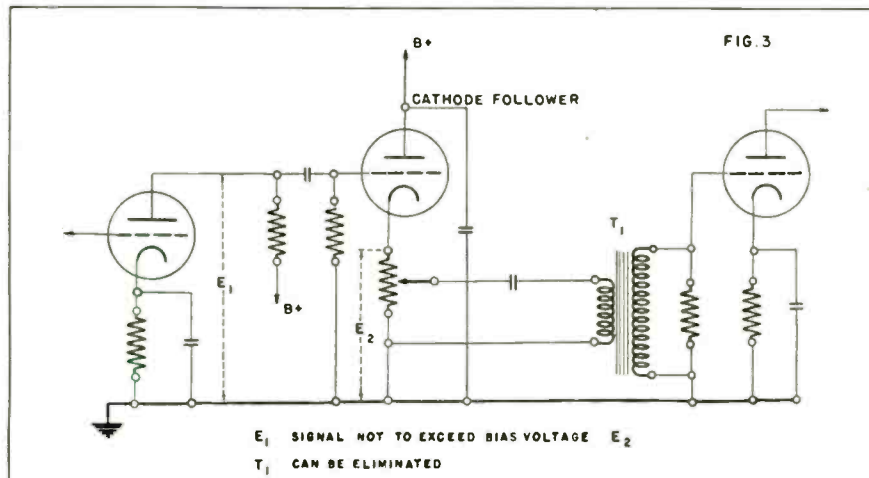
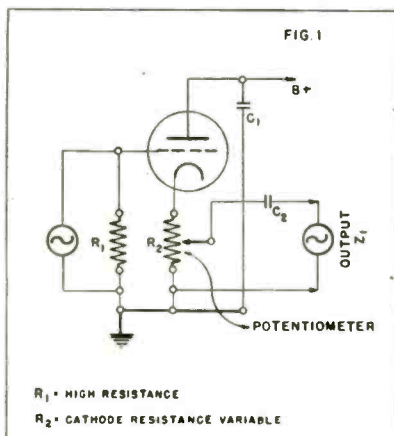

Fig. 1—Basic circuit of cathode coupled output stage. Input signal applied across R_1 . C_1 has low reactance at all frequencies used



microphone or phototube preamplifier is to be matched into a 600-ohm line. Generally we use a preamplifier-to-line output transformer to do this, that is, the primary of the transformer is fed from the final tube in the preamplifier and the signal appearing across this primary usually is stepped down to match the desired secondary impedance of 600 ohms. On the other end of the line we have another transformer, usually step-up, that feeds the grid of the next amplifier, whatever this amplifier might be. This operation calls for two line-matching transformers, and if the installation is high quality, the transformers have to be the best. To apply cathode follower circuits to this application to eliminate the need for the transformers, first ascertain the operating level of the signal that would be normally delivered to the primary of the line output transformer. Then select a tube whose bias is large enough to cover the maximum excursions of the incoming signal, and connect as per

Fig. 3, and tap the cathode resistor at a point equal to the desired line impedance of 600 ohms. The gain of the next unit is then raised slightly so as to compensate for the loss incurred in the cathode follower. Since line levels for preamplifier circuits are low, no real

problem will be experienced. Another point is that the grid input of the following circuit can be worked directly from the line, that is, high impedance input with no detrimental effects.

If the tube used happens to be a 6C5 then the impedances in the

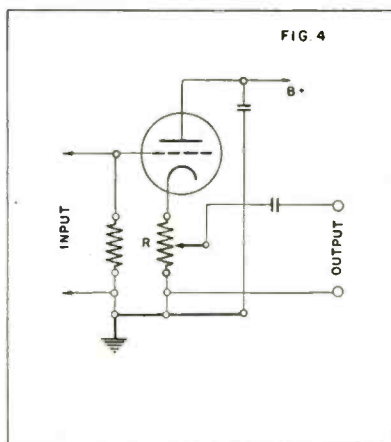

Fig. 4—Circuit for low frequency applications. Plate to ground capacitor can be several mfd

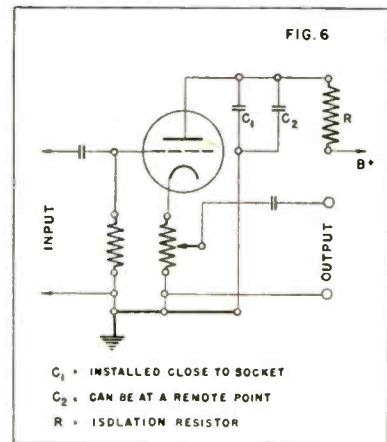
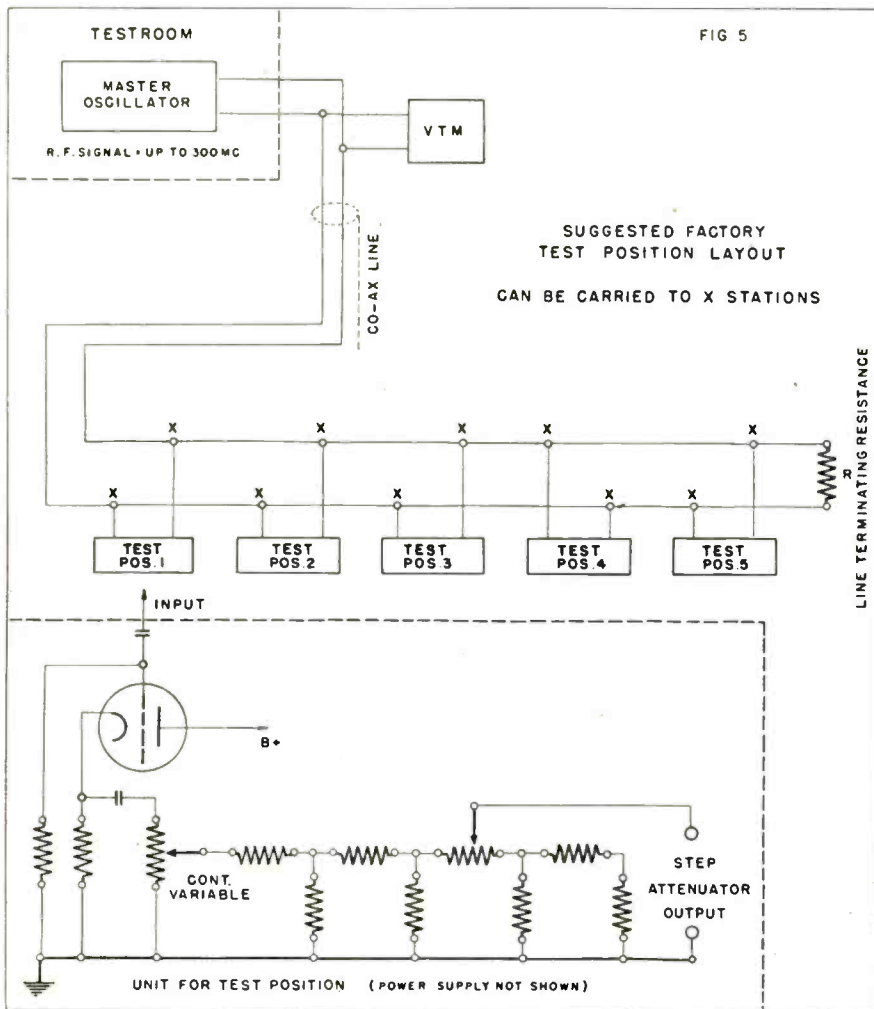

Fig. 6—Additional by-pass capacitor C_1 of mica type is added for high frequency use

Fig. 5—RF test signal distribution system using cathode followers to take signal from coaxial line. Tubes at each test position produce negligible loading of line, give low impedance output



output load impedance can be varied from 1 to 2000 ohms, with any intermediate step, that might be desirable as in Fig. 4. Distortion and frequency discrimination will be nil. Here a simple tube replaces a hard-to-get transformer.

This example covers one instance of the application. The next example will cover line matching where a number of points are to be supplied with signal energy as in the case of test positions in a radio set factory. The problem here is to feed a number of test positions with a 450 kc signal, as in Fig. 5. Here again the procedure is similar to the first problem. The required test voltage seldom runs over 3 volts. The line used will be coax. The master generator is terminated into the line either inductively or through a cathode follower. By tapping the cathode resistor as needed, the coaxial cable can be easily matched, terminating the far end into a fixed resistance. All test point positions have a cathode follower whose grid is fed directly from the line (high impedance input) and whose output can have a readily constructed output attenuator of the resistive type. Attenuation will be smooth and easily accomplished. No other forms of matching will be needed.

If the level on a line or output of a device runs as high as 100 or 200 volts, the only rule to be observed is to provide a cathode follower tube, whose bias is as large or larger than the max-

(Continued on page 196)

FLEXIBLE STUDIO CONSOLE

by PHILIP C. ERHORN

Design of speech input set-up to afford sufficient facilities and great versatility for small control room

● Broadcast studio technic has been pretty well standardized but tends to become more complex particularly where changes in circuits must be made frequently as a consequence of studio changes, addition of facilities and so forth. Illustrated is a block diagram of a typical studio control console containing all the audio equipment normally used in program production.

Circuits involved in this particular arrangement, which may well serve as a model for a small station, are flexible, and no circuit jacks and patch cords need be used. All functions are controlled by reversible key switches. As indicated on the diagram, the facilities are set up for two studio operations, although several of these units could be used to advantage for medium size stations having several studios. In the very small station, the console will serve as master control to the transmitter, the line output feeding directly to the modulator circuits.

In Studio A two microphones are directly connected to preamplifiers, and a third microphone runs through a transfer key ahead of the preamplifier. In the normal or "off" position of this key, the third microphone is connected to the No. 3 preamplifier. With the key in the up position, a fourth microphone in the control room itself, is connected to the preamplifier. This microphone may be used for talk-back use to the studio, in conjunction with an electrically interlocked loudspeaker relay, which will cut the control room loudspeaker to avoid acoustic feedback. It may also be used to talk on the air by the engineer running a record program, or reading news when he opens the station, and before the regular announcer arrives.

With this same transfer key in the down position, a fifth microphone located in Studio B, a news booth, will be tied to the third preamplifier. Two transcription pickups are connected to the No. 4 and No. 5 preamplifiers, although microphones could be connected if the turntable facilities are not wanted. The output of the five preamplifiers runs to five mixing pads.

These mixing pads are tied to transfer keys which in the normal position place termination resistors across the pads. Thus if any input position is not being used, the impedance of the mixer will not be upset.

With these keys in the down position, the output of the mixer is fed to a booster amplifier (to make up for mixer insertion loss), and then through a master gain control to the program or line amplifier. The program amplifier feeds the output line through a line key and isolation pad (fixed). Bridged across the output of the program amplifier is a volume indicator meter and a pad connected to the input of the monitor amplifier. The monitor amplifier consists of a booster amplifier, high impedance interstage gain control and power amplifier to feed loudspeakers in the control room and both studios.

When the "microphone" keys are thrown in the up position, instead of feeding to the program amplifier, the microphone or turntable output is fed to the monitor ampli-

fier for auditioning purposes. The transfer key on the monitor input must also be thrown from "air" to "rehearse." In this way it is possible to have, for instance, Studio A on the air, and at the same time the engineer can cue the transcription turntables in readiness for a following record program.

It will be noticed that three incoming remote pickup lines are also provided. One of these may be permanently connected to a network feed line. The remote lines are tied to transfer keys which in the up position feed through a terminating coil to the sixth mixer pad. Another transfer key associated with the sixth mixer pad, allows the remote line feed to be placed on the air or fed to the monitor for audition purposes.

With the remote line transfer keys in the down position, the output of a receiver or rf monitor cue line is fed to the lines for cueing the remote operator previous to his air time. These keys in the normal, or off position are connected to a ringer circuit in the control room. The remote operator has only to

Standard type Western Electric model 23C broadcast studio console



call down the line with his portable ringer, and the studio engineer immediately knows he is being called. He can then listen on the remote line with the monitor in the rehearse or audition setting, and can plug a handset into line jacks to talk back on the line.

In the event that trouble occurs in the program amplifier, all microphone, turntable and the remote mixer-transfer keys are thrown to the audition position. The line key is transferred to the output of the monitor amplifier, and the VU meter is placed across the monitor output by means of a transfer key. The monitor amplifier is thus available for feeding program to the line output in an emergency. A headphone jack and transfer key switch the headphones from the output of the program amplifier to either the receiver cue circuit or the incoming remote lines. The key on the monitor input, when in the normal position, connects the output of the cue line to the monitor, and makes it possible to hear how the program quality sounds from a radio receiver.

It can be seen that with the remote line keys in the down position, an incoming feed will be tied directly to the monitor input through the cue line, if the monitor input transfer key is normal. This is not an intentional feature, and will have no bad results. However it happens because it was thought advisable to feed cue to the remote line from a receiver rather than from the program or monitor amplifier. If the program amplifier failed, cue would fail. If cue were taken from the monitor,

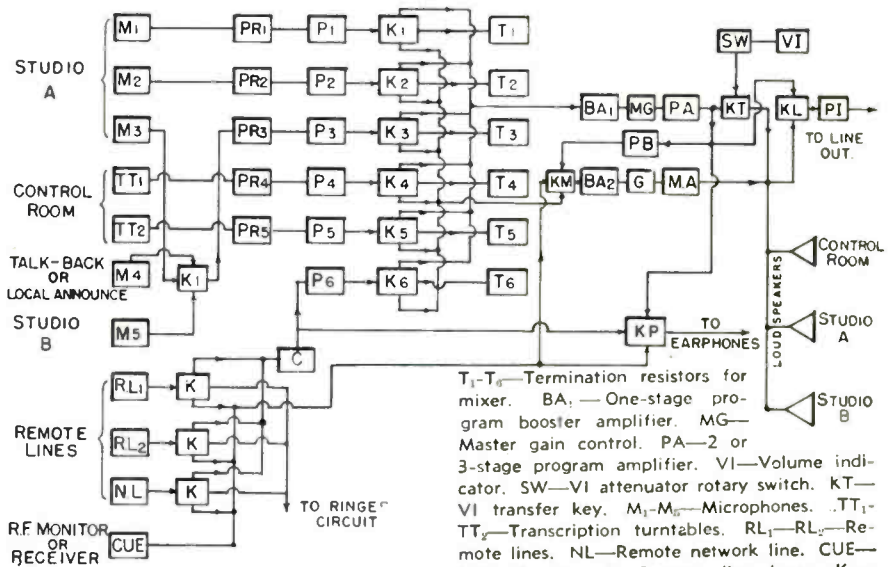

termination coil, PR₁-PR₆—Preamplifiers. P₁-P₆—Pads. K₁-K₆—Keys. T₁-T₆—Termination resistors for mixer. BA₁—One-stage program booster amplifier. MG—Master gain control. PA—2 or 3-stage program amplifier. VI—Volume indicator. SW—VI attenuator rotary switch. KT—VI transfer key. M₁-M₅—Microphones. TT₁-TT₂—Transcription turntables. RL₁-RL₂—Remote lines. NL—Remote network line. CUE—Network cue. K—Remote line keys. K₁—Transfer key for mixer at Pos. 3. C—Line transfer coil. PR₁-PR₆—Preamplifiers. P₁-P₆—Pads. K₁-K₆—Keys. KL—Output line key. PI—Output isolation pad. PB—Fixed bridging pad. KM—Monitor input transfer key. BA₂—One-stage monitor booster amplifier. G—Monitor gain control. MA—2 or 3-stage monitor amplifier. KP—Headphone monitor transfer key.

Speech input consoles, like everything else in modern broadcasting studios have undergone constant revision but good as they are none will do everything an engineer would like them to do. Diagrammed is a design representing a composite of the RCA 76B2 unit and the WE 23C model with suggested changes to adapt the equipment to the needs of most moderate sized studios

and the monitor used for rehearsal or audition, the cue would be cut. Naturally, when receiving from the remote lines, only one should be in the circuit at a time, although immediate transfer from one to another is possible, for example where a local remote feed is followed by a network line program.

Individual refinements may be added rather easily. Sequence operation of the loudspeaker re-

lays may be set up so that throwing a microphone key to either air or rehearse position cuts the studio loudspeaker. A separate talk-back key would enable the engineer to talk back to either Studio A or Studio B, in either case cutting the control room speaker when the talk-back was in use. The monitor amplifier could be so connected as to talk-back on the remote lines, and when the talk-back key was released, the remote line feed would be connected to the monitor. There are several commercial units available utilizing circuits of the same general order as the example shown. Some have self-contained power supplies, and others are supplied with a separate wall-box type power unit.

The control desk panel always features operating conveniences. The panel should slope away from the control engineer at an angle of about 30 deg. for increased operating convenience and relief from wrist strain when mixing a program. All mixing pads and master and monitor gain controls are placed near the bottom of the panel in a line. The mixer keys are placed directly above their respective control knobs. A rotary switch allows a milliammeter to be switched into each amplifier cathode circuit. A check can then be had on the performance of each tube. If program fails, a defective tube can be quickly located and replaced, or if none of the circuits show a reading, it would appear obvious that the power supply had failed.

This is the RCA model 76B2 console as used in many broadcast studios





PRODUCTION OF CATHODE

Viewing a few of the many processing operations carried on in one of the modern plants of the North

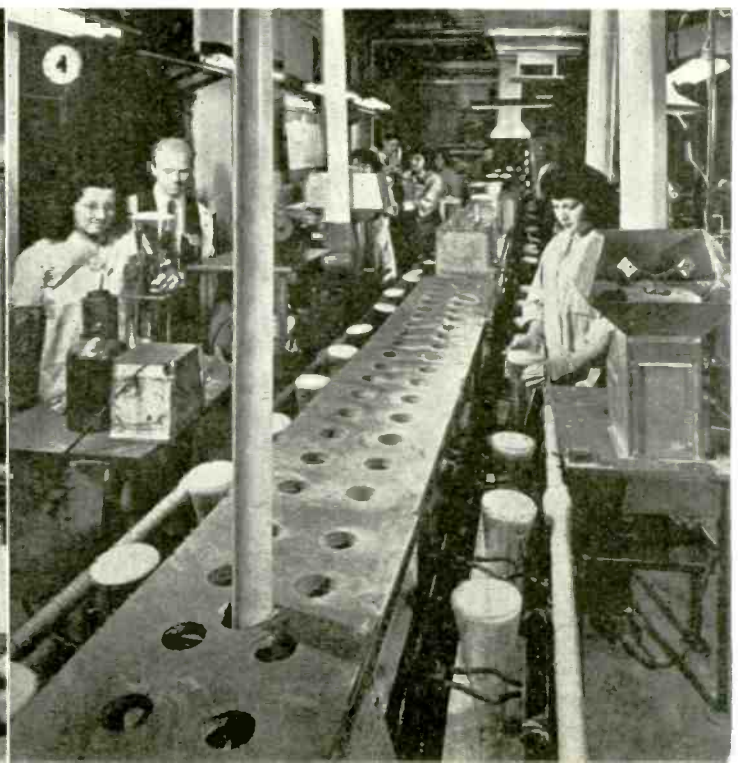

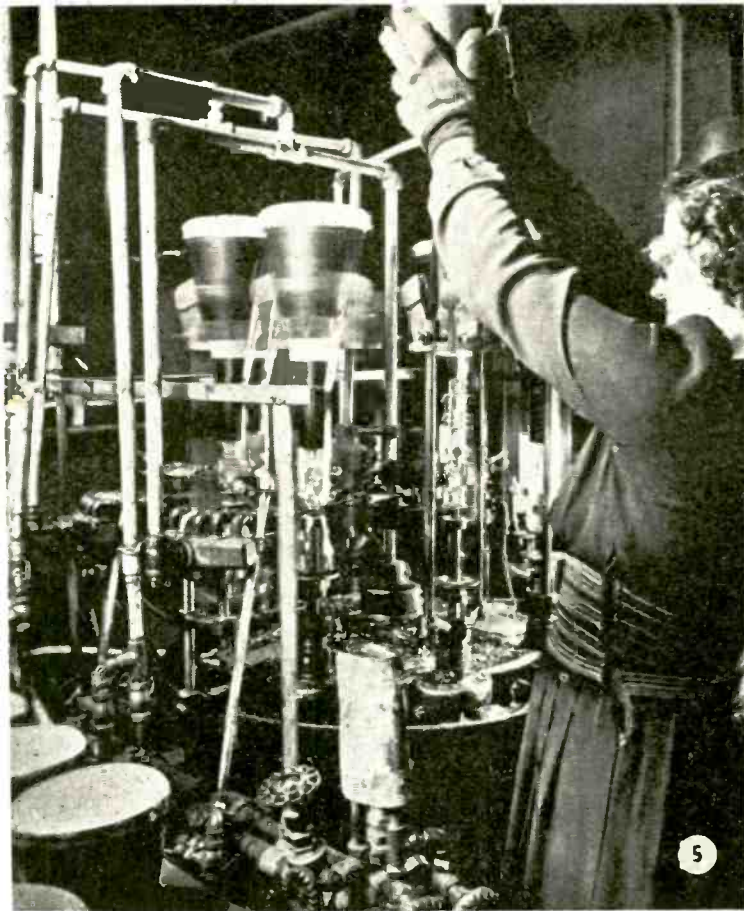

RAY TUBES

*involved in manufacture as
American Philips Company*

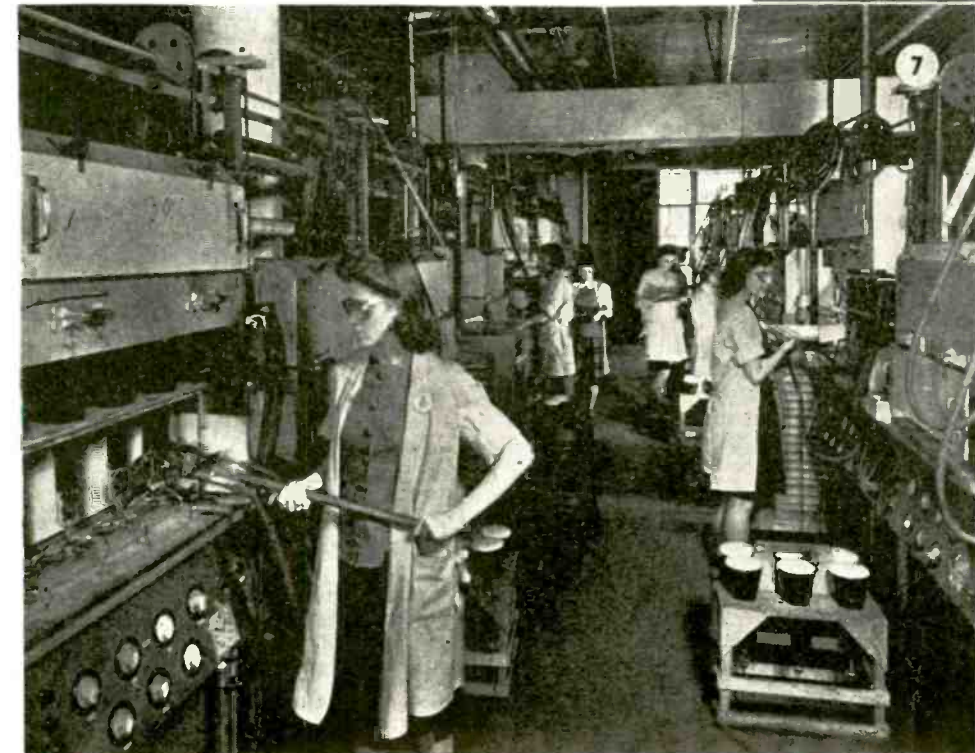

- 1—Applying the internal coat of Aquadag
- 2—Spotwelding elements to lead-ins
- 3—Drying and baking internal coatings
- 4—Bulb washing before screen application
- 5—Automatic sealing prior to exhaustion
- 6—Baking, bombarding and evacuation
- 7—Induction heating to expel gases

HIGH SPEED TIME BASES

by WILLIAM A. STEWART

Engineering Dept., Philco Radio & Television Corp.

Application of blocking oscillator produces a time base suitable for analysis of micro-second intervals

• Usual sweep circuits have not proved particularly satisfactory for the observation and measurement of recurrent phenomena of very short time duration. For certain of these uses, it is necessary to maintain a calibration of at least 0.05 microsecond, and make possible repeatable measurements with that accuracy.

It is, of course, possible to construct the usual type of RC saw-tooth generator, and with careful attention to the necessary bandwidth, build an amplifier to obtain sufficient voltage to operate the time base. Needless to say this method requires several tubes, entails considerable difficulty of design, and necessitates the use of many circuit components. After construction, even should the sweep circuit be satisfactory otherwise, individual variations of the several components with temperature, humidity, voltage, etc., make calibration difficult to maintain.

After due consideration of the factors involved in such a circuit, it would appear highly desirable to obtain necessary voltage for the operation of the time base directly from the saw-tooth generating circuit itself. Should this be possible, not only would the circuit difficulties be greatly reduced, but the calibration might prove to be much easier to maintain.

High energy content

Consideration of the usual means available for obtaining a saw-tooth voltage pulse of short duration indicate the necessity for a heavy current through a comparatively low value resistor, either for the period of time between sweeps or momentarily during a portion of the saw-tooth. It is obvious that the greater the voltage swing desired, the more current required through the saw-tooth generating circuit.

Hence, to use the first of the two methods would necessitate the utilization of a tube of large current carrying capabilities, and require a power supply capable of maintaining its voltage under the indicated current drain. Further, the resistor of the RC circuit would have to be capable of high heat dissipation. For example, if the resistor utilized were 1,000 ohms, the 500 volt saw-tooth required to obtain a fairly linear 300 volt sweep would necessitate a current drain of half an ampere with the voltage supply providing about 600 volts.

A cathode follower in the output would make possible the use of a higher resistor, but the added capacitance of the follower would tend to augment the nonlinearity of the saw-tooth, and hence make a smaller portion of it available for use. It appears likely, therefore, that there would be little gained. In view of the foregoing, this method appears impractical.

The second of the two methods of saw-tooth generation seems to offer more possibilities. If the plate dissipation of the tube used is taken as the limiting factor, it is evident that considerable current

may be drawn for short periods. For example, if the allowable plate dissipation of a tube is five watts at one kilovolt, it would be possible to draw five amperes for a period of one microsecond one thousand times a second before the rating was exceeded.

The limiting factor here, of course, would be the peak emission capabilities of the tube. However, taking the case mentioned in a preceding paragraph, where the current needed amounted to one-half ampere, an ordinary receiving tube, such as the 6SN7, might be used, provided the repetition rate were kept within reasonable bounds.

The requirement, therefore, resolves itself into a problem of driving the grid into the positive region and holding it there for a period long enough to permit the plate voltage to reach the value indicated by the plate current and the resistor of the RC circuit. Since this period also represents the "return-trace" it should be as short as possible.

Because the tube is to be completely cut off for the period between sweeps, and during its conducting period run at saturation, an idea of the grid swing required may be obtained. If cut-off is ten per cent of the plate voltage, the grid would have to swing more than sixty volts for a plate potential of 600 volts. Probably under such conditions, a grid bias of about 70 volts would be safe, and a firing pulse of between 80 and 100 volts needed.

This firing pulse would have to be a square wave of fairly short time-duration. If the time-base of the sweep is to be two microseconds long—four inches at 0.5 microseconds per inch—it would be logical to wish the "return-trace" to be at least not more than twenty-five per cent of that period, or 0.5 microsecond. Since this will represent the time during which the tube is conducting, it will also represent the entire duration of the triggering pulse.

Thus, the requirements for the firing pulse: Total duration, from cut-off to cut-off, not more than 0.5 microsecond; amplitude of pulse

Fig. 1—Oscillogram showing blocking oscillator action giving short duration positive pulse

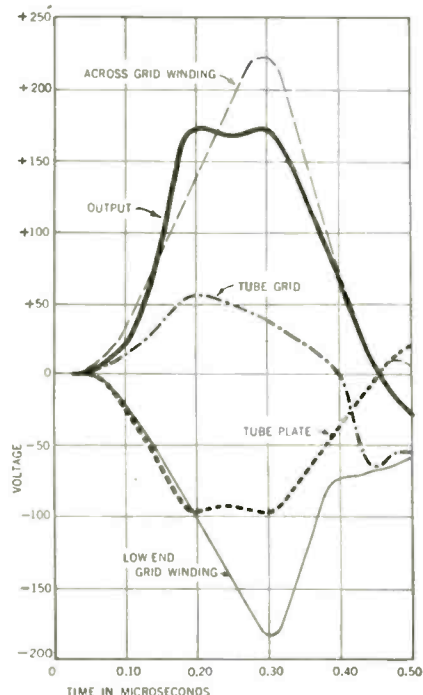

above cut-off, at least 80 volts; shape of pulse, as near a square wave as possible, at least on the leading edge, while the trailing edge must not distort the linear portion of the saw-tooth. The pulse must have a maximum amplitude of sufficient duration to permit the plate voltage to drop to its minimum value.

Examination of the several circuits capable of producing a positive pulse suggests two or three possibilities. The first such circuit which comes to mind is the familiar "trigger" circuit, a modification of the multivibrator where the first grid is held below cut-off until the system is placed in operation by a synchronizing pulse. Investigation of the operation of this circuit indicates that a one microsecond pulse is about the lower limit of pulse duration obtainable due to the inherent slope of the wave generated by this circuit.

For pulses of approximately one microsecond at half amplitude the wave shape is about that of a triangle. Durations of less time result in a reduction of amplitude with the triangle shape being maintained. This fact more or less rules out the use of a trigger circuit directly. It might be possible to differentiate the leading edge of such a pulse, amplify the result, clip, and perhaps obtain a satisfactory firing pulse for the saw-tooth generator. The difficulties involved in such a process probably would be no less than those inherent in amplifying a saw-tooth, so it may be ruled out.

Another possibility lies in a thyratron. This tube will generate,

Fig. 2—Experimental set-up showing circuit utilized in analyzing oscillator operation

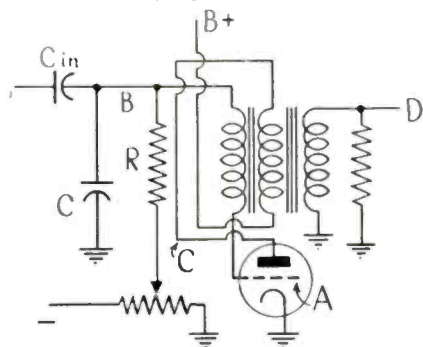
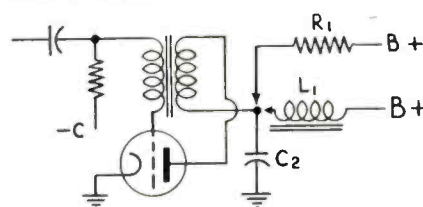

Fig. 3—Saw-tooth wave circuit, with alternate forms of output



when fired, a positive pulse of considerable amplitude across a resistor placed in its cathode circuit. The limitation here lies in the deionization time of the tube. However, the application could prove practical.

A third method of obtaining a pulse of the character required is the blocking oscillator. A simple circuit of this character, where the tube is run at cut-off and the operation started by a keying pulse, will depend for its pulse duration upon the inductance and capacity of the feedback transformer used, as well as upon the resistance and capacity in its grid circuit.

When the circuit is keyed by a positive pulse applied to the grid of the tube, a pulse having sufficient amplitude to overcome the bias voltage and start current flowing through the tube, the feedback action of the transformer will send the grid into the grid-current region, and the tube to saturation. Due to the inability of the plate voltage to maintain itself through the inductance of the plate winding of the transformer, the voltage at the plate will drop sharply.

Pulse polarity

The grid winding of the transformer, together with the effective capacitance in the circuit, will form a resonant circuit. Due to the presence of grid current, the grid-cathode resistance will be rather low, and the circuit will have a fairly high "Q". This circuit will be shocked by the voltage induced from the plate winding and oscillation will start to build up.

This oscillation will have its positive polarity at the grid, making the low end of the grid winding negative. When the energy supplied from the plate winding has accumulated on the capacitor, the direction of current flow in the grid winding will reverse. The feedback action of the transformer then sends the voltage at the plate of the supply voltage, and the grid to cut-off.

The action results in the generation at the plate of a negative pulse of considerable amplitude. A third winding may be added to the transformer, which will serve to invert the pulses and hence, the circuit may be utilized to supply a positive pulse having high amplitude, short duration, and essentially flat topped. The curves obtained at various points in the circuit are shown in Fig. 1.

This circuit has been discussed at some length because of its particular application in the generation of fast time bases. In the pre-

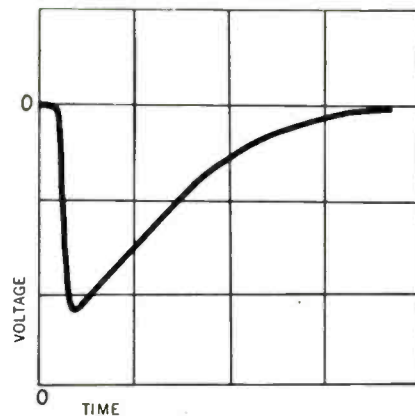

Fig. 4—Saw-tooth waveform from circuit used in Fig. 3 using R_1C_2 output

ceding paragraphs attention has been given to the usual type of circuit in which the saw-tooth generator has its own tube, while the firing pulse is supplied from another tube or tubes. Such a circuit may be set up utilizing the positive pulse generated by the blocking oscillator to fire the saw-tooth generating circuit.

However, the curves shown in Fig. 1, together with the function of the circuit as discussed, indicate that a heavy current passes through the blocking oscillator when it fires. The presence of this heavy current demand suggests its use directly in the generation of a saw-tooth. Such a circuit could be that shown in Fig. 3. The demand current is supplied by the capacitor C_1 , while the R_1C_1 combination provides the charge curve usable for the sweep. The type of curve obtained is shown by Fig. 4. The curves, Fig. 1, were obtained using the experimental set-up, Fig. 2. The trigger pulse was introduced through a capacitor "Cin", which is comparatively small, relative to "C", thereby introducing as little of the trigger voltage into the system as possible. The curves were obtained at the points indicated: "Output", from "D" on the diagram to ground; "Tube Plate", from "C" to ground; "Tube Grid", from "A" to ground; "Low End Grid Winding", from "B" to ground; and "Across Grid Winding" between "B" and "A".

Examination of Fig. 4 indicates the presence of only approximately 60 per cent of usable saw-tooth voltage. It is entirely practicable to use a comparatively high plate voltage; the saw-tooth generated by this means, at least for short-duration sweeps, will usually run between 50 and 80 per cent of the plate voltage. Attention should be directed, however, to the fact that the plate dissipation of the tube used should not be exceeded at the

(Continued on page 176)

BRIDGE-CONTROLLED

by WILLIAM H. BUSSEY

President, Electronic Research Laboratories, Consultants
232 E. Erie, Chicago, Illinois

Phase shift control based on a frequency-selective ac potentiometer circuit

● It has been shown by Black, Terman and others that inverse feedback may be used to obtain various frequency response characteristics in amplifiers. It has also been shown (Scott, IRE Proc., Feb., 1938) that a Wien bridge (or an equivalent T) may be used as the feedback network giving a response characteristic which is sharply peaked at the null frequency. This principle as in Fig. 1 has been applied to sound analyzers and to sine-wave generators requiring exceptionally pure output.

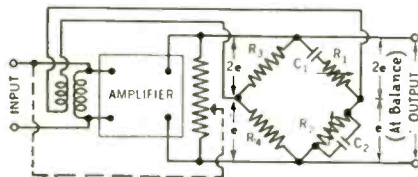

Fig. 1—Oscillating circuit consisting of feedback amplifier with frequency sensitive bridge network

Here the output of an ac amplifier is connected to a Wien bridge, the output of which feeds back through a transformer in proper phase to the amplifier input. At the null frequency, there is no feedback and the normal gain of the amplifier is attained. At other frequencies, however, the bridge will be out of balance and degeneration occurs. With proper design, the amount of degenerative voltage can be so large that the gain approaches unity at frequencies remote from the critical frequency, F_c , as shown in Fig. 2.

If the normal gain of the amplifier without feedback is large, then the ratio of gain or output voltage at F_c to the gain or output at other frequencies also

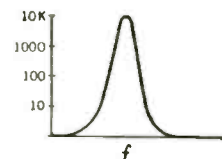

Fig. 2—Frequency characteristic of Wien bridge network

will be large and under these conditions, the equivalent Q of such a circuit easily may become greater than any value which readily could be achieved with ordinary capaci-

tors and inductances or electro-mechanical equivalents.

Note that in Fig. 1 an additional feedback path is shown in dotted lines. The phase of the feedback by this path is such as to produce regeneration in the amplifier. If, now, the voltage divider in the output is varied continuously from zero voltage, there will be some setting at which the system will oscillate and with other conditions as previously stated, the output voltage will be a very pure sine wave at the frequency F_c , (the null frequency of the bridge). In typical cases, the harmonic content will be less than that obtained with other types of oscillators. A value of less than one per cent is easily obtainable.

The frequency range for which such a system is suitable, either as an oscillator or as a selective amplifier, is the same as the range for which resistance coupled amplifiers may be constructed. It extends, therefore, from sub-audible frequencies through the audio and supersonic ranges to an indefinite maximum of perhaps several megacycles.

In the application of such a bridge to vacuum tube circuits, as shown by Scott there is one serious inherent disadvantage. The bridge is a four terminal network. Therefore, a transformer is required to adapt it to use with an ordinary, unsymmetrical amplifier, and this introduces several limitations to such use, since it is difficult to obtain transformers having desirably flat frequency characteristics for a large range. Those suitable for a large range are expensive and often bulky. It is in no case practicable to secure transformers for so large a range as that representing the maximum for which resistance coupled amplifiers may be easily designed. These disadvantages were recognized by Scott and, in his paper referred to, he shows an equivalent T network which is directly adaptable to ordinary amplifier circuits, as shown in Fig. 3.

In the majority of applications of such circuits to practical use, it

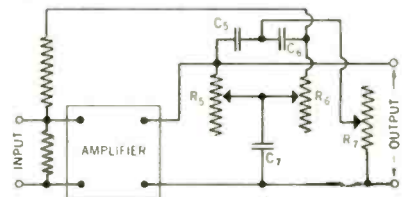

Fig. 3—Adaptation of T-network equivalent to bridge circuit provides simplification

is necessary that the frequency F_c to which the system tunes (or at which it oscillates) shall be adjustable. Referring to Fig. 1, the conditions for balance of the bridge are

$$f = 1/2\pi \sqrt{R_1 R_2 C_1 C_2} \quad (1)$$

$$C_2/C_1 = R_3/R_4 = R_1/R_2 \quad (2)$$

As usually arranged

$$R_3 = 2R_4, R_1 = R_2 \text{ and } C_1 = C_2 \quad (3)$$

$$f = \frac{1}{2\pi R_1 C_1} \quad (4)$$

In the case, however, of the equivalent T circuit shown in Fig. 3,

$$C_5 = C_6 = 1/2 C_7; \quad (5)$$

$$R_5 = R_6 = 2R_7 = \frac{1}{2\pi f C_5}$$

$$f = \frac{1}{2\pi R_5 C_5} \quad (6)$$

Therefore, in the equivalent T, it is necessary that three, rather than two, circuit elements be varied simultaneously, and this is a factor of major importance in the design of such circuits. Obviously, the variable elements (which can to most advantage be the resistors) should be ganged and controlled from a common shaft. Even a two-section ganged resistor, as required for the bridge proper, may give considerable difficulty in practical designs from backlash and mis-tracking. The three section unit required for the equivalent T network, presents far greater practical difficulties and for some applications is out of the question.

It is these difficulties, in fact, which have led to the development of the method and the circuits shown following. It is apparent

OSCILLATOR DESIGN

that there would be a distinct advantage in any new method involving the use of not more than two ganged variable resistors (or if required for some special reason, capacitors) if it could be applied directly to ordinary vacuum tube circuits. The advantage, actually, is greater than may appear since it is practicable to construct the two section variable resistor as shown in the sketch, Fig. 4.

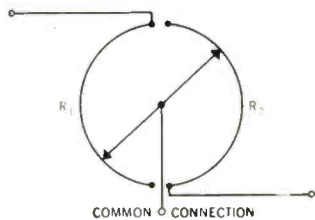

Fig. 4—Balanced frequency-control element suitable for precise adjustments

Here, the two semi-circles represent identical resistance elements, preferably wire-wound on insulating strips bent to this shape. They may be either linear with respect to rotation or have a taper, which may be logarithmic to advantage. The moving arm is represented in the sketch by the straight line bisecting the circle formed by the resistance elements. By making the connections as shown, it is apparent that the resistance in the two branches will be the same, and the common connection will then be made to the moving arm which is common to both sections.

This simplified type of control is, of course, made possible by the fact that the two variable resistors in the bridge have a common connection. The construction eliminates the backlash common to all ordinary ganged variable resistors. Furthermore, by this means, tracking error is reduced to a negligible minimum for most cases and this at no material increase in cost. In the arrangement utilized, the Wien bridge is used, with the values listed as in eq. 3 for all frequencies. If we let e denote voltage developed across R_1 , then $2e$ is equal to the voltage developed across R_2 . These voltages are independent of frequency.

Let us designate the upper right

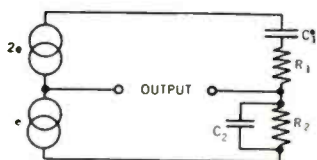

Fig. 5—Equivalent circuit arrangement for Wien bridge

hand arm of the bridge as the series arm, and the lower right hand arm as the shunt arm, since in these arms the resistances and the capacities are in series and shunt respectively. Also let e indicate the voltage across shunt arm at balance. Then $2e$ is the voltage across the series arm at balance, but these voltages are not independent of frequency.

It will be evident that if the two resistance arms of the bridge are replaced by two sources of voltage having a common connection, and if the source corresponding to R_1 has a voltage e while the source corresponding to R_2 has a voltage $2e$, and if the phase of these voltages, taken at the outer terminals 1 and 2 with reference to their common connection, differs by 180 deg. then obviously, balance will occur for this equivalent circuit precisely as in the bridge proper operated from the one source. Fig. 5 shows the equivalent circuit.

This is the principle of the basic method utilized in all of the following circuits. The frequency selective ac bridge is replaced by a frequency selective ac potentiometer, in a sense. The two sources have a common connection which may be at ground potential for convenience, and the remaining output terminal then replaces the two output terminals of the bridge as will be shown.

Let us consider some of the con-

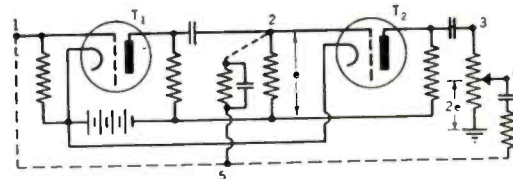

Fig. 6—Two tube feedback oscillator circuit which voids difficulties of Wien bridge circuit connections

ditions which exist in an ordinary resistance coupled amplifier. Fig. 6 shows the schematic for two triodes.

It is well known that if the output of T_1 , taken, let us say from point 2, is connected to the input of T_1 , the feedback will be degenerative. If, however, we connect the output of T_2 , taken from point 3 to the input of T_1 , the feedback will be regenerative and the circuit will oscillate as an ordinary multivibrator. Let us regard the output of these two amplifier stages as two voltage sources and assign to the output of T_1 , taken between point 2 and its own cathode, or ground, the value, e . Suppose, then,

that we adjust the voltage divider in the output of T_2 continuously from zero voltage. We will find some adjustment for which the voltage between point 4 and ground is $2e$.

Neglecting the small shift due to capacities in the amplifier, the phase of this voltage $2e$ differs from that developed between point 2 and the common ground (e), by 180 deg. If, now, we make the outer connection of the shunt arm to point 2 and the outer connec-

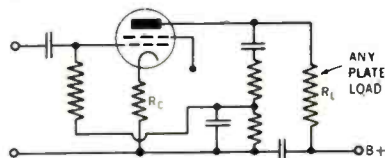

Fig. 7—System for providing regeneration at selected frequencies for tone accentuation

tion of the series arm to point 4, we thereby fulfill the requirements given for the equivalent potentiometer.

The common connection for the two voltage sources is ground. The common connection for the series and shunt arms is shown as point 5 in Fig. 6. For the frequency at which balance occurs, the voltage, therefore, between point 5 and ground or cathodes is zero. It follows, therefore, that if the grid of T_1 is connected either directly or through its input impedance to point 5 as shown in the dotted lines, then for the critical frequency, F_c at which balance occurs there will be no feedback for the conditions stated. The gain for the amplifier will, therefore, be a maximum.

If, on the other hand, the voltage divider in the output of T_2 is adjusted to some point giving a lower voltage than $2e$, then the voltage at point 5 will be

derived principally from the shunt branch, connected to point 2 in Fig. 6 and therefore will be degenerative. However, degeneration will be at a minimum for the critical frequency, so that the amplifier gain will be a maximum as in the previous case.

If, on the other hand, the output of the amplifier taken from R_2 , is adjusted continuously from the value $2e$ to larger values, the sign of the feedback will be positive for F_c . The gain of the amplifier will, therefore, be greater than that normally obtainable without feedback at the peak frequency. Now, if the adjustable voltage is in-

(Continued on page 186)

THE ENGINEER AS EXECUTIVE

by **RAYMOND M. WILMOTTE**

Consulting Radio Engineer

For management to get positive results it is essential that work of subordinates be interesting

● The problem of directing a small engineering concern is versatile to say the least, particularly if you happen to be an engineer and have knowledge of what is going on, what is being produced, and what are the things that your staff may want to kick about. During the war many of the problems have been changed but the versatile aspects have remained. The executive is faced with many ups and downs.

My organization is just small enough that I can keep in touch with all the engineering developments that are going on in it. We have covered a wide range from designing large communication circuits and installations along recognized lines through special aircraft equipment development, to radar in some of its most complicated forms. To say that I have been able to direct all these projects in detail is, of course, ridiculous.

When war was declared, we were asked to increase the staff to carry out certain jobs. It is in the selection of people that I have learned an interesting fact. In this organization most of the engineers have a good background of the theory and basic practice of radio and electronics, of what is possible and what is not possible, yet every one of these men attacks a problem from a different psychological angle.

I found that most of them attacked the problem with an almost certain knowledge that they would fail, that the problem was insoluble, or if it was not insoluble they were sure the component parts needed would never be obtained, and that the assistance available because of difficulties of obtaining skilled machinists, etc., would jam the development. On the other hand there were a few who, even though they might not have the same degree of knowledge, were able to bring to a problem a positive and creative attitude and felt that all problems were soluble unless proven otherwise.

In every case the work handled by these men has been superior, often more accurate and nearly al-



Raymond M. Wilmotte who has made notable contributions to the art of broadcast antenna engineering.

Born August 13, 1901.

1921—Graduated, first class honors, with degree of M.A. from Cambridge University, England. Published about 40 papers.

1921-1929—National Physical Laboratory. (The British counterpart of the Bureau of Standards.) Research Engineer.

1929-1931—Aircraft Radio Corporation—research and development on aircraft-radio equipment.

1931 to date—Consulting Electronics Engineer. Discovered that broadcast stations could fully and accurately protect each other by directional antennas. Designed and installed first of such antennas at WFLA. Developed automatic electronic devices. During war carried out development and service contracts for Signal Corps, Bureau of Aeronautics of U.S.N., and Office of Scientific Research and Development.

ways faster than that handled by those having a negative attitude, who in the particular cases of this organization often had considerably greater technical knowledge. Being interested in psychology, this lesson I learned quickly, and I have spent many hours of thinking out ways of presenting a technical problem in such a manner that it became attractive, interesting, and led to a positive reaction instead of a negative one, even from the most introverted.

That, I think, is the principal job of the engineer executive. It is because of the importance of this particular job that in an organization such as mine the executive should be an engineer, for he should really understand the conflicts and troubles that assail a man in charge of a development project which is coming up against unexpected difficulties, which occur invariably, and some of which at first sight may seem insurmountable.

I have had sufficient experience coming up against these apparently insurmountable problems to have accepted the theorem that if something looks reasonable it can be solved even if it deals with people rather than things, and although a concern of this size does not have within itself all the knowledge necessary to solve all the problems that are presented to it, since that knowledge is available somewhere it is also available to it. Only pride or egocentricity prevents the members of an organization from making use of the vast knowledge that is available to it outside of itself. In this way, from the purchaser's angle, a small concern may often be better fitted to give advice than a large concern that is often handicapped by a sense that it must be different from its competitors, that its developments must have the trademark of its own inventiveness and no other, that it must contain all knowledge within itself, must have its own solutions for all new developments.

Another job of the executive is
(Continued on page 214)

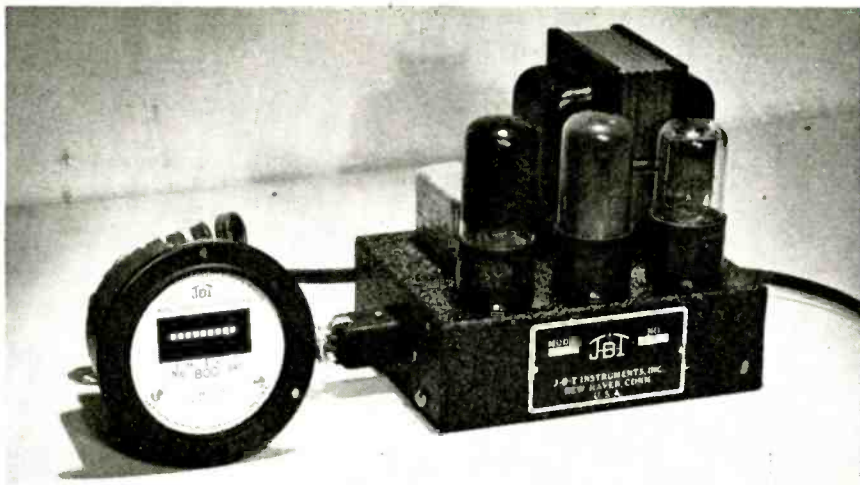

Fig. 1—Model 33-VTF indicating instrument, and the electronic unit with cover removed

FREQUENCY RANGE EXTENSION

Application of multivibrator to reed type instrument permits measurement of frequencies up to 3600 cycles

• Although vibrating reed frequency indicators are being used in large numbers by the armed forces on 50 and 60-cycle gasoline engine generator sets and in increasing quantities in measuring the 400-cycle power supplies of airborne equipment, accurate and compact units for measuring 800 and 1200-cycle frequencies have not been available in standard production. Frequencies as low as 10 cycles and up to 550 cycles are easily measured with vibrating reeds.

Such indicators cannot operate much above the latter value with easily-read amplitude, due to the decreasing length and increasing stiffness of the reed. Even with sufficient power available, the reed will not give good indication at resonance without exceeding its elastic limit and breaking. The well-known ability of the multivibrator to divide frequencies has been put to the task of extending the useful range of the vibrating reed frequency meter.

J-B-T Instruments, Inc. has been manufacturing a frequency indicator of the reed type* that is much simpler than the original European design of Frahm. This instrument contains a series of steel reeds passing through the axis of an exciter coil and into the field of a permanent magnet. The reeds vibrate vigorously whenever the fluctuations of the current are equal to the resonant frequency of the reed.

Calibration is performed with standard oscillators, checked against standard frequencies derived from tuning fork oscillators. Fifteen frequencies are available at various outlets throughout the plant which permit the operator to calibrate reeds at any desired frequency. The forks are checked daily against Bureau of Standards time signals and are maintained within an accuracy of 0.05 per cent. Thus it is not difficult to produce frequency meters with an accuracy of plus or minus 0.3 per cent.

A special circuit was worked out which was capable of division by 2 or 3 with perfect stability over a wide voltage range, Fig. 2. This was accomplished without the possibility of division by undesired integers which would give false indications.

A single 6V6-GT/G amplifier stage, coupled from the multivibrator stage, which uses a 6N7-GT/G tube, gives ample power. This amplifier also proves useful in applications where very little power is available to operate an indicator directly.

With a 6X5-GT/G rectifier tube, this unit will be capable of measuring either 800 or 1200 cycles, depending upon the setting of its only control, the range switch.

This stage is coupled to the secondary of the power transformer in the Model 33-VTF for operation directly from an inverter or other source, independent of a 60-cycle power supply.

The Model 39-VTF for laboratory work, which operates from a 60-cycle power supply and has a separate input for the multivibrator stage, requires negligible power drain from the source of frequency being measured. An input control permits operation over at least a ten to one voltage range. The Model 39-VTF also can be built with additional multivibrator stages to obtain checks at many points over a wide frequency range. Only two

stages will be necessary to check points between 400 and 3600 cycles.

The laboratory models have an input impedance varying from 75,000 to 500,000 ohms and are suitable for operation directly from an audio oscillator, or other high impedance line. The power consumption is approximately 25 watts. These laboratory models will be designed to cover a greater number of ranges, varying from 800 to 3600 cycles, or higher. Thus it will be possible to accurately check points in the audio spectrum such as 400, 800, 1200, 1600, 2400 and 3600 cycles.

No controls are used except the frequency range switch. Calibration at the factory is permanent and the instrument is always ready for use without further standardization. Frequencies outside the range of the instrument will cause no damage, however high, and are not indicated. The size of the electronic unit for this 800-1200 cycle inverter model is 4 5/8 in. deep x 5 1/2 in. wide x 6 in. high. Weight is approximately 6 lb. including the meter itself.

REFERENCES:

- (1) Lingel, Fred J. "Design of a Vibrating Reed Frequency Meter," The Instrument Maker, Vol. 12, No. 3, p. 18-22, March-April, 1944.
- (2) Andersen, Donald E. "Frequency Channels for Meter Calibration," Electrical World, Vol. 120, No. 22, p. 72, Nov. 27, 1943.
- (3) Andersen, Donald E. "Tuning Fork Standards for Meter Calibration," Electrical World, Vol. 121, No. 2, p. 92, January 8, 1944.

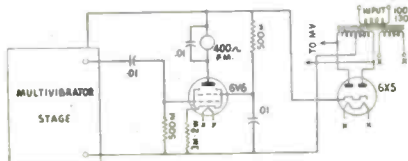
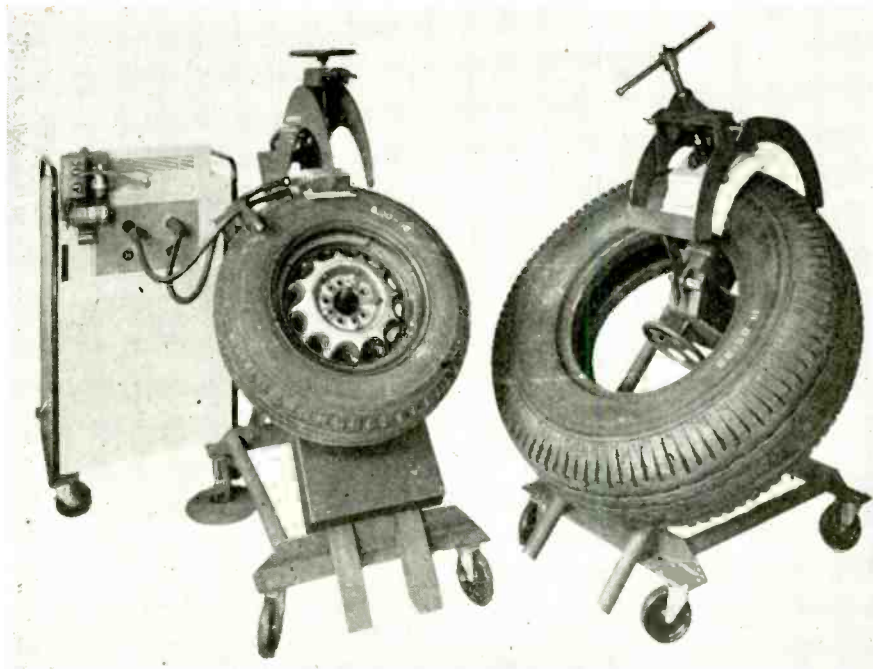

Fig. 2—Circuit for use with inverter at 800 or 1200 cycles. Power consumption about 20 watts

* Under patents pending of the Triplett Electrical Instrument Co.

TUBES ON THE JOB



Lab model HF generator and two types of tire fixtures. Repair time dropped to ten minutes

Concealed Weapon: Transmitter

In connection with testimony before the Lea Committee of the House of Representatives, Charles Wilson and C. A. Ellert of the Federal Communications Commission demonstrated the unusual transmitter illustrated. With such a unit concealed on his person, a man can walk down the street transmitting illicit information without giv-

ing the least outward indication of his nefarious deed!

The transmitter worn by Mr. Wilson was built by C. A. Ellert, at right, technical supervisor of the Radio Intelligence Division of the Federal Communications Commission, for the purpose of generating a signal of sufficient strength to demonstrate loop direction finding methods as used by the Radio Intelligence Division.

This transmitter is a three tube modulated cw crystal controlled unit, operated on 3960 kc, and utilizing a 1S4 tube as a crystal oscillator, 1Q5 modulator and a 1Q5 with two watts input. It is powered by miniature dry batteries of 135 volts and 1½ volts. It could easily be changed over to a 'phone transmitter by the addition of a microphone.

The antenna is capacity coupled to the final tank and consists of approximately six feet of flexible wire worn under the coat. It is draped over the wearer's shoulder and terminates down the trouser leg. The key lead is also concealed and terminate in a specially made "squeeze key" worn in the trousers pocket, thereby allowing the wearer to key the transmitter unobserved.

Similar transmitters used for illicit operation have been confiscated. They usually are built for 'phone operation in the ultra high frequencies.



FCC's Wilson and Ellert demonstrate 2-watt "wearable" transmitter. Antenna over shoulder

Electronic Tire Repairs

Developed especially to meet the needs of the armed forces at the front lines, a new electronic method of tire repair vulcanizing promises to find wide postwar commercial application.

Chief necessities mothering the invention were reduction of the vast bulk and weight of conventional steam or electric equipment and the need to cut something from the two hours required for an average repair. The process was developed by Army Lt. Colonel C. W. Vogt, working with the Lakso Co., Fitchburg, Mass., at Forest Products Laboratory, Madison, Wis.

Two types of tire fixtures are used. For sectional repairs, the tire wall is pressed between two spaced electrodes as illustrated. For spot repairs, many of which do not require removal of the shoe from the wheel, both electrodes are firmly applied to the outside wall. Dielectric losses occur in that area of the wall between the two electrodes, curing the repair to cord depth. With both types of applicators, two fabric bags filled with a sandy material effectively cause the electrodes to conform to uneven surface contours of the tire walls, thus obviating the need for the large number of costly molds associated with conventional equipment.

HF Heating Speeds Penicillin

Working with E. R. Squibb and Sons, RCA Laboratories, Princeton, N. J., have developed a new application of dielectric heating which



Dr. George Brown, of RCA Labs, with demonstration model of his high freq. penicillin drier

cuts the time required for the bulk reduction of purified penicillin solution from 24 hours to 30 minutes. A two kw power oscillator is used to boil the penicillin solution under a low vacuum, evaporating water at the rate of two litres per hour.

Previous method of reducing bulk involved quick-freezing and sublimation under high vacuum. Use of the new process in this typical installation will mean a reduction of operating costs of a ton of dry ice per day, or about \$65 per 24 hours, reduction in maintenance costs associated with refrigerating and high vacuum equipment, reduction in required floor space, and smoother, faster flow of the vital chemical. The radio frequency unit was designed to be sold for approximately \$6,000.



Electronic heating introduces new process of textile twist-setting at Industrial Rayon Corp.

Electronic Paychecks

Earnings of electronic and radio engineers are cited in an occupational study of the electronic field, conducted for the Occupational Index, Inc., of New York University, Washington Square, New York 3, N. Y., by Forrest H. Kirkpatrick of Bethany College (West Virginia) and John E. Crawford, Radio Corporation of America, New York City.

"The salaries in most electrical or electronic fields of engineering are comparable to the averages for similar ranks in other engineering areas," they report. "The choice of job should depend on interest and opportunity and other considerations rather than on any expectation of greater financial rewards in one job than in another.

"Apprentice engineers generally are paid about \$140 a month, from which they may advance to junior engineer, assistant engineer, and so on. An assistant engineer may earn from \$2,500 to \$3,500 a year. Beyond that, salaries depend largely upon the responsibilities of the job. Some chief engineers receive \$10,000 to \$15,000 a year, although such positions are relatively few in each organization."

New Twist in Tire Cord

Rayon tire cord manufactured by Industrial Rayon Corp. is now "set" by placing packages of the cord in a high frequency electrical field. Heat generated in the cord by this operation is distributed so uniformly that cones containing 18 pounds or more of rayon tire cord may be effectively treated. Such giant cones are used in the weftless method of tire construction.

The process is completed in a

matter of minutes and results in the production of a cord in which the twist is uniformly set. Control of the moisture content of the cord may be facilitated by wrapping the cones of cord in moisture-proof paper and processing them in this form.

The equipment originally installed for this process has been in operation at Industrial Rayon's Cleveland plant for more than eight months and includes high frequency power generating units having outputs of approximately 22,500 BTU per hour each. They were furnished by the Girdler Corp., through its Thermex Division, and each unit is capable of handling several thousand pounds of packaged tire cord in a 24 hour period.

Patent applications covering the use of high frequency heating for twist-setting of textile products generally, including tire cord, have been assigned to Industrial Rayon. The new process is also being used by The B. F. Goodrich Company, under license from Industrial Rayon, in connection with production of rayon tire cord.

Piezoelectric Probe

Developed by the physics department of the Leningrad, U.S.S.R., Medico-Pediatric Institute, a new tool for surgery depends upon piezoelectric principles and vacuum-tube amplification, providing an extension of the sense of touch. It consists of a small metal box, housing a bimorphous rochelle salt crystal pickup, fastened rigidly to the handle of an ordinary steel surgical probe. Contact of the probe with metal shell fragments, bone-splinters or other objects inside a wound, gives rise to partially damped high frequency mechanical oscillation of the probe. The electrical output of the crystal is fed to the pentode voltage amplifier, having a gain up to several hundred, which excites a pair of piezoelectric headphones worn by the surgeon. Thus, his normally sensitive touch-sense is materially aided by concurrent sounds heard in the 'phones. The overall amplitude/frequency characteristic of the unit is such that low frequencies, representing unwanted noise, are attenuated.

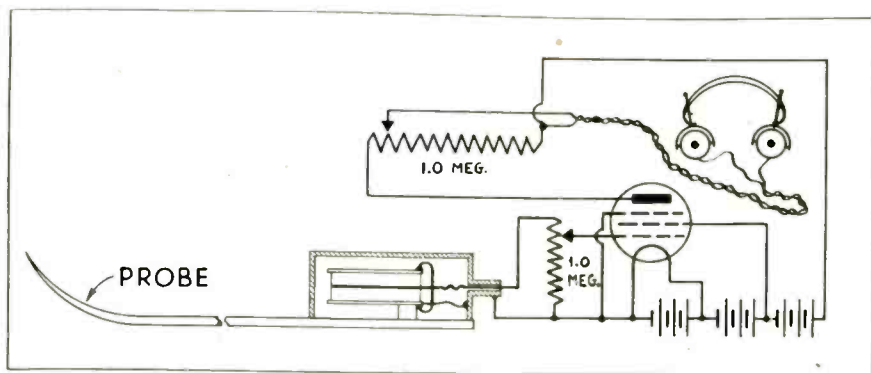

Complete surgical instruments, including piezoelectric probe, pentode amplifier, and phones

DIRECT READING FREQ METER

by R. D. HICKOCK, JR.

Vice-President, Hickock Electrical Instrument Co.

Iron core cross coil principle eliminates external reactor; reduces power consumption to under one watt

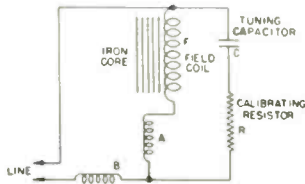

Fig. 2 — Balanced torques produced by resonant circuit networks

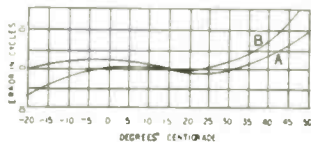

Fig. 3 — Extent of calibration error caused by fluctuation in voltage

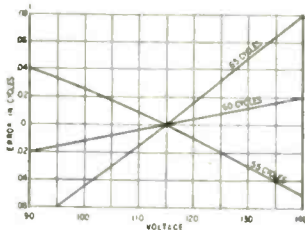

Fig. 4 — Capacitance and power factor changes due to temperature variation

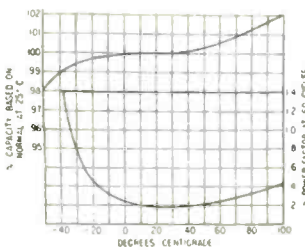

Fig. 5 — Combined temperature error of the frequency indicator

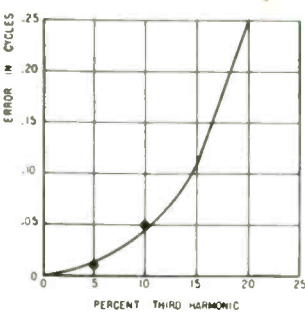

Fig. 6 — Harmonics have little effect on instrument calibration

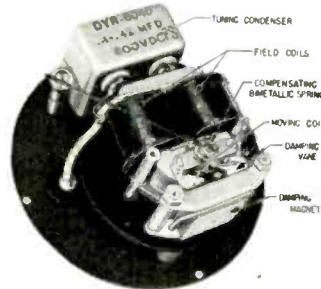

Fig. 1 — Internal elements of meter showing the coil assembly arrangement

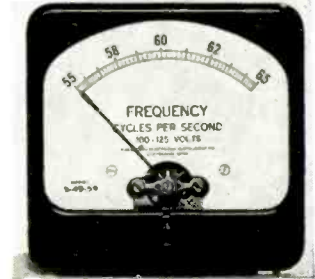

Fig. 7 — Frequency indicator in five-inch case for panel mounting

● It has been customary to think of low range frequency meters in terms of vibrating reed types. The simplicity of reading and interpolating a moving coil instrument is a great advantage. Fig. 7 shows a space saving, self-contained frequency meter which uses a cross-coil principle, which serves the purpose of the external reactor commonly used.

A maximum of 0.8 watts at 115 volts is consumed by this type of frequency meter instead of the usual 2.5 to 7.5 watts. The reduction is due to the use of an iron core which, of course, greatly reduces the ampere-turns necessary to produce the required field intensity. Low power consumption is essential in self-contained instruments in order that temperature does not rise beyond safe limits from heat generated in the windings. The use of an external reactor has, in the past, allowed sufficient radiation area, but it has made temperature compensation difficult because of the possible difference in the ambient temperatures of the instrument proper and the reactor.

Referring to Fig. 2, coils F and A form one leg of a parallel circuit, while capacitor, C, and resistance, R, form the other. The moving coil, A, being in series with the field coils F, tends to align itself with the magnetic flux in the air gap. However, the current in moving coil B, because of the resonance of the network, is 90 deg. out of phase with the flux generated in the air gap.

As the frequency varies from resonance or center scale value, the

impedance of the parallel circuit becomes inductive or capacitive in nature, depending on whether the frequency decreases or increases. The impedance increases as the frequency departs from resonance value. Consequently, the power factor and value of the current in moving coil B changes, and the coils and pointer are deflected in a clockwise or counter-clockwise direction.

The power factor through coil A is about 25 per cent, while it is about 97 per cent for the current through coil B. Consequently, for equal heat losses in the coils, the wire in coil B can be of about one quarter the cross section, and four times as many turns can be employed as in coil A. There results a high degree of deflection for a small change in power factor in coil B.

Damping is provided by an aluminum vane moving in the field of a strong permanent magnet adjustable when the instrument is assembled to suit conditions under which the meter is used.

The most important factors tending to cause false indications in frequency meters are variable line voltage, changes in ambient temperature and distortion of the voltage wave. Because of the high ratio of the torque produced by the moving coils to the torque inherent in the ligaments connecting the coils to the rest of the circuit, there is only a small error due to changes in line voltage, as shown in Fig. 3.

Change in ambient temperature
(Continued on page 212)

NO SUBSTITUTE NEEDED!

USE
HYTRON 6AL5

VERY-HIGH-FREQUENCY TWIN DIODE

TYPE 6AL5
(Developmental
Hytron D27)



BASING

- Pin 1 — Cathode 1
- Pin 2 — Plate 2
- Pin 3 — Heater
- Pin 4 — Heater
- Pin 5 — Cathode 2
- Pin 6 — Shield
- Pin 7 — Plate 1



CONSTRUCTIONAL FEATURES

- 1 Rugged mount is supported by short, heavy stem leads as well as by top mica.
- 2 Close cathode-to-plate spacing gives high perveance. (Note plate cooling fins.)
- 3 Electrostatic shield connects to pin 6.
- 4 Baffle mica shields the elements from getter spray.
- 5 Miniature stem permits negligible lead inductance and minimum interelectrode capacitances.

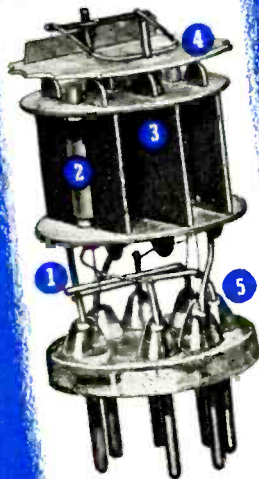

The 6AL5 fills the need for a high perveance twin diode with the low voltage drop required for many special r.f. circuit applications. WPB and the Services consider diode connection of the 6J6 twin triode (and other triodes) to be a wasteful misuse. With minor changes of socket wiring, the 6AL5 easily replaces the diode-connected 6J6.

Specifically manufactured and rated as a diode, the 6AL5 is tested as a diode. Close production control keeps within a narrow range the cutoff characteristic in the contact potential region. Designed throughout for efficiency on high and very-high radio frequencies, the 6AL5 has a separately connected shield which may be grounded to isolate the two diodes and their associated circuits. A midget miniature bulb permits extra space savings.

Possible uses include: Detector and AVC, clipper, limiter, FM frequency discriminator, special high-frequency diode, power rectifier.

HYTRON TYPE 6AL5

Very-High-Frequency Twin Diode

ELECTRICAL CHARACTERISTICS

Heater potential (AC or DC)	6.3 volts
Heater current	0.3 amperes
Peak inverse potential†	460 max. volts
Heater-cathode potential†	350 max. volts
Peak plate current per plate†	60 max. ma.
Average plate current per plate†	10 max. DC ma.

INTERELECTRODE CAPACITANCES

Plate 1 to plate 2	0.015 mmf.
Plate to cathode*	2.8 mmf.
Cathode to all*	3.8 mmf.

Capacitances are averages with close-fitting shield.

PHYSICAL CHARACTERISTICS

Bulb	T-5½ midget
Base	Miniature button 7-pin
Height overall	1.82 inches max.
Diameter	0.75 inch max.

† Maximum ratings shown are absolute; design maximums should be approximately 10% lower to allow for line voltage variations.
* Value is for one of the two twin diode sections.

OLDEST EXCLUSIVE MANUFACTURER OF RADIO RECEIVING TUBES

HYTRON CORPORATION
ELECTRONIC AND RADIO TUBES
SALEM AND NEWBURYPORT, MASS.



BUY ANOTHER WAR BOND

WHAT'S NEW

Devices, products and materials the manufacturers offer

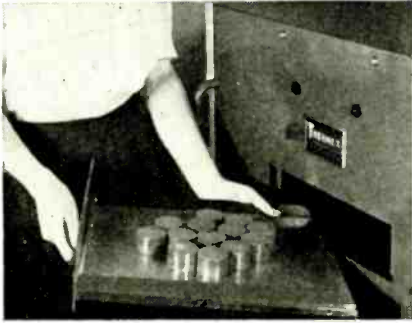

Preform Heater

To meet the demand for automatic high frequency equipment for preheating plastic preforms, the Thermex Division of the Girdler Corp., Louisville, Ky., has developed the No. 2-P Thermex which operates at a frequency of 25 to 30 megacycles. Using 230-volt, 60-cycle, single phase current, this model has an output in excess of 3,400 BTU's per hour. This compact Thermex unit measures 28 in. by 28 in., stands 47 in. high, and weighs only 614 lb. It is a flexible piece of equipment with built-in heating cabinet and removable 12 x 15 in. drawer-electrode. Being completely automatic, there is nothing to do but plug this Thermex in and load and unload the preform drawer. Closing the preform drawer turns on the high frequency power and timer. At the end of the prescribed time, which may be anywhere from 5 to 10 seconds up to 2 minutes, the red indicating light goes out, the operator removes the tray, and unloads the preforms into the mold cavities.

Electronic Sewing Machine

An industrial machine for bonding thermoplastic materials by dielectric heating has been developed by Richardson-Allen Corp., 15 West 20th St., New York, N. Y. Materials such as vinylite, Saran, Pliofilm and similar thermoplastics may be joined in a continuous airtight, watertight seam without use of cement, thread or other binder. Single or multiple seams may be formed simultaneously. Materials to be



joined are pulled through work wheels where high frequency power creates heat within the material to produce a bond. Wheels remain at room temperature. Model 1341-S power input 650 watts; adjustable motor speed. Pedal control of high-frequency power and drive motor.

Steel Towers

The Bantam King tower is made of four foot sections six feet in height, each of the sections being identical and interchangeable to form a complete tower from 30 to 100 ft. tall. For erection, the bases are set and the starting unit connected to these with three bolts at each leg, section upon section being added. The thirty foot tower, weighing only 596 lbs. less the base, ladders, boom and platform occupies a packing space of only eight cubic feet. The fifty foot tower, 998 lbs., occupies only fourteen cubic feet and the one hundred foot tower, weighing 2,154 lbs., occupies only thirty cubic feet. The thirty foot tower can be erected

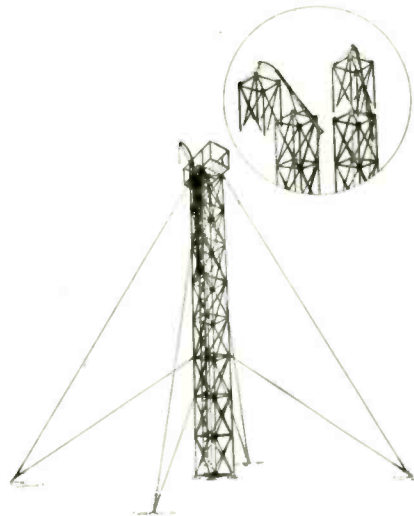

by three men in two hours. Each tower includes in its equipment, base, fittings, turnbuckles, guys, ground anchors, boom winch, platform, platform frame. The top platform measures four by eight feet, providing ample space for its varied utilities. Harco towers do not require skilled or experienced riggers for erection. The free space down the center of the tower from platform to ground allows for rotary beam drive shaft mechanism. Harco Steel Construction Co., Elizabeth, N. J., also makes a tapering tower suitable as a vertical radiator for low angle radiation.

Circuit Breaker

The "Push-Pull" feature of the Klixon D-6751 is new in aircraft circuit breakers. The "Pull" feature permits the opening of the circuit breaker manually, in order that maintenance and repairs to the circuit can be accomplished without deenergizing the entire power system and retains the desirable feature of being safe against accidental tripping when operating adjacent switches. The button travels outwardly approximately 1/4 in. and exposes a 3 colored band, part of which is luminous so that



indication is given under all conditions. A specially designed shunting switch is incorporated which provides non-trip-free action. The breaker will carry at least 120 per cent of rated current continuously, and trip ultimately at 138 per cent of rated current in an ambient temperature of 25 deg. C. (77 deg. F.). It is available in ratings from 5 amps. through 50 amps. with standard AN mounting dimensions and suitable for 30-volt dc systems. Maker is Spencer Thermostat Co., Attleboro, Mass.

Bolometer

A new type of bolometer, for the precise measurement of small high frequency currents, has been brought out by Tung-Sol Lamp Works, Inc., Newark, N. J. It is essentially a very fine platinum wire mounted in an evacuated glass envelope. Current passing through the bolometer produces a change in the resistance of the wire. Sensitivity for 1 per cent change in resistance is 4.5 microwatts.

Spiral Abrasive

A new development, Elek-Tro-Cut Three-M-ite cloth reinforced spiral wound abrasive strip, has been developed by Minnesota Mining & Mfg. Co., St. Paul. The center has been reinforced so that the strip can be bent into a suitable shape to reach through a center hole and be threaded through an oil hole for example. It is available in a wide range of grits, in diameters from 1/16th to 1/4 in. and in lengths from 4 in. and shorter, up to 12 in.

(Continued on page 208)



The NEW C-200 SECONDARY STANDARD LAVOIE CALIBRATOR

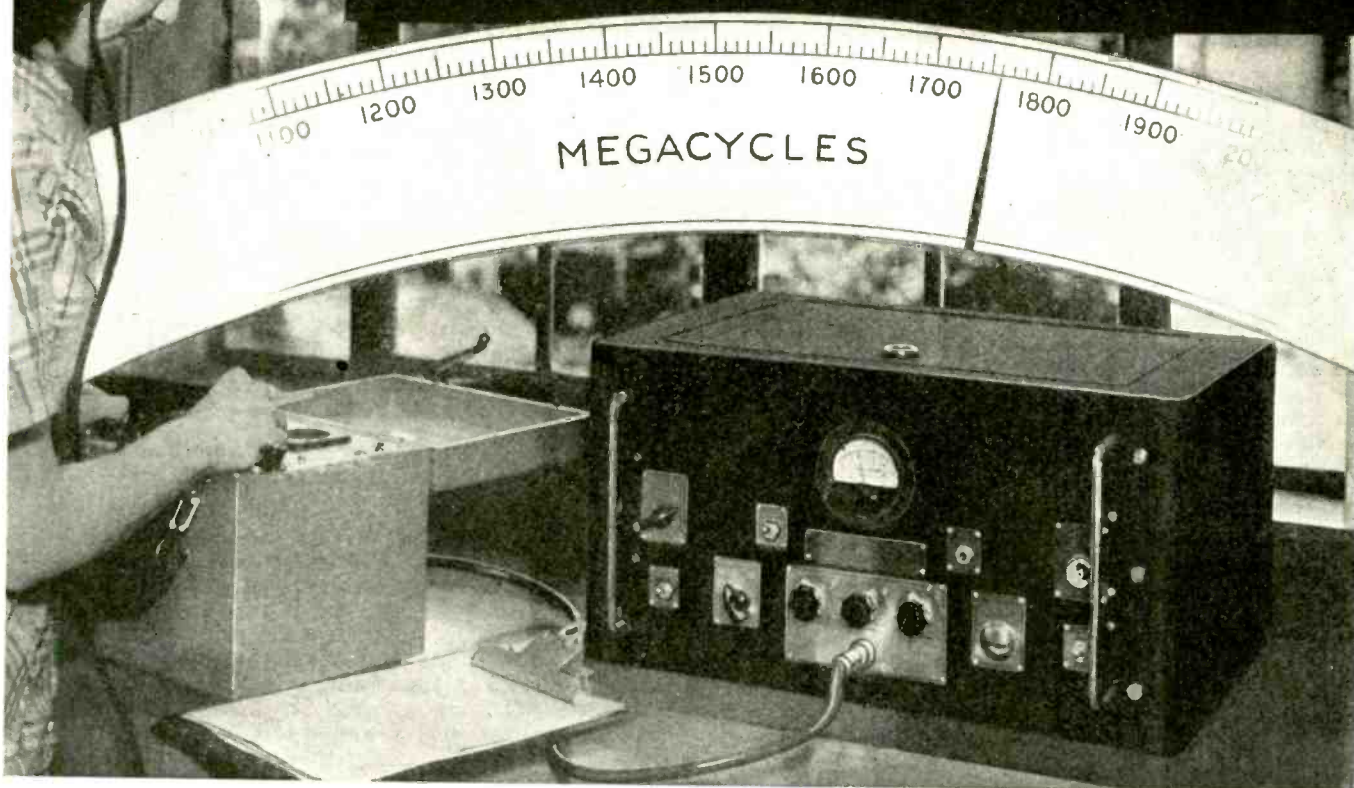

Establishes Frequencies at UHF with QUARTZ CRYSTAL Accuracy

- Designed especially for calibrating with crystal accuracy up to and beyond 2000 megacycles.
- Provides more usable output at higher frequencies.
- Affords FAST, EASY calibration.
- Especially suited for wavemeters, signal generators, oscillators, receivers, etc.
- Transmission line output. Detector unit built into calibrator.

Write for detailed information.



Lavoie Laboratories

RADIO ENGINEERS AND MANUFACTURERS

MORGANVILLE, N. J.

Specialists in the Development of UHF Equipment

SURVEY of WIDE READING

Electronic news in the world's press. Review of engineering, scientific and industrial journals, here and abroad

Impedance Concept in Wave Guides

S. A. Schelkunoff (Quarterly of Applied Mathematics, April, 1944)

A generalized impedance concept as either the voltage-current ratio, or as the constants in the expressions for the power as a function of voltage or current, respectively, or as the ratio between the electric and magnetic field intensities is introduced. The relations between the various impedances so defined are derived. This generalized impedance function is not affected by ideal transformers, i.e., the equivalent networks are identical but for the insertion of suitably dimensioned ideal transformers.

The ideas developed are adequate for expressing transmission properties of wave guides with discontinuities in terms of impedances and admittances associated with these discontinuities; equivalent circuits can be computed. For instance, it is shown that an infinitely thin, perfectly conducting iris between two wave guides of arbitrary cross-section can be replaced by an ideal transformer between two admittances.

Transmission Line Coupling in UHF Amplifiers

A. de Quervain (Association Suisse des Electriciens, Zurich, March 8, 1944)

Considerations on the use of transmission lines as coupling means in uhf amplifiers are given. At 1 to 2 meter waves, grid and plate resistance of a tube are of the order of 1000 ohms, the grid resistance being approximately one tenth of the plate resistance. Consequently, a comparatively considerable amount of energy is required at the input. Dimensioning of the lines is indicated by the fre-

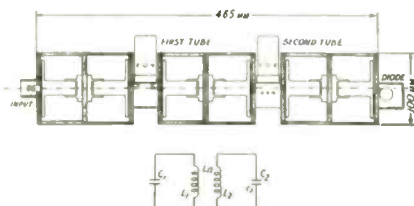

UHF amplifier with transmission line coupling

quency range to be passed. Care must be taken to efficiently screen the apparatus.

The figure shows a two-stage amplifier for 1.7 meter waves, amplification factor equal to 300, having 3 inductively coupled band pass filters each consisting of two transmission line sections. An equivalent circuit for the coupling between the two amplifier tubes is shown beneath the actual arrangement. Coupling factors and resonant frequencies are adjustable.

Relay Testing

W. Bacon (Electronic Engineering, London, June, 1944)

The circuit shown permits automatic determination of the current at which the relay operates and the current at which it releases. Switch S is rotated through positions (1), (2), (3), and (4) during the testing process; one set of contacts is closed in each position.

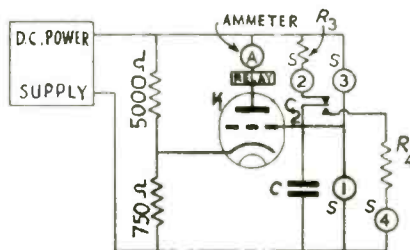

Relay testing circuit

With the switch in position (1), the capacitor C is shorted and the current through the relay is very low. On turning to position (2), C charges through the resistor R₃ and the relay contacts C₂ until the operating current of the relay is reached, and C₂ changes over. C is now no longer being charged, but, if of large capacitance and good quality, will retain the charge it has for some considerable time so that the operating current of the relay can be read on the ammeter.

Switching to position (3) makes the grid voltage considerably more positive, thereby giving the saturate position. In position (4), C discharges through R₄ until the release current of the relay is reached. Then C₂ changes over, stopping the discharge, and the ammeter then indicates the release current of the relay. Turning to

position (1) again restores the initial conditions.

A similar circuit is shown including an additional triode which permits the testing of any relay having contacts which open when the relay is operated, together with a circuit for testing relays which possess only contacts which close when the relay is operated.

Electron Lenses

J. L. Synge (The American Mathematical Monthly, April, 1944)

Starting from the variational principle of optics, the differential equations describing the electron paths are derived and investigated for the cases of rotational symmetry, i.e., for conditions being identical upon rotation of the system through an angle equal to $2\pi/n$, where $n=2, 3, \dots$, including symmetry of revolution corresponding to n equal to infinity.

Neglecting the terms accounting for aberration, it is shown that, for focusing purposes, any rotational symmetry for which $n > 2$ is just as effective as symmetry of revolution. This means that in an electrostatic microscope circular holes are not essential, holes having the shape of regular polygons may be used. The same remark applies to the holes in a magnetostatic microscope.

Amplification of Voltage Impulses

H. Koehler (Elektrische Nachrichten-Technik, Berlin, March, 1943)

The output voltage E₂ of the resistance-capacitance coupled amplifier is given by the following equation:

$$E_2 \left(j\omega p + q + r \frac{1}{j\omega} \right) = \mu E_1 R_1 R_2 C_1$$

where

$$\begin{aligned} p &= R_1 R_2 R_3 (C_2 C_3 + C_2 C_4 + C_3 C_4) \\ q &= R_1 R_2 C_2 + R_1 R_3 C_3 + R_1 R_4 C_4 \\ &\quad + R_2 R_3 C_2 + R_2 R_4 C_3 \\ r &= R_1 + R_2 - p\omega_c, \quad \frac{1}{p} = \Delta\omega \end{aligned}$$

ω_c is the center frequency of the pass band and $\Delta\omega$ is the pass band width down to $1/\sqrt{2}$ of the maximum amplitude at the center frequency ω_c .

(Continued on page 216)

From Drawing Board to Final Products

STEATITE BUSHINGS

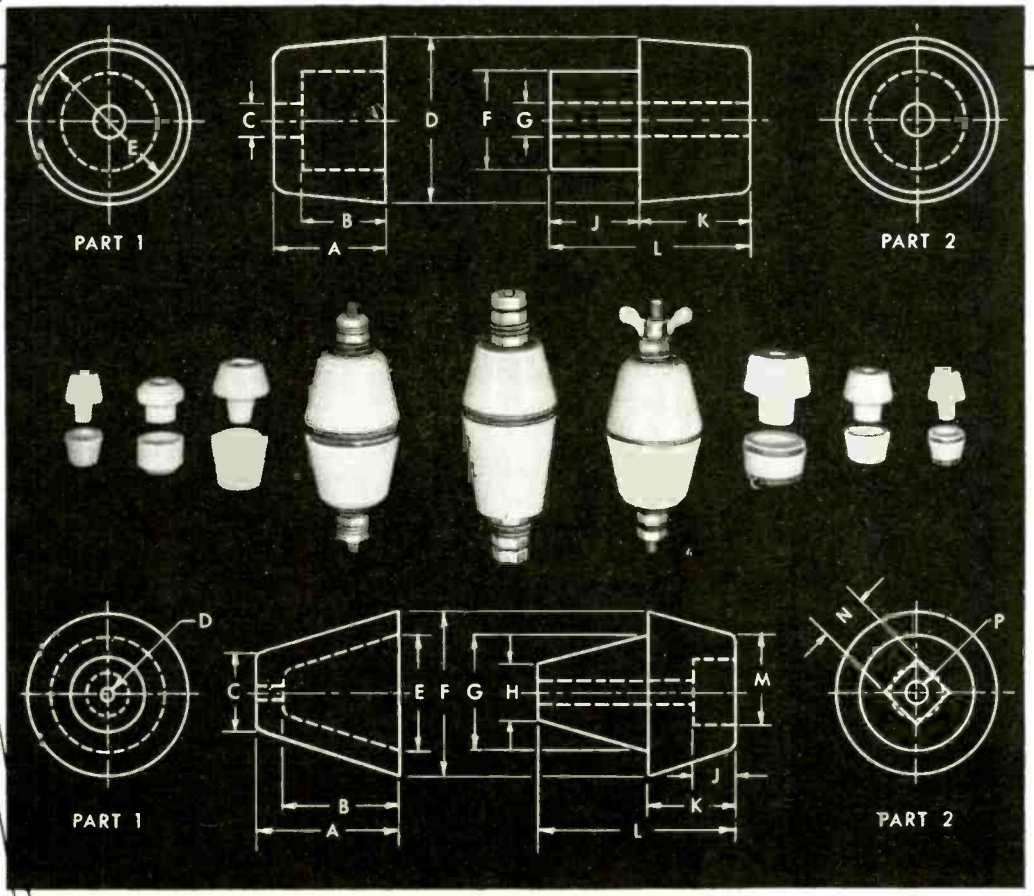
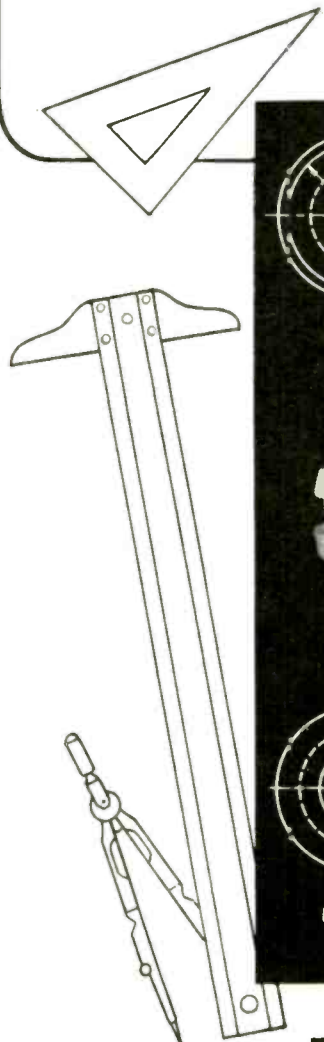

For TRANSFORMERS • LEAD-INS • ANTENNAS

BUSHINGS are but one of thousands of items which we produce for the electronic industry. Attention to every design detail, plus the Stupakoff precision method of manufacture, produces bushings of maximum mechanical strength and minimum electrical losses.

Stupakoff bushings are stocked in many sizes and styles—singly—in pairs, consisting of male and female—assembled with hardware; also bushings with metal bands for solder sealing. Special styles will be made promptly to your design.

Knowledge gained through years of experience, engineering ability and modern manufacturing facilities enable Stupakoff to produce millions of ceramic insulators daily. Your inquiries will receive prompt attention.

Do More Than Before—Buy EXTRA War Bonds



STUPAKOFF
Steatite
INSULATORS

Products for the World of Electronics
STUPAKOFF CERAMIC AND MANUFACTURING CO., LATROBE, PA.

WASHINGTON

★ ★ ★ ★
Latest Electronic News Developments Summarized
by Electronic Industries' Washington Bureau

RECONVERSION—Blueprint for reconversion of electronic-radio manufacturing industry is to be studied at August 15 meeting of the Industry Advisory Committee with the WPB, Surplus Property Administration and armed services. The extent and speed of reconversion, of course, is dependent on the fortunes of war at that time. Two of the four recent WPB orders designed to pave the way for limited reconversion are deemed to be of particular significance.

HELPFUL ORDERS—The July 29 order permitting the placing of unrated orders for machine tools and equipment will be helpful for the procurement of tools, jigs and fixtures especially for the manufacturing of plastic set cabinets. The August 15 order setting up procedures under which individual manufacturers can get WPB permission for limited civilian production will aid the smaller companies of the industry, it is felt. Under Order P-43 the industry has already had permission to make a small number of models for purely experimental purposes.

MILITARY PRODUCTION SAGS—A variety of reasons have contributed to the slipping back of electronic-radio-radar production for the Army and Navy during the past two months. The armed services and WPB's Radio and Radar Division are strongly urging the industry to keep up production so as to deliver the required electronic and radio equipment to the fighting forces.

STILL A JOB TO DO—There is still a job to do and the Army and Navy will not allow the combat forces to suffer losses because of "too little" and "too late" equipment. The serious deficits in radio and electronics equipment deliveries in May, 17 per cent under 1944 requirements, were still worse in June. Aircraft electronic-radio apparatus was one of the worst spots.

REASONS FOR REDUCED PRODUCTION—The need of the armed services for a large number of new types of equipment, born from experience on the fighting fronts, has been a major contributing cause of the lag in deliveries. The shortage of engineering staffs of the companies has made this problem of production shifts a "headache" for many units of the industry. The summer heat and weekend vacations have caused an increase in the absenteeism curves. However, the Army and Navy leadership are confident in the ability of the industry's management and employees to carry on and to make up the lost ground in the remaining months of the third quarter.

NAVY PROCUREMENT RISING FAST—The Navy's requirements of electronic equipment came to the forefront as the tempo of the war in the Pacific accelerated. Deliveries now average well in excess of \$100,000,000 monthly as contrasted with \$5,000,000 quarterly in 1941 and \$100,000,000 for the final quarter of 1942. The Navy's Radio Division of the Bureau of Ships disclosed that its deliveries now are five times as much as were produced in 1940 for the Army and Navy and for the entire civilian communications and broadcasting industries. In meeting the ever-changing battle requirements, the Navy has not only used its own laboratories, but has been greatly assisted by the re-

search establishments of the industry, including the Bell Telephone Laboratories, General Electric, Bendix, Westinghouse, RCA, Sperry, Hazeltine and the laboratories of a number of other companies.

SURPLUS DISPOSAL—The RFC's Defense Supplies Corporation, aided by the specialists of the WPB Radio and Radar Division and of the Army, Navy and Maritime Commission, is now evolving an orderly program for the handling of the probable large quantities of surplus equipment of the armed forces which may arise if the war takes a sudden turn for final victory in Europe and the Far East. The DSC with Stuart K. Barnes, one of its vice-presidents, is testing methods for the disposal of the current small amounts of the surplus electronic-radio-radar equipment which have become available so as to formulate the best means of surplus disposal when V-Day comes. WPB Radio and Radar Division Director Ray Ellis appointed Sam Drucker of his staff to aid in the surplus disposal program with his full time being given to that problem. The Procurement Division of the Treasury Department is handling all surplus home broadcast receivers, but the bulk of the items will be handled by the Defense Supplies Corporation.

FREQUENCY ALLOCATIONS—Considerable progress has been made by the government agencies studying the tremendous problem of the postwar spectrum allocation. The Inter-department Radio Advisory Committee has submitted a report on frequency needs and proposed allocations to the State Department which in turn has set up a special governmental subcommittee of its Telecommunications Postwar Planning Committee, headed by Dr. J. H. Dellinger, Radio Chief of the Bureau of Standards, to analyze this report. This State Department subcommittee commenced a series of conferences July 29 with the Radio Technical Planning Board and other branches of the communications and broadcasting industries to aid it in reaching a final determination, since the international aspects of radio wavelengths and interference are deemed paramount in the postwar allocations.

SPECTRUM OVERHAULED—For the domestic allocations, the FCC will consult with industry. While the results of the IRAC studies are still secret, it is known that IRAC gave the present spectrum allocation a considerable overhauling to fit in the new developments in radio, radar and electronics which have been created by military research. Aviation needs have been given the right-of-way in the projected allocations with considerably increased space below 200 megacycles.

TELEVISION TO MOVE UP?—Television, for the most part, is to be moved into the higher bands to pave the way for color video transmission. FM broadcasting was understood to have fared well with adequate bands, while the Marine, police and other safety services likewise were given good space assignments. Amateurs would function under the projected allocation in the highest experimental bands as they will be expected to carry their pioneering on as in the past.

National Press Building
Washington, D. C.

ROLAND C. DAVIES
Washington Editor

wherever a tube is used...

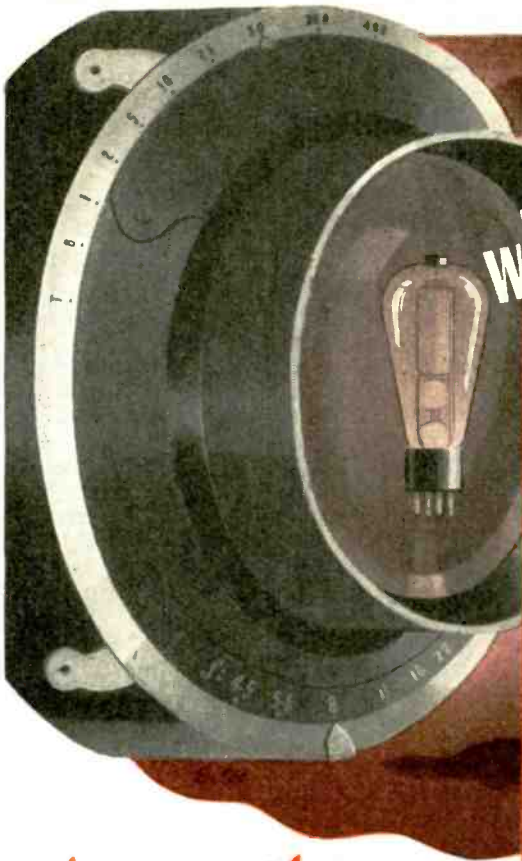

for example:

ELECTRONIC TIMING

Industry is making increasing use of electronic timers in timing or controlling intervals that are beyond the accuracy and scope of mechanical measurement. Such applications as measurement of the speed of a camera's shutter, welding control, plastic molding, photographic exposure and measurement of turbine speeds are typical.

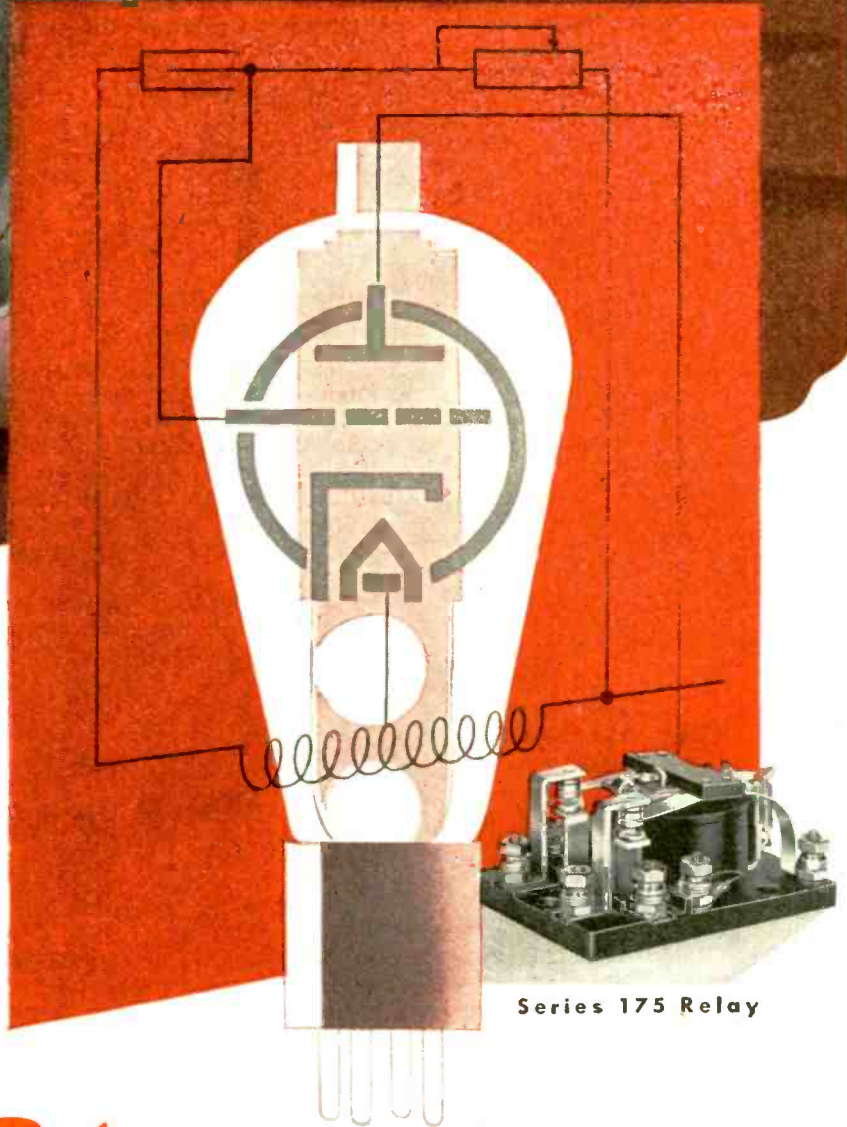

Series 175 Relay

THERE'S A JOB FOR *Relays* BY GUARDIAN

The above diagram of an electronic timing circuit shows a capacitor and an adjustable resistor connected to the grid of a thyatron or "trigger" type of tube. As the capacitor discharges, the grid potential reaches a point where the tube becomes conductive and energizes a relay.

The relay is generally a fast-acting type such as the Guardian Series 175 operating at a speed which minimizes interference with the timing interval. Coil operating voltages range from 6 to 110 volts D.C. (Also

available for A.C. in Series 170). Contacts are rated at 12½ amps. at 110 volts, 60 cycles, non-inductive in combinations up to D.P., D.T. Bakelite base is molded to reduce surface leakage. Has binding post terminals in place of solder lugs. Write for Bulletin 175.

Consult Guardian whenever a tube is used—however—Relays by Guardian are NOT limited to tube applications but are used wherever automatic control is desired for making, breaking, or changing the characteristics of electrical circuits.

GUARDIAN ELECTRIC

1622-J W. WALNUT STREET

CHICAGO 12, ILLINOIS

A COMPLETE LINE OF RELAYS SERVING AMERICAN WAR INDUSTRY

ASSOCIATION NEWS

NEMA's International Show Takes Shape

Discussed at National Electrical Manufacturers Association June meeting at Skytop, picturesque Pennsylvania resort, plans for the organization's International Electronics Exposition stepped forward apace. Aside from the fact that the affair is to be held in the latter part of 1945, provided conditions permit, no definite date or place have been selected as yet. One thing has been settled, though: exhibitors will not be restricted to manufacturers who are members of NEMA. The Exposition will be open to all manufacturers of electronic equipment and components. In accordance with the present plans of the sponsors:

1. Exhibits will be restricted as much as possible to working exhibits or demonstrations which utilize electronic principles.

2. There will also be an exhibit sponsored directly by the Electronics Section composed of graphs, charts, etc., showing the uses of electronic principles in industry and other non-mass entertainment fields.

3. Provision will be made for technical sessions or clinics under the sponsorship of technical groups in the industry on the subject of electronic principles.

4. It is expected that this will be the first of a series of annual expositions to be established as the outstanding event of the year in the electronics industry.

When the Permanent Exposition Operating Committee is appointed it probably will include among its members representatives of other NEMA Sections having a direct interest, such as Industrial Control, Panelboard and Distribution Board, Large Generating and Converting Apparatus, Switchgear, and X-ray, and possibly from one or two others.

RTPB Work "Effective"

The great amount of work involved in the task set for the Radio Technical Planning Board is progressing in a manner that is described as "effective but slow"—effective in the sense that most Panels have their respective jobs well in hand; slow only to those who do not fully understand the tremendous amount of detail involved. It is unlikely that any Panel will be in a position to render a complete report before some time in September and it is judged impossible for RTPB to let its rec-

ommendations be known before the early months of 1945. Interlocking of work assigned to various Panels has operated to slow proceedings to some extent. Panel 2 on Frequency Allocation, for example, has had no formal meeting as yet, due to the fact that other Panels, notably Panel 1 on Spectrum Utilization, has had nothing ready to pass along. It is anticipated that in another 30 days it may be possible to make public a general summary of progress to date.

Conventions and Meetings Ahead

American Institute of Electrical Engineers (H. H. Henline, 29 West 39th Street, New York), Pacific Coast Technical Meeting, Aug. 29-Sept. 1, Los Angeles.

Institute of Radio Engineers (330 West 42nd Street, New York City), September 6, October 4, New York.

American Association for the Advancement of Science (Smithsonian Institution Bldg., Washington 25, D. C.), Sept. 11-16, Cleveland, Ohio.

Radio Club of America (11 West 42nd Street, New York City), September 14, New York.

Associated Police Communication Officers (J. M. Wherritt, Police Dept., Jefferson City, Mo.), 11th Annual National Conference, Sept. 18-20, Commodore Perry Hotel, Toledo, Ohio.

American Society of Mechanical Engineers (Ernest Hartford, 29 West 39th Street, New York), Fall Meeting, October 2-5, Cincinnati, Ohio.

National Electronics Conference (B. Dudley, 520 N. Michigan Ave., Chicago), Oct. 5-7, Medinah Club, Chicago.

Electrochemical Society (Colin G. Fink, Columbia University, New York City), Fall Meeting, October 12-14, Hotel Statler, Buffalo, N. Y.

Society of Motion Picture Engineers (J. Haber, Hotel Pennsylvania, New York), Semi-annual Fall Conference, October 16-18, Hotel Pennsylvania, New York.

Electronic Parts and Equipment Industry Conference (H. Clough, Belden Mfg. Co., Chicago), Oct. 19-21, Stevens Hotel, Chicago.

IRE and RMA Engineering Department, Annual Convention for Receiver and Tube Design Engineers, Nov. 13-14, Sagamore Hotel, Rochester, N. Y.

Electronic Parts and Equipment Conference

The radio and electronic parts industry and trade have now jelled plans for the big get-together this fall. The event: Electronic Parts and Equipment Industry Conference. The place: Stevens Hotel, Chicago. The time: Thursday, Friday, and Saturday, October 19-20-21, 1944. The sponsors: Association of Electronic Parts and Equipment Manufacturers (formerly Western Division, Sales Managers Club); Sales Managers Club (Eastern Division); and the National Electronic Distributors Association.

The three days will be occupied with luncheons, dinners, meetings, conferences, fellowship, and talk fests. For Friday, the NEDA meeting, manufacturers' meeting, representatives delegates meeting, distributors luncheon, and manufacturers luncheon are scheduled. Each registered manufacturer will have a conference booth in the exhibition Hall, to be used for conferences only.

The Conference Committee is: General Chairman H. W. Clough (Belden Mfg. Co.) Manufacturers: A. P. Akeroyd, (Raytheon Products Co.) R. P. Almy, (Sylvania Electric Products, Inc.); J. A. Berman, (Shure Brothers); J. C. Fishel, (Federal Mfg. & Eng. Corp.); Charles Golenpaul, (Aerovox Corp.); Harry Kalker, (Sprague Products Co.); Roy S. Laird, (Ohmite Mfg. Co.); A. H. Petersen, (American Phenolic Corp.); and A. E. Schaar, (Talk-A-Phone Mfg. Co.) Distributors: Geo. D. Barbey, (National Electronic Distributors Assn.); Randall Bargelt, (United Radio Supply, Inc.); A. D. Davis, (Allied Radio Corp.); Aaron Lippman, (Aaron Lippman & Co.); F. A. Morris, (Specialty Distributing Co.); Sam Poncher, (Newark Electric Co.); William Schoning, (Lukko Sales Corp.); W. A. Shuler, (Shuler Supply Co.); and Robert M. Smith, (Radiolab).

Rochester Meeting

Annual Rochester Fall Meeting of members of the Institute of Radio Engineers and the Radio Manufacturers Association Engineering Department is scheduled for Monday and Tuesday, November 13 and 14. As usual the gathering will be held at the Sagamore Hotel, Rochester, N. Y., with the two days devoted to technical sessions and committee meetings.

(Continued on page 138)

All-Purpose Rectifier For a Constant Source of DC Power



FOR AIRLINE COMMUNICATIONS



AIRPLANE MANUFACTURERS



POLICE RADIO COMMUNICATIONS



INSTRUMENT MANUFACTURING, TESTING AND
ELECTRONIC LABORATORY TESTS



FOR INDUSTRIAL USE IN MAGNETIC CHUCKS,
SORTING METALS, AND ELECTROLYTIC APPLICATIONS

Mallory Rectopower Supply

Units for 115 volt single phase AC with outputs of 6, 12, 24 and 32 volts DC current at 10 or 25 amperes.

Units for 230 volt 3 phase AC with outputs of 12, 24 and 32 volts DC current at 50 amperes.



If you can't invade, invest!
—Buy War Bonds

Compact size and ease of installation make this Rectopower an ideal DC power supply for every application. It furnishes DC current by means of "Time-Tried and Proven" Mallory magnesium copper sulphide dry disc rectifiers. And *that* means longer life, greater operating efficiency, because of the absence of moving parts. For DC power supplies that entail no worries about current variations or power failures, see your Mallory distributor, or write direct.

P. R. MALLORY & CO., Inc., INDIANAPOLIS 6, INDIANA

*Rectostarter is the registered trademark of P. R. Mallory & Co., Inc., for rectifier units for use in starting internal combustion engines.

P. R. MALLORY & CO. Inc.
MALLORY

MAGNESIUM COPPER SULPHIDE RECTIFIERS—
STATIONARY AND PORTABLE D. C. POWER SUPPLIES—
BATTERY CHARGERS AND AVIATION RECTOSTARTERS*



★ TELEVISION TODAY ★

New Developments in the Video Field

\$50 Picture Boxes

Leonard F. Cramer, who is vice-president of Allen B. DuMont Laboratories, Inc., Passaic, N. J., believes that one way to get television started quickly, and to snowball interest in it, is for someone to start manufacture and distribution of an inexpensive "picture box" at \$50 or \$75—a video receiver attachment that can be plugged into most any FM broadcast receiver for the sound that goes with the pictures. He gave members of the Television Press Club the idea at that organization's June meeting. No, DuMont doesn't intend to build anything of the sort, will stick to high quality complete receivers. But Cramer submits that the other would stimulate interest and whet appetites, eventually work owners up to the purchase of real receivers. He points out that "it is perfectly practical to extend the tuning range of an FM receiver to make available the sound channel of television."

WRGB Award

Presentation of the American Television Society's coveted award for the year 1943-1944's outstanding contribution to the art of television programming was televised over station WRGB, Schenectady, N. Y., recipient of the award, July 15. Dan D. Halpin, newly-elected president of ATS, presented the award to Robert S. Peare, vice president of General Electric Co., which operates the station.

See 100 Tele Stations

Five years after the war at least half the population of the United States will be in a position to see television broadcasts believes General Electric's Howard Perdiue. Late last month he told members of the American Television Society that by that time more than 100 master television stations are expected to be in operation.

AT&T Radio Relays

In addition to announced plans for a nationwide coaxial cable network that can be used for both television and FM, American Telephone and Telegraph Co. is about to embark on experiments looking to the use of radio relay or booster transmission for similar services.

Late last month FCC licensed AT&T to establish and operate experimental uhf transmitters in New York and Boston to function as terminals of a proposed wide-band point-to-point repeater circuit suitable for FM, television, telephone, telegraph and facsimile. Twelve bands of frequencies were authorized as follows:

1,914,040 kc	to	1,925,960 kc
1,974,010 kc	to	1,985,990 kc
2,193,900 kc	to	2,206,100 kc
2,253,870 kc	to	2,266,130 kc
3,993,000 kc	to	4,007,000 kc
4,052,970 kc	to	4,067,030 kc
4,292,850 kc	to	4,307,150 kc
4,352,820 kc	to	4,367,188 kc
11,489,250 kc	to	11,510,750 kc
11,689,150 kc	to	11,710,850 kc
12,288,850 kc	to	12,311,150 kc
12,488,750 kc	to	12,511,250 kc

Television Organizations

American Television Society, 1140 Broadway, New York (CAledonia 5-7430)

President—Dan D. Halpin, RCA, Camden, N. J.; Vice-president—Ray Nelson; Treasurer—Don McClure; Secretary—Kay Reynolds; Directors: Norman D. Waters, George T. Shupert, David H. Halpern, Prof. E. C. Cole, Lela Swift, Charles Kleinman, J. R. Hutchinson.

Television Broadcasters Assn., Inc., 500 Fifth Ave., New York 18, N. Y. (Lackawana 4-4788)

President—Allen B. DuMont, Pas-

saic, N. J.; Vice-president—Louis Allen Weiss, Los Angeles, Calif.; Secretary-treasurer—Will Baltin; Provisional Assistant Secretary-treasurer—Jack R. Poppele, 1440 Broadway, New York City.

Society of Television Engineers (Pacific Coast)

Secretary-treasurer—Curtis W. Mason, c/o Earle C. Anthony, Inc., 141 No. Vermont Ave., Los Angeles 4, Calif.; RTPB Representatives: Frederic C. Wolcott, chief engineer, Gilfillan Bros., Los Angeles, Calif.; Frederick Ireland, General Radio Co., Hollywood, Calif.

Television Producers Assn., 1425 Broadway, Room 70, New York, N. Y.

Acting president—Bud Gamble, Farnsworth Tel. & Radio Corp.; Acting Vice-president—Edwin Woodruff, DuMont Labs.; Acting Secretary—Jay Strong; Acting Treasurer—Roger Caelos.

Television Press Club

Board of Governors—A. W. Bernsohn (Click Magazine), Richard W. Hubbell (author, editor, Television Review), T. R. Kennedy, Jr. (N. Y. Times), Ben Kaufman (Radio Daily), Stanley Kempner (Retailing - Fairchild's), Hermine Isaacs (Theatre Arts), Wanda Marvin (Billboard), Mike Wear (Variety), Louis Winner (Communications Mag.).

Bank Stages Television Demonstration



If prognostications of Franklin Sq. (L.I.) Bank hold good, 1,600,000 persons throughout the United States are saving to buy television receivers and will spend 652 millions of dollars on them, post war. Bank recently held a television demonstration, participated in by Preston R. Bassett, vice-president and general manager of Sperry Corp. (left), Lowell Thomas, and other celebrities, questionnaire depositors on savings earmarked for specific postwar products, got a return of 22 per cent who state they will buy television receivers at \$400

*Title registered U. S. Patent Office.

How to Choose Tubes for Electronic Heating

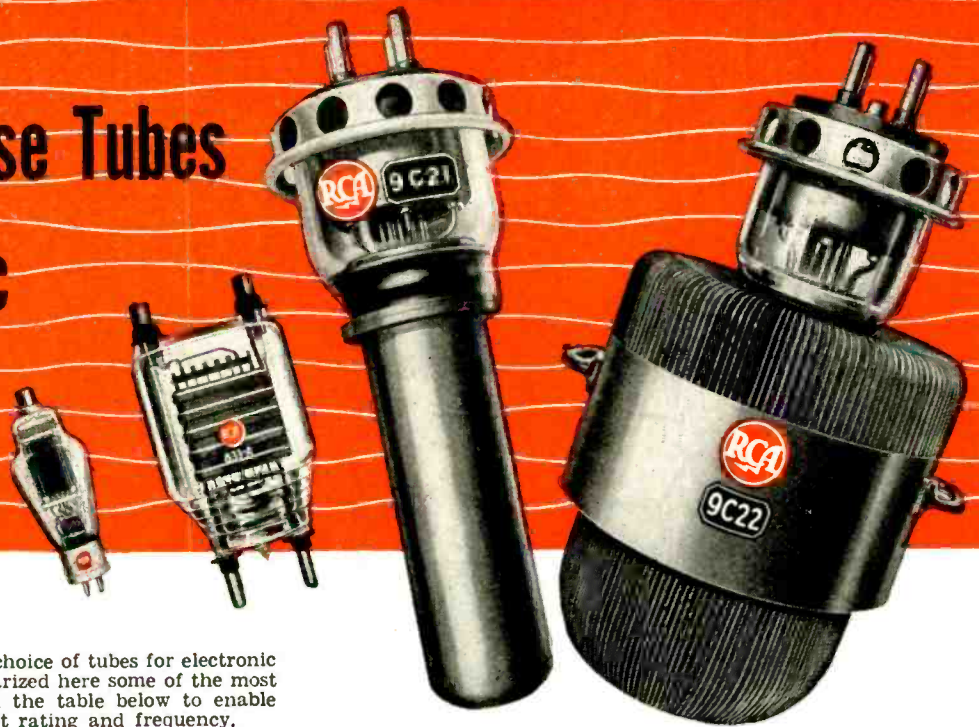

Because so many factors affect the choice of tubes for electronic heating, RCA engineers have summarized here some of the most important ones, and have prepared the table below to enable you to choose tubes by power output rating and frequency.

RCA TUBE TYPE	POWER OUTPUT**		MAX. FREQUENCY		COOLING METHOD	AMPL. FACTOR	PRICE
	at Max. Ratings		@ Max. Input Mc	@ % Max. Input %			
	1 Tube Watts	2 Tubes Watts					
9C21	100,000	200,000	5	25 @ 70%	W & F	38	\$1,000.00
9C22	65,000	130,000	5	25 @ 70%	F	38	1,100.00†
892	14,000	28,000	1.6	20 @ 50%	W	50	190.00
892-R	10,000	20,000	1.6	20 @ 50%	F	50	360.00†
889	10,000	20,000	50	150 @ 50%	W	21	220.00
889-R	10,000	20,000	25	100 @ 50%	F	21	325.00†
833-A*	1,440	2,880	20	75 @ 65%	F	35	76.50
	1,000	2,000	30	75 @ 72%	N		
827-R	1,050	2,100	110	150 @ 50%	F	16	135.00
806*	450	900	30	100 @ 50%	N	12.6	22.00
8000*	375	750	30	100 @ 50%	N	16.5	13.50
8005*	170	340	60	100 @ 60%	N	20	7.00
826	86	172	250	300 @ 80%	N	31	19.00

*Indicates that intermittent ratings are available.
 **Tube output values are shown. Deduct circuit losses for power to load.
 N—Natural air cooling. F—Forced-air cooling. W—Water cooling.
 †—Renewal price when similar radiator in good condition is returned prepaid at time new tube is purchased

best used by supplying direct current to the plates, and getting full output.

Filament voltages supplied to tubes should be accurately adjusted and should not fluctuate. Attention to this factor will help to assure long tube life.

Output Frequency: The chart shows that the RCA tube line provides for relatively high power even at very high frequencies. For special applications not covered by the tubes listed here, write RCA tube engineers (address below).

Cooling: Of the tubes listed, all those delivering 1 kw or more require forced-air or water cooling. Where mobility of equipment is desired, forced-air cooling is usually preferred to water cooling. To prevent unnecessary maintenance, especially for water-cooled tubes, carefully observe the cooling requirements of the tubes.

Intermittent Service: Certain RCA tubes (marked *) have increased ratings for intermittent service.

Dependability: In industrial service, continuity of operation is very important. To assure dependability, electronic heating equipment should be designed with comfortable "safety factors," not only with respect to tubes, but also for other components whose failure might cause tube damage and outage of the equipment. Electron tubes are inherently maintenance-free devices designed to give long life under normal operating conditions.

Take plant conditions, such as heat, dust, vibration, humidity, etc., into account when installing electronic equipment just as in the case of other industrial apparatus. Ordinarily, however, special precautions should not be necessary.

Tube Replacement: RCA distributing and warehousing facilities simplify tube replacement problems, giving quick service in all parts of the country. Naturally, wartime conditions create an abnormal situation, but rated orders are handled with dispatch.

Engineering Aid: RCA tube application engineers are available for consultation on your electronic design problems. Your inquiries are invited. Write, stating your problem, to Radio Corporation of America, Commercial Engineering Section, 729 So. Fifth St., Harrison, N. J.

Power Output: Not all RCA tubes available for electronic heating are listed above; those listed, however, make possible a range of tube output power in easy steps from 86 to 200,000 watts or more. Most types fall in the "medium mu" class, making them exceptionally stable, even under changing load, yet the "mu" is high enough to keep excitation requirements at an economical level. By utilizing tubes in push-pull or push-pull-parallel circuits, the power output required can be closely approached.

Power Supply: All power output values are for typical operating conditions under continuous service, and with d-c plate supply. If the oscillator tubes are to operate on a-c plate supply, the output power will be reduced.

In lower-power equipment, self-rectification may be economical; at high-power, however, the investment in power tubes is usually



RADIO CORPORATION OF AMERICA

RCA VICTOR DIVISION • CAMDEN, N. J.

The Magic Brain of all electronic equipment is a Tube . . . and the fountain-head of modern Tube development is RCA.

SEND THIS FOR MORE DATA

RCA, 729 So. Fifth Street, Harrison, N. J.
 Please send me data sheets on the RCA tubes checked below:

- | | | | |
|-------------------------------|--------------------------------|--------------------------------|-------------------------------|
| <input type="checkbox"/> 9C21 | <input type="checkbox"/> 892-R | <input type="checkbox"/> 833-A | <input type="checkbox"/> 8000 |
| <input type="checkbox"/> 9C22 | <input type="checkbox"/> 889 | <input type="checkbox"/> 827-R | <input type="checkbox"/> 8005 |
| <input type="checkbox"/> 892 | <input type="checkbox"/> 889-R | <input type="checkbox"/> 806 | <input type="checkbox"/> 826 |

Name.....
 Company.....
 Address.....
 City..... State.....



The HARVEY Regulated Power Supply 106 PA

You'll find it ideal for operation with pulse generators, measurement equipment, constant frequency applicators, amplifiers and any other equipment requiring a constant flow of D. C. voltage.

Designed to operate from 115 volts A. C., the HARVEY 106 PA has a D. C. voltage output variable from between 200 to 300 volts and accurately controllable to *within one per cent.* A model of efficiency and convenience, it has separate fuses on each

transformer primary as well as the D. C. output circuit: pilot lights on each switch; a D. C. voltmeter for measuring output voltage and a handy two-prong plug or binding posts to permit easy hook-up.

For complete information on this precision-built, thoroughly dependable source of constant voltage, write for the new HARVEY Regulated Power Supply bulletin. Address your requests for this useful new bulletin to



HARVEY RADIO LABORATORIES, INC.
441 CONCORD AVENUE • CAMBRIDGE 38, MASS.

LATE NEWS FLASH

HARVEY OF CAMBRIDGE ANNOUNCES NEW REGULATED POWER SUPPLY 206 P A... OUTPUT FROM 500 TO 1000 VOLTS - TWO RANGES, 500 - 700 AT $\frac{1}{4}$ OF AN AMPERE; 700 TO 1000 AT .2 OF AN AMPERE... BOTH RANGES CONTROLLABLE TO WITHIN ONE PER CENT... FUSED ON PRIMARY SIDE... OVERLOAD RELAY AND TIME DELAY RELAY... SPARE FUSES... ORDERS NOW ACCEPTED... FOR COMPLETE INFORMATION WRITE, PHONE OR WIRE HARVEY RADIO LABORATORIES, INC.

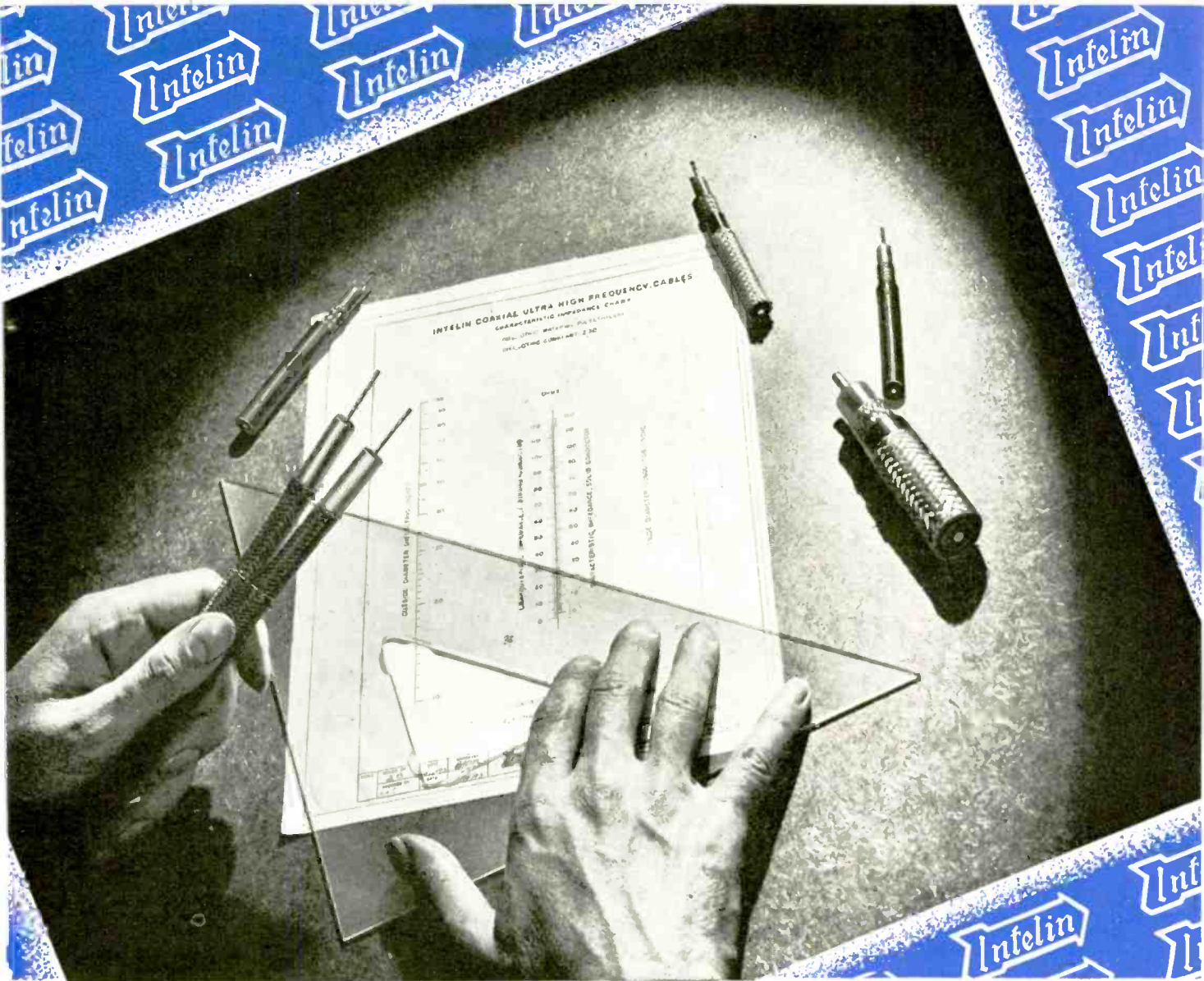

HOW BIG A CABLE?

The impedance characteristics of Ultra-High Frequency Cables are dependent on the physical dimensions — the size of center conductor and the inside diameter of the coaxial braid.

You can easily determine impedance by the use of this Intelin Chart. Apply a straight edge, with the crossover at the desired impedance on the center scale. The other two scales then indicate, for

BUY MORE BONDS

any scale position, the corresponding conductor size and dielectric size necessary for the desired impedance.

Federal, long recognized as a manufacturer of better vacuum tubes, now leads with new production methods resulting in still greater tube efficiency and length of life. Everywhere, it's Federal tubes for superior transmitting and industrial power performance.



A full size copy of this chart is yours on request. Write for it today!

Remember, Intelin Cable is more than insulated wire — it is specialized transmission line — made with watchmaker accuracy.

In the Intelin Cable family there is a type to match your ultra-high-frequency problems, a cable balanced in all electrical properties to do your job.

INVEST IN THE FUTURE

Federal Telephone and Radio Corporation



Newark 1, N. J.

"WHY THAT'S JOCK!"



Right on the field of battle is the CBC truck with its Presto recorder taking down the sounds of battle, the words of Canadian men doing the fighting . . .

Yes! It actually happens. Canadian families are now hearing the voices of their own loved ones on the battlefronts, thanks to a program service originated by the Overseas News Service of CBC. This enterprising and much appreciated service consists of recordings made right on the scene of battle, the actual sounds of battle forming a terrible background. The recordings are rushed to Algiers, short-waved either via London or direct to Ottawa, where they are re-recorded, and sent out over the CBC leased lines. All this is made possible by the use of PRESTO Recording Equipment, which is used throughout the Canadian Broadcasting Corporation.



. . . Transmitted by short wave to BBC in London, the broadcast is re-recorded on one of the fifty complete Presto recording installations in the British Isles . . .



Presto Recording Corporation, New York 19, N. Y., U. S. A.

World's Largest Manufacturers of Instantaneous Sound Recording Equipment and Cises



. . . Short-waved again, this time to CBC in Ottawa, the battle-recorded broadcast is then sent over wire lines to the stations on the CBC networks across the Dominion.

Recognition

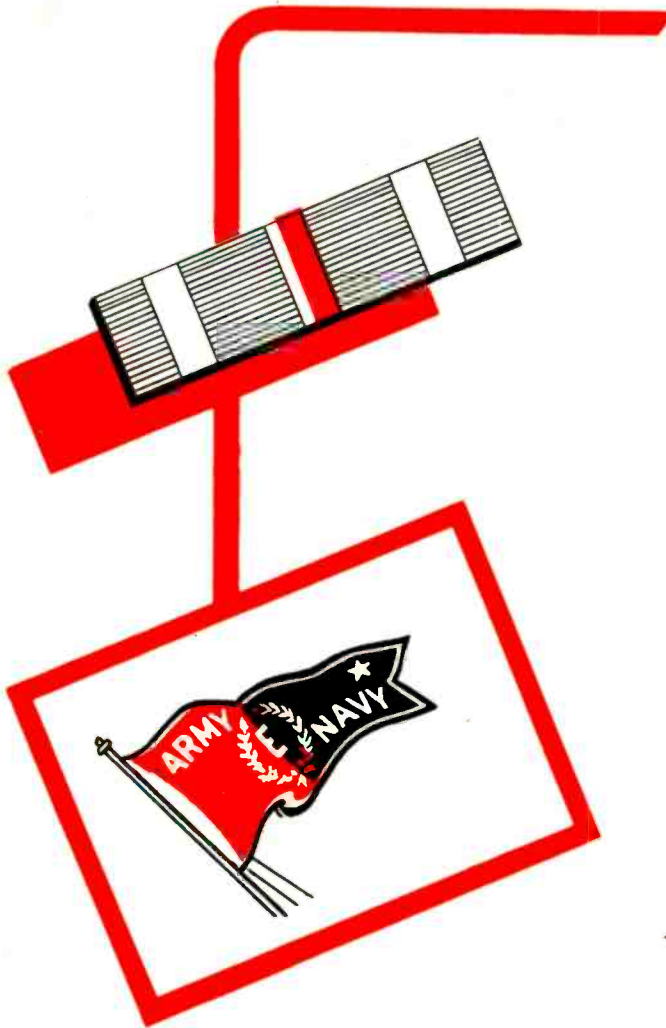

Proud is the wearer of this breast ribbon, for it is a testimonial to his conspicuous bravery on the field of battle.

Equally proud are we of the pennant that flies over our Willimantic plant — The Army and Navy "E", awarded "For High Achievement" in war need production.



At countless vital points in communications equipment, El Menco Molded Mica Capacitors serve unobtrusively, but with efficiency that has become a recognized standard.

Our New Capacitor Catalog for manufacturers of electronic equipment is now ready for distribution. Send for it today—on your firm letterhead.

El-Menco

MOLDED MICA CAPACITORS

THE ELECTRO MOTIVE MFG. CO.
Willimantic, Connecticut

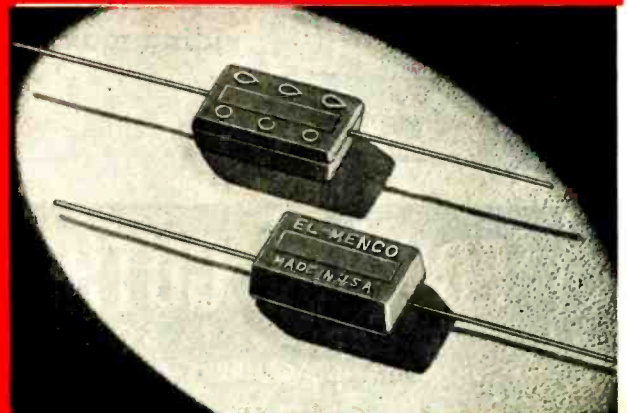

GUTHMAN *Discriminator* COILS in **F.M.** for Maximum Discrimination

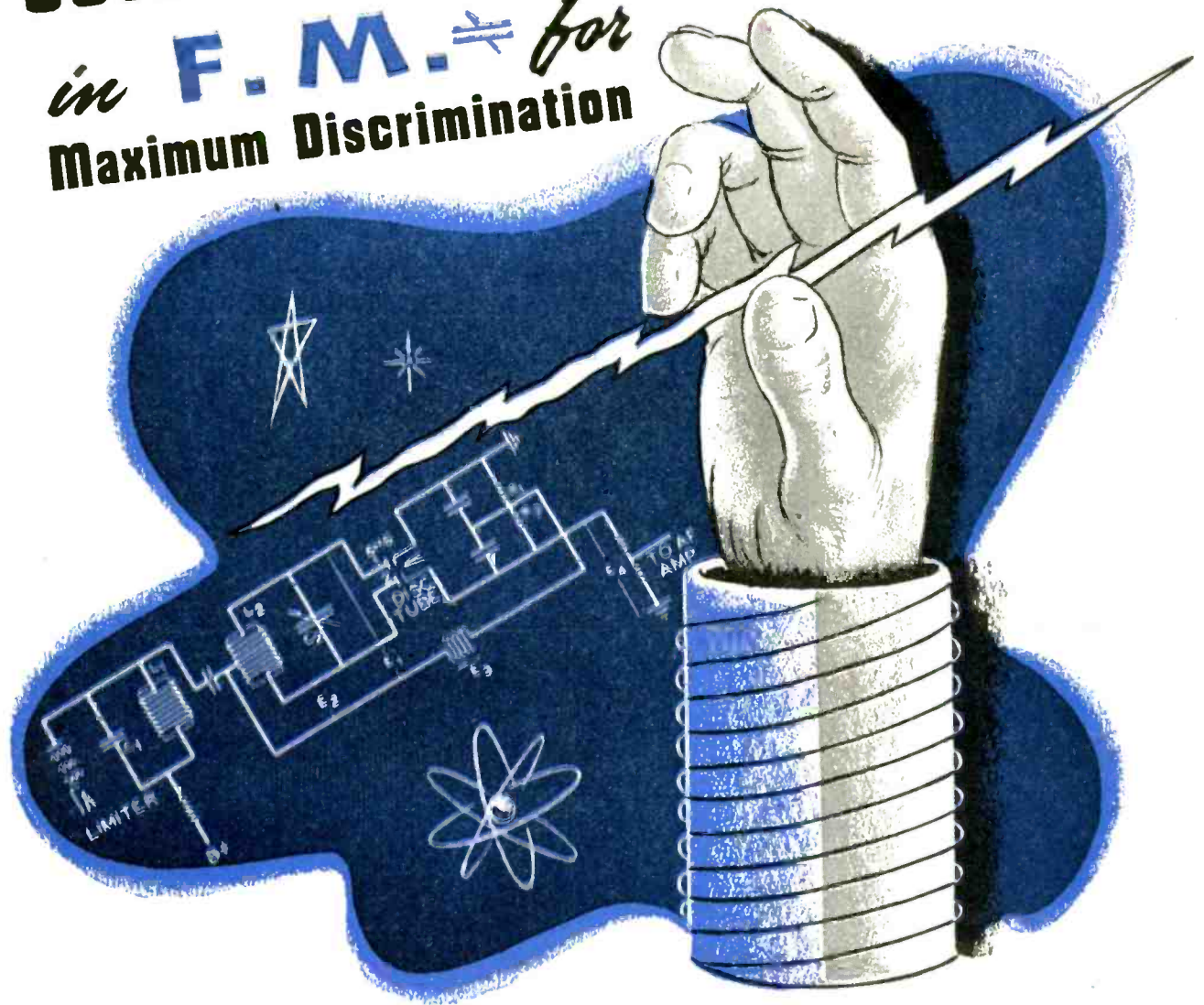

FREQUENCY MODULATION receivers require linear discrimination against undesirable signals. Guthman engineers have developed precise DISCRIMINATOR COILS to discriminate equally on both sides of the resonance curve, providing maximum discrimination.

GUTHMAN
*Leader in
Inductronics*

DO YOUR BEST . . .
INVEST IN WAR BONDS!



EDWIN I. GUTHMAN & CO. INC.

15 SOUTH THROOP STREET · CHICAGO

PRECISION MANUFACTURERS AND ENGINEERS OF RADIO AND ELECTRICAL EQUIPMENT

PHYSICAL AND CHEMICAL

PROPERTIES OF

"dag" COLLOIDAL GRAPHITE

1
Slippery—a Good Lubricant.
Softer than talc

2
Conducts Electricity

3
Withstands Temperature Extremes

4
Absorbs, Radiates and Conducts Heat

5
Maximum Purity

6
Low Coefficient of Expansion

7
Particles Bear Like Electric Charges

8
Insoluble in Acids and Alkalies

9
Black and Opaque

10
Gas Adsorbent

11
Little Photoelectric Effect

12
Miscible with Most Fluids

13
Films Adhere Tenaciously and Dry with Sharp Edges

14
Microscopically Fine Particles. Penetrates Fine Pores

15
An Excellent Suspension

Available as a smooth, black, liquid concentrate, Dag colloidal graphite puts a versatile company of physical and chemical properties at your service. Fifteen of the more important of these properties are listed here with a different color given to each for easy reference.

Match these properties by color with the colors on the medals below. Each medal represents a typical performance "citation" to Dag colloidal graphite. Dozens more could be shown, if space permitted, because this product is a dry film, a fluid film, a surface coating, an impregnation—and a few other things besides.



"Mr. Dag"



2, 14, 13, 15
CITATION: "Drive belts and other nonconductors traveling at high speed accumulate static charges which under certain conditions may constitute a hazard. This static electricity is controlled and bled-off harmlessly by a Dag colloidal graphite conductive film."



9, 13, 6, 14, 15
CITATION: "Dag colloidal graphite is used to retouch photograph negatives because of its complete opacity, because a film of minimum thickness is required and because it dries with a sharp edge."



1, 3, 5, 14, 15
CITATION: "When the work rotating chuck of this large honing machine was assembled and run-in using Dag colloidal graphite, running-in time was reduced approximately 35%, operating temperature dropped considerably, and the danger of bearing damage due to temporary oil film failure was eliminated."

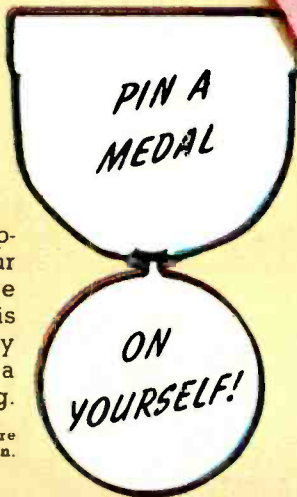

CHECK THE LIST and pick out those properties which you can use. Then state your problem to us and let our engineers give you the benefit of their experience. It is quite possible that they have already studied a parallel application. You'll pin a medal on yourself for calling in Mr. Dag.

Dag, Oildag, Aquadag, Castordag, Glydag and Prodeg are registered trade marks of Acheson Colloids Corporation. Copr. 1944 by Acheson Colloids Corp.



ACHESON COLLOIDS CORPORATION
PORT HURON, MICHIGAN

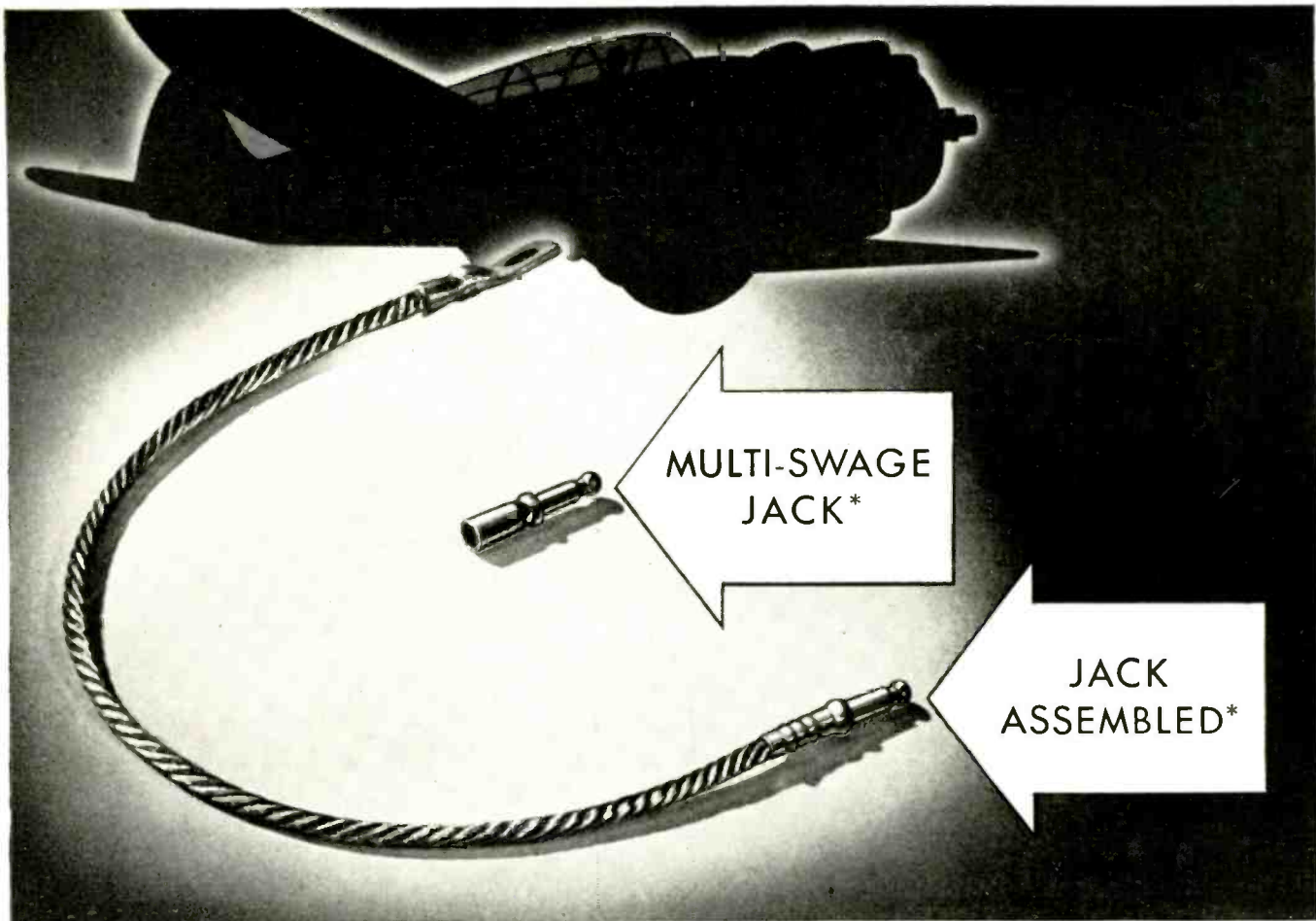

**Jack and complete disconnect bonding jumper designed and assembled by Aircraft-Marine Products, Inc.*

THE MOST ECONOMICAL METHOD

GOVERNMENT specifications require that every part of a military aircraft be electrically bonded. This precaution eliminates the hazard of fire that might result from electrical energy built up in one section of the plane being suddenly discharged to another, creating an arc.

Disposable gas tanks, engine cowls and other accessory parts are fitted with a length of high-conductivity cable. When the units are assembled the jack on the cable is plugged into a receptacle on the plane. These jacks are made by MULTI-SWAGE at a fraction of the cost of other methods.

The BEAD CHAIN MULTI-SWAGE PROCESS

forms small metal parts from flat stock. No metal is cut away and there is no drilling, thus no waste. Parts can be produced in volume and at high speed by MULTI-SWAGE while holding tolerances accurately. Our Research and Development Division will gladly assist you. Write for further information.



These are typical "Multi-Swage" products. This process will turn out large volume speedily while maintaining close tolerances accurately.



**BACK THE ATTACK
BUY MORE WAR BONDS**

THE MOST ECONOMICAL METHOD OF PRODUCING SMALL

METAL PARTS TO CLOSE TOLERANCES WITHOUT WASTE

THE BEAD CHAIN MANUFACTURING COMPANY
102 MOUNTAIN GROVE STREET, BRIDGEPORT 5, CONNECTICUT

IRON CORES

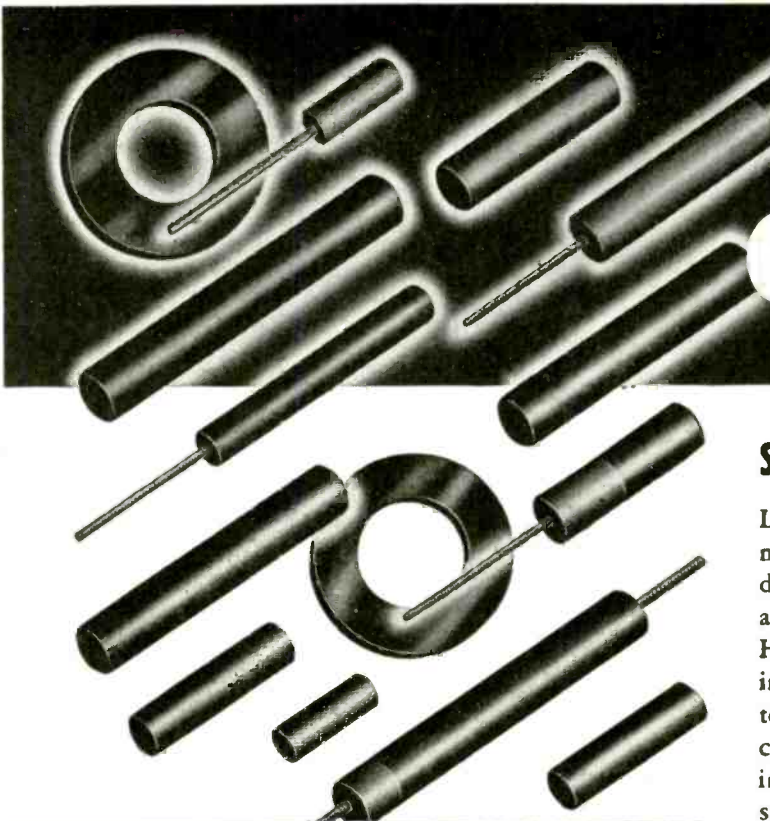

Standard and High-Frequency Types

Long the acknowledged leader in Iron Core manufacture, Stackpole can supply practically any desired type from 100 cycles to 175 megacycles and even higher. Both the Stackpole Standard and High-Frequency types are produced in an almost infinite variety of shapes, sizes, and characteristics to match your needs *exactly*. Also available is a complete line of Stackpole High-Resistivity Cores in either insulated or non-insulated types, and showing a resistance of practical infinity.

Insulated Types

The screws in these integrally-constructed units are insulated from the iron cores. Thus, the screw is kept out of the coil field and "Q" is greatly increased. The distributed capacity of the coil is reduced and, in applications where the screw is not grounded, there is also a big reduction in hand capacity effect. Ask for Stackpole Engineering Bulletin No. 7.

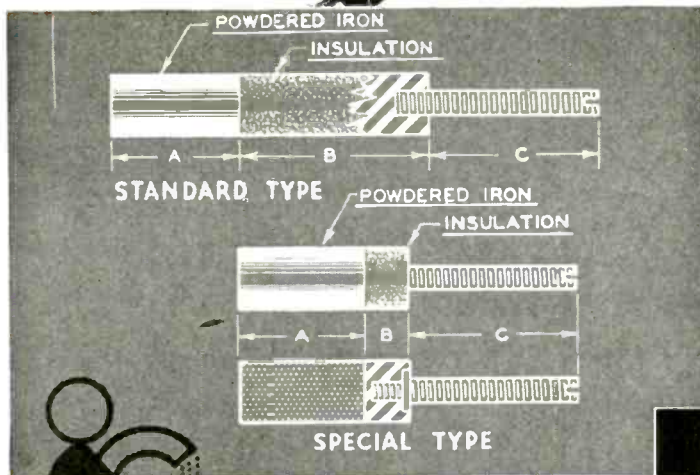

Iron Cores for CHOKE COILS

These popular Stackpole Cores are designed for use with audio chokes, "hash" chokes, r-f chokes, etc. Not only do they permit reductions in choke coil dimensions, but the iron materially increases the "Q". Insulated leads serve as coil connections and permit convenient point-to-point wiring.

Brushes—Contacts
Sintered Iron Components—Carbon
Regulator Discs—
Battery Carbons—
Fixed and Variable
Resistors—
Switches, etc., etc.

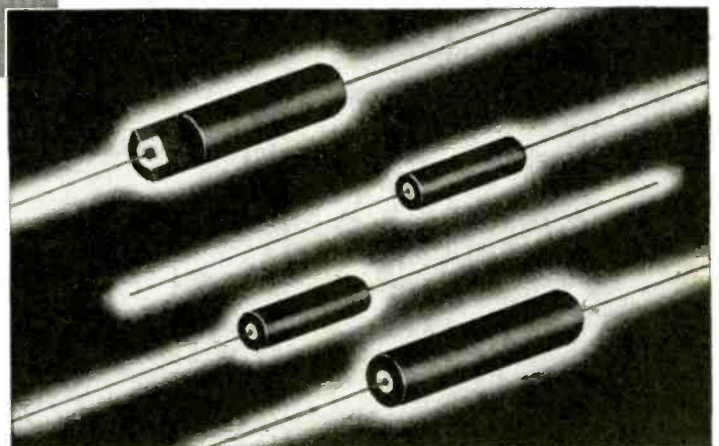

STACKPOLE

STACKPOLE CARBON COMPANY, ST. MARYS, PA.

The Answer

TO YOUR
PROCUREMENT PROBLEMS
MAY LIE
BETWEEN THESE COVERS!

WE OFFER
FAST DELIVERY
ON OVER
10,000
ITEMS

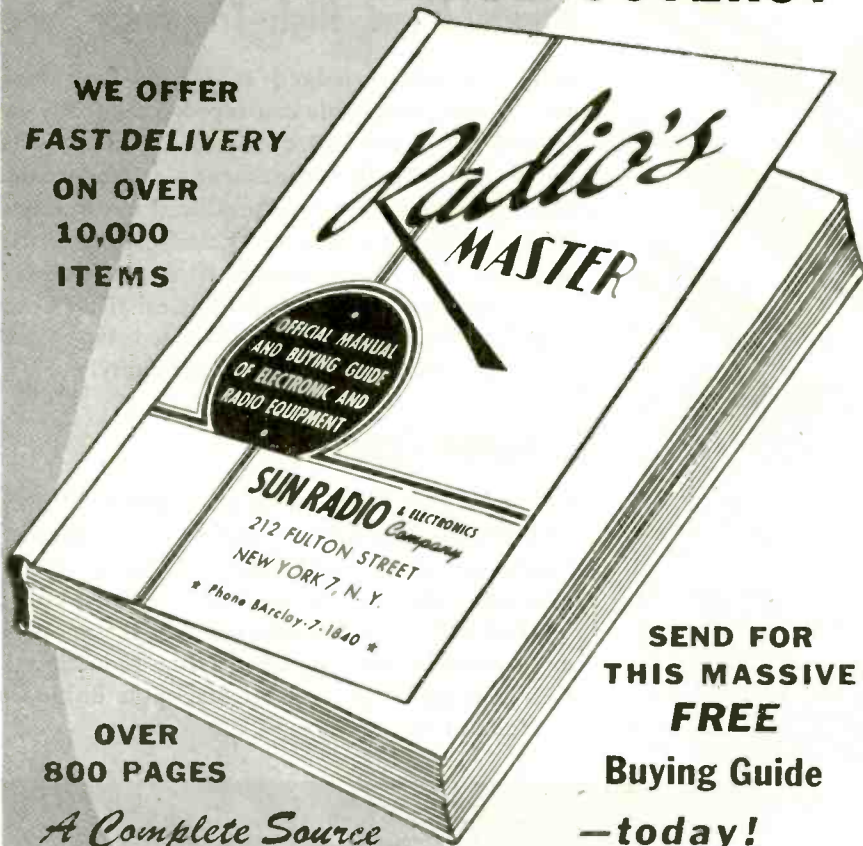

OVER
800 PAGES

A Complete Source
for

RADIO PARTS
RADIO TUBES
and **INDUSTRIAL**
ELECTRONIC EQUIPMENT

For INSTANT SERVICE—Telephone Barclay 7-1840

SUN RADIO
& ELECTRONICS CO.
212 Fulton Street, New York 7, N. Y.

SEND FOR
THIS MASSIVE
FREE
Buying Guide
—today!



Available without charge to authorized purchasing agents, engineers and expeditors, who write to us on Company stationery, stating their title.

Address Box T

New RMA Sections

Two new sections have been added to the Parts Division of Radio Manufacturers Association, bringing the total number of groups to twelve serving under Parts Division Chairman Robert C Sprague. New are the Vibrator Section and the Special Product Section. Present line-up of all sections follows:

Section	Chairman
Capacitor	Paul Hetenyi, Solar Mfg. Corp., New York.
Coil	Leslie F. Muter, Muter Co., Chicago.
Fixed Resistor	J. H. Stackpole, Stackpole Carbon Co., St. Marys, Pa.
Instrument	R. L. Triplett, Readrite Meter Works, Bluffton, O.
Socket	Hugh H. Eby, Hugh H. Eby, Inc., Philadelphia.
Special Product	W. R. MacLeod, King Laboratories, Inc., Syracuse.
Switch	Robert A. O'Reilly, Oak Mfg. Co., Chicago.
Transformer	James M. Bennan, Jefferson Electric Co., Bellwood, Ill.
Variable Condenser	Russell E. Cramer, Radio Condenser Co., Camden, N. J.
Variable Resistor	H. E. Osmun, Centralab, Milwaukee.
Vibrator	Ray F. Sparrow, P. R. Mallory & Co., Indianapolis.
Wire	R. G. Zender, Lenz Electric Mfg. Co., Chicago.

Police Conference

The 11th annual National Conference of the Associated Police Communication Officers will be held at the Commodore Perry Hotel, Toledo, Ohio, September 18, 19 and 20, 1944. The serious manpower situation, frequency allocation, inter-city communications and interference problems are some of the important discussions for this three day conference which will bring together the leading police communication men of the United States. It is anticipated that equipment from many leading manufacturers will be on display.

IRE 1945 Slate

Dr. W. L. Everitt, now serving in the office of the Chief Signal Officer, Washington, has been nominated for the presidency of the Institute of Radio Engineers. Vice-presidential nominee is Dr. H. J. Van der Bijl, Director-General of War Supplies, Union of South Africa. Directors nominated for the term 1945-1947 are: S. L. Balley, E. F. Carter, Keith Henney, F. M. Ryan, B. E. Shackelford and W. O. Swinyard.

Welding Information

Resistance Welders Manufacturers' Association, 505 Arch St., Philadelphia, has established an information service to assist in the solution of welding problems. Requests for information on welding and equipment will be answered.

KEY TEST

Opens Up New Sleeving Advantages

PROVE TO YOURSELF THE NON-FRAYING, FLEXIBLE QUALITIES OF BH EXTRA FIBERGLAS SLEEVING

MAKE THIS simple test right at your desk and you'll see that here at last is a truly non-fraying, flexible sleeving. Just take a length of BH *Extra Flexible* Fiberglas Sleeving and jam an ordinary key into one end. Turn it around and push it up and down in the sleeving. Notice how the sleeving spreads but doesn't fray. Now do the same with a similar size piece of your present saturated sleeving. It breaks and frays. Further abuse unravels it. But BH Sleeving stands up under rough handling and severe service alike.

BH EXTRA FLEXIBLE FIBERGLAS SLEEVING
NON-FRAYING • FLEXIBLE • HEAT-RESISTANT • NON-INFLAMMABLE • WATER-RESISTANT • VERMIN-PROOF
NON-DETERIORATING • HIGH DIELECTRIC AND YARN STRENGTH • NON-CRYSTALLIZING at LOW TEMPERATURES

BH Sleeving is woven from choicest continuous-filament Fiberglas yarns and treated by an exclusive BH process that gives it stamina and pliability. Natural properties of Fiberglas as an insulator are virtually unequalled. So why be content with any less efficient sleeving? You'll want to try the BH test yourself. BH Sleeving is available in all sizes from No. 20 to $\frac{5}{8}$ " inclusive. Write for samples of specific sizes *today* and be convinced. Bentley, Harris Manufacturing Co., Dept. I, Conshohocken, Pa.

THE RESULTS MAGNIFIED

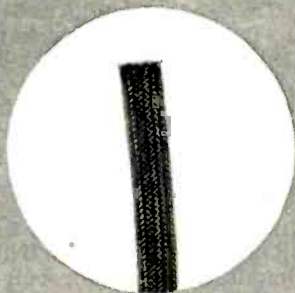

↓ The BH Way

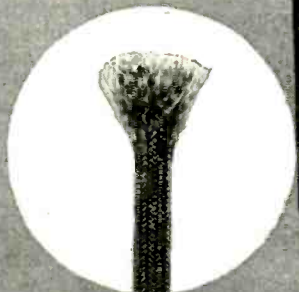

The Ordinary
Way ↓



NON-BURNING IMPREGNATED MAGNETO TUBING • NON-BURNING FLEXIBLE
VARNISHED TUBING • SATURATED AND NON-SATURATED SLEEVING

BENTLEY, HARRIS MANUFACTURING CO.
Conshohocken, Penna.

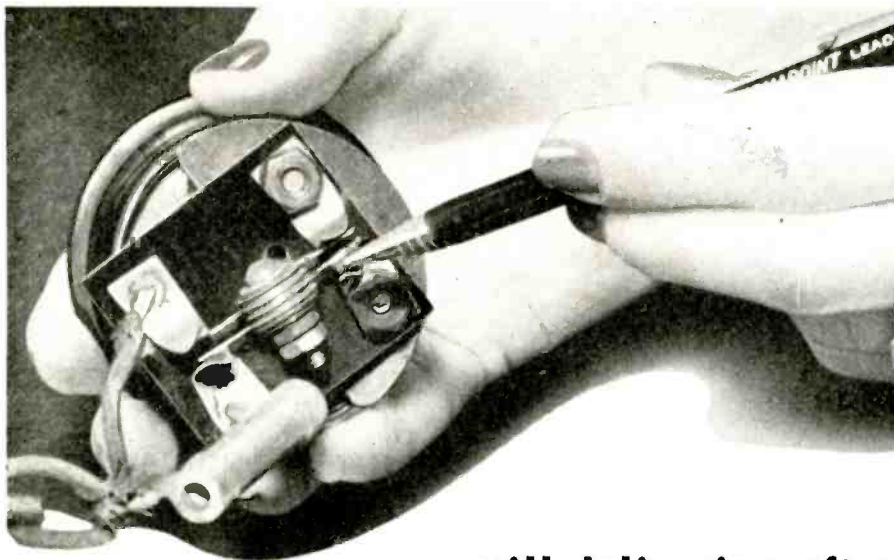

still delivering after
88,000 HOURS
 Continuous Service

This Conant type M rectifier was returned as defective on May 9, 1934. When routine tests failed to show any defects, this rectifier was mounted on the back of a 15 mil meter and put in operation as a line voltmeter, in an effort to detect any intermittent condition.

For more than ten years this "defective" Conant rectifier has been in continuous service—an estimated 88,000 hours—delivering a full 13 milliamperes, its original output. This is the milliamper-hour equivalent of several lifetimes of normal service.

This unintentional life test, begun a decade ago, makes it possible to safely predict a normal life of at least ten years for any Conant rectifier.

If it is important that your instruments retain their initial calibration for life—choose Conant rectifiers and be certain.



Instrument Rectifiers

ELECTRICAL LABORATORIES

6500 O STREET, LINCOLN 5, NEBRASKA, U. S. A.

20 Vesey St., New York 7, New York
 85 E. Gay St., Columbus, Ohio
 600 S. Michigan Ave., Chicago 5, Ill.
 1215 Harman Pl., Minneapolis 3, Minn.

2017 Grand Ave., Kansas City, Mo.
 7935 Eustis St., Dallas 18, Texas
 4018 Greer Ave., St. Louis, Mo.
 1526 Ivy St., Denver, Colo.

4214 Country Club Dr., Long Beach 7, Cal.
 4205 N.E. 22nd Ave., Portland 11, Ore.
 Caixa Postal 930, Sao Paulo, Brazil
 50 Yarmouth Rd., Toronto, Canada

Volume Control Standard

After more than a year of deliberation American Standards Association has placed its stamp of approval on standards for volume controls for home radio. The standard is one of a series of war standards developed by the ASA war committee on replacement parts for civilian radio at the request of the Office of Price Administration, after consultation with the Radio and Radar Division of WPB.

**Dr. H. H. Beverage
 Receives Award**

In recognition of "a great contribution," the United States Army Signal Corps has awarded its coveted Certificate of Appreciation to Dr. Harold H. Beverage, Associate Director of RCA Laboratories in Charge of Communications Research, Major General H. C. Ingles, Chief Signal Officer, who informed Dr. Beverage of the award, said: "Your tireless effort and valuable advice during the installation of a radioteletype circuit in the North Atlantic route constituted a great contribution to the Signal Corps in its gigantic task of furnishing the United States Army the world's greatest military communications system."

Free Electronic Training

Free training in radio and electronics for technical workers in California war industries will be given in a series of short courses which the University of California will start in August in major war production centers throughout the state, as part of the Engineering, Science, and Management War Training Program of the United States Office of Education. The instruction is designed for full-time workers who are willing to devote two hours a week to class lectures and an equal amount of time to home study. The training will be offered in both elementary and advanced levels, to meet the needs of those of varying degrees of experience.

The program will include evening lecture courses in radio and industrial electronics, meeting weekly for eighteen weeks, and an evening elementary electronics laboratory, meeting three hours a week for sixteen weeks. An advanced lecture-demonstration course in industrial electronics is also planned for later in the year. For instructors, the University will draw upon members of its own faculty as well as leading engineers in the electrical industry.

The prerequisites for enrolling for this instruction are employment

WRITE TODAY!

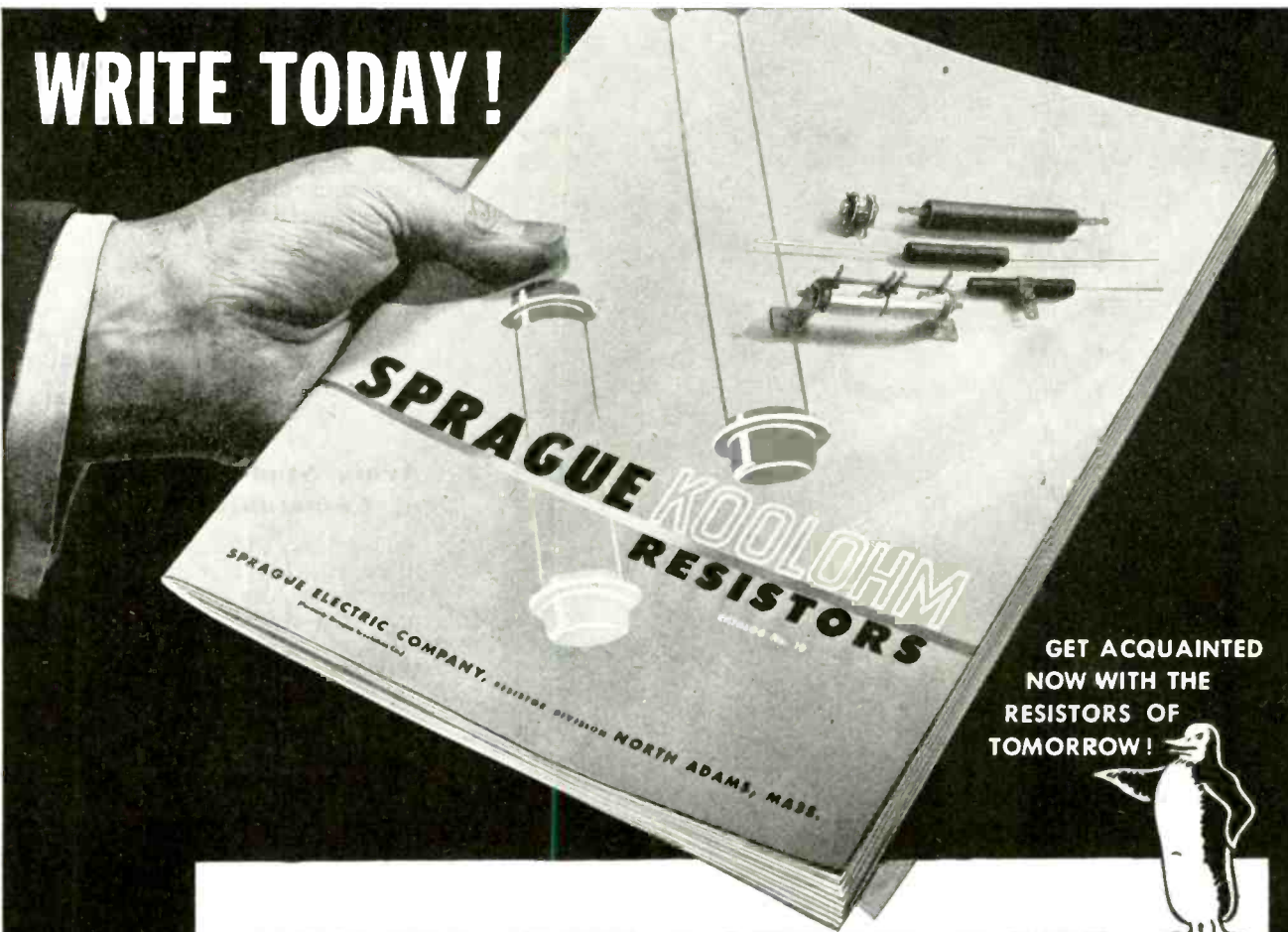

GET ACQUAINTED
NOW WITH THE
RESISTORS OF
TOMORROW!



HERE'S THE LATEST DATA... *on the most up-to-the-minute resistors*

Time and again, during the past seven years, Sprague Koolohms have demonstrated convincingly their ability to handle jobs that old-style, conventional wire-wound resistor types could not handle satisfactorily.

One after another, they have proved their superiority in practically every essential characteristic — from faster

heat dissipation with resulting use up to full rated wattage values, to better performance under humid conditions.

Whether for war use today, or for greater efficiency for your post war product tomorrow, it should pay you to become fully acquainted with this remarkable resistor development. Write for this big new catalog today!

Resistor types in this new catalog include:

Wire-wound power types, 5- to 120-watts. Inductive and non-inductive.

Hermetically-sealed wire-wound types, 10- to 120-watts.

Wire-wound bobbin types.

Voltage divider sections, 10-, 15- and 25-watts.

Hermetically-sealed precision meter multipliers resistors.

Megomax hermetically-sealed high-voltage, high-temperature resistors.

SPRAGUE ELECTRIC COMPANY, Resistor Division
(Formerly Sprague Specialties Co.) NORTH ADAMS, MASS.

The ONLY
Resistors
wound with
*CERAMIC
INSULATED
WIRE!

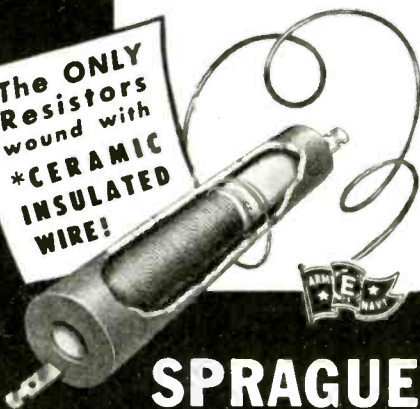

SPRAGUE KOOLOHMH RESISTORS

The Greatest Wire-Wound Resistor Development in 20 Years

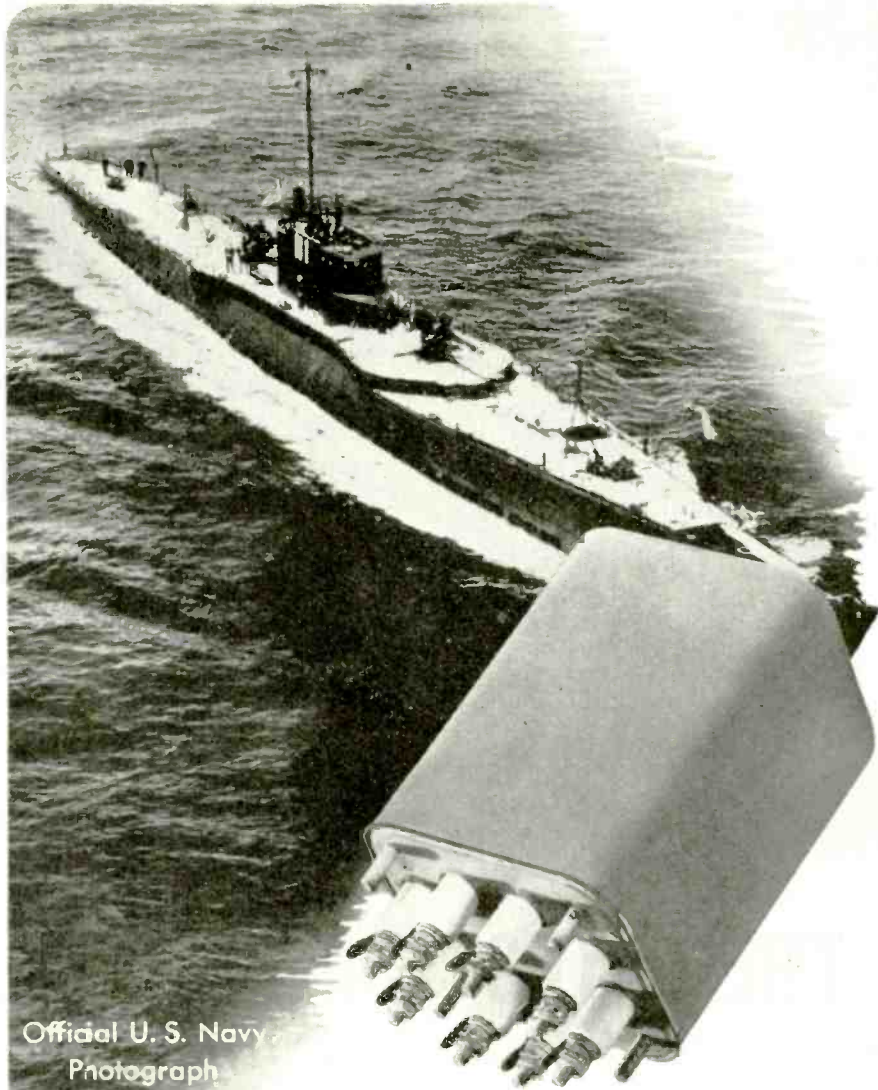

Official U. S. Navy
Photograph

TRANSFORMERS UNDER THE SEA

The utmost in dependability, accuracy and ruggedness is an absolute must where a single failure can end all.

The finest in men and team work, plus the best in modern equipment account for the outstanding success and low losses of the United States Submarine Services.

Chicago Transformer is proud to manufacture transformers of the type required for these underwater craft.

CHICAGO TRANSFORMER

DIVISION OF ESSEX WIRE CORPORATION

3501 WEST ADDISON STREET
CHICAGO, 18



in a war industry and high school graduation or equivalent education. To facilitate their class attendance, students may apply under OPA regulations for supplementary gasoline allowances.

Detailed information regarding time and place of class openings and course descriptions may be obtained from the following University of California War Training Centers: 201 California Hall, Berkeley 4, Calif. (THornwall 5377), 405 Hilgard Avenue, Los Angeles 24, Calif. (BRadshaw 2-2171), 1302 First Avenue, San Diego 1, Calif. (Main 2037)

Army Studies "History of Communications"

The Army Cavalry School at Fort Riley, Kan., has requested permission to use for instructional purposes the series of history of communications ads put out by the Universal Microphone Co., Inglewood, Calif. Lieut. Colonel Cecil Himes is chief of the dept. of communications.

Invasion Transmission

Press Wireless, Inc., made history Tuesday morning, June 13, when it transmitted and received the first news material to be radioed direct from the beachhead in Normandy to the United States. This was done from a mobile 400-watt transmitter of the company's own design and manufacture at a speed of 350 words per minute and upward. The transmitter was equipped with a low-hung doublet antenna and a Diesel driven power unit. Reception was effected at the Baldwin, Long Island, terminal of the company on one of the company's own receivers. The first dispatch, filed at the beachhead at 5:50 A.M., Eastern War Time, was delivered in a New York newspaper office in less than 21 minutes.



Herbert Gott, Traffic Chief, at Recorder in Press Wireless Operations Room, New York, on June 12, 1944, at 1:40 P.M., when first contact was made with mobile transmitter on Normandy beachhead

**LOW LOSS
AT
HIGH-FREQUENCY**

**HIGH
MECHANICAL
STRENGTH**

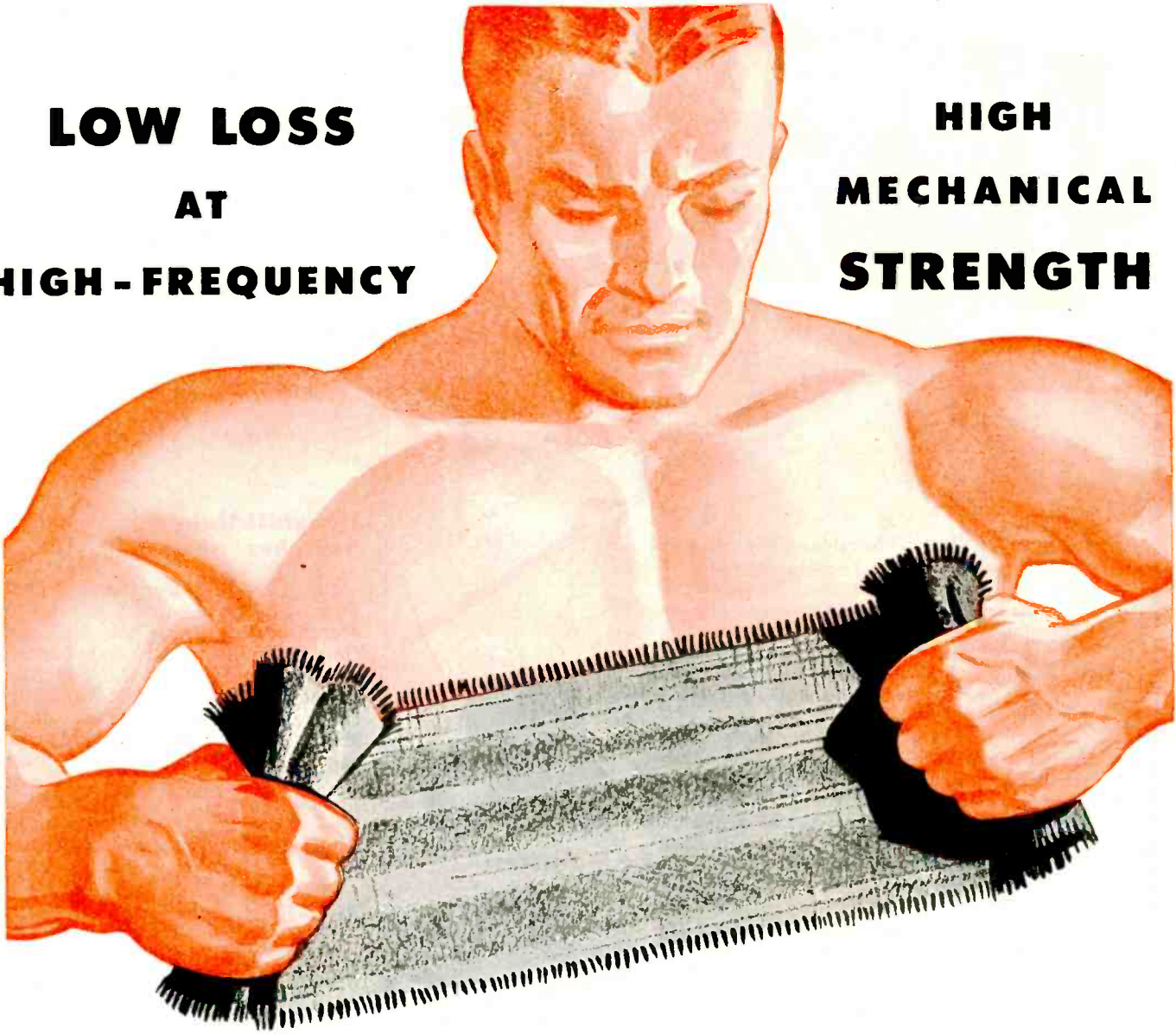

Until now most of the better high frequency insulators have been either brittle or subject to deformation at elevated temperatures. With the development of glass mat base Formica there is available an insulator that allows only minimum losses at high frequencies and at the same time retains the mechanical strength and machinability that is characteristic of other grades of Formica.

For low losses at high frequencies we suggest that you test Formica Grade MF 66 which has been found to be the answer for antenna insulators and coil forms on airborne and ground installations. It withstands the vibrations and mechanical stresses to which military radio equipment is subject. This material is resistant to attacks of fungus growth and can be used in the tropics.

Sample on request. "The Formica Story" is a moving picture showing the qualities of Formica, how it is made, how it is used. Available for meetings of engineers and business groups.



FORMICA

**THE FORMICA INSULATION COMPANY
4647 Spring Grove Avenue
Cincinnati, 32, Ohio**

ANDREW

No. 83

3/8" COAXIAL TRANSMISSION LINE

QUICK DELIVERY can be made on this extremely low loss transmission line. Especially suited for RF transmission at high or ultra-high frequencies, it has wide application (1) as a connector between transmitter and antenna, (2) for interconnecting RF circuits in transmitter and television apparatus, (3) for transmitting standard frequencies from generator to test positions, and (4) for phase sampling purposes.

Andrew type 83 is a 3/8" diameter, air-insulated, coaxial transmission line. The outer conductor material is soft-temper copper tubing, easily bent to shape by hand and strong enough to withstand crushing. Spacers providing adequate mechanical support are made of best available steatite and contribute negligibly to power loss.

Accessory equipment for Coaxial Transmission Line, illustrated:

Type 853 Junction Box: Right angle box required where very sharp right angle turn is necessary.

Type 825 Junction Box: Three way T box for joining three lines at right angles.

Type 1601R Terminal: Gas tight end terminal with exclusive Andrew glass to metal seal. Incorporates small, relief needle valve for discharging gas.

Type 810 Connector: Cast bronze outer connector with copper sleeve for inner conductor.

Andrew Company manufactures all sizes in coaxial transmission lines and all necessary accessories.

Write for Descriptive Catalog

Type 83

Type 853

Type 825

Type 1601R

Type 810

Andrew Type 83 (3/8" diameter) coaxial transmission line is manufactured in 100 foot lengths and may be purchased in coils of this length or in factory spliced coils of any length up to 1/2 mile.

ANDREW CO.



363 EAST 75th STREET
CHICAGO 19, ILLINOIS

UHF Equipment Display

A new Andrew display cabinet of UHF "plumbing" has received a good deal of favorable comment at Indianapolis, where it was used to illustrate a lecture on UHF, and at Chicago meetings of the IRE. Built by the Andrew Co., Chicago 19, Ill., it shows a collection of coaxial transmission lines of various diameters with some of the commonly used connectors, junction boxes and terminals. Two dry-air pumps are shown, an all-purpose model and a military model. This is the first display cabinet of its kind. The display cabinet is available for exhibition at conventions, meetings and other gatherings where radio men may be present.

Grayhill Makes Switches

Grayhill—that is the complete name of the company—has been organized by Ralph M. Hill and Gordon E. Gray to manufacture electrical and mechanical switching devices for the electronic and aircraft industries. General offices are at 1 North Pulaski Road, Chicago; the factory is in La Grange, Ill. Chief engineer and general manager is W. S. Lewis; Arnold Wassel is head of the plastic design engineering and production division.

Mec-Rad Expands

The Mec-Rad Division of Black Industries started construction of a new building, adjacent to the present plant at 1400 East 222nd St., Cleveland, to be devoted entirely to the manufacture of mechanical and electrical components. The new structure will provide more than twice the present floor space of the division. Expansion has been made necessary to complete contracts for the production of precision parts for high frequency antennas for our armed forces. In addition to doubling the productive capacity, the new plant will contain enlarged laboratory, testing and research facilities. Occupancy is scheduled for about September 1st. John Altmayer is General Manager of the Mec-Rad Division.

Anti-Fungus Parts

Anticipating a broad increase in the use of fungus-proof specifications, Shallcross Mfg. Co., Collingdale, Pa., is now supplying fixed wire wound resistors and switches, etc., treated with anti-fungus materials which meet Signal Corps specifications 71-2202A. Treatment involves no manufacturing delay.

The PLUS Answer
to B2A
Specifications

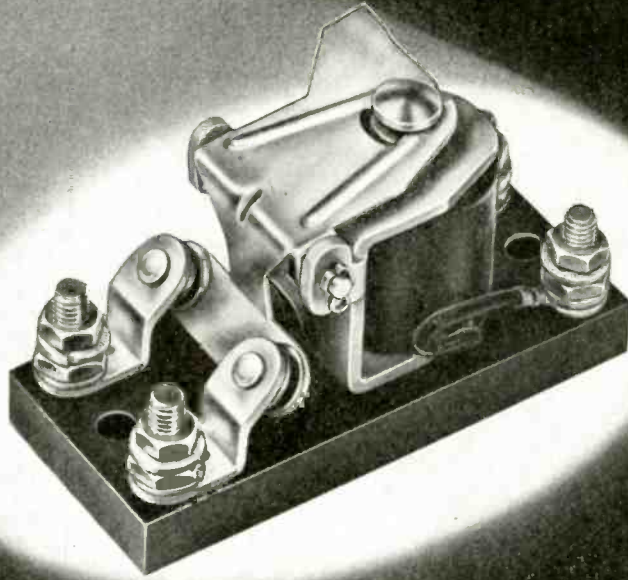

EXTRA HEAVY-DUTY CONTACTS PROVIDE BIG SAFETY FACTOR

Struthers-Dunn Nutcracker Type 61HXX100 answers the need for suitable relays for extreme services particularly where severe overloads may cause trouble on units on which contacts have a less generous heavy-duty safety factor. Typical applications include such services as controlling aircraft landing lights, or controlling a number of solenoids simultaneously.

These relays are compact and sturdy, have double-break contacts, and meet the latest 94-32185D specifications with contact safety factor to spare. By a simple system of removable links, they may be converted to meet any one of the earlier 94-32185 or 94-32185A, B, or C specifications—or, they can be supplied in their universal type which enables you to make your own adaptation, quickly and easily for *any* of these specifications.

STRUTHERS-DUNN, INC., 1321 ARCH STREET, PHILADELPHIA 7, PA.



**WITHSTANDS
90g's!**
A SHOCK-PROOF
RELAY... THAT'S
Really
SHOCK-PROOF!

If your problem is one of finding a B2A relay on which the contacts stay open or stay closed unflinchingly under the most severe conditions of shock and vibration, write for details on Struthers-Dunn Type 17AXX. Small in size, light in weight, it meets and exceeds all specifications for such services.

STRUTHERS-DUNN

5,288 RELAY TYPES

DISTRICT ENGINEERING OFFICES: ATLANTA · BALTIMORE · BOSTON · BUFFALO · CHICAGO · CINCINNATI · CLEVELAND
DALLAS · DENVER · DETROIT · HARTFORD · INDIANAPOLIS · LOS ANGELES · MINNEAPOLIS · MONTREAL
NEW YORK · PITTSBURGH · ST. LOUIS · SAN FRANCISCO · SEATTLE · SYRACUSE · TORONTO · WASHINGTON

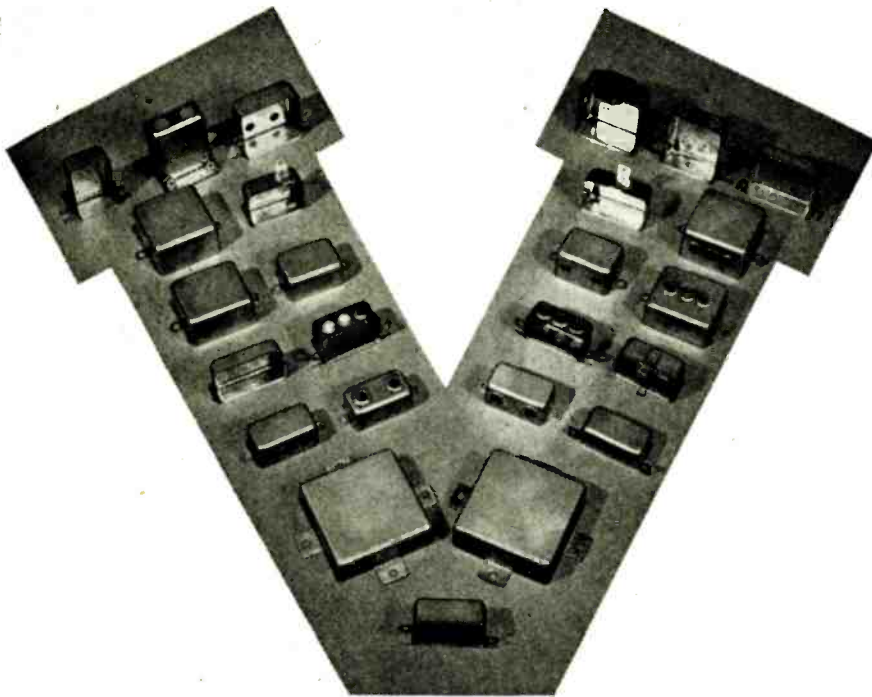

CANS

for **CONDENSERS and CAPACITORS
BRACKETS OF ALL KINDS**

On time! Ready for the assembly bench!

Great Metal offers you the ideal source of supply for stampings and deep drawings, pierced and hot-tinned as required, in *any* quantity and *when* you need them.

When it comes to cans and brackets, we are bottleneck busters. You can bank on Great Metal to keep your production going.

We have the finest types of automatic equipment. We use electronic control of production and high frequency heat in soldering. We are tooled up for continuous service, now and in the postwar period. We have ample capacity *and experience* to meet your needs.

GREAT METAL PRODUCTS ARE NOW BEING SUPPLIED TO THE FOREMOST MANUFACTURERS IN THE RADIO-ELECTRONIC FIELD

For your next order, get in touch with
G R E A T M E T A L



as the leading electronic plants have done — to their complete satisfaction.

3 SALES OFFICES FOR YOUR CONVENIENCE

GREAT METAL MANUFACTURING CORP.

Main Office—Brooklyn 6, 9-15 Wyckoff Ave. EVergreen 7-8590
Manager—Irving Friedman

Sales Office—Chicago, 612 N. Michigan Ave. SUperior 0923
Manager—Russ Diethert

Sales Office—Pittsburgh, 5730 Melvin St. JACkson 2720
Manager—Harold Friedman

To Make Resistors

Madison Electrical Products Corp. has been formed for the manufacture of precision wire wound resistors, electrical and radio assemblies, coil windings and special components used in communication work. The factory will be located in Madison, N. J., prime mover behind the venture being John G. Ruckelshaus, who will be the company's vice-president and chief engineer. The plant will be under the supervision of A. L. Livera, formerly assistant chief engineer of the Hardwick-Hindle Co. Sales offices will be maintained at 318 East 45th Street, New York and at 323 North 13th Street, Philadelphia.

Makes Birtcher Clamps

George S. Thompson Co., 5240 Huntington Drive, Los Angeles, has been formed by George S. Thompson, formerly vice-president of the Birtcher Co., and will manufacture stainless steel tube lamps under license to use all Birtcher processes and patents. John J. Thompson is vice-president of the company and Arthur Bruce is secretary.

Illinois Condenser Expands

Illinois Condenser Co. has added another floor to its plant at 1160 North Howe Street, Chicago, increasing production by 300 per cent. At the same time Jerome K. Kurland has been added to the staff in the capacity of chemical engineer.

Industrial Designers

Ruth Gerth, George Kosmak, Alexander Kostellow, and Rowena Alexander have joined forces for the practice of industrial design and architecture, with offices at 228 E. 61st St., New York 21, N. Y. Telephone number is REgent 4-5359.

New Hytron Tubes

Three new tubes have been added to the miniature line produced by Hytron Corp., Salem, Mass. These are a 6AK5, sharp cut-off rf pentode; 6AL5, high frequency twin triode; and 6AQ6, double diode triode.

Service Plaque

The service men's plaque recently dedicated by The Brush Development Co., Cleveland, has a picture of each employe, in the order of his or her entrance into the various services. Under each picture is the employe's name, department, army or navy rank or rating, APO address and anything outstanding relative to service life.



WHAT'S THE DIFFERENCE?

Many a Purchasing Agent may have asked that question in deciding where to place his order for coil forms or for steatite insulators.

There may be little or no difference in electrical and mechanical characteristics of competitive insulators but there may be all the difference in the world in accuracy of manufacture.

General Ceramics by precision control provides close dimensional accuracy . . . removes all uncertainty of adherence to blue prints and specifications. Production checking includes an advance sample and a detailed sample report. After customer's acceptance, adherence to approved sample is guaranteed.

Quick delivery can be offered on special parts requiring machining, such as coil forms, stand-off insulators with or without metal inserts, strain insulators, and coil support bars.

Your inquiry regarding your insulation problems is invited.

General Ceramics
AND STEATITE CORP.
KEASBEY
NEW JERSEY

★ Star Performers!

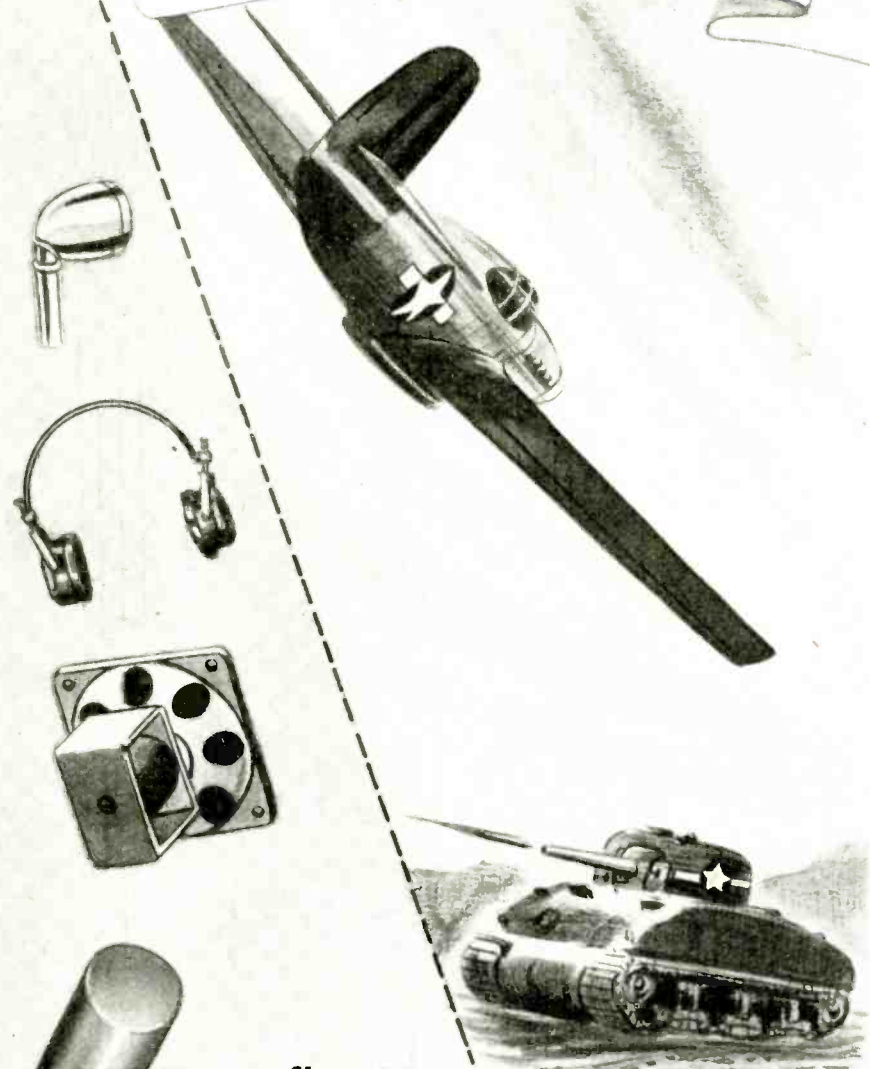

PermoFlux Means Progress!

When PermoFlux Engineers began developing wartime designs for acoustical communications equipment, old concepts of efficiency stood only as relative measures for improvement. PermoFlux contributions, by more than meeting anticipated requirements, have achieved new performance standards of far reaching importance. The value of these developments will be reflected in PermoFlux products of the future.

BUY WAR BONDS FOR VICTORY!

TRADE MARK
PERMOFLUX

PERMOFLUX CORPORATION
 4916-22 W. Grand Ave., Chicago 39, Ill.

PIONEER MANUFACTURERS OF PERMANENT MAGNET DYNAMIC TRANSDUCERS

PERSONNEL

Ott to National Union

Dr. Ellis R. Ott, mathematician and scientist, who recently resigned as associate professor of mathematics at the University of Buffalo, has joined the staff of National Union Radio Corp. research and development laboratories in Newark, N. J., as an executive engineer and assistant to the director of engineering.

WCEM Adds Six

Six new members have been added to the membership of the West Coast Electronic Manufacturers Association: Brittain Sound Equipment Co., Los Angeles; Merle F. Faber, San Francisco; Harvey Machine Co., Inc., Los Angeles; Howard Pacific Corp., Los Angeles; The Lake Mfg. Co., Oakland; Special Electric Laboratories, Los Angeles. The inclusion of these companies brings the total membership to more than fifty firms.

Cyrus T. Read, who has been an active radio amateur since before World War I, has joined the headquarters staff of the American Radio Relay League, as assistant to secretary K. B. Warner. He is dividing his time between this work and his permanent job with the Public Relations Department of Hallicrafters, Chicago.

Frank A. Bailey has joined the sales engineering staff of the Operadio Mfg. Co., St. Charles, Ill.

E. F. Lazar, manager of the Federal department of the Sperry Gyroscope Co., has been appointed manager of Special Electronics, a new department to handle the sales activities of electronic equipment for the ground forces of the Armed Services, electronic tubes, ultra high frequency measuring instruments, and equipment for the broadcasting and telecommunications fields.

R. J. Keogh, E. E., has joined the engineering staff of Webster Products, 3825 W. Armitage Ave., Chicago 47, Ill. For the last two and a half years he has been assigned to work with Colonial Radio Corp., Buffalo.

David M. Kelly has been added to the engineering staff of the John C. Dolph Co., Newark, N. J. He will have charge of the Industrial Service Division, was formerly connected with the ITE Circuit Breaker Co., Philadelphia.

OHMITE

Rheostats and Resistors

for Dependable Control of New Electronic Devices

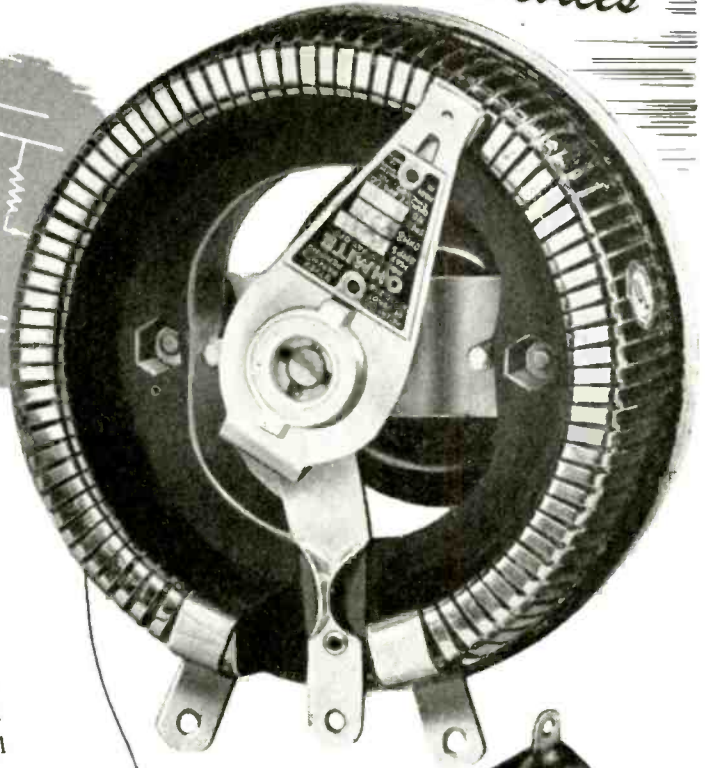
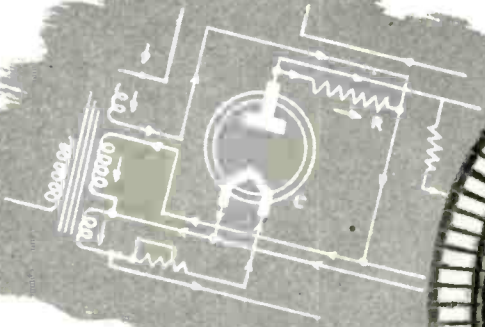

From experience . . . engineers, scientists and manufacturers have come to know and rely on Ohmite Resistors and Rheostats for fixed or variable resistance-control.

As electronic development advances, this assurance of reliability becomes increasingly important. As a result, you find Ohmite Units widely used not only in present-day war equipment, but also selected for use in the most advanced laboratory and industrial electronic devices designed to speed production, increase operating efficiency, improve product quality.

In resistance-control, Ohmite experience makes a difference.

OHMITE MANUFACTURING CO.
4984 FLOURNOY STREET • CHICAGO 44, ILLINOIS



Write on company letterhead for helpful 96-page guide in the Selection and Application of Rheostats, Resistors, Tap Switches.



Applications

A few of the advanced electronic devices using Ohmite units:

- Electron Microscope
- Industrial X-Ray
- Electronic Heater
- Photo-Electric Control
- Mass Spectrograph
- Electronic Voltage Regulator
- Electronic Motor Speed Control

Be Right with **OHMITE**
RHEOSTATS • RESISTORS • TAP SWITCHES

INDUCTORS



... BIG or LITTLE ...
STANDARD or SPECIAL

Here you see a large B&W low-frequency variometer-type inductor, tailor-made for a war equipment application, compared in size to the B&W 75-watt "Junior" of amateur radio fame. If a 25-watt "Baby" were put in the picture you'd hardly see it—and some of the new coils just coming off B&W production lines are many times smaller than that!

The point is that B&W offers inductors in the broadest assortment of shapes, sizes, and types on the market today. Whatever your requirement, write for recommendations and suggestions.

NOTE THESE ADVANTAGES OF B&W "AIR WOUND" CONSTRUCTION

- Weigh less
- Mount easier
- Less susceptible to damage
- Offer greater design adaptability
- Wound to uniform pitch
- Exceptionally low dielectric loss

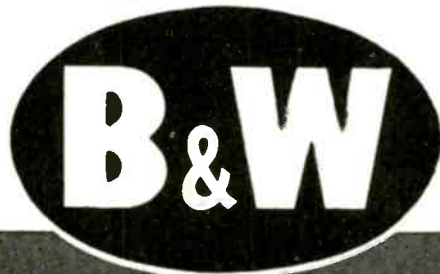

BARKER & WILLIAMSON
235 FAIRFIELD AVENUE UPPER DARBY, PA.

Export: LINDETEVES, INC., 10 Rockefeller Plaza, New York, N. Y., U. S. A.

Curtis A. Haines, formerly manager of the Mill Hall and Altoona, Pa., plants of Sylvania Electric Products, Inc., has been promoted to the position of general manufacturing manager of these plants and new plants at Huntington, W. Va., and Lexington, Ky.

McNamee Joins Littelfuse

Bernard F. McNamee has been appointed to head research work on electronic products and applications by Littelfuse Inc., Chicago and El Monte, Calif. Prior to joining Littelfuse, he was in charge of the engineering department of Consolidated Engineering Corp., Pasadena.

Sinko to Santay

Corporate style of the Sinko Tool & Mfg. Co., Chicago, has been changed to Santay Corp. There is no change in the business or personnel of the company.

Bierman Permoflux Chief Engineer

Raymond C. Bierman has been appointed chief engineer of the Permoflux Corp. of Chicago, manufacturers of high-fidelity acoustical equipment. Mr. Bierman (a graduate of Purdue, 1932), was for seven years associated with NBC Blue Network as studio field engineer, and was previously with WLW.

As chief engineer of Permoflux, his activities embrace the improvement of all forms of acoustic transducers, particularly those operating on the dynamic principle using permanent magnetic materials. An interesting feature of Mr. Bierman's work is the design of factory testing equipment assuring extreme uniformity of all Permoflux production units. Aside from his radio engineering management activities, Mr. Bierman's chief hobby is flying and he is an enthusiastic amateur pilot.



Raymond C. Bierman, who has been made chief engineer of Permoflux

DRIVE-IN THEATRE

INTERSECTION SUMTER AND FORT JACKSON HIGHWAYS
COLUMBIA, SOUTH CAROLINA

OFFICE OF MANAGER



We installed this Sola Constant Voltage Transformer because the Drive-In Theatre is out in the country, about five miles from town. The voltage is very irregular and it would be impossible to operate an amplifier without the unit.

J. H. Robinson

GREATER FIDELITY in sound projection is accomplished with built-in **CONSTANT VOLTAGE**

Because of the heavy demands for industrial power, stable voltages are practically non-existent on America's power lines.

These fluctuating voltages are noticeable in the operation of anything electrical. But where they affect the greatest part of the American public is in the operation of sound and communication equipment.

Even before Pearl Harbor the Drive-In Theatre of Columbia, South Carolina found it impossible to operate its amplifying system with the irregular voltages available from its power source. Only through the installation of a SOLA Constant

Voltage Transformer were they able to correct this situation and deliver an acceptable performance to their public. Many other theatres have followed this example.

The lessons learned before Pearl Harbor, and greatly amplified by the increased tempo of industrial production, will contribute towards the future enjoyment of entertainment and communication facilities.

But SOLA Constant Voltage Transformers are now at war and further improvements in theatre entertainment must wait until the guns are stilled. SOLA Constant Voltage Transformers are figuring prominently in

blue prints of the post-war world.

When victory is complete SOLA Constant Voltage Transformers will be available as a built-in part of motion picture and sound projection equipment, they will add to your enjoyment of FM and television, they will transmit your voice with greater clarity to distant parts of the globe, they will guide you safely through the air, and in hundreds of other ways contribute to the usefulness of all things electrical.

Custom-made units can be designed to exact specifications. Standard units are available in capacities from 10VA to 15KVA.

Constant Voltage Transformers

SOLA

To Manufacturers:

Built-in voltage control guarantees the voltage called for on your label. Consult our engineers on details of design specifications.

Ask for Bulletin 10CV-74

Transformers for: Constant Voltage • Cold Cathode Lighting • Mercury Lamps • Series Lighting • Fluorescent Lighting • X-Ray Equipment • Luminous Tube Signs
Oil Burner Ignition • Radio • Power • Controls • Signal Systems • Door Bells and Chimes • etc. SOLA ELECTRIC CO., 2525 Clybourn Ave., Chicago 14, Ill.

NEW BOOKS

Principles of Powder Metallurgy

By Franz Skaupy—Translated by Marion Lee Taylor, Ph.D. Published by the Philosophical Library Inc., New York, N. Y. 1944. 80 pages, clothbound, price \$3.00.

The translation of this monograph, on the important subject of bonding metal particles without fusion, calls attention to principles and technics that were used in Europe. While the date of the original manuscript is not stated, it may be presumed from the references (all of which appeared before 1930) that late practices are not included. However, the basic principles of powdered metal applications; the production, measurement and bonding of particles are well introduced and the properties and characteristics of objects so produced, may be of interest.

Industrial Electronic Control

By W. D. Cockrell, Industrial Engineer, General Electric Co., published by McGraw-Hill Book Co., Inc., New York and London, 1944. 247 + XII pages, 175 illustrations. Price \$2.50.

This book is an elementary guide to the study of electronic circuits, that are commonly in use for industrial regulation and control. It is written mainly for the service and maintenance worker and should do much toward dispelling the atmosphere of mystery that has surrounded such devices in many quarters.

The subject is handled by non-mathematical descriptions and operation of electron tubes, and the commonly used circuit components. This is followed by the basic principles of electronic circuits, and their application to industrial problems, including photoelectric circuits, speed control, relay applications and timing control and current regulation in welding process.

American War Standards

There has been prepared by T. H. Kemp, Acting Chairman, War Committee on Radio of the War Production Board, a bound compilation of the 21 American War Standards for electronic components, plus one additional proposed American War Standard. These have resulted from the standardization program initiated in the summer of 1942 by S. K. Wolf, then Assistant Director for

look ahead

and look to

Sperti

EVEN with the rapid advancement of science, spurred by war demands, we have seen only a glimpse of what lies beyond the uncharted horizons.

The contributions which Sperti has made in the field of electronics, irradiation and fluorescent lighting (as well as biodynes with all they imply in the field of medicine) are but a promise of significant *new* developments to come.

For beyond Sperti are laboratories devoted to pure research... staffed by scientists whose sole purpose is to unselfishly roll back the horizons of human knowledge for the betterment of mankind.

Sperti, Inc. exists to make their mature discoveries available in applicable form.

Even now, though Sperti is almost wholly engaged in war work, there may be a discovery which has a place in your postwar product planning.

It will pay you to keep Sperti in mind—as you turn *your* mind toward tomorrow.

Sperti

INCORPORATED

RESEARCH • DEVELOPMENT • MANUFACTURING • CINCINNATI, OHIO

Have you this kind of Faith in your instruments?

If you didn't have faith in your alarm clock you'd spend a restless night. As it is, you sleep soundly because you know that this clock won't fool you—at least not more than once.

But an electrical instrument is different. It doesn't reveal its faithlessness by ringing at the wrong time or by letting you oversleep. It may slowly begin to vary just a little from the truth, and this may not be discovered until great damage has been done.

The only way you can enjoy complete faith in your metering, measuring and testing equipment is to know how it is made. In the case of Boes instruments, we invite this kind of acquaintance. We want you to know how we engineer our instruments, how we earn your faith and confidence by building Boes instruments to meet incredibly stiff standards, how we provide for *sustained accuracy*.* We believe that an investi-

gation of our facilities, our products, and our methods will reward you with complete confidence in any Boes instrument that you may ever use.

* **SUSTAINED ACCURACY** is not an easy quality to achieve. It must take into account all factors of use—must then employ the design, the alloys, the construction that infallibly protect an instrument against all threats to its reliable performance. Such instruments, obviously, must be built with performance—not price—in mind. We invite the inquiries of those who are interested in such standards.



Boes instruments

for Measuring, Metering & Testing Equipment ☆ The W. W. Boes Co., Dayton, Ohio

CONFIDENCE

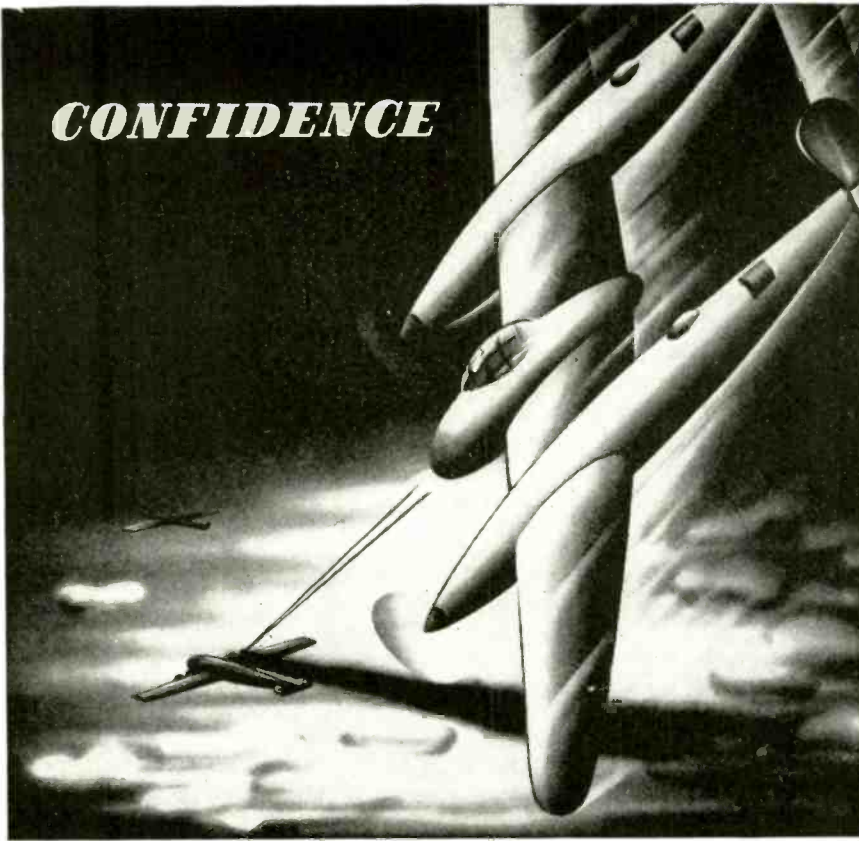

KOLD-HOLD . . . Co-Pilot

Performance builds the confidence of our fighting pilots in their ships . . . but, long before enemy objectives are sighted, PERFORMANCE is demanded in the testing of vital instruments and materials. . . KOLD-HOLD Sub-Zero equipment meets this challenge in assuring accuracy and dependability.

DO YOU

Have a Cold Processing Application:

Then you can use KOLD-HOLD'S Sub-Zero Industrial equipment. Machines from 2 to 400 cubic feet and -100° F. to $+200^{\circ}$ F. temperature range.

DO YOU

Require Temperature Testing Units with pressure and humidity control:

KOLD-HOLD Stratosphere and "Hi-Low" Machines will do a specific job for you, accurately, thoroughly, rapidly and economically.

DO YOU

Know that Cold Temperature Processing Is Vital to Modern Production Methods:

Hundreds of important War Production plants using KOLD-HOLD low and dual temperature machines daily demonstrate that cold processing is one of the foremost time savers of modern manufacturing.

● KOLD-HOLD units are productioneered* to YOUR specific problem. . . Catalog S-Z 431 illustrates many types of machines available now. Write for your copy today.

KOLD-HOLD

MANUFACTURING COMPANY

**Engineered for Production*

454 NORTH GRAND AVENUE

LANSING 4, MICHIGAN

NEW BOOKS

(Continued from page 152)

Production, Radio and Radar Division, War Production Board. These standards represent the completion of the program as far as the Radio and Radar and Conservation Divisions are concerned.

These standards were developed with the participation of the Armed Forces and of industry. It is believed that they combine the points of view of these two groups in such a manner as to satisfy the extremely critical requirements of the Armed Forces in all theaters of war, but are still not beyond the capabilities of industry to produce on a large scale. Therefore, it is believed that they will constitute a sound basis for standardization in this war and a nucleus for further development of this work after the war.

Additional standards

The Army-Navy Electronics Standards Agency is reprocessing most of these standards as Joint Army-Navy Specifications. In its program, the Army-Navy Electronics Standards Agency will continue to develop additional standards for such radio and radar components as may be required by the Armed Forces.

CORWICO

WIRES

MADE BY
Engineers FOR
Engineers

VICTORY
concentrating upon
for the duration . . .

cornish
WIRE COMPANY, INC.
15 Park Row, New York City, New York.

CORWICO

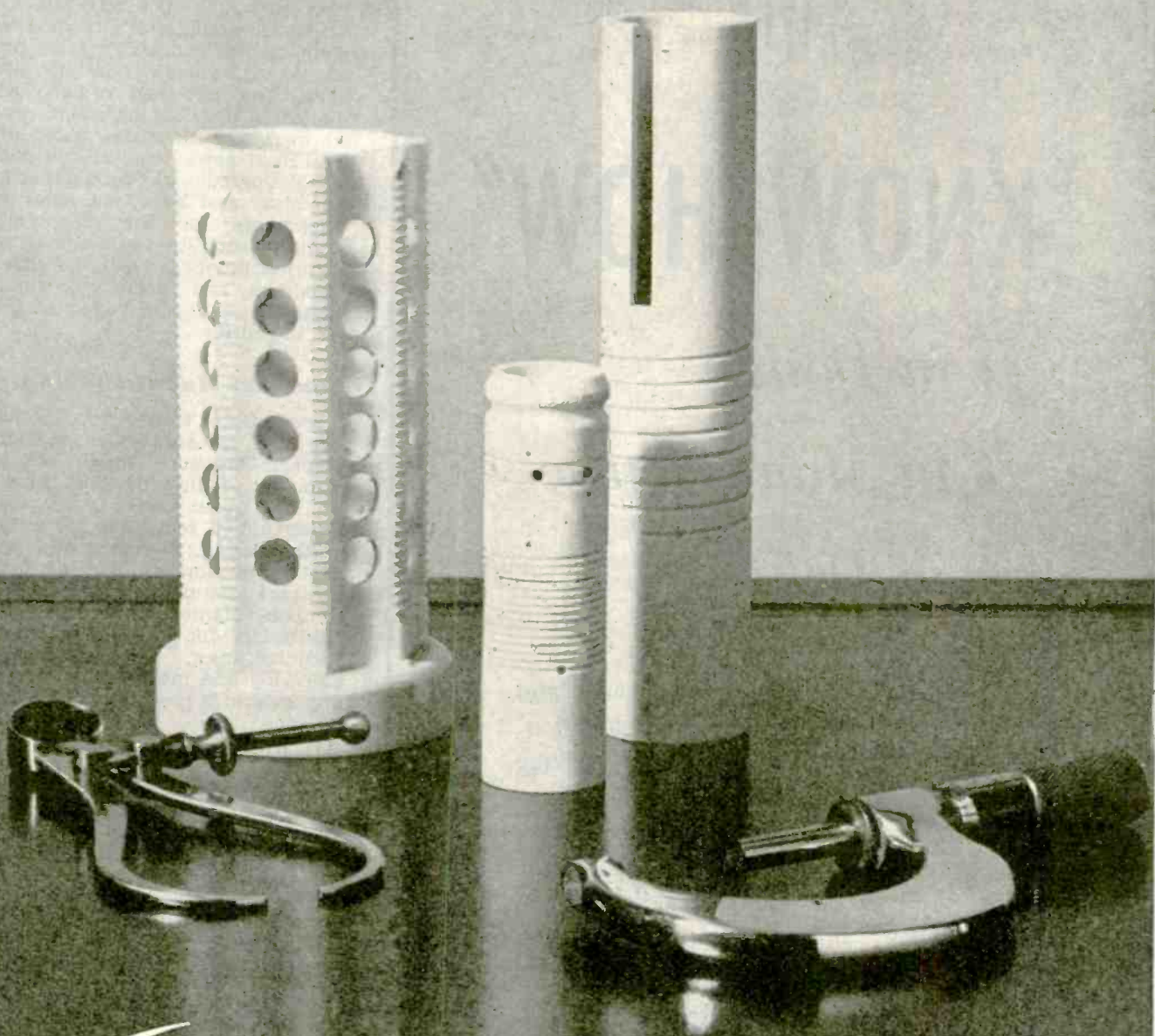

Fine ceramics by

Centralab



Division of GLOBE-UNION INC., Milwaukee



"KNOW-HOW"

- *in Design*
- *in Manufacture*
- *in Delivery*

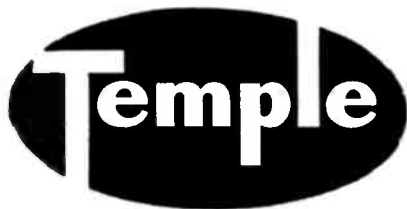
PRACTICAL experience sharpened and broadened by the exacting test of war. Such is the story of Templetone's amazing progress and growth in the field of electronics. From the designing stage, through every phase of manufacture to "on the dot" deliveries, Templetone's proven "know-how" in serving Uncle Sam pre-sages even greater Templetone progress in the peacetime era to come.



Electronics Division

**TEMPLETONE
RADIO COMPANY**
Mystic, Conn.

NEW BULLETINS

Operadio Bulletin

The Operadio Bulletin, newsletter published by the Operadio Mfg. Co., St. Charles, Ill., is a new development in the company's sales promotion and public relations program. The first issue recently was mailed to distributors, sound service men, and industrial music outlets. Brief news items inform dealers of Operadio war production for the Army and Navy, and sales developments for the commercial sound division are also emphasized. Pictures, proofs of Operadio advertisements, and reprints of timely magazine and newspaper articles are included.

Contract Manufacturing

Lewyt Corp., 60 Broadway, Brooklyn, N. Y., has issued a board bound 48-page brochure which tells a whole lot of the great deal there is to tell about this organization which for 50 years has specialized in the design, re-design and production of almost anything on a contract manufacturing basis. The company maintains a complete organization for the procurement, manufacturing, development engineering and marketing of almost any kind of a product.

All-Purpose Insulation

Mykroy, which is a compound of mica and glass brought together in powdered form under pressure to form an all-purpose insulator, is covered in great detail in a 24-page catalog just issued by Electronic Mechanics, Inc., 70 Clifton Boulevard, Clifton, N. J. The booklet describes many ways in which the product is used and can be used, outlines possible machining operations, catalogs standard sizes and shapes and includes engineering data on characteristics of the product.

Self-tapping Screws

Much useful engineering and production data about the application of self-tapping screws is given in a new Users' Guide, offered by Parker-Kalon Corp., 204 Varick St., New York 14, N. Y.

The eighteen pages are file size, tab-indexed, spiral bound, and arranged with a strong wall hanger. The guide includes a selector chart which tells at a glance which of nine types of self-tapping screws to use in various materials. Tables give recommended hole sizes, stock sizes and data on use of each type under different conditions. Application information covers use of self-

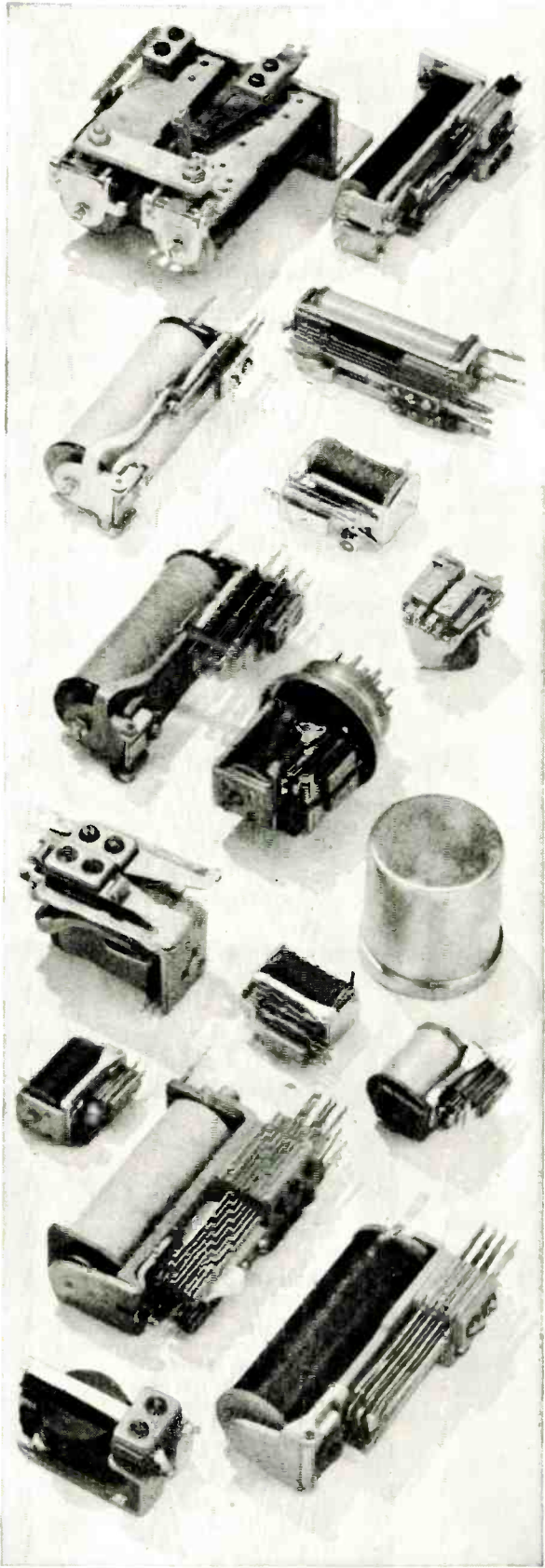

TO SELECT THE
Right Relay
TAKE THESE TWO STEPS

The *right* relay, of course, is the one which will exactly fit your needs, and give you the longest, most dependable service at lowest cost. Here's how you can get it:

1. Write for the Automatic Electric catalog. It lists over forty basic types of relays, providing every combination needed for modern electrical control. All technical facts are clearly tabulated for your guidance.

2. If you want help in applying this information to your problem, call in our field engineer. He will be glad to put his experience to work for you.

Send today for your copy of the catalog—or simply ask our field engineer to bring one over.



Relays
AND OTHER CONTROL DEVICES
by **AUTOMATIC ELECTRIC**

AUTOMATIC ELECTRIC SALES CORPORATION
1033 West Van Buren St., Chicago 7, Ill.

In Canada:
Automatic Electric (Canada) Limited, Toronto



*If you need
plenty of Nothing*

KINNEY PUMPS

VACUUM

KINNEY Compound Dry Vacuum Pumps do a hand-painted job in creating and maintaining low absolute pressures down to half a micron (0.0000097 lbs. per sq. in. absolute)! This reliable performance speeds production and reduces the percentage of rejections in the manufacture of lamps, tubes and other electronic products. Where the pump is working on a new lamp or tube every few seconds, the high recovery speed and exceptional ultimate vacuum produced make **KINNEY** Pumps the choice of leading tube manufacturers.

Thoroughly tested in years of service, **KINNEY** Compound Dry Vacuum Pumps produce extremely low pressures year after year.

For the next higher range of absolute pressures, **KINNEY** Single Stage Vacuum Pumps are available in 8 sizes, designed to work at absolute pressures down to 10 microns.

Write for Bulletin 18

We also manufacture Vacuum Tight Valves, Liquid Pumps, Clutches and Bituminous Distributors

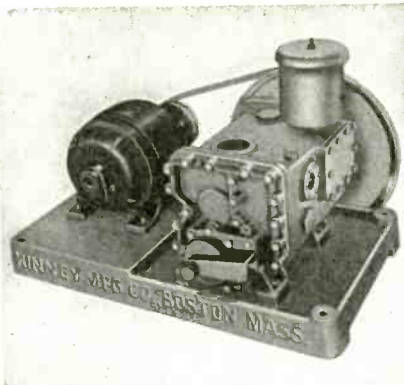

KINNEY MANUFACTURING CO.
3595 WASHINGTON ST., BOSTON 30, MASS.

NEW YORK CHICAGO PHILADELPHIA LOS ANGELES SAN FRANCISCO

NEW BULLETINS

tapping screws in sheet metal, steel, castings, plastics, plywood, asbestos and other compositions. Also shown are special heads and special forms of P-K screws which can be made for specific needs.

Selenium Rectifiers

A new type of selenium rectifier with dual sealed-in electrodes is the subject of a catalog sheet just issued by Selenium Corp. of America, Los Angeles, Calif. Construction provides shock and vibration proof qualities as well as protection against moisture and an increased field of applications. It is interchangeable with conventional selenium rectifiers.

Formica Facts

Most persons know what Formica is—a laminated product of synthetic resins and paper or fabric which has been cured into a hard compact material by heat and pressure—but not so many may be familiar with the great variety in which the product is supplied, the various finishes and colors available and the manifold uses to which Formica is put in the electrical and other industries. To clear up some

KIRKLAND Pioneer INDICATING LAMPS

New

D/E DOME TYPE LENS-CAP WITH HEAVILY WALLED, DEEPLY CUPPED GLASS LENS. SO OUTSTANDING THAT A COMPLETE LINE OF PILOT-LIGHTS HAS BEEN EQUIPPED WITH IT.

For Use With the Most Readily Obtainable Lamp Bulbs

Type No. 590 D/E Unit for use with the S6 candelabra screw base lamp on voltages up to 120 volts.



The No. 590 D/E Unit, List Price, (less lamp) \$1.25.

Specifications: Mounting hole, $\frac{3}{8}$ " diameter; overall depth behind the front of the panel 2"; length of threaded area $1\frac{1}{16}$ ". Underwriters' Approved.

Distributed Nationally By
GRAYBAR ELECTRIC CO.

Write for
Catalogue

THE H. R. KIRKLAND CO.
MORRISTOWN, N. J.

WELDRAWN

THE SUPERIOR WELDED-AND-DRAWN METAL TUBING FROM 5/8" OD DOWN

WELDRAWN is the trademarked Superior Tube Company welded tubing which combines essentially all of the physical and metallurgical qualities of seamless . . . smooth bright finish, homogenous structure, close tolerances, high tensile strength—with economy. **WELDRAWN** has a firm preferred place in industry . . . the result of wide usage and highly satisfactory performance.

Produced in Stainless Steels (various analyses), and "Monel."

WELDRAWN Stainless meets U. S. Government Specification AN-T-43—a typical example of the standard of performance which you may expect when you specify Superior **WELDRAWN** for a wide variety of small tubing applications.



SUPERIOR

SUPERIOR TUBE COMPANY, NORRISTOWN, PENNSYLVANIA



THE BIG NAME IN
SMALL TUBING

FOR EVERY SMALL TUBING APPLICATION FROM 5/8" OD DOWN

SUPERIOR  Seamless in various analyses. WELDRAWN  Welded and drawn Stainless, "Monel" and "Inconel"

SEAMLESS and Patented LOCKSEAM Cathode Sleeves

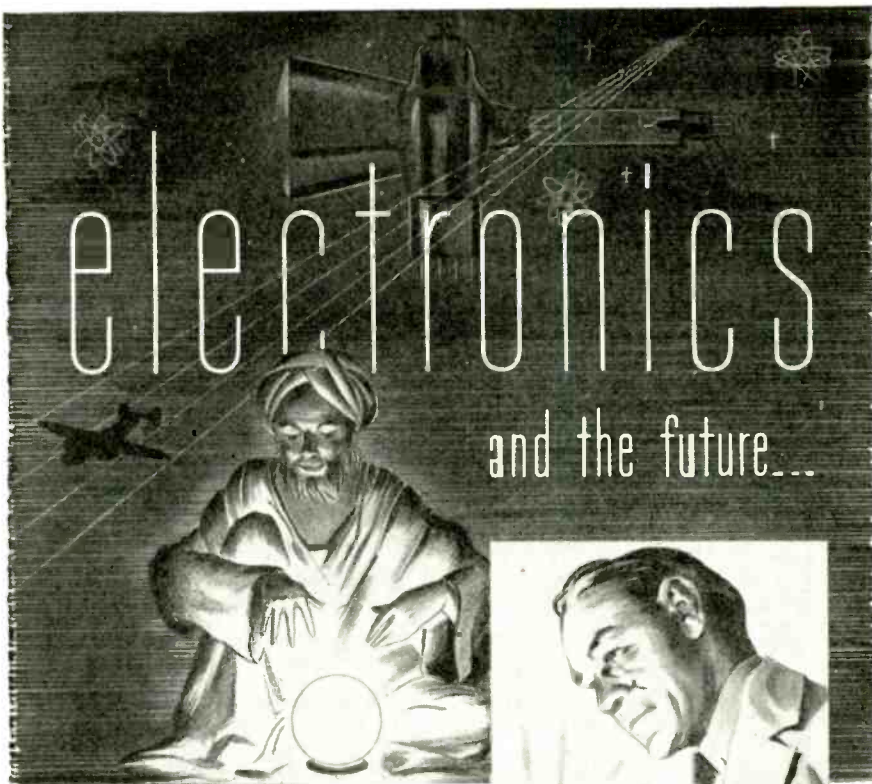

★ No need to crystal gaze into the future of electronics. For, as we at National Scientific Products Company engage in secret wartime electronic developments, many peacetime applications of these very same electronic principles are revealed daily.



New, cost-saving electronic designs which are applicable to post-war products ranging from radios, lighting units, thermal devices, timing and measuring instruments, electrical-therapy machines and door openers, to a host of other peacetime items, are everyday occurrences in National laboratories.

If your post-war product incorporates a tube, singly or in combination with an electrical control, or other electronic or electrical unit, we are prepared to make specific recommendations to bring it to maximum efficiency.

Write today. Your inquiry will receive prompt attention.

Electrical and Mechanical Engineering

NATIONAL SCIENTIFIC PRODUCTS COMPANY

Designers and Manufacturers of Electrical and Mechanical Devices

5011-25 NORTH KEDZIE AVE., CHICAGO 25, ILLINOIS

NEW BULLETINS

of that mystery the Formica Insulation Co., Cincinnati, O., has issued a vest-pocket booklet of 32 pages that covers the making and uses of the product and contains much information on machining, punching, sawing, drilling, tapping, threading and turning and milling.

Twenty GI Years

Tracing "20 Years of Progress," General Instrument Corp., Elizabeth, N. J., has issued an elaborate 16-page booklet lithographed in four colors, plastic bound, that invites readers to be a GI guest at the first Worlds' Series after the war. Aside from that the booklet rather attractively ties together the country's history with the company's—and hints at what GI may be doing after the war.

Small Coax Line

Specifications, a description and engineering data on three-eighths inch diameter coaxial transmission line are included in a new two-page folder just issued by the Andrew Co., 363 East 75th Street, Chicago. The folder also illustrates and describes a number of transmission line accessories, such as terminals, seals, connectors, junction boxes, etc.

Cannon Wall Chart

A new wall chart (38 x 50) to match other Cannon type AN charts has been issued by Cannon Electrical Development Co., Los Angeles. The chart contains in condensed form practically all needed information on type K connectors. A total of 189 full scale insert arrangements are shown together with information on how to identify and select a K connector for a particular use.

Radio Components

Audio Development Co., 2833 Thirteenth Ave., South, Minneapolis, Minn., has issued a new catalog covering the company's complete line of transformers, reactors, filters, equalizers, key switches, jacks, plugs and other components.

Technical Ceramics

Alsimag technical ceramics are being so widely used that a new 34-page booklet descriptive of their production and uses likely will interest engineers. The booklet describes extrusion, pressing, casting, surface treatment and precision grinding operations. In addition

KEN-RAD

Metal Tubes.



The superiority of Ken-Rad "self-shielding" metal tubes is best exemplified by 10 years' successful manufacture of over sixty million. Today millions more are demanded by the military. This experience and capacity becomes available for civilian requirements postwar.

• Write for your copy of "Essential Characteristics" the most complete digest of tube information available

KEN-RAD

EXECUTIVE OFFICES

OWENSBORO · KENTUCKY

EXPORTS 18 MOORE STREET NEW YORK

TRANSMITTING TUBES
CATHODE RAY TUBES
SPECIAL PURPOSE TUBES
RECEIVING TUBES
INCANDESCENT LAMPS
FLUORESCENT LAMPS

★ Now Available up to 10 MFD-600 V.D.C.

An Oil Type Capacitor For
Single Hole Mounting!

Saves Space
No Brackets
Needed

Oil Type EC CAPACITRONS

Already, many prominent manufacturers are stepping up production with these sturdy round style Capacitrons for single hole bracketless mounting. Available up to 10 MFD. at 600 V.D.C. and in a wide range of other standard capacities in voltages to 1500, these units offer unlimited possibilities for current and post war designs. Send for bulletins listing Type EC and other standard Capacitrons for immediate delivery.

Telephone: MICHigan 9656



The CAPACITRON Company

318 West Schiller St., Chicago 10, Illinois

NEW BULLETINS

there are illustrations, specifications and technical data on various types of bushings, lead-ins, insulators, stand-offs, line spreaders, strain insulators and couplings. Publisher is American Lava Corp. Chattanooga, Tenn.

Standard Transformers

A new bulletin describes the complete range of transformers made by Standard Transformer Co., Warren, O., to meet the smallest to the largest electric power requirements of the following types: Power, distribution, rural, street lighting, instrument, air cooled.

Precision Meters

Technical information on nearly a score of panel-type indicating meters is included in a folder produced by O. B. McClintock Co., Minneapolis. Included are round and square models for use on electrical test equipment, etc.

Adjustable Speed Motor Drives

A four-page, two-color technical bulletin No. WTM-44 has been issued by Weltronic Co., Detroit 19, Mich. It describes their new electronic, adjustable speed motor drives which operate any dc shunt-wound 1/2 hp to 15 hp motors from

110-VOLTS A.C. from DIRECT CURRENT

with Katolight Rotary Converters for operating radio and electronic equipment, moving picture projectors, sound apparatus, A.C. appliances, etc.

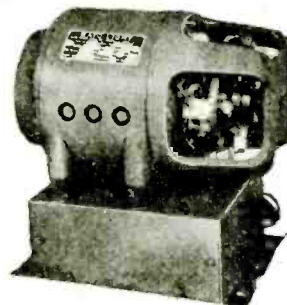

225 WATT CONVERTER

Available in sizes 110 through 2500 watts, 1800 and 3600 r.p.m. ball bearing designs. Furnish standard 110-volt, 60-cycle, A.C. from 32, 110 or 220-volts direct current. Quiet in operation. Can be furnished with special filtering equipment for sensitive radio work.

PIONEERS IN THE BUILDING OF SMALL ROTARY CONVERTERS

At present Kato's entire production must be directed to furnishing converters on high priority orders. Write us if you need this kind of equipment for orders.

Also manufacturers of A.C. and D.C. generators ranging from 350 watts through 25 K.W.; power plants; frequency changers; high frequency generators; and motor-generator sets.

KATO ENGINEERING CO.
151 SPRING ST. MANKATO, MINN.

Expanded Facilities Now Permit FASTER SERVICE TO OUR CUSTOMERS and Prospective Users of Our Products

HANDWHEEL CONTROLS with or without Pointers and Scales

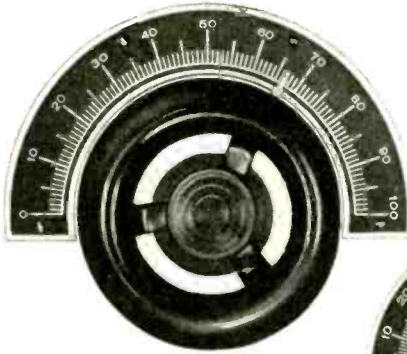

Jumbo Size Wheel
3 1/4" dia.



Large Size Wheel
2 1/4" dia.



Medium Size Wheel
1 5/8" dia.



Small Size Wheel
1 1/8" dia.

• Four sizes to cover all requirements. Made of thermo setting plastic with brass bushings for 1/4", 5/16" or 3/8" shafts. Chromium plated scales and pointers are available for each size. Scales, either standard or to your specifications, are not listed below.

No.	Diameter	Pointer	No.	Diameter	Pointer
308	3 1/4"	yes	312	1 5/8"	yes
309	3 1/4"	no	313	1 5/8"	no
310	2 1/4"	yes	314	1 5/8"	yes
311	2 1/4"	no	315	1 5/8"	no

VERNIER PLANETARY TUNING UNIT No. 599



• Dual ratio approximately 6 to 1 vernier and 1-1 direct drive. Positively no lost motion or backlash which is most essential in many applications. Widely used in radio tuning controls, as well as in industrial apparatus. End slotted for screwdriver adjustment.

HEAVY DUTY RF OR POWER RELAY No. 1000

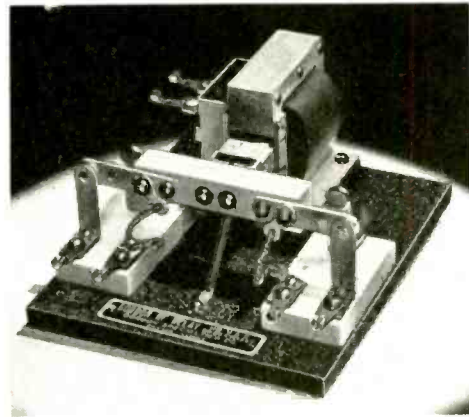

• A heavy duty D.P.D.T. relay providing many desirable electrical and mechanical characteristics. Alsimag 196 insulation which, because of its extremely low power factor of .04, shows negligible losses even at frequencies up to 300 mc.

When the control circuit is closed, a solenoid actuated plunger goes home instantly—powerfully holding the husky 3/8" silver, self-wiping contacts together with a 4 lb. pull! Contacts are spaced approximately 1/2" apart—generous leeway for high potentials—infinitesimal capacity effects. Absolutely no contact chatter or bounce. For 90-125 V 50-60 cycle AC. Size 4 3/4" x 5 9/16" x 3".



RUBBER GROMMETS High Dielectric Strength

Insulate holes in metal sheets up to 1/16" or 14 ga.

No.	Fit Chassis Hole	Inside Dia.	No.	Fit Chassis Hole	Inside Dia.
901	1/4"	1/8"	907	7/16"	5/16"
903	5/16"	3/16"	909	11/32"	11/32"
905	3/8"	9/32"	911	1/2"	13/32"

RUBBER BUMPER FEET



No.	Diameter	Height	No.	Diameter	Height
111	17/32"	1/4"	112	5/8"	3/8"
511	5/8"	5/16"	113	23/32"	7/16"

For 6/32 or 8/32 machine screws or No.6 or No.8 wood screws.

Mention your preference ratings and quantities desired.
Prices and delivery date will be quoted by return mail.

GORDON SPECIALTIES COMPANY

823 South Wabash Avenue, Chicago, Ill.

**FAST
DELIVERIES**

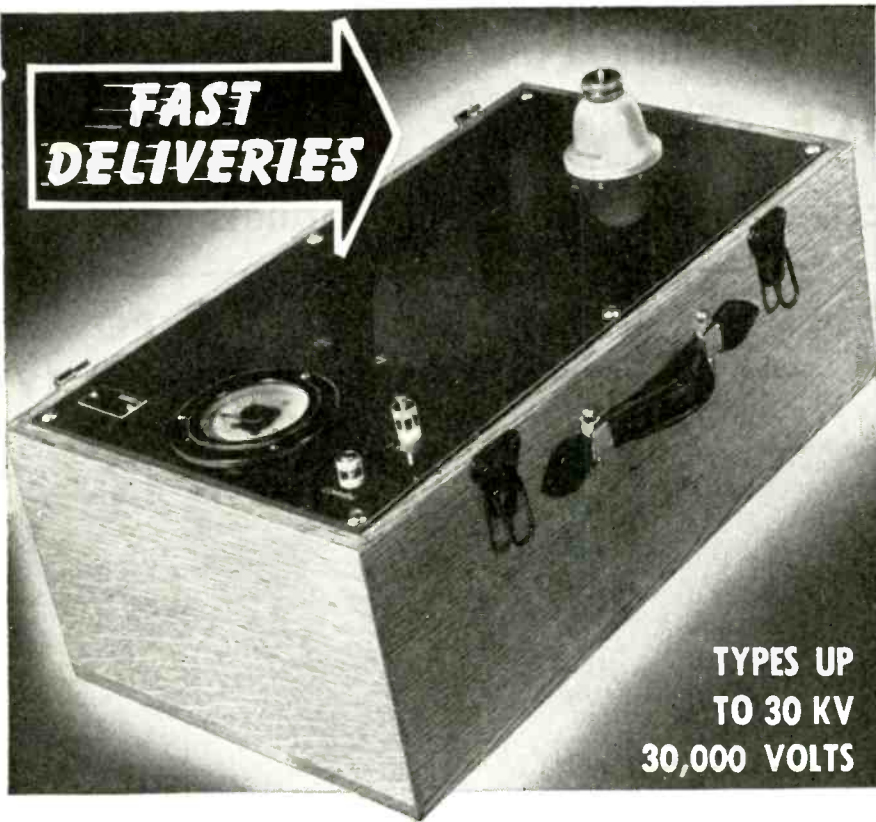

**TYPES UP
TO 30 KV
30,000 VOLTS**

Shallcross Portable KILOVOLTMETERS

Other Shallcross High-Voltage Equipment

- Kilovoltmeter Multipliers
- Corona-protected High-Voltage Resistors
- Special Apparatus for Any High-Voltage Measuring Requirement
- Write For Details

Now available for rapid delivery, Shallcross Kilovoltmeters are produced in a complete line for the measurement of the high potentials encountered in radio transmitters, radar, television equipment, X-ray systems, dust precipitators, and similar high-voltage equipment. Ruggedly constructed, yet light in weight, the instruments are suitable for either laboratory or field work, and are entirely safe in operation. Full scale accuracy on a typical 1,000 ohms-per-volt Shallcross D. C. Kilovoltmeter is $\pm 2\%$. The accurate fixed wire wound resistors are closely calibrated and properly aged. Corona protected resistors can be supplied for measurements up to 200 KV.

In addition to its standard line, Shallcross likewise produces regularly a wide variety of "tailor-made" Kilovoltmeters and high voltage Meter Multipliers to match individual requirements. Write for details or engineering recommendations.

SHALLCROSS MFG. CO.

DEPT. EI-84, COLLINGDALE, PA.

ENGINEERING • DESIGNING • MANUFACTURING

ac power supply for driving such machines as lathes, grinders, drill presses, conveyors, winches, printing presses, etc. Included are a detailed description and a schematic diagram showing the operation of this motor control, curves illustrating the Weltronic "Full Wave" armature current control which minimizes motor heating, and complete specifications of the line of motor controls.

NEW PATENTS ISSUED

Oscillator-Reactance Tube

Tube 8 operates as oscillator and simultaneously as reactance tube. Regenerative feed-back to oscillator grid 10 is provided by transformer 6, while modulated quadrature-feed-back is supplied to reactance grid 24 by transformer 14,22 and 16,22. Parallel coils 14,16 are wound on saturable iron cores 18,20, and coupled to the third coil 22 with opposite polarity so that no voltage is induced in the coil 22 when the currents in coils 14 and 16 are equal. For unequal currents, however, a voltage 90°

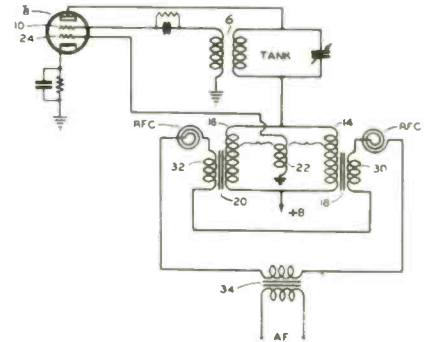

out of phase with the plate current will be induced in coil 22, and the magnitude of this induced voltage will depend on the modulating current through coils 30 and 32 which controls the saturation of the iron cores 18 and 20. W. van B. Roberts, RCA, (F) April 21, 1942, (I) April 11, 1944, No. 2,346,331.

Suppressor Grid Rectification

Suppressor grid 20 and cathode 12 of a pentode are used as a detector or rectifier. Output from plate 14 is applied to the suppressor grid and rectified by the cathode-suppressor grid combination acting as a diode. The resulting dc potential developed across resistor R_1 is fed back to the control grid through resistor R_2 to be amplified or to regulate the gain or other characteristics of the tube. In the embodiment shown, which measures the input amplitude, the increased negative potential on the input grid causes reduction in the space current which is measured by meter M. The principle finds use in the stabilization of oscillator outputs, or of negative feedback amplifiers.

(Continued on page 166)

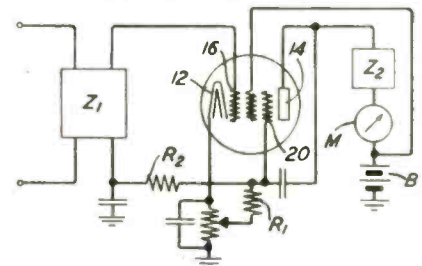

Quaint may be the word we'll have for the fantasies of Buck Rogers, Flash Gordon and Jules Verne . . . before long, too. For the pace at which this war fosters electronic invention and development foreshadows future realities to beat the wildest fiction.



I've hooked one, Mary! Put the potatoes on now!

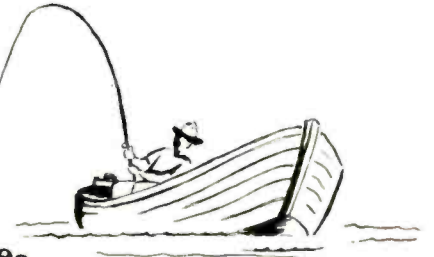

Before Pearl Harbor, we were America's oldest and largest manufacturers of portable phonographs—the famous Phonola line. Now, we build electronic communications apparatus for our armed services. Helping to meet the war's relentless need for electronic progress has equipped us to do new marvels. And we're eager to get on with wonderful ideas for civilian use. As soon as the call of the bugle is hushed, look for a still finer Phonola *and* its new companion line of Waters Conley electronic products to enrich the blessings of peace.

Phonola

WATERS CONLEY COMPANY, Rochester, Minn.
 17 East 42nd St., New York 224 S. Michigan Ave., Chicago
 VAnDerbilt 6-2079 HARrison 1880

Waters
 Conley

COMPANY

Moisture Proof OCTAL-TYPE BASE

Despite contraction and expansion caused by heat and cold, HOWARD'S Octal Type Base "seals out" all moisture and dirt by means of a gasket seated on a sealing ring. Designed for use in radio tubes, electrolytic condensers, and practically all types of plug-in equipment.

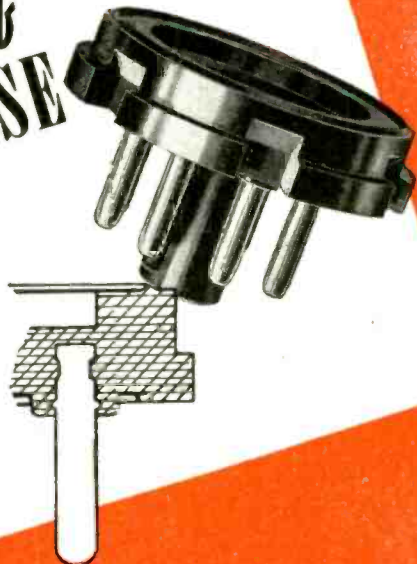

MOLDED-IN PINS

Because HOWARD Molds-in the pins there is a complete seal around the pins preventing the entrance of any moisture or dirt. HOWARD Octal type base is made in black or natural Bakelite. Write HOWARD today for prices.

★ BUY WAR BONDS ★

HOWARD MANUFACTURING CORP.

COUNCIL BLUFFS, IOWA

NEW PATENTS

F. B. Anderson, Bell Telephone Laboratories, (F) September 12, 1942, (I) April 11, 1944, No. 2,346,545.

Phase Modulator

In conventional phase modulators, the phase shift is not proportional to the modulating amplitude, the same increase in modulating voltage producing a comparatively small phase shift at large signal amplitudes. According to the invention, the amplitude of the 90-deg.-shifted-carrier wave, amplified by tube 12, is amplitude-modulated so as to make the phase shift in the output circuit 39 linearly phase modulated. For this purpose, amplification factor of tube 12 is reduced in response to an increase in modulating potential of either polarity by impressing suitable negative bias on suppressor grid 77. This negative

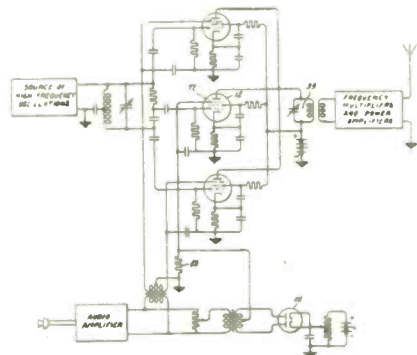

bias is derived from the audio amplifier, rectified by tube 116 having a load resistor 83 arranged to impress a negative bias on suppressor grid 77 during either half cycle of modulating potential. G. M. Brown, General Electric Co., (F) April 23, 1942, (I) April 25, 1944, No. 2,347,458.

(Continued on page 168)

Communication

U. S. A. Signal Corps

EQUIPMENT and COMPONENTS

PROMPT DELIVERY

Complete units or any component parts now available on the following:

NOW IN PRODUCTION

- CD-318-A JK-48 PL-68
- CD-307-A PL-47 "A" Plug
- CD-874 PL-54 BC-366
- JK-26 PL-55 BC-347-C
- PE-86 PL-58 SW-141
- JB-47 TD-3



TRAVLER KARENOLA

RADIO AND TELEVISION CORPORATION
1030 W. VAN BUREN ST., CHICAGO 7, ILL.

PRECISION RADIO AND COMMUNICATION EQUIPMENT

For Tomorrow's
Broadcasting—

LOOK TO ★ LINGO

For advanced design and superior performance in

VERTICAL TUBULAR
STEEL RADIATORS

PATENTED FM
TURNSTILE RADIATORS

We're "all out" for Victory, but our engineers are ready to work with you on post-war plans.

JOHN E. LINGO & SON, Inc.
CAMDEN, NEW JERSEY

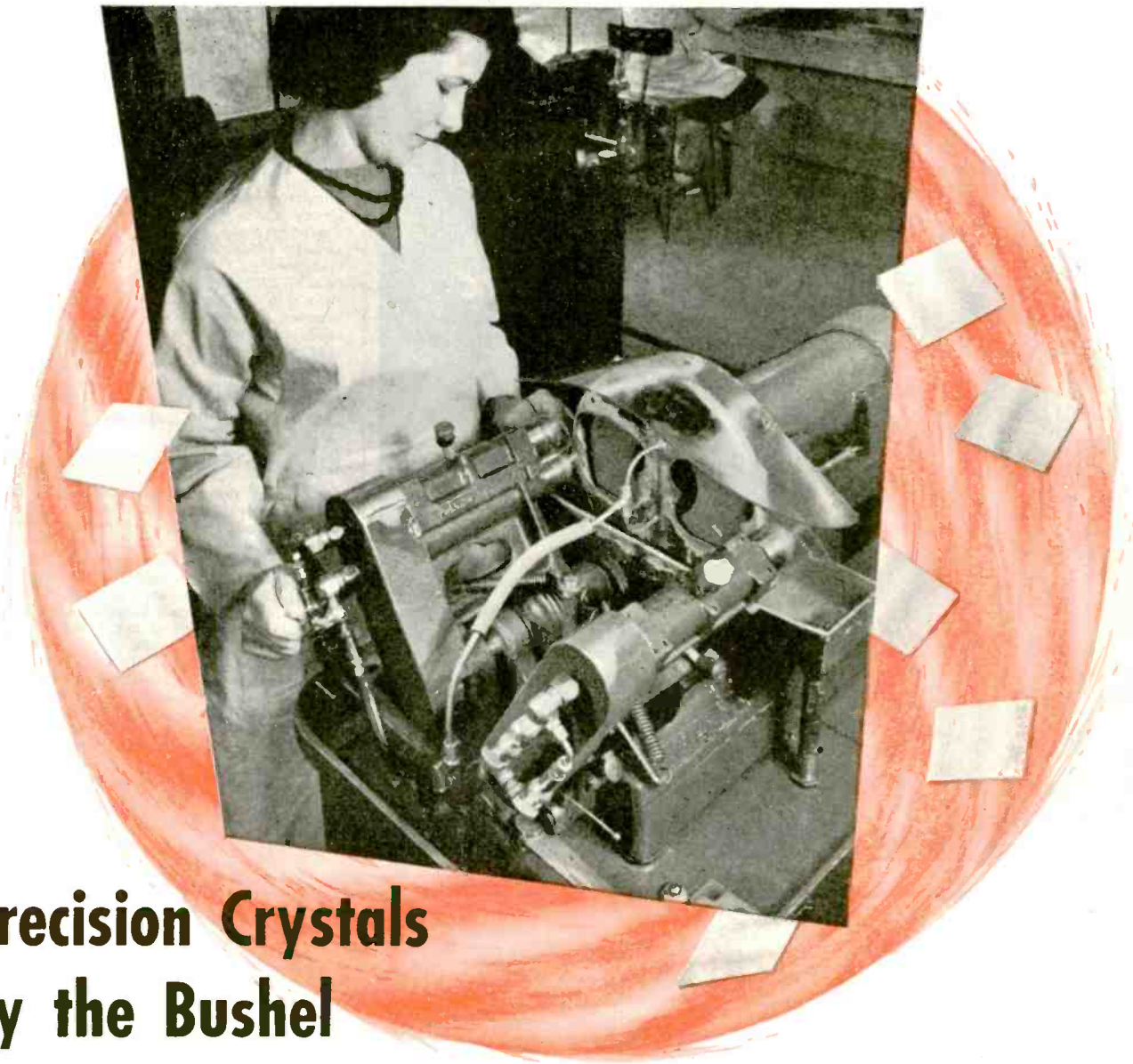

Precision Crystals by the Bushel

To meet the wartime demand for the mass production of quartz crystals having highly precise electrical characteristics, our engineers designed this special high-speed automatic lapping machine, known as the *Q-Lap*. Results: Fast rough grinding of single crystals up to $\frac{1}{4}$ " thick; parallel grinding of blanks with respect to reference surface to within .0002"; rapid grinding of special angle blanks to within 2 minutes of arc; excellent surface despite rapid grinding.

The *Q-Lap* and the X-ray Quartz Crystal Analysis Apparatus, both developments of North American Philips, are described in the booklet "How Quartz Crystals Are Manufactured." Write for it today.

Behind the North American Philips Company is a team of outstanding electronic engineers, headed by one of America's leading physicists, and coached by a group with world-wide experience resulting from fifty years of research and development. Today, we work for Victory; tomorrow, our aim will be to serve industry.

NORELCO PRODUCTS: Quartz Oscillator Plates; Amplifier, Transmitting, Rectifier and Cathode Ray Tubes; Searchray (X-ray) Apparatus, X-ray Diffraction Apparatus; Medical X-ray Equipment, Tubes and Accessories; Electronic Measuring Instruments; Direct Reading Frequency Meters; High Frequency Heating Equipment; Tungsten and Molybdenum products; Fine Wire; Diamond Dies. *When in New York, be sure to visit our Industrial Electronics Showroom.*

Send today for this
FREE booklet!



Norelco ELECTRONIC PRODUCTS by
Reg. U. S. Pat. Off.
NORTH AMERICAN PHILIPS COMPANY, INC.

Executive Offices: 100 East 42nd Street, New York 17, N. Y.
Factories in Dobbs Ferry, N. Y.; Mount Vernon, N. Y.
(Metalix Division); Lewiston, Maine (Elmet Division)

North American Philips Co., Inc.
100 East 42nd Street, New York 17, N. Y.

Gentlemen:

Kindly mail a free copy of the booklet, "How Quartz Crystals Are Manufactured" to:

Name _____
Title _____
Company _____
Address _____

PLASTIC PARTS

Large or small quantities. Produced to your specifications. Precision machining, stamping and forming all plastics. No molds required. Send your blueprint, or write for bulletin.

PRINTLOID, Inc.

93 Mercer Street

New York 12, N. Y.



NEW PATENTS

(Continued from page 166)

Phase Modulator

It is intended to reduce the intensity of the 90 deg. phase shifted wave in a phase modulator with increasing modulation signal intensity of either polarity as explained in Patent No. 2,347,458. (See preceding summary.) According to the present invention, however, the regulating voltage applied to the suppressor grid 77 is derived from the voltage across output circuit 39; this voltage increases with increasing modulating potential. With the embodiment described and shown in the patent, the linear relationship between phase shift of the carrier wave and modulating signal intensity is so improved that substantially perfect linearity obtains, even though the carrier wave be shifted as much as 60 deg. in either direction. W. F. Goetter, General Electric Co., (F) May 28, 1942, (I) April 25, 1944, No. 2,347,459.

Electron Lens

At least one of the electrodes 31,32,33 of the electron lens is embedded in a dielectric medium 28 of greater dielectric strength than the dielectric 29 through which the electrons pass. All electrodes and the dielectric 28 are of annular form. This construction permits relatively short axial length of the lens and, consequently, a short focal length, without incurring substantial danger of electrical breakdown. The dielectric 28 may comprise an insulating vitreous or ceramic substance such as glass, quartz, porcelain, or it may be constituted of a finely divided inorganic material, such as mica or asbestos, cemented or bonded together with a glassy binder, for example,

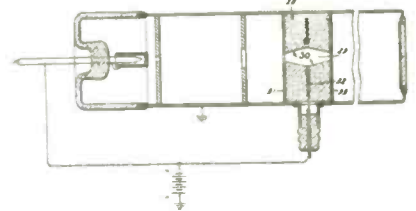

lead borate. The shape of the lens field in the part of the lens traversed by the electron beam is to some extent a function of the shape of the exposed surface 30 of the solid dielectric 28 so that by forming the dielectric in an appropriate manner it is possible to minimize aberrational effects. Several suitable lens configurations are shown and described, and the method of manufacture is explained. C. H. Bachman, General Electric Company, (F) Dec. 31, 1941, (I) May 2, 1944, No. 2,347,982.

Measuring Sharpness of Focusing

In secondary-emission, scanning microscopes. If the primary beam fails to strike the specimen, there will be no output current. Assuming that the specimen be moved slowly into the field of the beam, the time it takes for the secondary beam to rise from zero to maximum will be a measure of the relative diameter of the primary beam. For sharp focusing this time will be very short and a nearly square wave shape, having a large harmonic output, will be obtained. This output is passed through a high pass filter and applied to the horizontal plates of a cathode-ray tube or to an indicating meter. The amount of high frequency content, indicated by the meter or the cathode-ray tube, is a measure of the sharpness of the focusing of the primary electron beam. J. A. Rajchman, RCA, (F) April 20, 1942, (I) May 2, 1944, No. 2,348,031.

AM-PM Modulator

The input signal is frequency modulated and heterodyned with the carrier frequency in the converter unit to give a frequency-modulated intermediate frequency output. Unit 24 contains a series-tuned circuit

BLOWERS for Electronic Equipment

Easy-to-install . . . compact . . . quiet-running . . . economical . . . these are the features which make Pilot Blowers ideal for the important job of air circulation and ventilation in Radio Equipment. Available in standard models to move from 15 to 110 C.F.M. Write for Bulletin 507.



"SHADED POLE" F.H.P. MOTORS

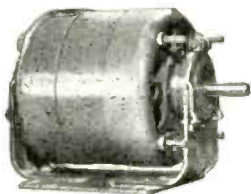

Tell us what your requirements are and we will send you "fact sheets" giving complete specifications on these dependable, efficient, low-cost Motors. For continuous or intermittent duty with H.P. ratings ranging from 1/15 to 1/500 H.P. and from 1550 to 3400 R.P.M. Plain round or with base or resilient mounting . . . open or enclosed cases.

F. A. SMITH MFG. CO., INC.
ROCHESTER 5



901 DAVIS STREET
NEW YORK

FRACTIONAL H.P. MOTORS **Pilot** CENTRIFUGAL BLOWERS



History of Communications Number Seven of a Series

EARLY COMMUNICATIONS BY AIR



While electronics use the ether and other media, one of the most speedy methods of communications in the early days was through the air by carrier pigeon. With a finely printed note fastened to the leg, these birds faithfully reached home to bring in the latest news events and stock market reports.

Today news commentary reaches into your homes in a flash of a second via electronic voice communications making use of the various types of Universal broadcast microphones. This being a modern age, the battle front is brought into the homes of the informed peoples of the democracies via military microphones such as those now being manufactured by Universal for the Allied Armed Forces.

< Model 1700-UB, illustrated at left, is but one of several military type microphones now available to priority users through local radio jobbers.

UNIVERSAL MICROPHONE COMPANY
INGLEWOOD, CALIFORNIA





**SAVE TIME
SAVE WORK**

call **ALLIED first**



**New R-F Resonance and
Coil Winding Calculator**

Easy to use! For fast accurate determination of resonance factors and coil winding data.

No. 37-955. Postpaid, 25c



**FREE
Complete
Up-to-date
BUYING
GUIDE**

ALLIED RADIO CORPORATION

833 West Jackson Blvd. Dept. 32-H-4, Chicago 7, Ill.

In the Heart of America's Transportation System

All these well known makes — and MORE!

- | | | | | |
|----------|------------------|----------------|------------|----------|
| RCA | IRC | Sprague | Littlefuse | Astatic |
| Raytheon | Centralab | Aerovox | Stancor | Amperite |
| Hickok | Burgess | Hallicrafters | Thordarson | Jensen |
| Triplet | Knight | Hammarlund | Belden | Utah |
| Supreme | Bliley | E. F. Johnson | Melssner | Sangamo |
| Mallory | General Electric | Cutler-Hammer | Amphenol | Dumont |
| Ohmite | Cornell-Dubilier | Hart & Hegeman | Shure | Bussman |

ALLIED RADIO

**Get Everything in
ELECTRONICS
and RADIO
from this One Source**

All you make is *one* contact. All you place is *one* order . . . for everything! Allied carries today's *largest and most complete* stocks under one roof . . . ready for *rush delivery*. Over 10,000 items to meet the most diverse needs. Procurement of "hard-to-get" items is facilitated by our close contact with leading manufacturers. This *centralized* stock and procurement service does the job—faster! It's always a good idea to call **ALLIED First** . . . for one item or a hundred!

Write, Wire, or phone Haymarket 6800.

NEW PATENTS

resonant at the intermediate frequency which has zero output at that frequency, F_c , as indicated by the amplitude-frequency characteristic on the diagram; its output will consist of side bands modulated in amplitude and frequency. In the following converter, the output of 24 is heterodyned back to the carrier frequency so that a constant carrier frequency, carrier-eliminated, amplitude-modulated output, i.e., the side bands only, is obtained. If this type of modulation is desired, it may be taken off lines 34 directly. If amplitude modulation with the carrier present is desired, the carrier is reinserted in the carrier and side-band combiner; the phase adjuster adjusts the phase

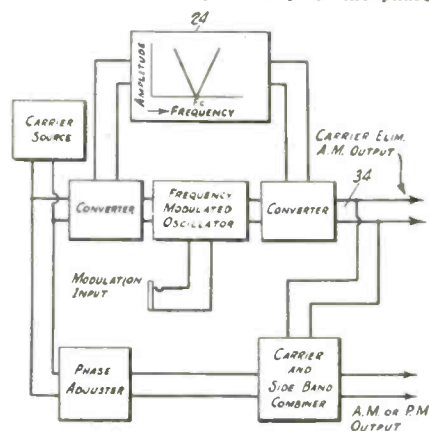

of the carrier with respect to the side bands so that the proper relation for amplitude modulation is obtained. If phase modulation is desired, the phase adjuster is set to introduce a 90 deg. phase shift with respect to the setting for amplitude modulation. M. G. Crosby, RCA, (F) May 1, 1942, (I) April 25, 1944, No. 2,347,398.

(Continued on page 172)

**ELECTRONIC
(Communications)
ENGINEERS
WANTED**

Openings in our permanent organization for several capable engineers with experience and initiative, trained in both designing and production problems in our or closely allied field.

Our line includes the designing and manufacturing of attenuators, switches, and audio test equipment.

We anticipate no readjustment in our engineering staff as a result of peacetime production requirements. In applying, kindly state qualifications and earliest availability. All inquiries will be held in strict confidence.

THE DAVEN CO.

191 CENTRAL AVE.
NEWARK 4, N. J.



Wheeler to Sickles to Uncle Sam!

How a wartime double play helps produce vital communication devices for the Signal Corps

Thanks to the "Handy-Talkie" which he carries, the soldier in the picture is not so isolated as he looks.

The "Handy-Talkie" is a "Walkie-Talkie's" kid brother. It is so light and so small that it can go practically anywhere a man can. Yet it both sends and receives speech, with a range of about a mile.

Needless to say, the "Handy-Talkie" takes terrific punishment in action. So every one of its parts is made with the kind of materials and workmanship that won't let a Signal Corpsman down in a tight spot.

The radio frequency coils and other component parts are made by

The F. W. Sickles Company, of Chicopee, Mass., one of the world's largest manufacturers of radio and electronic coils. In turn, the fine insulated wire and the litz wire which go into many of these parts are supplied to Sickles by *Wheeler Insulated Wire Co., Inc.*

In its 35-year history, Wheeler Wire has tried to make not the *most*, but the *finest* products possible. We are proud that our facilities and experience have enabled Sickles and many other important companies to produce vital war equipment for Uncle Sam — *quickly*.

The Wheeler Insulated Wire Co., Inc.

BRIDGEPORT 4, CONN.

Manufacturers of Magnet Wire... Litz Wire
Coil Windings... Transformers



The Right Filter

... as important
as the circuit itself!

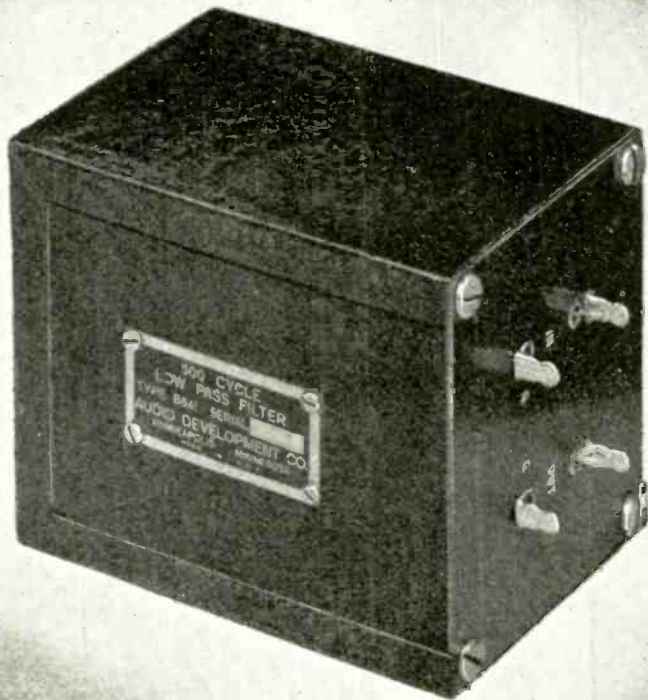

● Practical filter designs involve important compromises between several related factors if physical specifications and attenuation characteristics are to be achieved for predetermined circuit requirements. The overall performance of any design depends largely upon the carefulness and accuracy with which these considerations are carried out.

Behind every ADC Filter stands years of practical design experience—the type of knowledge that makes it possible to turn out filters for the most exacting service applications.

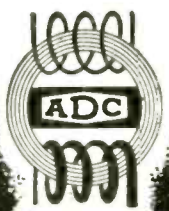

Audio Development Co.

2833 13th Ave. S., Minneapolis, Minn.

NEW PATENTS

(Continued from page 170)

Frequency Modulator

Feedback voltage is taken off the tank circuit C_1, L_1 between points 12 and 14 and applied over line L to control grids 26 and 28 of oscillator tubes V_1 and V_2 . The control grids 26 and 28 are excited in phase quadrature, but the phase of the feedback voltage at the intermediate point 35 is opposed to the phase of the voltage on plates 6,8 so that the grid excitation voltages are sufficiently out-of-phase with the plate voltages to insure oscillation. The line L is terminated by a variable resistance R_1 which with plate resistance of V_3 in the unmodulated condition is dimensioned to match the surge impedance of the line, and which is so adjusted that equal radio frequency voltages are fed back to the two control grids. If the output impedance of tube V_2 is lowered, by an increase in positive grid potential, the line surge impedance is no longer matched. This causes reflection and

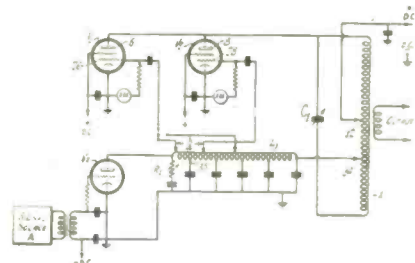

standing waves on the line, and the radio frequency excitation potentials on the control grids of tubes V_1 and V_2 are no longer equal so that the tubes feed unequal amounts of current to the tank circuit and the energy therein takes up a new phase, which is more nearly the phase of that tube feeding the greatest amount of energy to the tank circuit. The phase of the feedback energy shifts between two limits set by the phase displacement of the excitation voltages, and since the system is regenerative, the action is accumulative and results in frequency modulation of the output in the tank circuit. Another tube may be incorporated in the circuit to compensate for amplitude modulation. G. L. Usselman, RCA, (F) May 27, 1942, (I) April 18, 1944, No. 2,346,800.

Tuning Fork Oscillator

It is intended to adjust the frequency of the tuning fork 2 while maintaining the amplitude constant so as to obtain a constant output voltage at terminals 4. Coil 21 drives the tuning fork 2, and the oscillations of the tuning fork induce a voltage in coil 14 which is amplified in tube 1. Network 15,16 introduces a 90 deg. phase shift. Part of the output of tube 1 is applied to the rate control circuit 20, another part is amplified in tube 3 and made available at terminals 4. When the variable contact 45 is adjusted to the mid point on the resistor 44, rate control network 20 produces a phase shift equal and opposite to that obtained in the phase shifting network 15,16. Under such conditions a current impulse flows in drive coil 21 in a direction opposite to the current flow of the initial current impulse. This produces an opposite movement of the tines of fork 2 causing a second voltage impulse to be generated in pick-up coil 14 having a sign opposite to that caused by the first movement of the tines. This second impulse of voltage ex-

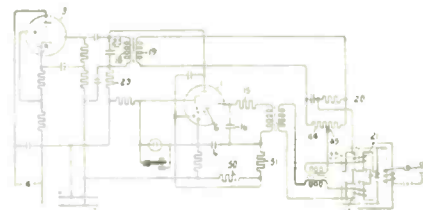

Electronic Wizardry

Philco Engineers Create a "Master Mind"
that THINKS...

READS...CALCULATES

...CALIBRATES

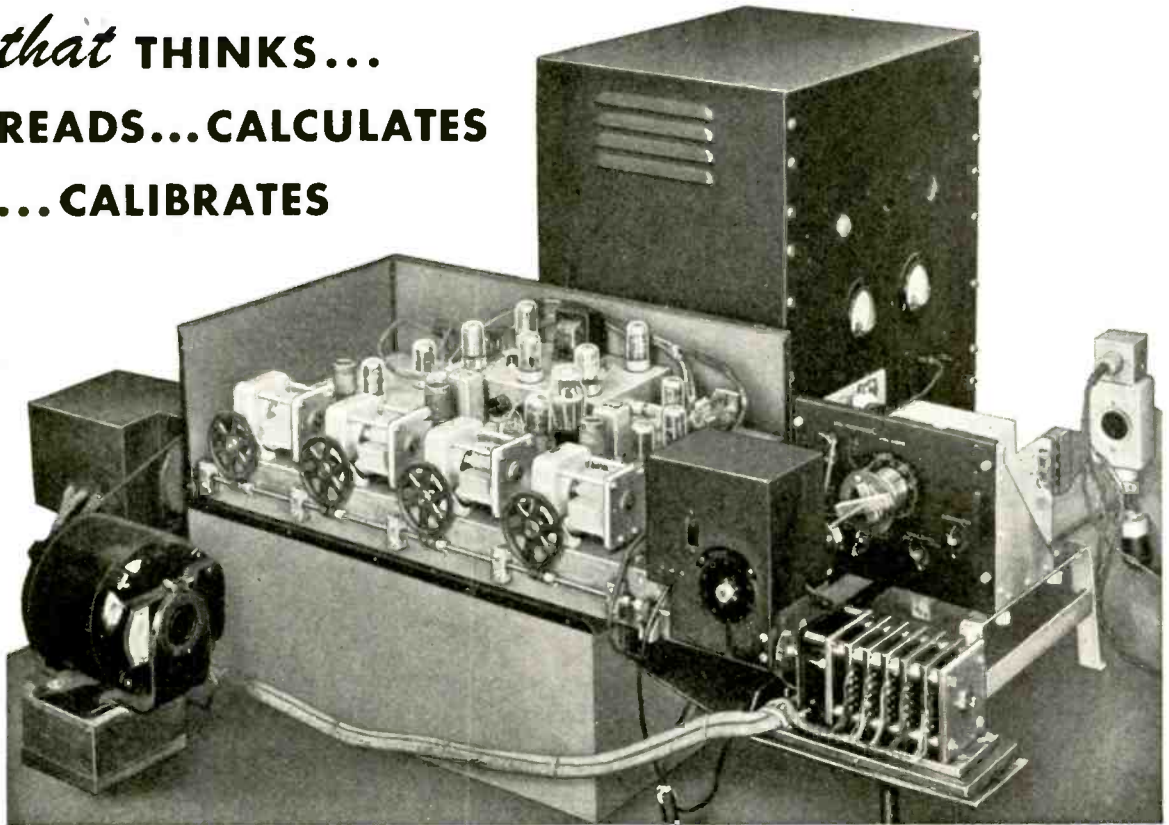

AMONG PHILCO'S many contributions to the war effort was the creation of the electronic "master mind" pictured here. Last year alone, it saved 144,000 man-hours of labor and, with other economies, reduced the cost of one type of radio equipment to the Government by \$1,170,000.

Perfected only after many months of exhaustive research and development by Philco engineering ingenuity, this device replaced a tedious and intricate hand calibrating operation, which was slow and subject to human error. Employing 126 tubes, the Philco "Master Mind" can "think," calibrate, calculate, and record

dial readings many times faster than any human being — at a great saving of time and without danger of error.

Another example of Philco research and engineering "know-how" which, while fulfilling emergency war needs, promises important peacetime applications in industry after Victory!

PHILCO

CORPORATION



ULTRA-Final

IT'S the FINAL ANALYSIS that tells the story when dynamotors reach this test board. During manufacture, countless checks and measurements are made of the various component parts. Then, after assembly and preliminary inspection, each unit undergoes an extended operation test on the run-in line. But the dynamotor must still prove itself by successfully passing a series of tests which are the basis of Eicor quality . . . using the finest test-equipment obtainable.

First, each unit is checked at over-voltage and overload to establish a predetermined electrical factor of safety. This is followed by a complete point-by-point check of the dynamotor and its performance, based on EICOR design specifications. Output, regulation, speed, and efficiency, together with other test data, are carefully noted for engineering appraisal.

Specializing, as we do, in the design and manufacture of rotary electrical equipment, our extensive experience is fully utilized in building the world's finest dynamotors and motors.



EICOR INC. 1501 W. Congress St., Chicago, U. S. A.
 DYNAMOTORS • D. C. MOTORS • POWER PLANTS • CONVERTERS
 Export: Ad Auriema, 89 Broad St., New York, U. S. A. Cable: Auriema, New York

NEW PATENTS

erts a controlling effect on tube 1 such that the instantaneous current flowing in the output circuit thereof is reversed in direction for the duration of the impulse. The interaction of fork vibration and amplifier ultimately reaches a condition of equilibrium in which the fork is vibrated at a constant frequency. By adjusting contact 45, the phase and amplitude of the voltage applied to coil 21 are changed. If the driving current lags behind the fork vibrations, the fork will vibrate at a frequency below its natural frequency, if the current leads the fork will vibrate at a frequency above its natural frequency. At the same time, when pointer 45 is moved from its mid point position, the current amplitude will change to such an extent as to keep the fork vibration amplitudes constant. M. S. Mead, (F) Aug. 25, 1942, (I) April 18, 1944, No. 2,346,984.

Electron Focusing

In cathode-ray tubes and velocity-modulation tubes it is frequently essential to obtain a narrow electron beam of high intensity. For this purpose, the concave shaped cathode 1 is surrounded by ferromagnetic cylinder 4; it may be either a permanent magnet or an electromagnet. At the edge 5, the magnetic field will be a non-homogenous fringe field which forces the electrons to move to the axis of the system. To further reduce dispersion of the elec-

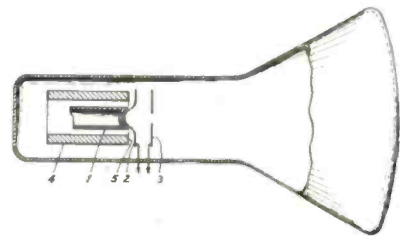

Contact Specialists for the Right Connector

Terminals - Lugs :-
 Solder - Compression
 - Solderless Types.

Standard Government Electrical Parts.

ATLAS PRODUCTS CORPORATION

30 ROCKEFELLER PLAZA
 NEW YORK, U. S. A.





haste without waste

The electronic engineer has been doing a tremendous job. The increasing importance of advanced electronic equipment in modern warfare has multiplied his task a hundredfold. But, the special training and vitally important knowledge of the electronic engineer enables him to tackle each day's job regardless of its magnitude and get it out of the way. The electronic engi-

neer is living proof that *haste without waste* is possible.

Advanced electronic tubes and equipment are playing a role of immeasurable importance in the Allied Nations' drive for Victory. When the war ends, the results of Raytheon's intensive research and manufacturing experience will be utilized to meet advanced electronic tube requirements.



ARMY-NAVY "E" WITH STARS
Awarded All Four Divisions of Raytheon
for Continued Excellence in Production

RAYTHEON

Raytheon Manufacturing Company
ELECTRICAL EQUIPMENT DIVISION
Waltham and Newton, Massachusetts

DEVOTED TO RESEARCH AND THE MANUFACTURE OF TUBES AND EQUIPMENT FOR THE NEW ERA OF ELECTRONICS

And Alexander Wept . . .

Because He Had No New Worlds to Conquer

Alexander went as far as he could go . . . for 323 B.C.

But his horizon was limited by his times. Today, with all the marvels of electronics and electricity before us, we of Webster Electric find no cause for tears.

Right now our energies are directed full tilt for victory. But we have things up our sleeve . . . crystal pickups and cartridges that will give even more brilliant tone production . . . when we can get to them.

Meanwhile, in thousands of homes all over America, life is more pleasant, relaxation more complete, because their owners enjoy the richness of radio-phonograph sets equipped with Webster Electric pickups.

For these homes . . . and many thousands more . . . Webster Electric will be ready with new designs . . . new products for use in the new world for which we are all waiting.

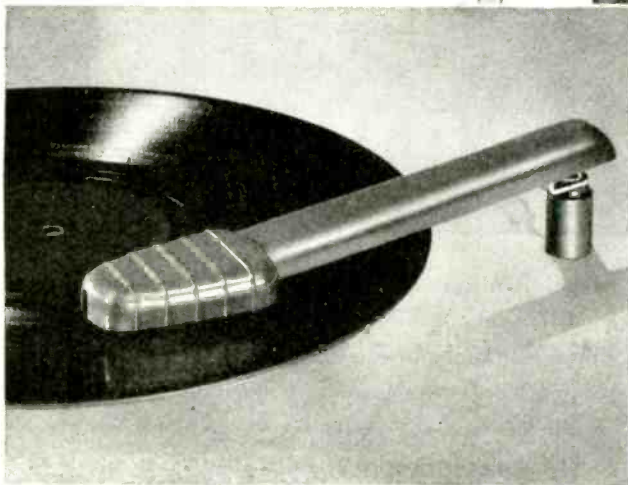

(Licensed under patents of the Brush Development Company)

WEBSTER ELECTRIC COMPANY, Racine, Wisconsin, U. S. A.
Established 1909. Export Dept.: 13 E. 40th St., New York (16), N. Y.
Cable Address: "ARLAB" New York City



WEBSTER ELECTRIC

"Where Quality is a Responsibility and Fair Dealing an Obligation"

LET'S ALL BACK THE ATTACK — BUY MORE WAR BONDS!

NEW PATENTS

trons, the electrostatic lines of force are caused to coincide as much as possible with the lines of force of the concentrating magnetic field. The ferromagnetic cylinder 4 is at a negative potential with respect to the cathode to promote the convergence of the electric lines of force leaving the cathode. With this arrangement, a large cathode surface of about 150 square millimeters can be used, and a current of, for example, 0.5 to 1.0 ampere may be obtained with very small loss by stray electrons. 2 is the control electrode and 3 is the first anode. F. Coetier, Alien Property Custodian. (F) Feb. 12, 1942, (I) May 2, 1944, No. 2,347,990.

Filter Network

It is desired to construct a filter having the frequency transmission characteristics of a resonant circuit but which, within a few cycles after the application of the resonant tone frequency, reaches its full output amplitude. Limiter tube VT7 permits no voltage amplitudes of unwanted frequencies to pass that would be strong enough, upon amplification and passage through resonant circuits TC3 and TC4, to overcome the 10 volt negative bias on rectifier VT9. Signal

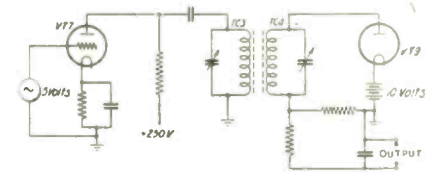

voltages within the desired frequency band, however, will develop enough voltage across circuit TC4 to operate tube VT9. Resonant circuits TC3 and TC4 have a high decrement and become fully excited within a very short time after application of the input voltage. S. Y. White, A. Thomson. (F) April 1, 1942, (I) April 18, 1944, No. 2,346,804.

TIME BASES

(Continued from page 113)

most rapid repetition rate at which the saw-tooth is to be used.

It is necessary, when using the foregoing, to employ a fairly high plate voltage, and throw away a comparatively good sized portion of the saw-tooth. This suggests that perhaps some better method of obtaining a saw-tooth shaped wave might be available.

Examination of Fig. 1 suggests that the sides of the pulses, being comparatively straight for a fair sized portion of their length, might be used. Further investigation discloses that these curves are those typical of the growth and decay of current in a reactor. It appears obvious that the larger the inductance, the slower the growth of current. Further, the higher the "Q" of the circuit, the larger the straight portion of the curve. It would appear that these physical facts might be put to good use.

Requirements for the generation of a saw-tooth have been noted:

- (1) Means for the momentary passage of a large amount of current.
- (2) Means for the supply of this current.
- (3) Means for slowing down the recovery of the circuit to a normal condition, and making that



"I want
A FLEXIBLE GASKET TO
WITHSTAND 2000° F."
said the airplane part maker



"I want
A RUSTLESS,
DURABLE PRESSING PAD"
said the laundry operator



"I want
A FINE TUBE GRID
THAT WON'T SAG"
said the electronic tube maker



"I want
A LASTING WICK FOR
AIRPLANE HEATERS"
said the cabin heater maker

They found what they wanted in

KNIT MESH

made of INCO Nickel Alloys



Today, metal mesh knit from INCO Nickel Alloys does *all* these varied jobs.

Tomorrow? Perhaps it's the answer to an electronic problem now on *your* drafting board.

For Knit Metal Mesh, product of the Metal Textile Corp., Orange, N. J., has many properties that point to its wide future use in electronics.

Knit from Monel, Nickel or Inconel, it is rustless corrosion-resistant, tough, strong, able to withstand high temperatures. In addition, its special *linked-loop* design is flexible, highly resistant to breakage, unusually strong on the bias. It offers, for instance, a firm fabric for grids because the linked loops allow normal expansion when the grid is heated, and return the fabric to its original shape as the grid cools.

The knit fabric holds together even when made of very fine wire (.0045 diameter), and with as few as 4 or 5 openings to the inch.

For further information about mesh knit from the INCO Nickel Alloys...and for other technical service on metal problems...address: The International Nickel Company, Inc., 67 Wall Street, New York 5, N. Y.



"I want
A BETTER
AIR FILTER MEDIUM"
said the filter manufacturer



"I want
A FLEXIBLE STRAP THAT
WON'T JIGGLE LOOSE"
said the magneto maker

NICKEL  ALLOYS

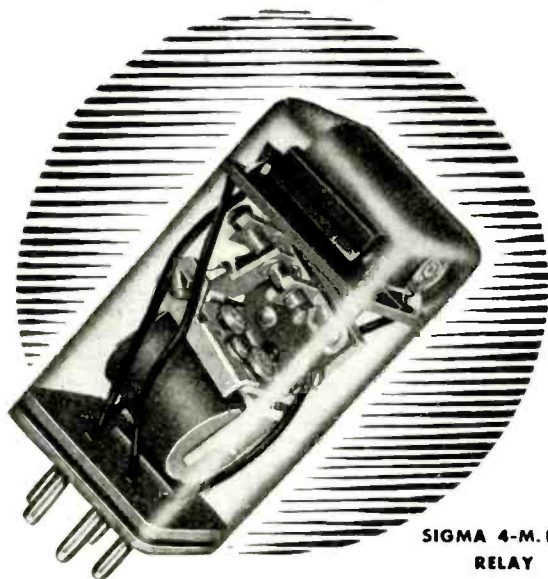

SIGMA 4-M. B. R.
RELAY

AC SENSITIVE RELAYS . . . WITH DC PERFORMANCE

The conventional AC relay of shaded pole construction has two limitations.

- (1) Its power sensitivity is only a small fraction of that afforded by the same relay operated on DC.
- (2) It cannot be successfully operated on a gradually variable voltage or current without passing through states of instability and chattering. This limits its usefulness to circuits in which the input is sharply changed from one level to another and rules it out for sensitive control on continuously variable AC.

SIGMA has perfected a complete unit which is an adaptation of most SIGMA Sensitive relays to AC operation with neither of the above disadvantages, by incorporating within the relay housing a midget selenium rectifier of the full wave type, with or without a filter condenser as circumstances dictate. Operation is attained on continuously variable AC with no instability or chatter, and at practically the same power sensitivity afforded on DC. Unit is more compact and saves space.

Suggested Operating Ranges:
(higher voltages may be used with series resistors mounted within the relay enclosure)

Type 4 MBR	Type 5 MBR
4.0-12.0 volts	4.0-12.0 volts
5.0-35.0 ma.	0.5-10.0 ma.

SIGMA
Sigma Instruments, Inc.
Sensitive RELAYS

NEW ADDRESS

70 CEYLON STREET
BOSTON 20, MASS.

recovery proceed along a definite curve, a fair portion of which is linear.

Toward the satisfaction of these requirements, there are the following:

- (1) A blocking oscillator to supply the means for creating the momentary surge of current.
- (2) A capacitor to supply the current for the surge.
- (3) An inductance to delay the return of the voltage to normal.

These may be connected as shown in Fig. 3 using the inductive-capacitive output connections.

Now, as the blocking oscillator is fired, the initial current for the generation of the plate pulse is drawn from the capacitor C_2 ; the presence of the inductance L_1 in the circuit prevents current from being drawn from the supply at this time. At the low point of the pulse, the grid cuts off, and the plate voltage returns to normal, with the capacitor C_2 recharging. The delay occasioned by the presence of the inductance L_1 in the circuit results in the capacitor C_2 recharging along a combination of the curve of the growth of current in a reactor, and the charge in a capacitor.

Fig. 5 shows the computed curves obtained from an inductance of 90 millihenries, a capacitance of 100,000 micromicrofarads, a resistance

DIALS PANELS and PLATES

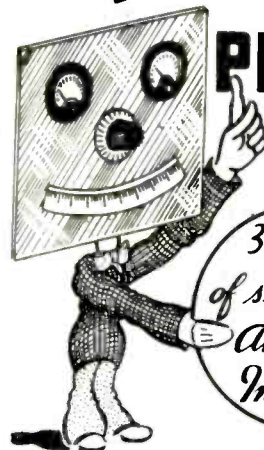

35 years
of service to
American
Industry

DIALS · PANELS · PLATES

made to your precise engineering specifications in etched metals and finishes.

**PREMIER
METAL ETCHING CO.**

21-03 44th AVE.
LONG ISLAND CITY, NEW YORK

The Resourcefulness of the N-Y-T SAMPLE DEPARTMENT

..is known even in Berlin and Tokyo!



The flexibility of N-Y-T engineering is emphasized by the type and scope of its transformer designs. Prior to the Defense era, N-Y-T technicians produced special custom-designed units for general precision applications. Then, with military preparations, transformers, rectifiers and solenoids — for practically every phase of electronic equipment—were included in N-Y-T production.

With the advent of war, the ingenuity and resourcefulness of the NEW YORK TRANSFORMER Sample Department kept pace with the unprecedented demands of Army, Navy and Air Forces.

The experience gained now in producing for the war effort is helping gear NEW YORK TRANSFORMER COMPANY to peace time requirements for both civilian and industrial transformer products.

Whether your post-war product involves a marine, aviation or industrial transformer for unusual application or performance, the N. Y. T. Sample Department can fulfill the requirement.



NEW YORK TRANSFORMER COMPANY

22-26 WAVERLY PLACE, NEW YORK, N. Y.





for EXCEPTIONAL PERFORMANCE

INSULINE has been awarded the Army-Navy "E" for exceptional performance in the production of Radio-Electronic Products.

With resolution, and naturally with pride, we accept this honor. The "E" pennant flying beside "Old Glory", is a ringing challenge.

It is a battle cry, saying: "Back up our fighting men . . . Give them the material strength with which to implement their fighting hearts!"

We are resolved that this call shall be answered with stepped-up production . . . with new records of exceptional performance worthy of the trust placed in us by the Armed Forces.



Looking Ahead! Though engaged in vital war work, Insuline is looking ahead. We are gearing our organization for the post-war requirements of the Radio-Electronics Industry.

Write for the 48-page Catalogue of ICA Products, and brochure on the ICA organization and facilities.



HEADQUARTERS FOR
RADIO-ELECTRONIC PRODUCTS



INSULINE

CORPORATION OF AMERICA

INSULINE BUILDING • LONG ISLAND CITY, N.Y.

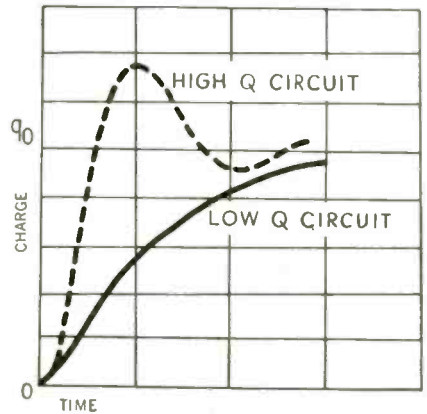

Fig. 5. Growth of charge in circuit having inductance, capacitance and resistance

of 200 ohms (dotted curve), and a resistance of 1250 ohms (solid curve).

From the solution of the differential equation for a series LCr circuit, and assuming $r^2/4L^2$ to be small as compared with $1/CL$, it can be shown that the charge on the capacitor will be equal to its initial charge, q_0 , after a time interval

$$t = (\theta + \pi/2) (1/CL - r^2/4L^2)^{-1/2},$$

where

$$\sin \theta = r(C/2L)^{1/2}$$

This then may be taken to be the approximate length of the sweep obtained in this manner. It might be noted that this time should also be that of the duration of the output pulse shown in Fig. 1, where the values are those of the grid circuit. L would be the effective inductance of the grid coil, while C would include the capacitance of the wiring, tube, etc.

It will be noted that the start of the curve is not abrupt. The linear portion, however, continues to a point well above the full charge line. This curve may be combined with the charge curve of a capacitor by placing a resistor in parallel with the inductance L_1 . This will have the added effect of "damping" the oscillation shown about the full charge line. The value of this resistor may be determined by experimental means; too small a value will cause distortion of the curve. The addition of this resistor will eliminate the gradual curve at the beginning of the slanting portion of the saw-tooth.

Reference to the equation giving the time of the sweep indicates that variation of C_2 would produce a change in the slope of the sweep. However, it also will be noted that the condition of $1/CL$ greater than $r^2/4L^2$ must be maintained to obtain the linearity desired. Therefore, a limiting value for C_2 will be found for each value of L and r in the circuit, beyond which the linearity will not be preserved.

Keeping these facts in mind, however, it will be noted that a

PROFESSORS PREFER...
JAMES KNIGHTS

Crystals

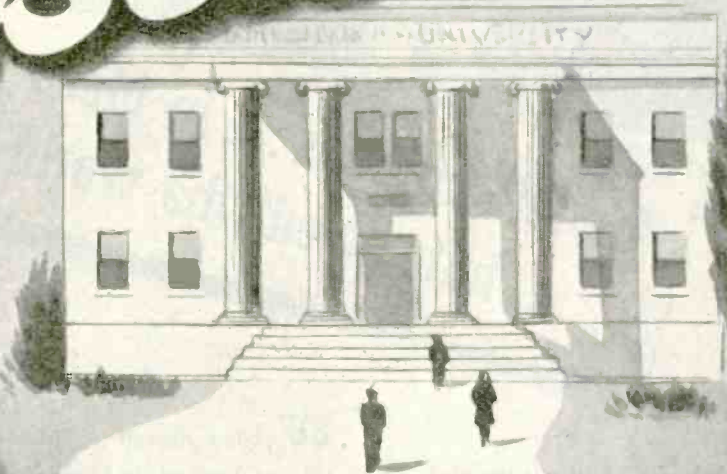
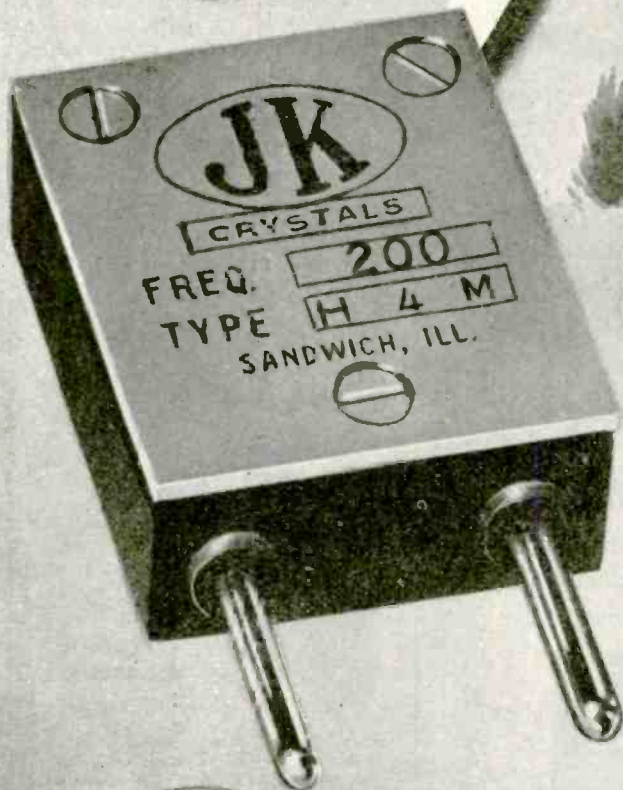

**..... for Efficiency,
Dependability and Accuracy**

In instance after instance, James Knights is called upon to supply precision quartz crystals to meet the intricate specifications of university experimental work. In many of these cases, research done in university laboratories with James Knights Crystals is contributing directly to war communication development. That James Knights Crystals are so often considered "first choice" with university scientists is proof of their superior qualifications under the most exacting conditions. Why not let the men of The James Knights Company help with your crystal problems!

BUY WAR BONDS FOR VICTORY!

The **JAMES KNIGHTS Co.**
SANDWICH, ILLINOIS



CRYSTALS FOR THE CRITICAL

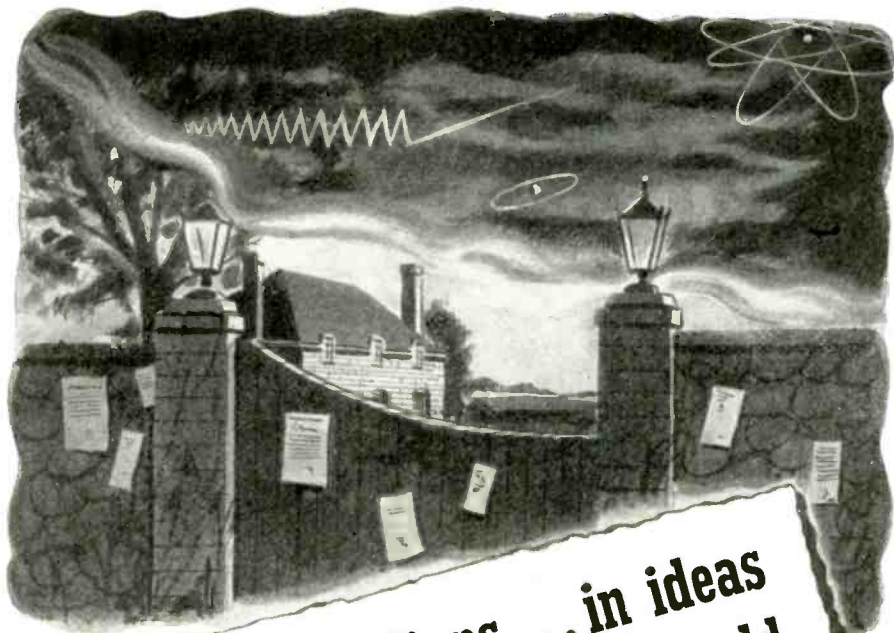

**He left millions... in ideas
... but "owed" the world**

HE called himself a "philanthropist", and yet the door of his villa at Torquay in France was nailed with notices for unpaid debts. He gave away discoveries worth millions of dollars to the communications industries. He founded the modern science of telephonic communication. His name? Oliver Heaviside.

Advance theories of communication have been forced into practice by urgent war needs. Fundamental to all new developments, in this and other fields of electricity, is the transformer. Stancor engineers are fully conscious of their responsibility to keep pace with and to set pace in their transformer designs for tomorrow's peacetime industry.

SEND FOR NEW COMPLETE CATALOG

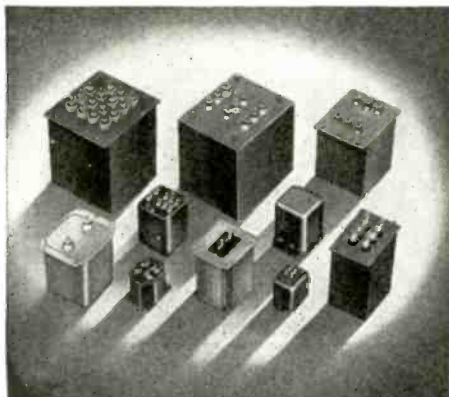

STANCOR

Transformers

STANDARD TRANSFORMER CORPORATION
1500 NORTH HALSTED ST. · CHICAGO 22



Manufacturers of quality transformers, reactors, power packs and allied products for the electronic industries.

sufficient variation in the time of the sweep may be obtained with a variable capacitor to permit calibration, provided the value of the inductance L_1 is chosen carefully, and the maximum capacity obtainable with the capacitor is still low enough to permit the above condition to be maintained.

It will be noted that the saw-tooth obtained by the use of the circuit shown in Fig. 4 is negative. Inversion of the polarity by means of a tube is possible, but for very short sweeps, somewhat impractical. Consideration of the method of obtaining the sweep leads to the observation that since the delay in the inductance actually forms the curve, the magnetic field in the core must vary along the same curve. Hence, it should be possible to utilize a transformer of reasonably good frequency response to invert the saw-tooth. Further, the step-up and step-down abilities of the transformer may be utilized.

Twice the saw-tooth voltage, accompanied by inversion may easily be had by this means, and further, each end of the secondary winding may be connected to a plate of the cathode ray tube.

If a high-voltage tube is used for the saw-tooth generator, giving rise to a high voltage pulse, say of the order of 2,000 volts, the voltage pulse may be turned into a



**PLUG-IN
CONDENSER**

Plug-in capacitors with a wide range of voltages and capacities are one of the many different paper and electrolytic capacitors manufactured by the Illinois Condenser Company. This unit is hermetically sealed and built to operate under the severest conditions. We also manufacture condensers for special applications with a wide temperature range of from -50°C to $+85^{\circ}\text{C}$ and from one volt to 500 volts D. C. working on the electrolytic types.



**ILLINOIS CONDENSER
COMPANY**

1160 NORTH HOWE STREET
CHICAGO 10, ILLINOIS

HOGARTH DOESN'T MIND—HE'S USED TO HAVING
A CROWD AROUND HIS **ECHOPHONE EC-1**

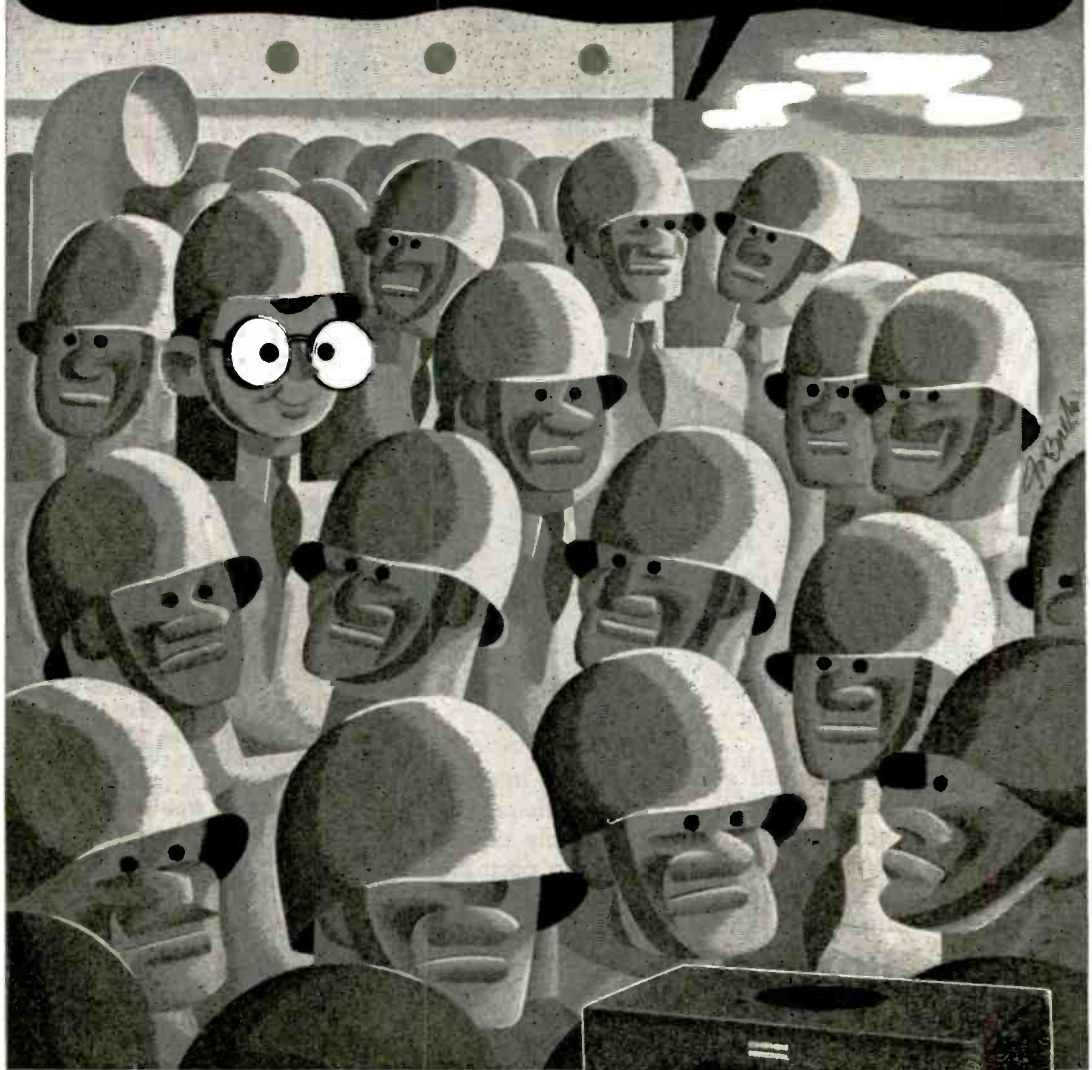

ECHOPHONE MODEL EC-1

(Illustrated) a compact communications receiver with every necessary feature for good reception. Covers from 550 kc. to 30 mc. on 3 bands. Electrical bandspread on all bands. Six tubes. Self-contained speaker. 115-125 volts AC or DC.



ECHOPHONE RADIO CO., 540 NORTH MICHIGAN AVE., CHICAGO 11, ILLINOIS

Dependable Power..

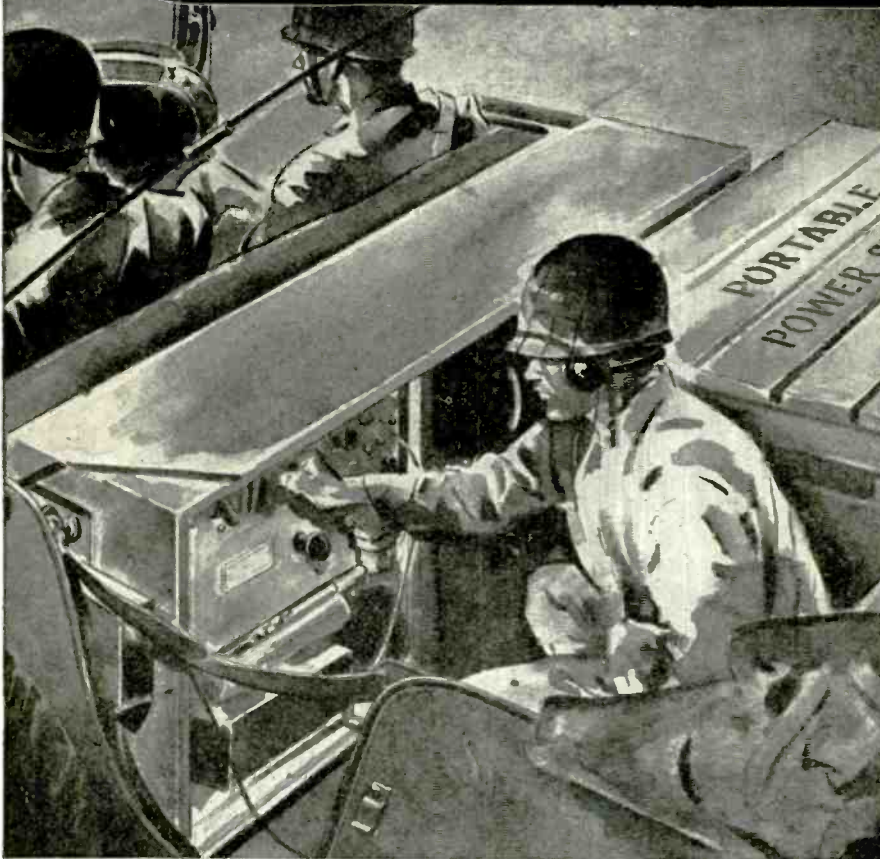

Probably the most important single factor in modern warfare is complete, dependable communications. Dependable communications require a dependable power supply. Pincor is proud of its part in furnishing portable gasoline-driven and other electrical power supply units to the fighting front as well as to the home front.

Look to Pincor for your postwar needs in power plants, motors, converters and battery chargers.

DYNAMOTORS . . . CONVERTERS
GENERATORS . . . D C MOTORS
POWER PLANTS...GEN-E-MOTORS

BUY WAR BONDS!

PINCOR
Products

PIONEER GEN-E-MOTOR
5841 W. DICKENS AVE.
CHICAGO 39, ILLINOIS

EXPORT ADDRESS: 25 WARREN STREET, NEW YORK 7, U. S. A. • CABLE ADDRESS: SIMONTRICE, NEW YORK

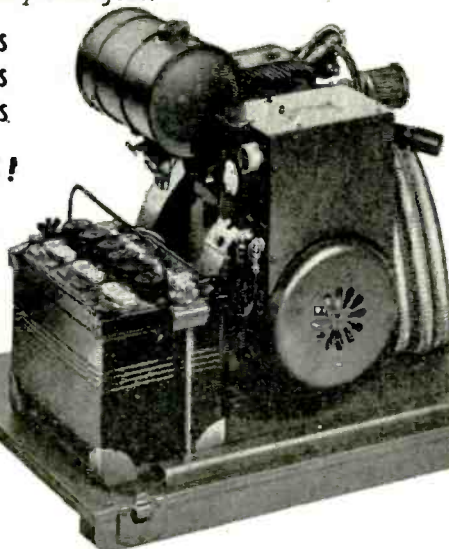

current pulse for use with magnetic deflection circuits by the use of a step-down transformer.

The curves shown in Fig. 1 were obtained by the writer with the aid of a sweep utilizing a step-up transformer. The oscillograph calibration was set at 0.25 microseconds per inch. The calibration has been maintained for some time without further attention. No difficulty has been experienced with "flicker" or "jitter."

The saw-tooth generating circuit makes use of a 6SN7 and a two-to-one step-up pulse transformer, the low winding of which acts as the inductance in the saw-tooth forming circuit. The high-winding of this transformer has an inductance of approximately 10 millihenries.

Another pulse transformer, having a rather straight-sided characteristic, a comparatively low inductance, and a four-to-one step up ratio between the plate and grid coils is used to regenerate the tube. The low winding is placed in the plate circuit. By this means the grid of the tube is forced to a rather high positive level, and the conductance of the tube correspondingly increased. This insures a comparatively good-sized plate swing.

The portion of the oscillation on the opposite side of the axis from the saw-tooth was clipped after inversion by a 6H6. Calibration was accomplished by a "trimmer" across the output from the transformer. It was discovered that with the inductance used in the plate circuit of the tube, the distributed capacity of the transformer and wiring was sufficient, hence the capacitor, which would be used with longer sweeps was omitted. The circuit is shown in Fig. 6, while the saw-tooth obtained is shown in Fig. 7.

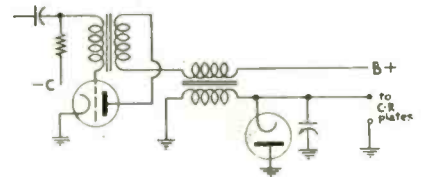
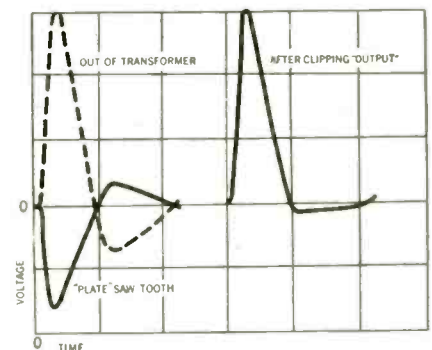

Fig. 6. High-speed sweep circuit giving saw-tooth output of waveform shown below in Fig. 7



Your **VACUUM TUBE
PROBLEMS..**



Let **TAYLOR** Engineers Help You

Whether your need of information is immediate or for postwar application, Taylor Tube Technicians are always at your service for consultation on any vacuum tube problem. If you are located near Taylor's headquarters in Chicago, you may find it convenient to come in for a personal discussion. If you wish to write, your correspondence is welcome.

✓ **TRANSMITTING** ✓ **ELECTRONIC**
✓ **RECTIFIER** ✓ **INDUSTRIAL**

Buy War Bonds For Victory!



Taylor HEAVY **CUSTOM BUILT** DUTY **Tubes**

TAYLOR TUBES INC., 2312-18 WABANSIA AVE., CHICAGO, ILLINOIS

Now! THE UNGAR ELECTRIC SOLDERING PENCIL WITH 5 DIFFERENT TIPS To Solve EVERY Soldering Problem

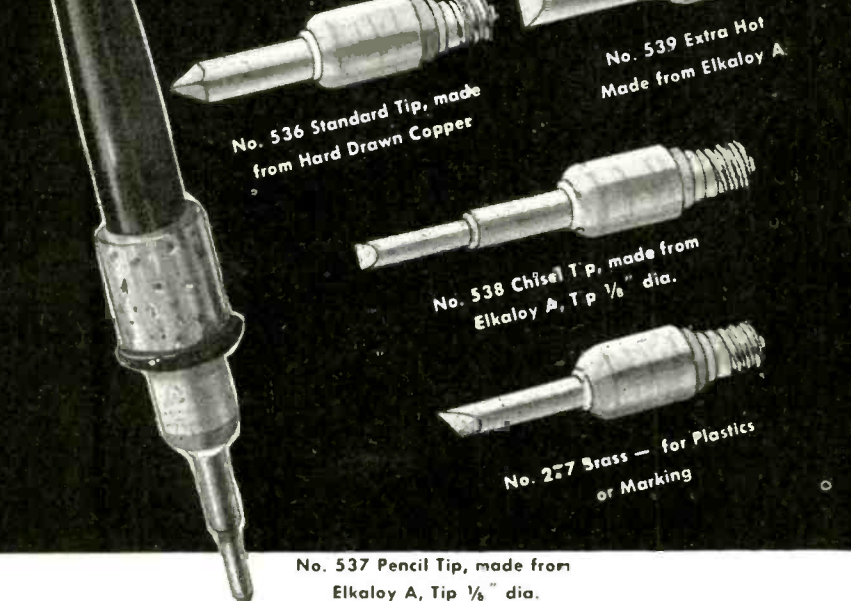

No. 536 Standard Tip, made from Hard Drawn Copper

No. 539 Extra Hot Made from Elkaloy A

No. 538 Chisel Tip, made from Elkaloy A, Tip 1/8" dia.

No. 277 Brass — for Plastics or Marking

No. 537 Pencil Tip, made from Elkaloy A, Tip 1/8" dia.

The "Quin-TIP-lets" make their debut

The Electrical industry's newest, trimmest, slimmest soldering tool—the Ungar light-as-a-feather Soldering Pencil — now available in your choice of FIVE INTERCHANGEABLE TIPS — each an entirely different design to solve your particular soldering problems.

Originally designed for speedy, precision production on intricate, hard-to-reach soldering jobs, the Ungar Soldering Pencil is now five times more versatile — 100% more efficient — can be used for everything from the most delicate operations to some of the larger, heavier soldering tasks.

The Ungar Soldering Pencil is ruggedly constructed, built to take plenty of punishment. Yet it's lightweight . . . weighs only 3.6 ounces . . . is perfectly balanced . . . handles with the ease of a fountain pen . . . heats in 90 seconds, draws only 17 watts. Overall length, 7 inches.

The soldering unit complete with handle and cord set, No. 776 and any one of the tips pictured above sells for considerably less than \$2.00 each. Priority required on all orders. Immediate delivery.

Please send your order to your nearest Electronics Distributor or Mill Supply House.

HARRY A. UNGAR, Inc.

615 Ducommun Street, Dept. 100 Los Angeles 12, California

Harry A. Ungar, Inc.

MANUFACTURERS OF ELECTRICAL WAR PRODUCTS

OSCILLATORS

(Continued from page 115)

creased further, a point will be reached at which the system will oscillate. The amplitude of oscillation will be a function of feedback voltage and for small amplitudes, the waveform is an extremely pure sine wave. The same system is thus adjustable for operation as either a selective ac amplifier or as an ac generator.

In either case, with this method the feedback voltage is the resultant of two voltages derived from separate amplifier stages having a phase difference of 180 deg. The sign and magnitude of this voltage is a function of frequency as shown previously for the bridge arrangement. From the juncture of the frequency selective arms to that point where the feedback voltage is introduced, there is but one feedback path. In this respect, as in the others referred to, the method differs from others.

The basic method is applicable to any vacuum tube amplifier capable of providing the necessary phase reversal. A modification for a single stage, useful for limited accentuation of bass or other frequencies is shown in Fig. 7.

The resistance of R_i is so chosen that its IR drop for the input frequency component is approximately equal to one-half the signal voltage

SKILL

that saves you
TIME • MONEY
WORRY!

FABRICATING
GLASS BONDED MICA

**COLONIAL
KOLONITE COMPANY**
2212 W. ARMITAGE AVE., CHICAGO, ILL.

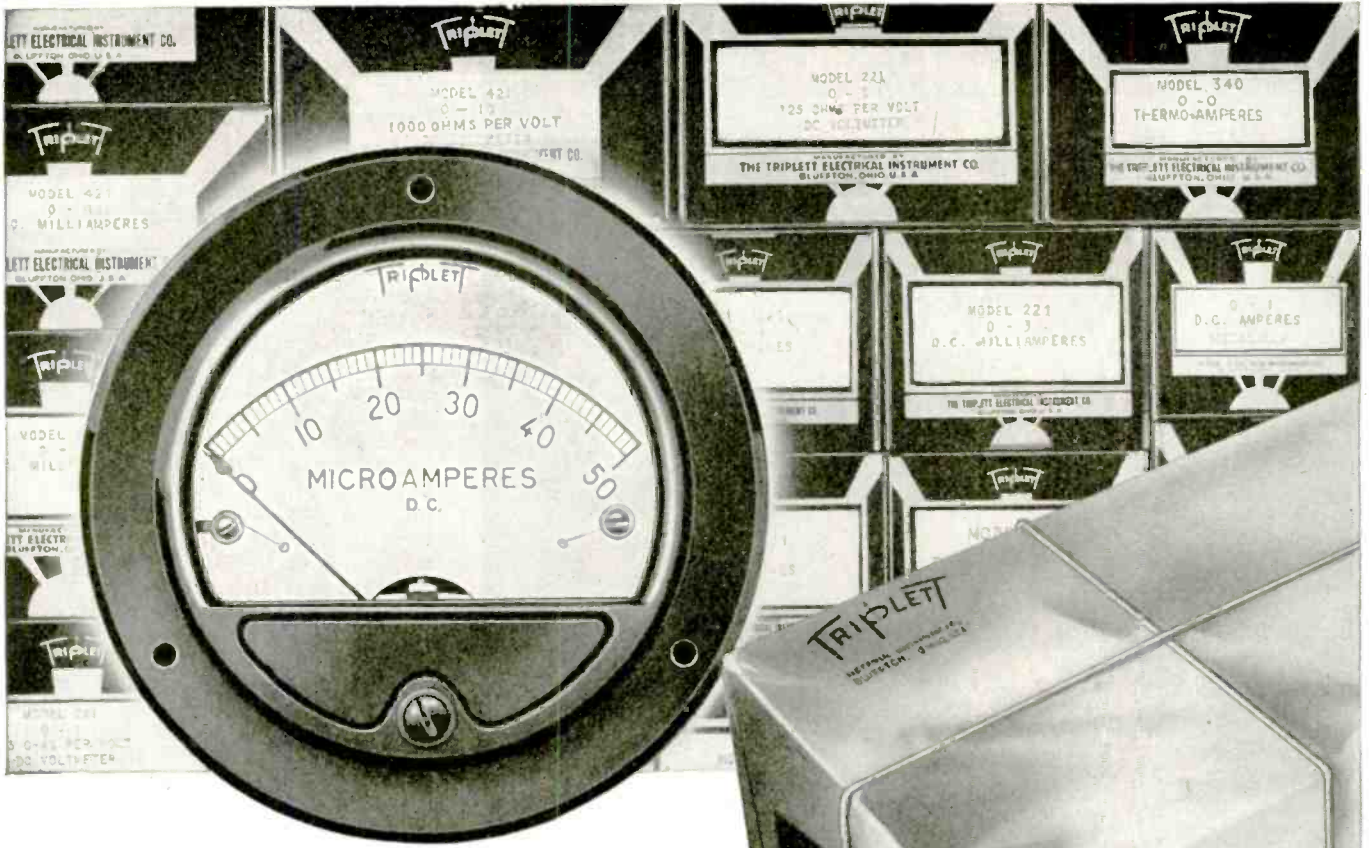

INSTRUMENT DELIVERIES!

American Instrument production is catching up with the needs of our armed forces—closing the gap between too little and enough. Caring for those needs has expanded Triplet production lines unbelievably far beyond previous capacities. And the experiences of war, added to more than forty years of instrument manufacturing, have bettered the products coming off those lines.

Now—instruments—better than ever before—are ready for general use. Better place your orders, at once, with Triplet—headquarters for a complete line of instruments made to one fine standard of engineering.

D'Arsonval Moving Coil D.C. Instruments Electrodynamicometer A.C.-D.C.
 Double Iron Repulsion A.C. Instruments R.F. and Rectifier Types; Sizes 2" through 7"

Triplet
ELECTRICAL INSTRUMENT CO.
 BLUFFTON OHIO ★ ★ ★

STANDARDS ARE SET BY





- ★ *Greater Production Capacity*
- ★ *Better Instrument Quality*
- ★ *Complete Line of Instruments*
- ★ *One Source of Supply*
- ★ *Prompt Deliveries*
- ★ **SEND YOUR ORDERS TO TRIPLETT NOW**

TODAY in WAR... TOMORROW in PEACE

BRACH

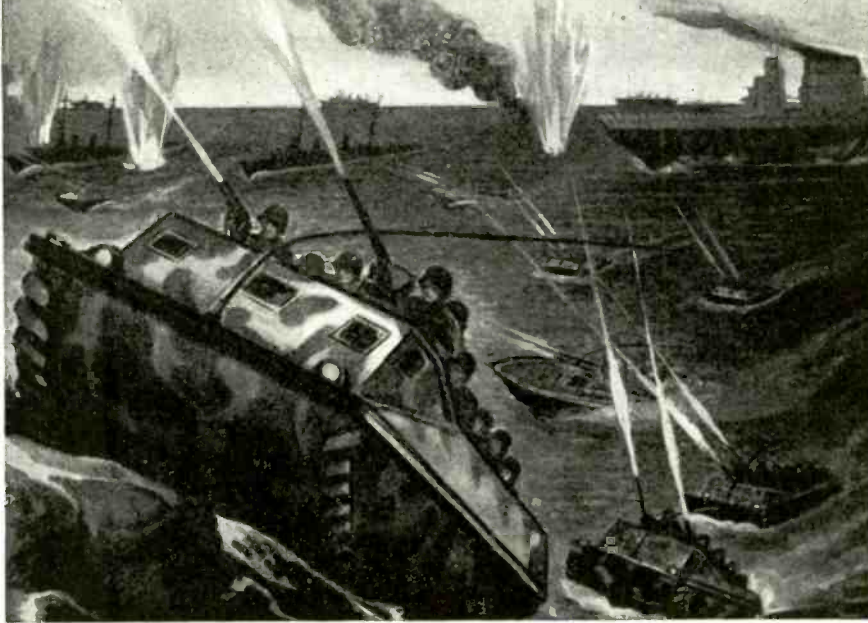
MARINE ANTENNAS and MOUNTS



Brach Marine Antennas and Mounts are now manufactured 100% for the service of Uncle Sam's amphibian tanks, PT boats, etc. But with the dawn of Victory we shall be ready and able to utilize our enhanced experience and wartime "know how" in supplying the civilian requirements for antenna equipment for ship-to-shore communication.

L. S. BRACH MFG. CORP.

World's Oldest and Largest Manufacturers of Radio Antennas and Accessories
55-65 DICKERSON STREET • NEWARK N. J.

Permanent Magnets

All Shapes, Sizes and Alloys. Alnico magnets cast or sintered under G. E. license. Chrome, Tungsten and Cobalt magnets stamped, formed or cast.

THOMAS & SKINNER

STEEL PRODUCTS CO. • INDIANAPOLIS, IND.
42 YEARS' EXPERIENCE

between plate and cathode. It is assumed that this value provides satisfactory bias by its dc drop or that some other means is provided therefore. Let $e =$ signal voltage across R_c . Then $2e =$ signal voltage between plate and cathode. Now, if the shunt and series arms of equal R and the grid are returned to their common connection, there will be no feedback at the balance frequency so that the amplifier output will be a maximum, while all other frequencies in the operating range will be attenuated by an amount depending upon the voltage gain of the stage.

Obviously, there are numerous variations of the general method. For example, in some instances it may be advisable to utilize feedback over more than one (or two) stages. It is in such cases possible to transpose the series and shunt arms where required by phase considerations. All of the methods used, for phase inversion in supplying a balanced output stage from a single tube may be adapted to this purpose. It is convenient for such cases to note that if the shunt arm is connected to a point which would otherwise connect to the grid of one of the push pull output tubes, the series arm will connect to a point normal for the grid of the other.

The required voltage for the series arm, which usually will be two or more times the voltage at the point where the shunt arm connects, may be adjusted by varying either the input or output of the stage by any desired means. Furthermore, while the most generally useful and the simplest type of selective circuit branches are discussed here (equal resistances and capacities) it is apparent that other combinations of resistance and reactive circuit elements may be used instead. In general, the circuit of the Fig. 7 with the dotted line additions, using either triodes or pentodes, best illustrates the application of this method.

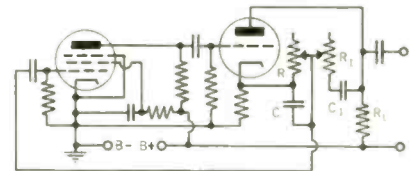

Fig. 8. Resistance-capacitance tuned oscillator of simple construction provides useful laboratory instrument

Fig. 8 shows a circuit which has been found to be very satisfactory for use in a general purpose audio oscillator. T_1 is a voltage amplifier pentode, T_2 an output triode. R_1 has a value somewhat larger than twice R_c , R and R_2 are equal 10,000-ohm wire wound sections of the control previously described. C and C_1 are equal within commercial tolerances.



READY TO TRANSMIT

—yet standby current is zero!

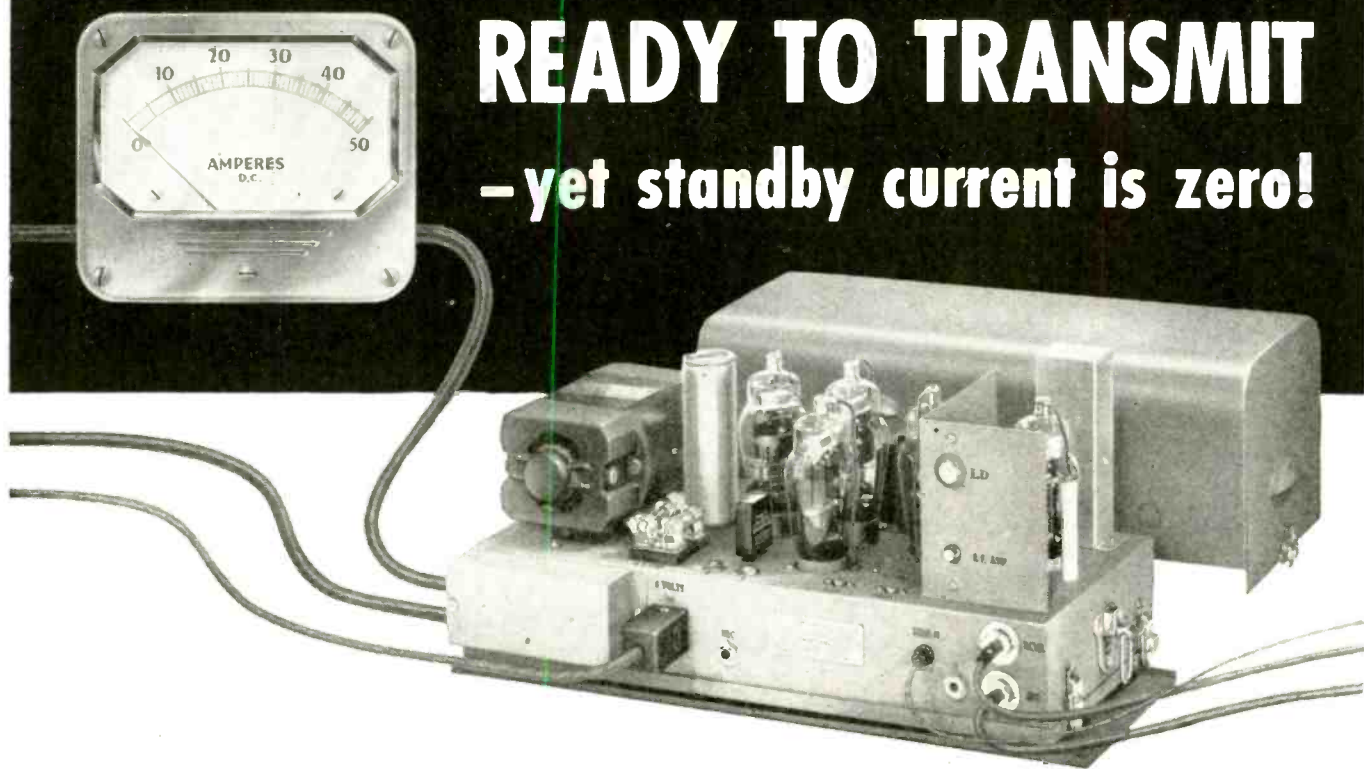

To reduce drain on batteries specify KAAR *Instant-Heating* RADIOTELEPHONES

One of the special features of Kaar mobile transmitters is their instant heating tubes. When the "push-to-talk" button on the microphone is pressed, the transmitter immediately goes on the air... but between transmissions standby current is zero. By eliminating battery drain during standby periods, this 22-watt transmitter can be operated from a vehicle's 6-volt ignition battery without requiring frequent re-charging.

The PTS-22X shown above operates on frequencies between 30

and 40 megacycles. (Available up to 62-MC on special order.) Two other Kaar transmitters, the PTL-10X and PTL-22X, for operation in the 1600-2900 KC band, are likewise equipped throughout with instant heating tubes.

Notice also how the dust cover can be removed by releasing two luggage type catches. Likewise the entire chassis can be removed for checking or servicing by releasing four additional catches.

These are but two of the features which make Kaar Radiotele-

phones so popular for military, civil and commercial communication between mobile units and a central station.

KAAR ENGINEERING CO.

PALO ALTO, CALIFORNIA



Export Agents: FRAZAR & HANSEN
301 Clay St., San Francisco 11, Calif., U. S. A.

MOBILE RECEIVERS—Crystal controlled superheterodynes for medium and high frequencies. Easy to service.



CRYSTALS—Low-drift quartz plates. Fundamental and harmonic types available in various holders.



CONDENSERS—Many types of small variable air condensers available for tank circuit and antenna tuning.



MICROPHONES—Type 4-C single button carbon. Superb voice quality, high output, moisture proof.



POWER PACKS—Heavy duty vibrators and power supplies for transmitters, receivers. 6, 12, 32, volt DC.



**ENEMY TANKS
POINT 39!**



Soldiers' lives and Victories depend upon the perfect performance of communications systems. It is the job of our Test Instruments to keep these vital systems operating at top efficiency.

We have pledged ourselves to maintain the standards of Boonton Radio quality and dependability in these instruments, in order to safeguard the lives of our boys and hasten ultimate Victory.



BOONTON RADIO
BOONTON, N. J. Corporation



DESIGNERS AND MANUFACTURERS OF THE "Q" METER . . . OX-CHECKER . . . FREQUENCY MODULATED SIGNAL GENERATOR . . . BEAT FREQUENCY GENERATOR . . . AND OTHER DIRECT READING TEST INSTRUMENTS

SOUND ON FILM

(Continued from page 101)

tained when ultra-violet is used for the recording, since its effect on the emulsion is to confine the exposure to the surface and reduce diffusion effects.

Suitable microphones for sound recording on film are conventional types with a rather narrow uni-directional characteristic and substantially uniform output over the required audio frequency range. Except for noise reduction circuits, amplifiers for sound-on-film are likewise conventional high-quality components, "flat" to eight or ten thousand cycles. It is important that the output contain very little total harmonic distortion or phase distortion since these products will be added to distortion products contributed by the film itself, not to mention the reproducers.*

Since very little power output is required for operation of a light valve or mirror-galvanometer (on the order of 1/40 watt) the problem is not complicated. Recording amplifiers frequently use push-pull throughout to minimize second and other even-order harmonic distortion. Volume-compression circuits help prevent overmodulation of the film record. Transformer coupling

*From studio to audience, the sound may pass through two acoustical states, six mechanical, four electrical, six optical, four chemical, and one radio wave energy stage, yet the final total harmonic distortion should be held to three or four per cent!

PERFORMANCE

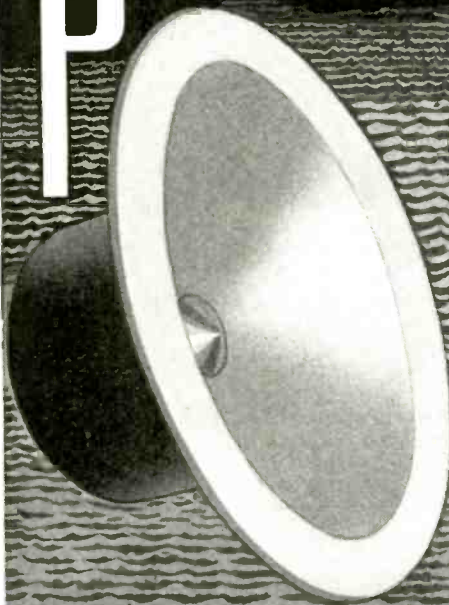

Today, front line performance that takes grueling punishment in stride — Tomorrow, the same unsurpassed performance for civilian use. In case delivery is slow, remember the armed forces get first preference. Watch Cinaudagraph Speakers After Victory!

Cinaudagraph Speakers, Inc.

3911 S. Michigan Ave., Chicago

"No Finer Speaker Made in all the World"



JONES BARRIER STRIPS

SOLVE MOST TERMINAL PROBLEMS

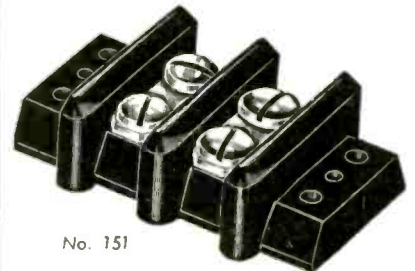

No. 151

A compact, sturdy terminal strip with Bakelite Barriers that provide maximum metal to metal spacing and prevent direct shorts from frayed wires at terminals.

6 SIZES

cover every requirement. From 3/4" wide and 13/32" high with 5-40 screws to 2 1/2" wide and 1 1/8" high with 1/4" .28 screws.

Jones Barrier Strips will improve as well as simplify your electrical intra-connecting problems. Write today for catalog and prices.

HOWARD B. JONES COMPANY

2460 WEST GEORGE STREET
CHICAGO, 18 ILLINOIS

IN EVERY NEEDED SIZE --- for Every Needed Purpose!

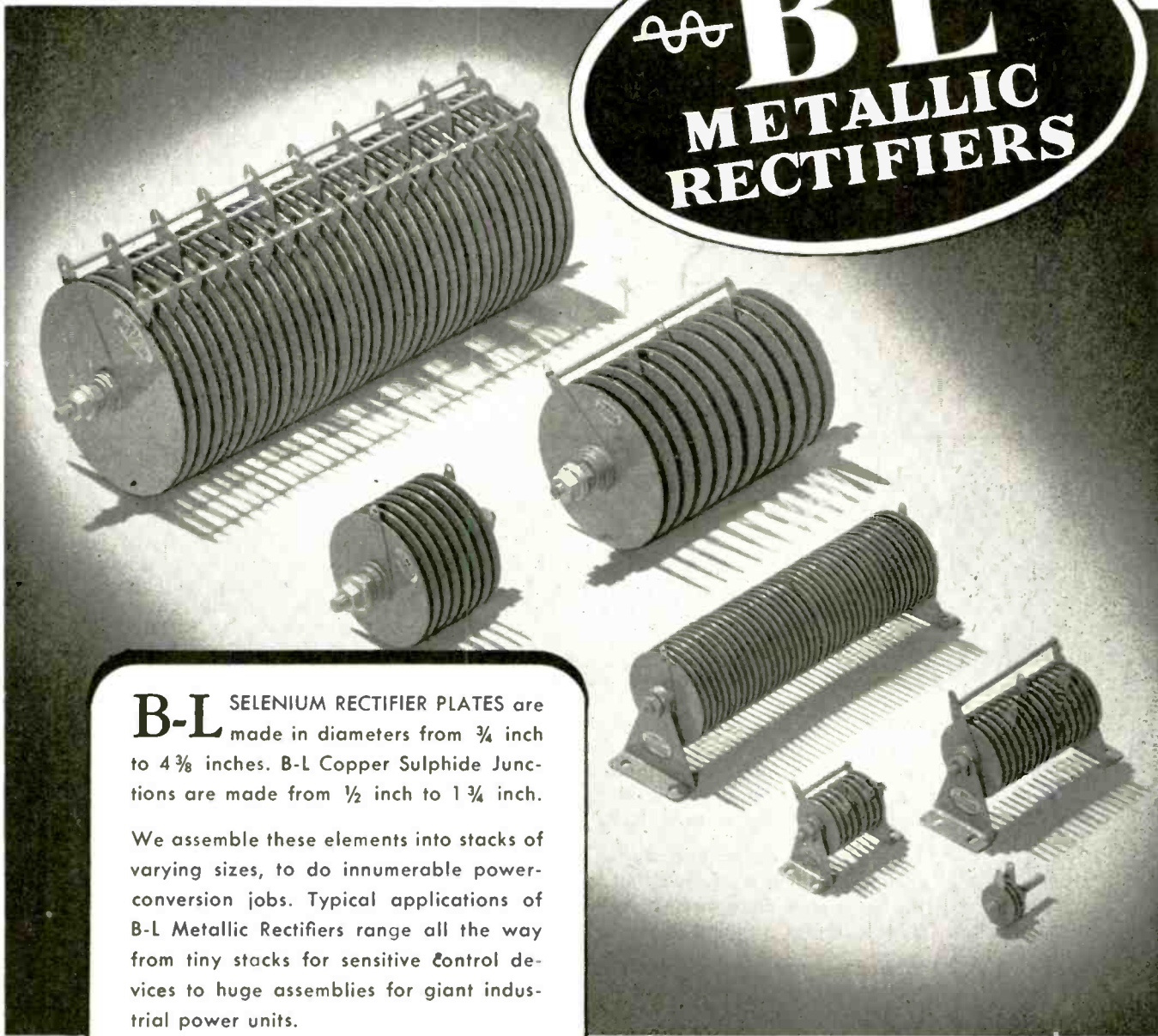

B-L SELENIUM RECTIFIER PLATES are made in diameters from $\frac{3}{4}$ inch to $4\frac{3}{8}$ inches. B-L Copper Sulphide Junctions are made from $\frac{1}{2}$ inch to $1\frac{3}{4}$ inch.

We assemble these elements into stacks of varying sizes, to do innumerable power-conversion jobs. Typical applications of B-L Metallic Rectifiers range all the way from tiny stacks for sensitive control devices to huge assemblies for giant industrial power units.

No matter what rectifier applications you are considering, B-L will be glad to work with you. Selenium and Copper Sulphide Rectifiers for all needs are available.

Write for Bulletin No. 99

B-L

THE BENWOOD LINZE CO. • ST. LOUIS 3, MO.

Designers & manufacturers of Copper Sulphide & Selenium Rectifiers, Battery Chargers, and D. C. Power Supplies for practically every requirement.

JUNIOR and SENIOR ASSISTANT DESIGN ENGINEERS

One of the country's leading designers and manufacturers of radio equipment, now engaged totally in critical war production of small intricate mechanical and electrical mechanisms, has a substantial opportunity for several men or women with at least three years of practical mechanical design and drafting experience. Must be able to make neat, accurate parts drawings with complete specifications, assembly drawings and layouts; assume responsibility, and have knowledge of general standard shop and field practices. Write fully stating age, education, experience, draft status, and compensation required. Must comply with W. M. C. regulations.

COLLINS RADIO CO.
CEDAR RAPIDS, IOWA

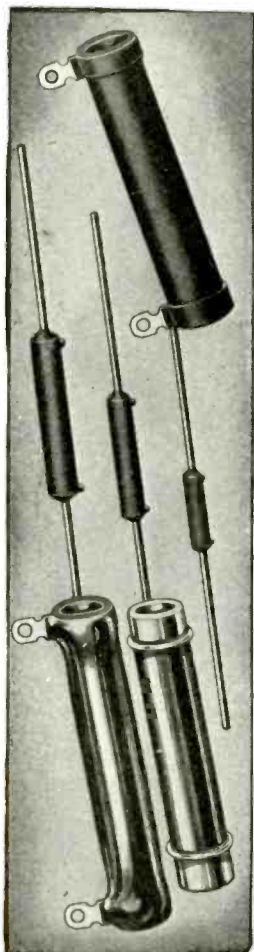

GROVES *blackohm* RESISTORS *meet the severest tests*

Grade 1, Class 2 tests are tough . . . call for rigid specifications. GROVES Organic Coated Blackohm Resistors meet, and exceed, these demands to provide the highest resistance to humidity, salt water immersion, and anti-fungus conditions.

Typical of the expert engineering and skillful manufacture built into the ferrule and terminal designs are the Groves miniature wire wound resistors of 2, 4, and 8 watt ratings, ranging in sizes down to $\frac{5}{8}$ ".

Where extremes in high heat are required, Groves Vitreous-Enamel Power Resistors are available with a durable, glossy coating, meeting the Class 1, Grade 2 "specs." They're built in standard sizes and ratings in both terminal and ferrule designs.

We'll welcome your inquiry for specific requirements.

GROVES
CORPORATION
CAPE GIRARDEAU • MISSOURI

has been popular in the design of motion picture electronic equipment but equal or superior results at lowered cost and with less weight have given impetus to the use of straight resistance coupling wherever impedance matching problems are not severe. Inverse feedback is widely employed to provide uniform output over a wide range of input levels and to reduce distortion.

One of the most important distinguishing features of electronic equipment for motion picture recording work is the almost universal employment of some scheme for film-noise reduction.

In variable area tracks, the necessity for noise reduction will be evident upon consideration of the fact that, during reproduction, any dirt, dust, scratches, or partially exposed, developed silver grains obscuring the transparent area will cause unwanted modulation of the scanning light beam. Similar defects on the dark side or portion of the track will have little effect on reproduction because this exposed portion is nearly opaque. The common form of noise reduction operates to reduce the lateral dimension of this clear portion of the track to a value just sufficient to accommodate the peak amplitude of the envelope or oscillogram of the sound being recorded. This may be done in either of two ways.

If a portion of the amplifier output be rectified and filtered, a direct current is obtained whose value is in proportion to the average amplitude of the ac signal. This dc may be applied either to the mirror galvanometer or light-valve or to another galvanometer actuating one or two spring-tensioned shutters which under no-signal condition close down on the illumination from the outside of the track, opposite the side corresponding to the ac axis of the oscillogram, or both sides in bilateral or variable density work. This will be made clear by inspection of drawing 1-A in Fig. 3, if it is remembered that this is a positive photographic print of the track as exposed in the recorder. In the bilateral track, 1-B, the biasing current may conveniently be applied to the galvanometer itself.

Any such system reduces noise by maintaining a constant signal to noise ratio for any level of modulation amplitude. If no noise reduction is used, on low level modulation the recorded envelope occupies a small portion of the lateral dimension of the track and dirt or silver grains on the wider clear area introduce spurious modulation of the scanning light beam of a relatively large magnitude.

Since the noise reduction bias is obtained from the signal itself, electrical and mechanical inertia

**Extra-rugged mechanically as well as electrically,
to withstand the most trying use and abuse . . .**

DUMONT Cathode-Ray Tubes

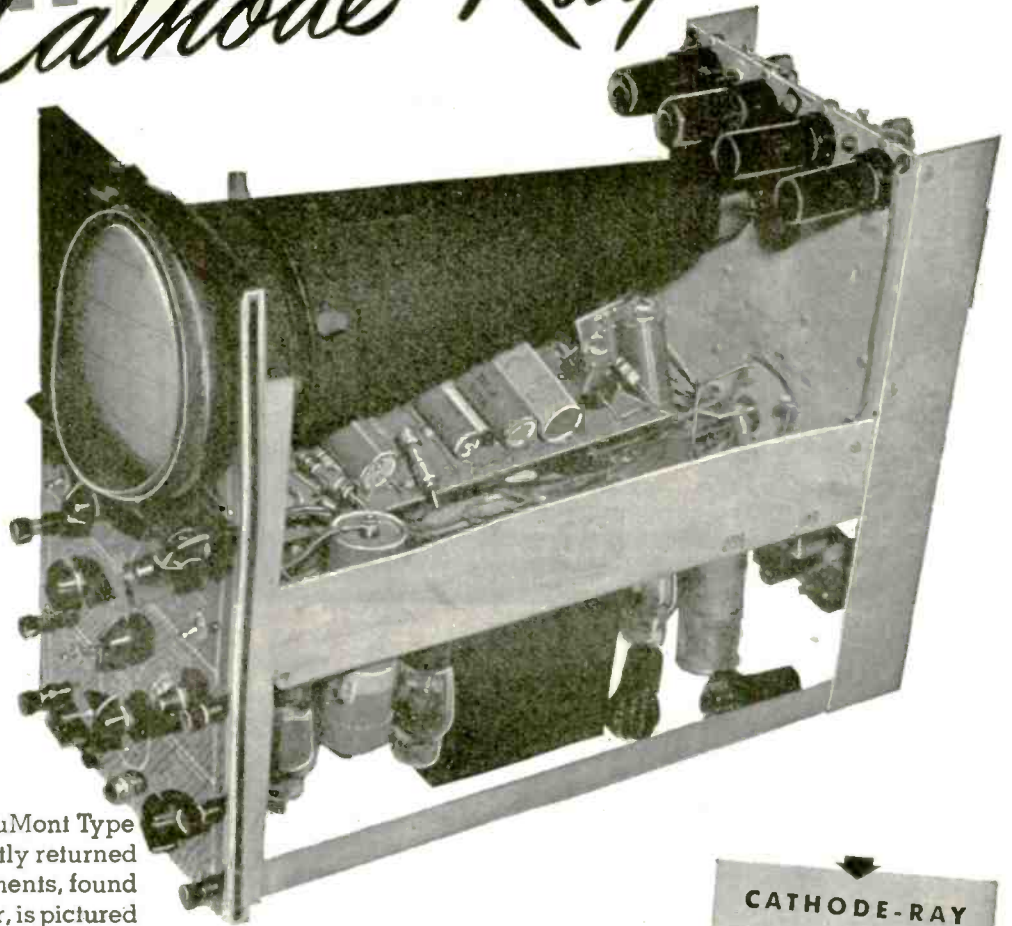

Several badly damaged DuMont Type 208 oscillographs were recently returned for repairs. One of the instruments, found to be definitely beyond repair, is pictured herewith. The main chassis was bent in two directions. The main bank was torn from its fittings, every lead wrenched free from its soldered connection. The panel was badly dented and twisted. Several tubes were jolted from their sockets. The instrument was only good for salvaged components. Yet . . .

The DuMont Type 5LP1 cathode-ray tube in that oscillograph was still in perfect operating condition, despite the surrounding wreckage.

Such is typically DuMont tube experience. For these tubes are extra-sturdy mechanically as well as electrically in order to withstand the most trying use and abuse. It is this extra factor of safety, along with dependable operating characteristics, that has made DuMont cathode-ray tubes the popular choice in much of the oscillographic equipment now in daily use.

CATHODE-RAY MANUAL . . .

The DuMont combination manual and catalog is available to engineers, designers, electronic equipment maintenance men, instrument-makers, manufacturers, etc. Write on business stationery for your registered copy.

© ALLEN B. DUMONT LABORATORIES, INC.

DUMONT

Precision Electronics & Television

ALLEN B. DUMONT LABORATORIES, INC., PASSAIC, NEW JERSEY • CABLE ADDRESS: WESPEXLIN, NEW YORK

ENGINEERS: Here's
the **BIG POINT** about
**AMPERITE
REGULATORS**

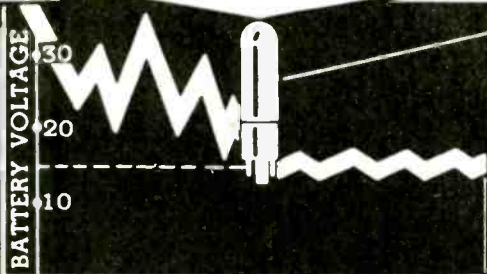

VOLTAGE OF 24V
BATTERY & CHARGER
VARIES APPROX. 50%
WITH AMPERITE
VOLTAGE VARIES
ONLY 2%

50% **2%**



Features:

1. Amperites cut battery voltage fluctuation from approximately 50% to 2%.
 2. Hermetically sealed — not affected by altitude, ambient temperature, humidity.
 3. Compact . . . light . . . and inexpensive.
- Used by U.S. Army, Navy, and Air Corps.

DELAY RELAYS: For delays from 1 to 100 seconds.
Hermetically sealed. Unaffected by altitude. . . . Send for catalogue sheet.

NEW! 4-page folder will help you solve Current and Voltage Problems; contains much valuable data in practical form — Write for your copy now.

AMPERITE CO., 561 Broadway, New York (12), N. Y.

In Canada: Atlas Radio Corp., Ltd., 560 King St., W. Toronto

often prevent the track-width from "opening up" in time to record the first waves of a large amplitude signal. This effect, known as "clipping," is reduced by designing for the lowest possible time-constant, in the bias amplifier and rectifier circuits, and reducing weight and inertia of the shutter or galvanometer. The problem is not generally difficult.

Several alternative technics have been the subject of considerable experimentation. One method employs two microphones, one a few feet closer to the sound source. The first controls the noise reduction amplifier channel and shutter bias, and, by proper adjustment, opens the track adequately by the time the sound wave has arrived at the second microphone.

In recording variable density track, the bias may be similarly applied to the light valve itself. In this case, the ribbons are closed down under no signal conditions, opening up with increasing signal only sufficiently to reach the proper mean spacing to accommodate the negative peaks of the signal at any given amplitude without over-closing and producing "clash." This technic yields a sound recording whose average density is always as light as possible for a given signal-voltage input, so that the print for projection is always as dark as possible. When shutters are used with variable density for the noise reduction current, the so-called "squeeze" track of 2-B is produced.

Another method of noise reduction depends on the fact that most of the film ground-noise is in the higher frequency range. Thus, pre-emphasis in recording and de-emphasis in reproduction of the higher frequencies give some noise reduction without affecting the amplitude/frequency fidelity of the signal itself.

The majority of commercial theater sound reproduction systems are not capable of doing justice to the products of the recording systems in general Hollywood use. Most 16 mm. reproducers available commercially are inferior to the best available 16 mm. sound track, made either by optical reduction from 35 mm. or by direct-on-16 recording. This is regrettable from the television standpoint, since much of what will be telecast will probably be on 16 mm. film. Again it should be pointed out that the final distortion in the home is the sum total of all distortion introduced along the line. Television motion picture sound being dispensed at present is not of highest quality, and the available projectors are currently one of the most important limitations.

Only one 16 mm. projector on the market provides for precise focus of the scanning light beam

*Laboratory
Standards*

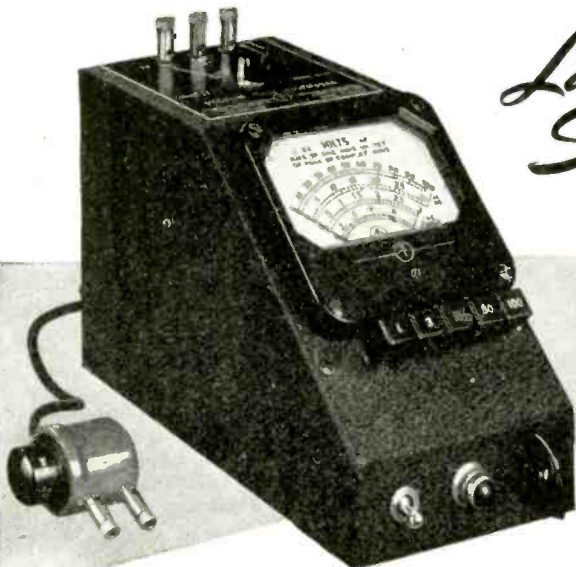

MODEL 62

VACUUM TUBE VOLTMETER

SPECIFICATIONS:

- RANGE:** Push button selection of five ranges—1, 3, 10, 30 and 100 volts a. c. or d. c.
ACCURACY: 2% of full scale. Useable from 50 cycles to 150 megacycles.
INDICATION: Linear for d. c. and calibrated to indicate r.m.s. values of a sine-wave or 71% of the peak value of a complex wave on a. c.
POWER SUPPLY: 115 volts, 40-60 cycles—no batteries.
DIMENSIONS: 4 3/4" wide, 6" high, and 8 1/2" deep.
WEIGHT: Approximately six pounds. **PRICE:** \$135.00 f.o.b. Boonton, N. J.

MEASUREMENTS CORPORATION
BOONTON, NEW JERSEY

VOICE* *in Industry*

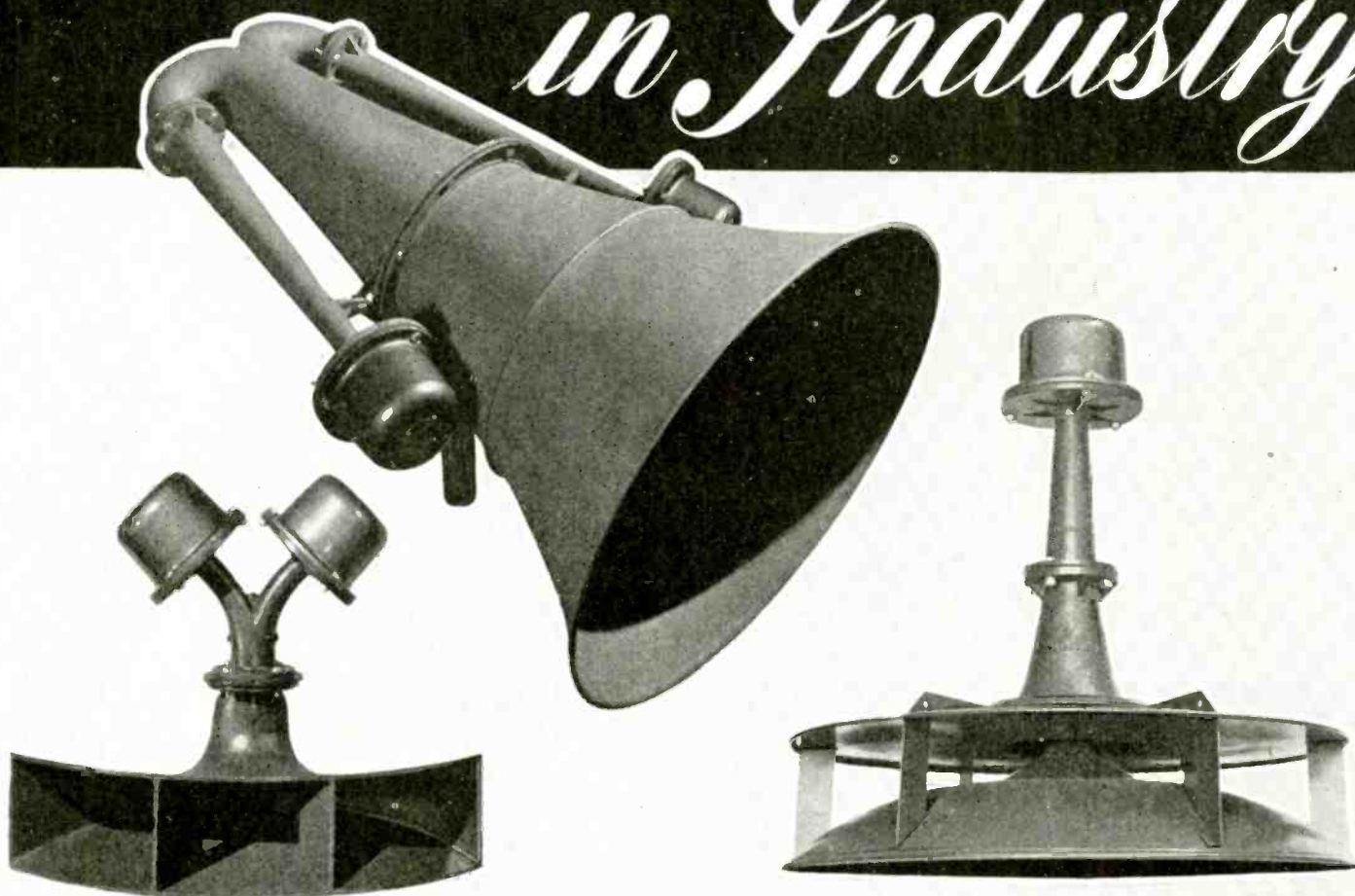

*Units illustrated are designed for maximum intelligibility through high noise levels plus economy of installation. Recommended for areas where wide angle distribution of high frequencies are necessary. Complete technical bulletins describing the above upon request.

Type 26-B is designed for voice reproduction when used by itself. Also an excellent high frequency component to a wide range system. Provides uniform distribution over horizontal angle of 120° and vertical of 40° . Handles power input of 40 watts when equipped with two Jensen U-20 drive units. 22" wide, 14½" deep, 20" high.

Type 24-A is primarily an outdoor speaker. At 50 watts input produces a sound level of + 94 db. (Zero reference level 10^{-16} watts per cm^2) at 100 ft. distance on the axis of horn. Two or four Jensen U-20 drive units allow a maximum of 50/100 watts input. 38" long, 26" wide, bell diameter 25".

Type L-360 is designed for 360° horizontal coverage and 40° vertical with uniform frequency and power distribution. Handles power input of 20 watts when equipped with a single Jensen U-20 drive unit. 23" in diameter overall; weight 25 lbs.

The Langevin Company

INCORPORATED

SOUND REINFORCEMENT AND REPRODUCTION ENGINEERING

NEW YORK

37 W. 65 St., 23

SAN FRANCISCO

1050 Howard St., 3

LOS ANGELES

1000 N. Seward St., 38

BACK THE INVASION — BUY MORE WAR BONDS NOW!

NO "SHORTS" IN DIALCO PILOT LIGHTS

New Improvement
**MAKES SOCKETS
PERMANENTLY ANCHOR-
TIGHT and FOOL-PROOF!**

ORIGINATED BY DIALCO.
ONLY DIALCO UNITS
HAVE THIS VITAL
IMPROVEMENT!

Note this rugged construction. Shell, bracket, and lugs are permanently ANCHOR-TIGHT and foolproof, preventing shorts. Dialco manufactures an extensive line of Pilot Lights and Socket Assemblies having this feature. Write for samples and Catalogue.

PLUS LAMPS To speed production, we can supply any Pilot Light assembled with G.E. or Westinghouse Lamps.

DIAL LIGHT
CO. of AMERICA, Inc.
900 BROADWAY
New York 3, N. Y.
Algonquin 4 5180 1-2 3

STAKED
TABS



NOTCHES

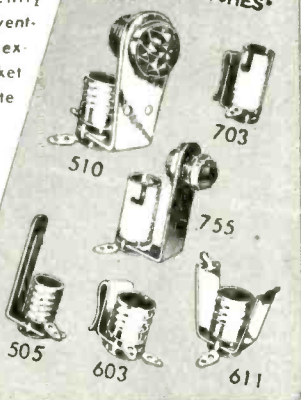

BACK THE INVASION — BUY MORE WAR BONDS NOW!

on the emulsion. Since emulsion position of 16 mm. prints frequently varies from the standard (toward the screen) some provision for accurate, pre-set change of focus should be made. Moreover, most 16 mm. projectors are subject to non-uniform film-flow problems of one kind or another. Uniform motion is no less a requirement in the projector than in the recorder.

REFERENCES

"Vacuum Tube Engineering for Motion Pictures," by L. C. Hollands and A. M. Glover, Research and Engineering Dept., RCA, Harrison, N. J.

"Motion Picture Sound Engineering," Research Council, Academy of Motion Picture Arts and Sciences, Hollywood, Calif. New York, D. Van Nostrand Co., Inc.

Journal of the Society of Motion Picture Engineers, Hotel Pennsylvania, New York, 1930 to date.

CATHODE COUPLING

(Continued from page 107)

imum signal encountered. When cathode follower tubes are used at high frequencies it is advisable to by-pass the plate circuits adequately as shown in Fig. 6. A plate isolation resistor can also be used to advantage especially where circuit interactions are experienced through the power supply.

The circuits shown are basic and small variations might have to be added in some instances of application.

Where it is desired to obtain greater power output several tubes can be operated in parallel. The only additional factor will be the total grid input capacitances of all the tubes in parallel which will be additive, but on the whole will not be detrimental in most cases.

The gain obtained, as mentioned is slightly less than unity. Referring to Fig. 1 the formula to be used is

$$G_m = \frac{\mu R_2}{R_p + R_2(\mu + 1)}$$

Where

μ = amplification of tube

R_2 = Cathode resistor in ohms

R_p = Plate resistance

The apparent output impedance Z_1 , Fig. 1 is

$$Z_1 = \frac{R_2 R_p (\mu + 1)}{R_2 + R_p / (\mu + 1)}$$

By proper application very low effective output impedance can be derived.

No doubt any number of other uses will suggest themselves and it is possible that many circuits will present themselves where the use of the "cathode follower" circuit will be of decided advantage in eliminating cumbersome matching difficulties.

Radiart's SALES POLICY



FULL COOPERATION

Radiart's Sales Policy has been and will continue to be based on full cooperation with our jobbers and service men.

Our civilian production is divided equitably among our jobbers to give each his share.

Our catalog (a new one is now being printed) is designed to give the greatest possible help on all vibrator problems. It is the only catalog with complete cross index.

Radiart is a leader in the vibrator field. Our entire sales policy of full cooperation with our jobbers and service men is directed toward maintaining that leadership.

Radiart Corporation

3571 W. 62nd. St.

CLEVELAND 2, OHIO

What is your sheet metal fabrication problem?

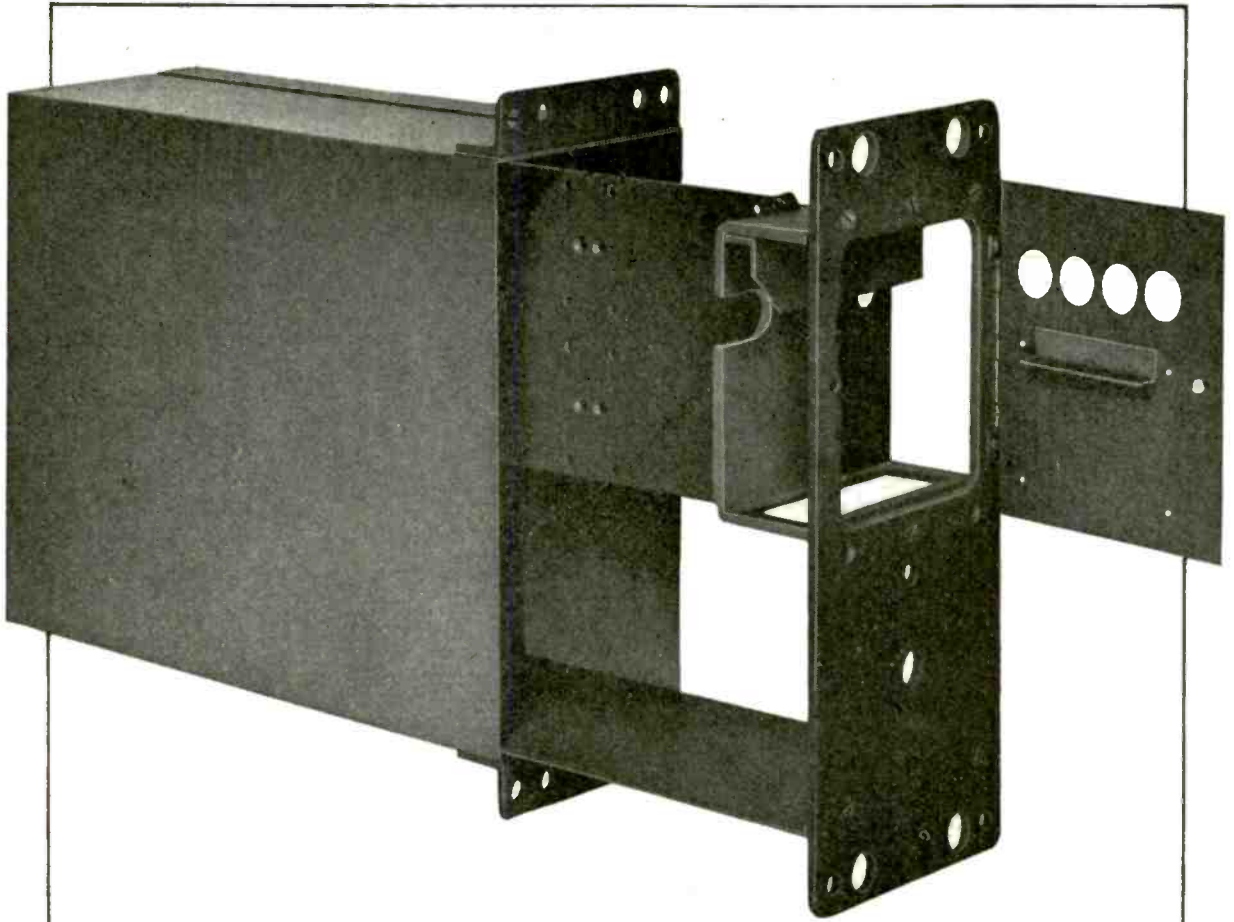

IS IT DELIVERY? IS IT QUALITY? IS IT PRICE?

The arithmetic is simple:

KARP'S production and engineering techniques plus tools, equipment, personnel and hundreds of stock dies ADD UP TO . . .

KARP'S savings for you in time, labor and expense and . . .

KARP'S universally praised quality and delivery at competitive prices.

ARTISANS IN
SHEET METAL

KARP METAL PRODUCTS CO., INC.

CABINETS • CHASSIS
RACKS • PANELS

126 30th STREET • BROOKLYN 31, N. Y.

IT'S IMPORTANT TO BUY WAR BONDS . . . MORE IMPORTANT TO HOLD ON TO THEM

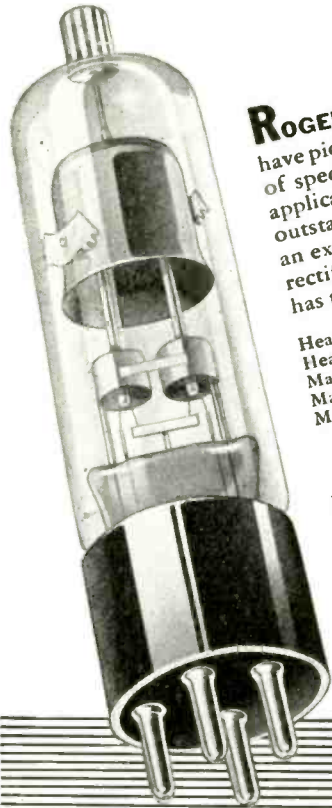

ROGERS ELECTRONIC TUBES LIMITED
 have pioneered in the development of a number of special purpose types of tubes for difficult applications. The type 12 X 3 illustrated is an outstanding example of a tube engineered for an exacting job. It is a high vacuum half-wave rectifier with an indirectly heated cathode, and has the following ratings:

Heater Voltage (ac or dc)	12.6 volts
Heater Current	0.65 amps
Maximum DC Heater-to-Cathode Potential	50 volts
Maximum Peak Inverse Voltage	7000 volts
Maximum Peak Plate Current (At $E_B = 270$ volts)	200 ma

Typical Operation:
 HALF-WAVE RECTIFIER (Condenser Input to Filter)
 AC Plate Voltage per plate (RMS) . 2500 volts max.
 DC Output Current 10 ma max.

You are cordially invited to write for further information on this and other special or standard tubes.

Makers of high-quality Transmitting and Receiving Tubes since 1926.

EN-3-44

ROGERS

ROGERS ELECTRONIC TUBES, LIMITED
 TORONTO CANADA

Electronic Baby Alarm

The apparatus, described by J. S. Worthington in a recent issue of Electronic Engineering, was designed and constructed to indicate that a baby was awake and crying. It can be arranged to give a warning in a distant room, in the garden, or anywhere else required. The sensitivity is such that a low moan or whimper two feet from the microphone will cause a relay to close, operating a buzzer at the remote point. The microphone input is amplified and applied to a rectified reaction stage which feeds the relay.

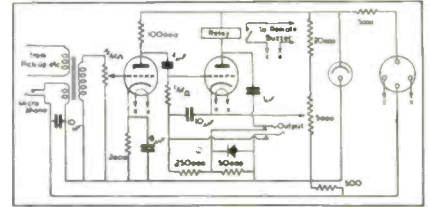

The unit may be operated as a pre-amplifier. By providing an input volume control and arranging to use the feedback capacitor and the impedance of the relay winding as output coupling and disabling the rectifier network, a high gain, high quality amplifier is made available.

NORTON N INSTRUMENTS

Hand Calibrated for Your Exact Needs

The scales of Norton Instruments are hand drawn and hand calibrated to meet your special requirements, thus assuring accuracy at every reading point.

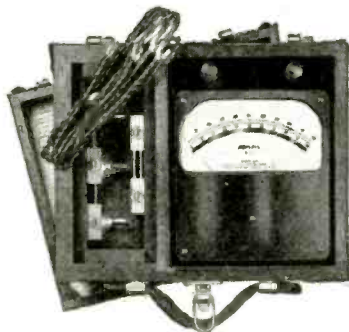

Furnished for both switchboard and portable use. Magnetically shielded. Hardened, specially ground pivots, supported by sapphire jewels.

Norton has served the industrial and marine fields for fifty years. Wherever accurate measurement of electrical units is called for, there is a Norton Instrument to meet the requirements.

Send for our new catalog

NORTON Electrical Instrument Co.
 85 HILLIARD ST., MANCHESTER, CONNECTICUT

PLASTIC

NAME PLATES

SCALES, GAUGES, CALCULATORS, CHARTS, DIALS, ETC.

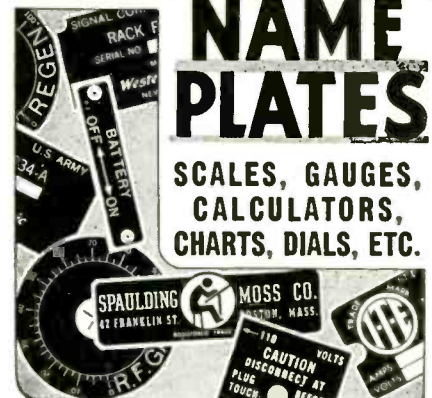

- Impervious to moisture, grease, oils, acids, alkalis.
- Printing guaranteed not to wash or rub off.
- Non-inflammable, non-corrosive plastic.
- Printed and laminated vinylite and cellulose acetate.

SAMPLES AND ESTIMATES GLADLY SUPPLIED ON REQUEST WRITE DEPARTMENT E, 1.

THE HOPP PRESS, INC.
 PRINTING — FABRICATING — FORMING
 460 W. 34th STREET, N. Y. C.
 ESTABLISHED 1893

WIEDEMANN HIGH ACCURACY PUNCHES and DIES

LOW IN COST, PIERCE CLEANER, LAST LONGER

The quality and low cost of Wiedemann Punches and Dies is no accident—they are the result of accurate machining, scientific heat

treatment, precision grinding, and rigid inspection; plus over 25 years' experience producing quality punches and dies.

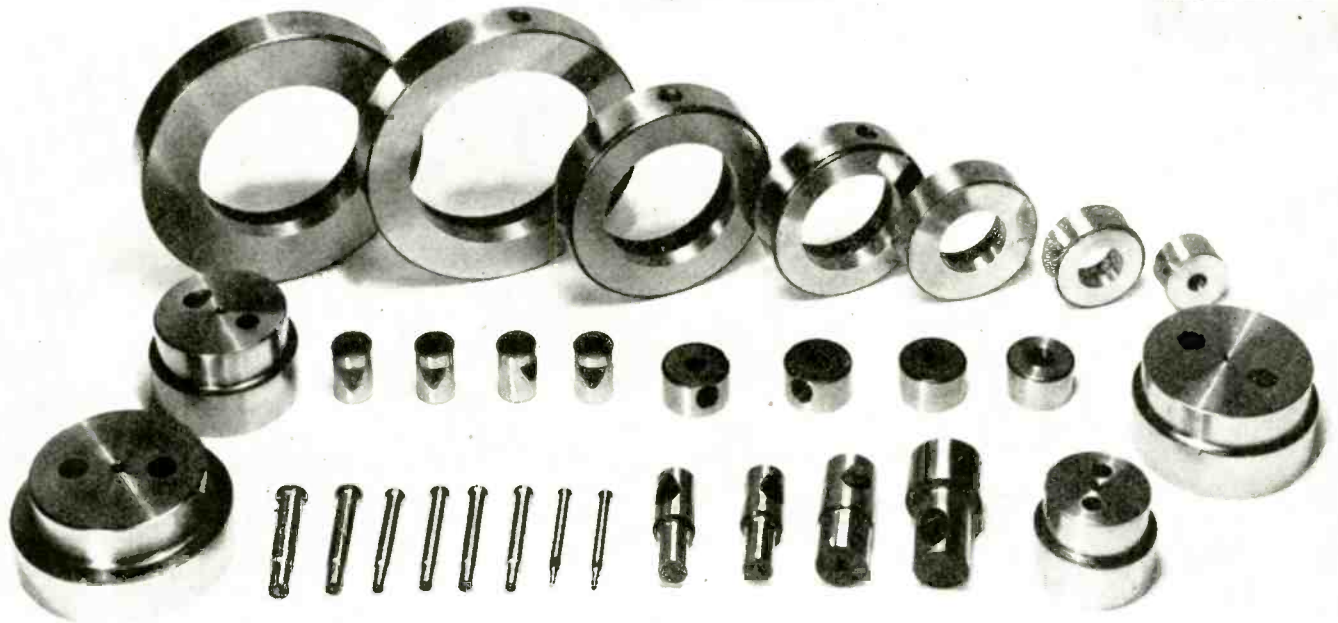

WIEDEMANN HIGH ACCURACY PUNCHES AND DIES

are being used extensively in the aircraft, electronic, ship building, electrical and sheet metal industries for the production of aircraft and parts, radio and electronic components and chassis, instrument panels, electrical boxes, housings, enclosures, bus bars, sheet metal parts and similar pierced sheet metal up to 3/16" in thickness. For heavier materials send details.

PHONE, WRITE OR WIRE ORDERS.
SAMPLE OF A SMALL SIZE PUNCH
AND DIE WILL BE SENT TO
QUALIFIED PRODUCTION MEN.



FILEWORTHY FACTS ABOUT WIEDEMANN PUNCHES AND DIES

1. All diameters precision ground, giving smoother surfaces and resultant lower stripping pressures and longer die life.
2. Shank diameters and punch diameters of all punches, as well as OD and ID of dies are ground concentric. *This permits interchangeability of punches and dies without realigning the die.* (Concentricity is maintained on dies having diameters of 3/16" and under, although ground on OD only.)
3. Punches up to 11/32" diameter have small shanks fitting into inexpensive insert sleeves.

SHIPMENT FROM STOCK ON PUNCHES AND DIES UP TO 3 1/2" DIA.

1. Wiedemann Punches and Dies are carried in stock in increments of 1/64" up to 1/2" diameter.
2. Punches and Dies over 1/2" diameters are carried in stock in increments of 1/16".
3. Popular sizes of letter and number punches and dies also carried in stock.
4. On large quantity orders of any one size, partial shipment is made from stock—balance of order is shipped in one week to 10 days.

WIEDEMANN MACHINE CO. 1833 SEDGLEY AVENUE
PHILADELPHIA 32, PENNA.

Designed for



Application

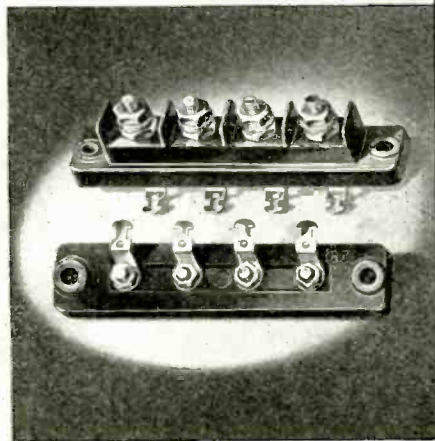

**The No. 37104
Terminal Strip**

is a sturdy four-terminal strip of molded black General Electric Textolite much used on present production Army and Navy equipment. Barriers between contacts. "Non turning" studs, threaded 8/32 each end.

**JAMES MILLEN
MFG. CO., INC.**

MAIN OFFICE AND FACTORY
**MALDEN
MASSACHUSETTS**



FRONT

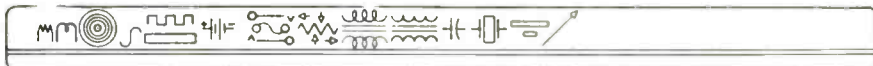

BACK

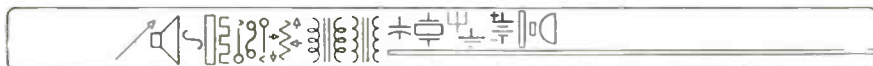

This lettering guide (Keuffel & Esser) has been developed for the use of draughtsmen and others in quickly and easily producing the newly standardized symbols in legible form

<p>FIXED</p> <p>VARIABLE OR ADJUSTABLE</p>	<p>OPEN</p> <p>CLOSED</p> <p>SIMPLE OR SEQUENCE</p>	<p>SIMPLE</p> <p>DETAILED</p> <p>SIMPLE</p> <p>DETAILED</p> <p>FIXED</p> <p>VARIABLE OR ADJUSTABLE</p>	<p>SIMPLE</p> <p>OR</p> <p>DETAILED</p> <p>OR</p> <p>FIXED</p> <p>VARIABLE OR ADJUSTABLE</p>	<p>OR</p> <p>OR</p> <p>OR</p>
<p>CAPACITOR</p>	<p>CONTACT</p>	<p>RESISTOR</p>	<p>INDUCTOR</p>	<p>TRANSFORMER</p>

Following many conferences designed to iron out differences in the use of symbols on circuit diagrams, these standards have now been adopted for both communications and industrial diagrams

CIRCUIT DIAGRAM SYMBOLS ARE STANDARDIZED

Progress in the coordination and simplification of basic electrical symbols to eliminate discrepancies between circuit diagrams produced by different organizations, has reached a climax in the issuance of a non-conflicting list of symbols by the American Standards Association. The long-standing conflict in electrical graphic symbols between the fields of electrical communications, power, control, and measurement were not considered serious until the war had accelerated the overlapping of these fields and the resulting confusion, notably in the aircraft industry and in industrial electronics, became serious for the industries affected. Technical articles sponsored by either group were received with irritation or else were unread by those in the other group.

A conference was held in New York on January 22, 1944, at which representatives of technical societies, trade associations, the War and Navy Departments, the Aeronautical Board, the National Aircraft Standards Committee and of certain other industrial organizations concerned attended. At this conference, a draft of a proposed standard was agreed upon and circulated for formal approval to the interested organizations. As the result of the circulation, certain objections and suggested changes were received.

Differences were ironed out during subsequent conferences and through correspondence, so that finally the symbols described here were unanimously recommended.

Arguments as to the relative ease of constructing the various symbols by ordinary drafting instruments are less important because of the widespread use of lettering guides and templates.

Already these symbols have been made available on commoner forms of drafting aides, such as the Leroy guide (Keuffel and Esser), one form of which is illustrated. Such aids will find much use in drafting departments where clarity and uniformity can be combined with speed in laying out a circuit, since the tedious work of showing resistors, inductances, etc., can now be handled by a single movement of a special pen.

Following recommendations apply to specific symbols:

Capacitor: Where it is necessary to identify the capacitor electrodes, the curved element shall represent the outside electrode in fixed paper-dielectric and ceramic-dielectric capacitors, the negative electrode in electrolytic capacitors and the movable element in variable and adjustable capacitors. When it is desired especially to distinguish trimmer capacitors, the letter T should appear adjacent to the symbol.

Contact: The line representing contacts shall be approximately equal to 1 1/4 times the width of the gap between the lines. The symbol for sequence contact may also be used for a simple contact in order to maintain uniformity and avoid confusion on drawings.

Resistor: *This symbol must always be used with an identifying legend within or adjacent to the rectangle.

Inductor: When it is desired especially to distinguish magnetic core inductors, a line or lines parallel to the axis of the loops should be used.

Transformer: When it is desired to show magnetic core transformer, a line or lines parallel to the axis of the loops should be used.



G-E MYCALEX

The development of G-E mycalex, the superior insulator possessing low dielectric power losses at high temperature, is of particular interest to the radio, electronic, industrial control and heating industries.

G-E mycalex has superior electrical characteristics and good mechanical strength. It has a low power factor, high arc resistance, chemical and dimensional stability and a low coefficient of thermal expansion. It is impervious to water, oil and gas and is unaffected by sudden temperature changes. Metallic inserts can be readily molded into the parts.

General Electric is molding mycalex for rectifier seals, brush holder studs, tube bases, switch insulation, structural parts in radio transmitters, arc chutes, relay insulators, terminal insulators and as inserts in die castings and organic plastics. For further information write Section O-251, Plastics Divisions, General Electric Company, 1 Plastics Avenue, Pittsfield, Mass.

Hear the General Electric radio programs: "The G-E All-girl Orchestra" Sunday 10 P.M. EWT, NBC. "The World Today" news, every weekday 6:45 P.M. EWT, CBS.

FIFTY YEARS IN THE PLASTICS INDUSTRY

GENERAL  ELECTRIC

PD-251

BUY WAR BONDS

Electrodes for Crystals

BUTTON TYPE. FLAT OR STEPPED TYPE

SQUARE, OBLONG AND ROUND

CLOSEST TOLERANCES

EXCELLENT FINISH

MINIMUM LAPPING
GREAT SAVINGS IN MAN HOURS
AND COSTS

PROMPT DELIVERIES

Send for full information

Gemex Company

UNION, NEW JERSEY

Plastics, \$250,000,000

It is estimated that in the past two years the plastics industry has expanded 100 per cent, with the value of plastics produced in the United States during 1943 totaling an aggregate value of \$250,000,000, reports Ralph Hemphill, founder of the Plastics Institute, 186 S. Alvarado St., Los Angeles, Calif. The figure represents the value of raw materials only and more than 85 per cent of the industry's energies are devoted to war production.

DEFLECTION BEAM

(Continued from page 93)

TABLE II
CIRCUIT PROBLEM SOLUTION

No.	Input Signal	Output Desired	Circuit No.
10.....	Voltage	Voltage and Displacement	N1a
11.....	Current		N1b
12.....	Displacement		N1c
13.....	Voltage	Current and Displacement	N2a
14.....	Current		N2b
15.....	Displacement		N2c
16.....	Voltage	Displacement	N3a
17.....	Current		N3b
18.....	Displacement		N3c

Null circuits are suited for all those applications where not only an indication of the unknown signal is wanted but where mechanical power is required to perform further operations in accordance with the applied signal. This leads immediately to the field of instru-

VOKMAR

Manufacturers of
RADIO, ELECTRICAL AND
ELECTRONIC COMPONENTS

ELECTRONIC PRODUCTS MFG. CORP.
DEXTER, MICHIGAN

BIRD & CO. GLASS INSTRUMENT BEARINGS

GLASS "V" BEARINGS
made to your specifications



We welcome your inquiries

RICHARD H. BIRD

Manufacturers of Jewel Bearings
for thirty years

23 MOODY STREET
WALTHAM, MASS.



QUALITY . . . IN QUANTITY!

Because permanent magnets must conform precisely to specifications, producing them by the million is an unusual engineering achievement. This company is America's largest exclusive maker of permanent magnets

The
INDIANA STEEL PRODUCTS
Company

6 NORTH MICHIGAN AVENUE • CHICAGO 2, ILLINOIS

★ **Specialists in Permanent Magnets Since 1910** ★

Manufacturers with permanent magnet problems to solve have received invaluable assistance from our design and development engineers. Their specialized experience is available to you, too. Write for a copy of our "Permanent Magnet Manual."

Help Win the War in '44 — Buy War Bonds!

COPYRIGHT 1944, THE INDIANA STEEL PRODUCTS COMPANY

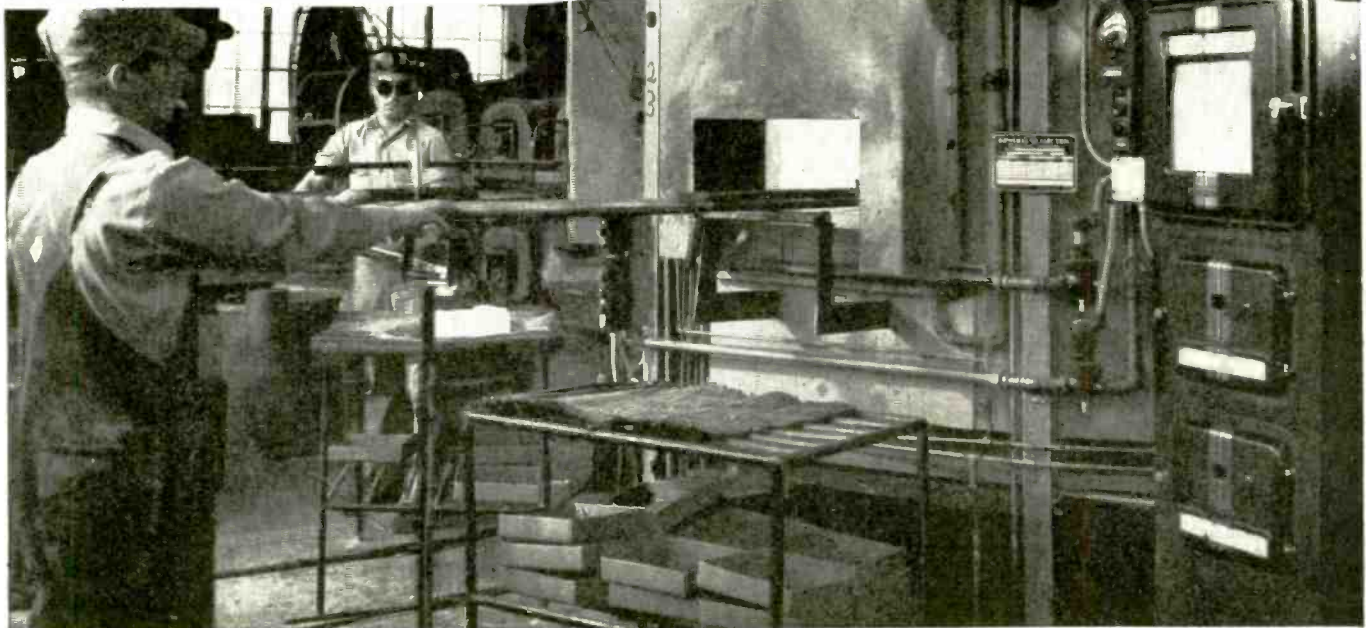

Specialists

... in Assembly and sub-assembly
of Precision Electronic Products

- Complete Facilities for Production
and Testing of Audio Equipment
- Consult us with your Production
Assembling Problems

RADELL

C O R P O R A T I O N

6323-27 GUILFORD AVENUE, INDIANAPOLIS 5, INDIANA

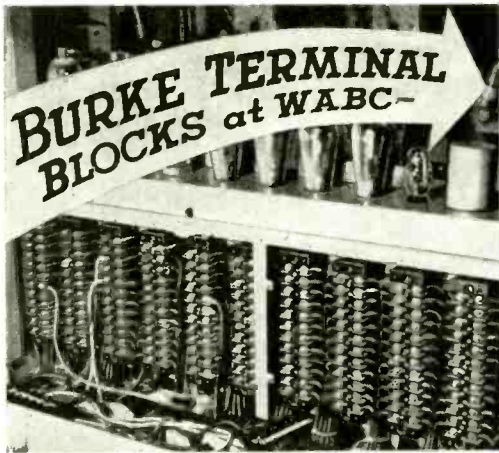

BURKE Terminal Blocks were selected for wiring in WABC'S new 50,000 watt transmitter. This great new transmitter with the salt-water-start projects a signal two to ten times stronger than before. You make a good start too, if you choose Burke high-quality Terminal Blocks.

*Write for folder and prices—
good deliveries assured.*

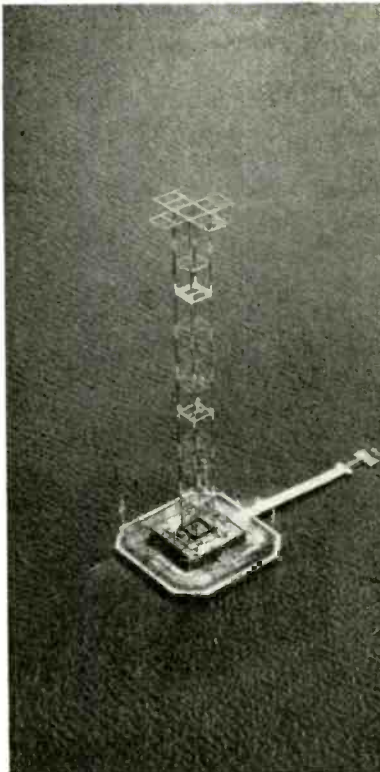

AC AND DC MOTORS AND GENERATORS
BURKE Terminal BLOCKS
BURKE ELECTRIC COMPANY • ERIE, PENNSYLVANIA

mentation and automatic control. As an illustration of this type of application, a simple pressure control system is shown in Fig. 10. The pressure at point P of a pipe line should be maintained at a predetermined value. At point P, therefore, a connection is made to a pressure-current converter which supplies current, proportional to the existing pressure, to the secondary deflection system of a beam tube. A setting voltage is applied to the primary deflection system. As long as the two deflecting forces are in balance the motor will not operate, and control valve V is in the correct position to produce the desired pressure at point P. Whenever the pressure at P deviates from this value the unbalanced electron beam will cause the motor to readjust the valve until the pressure has been brought back to the correct value.

Experimental circuits

A number of experimental deflection beam tubes are shown in Fig. 11. While the principles of standard cathode ray tube design can be readily applied a few special points should be mentioned briefly.

Although it is very convenient to use standard electron gun systems there is no need for a spot cross-section of the beam. The beam current can be greatly increased by employing a wedge shaped sheet of electrons rather than a beam of circular cross-section. The focusing system in this case will be similar to cylindrical optical systems.

The fact that the angle of beam deflection is comparatively small may lead to deflection systems of increased sensitivity.

Desirable design

The design and circuit connection of the target electrodes should be such as to suppress secondary emission from the target plates. However, secondary emission may be utilized, in another type of tube design, to furnish the target current.

Use of comparatively small anode voltages may be desirable in industrial applications and proper shielding should be provided as a protection against undesired external fields.

An experimental circuit of a single-target tube with associated current amplifier is shown in Fig. 12. The circuit corresponds to circuit A2a of Fig. 4. A laboratory model of the circuit is shown in Fig. 13.

The circuit was used to perform the two characteristic tests discussed earlier. In Fig. 13 the output current I is plotted against the signal voltage for different ratios of i/I . The curves show the ex-

A TYPE FOR *Every* APPLICATION OIL-FILLED CAPACITORS

● Functionally fitted to given application—that's the keynote of the extensive Aerovox oil-filled capacitor line. A plentiful selection of containers, mountings, terminals, sizes and impregnants, assures virtually custom-built capacitors with guaranteed performance.

Aerovox offers both Hyvol and Hyvol-M (mineral oil) liquid impregnants. For applications subjected to wide temperature variations, and where weight and size are important, Hyvol is recommended. Hyvol capacitors are considerably more constant with temperature variations than are those with other impregnating materials of the same specific inductive capacity, showing no capacitance drop until temperatures of -20° F. (-29° C.) are reached. At -40° F. (-40° C.) the maximum capacitance drop that may be expected is of the order of 5 to 10%.

Hyvol-M (mineral oil) capacitors have an exceptionally flat temperature coefficient of capacitance curve but approximately 35% greater bulk and corresponding weight which usually rules them out in favor of Hyvol.

At any rate, Aerovox offers both Hyvol and mineral oil capacitors, as well as wax-impregnated units for limited service—along with that wide choice of containers, mountings, terminals—to meet your exact needs.

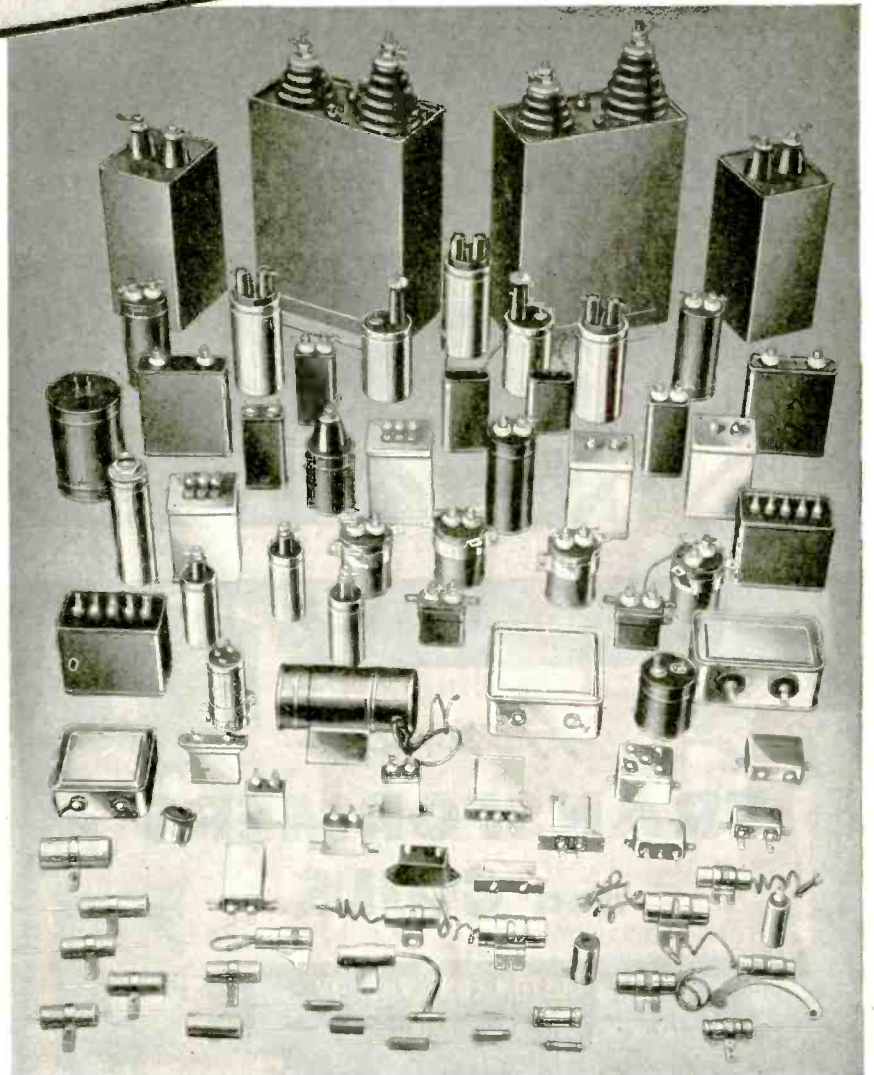

● **NEW CATALOG** lists the exceptionally wide selection of Aerovox oil capacitors, as well as other types. Write on business letterhead for registered copy available only to engineers, designers, electronic maintenance men, manufacturers of equipment, and executives.



Capacitors

INDIVIDUALLY TESTED

AEROVOX CORPORATION, NEW BEDFORD, MASS., U. S. A.

SALES OFFICES IN ALL PRINCIPAL CITIES

Export: 13 E. 40. ST., NEW YORK 16, N. Y. • Cable: 'ARLAB' • In Canada: AEROVOX CANADA LTD., HAMILTON, ONT.

NEW
NAVY SPEC.—
BAKELITE BASE

Gothard PILOT LIGHT

for 110 volt operation

This new light, with 1" jewel, is available in three models: No. 1032 faceted jewel; No. 1033 plain jewel and No. 1034 frosted jewel, colored disc. Sockets are molded of bakelite to meet Navy specifications, 17P4-CFG. Removable jewel holder, of snap-in type, permits change of lamp from front of panel. $\frac{3}{8}$ " between terminals. Designed for Mazda 6S6 lamps. Selection of jewel colors; red, green, amber, blue, opal and clear—specify choice when ordering.



Ask for the new
Gothard
Catalog
of other models

Gothard

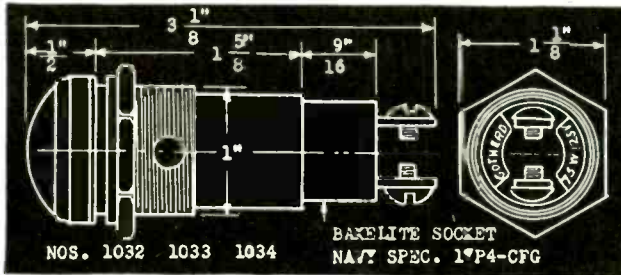

**MANUFACTURING
COMPANY**

1315 North Ninth St.
Springfield, Illinois.

pected strict linearity. The results of the second test are plotted in Fig. 14. Here the negative grid bias, i.e., the beam intensity, was changed and the output current measured. At the grid bias of -2.5 volts, for example, the beam intensity was reduced by 75 per cent as taken from the curve $i/I = 0$.

In spite of this great change of tube sensitivity the output current was reduced by only 1 per cent when the current ratio i/I was equal to 1. A comparison of the experimental curves of Figs. 14 and 15 with the theoretical curves of Figs. 6 and 7 indicates excellent agreement. It should be noted that the theoretical curves were calculated for a gain $K = 100$ while the gain of the test circuit was greater.

Null circuits

The test unit was used also to investigate the performance of null circuit N3a (Fig. 9). As shown in Fig. 14 the unit was connected to the motor control amplifier at right which energized a motor visible in the rear. The motor carried a small permanent magnet which can be seen above the beam tube. Whenever the primary signal voltage is changed the motor will run and carry the magnet along the beam tube until the electron beam has resumed its null position. The new position of the magnet is, then, a direct indication of the input signal applied to the primary deflection plates.

Conclusions

The deflection beam tube, as described in this paper, appears to be a tool of great flexibility for a variety of applications. The outstanding features of the tube are its usefulness in direct current negative-feedback circuits and its properties as a null instrument. Its industrial applications comprise circuits for dc amplification, measurement of electrical and mechanical quantities, remote position indication and transmission, solution of calculating problems, alternating currents of very low frequency and automatic control problems. Only a few of the many possible applications have been listed and described in this paper.

Acknowledgment is made to Mr. R. L. Campbell, Mr. E. D. Carter, Dr. T. T. Goldsmith, Dr. C. S. Szegho, and Mr. W. C. White for furnishing the tubes shown in Fig. 11, and to Mr. H. Ziebolz for his cooperation in this development.

References

- 1.—R. A. Watson Watt. Applications of the Cathode Ray Oscillograph in Radio Research. London, 1933, reprinted 1941.
- 2.—E. P. Rudkin. The Deflection Amplifier. Wireless World 40 (1937) 299.
- 3.—M. von Ardenne. Cathode Ray Tubes. Pitman 1939.
- 4.—R. R. Batcher. New uses for deflected electron beams. Electronic Industries, Sept., 1943, 64.
- 5.—W. Soler. U. S. Patent 2,096,653.
- 6.—H. Ziebolz. U. S. Patent 2,314,302.

ELECTRONIC INDUSTRIES • August, 1944



Hercules

TRANSFORMERS and COILS

Standard and CUSTOM CONSTRUCTION
to meet all specifications

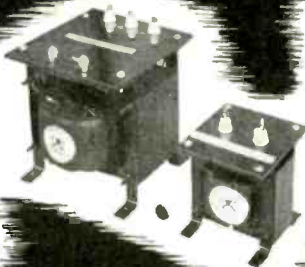

Prompt
engineering service
always available

HERCULES ELECTRIC & MFG. CO.

INCORPORATED

2416 ATLANTIC AVENUE ★ BROOKLYN 33, N. Y.

DC and AC WELDERS • TRANSFORMERS • MAGNETIC CLAMPS • SOLENOIDS • RIVET HEATERS
SPOT WELDERS • FLUORESCENT BALLASTS • SPECIAL CONTROLS

Army-Navy "E" Awards

Aerovox Corp., New Bedford and Taunton, Mass.

General Radio Co., 30 State St., Cambridge Mass. (4th time).

Insuline Corp. of America, 36-02 35th St., Long Island City, N. Y.

Raytheon Mfg. Co. (four divisions), Newton & Waltham, Mass. (2nd star added).

Universal Microphone Co., Inglewood, Calif.

"Spark Suppression" Would Improve Radio Reception

Postwar America can look forward to vastly superior shortwave radio reception if automobile makers adopt the war-developed technic — "spark suppression" — which eliminates radio interference from the engines of mechanized weapons, declares Delmar G. Roos, vice-president in charge of engineering for Willys-Overland Motors.

The resultant improvement in the field of high-frequency broadcasting would be of sufficient magnitude, he pointed out, to warrant enactment of legislation which would assure peacetime application of this radio development to all new automobiles.

Such a legal requirement, Mr. Roos added, would bring about the "suppression" of all cars and trucks on the highway within a period of five to seven years and thus, by releasing a vast number of shortwave bands previously denied the public, would clear the way for infinitely better reception.

This technic, Mr. Roos disclosed, has been in effective operation for more than a year on tanks, "jeeps" and half-tracks. Previously, it was difficult to transmit and pick up dispatches on certain shortwave bands, especially when these vehicles were traveling in convoy or close battle formation, owing to the radio interference emanating from their electrical equipment.

"In like manner," it was explained by the designer of the Army's standard-model Jeep, "every civilian car now on the highway emits radio disturbances which can be heard in homes several miles away on radios operating in the high-frequency bands."

If shortwave receiving equipment were to be installed in automobiles at the present time, he pointed out, the efficiency of the set would be seriously curtailed by the radiations from the vehicle itself, as well as from unsuppressed cars and trucks in the vicinity.

A special technic making possible mass production treatment of vehicles to eliminate this phenomenon, has been developed.

WANTED

SENIOR ENGINEER

with at least seven years' industrial experience in important electronic research and development work. Capable of executing important assignments from development to finished products.

JUNIOR ENGINEERS

with sound educational background and at least one year's experience in factory or engineering departments.

RADIO TECHNICIANS

with factory or model shop experience in building test equipment on production testing electronic equipment.

MECHANICAL ENGINEER

preferably experienced in electronic field.

PRODUCTION MAN

experienced in setting up and supervising production lines.

These positions offer unusually good permanent opportunities—top compensation commensurate with qualifications—congenial, progressive organization with new and one of the best equipped laboratory and factory facilities in the industry. Interesting work on most advanced type of military communication equipment now and broad field of quality radio-phonograph and industrial electronics after V-Day. Please write detailed qualifications, including availability, if not occupied to full extent of ability in war work, to Dept. F.

THE MAGNAVOX COMPANY

Fort Wayne, Indiana

G-E Safety Door Interlock Switch

OPEN the door and the power's off! Prevents accidents, protects equipment. Will not fail mechanically. For complete details, write:

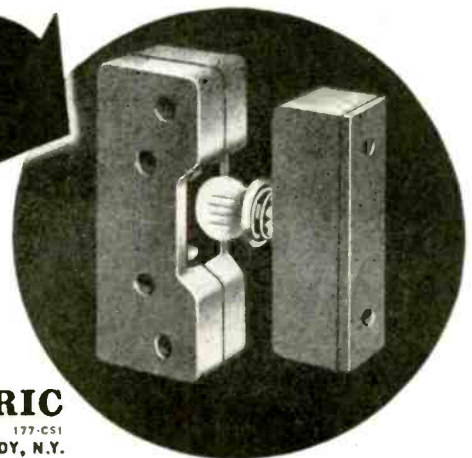

GENERAL  **ELECTRIC**

ELECTRONICS DEPARTMENT

SCHENECTADY, N.Y.

If you want



- CRYSTALS
- CABLES
- HARNESES
- ELECTRONIC ASSEMBLIES
- CABINETS

Telephone Peru, Indiana
151

Serving the Radio and Electronic Industries with precision engineered products.

Wm. T. WALLACE MFG. Co.

General Offices: PERU, INDIANA
Cable Assembly Division: ROCHESTER, INDIANA

BUS-BAR

Formed in
2 PLANES to
.001" ACCURACY

ONE-HALF
ACTUAL
SIZE

WITH
DI-ACRO

BENDER
No. 2



A heavy Copper Bus-Bar for panel board and terminal assemblies is illustrated, accurately duplicated in two planes with angles formed both flat and edgewise, across the material horizontally and vertically.

DI-ACRO Bender No. 2 has a forming radius up to 6" and capacity of 1/2" cold rolled solid steel bar or equivalent.

Send for Catalog
"DIE-LESS
DUPLICATING"

showing all models of DI-ACRO Benders, Shears and Brakes, and many examples of parts formed by

"DIE-LESS DUPLICATING"



Many electrical and other parts can be duplicated without dies, saving Man Hours and Critical Materials and helping to meet rush delivery schedules. DI-ACRO Precision Machines — Shears, Brakes, Benders — form angle, channel, rod, tube, wire, moulding, strip stock; bi-metals, dielectrics, sensitized materials, fiber slot insulation, frequency reeds, etc.



← Pronounced "DIE-ACK-RO"

O'NEIL-IRWIN MFG. CO.

348 Eighth Ave. So.,
Minneapolis 15, Minn.

WHAT'S NEW

(Continued from page 122)

Meter Rectifier

Selenium Corp. of America, 1719 West Pico Blvd., Los Angeles, has developed a new meter rectifier styled type N-6, consisting of six selenium rectifying elements enclosed in a tubular plastic case. Rating of the rectifier is 1.5 ma. and the maximum voltage to which it may be subjected is 150 volts ac. Frequency response is flat to 6000 cycles and at 20,000 cycles efficiency is 35 per cent of rated value. The rectifier may be used within a temperature range of -40 to +70 degrees C.

Appliance Tester

A new improved electrical appliance tester is now built to operate at an extremely low range of 0-20 watts as well as the high range to 2,000 watts. It tests all electrical appliances from bell transformers and clocks to electric irons and ranges operating on the 220 volt three wire Edison system. This tester measures actual load values of volts,

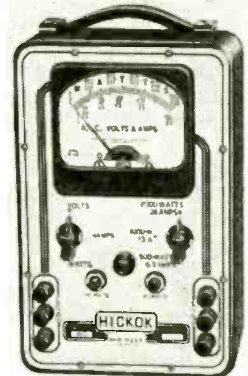

amperes, and watts. It is fused. Overall dimensions are 9 1/2 in. high, 6 3/4 in. wide, 3 in. deep, weighs 8 1/2 lb.; meter 4 in. square. This is the new Model 900 manufactured by the Hickok Electrical Instrument Co., 10528 Dupont Ave., Cleveland 8, Ohio.

Vacuum/Pressure Pump

This two-cylinder pump is of the rotary type and is used for air pressures up to about 50 lbs. per sq. in. and for vacuum up to about 28.7 in. mercury. While one cylinder may be used for pressure the other may be used for vacuum, or both may be

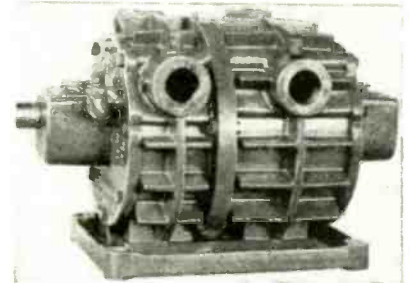

used for pressure or for vacuum. One cylinder may pump into the other for the purpose of increasing the air pressure, or one may pump from the other to increase the vacuum as occasion may require. Maker is Leiman Bros., 189 Christie St., Newark, N. J.

Self-Locking Palnut

A new Palnut with a triple grip has been developed by The Palnut Co., 83 Cordier St., Irvington, N. J. The base of Type 6NAO is like a standard Palnut, with six spring steel jaws that fit the bolt thread. When the nut is tightened, its arched slotted

WHAT'S NEW

jaws close in all around the bolt like the jaws of a chuck. A third grip is exerted on the bolt by the top portion of the Palnut. The sides have been extended up and in, but instead of having a closed top, the ends of the "petals" are turned in, leaving a hole in the top slightly smaller in diameter than the outside diameter of the bolt. When the bolt extends through the top of the Palnut, it forces the top open so that a strong spring pressure is exerted here on the bolt. \square around, thus giving triple grip.

Chest Microphone

This chest microphone set is a Signal Corps equipment item consisting of a chest unit, equipped with a switch; junction box; two cotton webbing straps; and two cords for connecting a throat or a lip mike to a transmitter. The unit has a toggle switch which has three positions,—on, off, and momentarily on. The junction box is on the chest plate directly above the switch, and has a molded bakelite housing. The microphone cord is a two-conductor stranded copper wire cord equipped with a JK-48 jack. The other cord which is plugged into the transmitter is three-conductor tinsel cord with a PL-58 plug. The set is a regular production item with the Trav-Ler Karenola Radio & Television Corp., 1036 West Van Buren St., Chicago.

Solderless System

A complete system of solderless knife-disconnect splicing has been developed by Aircraft-Marine Products Inc., 1591 D North Fourth St., Harrisburg, Pa. The system incorporates throughout the basic design of the manufacturer's splicing terminal in which identical ends are put into 4-point electrical connection by knife-wiping action. The connection is main-

A New Miniature Diffusion Vacuum Pump

Compact.. All-Metal

THE DPI miniature all-metal pump, Type VMF-10, marks an entirely new application of the fractionating, self-conditioning principle for the production of high vacua. The VMF-10 meets the demand of industry for a rugged yet compact pump capable of reaching pressures of 10^{-6} mm. and lower.

This unit was primarily designed for use on electron microscopes, automatic exhaust machines, continuously evacuated tubes, and other industrial applications where an inexpensive miniature metal pump is required. It will be found useful on any system of moderate size. Choice of water or air cooling.

CHARACTERISTICS

SPEED	10 L/sec. at 10^{-4} mm. Hg.
ULTIMATE VACUUM	1×10^{-6} mm. Hg. with Octoil-S
REQUIRED FOREPRESSURE	0.125 mm. Hg.
HEIGHT	7 $\frac{3}{8}$ in.
WIDTH	3 $\frac{1}{8}$ in.
WEIGHT	2.5 lb.

*Radio-Electronic
Materials*

★ Try us for those items you need in a hurry. Our stocks are big—our service, extra fast!

We've been at it since 1925—and we know how!

Just Try Us!

H. L. DALIS, INC.

Wholesale Distributors

RADIO-ELECTRONIC SUPPLIES & PARTS

17 Union Square

NEW YORK 3, N. Y.

Phones: ALgonquin 4-8112-3-4-5-6-7

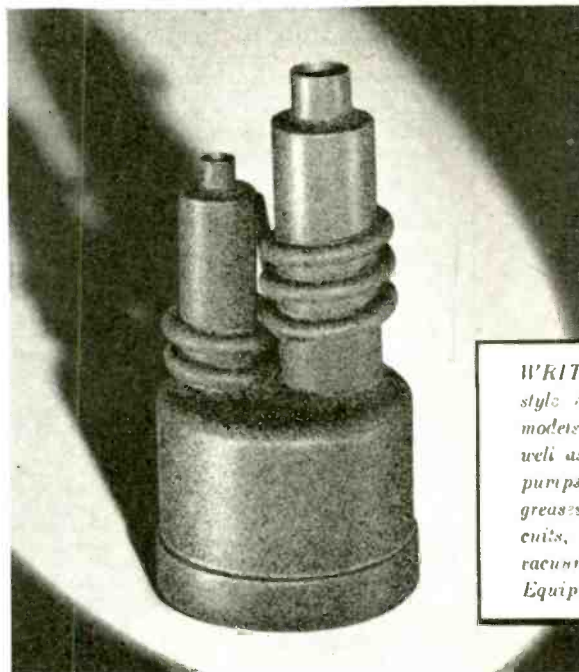

METAL FRACTIONATING PUMP, TYPE VMF-10 (Water-Cooled)

WRITE for details about this new-style diffusion pump—or similar models with different capacities—as well as 20 other types of diffusion pumps, low-vapor-pressure fluids, greases, vacuum gauges, control circuits, and other items for high-vacuum technology. Address Vacuum Equipment Division.



DISTILLATION PRODUCTS, INC.

Jointly owned by EASTMAN KODAK COMPANY and GENERAL MILLS, INC.

ROCHESTER 13, N. Y.

Be up to date on
Electromagnetic Theory
READ

Fields and Waves in Modern Radio



By

SIMON RAMO, *Electronics Laboratory of General Electric Company, and Union College, and*

JOHN R. WHINNERY, *Electronics Laboratory of General Electric Company.*

Written from an engineering standpoint, the material in this book has proved highly successful in training radio engineers

For here's a book that:

- **Relates**—field and wave theory.
- **Supplies**—the fundamentals of ultra-high frequency engineering.
- **Explains**—high - frequency circuits and how to apply the field and wave theory in modern radio.
- **Includes**—physical pictures and useful methods for the calculation of characteristics of radio system components.
- **Requires**—only a basic knowledge of elementary calculus and physics to understand its content.

Increase your skill in using this essential field and wave theory by increasing your knowledge through the diagrams, charts, problems and tables reproduced in "Fields and Waves in Modern Radio."

503 Pages Illustrated \$5.00

ON APPROVAL COUPON

JOHN WILEY & SONS, Inc.

440 Fourth Ave., New York 16, N. Y.
Please send me on ten days' approval a copy of FIELDS and WAVES IN MODERN RADIO. At the end of that time, if I decide to keep the book, I will remit \$5.00 plus postage; otherwise I will return the book postpaid.

Name

Address

City and State

Employed by

EI-8-44

tained until intentionally taken apart. This design has been adapted to "T-Link", "Y-Link", "H-Link" and "Cross-Link" applications, and to stud tabs, jumpers and small electrical assemblies such as switches, relays, etc. All terminals are fully annealed, hot-electro-tinned copper. The Diamond Grip Insulation Support type terminal is available in wire sizes 22 to 10 and the Standard Type B is available in wire sizes 22 to 8.

Pocket Multitester

This pocket multitester (Model 420) is compact and rugged, being $6\frac{3}{4} \times 3\frac{1}{2} \times 3$ in. and weighs 25 oz. Meter movements are guaranteed to be accurate within 2 per cent. Voltage multipliers are metallized matched pair resistors having a tolerance of 1 per

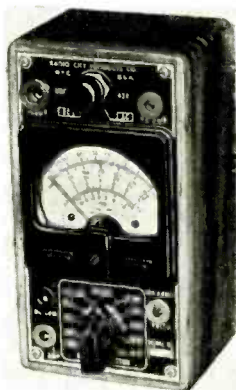

cent. The basic meter is 0.400 microamperes. Db meter, output meter, milliammeter and ohmmeter provide a total of 23 ranges. Ac and dc voltmeter up to 5,000 volts at 1,000 ohms per volt sensitivity. Maker is Radio City Products Co., 127 West 26th St., New York 1, N. Y.

Fungus-Proof Resistors

Shallcross Mfg. Co., Collingdale, Pa., fixed wire wound resistors, switches, etc., are now available treated with anti-fungus materials which meet Signal Corps Specifications No. 71-2202A. These units are supplied without any manufacturing delay occasioned by the special treatment.

Multi-Cellular Speaker

By combining both high and low frequency units in a compact two-way multi-cellular loudspeaker requiring less than one and one-half cubic feet of space, Altec Lansing Corp., Hollywood, Calif., has provided a point source of high quality sound for monitoring, radio, public address and recording. This new multi-cellular speaker provides up to 1200% increased area of distribution. Its horizontal area of distribution is 60°. In the vertical plane, its area of distribution is a full 40°. The voice coil is wound with rectangular aluminum wire and operates in a magnetic field of high flux density, which is supplied by a recently perfected type of permanent magnet. The aluminum alloy metal diaphragm provides mass stiffness and high velocity of transmission speed at least five times greater than through paper cone material. This high frequency unit is designed to operate as a piston up to frequencies above the limit of audibility. The high frequency horn is a multi-cellular unit having six cells in a 2 x 3 configuration. Each cell covers a 20° solid angle, which means a combined area of distribution in the horizontal plane of 60° and 40° in the vertical plane. The high frequency horn is covered with a sound deadening material and mounted in the face of the low frequency unit. Power from the high frequency unit is supplied through the pole piece of the low frequency unit.

The three-inch voice coil of the low frequency unit is also wound with rectangular wire. The low frequency voice coil assembly is mounted in a 15 in. stiff paper cone resonant at 38 cycles. The input impedance of the duplex speaker is 20 ohms and a dividing network of the constant impedance type is used with a crossover frequency of 1200 cycles for separating the power for each unit. This crossover point permits the horn to adequately load the high frequency unit down to a point where little power is being transmitted. It also eliminates any tendency to produce distortion effects as well as to prevent damage to the high frequency unit. The speaker is available separately or mounted in a walnut finished cabinet.

Molding Compound

A new phenolic molding compound of improved performance in high frequency electrical insulation has been developed by Monsanto Chemical Co., St. Louis. Designated as Resinox 7934, the new material is mica-filled and based on a newly developed phenol formaldehyde resin. Principal advantages of the product are low dielectric constant and power factor, extremely low water and moisture absorption and relatively high heat resistance.

Weld Control

A new voltage regulator for use with most G-E resistance-welding controls that include the phase-shift method of heat control, has been developed by the Industrial Control Division of the General Electric Co. It is designed to regulate the welding current automatically, so that it is held constant regardless of line-voltage variations of as much as plus 10 or minus 20 per cent. The regulator consists of a resistor circuit connected to the power line which supplies the welding machine, and an electronic circuit. When the regulator is in use, this electronic circuit functions not only to hold the average voltage of the resistor current constant, but also changes, electronically, the phase control voltages of the main welding control panel automatically holding the welding current constant within close limits. The regulator, which is housed in a sturdy, easily opened steel enclosure, can be used on welding circuits whose power factor is from 20 to 70 per cent, and can be operated from 230/460/575 volts on a 50/60-cycle power supply. It operates whether or not the welding current is flowing. This feature enables it to compensate for a sudden voltage drop in less than three cycles, with approximately 75 per cent of the compensation taking place during the first cycle.

Continuity Tester

The W-J continuity tester tests for open circuits or shorts in coils, fuses, lamps, tubes, appliances, and in more complex assemblies. The unit lights up at point of application and eliminates the need for looking back and forth at a meter. The tester is excellent for intermittent or for constant production testing. It is made by Walker-Jimieson, Inc., 311 South Western Ave., Chicago 12, Ill.

(Continued on page 224)



National Electronic Conference Program

Program for the National Electronic Conference, scheduled to be held at Medinah Club, Chicago, October 5 to 7, has taken tentative form and already includes some 20 addresses by leaders in science and industry on nine general topics embracing television, ultra-high frequency propagation, radio, industrial measurements and special devices, industrial electronic controls, induction heating, medical applications of electronics.

Keynoting the objectives of the Conference will be an opening address by Ralph R. Beal, Research Director for the Radio Corporation of America, entitled, "Electronic Research Opens New Frontiers." W. C. White, Director of the Electronics Laboratory, General Electric Co., will speak on "Electronics in Industry" at one of the Conference luncheons.

The tentative program of technical topics for the Conference includes the following papers grouped according to main topic divisions:

(1) Television

Color and Ultra-High Frequency Television by Dr. P. C. Goldmark, Columbia Broadcasting System.
Reflective Optics in Television by I. G. Maloff and D. W. Epstein, RCA Manufacturing Co.
Radio Relay Systems by C. W. Hansell, RCA Laboratories.

(2) Ultra-High Frequencies

A Lighthouse Tube; a Pioneer UHF Development by E. F. Peterson and E. D. McArthur, General Electric Co.
Principles of Klystron Amplifiers by Dr. Robert Haxby, Sperry Gyroscope Co.
Developments of Electronic Tubes by I. E. Mourontseff, Westinghouse Electric and Mfg. Co.
Wire-Frequency-Range Tuned Circuits for High Frequencies by Dr. D. B. Sinclair, General Radio Co.
Ultra-High Frequency Converters and Conversion Diagrams by Dr. Harry Stockman, Cruft Laboratory, Harvard University.

(3) Radio

A Method for the Generation of Quasi-Continuous Frequency Spectra for use with Secondary Frequency Standards by Dr. Harold Goldberg and Richard G. Talpey, Stromberg-Carlson Telephone Mfg. Co.
A Frequency Dividing Lock-in Oscillator F-M Receiver by G. L. Beers, RCA Mfg. Co.
Incremental Permeability Tuning by W. J. Polydoroff, Consulting Engineer.
Audible Audio Distortion by H. H. Scott, General Radio Co.
Broadband Carrier and Coaxial Cable Networks by F. A. Cowan, American Telephone and Telegraph Co.

(4) Industrial Measurements and Special Devices

The Supersonic Reflectoscope; an instrument for Inspecting the Interior of Metal Parts by Means of Sound Waves by Dr. F. A. Firestone, University of Michigan.
Dynamic Strain Gages by C. A. Dohrenwend, Armour Research Foundation.
The Mass Spectrometer and its Practical Applications by J. A. Hipple, Research Laboratories, Westinghouse Electric and Mfg. Co.
Two-Million Volt X-Ray Unit by Dr. E. E. Charlton and W. F. Westendorp, General Electric Co.
Industrial Fluoroscopy of Light Materials by Dr. Scott W. Smith, Kelly-Koett Mfg. Co.
Application of Amplifier Theory to Mechanical Stability Problems by John M. Cage, Allis-Chalmers Mfg. Co.

(5) Industrial Electronic Controls

Electronic Mechanisms in Process Plant and Industrial Laboratory by T. A. Cohen, Wheelco Instrument Co.
Electronic Measurements of Non-Electrical

Ingenious New Technical Methods

Presented in the hope that they will prove interesting and useful to you.

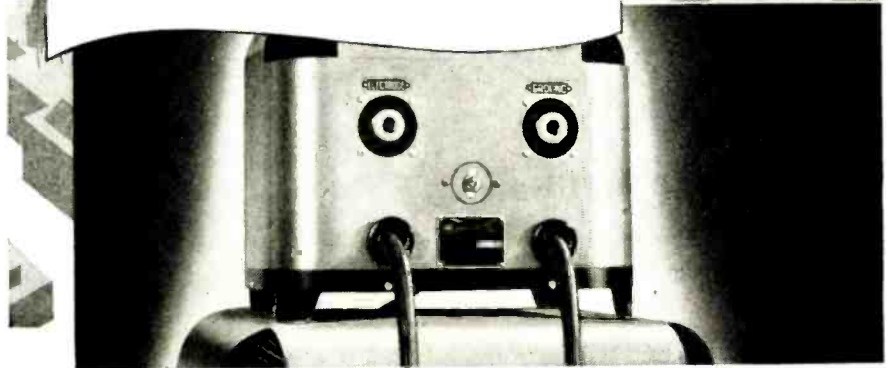

Revolutionary Hy-cycle Automatic Arc Provides Complete Control of Arc and Heat

At last, a development that automatically starts the arc before the welding electrode actually comes in contact with the work! Eliminating the "pecking" or "scratching" that so often creates tension and operator fatigue. Its many advantages contribute largely to saving time and labor because an operator can be trained in far less time than usual, and higher speeds can be obtained. This hy-cycle automatic arc unit, called "Missing Link," permits the operator to weld with any welding rod, bare steel or alloy. Rods that could not be used before can be burned with ease—such as bare mild steel, dust coated, reverse polarity, aluminum, bronze, stainless steel, etc., AC or DC.

One of its most important advantages is welding light gauge. Light gauge requires low heat—making many jobs almost impossible for ordinary methods. Since the "Missing Link" starts automatically on as low as one ampere of heat, the welding of light gauge sheet can be done with surprising speed with no time out for "pecking" and "sticking."

You all know that our fighting men need the finest quality materials that we here at home can produce. That goes for Wrigley's Spearmint Gum, too. Although our stock pile of quality raw materials is getting lower and lower we are maintaining our standards of quality. Naturally, we are forced to limit production. So we are giving priority where it is needed most—and where you want us to—our fighting men and women overseas only. Because chewing gum is essential to them—they are getting all of our limited production of Wrigley's Spearmint Gum.

You can get complete information from Mid-States Equipment Company, 2429 S. Michigan Ave., Chicago 16, Ill.

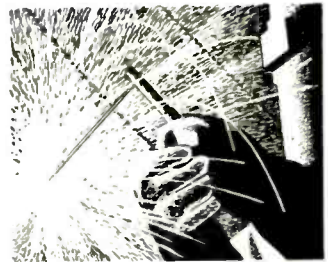

Simplifies welding vertical and overhead

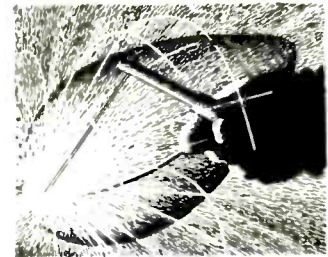

Makes it easy to weld light gauge work

Y-133



BERYLLIUM, Flake and Cast Bar
BERYLLIUM OXIDE, Metal Grade
BERYLLIUM OXIDE, Fluorescent
BERYLLIUM ALLOYS

Manufactured by

CLIFTON PRODUCTS, INC.
PAINESVILLE OHIO

LUXTRON*

PHOTOCELLS

Give Simple
Means of
Precision Control

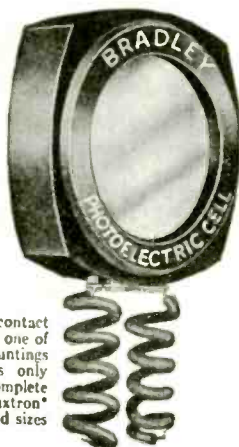

This pigtail-contact model is only one of a series of mountings and indicates only one of the complete range of Luxtron* cell shapes and sizes available.

Circuit simplicity contributes to a constant flow of power. The ability of Luxtron Photocells to operate instruments and instrument relays, without amplification, removes the hazards of complex circuits.

This fact alone recommends their application to precision control problems. Another quality is their exceptional resistance to vibration, shock and general mechanical violence. These factors assure long service and unusual adherence to calibrated accuracy.

Engineering inquiries are always welcome.
Illustrated data sent on request.
*Reg. U. S. Pat. Off.

BRADLEY

LABORATORIES, INC.

82 Meadow Street, New Haven 10, Conn.

Quantities in Industrial Processes by H. D. Middell, General Electric Co.
Cathode Ray Tubes and Their Application by Dr. P. S. Christaldi, Allen B. DuMont Laboratories.
Electronics in Industrial Instrumentation by Walter P. Wills, Brown Instrument Co.
Design Factors in the Application of Relays to Electronic Circuits by R. H. Herrick, Automatic Electric Co.

(6) Induction Heating

High Frequency Induction Heating by C. J. Madsen and R. M. Baker, Westinghouse Electric and Mfg. Co.
New Methods and Techniques in High Frequency Heating by Dr. Eugene Mittelmann, Illinois Tool Works.
The Use of High Frequency Electronic Generators to Obtain Controlled Power Concentrations for Industrial Heating Applications by Dr. Wesley Roberds, RCA Mfg. Co.

(7) Electronic Applications in the Power Field

A Survey of Power Applications of Electronics by A. C. Montleth, Westinghouse Electric and Mfg. Co.
Power Rectifiers and Inverters by J. A. Cox and G. F. Jones, Westinghouse Electric and Mfg. Co.
Electronic Power Converters by Dr. E. F. W. Alexanderson, General Electric Co.

(8) Medical Applications of Electronics

Electronic Equipment in the Medical Profession by Dr. A. H. Carter, American Medical Association.
Electroencephalography by Dr. Ralph Girard, University of Chicago.

(9) Recent Theoretical Developments in Electronics

Theory of Microwave Oscillation Generators Using Velocity Modulated Electron Beams by Dr. E. U. Condon, Westinghouse Electric and Mfg. Co.
Theorem of Lorentz and Its Importance for all Problems of Electrons in Magnetic Fields by Dr. Leon Brillouin, Columbia University.
Transient Response of Wide-Band Amplifiers by Dr. W. W. Hansen, Sperry Gyroscope Co.

FREQ. METER

(Continued from page 120)

affects the resistance of the coils and the capacitance of C. A zero temperature coefficient resistor is used in series with the capacitor. The capacitor is of the oil-filled type and it has a low and practically constant coefficient of capacitance and power factor within normal temperature ranges as in Fig. 4. Fortunately, the temperature coefficient of capacitance is positive and therefore it partially offsets the effect of the positive resistance-temperature coefficient of the coils. This fact together with the use of the zero temperature coefficient resistor, results in very good compensation over the minus 20 deg. to plus 45 deg. range as in Fig. 5.

Distortion of the voltage wave by the variety of equipment used by the power customers, in effect, introduces harmonics on the line. Of these harmonics, only the lowest, notably the third, need be of great concern. Higher frequency harmonics have practically no effect because of the inductive reactance of the field circuit. Fig. 6 shows the effect of the third harmonic, ranging up to 25 per cent of the fundamental magnitude. In practice, the third harmonic rarely exceeds 5 per cent.

The instrument has an over-all accuracy better than 2/10 of a cycle in 60 cycles, which permits a 10 per cent third harmonic and a voltage range of 90 to 140 volts and an ambient temperature range of -10 deg. to +40 deg. C.

COPROX

RECTIFIERS

Include Many
Extras for
Longer Life



"Coprox" Model CX-1C2B1, a center tap, full wave rectifier. Completely enclosed in Bakelite. Low capacitance. Rectifies high frequency current. Conservatively rated up to 4.5 volts A.C., 3.0 volts D.C., 500 microamperes D.C. Other models and capacities to meet all needs.

Special terminals, or pre-soldered lead wires, prevent overheating during assembly. Standard units sealed with waterproof lacquers, critical-application units potted in wax. Standard "pellets" gold coated on front surface, forming positive contact; for critical applications, gold used on both sides. High leakage, but very low forward resistance. Highly adaptable mountings.
To these extras, add Bradley's ability to produce "Coprox" rectifiers for special applications, then:

Ask for samples and full technical data.

BRADLEY

LABORATORIES, INC.

82 Meadow Street, New Haven 10, Conn.

Sees Electronic Control In Home Heating

Super-sensitive electronic controls will eliminate, in the not too distant future, the cold floors and drafts prevalent in the majority of homes today, John E. Haines, chairman of the postwar planning committee of Minneapolis—Honeywell Regulator Company, told the American Society of Heating and Ventilating Engineers at Washington, D. C., recently.

Such controls will be valuable in air-conditioning and heating of both homes and industrial plants, since they react to minute temperature variations. Electronic control added to present-day temperature control equipment will mean greater comfort, convenience, and safety for home and factory.

"While electronic control equipment today would cost nearly twice as much as equivalent electric or pneumatic equipment, the cost is being constantly reduced. In the near future," Haines said, "any additional cost—if it exists—will be more than offset by the improved results which will be obtained."

Because of its great accuracy and independence of vibration or changes in altitude, electronic temperature control appears to be especially well suited for aircraft, railway cars and similar vehicles, he pointed out.



TEST INSULATION
THE MODERN WAY

... WITH A
MODEL B-5

MEGOHMER NEW BATTERY-VIBRATOR TYPE

No more tiresome cranking of a hand-driven generator. Entirely self-contained. Steady test potential of 500 volts D. C. available at the touch of a switch. Direct reading in insulation resistance. Various new models and ranges.

Write or phone for Bulletin 430

HERMAN H.

Sticht

COMPANY, INC.

27 PARK PLACE

NEW YORK, N. Y.

Coto-Coil

ELECTRICAL COIL WINDINGS

Since 1917



For the
Home Front

For the
War Front

DOWN through the
years COTO-COIL

has pioneered in the manufacture of every
type of coil winding.

All of this experience and skill acquired
thru "doing" now are directed to the pro-
duction of vital military equipment.

When *'C' Day comes we will be ready and
waiting. May we help you NOW or THEN?

*If you have a coil winding
problem, phone, wire or write.*

*'CONVERSION DAY'

COTO-COIL CO., INC.

65 PAVILION AVE.

PROVIDENCE 5, R. I.



"PACKAGE UNIT" HEAT CONTROLS REQUIRE NO CHANGES IN WELDING CIRCUITS

Close current regulation in virtually any type of resistance welding installation can now be obtained by the simple addition of a Weltronic "package unit" heat control.

These controls are now available in three types: the 50Y single dial type where only one adjustment is required for one or more welds; the 50W with multiple dials for individual adjustments or for adjusting individual pulsation values; the 50XX providing adjustable automatic heat rise from preset minimum to preset maximum.

Write for Bulletin No. 50



Weltronic
COMPANY
DETROIT 19, MICH.

ENGINEER EXEC.

(Continued from page 116)

an engineering one in which he actually takes part in thinking out an engineering problem and weighing the various angles that are brought to him and making a decision as to what will be done, what the panel will look like, which is the best circuit to use, whether a proposal for solving a difficulty is worth the time that it will take to put it into operation, whether a particular development which has been going on for some time should be dropped or continued. This is his easiest task, assuming, of course, that he has a really thorough background of theory and practice, because here he acts as a critic. The work is done for him and he merely judges. If his work is difficult, it is his fault for not having the right men doing the work, or not stimulating them sufficiently so that they provide all the answers for him.

A job that falls on the executive's shoulders, which has not yet been mentioned, is that of getting business, and that again is a problem from which I feel the engineer has been kept away in most organizations. The reason is probably that most engineers are very much introspective, the fact that they are is probably the reason they have taken up engineering which deals principally with things as against some other profession which deals more with people.

However, since it is impossible to deal with things without dealing to some extent with people, most engineers have some extrovert qualities and to the extent that these extrovert qualities are valuable to the firm they should be compensated. In my opinion the engineer receives a salary for doing a job, and that is what his services in connection with the job are worth. On the other hand, he may do more than his job, he may be valuable in other ways to the concern.

He may make inventions which, when developed, may become remunerative and for them he should receive a corresponding part of the return of that invention; or he may be directly responsible for bringing in business and, provided he does it in a manner which fits in with the policies of the concern, he should receive a return from that business just as though he were a sales engineer. In other words, he should be part of the concern to the extent that his introvert and extrovert tendencies permit him, and he should be fully recognized for the value which these qualities produce. Since in the final analysis the burden of success rests on his shoulders, the engineer must be given a psychological sense of his responsibility and a proportionate and tangible economic reward.



HOW TO GIVE YOUR A-C POWERED MACHINES D-C FLEXIBILITY

You can now obtain all the flexibility associated with D-C machine operation without the use of motor-generator sets, D-C distribution systems, etc.

The new Weltronic Motor Control makes possible the conversion of A-C powered machines to D-C performance merely by substituting an ordinary STANDARD D-C shunt wound motor for the A-C motor.

The Weltronic "package unit" Motor Control does the rest: provides (1) infinitely variable speeds from a few rpm to twice basic speed in either direction at rated motor horsepower; (2) fast, timed, dynamic braking of machines; (3) ability to "inch" machines; (4) close speed regulation even under varying loads; (5) smooth starting without line-starters; (6) smooth automatic acceleration to preset speed; (7) elimination of line-surge; etc.

Adaptable to virtually any machine or process or can be built into new machines. Requires no skill to operate



Ask for Bulletin WTM-44

Weltronic
COMPANY
DETROIT 19, MICH.

Just in case you've eased up...
ON YOUR PAY ROLL PLAN



Pause one brief moment. Compare your lot—and that of the men and women in your employ—with the lot of the infantrymen who meet the enemy face to face, who do the hardest fighting, who suffer the most casualties.

Let the full impact of war's unending grimness swiftly convert any tendency toward complacency into revitalized urgency. Remember—the war is not yet won.

As top management and labor, you've been entrusted with two major responsibilities—steadily maintained production, and steadily maintained War Bond Sales *through your Pay Roll Savings Plan.*

Decide now to revitalize your plant's Pay Roll Plan. Have your Bond Committee recheck all employee lists for percentages of participation and individual deductions. Have Team Captains personally contact each old *and new* employee. Raise all percentage figures wherever possible.

Don't underestimate the importance of this task. This marginal group represents a *potential sales increase of 25% to 30% on all Pay Roll Plans!*

Your success will be twofold: A new high in War Bond Sales; and a new high in production. Because a worker with a systematic savings plan has his mind on his work—not on post-war financial worries. He's taking care of the future now. His own. And his Country's future. *Help him!* **REVITALIZE YOUR WAR BOND PAY ROLL SAVINGS PLAN.**

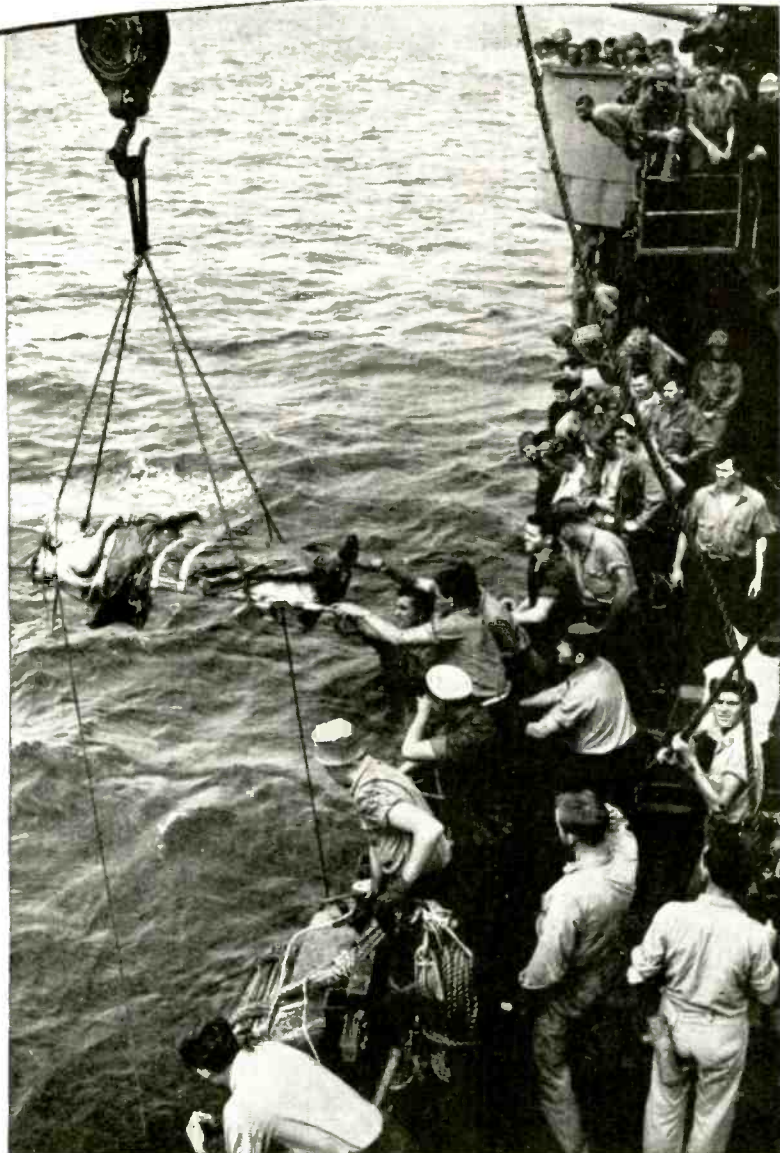

Official U. S. Coast Guard Photo: The elevator to a Coast Guard-operated transport hospital

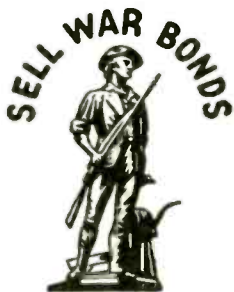

Back the Attack!
SELL MORE THAN BEFORE!

The Treasury Department acknowledges with appreciation the publication of this message by

ELECTRONIC INDUSTRIES

This is an official U. S. Treasury advertisement—prepared under the auspices of Treasury Department and War Advertising Council.

PRECISION PARTS

GRINDING OUT MESSAGES FOR G. H. Q.

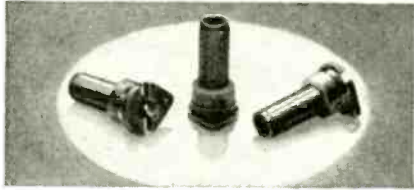

... mass-production with accuracy ...

Teletype, that miraculous contrivance that writes out a message hundreds of miles away as fast as the sender can type at the other end, plays a leading role in vital operations. These little pieces, ground to close tolerances by Ace, are an important part of the teletype machine.

From rough-machined and hardened blanks, Ace grinds and hones the inside diameter. Then, locating from this diameter, they cylindrical grind the two outside diameters and faces, holding the shoulder lengths. Next, each piece is placed in a fixture and surface-ground on both sides of the slot. The center line of the slot and the center line of the bore are held to very close tolerances. Ace made the tools and gauges and engineered the entire finishing operations.

This is typical of Ace service and ingenuity from start to finish. Consult Ace on small precision-parts or assemblies calling for stamping, machining, heat-treating, or grinding. Send sample, sketch, or blueprint for quotation.



Keep a copy of this booklet in your post-war planning file. It will come in handy.



ACE MANUFACTURING CORPORATION
for Precision Parts



1239 E. ERIE AVE., PHILADELPHIA 24, PA.

WIDE READING

(Continued from page 124)

At a frequency ω , the ratio V_n of the output amplitude A_2 to the input amplitude A_1 , for n equal amplifier stages, will be:

$$V_n = \frac{A_2}{A_1} = \left[\frac{K_o R_f C_E}{q} \sqrt{\frac{\omega^2}{\omega^2 \rho^2 + \omega^2 \left(1 - \frac{2r\beta}{q^2} + \frac{r^2}{q^2}\right)}} \right]^n \cdot \left[\frac{\omega \Delta \omega V_o}{\sqrt{(\omega^2 - \omega_o^2)^2 + \omega^2 (\Delta \omega)^2}} \right]^n$$

The maximum of this ratio, V_o , which is located at the center frequency, for one stage is given by the formula:

$$\frac{K_o R_f C_E}{q} = V_o$$

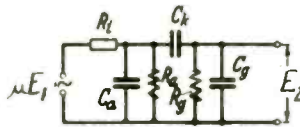
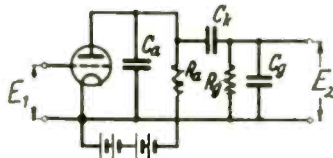

Capacitance—resistance coupled amplifier and equivalent circuit

The transient output voltage resulting from the sudden application of a dc voltage A_o is equal to

$$E_2 = A_o 2V_o \frac{1}{\sqrt{1-4\left(\frac{\omega_o}{\Delta\omega}\right)^2}} e^{-\frac{\Delta\omega}{2} t} \sinh\left(\frac{\Delta\omega}{2} \sqrt{1-4\left(\frac{\omega_o}{\Delta\omega}\right)^2} t\right)$$

and the time delay t_m after which the output amplitude reaches its maximum value can be found by the expression:

$$t_m = \frac{2}{\Delta\omega} \frac{\tan^{-1} \sqrt{1-4\left(\frac{\omega_o}{\Delta\omega}\right)^2}}{\sqrt{1-4\left(\frac{\omega_o}{\Delta\omega}\right)^2}} = \frac{1}{\Delta\omega} F^*\left(\frac{\omega_o}{\Delta\omega}\right)$$

The function F^* is shown in the graph.

The maximum amplification V_o for a square wave input pulse is given by

$$V_o = \left[V_o \left(1 - \delta_1 \left(\frac{\omega_o}{\Delta\omega}\right)\right) \right]^n$$

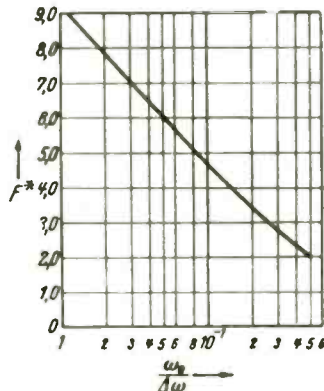

PRECISION . . . and QUICK RESULTS



Two factors that make the "block-buster" a first-line weapon in modern warfare also make "BELL Sound Systems" a name of first-line importance in the field of electronic devices. For it was with "precision and quick results"—typical of Bell's long-established, rigidly-maintained policy in attacking new problems—that BELL supplied new war-vital electronic equipment to meet sudden military needs. BELL engineers and technicians make a practice of keeping ahead—in research, experiment, production methods and initiative. That's why you can look to BELL for leadership in postwar development of new and improved sound equipment and electronic devices.

BELphone

INTERCOMMUNICATION SYSTEMS

Speed production, streamline management with complete vocal contact between all executives, offices, departments. Instant, fingertip control. All desirable special features available. Write.

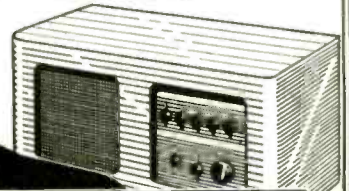

BELL
SOUND SYSTEMS, Inc.

1195 Essex Ave., Columbus 3, Ohio
Export: 4900 Euclid Ave., Cleveland 3, Ohio



**YOURS
..FOR THE
ASKING**

Available from local dealers or by writing factory direct.

UNIVERSAL STROBOSCOPE

This handy phonograph turntable speed indicator, complete with instructive folder, is now available gratis to all phonograph and recorder owners through their local dealers and jobbers. As a recorder aid the Universal Stroboscope will assist in maintaining pre-war quality of recording and reproducing equipment in true pitch and tempo.

Universal Microphone Co., pioneer manufacturers of microphones and home recording components as well as Professional Recording Studio Equipment, takes this means of rendering a service to the owners of phonograph and recording equipment. After victory is ours—dealer shelves will again stock the many new Universal recording components you have been waiting for.



“Urgent Equipment”

Builders of —

SPECIALLY DESIGNED

INCANDESCENT LAMP

RADIO TUBE

**ELECTRONIC TESTING and
PRECISION MACHINERY**

For the past 25 years!

Submit your drawings and designs, which will be treated with strict confidence.

* * *

We do not design or sell machinery.

Write — Telephone — Wire
for Quick Action

Daly Machine & Tool Works

923 FRELINGHUYSEN AVENUE
NEWARK, N. J.

Blgelow 3-0234 and 0235

WIDE READING

where n is the number of stages. The function $1-\delta \left(\frac{\omega_0}{\Delta\omega} \right)$ is shown in the graph.

From the above formulae it will be seen that the delay time t_m is inversely proportional to the bandwidth and proportional to a function which increases with the ratio of bandwidth to center frequency. The logarithmic decrement of the amplifier is equal to the reciprocal of half the bandwidth. The amplification of a square wave pulse V_1 corresponds to the maximum amplification factor times a factor which approaches 1 with increasing ratio of bandwidth to center frequency.

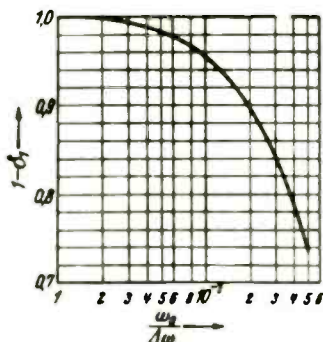

The ratio of the impulse output voltage to the noise output voltage for one and two stage amplifiers, G_{r1} and G_{r2} , are given by, respectively,

$$G_{r1} = \frac{A_0}{9.2\sqrt{R+R_0}} \cdot 10^{11} \frac{1}{\sqrt{\Delta\omega}} \cdot 2(1-\delta_1)^2$$

$$G_{r2} = \frac{A_0}{9.2\sqrt{R+R_0}} \cdot 10^{11} \frac{1}{\sqrt{\Delta\omega}} \cdot \sqrt{2}(1-\delta_1)$$

where R is the noise resistance at the amplifier input and R_0 the equivalent noise resistance of the first tube. The ratio of impulse voltage to noise voltage increases with a decrease in the bandwidth $\Delta\omega$, but at the same time the delay time t_m also increases. It is advantageous to make $\omega_0/\Delta\omega$ very small as G_r will then assume its greatest value for a given t_m . If $\omega_0/\Delta\omega \gg 1$,

$$G_{r1} = \frac{A_0}{9.2\sqrt{R+R_0}} \cdot 10^{11} \frac{1}{\sqrt{\Delta\omega}} \phi_n$$

the function ϕ_n is shown in a table, indicating that an increase in the number of stages improves the quality of the amplifier.

Magneto-Striction Noise

M. T. Dow (Bell Laboratories Record, June, 1944)

The alternating stresses in taut telephone wires vibrating under the influence of the wind result in corresponding changes in the mag-

6 Opportunities for Designers at RCA

Nature of the Work: Designing the following components for electronic equipment:

- ① Power transformers up to 5 kw
- ② Reactors
- ③ Audio transformers
- ④ Special filters (for television, etc.)
- ⑤ Tuning systems
- ⑥ R-f coils and transformers (including powdered-iron-core types)

All of these positions are now connected with direct war work.

- ✓ **Good Future:** These positions are not temporary. Every one of them offers a good future after the war.
- ✓ **Location:** At our Camden, N. J. plant.
- ✓ **Pay:** Starting rate depends on your experience and ability. Rates are comparable to those for similar positions throughout the industry.
- ✓ **Security:** When you work at RCA, you can be sure you are with a solid organization—25 years in the field, and today more progressive than ever.
- ✓ **Other Positions Available:** Our engineering and manufacturing organizations are always looking for good engineering talent. If you do not qualify for the positions listed, but are interested in a good future at RCA, let us hear from you.
- ✓ **WMC Regulations** will be strictly followed. If you don't know how they affect you, write us about yourself and we will check with WMC or USES.
- ✓ **WRITE TODAY!** Don't wait—write us about yourself right away. If RCA has a position for which you qualify, a personal interview will be arranged. Address: Radio Corporation of America, Personnel Administration, Camden, N. J.



Personnel Administration

**RADIO CORPORATION
OF AMERICA**

RCA VICTOR DIVISION • CAMDEN, N. J.

Baer FIBRE FABRICATIONS

...for functional efficiency!



BAER engineers — specializing in stamping, punching, drilling, sawing and machining of fibre parts—assure the utmost precision in every phase of production. Fabrication to extremely close tolerances offers the solution to innumerable design problems.

Baer vulcanized fibre products have high insulation qualities and are exceptionally tough and durable; phenol fibre parts are especially applicable where low moisture absorption is a factor. Write for illustrated Bulletin 128.

Specify BAER FOR WASHERS, STAMPINGS, GASKETS, SPECIAL SHAPES, TERMINAL BOARDS AND BUSHINGS



N. S. BAER COMPANY

CRAFTSMEN IN FIBRE FABRICATION
9-11 MONTGOMERY ST., HILLSIDE, NEW JERSEY

THE EYE CAN'T SEE ITS EXCELLENCE

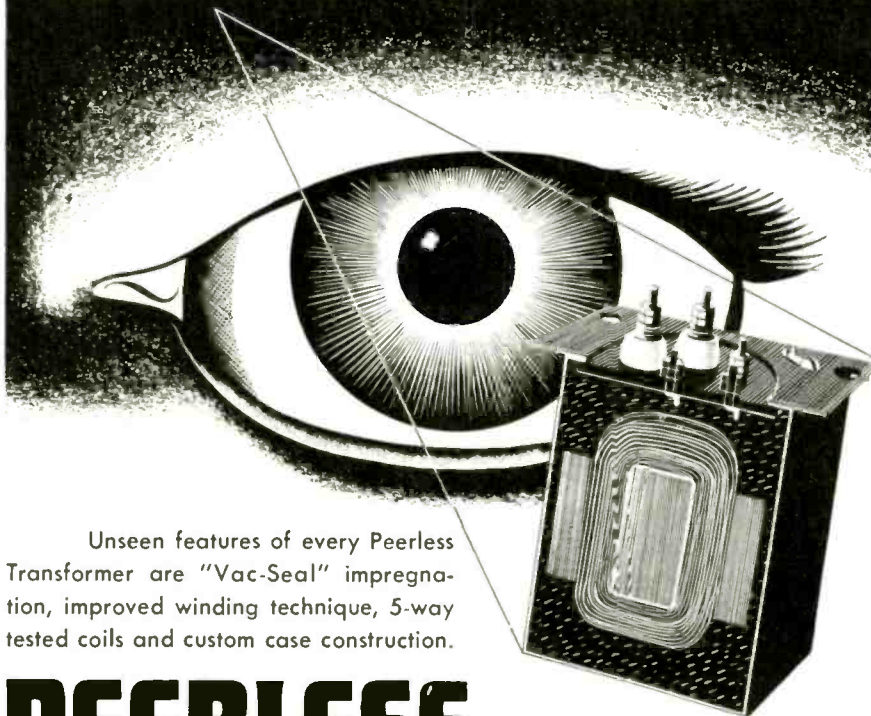

Unseen features of every Peerless Transformer are "Vac-Seal" impregnation, improved winding technique, 5-way tested coils and custom case construction.

PEERLESS
ELECTRICAL PRODUCTS CO.

6920 MCKINLEY AVENUE • LOS ANGELES 1, CALIFORNIA

WIDE READING

netization of the steel wires, and these magnetic fluctuations induce voltages in the wires that appear as noise at the ends of the line. No effect is noticeable in copper lines, because copper is not a magnetic material. Results of experiments to establish the relationship between the intensity and frequency of the disturbing magnetostriction noises and the wire diameter, the wind velocity and other pertinent factors are reported.

Modulation and Frequency Conversion

H. Stockman (Journal of Applied Physics, May, 1944)

Mechanical models for the demonstration of square-law, screen grid, and suppressor grid modulators, as well as frequency converters have been designed. To explain their operation, relations and differences between modulation and frequency conversion, as well as those between the square law and the double-input systems are studied.

The difference between a converter and a modulator lies in the filter properties of the load. In a modulator the complete wave is passed on while in frequency conversion only the sum or difference term is passed on and the other frequencies are filtered out.

The square law systems operate on a non-linear portion of the converter characteristic (crystal, diode, or single input tube); the double-input systems change from one straight line characteristic to another (multiple-grid tube). In the first instance, the added inputs are distorted by the non-linear characteristic so as to yield the essential product term, in the second instance, the gain is varied which again results in the product term to be present in the output wave.

The Etherscope

D. G. Hull (Electronic Engineering, London, May, 1944)

The etherscope is an experimental device designed to enable the signals from all stations in a given waveband to be viewed simultaneously on a cathode ray tube. It may be used either for viewing active short wave bands, (commercial, broadcast or amateur) or for automatically searching the comparatively inactive uhf bands, (police, aircraft service, etc.).

The underlying principle consists of rapidly tuning a receiver across the required band, at a predetermined repetition frequency, and synchronizing the time base of an oscilloscope to this periodicity; the dc component of the receiver

FAST, PROPER AND EASY

FERRULING
with
AMPHENOL
FERRULE CRIMPING
MACHINE

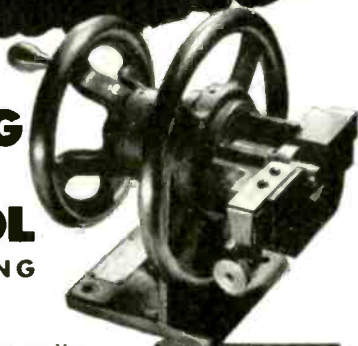

Amphenol Ferrule Crimping Machine with mandrels and collets in separate case.

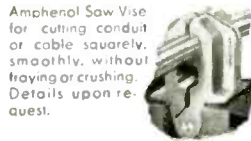

Amphenol Saw Vise for cutting conduit or cable squarely, smoothly, without fraying or crushing. Details upon request.

Here is a machine that really puts ferrules on flexible conduit SQUARELY and SECURELY. It rolls two smooth beads into ferrule and conduit—makes a secure and thoroughly workmanlike job. Connections made by this machine stand strains greater than called for by AN Specifications. The machine is furnished with mandrels and collects for 8 sizes of ferrules.

Anyone can learn in a few minutes to apply ferrules fast and properly with this machine.

Write for detailed information.



AMERICAN PHENOLIC CORPORATION
1830 So. 54th Ave. - Chicago 50, Illinois
Makers of Cable Assemblies, Conduit, Connectors, U.H.F. Cable, Radio Parts and Molders of all Types of Plastics.

SKILL

To Meet Your Specifications

PERFORMANCE is the real measure of success in winning the war, just as it will be in the post-war world. New and better ideas—production economies—speed—all depend upon inherent **skill and high precision** . . . For many years our flexible organization has taken pride in doing a good job for purchasers of small motors. And we can help in creating and designing, when such service is needed. Please make a note of Alliance and get in touch with us.

ALLIANCE DYNAMOTORS

Built with greatest precision and "know how" for low ripple, high efficiency—low drain and a minimum of commutation transients. High production retains to the highest degree all the "criticals" which are so important in airborne power sources.



ALLIANCE D.C. MOTORS

Incorporate precision tolerances throughout. Light weight—high efficiency—compactness—continuous duty. An achievement in small size for continuous duty and in power-to-weight ratio. Careful attention has been given to distribution of losses as well as their reduction to a minimum.



Remember Alliance!
—YOUR ALLY IN WAR AS IN PEACE

ALLIANCE

MANUFACTURING CO.

ALLIANCE . OHIO

Need Wire Now?

COLUMBIA is reliable!

Immediate Delivery!

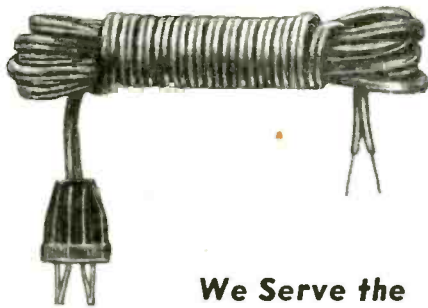

- **WIRE**
#22 to #12 Gauge
- **CABLES**
All Types
- **CORD SETS**
Ready-to-attach Assemblies

We Serve the

RADIO & ELECTRONIC INDUSTRY

We cut, strip, and tin wire; attach lugs and eyelets to meet your requirements.

INQUIRIES ARE WELCOME

Columbia 

COLUMBIA WIRE AND SUPPLY COMPANY

4106 N. PULASKI RD.

CHICAGO 41, ILL.

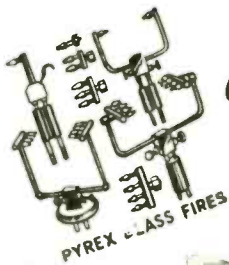

EISLER'S General Glass Working Equipment

manufacturing RADIO, CATHODE RAY,
ELECTRONIC and FLUORESCENT TUBES,
ELECTRONICS LABORATORY UNITS.

WELDERS, TRANS-
FORMERS FROM
1/4 TO 500 KVA.



Class Cutter



Ampule Machine



Tipless Stem Mach.



Sealing Machine

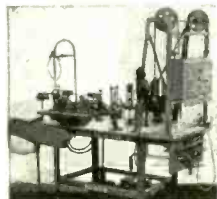

Electronics Laboratory Unit



Flare Machine

**CHAS. EISLER
EISLER ENGINEERING CO.**
778-SO. 13th ST. NEAR AVON AVE. NEWARK, 3 N. J.

WIDE READING

output is applied to the vertical plates of the oscilloscope. The result will be a straight horizontal line, representing a frequency base—which must be calibrated in some way—with several small vertical lines rising from it, each representing the presence of a radio station.

Receiver tuning by various electronic means is discussed, and it is found that it does not meet wide-band requirements. Therefore, motor-driven tuning capacitors are used, and their speed synchronized with the time base by means of switch contacts operated from the motor shaft. Details of the capacitor design and of the accessory apparatus are given. With the device, a frequency excursion of some 15 per cent was obtained on the 45 megacycle band.

Action of the Geiger Point Counter

J. Morgan and J. Loyd Bohn (*Journal of the Franklin Institute*, May, 1944)

Investigations have been made on a point counter, i.e., a negatively-charged needle extending within a positive cylinder, to determine the dependence of the threshold voltages (with and without ionizing rays and for continuous discharge) on such factors as the geometry of the tube (and, particularly, of the point), the gas pressure and the nature of the gas used, the ionizing agent, and the material and position of the point.

A theory by which the operation of the counter is described is based on the presence of a high resistance layer of adsorbed gas at the point. It is further assumed that electron emission from the point may take place in the absence of ionizing radiation or as a result of positive ion bombardment of the point. This theory seems to be consistent with the phenomena observed by the authors and with those reported by other experimenters.

Coincidence Counters

C. L. Meaker and A. Roberts (*Review of Scientific Instruments*, June, 1944)

In testing coincidence counters, it was found that, with a very short resolving time, the fraction of the true coincidences was a function of both the counter voltages and the absorber between the counters. This dependence is explained by the difference in amplitude between the two counter voltages. The small capacitance in the input circuit to the last amplifier stages, followed by the mixer stage, differentiates the pulses, transforming the differ-

Wherever Precision Counts Most...

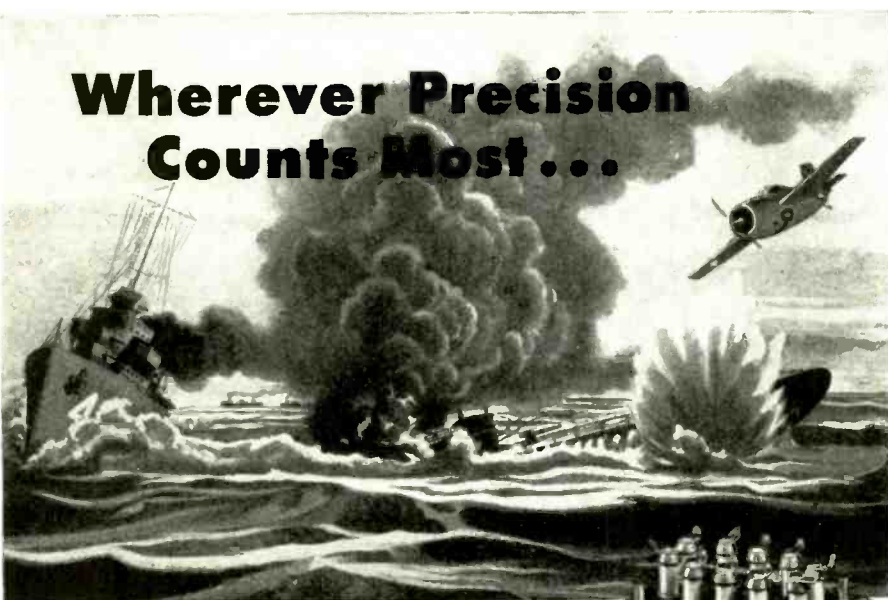

Products of "MERIT" are passing the test

Complying with the most exacting requirements for precision workmanship and durable construction, MERIT has established its ability to produce in quantity and deliver promptly—

Transformers • Coils • Reactors • Electrical Windings of All Types for Radio, Radar and Electronic Applications.

Today these dependable MERIT precision parts are secret weapons; tomorrow when they can be shown in detail as MERIT standard products you will want them in solving the problems of a new electronic era.

Illustrated: High Voltage Transformers A-2123 (small) and A-2124. Designed for high altitudes. Oil-filled and Hermetic sealed.

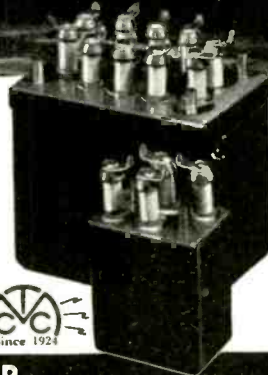

MERIT COIL & TRANSFORMER CORP.
311 North Desplains St. CHICAGO 6, ILL.

STURDILY BUILT FOR Dependable Service

Drake Assemblies are widely known for their unfailing dependability. However severely they may be used, these fine Pilot Light Assemblies keep on giving economical trouble-free service. For, quality is inherent in every detail of their design and precision manufacture. DRAKE'S patented features, developed by our research engineers, also add greatly to the efficiency, economy and dependable performance of these Assemblies. Currently, vital industries can get deliveries of custom assemblies within 3 weeks if no special blanking dies are needed. Every conceivable type of Dial Light is available... all measuring up to the same high DRAKE standards. Please refer to newest catalog for details about our complete line.



TYPE NO. 50
Pat. No. 2220516

PILOT LIGHT ASSEMBLIES

DRAKE MANUFACTURING CO.
1713 W. HUBBARD ST. • CHICAGO, U. S. A.

PRODUCTION MANAGER

LEADING ELECTRONIC TUBE MANUFACTURER has opening for production manager with wide experience in tube manufacturing. Excellent opportunity for right man. Apply by letter stating experience, education, etc. Reply Box U-14.

ELECTRONIC INDUSTRIES
480 Lexington Ave. New York 17, N. Y.

Kahle
ENGINEERING COMPANY
ELECTRON TUBE MACHINERY
All types, standard and special design.

Specialists in equipment and methods for the manufacture of:

RADIO TUBES	NEON TUBES
CATHODE RAY TUBES	PHOTO CELLS
FLUORESCENT LAMPS	X-RAY TUBES
INCANDESCENT LAMPS	GLASS PRODUCTS

On Production or Laboratory basis

1307-1315 SEVENTH ST., NORTH BERGEN, N. J., U. S. A.



COLE

STEEL EQUIPMENT COMPANY

SPARE PARTS BOXES

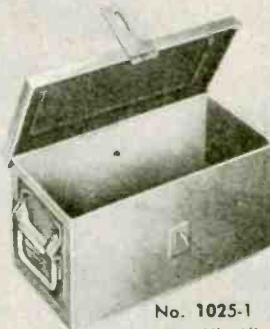

No. 1025-1
12" x 5" x 6"

Made as per specification —42 B 9 (Int) for shipboard use, Electrical and Mechanical. Navy grey finish. Immediate Delivery.

24 STOCK SIZES			
Number	Length	Width	Height
1025-1	12	6	6
1025-2	12	9	6
1025-3	12	12	6
1025-4	12	9	9
1025-5	18	9	6
1025-6	18	9	9
1025-7	18	12	9
1025-8	18	6	6
1025-9	18	15	9
1025-10	18	12	6
1025-11	18	15	12
1025-12	18	12	12
1025-13	18	18	12
1025-15	24	15	12
1025-16	24	15	15
1025-17	24	18	12
1025-18	24	18	15
1025-19	24	18	18
1025-20	24	12	9
1025-23	30	15	9
1025-14	30	15	12
1025-22	36	12	9
1025-21	42	9	9
1025-24	42	12	9

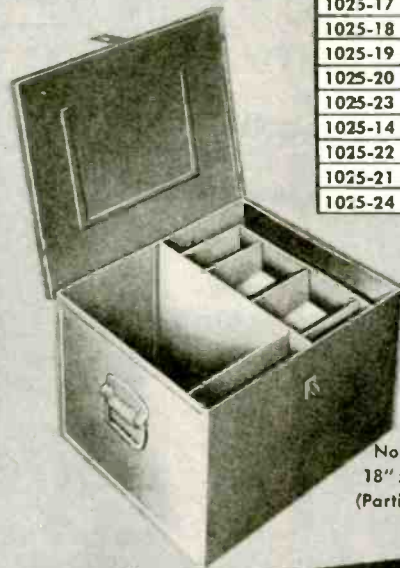

No. 1025-11
18" x 15" x 12"
(Partitions extra)

WRITE FOR PRICE LIST

Cole Steel
office equipment
will again be available
after the war

COLE

STEEL EQUIPMENT COMPANY

349 Broadway, New York 13, N. Y. Factory: Brooklyn

HARVEY'S
DIRECTIVE:
*to purchasing
agents of
electronic
and radio
components*

BECAUSE: You have so much to do in so little time.

BECAUSE: HARVEY has in stock, or can quickly obtain for you, supplies of

**TUBES • CAPACITORS
RELAYS • RESISTORS
TRANSFORMERS
TEST EQUIPMENT**
*And other needed
RADIO and ELECTRONIC
COMPONENTS*

AND BECAUSE: HARVEY can advise you on technical or priority problems.

WE SUGGEST: that you come to HARVEY for your next order. 17 years experience enables us to fill orders efficiently, and expeditiously.

**And, WE DELIVER
... within 24 hours, if
possible.**

**TELEPHONE ORDERS TO
LONGACRE 3-1800**

**HARVEY
RADIO COMPANY
HARVEY**
103 WEST 43rd ST., NEW YORK 18, N. Y.

WIDE READING

ence in amplitude to a phase difference, so that the two pulses are no longer simultaneous. Consequently, the pulses are not registered by the counter. The effect may be used to distinguish between particles of different energy.

Attenuation Equalizer

F. Pyrah (Post Office Electrical Engineers' Journal, London, April, 1944)

A small, two-terminal, shunt-type attenuation equalizer for use with audio amplifiers is described. The maximum loss at low frequencies, the resonant frequency at which the loss is a minimum, and

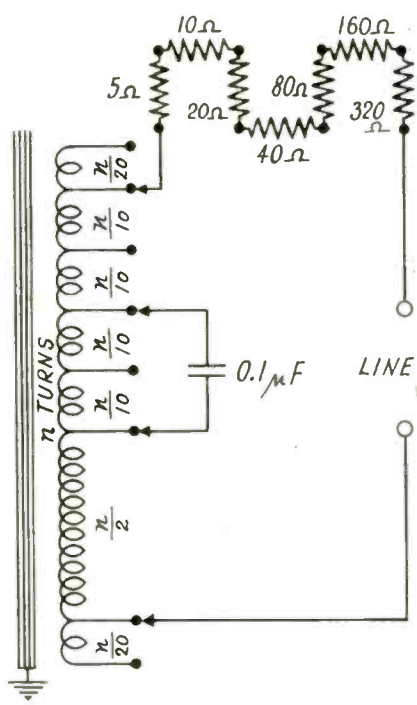

Attenuation equalizer

the rate with which the loss decreases with change in frequency, from the maximum loss to the resonance (or minimum) loss are each independently adjustable. A 20 db range of basic loss can be covered.

Induction Heating of Aluminum

E. H. Plesset and J. R. Chadwick (Iron Age, June 1, 1944)

It is pointed out that aluminum, because of its comparatively low resistivity, can be successfully heated by a 250 cycle induction heating equipment. A suitable apparatus was built and found satisfactory.

The New
DUMONT
TYPE P6
Paper
CAPACITOR

"DURASEALED"
for high temperature uses.
No END WAX
to run out.



PAT. PEND.

- The New Dumont "DURASEALED" has its ends sealed in Bakelite Resinoid... therefore they cannot drip out under any temperature... they are highly moisture-proof.
- Suitable for operation for requirements at 95% to 100% humidity.

**BUY
MORE
BONDS**

* If your Jobber cannot supply you write us.

**DUMONT
ELECTRIC CO.**
HEADS OF
CAPACITORS FOR EVERY REQUIREMENT
34 HUBERT STREET NEW YORK, N. Y.

ESICO

REG. U. S. PAT. OFF.



SPOT SOLDERING MACHINE
designed for treadle operation for advancement of iron and solder, leaving operator's hands free for handling of product.



SOLDERING IRONS

are widely used in industrial plants throughout the country. They are designed to withstand the strain of continuous service required of factory tools.

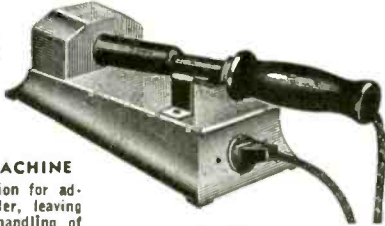

SOLDERING IRON TEMPERATURE CONTROLS
prevent overheating of soldering irons between soldering operations. Irons do not deteriorate when being used. The idle period causes oxidation and shortens life.

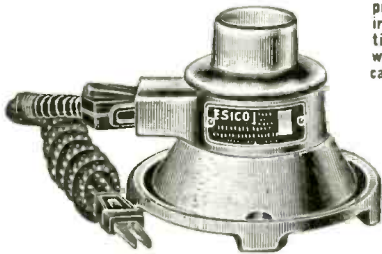

SOLDER POTS

ruggedly constructed pots of various sizes designed for continuous operation and so constructed that they are easily and quickly serviced, should elements have to be replaced.

Write for Catalog

ELECTRIC SOLDERING IRON CO., INC.
2344 WEST ELM STREET, DEEP RIVER, CONN.

Continuously
Since 1930

PRECISION GROUND

Crystals
BY
HIPOWER

AIRCRAFT
MARINE • BROADCAST
POLICE • COMMERCIAL • AMATEUR

HIPOWER CRYSTAL COMPANY
Sales Division — 205 W. Wacker Drive, Chicago 6
Factory — 2033 Charleston St., Chicago 47, Ill.

WANTED

SENIOR Radio Engineers

Executive type with thorough practical and educational background in radio and electronics. Must have substantial experience and demonstrated initiative in design, research, and development. Capable of supervising development and production engineers. Excellent working conditions. Permanent positions with ample opportunity for advancement. Outline complete details of qualifications, experience, and when available. Salaries open. Confidential inquiries respected. Write.

Personnel Director
AIR COMMUNICATIONS, INC.
Kansas City 10, Missouri



BIG or SMALL Consumers

They're All Equally Important

to



"Gentlemen:
"I must say I was surprised and pleased to receive your letter. Imagine a concern as large as yours asking for post-war business at the present time under the hardships which must confront you in the way of raw materials, etc. Yours is the only company which has written in regard to our business, small though it has been with you, and believe me when priority restrictions are lifted from inventory stocks, we look forward to having a complete stock of 'Stronghold' items."
(Signature upon request)

IT IS A matter of policy with STRONGHOLD that all orders or inquiries pertaining to fastening products are of EQUAL IMPORTANCE, regardless of the size of the order or the size of the company from which it comes.

STRONGHOLD serves many of America's industrial giants whose use of fasteners run into astronomical figures. It also serves, with equal promptness and concern, thousands of smaller companies whose use of fasteners is limited—but equally important in the construction of the products they make. We welcome your inquiries for samples or prices of either standard or special screw products. You will hear from us promptly.

It's faster to telephone
Call **WHitehall 4680**

**MANUFACTURERS
SCREW PRODUCTS**

268 W. Hubbard St. Chicago 10, Ill.



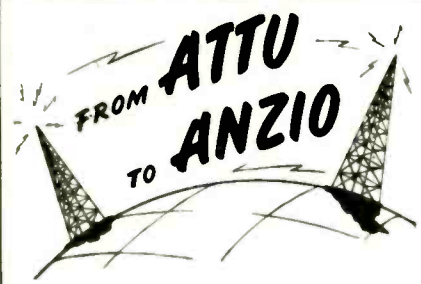

**From ATTRITION*
To INVASION**

Unseen, Unobtrusive

Crystals Are the Detectors, the Transmitters, the Silent Servants of the Signal Corps.

And Valpey Crystals,

custom cut and precision ground, perform many a complex duty in this war. In subzero temperatures, in tropical zones, wherever men fight and wherever men 'phone, Valpey crystals coordinate.

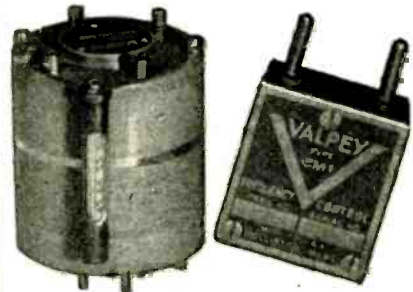

THE XLS

Valpey's Specially Designed Low Frequency Unit Built for Today's Business — War.



Have you used Valpey

Crystals for that specially complicated setup? Valpey laboratories are on the job, devising, designing, developing new crystal uses for War now—for Peace Tomorrow. Valpey experience and expertness are yours for the asking.

*The wearing down, as of resources by continual slight impairments, as a war of attrition.

BONDS ARE BOMBS . . . BUY MORE BONDS

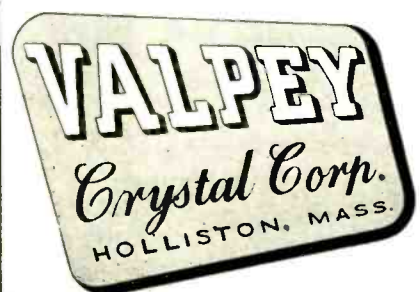

WHAT'S NEW

(Continued from page 210)

Portable Sound System

A portable sound system with self-contained power supply is being manufactured by the Newcomb Audio Products Co., 2815 So. Hill St., Los Angeles. The complete system, easily carried by one person, weighs only 39-1/2 lb. including microphone, amplifier, power supply and loudspeaker. It is designed to create high acoustic output

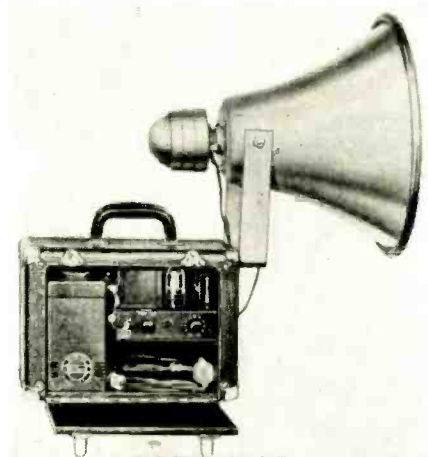

(approximately 95 decibels at 100 feet) with low battery consumption. A special press-to-talk switch in the microphone handle automatically connects the power supply only when commands or "speech" are required. Power requirements are thus reduced approximately 85 per cent during stand-by periods.

Interval Timer

Haydon Mfg. Co., Inc., Forestville, Conn., has a new synchronous motor-operated automatic reset time delay and interval timer for time delays of one second to five minutes with fixed or adjustable intervals. The units are available with various assemblies of actuating arms, reset springs, terminal mountings and precision snap switches, NC, NO and DT. The 5900 series type, fixed interval reset timer for timed periods up to one minute may be permanently installed across the line. Because of the larger torque built up in the motor at slower speeds than 1 rpm, where a longer period is required, it is necessary to use an auxiliary relay to release the timing motor at the end of the timed period. With the adjustable time delay units available (1817 series) a 5 rpm motor is ordinarily used to give an adjustable delay of 1-10 seconds. The adjustment is set by means of a stop nut which controls the position of the stop against which the motor arm resets at the end of return travel. In the adjustable units for timing intervals of 10 seconds to 5 minutes, a correspondingly slower speed motor is used, depending on the timed period required. The units are also available for dc operation.

Silicon Products

A series of organo-silicon polymers, has been developed by Dow Corning Corp., Midland, Mich., for essential applications. These products, because of their unusual properties, have solved many problems where conventional materials have failed. Dow Corning Corp. was formed in February, 1943 by Corning Glass Works and the Dow Chemical Co. to manufacture and develop silicones more intensively. Corning Glass Works had been conducting research in organic derivatives of silicon for more than a decade. In the course of investigations water white liquid polymeric silicones having unusual chemical and physical properties were discovered. These materials, under the name of Dow Corning Fluids, are manufactured in various viscosities ranging from liquids as thin as

**Sorry..
22 ADS
OMITTED
FROM THIS ISSUE**

Failure to meet our published closing date—1st of month preceding date of issue—has resulted in the omission of 22 separate ads from this issue.

While we regret this as much as the advertisers, we repeat: *late copy will be omitted.* An inflexible wartime printing schedule is the reason. Only by strict adherence to the following schedule can future omissions be avoided:

**CLOSING DATE —
1st OF MONTH
PRECEDING DATE OF ISSUE:**

For composition, proofs, corrections, key changes, foundry work, etc. The last form is kept open until the 10th of the month for a limited number of complete plates, ready to print and definitely scheduled by us. September issue closes August 1.



**CALDWELL-CLEMENTS, INC.
480 Lexington Avenue
New York 17, N. Y.**

**NEW
KURMAN
Ideas**

**A NEW FEATURE
OF GREAT IMPORTANCE
ADDED TO OUR "OLD TIMER"**

Now . . . Chatterless operation is added to the known sensitivity of our "Old Timer" (200 Series) . . . The new feature consists of an energy absorbing material sealed within a contact carrying cage. The compound used is not affected by age, oil, or moisture.

No Bounce! No Chatter!
... in the new Kurman
200S Flat Keying Relay

KEYING FEATURES:

1. No bounce. No chatter.
2. Input 50 Milliwatts.
3. Will key up to 150 words per minute, or 60 impulses per second.
4. Armature is mica insulated; is suitable for keying a 50 Mega-cycle R.F. signal.
5. Contacts will carry up to 2 Amps.

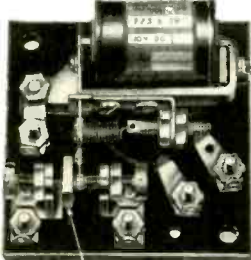

New Feature . . . eliminates "bounce" and "chatter"

Oscilloscopic wave form looks like this



NOT like this



Send a  for complete information on the new line of KURMAN vibration-proof RELAYS.

KURMAN ELECTRIC CO.



35-18 37th STREET • LONG ISLAND CITY 1, N. Y.

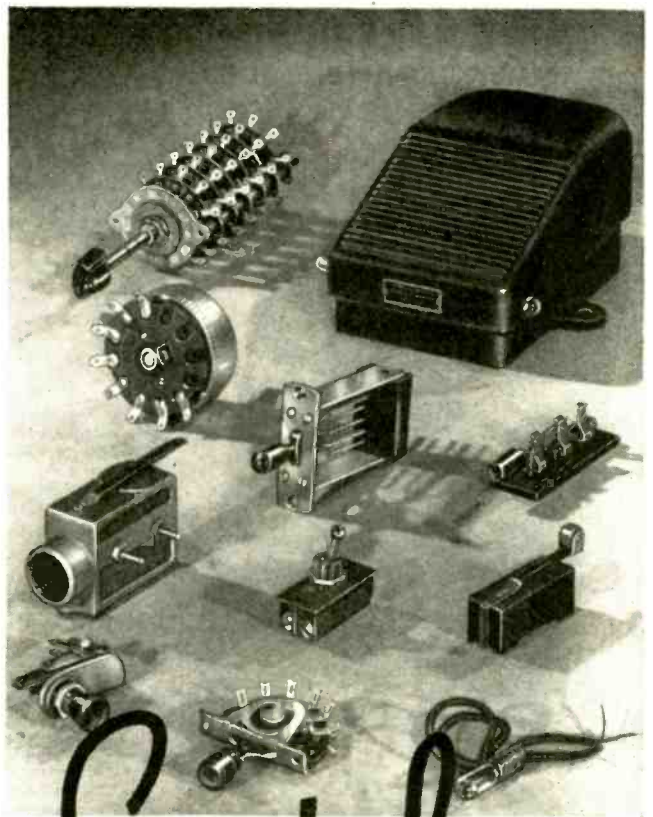

Switches

**In Endless Variety
for Emergency Shipment to Industry**

FOR want of a Switch, many days could be lost! And when it's vital war work that is delayed, that Switch assumes tremendous importance. Now, war industries from coast to coast can get quantities of Switches of many different kinds, with amazing speed and efficiency. We three distributors have organized a *National Industrial Emergency Service* which delivers Switches and thousands of other Radio and Electronic Items with speed heretofore considered impossible. Oversized, over-diversified stocks, expert technicians, unique streamlined methods . . . every facility is employed to *help keep your work on schedule!* Send us a test order, or ask for all the facts NOW!

WRITE OR PHONE YOUR NEAREST DISTRIBUTOR

TERMINAL RADIO CORP.

85 Cortlandt St., Phone WOrth 2-4416 NEW YORK 7

WALKER-JIMIESON, INC.

311 S. Western Ave., Phone CanAl 2525 CHICAGO 12

RADIO SPECIALTIES CO.

20th & Figueroa, Phone ProsPect 7271 LOS ANGELES 7

NATIONAL INDUSTRIAL EMERGENCY SERVICE

ENGINEERS — DRAFTSMEN

POST WAR OPPORTUNITY

Progressive New York Electronic Manufacturing Company is now seeking additional personnel. Require two (2) transmitter, five (5) receiver and two (2) special equipment engineers, as well as four (4) draftsmen and two (2) laboratory technicians.

This is not a "Duration" program. Personnel of proven capabilities assured a post war position, comparable current status. Transportation will be paid to New York. Salaries commensurate with experience and ability and current earnings. All negotiations confidential. Address replies to

ELECTRONICS, SUITE 411

280 BROADWAY

NEW YORK, N. Y.

**Radio
AND
ELECTRONIC
DEVICES**

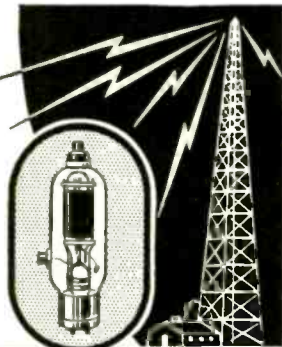

BURSTEIN-APPLEBEE CO.

1012-1014 McGee St.

Kansas City 6, Missouri

THE LATEST UP-TO-THE-MINUTE RADIO AND ELECTRONIC CATALOG IN THE COUNTRY TODAY!



Available

Newest listings of amplifiers, communications equipment, radio tubes, testers, etc. • The latest developments in intercommunications equipment. • Greatly expanded listing of needed tools, especially for assembly and factory use. • Advance listings of 1944 radio and electronic books; repair and replacement parts; bargain section of values. • A brand new, up-to-the-minute catalog that should be in the hands of industrial plants, laboratories, government and military services, schools, radio servicemen and dealers (on L265), everybody engaged in vital war and civilian work.

FREE! The Lafayette Radio Catalog No. 94 will be rushed to you upon request. Fill out this coupon NOW!

LAFAYETTE RADIO CORP.
901 W. Jackson Blvd., Chicago 7, Ill.
Dept. J-8

Please rush my FREE copy of the Lafayette Radio Catalog No. 94.

NAME

ADDRESS

CITY STATE

Back the Attack Buy More War Bonds

Lafayette Radio Corp.

901 W. Jackson Blvd. 265 Peachtree Street
CHICAGO 7, ILLINOIS ATLANTA 3, GEORGIA

WHAT'S NEW

water to those which barely flow at room temperature. Their most outstanding property is an exceptionally low rate of viscosity change with temperature, compared to that of previously used liquids. Certain types are made that do not freeze at dry ice temperatures and these same products can be used at temperatures up to 400-500 deg. F. Silicone resins for electrical insulation extend the range of operating temperatures possible in electrical equipment beyond the limit of thermal stability of conventional organic materials. One of the resins is available as a coating and impregnating varnish which may be applied to Fiberglas cloth, asbestos cloth, asbestos paper and Fiberglas served wire, or the like, by conventional dipping and drying methods. It requires baking at a temperature of 250 deg. C. for one to three hours to cure to a non-tacky state. Another is an impregnating varnish which sets with heat at 200 deg. C. These materials do not carbonize or darken when subjected to prolonged heating at the curing temperatures.

Diffusion Pump

Designed by Distillation Products, Inc., Rochester, N. Y., especially for the new-style rotary exhaust machines in which a diffusion pump moves around with each tube, as well as for portable electron microscopes and similar apparatus, this compact metal diffusion pump incorporates the fractionating principle and does not require any liquid air trap. The construction is radically different from previous designs and has

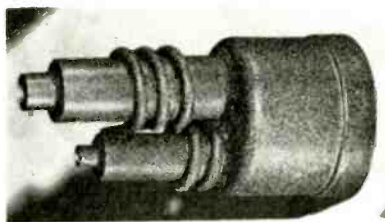

been designated by the symbol VMF. Three sizes are available; the smallest, Type VMF-6, is 2 3/4 in. in diameter and 6 in. high, while the largest, Type VMF-20 is 5 1/2 in. in diameter and 9 1/2 in. high. The characteristics of the intermediate size, Type VMF-10, are:

Speed 10 liters/sec. at 10⁻⁴ mm. Hg. Ultimate Vacuum
1 x 10⁻⁶ mm. Hg. with Octoil-S
Required Forepressure 0.125 mm. Hg.
Heater Power 135 watts
Height 7 3/4 in.
Width 3 3/8 in.
Weight 2.5 lb.

The problems of heat transfer which had hitherto made small metal pumps impracticable were solved by a unique boiler design. The units are normally cooled by water, but special air-cooled models are also available.

Signal Generators

Type 804-CS1 and 804-CS2 uhf signal generators are laboratory type instruments, capable of producing a range from 7.6 to 330 megacycles; frequency calibration accurate to plus or minus 2 per cent, and this voltage output is controlled by an accurately calibrated attenuator network which allows control from 1 microvolt to 20,000 microvolts. Output is arranged so that an internal source of modulation at a frequency of 1,000 cycles may be used, or, by use of an incorporated switching arrangement, external sources of modulation may be used between 30 cycles and 20,000 cycles, adjustable from 0 to 60 per cent, indicated by a direct-reading modulation

PEERLESS PLUG & JACK

*Perfect contact
always assured*



BUILT with machine precision, ruggedness and strength. Perfect contact always assured because the side pressure is not carried by contact elements. Pin held in a bulldog grip by U-shaped member (see dotted lines) that fits over core of the jack. Wobbleproof. Can't work loose. Unfailing operation. Versatile—can be fitted to any standard terminal or cable connector. Accurately machined and threaded for permanent union with hard rubber sleeve or bushing. Quickly assembled. Nothing to get out of order.

Write for literature on switches, condensers, etc.

PEERLESS LABORATORIES

115 East 23rd Street, New York 10, N. Y.

SYLVANIA ELECTRIC PRODUCTS INC.

has openings for

**ELECTRICAL ENGINEERS
MECHANICAL ENGINEERS
MACHINE DESIGNERS
RADIO TECHNICIANS**

to work with our design, development and production of radio tubes, fluorescent lamps, electronic equipment and devices.

We want men who have the "know how" of getting things done under pressure, and who would like to become associated with a company whose post-war future is indeed encouraging.

Reply giving age, education, and experience to our

**INDUSTRIAL RELATIONS
DEPARTMENT**

500 Fifth Ave., New York (18), N. Y.

New!

PERMANENT MAGNETS MANUAL

From many years experience in the production of ALNICO permanent magnets, The Arnold Engineering Company has prepared an authoritative, up-to-date manual of valuable information on the design, production and application of the modern permanent magnet.

Contents include such subjects as Magnet Materials, Resistance Comparisons, Physical and Magnetic Properties, Demagnetization and Energy Curves, Fabrication, Design and Testing. Charts and tables illustrate and explain various aspects of the discussion.

Recent improvements have opened many new fields for permanent magnets to reduce the cost and improve the efficiency of many devices.

Write today for your copy on your company letterhead.



THE ARNOLD ENGINEERING COMPANY

147 EAST ONTARIO STREET, CHICAGO 11, ILLINOIS

Specialists in the
Manufacture of ALNICO
PERMANENT MAGNETS



Two Symbols of Quality!

IN WAR



We are manufacturing to the toughest specifications of the armed forces and are producing cordage to their satisfaction.

IN PEACE

We shall produce the type and quality of cordage you must depend on for your electrical appliances.



A Complete Plant from Copper Drawing to Assembled Cords

Diamond Wire & Cable Co.

CHICAGO HEIGHTS, ILL.

Manufacturers of electrical flexible cord, cables, and instrument wires for radio and appliances

REFLEX SPEAKERS



**DESIGNED
for
WAR
USE**



★ **HIGH
EFFICIENCY** ★



★ **RUGGED
CONSTRUCTION** ★



★ **HIGH
POWER** ★

★ **UNIFORM
RESPONSE** ★

★ **HIGH
INTELLIGIBILITY** ★

★ **WEATHER
PROOF** ★



★ **REFLEX
SPEAKERS
ARE THE
ACCEPTED
STANDARD
FOR ALL
WAR
USE** ★



Every high efficiency speaker in University's extensive line of speech power reproducers has a vital part in the WAR program.



Submit your special loudspeaker problem direct to our engineering department.



WHAT'S NEW

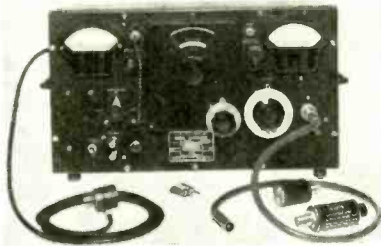

meter. A special input circuit is also incorporated so that, by a circuit-switching device incorporated in the panel control assembly, it is possible to modulate the generator from an external source, with a pulse modulation having very steep wave fronts and extending in rapidity to pulses of about 20 micro-seconds. A stabilized power supply is incorporated in the unit for operation at either 115 volts or 230 volts, 40 to 60 cycles, single phase. Manufacturer is Federal Mfg. & Engineering Corp., 211 Steuben St., Brooklyn 6, N. Y.

Indicating Light

The No. 590 indicating light for heavy duty service on 120 volts, mounts in a single $\frac{7}{8}$ in. hole on panels of extreme thickness. The lens-cap is threaded and contains a heavy walled glass lens, cupped in shape. The tip of the S6 Standard 120 volt lamp bulb extends well into the cup of the lens, making easy the servicing of the bulb without the use of tools and eliminating springs, etc. This lens design also provides 180 degree of visibility. Lenses are available in red, green, blue, amber and white with the interior surface sand-blasted. Lenses are also available without sand-

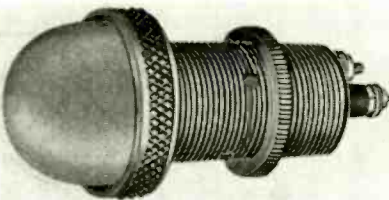

blasting in clear glass. The socket is Underwriters' approved for 120 volt service, and is the screw candelabra base type for use with the T4 $\frac{1}{2}$ Neon Glow lamp bulb as well as with the S6 tungsten bulb. The lens-cap is also available with socket sections for use with other type lamp bulbs, such as the No. 555 D/E Unit for use with G6 double-contact bayonet base bulbs and the T3 D/E Unit for use with the single-contact miniature bayonet base T3 $\frac{1}{4}$ lamp bulbs. Manufactured by The H. R. Kirkland Co., Morristown, N. J.

Megohm Meter

Essentially a direct-reading ohmmeter but incorporating a vacuum-tube voltmeter in order to cover relatively high resistance values, Model L-2 Megohm Meter developed by Industrial Instruments, Inc., 156 Culver Ave., Jersey City, N. J., offers several new features for this type of instrument. Entirely self-contained, it operates on 110-volt 60 cycle ac. The instrument is mounted on a sloping panel. Arrangements are provided for the rapid charging of condensers under test. An external battery voltage supply may be used where voltages other than the self-contained 200-volt supply, are desired. The instrument may be satisfactorily operated with external voltages up to 1000. Internal resistance standards enable the operator to check calibration and make compensating adjustments when necessary. Full length of scale is 3 $\frac{3}{4}$ in. with less crowding at high-resistance end

TECHNICAL NOTES

Excerpts from New Home Study
Lessons Being Prepared under
the Direction of the CREI
Director of Engineering Texts

Phase Inverter Circuit

In the August issue of its monthly magazine, CREI NEWS, The Capitol Radio Engineering Institute continues its series of interesting technical articles. The coming issue deals with an interesting type of phase inverter circuit, particularly suitable for wide band operation, such as for a cathode-ray oscilloscope.

Part I, which appears in the August issue, describes the circuit, compares it with other types of phase inverter circuits, and analyzes its basic action.

A second article on the phase inverter circuit will appear in the September issue of the CREI NEWS. It will evaluate its gain and its stability under variable operating conditions.

We are making these technical articles available to every interested radioman. If you want to receive these articles on the phase inverter circuit, and other articles to follow, merely write to the Capitol Radio Engineering Institute, and ask for the August issue of the CREI NEWS containing this article. This and other future issues will be sent to you free and without obligation.



The subject of "Phase Inverter Circuit" is but one of many that are being constantly revised and added to CREI lessons by A. Preisman, Director of Engineering Texts, under the supervision of CREI President E. H. Rietzke. CREI's home study courses are of college calibre for the professional engineer and technician who recognizes CREI training as a proven program for personal advancement in the field of Radio-Electronics. Complete details of the home study courses sent on request. . . . Ask for 36-page booklet.

CAPITOL RADIO ENGINEERING INSTITUTE

E. H. RIETZKE, President

Home Study Courses in Practical Radio-Electronics Engineering for Professional Self-Improvement

Dept. EI-8, 3224-16th St. N. W.
WASHINGTON 10, D. C.

Contractors to the U. S. Navy—U. S. Coast Guard—Canadian Broadcasting Corp.—Producers of Well-trained Technical Radiomen for Industry.

WHAT'S NEW



than is usual in such an instrument. Using the internal 200-volt supply, maximum range extends from 1 megohm to 100,000 megohms in four overlapping ranges but can be extended to 500,000 megohms with an external 1000-volt supply. Maximum resistance in series with condenser or insulation under test is only 1 megohm. This assures practically constant voltage across test terminals and minimizes the effect of tube ground current. Stability is assured by balanced tube circuit and voltage regulators in the internal power supply. The Model L-2 Megohm Meter measures 10 in. x 8 in. x 15 in. deep, and weighs 10 lbs.

DC Meters

A standard line of voltmeters, ammeters, microammeters and milliammeters is being produced by Dale Instruments Electronic Development Co., 2055 Harney St., Omaha, Nebr. They are available in two- and three-inch cases. A solid bakelite bridge construction of conventional design forms the body of the movement which incorporates soft iron pole pieces to insure uniform scale distribution. A special type of balance system is used to assure good balance for all positions of mounting.

Hardware Kit

This 1,500-piece radio hardware kit is contained in an 18-compartment clear plastic box and includes small, medium and large 6-32, 8-32 and 10-32 screws with service binder, washer and rounded heads, nuts and washers as well as assorted lock washers, Parker-Kalon self-tapping screws, spade bolts, rivets, plus switch and volume control hardware. Most parts are brass stock with assorted finishes, nickel, copper, oxidized, endmium and parkerized. Maker is Walker-Jimieson, Inc., 311 South Western Ave., Chicago 12, Illinois.

"Packaged" Weld Timer Units

Combination timer-contactor "package" units designed to provide the simplest, lowest cost, automatic, electronic control for resistance welders are announced by Wel-tronic Co., 19500 W. 8 Mile Rd., Detroit 19, Mich. The new combination units may be used with new machines or to convert manually or cam-timed welders to electronic control. When used with air or hydraulically operated welders, the new package units eliminate inter-unit wiring, simplify installation and maintenance, and permit mounting of all controls on a machine if desired.

Multi-Output Dynamotors

The heavy drain on storage batteries by the use of several electric motor-generators in mobile equipment has been reduced by the development of the multi-output dynamotor produced by the Carter Motor Co., 1608 Milwaukee Avenue, Chicago. The new

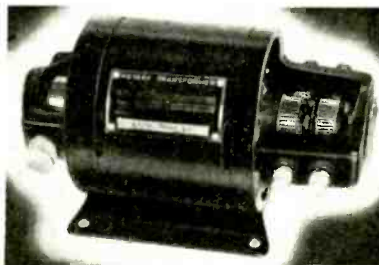

type dynamotor delivers as many as three separate outputs simultaneously. It is possible to use 6.3-volts ac, as well as "B" power for the receiver and also have the high-voltage for the transmitter available at the flick of a switch.

Electrical Connector

Newest Cannon electrical connector in the Army-Navy specifications line is the type known as AN 3101, according to the proposed AN-W-C-591a specifications. Although in general appearance this new type looks like a plug, it has been designated as a "receptacle" inasmuch as it has a male coupling thread similar to Types AN 3100 and AN 3102. AN 3101 is a mating cord connector for AN 3106 and AN 3108. Since it has no mounting facilities such as the flange on Types AN 3100 and AN 3102, it may be used in place of an AN 3100 or AN 3102 when regular mounting is not necessary. Also adaptable for use with an extension cord. Available are sizes 8s and 16s, and 12 to 36 (incl.). All tooled Cannon insert arrangements are adaptable and interchangeable in Cannon Type AN 3101. Maker is Cannon Electric Development Co., 3209 Humboldt St., Los Angeles 31.

Matched MIDGET CONTROLS

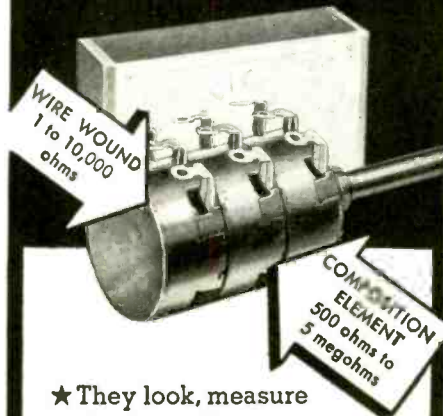

★ They look, measure and operate the same — these Clarostat wire-wound and composition-element midget controls. Fully interchangeable, mechanically. Can be made up in various tandem assemblies.

Clarostat Type 37 midget composition-element controls have been available for several years past. Their stabilized element has established new standards for accurate resistance values, exceptional immunity to humidity and other climatic conditions, and long trouble-free service. 1 watt. 500 ohms to 5 megohms.

And now the Clarostat Type 43 midget wire-wound is also available, to match Type 37 — matched in appearance, dimensions, rotation, switch. 2 watts. 1 to 10,000 ohms. For neatness, compactness, convenience, trouble-free operation — just specify Clarostat matched midget controls.

★ Write for literature . . .



CLAROSTAT MFG. CO., Inc. • 285-7 N. 6th St., Brooklyn, N. Y.

G-E INDICATOR LAMPS

Vibration-proof Lock-on Cap • With or without adjustable "Dimmer" feature
• Choice of five colors • Well-insulated plastic body • Rugged construction • Easy to mount • Light weight.

For complete details, write to

GENERAL ELECTRIC ELECTRONICS DEPARTMENT
SCHENECTADY, NEW YORK

177-C5

THE FUSE CLIP IS A VITAL PART OF COMPLETE CIRCUIT PROTECTION

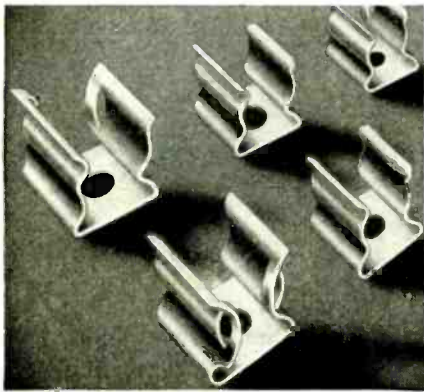

Littelfuse FUSE CLIPS

Phosphor Bronze, Nickel-Plated, and Beryllium Copper, Silver-Plated
In Littelfuse the science of the Fuse Clip has kept pace with that of the fuse itself. This is absolutely necessary to meet dependably the many new efficiency factors of complete circuit protection today—in electrical industry, in electronics, in communications, in radio and television, as well as in aircraft, ordnance and marine equipment, and other services.

Ask for the NEW Littelfuse Fuse Clip Bulletin
See what exclusive Littelfuse improvements have wrought in design and forming, for better contact with the certain results of maximum electrical conduction—lower coefficient of heat, with protection of panel boards and switches. Littelfuse Clips provide contact over the largest possible area, with firm dependable grip.



Wherever clips are used, Littelfuse can help in *your* circuit protection.

LITTELFUSE INCORPORATED
200 Ong Street, El Monte, California
4757 Ravenswood Ave., Chicago 40, Illinois

RCA's Electronic Institute for Industrial Engineers

An introduction to electronic power heating, plant broadcasting and industrial music systems, and industrial uses of the electron microscope was given to a group of industrial engineers of the Philadelphia Electric Co. at a four-day Electronic Institute May 16-19 by the RCA Victor Division of the Radio Corp. of America at Camden, N. J.

The program, first of its kind ever held, included talks, demonstrations, sound motion pictures, and tours of engineering laboratories and other sections of the RCA plant. The first three days of the institute were devoted largely to the principles of electronic power heating and the equipment and technics involved in the generation of high-frequency power and its application to various industrial processing operations. Plant broadcasting and communication systems and the electron microscope were described and demonstrated on the fourth day.

Welcomed by Jolliffe

The Philadelphia Electric Co. group was welcomed at the opening session on Tuesday by Dr. C. B. Jolliffe, chief engineer of the RCA Victor Division. At a dinner given by RCA at the Walt Whitman Hotel in Camden Tuesday night, the group was greeted by Frank M. Folsom, vice president in charge of the RCA Victor Division, and heard an address by S. B. Williams, editor of Electrical World.

Termining the institute a pioneer-

ing venture, David J. Finn, sales manager of RCA's Industrial and Sound Department, pointed out in opening the initial session that the field of electronics in industry is so new that "no one pretends to have all the answers. This new art and its applications," Finn said, "is as large and unlimited as your imagination cares to make it."

An explanation of electronic power heating was given by Fred W. Wentker, manager of the Electronic Apparatus Section, in a brief talk at the opening session.

Graphic evidence of its advantages was presented in demonstrations of soldering, drying, sealing, and other processes at frequencies of 400 kc to 200 mc.

Describe industrial sound

Presenting the subject of plant broadcasting and industrial music, Dan D. Halpin, of RCA's Sound and Picture Section, declared that these services are helping to compensate for manpower shortages in many war industries, both by direct saving of time, and by improving net output of workers.

Discussing point-to-point communication systems in industry, Russell Stier, commercial engineer, pointed out that industrial expansion, adding acres of floor space and thousands of workers, has made such systems essential for efficient direction and control of many plants. In this type of installation, he said, microphone stations are located at vital control points or at specific operating positions, while loudspeakers are so placed as to cover operating positions or local areas only.

Armstrong Honored by Signal Corps

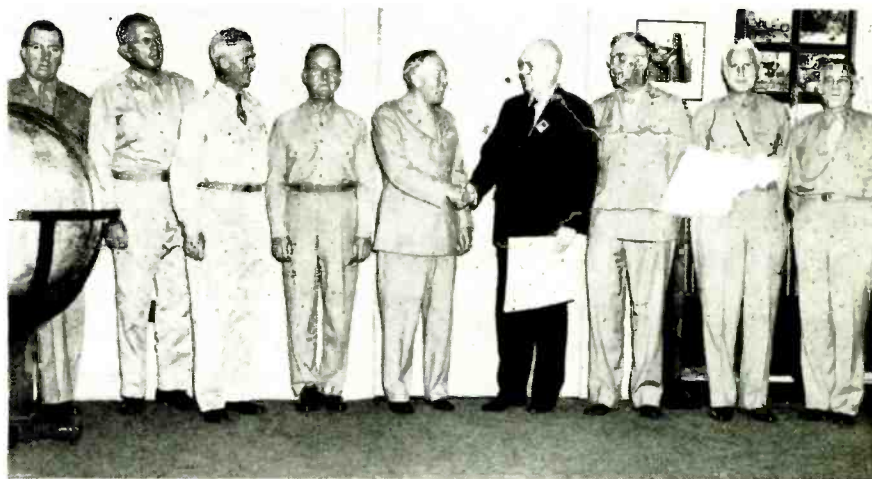

Major General H. C. Ingles, Chief Signal Officer, congratulates Dr. Edwin H. Armstrong upon the occasion of Dr. Armstrong's receipt of the first Chief Signal Officer's Certificate of Appreciation. The presentation was made in General Ingles' office in June. Left to right: Col. J. D. O'Connell, Col. W. Preston Corderman, Brig. Gen. Frank C. Meade, Brig. Gen. Jerry V. Matejka, General Ingles, Dr. Armstrong, Maj. Gen. Roger B. Colton, Maj. Gen. William H. Harrison, and Maj. Gen. James A. Code, Jr.

ELECTRONIC INDUSTRIES

Advertisers

AUGUST 1944

	Page		Page		Page
Ace Mfg. Corp.	216	Electro-Voice Mfg. Co., Inc.	70	Panoramic Radio Corp.	27
Acheson Colloids Corp.	136A	Erie Resistor Corp.	43	Peerless Electrical Products Co.	218
Aerovox Corp.	205	Federal Telephone & Radio Corp.	38, 133	Peerless Laboratories	226
Aircraft Accessories Corp.	28, 29	Formica Insulation Co.	143	Permoflux Corp.	148
Air Communications, Inc.	53, 223	Gemex Co.	202	Philco Corp.	173
Alliance Mfg. Co.	219	General Ceramics & Stealite Corp.	147	Picker X-Ray Corp.	61
Allied Radio Corp.	170	General Electric Co.	10, 11, 12, 13, 37, 69, 201, 207, 229	Pioneer Gen-E-Motor	184
American Lava Corp.	56	General Instrument Corp.	57	Precision Fabricators, Inc.	50
American Phenolic Corp.	73, 219	General Radio Co.	22	Premier Metal Etching Co.	178
American Transformer Co.	49	Gordon Specialties Co.	163	Presto Recording Corp.	134
Amperex Electronic Corp.	2	Gothard Mfg. Co.	206	Printloid, Inc.	168
Amperite Co.	194	Great Metal Mfg. Corp.	146	Radiell Corp.	204
Andrew Co.	144	Groves Corp.	192	Radiant Corp.	196
Arnold Engineering Co.	227	Guardian Electric Mfg. Co.	127	Radio Corporation of America: RCA Commercial Engineering	Cover 4
Atlas Products Corp.	174	Guthman & Co., Edwin I.	136	RCA Victor Division	131, 217
Audio Development Co.	172	Hallcrafters Co.	19	Radio Specialties Co.	225
Automatic Electric Sales Corp.	157	Hammariund Mfg. Co., Inc.	14	Raytheon Mfg. Co.	60, 175
Baer Co., N. S.	218	Harvey Radio Co.	222	Remler Co., Ltd.	66
Barker & Williamson	150	Harvey Radio Laboratories, Inc.	132	Rogers Electronic Tubes, Ltd.	198
Bassett, Inc., Rex	48	Heintz & Kaufman Ltd.	8	Santay Corp.	34
Bead Chain Mfg. Co.	136B	Hercules Electric & Mfg. Co.	206	"S" Corrugated Quenched Gap Co.	79
Bell Sound Systems, Inc.	216	Hipower Crystal Co.	223	Sentinel Radio Corp.	62
Bentley, Harris Mfg. Co.	139	Hopp Press, Inc.	198	Shallcross Mfg. Co.	164
Berwood Linze Co.	191	Howard Mfg. Corp.	166	Sherron Metallic Corp.	32
Bird, Richard H.	202	Hytron Corp.	121	Shure Brothers	26
Billie Electric Co.	74	Illinois Condenser Co.	182	Sigma Instruments, Inc.	178
Boes Co., W. W.	153	Indiana Steel Products Co. Industrial & Commercial Electronics	18	Small Electric Motors (Canada), Ltd.	31
Boonton Radio Corp.	190	Insuline Corp. of America	180	Smith Mfg. Co., Inc. F. A.	168
Brach Mfg. Co., L. S.	188	International Nickel Co.	177	Snyder Mfg. Co.	227
Bradley Laboratories, Inc.	212	Johnson Co., E. F.	24, 25	Sola Electric Co.	151
Burke Electric Co.	204	Jones Co., Howard B.	190	Sprerry Gyroscope Co.	63
Burstein-Applebee Co.	225	Kaar Engineering Co.	189	Spart, Inc.	58, 152
Cannon Electrical Development Co.	77	Kahle Engineering Co.	221	Sprague Electric Co.	141
Capitol Radio Engineering Institute	228	Karp Metal Products Co., Inc.	197	Stackpole Carbon Co.	137
Capacitron Co.	162	Kato Engineering Co.	162	Standard Transformer Co.	182
Carborundum Co.	234	Ken-Rad Tube & Lamp Co.	161	Sticht Co., Inc., Herman H.	213
Celanese Celluloid Corp.	21	Kinney Mfg. Co.	158	Struthers-Dunn, Inc.	145
Centralab	51, 155	Kirkland Co., H. R.	158	Stupakoff Ceramic & Mfg. Co.	125
Chicago Telephone Supply Co.	33	Knights Co., James	181	Sun Radio & Electronics Co.	138
Chicago Transformer Corp.	142	Kold-Hold Mfg. Co.	154	Superior Tube Co.	159
Cinaudagraph Speakers, Inc.	190	Kurman Electric Co.	225	Sylvania Electric Products, Inc.	5, 226
Clarostat Mfg. Co., Inc.	229	Lafayette Radio Corp.	226	Synthane Corp.	35, 36
Clifton Products, Inc.	211	Langvin Co.	195	Taylor Tubes, Inc.	185
Cole Steel Equipment Co.	40, 221	Lapp Insulator Co., Inc.	16	Templeton Radio Co.	156
Collins Radio Co.	192	Lavoie Laboratories	123	Terminal Radio Co.	225
Colonial Kolonite Co.	186	Lingo & Son, Inc., John E.	166	Thomas & Skinner Steel Products Co.	188
Columbia Wire & Supply Co.	219	Littelfuse Inc.	232	Thordarson Electronic Mfg. Co.	4
Conant Electrical Laboratories	140	Magnett Laboratories, Inc.	47	Tray-Ler Karenola Radio & Television Corp.	166
Connecticut Telephone & Electric	30	Magnavox Co.	207	Triplet Electrical Instrument Co.	187
Connector Division of International Resistance Co.	9	Maguire Industries, Inc. Electronics Div.	75	Tung-Sol Lamp Works, Inc.	76
Consolidated Radio Products Co.	55	Mallory & Co., Inc. P. R.	Cover 2, 129	Ungar, Inc., Harry A.	186
Cornell-Dubilier Electric Corp.	81	Manufacturers Screw Products	223	United Electronics Co.	71
Corning Glass Works	65	Measurements Corp.	194	United Screw & Bolt Corp.	80
Cornish Wire Co.	154	Mec-Rad Division—Black Industries	20	United Transformer Co.	82
Corry-Jamestown Mfg. Corp.	44	Merit Coil & Transformer Corp.	220	Universal Microphone Co.	169, 217
Coto-Coil Co., Inc.	213	Micamold Radio Corp.	78	University Labs.	278
Dalis, Inc., H. L.	209	Micro Switch Corp.	67	U. S. Treasury	215
Daly Machine & Tool Works	217	Millen Mfg. Co., Inc., James	200	Utah Radio Products Co.	46
Daven Co.	170	Mitchell-Rand Insulation Co., Inc.	15	Valpey Crystal Corp.	224
Dazor N	42	National Scientific Products Co.	160	Walker-Jimieson Co.	225
De Jur-An.	41	National Union Radio Corp.	23	Wallace Mfg. Co., Wm. T.	208
Deutschmann Co.	3	New York Transformer Co.	179	Waters Conley Co.	165
Dial Light Co. of ORS, Inc.	196	North American Philips Co., Inc.	167	Webster Electric Co.	176
Diamond Wire & Cable Co.	227	Norton Electrical Instrument Co.	198	Weltronic Co.	214
Distillation Products, Inc.	209	Ohmite Mfg. Co.	149	Western Electric Co.	54
Dolph Co., John C.	234	O'Neil-Irwin Mfg. Co.	208	Westinghouse Electric & Mfg. Co.	59
Doolittle Radio, Inc.	45			Wheeler Insulated Wire Co., Inc.	171
Drake Mfg. Co.	221			Wiedemann Machine Co.	199
Dumont Electric Co.	222			Wiley & Sons, Inc., John	210
DuMont Laboratories, Inc., Allen B.	193			Wilson Co., H. A.	64
Eastern Air Devices, Inc.	39			Wrigley Co., Wm.	211
Echophone Radio Co.	183			Zierick Mfg. Corp.	233
Eicor, Inc.	174				
Eisler Engineering Co.	220				
Eitel-McCullough, Inc.	52				
Electric Soldering Iron Co.	223				
Electro Motive Mfg. Co.	135				
Electronic Laboratories, Inc.	17				
Electronic Mechanics, Inc.	72				
Electronic Power Co.	68				
Electronic Products Mfg. Corp.	202				

SAVE MAN HOURS SMALL METAL PARTS by ZIERICK

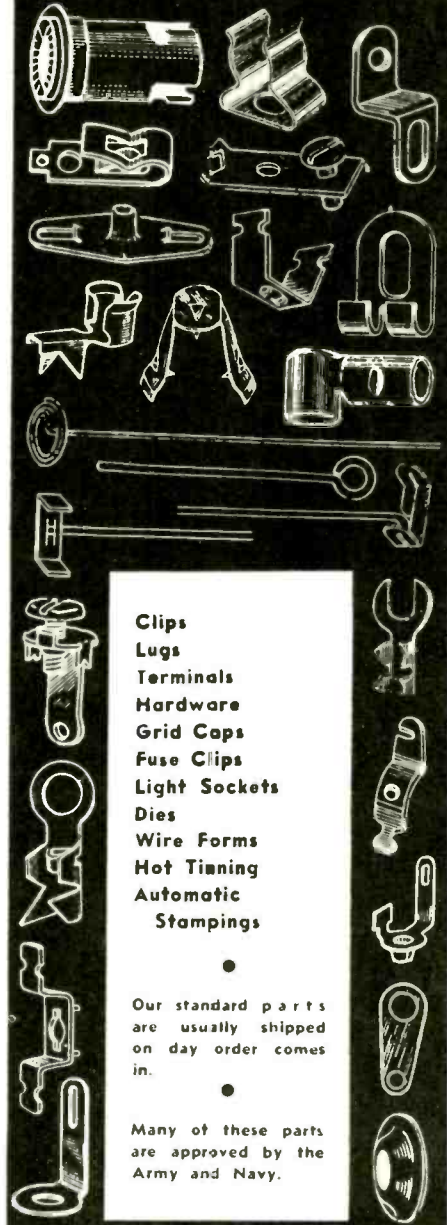

**Clips
Lugs
Terminals
Hardware
Grid Caps
Fuse Clips
Light Sockets
Dies
Wire Forms
Hot Tinning
Automatic
Stampings**

Our standard parts are usually shipped on day order comes in.

Many of these parts are approved by the Army and Navy.

PLEASE TEAR AND MAIL TO
Zierick Mfg. Corp.
385 Gerard Ave., New York City 51, N. Y.

ZIERICK MFG. CORP.
385 Gerard Avenue
New York City 51, N. Y.
Telephone MOtt Haven 9-2727

Please send your descriptive catalog.

NAME.....
COMPANY.....
ADDRESS.....

While every precaution is taken to insure accuracy, we cannot guarantee against the possibility of an occasional change or omission in the preparation of this index.

For deep coil penetration
specify **DOLPH'S**
INSULATING
VARNISHES



Tightly wound fine wire coils having many turns, naturally need a varnish which will provide maximum penetration and cure completely throughout. The photograph above illustrates tightly wound fine wire coils which have been treated with DOLPH'S SYNTHITE Insulating Varnishes. Note the firmness at the points where the coils have been cut. This firmness is the result of deep penetration as well as thorough curing of the varnish.

DOLPH'S SYNTHITE PG-1 Clear Baking Varnish and SYNTHITE PG-4 Clear Baking Varnish are excellent for coil impregnation. It will be worth your while to investigate the merits of these insulating materials. Why not send for the folders which will give you information regarding the methods of treating electrical units? These folders are yours for the asking.



JOHN C. DOLPH COMPANY

Insulating Varnish Specialists

173-C Emmet St., Newark, New Jersey

Police Use of FM

Some idea of the extent to which radio communications facilities are being used by police may be gained from a statement emanating from the Galvin Mfg. Corp., Chicago, to the effect that this one company has more than 500 complete 2-way radiotelephone systems in operation throughout the world. In addition, Motorola FM standard radio communications equipment is used extensively by the armed forces of the Army and the Navy as well as by the Coast Guard, Secret Service and White House staff. It is in operation at Alaska, the Aleutian Islands, the South Pacific Islands and in North Africa.

Ninety-two U. S. ordnance plants use Motorola 2-way radiotelephone systems including such famous plants as the Ford-Willow Run bomber establishment, Hudson tank arsenal, Chrysler tank plant, Douglas aircraft plant, Chrysler-Dodge Chicago engine plant, Fisher aircraft plant at Cleveland, Boeing aircraft at Wichita, Dow Chemical's magnesium plant at Freeport, Texas, the Harrison oil plant for high octane gas at Sweeney, Texas, the Continental oil plant at Ponca City, Oklahoma, and the great Naval Ammunition plants at Crane, Indiana, and at Fallbrook, California. Then there are the very extensive Motorola communication systems now in service at the secret chemical areas.

Andrew's Field Service

The Andrew Co., Chicago, coaxial line specialist, has added a field engineering and allocation service as an aid to standard and AM broadcasters. Walter F. Kean, for the past three years in charge of radio and radar project testing for Western Electric, heads up the new division.



Walter F. Kean heads field engineering and allocation service for Andrews Co.

Globar BRAND

TRADE MARK

SEMI-INSULATED CERAMIC RESISTORS

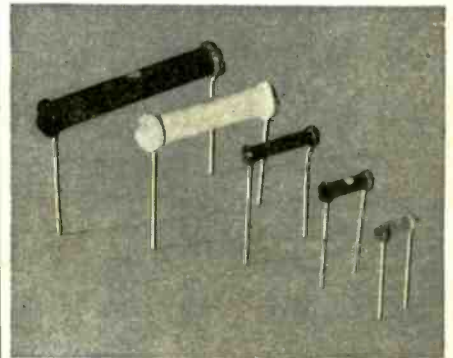

● Low ohmic values are made in body type "CX" only whereas type "A" body is offered in a wide range of resistance values.

Globar Brand Resistors are unusually rugged as your tests will prove. Those illustrated are standardized sizes and resistance values. In case you require resistors having special characteristics we can furnish them. Larger units or special sizes can be provided.

Write us outlining your resistor problem, it will receive prompt and careful consideration.

PHYSICAL AND ELECTRICAL SPECIFICATIONS TYPE "A" RESISTORS

PART NUMBER	WATT RATING	RESISTANCE RANGE	OVERALL LENGTH	OVERALL DIAMETER
997-A	1/5	150 Ohms to 4.7 Megohms	2 1/4"	3/64"
763-A	1/4	47 Ohms to 15 Megohms	5/8"	7/32"
759-A	1/2	33 Ohms to 15 Megohms	3/4"	1/4"
766-A	1	47 Ohms to 15 Megohms	1 1/8"	1/4"
792-A	3	22 Ohms to 150,000 Ohms	1 7/8"	15/32"
774-A	5	33 Ohms to 220,000 Ohms	2 1/8"	15/32"

TYPE "CX" RESIST

PART NUMBER	WATT RATING	RESISTANCE RANGE	OVERALL LENGTH	OVERALL DIAMETER
997-CX	1/4	1 to 150 Ohms	2 1/4"	3/64"
763-CX	1/2	1 to 47 Ohms	5/8"	7/32"
759-CX	1	1 to 33 Ohms	3/4"	1/4"
766-CX	2	1 to 47 Ohms	1 1/8"	1/4"
792-CX	4	1 to 22 Ohms	1 7/8"	15/32"
774-CX	6	1 to 33 Ohms	2 5/8"	15/32"

STANDARD RESISTANCE (Tolerances 5% - 10% - 20%)
ALL RESISTORS COLOR CODED according to R. M. A. Standards.
ORDER BY PART NUMBER, RESISTANCE VALUE AND TOLERANCE.

Globar Division
THE CARBORUNDUM COMPANY
TRADE MARK

NIAGARA FALLS, N. Y.

{Carborundum and Globar are registered trade marks of and indicate manufacture by The Carborundum Co.}

FIXED ATTENUATORS ENGINEERED *by* DAVEN



DAVEN Fixed Attenuators are available in any desired impedances, and any loss from minimum for the selected impedances upward. Extensively used in major broadcasting and motion picture sound studios, and for laboratory standards of attenuation, DAVEN Fixed Attenuators are backed by years of experience and skill. Our engineers will gladly cooperate on special problems.

RECTANGULAR: TYPE 153 ... 3 $\frac{3}{8}$ " high x 1 $\frac{1}{2}$ " long x 1 $\frac{1}{8}$ " wide (overall), height of standard key-lever switch.

TYPE 154 ... 1 $\frac{3}{4}$ " high x 1 $\frac{1}{2}$ " long x 1 $\frac{1}{8}$ " wide (overall), approx. half height of key-lever switch.

CYLINDRICAL: TYPE 950 ... $\frac{1}{16}$ " diameter x 1 $\frac{1}{8}$ " long, for use in small space; mounts with No. 6 screw through center hole.

TYPE 1030 ... 1 $\frac{3}{8}$ " diameter x $\frac{7}{8}$ " long, type for tapped fixed attenuators; mounts with No. 6 screw through center hole.

PLUG-IN: TYPE 691 (octal tube base) ... 1 $\frac{3}{8}$ " diameter x 3" long; provides convenience in interchanging fixed value networks.

CIRCUITS: "T" or Bal. "H", and where required, "L", "U", "O", " π "

DAVEN Fixed Attenuators are precision-built of accurately adjusted, card-type resistors, non-inductively wound on bakelite strips. Standard accuracy $\pm 2\%$ (type 691, $\pm 1\%$), closer tolerances available on request. Properly aged to retain accurate characteristics. Mounted in metal shielding. Wattage, maximum dissipation 1 watt (type 950, 0.6w), special units to 20 watt.

DAVEN SPECIAL FIXED ATTENUATORS: Multiple output networks (size of type 153)
Medium wattage networks (up to 20w, type 153) Tapped fixed networks (type 1030)

YOU CAN HELP SPEED V-DAY BY BUYING WAR BONDS

THE **DAVEN** COMPANY

191 CENTRAL AVENUE
NEWARK 4, NEW JERSEY

All

MINIATURES

All

ON THE ARMY-NAVY PREFERRED LIST

All

AND

DEVELOPED BY RCA!

The 17 RCA Miniatures shown on this page—all of them on today's Army-Navy Preferred List of Vacuum Tubes—are:

- | | |
|-------------------------------------|--|
| 1A3 —H-F diode | 6AG5 —R-F amplifier pentode |
| 1L4 —R-F amplifier pentode | 6AL5 —twin diode |
| 1R5 —pentagrid converter | 6AQ6 —Duplex-diode High-Mu triode |
| 1S5 —diode-pentode | 6C4 —H-F power triode |
| 1T4 —R-F amplifier pentode | 6J4 —U-H-F amplifier triode |
| 3A4 —power amplifier pentode | 6J6 —twin triode |
| 3A5 —H-F twin triode | 9001 —Sharp cut-off U-H-F pentode |
| 3S4 —power amplifier pentode | 9002 —U-H-F triode |
| | 9003 —Super-control U-H-F pentode |

Once Victory is won, it will be our privilege to work with you designers so that, together, we may play our continuing parts in miniature tube type development and use for peace-time purposes. We look forward to that day. And we will gladly advise you now which tubes—Miniatures, and others—will most likely be on RCA's post-war list of "Preferred Tube Types," if you will write to RCA Commercial Engineering Section, 719 South 5th St., Harrison, N. J.

The Magic Brain of all electronic equipment is a Tube and the fountain-head of modern Tube development is RCA.

TINY tubes like these—every single one of them developed by RCA—were destined for the spotlight—thanks to your recognition of their possibilities.

The spotlight picked them up first in June, 1940, when the "Personal Radio" was announced—the history-making portable designed around RCA's staunch little quartet, Miniatures 1R5, 1S4, 1S5, and 1T4.

War found Miniatures instantly available for overseas service—for example, in such equipment as the paratrooper's air-borne "Handie-Talkie."

BUY
WAR
BONDS



RADIO CORPORATION OF AMERICA

RCA VICTOR DIVISION • CAMDEN, N. J.