

The TALKING MACHINE WORLD

For the
makers &
sellers of
talking
machines

Published Each Month by Edward Lyman Bill, Inc., at 383 Madison Ave., New York, September 15, 1923

Victrola

REG. U. S. PAT. OFF.

The word "Victrola" as well as the picture "His Master's Voice" is an exclusive trademark of the Victor Talking Machine Company. Being registered trademarks they cannot lawfully be applied to other than Victor products.



"HIS MASTER'S VOICE"
REG. U. S. PAT. OFF

Victor Talking Machine Company, Camden, N. J.

Look Below the Surface!

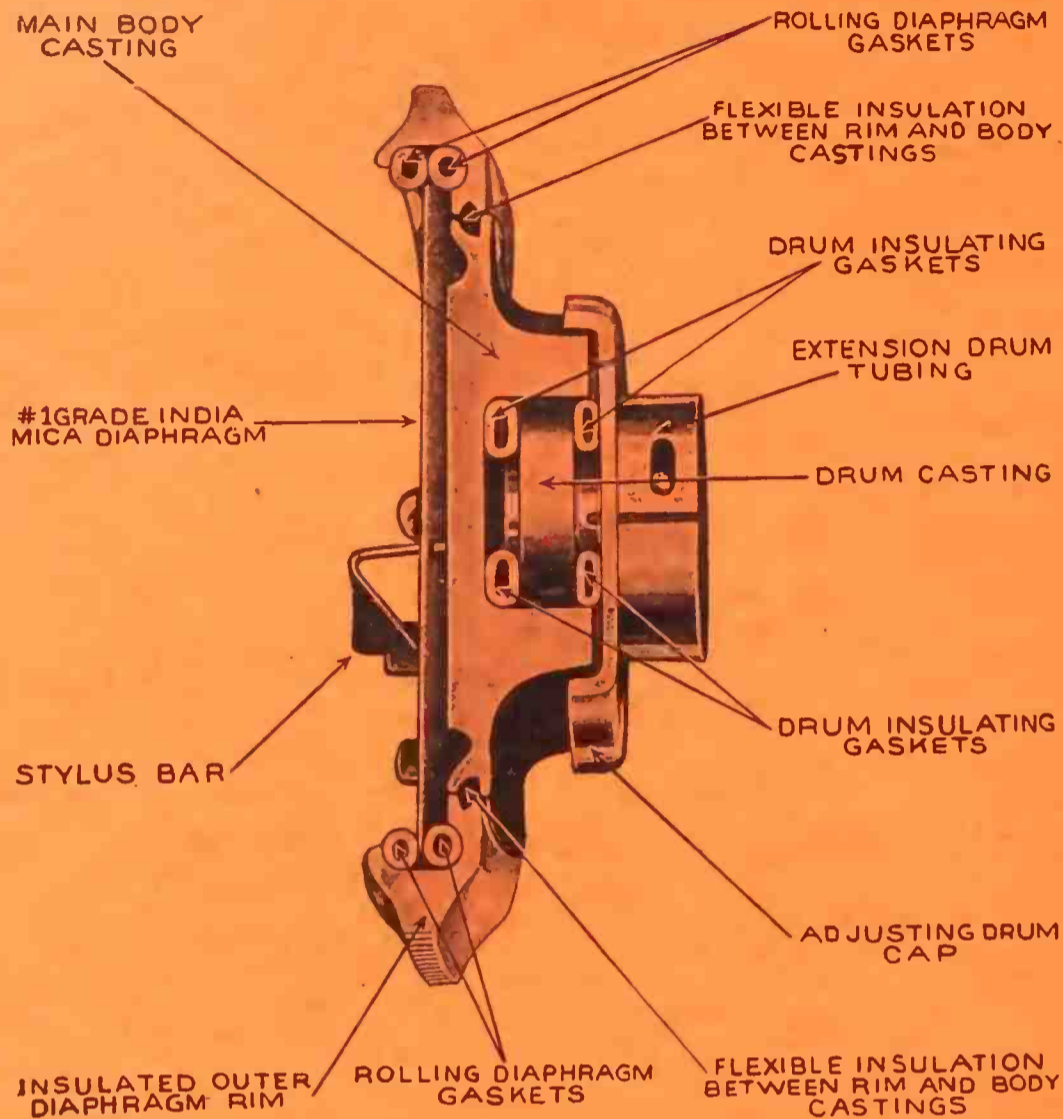

SAWED-THROUGH SECTION OF SONORA REPRODUCER

Cash In on Sonora's Fall Advertising Campaign

ABOVE is shown a half-tone reproduction of the illustration used in the first ad of Sonora's "Look Below the Surface" campaign, now running in city newspapers throughout the United States. Beginning with September, Sonora ads will appear regularly throughout the fall. These newspapers have a combined circulation of more

than twelve million each week. Think what this means to Sonora dealers, and what it can mean to you.

The campaign is based on Sonora's interior construction features, the most thorough and costly of any phonograph made, and is bound to stimulate a tremendous and universal demand for Sonora. Cash in on this demand. Wire today for our proposition.

Sonora Phonograph Company, Inc.

279 Broadway, New York

Canadian Distributors: Sonora Phonograph, Ltd., Toronto



The Highest Class Talking Machine in the World

The Talking Machine World

Vol. 19. No. 9

New York, September 15, 1923

Price Twenty-five Cents

A. H. CURRY RETIRES FROM HIS IMPORTANT EDISON POST

Chas. Edison Pays Tribute to His Work as Vice-president and Manager of Edison Phonograph Industry for Past Two Years—Will Concentrate on Edison Jobbing Business in Dallas

Chas. Edison, chairman of the board of directors of Thos. A. Edison, Inc., on September 8 issued the following statement:

"The board of directors of Thomas A. Edison, Inc., announces with regret the resignation of Mr. A. H. Curry, who has been vice-president and manager of the Edison phonograph industry during a successful two years' regime. Mr. Curry's clean fighting qualities, hitting ability and business sagacity have been of inestimable aid in placing the Edison phonograph industry in its present healthy condition. Mr. Curry leaves on October 1, approximately in accordance with his original idea. A successor to Mr. Curry will be introduced shortly."

A. H. Curry, whose resignation from the vice-presidency of Thomas A. Edison, Inc., was announced in the foregoing official communication, has been the manager of the Edison phonograph industry for the past two years. On the eve of his departure for his Edison jobbing headquarters in Dallas, Tex., Mr. Curry kindly agreed to review for *The World* some of the many progressive accomplishments of the Edison Co. during the past two years—improvements which have been apparent to the entire phonograph industry. He modestly disclaimed any individual responsibility for these developments, and insisted that he was merely of assistance because of his practical knowledge of general business principles and his long experience as an Edison dealer, Edison traveler, Edison jobbing house manager and Edison jobbing house proprietor. He said in part:

"A few years ago the phonograph industry was in the grip of the greatest business depression it had ever known. The men selected to take the helm of any manufacturer's business had a man-size job cut out for them. The buyer orgy was over; sensible conservative business policies were needed—selling methods and expenses had to be tempered with veteran business judgment.

"The progress of Thomas A. Edison, Inc., in the face of this condition and during the past two years is found in such noteworthy accomplishments as the reduction in the prices of records, both disc and Amberol; the reduction in the prices of certain disc phonographs and of Amberol phonographs; and the introduction of a new line of low-priced disc models of remarkable value. Needless to say, these price reductions and attractive additions to the Edison line have greatly reduced the selling resistance offered to Edison dealers. Better trade discounts have been passed along to jobbers and dealers. The dealer's margin of profit was never so great, and there is, therefore, now a much greater incentive for dealer activity.

"A safe and sane phonograph order system has been installed which is advantageous to the dealer, jobber, Edison sales division and the Edison production division. Over-stocks, the constant danger signal in the phonograph field, are prevented by this shrewd system, which, nevertheless, provides for excellent service.

"One year ago the Edison Co. conceived and launched the idea of instantaneous record release, which has proved a boon to the entire phonograph industry. This clever plan prevents over-stock anywhere along the line and insures rapid turnover by jobbers, dealers and the factory.

"The foregoing record of accomplishments was made possible, to a great extent, by decided economies in the Edison phonograph industry at Orange—savings which have been reflected in the various discounts passed on to the Edison trade and in improvements in the Edison product.

"Obviously, the Edison phonograph business was never on a more solid foundation and never so well equipped to forge ahead to a lofty pinnacle of lasting prosperity. In fact, it is safe to predict that it will continue to improve from year to year for the next decade at the same rate it has grown in 1923 as compared with 1922."

Regarding his plans for the future, Mr. Curry stated that he has some rather revolutionary merchandising ideas which, when applied to Edison dealers, served by his Edison jobbing house, the Texas-Oklahoma Phonograph Co., of Dallas, will double or perhaps treble their sales of Edison phonographs and probably at a reduced cost of selling. At the moment Mr.



A. H. Curry

Curry declined to discuss these plans in detail. He said, however, that it is his intention to diligently devote himself to the Edison jobbing business and asserted that he will find unbounded pleasure in renewing direct contact with all of his old dealer friends in Texas and Oklahoma and will interest himself in their welfare as heretofore. In this connection Mr. Curry wisely insists that unless the dealer profits no one in the industry profits and the industry is weakened thereby. Consequently, Mr. Curry's interest is always centered in dealer welfare.

Having made many personal friends in the Edison organization while directly connected there, and his affection and respect for Mr. Edison made more profound during the two years of personal association, there was a note of sadness in Mr. Curry's voice when he spoke of his departure. He found consolation though in the fact that he will visit Orange and "the wizard" several times each year in accordance with his usual custom as an Edison jobber.

VICTOR MEETING IN JACKSONVILLE

Dealers in Florida and Neighboring States to Attend Convention Under Auspices of French Nestor Co. on October 10 and 11

JACKSONVILLE, FLA., September 7.—A majority of the Victor dealers in Florida, southern Georgia and South Carolina are expected to attend a sales convention to be held in this city on October 10 and 11, under the auspices of the French Nestor Co., when business problems in general will be discussed and new selling plans analyzed. One of the speakers will be Martin L. Pierce, of the Hoover Suction Sweeper Co., who will explain successful canvassing methods, and one of the Victor factory officials is also expected to attend and speak. An elaborate program is now being prepared by the company.

DESCRIBES NEW ZEALAND METHODS

L. Alfred Eady, Whose House Handles a Substantial Talking Machine Business in That Country, Offers Some Interesting Views

A trade visitor of unusual importance during the past month was L. Alfred Eady, managing director of Louis R. Eady & Son, Ltd., Auckland, N. Z., who came to the United States with Mrs. Eady to attend the International Convention of Rotary Clubs in St. Louis, and then made an extended visit to England and Germany, stopping off in New York and Chicago, both going and coming.

Mr. Eady's company is very active in the talking machine field of New Zealand, handling both "His Master's Voice" and Columbia lines of machines and records. He stated that at the present time New Zealand is in a particularly prosperous condition and is enlarging its field for dairy products, exporting them to many parts of the world. He stated that 90 per cent of the country's business is made up of the handling of agricultural products, for which good prices were being realized.

Incidentally, it might interest talking machine dealers in this country who are straddling the fence on the interest question to learn that in New Zealand, under what is known as the "hire purchase" system, interest is charged on all time sales. The interest is taken on a flat basis. In other words, if a machine is to be paid for in twelve months 5 per cent interest is added to the total price. If it is to be paid for in twenty-four months 5 per cent per year, or 10 per cent in all, is added to the original cash price, and the principal and interest divided into regular monthly payments. This is done because under the "hire purchase" law interest does not figure, the customer simply hiring the instrument month after month until final payment is completed, when the title changes. If he defaults on a payment the contract is broken automatically and the dealer can recover the instrument without further ado.

Mr. Eady spent some time calling on the various manufacturers of talking machine products and accessories in New York and then left for Chicago on his long journey home. He stated that business methods in New Zealand were distinctly similar to those followed in the United States and that they were, in fact, patterned largely after our most successful systems.

E. BLOUT INCORPORATES BUSINESS

Talking Machine and Piano Dealer of New York Head of New \$500,000 Corporation

Emanuel Blout, of 2786 Broadway, New York, for many years a large wholesaler of Victor talking machines and records, and who still continues to handle that line at retail, and in his stores in this city, in Bayonne, N. J., and in Poughkeepsie, N. Y., having recently installed piano departments, incorporated his business last week with a capital stock of \$500,000.

The new company will operate under the name of E. Blout, the incorporators being Emanuel Blout, E. Blout and E. R. Rye, Inc., with S. M. Kronheimer as legal representative. Mr. Blout, who was for many years located at the corner of Broadway and 108th street, sold the property recently, and on the first of the month held a formal opening of his new store which is located at 2786 Broadway.

MILWAUKEE CONCERN CHARTERED

MILWAUKEE, Wis., September 6.—The North Avenue Music Shop, of this city, was recently incorporated under the laws of this State, with a capital of \$25,000. Incorporators are Hugh Hoeveler, Ralph J. Stauss and A. H. Nemitz.

Delivery Service as a Business Builder

Problem of Speedy, Economical Delivery Service Solved by the Use of Motorcycle—Increased Business Justifies the Expense

A Western dealer writes in to state that he contemplates establishing a special delivery service for records and for musical merchandise with a view to making more rapid deliveries to customers, but has hesitated taking the final step in the belief that possibly the expense of the service would outweigh any increase of business that might be traced thereto.

As a matter of fact there are a number of talking machine retailers in various sections of the country who credit no small part of their business increase to the fact that they put such a service in operation, gave it full publicity in their newspaper advertising and circulars and gave the public the impression that, if they wanted anything in the record or accessory line, they could get it quickly from that particular store.

Better Service Means More Business

It is generally recognized by the average dealer that in sections where competition is strong about the only thing he has to offer the customer that is individual and which cannot be offered in the same way by a competitor is better service. He cannot always do this through the operation of a wagon delivery, no matter how earnest the attempt, for the reason that a truck or wagon must be routed carefully to cover definite sections and as much ground as possible during the day if delivery costs are not to prove prohibitive.

In the routing of the wagons it is sometimes necessary to hold up special deliveries for several hours until there are a sufficient number of orders from a certain section to warrant a trip. It is here that the special messenger service proves of value, whether the messenger travels

by street-car or whether he uses a modern conveyance, the motorcycle—preferably one equipped with a commodious box as a side-car. Not only is the cost of maintaining a motorcycle very small, but it is also calculated in many cases to save the cost of an extra wagon or truck for the reason that good-sized machines, as well as records, accessories and musical merchandise may be carried about with it with little difficulty.

Speed Results in Economy

In a number of cases all record deliveries, with the exception of those made in company with a machine, are handled by motorcycle and side-car, for it can get about quicker and can leave the wagon free to deliver machines only and deliver more of them within a given time.

The selling argument for the special delivery is that customers may phone for any desired records and have them delivered within the city limits within an hour or so. On the face of it it looks as though the offer was overliberal and liable to prove costly, but the fact is that only about 10 per cent of those who phone are in any particular hurry for the records and hardly one in a hundred complains if they are not delivered within an hour or so. In the case of the other 10 per cent, however, it is quite possible that sales may be lost through slowness.

If a youth on a motorcycle were kept waiting throughout the business day for the purpose of making special deliveries of records the cost of such service would be entirely out of proportion to the possible profit, but when the service is used for practically all record deliveries, as well as the delivery of small instruments, it can accomplish as much as the average truck or

wagon in the course of the day and at a tremendous saving in maintenance.

Experience has shown that where the special service is used for regular delivery the messenger is seldom away from the store for more than an hour at a time even in large cities and is thus available for any hurried deliveries that may develop during the day. One dealer solved the cost problem by using a motorcycle equipment for errands as well as special deliveries and using one of the porters to operate the machine.

Efficient Operation Necessary

The question of a special delivery service, as with any other part of store service, is that of operating efficiently and at minimum expense. This can be worked out successfully when the service is used to its maximum and the messenger kept sufficiently busy to earn his pay. If the repairman out in his territory needs some extra parts the special service can bring them to him. If there are mail orders to be filled the same service can carry packages to the post office and leave larger wagons free for haulage purposes, and at the same time the dealer has at hand a very strong talking point in making a plea for business from those who appreciate prompt service.

There are, of course, some stores whose business does not warrant the maintenance of any permanent system and who find it cheaper to send an errand boy out with records and to hire a truck for the delivery of machines, but where the business warrants the permanent use of even one wagon which is occasionally taxed to cover the territory properly, then the special motorcycle delivery will not only effect a saving in money, but help business.

How About RECORD Albums?

Have you prepared for your Fall Business?

THE TALKING MACHINE'S HELPMATE



The demand is now for NYACCO QUALITY ALBUMS. We are in the position to judge. Our line covers all grades. We have two factories, in New York and Chicago. Save freight and insure prompt delivery by ordering from point nearest to you.

Ask for our No. 600 Nyacco album, the highest grade album on the market. Samples sent on request to responsible houses.

TO JOBBERS ONLY:—

Write for samples of our new delivery bags of No. 1 Kraft paper (35 lb.) with strings and buttons at very attractive prices.

The Best Interchangeable Leaf Record Album on the Market



Write for display card—mailed without cost. It will help you sell more Nyacco Albums

New York Album & Card Co., Inc.

NEW YORK
23-25 Lispenard St.

CHICAGO
415-417 S. Jefferson St.

Pacific Coast Representative: Munson-Rayner Corporation, 643 South Olive Street, Los Angeles, Calif.

Victor supremacy is the supremacy of performance



Victrola IV, \$25
Oak



Victrola VIII, \$50
Oak

The commercial triumphs of the Victor naturally follow its musical superiority. This inevitable result is a consideration of vital importance to every dealer in Victor products.



Victrola No. 80
\$100
Mahogany or walnut



Victrola No. 125
\$275
Electric, \$315
Mahogany



Victrola No. 215
\$150
Mahogany or walnut



Victrola No. 230
\$375
Electric, \$415
Mahogany



Victrola No. 400
\$250
Electric, \$290
Mahogany



Victrola

REG. U.S. PAT. OFF.

Look under the lid and on the labels for these Victor trade-marks

Victor Talking Machine Company

Camden, New Jersey

Sales Arguments That Win the Customer

Every Dealer From Time to Time Must Cope With the "Difficult" Patron—Frank H. Williams Cites Methods of Several Retailers

A talking machine dealer in the Middle West had been spending almost an entire morning demonstrating various instruments in his store to a man and a woman, both of middle age, who were unable to make up their minds to buy. In fact, as it drew on toward the noon hour it became evident that the prospects were going to leave the store without anything definite having been accomplished at all toward closing the sale. Upon seeing this intention on the part of the prospects the dealer determined to put the sale over if it was the last thing he ever did. He did some rapid thinking on the proposition and just as the prospects, after the usual line of excuses and statements about coming back again, were turning to leave the store he said:

"Mr. Jones, you've told me that you are in the furnace business. You have had a wide experience in selling and so perhaps you can help me out. I'm up against a certain difficult selling proposition and I don't quite know what to do about it. Will you help me out in it?"

Mr. Jones looked somewhat flattered at this. "Sure, I'll help you out, if I can," was the reply.

"Well," said the dealer, "the proposition is this: Two prospects come into the store, show an interest in all the machines I have for sale and are very evidently going to buy a machine. But—I can't sell them! What sort of an argument can I put up to these prospects to make the sale? Why is it that I can't put the proposition across? You know, in your own business, how important it is to know whether you are falling down in any particular part of your business or not. It's equally important to me to know if I'm falling down in any part of this business and I sure will appreciate it if you'll help me out. Why is it I haven't been able to sell a machine to you and your wife?"

This blunt way of putting the thing was a facer for Mr. Jones. He looked a trifle surprised and embarrassed at first. Then he smiled.

"Say," he said, "you're all right. You put the thing up to me in a way I'd never thought of before. If I was in your place and had spent

as much time as you have in being courteous to us and then didn't make a sale I'd be mighty sore."

This led to some further talk about the question of clinching sales which eventually put the sale across for the dealer.

How Sales of Records Were Increased

And there is probably a worth-while suggestion in the experience of another Middle Western dealer who had a customer come in and spend the greater part of a busy afternoon in one of the hearing rooms and who then bought only one \$1.25 record. The dealer naturally cast about in his mind for some way of increasing sales to this customer. It was, really, a puzzling proposition and, for a moment or so, the dealer felt that the best thing to do would probably be to let the customer get away without trying to sell her any more goods. He finally hit upon a plan, however.

Accordingly, when putting the customer's one lone purchase into an envelope the dealer said: "Mrs. Brown, I notice that all of the records you have been trying this afternoon have been classical records and I have been wondering what you and your children like among the more popular selections we have on hand. I know that you have a musical family and that the members of your family are all splendid judges of music and so I would much appreciate it if you'd let me pick out some popular selections to try out at your home to-night and then tell me to-morrow which of them you like the best and which your family likes best."

Mrs. Brown agreed to this proposition and the dealer accordingly gave her a dozen of the newest and most popular selections handled by the store. Then the next day he went around to Mrs. Brown's house and she bought eight of the records!

In explaining this sale the dealer said:

"When I was figuring out ways and means of selling more records to Mrs. Brown I happened to remember that she has three lively young children who, naturally, would be greatly interested in dance music. So I thought that if I could get some popular selections into her

home and get her to try them out on their own instrument the children would demand their purchase and the sale would be made. And that's just exactly what happened. And it is my opinion that numerous sales of popular selections could be made by dealers to families which have concentrated too heavily on classical selections if the dealer would only recall which families these are and then get the popular selections into their homes."

Sales Arguments That Made a Machine Sale

And here is the way that another dealer put over a difficult sale:

A rather elderly man and his wife came into the store to look at talking machines and right away the dealer saw that the man wanted to buy a machine, while the wife was hanging back.

"We're looking around for a wedding present for our youngest daughter, who is going to get married soon," the man explained, "and I say we ought to get her a phonograph, while my wife's got her mind all set to buy them a washing machine."

Of course, upon hearing this the dealer realized that he was up against a hard sales proposition and that the person in the ease who must be sold was the wife, as the husband was already sold on the proposition.

Consequently, as the dealer showed and demonstrated various kinds of machines he was busily thinking of sales arguments.

"Of course," he said, "you want to give them something they will appreciate."

"Indeed, we do," said the wife, "and I just know my daughter will appreciate a washing machine more than she will a phonograph."

"Perhaps," said the dealer, "but look at it this way: The washing machine would be used on only one day of the week or, perhaps, only one day every other week. The phonograph, on the other hand, would be used every day and several times every day and it would help to make home cheerful every day of the week, it would help your daughter in getting her friends to her house and it would help her in feeling happy all the time. Isn't a gift which will remind your daughter and husband every day of the week of the givers better than a gift which is used only once every other week?"

The woman saw the point at once and the result was that the sale was made by the dealer.

W. T. HADDON ENTERTAINS FRIENDS

Well-known Victor Jobber Keeps Open House at Summer Home at Island Heights, N. J.

Wm. T. Haddon, of the Ohio Talking Machine Co., Cincinnati, who maintains a Summer home at Island Heights, N. J., with a full equipment of motor boats and other seashore accessories, has entertained a number of the members of the Victor family during the past month. The visitors included Mr. and Mrs. L. W. Collings, of Collings & Co., Victor wholesalers, of Newark, N. J.; Charles K. Bennett, general manager of the George C. Beckwith Co., Victor wholesalers, of Minneapolis; Harry Goldsmith, general manager of the Badger Talking Machine Co., Milwaukee, and several others.

REMODELED QUARTERS IN MEMPHIS

MEMPHIS, TENN., September 1.—Witzman Stuber, Inc., who feature the Brunswick phonographs and records in a big way in this city, are now settled in their handsome remodeled quarters at 99 North Second street, where a concert hall has been fitted up for recital purposes and a full equipment of booths installed.

The Sonora Appeals to the Buyer of Quality

The Sonora dealer is right now preparing not only to make the year 1923 the largest in his history, but also the year 1924—indeed, all the years to come.

Because every Sonora he sells adds to his reputation as a quality merchant, the complete satisfaction and confidence engendered by Sonora performance raises his enterprise to the position held by all merchandisers of quality products.



Greater City Phonograph Co., Inc.

Exclusive Distributors for New York, Staten Island
and the Lower Hudson Valley

234 West 39th Street

New York

Victor supremacy is the supremacy of performance



Victrola VI, \$35
Mahogany or oak



Victrola IX
\$75
Mahogany or oak



Victrola No. 100
\$150
Mahogany or walnut



Victrola No. 111
\$225
Electric, \$265
Mahogany or walnut

The universal recognition of Victor supremacy makes the Victor the safest, most reliable and so most profitable line for music dealers to handle.



Victrola No. 210
\$100
Mahogany or walnut



Victrola No. 330
\$350
Electric, \$390
Mahogany



Victrola No. 405
\$250
Electric, \$290
Walnut



"HIS MASTER'S VOICE"

Victrola

REG. U. S. PAT. OFF.

Look under the lid and on the labels for these Victor trade-marks

Victor Talking Machine Company

Camden, New Jersey

Principles of Retail Advertising Success

Some of the Many Angles of Advertising Which Dealers Must Consider in Preparing and Placing Copy Analyzed by W. Braid White

Advertising is called "salesmanship on paper," and, in a large sense, the name is not inaccurate. In a more restricted and special sense, however, there is a vast difference between the sort of salesmanship which works through the medium of print, illustrations and paper and that which depends upon the personal contact of the salesman with his prospective customer. In the talking machine business the difference is so complete and the distinctions so clear that there never need to be the confusion which constantly exists as to the functions of the two.

Articles from my pen in The Talking Machine World have often stressed various sides or facets of the art of salesmanship, always from an analytical point of view. The aim has always been less to give concrete rules than to stimulate thought; for salesmanship, as William Maxwell has said, is much like acting. All the lessons in all the dramatic schools in the world can do no more than instruct the student actor or actress what not to do. Only natural feeling for the art can never teach one, on the contrary, what positively to do. The salesman, therefore, in his individual contact with the prospect, will be able, if he has the natural flair for his work which marks out the man destined for success, to treat each problem as it comes along. The more he has learned what not to do the more he is likely to do positively the right thing at the right time. On the other hand the salesman in print (the advertising man) cannot make the definite individual contact. He cannot deal with the complex personality of each person who is likely to read his advertising copy. He is, therefore, driven to base his appeal on the ideas or beliefs which appeal to the largest number of people; that is to say, to the largest number of those who read, or are likely to read, the media in which the advertising is inserted.

What Is the "Largest Number"?

This elementary truth is, however, likely to be confounded with the pestiferous notion so prevalent among certain advertising men that "the largest number" always means the same thing, no matter in what medium the advertising is done. The "largest number theory" does not mean always the same thing. On the contrary, there is a largest number of average newspaper readers, a largest number of readers of the American magazine type of literature, a largest number of readers of the Saturday Evening Post mentality and a largest number of readers of the Atlantic Monthly and Harpers' type. Each of these artificial classes corresponds, moreover, with an actual class of existing tastes

and mentalities; so that if salesmanship in print is to meet all requirements it must take on diverse shapes and be embodied in as many forms as may be needed to reach each of the classes aforesaid.

The Newspaper Argument

Obviously the largest number of those who read the daily newspaper is only average in point of education and ability to think, while at the same time every other class is represented, so that it is the part of wisdom not to key newspaper advertising too low. The highest type of mentality will respond to reason and so should be catered to by seriously written and rational arguments. On the other hand, the lower mental type, representing the majority, will respond to prestige and this should be capitalized to the utmost in all newspaper advertising.

The only appeal which is sufficiently broad besides these is the appeal based on price and terms. Newspaper advertising is advertising for immediate results, and to this extent must be based upon arguments which make for immediate action. Prices and terms are, of course, the most powerful of these.

Nevertheless, even in the most ephemeral rapid-fire sort of newspaper advertising the prestige argument should always be made. It is never safe to leave out any distinctive motto, name or symbol which has become identified with the article of sale in the public mind. That is why the Victor dog is always shown in every advertisement relating to Victrolas and records, no matter how small and ephemeral.

Such mottoes as "The Re-creation of Music" (Edison), "The New Hall of Fame" (Brunswick), "Plays All Records Better" (Cheney) are not only useful, therefore, but absolutely essential. They help to build up in the minds of readers of advertising (which means everybody) mental pictures which make the work of the human salesman easier. And it is this making easier the work of the human salesman which the salesmanship on paper can best—and, indeed, can only—accomplish.

Advertising Not Direct Seller

There may be some articles—such as ready-made foods and other things of the kind—which can be sold directly by advertising. In fact there are such articles. Chewing gum is one of them. But talking machines cannot be sold in this way and there is no sense in hoping that they can. Advertising can and will put a prospective customer inside a store door and can, and will, cause that customer, in some cases, to ask to see a certain machine; but that is all. So long as selling has to be done

through retail merchants—in fact, so long as there is any kind of competition between machines of anything like similar styles and price—the ultimate decision will be in the hands of the salesman, or at least will be between the salesman and the prospect. It is the mission of advertising to prepare the way for the salesman, and this mission it can most effectively perform by impressing in the minds of as many readers as possible the idea of Prestige as indelibly associated with the article advertised.

Copy Varies With Medium

Here comes in the question of class of medium. When I spoke above of the theory of the largest number I also said that there are classes, and that "largest number" must mean, for our purpose, the largest number in each class. This is undoubtedly true, and requires to be thoroughly grasped and practiced. The community as a whole is made up of many types and classes of mentality, varying in natural gifts, in educational opportunity and in culture. To each and every one of these, however, the most powerful argument which can ever be made is the argument of Prestige, for it is this argument which, when assimilated and made its own by the members of each class of readers, delivers them, as it were bound, into the hands of the salesman. Prestige, however, has to be translated into as many tongues as there are classes in the community, if maximum results are to be achieved in talking machine or any other advertising.

It might be said, very roughly, that there are four classes thus to be dealt with, which, for purposes of illustration, may be divided as follows: The Atlantic Monthly class, the New Republic class, the Saturday Evening Post class and the daily paper class. These, in rough classification, may be called the Solid, the Radical Intellectual, the Main Street and the Mob classes. Of course, there are divisions even in the last-named, which in its largest sense means all of us; at least, all of us some time each day. Even among daily paper readers there are, of course, many different strata, and what will please the reader of the New York Times will probably not please the reader of the New York Journal. Generally, however, and with due regard to the grand division between high and low in the newspaper class, one may say that in the four classes of media mentioned above Prestige may be built up by (1) the argument of establishment, solidity of position and social favor, (2) the argument of tone, (3) the argument of what all the better people in town are doing and (4) the argument of bargain, price and sensation.

NATURELLE

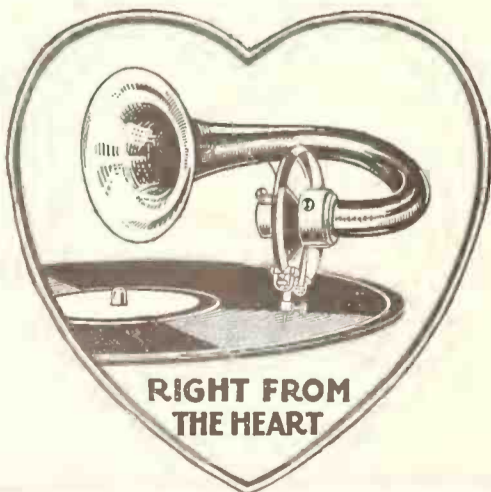

For
Portable
and
Cabinet
Phonographs

The Naturelle Co.
125 East 23rd St.
New York, N. Y.

*"Your Naturelle Reproducer
is everything I've always
wanted to be & a great deal more"*

*"Enclosing check for the sample Naturelle,
with compliments to you for putting this
invention on the market"*

*"I will push the instruments as I am
personally quite enthusiastic over their merits and am very pleased
with the tone and distinctness of undertones produced by use of the
instrument."*

Here's How!!

PEERLESS ALBUMS SELL RECORDS

Good Foresight!

You do not need a spy-glass to see the possibilities of the coming season. Already there is every indication of it being one of the most active in the history of the phonograph industry.

The many new models, weekly record releases and big advertising campaigns—all bound to develop keen public interest in the products you sell and assure a lively response to your door.

PEERLESS—the album—and the efficient organization behind it is also adding impetus to the Fall campaign and is fully prepared to do its share toward your success this season.

Prepare your stock now—with the popular, fast-selling Peerless albums and get the cream of the business at its very peak.

The retailer with foresight will order his Peerless albums NOW.

Phil Ravis

If you are curious to know how many people in your neighborhood have \$10.00 to spend in your store—try this sales plan:

Place a sign in your window reading—

PEERLESS DANCE ALBUM

“24 Dances in a Book”

\$ 10.00

INQUIRE WITHIN



Take a 10-inch Peerless Album and insert 12 10-inch 75c records and label it, using the Peerless Classification Label, “Dance”—all ready for the home record library.

On the authority of one of our Mid-West dealers, “You’d be surprised.” It’s worth trying.

P. S.—Somebody has a birthday every day in the year and, after all, \$10 isn’t so much money nowadays.

PEERLESS PRODUCTS

- DeLuxe Record Albums
- All Grades of Record Albums
- “Big Ten” Albums
- Record-Carrying Cases
- Interiors for Victrolas
- Interiors for Phonographs

- Classification Systems for Albums
- Record Album Sets for All Make Machines
- Record Stock Envelopes
- Record Delivery Bags
- Supplement Mailing Envelopes
- Photograph Albums

Write us for Quotations on Special Grade No. 6 Album

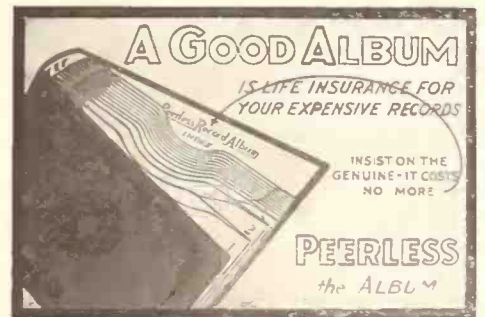

A postal will bring this sign to you in the next mail—write

PEERLESS ALBUM COMPANY

PHIL. RAVIS, President

**636-638 BROADWAY
NEW YORK**

WALTER S. GRAY CO., San Francisco and Los Angeles.

The TALKING MACHINE WORLD

For the makers & sellers of talking machines

(Registered in the U. S. Patent Office)

PUBLISHED BY EDWARD LYMAN BILL, Inc.

President and Treasurer, C. L. Bill, 383 Madison Ave., New York; Vice-President, J. B. Spillane, 383 Madison Ave., New York; Second Vice-President, Raymond Bill, 383 Madison Ave., New York; Secretary, E. L. Bill; Assistant Treasurer, Wm. A. Low.

J. B. SPILLANE, Editor

RAY BILL, B. B. WILSON, BRAID WHITE, Associate Editors

C. R. TIGHE, Assistant Editor

LEE ROBINSON, Business Manager

L. E. BOWERS, Circulation Manager

Trade Representatives: V. D. WALSH, E. B. MUNCH, ROBERT C. ANDERSON, JR., A. F. CARTER, F. G. SANDBLOM, C. CHACE, EDWARD LYMAN BILL, A. J. NICKLIN

Western Division: Republic Building, 209 So. State Street, Chicago, Ill. Telephone, Wabash 5242. EUGENE F. CAREY, Representative

Boston: JOHN H. WILSON, 324 Washington Street

London, Eng., Office: 2 Gresham Building, Basinghall St. W. LIONEL STURDY, MGR.

The Talking Machine World has regular correspondents located in all of the principal cities throughout America.

Published the 15th of every month at 383 Madison Ave., New York.

SUBSCRIPTION (including postage): United States, Mexico, \$2.00 per year; Canada, \$3.00; all other countries, \$4.00 Single copies, 25 cents.

ADVERTISEMENTS: \$5.50 per inch, single column, per insertion. On quarterly or yearly contracts a special discount is allowed. Advertising pages, \$150.00.

REMITTANCES should be made payable to Edward Lyman Bill, Inc., by check or Post Office Money Order.

NOTICE TO ADVERTISERS—Advertising copy should reach this office before the first of each month. By following this rule clients will greatly facilitate work at the publication headquarters.

Long Distance Telephones—Numbers 2642-3-4-5-6-7-8 Vanderbilt
Cable Address: "Elbill," New York

NEW YORK, SEPTEMBER 15, 1923

A VIGOROUS POLICY IN RETAILING NEEDED

THE business outlook, as far as any reasonable deduction can be made, promises well for the Fall and Winter seasons of activity upon which the trade is now entering. The leading authorities are a unit in declaring that with the settlement of the strike in the anthracite coal regions—one of the most disturbing factors in curtailing prosperity—we may reasonably expect a considerably larger volume of business for the remaining months of 1923 than for the same period of 1922.

How much of this business will come to the talking machine dealer rests largely with himself. The keen competition in the retail field to-day calls for the utilization of every new idea possible in interesting the public in the products handled. The dealer who can get away from the beaten track is the man who is going to win. The time is past when a man can depend upon the public coming in voluntarily to buy his goods. The talking machine man who thinks thus is not in touch with the times. Business can be had if it is sought—that is, if it is sought intelligently and strenuously. There is still a big, unexplored field in which to operate. The public has plenty of money to spend if convincing arguments are presented whereby it can be demonstrated that a talking machine and a goodly library of records are essentials.

Judging from the report of the New York Savings Banks Association there is a veritable reservoir of wealth in this State alone, a fair portion of which is available to the talking machine trade. It is noteworthy that the savings deposits in this State have now passed the three billion mark by a considerable amount. Even in New York City, where money is spent so lavishly, there are more than 2,800,000 savings deposits representing the largest share of the State's savings. In the United States at large savings deposits amount to practically \$17,500,000,000. Bear in mind that these savings accounts are largely in the names of salary and wage earners, who after all are the biggest purchasers of musical instruments of the talking machine type. These "Franklinites," or any other people in the United States for that matter, will not spend money willingly, but they can be induced, if dealers go after them intelligently and persistently, to spend a reasonable proportion of

their surplus savings for the tremendous enjoyment which the talking machine affords in the home.

The prosperity of the talking machine industry rests entirely in the hands of the dealers, and they can, if they will, make it more prosperous than it is to-day. In this campaign they will have the unlimited and enthusiastic support of manufacturers and jobbers who are always aiding them in a most effective way to acquaint the people with the merits of the products which they are handling. From now until the Spring of 1924 we should witness in this country the greatest and most successful campaign of retail selling ever recorded, and we hope that every talking machine dealer will recognize his importance in achieving this end.

NEW CAMPAIGN TO DEVELOP RECORD SALES

ANNOUNCEMENT of new developments in the marketing of standard and classical records by prominent artists that have already been made, and moves that are in the offing, lead to the belief that the coming months will show a substantial increase in the demand for records of the better sort—the kind that are calculated to form the basis of permanent libraries and keep the talking machine owner more keenly interested.

The issuance of double-faced records of a high-class order and the readjustment of list prices give the dealer the necessary stimulus to go after this sort of business with the confidence that he can capture a very substantial share of it. Certainly a great many retailers have been inclined to follow the easiest way in handling record business by catering only to popular demand and it is believed that even these individuals will see the possibilities of the reopened channel for record sales. The fact is generally accepted that popular records seldom sell themselves in a large measure—that the current advertising by the record companies and the popular character of the records keep them moving without any great effort on the part of the dealer or his salesmen. In fact, it often happens that the problem is to get the hits soon enough and in sufficient quantities to meet the ever-present demand.

With this condition existing, it would seem as though any business that may be built up with better class records means that much more profit for the dealer. It may require a little selling effort, but if the customer will buy a few popular numbers voluntarily it is worth a little salesmanship to persuade him to take one or two records of the better class at the same time. With these new inducements in the record field and with lines of machines that have been rounded out during the past few months with numerous desirable models there is no reason to believe but that the Fall and Winter business will be just what the dealer cares to make it. He has the best opportunity offered in many years to capitalize on the progressive methods of the manufacturers by going after prospective customers more aggressively and consistently and with more convincing arguments.

The element of competition will, of course, enter as it always does, but if the selling system is right that fact is not going to keep even the average dealer from getting his share of business.

CAUTION IN EXPANDING IS ADVISABLE

THERE is evident at times a tendency on the part of many talking machine dealers, whose business has been exclusively devoted to dealing in talking machines and records, to stock other lines of goods in an endeavor to increase the volume of their business and consequently their profits. A number of the dealers who have spread out have done so with distinct success largely as a result of confining themselves to a line of goods of musical character, such as musical merchandise, sheet music, band instruments, and recently radio equipment. If the lines are properly selected and produce a rapid turnover, the move is certain to give the dealer increased income without making any great inroads into the capital necessary to the conduct of his principal business.

It happens, however, that some dealers have seen fit to tie up money in lines not even indirectly associated with music and the result has been disastrous in some cases. It is logical to assume that a talking machine or record buyer is interested in music and that eventually he or some member of his family may be inclined to buy a band or orchestra instrument of some sort or, perhaps, even a piano and will come to the store that he regards as his music center to make the purchase.

It is not logical for the dealer, however, to expect that regular

customers will come to a talking machine store for merchandise that belongs in a hardware, paint or drug store, and the result is that waiting for transient trade his turnover is slow and the money he needs for his talking-machine business is found to be tied up in slow-moving stocks of other goods.

It might be well for dealers with limited capital to look well before they leap in expanding their business, for the big things to be considered are first, turnover, and second, the appeal the added lines are likely to have to those who already patronize the store regularly. When the dealer stocks something that requires a special sales organization and a special line of customers, then he is entering a new business rather than expanding an establishment, and entering a new business under any conditions entails a certain risk.

Perhaps certain dealers may not feel that their talking machine business is producing all the income they desire and see no immediate way of expanding it to the desired proportions, but it is much better to go slow in adding other lines foreign to their established calling than, perhaps, jeopardize their entire business career.

PROBLEMS ASSOCIATED WITH REPLACEMENTS

WITH the introduction of elaborate new models of talking machines, particularly of the period, console or horizontal types, there has developed in the trade a substantial replacement business which has given rise to a number of problems associated with the handling of instruments taken in trade and which have long been familiar to other lines of business, including the piano industry.

In view of the used machines that are piling up in warerooms and storehouses of some active dealers, there arises the question as to just how energetically this replacement business should be followed or, rather, how it can be handled profitably rather than as a result of gathering trade-in stock.

There is without question a logical field for replacements. The vacationist who has bought a portable or cheap table model for bungalow use is a logical prospect for the sale of a large cabinet instrument for his permanent home when the Summer season is over and to neglect such a prospect is poor business. Likewise there is the individual who invested in one of the non-descript "bargains" that were offered so generously a few years

ago and who, becoming dissatisfied with his purchase, is a ripe prospect for a standard machine of guaranteed quality.

If the average dealer follows up his regular prospects for new machines energetically and conscientiously and in addition gives attention to the two profitable fields for replacements mentioned above, he should, under ordinary conditions, have a distinctly satisfactory volume of business without being forced to take in exchange cabinet machines more or less modern in character for the sake of placing in the home a console model. There should be, and in a number of cases there is, a distinct line of demarcation between replacement business that helps the dealer by giving him a direct profit on the resale as well as opening up a fresh channel for record sales, and the replacement that calls for a trade-in that, unless a quick turnover is made, cuts the profit to the quick and means the piling up of dead new stock.

In accepting trade-ins of any sort the dealer might well follow the methods utilized successfully in other trades and allow only as much for the old machine as can be realized when it is resold, deducting from the allowance, of course, repair and re-selling costs. It must be remembered that as soon as a new machine leaves the dealer's store it becomes a used instrument and suffers an immediate depreciation in value. According to some automobile men this depreciation amounts to 25 per cent of the retail price to cover the selling cost and expenses incident thereto. If the dealer, therefore, first deducts the 20 or 25 per cent selling cost from the purchase price of the used instrument and then deducts a proper amount for depreciation, due to age, wear and tear, he is going to arrive at a valuation that may not always prove pleasing to the customer, but will at least be fair to himself.

If the average dealer gives proper attention to new prospects and then, in order, to former purchasers of portable and non-descript models, and, finally, to owners of upright cabinet models who can be persuaded to buy consoles, he is not likely to handle a sufficient amount of the latter class of business to cause him embarrassment. And it might be said right here that the taking of a portable model in exchange for one of the cabinet types is in 99 cases out of 100 the result of bad salesmanship somewhere. Keep the portable sold for next Summer's vacation.



Watch Our Smoke

When your record order arrives on time—ahead of time—it's Pearsall, of course!

Ask any Pearsall dealer, he'll tell you.

"Desire to serve, plus ability."

10 EAST 39th ST.

NEW YORK CITY



THOMAS F. GREEN, *President*

Management Reflected in Sales Results

Sales Manager Largely Responsible for Achievements of Salesmen
—Too Much Managing Curtails Initiative and Business Declines

Upon the sales manager of the talking machine establishment or the proprietor, if he acts in that capacity, depend the results obtained from the sales organization. In other words, getting maximum results as represented by volume of sales from the selling force is no sine-cure and keen foresight and knowledge of the business and the various characteristics of each member of the staff are necessary. There are some sales managers who have the happy faculty of keeping their men on their toes all of the time and who, through scientific handling, consciously or unconsciously, are able to keep the enthusiasm of the men for the line and concern they represent to a high pitch. There are also sales managers who, in the belief that they are all-wise and infallible, are constantly rubbing the "fur" of their men the wrong way. This constant friction creates a dissatisfaction and multiplicity of other feelings on the part of the men, kills the real enthusiasm for the house and for the merchandise which is most necessary to the maximum sales results and, consequently, sales are nowhere near what they would be if harmony existed and the best was encouraged and brought out in each individual.

Must Consider Individuals

The sales organization consisting of several or more men should not be looked upon as a mass, but the sales manager should consider each man as an individual. The most successful sales managers in the country in all lines of business realize this fundamental of good management. They are aware of the fact that, while one man produces the best results through driving, another will not respond to this treatment

at all. On the contrary, there is a certain type of salesman who, if driven, will become nervous, irritable and dissatisfied, when, if different tactics were used, this type could be made an enthusiast and consistent producer. It depends, in a large measure, on the sales manager.

Too Much Management Harmful

There are many other considerations involved in the efficient handling of the sales organization. Probably one of the greatest faults in management to-day is too much management. In short, unintentionally, initiative and independent thinking, to a large extent, are discouraged and the result is that many salesmen who could go out and clean up if they were given wider scope refrain from doing so. The sales manager of one of the largest and most successful sales organizations in the East stated the same facts in slightly different language to the writer recently. "Those salesmen who are made to realize that they must use their own wits and skill to deliver the goods will produce the best results," he declared. "I do not mean that the house and the sales manager should not do everything possible to help the men, but what I do mean is that the average salesman will not progress as rapidly as he might if his abilities are not recognized and he is not given a chance to display them. A long time ago we corrected one of the worst mistakes a house can make and as a result our sales increased steadily. The situation was this: We have a large outside sales organization and these men are responsible for bringing many people into the store. Now it was formerly the practice for the salesman to deliver his sales talk to the cus-

tomers up to a certain point and then turn him over to one of the floor managers to close the sale. Now, you know as well as I do that every salesman should have the ability to close his own sales, but this had been the method with this house and it was continued until sales dropped to such an extent that something had to be done. As soon as the salesmen were placed on their own responsibility they went to work with renewed enthusiasm and confidence in their ability, which was reflected in an immediate increase in business."

Sales Conferences Helpful

Fortunately this is a very rare condition in the talking machine business, but it serves to illustrate how overmanagement can do more harm than good. To overcome any possibility of overmanagement, especially where a considerable force is employed, there is nothing quite so effective as sales conferences where salesmen and their manager can discuss and suggest freely and frankly. It must be remembered that the men on the outside come in contact with many prospects each week and they have the opportunity of observing conditions and problems which are seldom encountered in the store. Open discussions of those problems in which all of the men have an opportunity to voice their opinions often bring about a solution and, consequently, pave the way to more sales. It is, indeed, a wise sales manager who realizes that the men under his direction can help him to achieve greater results and that, after all, is what he is or should be most concerned in. Indeed, his reputation depends to a large extent on the performance of his men.

MIS Co



*A Complete Victor
Jobbing Service*

*Merchandise — Selling
Advertising — Finance*

Musical Instrument Sales Co.

Victor Wholesalers
673 Eighth Avenue
TELEPHONE 9400 LONGACRE
New York

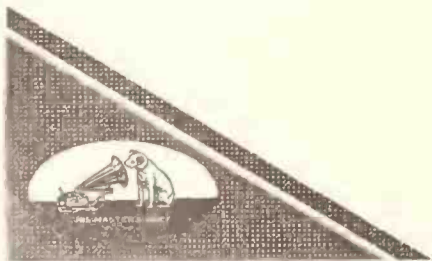

---AND THE AVERAGE PRICE IS LOWER



A SIZE FOR EVERY PHONOGRAPH MOTOR

A Complete Line of Talking Machine Repair Materials

Everybody's
TALKING MACHINE CO. INC.
PHILADELPHIA, U. S. A.

Makers of Honest Quaker Main Springs & Umartone Needles

How Letters Pave Way to More Business

Concrete Examples of the Type of Direct Mail Literature Which Is Bringing Customers to the Sterling Piano Co., Brooklyn, N. Y.

The importance of a consistent direct-by-mail drive for business has been stressed many times in the columns of *The World* and many talking machine retailers are finding this a prolific source of business and live prospects. However, a large percentage of the members of the trade are skeptical of the power of such a campaign and, consequently, this medium for bringing the sales message of the dealer to his patrons is too often neglected. Of the live and successful concerns who are realizing excellent results from direct mail, refuting the contentions of those who believe these drives represent money wasted, is the Sterling Piano Corp., 81-87 Court street, Brooklyn, N. Y., which is constantly extending its business by this means. This concern, by the way, is one of the most successful in the entire metropolitan territory, not only in the merchandising of talking machines and records, but in the sale of pianos and general musical instruments as well.

The latest piece of direct mail literature which is being sent out by E. T. LeTure, the aggressive manager of the talking machine department, is an unusually effective folder setting forth the merits of the Victor and Sonora machines, which it handles, and an extensive line of radio merchandise, including the Kennedy Intermediate receiver and the R. C. A. line of radio outfits. The side of the folder on which the address of the prospect appears bears the legend: "Happiness Right Out of the Air for You." This curiosity stimulator impels the recipient to open the folder, where the real message strikes the eye. On the right-hand margin of the opened piece of publicity appear reproductions of various models of Victor and Sonora instruments and on the left-hand margin are pictured several models of the radio receiving units handled by the firm. Below a large heading: "Phonograph or Radio Offers Perfect Enjoyment," there are two columns of text, one devoted to talking machines and the other to radio, as follows:

"The wealth of happiness and pleasurable satisfaction that a phonograph brings to your home!

"The golden voice of Caruso, the appealing charm of John McCormack, the strains of soul-stirring Sousa Marches, or the scintillating syncopated dance rhythms of Paul Whiteman's Orchestras.

"All are yours to enjoy, to revel in to your heart's content.

"We have assembled in our phonograph department a noteworthy collection of the best instruments.

"Here you may find out by actual test and comparison the particular instrument best suited to your individual requirements.

"A moderate initial payment will give you immediate access to the World's Greatest Music and Musicians. The balance may be distributed in convenient amounts extending over a period of many months."

☺ ☺ ☺ ☺ ☺

"What's on the air to-night?"

"A complete Broadway Musical Comedy—a celebrated speaker—an operatic concert—dance music—and a long list of items of fascinating interest.

"Day and night the air is full of good things for the Radio owner.

"The Radio is far more than a musical instrument.

"It brings a world of information on timely topics that are always interesting and instructive.

"The Radio instruments at the Sterling store have been chosen for their simplicity and all-round reliability.

"And, if you wish, we'll install your Radio for you complete, ready to 'tune in.'

"We should like to demonstrate how easy it is to operate and derive a maximum amount of pleasure from the 'air.'"

The opened folder also discloses a self-addressed post card, the text and form of which, abbreviated, is reproduced below:

STERLING PIANO CORP.
81-87 Court Street
Brooklyn, N. Y.

Please send me full information regarding
 Talking Machines
 Radio

(If you have any preference as to make or model indicate it on the line below.)

Name

Street Address

City

The Sterling Piano Corp., in addition to selling many talking machines, does a large business in pianos and E. L. LeTure, manager, believing that these satisfied piano customers are

good talking machine prospects, has reached out after this business by sending the piano customer the following letter on its regular stationery and signed by the manager of the talking machine department:

"Some time ago we had the pleasure of selling you a Piano. The transaction was so satisfactory from our standpoint, and we hope from yours as well, that we are anxious to extend these pleasant business relations.

"You have undoubtedly found a great deal of pleasure in your piano, but even a piano has its limitations.

"Doubtless you have frequently desired vocal, violin or orchestra music—some form of music which it is not possible to obtain from your piano. With a Victrola every musical longing can be satisfied.

"With it you can enjoy such artists as Caruso, Galli-Curci, McCormack and Melba; and can also have Sousa's Band, Victor Herbert's Orchestra and other famous musical organizations. These artists are under exclusive contract to perform only for the Victor.

"Then there is the little dancing party, in your own home, with perfect dance records supervised in the making by such great exponents of modern music as Paul Whiteman. These are just a few of the possibilities of the Victrola. Allow us to convince you at our expense of the pleasure you can obtain from this wonderful musical instrument.

"May we have the pleasure of seeing you in our Victrola Department soon? Let us explain to you our easy method of purchasing a Victrola on the deferred payment plan. We would like to show you the beautiful instruments that may be had to suit every purpose. Very sincerely."

This tie-up with piano customers has resulted in the sale of many talking machines, the sales coming the more easily because these prospects were already satisfied customers of the house.

Another clever piece of direct-by-mail work, designed to interest people who are already customers as well as those who have never purchased from the Sterling Piano Corp. and which has been productive of big results, is the following letter:

"Everyone loves Music! That is why we feel that you, as a valued patron and friend of our store, will be interested in knowing about our Victrola Department, to which we cordially invite you.

"You will find this Department splendidly equipped with all the latest Victrolas and thousands of Victor Records. We will also find an intelligent sales force anxious and willing to assist you in every possible way in selecting the instrument or records you may desire.

"Won't you come into our Victrola Department the next time you are in our neighborhood? You will be surprised at the easy terms of payment we will be happy to make you on any instrument you may select.

"If it is not convenient to come into our store mark on the enclosed post card the outfit you are particularly interested in. Mail it to us. Full information will be sent you immediately and without any obligation on your part. Very sincerely."

"P. S.—If you own a Victrola and are not buying your records from us, begin now to use our service. Our stock is complete. Each record we sell you is guaranteed to be in perfect condition and we will be pleased to open a charge account for you in purchasing records."

As has been mentioned in the introductory paragraph the Sterling Piano Corp. is one of the successful music houses in the metropolitan territory, and what is of even greater significance is the fact that this firm's business is steadily increasing. Direct-by-mail has played an important part in the development of this business and it is certain that what has been accomplished by one live dealer can be duplicated by others. There are several important factors which must be considered by the dealer who contemplates a drive of this character. These include the type of people to whom the literature is to be sent and preparation of copy accordingly, appropriation (if the appropriation is very small do not send out cheap literature in an effort to reach a great many people. Quality is necessary even if the mailing must be limited as a result), follow up of prospects; upon the latter depends the ultimate result of the drive.

Ernest J. Lavagnino has purchased the music store operated in Sonora, Cal., by A. McDowell under the name of the Oakdale Music Co.



HENRY BURR



ALBERT CAMPBELL



JOHN MEYERS

EIGHT POPULAR VICTOR ARTISTS

In Concert and Entertainment

Personal Appearance of

Eight Popular Favorites on One Big Program

A live attraction for live dealers and jobbers

Bookings now for season 1923-1924

Sample program and particulars upon request

PHILIP W. SIMON, Manager

1674 Broadway

New York City



FRANK CROXTON



MONROE SILVER



BILLY MURRAY



RUDY WIEDOEFT



FRANK BANTA

Popular Ensembles including
Campbell & Burr - Sterling Trio - Peerless-Quartet



THE KENNEDY MODEL X

Beautiful hand-rubbed Mahogany Cabinet with Satin Wood and Ebony inlay. Extremely simple to operate, yet maintaining the Kennedy standard of selectivity. Only two dials—one for "tuning in," the other to control sound volume. Two stages of audio amplification. Built-in loud speaker. Control panel of highly polished black Formica. Gold-plated metal trimmings on front—including dials. Responds to all broadcasting wave-lengths. Price, complete with three dry-battery tubes, adapters for any standard tube, all dry batteries, Kennedy phones with plug\$285.00

All Kennedy Radio Receiving Sets are regenerative—licensed under Armstrong U. S. Patent No. 1,113,149.

New Kennedy Radio Sets In Beautiful Furniture Models

THIS is the first of the new Kennedy Furniture Model radio receivers—of particular interest to music dealers. They mark the perfection of radio sets, for, added to their appealing exterior beauty—their purity and harmony of design—are many other characteristics which make them especially desirable as radio furniture.

Each is a completely self-contained unit, with ample internal space for all dry batteries. The absence of "extras" makes stocking, displaying and selling easy.

And, added to the profit and prestige in handling Kennedy radio sets is the assurance of perfectly satisfied customers. Far-seeing music houses, recognizing the value to them of being appointed exclusive dealers for Kennedy sets are applying for exclusive territories.

If interested in a profitable radio business, whether or not you are in a position to assume exclusive agency, write for further details of the new sets and merchandising policy.

THE COLIN B. KENNEDY COMPANY
 SAINT LOUIS SAN FRANCISCO

K E N N E D Y

The Royalty  *of Radio*

The new Columbia in a complete line



**New Columbia
MODEL 240—\$75**

New two-spring motor. New Reproducer. Finished in Red Mahogany, with all exposed metal parts in nickel. Exclusive tone-control leaves.



**New Columbia
MODEL 441—\$165**

New three-spring motor, New Non-Set Automatic Stop and new Reproducer. Push button ejector for records. Finished in Red Mahogany or Brown Mahogany, with all exposed metal parts in nickel. Exclusive tone-control leaves.

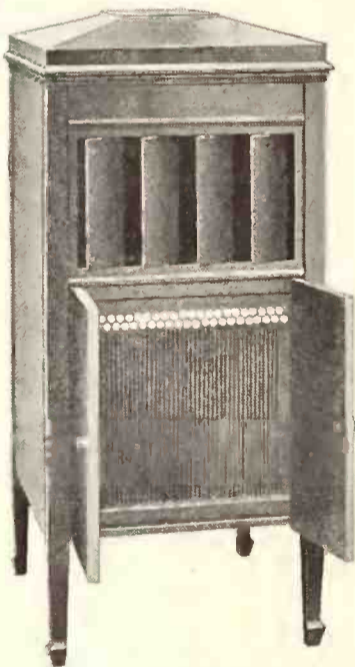

**New Columbia
MODEL 421—\$115**

New three-spring motor. New Reproducer. Record compartments with push button ejectors. All exposed metal parts nicked. Finished in Red Mahogany or Brown Mahogany. Exclusive tone-control leaves.

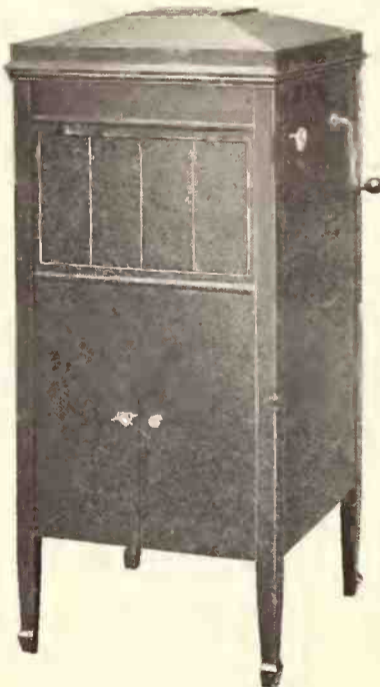

**New Columbia
MODEL 420—\$100**

New three-spring motor with the new Reproducer. Shelves for records. Finished in Red Mahogany, Brown Mahogany, Golden Oak and Walnut. All exposed metal parts in nickel. Exclusive tone-control leaves.



**New Columbia
MODEL 340—\$120**

New three-spring motor with new Reproducer. Shelves for records. All exposed metal parts nicked. Finished in Red Mahogany, Brown Mahogany and Golden Oak. Exclusive tone-control leaves.

IN addition to the consoles, The New Columbia comes in a wide range of upright styles—each a masterpiece of the cabinetmaker's art—each with the mechanical refinements which place The New Columbia in a class by itself.

The *motor* is new. It runs with the precision and accuracy of a fine watch. An ingenious system of oil tubes lubricates all the important bearings. Highly tempered steel springs deliver an even flow of power, which gives the motor an unvarying rate of speed.

The *new non-set automatic stop* is sure in its action. The *automatic tone-arm start* is another brand new Columbia feature. The motor starts as soon as the tone-arm is moved over to place the needle on the record.

The *new reproducer*, with its patented cushion springs, eliminates the blast and blurred tones from the reproduction, even on the highest soprano notes and on the heavy instrumental bass.

The *tone leaves*, an exclusive Columbia feature, scientifically control the volume of the music without losing the value of the different tones.

The New Columbia, both in console and upright models, is an instrument which you can enthusiastically present to your customers.

COLUMBIA GRAPHOPHONE

the most perfect phonograph ever built of upright models

New Columbia
MODEL 450—\$175

New four-spring motor with New Non-Set Automatic Stop and new Reproducer. Shelves with complete set of albums for records and an extra record capacity in the back of the cabinet. Finished in Red Mahogany, Brown Mahogany and Walnut with all exposed metal parts in nickel. Exclusive tone-control leaves.



New Columbia
MODEL 430—\$125

New three-spring motor with New Non-Set Automatic Stop and new Reproducer. Shelves for records. All exposed metal parts nicked. Finished in Red Mahogany, Brown Mahogany, Golden Oak and Walnut. Exclusive tone-control leaves.



New Columbia
MODEL 460—\$225

New four-spring motor with New Non-Set Automatic Stop and new Reproducer. Records are stored in novel filing device, with an extra record capacity in the back of the cabinet. Finished in Brown Mahogany or Walnut, with all exposed metal parts in gold finish. Exclusive tone-control leaves.



Novel filing device in front, and extra record space in back of cabinet—\$225 Model.

New Columbia
MODEL 440—\$150

New Reproducer. The new three-spring motor, with New Non-Set Automatic Stop. Shelves for record storage. All exposed metal parts nicked. Finished in Red Mahogany, Brown Mahogany, Golden Oak and Walnut. Exclusive tone-control leaves.

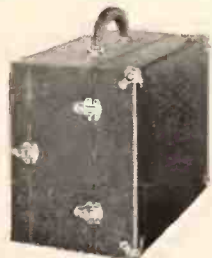

New Columbia
MODEL 140—\$50

New one-spring motor. New Reproducer. Finished in black fabricoid with nickel trimmings. Record drawer with a capacity for eight records. Exclusive tone-control leaves.

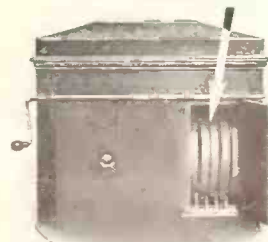

COMPANY



NEW YORK

The ALBUM method EXCELS all other RECORD FILING systems EVER TRIED



SELECTING THEIR FAVORITES

To the Trade:

Our Record Album factory—all or any part of it—is at *your command*. Hundreds of customers can and will gladly testify as to the good quality of our production.

Our large and growing business is due to satisfied customers and repeat orders.

Imprint (firm name or trade mark) stamped on covers if desired when orders are sufficiently large to justify it.

OUR ALBUMS ARE MADE TO CONTAIN VICTOR, COLUMBIA, EDISON, PATHE, VOCALION AND ALL OTHER DISC RECORDS

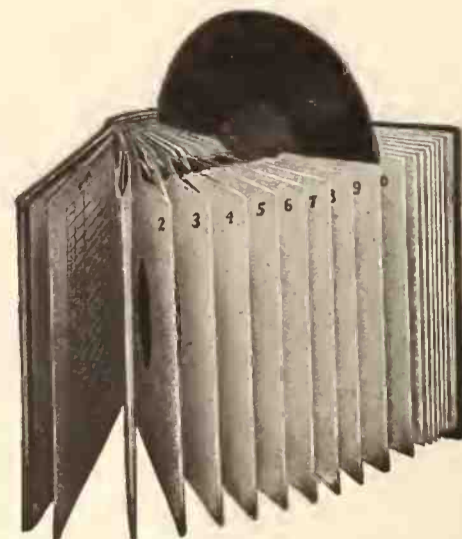

THE PERFECT PLAN

NATIONAL PUBLISHING CO., 239 S. American St., PHILADELPHIA, PA.

New York Office, 54 Franklin Street, Telephone, Franklin 1227, James E. Maguire, Representative

C. C. ALEXANDER WITH J. K. POLK

Becomes Member of Sales Staff of Wholesale Phonograph Division of Atlanta Distributor

ATLANTA, GA., September 5.—P. C. Brockman, sales manager of the wholesale phonograph division of James K. Polk, Inc., Southeastern distributor of Okeh records, Honest Quaker main springs and repair parts, and other talking machine accessories, announces the recent appointment of C. C. Alexander as a member of the company's sales staff.



Mr. Alexander, who has been connected with the Polk organization for the past year, is thoroughly familiar with the many lines distributed in the Southeast by this company, and it is expected that he will make many friends among the talking machine trade within a short time. He is now on an extended trip in Alabama and Florida and reports business as being good in this territory, stating that prospects are very bright for the big Fall and Winter season, for which the trade in this territory is making preparations.

NEW EDISON FRANCHISES GRANTED

Phonograph Corp. of Manhattan, Edison Jobber. Predicts Busy Fall Season

Among the new Edison accounts established by the Phonograph Corp. of Manhattan, Edison jobber in the metropolitan district, are Roseville Music House, Newark, N. J.; George Brooks & Co., Sommerville, N. J., and Graham Music Shoppe, Jersey City, N. J. This company reports a good business among its dealers for the month of August and an excellent outlook for the Fall. In the mining districts of eastern Pennsylvania the dealers are exceedingly well pleased over the settlement of the coal strike and, as a consequence, wholesale orders are coming in far in excess of those placed a year ago at the same time.

KOCHANSKI TO TOUR COUNTRY

Popular Polish Violinist and Vocalion Record Artist to Make Recital Tour

Paul Kochanski, popular Polish violinist, whose first Vocalion record was released recently and who is to record for this company exclusively in the future, has completed plans for a transcontinental recital tour, upon which he will start early in October. An interesting feature of the tour will be the use by Mr. Ko-

chanski of an inlaid Stradivarius violin declared to be one of three made by the great master for the Court of Madrid, and which was used at one time, it is said, by the famous Ole Bull.

Kochanski's full itinerary will be announced shortly and dealers in Vocalion records will have an excellent opportunity for tying up directly with his appearances in the various cities.

J. RIESENBURGER RETIRES AS DEALER

Popular Victor Merchant Sells Business to Jack and William Abrams—Store Redecorated

Irving Riesenburger, furniture dealer in Flushing, L. I., for about twenty-five years and exclusive Victor retailer, has decided to retire



J. J. Davin, J. J. Abrams and I. Riesenburger from active business and enjoy life. In pursuance of this idea he has sold out his entire business at 27 Main street to Jack J. and William Abrams, brothers, who conduct eighteen furniture stores in New York City and nearby towns. They have been in business for the past twenty years, and are well known in retail circles.

A new double-deck front is being added to the store occupied by Mr. Riesenburger, which will add materially to the window capacity. The new owners plan to institute an aggressive campaign, featuring the Victor line, and their long experience in the retail field will undoubtedly enable them to attain pleasing success in their new proposition.

Mr. Riesenburger is retiring with the good wishes of a host of friends. He was recently elected a director of the Queensboro National Bank of Corona, and he is also a director of the Business Men's Division of the Flushing United Association. According to his present plans Mr. Riesenburger will visit California this Winter, accompanied by his wife and son.

A new talking machine store was recently opened in Broughton, Pa., by Harry Goldman.



FOR THE FIRST TIME,

since last September, we are in a position to establish a few more Edison Dealers in the Metropolitan District.

OUR POLICY,

during a shortage, is to give all goods possible to the merchants who have been Edison Dealers and who have previously spent their time and money in working up sales and prospects.

CONSEQUENTLY,

and because we are now making up our Fall and Winter requirements, we invite inquiry from merchants who are located at good trading points, who believe in fair profits and who consider quality necessary to success.

The Phonograph Corporation of Manhattan

Metropolitan Distributors

Orange

New Jersey

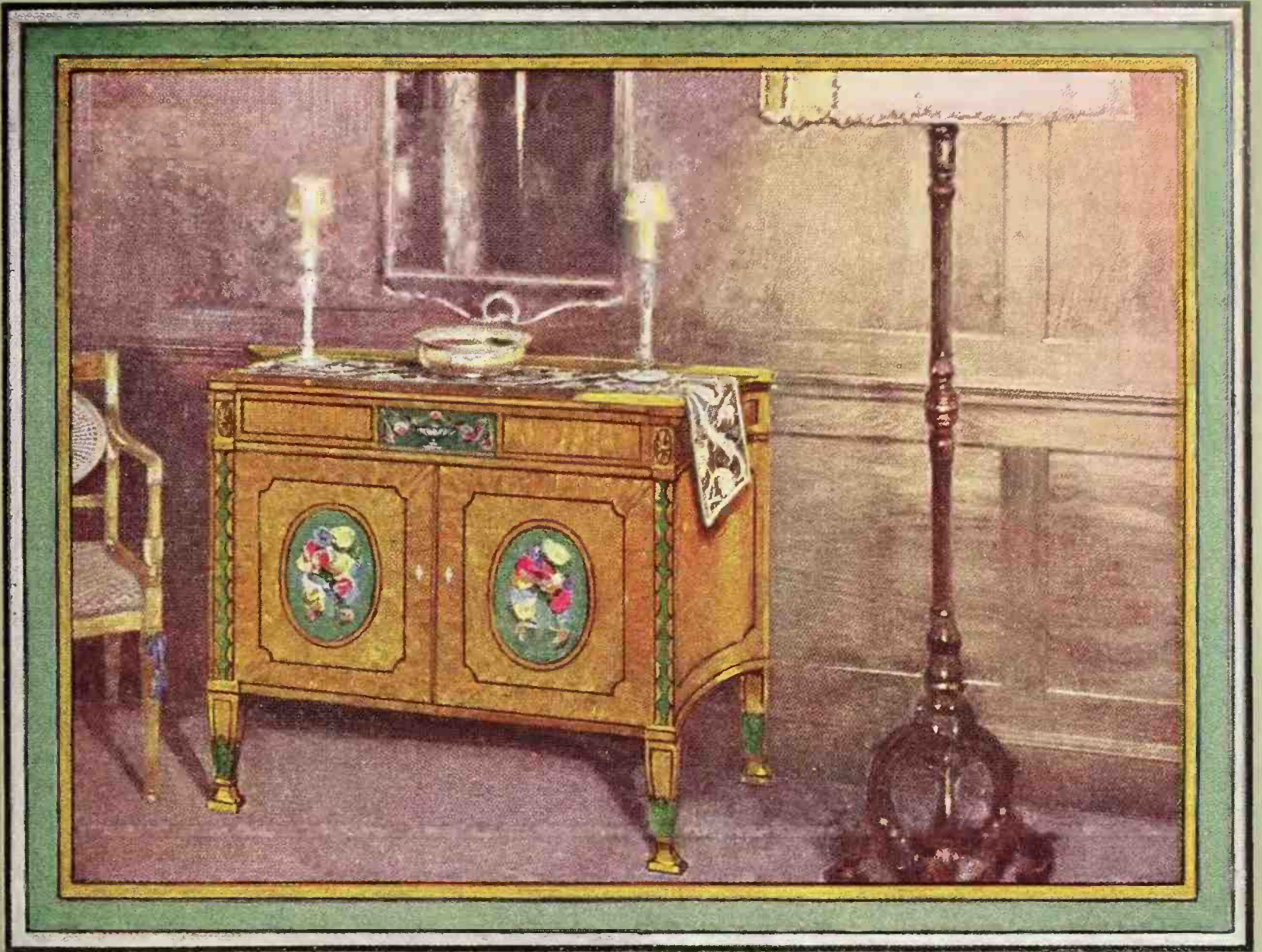

Aeolian-Vocalion, in commode of Adam design, constructed of satinwood with delicate inlay, the two doors decorated with floral plaques. Designed and executed by Tiffany Studios of New York

THE Aeolian Company produced the first period phonographs, which set a standard in the phonograph field that demanded that these instruments be as beautiful to see as to hear.

The Aeolian-Vocalion, constructed on principles developed by the world's leading experts on reproduced tone, had gone a long way to banish mechanism in favor of music. The Aeolian classic period styles set this instrument in a worthy, artistic cabinet and a new era began for phonographs.

THINK what it means when you use the superlative sales phrase—"The World's Most Beautiful Phonograph"—to have your statement endorsed by the greatest designers, craftsmen and decorators.

This innovation gives Aeolian representatives an unquestioned lead in the luxury market. Think of the many homes where an



Aeolian-Vocalion, in a cabinet of the Queen Anne Period, walnut, enriched with comino wood burr. Designed and executed by W. & J. Sloane, New York

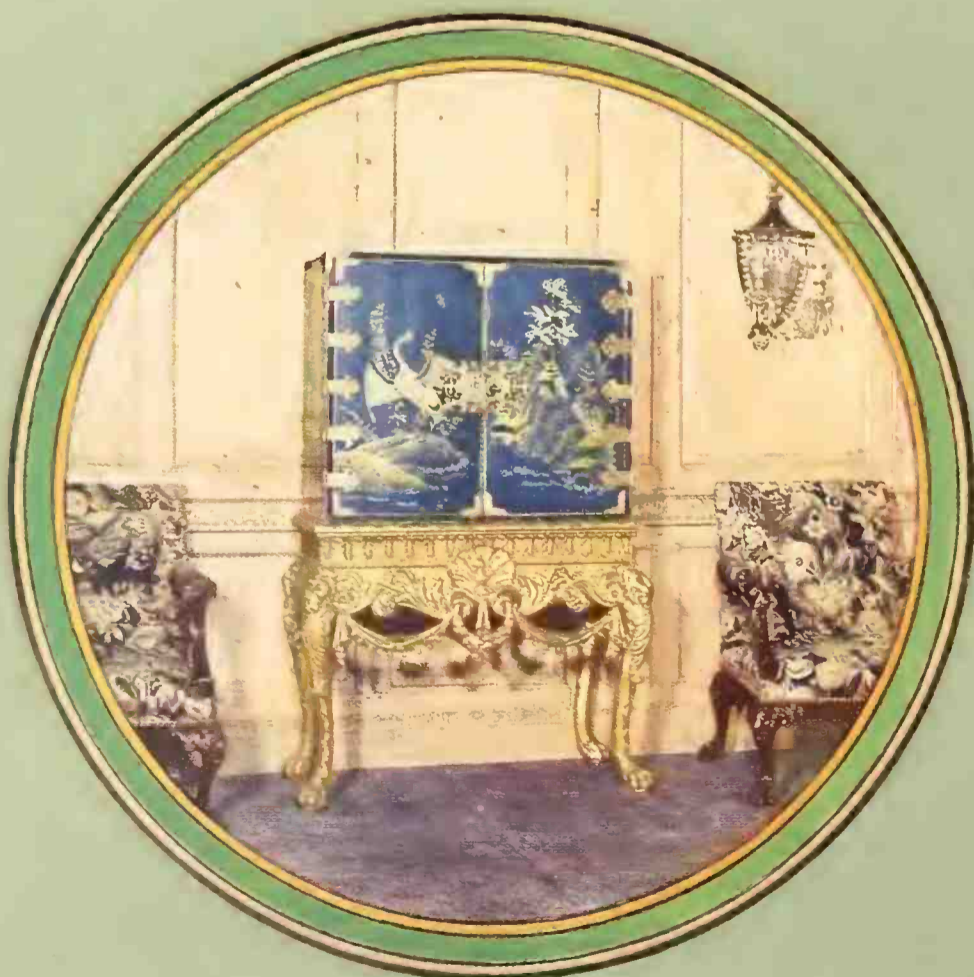

Aeolian-Vocalion (early Georgian Period). The cabinet is decorated with silver leaf, lacquered, the base is hand-carved and finished in English silver gill, glazed. By Wm. Baumgarten & Co., Inc., New York

ordinary phonograph case would be out of keeping with elaborate plans of decoration. Think of the many anniversaries, weddings, etc., when an ordinary cabinet would seem inappropriate.

These are the opportunities which are open to Aeolian-Vocalion dealers through the creation of these classic period models, designed by the world's leading decorators and craftsmen.

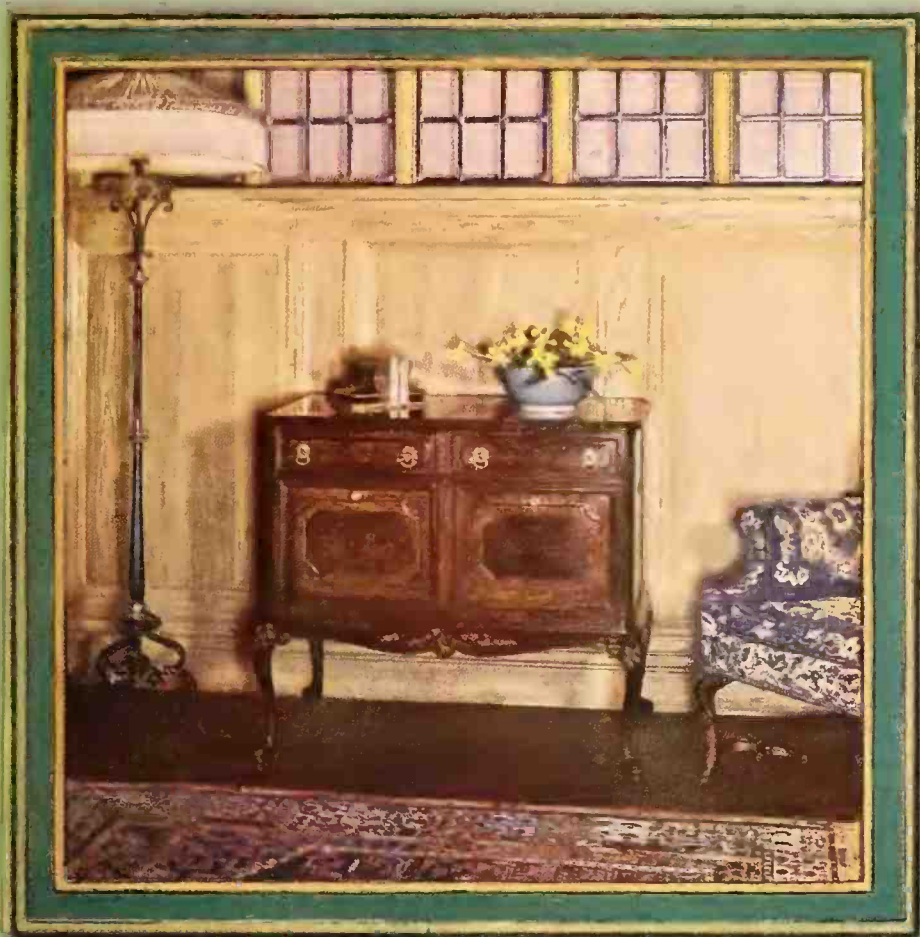

*Aeolian-Vocalion (Queen Anne Period)
This case is of mahogany with panels of walnut
and burl redwood. Hand carving*

STUDY these authoritative art models and you will realize that The Aeolian Company has again pioneered in creating a new standard of perfection by placing the Aeolian-Vocalion in the lead as the most musical and the most beautiful of phonographs.

During 1923 still another stride has been taken, and to fill the demand for a musical instrument which would grace the most magnificent

home, The Aeolian Company ordered designs from the World's Leading Interior Decorators and Designers.

The results are an artistic triumph and include models conceived by—

The Tiffany Studios, Charles of London, D. H. Hess & Co., Wm. Pierre Stymus, Jr., Inc., W. & J. Sloane, Wm. Baumgarten & Co., Inc., H. F. Huber & Co.

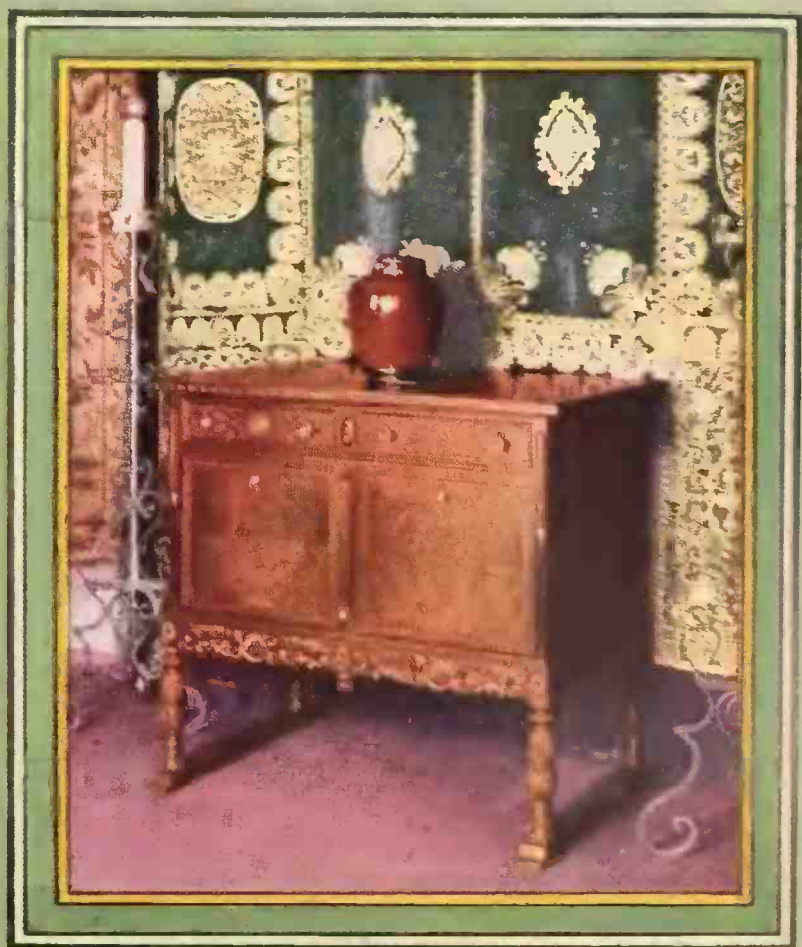

*Aeolian-Vocalion (Florentine). The exquisite technique of the Italian master craftsmen well exemplified.
In walnut, with polychrome band decoration*

The AEOLIAN-VOCALION

*The phonograph which offers the dealer the advantage of
exclusive distribution in each city*

The only phonograph which has the sales advantage of being manufactured by the world's leading musical instrument manufacturer.

The increased demand for Aeolian-Vocalion Phonographs offers several opportunities for representatives in newly opened territory.

WRITE FOR OUR 1923-24 PROPOSITION

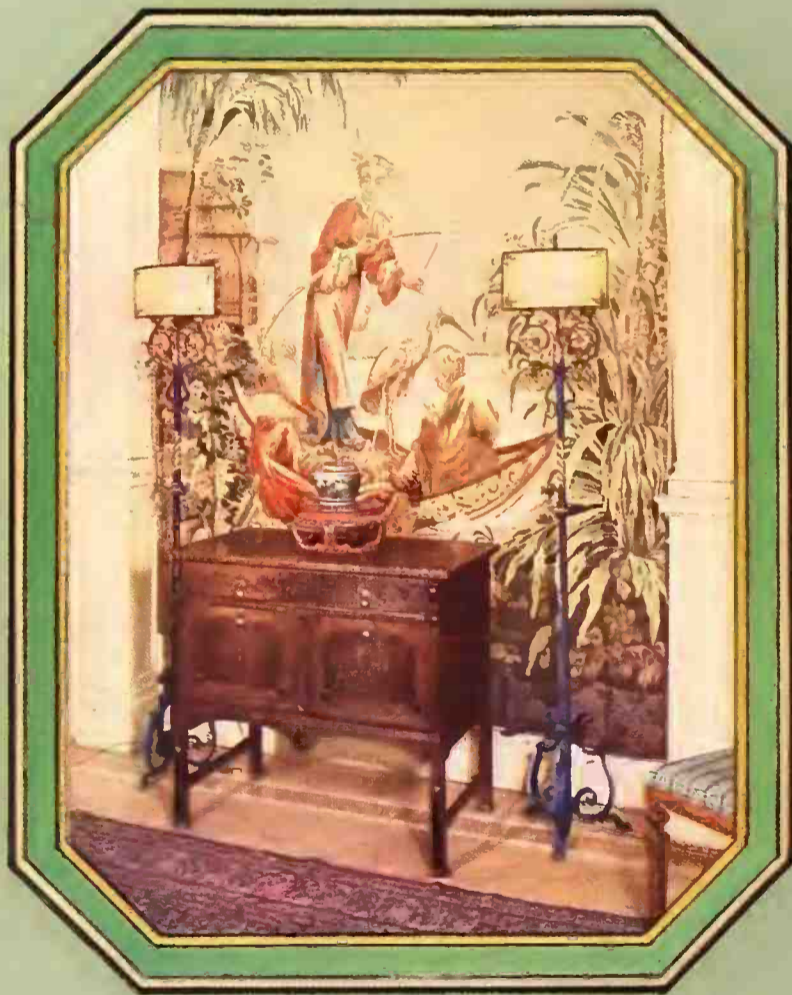

*Aeolian-Vocalion (Italian Period)
A graceful and well constructed cabinet typifying
the austere charm of the period. In shaded walnut*

THE AEOLIAN COMPANY
AEOLIAN HALL - NEW YORK

LONDON

PARIS

MADRID

SYDNEY

MELBOURNE

Undeveloped Fields in "Talker" Selling

New Opportunities for Making Sales Await Alert Retailers—
Possibilities in Group Sales of Instruments—Men as Prospects

One of the most vital considerations in the talking machine retail business is the securing of new live prospects. Every member of the trade must be on the alert for new avenues of sales and a never-ending campaign is necessary to make the prospect list worth while. It is astonishing how few merchants really make any serious effort to secure new potential customers. In a canvass made by the writer covering about a dozen dealers only one made any effort to get prospects and three utilized the services of skilled outside salesmen to make the personal contact which so often leads to sales. Another significant factor was the assertion by these three dealers that they only occasionally made personal outside calls or had their salesmen do so; nor did any of them utilize direct-by-mail to come in contact with their prospects. According to their own statements they made no effort to secure new prospects, but depended chiefly upon the recommendations of former purchasers and their advertising for new business. It is significant that all of these dealers with the exception of the one who made an effort to dig up new prospects and then followed the matter up in an aggressive manner were more or less affected by the Summer slump.

Time and time again The World has published articles showing how live dealers have achieved success and done a large business through some systematic method of adding new names to the prospect list and then going after this potential business through direct contact, direct-by-mail, etc., etc. There are any number of ways in which the dealer can keep his list up-to-the-minute with comparatively little trouble. Of course the real stunt is making the sale and here the dealer must use his own initiative.

Making Group Sales of Machines

There is nothing new in the group sales plan in other lines of business and it has been tried in the record end of the talking machine business with considerable success. In fact, the so-called "group" sales plan is receiving more and more attention from the most successful members of the trade. This applies to records only, however. As far as machines are concerned, little or no effort has been made to

make group sales. Yet, there exists an unparalleled opportunity for this type of sales promotion work. Take, for example, fire houses: Much of the time of the firemen is spent in lolling around the headquarters with comparatively little to do between alarms. Here is the best kind of a prospect. A live salesman should have very little trouble in selling machines to every fire station in his community and those in surrounding towns and villages. If he takes a good machine with him, sets it up in the fire house, makes a thorough demonstration and explains a plan to the firemen whereby they can all contribute a small sum to pay cash or purchase on the instalment plan, he is pretty certain of making sales. Moreover, he makes a contact with the firemen which, with tactful questioning, enables him to determine which members of the organization do not possess instruments in their homes and while the men are all together he may be able to close two or three additional sales of machines for delivery in homes. School teachers offer another similar opportunity and this also goes for the police department and other city departments where there are groups of men.

Men as Prospects

In the past talking machine dealers have concentrated largely on women as prospects on the theory that the woman of the house is the deciding factor in such matters. In a surprisingly large number of instances such is not the case. The breadwinner of the household often offers the best opportunity of making sales, and, therefore, he should not be left out of the scheme of things. A man will often buy a machine on the strength of the argument of the salesman that he owes it to his wife and children to increase their enjoyment of life by providing them with music, etc. Then, again, many factories and business houses these days provide rest rooms for their women employes and in a large number of business organizations there are recreation rooms. A canvass of the larger factories and business houses in the community where the dealer has his establishment and adjacent territory will add many fine prospects to his list. The head of a business to-day realizes that happy employes are the best producers and the business man has intelligence

enough to see the point when the salesman for a talking machine house points out that music is one of the best means for insuring happiness and contentment on the part of employes. In addition, through the sale of an instrument to a business house, the fact that employes see and play the instrument constantly impresses on their minds whether the instrument is good, bad or indifferent. If the dealer handles a standard line of goods there is no reason why other sales should not be made to employes, the instruments to be used in their homes, of course.

Only a Few of Many Opportunities

These are only a few of the many opportunities which await the live dealer and, moreover, these fields have been largely neglected. There are many other methods of securing new business which the dealer will unearth if he sets his mind to it. Thought translated into action is the thing. With the keen competition existing in the talking machine business to-day the dealer, if he desires to grow, must not let any opportunities slide for securing new prospects and then following up energetically until the sale is made or lost. Remember, every sale of a machine means just so much gain in record and accessories business. Before this can be realized, however, the machines themselves must be sold and it is absolutely certain that the dealer who does not have energy enough to go after business will not expand to any great extent, considering present competition.

JOINS OKLAHOMA T. M. CO.

R. A. Hickerson Elected Secretary and Treasurer of Victor Wholesale House

OKLAHOMA CITY, OKLA., September 1.—R. A. Hickerson, who has had long experience in the retail field and in the promotion of sales generally, has joined the executive staff of the Oklahoma Talking Machine Co., Victor wholesalers, with headquarters in this city, in the capacity of secretary and treasurer. Mr. Hickerson will devote his efforts especially to cooperating with Victor dealers in this territory in the arrangement of their stores and in their selling campaigns.

ADD-A-TONE

THE SUPREME TONE AMPLIFIER

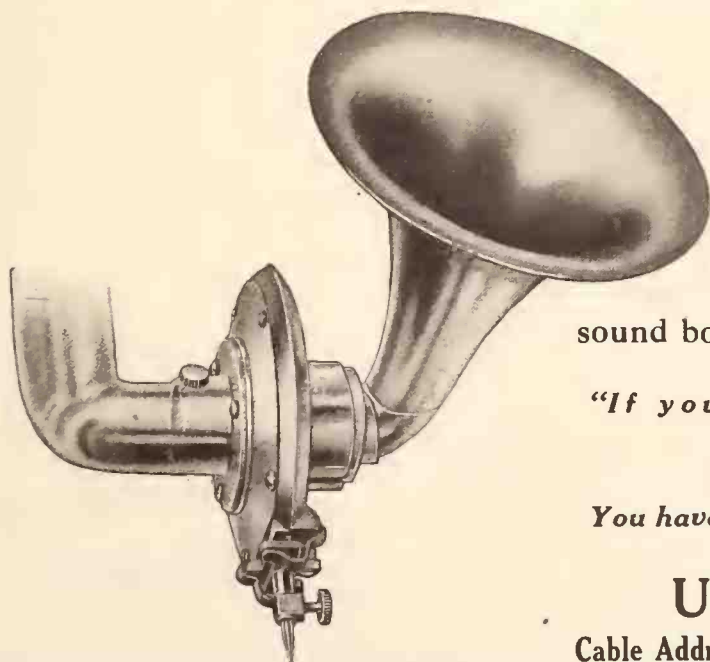

Adaptable to all machines. Incomparable for dancing. Doubles the volume, yet improves the quality and detail. Invites comparison with any sound box on the market.

*"If you haven't heard the
ADD-A-TONE
You haven't heard your machine"*

Mr. Herman Segal,
Unique Reproduction Co.,
New York City, N. Y.

Dear Mr. Segal:

Thanks very much for your promptness in sending to us the 50 Add-A-Tones ordered. We understood, of course, that you were closed Saturday and were very pleased to receive the merchandise Tuesday, enabling us to fill some special rush orders.

While business is extremely slow in Philadelphia, due to the extreme heat, the Add-A-Tone is still going strong. It seems to be a year-round seller and independent of summer and slow seasons.

Yours very truly,

FOX PHILADELPHIA COMPANY,

L. R. Fox.

UNIQUE REPRODUCTION CO., Inc.

Cable Address, "Addatone" N. Y.

32 Union Square, New York

Making Every Employee a Prospect-Getter

How Lyon & Healy, Inc., Enlisted Every Employee As a Prospect-Hunter, Realizing 6,000 New Names and \$450,000 in Business

In every retail music house there is a latent selling force which too often the head of the concern fails to encourage, to the detriment of his sales volume. That force is the personal contacts of all employes on the payroll. Whether it be the office boy or the store porter, the head of a department or some other equally important executive, each one of them has a large number of personal contacts which, if properly utilized, can be made to create sales. A store having any number of employes can thus reach a considerably large number of people who in many cases are not touched by the regular sales force and a considerable number of sales can be made that otherwise would go to competitors, or not be developed at all.

But this latent sales force does not spring into activity of its own volition. It must be brought into existence, that is, active experience, through the action of the house itself. Many of the

percentage of those who are sold is high, as any music man can see. C. H. Anderson, secretary of the company, recently described this system in the Retail Ledger as follows:

"It never seemed good business to ignore the fact that our 1,000 employes must continually come in contact with relatives and friends who need pianos and other musical goods, or hear of strangers who might be interested.

"This idea, growing all the time, caused the president, Marquette A. Healy, to inaugurate a plan in the early part of 1921 which would offer an incentive to employes of the non-selling divisions to use their eyes and ears for the benefit of the sales staff. Mr. Healy gave the crude idea to a member of the sales staff and myself to develop.

"At the start there were arranged thirty teams of eight employes each, including a captain for each team, the team captain selecting his own

figures mentioned at the start of this article. This is due partly to the fact that the team captains are in position to keep the interest alive, the captains being chosen because of their interest in the plan, their ability and the attitude of the employes toward them.

"Team captains make it a point from time to time to ask their team-mates about prospect cards and in this way the stream of cards is never allowed to slacken. When sales show the need for a stimulant they can be helped by using effort along this line.

"'How about filling out a card for us to-day?' a team captain asked a young woman in a department on his floor a few months ago when the prospects were not coming in as they should. This young woman did not like to fill out a card. She took one to hold until she could think of a name. Later she recalled that a few days previously she heard a woman mention the fact that a relative of the woman would have purchased a second-hand piano of a neighbor had she known of the instrument being for sale. The young woman lost no time in getting the required information over the telephone from her friend. She filled out and filed a card and the salesman did the rest. This opportunity might have been overlooked.

Commissions Paid Cheerfully

"This organized effort to solicit prospect names from employes was not used much prior to August, 1921. As a matter of fact, very little encouragement was given the employes to seek business on their own time.

"We found it to be of sufficient interest to employes for them to know that they would receive their commission without any difficulty and that they would not have to resort to argument to prove that they were entitled to the commission. Lyon & Healy let them see that the store was glad to pay the commission. Employes were assured that every effort would be made to close the sale for them.

"One of the strongest factors in retaining the support and interest of the employes is that the department is directly controlled from the executive office. It assures the employes a fair deal and, from the other angle, serves as a lever on our sales departments to give the proper attention to prospects filed.

"A glance at the prospect card shows it to be self-explanatory. As soon as an employe hears of a prospect for any of the merchandise that we sell he secures a card from his team captain or sub-captain and fills it out in duplicate. When he receives this pair of cards the captain makes out one for his own file, sending the first two to the executive office, which is the headquarters for the Inner Sales Division.

"'John Johnson' filed the specimen card reproduced on May 15, showing that 'John Smith' is a prospect for a piano. On the reverse side of this card appear notations showing the progress of the follow-up and the results of the case. The promptness and thoroughness with which prospects thus secured are handled impresses the employes with the fact that it is an important part of the business.

"These notations, typical of many actual cases, show that on May 16 and 17 our sales department called on this prospect. On May 25 we had not received a further report on this prospect, so a tracer from the office was sent. The final form shows the result of the tracer—on May 27 a piano was sold for \$1,425, less the credit from an old piano accepted in trade for \$125, leaving the net sale \$1,300. The commission of 5 per cent would amount to \$65, which would be due on or before June 15, as this was a cash sale.

(Continued on page 22)

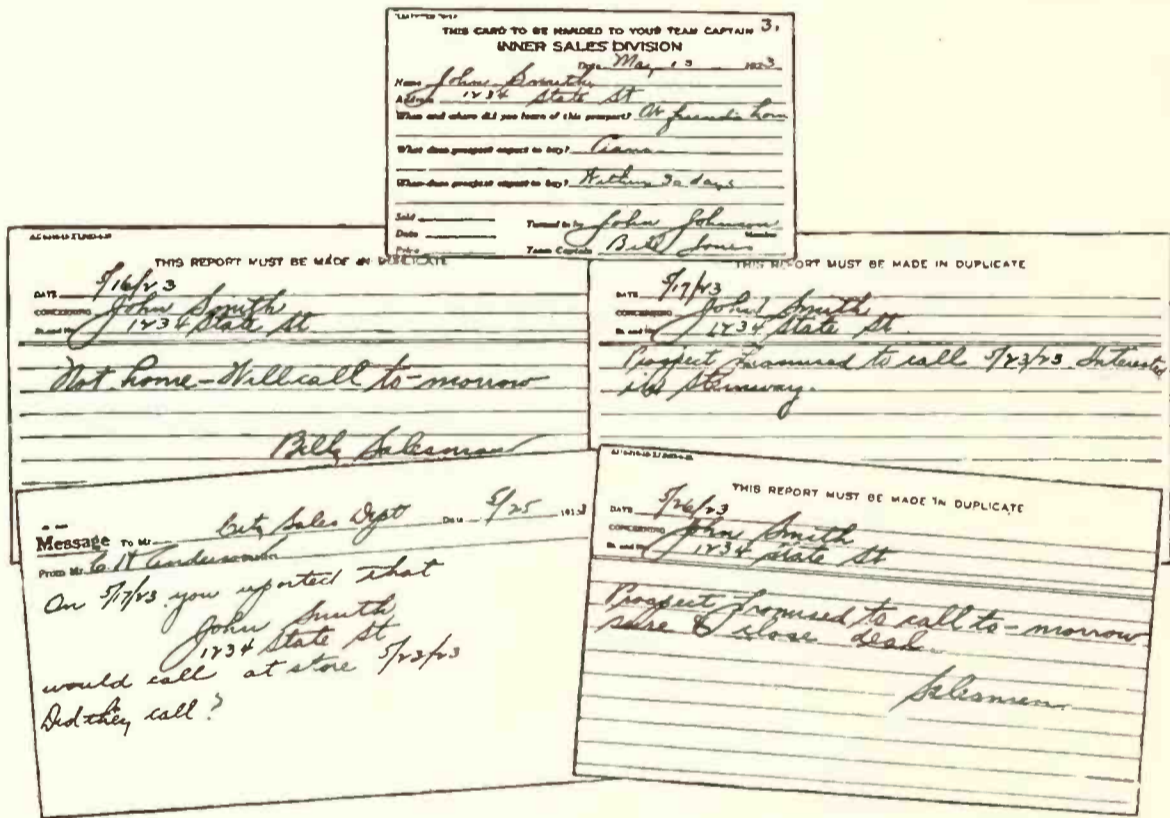

Lyon & Healy, Inc., Employees' Prospect Cards

leading music retail houses of the trade have studied this question carefully and have developed plans whereby this auxiliary selling force has been a consistent factor in creating volume. Such houses as Sherman, Clay & Co., the Pacific Coast chain, the Knight-Campbell Music Co., of Denver, Col., have worked out and have in operation plans which make practically every employe on the payroll a constant source of prospects, through offering commissions and other remuneration to employes who turn in prospects that are ultimately sold. In every case this system has proved profitable, not only in direct results, but in creating a better spirit among the employes, in linking them more closely with the house and developing that feeling of solidarity which is one of the most valuable factors in any organization.

The Lyon & Healy System

Lyon & Healy, Inc., of Chicago, is one of those houses which have carried this system to its greatest development and which have thus received the greatest results from it. It is stated that the "Inner Sales Division," as it is termed, has received \$25,000 in commissions since August, 1921, which represents a great total of sales directly traceable to that work. During that time the names of 6,000 prospective customers were turned in, of which 20 per cent were sold \$450,000 worth of merchandise. Names, it is stated, come in from this division at the rate of from 200 to 400 per month, and

members. Individual meetings were held each day until all had been instructed as to how to obtain prospect names and the amount of the commission.

"Captains" on Each Floor

"Since then a more practical and more successful arrangement has been made. Now the Inner Sales Division is divided into floors, one team to a floor, because of the fact that each floor is devoted to one line of goods or closely related lines in one group. One employe on each floor is responsible for instructing new people as to the system and the general history of the division. He also accepts prospect cards. If the floor carries a large number of employes the captain will have a sub-captain to assist him. In addition to this instruction, the personnel department assembles employes who have joined our organization during the last few months, and I give them a short talk on the history of the Inner Sales Division and the benefits they may derive.

"We allow a captain a commission of one-half of 1 per cent on all sales secured from prospect cards turned in by employes on his floor and the commission to the employe who turns in the card amounts to 5 per cent of the net amount of the sale.

"This plan has proved to be most satisfactory to both employes and the store. Where we had only forty-six prospect cards in three months in the first tryout, they jumped to the higher

Read What This Progressive and Highly Successful Merchant,
Operating Several Stores, Has to Say About

REDUCING COST

of Selling Records

—HE KNOWS

111 SECOND AVE. New York Orchard 8271	1366 FIFTH AVE. New York University 3701	813 WESTCHESTER AVE. Bronx, N. Y. Melrose 9919	595 W 181st ST New York Wadsworth 9007	1730 PITKIN AVE. Brooklyn, N. Y. Dickens 2420
---	--	--	--	---

SAUL BIRNS

VICTROLAS  PIANOS

111 Second Ave
Aug. 15, 1923.

The Audak Co.,
565 Fifth Ave.,
New York, N.Y.

Gentlemen:

This is to acknowledge receipt
with thanks of the AUDAK roller-weights
with this morning's mail.

The thirteen AUDAKS we have
since last April are giving excellent
service and we are now interested in pur-
chasing additional ones for our other
stores.

Eliminating as it does the ex-
cessive cost of retailing of records,
the AUDAK is bound to have the serious
attention of every progressive dealer.

Very truly yours,
SAUL BIRNS
Saul Birns

SB:JD.

SAUL BIRNS service means QUALITY and SATISFACTION

AUDAK IS Recognized as the greatest modern step forward toward the reduction of the cost of selling records and bringing the increased profit to the Dealer, which, today, he must have.

Write for Details of This Modern System for Selling Records Without the Use of Booths

AUDAK CO., 565 Fifth Ave., New York

Gilt Edge NEEDLES



The
Counter
Display
Stand

Minger says

Gilt Edge Dealers Can Readily Double, Even Triple, Last Year's Business

Our sales in the past six months have quadrupled last year's entire total. What other item can boast of such success? It proves conclusively that wherever introduced the public wants

GILT EDGE

The Needle That Plays 10 Records

The Counter Display Stand is the salesman that does all the talking. It will stand out above any other display. With it comes an assortment of (40 Loud, 20 Extra Loud, 20 Medium, 20 Dance tone) 100 packages of 10c sellers, total \$10. The entire outfit costs you \$5.00, a profit of 100%.

Reflexo Blue Steel Needles Are an Innovation for Music Lovers

Plays any tone (soft, loud or medium) with a little twist of the needle. Order a sample Display Stand of 100 packages. Sells for 15c—total \$15.00. Cost \$7.50. Test it.

Write for Samples
Order from Your Jobber

The
Counter
Display
Stand



Reflexo Products Co., Inc.
Selling Agents for
W. H. BAGSHAW COMPANY
347 Fifth Avenue,
New York

EMPLOYEES AS PROSPECT-GETTERS

(Continued from page 20)

"On term sales, as soon as 25 per cent of the net sale has been paid the commission of 5 per cent is paid to the employe turning in the prospect card that led to the sale.

No Duplication of Prospects

"Before a card is turned over to the sales department—such as pianos, phonographs and so on—a search is made to learn whether or not a prospect card has been turned in previously covering the same prospect by another salesman or non-selling employe. If the prospect has already been handed in the card is returned to the Inner Sales Division and the employe who turned it in is told immediately that the name is already on file. This forestalls any feeling of unfairness and gives early opportunity for any adjustment of the matter.

"If no record is found of the name as a prospect it is given to the sales department interested and followed up as closely as the example mentioned previously.

Aid in Closing

"Sometimes the salesman following the case suggests that the employe turning in the name can be of help in closing the sale, and in such a case the employe is so advised and his or her aid solicited. The salesman may report that the prospect is not interested and advise that the card be put in the 'dead' file. In that case the employe turning in the card is so notified and asked to co-operate with the sales department, a plan that has resulted in many 'dead' prospects being revived by employes.

"Each day there comes to the Inner Sales Division a list of the sales made in each department and a young man in this office compares the names on these lists with the prospect card file, in order to pick out the sales that are the result of these Inner Sales Division prospect cards. In each case thus found the young man makes a notation on the reverse side of the prospect card and places it in the sales file. The floor captain is then notified that a sale has been made for one of his members.

"At the end of the month the young man delivers the cards to the accounting department where the number of payments made on each account during that month are listed. Thus this office learns when 25 per cent of the net sales amount is reached. We do not ask the employe to call at the cashier's desk to ask for his commission, nor is he compelled to put up any argument with us as to what is due him. As soon as the required 25 per cent is reached we bring the money to him. This practice has earned for us a great amount of good will among the employes.

Helps in Selling Employes

"Running back to the early part of 1921 many firms doubtless will recall that when salaries were necessarily reduced it became difficult to retain the loyalty of employes. It was then that the first of our Inner Sales Division plans was launched. Now our employes are very much interested in this work. Owing to the fact that they are removed from selling activities we had some difficulty in selling the plan to our factory employes, but by holding monthly meetings to show them that the house is willing to pay them commissions for simply handing in the names of friends interested in our goods we have enlisted their co-operation.

"To keep the interest at a high point we hold floor meetings about twice a year. These meetings are addressed by Mr. Healy and by employes whose success in securing prospects' names has been very marked. Recitals of these employes as to how they handle the work stimulates others who might drift into indifference.

"One of the duties of the floor captains is to question the employe filling out the card with the idea of ascertaining whether or not it is worth sending a salesman to call or is just a name. This helps us to keep the percentage of live prospects to a high mark. As I have mentioned before, we sell about 20 per cent of the prospects received in this way.

Our A A A Quality India Ruby Mica DIAPHRAGMS

Are, without doubt, the finest Diaphragms manufactured.

Samples and Prices on Request

WILLIAM BRAND & CO.
27 East 22nd Street New York City
Telephone, Ashland 7868

"Sometimes prospects come far in advance of the date the employe gives as the probable buying date, such as a birthday, a wedding, or graduation date. We set them in the files to come to attention about a week ahead of the date the employe sets.

"Employes are invited to call at the Inner Sales Division at any time to investigate the situation in regard to any cases they are interested in, and this scanning of reports sometimes helps them to help the salesmen on the job. Sometimes the employes themselves, on their own time, follow up the prospects. Sometimes they influence the prospects to come to the store. Probably one-third of the prospects who come to us in this way ask to see the parties who gave us their names. That fact indicates that the employes have been doing some talking for the store.

"Experience Meetings"

"When the 'experience meetings' of the employes begin to bring out the methods that have produced commissions for the successful, all of the employes can see that they come in contact with live prospects almost daily.

"For instance, a friend with an old piano that has outlived its usefulness can get a credit for it to apply on the purchase of a new one. But until the idea is suggested the friend of the employe interested never gives the matter serious thought.

"'We've got a fine piano,' a matron told one of our women employes, 'but we seldom play it.'

"'Why do you not secure a player-piano?' our employe suggested. 'You can secure credit for your piano—then you can have a piano that any of you can play, and pay for it on easy terms.'

"That started another prospect card that gave the outside salesman a chance to finish a sale.

"A boy in the community may be asking so strongly for a saxophone that his father is thinking of buying one for him—and if one of the Lyon & Healy employes happens to hear of it that means another prospect. A piano salesman may learn that there is no phonograph in the home where he has just sold a piano. Many times a sheet music salesman or a salesman in our small goods department will learn of a home that lacks a piano through the counter conversation with a stranger. An employe may put on a card the name of some friend or acquaintance's friend who is about to be married, to graduate or to celebrate a birthday. Perhaps some family known to an employe is about to move into an apartment or flat where the upright piano of the old type will be too large. In clubs, lodges, church circles and other circles our employes have always been hearing of prospects—our Inner Sales Division is encouraging them to make profitable use of their 'tips.'

Prizes Stimulate Effort

"Last year, during the month of May, as a special inducement to the employes we offered three prizes that stimulated prospect-getting! As the first prize a two weeks' vacation on full pay was awarded to the employe having the highest amount of sales; as the second, one week's vacation, and the third, four days' vacation. In order to participate an employe had to file at least five bona fide prospect cards. The members of our tuning department had to sell twice as much as an employe of any other department. Our sales chart for that May showed a substantial increase in sales and the effort and prizes were justified."

The CAMP=FONE

at \$**25**⁰⁰
List
Price



Camp-Fone weighs only 15 pounds. Measures 14 x 11½ x 6, closed. Retails at \$25. Quick sales and liberal profits for live dealers.

The **Camp-Fone** is a quick easy sale at \$25 because it looks like a lot more money. Handsome mahogany finish, hardwood case, trimmed in silver nickel, comfortable leather handle, 10 inch turn table, heavy-duty noiseless motor, triple weight governor, speed adjuster, needle cup with safety cover, sturdy 10 inch piano hinge with strong top holder catch. Equipped with album holding 6 records. The first high-class small portable ever produced.

Provides the retailer with a quality portable at a popular price. Three new factories were recently added to take care of the exceptional demand for the Camp-Fone.

The portable has proved an all year 'round seller and an excellent holiday number. The Camp-Fone provides a particularly attractive number for the Fall and Holiday seasons.

Our increased facilities enable us to sell more dealers. Write to us today for full details.

HEALTH BUILDERS, Inc.

DEPARTMENT W 9

334 FIFTH AVENUE

NEW YORK, N. Y.

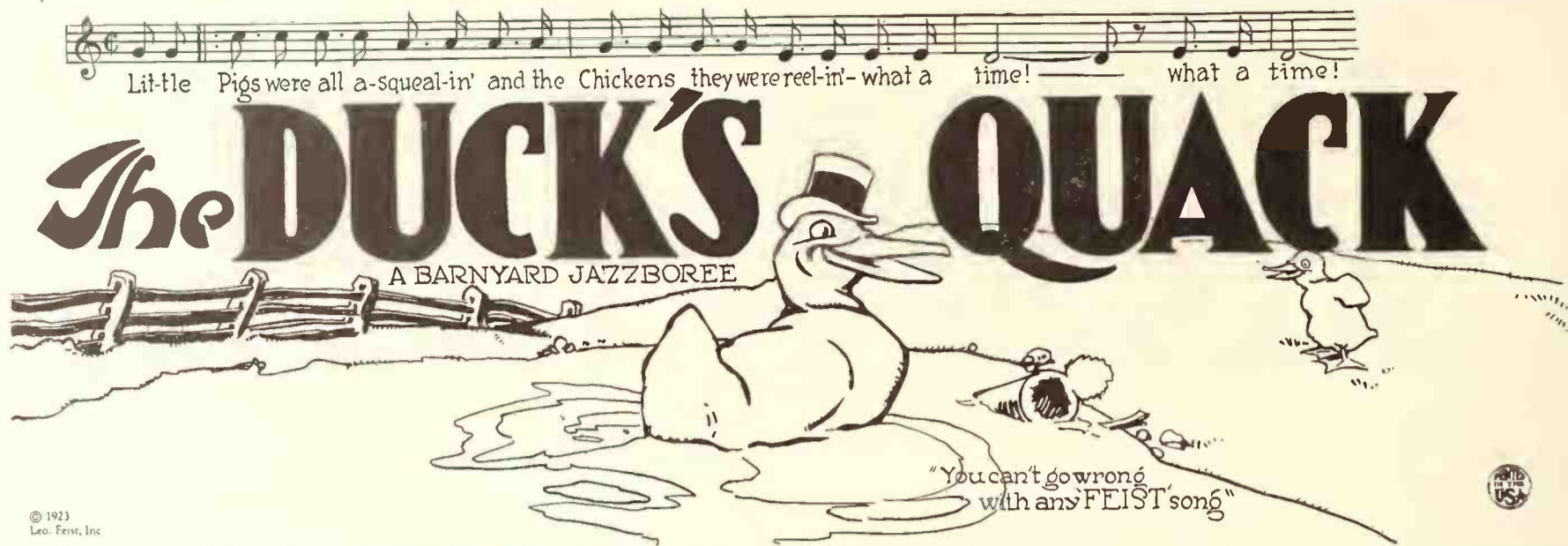

TO FEATURE RED SEAL RECORD LIST IN FALL CAMPAIGN

Victor Co. Announces List of 140 Red Seal Records by Noted Artists That Will Be Featured Specifically in October and November Magazine Advertising

CAMDEN, N. J., September 4.—In announcing to Victor dealers its advertising plans for the remaining months of the year, and particularly for October and November, the Victor Co. calls attention to the fact that in the October and November issues of the magazines which it customarily uses there will appear groups of records by twenty-seven of the leading Red Seal artists, the single and double-faced records of each selection being featured with equal prominence in the copy.

In view of the readjustment of Red Seal prices and the announcement of the double-faced Red Seal records this advertising program should serve to stimulate materially Red Seal business throughout the remaining months of the year and, for that matter, during the opening months of 1924.

As has already been announced, the new dou-

ble-faced Red Seal records will be offered to the public formally on or about September 21, and the daily newspapers will be used to carry the message to record buyers at that time. However, the October issues of a number of the national magazines featuring the special series of Red Seal records will in many cases be for sale on newsstands on the fifteenth of September or before.

One hundred and forty records in all have been selected for the special exploitation. They are divided into nine groups and the artists represented in the list include Paderewski, Melba, Kreisler, McCormack, Gluck, Rachmaninoff, Gigli, Galli-Curci, Elman, Chaliapin, Jeritza, Scotti, Martinelli, Bori, DeLuca, Werrenrath, Alda, Heifetz, Schumann-Heink, Farrar, Homer, DeGogorza, Samaroff, Zimbalist, Stokowski, Coates and Mengelberg.

CONDUCTORS' BATONS FOR TEACHERS

S. V. Goddard, of the R. S. Williams & Sons Co., Makes Some Interesting Suggestions for the Benefit of Music Merchants

S. V. Goddard, manager of sales and sales promotion for the R. S. Williams & Sons Co., Ltd., musical instrument manufacturer and importer and Edison distributor, of Toronto, Ont., makes the interesting suggestion that dealers handling band instruments and musical merchandise might take profitable advantage of the growing importance of music in the schools by going after teachers to develop the sales of conductors' batons.

Various boards of education, of course, provide long pointers for the use of teachers, these pointers being used for beating time to music, as well as for indicating items on the blackboard. Mr. Goddard maintains that the ordinary baton might prove much more con-

venient than a ruler, not only in connection with musical work, but in carrying on general classroom work where the teacher in moving about desires to point out errors.

Certainly a baton of convenient size would prove much more acceptable to the teachers than does a long ruler that for ordinary work is awkward to handle. It might be well for music dealers to give thought to the suggestion, for the sale of batons would not only mean a certain percentage of direct profit, but might be calculated to lead to a closer contact with the teachers and therefore to subsequent sales.

JOHN CARTWRIGHT ENTERS FIELD

GREENCASTLE, IND., September 4.—An attractive talking machine store and gift shop has been opened here by John Cartwright, of Delphi. This is the only establishment of its kind in the city and the Victor line of machines and records are featured exclusively.

CONFIRMS DE FOREST RADIO DEAL

Dr. DeForest Disposes of \$1,000,000 of His Stock to a Syndicate Headed by E. H. Jewett

Dr. Lee DeForest last week confirmed a report of the sale of approximately \$1,000,000 of his stock in the DeForest Radio Telephone & Telegraph Co. to a syndicate headed by Edward H. Jewett, of the Jewett-Paige Motor Car Co., Detroit. Mr. Jewett was elected president of the DeForest Co. about three weeks ago. The option held by the syndicate on the DeForest stock since last April was taken up at a conference in New York on August 23.

Besides Mr. Jewett, who also is the head of the Jewett Phonograph Co., the syndicate includes Frank W. Blair, president, Union Trust Co., Detroit A. C. Allyn; and Theodore Luce, of A. C. Allyn & Co., New York; William H. Priess, engineer of the DeForest Co.; Mr. McVey, banker, Cincinnati, and Bird & Sykes, brokers, St. Louis.

Dr. DeForest now holds 6 per cent of the DeForest Co., as against 86 per cent up to the completion of the deal. The company will complete with the Radio Corp. of America. Dr. DeForest said he would devote his time to his inventions. Under a contract these inventions will go to the company for a period of ten years.

PLAN EXHIBITS FOR TRI-STATE FAIR

MEMPHIS, TENN., September 4.—Talking machine dealers throughout the city are beginning to consider plans for exhibits at the Tri-State Fair which will be held here during the last week of this month. The Fair is always a big event in this city and from past experience talking machine merchants have found that these exhibits invariably are profitable. The Fair this year is expected to be the biggest ever held and the trade is anticipating big results from the displays.

WILMINGTON, DEL., FIRM CHARTERED

WILMINGTON, DEL., September 4.—The Automatic Repeating Phonograph Co., of this city, was recently granted a charter of incorporation under the laws of this State to engage in radio transmission. The concern is capitalized at \$1,000,000.

KNEISEL MUSIC CO. BANKRUPT

TOLEDO, O., September 3.—The Kneisel Music Co., of this city, band instrument and talking machine dealer, recently filed a petition in bankruptcy with assets given as \$12,900 and liabilities at \$8,453.

The Violin Spruce Reproducer Offers Two-Fold Sales Possibilities

ARE you taking advantage of the sales opportunity offered by the Violin Spruce Reproducer? Replace the present reproducer on your demonstrating machine with this beautiful instrument of Violin Spruce from far Alaska. The improved tonal qualities of your records will astonish your customers. The perfect reproduction will increase your record sales and create a demand for this wonderful reproducer.

Write us today for a trial instrument and allow us to tell you about our money-making sales franchise.

THE DIAPHRAGM COMPANY

1836 EUCLID AVENUE, CLEVELAND, OHIO.

New York Representative:
LOUIS JAY GERSON, 63 Reade Street

Chicago Representative:
ILLINOIS DIAPHRAGM CO., 208 N. Wabash Ave.

COTTON FLOCKS

.. FOR ..

Record Manufacturing

THE PECKHAM MFG. CO., 238 South Street
NEWARK, N. J.

Create Interest in New Phonograph Styles

Dealers Can Find a Profitable Field for Sales Among Owners of Talking Machines Bought Years Ago—Some Plans of Procedure

One great field for sales of talking machines which is neglected by too many dealers is that composed of people who already own instruments. It is safe to say that in every community there are many people who own talking machines which are of a type not suited to their needs. In other words, instruments that have become old, that were purchased when the family purse was smaller than at present, that do not harmonize with the rest of the furnishings of the home, etc. Proper canvassing and publicity methods will, no doubt, give the dealer a profitable return in sales of new instruments.

Opportunity in Selling Owners

Take the case of people who own old, and now obsolete, models of talking machines, or instruments which are not of standard make, discontinued models, etc. The very nature of the machine owned gives the dealer an entering wedge of the best kind for a good sales argument on why the latest model instruments are best. In the first place, the instruments produced to-day are more beautiful as regards cabinet work than ever before and in the last few years improvements have been made to the mechanical parts of the machines which make for much better musical reproduction. Here is an argument which few music lovers who own old types of machines will be able to resist if it is presented strongly enough. The arguments in favor of well-known talking machines of

standard make over those of doubtful quality and discontinued models are too obvious to need repetition.

Then there are the large number of people who managed to scrape enough money together to purchase a cheap instrument in the days when they were not so well off financially as they are at present. Now, it is a well-known fact that during the past year, at least, labor has never been so well paid nor so steadily at work. It necessarily follows that all classes of mechanics and tradesmen are now prosperous and well able to afford good instruments. The dealer can easily determine just what models of talking machines have been purchased from him in the past by inspecting his books and records. Every customer who has an instrument which, in the opinion of the dealer, might be replaced with a better one should be solicited.

Question of Trade-ins

In this connection the question of trade-ins assumes considerable importance and there are some members of the trade who try to steer clear as much as possible of taking in old instruments as part payment on more expensive models. This evil can be removed, to a large extent, if the dealer is tactful. A dealer in the metropolitan district who made quite a few sales to people who already owned talking machines got around the difficulty by offering a very low price for the old machine. When customers

objected he pointed out to them that, although the instrument was probably worth more than he offered, he was not in a position to offer a greater sum, due to the fact that the overhead involved in bringing the instrument to the store, reconditioning it and finally selling it was so great that a loss would be sustained by the firm. In every case he suggested to prospective customers that they could realize a much greater price by selling the instrument themselves. He pointed out that a small advertisement in the classified columns of the local newspaper would most readily accomplish this result and the cost would be very little. The result of this was that the firm in very few cases was compelled to take in old instruments in exchange and, when it did take them in, the allowance was small enough to make the resale yield a profit, a small one to be sure, but, nevertheless, a half loaf is better than none, as the saying goes.

Re-creates Interest in Records

Then, too, it must be remembered that every time the dealer succeeds in selling a new instrument he re-creates the interest of that customer in the talking machine and the music it can produce. Thus, he opens the way for record sales and still greater profits. A campaign of the sort suggested is not expensive and, if properly carried out, the results should be very satisfactory from the standpoint of profits and stimulated business.

MUSIC ACTION COLOR GAYETY

The "PHONO-VAUDETTE"

Bring into the home all of the joy-giving pleasure of a choice seat in the theatre. Entertainment is provided to delight all ages and add immeasurably to the enjoyment of the phonograph. There are four dancing characters which call for a diversified class of music, therefore the acts are different and the programme extended.

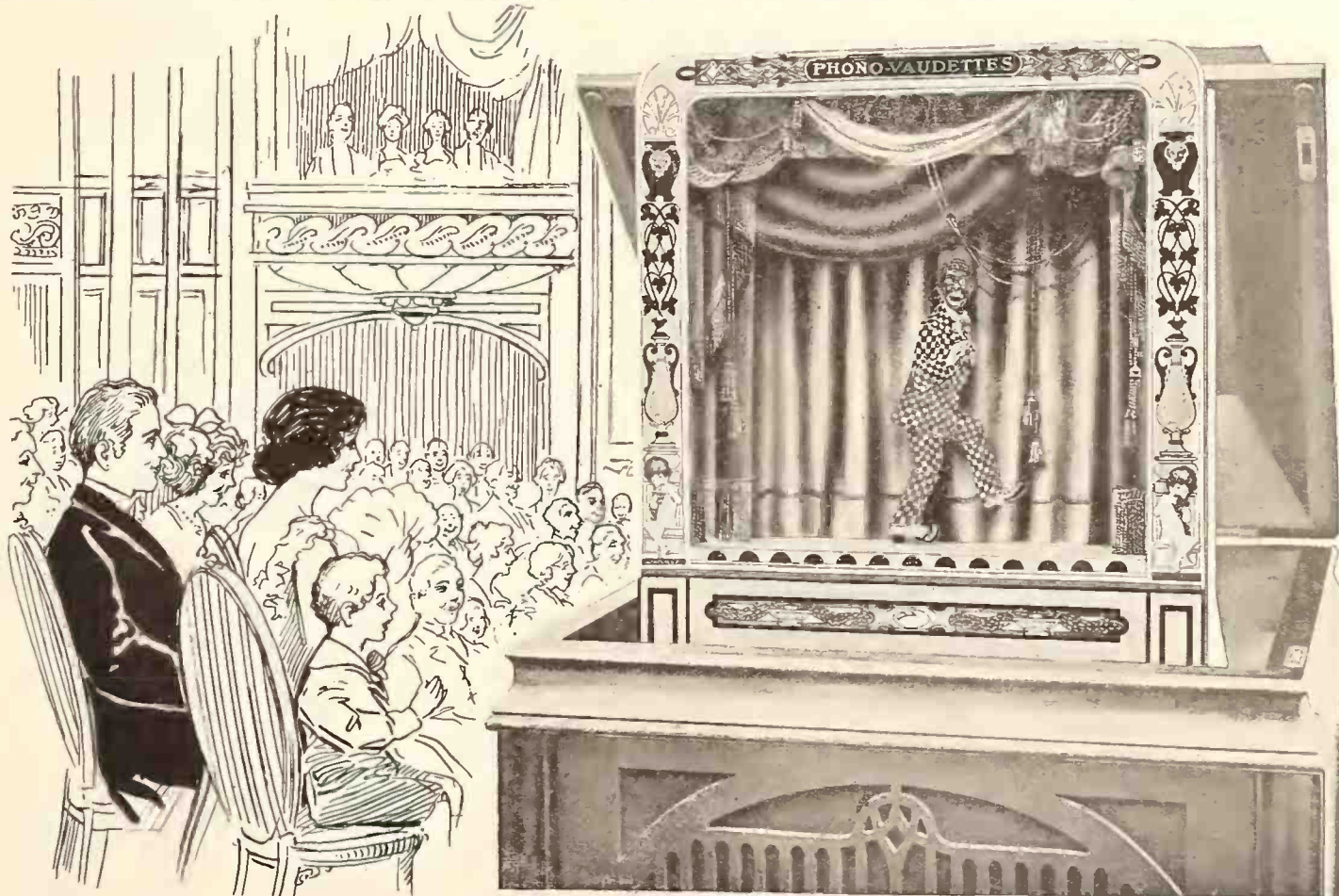

A well constructed, artistically designed, brightly colored stage, all complete with back drop, wings and proscenium arch. furnishes a realistic setting for the clever performers.

Patents Pending

Nothing could be more simple than the operation of the "PHONO-VAUDETTE." There are no attachments of any kind to mar or deface the finest instrument. Simply stand the "PHONO-VAUDETTE" on the front of the phonograph and the revolving turn-table does the rest. The entire outfit is compact, comes "set up" in a strongly made box and is ready to entertain the moment it is opened.

Retail price, \$3.50

Dealers are furnished with effective advertising circulars and a special offer awaits all who write for particulars.

COMMERCIAL ART SHOP - - -

Dept. "W"
COVINGTON, KY.

You SEE the

THROUGH the New Edison Phonograph, the world's richest, rarest musical treasures have been brought into the homes of people everywhere.

And the ever-increasing demand for this foremost phonograph of all time is the surest possible testimonial to genuine worth.

The cabinets which encase the New Edison are in keeping with the superior reproducing qualities of the instrument itself. The wide variety of artistic models, the broad price-range and the superior Re-Creating qualities are the factors which influence the preference of music lovers for the New Edison.

The New Edison Baby Console Model wins the approval of music lovers because it Re-Creates the exact tones of the original artists; is of conservative, artistic design; and is moderately priced at \$175.

THOMAS A. EDISON, Inc.
ORANGE, NEW JERSEY

The **NEW**
P H O N O

Instrument, But—



EDISON
G R A P H

You HEAR the

FROM that immense group of world-famous artists—who have truly perpetuated their art by recording for the only phonograph that dares compete with them—one may select those who shall furnish an evening of really great music.

The New Edison actually Re-Creates the voice of the living artist, with every golden tonal quality, every delicate shading—unimpaired. You see the instrument; but you *hear* the artist's true performance.

And it is this absolutely faithful Re-Creation which is responsible for the ever-growing demand for the New Edison.

THOMAS A. EDISON, Inc.
ORANGE, NEW JERSEY

The **NEW**
P H O N O

Living Artist



EDISON
G R A P H



Another Superior Point for THE NEW COLUMBIA

The line of New Columbia Upright Models is all-inclusive. There is an instrument for every purse and a cabinet for any taste. Each has the mechanical refinements that make the New Columbia the most perfect phonograph ever built. And all the models are most satisfactorily priced to the dealer and to the public.

COLUMBIA GRAPHOPHONE CO.
New York

BRUNSWICK RECORD PRESSING PLANT IN LOS ANGELES

Move Made to Meet Big Demand for Brunswick Records in Pacific Coast Districts—Closing Great Recording Expedition—A. J. Kendrick, General Sales Manager, a Visitor

LOS ANGELES, CAL., September 6.—One of the most important developments of the month has been the announcement to the effect that plans are being made by the Brunswick-Balke-Collender Co. for the establishment of a permanent record-pressing plant in this city to take care of the steadily increasing demand for Brunswick records throughout the Pacific Coast districts. A. J. Kendrick, general sales manager of the Brunswick Co., accompanied by S. K. Darby, W. G. Haenschen, director of popular music, and other members of the main laboratory staff in Chicago, were in this city recently making records of local orchestras and artists, including Lyman's Coconut Grove Orchestra.

From here the party, which is equipped with a complete recording outfit, moved to San Francisco and later planned to go to Seattle and Portland for the purpose of making records of local organizations in those cities. It is said to be the first time that such a recording expedition has been undertaken in this country and has enabled the Brunswick Co. to make numerous records that otherwise could not have been obtained because of the inability of the orchestras and artists for one reason or another to go to the Chicago headquarters.

Another angle of the move is that the com-

pany will be able to offer to its dealers on the Pacific Coast the numbers that are particularly strong hits in that section of the country. The records made by the expedition will be pressed in Chicago, but, after the pressing plant in this city is completed, all the work will be handled here.

In discussing the move Mr. Kendrick stated: "We have found that Los Angeles and the Pacific Coast have originated a large part of the fine and popular musical numbers which are much sought after for recording purposes and feel that the time is rapidly approaching when it will be found more economical to make our own records here than to defray the expenses of orchestras and artists in bringing them East for recording purposes."

CASHES IN ON DOLLAR-DAY DRIVE

BANGOR, ME., September 4.—The Andrews Music Co., one of the leading concerns of this city, received considerable publicity recently through its co-operation in helping to make the Dollar Day staged in Bangor a success. In order to stimulate the interest of the public in the event the company donated a portable talking machine and a piano as gifts to lucky shoppers on that day.

NEW SCHOOL SERVICE LEAFLET

Portraits of Forty-two Composers for Use of Contestants in Music Memory Contests Just Issued in Flat Sheet Form by Victor Co.

The Victor Talking Machine Co. has just issued an interesting addition to its great volume of educational literature in the form of a special sheet bearing the portraits of forty-two famous composers designed to be cut out and pasted in music appreciation and music memory contest notebooks as an aid to the memory of the contestant. The pictures are in black and white, each measuring $1\frac{3}{8}$ by $1\frac{3}{4}$ inches and are printed on coated paper. The growing number of music memory contests and established character of that method of arousing interest have made worth while a great deal of literature calculated to assist in the conduct of such affairs, and this sheet of composers' pictures should fit well into the general scheme. Dealers are urged to bring the sheets to the attention of music supervisors in schools in order that they may be used as extensively as possible.

FIDDLIN' JOHN CARSON JOINS OKEH

Picturesque Southern Mountaineer Makes Okeh Record—Is Fiddling Champion of South

A picturesque addition to the Okeh record catalog is the announcement of Okeh records by Fiddlin' John Carson, an old mountaineer from the hills of northern Georgia, who made these records during the recent visit of the special Okeh recording expedition to Atlanta. Once each year all of the best-known fiddlers in the South gather in Atlanta for a convention, where they compete for the championship and the prizes. Fiddlin' John Carson has won the championship for seven years in succession and his name is familiar to everyone throughout the South. On his Okeh record Fiddlin' John Carson plays the accompaniment for two famous Southern selections and sings the numbers in his own quaint way.

CONVENTION HELPS BUSINESS

MEMPHIS, TENN., September 5.—Talking machine and music dealers generally cashed in on the Cotton States Merchants' Convention which was held here late last month. The convention lasted three days and the trade took advantage of the opportunity to bring the various lines to the attention of the thousands of visitors through special window displays and also through musical features connected with the convention itself.

OPENS BRANCH IN OAK PARK

Benson's Music Shop has opened a branch store at 5915 Division street, Oak Park, Ill., where Cheney and Vocalion phonographs and records, together with sheet music, are handled.

BRUNS MADERITE Phono Moving Covers

Cover, Straps Attached



For all models of Upright and
Console Machines

Every progressive dealer needs a supply of dependable moving covers. Mr. Average Man dislikes to unpack anything he buys. By using padded delivery covers you protect and deliver a perfect instrument with no necessity for dirt, inconvenience or trouble to your customer.

It is much more simple to slip a cover over an instrument at the store and off at point of delivery and the impression left with your customer is pleasant. MADERITE covers are strong, well padded and satisfactory from every standpoint.

Consult your accessory jobber, phono distributor or write us for literature and prices.

A. BRUNS & SONS

Manufacturers of Canvas Goods

50 Ralph Avenue

BROOKLYN, N. Y.

Concentrated Canvassing Insures Results

Many Retailers Pay Too Little Attention to the Possibilities of the Canvassing Drive—Some Attendant Problems and Solutions

A recent survey of the talking machine trade in greater New York and the cities immediately adjacent thereto disclosed the fact that comparatively few dealers realize the benefits of canvassing and outside selling. A personal visit to the home of a prospect is the exception, rather than the rule. This applies particularly to exclusively talking machine stores. Where pianos and other lines are handled in combination personal visits and canvassing are resorted to much more often. In fact, the consensus of opinion among retailers who handle both pianos and talking machines seems to be that canvassing and personal outside contact with live prospects is the most effective manner in which to bring about a sale. However this may be, the fact remains that in many instances talking machine dealers pay too little attention to the possibilities of getting business through ringing door bells.

Advantage of Outside Workers

The very fact that a salesman or canvasser covers intensively a territory surrounding the store—within a radius from which customers may logically be drawn—is bound to be beneficial. These workers come in direct contact with the prospect and merely by delivering the sales talk they impress on the minds of the potential customers the name of the store and the line featured. While the immediate effect of a canvassing drive may not be entirely up to the most sanguine expectations of the retailer the cumulative returns are almost certain to result in a substantial dividend.

Bearing out this point is a little story by C. C. Casey in the current issue of *Printers' Ink Monthly*. Although the instance mentioned relates to another business it applies with equal force to the talking machine trade. The story follows:

"A typewriter agency had a 'salesman' who was not getting anywhere—he already had been carried too far on 'hopes.'

"The manager went to him one day and made him a proposition:

"'You go out to-day and make calls—all the calls you can make. Don't worry about sales. I'll pay you five cents for every call you make. Just go in and ask them, 'Do you need any typewriters to-day?'" and leave your card and get out. Remember, five cents for every call.'

"The salesman went out and 'made calls.' He went into an office building where offices were only a few feet apart and asked that question, over and over—eighty times the first day.

"The answer was invariably the same—always 'No.' But at the end of the week he had brought his name and his typewriter to the at-

tention of over 400 offices. Eight of these offices telephoned his branch before the first week was up and ordered typewriters."

The point of this story is obvious and needs no further elaboration as to value of personal contact.

Making Canvassing Effective

Merely sending canvassers out into the territory and allowing them to cover whatever part of the city they desire is inefficient and will not bring returns commensurate with the amount of energy expended. The entire territory to be covered should be mapped out into sections and one section should be assigned to each canvasser. Moreover, his daily route should be planned so that a definite schedule will be followed. The only kind of a canvassing campaign that has ever brought home the bacon has been the one where the canvasser worked intensively, i. e., visited every house on one block before going to the next. When this procedure is followed faithfully and finally completed the retailer may be sure that he knows who are the potential customers in his community.

Collecting Data for Later Use

It is important that the canvassers turn in a report to the dealer each evening of each indi-

vidual prospect called upon. These data should include all possible information which will be of help in deciding whether the person called upon is really a live prospect. Once the dealer has this information properly classified into groups composed of live prospects, owners of instruments, record prospects, etc., he can get busy with his direct-by-mail work, and his regular salesmen can also get busy in making personal calls on the live machine prospects with the intention of making sales. Of course, those people upon whom the canvassers have called and who do not offer any possibilities for sales are immediately eliminated from the list. To do anything else would be wasteful and foolish.

Now Is the Best Time for a Canvassing Drive

The vacation season is now ended and Fall is with us once more. The average family is again settled at home preparing for the Winter season, and whether these preparations and plans include talking machines and records depends to a large extent on the retailer. This is the ideal season for a canvassing and outside sales campaign and it behooves those members of the talking machine trade who desire to make capital of this opportunity to take action at once by carefully mapping out their campaigns.

INTERESTING NEW BOOK ON MUSIC

"Messages of Music," Recently Published, Leaves a Story About Each Composition and Refers Its Readers to Victor Records

A book with which Victor dealers should become familiar is that entitled "Messages of Music," written by the Rev. Henry Brenner, of the Order of Saint Benedict, and which has been published by the Stratford Co., of Boston. In the book the author treats of no less than 300 compositions, setting forth the stories connected with them, the ideas suggested in the minds of the composers when they were written, or other interesting material calculated to develop a stronger and more lasting interest in each of the selections.

An interesting fact regarding the book from a trade angle is that direct reference is made to the Victor records of the compositions mentioned in every case where they have been recorded, and there is also an index of Victor artists classed by the character of their music, whether vocal or instrumental, etc. The volume should interest the dealer from the fact that it will furnish him with some interesting facts regarding the music he handles which should aid him in his record selling. It is most authoritative and educational.

TO BUILD NEW HOME IN MEMPHIS

Four-story Building to Be Erected for Reinhardt's, Inc., on South Main Street

MEMPHIS, TENN., September 4.—Reinhardt's, Inc., the well-known piano and talking machine house of this city, which handles the Columbia line, has arranged for the erection of a new home on South Main street, between Union and Dayora streets. The new building, which will be constructed with a special view of meeting the requirements of the company, will be four stories high and is expected to be ready for occupancy some time during the Fall.

HERALD MUSIC SHOP OPENS

The Herald Music Shop, which recently opened in the old Herald Building, corner of Thirty-sixth street and Broadway, and which runs through to Sixth avenue, will feature Regal records and "Little Tot Nursery Tunes." Upon the opening of this new store the management hung two large posters carrying the Regal record announcement over the Broadway side of the building. These new warerooms are adjacent to the shopping center and several of the largest department stores and should attract many visitors musically inclined.



REPAIR PARTS

"CERTIFIED" repair parts are precision made—accurate to the thousandth part of an inch.

Phonograph REPAIR MEN

---This Book Will Interest You!

The PLAZA MUSIC COMPANY has issued a complete catalog of "CERTIFIED" repair parts, main springs, talking machine supplies. This book also contains reference to a very complete line of phonograph accessories. If you have not received your copy, write us. TO-DAY!



REPAIR PARTS

Every "CERTIFIED" repair part bears an unconditional money-back guarantee against all defective materials and workmanship.

PLAZA MUSIC COMPANY

18 West 20th St., New York, N. Y.

BAGSHAW NEEDLES



are Supplying the Increased Demand!

If your fall and holiday orders have not been placed for BAGSHAW Needles we urge immediate action. We have done our utmost to avoid last year's difficulty in meeting the demands of the trade. To prevent an advance in prices we have contracted for an immense supply of raw materials, but orders this year are four times as heavy as last fall and while we can take care of orders received now, we can make no promises regarding either price or delivery, beyond materials we have on hand.

You realize that we cannot control the cost of steel and raw materials when our present supply is exhausted. Prices may advance, the steel mills may not give us all the material we require, therefore you are urgently advised to order your entire season's needs of BAGSHAW Needles Now, At Once, so that you may be reasonably sure of having your complete order filled at present prices.

W. H. BAGSHAW CO.

Factory, Lowell, Mass.

370 SEVENTH AVENUE

AT 31st STREET

NEW YORK

SUITE 1214

Pacific Coast Distributor:
Walter S. Gray Co.
1054 Mission St.
San Francisco, Cal.

Canadian Distributor:
The Musical Mdse. Sales Co.
79 Wellington St., W.
Toronto

Western Distributor:
The Cole & Dumas Music Co.
430 So. Wabash Ave.
Chicago

Foreign Export:
Chapman, Ltd.
8-10 Bridge St.
New York City

HIGHEST GRADE NEEDLE IN THE WORLD
MADE IN AMERICA BY AMERICAN LABOR



In Envelopes of
100
Dance, Extra Loud,
Full, Petmecky,
Light, Halftone,
Medium



In Tins of 200
Dance, Extra Loud,
Full, Light, Half-
tone

The Present is Certain!

The Future is Not!

During the Fall and Holiday seasons of last year we could not keep pace with the tremendous demand for the famous Brilliantone Needle. Dealers throughout the country were disappointed.

This year the future is still an unsolved problem. To avoid a predicted advance in price, we have arranged for twice the quantity of this superfine quality needle over last year, but our business has more than doubled and the demand is still increasing.

Right now we can fill all orders for Brilliantone needles, but we can make no promises for the future.

We urge all Brilliantone dealers to send in their orders now for the Fall, Winter and Holiday seasons.

Play safe! Stock up now—at present prices—while you can be assured of prompt and complete deliveries.

BRILLIANTONE

STEEL NEEDLE COMPANY of AMERICA, Incorporated

Selling Agents for W. H. Bagshaw Co., Factories, Lowell, Mass.

370 SEVENTH AVENUE, at 31st St., Suite 1214, NEW YORK

Pacific Coast Distributor:
Walter S. Gray Co.
1054 Mission St.
San Francisco, Cal.

Western Distributor:
The Cole & Dumas Music Co.
430 So. Wabash Ave.
Chicago

Canadian Distributor:
The Musical Mdse. Sales Co.
79 Wellington St., W.
Toronto

Foreign Export:
Chapman, Ltd.
8-10 Bridge St.
New York City



In Tins of 300
With your name on each
can—all tones



Combination Record
Cleaner and Container of
500 Needles
Dance, Loud, Medium



Another Superior Point for THE NEW COLUMBIA

The Console Models of the New Columbia are the finest examples of the cabinet-maker's art. The lines are unrivaled in simple elegance. The woods are the choicest, painstakingly selected for natural beauty. The finishing, without exception, is as perfect as skill or experience can direct. The price completes their immediate appeal to customers of every class.

COLUMBIA GRAPHOPHONE CO.
New York

GIVES RECORDS TO DANCERS

San Francisco Dealer Conceives Unusual Manner of Securing Record Distribution

SAN FRANCISCO, CAL., September 3.—J. Allen Grisham, who was formerly connected with the Carey Music Shop, Golden Gate avenue, this city, has now taken over the talking machine and record concession in the Fillmore Drug Co., 1641 Fillmore street. Mr. Grisham will devote the entire mezzanine floor to the display of talking machines and records and is planning to introduce a novel sales stunt which bids fair to be a master stroke in record sales promotion. He has fitted up a dance floor to which admission of 75 cents will be charged. This permits visitors to dance as long as they wish and for the charge of 75 cents each visitor is given a record valued at that price.

WHISTLING IN DANCE RECORDS

An interesting novelty among the recent Vocalion records is the bird whistling of Sibyl Sanderson Fagan as a part of the dance record of "Tweet Tweet," played by Albert E. Short and His Tivoli Syncopaters. The whistling effects by Mrs. Fagan, well known in musical circles, are excellent.

A live dealer increased his record sales by placing cardboard discs (imitation records) on the turntables of machines on display. These bore titles and prices of records.

KOCHANSKI RECORDS FOR VOCALION

First Records by Noted Polish Violinist to Be Released This Month by Aeolian Co.

The latest addition to the growing list of noted artists recording for the Vocalion records is Paul Kochanski, the prominent Polish violinist, two of whose Vocalion records will be released this month. The first bears on one side Kochanski's rendition of "La Gitana," a Spanish gypsy song of the eighteenth century, arranged by Kreisler, and on the other side the Hungarian Dance No. 1 by Brahms-Joachim. The second record bears on one side Kochanski's playing of "Le Carnaval Russe" and on the reverse side Sarasate's "Malaguena."

Kochanski is generally accepted as being one of the leaders among the later Polish school of violinists, and has achieved genuine triumphs in European capitals as well as having won success in the United States. Arrangements have been made to release several other records by this violinist following his introductory number.

NEW BRADFORD CO. BRANCH

Milwaukee Piano House to Open New Store in That City With 8,000 Feet of Floor Space

MILWAUKEE, WIS., September 5.—Announcement has been made by the Bradford Piano Co. that a lease for a large branch store in the new building at Seventh avenue and Mitchell street has just been obtained. The new quarters will afford nearly 8,000 square feet, and will be ready for occupancy about October 15. The stock in the new store will include such makes of pianos as the Mason & Hamlin, Sohmer, Weber, Conover, Steck, Kingsbury, Wellington, Brambach and Remington. In addition, the Brunswick and Vocalion phonograph lines will be carried. The main store of the Bradford Piano Co. has been established for 52 years at 411 Broadway, and has a South Side branch temporarily located at 431 Mitchell street until the new store is ready for occupancy.

SAN ANTONIO MERCHANTS MEET

Consider Means for Co-operating With National Association of Music Merchants

DALLAS, TEX., September 1.—Robert N. Watkin, president of the National Association of Music Merchants, recently presided at a special meeting of members of the local music trade held at San Antonio for the purpose of developing plans for co-operating directly with the work of the national body.

The meeting was called by L. N. Walthall, of the Walthall Co., San Antonio, who succeeded in turning out a large group of music tradesmen to greet the national president.

One little sprig of Hustle is worth more than a whole garden full of four-leaf clover.

TO REPRESENT CHENEY IN IOWA

G. W. Guess Appointed Representative for Eastern Iowa of Cheney Sales Co. of Omaha—Trade Conditions Reported Good

OMAHA, NEB., September 3.—H. H. Heintzelman, manager of the Cheney Sales Co., distributor for the Cheney phonograph in this city, announces that he has appointed G. W. Guess, of Cedar Rapids, Ia., to represent his company throughout the eastern half of Iowa, making his headquarters in Cedar Rapids.

Mr. Heintzelman recently returned from an extensive trip through Colorado, Wyoming and western Nebraska and states that business conditions generally throughout that country are much better than a year ago, particularly in the phonograph trade. Every indication points to an active Fall and Winter business.

NEW STORE IN NEW ALBANY, IND.

Montford Music Shop to Handle Pianos and Talking Machines in That City

NEW ALBANY, IND., September 4.—The Montford Music Shop has just been opened at 143 East Market street and will handle Victor, Columbia and Edison talking machines and records. Pianos and players will also be carried in stock. Don Montford, proprietor of the new store, was for many years the manager of the Gable Furniture Co., of this city. When that concern sold out recently to the Huff Furniture Co. Mr. Montford took over the entire stock of the music department for his own store.

NEW COLUMBIA CONSOLE

The general sales department of the Columbia Graphophone Co. of New York has just announced the addition to the new Columbia line of phonographs of a console which will be known as No. 520. This new console, which will retail at \$125, fills out the console line in the new Columbia product, and at the present time there are five consoles in the line, consisting of models retailing at \$100, \$125, \$150, \$175 and \$200. The new console is ready for delivery to the trade.

SECOND YEAR SUCCESSFUL LEADER

Canada Patent Applied

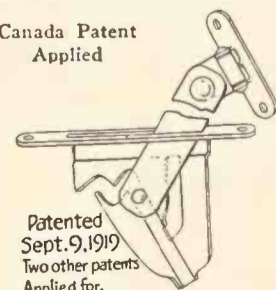

Patented Sept. 9, 1919
Two other patents Applied for.

Samples on request.

The Most Dependable and Inexpensive Lid Support on the Market

The bottom plate is constructed of one piece of metal and it works automatically perfect. No parts to go out of order. The hinges are made in two styles—flexible and bent.

STAR MACHINE & NOVELTY CO.

81 MILL STREET

BLOOMFIELD, N. J.

G. L. LAING CO., Canadian Distributor
41 Richmond St., East Toronto, Ont.

Recordion Phonographs
TRADE MARK

Reg. U. S. Pat. Off.

5 Upright
3 Console
1923 Models
of Standard
Value Always
Offering the
greatest opportunity to dealers

Also Radio Cabinets



WANTED—Jobbers and dealers to handle this long-established line. Reputation, quality and service responsible for past success, locally. Sales plans now include entire country. Write to-day for full details and secure exclusive territory rights now being awarded.

COLUMBIA MANTEL CO.

175-177 Powers St. Brooklyn, N. Y.

Real Merit Wins—The "Recordion" has it

Radiola Grand

WITH the Radiola Grand, radio takes on new meaning. The simplicity of tuning in—just a knob or two to turn. The big distances it covers—picking up far-away stations with volume enough to fill a room. The perfection of tone with which the loudspeaker—carefully built in like the horn of a fine phonograph—gives forth the music and speech. All this—combined in a cabinet of skillful workmanship and tasteful design—places radio in the home where beauty counts—and performance.

Points to note:

All the batteries—dry cells—are hidden away inside.

You can regulate the volume of sound by a control that governs the loudspeaker.

For long distance, plug in the headphones. Coast to coast reception is no unusual record for Radiola Grand!

Famous for true reception, undistorted. For keen sensitivity. And for beauty.

"There's a Radiola for every purse"

Radio Corporation of America

Sales Department
Suite: 3004
233 Broadway
New York

District Sales Offices
10 So. LaSalle Street
Chicago, Illinois

433 California Street
San Francisco, California



Radiola Grand and Mahogany Stand with "B" batteries and 4 Radiotron WD-11 dry cell vacuum tubes \$350.00

DEALERS: Write today for the RCA catalogue, full description of the Radiola Grand, and the RCA selling plan.

Radiola

REG. U. S. PAT. OFF.



This symbol of quality is your protection



This symbol of quality is your protection



Van Veen Equipment for Phonograph and Musical Merchandise Dealers Is a Permanent Investment

The truth of this is thoroughly known to our customers who have had occasion to enlarge, remodel or remove their establishments. Van Veen products are built to be efficient as long as the dealer stays in business. Their moderate cost

will please you, their drawing power makes them self-paying.

Your inquiry for catalogues and prices will receive immediate attention. All material held in stock ready for shipment.

In Yonkers, New York, a city of 100,000 population,

almost every progressive dealer has Van Veen equipment in his store. The following list, all Yonkers dealers, proves the retailers are almost unanimous in their choice of Van Veen products because of the value, quality and service:—

Broadway Music Shop, 17 Main St.
Yonkers Talking Machine Company, 457 So. Broadway.
Azzara's Music Shop, 153 New Main St.

Steadman Music House, 43 Warburton Ave.
Hudson Music Shop, 493 Warburton Ave.
David Goran, 201 Ashburton Ave.
Orpheum Music Shop, 116 New Main St.

These business men get together often and compare notes. Does this mean anything to you?

VAN VEEN & COMPANY, Inc.

Offices and Warerooms:
413-417 East 109th Street

'Phone Lehigh 5324

NEW YORK CITY

BRODWIN OPENS NEW WAREROOMS

Increasing Business Forces Bronx Merchant to Move Into Larger Quarters

A remarkable economic metamorphosis has been completed this month by Harry Brodwin, a New York music merchant, who has just opened an up-to-date piano and phonograph wareroom at 149th street and Cortlandt avenue. Nine years ago Mr. Brodwin entered the piano business as an outside canvasser for William



The New Brodwin Wareroom

Knabe & Co., under John W. Post, with a six-dollar-a-week drawing account. After five years' work he started a small store of his own in the Bronx, at 535 Cortlandt avenue, where his business has grown until it has become necessary to move into his new larger quarters across the street.

The new store of Brodwin & Co. is a model for medium-sized showrooms anywhere. The ground floor, shaped like an L, is utilized for displaying new pianos and phonographs. Brodwin carries the Schubert, with the Virzi tone-amplifier, the Autopiano, Schencke and Sterling pianos and the Knabe. Four neat sound-proof booths, well lighted and equipped with electric fans, afford space for demonstrating Sonora and Brunswick talking machines and records.

In addition to his brother, Irvin, who was recently given an interest in the business, Mr. Brodwin has four or five canvassers in his employ. The store is a striking example of studied organization and scrupulous neatness. According to the proprietor, there is nothing magical about his success, which can be traced to two governing precepts—perseverance and honesty—to which he conscientiously subscribes. A walk through the Brodwin concern establishes the same atmosphere of completeness that one feels in any metropolitan music house.

CRISWELL HOLDS FORMAL OPENING

HERMOSA, CAL., August 28.—The formal opening of C. C. Criswell's new Brunswick Shop, 1320 Hermosa avenue, was held here recently, and a varied musical program by local artists marked the occasion. Many of Mr. Criswell's friends from Redondo and neighboring towns attended the affair. The new establishment will carry pianos and musical instruments as well as the Brunswick line of records and phonographs.

Mrs. Ralph L. Freeman, wife of the director of distribution of the Victor Co., accompanied by her sister, Mrs. Edward MacEwan, returned recently from a two months' trip to the British Isles and the Continent.

ENDORSES "CONSTITUTION WEEK"

Music Industries Chamber of Commerce Pledges Industry's Support to Movement

The Music Industries Chamber of Commerce has pledged the support of the industry at large to furthering the observance of "Constitution Week," September 16-22, 1923, which has been inaugurated by the citizenship committee of the American Bar Association, "to re-establish the Constitution of the United States and the principles and ideals of our Government in the minds and hearts of the people." It is planned to make the celebration national in scope, and it is expected that music will have a prominent place on every program of observance, as it deserves in such a celebration.

NEW QUARTERS IN SALAMANCA

SALAMANCA, N. Y., September 3.—The music store of Frank A. Forness has just been opened at the new location in the Strand Theatre Building. Mr. Forness has announced that he will maintain an automobile business at his old stand.

The Hayes Music Co., of Yonkers, N. Y., has filed an application in the County Clerk's office for a voluntary dissolution of the company.

GET THE HABIT

For Quality Use "Specialty Brand" Products

MAIN SPRINGS - REPAIR PARTS - MOTORS

Write for our descriptive catalogue and price list which will be of great interest and value to you

(SOMETHING NEW)

The Specialty Phonograph and Accessories Co.

210-212 EAST 113th STREET

NEW YORK, N. Y.

A NEW IDEA IN RECORDS

*Well Known Fairy Stories
Set to Music*

*Triple Your Record Sales with
“Triple Records”*

Here's a brand new idea in record selling—sell three records instead of one. “*Junior Operettas*” are Fairy Stories that everyone knows—set to attractive music—reproduced in six parts on

**THREE 10 INCH
Unbreakable Records**

These new records will not break with ordinary handling or dropping—safe for the children. This is one of the advantages that will sell the records to every father and mother.

Little Red Riding Hood First JUNIOR OPERETTA

The first *Junior Operetta* sings the story of Little Red Riding Hood. You can hear the wolf growl, dog bark, birds chirp, tuneful *solos*, duets and choruses of wood cutters sung and played by 20 well-known artists directed by Chas. A. Prince.

The *Junior Operettas* are not nursery rhymes for babies, but stories and music that appeal immensely to children of all ages—to grown-ups, too.

Other JUNIOR OPERETTAS Coming Soon, Such As

Cinderella

Snow White

Goldilocks

The Three Bears

Jack and the Beanstalk, etc., etc.

The JUNIOR OPERETTA Series

The Complete Operetta—Three Records IN A NEW PATENTED CONTAINER

Each *Junior Operetta* is reproduced on three double-faced 10-inch records, packed in a patented container, attractively illustrated and printed in six colors, convenient for any record library.

This container, as illustrated below, makes a beautiful counter or window display and will help sell these Operettas on sight.

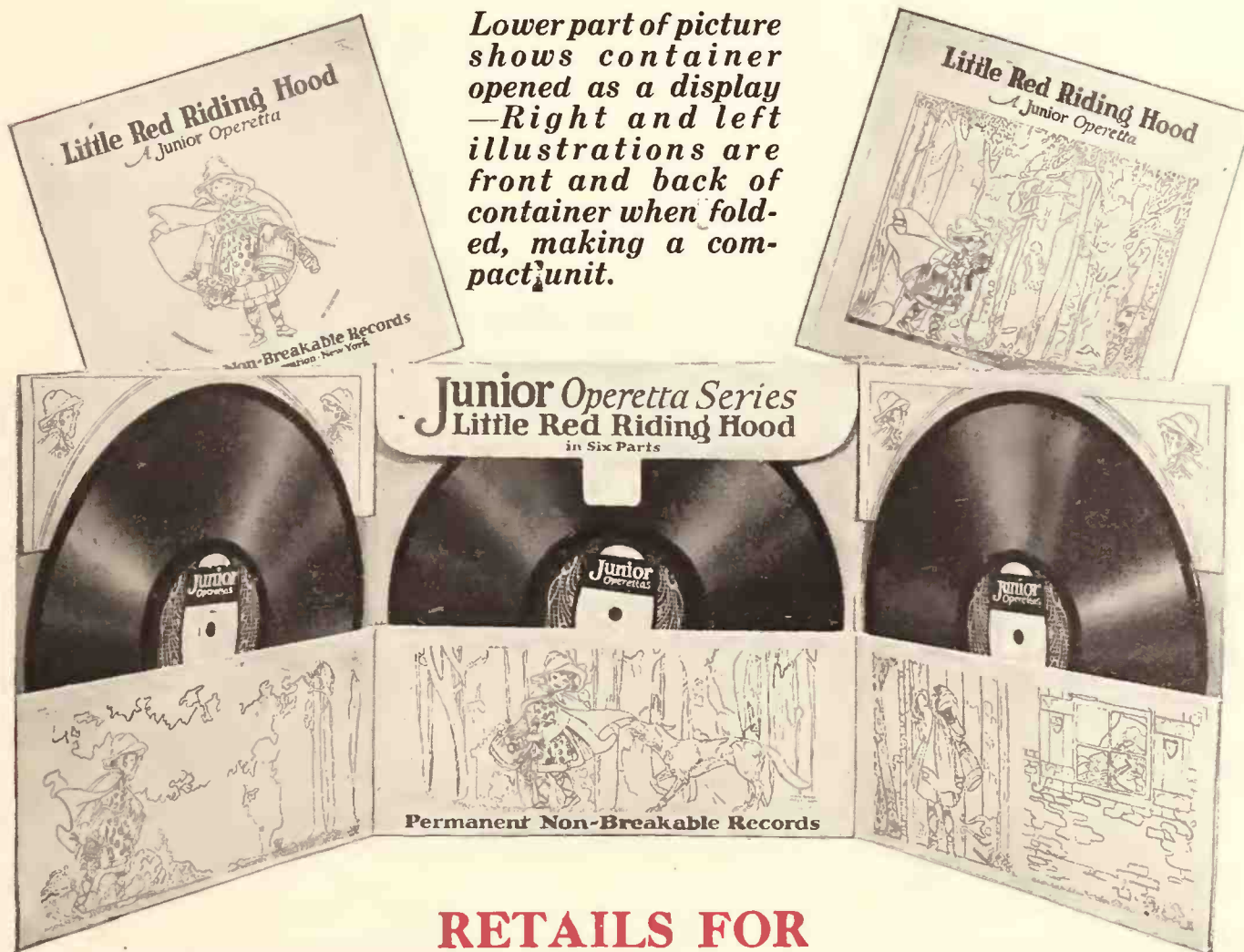

Lower part of picture shows container opened as a display—Right and left illustrations are front and back of container when folded, making a compact unit.

**RETAILS FOR
\$2.50**

Only \$2.50 for the complete Operetta—3 double-faced, 10-inch records. Easier to sell the complete set for this price than three individual, ordinary records. And the discount to the trade is exceedingly generous.

Ready for Delivery NOW

Little Red Riding Hood is ready for immediate delivery. Wire for sample order direct.

VULCAN RECORD CO., 15 East 40th St., N. Y. C.



Another Superior Point for THE NEW COLUMBIA

Every exposed part of the New Columbia motor is heavily nickel-plated. This means that where the motor is subjected to the severest tests of use and climate, there will be found a protective armor that greatly prolongs its life. Just another refinement that makes the New Columbia an instrument not duplicated for merit.

COLUMBIA GRAPHOPHONE CO.
New York

WATCH REGISTERED LIBERTY BONDS

Treasury Department Holds That Parents Cannot Transfer to Merchants Registered Bonds of Minors in Payment for Merchandise

Talking machine dealers who have made a practice of accepting Liberty Bonds in full or part payment for machines or record purchases have been warned by the Music Industries Chamber of Commerce to observe care in accepting bonds from minors or registered bonds owned by minors and transferred to the dealer by the parent.

Having learned of dealers who met with difficulties and loss in handling such transactions the Chamber took up the question with the Treasury Department at Washington, which held that the transfer of a registered bond of a minor could only be made to prevent actual hardship or deprivation. The Chamber claimed that to deprive a child of a musical instrument to be used as part of its education might be construed as a hardship, but the Department refused to take this view of the case and its ruling said:

"In considering the question presented the following facts must constantly be borne in mind: First, that the above quoted provisions of the said Sixth Supplement do not apply to any case in which there is a legally qualified guardian. Legal qualification in substantially all the States requires appointment by a court of competent jurisdiction. Second, that registration in the name of the minor or in a form substantially similar to 'John Jones, a minor, by Samuel Jones, father, natural guardian' vests title to the security in the minor. Third, a parent as such or as natural guardian has in general no power or right to dispose of property owned by his minor child. Such property can legally be sold or transferred only by a legally qualified guardian. Fourth, that parents as such are legally bound to support and educate with their own funds their minor children, furnishing such support and education as is appropriate for the children with due consideration of their station in life, and that such parents are not entitled to use for this purpose property of the children themselves.

"Based upon these considerations the Department will require assignment by a legally qualified guardian for any transfer or exchange of registered securities owned by minors, with one exception: That where the gross estate

of the minor does not exceed \$500 in value and where the parents are financially unable upon the evidence submitted to furnish proper support and education from their own funds the Department will, upon a proper showing, permit the sale of registered securities in the name of the child upon assignment by the parent as natural guardian. This provision is intended to relax the strict requirements of the law where the requirements would entail actual hardship or deprivation as the result of the expense incident to the appointment of a legally qualified guardian. It cannot be taken advantage of unless it can be definitely shown, first, that the parents are financially unable to furnish support and education in accordance with the child's station in life; second, that the proceeds of the sale are actually necessary in order that the child may receive the support and education to which he is entitled, and that such proceeds are actually to be used for that purpose. In general the Department will require evidence which would justify a judge of a court of probate in authorizing the sale by a legal guardian of the principal of the child's estate for the purposes of support and education.

"I recognize that it is not inconceivable that cases might arise where a musical education is sought as a direct means of livelihood and certain cases of this description might come within the provisions of that portion of the Sixth Supplement to which I have referred. Where, however, as in most cases which have been presented to the Treasury, a musical education is sought principally or entirely for the purpose of social or cultural benefit, I am unable to concede that such education is actually necessary, within the meaning of the regulations."

SHOW DURING "BETTER HOMES" WEEK

Among those who made displays at the "Better Homes Week" celebration held recently in Pocatello, Idaho, was the Bruce Music Co., that city, which made an excellent showing of Brunswick and Sonora phonographs, which lines are featured by the company. It is reported that a substantial number of sales were booked and many prospects listed and in addition considerable publicity resulted.

INCREASES CAPITAL STOCK

Glick's Talking Machine Shop, Inc., Chicago, has increased its capital stock from \$100,000 to \$200,000, at the same time decreasing the par value of the shares from \$100 to \$10 per share.

HANDSOME NEW STORE IN OMAHA

Branch of the Rialto Music Shop at 4907 South Twenty-fourth Street, That City, to Handle the Brunswick Phonographs and Records

OMAHA, NEB., September 4.—R. S. Pribyl, district manager here for the phonograph division of the Brunswick-Balke-Collender Co., announces that the Rialto Music Shop recently opened at 4907 South Twenty-fourth street as a branch of the store of the same name on Douglas street will handle Brunswick phonographs and records exclusively and has already placed a substantial order for those goods.

J. Himelstein is owner of the store, which is under the direct management of A. Kostka, who has had wide experience in the phonograph field. The store is one of the handsomest in the city and is fitted with a full equipment of Unico record demonstration booths and record racks finished in old ivory.

NEW PLAZA CATALOG FOR TRADE

The Plaza Music Co., 18 West Twentieth street, New York, is now forwarding to the trade a new and comprehensive catalog containing complete lists of talking machine supplies and repair parts and other accessories, including record brushes, record envelopes, steel needles, mica, player rolls, toy novelties and sheet music. The catalog contains many illustrations, dimensions of various products and parts and an up-to-date price list.

NEW STORE IN HERMOSA, CAL.

The Redondo Brunswick Shop has been opened in Hermosa, Cal., by C. C. Criswell. The new store is located on Hermosa avenue, near Thirteenth street, and is fully equipped with sound-proof booths, record racks and other modern accessories.

A FEW JOBBING TERRITORIES STILL OPEN

WALL-KANE NEEDLES

Each needle guaranteed to play ten records.

CONCERT NEEDLES

Steel needles in tones of extra loud, loud, medium and soft.

JAZZ NEEDLES

The special extra loud needle. The only one of its kind in the world.

Profit-Producing Jobbing Proposition

WALL-KANE NEEDLE MFG. CO., 3922 14th Avenue, BROOKLYN, N. Y.

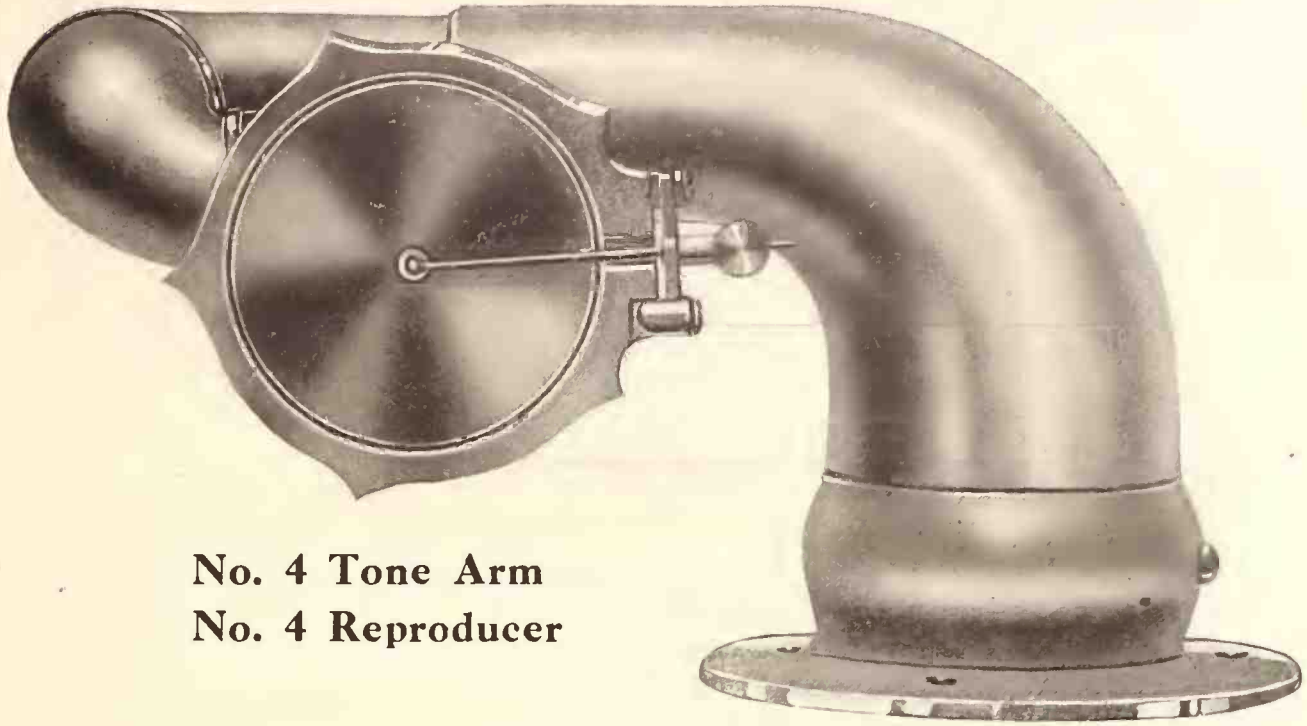

No. 4 Tone Arm
No. 4 Reproducer

Introducing Number Four

The phonograph world moves in common with the rest of the universe. People are trying to get away from the conventional, always in quest of things new and better. Realizing this our engineers set to work to design a Tone Arm and Reproducer that is original, attractive and good.

The result is our No. 4 Throw-back Tone Arm with Swelled Base and No. 4 Pentagon-shaped Sound Box—a welcome

relief from the staid equipment used heretofore. Its pleasing appearance lends an air of distinction to the best of phonographs, and appeals to the taste of the purchaser.

But the real achievement of our engineers was not alone in the design, for a phonograph cannot sell solely on its outward aspect. After weeks of experimenting they perfected a full, resonant-toned reproducer which defies comparison.

Samples can be obtained at the following prices:

Tone Arm No. 4, with Reproducer No. 4	\$4.50
Tone Arm No. 4, only	2.75
Reproducer No. 4, only	2.25

**MUTUAL PHONO
PARTS MFG. CORP.**

149-151 Lafayette Street
New York City

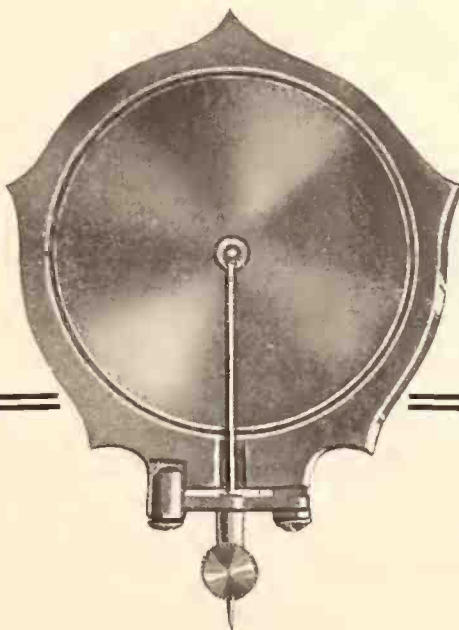

The Russell Gear & Machine Co., Ltd.,
1209 King St., West, TORONTO, CAN.

Exclusive Distributors for Canada and All
Other British Possessions

INDUSTRIAS UNIDAS, S. A.,
Balderas 110, MEXICO CITY,
Exclusive Distributor for Mexico

STEALING to VIRGINIA

A Dancing Song

"You can't go wrong
With any FEIST song"

Words by **GUS KAHN** Music by **WALTER DONALDSON**

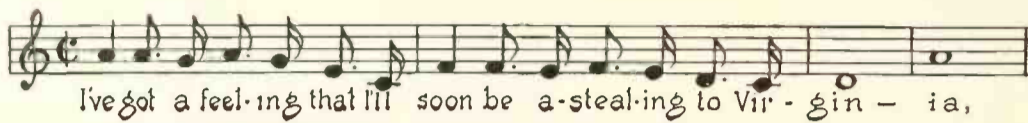

© LEO. FEIST Inc. N.Y.C.



A NEW FIELD FOR WOMEN'S WORK

Howard, Farwell & Co. Use Woman to Adjust All Complaints and to Follow Up New Sales in Order to Keep the Customers Satisfied With the Musical Instruments Sold Them

MINNEAPOLIS, MINN., Sept. 4.—Tell your perplexities to the attractive young woman in the picture. Miss Myrtle McLaughlin or "Mac,"



Myrtle McLaughlin

as she is known, smooths out perplexities and adjusts complaints for purchasers from the St. Paul, Minn., store of Howard, Farwell & Co. Her position is quite unique, representing service in one of its most attractive forms.

Shortly after a piano or high-grade Victrola is purchased "Mac" and her smile appear at the customer's door, ready to help in player-piano operation, Victrola operation and to ascertain if the purchase is proving as satisfactory as the purchaser expected it to be. Her services are particularly appreciated by player-piano purchasers.

Her prompt appearance and her offers of continued help from Howard, Farwell's service department are winning many friends for the

store, as well as the many live new prospects. When a prospect materializes into a purchaser, Miss McLaughlin introduces the friend who suggested the prospect to a wonderful array of premiums, including 1847 Rogers' silverware, a set of dishes, a half dozen Phoenix hose, watches, clocks, cigarette cases, etc. These premiums are available to anyone who has suggested a prospect who buys either a piano or Victrola.

When not engaged cementing the company's and customers' good-will, Miss McLaughlin takes a musical census which yields the firm a list of prospects.

Charles P. Wagner, assistant treasurer of the company, heads the service department and was chiefly responsible for the creation of the post of field representative which Miss McLaughlin fills so capably and successfully.

It is possible that some other concerns have carried out the idea to a greater or less degree in certain instances, but it is doubtful if in any single instance the policy has been followed out as consistently as in the case of Howard, Farwell & Co. The plan has passed the experimental stage and has proved of definite value not only in cementing friendship between the house and its customers, but in bringing in actual business through direct sales and the securing of actual prospects as well as satisfying the customers.

The success of the work is due in no small measure to the pleasing personality of Miss McLaughlin, who has firmly established her faculty for securing satisfaction for the complaining customer and turning him into a firm friend of her company.

JOHN CHAS. THOMAS IN LONDON

Well-Known Tenor Sails to Fill Special Engagement at Albert Hall

John Charles Thomas, the well-known tenor and Vocalion record artist who recently completed his work as movie star in the new Cosmopolitan film "Under the Red Robe," has sailed for England for a short rest prior to his appearance in recital at Albert Hall, London, on September 30. Mr. Thomas will sail from England on October 3 in order to appear in recital at Aeolian Hall, New York, on the 14th of that month.

PAUL SPECHT WELCOMED HOME

Head of Columbia Recording Organization Given Dinner on Evening of August 20

Paul Specht and His Orchestra were the guests of honor at a dinner given late in August by the representatives of music industries, including music publishers, songwriters and others, at the club rooms of the National Vaudeville Artists, 225 West Forty-sixth street, New York. This famous orchestra arrived in New York recently on the S.S. "Aquitania" after spending eight weeks in London in appearances at Lyons' New Corner House, the largest restaurant in the world, the Empress Rooms of the Royal Palace Hotel and the Coliseum and Alhambra theatres of London. The success of Paul Specht and His Orchestra in London was sensational, and the orchestra returned to New York to open an engagement at the Alamac Hotel, Seventy-second street and Broadway, New York, beginning September 15.

At the dinner E. C. Mills, chairman of the M. P. P. A., officiated as toastmaster, and among the guests were many prominent members of the theatrical and musical worlds. Bird S. Coler, Commissioner of Welfare of the City of New York, represented the city administration, and George W. Hopkins, vice-president and general sales manager of the Columbia Graphophone Co., was also one of the speakers of the evening. Paul Specht and His Orchestra make Columbia records exclusively.

ARMSTRONG CO. DAMAGED BY FIRE

Newark Piano House Suffered Smoke and Water Loss—Reconstruction Under Way

A considerable part of the stock of the Armstrong Piano Co., 587 Broad street, Newark, N. J., was damaged by smoke and water in a recent fire, which started on the floor above its showrooms. According to estimates, the total damage, which affected two or three adjacent stores, exceeded \$15,000, but that suffered by the Armstrong store was covered in the main by insurance. The stock from the showrooms, including many expensive Knabe grands and Ampicos, has been transferred to the stockroom of the Lauter Piano Co., at 14 Central avenue.

Workmen are already busy repairing the damage caused by the fire, the ceiling of the establishment having been considerably damaged. The work is being rushed and the store will be reoccupied in a month or so.

ROY L. ALEXANDER TO OPEN STORE

SALINAS, CAL., August 28.—Arrangements are now being made by Roy L. Alexander to establish himself in a music and stationery business here about September 1. He recently leased the premises on the easterly side of Main street, near Gabilan, and his stock and fixtures have already been ordered.

PHONOGRAPH CASES RADIO CASES

Reinforced 3-ply Veneer

The Standard Case for Talking
Machines and Radio Sets

Let us figure on your requirements

MADE BY
PLYWOOD CORPORATION, Goldsboro, N. C.
Mills in Va., N. C. and S. C.



TIME THE LITTLE "BIG MAN" HAD RECOGNITION

By A. M. BURROUGHS
Accounting Specialist, Burroughs Adding Machine Co.

It is high time that the little "big man" had his inning.

All the fine things that have been said and written about the captains of industry and finance are well deserved. But for every big figure in national life who has directed his million-dollar corporation wisely and profitably there are dozens of smaller business men—retail merchants, retail distributors of every conceivable kind of manufactured commodity—who have done fully as well in their more limited fields.

There comes to mind that type of merchant who handles his thousands with the same wisdom, the same foresight as the merchant prince his millions.

In every community there is one or more men of that type. Business comes to his store in panicky times as well as in boom times. His store is a clearing house for goods. His purchases and sales over a year bulk large. Wholesaler and manufacturer value a connection with him. His business yields a steady stream of profit. His banker welcomes his visits.

What is the difference between John Small and John Big? Size only. For their methods are pretty much alike.

John Small's store is a 1923 model. Next year it will be a 1924 model. Small never condemns an innovation simply because it is new. Nor does he rush in headlong after some untried frill.

There is this everlasting similarity between Small and Big. They think and act in the terms of "Two and two are four."

What an interesting, yet dismal, story those 22,000 merchants who failed last year would tell.

It would be a composite of "I thought—I didn't think—. That looked all right—. This seemed to be a good way—. I guess I could. My friends thought, etc."

John Small's hardest competitor can say nothing worse of him than: "John is a good manager."

Simmer it down to one thing and it is: Get the facts and use them.

We are not stripping any glamour from the crown of John Big when we reveal the secret of his success. He measures every situation in his business by a yardstick. He can buy so much merchandise with so much money. He can sell it again by certain definite methods. He can foresee practically every contingency.

John Small operates the same way. He wants to stock a two weeks' supply of a certain brand of goods. Well and good. Now, what is a two weeks' supply? It may be window-screens, windlasses, harmonicas or essence of winter-green. It is something that the public will buy. He can make a profit by selling it.

Small can't remember how much he sold last month or the corresponding two weeks of last year. But he can go to his sale records and see the accurate figures.

John Small is just as big as John Big. Standing beside the yardstick of success their height is the same. Both are good managers.

Small and Big both have reservoirs of information about their business. It lies in their ledgers and other bookkeeping records. It is there, ready to be pumped out for them. And it comes out every day in the form of definite, usable facts. They run their business on the strength of them. There is no such thing as guess in either the Small or Big store. A guess is kicked out before it has time to get in the door.

Small is just as important to the country's good as Big.

Manage your business or your business will manage to freeze you out.



Put Color, Motion and Illumination Behind Victor Record Sales

VACATION days are over. People are home. Talking Machines are again popular. New records are in demand. Prepare for more sales than ever. Use the

Da-Lite Electric Display

It's new. Different. Announces latest Victor Record releases in color, motion and illumination. Hundreds already in use by leading Victrola dealers. Extremely economical. Cost of operation only half a cent an hour. One bulb furnishes both motion and illumination. Just as effective during day as at night.

A New Display Panel Each Week



A weekly sign service is included in every contract for Da-Lite Display. Each panel announces a new popular record.

* * *

Panels are made exclusively for Da-Lite Display service. Each is an original design. Handsomely hand colored in brilliant transparent hues.

* * *

Delivery of panels to subscribers conforms to the weekly release of records by the Victor Company.

* * *

With the Da-Lite service you are in a position to announce the new re-

leases in a distinctive and unusual way—a way that will attract widespread attention and remind people to buy.

* * *

The profit on one record will more than pay the daily cost of Da-Lite Electric Display service.

* * *

Investigate this wonderful service. Costs very little. Results amazing. Features the very latest records. Reminds the people to buy. Makes extra sales daily. Write us for descriptive circular. Sample panel upon request. Address

The Da-Lite Electric Display Co.

116 N. Erie Street

Toledo, Ohio.

SHRINERS TO RECORD FOR GENNETT

Cincinnati Delegates Who Sang So Well in Washington to Record Their Voices

CINCINNATI, O., September 3.—Some of the Shriners who sang so well in Washington during the recent Shrine gathering there that the late President Harding came down from his reviewing stand to meet them are to record their song on the Gennett record to-day. The men, who are well known in the musical circles of Cincinnati, are Dr. Eddie Ball, a Cincinnati dentist; Howard Heffler, of the Willis Music Co., and William Waterworth, of the Otto Grau Piano Co.

DELANEY AGAIN WITH VOCALION

T. F. Delaney, who for several years covered a large territory in the East in the interests of Vocalion phonographs, has rejoined the Aeolian Co. organization as a member of the wholesale staff of the Vocalion department. His headquarters are in Aeolian Hall, New York City.

NEW EDISON FOLDER USED AT FAIRS

Designed in the Form of an Edison Record, It Makes Attractive Piece of Literature

For the use of the many dealers who take advantage of the opportunity for displaying their lines at the various fairs held about the country during the Fall, Thos. A. Edison, Inc., has prepared an unique folder in the shape of an Edison blank record bearing the legend: "The New Edison Phonograph and the Edison Record. Real Music by Real Artists." The inside of the folder illustrates the various Edison disc models, both upright and console, with the prevailing retail prices. The folder has already demonstrated its value at fairs and exhibitions where it is being used.

NEW MANAGER IN LOGAN, UTAH

M. W. Lundstrom has been appointed manager of the phonograph department of the Lundstrom Furniture & Carpet Co., in Logan, Utah.

ILSLEY'S GRAPHITE PHONO SPRING LUBRICANT

Ilsley's Lubricant makes the Motor make good. Is prepared in the proper consistency, will not run out, dry up or become sticky or rancid. Remains in its original form indefinitely.

Put up in 1, 5, 10, 25 and 50-pound cans for dealers. This lubricant is also put up in 4-ounce cans to retail at 25 cents each under the trade name of

EUREKA NOISELESS TALKING MACHINE LUBRICANT

Write for special proposition to jobbers

ILSLEY-DOUBLEDAY & CO., 229-231 Front St., New York

ROSA RAISA TO SING IN "NERONE"

Popular Soprano and Vocalion Record Artist Selected by Toscanini for Leading Soprano Rôle in Opera Premiere in Milan

According to a cablegram received from Milan, Rosa Raisa, dramatic soprano and Vocalion record artist, who has appeared in this country with the Chicago Civic Opera Co. and who, incidentally, is a naturalized American citizen, has been chosen by Maestro Toscanini to sing the leading soprano rôle of the world premiere at La Scala of the opera "Nerone." The selection of Mme. Raisa for the rôle is accepted as a distinct tribute to her artistic ability.

NEW BANNER RECORD SERIES

Scheduled for Release by Plaza Music Co.—Planning Extensive Publicity

The Banner record division of the Plaza Music Co. has arranged three permanent scheduled releases of new numbers for each month. These will include all current successes in either instrumental or vocal form or both. In addition, from time to time the Plaza Co. will continue to make special record releases of numbers that show unusual possibilities. Advertising material of this series of listings has been planned and hangers, cut-outs, bulletins, consumer literature and other dealer helps will either accompany shipments or be forwarded several days prior to delivery. For the Fall season the Banner record will be given much additional publicity other than that scheduled from month to month.

SASCHA JACOBSON'S NARROW ESCAPE

Sascha Jacobson, the well-known violin virtuoso who recently visited New York for the purpose of making records, had a narrow escape from death on August 24. After dinner in the evening he complained of a cold and took some tablets from a wrong receptacle and was taken immediately afterwards with violent cramps and convulsions. Antidotes were given as quickly as possible and, after a strenuous fight, he was relieved. After a short stay with his brother-in-law, Dr. Rothblatt, 704 West 180th street, New York, he left for his country home at Gansevoort, N. Y.

ENTERTAINMENTS BUILD GOOD-WILL

RIDGEWOOD, N. J., September 4.—J. A. Bliesenick, proprietor of the Ridgewood Talking Machine Co. here and one of the best-known and most aggressive merchants in this city, last week staged his second annual entertainment at the Bergen County Isolation Hospital. Music, moving pictures and refreshments were included in the program. These entertainments comprise part of Mr. Bliesenick's plan for building goodwill and at the same time co-operating with the various local charitable institutions.

Dealers' Repairs

FINEST SHOP IN THE CITY
Facilities for the repair of every make of sound box and motor

Special attention to out of town trade sent to us by mail

IDEAL REPAIR SERVICE

284 East Houston St. New York City

Comparative Tests Invited

Silent Motors have proved their supremacy to the satisfaction of a great number of the largest manufacturers of Machines in America and foreign countries.

Produced in Three Types

Model S. S. guaranteed to play in excess of two records, especially constructed for Portables or table machines.

Model K. K. guaranteed to play in excess of three records.

Model H. H. guaranteed to play in excess of five records.

Samples and information supplied upon request.

THE SILENT MOTOR CORPORATION

CHARLES A. O'MALLEY, *President*

321-323-325 Dean Street

BROOKLYN, N. Y.

Telephone Sterling 4861

Securing and Keeping Up the Mailing List

Pointers on How Best Results Are Secured Through a Mailing List Which Is Kept Fully Up to Date—Eliminating the Deadwood

Building up a mailing list is one of the problems that are always before the retail dealer who believes in keeping his name and the name of the product he represents constantly before prospective customers. There are some who simply handle the mailing list as a matter of course and do not give it the attention it deserves, but the merchant who seeks real results must give as much thought to his mailing list as he does to the prospect list upon which the salesmen work personally.

The retailer would not think of sending his salesman to see a prospect who had died or moved away, and he should take just as much care to see that his valuable mail matter is not sent to people who have moved, or who for one reason or another do not exist. This means constant checking and building up.

The well-known channels for getting names for the mailing list have been pretty well worked, such as the telephone directory, lists covering certain exclusive localities, the social register, etc. Likewise, an increasing number of dealers find the newspaper announcements very successful prospect sources and see to it that all newly married couples are placed on the mailing list. This same information regarding the newlyweds can be obtained from the list of marriage licenses issued by the various cities and published in local newspapers, or at least placed on file at the License Bureau, where they may be perused by anyone interested.

Real estate records also offer possibilities for first-class mailing lists, for the buyers of suburban homes make excellent prospects, provided, of course, they are not already supplied with machines. In any event, they loom up as possibilities for record sales.

New Sources for Prospects

There are now and then some original methods developed by individual salesmen for digging up prospects and in this connection a story is told of a young Italian who got a job as outside salesman for a dealer in Brooklyn, N. Y. The new man went to work earnestly and for the first couple of weeks he turned in to the house each day from five to ten prospects. The best part of it was that a very fair percentage of them bought machines and records during that period. There could be no question regarding the authenticity of the lists. The man-

ager was puzzled at the success of the new man and finally, unable to control his curiosity any longer, said: "Where do you get all these names, Joe?" "Pretty good, eh?" the Latin answered evasively. "Come on, be a sport. I just want to find out your system for the sake of my other men. How many families, having talking machines, do you call on each day before you get the names of six prospects?" asked the dealer. "None," laughed the fellow, enjoying his employer's confusion.

"Well, now, listen here, Joe," said the dealer suspiciously; "if you mean to say that you call on only six or seven people a day and find them all without talking machines, somebody is giving you those names. Come now, who is it?"

"Sure, somebody gives me names. He give me names and address. My father and brud they all in the moving van biz, five trucks, and each day they move five, six ten peep, see no talking machine on truck, give me his name."

It does not happen that every salesman or every dealer lists among his friends a moving van owner who will give him such explicit information, but if he approaches some of the real estate dealers in his vicinity in the proper way it is no great problem to get from them lists of new tenants who may be solicited in the regular way, and often with good results.

Keeping the List Really Alive

It is not always a question of getting new names, however, for care must be taken to see that certain names are bona-fide and worth following up. In some cases arrangements can be made with the local postmaster to revise the dealer's mailing list so far as it covers his territory, bringing it up-to-date at a nominal charge for clerical work. But even when such service is not available the dealer can have a fairly accurate check on his list by imprinting his envelopes with a return postage guarantee and then seeing that the returns are not simply thrown aside, but are checked up very carefully against the list.

In addition to those who die each month, it often happens that a certain portion of the people on the mailing list have succumbed to the wiles of competing salesmen and bought machines and records of other makes. For the purpose of checking up these it is well occasionally to send out a "tickle" in the form of

a return post card to be filled in by the recipient stating what kind of machine he owns, if any, what kind of records he uses and whether or not he is interested in continuing to receive bulletins and other printed matter.

Checking Up From the Recipient's End

While on the subject of mailing lists, it might also be apropos to suggest that the dealer check up occasionally to see how his printed matter is being received by his prospects. This applies particularly in cases where the dealer goes to considerable expense in preparing original forms of mail matter in the hope of arousing special interest. A big user of mail matter suggests that before any new mail matter is sent out, particularly material printed on cardboard more or less delicate in character, the dealer have several samples mailed to himself from various localities. When it is received he can inspect it and see whether it has been properly packed or whether the envelope used is of the right sort to give full protection. Should anything be wrong he can remedy it before sending the material out to the full list.

It happens very frequently that expensive calendars printed on cardboard, and with considerable filigree work, are received by prospects in so mangled a condition as to be useless and the story is told of a manufacturer who conceived the bright idea of having his message recorded on small records and sent them to his clients. In order to attract attention he left the envelope blank and included no literature. Even the record did not bear his name, simply the fact that it bore a message of interest to the client. The trouble came when a large number of records through improper packing were all smashed up when they reached the recipient. In all such cases the important message on the record remained a secret. The unfortunate part was that in his eagerness to be original the manufacturer placed no key on the envelope or contents that would permit of the recipient writing to him for another record to be more securely packed.

Soliciting by mail is, at best, a more or less expensive practice and it stands to reason that a piece of literature to be sent by mail, if it is worth preparing, is worthy of careful attention in the matter of shipping and certainly should contain the name of the sender.

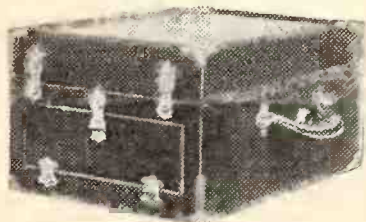

The
Modernolette

Retail Price —East of Mississippi —\$35.00
—West of Mississippi —\$40.00



ARE you getting your share of the portable business? Are you selling the right machine? The Modernolette is selling fast. It is constructed of solid walnut, wax finish. Has a reliable motor and tone arm. In quality, it is in the high priced class. In price it is low. We still have some valuable territory open for jobbers.

Manufactured by

MODERNOLA COMPANY

JOHNSTOWN, PA.

New York Distributor: PROGRESSIVE MUSICAL INSTRUMENT CORP., 319 Sixth Ave., New York, N. Y.



Baby Grand
\$200

*The Choice of those who've
heard them all.*



Serenade
\$150

Sonora Dealers Are Profiting Through High Quality NOW

ALREADY early September sales to Sonora dealers are acting as sales barometers, showing the extent to which they are going to profit this fall through handling "The Instrument of Quality."

Their customers, everywhere affected by country-wide prosperity, are in the market for high quality merchandise. And these people, many of them with the actual cash in hand for their purchases, are making this demand known in no uncertain terms.

Sonora dealers are in better position than all others to satisfy this demand. Handling "The Highest Class Talking Machine in the World" and backed by Sonora's comprehensive national advertising and effective dealer helps, their fall season is going to be the largest they have ever enjoyed.

You, too, may cash in on this Sonora demand, which is increasing by leaps and bounds. Wire or write the local distributor listed on the page opposite for full details.

SONORA PHONOGRAPH CO., Inc.

279 BROADWAY

NEW YORK

Canadian Distributors

SONORA PHONOGRAPH, Ltd.

Toronto

THE INSTRUMENT OF QUALITY
Sonora
CLEAR AS A BELL 

The Highest Class Talking Machine in the World

The distributor named below who covers the territory in which you are located will be glad to answer all inquiries regarding a Sonora agency on receipt of a letter from you

State of New York

with the exception of towns on Hudson River below Poughkeepsie and excepting Greater New York.

Gibson-Snow Co.,
Syracuse, N. Y.

Lower Michigan, Ohio and Kentucky

Sonora Phonograph — Ohio Company,
417 Bulkley Bldg., Cleveland, Ohio.

Wisconsin, Upper Michigan

Yahr & Lange Drug Co.,
Milwaukee, Wis.

State of New Jersey

Sonora Sales Co. of New Jersey,
605 Broad St., Newark, N. J.

States of North Dakota, South Dakota, Minnesota and Northern Iowa

Doerr-Andrews-Doerr,
Minneapolis, Minn.

Eastern Pennsylvania, Maryland, Delaware, District of Columbia and Virginia

Sonora Co. of Phila., Inc.,
1214 Arch St., Philadelphia, Pa.

State of Indiana

Kiefer-Stewart Co.,
Indianapolis, Ind.

Missouri, Northern and Eastern Part of Kansas, and 5 counties of N.E. Oklahoma

C. D. Smith Drug Co.,
St. Joseph, Mo.

Western Pennsylvania and West Virginia

Sonora Dist. Co. of Pittsburgh,
505 Liberty Ave., Pittsburgh, Pa.

State of Nebraska and Western Iowa

Lee Coit Andreesen Hardware Co.,
Omaha, Nebr.

States of Montana, Colorado, New Mexico and Wyoming East of Rock Springs

Moore-Bird & Co.,
1720 Wazee St., Denver, Colo.

All of Brooklyn and Long Island

Long Island Phonograph Co.,
17 Hanover Place, Brooklyn, N. Y.

The New England States

Sonora Phonograph Co. of New England,
221 Columbus Ave., Boston, Mass.

Utah, Western Wyoming, Southern Idaho and Eastern Nevada

Strevell-Paterson Hardware Co.,
Salt Lake City, Utah.

New York City, with the exception of Brooklyn and Long Island

Counties of Westchester, Putnam and Dutchess; all Hudson River towns and cities on the west bank of the river, south of Highland; all territory south of Poughkeepsie.

Washington, California, Oregon, Arizona, Western Nevada, Northern Idaho, Hawaiian Islands

Sonora Phonograph Co. of Pacific Coast,
115 Jessie St., San Francisco, Cal.

Illinois and Eastern Iowa

Illinois Phonograph Corp.,
616 S. Michigan Ave., Chicago, Ill.

Greater City Phonograph Co., Inc.,
234 W. 39th St, New York

Every Night I Cry Myself To Sleep Over You

"You can't go wrong
With any FEIST song"



Ev-ry night I cry my-self to sleep o-ver you, —

**FOXTROT BALLAD—WITH A PUNCH IN BOTH
MELODY AND LYRIC**

© LEO FEIST INC
N.Y.C.

OUR EXPORTS OF TALKING MACHINES

Export Figures on Talking Machines and Records Show Increasing Tendency as Compared With Last Year—Our Buyers Abroad

WASHINGTON, D. C., September 8.—In the summary of exports and imports of the commerce of the United States for the month of June, 1923 (the latest period for which it has been compiled), which has just been issued, the following are the figures bearing on talking machines and records:

The dutiable imports of talking machines and parts during June, 1923, amounted in value to \$86,441, as compared with \$35,901 worth which were imported during the same month of 1922. The twelve months' total ending June, 1923, showed importations valued at \$615,425, as compared with \$528,203 worth of talking machines and parts during the same period of 1922.

Talking machines to the number of 5,795, valued at \$243,117, were exported in June, 1923, as compared with 5,460 talking machines, valued at \$168,503, sent abroad in the same period of 1922. The twelve months' total showed that we exported 61,241 talking machines, valued at \$2,371,065, as against 39,147 talking machines, valued at \$1,561,064, in 1922.

The total exports of records and supplies for June, 1923, were valued at \$123,194, as compared with \$86,374 in June, 1922. The twelve months ending June, 1923, show records and accessories exported valued at \$1,242,901, as compared with \$1,471,853 in 1922.

The countries to which exports were made in June and the values thereof are as follows: France, \$325; United Kingdom, \$10,810; other Europe, \$6,417; Canada, \$67,847; Central America, \$4,647; Mexico, \$13,981; Cuba, \$15,610; Argentina, \$1,514; other South American countries, \$14,796; China, \$2,598; Japan, \$30,296; Philippine Islands, \$2,365; Australia, \$41,234; Peru, \$3,070; Chile, \$11,550; elsewhere, \$16,057.

Meyer Levin, operating as the Mandel Talking Machine Co., dealer in phonographs, records and sporting goods at 53 East Twenty-third street, New York, made an assignment recently to Ralph Honig, of 2486 Davidson avenue, New York.

G. J. BENSBERG EXPANDS

Progressive Arkansas Dealer Acquires Talking Machine Stock of Davidson Furniture Co.

CAMDEN, ARK., September 1.—G. J. Bensberg, proprietor of Bensberg's Music Shop on South Adams street, has purchased the stock of phonographs of the Davidson Furniture Co., which recently opened a store in Camden.

The Bensberg Music Shop is one of the leading dealers in musical instruments in Arkansas and is the largest dealer in Edison phonographs in the State. In addition Victor and Columbia machines and pianos are handled.

MISS DOROTHY SILBERT WEDS

Miss Dorothy Silbert, cashier in the accounting department of the Emerson Phonograph Co., Inc., became Mrs. Herman Sanders on August 26. As a mark of appreciation of the many years of amiable association with her co-workers Mrs. Sanders was presented by them with a "Lady Churchill" phonograph, one of the new artistic Emerson period models. In addition the young lady was the recipient of numerous household gifts.

N. COHEN ENDS SUCCESSFUL TRIP

N. Cohen, president of the Wall-Kane Needle Mfg. Co., Brooklyn, N. Y., returned from a very pleasant and successful trip across the continent. Due to the illness of Mrs. Cohen, who accompanied him, the trip was concluded before all the cities on the itinerary were reached. Mr. Cohen reports that a general spirit of optimism was manifested everywhere and orders for Wall-Kane and concert needles were plentiful.

9,000 PATENTS EVERY MONTH

WASHINGTON, D. C., September 4.—The most mistaken man in the world is he who insists "there is nothing new under the sun," according to officials of the Patent Office. For the last two years applications for registry of patents and trade-marks have averaged 9,000 per month. Despite the increased flow of new ideas the clerical work of the bureau has kept entirely up with it.

ACTIVITY IN DEALER EQUIPMENT

Zimmerman-Bitter Co. Closing Many New Contracts—Dealers Getting Ready for Fall

Among installations recently completed by the Zimmerman-Bitter Construction Co. is that of Landay Bros., consisting of the remodeling of the entire ground floor, in both the Fifth avenue and Forty-second street stores, New York City; also the addition of new musical instrument cases.

A number of new contracts have been received lately, including that of the Greeley Music Shop, New York City, consisting of six hearing rooms, record racks, service counters and redecorating the entire store in colonial period design. Another large installation, which when completed will be one of the best in the State, is that of Dunkerley & Co., of Passaic, N. J. This installation will consist of fifteen hearing rooms, piano warerooms, record racks with a capacity of 25,000 records and new show windows. The store will be redecorated throughout and the entrance will consist of an ornamental arch being finished in French period design. Radel's Music Shop, New York City, has contracted for the remodeling of its store and the installation of musical instrument and sheet music departments.

CASH IN ON ARTISTS' APPEARANCE

SPRINGFIELD, O., September 4.—The L. C. Gorsuch Co., Columbia dealer, of this city, made capital of the local appearance of Lasses White's Minstrels, Columbia artists, by featuring the records of these artists in an unusually attractive window display.

Oké Records STRAND and OUTING PHONOGRAPHS

Brilliantone, True Tone, Tonofone and Gilt-Edge NEEDLES
DELIVERY BAGS AND ACCESSORIES

Complete Stocks and Prompt Service

IROQUOIS SALES CORPORATION

Wholesale Distributors

210 Franklin Street

BUFFALO, N. Y.

ITALIAN Popular Music



AND



MONTHLY RELEASES
WRITE FOR CATALOG
Out-of-Town Agents Wanted
Distributed by

ITALIAN BOOK CO.
145 Mulberry St. New York, N. Y.

25 YEARS OLD AT BIRTH!

The Progressive Musical Instrument Corporation is not "just another" jobber of musical instruments, nor is it a new-comer in the musical instrument field. It is composed of men who have been actively engaged in this business for 25 years—in other words Progressive is 25 years old at its birth!

New Ideas - New Merchandise - New Prices

To outline the Progressive policy is to say: "Our Name is Our Slogan!" It has taken considerable time to assemble such a complete line of musical merchandise as is in our stock. Nor have we completed the list of products we are to be distributors of. The selection of the lines was governed first by quality, then standing and then price. In each instance we have considered the dealer's viewpoint, remembering he must make a fair margin of profit and at the same time make a customer.

It is only natural that our "service" policy should also be in accord with our name. There will be no delays in delivery—our speed autos will take care of that! Out of town orders will be shipped within 24 hours after receipt. Music merchants everywhere will welcome the rapid service and exceptional attention their orders will receive at the hands of Progressive!

Our showrooms and lines of merchandise are now open for your inspection. Progressive is conveniently located in the musical merchandise center of the city. Drop us a postal card for our catalog ready for distribution shortly. Dealers now being appointed in some of our exclusive territories.

DISTRIBUTORS OF

- Holton Band Instruments.
- Bacon Banjos, Guitars, Ukuleles, etc.
- M. Hohner Harmonicas, Accordeons, etc.
- Perfacktone Band Instruments.
- Perfacktone String Instruments.
- Sonorotone Violins, Accessories.
- Bell Brand Strings.
- Black Diamond Strings.
- Samson Strings.
- Hercules Strings.
- Supreme Rosin.
- Santacilla Guitars.
- La Clavel Guitars.
- Ludwig & Ludwig Drums, etc.
- Major Drums, etc.
- P'MICO Ukuleles.
- Hamilton Stands.
- Grover Pegs.
- and a complete line of the finest grade of Accessories.

Wholesalers of Musical Merchandise of Every Description

Progressive
MUSICAL INSTRUMENT CORPORATION

319 Sixth Avenue (Bet. 19th and 20th Streets) New York

Telephone Nos. Watkins 4297, 4298, Chelsea 9237

Making Small Advertisements Effective

Originality in Lettering and the Use of Small Cartoons Make the Copy Stand Out From Straight Type Ads and Get Attention

The talking machine dealer who handles any one or several of the established lines of records has at his command probably more free publicity matter of high quality than is to be found in any other line of business, for not only do the manufacturers themselves spend hundreds of thousands of dollars each year in supplying window cards, bulletins, cut-outs, etc., for the use of dealers, but many distributors follow the same practice and many music publishers, as well, have also seen the possibilities of having their songs in record form suitably featured in the dealer's window by specially prepared cards.

The complaint seems to be, and justly so, that a great many dealers do not take the fullest advantage of the opportunity of informing the

public of the new features among the records. Either they neglect to display some of this material entirely or they display it in a way that shows lack of thought in its arrangement. This criticism, of course, does not apply to those retailers who believe in individuality in presenting the record hits to the public and who arrange individual window displays to attract attention either to a single record or to a special group.

There are a class of dealers, fortunately, who not only make full use of the advertising equipment supplied by the manufacturer, but who

junction with straight type advertisements the special lettering stands out like a sore thumb and the campaign has reached a point where many record buyers admit that they look for the advertisements just as they do for the other special features of the newspapers. Certainly the results of the campaign indicate that it has gone over.

E. H. Jackson, owner of the Jackson Talking Machine Shop, makes excellent use of the cartoon in giving character to many of the advertisements. It might be said here that the cartoon has also been used effectively by other

Mr. Edison Man:—
Don't Say
"KAN'T," say **"KENT"**
Write for catalog of complete line
The KENT No. 1
With "S" Sound Box
Has given complete satisfaction
for years

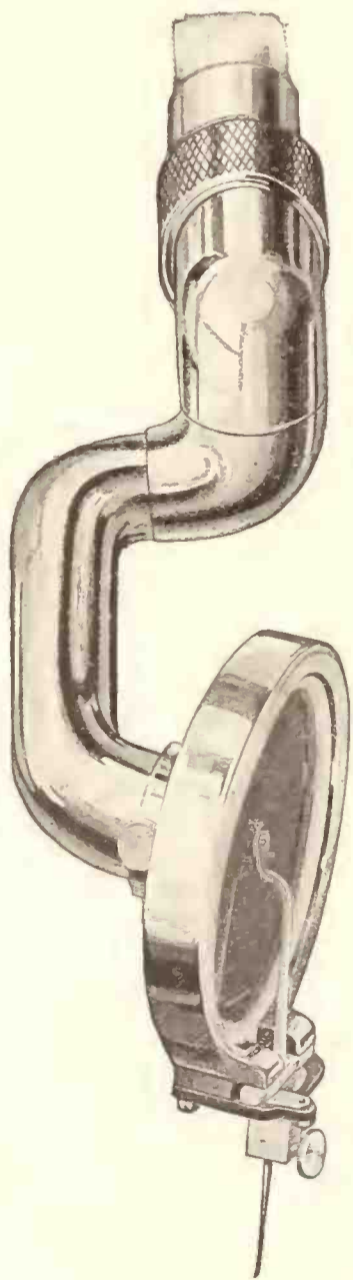

Reg. U. S. Pat. Off.

F. C. KENT CO.

Irvington, N. J.



Some Clever Small Advertisements of Jackson Talking Machine Shop, Rockford, Ill.

also create individual advertising to give additional punch to the publicity. They realize that, with a half dozen or more dealers in their own section handling the same line and using the same publicity, the passer-by is not likely to be attracted particularly to their own store, even though he may become interested in the record itself. In other words, the general publicity is just as likely as not to bring a certain amount of the business to competitors.

In the preparation of the individual advertising the dealer can offset this tendency to a certain degree. When the record buyer has seen the record featured in the same way in a half dozen stores and then comes across an original presentation of it he is very likely to find his curiosity developing into a buying urge and to give his business to the retailer who has had gumption enough to go after it in a new way.

This originality in advertising can be adopted in newspaper advertisements as well as in show window cards and the idea has been carried out successfully in numerous cases. In other words, instead of simply publishing the name of the record, something of its history and perhaps a picture of the orchestra playing it or the artist singing it, the dealer uses a cartoon or special type arrangement that is distinctly out of the ordinary run.

A case in point is found in the series of specially lettered record advertisements used in the local newspapers by the Jackson Talking Machine Shop, of Rockford, Ill. Appearing in con-

dealers, among them Ned Straus, manager for the A. B. Clinton Piano Co., Hartford, Conn., whose cartoons were reproduced in The World some time ago. Mr. Straus, as well as Mr. Jackson, has a belief that the tired business man and his wife like a little humor in the advertisements, with the result that most of the cartoons are calculated to develop a smile on the part of the reader, as well as to attract his attention to what the announcement is all about.

The sum and substance of the matter is that anything that makes for individuality in publicity, whether in the newspapers or in the store, is likely to elevate that particular dealer above the general run of his fellows and concentrate on his store the interest that ordinarily might be divided among a half-dozen competitors.

It is natural to assume that no one dealer can get all of the business, but if he does things a little differently in his advertising and his selling and service methods he is liable to get sufficiently out of the rut to be able to capture more than his proportionate share of business.

NEW DEPARTMENT IN BILLINGS

H. E. Nielsen has been appointed manager of the new Edison phonograph department opened recently by the Lee Warren Drug Store, 2703 Montana avenue, Billings, Mont. The department is located on the balcony of the store and has been fitted out in a thoroughly up-to-date manner.

QUALITY IS NOT AN ACCIDENT

The superior quality of our COTTON FLOCKS for record manufacture is the result of continual study of the manufacturer's requirements—diligent adherence to the use of raw materials which will produce the best flocks and scrupulous attention to every detail of their manufacture.

Numerous record manufacturers are profiting by the cleanliness and uniformity of our product through reduction in spoilage of records.

ARE YOU ONE OF THESE MANUFACTURERS?

CLAREMONT WASTE MFG. CO.

Claremont, N. H.

LITTLE TOTS' NURSERY TUNES

SONGS, GAMES, STORIES -- ON RECORDS

Juvenile Records— in a LOOSE LEAF album



\$1.00 Complete Book

The appearance of the LITTLE TOTS' BOOK is its own best salesman. The covers are of a heavy blue Buckeye stock finished in full color Mother Goose designs. The inside record pockets are also of a heavy blue stock pictured with typical children's settings.

Each album contains six picture and verse cards, beautifully illustrated and process printed in colors. The book is attractively bound in loose leaf style with telescope eyelets and colored silk cord. It is finally packed in a glassine wrapper.



Individual Records 25c

Two selections on a 7-inch double-faced record, with picture and verse cards in a printed envelope—ready for insertion into the loose leaf book.

Outstandingly Superior.

Six different selections. On SEVEN-inch DOUBLE-FACED records. With picture and verse cards. All in a beautiful LOOSE-LEAF album. \$1 retail.

Simply wonderful.

See the book and look at the beautiful pictures. Above all, play the wonderful records. Marvelously clear. Unusually strong. You hear every note. You understand every word.

Individual records also. At 25c each. SEVEN-inch DOUBLE-FACED (2 selections). With picture and verse cards.

Things are humming. Everybody is ordering. Everybody is re-ordering. Write TO-DAY.

Liberal Discounts to Jobbers and Dealers!

REGAL RECORD CO. Little Tots' Record Division
20 West 20th Street, New York

On The Shores & Aloha Land



"You can't go wrong
With any FEIST song"

Hawaiian Serenade
Waltz

Dream-ing of — A — lo — ha land,—

© LEO.FEIST Inc. N.Y.C.

YATES SHOP CHANGES NAME

Lankershim, Cal., Concern to Be Known as the Lankershim Brunswick Shop

LANKERSHIM, CAL., Sept. 6.—Due to a change of ownership, the Yates Music Shop will, in the future, be known as the Lankershim Brunswick Shop, and the stock of phonographs, pianos and musical merchandise will be materially increased. D. E. Langlands and W. H. Schade came into possession of the store some time ago and have already assumed active management of the concern. Mr. Langlands has been assistant manager of the musical merchandise department of the Southern California Music Co. of Los Angeles for eleven years, and recently organized a band at Culver City.

T. A. EDISON'S RECENT DISCOVERY

A new artist is likely to be added to those making records for Thomas A. Edison, Inc., as a result of the vacation motor and camping trip recently taken by Mr. Edison and his friends, Henry Ford and Fred Firestone. It seems that while in Paris, Mich., Mr. Edison heard of the skill of a local "fiddler," Jasper E. Bisbee, and, after hearing him play the music in vogue for dancing fifty years ago, Mr. Edison promised to arrange for the making of test records at the Edison laboratories in Orange, N. J.

Recording for the Phonograph Trade

The best equipped and efficient—low cost—laboratory in the industry.

Our success in recording for some prominent makes of records assures you a high-class product.

A visit or telephone call will give you the details.

Let us solve your technical problems.

We will be glad to send samples of late recordings.

A. J. BAUM, Manager
ARTHUR BERGH, Musical Director
FRED OCHS, Recorder

**INDEPENDENT RECORDING
LABORATORY, Inc.**

102-104 West 38th Street New York

A FACTOR IN AUGMENTING SALES

How the Audak Demonstrating Device Operates in Making the Dealer's Sales Department More Effective in Service to Customers

In these days of modern merchandising with heavy overhead, due to increased costs for salaries and the demand of customers to be waited on promptly and efficiently, with all that this means in extending service, the retailer willingly grasps at any proved plan that aids in the



The Audak (Style 10) in Operation

simplification of sales. In this connection several leading dealers and a number of department stores, in planning to eliminate lost motion and add to the speed in making sales, have recently adopted the Audak demonstrating device. A particularly popular model of this product is the Audak No. 10, mounted on a small table, occupying very little space, at which the prospective customer may sit and hear any number of records without interference from record renditions at adjacent tables. This equipment is delivered in the color of the woodwork of the store and can be set up for demonstration without delay immediately upon delivery. A series of such tables occupy very little floor space. A group of popular selections is placed in the rack before the customer and a demonstration of those selected is made by the prospective purchaser. The floor salesman, from time to time, exchanges or adds to the records set aside for the individual's demonstration, who requires little other attention until the sale is about to be completed. In this manner a full battery of tables, equipped with the Audak, can not only be cared for by one salesman, but allows him sufficient time to extend to the various prospective purchasers other minor services. When the store is unusually crowded this has

been found one of the most feasible, successful and profitable methods of record demonstration. The majority of folks seem not only well satisfied with such methods, but often show particular pleasure with the arrangements. It is a weakness of human nature to desire attention; if the store is crowded to the extent that the salesman cannot take care of all those before the counter a seat at the table where a series of records may be gone over not only suffices to hold the customer within the confines of the establishment, but gives more than a little assurance that he will make a reasonable amount of purchases.

BROADCASTING PIANO SOLOS

Microphones are the prime essentials in radio broadcasting and their perfection is one of the trials of the radio engineers. It is quite simple to broadcast the human voice, for the speaker or singer stands directly in front of the microphone. It is equally simple with the violin or even a full orchestra, in the latter case the combined sounds of the instruments being gathered into a large receiving horn by means of a curved sounding board.

But until within a recent period or so the transmission of piano pieces had not been as satisfactory as the radio engineers felt was possible. Now they are, due to the perfection of a device by radio engineers in the largest transmitting station up the State. By means of coils anchored to the piano sounding board and a magnetic system connected with the coils and attached to the piano frame itself every tone is faithfully reproduced electrically, with all the tonal shadings, and so sent on to the broadcasting machine.

MAKING TALKING MACHINES IN SYDNEY

We are in receipt of a copy of the Australasian Manufacturer, published in Sydney, a most interesting magazine, by the way, in which appears a three-page illustrated story of the construction of the Raxonola talking machine, which is made by the firm of Jackson & Macdonald in Sydney. This instrument is a complete Australian product and the writer of the article, who describes its manufacture in the fullest detail, naturally expresses pride in the fact. Two illustrations of recent Raxonola styles also appear.

MARKET FOR AMERICAN "TALKERS"

WASHINGTON, D. C., Sept. 6.—A firm of importers in Melbourne, Australia, is in the market for American talking machines, according to advices received by the Bureau of Foreign and Domestic Commerce, this city. Complete details may be secured by communicating with the Bureau or any of its district offices and mentioning File No. 7241.

The Texas Music Co., Breckenridge, Tex., has been damaged by fire to the extent of \$3,500.

VINCENT LOPEZ

AND HIS

HOTEL PENNSYLVANIA ORCHESTRA

Creators of a new style of dance music

A LITTLE over one year ago Vincent Lopez and His Hotel Pennsylvania Orchestra boldly departed from the beaten paths of mere syncopation and created a new style of dance music.

It was startlingly unusual—oddly original. It was daringly different from anything the dancing public had previously heard. Soon, by means of nightly playing at the Hotel Pennsylvania, the world's largest hotel, wireless broadcasting and phenomenally successful, record-breaking Keith vaudeville tours, the fame of this delightfully novel dance music spread far and wide. Today, this very same style of inimitable dance music, coupled with superb musicianship, has attained for Lopez and his talented organization a tremendous popularity that is unparalleled by any other dance orchestra. Their exclusive Okeh recordings are acknowledged to be the finest dance records obtainable.

As an Okeh dealer, your share of the ever-growing demand for Lopez's exclusive Okeh Records is assured. Get it more quickly—make it as big as possible. Get behind these incomparable dance records and give them some real, honest-to-goodness sales effort. Let the public know you have Lopez records. Talk them up. Play them for your customers at every opportunity. Give your neighborhood the Lopez habit. Dealers all over the country are doing it—and steadily cashing in big as a result of their sales efforts.

Your share of this Lopez boom is there for you to get. Why not go after it?

Four of the Latest Lopez Hits

- | | | | |
|--------|-------------------------|--------|-----------------------------|
| 4881 | SWINGIN' DOWN THE LANE | 4878 | WONDERFUL ONE |
| 10 in. | | 10 in. | |
| 75c | WHEN YOU'RE NEAR | 75c | ON A MOONLIGHT NIGHT |
| 4869 | BESIDE A BABBLING BROOK | 4857 | DOWN AMONG THE SLEEPY HILLS |
| 10 in. | | 10 in. | OF TENNESSEE |
| 75c | BLUE HOOSIER BLUES | 75c | MARCH OF THE MANNIKINS |

Recorded Exclusively for

Okeh Records

The Records of Quality



VINCENT LOPEZ
(Exclusive Okeh Artist)



General
Phonograph Corporation

OTTO HEINEMAN, President
25 West 45th St. New York

Another Superior Point for THE NEW COLUMBIA

The new reproducer is the most satisfying ever constructed. It has the most natural tone of any reproducer on the market today, and an unequalled capacity for volume. Freedom from blast has been accomplished by a unique system of "shock absorbers." Every musical tone, whether vocal or instrumental, is given with beautiful fidelity.

COLUMBIA GRAPHOPHONE CO.
New York



HARRY CUDDEBACK WELL AGAIN

Head of Da-Lite Co. Back at Desk—Company Revises Schedule of Panel Distribution to Comply With Victor Record Release Plan

TOLEDO, O., September 6.—Harry Cuddeback, head of the Da-Lite Electric Display Co., in this city, well-known manufacturer of electric display signs for the Victor dealer, is back at his desk after a six months' illness. Mr. Cuddeback has resumed activities with his usual energy and is now making plans for an aggressive Fall campaign.

Coincident with the recent Victor announcement to the effect that Victor records will hereafter be released weekly the Da-Lite Electric Display Co. will issue one panel each week, featuring the outstanding record of each particular list. This arrangement will provide for fifty-two panels per year, instead of forty-eight as heretofore, thereby giving the dealer a series of timely, effective displays that will undoubtedly act as a most effective sales stimulant the year round.

H. LAUTER CO. ADDS NEW MODELS

INDIANAPOLIS, IND., September 6.—The H. Lauter Co., of this city, well-known manufacturer of talking machines and furniture, has just added six new console models to its talking machine line. The company is preparing an attractive circular featuring these models, emphasizing the fact that the cabinets are made at the Lauter plant and that the equipment includes well-known standard products. The six new models in the Lauter line are known as Models D, E, F, G, H and I and are manufactured in combination American walnut and combination brown mahogany. The cabinet designs are distinctive and the company is preparing to take care of the active Fall demand which present conditions indicate.

BLOOMINGDALE DEPARTMENT MOVES

Talking Machine Quarters Now in Fine Location on Third Floor—Audaks and Other New Equipment Add to Department's Efficiency

In order to take care of its increased business the talking machine department of Bloomingdale Bros., Inc., has moved to new quarters on the third floor directly in front of the elevators. The department took possession of its new home on September 4, and H. G. Berkeley, manager of the Bloomingdale phonograph division, states that his department is making plans for the greatest Fall trade in history.

The present home of the department is new in practically every sense of the word, as almost all of the old equipment was discarded in order to introduce new ideas to cope with changing conditions and modern requirements. A battery of Audaks is being used instead of booths, as only a few of the latter were retained. Unique display fixtures for presenting machines are located at vantage points in the department and maximum service is offered the store's clientele. Mr. Berkeley states that no change is contemplated in the lines to be handled by the department, which now comprise Victor, Sonora, Brunswick and Pooley.

OPENS WHOLESALE ESTABLISHMENT

The Specialty Phonograph & Accessories Co., manufacturer of "Specialty Brand" phonograph products, recently opened a wholesale establishment at 212 East 113th street, New York, N. Y. This company will manufacture the "Specialty" motor, suitable for portable and small talking machines, and will also be a jobber of parts and accessories, including needles, tone arms, main springs, sound boxes, tools for repair work, etc. The concern, which is well equipped to efficiently serve a large clientele, is planning a vigorous drive for business.

OKEH ARTISTS COMBINE IN TOUR

Dealers in Cities in Which Sara Martin and Handy's Band Are Scheduled to Appear Taking Advantage of Opportunity by Tie-ups

Two prominent Okeh record artists, Sara Martin, well-known blues singer, and Handy's Band, popular New York organization, have joined forces and are now on a concert tour. Under the direction of the National Music League, Inc., of New York, these artists are booked ahead through the South until October 1, after which they are planning to go to the Pacific Coast. They are playing to capacity audiences and attracting considerable attention on the road. The itinerary to date has included such well-known cities as Raleigh, Durham, Greensboro and Charlotte, N. C.; Columbia and Greenville, S. C.; Augusta and Atlanta, Ga.; Birmingham, Ala.; Memphis and Nashville, Tenn.; Paducah, Louisville and Lexington, Ky., and Cairo, Ill.

Sara Martin has won considerable popularity through her distinctive rendition of colored melodies and her Okeh records have won favor from coast to coast. W. C. Handy, leader of the band bearing his name, is well known as a publisher, composer and orchestra director and constitutes a perfect accompaniment for Miss Martin's singing. The artists sing and play all of the selections they have recorded for the Okeh library, and Okeh dealers in the cities where the company appears are using a great deal of very effective publicity featuring the concerts to excellent advantage.

FIELDS SONG SHOP BANKRUPT

A petition in bankruptcy has been filed against the Arthur Fields Song Shop, talking machine dealer, with a store at 2094 Seventh avenue, New York City. The liabilities of the concern are placed at \$14,973; assets unknown.

COMPARTMENT TO HOLD SIX RECORDS

HANDLE PUT ON TO STAY

AMPLIFYING TONE ARM DETACHABLE

WONDERFUL "ARTOIS" REPRODUCER

10 OR 12 INCH RECORD TABLE

STRONGLY CONSTRUCTED CASE

STRAPS TO FASTEN TONE ARM WHEN CARRYING

NEEDLE WELLS

POWERFUL SPRING WINDING ARM DETACHABLE FOR CARRYING

SPEED REGULATOR

STURDY LOCK FASTENERS

CONCEALED AMPLIFYING TONE CHAMBER

The MODEL "E" PORTABLE PHONOGRAPH

Artistic---Superior Tone Quality---Light Weight---Compact---Durable.

Not a Seasonal Portable.

By removing four screws, which hold the phonograph in the case, it is instantly converted into a table model.

A VERY DESIRABLE AND EXCLUSIVE FEATURE. PLAYS ALL RECORDS.

Write for Our Proposition

THE GENERAL PHONOGRAPH MFG. CO.
ELYRIA, OHIO.

"No, no, No-ra, no - bod-y but you, - dear,"

NO! NO! Nora!

A Fox Trot Sensation

"You can't go wrong With any FEIST song"

© LEO. FEIST Inc. N. Y. C.

OGDEN

Home Building Movement Felt by Trade in Increased Sales—Business Prospects Good—The News

OGDEN, UTAH, September 5.—Prospects for brisk Fall trade are exceedingly bright in this district, according to George S. Glen, of the Glen Bros.-Roberts Piano Co. "Already we have felt the influence," said Mr. Glen, "and if present indications may be taken as a criterion we have reason to believe that a decided impetus will be given the talking machine business in northern Utah, southern Idaho and western Wyoming. Particularly gratifying are the sales of higher-priced console Victor machines, which seem to be the most popular right now. The home-building movement is reacting in our favor. Many of the home buyers are young folks who are furnishing their places completely and we are benefiting by the sale of pianos, talking machines and small goods."

Thomas J. Holland, sales manager of the Glen Bros.-Roberts Co., reports an unusually successful campaign among the women attending the annual cooking school conducted by a local newspaper. Daily demonstrations of pianos and talking machines were conducted before 2,000 women, altogether, he said. They were shown the latest types of machines and heard the latest records, both popular and classic. "This gave us a valuable personal contact with the women, who are the actual buyers," said Mr. Holland, "and we benefited very materially."

Mr. Holland recently returned from a tour of southern Idaho and the prospects of bumper crops this Fall have put the farmers in a very optimistic mood, he said. "The outlook in southern Idaho and northern Utah appears so bright that the company has put men in these territories permanently."

Ezra Jones, of the Jones Phonograph Shop, Brunswick and Sonora dealer, has returned from a business trip to Wyoming with Leroy Madsen, of the Lyric Music Co. They arrived at Kemmerer, Wyo., just after the explosion in the Frontier mine that killed ninety-eight men.

The trip took the two into the Jackson's Hole country of Wyoming, where they sounded business conditions. The abundant rain has benefited the dry land crops and lifted the ranchers out of the depression they have been in for the past two years. Mr. Jones said he sold a number of phonographs on the trip and at Big Piney, Wyo., a ranching town, he sold talking machines to the two hotels. He remarked that local business has improved and that he is preparing for a very active Fall season.

Glen Thomas, of Browning Bros., Brunswick dealers, who has returned from his vacation spent in Jackson's Hole, Wyo., says that business, although quiet during the Summer months, has picked up materially. The demand for popular records is still good and business in the more classical numbers is improving.

The Proudfit Sporting Goods Co., distributor for the Edison, states that indications point to the resumption of active business that has been in a slump. The outlook has improved to such an extent, the company said, that Thomas S. Hutchinson, field representative, is being kept the greater part of the time in southern Idaho, where prospects for the sale of machines and records are unusually good.

The William Music Co., Steger and Pathé dealer, reports a revived interest in talking machines.

C. E. Armstrong & Co. report that business is keeping up well in view of the usual slow season. "Better business than usual" is the report of this concern. The company handles Edisons and Pathés.

NEW MUSIC HOUSE IN NORFOLK, VA.

The Foreman Music Co., Inc., Norfolk, Va., has been incorporated with a maximum capital stock of \$25,000 and a minimum of \$1,000. E. C. Foreman is president of the company; C. B. Foreman, secretary, and V. L. Page is the other incorporator. The company will deal in musical instruments and supplies of all kinds.

BLATT BACK AT OLD LOCATION

COLUMBUS, O., September 6.—The Blatt Music Store has resumed business at its former location, 133 South High street, after four months of building and repairing following the fire.

THE NEW HOLIDAY BUSINESS BOOSTER

A Celluloid Button with body attachment in four colors with dealer's imprint. So cheap they can be given away generously. 5,000 kiddies wearing these will give the dealer some publicity. Splendid jobbers proposition. Write at once for samples, prices and full details.

Philadelphia Badge Company
Manufacturers
942 Market Street Phila., U. S. A.

"RED HEAD GAL" CONTEST

Live Brunswick Dealers Promote Sales of Records by Unique Popularity Contest

Hallett & Pierson, Brunswick dealers in Rutherford, N. J., have achieved considerable publicity recently by asking who is the most popular "Red Head Gal" and offering a reward for the answer. Announcements over the signature of Hallett & Pierson, giving the details of this unique contest, read as follows: "To the auburn-haired lady receiving the most votes between now and September 10 we will present a beautiful ukulele. Ten votes are given with each purchase of Brunswick records, regardless of selection, but if you want to get enthused over auburn hair hear 'That Red Head Gal' by the Isham Jones Orchestra on record No. 2412, and by Marion Harris on record No. 2444." The contest provided a number of interesting questions, particularly as to just what shade of hair may be called auburn and not red.

FRANK ELMER TO OPEN NEW STORE

WATERTOWN, N. Y., September 7.—Preparations have just been started on a new music store at No. 4 Paddock Arcade, which Frank M. Elmer will occupy in a few weeks. Mr. Elmer already has a store in the Paddock Arcade and also conducts a branch on Arsenal street. Victrolas, records and phonograph supplies and accessories are handled.



The demand of the public for the NEW EDISON was never greater. The models never more artistic. The records never better. The service in record releases never so prompt.

These with the new low level in prices on instruments and records make

Large Profits Certain

We have a few towns open for dealers.

Write for particulars.

Proudfit Sporting Goods Co.
OGDEN, UTAH
Intermountain Distributors
Utah, Idaho, and Part of Wyo. and Nev.



Button 1 1/4" dia., with body 2 3/4" long

THE TREASURE CHEST



“Add to Your Treasure”

The “Treasure Chest” is not a thing that happened over night, nor through accident. Nor is it the result of a pet idea. It is the “brains” of merchandising experts, keen minds in the talking machine business; men who have had years and years of thorough, hard and practical schooling—yes, those who know what will “go over” with the public.

Not only was matured thought necessary to create the “Chest” but it required the outlay of a large sum of money.

And what was all this done for? To profit in selling “containers and record envelopes” to Victor Dealers? No indeed!

Mr. Victor Dealer, the “Treasure Chest” itself returns no profit whatever to us nor any other Victor Wholesaler. It was not gotten up with that thought in mind. The “Treasure Chest” was made solely for one purpose—to produce greater record sales for Victor Dealers. And it does precisely that.

Dealers who are handling this wonderfully attractive offering well know its value—and equally appreciative is the public who have seen it.

The BRUNO organization sincerely works in the interest of all enterprising Victor Dealers. What it creates or produces is for the sole benefit of those Victor Dealers everywhere.

Now's the time to “add to your treasure” by adding the “Treasure Chest” to your stock.

*Ask your Wholesaler for the “Treasure Chest.”
He will serve you.*

C. Bruno & Son, Inc.

351-353 Fourth Avenue

New York

Victor Wholesalers to the Dealer Only

The “Treasure Chest,” beautifully printed in full color, comprises six ten-inch double-face records (12 selections) of the choicest instrumental music of foreign lands. The Chest and envelope of each record has on it a spirited and effective drawing appropriate to the music, together with an interesting and vivid annotation.

NOVEL RECORD ADVERTISING STUNT THAT WENT OVER BIG

Souvenir Records of the Appearance of Marion Harris, Brunswick Artist, in Local Cafe, Prepared by the Fitzgerald Music Co., of Los Angeles, Sell Like Proverbial Hot Cakes

One of the most novel advertising "stunts" for tying up with the local appearance of an artist was recently put over by the Fitzgerald Music Co., of Los Angeles, Cal., during Miss Marion Harris' appearance at a local café, the Club Royale, on Washington boulevard, near the City of Angels.

The Fitzgerald Music Co. is an exclusive Brunswick dealer and Miss Harris is an exclusive Brunswick artist, so, in addition to a great amount of newspaper publicity and to an unusual window display featuring Marion Harris' appearance and her Brunswick records, the Fitzgerald Music Co. evolved the idea of hav-

records sold might be kept as souvenirs of the occasion and be lasting reminders of Miss Harris, the Club Royale and the Fitzgerald Music Co. This label is a cut-out, so that when pasted on the records neither the name Brunswick nor



Autograph Souvenir Record Distributed

The wording on the label above the signature and address of the Fitzgerald Co. reads: "Souvenir autographed Brunswick record commemorating Marion Harris' Club Royale appearance, July-August, 1923. Sincerely yours, Marion Harris (Signature). Singing at the Club Royale, Los Angeles' most distinctive cafe."

the title or number was hidden, but prominent on the label was the name of the Club Royale Café, with Miss Harris' own personal signature just above and the Fitzgerald Music Co.'s name on the bottom. The background of the label was white with crimson and gold letters.

In the lobby of the Club Royale Café the Fitzgerald Music Co. placed a table with a display of Marion Harris souvenir records and had in attendance at this table a very attractive young lady dressed in Spanish costume who sold the records. Attractively engraved cards announcing the sale of the records were placed on each table in the café.

Miss Harris sang twice during each evening; first at 10 o'clock and the second time at 12 o'clock, and directly after each one of Miss Harris' appearances the young lady in charge of record sales would go around among the tables with a tray of souvenir records and sell or take orders for them.

The records delivered to the customers in the

café were enclosed in an envelope specially designed and printed for the occasion, but in most cases the young lady merely took orders and had the records delivered to the customers the next day, thus saving the purchasers the trouble of carrying a package of records with them and demonstrating the firm's service.

The idea was entirely new and novel, but went over in the biggest sort of way—the first week or ten days the record sales at the café averaged almost one hundred per night—and this in view of the fact that the price of these souvenir records was raised from 75 cents to \$1 each, but the actual sales made at the café were really one of the smallest benefits derived. The great advertising and publicity received by the Fitzgerald Music Co. from this unusual sort of tie-up have been inestimable.

As the Club Royale Café is one of the largest and highest class "dance palaces" in Southern California, and as some six to eight hundred better-class, amusement-loving people visit this café each night, the value of the "stunt" in an advertising way can readily be seen.

A NEW FORM OF RETAIL SWINDLE

So-called Talking Machine Salesman Works Fast in Ohio and Mulcts Dealer of Money, Machine and Records

It sometimes happens that a talking machine dealer is called upon to guard against dead beats within his own establishment, as well as those outsiders who make a practice of endeavoring to get something for nothing. A case in point has come up in Ohio where a so-called salesman has developed a somewhat new form of swindle, which is described in a letter sent to Secretary Hyre of the Music Merchants' Association of Northern Ohio as a warning to other music merchants in that section of the country. It might be well for trade members to study the case in order to be on their guard against a similar experience, which is described in a letter as follows:

"One of the things our Music Merchants' Association is for is the protection of its members, and we feel it our duty to pass along the benefit of a recent experience.

"A good-looking stranger with a foreign accent came to town and asked for a job selling machines on a commission basis, stating that he could pick up a few orders among the Polish people who preferred to deal with one of their own countrymen.

"Agreeing that no results, no pay was the contract, we let him have catalogues, and later in the day he phoned in that he had a sale for a portable Victrola, asking that it be gotten ready for him to demonstrate to a customer. Later, still, he came for a machine, with a list of Polish records, stating that he had a prospect for a larger machine, also.

"A few minutes before closing time he rushed in with a check purporting to be given by a local Polish resident and made out for a few dollars more than the price of the Victrola and records.

"We cashed back the balance plus 10 per cent commission and the good-looking gentleman departed with a promise of 'More business tomorrow'."

"Of course the check is no good, so the loss is machine and records plus a few dollars of real cash.

"The name of John Potocki was given, the man being about forty years old, five feet eleven inches tall, well dressed and well posted on phonographs and pianos."

MOTORS

Ready for Delivery

Double Springs; play two 10-inch Records; suitable for Portable Phonographs. Sample, \$3.75. Larger motor playing two to three 12-inch Records; suitable for Phonograph selling for \$100. Sample, \$5.75.

MERMOD & CO., 16 East 23d St. N. Y.
Telephone Ashland 7395



The Fitzgerald Co. "Record Girl"

ing her records on sale at the café during her appearance there and of designing a special label for the occasion to be pasted over the regular Brunswick label on the records, so that the

FULL LINE of HARDWARE

FOR UPRIGHT, CONSOLE AND PORTABLE PHONOGRAPHS. IN NICKEL, GOLD AND SPECIAL FINISHES.

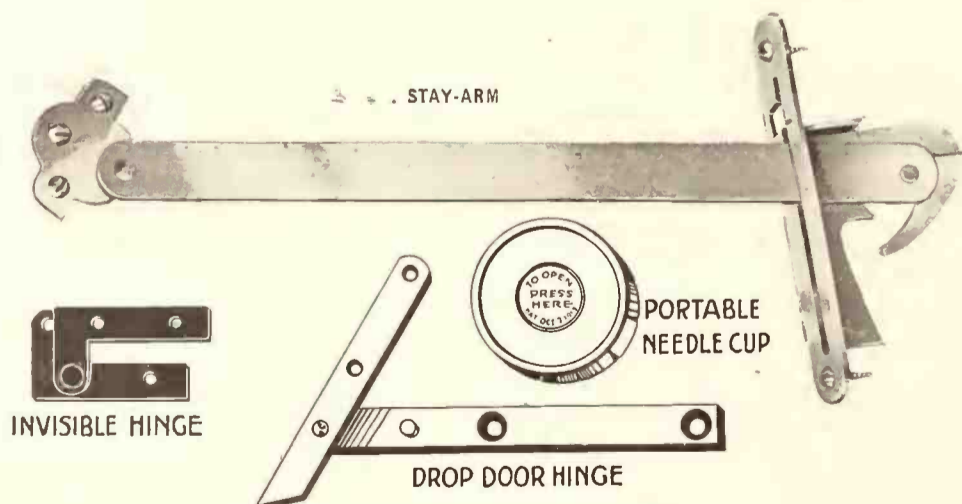

We have been catering to the hardware needs of the talking machine industry for a number of years. Consequently we are in a position to give attention and service of the highest calibre.

H. A. GUDEN CO., Inc.

227 CANAL STREET

NEW YORK, N. Y.



The INSTRUMENT FOR PARTICULAR PEOPLE

Three Reasons Why the Kimberley is a Sales Leader

1. **DISTINCTIVE CABINET DESIGNS**
2. **HONEST VALUES**
3. **UNUSUALLY LIBERAL DISCOUNTS**

Distinctive Cabinet Designs

Every cabinet in the Kimberley line was designed by experienced cabinet draftsmen and represents the last word in modern cabinet construction. Designed to satisfy the requirements of the most discriminating purchasers, Kimberley cabinets are noteworthy for their artistic lines, superb finish and superior workmanship.

Honest Values

The Kimberley phonograph is manufactured in its entirety in our modern, up-to-date plant at Perth Amboy, N. J. We are not attempting to produce a cheap, inferior product of the commercial type, but on the contrary are offering the trade and public honest values that challenge comparison. Every piece of material entering into the construction of the Kimberley phonograph is the best the market affords, and for this reason we do not hesitate to market Kimberley phonographs on a basis of guaranteed satisfaction to the purchaser.

Unusually Liberal Discounts

The discounts we offer to the trade are exceptionally liberal, but we are not sacrificing quality to provide for this discount. By cutting down our overhead to a minimum, by manufacturing in large quantities and by reason of unusually favorable factory and shipping facilities, we can give the dealer or jobber far larger discounts than the recognized trade figures.

You Need the Kimberley Agency Now

The Fall season is here, and you must have a recognized sales leader to get your share of the business. Write today for our illustrated catalog, showing the complete Kimberley line, consisting of seven models, retailing from \$100 to \$275. Let us tell you all about our special dealer proposition. It will mean money in your pocket.

There is limited territory open for a few jobbers. If you are interested write today

The Kimberley Phonograph Company of New Jersey

Perth Amboy, N. J.

Factory:
Perth Amboy, N. J.

Office and Show Rooms:
206 Broadway, New York City

RICHMOND

Jobbers Are Rushed Supplying Retailers — Plenty of Employment and Good Crops Create Optimism

RICHMOND, VA., September 7.—The fact that there is plenty of employment for everybody who wants to work, coupled with the fact that crop prospects in the Richmond territory are declared to be better than they have been for several seasons, is helping to stimulate business greatly.

Indications point to an exceptionally good Fall business, according to Richmond talking machine jobbers and retailers. H. Wallace Carner, Starr jobber, says that orders are coming in so fast that he is finding it difficult to supply the demand in the Virginias and Carolinas which he covers. Demand is particularly brisk for console models which, he says, are now selling 50 per cent better than cabinet, whereas the latter used to be the leader in demand. While he has appointed no new dealers in recent months, he has been having his hands full keeping up with the business coming in from those already appointed. Record business is also brisk, having doubled within the past year. The new Gennett record, "Cut Yourself a Piece of Cake," gives promise of equaling, if not surpassing, "Yes, We Have No Bananas" in popularity, he says. Mr. Carner has just returned from a business trip through southwest Virginia and reports the outlook in that section better than ever before.

Bright Prospects, Says R. C. Gentry

R. C. Gentry, who travels southern Virginia and both the Carolinas for the Corley Co., Victor jobber, reports that there is a marked improvement in conditions in South Carolina, which had been considerably below standard for some time. The boll weevil menace is not so great this year, he says, and the farmers are looking for a better cotton crop as a consequence. Conditions are also improved this

year in eastern North Carolina, where cotton is the staple crop. In western North Carolina, where there is a greater diversity of industry, everybody is apparently prosperous and looking ahead to big Fall business in practically every line. Virginia is likewise on a stable basis, with bright prospects ahead. Tobacco, the staple crop of this territory, gives promise of bringing big prices.

Live "Victor" Dog in Window Attracts

Medium-priced consoles are the leaders throughout the territory, Mr. Gentry ascertained, in calling on various dealers. In Greensboro he came upon one dealer who has devised a novel advertising scheme to exploit the Victor. The advertisement consists of the display of a live fox terrier in a front window that is a facsimile of the famous Victor trade-mark. The dealer is the Greensboro Music Co.

In Charlotte Mr. Gentry and several other Victor salesmen chanced to come together and were thus enabled to exchange views on business, all being pleased with prospects.

In the group besides Mr. Gentry were Dave Pruitt, Victor factory representative; Clem Salter, Parker Gardner, Charlotte, and C. H. Ray, Elliott Talking Machine Co., Atlanta.

New Victor Dealer Appointed

The Corley Co. announces the appointment of Winstead's, of Conway, S. C., as a new Victor dealer. This firm reports that colored artist records are going best in Virginia and the Carolinas.

Walter D. Moses Co., Victor dealer, reports business having been from 10 to 20 per cent better in August than in the corresponding month of last year. This is taken as an indication that September and the other Autumn months are going to be better than the same period in 1922.

Brisk Demand for the Edison

The C. B. Haynes Co., Edison jobber, found August a better month than July and the company is anticipating greatly improved business during the Fall. Substantial sales have already been made and in addition there has been an extra number of inquiries. Encouraging reports were brought in recently by the following deal-

ers visiting the Richmond house: Bernard Allsbrook, Dixie Furniture Co., Scotland Neck, N. C.; George I. Allen, Worley Furniture Co., Wilson, N. C.; N. Strauss, Bennettsville, S. C.; C. D. Hubert, Hubert Jewelry Co., Victoria, Va.

Edisons as Charity Contest Prizes

The C. B. Haynes Co. announces that the Methodist Orphanage of Richmond won first prize in the charity contest, in which a radio outfit and eleven Edison machines were offered as prizes, that institution polling a total of 5,392,969 votes. As it was already equipped with a talking machine, the orphanage selected the radio set. Sheltering Arms Hospital came second with 4,149,759 votes and St. Joseph's Orphanage third with 3,197,184 votes. The Baptist Home for Aged Women captured fourth place with 2,220,452. Twenty-nine Richmond business houses participated in the contest. Under its terms a vote was allowed for each penny's worth of purchase. Most of the participating houses expressed themselves as well pleased with results achieved.

The Haynes Co. thinks so well of it as a sales promotion idea that it has circularized its dealers suggesting that they endeavor to have similar contests staged in their communities.

A. L. M. Wiggins, vice-president of the Trust Co. of South Carolina, president of the Southern Retail Merchants' Association and general manager of J. L. Coker & Co., Inc., Edison dealer in Hartsville, S. C., was a recent visitor to Richmond on the occasion of the Southern retail merchants' annual conference, over which he presided. Mr. Wiggins called on the C. B. Haynes Co., Edison distributor, and placed a substantial order for Edisons.

J. D. Spiers, Edison dealer in Smithfield, N. C., and Mrs. Spiers were visitors to the C. B. Haynes Co. Mr. Spiers has been enjoying an increasing business all Summer and is preparing to do an exceptionally large Edison business this Fall. Other visitors included H. B. Lasting, in charge of the Edison department of S. Lasting & Bro., Portsmouth, Va.

F. W. Danner, Edison field representative for the C. B. Haynes Co., has returned from a successful trip through North Carolina. Mr. Danner has turned in an exceptionally large volume of business from the dealers he called on and reports that dealers are preparing for a large Fall business.

Goldberg Bros. Busy in New Home

Goldberg Bros., Pathé jobbers and dealers, who recently moved from 1211 East Main street, this city, to more spacious quarters at 5 North Thirteenth street, report a brisk business in Pathé concert models designed for use in dance halls and other public places. One of these models was recently sold to the Lakeside Country Club. Another country club of this city has asked that one be placed on display.

Petersburg Music Co. Incorporates

The Petersburg Music Co., Inc., Victor dealer, which recently took out papers of incorporation, had been previously operating as the Petersburg Music Co., with George B. Carter and J. K. Fletcher as partners. Officers of the incorporated firm are: George B. Carter, president; F. N. DeLuca, vice-president, and J. K. Fletcher, secretary. Mr. Carter is an automobile dealer and is not actively identified with the firm. Mr. Fletcher has been its manager and will continue in that capacity. Mr. DeLuca is well known in Petersburg musical circles. The firm handles general musical merchandise lines. Maximum capital is limited to \$50,000 and minimum to \$5,000.

J. Flegenheimer, field representative of the C. B. Haynes Co., has returned from a pleasant vacation spent in the North and has departed on a trip to call on Virginia and Tennessee dealers.

THE C. B. HAYNES, CO. INC.

Disc and Amberola Instruments
DISTRIBUTORS
Recreations and Amberol Records

\$ A L E S P R O F I T S \$

Brisk fall business has begun and the busy winter season is approaching

A few more dealerships must be established to serve this growing demand

Our Salesmen are now in the Carolinas and Virginia calling on interested merchants

A letter from you may result in the most profitable transaction you have ever made

ACT NOW

RICHMOND, VIRGINIA

E
D
I
S
O
N

S
E
R
V
I
C
E

T
H
A
T

S
A
T
I
S
F
I
E
S

Goodnight

The Waltz Sensation of 1923

Nearly as good as
"Three O'Clock in the Morning"

"You can't go wrong with any FEISTSONS"

The Jewel-Tone Reproducer and Tone Arm

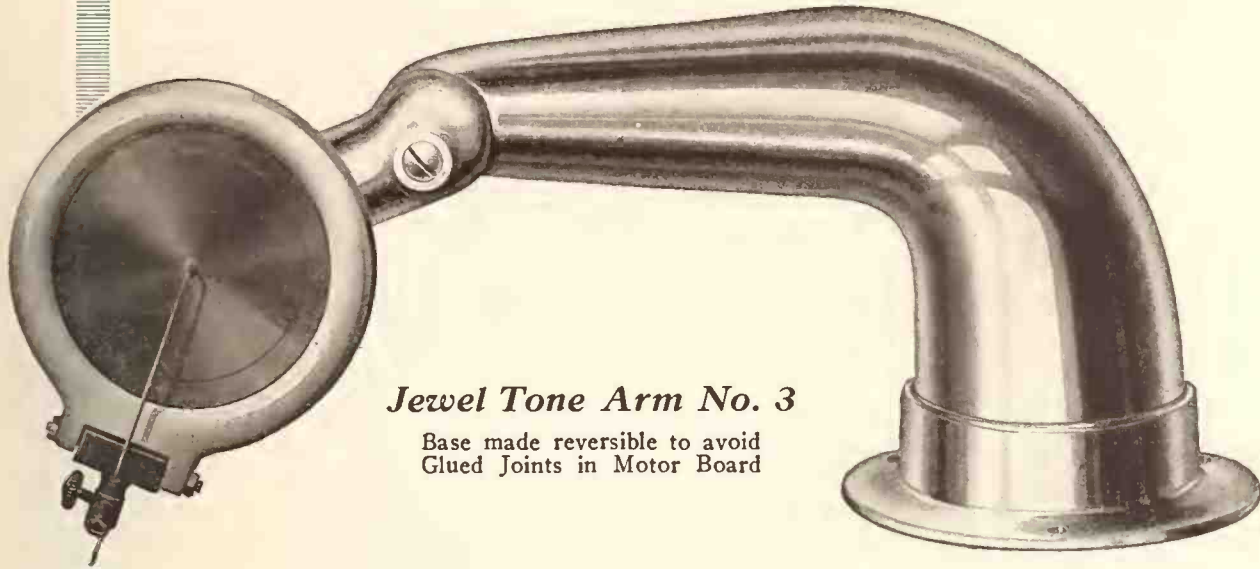

Jewel Tone Arm No. 3

Base made reversible to avoid
Glued Joints in Motor Board

Original and Exclusive Features

Play Edison and Pathe Records in actual Edison position and with a fibre needle.

Made in 8½", 9½", 10½". When thrown back on tone arm in Edison position, the reproducer lies flat, so dome cannot touch it when closed.

Finished in nickel or gold plate.

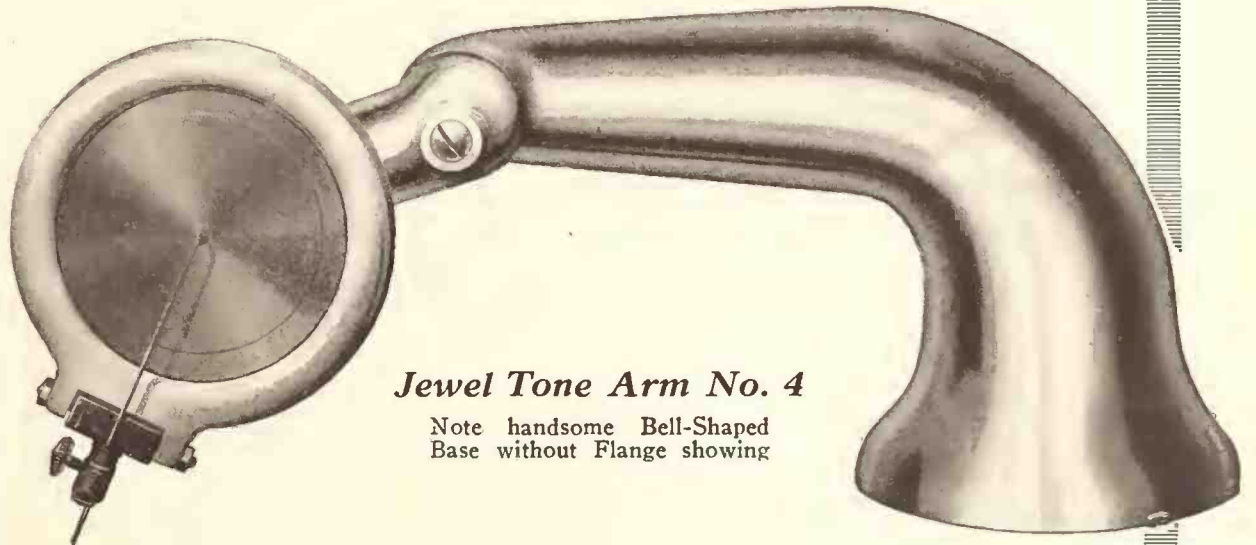

Jewel Tone Arm No. 4

Note handsome Bell-Shaped
Base without Flange showing

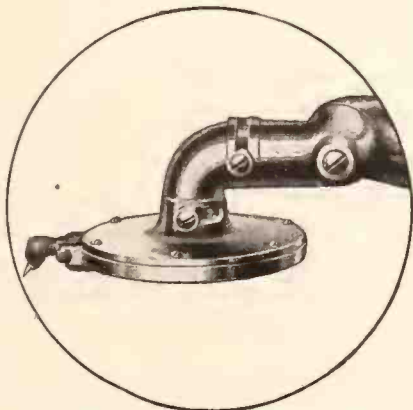

Reproducer in position to play
Edison Records with Saffo
point or fibre needle.

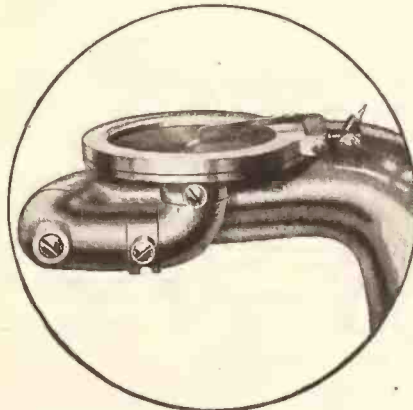

Shows reproducer thrown back
on tone arm in Edison position.
Dome cannot touch it.



Equipped with or without
Mute, Mica or NOM-Y-KA
Diaphragm.



150-160 Whiting Street

CHICAGO, ILLINOIS, U. S. A.

NEW PHONOMOTOR CO. CATALOG

Various Talking Machine Accessories Manufactured by Prominent Rochester, N. Y., Concern Described in Attractive Booklet

ROCHESTER, N. Y., September 5.—The Phonomotor Co., of this city, has just issued an attractive catalog featuring its various products—the Phonomotor, the Phonostop and the Need-A-Clip. W. F. Hitchcock, proprietor of the Phonomotor Co., is responsible for the preparation of this catalog, which can, undoubtedly, be used to splendid advantage by the trade.

The Phonomotor, which is an electric equipment complete in every detail, is illustrated and described effectively. Particular attention is paid to the fact that this product is guaranteed perfect from all defects, except those caused by its abuse by the owner. The Phonostop, which is an automatic stop well known throughout the trade, is also described briefly, and the Need-A-Clip, a fibre needle pointer that has attained considerable popularity, is interestingly featured.

The text of the book calls attention to the salient points of the Phonomotor, giving details regarding the frame, bearings, worm gear, the number of moving parts, etc. There are also presented several letters that Mr. Hitchcock has received regarding the satisfaction the Phonomotor has given its purchasers.

TO MAKE RECORDS IN LOS ANGELES

LOS ANGELES, CAL., September 4.—The Harris Record Co. has been organized in this city, with Jess M. Harris, vice-president and musical manager, and Arthur H. Walbridge, secretary and treasurer. The company has secured a plant in Hollywood and has begun manufacturing operations. The records will bear the trade-mark name "Triumph."

The Munholland-Danwitz Furniture Co., Columbia dealer, Monroe, Pa., has moved into a new building at 349-351 De Siard street, and the firm now operates one of the finest music stores in this vicinity.

REPAIRS

TALKING MACHINE TROUBLES AND HOW TO REMEDY THEM

Conducted by Andrew H. Dodin

THE SALESMAN AND THE MACHINE

In the construction of a talking machine there are any number of important little facts that a salesman should make himself thoroughly conversant with, so that, when a customer wants to know this or that about the machine being demonstrated, he will be able to answer accurately and promptly.

The placing on the market of so many different machines in the last few years has put the salesman in a different position than he held formerly, when he sold his goods by name only, the customer never asking, or, for that matter, caring, what was on the inside of the machine.

To-day one must show what merit the motor has in comparison to another, what the good points of the sound box and tone arm are and how the cabinet is made and finished to be equal to, or better than, another make.

The salesman should first get all the information he can from the manufacturers of his particular machine, particularly in relation to the motor construction, and then he should make his own comparisons with the machines of the same type and price in other makes.

He should acquaint himself with the different parts of the motor, the width and length of the main springs and the number of records it will play with one winding.

He should be able to point out to the customer the proper places to oil and grease the motor and should make it very plain that it is to their benefit to oil the motor every few weeks to prevent wear of parts and to insure perfect running.

He should be able to point out the construction of the governor and explain the action of the governor regulator, how by moving the speed screw it in turn moves the governor lever and friction pad, allowing the governor to go faster or slower, which raises or lowers the pitch of the voice or music, as the case may be.

The sound box is most important and the customer is always very much interested in how the voice is obtained from it. Get acquainted with its construction. Is the diaphragm made of mica, paper, aluminum or some special composition? Are the insulating gaskets of solid rubber or tubing? Has the tone arm a universal joint enabling you to play any make of record, and can you regulate the volume of sound in any other way than by changing to a softer-toned needle?

Are the panels of the cabinet made of three or five-ply material, which parts are of solid wood and which veneer; has the cabinet been given two coats of varnish or three; how many records can be placed in the record compartment? These are some of the numerous questions which the average customer asks and for which the salesman should have ready, intelligent answers.

SOME GOOD COLUMBIA PUBLICITY

The Columbia Graphophone Co. is receiving timely publicity through the use of a Columbia phonograph in one of the acts featured in "George White's Scandals," at the Globe Theatre. The phonograph plays a prominent part in the skit and so far has not been afflicted with stage fright.

GILSENAN OPENS IN PERTH AMBOY

PERTH AMBOY, N. J., August 14.—The Gilsenan Piano Co. has just opened a store here at 284 State street and has inaugurated a special sale of uprights and players by way of introduction to this community. This concern also has a store in New Brunswick.

BANNER RECORDS

"full-o-pep"

a famous 50c record



BARNEY GOOGLE

BANNER RECORDS

"full-o-pep"

beat the field
on EVERY ONE of these hits!

Proof that BANNER releases the hits FIRST!
Assurance that BANNER brings extra profits!

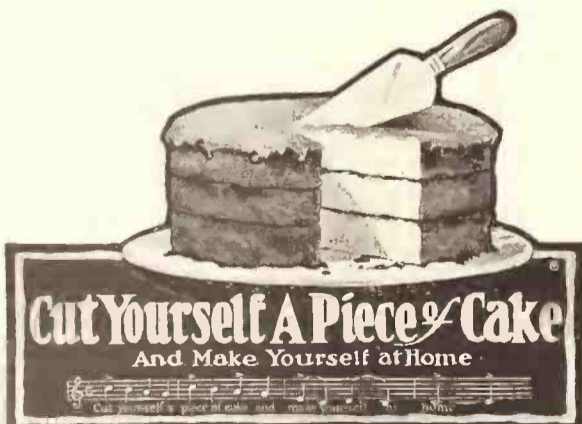

HOT ROASTED PEANUTS

(A NUTTY SONG WITH A CRACKIN' GOOD TUNE)

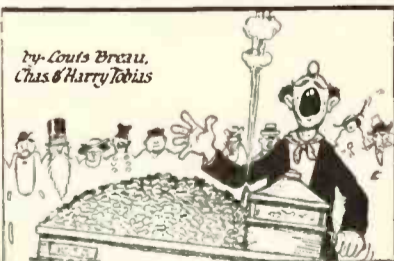

Can you afford to overlook this service?

PLAZA MUSIC COMPANY

18 West 20th Street

New York City

TALKING MACHINE MEN'S OUTING

Sports and Sail on Long Island Sound Contribute to Enjoyment of Gotham Dealers and Friends at Annual Outing of Association

With perfect weather as an added attraction, the members of the Talking Machine Men, Inc., thoroughly enjoyed their annual outing held on Tuesday of this week. This year's event took place at Karatsony's Hotel, Glen Cove, L. I., where last year's outing was held, but the entertainment committee provided a program that made the 1923 outing the best ever.

Instead of using buses, the dealers and their friends assembled at Pier A on the North River, where the steamer "Seagate" was waiting for their special accommodation. A delightful two and one-half hour sail up the sound provided the necessary incentive for an enjoyable "shore breakfast," subsequent to which various athletic games were scheduled. Sol Lazarus, chairman of the entertainment com-

mittee, was in charge of the field sports. An interesting baseball game between teams captained by "Jim" Donnelly and "Jim" Davin resulted in a victory for the former by the score of 6 to 5. In the swimming and diving events O. P. Graffen proved the champion, winning several prizes after keen contests. In the three-legged race H. E. Speare and "Chick" Mariniss, representing the Musical Instrument Sales Co., were the winners. Mrs. Norman won the ladies' race on the cinder track and also the ladies' swimming race. The prize fox-trot was captured by "Jim" Davin, with Mrs. Sidney Coleman as his partner. Otto Goldsmith, dancing with Sol Lazarus' daughter, Ethel, was the winner in the lucky number waltz contest. The fat man's race was won by one of the members of Selvin's Orchestra, which furnished music during the outing.

After the games were finished the members of the party did ample justice to an excellent shore dinner, and the ride home by moonlight was a fitting climax to a day of enjoyment.

PLANS "PHONO-VAUDETTE" CAMPAIGN

Commercial Art Shop, Covington, Ky., Arranging for Drive on Clever Phono-entertainment Device—Excellent Window Attraction

The Commercial Art Shop, Covington, Ky., is making plans for an energetic sales campaign in behalf of the "Phono-Vaudettes." This unique product consists of a miniature stage which is just large enough to stand on the phonograph in front of the table. It is artistically designed and brightly colored, furnishing a realistic setting for the performers, who dance to the record as it plays.

The operation of the Phono-Vaudette is very simple, but unusual effects are received by reason of the fact that the performers are constantly going through new and original evolutions while keeping step to the music. The dancing characters presented in Phono-Vaudettes include "Shuffling Sambo," "Scotch Lassie," "Hawaiian Dancer" and "Tramp Comedian." The Commercial Art Shop has suggested to the dealers that Phono-Vaudettes can be used to advantage as a window attraction to draw the attention of passers-by, and this is especially true during the Fall and holiday season. The company is planning to co-operate with its dealers along practical lines in developing a demand for this novelty.

OUTING GREETINGS FROM THE AIR

At the recent outing of the Talking Machine Men, Inc., held at Glen Cove, L. I., one of the interesting features was the appearance in the skies of the "Brunswick Aeroplane," from which were scattered greetings to the outing visitors from the Brunswick-Balke-Collender Co. The aeroplane "Brunswick" is maintained in Jamaica, L. I., by Archie Smith, of Smith's Brunswick Shop, and under an arrangement with H. A. Beach, Eastern sales manager of the Brunswick Co., it appears frequently over the Polo Grounds and at other outdoor sporting events in Greater New York.

L. HOCHBERG BUYS BUSINESS SITE

GREENSBURG, PA., September 5.—The new quarters at West Otterman street and Pennsylvania avenue here of L. Hochberg, prominent local music and jewelry dealer, are being remodeled and renovated to meet the needs of Mr. Hochberg's business. In addition to jewelry a complete stock of talking machines and pianos is handled by this enterprising dealer.

HUDSON MUSIC CO. INCORPORATED

The Hudson Music Shop, of Hastings, N. Y., has been granted a charter of incorporation under the laws of this State. The concern is capitalized at \$10,000. Incorporators are A. Barchas, R. Lurie and P. Block.



Members of the Talking Machine Men, Inc., and Their Wives and Friends at the Annual Outing at Karatsony's, Glen Cove, Long Island

The PHONOMOTOR CO.

WM. F. HITCHCOCK, Proprietor

121 West Avenue Rochester, N. Y.

An Electric Equipment for the PHONOGRAPH

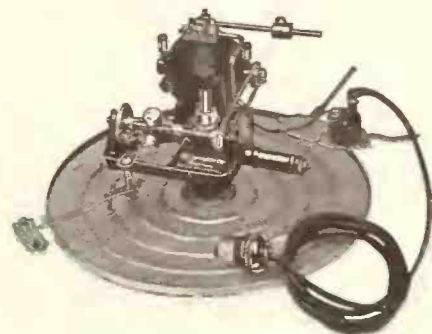

Fully GUARANTEED

Universal—alternating or direct current. Complete, with every part ready to run.

Sample, mounted on motor board, 12x12 3/4, \$25.00 C.O.D. Money back if not satisfactory.

The PHONOSTOP

An automatic stop for all talking machines, 100% efficient. **STANDARD FOR EIGHT YEARS**



Guaranteed.

Sold direct to manufacturers all over the world.

Nickel or Gold.

Your phonograph is worthy of the best stop.

This is the only one.

Your customers appreciate it

Our NEED-A-CLIP

A fibre needle clipper with hardened tool steel blade, retails at 75c, does its work perfectly, indefinitely.

WE ALSO SELL GENERAL PHONOGRAPH HARDWARE

Trade Prices upon application

The PHONOMOTOR

Trade-Mark Reg. U. S. Pat. Office

TAX PROBLEMS ARE AGAIN TO THE FORE IN WASHINGTON

Coming Session of Congress Likely to Take Up the Entire Tax Situation Once More—President Said to Favor Such Action—Strong Move Likely to Enact a General Sales Tax

WASHINGTON, D. C., September 8.—With the return from Europe of Senator Reed Smoot, of Utah, who will be chairman of the Senate Finance Committee in the next session of Congress, plans are taking shape for the reopening in December of the tax question. During the coming session of Congress there is no doubt but that energetic efforts will be made to secure the repeal of all remaining war taxes, with which will be coupled, in one form or another, a sales tax which is expected to furnish the revenue which would be lost by the elimination of the other levies.

It is understood that President Coolidge is in favor of the opening up of the tax question in a general way, so as to bring about a reduction in income taxes, particularly in the lower brackets and the surtaxes on large incomes. At the same time the Administration is on record as favoring a constitutional amendment

under which bonds now exempt from tax would be reached. It is estimated that more than \$10,000,000,000 have been invested in such bonds, and that money returns no revenue to the Government. On the other hand, Senator Smoot is opposed to the opening of the question because of the fear that the radicals will take advantage of the opportunity to slip in legislation providing for a return of the excess profits tax and other features that the leaders are side-stepping.

The House of Representatives, generally speaking, favors tax reduction and tax revision. A big fight will be waged, if the opportunity is afforded, for a return of the excess profits tax. The sales tax will be seriously opposed, and it is doubtful if it can be put through, especially in view of the many changes in the House membership just brought about at the last elections. The farmers are antagonistic to this

proposal, and the farming interests will wield far-reaching influence in the next Congress. Senator Smoot, however, will again push his sales tax plan, and expresses optimism as to the result, and the United States Chamber of Commerce, representing about half of the business men of the country, has gone on record as being in favor of such a tax and has carried its recommendation to President Coolidge. The Chamber advocates the repeal of all remaining war excise taxes, with any revenue which might be needed as a result of their elimination to be collected by the tax on sales, making all share the burden equally.

Tax legislation, under the Constitution, must originate in the House. President Coolidge will talk with House leaders on the matter of revenues, but Senator Smoot and his Senatorial colleagues will have a great deal of influence with the Administration in mapping out the kind of legislation to be sought. While this legislation must originate in the House, it is generally in the Senate that the final pruning is given to bills, and it is in the upper branch of Congress that undesirable legislation is most often defeated. The Finance Committee is the most powerful body in that respect, and with a decided Republican majority there would be no doubt as to the fate of legislation introduced by opponents of the Administration. However, the Republican majority in the Senate, which was twenty-one at the last session, has been cut to six, and of the ten Republican members of the old Finance Committee only five will be in Congress this year. It is probable, in view of the reduced Republican majority, that there will be a demand for increased Democratic representation on this committee, and also for more complete representation of the so-called farm bloc.

PHILPITT & SON GOT THE LETTER

Missive Addressed to "Best Music House" Reaches Proper Destination

JACKSONVILLE, FLA., September 7.—That the music house of S. Ernest Philpitt & Son in this city stands pretty high in the estimation of the postal officials was indicated recently when a letter addressed simply "Best Jacksonville Music Store, Jacksonville, Fla.," was delivered without delay to the Philpitt offices. As a matter of fact, the post office was right, for the letter was intended for that particular music house, as were several previous letters bearing similar general addresses.

Theodore H. Bower, manager of the local Philpitt store, with Mrs. Bower, will leave this week for a vacation trip through the North, stopping at Baltimore, New York and various points in New England.

INAUGURATES DIRECT-MAIL DRIVE

Columbia Mantel Co. Uses Letters to Show Merit of Talking Machine and Radio Products

The Columbia Mantel Co., Brooklyn, N. Y., has inaugurated its Fall campaign with two well-written sales letters under the signature of C. H. Gudegast, secretary of the company, one on the subject of radio cabinets and the other covering the talking machine line. In the radio letter is offered a full line of cabinets, both upright and of console type, with or without phonograph combination. The talking machine letter features the "Recordion" line of talking machines which this company produces.

The Columbia Mantel Co. has been in existence many years and has built up an excellent reputation through its products.

CONSOLIDATION IN SENECA FALLS

E. J. Ryan, of Seneca Falls, N. Y., has purchased the block occupied by Fred Teller, in Seneca Falls, and will consolidate with him. After elaborate changes are made they will open a first-class music and furniture store.

NOW AVAILABLE FOR The AMERICAN INDUSTRY

EUROPE'S MOST CELEBRATED

THORENS Phonograph Motors, Tone-Arms & Sound-Boxes

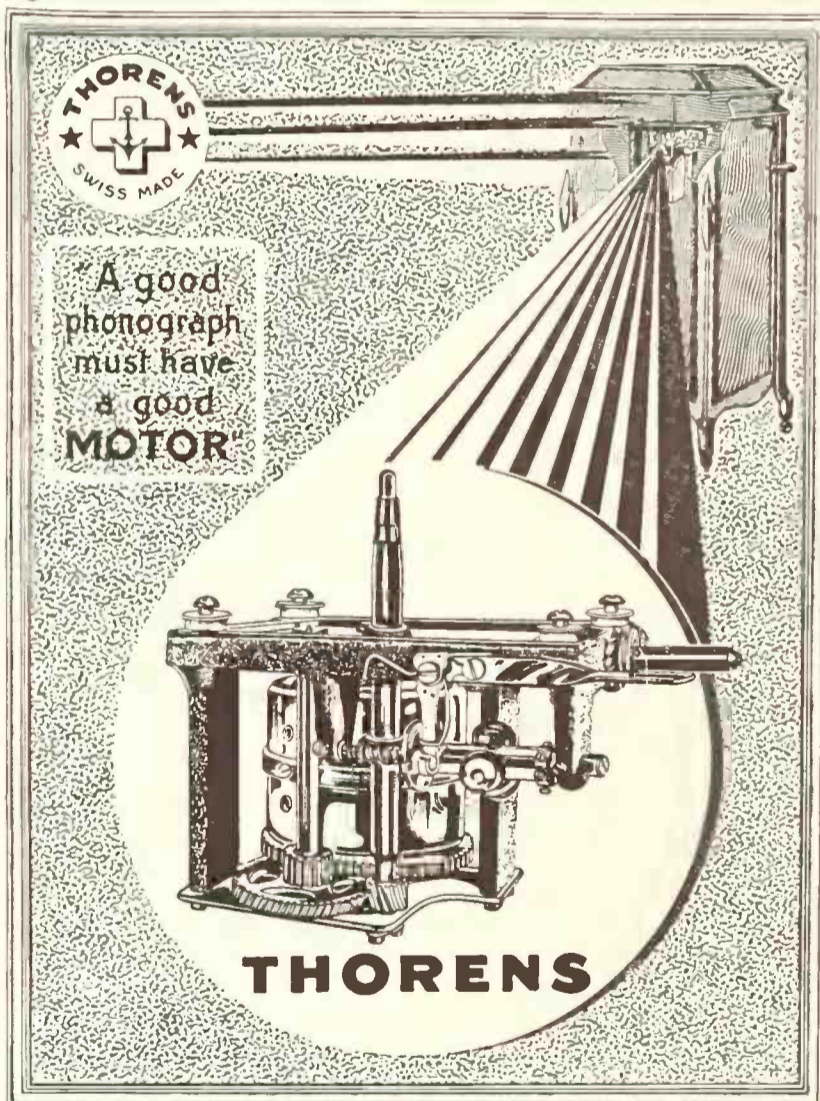

Made in all standard types, from 1 to 4 springs, embodying the very best in metals and processes, and according to the superlative Swiss workmanship of **HERMANN THORENS, Ste. Croix, Switzerland**

Priced in America on a basis to interest all successful talking machine manufacturers who desire distinctive motive equipment of the highest excellence.

Inquiries from manufacturers invited.—District representatives now being appointed

104 Fifth Avenue **L. H. JUNOD & CO.** New York, N. Y.
EXCLUSIVE AMERICAN AGENT

The Player-Tone

IT'S SIMPLY GREAT

No Better Tone Instrument In the World

TWO

High Grade Lines of Phonographs With a Price That Will Sell

Every instrument on this page is exceptionally good, regardless of price, with the house back of it for years.

We offer you phonographs that are masterful in their perfection of high grade cabinet work, exquisitely finished by skilled workmen, and when you sell one of these perfect tone producing instruments, you prepare the way for another sale.

The more closely you analyze our high grade construction, combined with perfect tone quality, the more fully will you realize its unqualified value.

Write for our booklet and net prices, which are exceptionally low, in large or small quantities of either line.

Player-Tone Talking Machine Co.

Office and Salesrooms

632 Grant
Street

Pittsburgh,
Pa.



New List \$100.00
Model 17
Brown Mahogany or
American Walnut
Round Ivory Horn,
record shelves, gold
equipment.



New List \$125.00
Model 20
Brown Mahogany Only
Music Master Horn
No. 44 Motor, record
album filing device.
All exposed parts gold-
plated.



Model 100
Height, 36"; width, 36";
depth, 24". Adam Brown
Mahogany or American
Walnut.



Model 125
Height, 36"; width, 36";
depth, 24". Adam Brown
Mahogany or American
Walnut.



Model 40
All gold equip-
ment, with 5
record filing al-
bums. \$150.00



\$150.00
Model 901
All Gold Equipment



\$80.00
Model 310
Mahogany and Oak



\$100.00
Model 311
Oak or Mahogany



\$110.00
Model 314
Oak, Mahogany or Walnut



\$125.00
Model 316
Oak or Mahogany

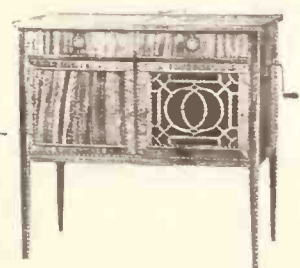

Model 30
All gold equip-
ment, with 5
record filing al-
bums. \$135.00

Concert Plans of Famous Record Artists

Opportunities for Dealers to Tie Up This Fall With Leading Singers and Instrumentalists Who Record for Leading Companies

Judging from the announcements that have already been made regarding the plans of prominent musical artists for the coming season and the additional tours that are now being arranged, the season will undoubtedly be one of the most interesting in a number of years. Not only are those artists who make annual tours of the country arranging to do so again this season, but there are several who have never been heard before in America or who have not been here for a number of years.

From the angle of the talking machine dealer who realizes the permanent good that comes from featuring high-class records by well-known artists, the elaborate plans for the new season are prolific with opportunities for tying up with the various artists while appearing in this or that city. The itineraries are always published well in advance and the dealer can get them either from the record company whose product he represents or direct from the artist's manager.

The local appearance of a great record artist can be capitalized most successfully by the retailer who thinks clearly and can arrange his plans well in advance. It is conceded that no amount of printed literature regarding the artist and no amount of selling talk can be made quite so effective as personal contact with the artist himself through the medium of the local concert stage. Numerous instances are on record where individuals with no particular musical training or enthusiasm have attended recitals of big artists largely from curiosity or because it was the thing to do and then became consistent and persistent buyers of records of these artists. In such cases the contact developed through the local recitals makes the

talking machine owner feel as though he was buying the recordings of a friend, or at least of some person who represented something tangible in the flesh rather than simply a name.

There are so many ways in which an energetic dealer can tie up with the appearance of the artist that space prohibits the listing of them all, but it might be mentioned that simply carrying the prepared advertisement of the manufacturer or placing a list of the artists' recordings in the show window is not sufficient. The proper method is to tie up directly with the advance advertising of the artist, featuring particularly those numbers that will be included in his program and have been recorded, provided the advance program can be obtained, which is generally the case. Then an effort should be made to carry a special announcement in the concert program, listing not only the programmed numbers, but also other records by the artist which are calculated to appeal to good musical tastes.

More than one dealer has added materially to his record-buying clientele by giving a recital or two at his store a few days before the appearance of an artist, or, for that matter, an opera company, playing over and explaining at the recital the selections that are to appear in the regular concert program. A surprising number of music lovers will take the opportunity of refreshing their memories regarding certain numbers that they may enjoy the work of the artist himself more intelligently and cases are known where confirmed opponents of music in record form—fortunately they are growing fewer each year—have had their prejudices removed by just such recitals.

The main thing is that several scores of

artists whose names stand high in the musical world are going to tour the United States during the coming season and there will be hardly a city or town of even moderate size where at least one or several artists will not appear. Even when the recitals are held in neighboring cities and towns the small-town dealer can still capitalize the event possibly as some Western houses do it—by arranging personally conducted excursions to the largest center for the benefit of their friends and patrons. The opportunity is here; the next question is to capitalize it.

The first announcements of the Fall plans of the artists notable in the field of recording appear herewith and are worth close study:

Among the Singers

Mme. Schumann-Heink, Victor artist, now at her California home, will come East to sing in Carnegie Hall on Sunday, October 14, starting from New York her new tour under S. Hurok's direction.

Merle Alcock, Edison artist, who has been engaged for the Metropolitan, will return from France in October.

Paul Althouse, Edison artist, arrives in New York late this month to prepare for a long concert tour.

John Barclay, Brunswick artist, will start his season with a New York concert early in the Fall.

John Charles Thomas, Vocalion artist, who is to give a recital at Albert Hall, London, September 30, will sail for home on October 3 and open his concert tour at Aeolian Hall, New York, October 14.

Frieda Hempel, noted soprano and Edison
(Continued on page 64)



Sherman, Clay & Co.

Victor Distributors on the Pacific Coast

*Victrolas Victor Records
Victor Accessories*

Main Wholesale Depot:

741 Mission Street, San Francisco, Cal.

Branch Wholesale Depots:

10th and Santee Streets, Los Angeles, Cal.

N. W. Corner 13th and Glison Streets,
Portland, Oregon

Oceanic Bldg., Cor. University and Post Streets,
Seattle, Washington

330 West Sprague Ave., Spokane, Washington

5 DISTRIBUTING DEPOTS for YOUR CONVENIENCE

Announcing the New Pathé Models



Model 36

The Queen Anne Model illustrated above is furnished in brown mahogany and walnut; exposed metal trimmings in antique silver finish; universal tone arm; Pathé perfect tone control; Pathé reproducer; nickel fittings; new oval horn; double spring motor or noiseless electric motor; automatic stop; size 35½ inches high; 35 inches wide; 20½ inches deep.

PRICE, with spring motor \$125.00
 " with electric motor \$140.00



Model 15

Every detail is perfectly carried out in this luxurious model No. 15. It is furnished in mahogany; all exposed parts nickel plated; universal tone arm; Pathé perfect tone control; Pathé reproducer; new oval horn; double spring motor or noiseless electric motor; automatic stop; size 44 inches high; 20 inches wide; 21 inches deep.

PRICE
 With spring motor.... \$100.00
 With electric motor.. \$115.00



Model 31

This handsome model is furnished in brown mahogany and oak; exposed metal trimmings in antique silver finish; universal tone arm; Pathé perfect tone control; Pathé reproducer; nickel fittings; new oval horn; double spring motor or noiseless electric motor; automatic stop; size 35½ inches high; 35 inches wide; 20½ inches deep.

PRICE, with spring motor..... \$110.00
 " with electric motor..... \$125.00



The New Pathé Portable

A complete phonograph with an automatic stop and a perfect filing device holding ten records, furnished in Waxed Golden Oak; Fumed Oak; Mahogany Finish; or covered with DuPont fabrikoid leather; interior in natural wood finish; nickel plated hardware; universal tone-arm; Pathé reproducer; double spring motor; size 14 x 15½ x 8; weight 20 pounds.

Mahogany Finish } \$40.00
 Golden Oak }
 Fumed Oak }
 Fabrikoid Leather \$50.00

THE NEW



PATHE—A name famous the world over is indeed dignified by this really wonderful new and complete line of Phonographs. Every model priced right, artistic in design, beautifully finished and of course equipped with new and exclusive PATHE features.

All the new models are equipped with the New PATHE automatic stop.

All the new models (except the Portable) have the new oval PATHE horn.



Model 40

This Italian Renaissance Model is furnished in mahogany and oak; universal tone arm; Pathé perfect tone control; Pathé reproducer; nickel fittings; new oval horn; extra large double spring motor or noiseless electric motor; automatic stop; size 36½ inches high; 41 inches wide; 21½ inches deep.

PRICE, with spring motor..... \$185.00
 " with electric motor..... \$200.00

Pathé the World Over

Pathé Phonograph and Radio Corporation—20 Grand Ave., Brooklyn, N. Y.

ARTISTS' PLANS FOR MUSICAL SEASON

(Continued from page 62)

artist, who has been re-engaged for a Jenny Lind concert at Albert Hall, London, on October 21, will sail for New York soon after and resume her concert tour of the United States.

Lucrezia Bori, the popular Victor artist, is booked for a concert tour starting in September and lasting until the opening of the Metropolitan.

Sophie Braslau, Victor artist, who has been singing in the West, will be heard again in New York, her home town.

Mme. Emma Calvé, Victor artist, will start her season this Fall with a concert in New Orleans.

Feodor Chaliapin, Victor artist, who sings at the Manhattan on October 7, sails hither September 27 from England on the United States liner "America."

Claire Dux, Brunswick artist, has been re-engaged as a guest of the Chicago Civic Opera.

Geraldine Farrar, Victor artist, will again de-

vote herself to a transcontinental concert tour.

Emilio de Gogorza, Victor artist, will come from Maine to start his concert tour early in October.

Amelita Galli-Curci, Victor artist, has prepared the leading soprano rôle for the Metropolitan revival of Rimsky-Korsakoff's "Coq d'Or."

Mary Garden, Columbia artist, includes an appearance at the Town Hall in her forty concerts from here to the Pacific Coast.

Mabel Garrison, Victor artist, who has been filling Summer concert engagements, will be heard again in recital.

Mme. Louise Homer, Victor artist, begins in September an all-season concert tour, interrupted only by her appearances with the Chicago Civic Opera.

Maria Ivogun, Brunswick artist, will start her third American concert tour in January.

Nina Koshetz, Brunswick artist, lately singing in South America, is to reappear with the Philadelphia and New York Philharmonic Orchestras.

Hulda Lashanska, Victor artist, absent from the concert stage for a year, will be heard with the Philadelphia Orchestra.

The plans of John McCormack, Victor artist, call for seventy American concerts, after which the tenor will go to Japan and China.

Edward Johnson, Victor artist, after singing in England, will return in concerts prior to the opening of the Metropolitan.

Barbara Maurel, Columbia artist, is to give a recital in Paris and two in London before returning to fill American engagements.

Sigrid Onegin, Brunswick artist, starts her second American concert tour at Brockton, Mass., on September 30.

May Peterson, Vocalion artist, will return in October, after appearing at the Paris Opera Comique.

Virginia Rea, Brunswick artist, will give her first New York recital in October.

Helen Stanley, Edison artist, is to make an appearance as soloist with the State Symphony Orchestra.

Oda Slobodskaya, last heard with the Ukrainian National Chorus (Brunswick), will appear in recital.

Marie Tiffany, Brunswick artist, will make a concert tour before the opening of the Metropolitan.

Reinald Werrenrath, Victor artist, began his season early with a Summer concert arranged by the Lakeside Association of Ohio.

With the Wielders of the Bow

Jascha Heifetz, Victor artist, who goes for a tour of Japan, will return to begin his American concerts on New Year's Day at Carnegie Hall.

Albert Spalding, Edison artist, is bringing some new compositions with him from England for his recitals and orchestral engagements.

Fritz Kreisler, Victor artist, has been making a long concert tour of the Orient.

Pablo Casals, Columbia artist, has been spending the Summer in Spain. Toscha Seidel, another Columbia artist, will be heard in recital this season.

Renee Chemet, Victor artist, will return to America for a full season of concert engagements.

Carl Flesch, Edison artist, after eight years will reappear as soloist with the Philharmonic, Philadelphia and Cincinnati Orchestras.

Paul Kochanski, Vocalion artist, will return shortly to begin a concert tour.

Hans Kindler, 'cellist and Victor artist, will be heard again in recital and as soloist with the Philharmonic Orchestra.

Maurice Dambois, 'cellist, is arranging for an extensive concert tour.

Celebrated Pianists to be Heard

Ignace Paderewski, Victor artist, will arrive in this country from Switzerland for a series of seventy concerts starting November 19.

Vladimir de Pachmann, Victor artist, returned to America late last month to make a farewell concert tour.

Percy Grainger, Columbia artist, who has just returned from Europe, has started preparations for a busy concert season.

Elly Ney, Brunswick artist, will be heard November 7 at Aeolian Hall in her first program of the season.

Olga Samaroff, Victor artist, early in the Fall will play at the "All American" music festival in Buffalo.

E. Robert Schmitz, Edison artist, is preparing a program for a December recital at Aeolian Hall.

Mischa Levitzki, Columbia artist, will go to Havana in January for concerts arranged by the Sociedad Pro Arte Musicale.

Benno Moiseiwitsch, Victor artist, will return from Australia in November.

DECREASE CAPITAL STOCK

DALLAS, TEX., September 3.—The capital stock of the Texas-Oklahoma Phonograph Co., Edison jobbers here, has been decreased from \$200,000 to \$100,000.

The PHONOGRAPH'S "RIGHT ARM" is the PHILLIPS TONE ARM

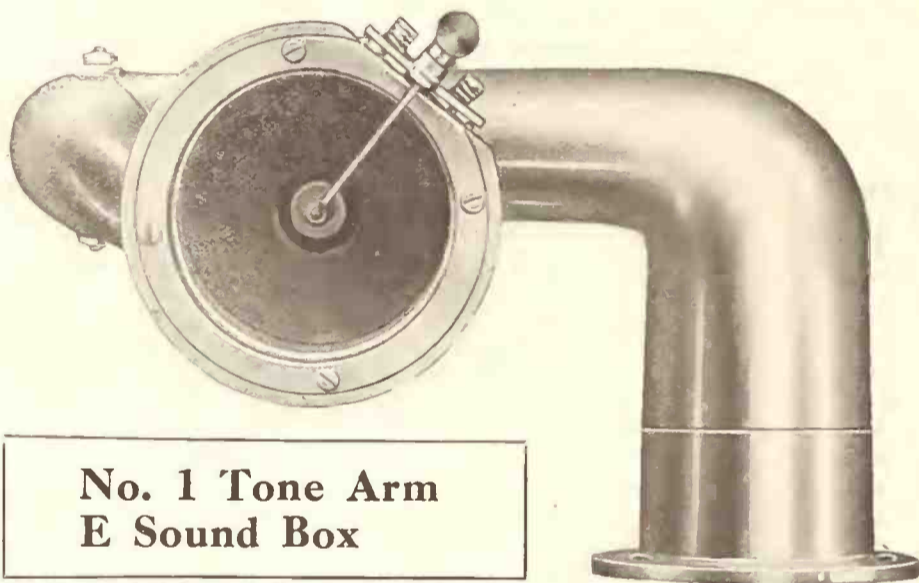

**No. 1 Tone Arm
E Sound Box**

Highly Nickel Plated. Length 8 - 8½ inches

New improved throw back arm at an interesting quantity price. Remarkable tone. Suitable for small consoles and medium priced machines.

For Better Grade Talking Machines

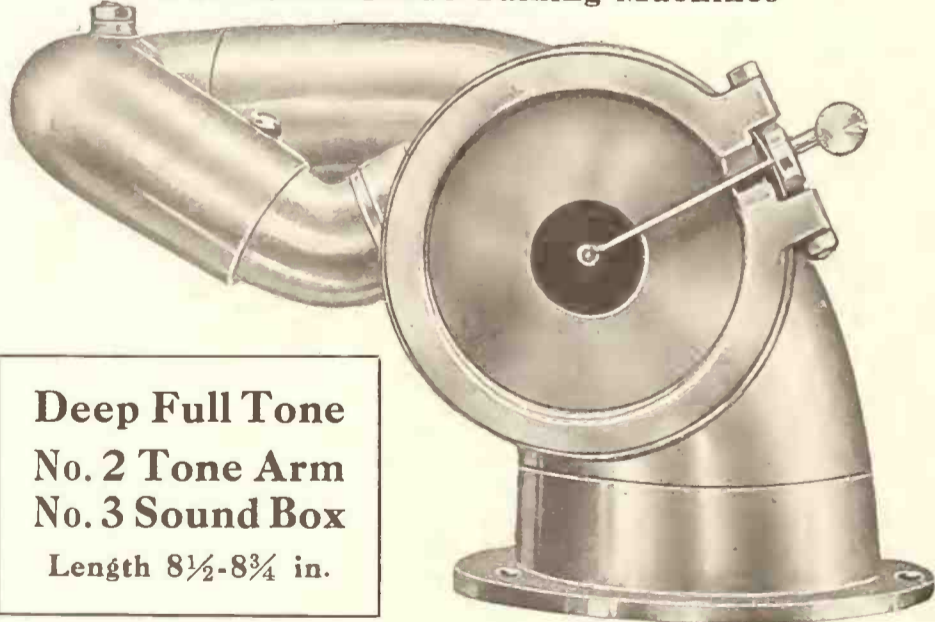

**Deep Full Tone
No. 2 Tone Arm
No. 3 Sound Box**
Length 8½-8¾ in.

Our No. 2 Arm is being used by some of the largest manufacturers in the country and is universally known. Samples sent to manufacturers of talking machines only.

Sound boxes shown above are interchangeable with either arm.

WM. PHILLIPS PHONO PARTS CORP.
145 West 45th Street
CABLE ADDRESS: PHONOPARTS
New York City



Unico Equipment That Increases Sales for L. Bamberger & Co., Newark, N. J.

Clothes Make the Man

*—and Good Equipment “Makes” the Store—
Increasing Its Value as a Profit Producer*

THE reason that attractive stores make more sales is simple enough. A Music Store sells to the best homes in town—homes where quality is appreciated.

A Quality Atmosphere in your store, in line with the Quality Product you sell, begets confidence—and that lessens sales resistance, increasing sales.

Unico Service specializes in attractive Equipment, creating an environment that instills confidence.

Take advantage of Unico confidence building, sales increasing service now. Prices are moderate, and deferred payment plan enables you to pay out of profits.

SPECIAL PRICES ON TWO UNICO PRODUCTS

Unico Efficiency Bench—especially manufactured for Phonograph Repair Service—accommodates all necessary repair parts, eliminates loss, promotes efficiency.

Former Price \$135.00, Special Price on Limited quantity \$50.00.

Special Price solid mahogany Unico Stand for Victrola No. 50—\$5.00. Less in quantity lots. All prices f.o.b. Philadelphia.

UNIT CONSTRUCTION COMPANY

RAYBURN CLARK SMITH, *President*

58th Street and Grays Avenue,

NEW YORK, N. Y.
299 Madison Ave.

CHICAGO, ILL.
30 N. Michigan Blvd.

ATLANTA, GA.
25 Moore Bldg.

NEW ORLEANS, LA.
506 Marine Bank Bldg.

English Sales Agents — H. A. MOORE & CO., LTD., Premier House, London, England.

Branches:

DALLAS, TEXAS
209 Dallas Co. Bank Bldg.
SAN FRANCISCO, CALIF.
275 Post St.

S. African Sales Agent—PHILIP M. COHEN, Johannesburg, South Africa.

Philadelphia, Pa.

SALT LAKE CITY, UTAH
150 Main St.

DENVER, COLO.
1642 Arapahoe St.



"DEEZE" "DOZE" and "DEM"

Kute-Kid-Kalqulation in Fox Trot

"You can't go wrong
With any FEIST song"

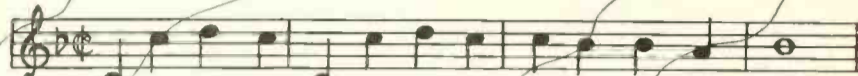

You take "deeze," and you take "doze," and I'll take some of "dem;"

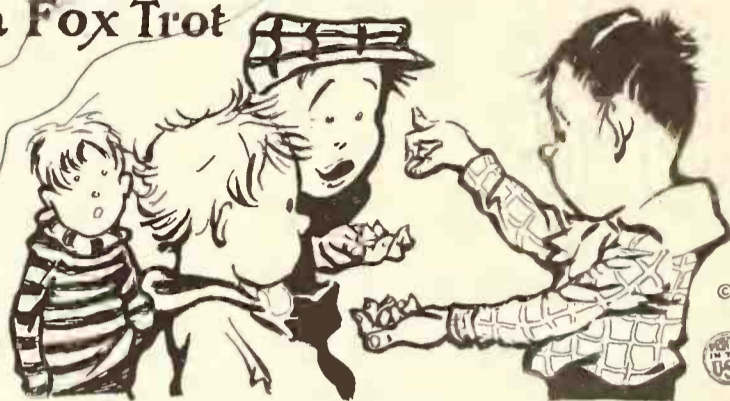

©LEO FEIST Inc.
N.Y.C.



DEALERS INSPECT CHENEY FACTORY AT GRAND RAPIDS

Cleveland, Toledo, Akron and Pittsburgh Retailers Spend Two Days at Cheney Plant Inspecting Manufacturing Process—Address by Prof. Forest Cheney and Banquet Features of Trip

TOLEDO, O., September 1.—Recently Cheney dealers from Cleveland, Pittsburgh, Toledo and Akron journeyed to the Cheney factory at Grand Rapids, Mich., on a trip of inspection. The group was personally conducted by C. B.

greeted by H. A. Ackerman, Howard Jackman, M. D. Green and Prof. Cheney, of the Cheney organization.

The two days' stay in Grand Rapids was devoted almost entirely to business, with just enough relaxation mixed in to prevent the gathering from becoming boresome. In addition to a careful inspection of every manufacturing process and acquainting the merchants with the complete Cheney service, which consumed considerable time, Prof. Cheney delivered an address on acoustics.

A banquet was tendered the visitors on Tuesday night and on Wednesday, after the business sessions, a motor trip around the city was a feature of the visit.

Those attending stated that it is seldom so much instructive and helpful service is crowded into so short a period. They came away better Cheney dealers and more enthusiastic retailers.

A photograph of the group as they were leaving the factory is herewith presented. Among the dealers were Henry Wood, of Boggs & Buhl, Pittsburgh; A. R. Meyer and young son, Pittsburgh; Doc Schuyler, Cleveland; W. Murstein and W. P. Laphan, Euclid Music Co., Cleveland; Helen Liddicote, Buescher Music Co., Cleveland; George H. Dales, Dales Music



Cheney Dealers Who Visited Factory

Hammond and Miss N. M. Smith, of the Cheney Phono Sales Co., Cleveland, the first stop on the trip being at Detroit, where a theatre party was given for the guests. After that they boarded the Pullmans for Grand Rapids, arriving on Tuesday morning, when they were

Co., Akron, O.; Forrest O. Edwards, of La Salle & Koch Co., and Edward A. Kopf, of the J. W. Greene Co., Toledo, O.

CARTWRIGHT MUSIC SHOP OPENS

Musical Program and Distribution of Victor Dogs and Gifts Featured the Formal Opening of Fine New Greencastle, Ind., Store

GREENCASTLE, IND., September 6.—The formal opening of the Cartwright Music Shop was held here on Saturday, August 25.

One of the features of the day was the giving away of an Outing portable. Another feature was the giving of a small Victor Dog to the first ten customers each hour, during the afternoon. A musical program during the entire day added greatly to the enjoyment of those present.

The Cartwright Music Shop is one of the most attractive business stores in town. The place has been remodeled and beautified, and with its stock of Victor talking machines and Kimball pianos is most attractive.

OPENS NEW SONORA ACCOUNTS

Greater City Phono. Co. Active in New York Trade—Making Plans for Healthy Fall Business—Maurice Landay Back at Desk

The Greater City Phonograph Co., Inc., New York, N. Y., Sonora distributor, has opened a number of new accounts recently, among these being Joseph Isaacs, 176 Sixth avenue; Resik & Ray Furniture Co., 1967 Third avenue; Abelowitz Phonograph Co., 1353 St. Nicholas avenue, and Frank Mandel, 366 Canal street, all of New York City.

Arthur Morris, of the company's sales staff, states that an excellent Fall business is anticipated and that the company enjoyed a substantial increase in August business as compared with August of last year. Maurice Landay, president of the company, recently returned from a two weeks' vacation, which he spent at Lake George.

COPLIN OPENS STORE IN LOUISBURG

LOUISBURG, KAN., Sept. 6.—Harry M. Coplin, director of the Louisburg Concert Band, has opened a music store in the Hinds' Building, of this city. He will handle the Victor and Edison lines of talking machines, the Frank Holton band instruments, records, sheet music and other instruments.

UNIVERSITY STORE IN NEW HOME

SEATTLE, WASH., September 1.—Mercer Meany will be in charge of the service department of the University Music Store, which is now moving to its attractive and advantageous new location at 4511 University Way.

"LAUTER" TALKING MACHINES



Model D



Model G

Combination American Walnut and Brown Mahogany Two Tone Varnish Finish

Write Today for Cuts and Prices

Send us your specifications and give us an opportunity to figure on your requirements of UPRIGHT and CONSOLE TALKING MACHINES.

THE H. LAUTER COMPANY

West Washington and Harding Streets

Indianapolis, Ind.

Imported **ODEON** Recordings

of
Franz Schubert's

Symphony In B Minor

**The first, complete recording
of this famous masterpiece**

EVERYONE who is at all interested in music knows of the famous Symphony In B Minor—the supreme accomplishment of the musical genius, Franz Schubert. Only certain parts and selections from it, however, are really familiar to the general music-loving public. A complete rendition of this masterpiece is a musical treat that is rarely heard.

For this reason we have pressed three double-face records, from matrices imported from Europe, of the entire Symphony exactly as it was written by Schubert, note for note. To the best of our knowledge, these records are the only ones of their kind in existence.

No finer organization than The Orchestra of The German Opera House, Berlin, under the direction of Eduard Moerike, could have been chosen to render the complete Symphony. Moerike is today recognized as one of the foremost conductors of music in Europe and became very popular in New York, where he conducted last March. Every member of his orchestra is an accomplished musician of note on the Continent.

These unusual records are released under the ODEON label and are sold in sets only. Each set consists of three double-face records contained in a handsome black leatherette album imprinted in gold and bearing on the inside cover the history of "The Unfinished Symphony." The complete set retails for five dollars.

By special arrangements with the leading record manufacturers of Europe, we alone are able to offer the American public, on ODEON RECORDS, a notable repertoire of rare record importations that feature the foremost artists of Europe. The steadily increasing demand for these records is a clear indication of public approval and appreciation. ODEON RECORDS are

Pressed by the Manufacturers of

OKeh Records

The Records of Quality



Franz Peter Schubert

The composer of the famous SYMPHONY IN B MINOR—popularly known as "The Unfinished Symphony."

Contrary to popular conception, death did not interrupt the completion of his beloved masterpiece. He was forced, by the stress of extreme poverty, to abandon it in order to earn a scanty livelihood. Schubert never heard even an orchestral rehearsal of his Symphony. It was played in public for the first time thirty-eight years after his death. Today, the world's foremost musicians concede "The Unfinished Symphony" to be one of the musical masterpieces of the century.



**General
Phonograph Corporation**
OTTO HEINEMAN, President
25 West 45th St. New York

DALLAS

*Improving Business Conditions
Create Optimism in Local Territory—Trade Happenings of Month*

DALLAS, TEX., September 6.—The Summer lethargy in Texas, so far as the music trades are concerned, is about ended, and stores everywhere are reporting improving business conditions. Recent general rains over Texas have improved the crop outlook and restored confidence, and rural merchants are looking for a good Fall trade.

The recent two weeks' buying season in Dallas, which marked the formal Fall opening of the wholesale dry goods and clothing stores, brought merchants and buyers from all over the Southwest to Dallas, and greatly stimulated business in the music trade. Jobbers and distributors of musical instruments of all kinds, notably of talking machines, report a marked stimulus to their business.

Lester Burchfield, manager of the talking machine department of Sanger Bros., distributors of Victor machines, reports satisfactory business. The rural merchants bought liberally during the recent two weeks' market opening in Dallas. Mr. Burchfield said that reports everywhere indicate a return of normal business conditions. The Southwest seems to be prosperous and a heavy Fall business in talking machines is expected, he said.

The Texas-Oklahoma Phonograph Co., distributor of Edison phonographs and records, finds a greatly improved condition of business in the very important territory to which it caters. O. G. Feltner, secretary and treasurer in charge of sales, remarked that conditions throughout the Southwest are picking up and that a decided spurt has been noticed by dealers for the last two weeks. Coincident with the Fall season this activity should be increased materially. The Texas-Oklahoma Phonograph Co. is well prepared to cater to its clientele, and has arranged for a stock of machines and records to meet all demands. This company is doing a great deal to stimulate dealers not only to a greater activity, but to a realization of the great possibilities in the phonograph business if properly developed.

A company is being organized in Dallas to finance the erection of a Fine Arts Building, which will contain a large auditorium, studios for music teachers and stores for music merchants. The building, as plans prepared by R. H. Hunt & Co., architects, show, will be a six-story structure of artistic design to cost approximately \$750,000.

The Haverty Furniture Co., which recently purchased the entire store of the Columbia Phonograph Co. here and placed this stock on sale at its Elm street store, has already disposed of the larger part of this stock and business continues to improve.

Sanger Bros., Victor distributors of this city, have received a letter from one of their dealers, the Walter Piano & Auto Co., Waxahachie, Tex., under recent date, which reads:

"Would you not get out a bulletin at once warning all your dealers against a swindler that on yesterday (Saturday) evening late put up a smooth job on us. He is medium height, neatly dressed in light or brown Summer clothes, straw hat, about thirty to thirty-five years old, smooth shaved, slightly stooped, head leans forward, about 140 pounds, very quiet in talk and manner. His scheme is to come in and engage with a salesman about a phonograph, saying he worked in Dallas (in this case) for Higginbotham-Bartlett Co., builders' materials, and that his father and mother, who live here (in the place he happens to be) are alone and getting old and that he wants to send them some music, but he cannot pay cash for the instrument; in fact, could not pay anything to-day as he has not cashed his check which he has in his pocket, says he

EACH IS A NEW EDISON.
Each will sustain the test of direct comparison with the living artist. Each is a money-maker for the fortunate merchants who represent the NEW EDISON

TEXAS-OKLAHOMA PHONOGRAPH CO.
2025 Jackson St. Dallas, Texas

will come back to-morrow or Monday and, although he does not want to put the salesman to the trouble to cash the check, finally agrees to get him to do so and draws out a check from the above firm made out by typewriter on one of firm's regular printed named checks for \$60, protectograph being used on check and everything seeming regular, agrees to pay \$35 down and signs the contract for the balance and gets the rest \$25 in money, leaves some number on a well-known street to have the instrument sent and that is the last of him. After not being able to find any Rev. King, who he said was his father, we got suspicious and found it was a swindle. He gave his name as A. N. King. We thought you might do this in the interest of all and with the hope that we might catch him working the scheme on some other talking machine dealer and, if detected, have him arrested and notify us. If you would act promptly getting out the bulletins immediately he may be caught in this territory."

NEW OKEH JOBBER DOING WELL

Texas Radio Sales Co., Dallas, Tex., Meeting With Success in Distribution of Okeh Records —Plans Addition of Important New Lines

DALLAS, TEX., September 5.—The Texas Radio Sales Co., of this city, which was recently appointed a jobber for Okeh records, is meeting with very pleasing success in the introduction of this well-known line to the trade in this territory. The company's sales force is establishing dealers in the leading cities and the general publicity used in behalf of Okeh records is helping these dealers stimulate sales. The Texas Radio Sales Co. is admirably equipped to develop Okeh business, as it is well known throughout this territory. For some time past it has been a distributor for the Radio Corp. of America and, according to its present plans, several other talking machine products will be handled in addition to Okeh records.

"We Serve the Southwest"

AS new distributors for "The Records of Quality" in the Southwest, we plan to play no small part in aiding hundreds of dealers to reap the benefits that come from handling the famous, fast-selling Okeh Records.

We have gained the invaluable reputation among our dealers that comes only through handling their orders—large or small—with unfailing promptness and absolute dependability, and offering them our hearty co-operation in the solution of their merchandising problems.

Okeh Records

The Records of Quality

Wholesale Record Division

TEXAS RADIO SALES CO., Inc.

Offices and Show Rooms:

2005 Main Street DALLAS, TEXAS

Inquiries from Dealers Solicited

I Love You

That Irresistible Melody from
The Musical Comedy
"Little Jessie James"

"You can't go wrong
With any FEIST song"



© LEO. FEIST Inc. N. Y. C.

"I love you, I love you," is all that I can say.—

C I N C I N N A T I

Trade Stimulated by Festival and Exposition—Outlook Bright—
Dealers Face Trade-in Problem—L. L. Harding Dead—The News

CINCINNATI, O., September 7.—Cincinnati dealers have been experiencing a period of unusually good business during the last month. This good trade is in rolls and records as well as in talking machines. In fact, those dealers who did not place their orders early have been unable to get records for several weeks after they should have been issued. Every available means is being employed to get a greater turnout, with the result, according to Mr. Purnell, of the Starr Piano Co., that the number of records being made this year will be double the output of last year.

Festival and Exposition Boost Trade

One possible reason for the present good trade in the city is the great Fall Festival and Industrial Exposition which brought thousands of strangers to the city. Some of these people are here on pleasure, but most of them are here with business in mind and the music merchants are reaping some of the benefits. A few of the dealers, with this in mind, are running the following thought in their ads: "The pleasure-seeking people are invariably lovers of music,

and some of them will want to buy musical instruments to send or bring back to their loved ones at home." Several of the dealers have very attractive booths at the Festival. The Brunswick Co. is represented by a display of upright and console models of Brunswick phonographs; the Pandorf Music Shop and the Vocalstyle Music Co. combined to produce a very effective booth displaying console and upright models of the Brunswick, Victor and Strand instruments, and Vocalstyle records. The festival extends from August 25 to September 8 and the outlook is that it will have a stimulating effect on trade.

Uses Airplane to Advertise Brunswick

Other of the Brunswick dealers are doing some unique advertising. J. P. Riddle, of Pikeville, Ky., has just moved into his new home on Second street and it is expected that he may try some more sensational stunts like the one which he tried recently. Mr. Riddle, the president of the Riddle Co., is an ex-aviator, and to advertise his instruments he excited the whole town of Pikeville by making some risky tail spins and

barrel rolls above the town in an airplane. He scattered pamphlets as he flew near to the ground.

Edison Popularity Grows

The demand for Edison phonographs and records continues to grow throughout this territory, and as a result the Phonograph Co., Edison distributor, with offices in this city and in Cleveland, is kept busy supplying its large clientele with a sufficient quantity of stock. Most of the Edison dealers hereabouts are live wires and they lose no opportunity of bringing the merits of the Edison to the public. Window displays, advertising, circularizing and personal solicitation are all playing an important part in bringing the sales volume of individual dealers to a very satisfactory figure.

Dealers Dispose of Used Instruments

There seems to have been a slight increase in the percentage of trade-ins which have come in recently. To dispose of these used instruments many local stores are now conducting sales of used instruments. It is the general opinion that these sales have been a great factor in stimulating business. Even those sales which did not turn out as well as was expected have brought about a noticeably increased trading. On the whole, business is about 70 per cent more than that of this time last year. There has been a gratifying increase in the number of inquiries for high-priced talking machines, with a much greater number of these inquiries convertible into orders than heretofore.

Harmonize Instrument With Home

The policy of the Chubb-Steinberg Co. is to harmonize the instrument with its surroundings in the home, and, with this in view, it has a mechanic-artist follow up the delivery to so adjust the machine to its surroundings that it will look and sound best. It is felt that this plan has stimulated the sale of more expensive uprights, which are about 30 per cent of the current trade.

Death of L. L. Harding

L. L. Harding, vice-president of the Vocalstyle Music Co., of this city, died recently at his home in Canon City, Col. Mr. Harding had not visited the city for several years, but for a long time he used to visit Cincinnati semi-annually to take care of his business. He is survived by a son and five daughters. He was seventy-two years old when death overtook him.

Local Men to Visit Brunswick Plant

J. E. Henderson, sales manager of the Cincinnati Brunswick store, and U. S. Carter, of Ashland, Ky., a dealer, with two of the city salesmen, Ralph Hooke and C. T. McKelvy, are now taking an auto trip to Michigan, and while in Muskegon they plan to go through the Brunswick factory there.

Mr. Hess, of the Hess Printing Co., W. Va., and J. D. Haggard, musical instrument dealer of Ravenna, Ky., stopped in to see Ben L. Brown, of the Sterling Roll & Record Co., of this city, while they were here recently. On August 27 B. L. Brown went to Louisville to attend the concert given there by Sara Martin, an exclusive negro Okeh artist, and Handley's Orchestra, who are making quite a hit on their trip.



The NEW EDISON.

COMPARISON WITH THE LIVING ARTIST
REVEALS NO DIFFERENCE

Net Profit—Counts!

Edison Dealers Figure Net Profit
This Way

1. DOLLARS and CENTS—Even after Uncle Sam has taken his there is a very substantial sum left.
2. GOOD WILL—No line pays as well in good will as the Edison. This is a real asset and can be capitalized.
3. THERE'S A SENSE OF SATISFACTION in knowing you have given your customers the best. This is non-taxable and you cannot lose it.

Investigate the Edison Dealers' Proposition

THE PHONOGRAPH COMPANY

CINCINNATI
314 West 4th Street

CLEVELAND
1240 Huron Road

—specially designed for the Talking Machine Trade

Cutting and Washington Radio Receiver 11C—cabinet design console type. Completely self-contained, a three-tube set that has proved in comparative tests to have higher selectivity and volume than any other instrument in its class.

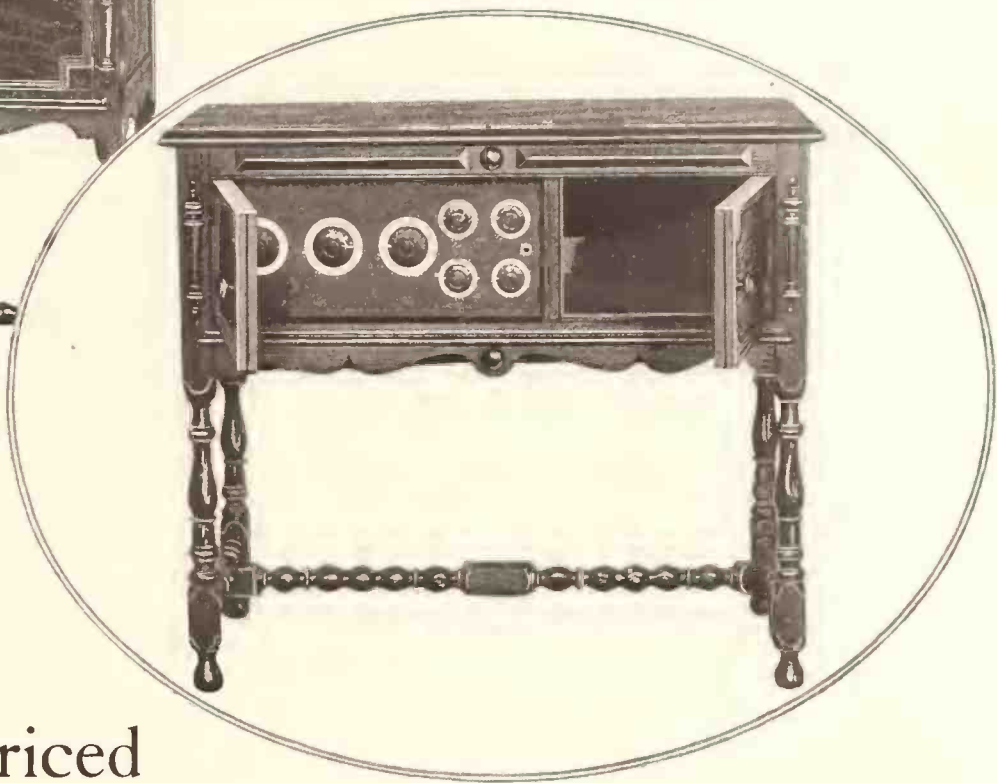
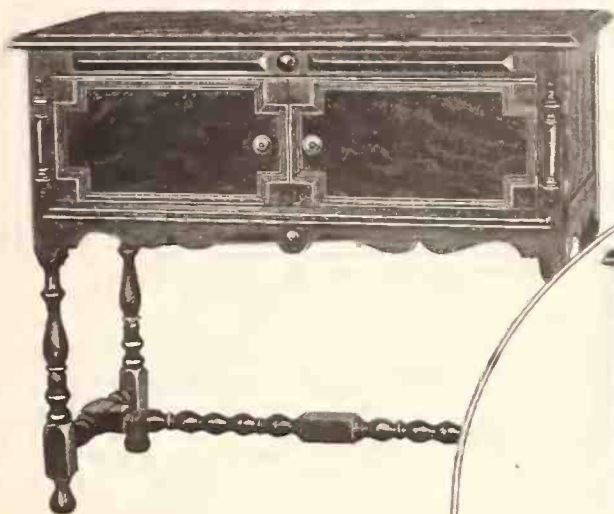

A moderate-priced Cabinet Receiver—Console Type

Here at last is the instrument which enables the talking machine dealer to enter confidently into the radio business, feeling that he is now assured of success.

Designed by Cutting and Washington, two of America's best-known radio engineers, pioneer manufacturers of radio equipment—a concern with strong financial backing that has a reputation for service. This new instrument is the leader

of the C. & W. line, which covers all ranges of price. All sets licensed under the Armstrong Patents—admittedly the best for radio reception.

Dealers securing the C. & W. franchise are given territorial protection and backing by a comprehensive advertising campaign.

Secure the details at once and be in position to profit by the radio business this Fall and Winter.



Cutting and Washington Receiver 12A—"Town and Country" model (portable type). A two-tube set which makes an ideal receiver both for the home and for outing use. For either single circuit or double circuit.

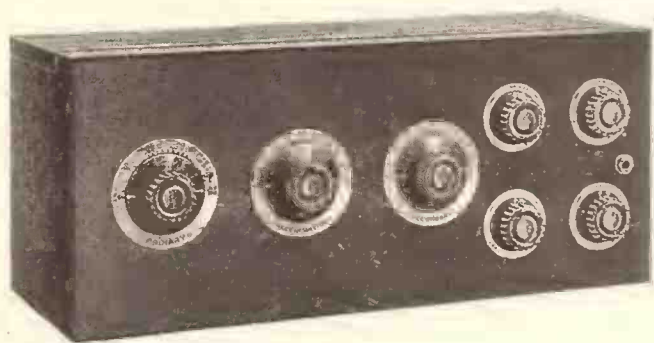

Cutting and Washington Radio Receiver 11A—similar in mechanical design to the receiver used in the cabinet model but of the box type—an instrument that has already had a big sale all over the country.

**TALKING MACHINE
DEALERS & DISTRIBUTORS**

Write for full details of the Cutting and Washington dealer plan and copy of the book, "The Future of Radio Retailing," sent without obligation to Talking Machine Dealers.

Cutting and Washington Radio Corp.
Operating Station WLAG—"Call of the North"
Minneapolis Minnesota

Cutting and Washington

America's oldest manufacturers of commercial radio

BRUNSWICK FEATURED IN REVUE

Mammoth Brunswick Console Used in Jos. Howard's New Production—Important Factor in Revue's Success—Offering Booked Solid

A mammoth Brunswick console phonograph is being featured in a new vaudeville production launched at the Palace Theatre, New York, the week of August 27 by Joseph E. Howard, prominent composer and songwriter, and Ethelyn Clark. This revue, which is one of the most pretentious offerings shown on the vaudeville stage in recent years, is entitled "Etchings From Life," and judging from the reception it was accorded at the Palace the success of the production is assured. The hit achieved at the Palace is especially noteworthy in view of the



Jos. Howard's Unique Production

fact that this theatre is the leading vaudeville house in America.

The Brunswick phonograph, which is designed after the Stratford model, is finished in gold and black, with the name Brunswick prominently featured, and a handsome black curtain setting off to advantage the entire display. When the curtain rises the music from an organ is the first "business" in the production and after a few strains Mr. Howard and Miss Clark emerge from the phonograph. The complete scene is entitled "Brunswick Town" and is without question the most important factor in the new production.

Harry A. Beach, Eastern sales manager of the Brunswick Co., co-operated with Mr. Howard in handling the details incidental to the introduction of the Brunswick phonograph in the new revue. To properly celebrate the week at the Palace Mr. Beach was the host at a formal dinner given to Mr. Howard and James J. Morton, one of the members of the revue, on Monday evening, August 27. Among the Brunswick executives who were present at the dinner were E. A. Straus, P. A. Ware, Chester I. Abelowitz and Don Leopold. At the close of the dinner the entire party adjourned to the Palace Theatre, where an enthusiastic reception was given Mr. Howard and his production. It is planned to feature the use of the Brunswick to excellent advantage, as the production is booked solid over the Keith circuit.

VICTOR RECORDS BY RACE ARTISTS

Special Release of Three Records by Colored Artists Is Particularly Timely

In view of the apparently growing interest in records by colored artists, termed by some manufacturers "race" records, a special release of three new records of that type by the Victor Co. is most timely. The first of the new records bears on one side "If Anybody Here Wants a Real Kind Mamma" and on the other side "Memphis, Tennessee," both sung by Ethel Ridley, accompanied by Bradford's Jazz Phools. The second record is of "Bleeding Hearted Blues" and "You Can't Do What My Last Man Did," two piano numbers played by James T. Johnson, and the third record is of "Midnight Blues," sung by Rosa Henderson, and "Cotton Belt Blues," sung by Lizzie Miles.

REPRESENT THORENS PRODUCTS

L. H. Junod & Co. American Agents for Swiss Motors, Tone Arms and Sound Boxes—Fall Sales Campaign Is Now Under Way

L. H. Junod & Co., 104 Fifth avenue, New York, are making plans for an energetic Fall campaign in behalf of Thorens motors, tone arms and sound boxes. These products, which are manufactured by the Herman Thorens organization at Ste. Croix, Switzerland, are well known in the talking machine industry, as they were introduced in this country many years ago. L. H. Junod & Co. have been appointed American representatives for the Thorens organization and complete sample lines are now on display at their warerooms.

Although a newcomer in the talking machine field, Mr. Junod is well known in general business circles. A number of years ago he became identified with the export industry, representing the firm of Steiger & Co., and later becoming American agent for Eisenhut & Co. and other prominent houses. Since 1909 Mr. Junod has represented the Swiss Government in consular affairs in New York, beginning as vice-consul, and in 1912 becoming Swiss consul here for New York and the New England States. As he is a native of Switzerland, Mr. Junod is thoroughly familiar with the economic and commercial conditions of his home country and has rendered invaluable service to the Swiss Government in many ways. He also has the unique record of having crossed the Atlantic Ocean on seventy voyages during his business career to date.

Incorporation papers have just been filed for the Hudson Music Co., Hastings-on-Hudson, N. Y. A. Barchas, R. Lurie and P. Block are the officers of the company, which will be capitalized for \$10,000. Acting as legal representatives will be the firm of Kaplan, Kosman & Steusand, 1540 Broadway, New York. The concern will deal in musical instruments.

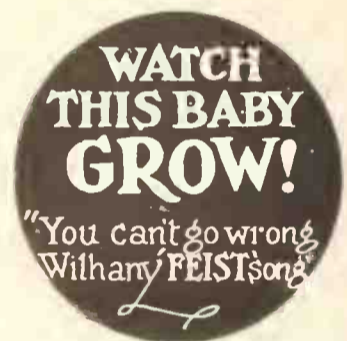
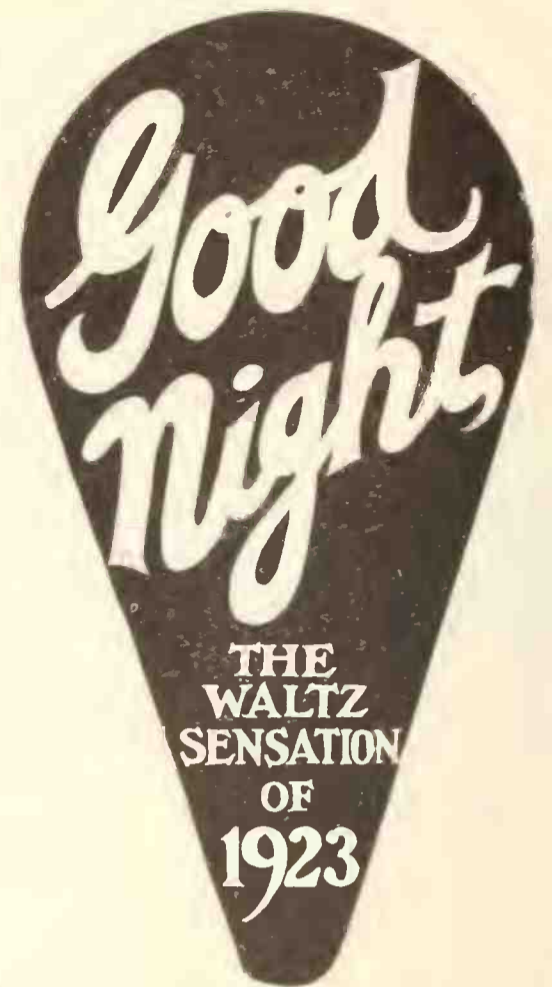

B. D. COLLEN RETURNS FROM EUROPE

B. D. Colen, president of the Musical Products Distributing Co., New York, manufacturer of the "Standex" display stands and jobber of Vocalion records, returned recently from a trip to Europe. Mr. Colen visited several countries abroad, spending about three weeks in Berlin, making an investigation of commercial and economic conditions. Upon his return to New York he was glad to find that his company's activities during the Summer months were well ahead of all expectations and at the present time he is busy making plans for the Fall trade.

NEW STORE IN SAND SPRINGS, OKLA.

SAND SPRINGS, OKLA., September 5.—A music store has been opened here at the former location of the Star Café by Daltry and DeArmand, of Hugo.

AT LAST!

A Perfect reproducing
phonograph to retail at **\$10**

Strong, easy running motor with spring of best material—one winding plays entirely any twelve-inch lateral record—reproducer duplicated only on very much higher-priced ma-

chines—eight-inch, heavy steel turntable, nickel-rimmed and covered with best grade of felt—efficient speed regulator—cabinet made of mahogany finish wood.



YALE Phonographs

For trade prices and details, write to
Davis Mfg. & Sales Co., 763 State Street, New Haven, Conn.



The
**FLETCHER UNIVERSAL
 TONE ARM and REPRODUCER**

Gives Proper Playing Weights for All Records. No Adjustment Screws or Springs
 SAMPLES \$8.00 Specify 8½" or 9½" arm

FLETCHER-WICKES CO., 116-122 West Illinois Street, Chicago, Illinois

THE McLAGAN PHONOGRAPH CORPORATION, LIMITED, STRATFORD, ONTARIO, EXCLUSIVE CANADIAN AGENTS

FLETCHER REPRODUCER

Scientifically

Constructed



Gives Perfect
 Reproduction
 of Voice
 or Instrument

Volume and
 Perfect Detail

Dealers, Send for
 Prices and Terms

Reproducer
 and Connection
 for
NEW EDISON
 Plays all Records



ACTUAL SIZE

Carried in Stock for Victor and Columbia

THE FLETCHER "STRAIGHT"

Design Patented November 29th, 1921



**STRAIGHT INSIDE—Taper Outside
 BALL BEARINGS THROUGHOUT
 NEW DESIGN NEW CONSTRUCTION**

It is universal and equipped with the Regular Fletcher
 Reproducer, giving the same natural tone quality as heretofore
 Made in two lengths, 8½" and 9½" SEND FOR PRICES AND TERMS



FLETCHER-WICKES COMPANY
 116-122 WEST ILLINOIS STREET CHICAGO

THE McLAGAN PHONOGRAPH CORPORATION, LIMITED, STRATFORD, ONTARIO, EXCLUSIVE CANADIAN AGENTS

PAUL WHITEMAN AND HIS ORCHESTRA RECEIVE UNPRECEDENTED WELCOME ON RETURN FROM EUROPE

Many Prominent in Talking Machine, Musical and Theatrical Circles Meet Leviathan at Quarantine—Musical Program and Airplane Play Part in Welcome—Guests at Banquet and Reception

Paul Whiteman and His Orchestra, exclusive Victor artists, arrived in New York a few weeks ago on the "Leviathan" after a triumphal season at the London Hippodrome. The "Leviathan" was met down at the Quarantine station about twenty miles below the city by a boatload of talking machine, musical and theatrical people. A band on the guest boat serenaded Paul Whiteman and His Orchestra all the way to the "Leviathan" dock, while overhead a big army bombing plane carried Charles Dornberger and His Orchestra from "George White's Scandals," who also serenaded the returning orchestra. A third band in life-saving suits played in the water at the side of the "Leviathan" at the Quarantine station and, upon arrival at the dock, a fourth band of serenaders appeared and played until Paul Whiteman and His Orchestra had disembarked.

By prearrangement among the representatives of the music industries in New York a reception was held on the "Leviathan" dock, in the course of which Paul Whiteman was crowned "King of Jazz." The crown for the coronation was made by the Buescher Band Instrument Co., Elkhart, Ind., to the specifications of the reception committee. The Buescher Band Instrument Co. made the set of instruments used by Paul Whiteman and His Orchestra and the crown bore replicas of these various instruments, including, of course, the popular saxophone. The coronation address came over the long-distance telephone from Elkhart, being sent by F. A. Buescher. The golden crown is inscribed "To Paul Whiteman in appreciation of his art and artistry and his aid to self-determination in the music of the nation."

The day following their arrival Paul Whiteman and His Orchestra were the guests of

honor at a banquet and reception given at the Waldorf-Astoria. Many well-known members of the music publishing and allied industries

success. The guests of honor at the dinner comprised the following: Victor Herbert, Senator E. I. Edwards, S. J. Kaufman, Jules Glaenger, Frank Crowninshield, Murray Hulbert, George S. Kaufman, Irving Berlin, Congressman Sol Bloom, Com. Richard Enright, George M. Cohan, Marc Connelly and Capt. Herbert Hartley. Murray Feil officiated as stage director and the Paul Whiteman Welcome Home Com-



Incidents Connected With Great Welcome to Paul Whiteman

1—The Seaplane Welcome. 2—Paul Whiteman Broadcasts by Radio. 3—The Submarine Band Does Its Bit. 4—The Paul Whiteman Welcome Home Committee's Yacht.

were present, together with half a dozen bands, which alternated in playing for the assembled guests. The entire program was broadcasted by radio and, under the direction of William Collier as toastmaster, the event was a decided

mittee, which was directed by Phil Kornheiser as chairman, comprised the following: William Collier, Victor Herbert, George M. Cohan, John Philip Sousa, Irving Berlin, Senator E. I. Edwards, Senator J. J. Walker, Jay Witmark,

Paul Whiteman and His Orchestra

VICTOR RECORD
STARS

USE

BUESCHER

INSTRUMENTS

EVERY time you sell a Paul Whiteman Orchestra record, many young persons will hear it who will wish they could play a Buescher Saxophone as well as Donald Clark, Hale Byers or Ross Gorman, or wish they could play a Buescher-Grand Trumpet so brilliantly as Henry Busse or Thomas Gott, or a Buescher-Grand Trombone so well as Samuel Lewis, or play a Buescher Bass so sweetly as John Barsby.

You, Mr. Record Dealer, ought to sell Buescher Instruments.

You are in a favored position to take advantage of that desire which every sociable young person has to play a musical instrument, and which is roused to the purchasing point when a Paul Whiteman Orchestra record is played.

75% of the best orchestras in all record catalogs use Buescher instruments. Window trims and mailing pieces showing great record artists help you to sell more records and sell Buescher instruments too!

Buescher Saxophones are easily learned from home study charts. Mutes make home playing of Buescher Trumpets, Cornets and Trombones not only practicable but popular.

Write for catalog and Buescher literature featuring record artists. We'll quote you trade figures that will show you profit. Address your letter to Mr. F. A. Buescher, personally, care of

BUESCHER BAND INSTRUMENT COMPANY, G-93 Buescher Block, Elkhart, Indiana



PAUL WHITEMAN AND HIS ORCHESTRA

will devote several weeks to the making of

NEW VICTOR RECORDS

in which will be embodied the greatest musical thrills ever recorded

The foremost musical critics and writers have acclaimed Paul Whiteman as an important factor in America's musical life

An extract from Gilbert Seldes' article in the August issue of "The Dial," one of America's leading literary magazines

*"Today I know of no second to Whiteman in the complete exploitation of jazz. Like Karl Muck and Jim Europe, Whiteman is a bit of a 'Kapellmeister'; his beat is regular or entirely absent. He never plays the music with his hand or designs the contour of a melody, or otherwise ACTS. I know that people miss these things; I would miss them gladly a thousand times for what Whiteman gives in return. ***** I mean that a sudden bellow or a groan is all very well, but the real thrill is in such a moment as the middle of Whiteman's performance of a 'Stairway to Paradise,' when the 'Beale Street Blues' occur. That is real enjoyment and the rest is nowhere. ***** He has arrived at one high point of jazz, the highest until new material in the music is provided for him."*

Watch for Paul Whiteman's New Records

Management

UNITED ORCHESTRAS

Incorporated

160 W. 45th Street

New York City

Buddy de Silva, E. C. Mills, Jules Glaenger, Hon. Sol Bloom, Walter Douglas, Dan Winkler, Hugh C. Ernst, Saul Bernstein, Otto Jordan, Elliott Shapiro, Mose Gumble, Edward T. King, James H. Thompson, Leo Wood, Julius Rosenthal, Louis Bernstein, Sam Salvin, Lou Davis, Jerome Keit, E. F. Bitner, Edward Marks, Edgar Leslie, Grant Clarke, Jack Robbins, Jack Mills, Will von Tilzer, Al Beilin, Fred Fisher, Henry Waterson, Milton Ager, Jack Yellen, Ben Bornstein, Mack Stark and Rubey Cowan.

This reception to Paul Whiteman, which constituted one of the greatest ovations that have been given a member of the music industry for many years, was in thorough accord with the tremendous success achieved by Paul Whiteman and His Orchestra in London. During their stay abroad this organization won the approval and enthusiastic praise of the English public, music lovers and musical fraternities. The orchestra played to capacity audiences at every performance and this visit to England gave international fame to an orchestra that has become celebrated in America from coast to coast as the leading modern interpreters of music.

Asa A. Pond, Columbia dealer in Pawtucket, R. I., is on the talent committee of the Elks' Lodge, which will put on a course of concerts this Fall.

Repair Parts, Main Springs, Motors

- Single-spring Motors\$ 2.50
- Double-spring Motors 3.25
- Liberty Motors 6.00
- Three-spring Motor 12.50
- Four-spring Motor 15.00
- Tone Arm and Sound Box, per set, \$1.35 and up

WRITE FOR CATALOG

PLEASING SOUND PHONO. CO.

204 E. 113th St. New York, N. Y.

L. D. ROSENFELD IN NEW POST

Has Joined Staff of the Regal Record Co., Inc. —Now in South Appointing Jobbers for "Little Tots' Nursery Tunes"

Louis D. Rosenfeld, who has been connected with some of the most successful record manufacturing companies in the sales and advertising departments, has joined the staff of the Regal Record Co., Inc., and will give particular attention to the "Little Tots' Nursery Tunes" division of that company.

Mr. Rosenfeld has a wide acquaintance in the talking machine field, both among distributors and retailers. He recently returned from a several weeks' trip through New England territory, where he found a great deal of enthusiasm among retailers for these new records. Mr. Rosenfeld is now traveling through the South and Middle West, where he is appointing jobbers for the distribution of these records.

MISS LILLIAN GUTH BACK AT DESK

Miss Lillian Guth, secretary and credit manager for the Emerson Phonograph Co., Inc., returned to her office early in September following an auto trip to Maine and other New England territory. The trip was made for a much-needed vacation, following an unusually active Spring and Summer in Emerson business. Miss Guth recently reported that, since the reduction in the retail price of Emerson records, the distribution of this product has been greatly enlarged. The addition of several models to the Emerson line of machines has also added to the activities of all departments of the company.

BUYS CHILD MUSIC CO. STOCK

Louis Harter has bought the stock and equipment of the C. L. Child Music Co., Victor dealer, of Maplewood, Mo. Mr. Harter will move the stock to his new store in Webster Groves, Mo.

W. C. FUHRI RETURNS FROM COAST TRIP

Okeh General Sales Manager Appointed Two New Okeh Jobbers—Opened New Branch in San Francisco—Found Conditions Satisfactory

W. C. Fuhri, general sales manager of the General Phonograph Corp., manufacturer of Okeh and Odeon records, returned to his desk recently from a trip to the Pacific Coast, during which he called upon Okeh jobbers in various cities and made a number of important Okeh jobber appointments. At Dallas, Tex., the Texas Radio Sales Co., Inc., was appointed an Okeh jobber. This company has leased a large building at 2005 Main street and is making plans for an aggressive Fall campaign.

After leaving Dallas Mr. Fuhri visited Los Angeles, where the former General Phonograph Corp.'s branch is now conducted by the Okeh-Smith Co. as a jobber of Okeh records. C. N. Smith, head of this concern, is keenly enthusiastic regarding the future outlook for Okeh records in his territory.

W. E. Henry, formerly manager of the Los Angeles branch, accompanied Mr. Fuhri to San Francisco, and a new branch of the General Phonograph Corp. was opened at Third and Mission streets, San Francisco, under Mr. Henry's capable direction. From San Francisco Mr. Fuhri journeyed to Portland, Ore., establishing as an Okeh jobber in that city L. D. Heater, one of the best-known wholesale phonograph men on the Pacific Coast. Following the establishment of these new jobbers Mr. Fuhri called on several Okeh jobbers in the Middle West, stopping at Salt Lake City, Denver, St. Louis, Minneapolis, Kansas City, Detroit, Chicago, Cincinnati and other trade centers. He reports business conditions as looking very favorable and that Okeh jobbers are in the midst of preparations for a banner Fall trade.

DEATH OF CONNELLSVILLE MERCHANT

CONNELLSVILLE, PA., September 1.—J. Aaron, head of Aaron's, operating large department stores in Uniontown and Connellsville, died at his home after a brief illness. Mr. Aaron was a native of Germany and located in America at an early age. He had just reopened the Uniontown store, which had been remodeled and renovated a few weeks ago. Both stores have model Victrola departments. The funeral services held at Connellsville were largely attended.

At Last! A Perfect Repeating Device
Cesco Repeater



Price \$1.00

Here at last is a perfect repeating device—absolutely new in principle, new in construction and more salable than any other like device. Unique and novel in operation. Decidedly simple. Needs no adjusting whatever. Just sets in the center of the record. No break or pause between ending and starting—its action is instantaneous.

SEND FOR SAMPLE

The CESCO Repeater is sold to the trade through jobbers and distributors. Samples furnished to dealers on receipt of jobber's name.

THE RAPID REPEATER COMPANY

260 Van Alst Ave., Long Island City

BROOKLYN MERCHANTS PLACING FALL ORDERS

End of Vacation Season Finds Retail and Wholesale Trade Busy With Plans for Fall Campaigns—Trade Expansions—Some Unusual Window Displays—Other Interesting News and Activities of Long Island Trade

Among talking machine jobbers and dealers in the Brooklyn and Long Island territory there is an increasing evidence of optimism regarding the outlook for Fall trade. Dealers are ordering stock to meet their demands in a liberal way, and with the Summer vacations almost over, and the sales staffs of the various jobbers once more at the helm, we can expect marked sales activity in the Brooklyn and Long Island territory around the middle of September

Opportunity for Portables Sales

That the season for portable talking machines does not end with the Summer months is noted by a prominent Brooklyn dealer. The Fall months, particularly those just preceding the Christmas season, have been found to be, among a certain class of prospects, a good time for the sale of portable machines. These prospects are the parents of children and young people who attend schools and colleges away from home. It is possible to sell the machine with the idea in mind that they make a very acceptable gift for the students, and can be easily transported back and forth at the close of the scholastic year.

Magers Music Shop Expands

Benton's Music Shop, Central avenue, Cedarhurst, L. I. Victor dealer, has sold out to Magers Music Shop, and business will continue under that name at the above address.

Pravder Music Shop Adds Sonora

The Long Island Phonograph Co., Sonora distributor of Brooklyn and Long Island, has secured as a new account the Pravder Music Shop, 531 Sutter avenue, Brooklyn. A sales drive by this new addition will soon be started.

Vorbach Bros. Help to Lower the Temperature

Vorbach Bros., 10927 Jamaica avenue, Jamaica, L. I., recently used a rather novel window display, considering the time of the year. It consisted of a Winter scene. A partition was built in the window representing a house. Snow covered the ground and the roof of the house. Several small evergreen trees appeared in the foreground. A caption was printed which invited the people to enter the store and be as cool as the scene depicted in the window. The

The Victor Dealer

WHO DELAYS PLACING HIS ORDER FOR MACHINES FOR FALL REQUIREMENTS WITH HIS DISTRIBUTOR, IMMEDIATELY, IS MAKING A MISTAKE.

DO NOT BLAME ANYONE BUT YOURSELF AT A LATER DATE IF THE FAULT IS YOUR OWN.

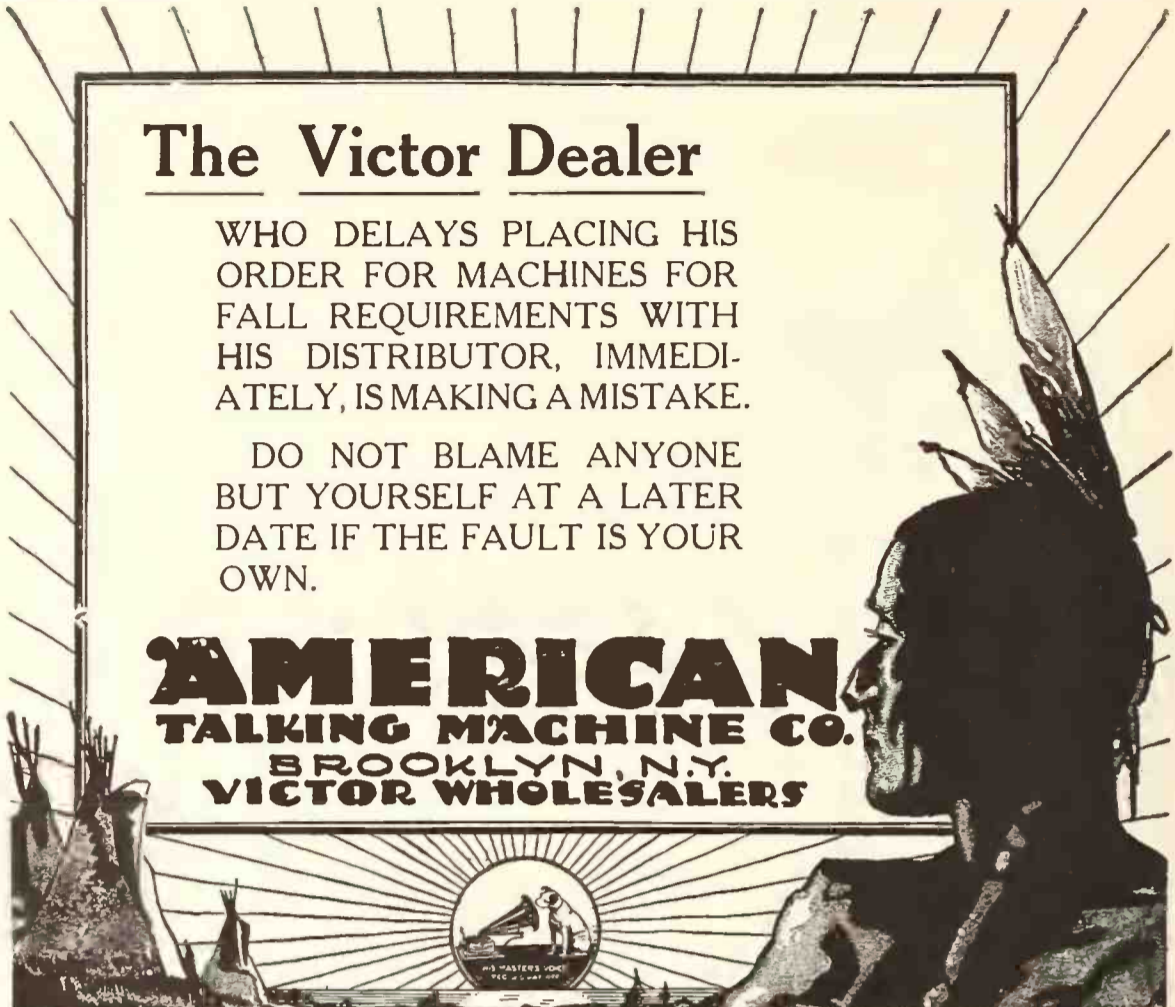

AMERICAN

TALKING MACHINE CO.

BROOKLYN, N. Y.
VICTOR WHOLESALERS

interior of the store was arranged to represent the living-room of a house, several talking machines being displayed on the floor and also a piano and musical merchandise. This window display attracted unusual attention inasmuch as it appeared during the hottest months in Summer, namely, July and August. Mr. Vorbach attributes the sale of at least ten talking machines to this display.

Noting and Acting on an Opportunity

This concern is quick to take advantage of local happenings and did so during the recent automobile show held in the neighborhood. An automobile firm had displayed large signs inviting the public to come and view the 1924 models of cars. Accordingly Vorbach Bros. displayed a similar sign which read "Come and see our 1924 model," and had on display a number of talking machines of the latest models. It has always been the policy of this store to make its customers feel at home. Often a num-

ber of young people will come in and play pieces on the piano, and in some cases even dance. The good-will that is built up in this manner has led to a number of sales.

Victor Demand Grows Steadily

Victor business in the Brooklyn and Long Island territory shows a greatly increased activity at the present time. Richard H. Morris, secretary, treasurer and general manager of the American Talking Machine Co., Victor wholesaler, states that an exceptionally good Fall business is anticipated. Now that the consolidation of the G. T. Williams Co. with the American Talking Machine Co. has been completed, Victor dealers in the territory are receiving better service than ever before. R. H. Morris and G. T. Williams have spent considerable time recently in contact with the dealers in the territory, who are optimistic over Fall prospects.

Planning Fall Aeolian Drive

C. G. Davis, manager of the Aeolian Co., of Brooklyn, who recently returned from a two weeks' vacation, is one of the most popular members of the Brooklyn trade planning to carry on a very active Fall sales campaign. This concern, by the way, is one of the most prosperous in this territory.

Padula Occupying New Store

Vincent Padula, Sonora dealer of Corona, L. I., is now occupying his new store at 9 Forty-sixth street, Corona, L. I., under the name of the Corona Music Shop. The new quarters are advantageously located, and modern fixtures make this one of the most up-to-date establishments in this vicinity.

Simplicity of Window Displays Pays

A window display which has been found effective by a prominent Sonora dealer in Brooklyn is based on the idea that a heterogeneous mixture of stock displayed in a window is not always the best method of advertising. It is his belief that oftentimes the store is liable, through a desire to take advantage of all available window space, to place too many articles on display. He states that he finds if a number of talking machines, records, musical instruments and small goods are placed in the window, there is too much on view at one time and the different objects tend to detract attention from one another. Inasmuch as an adequate stock is carried on the floor itself, and the real reason for a window display is to get people to enter the store, if it can be accomplished by the display of only one or more articles, so much the better. When the customer comes into the



SERENADE

*The Highest Class Talking
Machine in the World*

*Now for a
Bigger Fall Business*

THE INSTRUMENT OF QUALITY
Sonora
CLEAR AS A BELL



Here is the whole story of our attractive proposition to dealers—in a paragraph.

The SONORA, with its mechanical and artistic perfection; and our service which is uniformly active, satisfactory, smooth running and profitable, place you in a position of utmost satisfaction season after season.

Let us explain more fully—write

Long Island Phonograph Co., Inc.

17 Hanover Place, Brooklyn, N. Y.

Telephone Main 1217-18

Sonora Distributors for Brooklyn and Long Island

Another Superior Point for THE NEW COLUMBIA

Each individual model of the New Columbia has been thoughtfully and artistically designed. The lines are charming in their simplicity and quiet elegance. Only the choicest woods are used, with their natural beauty brought out to best advantage. The hardware and other minor details make a harmonious whole unsurpassed in the realm of furniture.

COLUMBIA GRAPHOPHONE CO.
New York



store he or she has an unlimited collection. The display in this case consisted of a motor and turntable; on the latter there was a dancing doll. Besides this there was one cabinet talk-

ing machine displayed in the window. The motor revolved continuously, and the movement of the doll attracted the attention of many people as they passed the window.

analyzing the orders placed by Sonora dealers last Fall and pointing out that practically every dealer could have used at least 25 per cent more merchandise last year than the company was able to furnish. At this point order blanks were distributed among the dealers and the suggestion was offered that wherever possible the dealers anticipate their requirements for the next three months. This plan met with an enthusiastic response from the Sonora merchants present and orders were placed at the meeting which called for considerably more Sonora instruments than the sales totals presented by Mr. Keith in his address.

LONG ISLAND PHONO. CO. HOLDS FIRST DEALER MEETING

Constructive Addresses by Executives of Prominent Brooklyn Sonora Wholesaler and George E. Brightson, President of the Sonora Co., and Other Officials Feature Event

The Long Island Phonograph Co., Brooklyn, N. Y., Sonora jobber for Brooklyn and Long Island, was the host at a convention of Sonora dealers in this territory held at the Hotel Bossert, Brooklyn, N. Y., on August 30. The meeting was a decided success and, in all probability, similar gatherings will be held in the near future in order to give the company and its dealers an opportunity to exchange ideas.

success as an executive with several prominent organizations, gave a general review of business conditions, showing by facts and figures just why the coming Fall season should prove to be one of the most prosperous of recent years. Other speakers included Irwin Kurtz, president of the Talking Machine Men, Inc.; E. S. White, Frank Goodman, J. J. Schratweiser and Herbert G. Young.

Quite a number of the dealers took advantage of R. H. Keith's invitation to join an open forum and brief talks were made by the following Sonora retailers: C. S. Hammond, manager music department, Frederick Loeser & Co.; James Quinn, C. J. Iannell, manager of phonograph department, H. Batterman & Co.; S. M. Creedman, Leon Brick, Mrs. Albert Bersin and other well-known Long Island dealers.

Before luncheon was served the Sonora dealers, with their friends, were invited by R. H. Keith, president of the Long Island Phonograph Co., to inspect the new "Argyle" Sonora console which was recently added to the line. This instrument met with the enthusiastic approval of all the visitors and it was predicted that the "Argyle" would prove to be one of the leading sellers during the coming season.

In behalf of the Long Island Phonograph Co. C. W. Keith furnished the guests with pertinent information relative to sales figures and sales possibilities. He reviewed 1922 conditions,

In a brief address of welcome Mr. Keith told the dealers that the meeting was theirs and during the course of the luncheon an interesting musical program was presented, including several selections by Miss Alexander, a well-known Spanish soprano. Mr. Keith officiated as toastmaster and seated at the guests' table were the following executives of the Sonora Phonograph Co.: George E. Brightson, president; S. O. Martin, vice-president and general manager; O. S. Keyes, treasurer; L. C. Lincoln, advertising manager; Frank Goodman, assistant general sales manager, and E. D. Coots, dealer service manager. Other guests at the speakers' table were E. S. White, Sonora Co. of Philadelphia; Herbert G. Young, assistant sales manager, Sonora Sales Co. of New Jersey; C. W. Keith and J. J. Schratweiser, of the Long Island Phonograph Co.

Mr. Brightson favored the dealers and their friends with one of his usual interesting addresses, stating that the Sonora Phonograph Co. has sufficient orders on hand at the present time to keep the factories working to capacity until March. Mr. Martin, who has won considerable

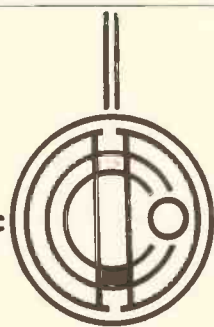

DOEHLER

The World's Largest Producer of
DIE-CASTINGS

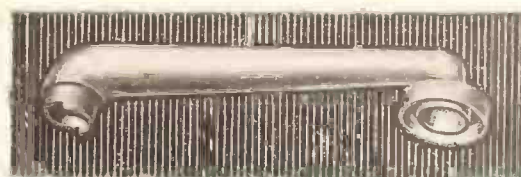

Doehler Die-Cast Zinc Alloy Phonograph Tone-Arm

Doehler engineers and metallurgists—in the Doehler laboratories—are constantly engaged in research and development work in metal alloys for die-castings. And they are in constant touch with progress and discovery in other metallurgical and chemical fields.

As a result, Doehler customers are assured the full advantages of the very latest practice, and may feel the confidence that every Doehler Die-Casting is up-to-the-minute in the best metallurgical knowledge.

DOEHLER DIE-CASTING Co.
BROOKLYN, N. Y.
TOLEDO, OHIO.

A. Centonze Music Co.
PUBLISHERS

Distributors and Jobbers in

**RECORDS and
PIANO ROLLS**

**174 JOHNSON AVENUE
BROOKLYN, N. Y.**

Widdicomb

PHONOGRAPH
The Aristocrat of Phonographs

A two-fold appeal to good taste

—unusual tonal beauty and faithfulness of reproduction

—exquisite cabinet work in popular period styles.

MANY successful phonograph merchants have found that the two-fold appeal of the Widdicomb is building them a steadily increasing patronage and prestige among discriminating buyers. If you are genuinely interested in increasing your business among the best class of trade, write us today for complete catalog and full particulars regarding the Widdicomb franchise.

THE WIDDICOMB FURNITURE COMPANY
Grand Rapids, Michigan

Fine Furniture Designers Since 1865

NEW YORK: 105 W. 40th ST. CHICAGO: 327 S. La Salle St.



Queen Anne Model 6
—finished in Red or
Antique Mahogany or
Walnut. Equipped with
albums for records, au-
tomatic stop and pa-
tented tone control.



Adam Model 12—finished in Red or
Antique Mahogany or Walnut. Equipped
with albums for records, automatic stop
and patented tone control.

Widdicomb Phonographs in Period Styles are faithful interpretations of the best designs of the old masters of the art of wood fashioning. They are the handicraft of an organization which for three generations has enjoyed a reputation for leadership as designers of fine furniture. Widdicomb Phonographs play all records. Prices on the various models range from \$90 to \$260.

SAN FRANCISCO

Business Gains Make Fall Prosperity Certain—Period Models Most Popular—Several Firms Move—Important Trade News of Month

SAN FRANCISCO, CAL., September 1.—The calamity howlers will be disappointed again, for there will be no period of depression this Fall. Business conditions on the Coast have been improving steadily, and as far as the talking machine trade is concerned most of the dealers report a big increase in sales over last month. The reduction in price on Victor Red Seal records has stimulated record business on high-class records and the volume of sales on Columbia records is unprecedented. Edison, Vocalion and Brunswick records are growing steadily in popular demand out this way and the prospects are for a revived interest in Okeh records now that the General Phonograph Corp. has extended its Coast representation.

Popularity of Period Models

"The fine art models of talking machines," says Robert Bird, Pacific Coast sales manager of the wholesale-Victor department of Sherman, Clay & Co., "have undoubtedly done much to raise the average price paid for talking machines these days. Even in the neighborhoods inhabited almost entirely by wage workers the demand for period styles is insistent."

This would seem to indicate that public taste is becoming elevated to a higher plane in the matter of machines as well as in record selections. Some claim the more fastidious popular taste is directly due to the influence of the luxurious interior furnishings exhibited in the motion pictures. Surely the increased appreciation of good music is largely due to the excellent programs of the movie orchestras.

Trade and Public Welcomes New Edison

The educational work of Edison Phonographs, Ltd., in promoting a critical valuation of fine art in music is appreciated by the trade, no matter what line is carried. The Edison re-creations represent the highest achievement and consequently it is no wonder Edison fans are multiplying in all quarters. The Coast trade certainly welcomes the recent splendid additions to the Edison record library and the fine line of Edison phonographs now available.

Work Starts on New Victor Plant

Excavation work for the new pressing plant of the Victor Co. in Oakland is about to com-

mence. The plant is expected to be ready for use within a year.

New Sherman, Clay Building Soon Ready

The new wholesale building of Sherman, Clay & Co., on Mission street, this city, is nearing completion and plans are being made to occupy it before October 15.

The Stockton store of Sherman, Clay & Co. was completely destroyed by fire a few weeks ago and the company is now occupying temporary quarters in Stockton. The company will rebuild bigger and better.

The big talking machine sale at Kohler & Chase is over and Jack Bray, manager of the talking-machine department, has fled the city to take a much-needed vacation. Accompanied by Mrs. Bray, he is exploring northern California.

General Phono. Corp. Opens Offices

The General Phonograph Corp., of New York, manufacturer of Okeh and Odeon records, has just opened a branch at 86 Third street, this city. The office is in charge of Bob Koltart, who was formerly with the Columbia Co. in San Francisco, and who later engaged in the talking machine business in Honolulu and Australasia. W. E. Henry, better known as "Pop" Henry, is the Pacific Coast manager of the General Phonograph Corp. He recently opened up the main office in Los Angeles. "Pop" is also an old Columbia representative and at one time was in charge of the San Francisco office.

Quarg Music Shop Is Expanding

William Quarg, manager of the Quarg Music Shop, as "The Phonograph Studio" is now renamed, is taking a business trip to Los Angeles. The shop was started a few years ago as an exclusive talking machine store, but gradually it has expanded until now several lines of musical merchandise are carried. A special show window this week is devoted to featuring Victor and Columbia records of the popular song, "Cut Yourself a Piece of Cake and Make Yourself at Home." A huge wedding cake is the piece de resistance of the display. The window was put in in co-operation with the Leo Feist Co., publisher of the selection in sheet music form.

Hazel Rae Love, of the Quarg Music Shop, the all-round authority on talking machine mer-



NYOIL

FOR YOUR PHONOGRAPH

Made in Our Watch Oil DEPARTMENT

which for half a century has made 80% of all the watch, clock and chronometer oil used in America.

The Best Oil For Any Talking Machine

In refining, Nyoil is given the same care as our famous watch oil receives. All gums and impurities are removed, leaving it

Colorless, Odorless and Stainless.

Housekeepers say they would not be without Nyoil because it is best for phonographs and sewing machines—for polishing furniture and woodwork and is odorless and will not stain. It is free from acid and will not gum, or become rancid. Sportsmen find it best for guns because it prevents rust.

Nyoil is put up in 1-oz., 3-oz. and 8-oz. Bottles and in Quart and Gallon Cans.

For Sale by all Talking Machine Supplies Dealers

WILLIAM F. NYE, New Bedford, Mass., U.S.A.

chandise, is back at her post after a vacation trip which extended from Fresno on the south to Eureka on the north.

Frank B. Long Moves

Frank B. Long, inventor and manufacturer of the Melodiola phonograph, is moving into a new and handsomely equipped establishment at 463 O'Farrell street.

To Move Brunswick Department

The Sterling Furniture Co., on Market street, is to come down to the main floor with its exclusive Brunswick department some time before the close of the year. The company has such faith in the line that it wishes to give it greater prominence in display and the sales department.

F. Travers on Business Trip

F. Travers, manager of the Sonora Phonograph Co., of the Pacific Coast, is making a business trip through the Northwest during which he will visit a number of the Sonora dealers. O. N. Rothlin, manager of the Phonograph Shop, on Stockton street, dealer in Victor and Sonora merchandise, finds interest in period styles more keen than ever before.

New Brunswick Accounts

The Alexander Music House, of Salinas, and the Pierce Piano House, of Eureka, are two new California agencies for the Brunswick line.

The Brunswick Co. has completed making a series of Paul Ash jazz and semi-standard records which will shortly be placed on the market. The records were made in a room of the San Francisco branch of the Brunswick Co.

Miss Bessie Lee, of the talking machine department of the Nathan-Dohrmann Co., San Francisco, is on her vacation. Incidentally, it is her honeymoon, for she deserted the ranks of single blessedness on August 18.

W. A. CARROLL VISITS EMERSON CO.

Detroit Emerson Jobber Makes Encouraging Report on Business Conditions and Prospects

One of the recent visitors to the offices of the Emerson Phonograph Co., Inc., was William A. Carroll, president of the Emerson Record Sales Co., Detroit, Mich., distributor of Emerson phonographs and records in Michigan and Ohio territory.

B. Abrams, president, and Arthur H. Cushman, sales manager of the Emerson Co., were quite gratified at Mr. Carroll's report of sales activities in the Middle West. Emerson sales have shown substantial increases and all indications point to a most active Fall season. Mr. Carroll, who has been an Emerson distributor for over seven years, stated that the reduction in the retail price of Emerson records has influenced many responsible dealers to stock the product.

Roger Babson and
The Pacific Coast

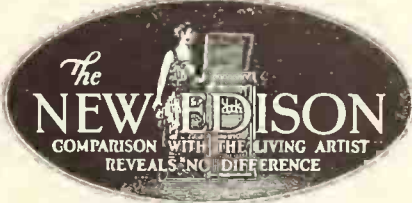

Two Pacific Coast cities are mentioned among ten American cities as good advertising distributing centers.

A good distributing center depends on the surrounding territory for selling.

This recognized authority is therefore your guarantee that the Pacific Coast affords an excellent business opportunity.

We serve the entire coast and have several locations open for Edison representation in this favored section of the country.

Edison Phonographs, Ltd.

Portland San Francisco Los Angeles



New Gennetts Every Week!

In the Blue Label Gennett Records are released the latest popular songs and dance hits and standard numbers. Their timeliness, wide range and quality have given them tremendous popularity.

Gennett Records released under the Green Label represent the highest attainment in the art of sound recording. The best standard numbers come under this label, which assures variety in selection, perfect reproduction and the real musicianship of the artist.

"First and Best on Gennetts" is the slogan today. There is an opportunity for you in selling Gennetts. Get acquainted with them.

GENNETT RECORDS

Manufactured by
THE STARR PIANO COMPANY
 Richmond, Indiana

New York—Chicago—Los Angeles—Birmingham—Detroit—Cincinnati—Cleveland—Indianapolis
 Boston—London, Canada

The Trade in PHILADELPHIA and LOCALITY

TRADE REMAINS IN OPTIMISTIC MOOD DESPITE LABOR TROUBLES IN COAL MINING CENTERS

Growing Demand for Records Features Trade—Fall Prosperity Depends in Large Measure Upon Satisfactory Settlement of Coal Controversy—News and Activities of the Month

PHILADELPHIA, PA., September 7.—Sultry August days and pleasanter September weather in the Philadelphia district both brought with them many inquiries of a character suggesting orders to follow later on and, better still, a little more than the usual amount of mid-Summer business. The wholesale distributors of records are particularly enthusiastic over conditions as they exist and as indications portend they will be. The outstanding feature of the wholesale trade is the very large amount of business conditionally placed by retail distributors of records throughout the State and particularly in the hard-coal regions, which during August remained a storm center of agitation between mine owners and miners. These orders were placed subject to the results of the negotiations over wages and other matters at issue between employers and employes and, in the event of a successful termination of them, indicated by the late intervention of the Governor of the State, there is certainty of a splendid Fall business in this territory. The trade believes that the men will be successful in securing a wage increase, in which event their purchases of records will be large. Another element in this situation is that the radio is not so extensively in use in the mining district as elsewhere and, consequently, records form a larger element of popular entertainment.

City trade among the distributors of records, both in a wholesale and in a retail way, was seasonably draggy, but there is not a note of doubt as to its future brightness. Reduction in price of Victor Red Seals had the effect of considerably stimulating sales of these products. The trade understands that the new double-faced Victor Red Seals will be placed on the market September 23 and, in view of that fact, ordering of old records was held back to some extent. A very large increase in Victor record sales is anticipated when the new records are offered to the public. The market for talking machines was merely seasonably quiet. That, too, with the coming of the cooler months, in dealer opinion, largely will increase. As a matter of fact, August of this year was decidedly more satisfactory in the volume of sales than the corresponding month of a year ago.

Clever Display Emphasizes Service

A novelty in sales promotion and which resulted most satisfactorily was staged during the month at the Widener Store, 1109 Chestnut street. At the close of each week there were hung in the Chestnut street show windows, past which thousands of shoppers go, two immense reproductions of clock faces. On the left-hand face the hands indicated 8:30 o'clock and on the right-hand 1 o'clock. An explanatory note emphasized the point that orders re-

ceived for machines as late as 8:30 o'clock on Friday would result in positive deliveries by 1 o'clock on Saturday, giving a seventeen-hour guaranteed service. The diagrams so vividly brought home this lesson that attention perforce was arrested and sales attributable solely to this effective display were made. In the opinion of Manager R. L. Perrett it was most effective. The displays were made only at the week-ends.

C. Bellak Defers Retirement

It was officially announced during the week that the negotiations which had for a long time been pending over the disposal by sale of the piano and talking machine business of Jas. Bellak's Sons, Twelfth and Chestnut streets, finally were off and that the business would continue under the present management. This firm enjoys the reputation of being the oldest in continuous business history in Philadelphia, the establishment dating back to 1854. It is the intention of the present owner, Charles Bellak, to retire and for a time it looked as if he would do so, but at the last minute the negotiations fell through and for the present at least he will continue to direct its affairs as he has been doing for several decades.

Champion Phonograph Globe-trotter

The local branch of the Columbia Graphophone Co. believes that it has located the champion phonograph globe-trotter. The following letter was received recently by the branch and is the basis for making this claim for championship:

"During my army career, 1917-21, the phonograph has been round the world with me three times and, when surgeon on the U. S. Trans-

(Continued on page 80)

Dependability

It is a fine thing when you feel assured that your Jobber can be depended upon to give you Victor Merchandise just when you need it.

We count it a privilege that so many Victor Dealers in our territory place their dependence on us.

Our aim is to merit this confidence by making good and we invite such as have not done so to get in touch with and tie up to

THE LOUIS BUEHN COMPANY

OF PHILADELPHIA

Victor Wholesalers



\$100
RETAIL
PRICE

THERE IS NO SUBSTITUTE
FOR THE NEW EDISON.

GIRARD PHONOGRAPH CO.

A FEW
DEALERSHIPS OPEN
WRITE US

Edison Distributors Exclusively
1819-1859 NORTH 10th STREET
PHILADELPHIA, PA.

PLAYS ALL RECORDS

THE TRADE IN PHILADELPHIA AND LOCALITY—(Continued from page 79)

port, it accompanied me to Finland on the famous Bolsheviki deportation trip. Your phonograph has had a stormy, strenuous and stirring existence. Crossing the ocean it has been left out on deck during a hurricane, yet it never failed to operate, whether in Northern or tropical latitudes. I would not part with it at any price."

Organize the G. F. Fields Music Co.

G. F. Fields has announced in a general communication mailed to the trade that he has disposed of his interest in the United Music Stores, Philadelphia, and has formed the G. F. Fields Music Co., which will act as wholesaler and jobber of music rolls, musical merchandise and radio sets. Mr. Fields has also announced that he has secured the exclusive jobbing of International player rolls for Pennsylvania territory. A location has been secured at 269 South Eleventh street, Philadelphia.

Everybody's T. M. Co. in New Home

In the new warehouse recently acquired by Everybody's Talking Machine Co., Inc., 810 Arch street, there will be opened an addition to the mail order department for the purpose of enlarging that division to take care of increased business which the firm enjoys nationally. The new building, located at Ninth and Filbert streets, consisting of a two-story structure, provides the firm with 6,000 more square feet of

space, part of which will be devoted to warehousing purposes and part to the mail order. Production of the Honest Quaker main springs is being speeded up in order to take care of the large bookings of orders now in hand and they are being shipped as fast as manufactured. With the new warehousing facilities it is planned to increase production. Samuel Fingrudt, in charge of the advertising department, is conducting a national advertising campaign and it is due partly to this development that business has been stimulated.

Vocalion Race Records Popular

Increased sales have followed in the Vocalion records distributed by the Lincoln Business Bureau, 1011 Race street, of which Bertram H. Matthews is proprietor, through the recording of that company of colored artists. The increased volume of business centers in stores, adjacent to or conducted where there is a large colored population. The August sales of this class of records have exceeded all expectations in Vocalion records.

Displays Boost Victor Record Sales

H. Royer Smith, who conducts a retail store at Tenth and Walnut streets, has had a record month in sales of Victor Red Seal records, which he featured in store and window displays. Miss Madeline, record buyer for the Smith store, left the first of September for a two

weeks' vacation trip to New York, where she visited the various Victor dealers, getting ideas of business promotion through the sales and display methods employed.

Inaugurates Drive on Records

Owing to the large number of Red Seal records which will be stocked by the Talking Machine Co., 1025 Arch street, it has arranged for the renumbering and redistribution of these lines in the shelving accommodations at the headquarters. The latter part of August clerks were kept busy rearranging the stock racks for the purpose of classifying the serial numbers and to make way for the incoming orders of double-faced Victor Red Seal records which will be carried during the coming season. The firm is prepared for a prosperous season in the new double-faced Victor Red Seals and expects that these will outsell the old single-faced record because of the comparatively low price. The firm announces that many dealers are awaiting the exchange proposition which shortly is expected from the Victor headquarters and which will deal with the returnable numbers of Red Seals. It is holding off orders for the new Red Seal records, expecting to clean up the old stock before placing orders for the new requirements. The entire sales force of the company started out on September 4 in order to clean up the Fall business. E. M. Stern, president of the company, is on an extended automobile trip through Canada and is expected to return by the middle of September.

Victor Dealers Ordering Fall Stock

Orders for the Victor machines placed with H. A. Weymann & Son, Inc., 1115 Chestnut street, cover September, October and November deliveries. Owing to the large number of orders on hand the firm is making every effort to speed up deliveries but feels that some dealers' wants will remain unsatisfied the next three months because of the demands on the output of the Victor factory, and the accumulated orders are far in advance of the number of machines to be had in stock. It is sending out announcement to the trade that concentration is being made on speeding up deliveries from the factory. Harry W. Weymann, president of the company, left the latter part of August for an auto trip along the St. Lawrence River and

H. A. WEYMAN & SON, INC.

1108 Chestnut Street

Philadelphia, Pa.

VICTOR WHOLESALERS



AT YOUR SERVICE

Colin B. Kennedy Radio Equipment

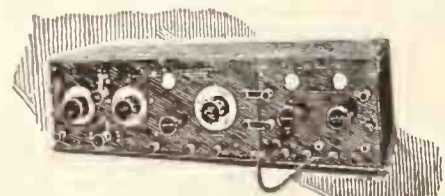

Jobbers of only Nationally Advertised
Radio and Musical Merchandise
UNITED MUSIC STORES
619 Cherry St. Philadelphia, Pa.

THE TRADE IN PHILADELPHIA AND LOCALITY—(Continued from page 80)

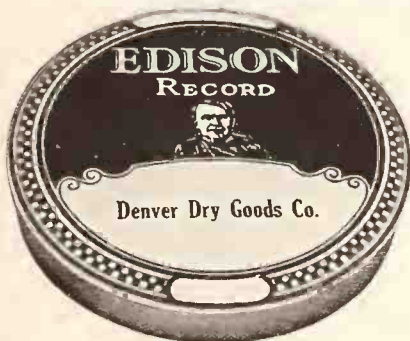

3 1/2" Dia.

VELVALOD RECORD CLEANERS

Dealers—Advertise direct in the home thru the best advertising medium on the market. Jobbers—Get your samples for your salesman. Prepare for the Holiday Trade. We will help you get it. Write at once.

Philadelphia Badge Company

Manufacturers and Patentees

942 Market Street Phila., U. S. A.

other Canadian points. He was accompanied by Mrs. Weymann and their son, Herbert W. Weymann, in charge of the publicity end of the business. During the absence of Mr. Weymann C. W. Bahls, general manager, is taking care of the talking machine department.

Louis Buehn Travelers Out

The four members of the sales force of the Louis Buehn Co., 835 Arch street, who have been on vacation, returned to headquarters the latter part of August preparatory to starting out after Labor Day on the Fall trip, visiting the dealers in their territories. C. E. Sheppard will spend the month visiting northeast Pennsylvania. Frank R. Ransley will look after Philadelphia. Harry Pierce will visit the southern New Jersey and southern Pennsylvania districts, while Thomas Hower makes the rounds of central Pennsylvania. Louis Buehn, head of the firm, has returned to headquarters from an extensive automobile trip to New England. While in the New England States he visited several of the golf courses for the purpose of training up for the big game to be played at the Seaview Golf Club near Absecon, just outside of Atlantic City. Mr. Buehn will enter the contest for the Blackman cup, to be held on September 15 on the Seaview golf course, and is expected to make a good showing because of his prowess in the game.

Girard Co. Planning Tone-tests

Plans for a series of tone-tests to be given during the coming Fall season are now under way at the Girard Phonograph Co., 1819 North Tenth street, co-operating with the dealers who feature the Edison phonographs and records, for which the Girard Co. is the local distributor. The series of tests will be featured in the eastern Pennsylvania, southern New Jersey, Delaware and Maryland districts, which come under the local territorial rights, where the dealers have arranged, in conjunction with the Girard and the Edison Co., to give concerts in halls, churches and other public gathering places, where the artists will personally appear and give concerts, while the vocal selections will be duplicated on the Edison. A. W. Rhinow, of the Girard Phonograph Co., is now perfecting plans with the dealers and the Edison Co., so that an early listing by the dealers will give ample opportunity for securing such talent as may be desired in the territory in the immediate future.

Concludes Sale of Old Columbias

During the month there were closed out at the Gimbel store the last of the special lot of Columbia cabinets of which this establishment had secured a very large proportion. Manager G. F. Wurtele, of the record department, enjoyed a brief vacation during the month and fully prepared himself for the big season ahead, which traditionally opens about September 15.

New Cheney Model Makes Debut

In the recently acquired home of the Cheney Sales Corp., in the Jefferson Building at 1015 Chestnut street, there is being featured the newest addition to the Cheney family of phonographs. It is listed as No. 119 and it was placed on the market the middle of August. It is a console constructed of mahogany, with an attractive and artistic grilled door, and retails at \$165. Customers who have viewed the new model in Room 808 in the Jefferson Building,

to which the firm removed from its former quarters in the Story & Clark Co. Building at 1105 Chestnut street this Summer, have placed large orders for the new model and dealers find little effort necessary to dispose of them; consequently, generous repeat orders are being received. The new location of the Cheney Corp.

is used as display room and sales offices and is the executive headquarters of G. Dunbar Shewell, president of the corporation. The local offices are under the management of D. H. Fulmer. G. Dunbar Shewell, Jr., advertising manager and son of the president, spent August on a vacation trip to Maine.

Wanamaker Makes Drive on Brunswicks

The John Wanamaker Store conducted an extensive Brunswick newspaper campaign, employing the use of every paper in Philadelphia, with the exception of one, in advertising these machines and, as a result, found business for the Brunswick greatly increased. Under the direction of the Philadelphia Brunswick manager, O. F. Jester, there is being conducted from the local headquarters at 1002 Arch street a full-page newspaper advertising campaign, with the Sunday Ledger, one of the best-known and leading Quaker City news journals, as the medium for getting the Brunswick be-

(Continued on page 82)



14-inch Horn, used in the Home, \$30

21-inch Horn, for Dancing and Concerts, \$35

Unrivaled Clarity!

MUSIC MASTER'S clean-cut, scratchless reproduction of tone is the marvel of all who hear it. It does not imitate the singer's voice; it gives forth the voice ITSELF, without distortion.

It always speaks highly for itself when attached to any demonstration set. Put one on your show outfit now and **DRAW THE CROWDS!** Dealers who have sold it know MUSIC MASTER to be one of the quickest turning-over items in radio.

Send for full description of the entire line of GERACO Proven Radio Products and prices.

GENERAL RADIO CORPORATION

Makers and Distributors of High-Grade Radio Apparatus

WALTER L. ECKHARDT, President

S.W. cor. 10th and Cherry Sts., PHILADELPHIA; 1005 Liberty Ave., PITTSBURGH

"GERACO" on radio apparatus means it is thoroughly tested and guaranteed. Get details on full line. Sold through jobbers and dealers everywhere.

DISTRIBUTORS for OKEH Records, STRAND Phonographs and GOLD SEAL Record Repeaters.

Music Master
RADIO REPRODUCER

NOW EXCLUSIVELY WHOLESALE

but with the advantage of many
years of retail experience.

The Talking Machine Company

Victor Wholesale Exclusively

1025 Arch Street Philadelphia, Pa.

"LET PHIL FILL 'EM"

THE TRADE IN PHILADELPHIA AND LOCALITY—(Continued from page 81)

fore the public. The object of this newspaper campaign is to co-operate with the dealers in preparation for the Fall and holiday business. The series will include not only the Brunswick machine advertisement, but the records as they are issued monthly. The newest console model, the Raleigh, was introduced to the local trade the last week in August and many advance orders were placed.

Wilde's Music Store, of Shenandoah, Pa., has just taken on the Brunswick line and will handle these instruments exclusively.

R. O. Lamforth, who for more than a decade has been connected with the talking machine business and recently manager of the talking machine department of The Fair, in Chicago, Ill., is now covering the coal regions of Pennsylvania as representative of the Brunswick Co.

Remodeling and Expanding

Remodeling and redeccorating of the talking machine department of the Estey Piano Co., Seventeenth and Walnut streets, is now under way in preparation for the opening of the busy season and the warerooms will be in readiness by the middle of September. The department recently was enlarged, part of the main floor rear being devoted to the record department, while the entire second floor is given over to the display room for the Victor, Cheney and

Sonora machines which the firm handles. The booths are being decorated in a scheme of gray and blue and this is followed out in the upholstering of the newly installed wicker furniture, and every comfort for the service to customers is to be had in the new department. With the confinement of machines to the second floor on a greatly enlarged space there was provided room for an enlarged stock of records and for the stocking of a greater number of machines. Four new salesmen will be added to the forces during the coming month.

Entering Radio Field

One of the newest departments which is being featured especially for service to the music dealers, and particularly for those carrying talking machines, is that of radio equipment. The new department now occupies six rooms on the mezzanine floor, where are carried a line of the Ware, Western Electric, Crosley, Radio Corp. of America and the firm's own specialty, the Estey Tea Table model radio sets and accessories. It is the purpose of the Estey Co. to make the radio department a wholesale center for talking machine or music stores which desire to carry sets and accessories, particularly the former, which will need no technically trained sales forces. The various sets are complete at varied prices. Four salesmen have been

added to the forces to take care of the territory included in the Eastern States. They are J. A. Bailey, Jr., Gilbert Farrell, George Rieger, Jr., and J. W. Mackin. A special department of the radio store is the contract department, under the supervision of Gerald L. Quinby, who is in charge of the radio service and who will feature the installation of radio in buildings. The Estey Co. is now conducting negotiations for the acquisition of a well-known radio factory and, when completed, announcement will be made of the firm's purpose to manufacture its own parts and radio sets under the Estey brand. This factory, one of the best-known devoted to the manufacture of radio equipment, will provide the Estey Co. with a thoroughly equipped plant for its own use. Mrs. Terese M. Quinby, in charge of the talking machine department of the Estey Co., accompanied by her son, Gerald L. Quinby, manager of the radio department, made an extensive vacation trip through the Great Lakes and returning by way of Albany, a trip down the Hudson and New York, arrived at headquarters the last week of August.

Now Victor Wholesales Exclusively

With the disposition of its remaining four retail stores, The Talking Machine Co., of this city, has become a Victor wholesaler exclusively. The sales of the other stores were chronicled in The World from month to month, the last four having been recently disposed of. They were purchased by Morton's, Inc., a new corporation headed by Morton L. Stern who will conduct the business in the same high-grade manner which has been noticeable in the past.

Clever Exploitation of "Music Master" Horn

The idea that the Summer months must necessarily be quiet months for the radio industry is disproved by the experience of the General Radio Corp., of this city. Walter L. Eckhardt, president of the company, in a talk with The World, produced figures which showed that August has proved the biggest month in the history of the business. Mr. Eckhardt contributes this large volume of business almost entirely to the quality of the products, as the big Fall campaign which has been planned has not as yet been put into effect. An analysis of the business consummated during August shows that the greatest volume of business was done on the "Music Master" horn and "Geraco" radio parts. An augmented staff has been put into effect in the factory at Putnam and Mr. Eckhardt is working towards the goal of a quarter-of-a-million dollars' worth of business each month.

An effective stunt, showing the enterprise of Mr. Eckhardt and his associates, has been put into effect, featuring "Music Master" horns. The services of an aviator and his plane have been secured to fly over cities east of Pittsburgh, featuring this horn. The words "Music Master" appear on the entire spread of the wings, as well as the tonneau of the plane, and are distin-

On Guard



Penn-Victor Dogs are the best watchmen of Victor Welfare in the Home.

Sold by most Victor Distributors.
Write them or us for prices.

Penn Phonograph Company

913 Arch Street

Philadelphia, Pa.

Victor Wholesale Only

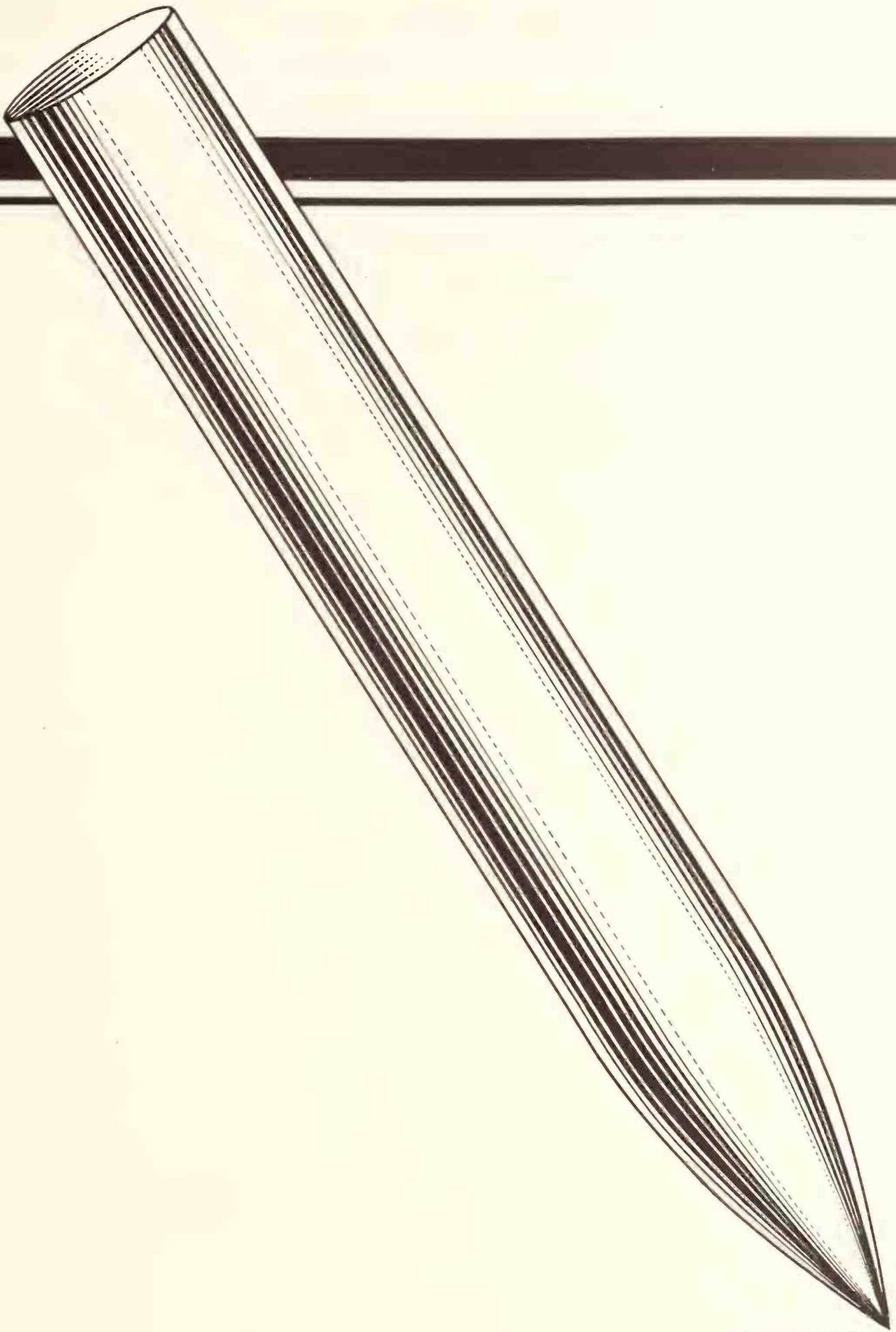

NEEPLES—those important trifles—
can make or mar your record sales.
Perfect reproduction and satisfied
record buyers are synonymous with—

Okeh

QUALITY

NEEDLES

General Phonograph Corporation

OTTO HEINEMAN, President

25 West 45th Street

New York

NICKEL in the SLOT

A Musical Novelty by
Zez Confrey
Writer of
STUMBLING



"You can't go wrong
with any FEIST song"

© LEO FEIST INC. N.Y.C.

The ice cream started a-melting, No one cares what happened to it All thru a little nickel in the slot.

THE TRADE IN PHILADELPHIA AND LOCALITY— (Continued from page 82)

guishable at a great altitude. While flying the aviator releases flocks of literature on the "Music Master" horn. This literature itself is printed on cardboard cut in the shape of an aeroplane. The opening gun in the big Fall consumer campaign will be found in a full-page ad in the Saturday Evening Post in the first issue of October.

The New York territory has shown wonderful progress during the past month, many substantial dealers having been added in this territory during that period.

Talking Machine Demand Is Active

Mr. Eckhardt also reports that the talking machine business has shown steady increase and looks forward to excellent Fall business in this line. In spite of the fact that the export business of this company has never been gone after, business with foreign countries has grown of its own accord. In the past month merchandise has been shipped to Chile, Mexico, Cuba, Argentine Republic, Australia, South Africa, Canada, Japan and England.

The remainder of the capital stock of the General Radio Corp. has been sold, making a total of \$250,000 paid into the treasury of the company.

Following Mr. Eckhardt's well-defined plan of gathering about him associates of particular ability it is announced that Henry E. Marshall, for many years with the Columbia Graphophone Co., has joined the staff of the General Radio Corp. to take up special executive work.

Buehn's Red Seal Campaign

The reduced price on single-faced Red Seal Victor records was broadcasted to the buying public by Philadelphia retailers in newspapers and other means of publicity. Following the usual enterprise it has always manifested the Victor distributing firm of the Louis Buehn Co. immediately prepared window signs for its dealers announcing the reduction in price. This sign was very attractively prepared and dealers lost no time in making use of it.

Among recent visitors to the Buehn headquarters was Mrs. Ida M. Huber, head of the Victor department of the Donovan Co., Lancaster, Pa., who was on her way to the Victor Talking Machine Co.'s factory at Camden.

Girard Co. Engages Miss Morrisey

Miss Marie Morrisey, the popular concert contralto, has again been engaged by the Girard Phonograph Co., Edison distributor, for an extensive Tone-Test tour this Fall. Owing to popular demand, this will be the fifth successive season that Miss Morrisey will tour that territory.

According to a statement made by Mr. P. R. Hawley, general manager of the Philadelphia jobbing organization, Miss Morrisey's limited engagement requires that her itinerary be confined to those cities where the contralto has previously appeared and where her popularity among Edison enthusiasts warrants a repeated engagement.

Bookings up to the present time in the Philadelphia territory promise a number that will exceed those of previous seasons, and there is every likelihood that three separate tours shall be required to fill the demands of dealers.

Extensive Fall Campaign Planned

The Guarantee Talking Machine Supply Co. reports that Fall business is already being received at its headquarters in this city. The need of the new quarters recently acquired is already being felt and extensive plans for a Fall campaign are under way. Within a short period this company will box all its springs under the trade name of "Guarantee."

A. L. Stott Covering Maryland and Delaware

Edison dealers in Maryland and Delaware have greeted enthusiastically the announcement made by the Girard Phonograph Co., Edison distributor, that Albert L. Stott, field representative, will spend most of his time in the development of the Edison business in that section. Since he joined the field staff of the Philadelphia distributors last Fall, Mr. Stott has spent considerable time in these two States and enjoys a

wide acquaintance with the Edison trade. Through his associations he has gained an intimate knowledge of the possibilities afforded the Edison line in the southern portion of the Philadelphia territory, and it is believed generally that his new appointment is but a forerunner to a largely increased volume of Edison business in the locality he will cover.

500 Accounts Opened Since May

The mythical Summer dullness did not manifest itself near the headquarters of Everybody's Talking Machine Co. S. L. Fingrudt, secretary of the company, reports that over 500 new accounts have been opened since May 1. New headquarters, opened the early part of the year and additional storage space nearby, have been secured to meet demands. An aggressive Fall sales campaign has been planned and, in anticipation, work has already commenced on the enlargement of office space. A new catalog, which bids fair to not only surpass all others, but to take first place among repair part literature, is now in the course of preparation.

Arthur W. Merrihew's Big Achievement

The proverbial "feather in the cap" this time goes to Arthur W. Merrihew, according to a report covering the first half of the year just disclosed by the Girard Phonograph Co., Edison distributor of this city.

Mr. Merrihew holds the distinction of having opened the largest number of new Edison dealerships in the Philadelphia territory since the inauguration in January, by the distributor, of the intensive publicity campaign for new dealers.

Although he has devoted considerable time to development work among Edison dealers already established, which is a part of the duties ascribed to every member of the Philadelphia staff, Mr. Merrihew set out at the beginning of the campaign not only to exceed his quota but with the expressed intention of outdistancing the remainder of the staff, and the results thus far indicate that the end of the year will find him still at the head of the list.

JOBBERS

- GUARANTEE REPAIR PARTS
- GUARANTEE REPAIR TOOLS
- GUARANTEE GRAPHITE
- GUARANTEE NEEDLES
- GUARANTEE ALBUMS
- GUARANTEE SAPPHIRES



TRADE MARK

"All that the name implies"

THE windows are washed, the floors are scrubbed! we are all set for a real-honest-to-goodness Fall business.

Our new building is all ready with its shelves and bins bulging with complete stocks, at your service all the time.

Look over your stock now, and let us fill your wants.

JOBBERS

- MOTORS
- TONE ARMS and SOUND BOXES
- KENT
- ATTACHMENTS
- THREE-IN-ONE OIL
- ADD-A-TONES
- BRILLIANTONE
- NEEDLES

GUARANTEE TALKING MACHINE SUPPLY CO.
109 N. TENTH STREET, PHILADELPHIA



Another Superior Point for THE NEW COLUMBIA

Lubrication, the life of every motor, has received especial attention in the New Columbia. The hard-to-oil parts, which usually are neglected in all phonographs, are cleverly provided for by a central oil well from which the oil is led by tubed wicks to five important bearings. An absolutely silent, longer-wearing motor is perfectly insured.

COLUMBIA GRAPHOPHONE CO.
New York

OMAHA

Business Holds Its Own—Water Shortage Causes Unemployment and Hurts Business—The News

OMAHA, NEB., September 6.—In spite of a tendency on the part of the many talking machine dealers during the late Spring to look forward to a dull season during the months of July and August, they have been agreeably surprised by the fact that trade has held its own, and in some instances has surpassed the volume of business done during preceding months. A slight falling off was noticeable in the city of Omaha during the last two weeks of August, although this did not affect the outlying territory controlled by Omaha wholesalers. Dealers attribute the diminution in the retail business to the fact that Omaha was in the clutches of a water famine for a period of ten days. The Missouri River, always erratic in its course, washed away one of its banks at a point where the deposit was swept into the city water supply. The sediment basins and the filtration plant were unable to take care of this extra burden, and the result was that the city water contained nearly a 25 per cent content of mud, rendering it entirely unfit for use and necessitating the packing plants and many other large business interests in the city to close down. Unemployment is always reflected in curtailing the purchase of other than necessities, and, as a consequence, talking machines were out of the running for a time.

Business has been very satisfactory during the greater part of the Summer, according to Schultz Bros., Edison jobbers, and, judging by the way orders are coming in, the Fall trade bids fair to break the record.

The Ed. Patton Co. is now the only exclusive Victor dealer in Omaha. This company has just

taken over the entire retail Victor business of the Mickel Music House as well as its line of small musical instruments. The Conn saxophone, formerly featured by the Mickel Music House, is now carried by the Patton Co. A. O. Topping, manager of the phonograph department of the Ed. Patton Co., has recently returned from a vacation and business trip to St. Louis, St. Joe and Kansas City. He reports himself well pleased with prospects for a splendid Fall and Winter trade.

J. H. Nicklensen, who has charge of the record department of the Patton Co., states that it is prepared to push its campaign of educational records. He expects the new double Red Seal Victor records to be very popular due to their combination of merit and economy.

The Cheney Co., which has a branch office in Omaha, reports a good season. The Salisbury model has proved a good seller throughout the territory, and dealers are sending in orders that augur well for the September trade.

The Brunswick-Balke-Collender Co. is busy preparing for a great trade this Fall. R. H. Pribyl, district manager, is most enthusiastic in his report, and declares himself highly pleased with the outlook.

William H. Schmoller, senior partner of the Schmoller & Mueller Music Co., who makes an annual visit to his birthplace in Eisenach, province of Thuringen, Germany, writes that reports of distress in Germany are not exaggerated.

S. S. Oakford, president of the Oakford Music Co., Sonora dealer, has returned from a three weeks' trip to the West Coast, having visited San Francisco, Los Angeles and Long Beach. Mr. Oakford visited relatives and transacted business on his trip.

The "Playon" record repeater, made by the continuous Phonograph Player, Inc., of Philadelphia, has been featured during the Summer months at Atlantic City, where it attracted much attention.

EXHIBIT AT KUTZTOWN FAIR

I. E. Albright & Son, of Allentown, Get Excellent Results From Annual Exhibit

ALLENTOWN, PA., September 5.—I. E. Albright & Son, music dealers, of 129 North Eleventh street, this city, following their custom for the past fifteen years, had an elaborate display of pianos and talking machines at the Kutztown Fair held recently in Kutztown, Pa. The display, which was in charge of Claude T. S. Albright, consisted of Becker Bros. pianos and player-pianos, Columbia talking machines and records, etc. Considerable business resulted.

HACKETT TO SING FOR KING ALFONSO

The New York Tribune carried a cable announcement recently to the effect that Charles Hackett, famous American tenor and exclusive Columbia artist, would sing during the present San Sebastian opera season before King Alfonso of Spain by special command. American Ambassador Moore is expected to introduce Mr. Hackett at a special concert to be devoted to songs of American composers. Mr. Hackett will tour with the Chicago Opera Co. after the San Sebastian season.

ODEON RECORDS AVAILABLE

The foreign language division of the General Phonograph Corp. has suggested to its dealers that they take advantage of the concert tour of Erno Kiraly, Hungarian artist, who arrived recently in this country. A. H. Thallmayer, manager of the company's foreign record department, states that Mr. Kiraly's records under the Odeon, Beka and Favorite labels, which he made in Europe, are available to the General Phonograph Corp.'s dealers through the company's contract with the Carl Lindstrom organization in Berlin.

Edison Is Always First!



The first Phonograph
First with Console Phonographs
First with Broadway "Hits"
First to play all makes of Records

EDISON INVENTED IT—EDISON MANUFACTURES IT

SHULTZ BROTHERS, Inc.

16th and Howard Streets
OMAHA

Edison Distributors for Nebraska
and Western Iowa

A few dealerships open. Write
or wire



for beauty—for tone—for price



Two-tone finish has the call

(Beautiful two-tone effects in this new Strand)

There is sure to be a shortage

(Write your order while delivery is dependable)

The dealer's discount does the rest

These Direct STRAND Representatives Are Ready to Serve You:

R. H. ARNAULT, 95 Madison Avenue,
New York City.
ARTOPHONE CORPORATION, 1213
Pine Street, St. Louis, Mo.
ARTOPHONE CORPORATION, 317
Kansas City Life Bldg., Kansas City,
Mo.
CONSOLIDATED TALKING MACHINE
CO., 227 W. Washington Street, Chi-
cago, Ill.
OTIS C. DORIAN, 321 King Street,
E. Toronto, Ont.
A. C. ERISMAN, 174 Tremont Street,
Boston, Mass.

W. L. ECKHARDT (General Radio
Corp.), Tenth and Cherry Streets,
Philadelphia, Pa.
W. S. GRAY, 1054 Mission Street, San
Francisco, Cal.
W. S. GRAY, 926 Midway Place, Los An-
geles, Cal.
L. D. HEATER, 357 Ankeny Street,
Portland, Ore.
IROQUOIS SALES CORPORATION,
210 Franklin Street, Buffalo, N. Y.
R. J. JAMIESON, 625 Swetland Bldg.,
Cleveland, Ohio.
M. E. LYLE, 65½ Walton Street, At-
lanta, Ga.

RICKEN, SEEGER & WIRTS, Globe
Bldg., Detroit, Mich.
STERLING ROLL & RECORD CO., 137
West Fourth Street, Cincinnati, Ohio.
GENERAL RADIO CORP., 1005 Liberty
Avenue, Pittsburgh, Pa.
L. C. LE VOIE, 622 Nicollet Ave., Min-
neapolis, Minn.
SHARP MUSIC COMPANY, 823 Fif-
teenth Street, Denver, Colo.
W. O. CARDELL, Box 1271, Tulsa, Okla.
R. W. ORTTE, 310 Magazine Street, New
Orleans, La.
H. J. IVEY, Box 235, Dallas, Texas.

To responsible dealers we offer a profitable franchise in localities not yet being covered. *Write or wire.*

MANUFACTURERS PHONOGRAPH CO., INC., GEO. W. LYLE, President, 95 Madison Avenue, NEW YORK

BUFFALO

Retailers and Wholesalers Preparing for Busy Fall and Winter Seasons—Activities of the Trade

BUFFALO, N. Y., September 7.—Preparations are being made by dealers in talking machines in the Buffalo and western New York districts for a record-breaking Fall trade. At present dealers throughout this district are enjoying a business of unequaled proportions for this season and indications point toward an exceptional Winter trade.

C. E. Seigesmund, of Curtis N. Andrews, Victor wholesaler, says the demand for higher-priced Victrolas is prevailing in this district. Dealers are receiving favorable results with the new Victor console models 400 and 405. Present indications are that it will be difficult to meet the holiday demand that is certain to come. Instruments retailing from \$100 to \$150 are in a greater demand than can be supplied.

The decrease in price on Red Seal records has been a big boon to the record departments of dealers in Buffalo, who are eagerly awaiting release of the double-faced Red Seal records.

F. C. Clare, manager of the Iroquois Sales Corp., says the company is planning for the busiest Fall it has ever had. Advance orders from dealers throughout the western New York section for Strand talking machines for September and October deliveries are indications of a tremendous trade. G. R. Kuehner has returned from a trip to Rochester and other western New York towns, where he has arranged with dealers for their Fall and early Winter stock of Strand machines and Okeh records.

Harold A. Scrimshaw has been placed in the Eastern section by the Iroquois Sales Corp. and has proved himself very capable. W. Howard Webb, 150 Genesee street, is the only dealer

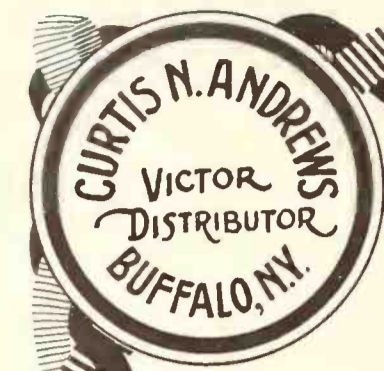

A Victor Year

Victor weekly releases, coupled with the double facing of Victor Red Seal records, means unlimited sales possibilities for the aggressive Victor retailer. The new

Victrolas 400, 405 and 410 are the finest instruments ever presented to the trade, and will be important factors in making 1923 "A VICTOR YEAR."

Victor products will be at a premium this Fall. There is going to be an unprecedented demand for Victrolas and Victor records, and orders placed now will enable you to meet this demand.

We are at your service

CURTIS N. ANDREWS

Victor Distributor
BUFFALO, N. Y.



with a display at the Erie County Fair this year. He has a very attractive exhibit of Okeh records and Strand instruments.

The Hoffinan Piano Co., carrying the Brunswick and Sonora talking machines, is conducting a sale preparatory to installing its new Fall stock. Albert Stettenbaus and Albert Diddion have been added to the sales force of this company. Both are widely experienced.

The Buffalo Talking Machine Co., Victor dis-

tributor, with headquarters in this city, is experiencing a most satisfactory demand from the many dealers whom it serves, indicating that retailers are enjoying a state of prosperity. Many orders for Fall and holiday stock are being placed, the trade evidently being determined not to be caught short when the expected Fall trade boom is actually here.

The \$75,000 addition to the Broadway store of the Erion Piano Co. will make this one of the finest and largest stores of its kind in the city. The first floor of the three-story addition will be devoted to the display of talking machines, records and pianos, while the upper floors will be used for storage and repair departments. The main store has an excellent location on William street.

Joe Armbruster and His Society Band of Buffalo have returned from New York, where they made several Okeh records for the General Phonograph Corp., manufacturer of Okeh and Odeon records. The company is very much pleased with Armbruster's records of "Ritzi Mitzi" and "Japanese Sunset."

William R. Stagg has opened a distributing office in Buffalo for the Cheney talking machine in the Calumet Building, West Chippewa street. He will cover the western New York district for the Cheney instrument.

Bennie Krueger and his Brunswick recording dance orchestra recently played a return engagement at the Clifton House in Niagara Falls, Ont., where they received an enthusiastic reception from local music lovers.

F. F. Barber has been made manager of the J. N. Adam Co. Music Store, following the resignation of F. C. Culp, who has gone to Canada with the hope of regaining his health. Mr. Culp was presented with a silver loving cup by employes of the store as an indication of the esteem in which he is held.

George F. Schafer, formerly located at 20 Main street, has opened his new music store at 52 Main street, Batavia. It is equipped with every modern convenience. The interior finish of gold and white makes a beautiful setting for his fine stock of talking machines, records and pianos and the modern fixtures installed makes this one of the most efficient local stores.

E. J. Ryan, dealer in furniture and musical instruments in Seneca Falls, N. Y., has bought the block and business of Fred Teller at 100 Falls street and will consolidate his business with that of Mr. Teller's. Plans have been made for extensive improvements in the store.

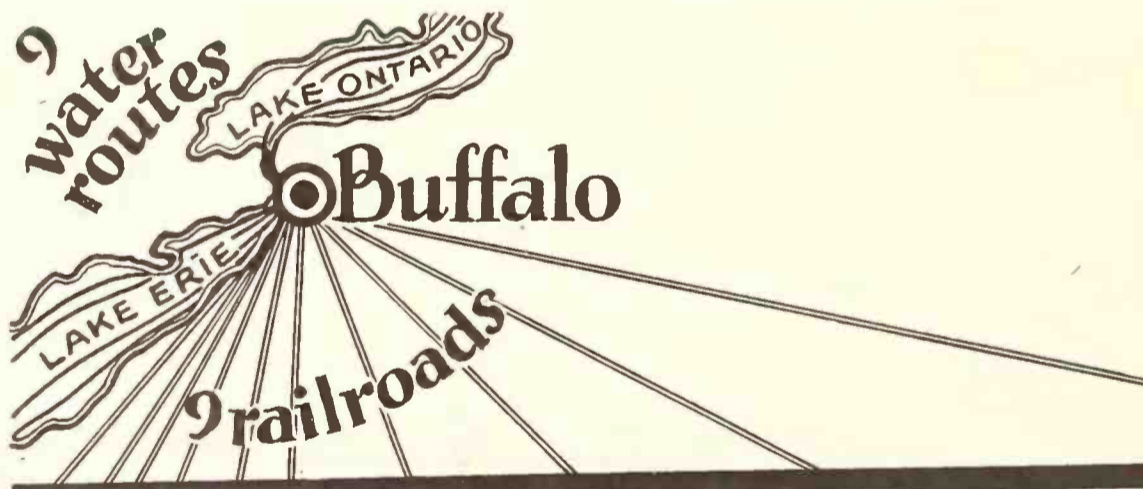

BUFFALO

*A NIGHT'S RIDE FROM EVERY
IMPORTANT TRADE CENTER
IN THE EAST*

The veritable network of shipping facilities which Buffalo offers to Victor dealers—is the answer why the Buffalo Talking Machine Co. service is reaching a larger number of dealers each year.

This is unquestionably a real service which builds long-lasting friendship with a better and more efficient business for all.

Why not try this service? It will pay you.

BUFFALO TALKING MACHINE CO.

Victor Wholesalers
BUFFALO, N. Y.

Bakertone
for Phonographs

No surface noise and no sacrifice of volume or tone quality.
No need to alter the phonograph. A simple attachment that can be added by anyone. Helps records sales. Sells at \$3.50.
Ask for discounts.

Bakertone Corporation
408 Pearl Street
BUFFALO, N. Y.



W. L. Forohley, of Hamburg, who lost his stock of talking machines in the \$20,000 fire there, has taken temporary quarters with John B. Gueting.

Victor Smotch, talking machine dealer at 169 Niagara street, recently retired from business.

Henry Poucher, of Fairport, N. Y., dealer in musical instruments and furniture, died recently. He was ninety-two years old and remained active in his business until a few months before his death. He had many friends in the trade.

At a recent meeting called by the Buffalo Better Business Commission with representatives of the Buffalo daily press advertising of two local music dealers was discussed. It was charged by the Better Business Commission that these dealers used misleading advertising to make sales. Chief among the charges was the misuse of the word "Free," used in advertising talking machines. These dealers had been warned by the Better Business Commission to change their policy of advertising, it is claimed, but continued their old methods. The Buffalo newspapers have been asked to refuse copy from these houses until they change their advertising policy.

COLUMBIA DEALER USES TIMELY "AD"

Selden Drug Co., Lewistown, Mont., Represented in Co-operative Ad Campaign

LEWISTOWN, MONT., September 5.—On August 24 the second page of the Lewistown-Denver News carried a full-page spread headed "Yes, We Have No Bananas, But—" and after the word "but" came the advertisements of eleven different merchants, telling of the many things that had to sell as substitutes for the much-lamented bananas. Only one phonograph merchant, the Selden Drug Co., Columbia dealer, was represented. His message stated that the public demand for the popular banana song had sold out the first shipment of Columbia records, but that other new hits were in stock, including three popular selections that were listed. The famous Columbia trade-mark was used to advantage by the Selden Drug Co. and the advertising produced splendid results.

STARTS DRIVE ON FOREIGN RECORDS

HERRIN, ILL., September 6.—Miss Fleata Trout, of the Victrola department of Cline's Drug Store, this city, is making a special drive for foreign business in her locality. One large booth has been set aside exclusively for her foreign customers. In this booth are located the files for the foreign records and the walls are covered with foreign hangers, photographs of foreign patriots and foreign scenes. Miss Trout has had exceptional success with the foreign population of this mining district.

Walter Scandan, a popular Irish tenor and Edison artist, is touring the country this year with a new Irish play, "The Blarney Stone."

"TALKER" RECORD AS EVIDENCE

Used by German Concern in a Suit Involving a Business Misunderstanding

A German court now faces the problem of deciding on the legal status of a talking machine record of a business conversation, recent dispatches from Berlin say. The case is of importance because of the growing use in Berlin of phonographs to record telephone messages.

The case hinges on a telephone conversation which the plaintiff contends constituted a contract for the delivery of a quantity of gasoline. The defendant in the case misunderstood and did not deliver the gasoline. The representative of the firm had switched on a recording apparatus when giving the order and the phonographic cylinder was filed.

When the case came before a Berlin civil court the wax record of the conversation was placed on a talking machine in the courtroom and the verbal contract was reproduced. The case was referred to a higher court.

PAUL BOLONGNESE WITH EMERSON CO.

Made Manager of Foreign Record Department —Prepared New Foreign Record List

Paul Bolongnese has rejoined the Emerson Phonograph Co., Inc., as manager of its foreign record department. Since his return to that organization he has prepared a new list of Italian, Jewish and Polish records. These latter selections will cover a wide range of titles and as the demand for such works is quite active the release of the new list is looked forward to by retailers who specialize in foreign selections. Mr. Bolongnese has had wide experience in foreign recordings. He is acquainted with the majority of foreign record artists and in other ways keeps in touch with the particular demand and vogue in foreign selections.

A. H. Mayers, prominent member of the New York talking machine fraternity, who has been spending the Summer abroad, expects to sail for home on September 22.

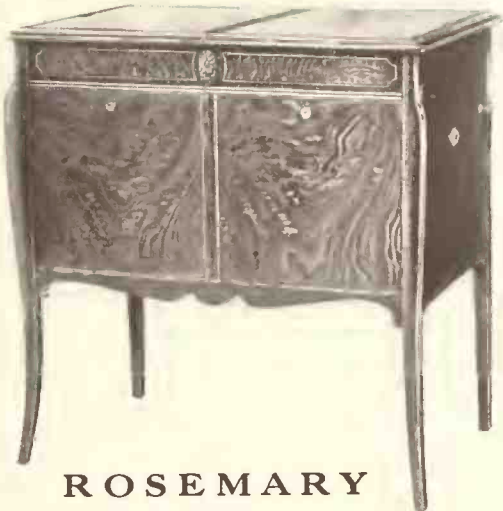

A tone unsurpassed for beauty and richness

Smart in appearance; magnificent two-tone-wood effect

ROSEMARY

F i s c h e r

Are you willing to stock a phonograph which is

<ol style="list-style-type: none"> 1. Unsurpassed by any in tonal quality. 2. Unsurpassed by any in excellence of construction. 3. A gem as an article of furniture. 4. Sold f.o.b. your city anywhere in the U. S. 5. Certain to bring you a bigger profit than any high 	<ol style="list-style-type: none"> grade instrument you now handle 6. Selling easily and in steadily everlasting quantities wherever it has been introduced. 7. Sold direct to you—no local distributors. 8. Available in very handsome, popular walnut and brown mahogany.
--	---

NOW mail this coupon to

Mayer Bros. & Bramley, Inc.
417 West 28th Street
New York City

Mayer Bros. & Bramley, Inc.
 417 West 28th Street
 New York
 Please send full information and prices on
 your ISABEILLA, ROSEMARY and FETTER
 PAAN models of the Fisher Phonograph.
 Name _____
 Street _____
 City _____
 State _____

THE TWIN CITIES

Exhibitors at State Fair—Lucker Keeps Open House—Distributors Prepared for Active Fall Trade—The News of the Month

MINNEAPOLIS AND ST. PAUL, MINN., September 7.—The throngs attending the great Minnesota State Fair are looked to to furnish innumerable good talking machine prospects to the firms which are exhibiting their wares at this perennial show. Fair Week (September 3 to 8) has also brought its quota of out-of-town customers to firms not represented at the Fair. Booths are being maintained by W. J. Dyer & Bro., Victor jobbers; Laurence H. Lucker Co., Edison distributor; Edward G. Hoch Co., Cheney & Stone Piano Co., Vocalion Red records.

The Edison people, occupying a double booth in the Liberal Arts Building at the entrance to the grandstand, have inaugurated various plans of increasing interest in the display, one of which will net someone a handsome Edison console phonograph retailing at \$175.

A Cheney Queen Anne model will also be given away to a lucky visitor at the booth of the Edward G. Hoch Co. The Cheney booth is made doubly interesting by an exhibit of the various stages in the process of making a Cheney machine, a stunning console representing the finished product.

Foreign Record Demand Grows

The Northwest, with its large proportion of foreign-born population, is buying a large amount of foreign records. By means of a cleverly contrived campaign W. J. Dyer & Bro., Victor jobbers, are experiencing great activity in records in foreign languages.

George A. Mairs, manager of the Victrola department, stated that records are going big and that the demand is unprecedented for the month and for this year. A few of his largest orders are bound for the Pacific Coast.

"I believe the record business throughout the country is picking up," Mr. Mairs declared. "We are also receiving good orders for machines." The firm's campaign on portables No. 50, which proved so successful, is even yet bearing fruit, although Fall is setting in.

The Consolidated Music Co. is also doing a large and successful foreign record business.

The Minneapolis Symphony Orchestra has obtained Renee Chemet, violinist and Victor artist, as soloist in St. Paul and Minneapolis engage-

ments later in the season, which undoubtedly will have a bearing on the sale of this violinist's records throughout this territory.

New Victor Records Stimulate Sales

G. A. Zoller, manager of the Golden Rule phonograph department, says that his business is fairly brisk, largely due to the introduction of the double-face Red Seal records, which is rapidly clearing out his stock of single-face numbers. Miss Edith Clark has returned from Chicago, where she continued her study of voice training, and is back as saleswoman in the Golden Rule's Victrola section.

Brunswick Activities

Eugene F. O'Neill, veteran talking machine man with Brunswick-Balke-Collender Co., says: "Every report indicates that the Northwest is convalescing. While there are some sections where the returns will be light, due to low grain prices and poor yields, yet the situation is more encouraging than last year. Collections are improving and merchants are now ordering for their Fall requirements. As a section, however, the Northwest is very 'spotty.' Among recent visitors at the Brunswick office have been William Hardt, of Winona; Syd Sather, of Grand Rapids; R. E. Hamlin, of Moose Lake, and W. H. Schemley, of Durand, Wis.

The new full-page advertising campaign of the Brunswick made its initial appearance in the Minneapolis Sunday Tribune August 26, and has been favorably commented upon by the trade. A car of the new Brunswick "Raleighs," retailing at \$200, is in transit and will be sent out on back orders when received.

Harry L. Davis, southern Minnesota and South Dakota Brunswick traveler, is back from an extensive tour of his territory. He reports conditions fair, with South Dakota badly "spotted" in sections.

Sam Hilde, of the Brunswick Co., who travels in Montana territory, reports that there are encouraging prospects, but North Dakota merchants, he says, are not optimistic. Fred Nelson, of the Brunswick Co., has just returned from his vacation, motoring in Wisconsin, and is tuning up his Elcar for a trip among the northern Minnesota dealers.

Radio and phonograph combined are displayed in the combination radio and Brunswick which Boutell Bros., furniture dealers, are displaying.

Laurence H. Lucker Co. Keeps Open House

The Laurence H. Lucker Co., Edison distributor, is doing a nice business, according to J. Unger, who says the company is holding open house all week for State Fair visitors, and to date the booth in which the Edison line is very attractively displayed has been one of the most popular stopping places at the Fair.

Sonora Consoles Popular

One-third above last year's figures is the expectation of the Sonora jobbers, Doerr-Andrews & Doerr, according to John E. Date, who remarked: "Business in the last few weeks has made a phenomenal return. Reports from South Dakota show that dealers there are looking for a good Fall business. Personally, we have larger stocks than we have had at any time in our history. We will be able to furnish all dealers with console models." Mr. Date finds that these models constitute 90 per cent of the demand, which is in line with a prophecy he made a long time back.

Sonora Ad Drive to Start Soon

Sonora advertising bearing the slogan, "Look below the surface on quality merchandise," supplied by the home office advertising department, will start in the Twin City and Duluth press September 16, the campaign continuing throughout the remainder of the year.

Harry J. O'Connor, sales manager for the Sonora Co., accompanied by Mr. Date, has been spending a fortnight visiting the territory. He is the guest of Mr. Date at his Summer home at Tonka Bay, Lake Minnetonka. Mrs. Mary Leonard, of the Leonard Piano Co., of St. Paul, made a visit to the Date Summer home recently.

Visitors Order Fall Stock

Visitors at the Doerr-Andrews-Doerr offices include: A. L. Miles, of the Miles Music Co., Sonora dealer in Duluth, and his son, Donald, manager of the phonograph department; E. D. Wetzel, Little Falls; H. Hall, of the Hall Music Co., Brainerd, and John B. Christeau, of Owatonna, one of the largest and most progressive phonograph dealers in southern Minnesota, all of whom placed substantial Fall orders.

Odeon Records Sells Quickly

Mrs. B. C. Eggar, manager of the Consolidated Music Co., says: "Business is much better, although sales in North and South Dakota are going slowly, the best territory being the iron range towns in northern Minnesota. At the Consolidated Co. the foreign records are exceptionally popular, especially the line of instrumental Odeon records. The demand, she says, seems to be more or less even among the various nationalities, some territories being partial to the Scandanavian, German or French, while others favor the Polish, Russian, etc." E. A. Fearn, president of the Consolidated Co. in Chicago, arrived Tuesday morning to visit the Minneapolis branch.

Miss Edna Baer Goes West

Miss Edna Baer, who has been in charge of the record ordering at the Cable Piano Co. for some years, left late last month for San Diego to reside. She has been succeeded by Miss Dos.

Interesting News Gleanings

John Lang, manager of the Dayton Co.'s phonograph department, and Neil Schumacher, phonograph manager of the Cable Company, have returned from vacation.

John J. Roden, of Dayton's, surprised his friends among the phonograph trade by his recent marriage to Miss Lucille Conley.

Big Victor Demand Presages Shortage

"Business is starting with a bang," according to Charles K. Bennett, manager of George C. Beckwith Co., Victor jobber. "Our men on the road have sent in most encouraging orders. We expect to be up against a machine shortage. The double-facing of Red Seal records has acted as a tremendous stimulus to sales and our dealers have started replenishing their stocks with the new records."

Mr. Bennett is back at his desk after a fortnight in the East, visiting at Chicago, Philadel-



**Edison
Dealers
Enjoy
Every
Advantage**

The New Edison is recognized as the foremost phonograph of all time. It means prestige to the merchant who sells it.

The new low priced models—upright and console—new increased discounts, quick turnover and timely release of the latest hits offers steady increasing profits.

We have a liberal proposition and open territory for live merchants of the Northwest. Write now. Cash in on the Fall and Holiday demand.

LAURENCE H. LUCKER

Northwest Edison Distributor

Established 1902

17 South Sixth St.

Minneapolis, Minnesota

Another Superior Point for THE NEW COLUMBIA

Maximum storage capacity for records is an outstanding feature of every New Columbia. Especially noteworthy is the ingenious use of excess space at the back of the \$225 Upright Model for convenient storage of surplus numbers. Even the Portable Model has a special drawer with a capacity of eight records.

**COLUMBIA GRAPHOPHONE CO.
New York**



phia and New York, and spending some time with Harry Goldsmith, of Milwaukee, as the guests of W. T. Haddon, Island Heights, N. J.

Mr. and Mrs. H. J. Jeronimus, of Duluth, exclusive Victor dealers, spent August 27 at the Beckwith offices and Monday evening were entertained at dinner at the Nankin by Mr. and Mrs. Bennett, in company with Miss Aileen Stanley, "The Phonograph Girl," appearing at the State Theatre, and her manager, after which the Jeronimuses and Bennetts attended the theatre to hear Miss Stanley.

Keep Your Wife at Home With Music

The phonograph has a new function if an incident reported by Mrs. Flygen, in charge of the Central Furniture Co.'s Victrola department, is a criterion. A much-worried man approached Mrs. Flygen, explaining that his wife had deserted him and their two small children. Knowing her whereabouts, he thought to soften her heart and speed her return by sending her some appropriate records. Mrs. Flygen finally helped him select "the Twenty-third Psalm," "Psalm of

Life" and one of Rodeheaver's revival hymns. At his next appearance the customer was radiant, reporting that his wife had played each piece three times and decided to return home.

Do Record Machine Business

Whitney-McGregor's phonograph department, under the management of Mr. Rosenstein, had a red-letter day recently when the department did four times as much business as any previous day this year. By featuring a low-price machine many prospects were entertained, most of whom bought a more expensive instrument than the advertised product. As a consequence, Mr. Rosenstein disposed of his old-style Victrolas.

Harry Wunderlich, of the Wunderlich Music Co., Kansas City, Mo., has been enjoying a Minnesota Summer at his new big log cabin at Lake Washburn, in the vicinity of Outing, Minn.

Cheney Shortage Probable

"Our business for Fall is assured," Edward G. Hoch, head of the Edward G. Hoch Co., Cheney distributor, said, "and it will be ahead of last year. We are advised by our central office that

some models are sold out until February of next year." The Cheney line has just been taken on by the Emporium department store in St. Paul. The first ones are now on display there. Foster & Waldo, who handle the Cheney in Minneapolis, say they have a list of Cheney customers who are so well satisfied that they bring in their friends as prospective purchasers.

The trade, says Mr. Hoch, is most enthusiastic about the Cheney sales manual, recently issued, probably the first of its kind in the talking machine trade. This book, in the form of a questionnaire, is an excellent aid to selling.

MUSIC STORES FOR NEW ARCADE

CANTON, OHIO, August 27.—Applications have been received from two music dealers for space in the new Piper Arcade, Tuscarawas street, to be completed by September 15.

The Piper Arcade is one of the finest in this section of the country and is modeled after the Taylor Arcade in Cleveland.

TAKE STOCK OF YOUR PROFITS

Are your earnings in a rut?

Are you making the money you should?

Is someone else making some of your money?

Does your manufacturer give you the utmost in money-making opportunity?

Take Stock—Face Facts—Investigate

Write Us Today

You'll get surprising information

THE WOLF MANUFACTURING INDUSTRIES
MAKERS OF MASTERCRAFT PHONOGRAPHS
QUINCY, ILLINOIS

Brunswick

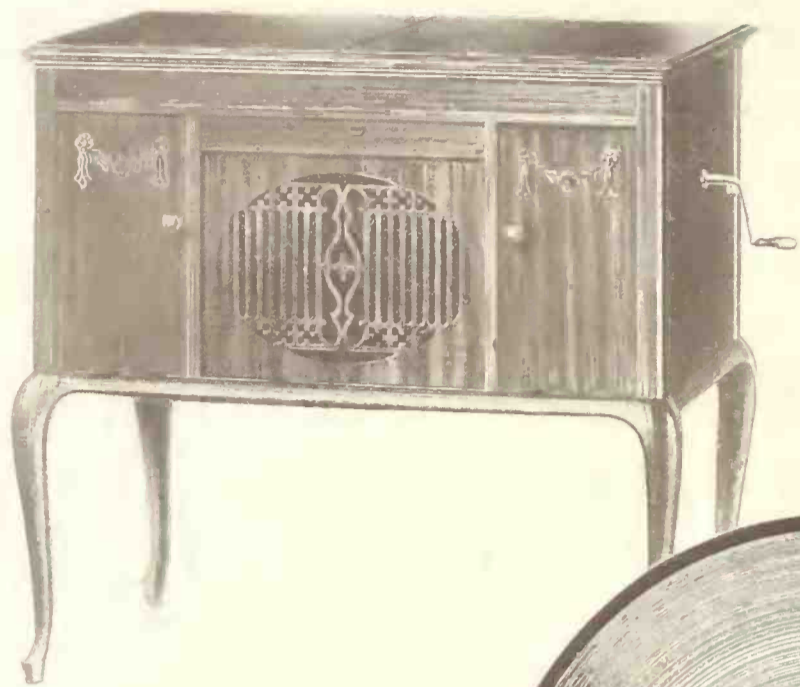

Brunswick's precedent-shattering evolution of the talking machine field gives you genuine *selling points* which make profitable sales. Have your clerks familiarize themselves with the Brunswick story. You'll find it translates into greater profits.

The New Hall of Fame

MICHAEL BOHNEN
MARIO CHAMLEE
GIUSEPPE DANISE
CLAIRE DUX
FLORENCE EASTON
LEOPOLD GODOWSKY
JOSEF HOFMANN
BRONISLAW HUBERMAN
MARIA IVOGUN
THEO KARLE
GIACOMO LAURI-VOLPI
ELLY NEY
SIGRID ONEGIN
MAX ROSEN
MARIE TIFFANY

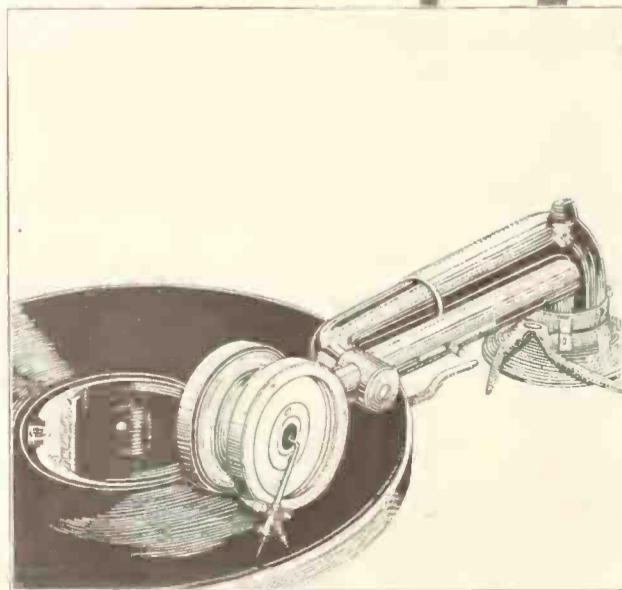

Establishes Precedents in the Phonograph Field



*For your own information note how
Brunswick has blazed the trail*

It was Theodore Roosevelt who said: "We do not go by precedents. We make them."

This saying might be applied to the Brunswick policies. From the start Brunswick phonographs and records have established precedents, have blazed new trails in the reproduction of music.

Here are *four* Brunswick revolutions in the history of talking machines that upset all precedent and created new possibilities in the field. These precedents have helped Brunswick dealers to gain a commanding position in the musical field.

All Records Playing

Brunswick Precedent No. 1—The advent of Brunswick introduced the perfected reproducer that *plays all* makes of records. The Brunswick reproducer opened to owners of Brunswick phonographs all the music of the world on records. It was a sensational success from the start.

Consoles

Brunswick Precedent No. 2—The first console models, with flat and split tops, with balanced lids, were made by Brunswick. Brunswick console models are the most popular made—and much imitated.

Double-faced Operatic Records

Brunswick Precedent No. 3—Before Brunswick began marketing its double-faced Gold Label operatic and classic records great artist records were generally single-faced. The Brunswick supremacy in interpreting the art of great artists,

combined with two records on one disc, established these Gold Label records as the greatest value and the best phonograph music to be had.

Continuous Record Service

Brunswick Precedent No. 4—Until Brunswick blazed new trails records were released once a month, with an occasional "special" release. Brunswick instituted the revolutionary policy of "Always Something New on Brunswick Records," keeping new records flowing from the factory to the dealer in a ceaseless stream, enabling dealers to provide new Brunswick records, the latest and best music, day by day.

All For Greater Profits

The Brunswick method of merchandising records, with its quick turn-over, together with a carefully limited catalog, and consequent low inventory, has meant ever mounting profits for Brunswick dealers. They no longer have to keep a heavy stock of slow moving records to meet the possible demand, and quick selling records have meant quicker and greater profits.

Brunswick's first consideration is the success of its dealers. The progressive policies enumerated above, the careful guarding of dealers' interests through our own branch offices and distributors working in close harmony with our methods, have given Brunswick dealers significant advantages, and the prestige of an unexcelled popular prestige.

Prestige, profit and protection are the cardinal points of Brunswick service.

New England Distributors:
Kraft, Bates & Spencer, Inc.,
89 Kingston St.,
Boston, Mass.

THE BRUNSWICK-BALKE-COLLENDER CO.
Manufacturers—Established 1845

General Offices: Chicago Branches in All Principal Cities

Canadian Distributors:
Musical Merchandise Sales Co.,
79 Wellington St., West,
Toronto, Ont.

Brunswick
PHONOGRAPHS AND RECORDS

 UNITED

The End of a Costly, "Mussy" Job

REPLACING a broken phonograph spring in the customer's basement or backyard is about "zero" in employment from the repair man's viewpoint.

The savage way the caged derelict springs out the instant the barrel is opened, spattering dirty oil over the premises seems to shout its revenge for a long imprisonment at hard labor.

And the labor of coiling a new spring into the old grimey casing is far from child's play.

Both these disagreeable costly, time-eating, profitless, jobs are hereby abolished for users of

"United" Motors

For we have instituted a new system, by which we supply our trade with complete spring assemblies—spring, barrel, shaft and gear—ready to slip into the place of the old barrel.

Read the short paragraphs under the cuts—they tell the whole simple story.

You need never open a barrel. We do that for you at the factory. Just send us from time to time, your accumulation of old barrels; we put new springs into them and return them to you, charging only a few cents a piece to cover our actual material and labor cost.

You can make the replacement for your customers at a lower charge, because the labor involved is a matter of minutes instead of hours—and yet pile up a nice yearly profit, instead of a deficit for your service department.

Cast Iron Motor-Housing "United" motors are the only ones in which the entire mechanism is completely housed in, and protected by, a dust-proof, oil-tight cast iron housing. This is a permanent safeguard against injury to motor during the assembly, shipment, demonstration, delivery and operation of the instrument. It multiplies the life of the motor and enhances the reputation of every United-equip phonograph.

Automatic Wick-oiling Exclusive with us. An oiled pad in the bottom of the sealed cast-iron housing feeds lubricant, by capillarity through cotton wicks, to the moving parts—automatically, continuously, uniformly, and for years without re-oiling. A phonograph motor that must be oiled by Mrs. Brown or daughter Bess—just isn't oiled! And when Mr. Brown gets on the job, he floods it by main strength. None of this with a "United" motor.

Send for our book—"The Heart of the Phonograph"

UNITED MANUFACTURING & DISTRIBUTING CO.
9705 COTTAGE GROVE AVE., CHICAGO, ILL.

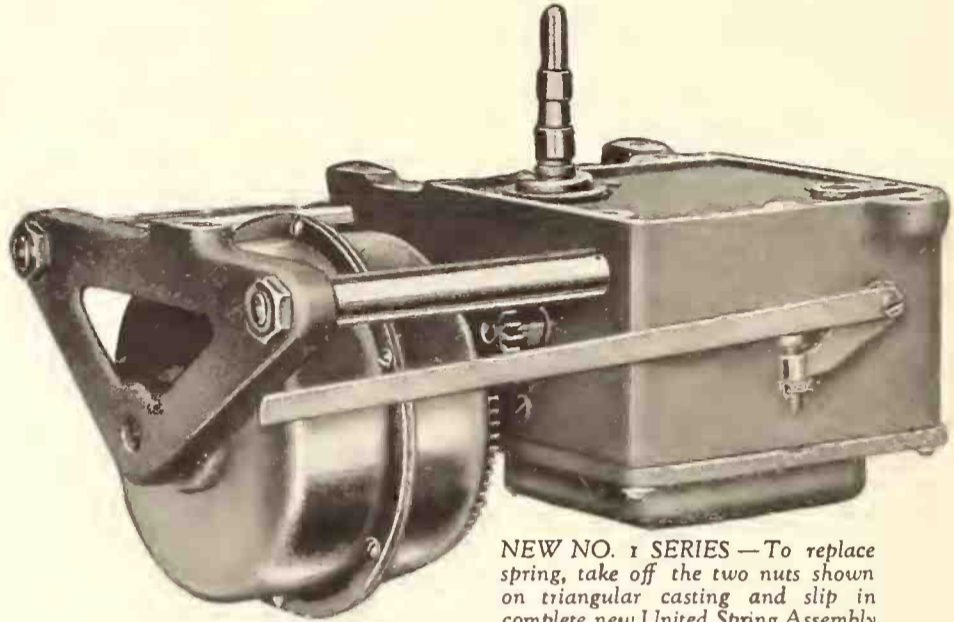

NEW NO. 1 SERIES—To replace spring, take off the two nuts shown on triangular casting and slip in complete new United Spring Assembly

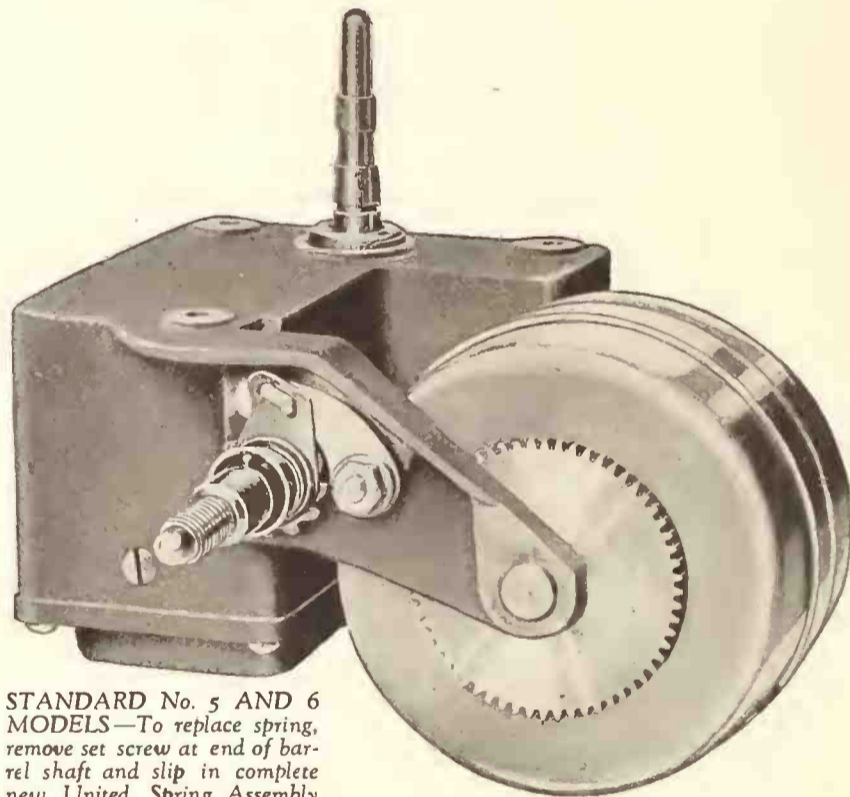

STANDARD No. 5 AND 6 MODELS—To replace spring, remove set screw at end of barrel shaft and slip in complete new United Spring Assembly

A Fine Swinging Fox Trot Melody

LOVE TALES

"You can't go wrong with any FEIST song"



IN DES MOINES

Brisk Record Business Features Trade—Winning Edison Dealers on Eastern Trip—Month's Changes and Activities in the Trade

DES MOINES, IA., September 7.—August business closed and September business opened as good or a little better than any of the dealers or distributors expected for this time of the year. Most distributors report that business for this Summer has been somewhat better than for several years past and attribute this to the fact that business in general is coming back to a state of prosperity.

Des Moines dealers are reporting a record business that is unusually good. Much of this increase, it is pointed out, is due to the discontinuance of the "records on approval" which went into effect August 1. People no longer take out records, tire of them and return them at the expense of the dealer. Des Moines dealers are unanimous in their approval of the "cash and carry" plan. Other plans for the betterment of the talking machine business in Des Moines are said to be under consideration by the Des Moines Dealers' Association.

Mickel Bros., Victor distributors, have planned their advertising helps for dealers in conducting "Victrola Clubs." Under the direction of H. B. Sixsmith, sales manager, a campaign of advertising displays, letters, copy, blotters, tags, etc., has been prepared for the dealers at nominal cost. Dealers who have tried the "Victrola Club" plan have found it to be very successful, and many are planning to use it again this Fall and Winter to stimulate business. According to Mr. Sixsmith, dealers have shown a tendency this year to place their orders for Fall and Winter goods very early.

George E. Mickel, president of Mickel Bros., visited Des Moines September 1 on business,

returning the following week to his home in Omaha.

Harger Blish, of Harger & Blish, Edison jobbers, left August 20 with the winning dealers of the contest promoted by the company on a trip through the East. The winning dealers were: F. N. Cooper, Woodward, Iowa; Harry Shraycr, Bethany, Mo.; A. L. Heggland, Pierre, S. D.; Paule Jewelry Co., Burlington, Ia.; and the Odell Jewelry Co., Keokuk, Iowa. The latter dealer was the winner of the "lucky" trip. According to H. H. Blish, the contest was very successful in stimulating Summer business for dealers. Sales during the period of the contest were 100 per cent better than during any previous year's contest.

A. L. Heggland, the winning Edison dealer from Pierre, S. D., made a spurt in his sales efforts in the last twenty-four hours before the close of the contest and turned in orders amounting to over \$3,000. Considering the fact that Heggland is a mail carrier in Pierre and is able to work at sales only in evenings and spare time, the record is remarkable. The Paule Jewelry Co. rated the highest in sales and points of any firm entering the contest.

Harger & Blish report that orders for Fall and Winter stocks are coming in earlier than usual this year. Dealers' stocks are very low, according to Mr. Blish, but most dealers are buying early and showing very good judgment in their buying.

During Iowa State Fair Week, August 22-31, Joe Thomas' Saxatet was one of the popular bits of entertainment on the program. During their stay in Des Moines, the members of the

organization were frequent visitors to the Dunning Co., distributor of Starr phonographs and Gennett records. Two records, "Anabelle" and "Barney Google," by Gennett, featuring the Saxatet, have been very popular locally.

Ralph Lohr, Victrola dealer at Muscatine, Iowa, did some effective advertising of his own at the West Liberty fair. Dressed in rustic attire and carrying a portable Victrola under his arm, he attracted the attention of the crowds when he seated himself in the shade, started the Victrola and proceeded to eat his lunch. The stunt was repeated at various points of the fair ground and Lohr never failed to draw an interested crowd.

Russell Elam, formerly in charge of the piano department of the Scruggs, Vandervoort & Barney Co., St. Louis, has just been appointed sales manager of the Massey Piano Co. here.

The Iowa Victor Dealers' Association will hold its annual convention at the Hotel Savery here September 17-18. The meetings will be given over to talks by dealers and a program arranged by President L. A. Murray, of Davenport, Iowa. Professor Bristol, of Iowa State College, will be one of the principal speakers at the meeting. G. L. Richardson, district representative of the Victor Co., will attend.

The Massey Piano Co., which recently bought out the stock of the Haddorff Piano Co., held an effective clearance sale the first part of September.

Ginsberg's Furniture Co. will handle Victor products exclusively in the future.

Chapman Bros. Furniture Co. has been moved to its new location at Fifth and Walnut streets, and a large new stock of talking machines is being received. The entire balcony of the new store will be given over to the talking machine and record departments.

E. O. Rockwood, general credit manager of the Columbia Graphophone Co., has returned to New York after a vacation at Ogunquit, Me.

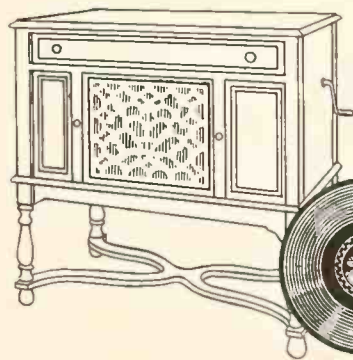

Edison



COMPARISON WITH THE LIVING ARTIST REVEALS NO DIFFERENCE

HARGER & BLISH DES MOINES

The CHENEY

THE MASTER INSTRUMENT

The most perfect music-reproducing instrument

*The newest
Cheney
console model*

The KENT

*A modern day
expression of
Sheraton*



Top, 20 inches by 38 inches; 33 inches high. Biltmore mahogany with a rich brown finish. Nickel-plated metal parts. Four record albums.

*Retails for \$165
East of the Rockies*

A Beautiful Console—Low in Price

The New KENT Model Exemplifies Wonderful Values Which Are Increasing Cheney Sales

The rapidly increasing sales of every dealer who sells The Cheney are due to two things—a very high degree of intrinsic worth, and most unusual artistic value, in this “master instrument.”

There could be no better demonstration of the wonderful values which every Cheney dealer offers than this new model which fills out the line with a low-priced console.

Though its retail price is so low that it comes within the range of popular demand, The KENT has the characteristics of many instruments much more expensive. There is both distinction of design and beauty of finish to add materially to any setting in which it is placed.

Above all, this instrument is a Cheney—endowed with the Cheney Acoustic System. That is a distinction which is coming to mean much, for the public is learning that no other phonograph can match the fidelity and beauty of Cheney reproductions.

While our stocks are full at present, there is such a growing demand for The Cheney that we urge all dealers to place orders for their fall requirements immediately. Dealers who look forward to adding The Cheney to increase their phonograph volume should let us know immediately.

THE CHENEY TALKING MACHINE COMPANY · CHICAGO

DISTRIBUTORS

CHENEY PHONOGRAPH SALES CO.
1965 E. 66th St., Cleveland, O.
806 Pennsylvania Ave., Pittsburgh
Ohio, W. Va., Western Pa.

CHENEY SALES CORPORATION
1107 Broadway, New York City
Greater New York, Western Conn.,
New Jersey

CHENEY SALES CORPORATION
1105 Chestnut St., Philadelphia
Eastern Pa., Del., Md., Washington, D. C.

CHENEY SALES CORPORATION
376 Boylston St., Boston
New England

CHENEY SALES COMPANY
Brandeis Bldg., Omaha
Iowa, Nebr., Colo., Wyo.

EDW. G. HOCH & CO.
27-29 Fourth St., N., Minneapolis
Minn., N. D., S. D., Northern Wis., Mont.

RIDDLE PHONOGRAPH CO.
1205 Elm St., Dallas, Tex.
Texas, Southern Okla.

ROLYAT DISTRIBUTING CO.
Provo, Utah
Utah, Southern Idaho

CHENEY PHONOGRAPH CO.
212 Selling Bldg., Portland
Washington and Oregon

MUNSON-RAYNER CORP.
643 S. Olive St., Los Angeles
86 Third Street, San Francisco
California, Western Nev., Ariz.

*All territory not listed above is handled direct
by The Cheney Talking Machine
Company, Chicago*

The Trade in **BOSTON** *and* **NEW ENGLAND**
 JOHN H. WILSON, Manager
 324 WASHINGTON ST., BOSTON, MASS.

WHOLESALE DEALERS URGE DEALERS TO PLACE EARLY ORDERS FOR THEIR FALL AND WINTER STOCKS

Plans for National Music Exposition Maturing—Hallet & Davis Travelers Hold Conference—Many Dealers Add New Lines—Machine Shortage Feared—Other Important Trade Activities

BOSTON, MASS., September 5.—There has been very little complaint about Summer business, now at end, on the part of the talking machine trade. The early weeks of the season found many good prospects, and these were "worked" vigorously during the Summer with the result that, on the whole, a good many instruments have been sold. The demand for records has kept up pretty well also. And the popular hits which all of the leading houses carry have been very much in demand. There is a general feeling that business for Fall and the rest of the year is going to go big, and jobbers everywhere are urging the dealers to place their orders early, else there is sure to be a shortage such as they will regret later on in the season.

Plans for National Music Exhibition

Plans continue to mature for the National Music Exposition to be staged at Mechanics Building the week of November 26 under the direction of the National Exhibition Association, Inc. On the whole, the trade is taking kindly to the proposition, but in order that local dealers may be better informed a circular bearing the signature of Secretary William B. Merrill, of the New England Music Trade Association, has just been sent out—nearly 300 of them to the trade throughout New England—giving definite information of what the exposition really purposes to be. In a few days it is planned to get the Association together so that the thing can be talked over man to man, after which it is believed there will be little difficulty in getting pretty nearly all the music trade into line insofar as taking space is concerned.

Hallet & Davis Co. Travelers Convene

At this writing there is a very interesting conference at the Hallet & Davis Co. warerooms and factory in which the road men of this house are participating. Considerable attention is being given to the merchandising and advertising of the company's talking machine, and those who are addressing the conference at the wholesale warerooms are E. E. Conway, C. C. Conway, John L. Cotter and R. O. Ainslie. Mr. Cotter,

who is in charge of the sales and advertising division of the company's business, has prepared a most comprehensive campaign which he is to present to the roadmen. On Thursday evening, September 6, the program calls for a dinner at the Engineers' Club. Some of the traveling men who have come to Boston for this Hallet & Davis conference include P. A. Weeks, of Atlanta, Ga.; H. E. Morrison, of New York City; J. A. Stitt, of Los Angeles, Cal.; B. F. Clark, of Dallas, Tex., and A. J. Cullen, of Chicago.

Sonora Officials Enjoy Vacation

Joe Burke, of the Sonora Co. of New England, is on the job again after a vacation in the White Mountains, where he and his family were registered at the Alpine House at North Woodstock, N. H. For a part of the time with Mr. Burke was Frank Coupe, vice-president of the Sonora Phonograph Co. of New York, who had with him Mrs. Coupe and their daughter, Miss Norma Coupe. Mr. Coupe and his family remained somewhat longer than Mr. Burke and when they finally returned to New York City they carried back with them the young son of the household, Bennett Coupe, who had been at a Summer camp in the mountains.

Manager Burke says the prospects for September are splendid, but that while machines are coming through pretty well they are not fast enough to take care of the trade which has largely increased of late through many new merchants taking on the Sonora line. Raymond Burke, Joe's brother, has been on a business trip through western Massachusetts and Vermont, and the reports he sent home were of the most encouraging character.

Remick Manager on Motor Tour

Lee Myers, manager of the Boston stores of the Song and Gift Shop of Jerome H. Remick & Co., is home from his vacation. He spent two weeks touring through central and northern New York State, going over the Mohawk trail to Albany, through the Berkshires and later into the Adirondack Mountains. But all the while he could not forget the latest Columbia hits

Buy Now
 For
 Fall

Exclusively



Wholesale

The Eastern Talking
 Machine Co.
 85 ESSEX STREET
 BOSTON MASS.

which he had been doling out to his customers before he left his store duties.

New Okeh Dealers Listed

Two new accounts just signed up for the representation of the Okeh and Odeon records are the L. M. Pierce Co., of Hartford, Conn., and Pittsfield, Mass., which were arranged by P. J.

(Continued on page 96)

**Fall Business Is Here
 Are You Ready for It?**



Are your Victrola and record stocks complete and ready to meet the demand? Are your sales policies for the coming months fully settled upon? Have you arranged for wholesale service that is dependable in a pinch?

DITSON SERVICE

Victor Exclusively

will help you meet your problems.

OLIVER DITSON CO.
 BOSTON

CHARLES H. DITSON & CO.
 NEW YORK

Love of Good Music Is Not Limited to Any Class, Creed or Race

The NEW EDISON

Through its marvelous REALISM, bringing to actual LIFE the subtle personalities of the artist, perfect technique, the individual tone of voice and instrument, this

phonograph, The NEW EDISON, fully meets every desire of all exacting MUSIC LOVERS. It will bring increased patronage to every Edison Dealer's store.

FULL CABINET MODELS IN CONSOLE AND UPRIGHT DESIGNS, \$100 UP

Certain
Localities
Offer Dealer-
ship Opportuni-
ties. Write us.

THE PARDEE-ELLENBERGER CO., Inc.

Edison Jobbers for New England

26 Oliver Street

Boston, Massachusetts

Edison
is
FIRST
with
HITS

THE TRADE IN BOSTON AND NEW ENGLAND—(Continued from page 95)

Donovan, of the staff of the General Phonograph Corp. of New England; and Henry L. Kincaide & Co., of Quincy, which deal was closed by C. E. Hodgkins, of the same staff. Manager N. B. Smith, of this New England department, was over in New York for several days visiting the home offices of the General Phonograph Corp. Just now his secretary, Miss Rose M. Gallagher, is finishing her vacation at Onset, down on Cape Cod.

Concert of Handy Band Postponed

The concert scheduled for Symphony Hall one Sunday evening in July did not come off for the good reason that the fact was overlooked by General Manager Smith, of the General Phonograph Corp., which was to father the concert, that no jazz could be played here on Sunday. The concert was to have been given by "Handy's Famous Original Band," and as there were other impending engagements that carried this aggregation into the South the concert had to be postponed until some date this coming Fall. Much of the music that will be heard when the concert does take place is such as is or will be well known on the Okeh records.

Fred E. Mann on Organ Committee

Manager Fred E. Mann, of the Boston branch of the Columbia Co., has been chosen one of the committee at the Boston City Club to purchase and install a pipe organ during the coming Fall

and Winter. Mr. Mann has just returned from Toronto, Canada, where he was the guest of Manager McMurtry of the Columbia branch in that city over the border.

Louis Buehn a Visitor

A welcome visitor to Boston lately was Louis Buehn, of the Louis Buehn Co., of Philadelphia, Victor jobber. As soon as he got in touch with Robert Steinert, of M. Steinert & Sons, of course he had to be driven out to the links for a game of golf. The Charles River Country Club was the scene of the "encounter," but the details of the game are shrouded in more or less mystery.

Visits the Victor Factory

Nicolo Carbone, whose Fields Corner Music Shop—for he runs several talking machine establishments—is exclusively Victor, has been enjoying a trip to the Victor factory. Another Victor enthusiast, who has been a guest at the factory, is Miss Josephine Anderson, of the Steinert Co.'s Lowell establishment.

Busy Times With the Brunswick

Harry Spencer, head of Kraft, Bates & Spencer, is right on the job almost night and day lately, for there are a thousand-and-one things demanding his constant attention. He says the New England department is flooded with orders. A letter which was just received the day The World representative called on him was from a titled woman in London who asked for a cata-

log of the Brunswick line, and stated that she was soon to visit this country and was so much interested in this line that she was going to make a close study of it in all its branches. Mr. Spencer says that the new advertising campaign is receiving cordial cooperation from the local dealers, and that those who have been eager to tie up to the full-page idea in certain selected Sunday and daily newspapers include the Jordan Marsh Co., R. H. White Co., the Shepard Stores, the C. C. Harvey Co., Vose & Sons, Henry F. Miller Co., and a number of dealers in cities in Massachusetts, New Hampshire and Vermont. The first of these advertisements is to appear during the early part of September.

Charles Von Euw a Proud Daddy

Charles Von Euw, manager of the stockroom of M. Steinert & Sons, at 35 Arch street, has become the proud father of a seven and one-half pounds son, who was born a few weeks ago. It is understood that the youth is answering to the name of Charles Kenneth, the latter being "some name" around the Steinert establishment.

New Victor Dealer in Wollaston

A new Victor dealer in Greater Boston is Charles W. Bahr & Co., who have opened a fine store at 679 Hancock street, Wollaston, where they are carrying this line exclusively. The store was opened on August 18 and Manager Kenneth E. Reed, of the Steinert establishment, went out to assist in the auspicious event. Still another Victor establishment to throw open its doors is C. C. Beedle & Co., who have a new store in the center of the town of Keene, N. H. Mr. Beedle, however, is not new to the business, as he has been conducting a prosperous talking machine business in Keene at another location for twenty-five years.

Many New Edison Dealers

Frederick H. Silliman, head of the Pardee-Ellenberger Co., Inc., has just signed up several good houses which, from now on, will carry the Edison instruments and records. These include the Fox Furniture Co., at Newton; Miller's Music Store, at Salem; Miller's Music Shop, at New Haven, Conn.; W. G. Shaw, Quincy; J. S. Silva, Provincetown; D. Levenson, East Boston; Clinton Optical Co., Clinton; Norwood Music Shop, Norwood; C. L. McGaw, South Weymouth; Charles Stanley's Sons, Mexico, Me., and F. E. Tucker & Sons, Haverhill. Mr. Silliman is most enthusiastic over the prospects for the Fall and Winter, and he says business for this time of year was never better since he has been handling the Edison line.

F. H. Silliman Enjoys Vacation Via Auto

Frederick H. Silliman managed to get away from the daily grind of work long enough to take a delightful auto trip with Mrs. Silliman, on which they were away a little more than a week. They started out in the direction of the Adirondacks, touching Plattsburg, then headed north for Montreal, Canada, where they remained only about a day; then went over the famous high-

We Serve New England!

PREPARE now for a busy Fall season. Examine your stocks and plan your campaigns for bigger and better business. Then, call on us. We can and will gladly be of service to you.

Our complete stocks of all Okeh Records, including the foreign language and Irish records, and the employment of modern methods of distribution assure you of speedy and accurate filling of all record orders. The benefits of our experience in, and the knowledge of, the New England market are at your service at all times in the solution of arising sales or business problems.

General Phonograph Corporation of New England

142 Berkeley Street

Boston, Mass.

Okeh Records



THE TRADE IN BOSTON AND NEW ENGLAND—(Continued from page 96)

way to Quebec and back home by way of Sherbrook and St. Johnsbury, Vt. They had good weather all of the time and for the most part Mr. Silliman says he found the roads in pretty good shape. He is especially enthusiastic over the country in the Green Mountain State, which he and Mrs. Silliman greatly enjoyed.

Several of the Pardee-Ellenberger staff are just finishing their vacations. F. S. Boyd has been at Duxbury for a fortnight, dividing his time between digging clams, fishing and sailing and incidentally enjoying the swimming. Guy R. Coner has been spending his vacation on motor trips to interesting places. William G. Adams took an extra week and is on his way home from Moosehead Lake, Me., where he had a fine rest in the wilds with some of his friends. E. B. Compton has been at Clarksville, O., where he has been visiting members of his family.

Donnelly Does Business on Vacation

George P. Donnelly, the popular assistant manager of the Columbia Co.'s Boston branch, is back home from his vacation, which was spent in Maine. As he couldn't entirely get away from business, he called upon a number of the Columbia dealers in the Pine Tree State before coming home. While in the vicinity of Portland Mr. Donnelly spent considerable time in the company of Salesman Ingalls.

Cupid Busy With Columbia Staff

Cupid appears to be getting busy around the Columbia offices. Lately the engagement was announced of Peter McInerney, supervisor of orders and inventories, to Miss Ruth Schubmehl, who resides in a neighboring city; and more recently the engagement was made known of Miss Margaret J. Reardon, for some time secretary to Manager Fred E. Mann, to John J. Moore, Jr., who is now Columbia salesman in southeastern Massachusetts and Rhode Island; and it is rumored that there are other engagements within the Columbia ranks soon to be announced.

George W. Lyle a Visitor

President George W. Lyle, of the Strand Phonograph Co., was a Boston visitor toward the latter part of August, making his headquarters here with Arthur C. Erisman, of the Strand and Vocalion forces. Mr. Lyle left Boston for Indianapolis, Ind., for the special purpose of speeding up production, which, he says, must be hurried in order to keep up with the Strand orders, a statement that is backed by Manager



Fore-Warned is Fore-Armed

Profit by the experiences of former years and lay in a reserve supply of Victrolas—now.

We, as wholesalers, are endeavoring to do so, thereby protecting the interests of our Retailers.

You, as Retailers, should not wait until the eleventh hour to secure your necessary quota.

“We can help those who help themselves”

M. STEINERT & SONS

Victor Wholesalers

35-37 Arch Street Boston, Mass.

Exclusive Territory for DeForest Radio Dealers Still Exists

ANYWHERE IN NEW ENGLAND

Erisman, who says that the business has been unprecedented this Summer and that orders ahead in the New England territory are very large, necessitating a greater output.

Joins Kraft, Bates & Spencer Staff

F. E. Warren is the latest one to join the staff of Kraft, Bates & Spencer, and his territory will include western Massachusetts and Vermont. Mr. Warren is a man of experience, knows the trade as well as people, and has a wide following so he is in every way equipped to increase the Brunswick business in his particular field.

Stock Shortage in Sight

The Eastern Talking Machine Co. has had a very good Summer, but, like other distributors, it is finding it somewhat difficult to convince dealers that there is to be a shortage of Victor

goods this Fall, and already this is being forced home by reason of the heavy demands placed on the Eastern Co. for quick delivery of goods. Manager Herbert Shoemaker, who is keen to sense the situation, says that there is every indication of good business ahead and he is stocking up so as to be able to give the promptest service possible to all the dealers whom his house serves. Mr. Shoemaker lately returned from a vacation spent at Jackson, N. H., where he got well rested for the strenuous days ahead.

Visitors to Columbia Headquarters

General Auditor J. J. Munro and Assistant Auditor T. A. Lawrie, of the Columbia Co., were recent visitors to the Boston branch, where they were entertained by Manager Fred E. Mann. Other visitors included R. V. Lewis, manager of the Columbia department of the Summerfield Co. at Worcester, who when here expressed himself as greatly pleased with the new Columbia models; and E. C. Edwards, manager of the Columbia department of G. H. Tilden Co., at Keene, N. H., who is mapping out plans for a busy Fall and Winter season in his store.

Jordan Marsh Co. Adds Brunswick

The big department store of Jordan Marsh Co., of Boston, is one of the latest concerns to take on the Brunswick line in its talking machine department. The talking machine department of this large store has for some time been carrying the Victor, Sonora and Avona makes.

Returns to Retail Business in Malden

M. C. Perkins, who has been with Arthur C. Erisman as an inside man for more than a year, has again gone back into the retail business and the store which he once operated in Malden is now located at 209 Pleasant street, that city, quite near to Malden square, where his many friends are hoping that he will make a big “go” of it.

Erisman Visits Widener

Arthur C. Erisman, the popular Strand and Vocalion distributor for New England, spent a week-end in August with “Jim” Widener, who has a beautiful Summer home at Meganset, on Cape Cod, which has been the scene of much hospitality during the Summer, and where Mr. Widener manages to get in long week-ends.

C. F. De Forest With Meiklejohn Co.

An important piece of news emanating from the Pardee-Ellenberger Co., Inc., is that Charles F. De Forest, who has been with this concern

(Continued on page 98)

KRAFT-BATES AND SPENCER INC.
NEW ENGLAND DISTRIBUTORS

New Brunswick Records Every Day

No waiting now for Brunswick records—they come NEW EVERY DAY. A constant stream of the novelties in music to bring customers into the store of Brunswick dealers every day, instead of once a month.

Always something in advance to play for the record customer. The public is pleased. The sales of records prove it. Dealers like it. Their profits prove it.

Brunswick records can be played on any phonograph. Brunswick phonographs play all records.

KRAFT, BATES & SPENCER, Inc.
80 KINGSTON STREET, BOSTON, MASS.
New England Distributors

Steel Needles Motrolas Record Brushes Khaki Covers



Another Superior Point for THE NEW COLUMBIA

The New Columbia motor eclipses every other motor in use in the phonograph industry today. Amply powered, perfectly lubricated, designed by real engineers—it is sturdy as an automobile engine and runs with the precision of a fine watch.

COLUMBIA GRAPHOPHONE CO.
New York

THE TRADE IN BOSTON AND NEW ENGLAND—(Continued from page 97)

for several years, principally at the New Haven, Conn., department, has accepted a position with the well-known Rhode Island house of the Meiklejohn Piano Co., whose principal store is in Providence, but which also has establishments in Pawtucket and Woonsocket. Mr. De Forest is to have charge of the talking machine and piano departments of these stores, and as he has had wide experience in the talking machine business the Meiklejohn Co. is to be congratulated on having obtained the services of so valuable a man.

Growing Sales Force Expansion

The West End Phonograph Co., Columbia dealer, of Leverett street, this city, has been enjoying a splendid business and has been forced to increase the number of hearing rooms and display space for new Columbias in its store. The same holds true with Mr. Carbone, of the Washington Music Shop, Columbia dealer, located at 1865 Washington street, Rox-

bury, Mass. Mr. Carbone has set aside a large space for displaying practically exclusively the new Columbia models.

Lee Myers Enjoys Auto Tour

Lee Myers, manager of the Boston stores of the Song and Gift Shop of Jerome H. Remick & Co., Columbia dealers, just returned from a well earned vacation. Mr. Myers spent two weeks touring through central and northern New York State.

New Columbia Agency

The East Boston Music Store, Meridian street, East Boston, has acquired a Columbia franchise and has actively started a campaign of retail distribution of Columbia products through East Boston and vicinity. Anthony Riccio is the proprietor.

Oscar W. Ray Remembers Friends

Oscar W. Ray, who is now associated with the wholesale department of the Vocalion, has been heard from in Europe, whither he went early in

the Summer on business for his house. Mr. Ray, who returned to New York on the Leviathan, made many friends while he was in Boston during the days that he was with the Emerson organization.

Arthur Stout Summers at Oceanside

A welcome visitor to Boston the latter part of August was Arthur Stout, who is the head of the manufacturing end of the Strand instruments. Early in the Summer he brought his family here from Indianapolis, and they have been guests at the Oceanside, Magnolia, for several weeks. He visited Arthur C. Erisman several times while here.

H. Rosen Joins Summerfield Co.

Harry Rosen, widely known to the talking machine trade throughout this city, and a brother of George Rosen, local Emerson record and radio distributor, recently joined forces with the Summerfield Co. in the capacity of buyer in the talking machine and related departments. This concern operates one of the largest house-furnishing businesses in the New England territory and the talking machine department is an important part of the enterprise.

News of the Vacationists

George McDonald, record supervisor for the Eastern Co., spent his vacation of two weeks at Boothbay Harbor, Me., and with him was James E. Dunn, head shipper for the same concern.

E. W. Kilgore, sales manager for the Eastern Co., got back after Labor Day from his vacation, which was spent largely in New York, where he visited his family.

Norman Mason, of the sales force of the Erisman Co., spent his vacation at Silver Lake, N. H., and he has been showing his friends some pictures of the big fish he caught while away.

Fred E. Mann, of the Columbia Co., Boston office, is now a proud grandfather, the sturdy youth being named Stuart G. Hall, Jr. Mrs. Hall formerly was Miss Emily Jane Mann.

Arthur C. Erisman went down to New London, Conn., a few weeks ago, where he was the guest of some of the members of the New York Yacht Club, and for several days he lived like a European potentate.

Ernest A. Cressey, of the C. C. Harvey Co., is back from his vacation, which was spent at Belgrade Lakes, Me., where he and Mrs. Cressey have been going for several Summers.

Arthur W. Chamberlain, of the Strand and Vocalion staff, has returned from his vacation, spent at Hebron, N. H.

BRIGHTWOOD MUSIC SHOPPE OPENS

SPRINGFIELD, MASS., September 7.—The Brightwood Music Shoppe has opened its doors at 225½ North Main street, in the Brightwood section of this city, with a line of new Columbia instruments. Messrs. Brodsky and Neiburg, the proprietors, have been connected with the music trade of New England for some time, and their wide knowledge of the trade as well as their aggressiveness will stand them in good stead.

Edison Dealers:—

Here is a way to make extra profits.
Investigate the "Perfection" and see
for yourself its big possibilities.

A new gold finish by the Chesley process is now being put on all Perfection attachments. It's a good, heavy, durable gold finish—a "five-ply" finish. You can recommend and sell Perfection attachments, with a guarantee of 100% service.

Every Edison owner is a prospect.

It makes possible the playing of all makes of lateral cut records on Edison machines.

Construction and finish—the best.

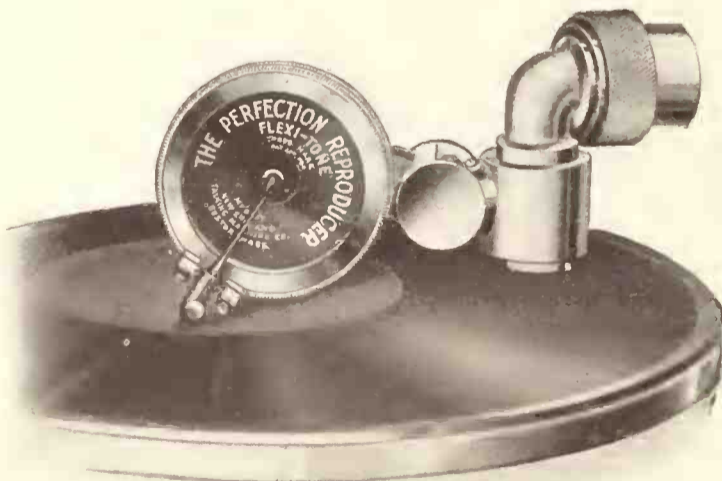

This is the "Perfection" Edison Attachment (Nos. 4 and 7)

Send today for complete information, prices
and dealers' proposition.

NEW ENGLAND TALKING MACHINE CO.
16-18 BEACH STREET
BOSTON, MASS.



Magic-Tone
PATENTED 1923
FOR YOUR PHONOGRAPH
Attached To The Stylus Bar. It Effects a Most Delightful and Fascinating Reproduction, Reducing Metallic Harshness and Surface Sounds.

25¢

100%—Silent Salesman—100%
Holding 3 Doz. Magic-Tones—
Printed in Snappy 5 Colors

Magic-Tone { **THE LATEST:**
A Novel and Use-
ful Invention } **PRICE**
Patented February 5, 1923
For Your Phonograph { **25c**
Maximum Cost 15c
Minimum Profit 10c }

Loud Tones Instantly Modified to a Whisper and Amplified at Will

“EVERY OWNER OF A PHONOGRAPH A CUSTOMER”

Sold on Guarantee—100% Satisfaction or Money Refunded.
Orders Are Coming in Hourly by Wire, Mail and Telephone.

BE THE FIRST DEALER IN YOUR DISTRICT

Order Sample Silent Salesman Holding 3 Dozen Magic-Tones with Booth and Window Cards and Illustrated Leaflets. By **\$5.25**
Prepaid Insured Parcel Post—SPECIAL AT

Jobbers: Write or Wire for Territory and Terms

MAGIC-TONE SALES COMPANY
BURTON COLLVER, President
Sole Distributors

105 WEST 40th STREET NEW YORK, N. Y.
Phone Longacre 4094



Magic-Tone
PATENTED 1923
FOR YOUR PHONOGRAPH
Attached to the stylus bar of the reproducer effects a most delightful and fascinating reproduction of all phonograph records.

25¢

MAGIC-TONE SALES CO.
105 WEST 40th ST. NEW YORK CITY.

Booth and Window Card
Hangs or Stands
5 Colors on 10 Ply Board

PREDICTS A TWO-TONE SHORTAGE

Geo. W. Lyle Looks for Unprecedented Two-Tone Demand—Factories Will Work to Capacity to Handle Dealers' Requirements

Geo. W. Lyle, president of the Manufacturers Phonograph Corp., New York, maker of the Strand phonograph, who returned recently from a trip to the Pacific Coast, makes the prediction that the next twelve months will see an unprecedented demand for two-tone models. "As sure as fate," said Mr. Lyle in a chat with The World, "we are going to see a two-tone year. I look for a volume big enough to result in a pronounced shortage of two-tone merchandise, a bigger shortage of merchandise than in any year since the war. The Strand factory is going to act on that estimate of the future by turning out every two-tone instrument that our capacity will permit, and if I were a retailer I would certainly stock a substantial proportion of two-tone models. The public wants them, and we will be guided by this demand."

The Manufacturers Phonograph Corp. has just issued a handsome new catalog which illustrates and describes its complete line. Included in these instruments are a number of two-tone models, among which are the Queen Anne, Model 80; Queen Anne "Special," Model 260; Louis XV, Model 10, and the Italian Renaissance, Model 40.

LATEST EDISON RECORD RELEASES

Among the important recent record releases by Thomas A. Edison, Inc., are: "On the Isle of Wicki Wacki Woo," by Aileen Stanley, on the reverse of which is "What You Was, You Used to Be," by Sally Collins; "Mira o Norma-Norma," by Alice Verlet and Anita Rio; on the reverse of which is "Ah! ne fuis pas encore!" (Ah! Linger Yet a Moment), by Alice Verlet and Ralph Errolle; "Marcheta" (A Love Song of Old Mexico), by Schertzinger, tenor, with vocal obligato, Walter Scanlan and Betsey Lane Shepherd; the reverse bearing "Say It With a Ukulele," rendered by Bailey and Bent; "Long Ago in Alcalá," and on the reverse side, "Down Deep Within the Cellar," both sung by Arthur Middleton; "Abie at the Opera," by Paul Burns, on the reverse side of which is "Goldberg's Automobile Troubles," by Dave Martin; "Finlandia" and, on the reverse side, "Badinage," both by American Symphony Orchestra.

A TRIBUTE TO EDDY STEADY

Eddy Steady, popular and aggressive Columbia dealer at Berlin, N. H., is quite flattered to know that his name is presented on a New Process Columbia record, for such is the case with record No. A934. He is, however, somewhat at a loss to understand why it was necessary to place his last name in brackets, but, nevertheless, he plans to make the selection "Eddy (Steady)" the hit of 1923 in Berlin.

BAERWALD RETURNS FROM EUROPE

Paul L. Baerwald, Eastern sales manager of the General Phonograph Corp., returned to New York recently on the steamer "Laconia" after spending six weeks abroad. Mr. Baerwald's trip was primarily a pleasure journey and his principal purpose in going abroad was to visit his mother in Berlin. Mr. Baerwald has a host of friends in Germany and during his stay there he visited the leading trade centers, acquiring an intimate knowledge of business and economic conditions in that country. In a chat with The World Mr. Baerwald stated that the phonograph industry in Germany was making steady progress, but there was a dearth of satisfactory phonograph motors.

Caroline Lazzari, contralto, who is an Edison artist, recently appeared at Monteagle, Tenn., at a concert given under the auspices of the local Women's Association.

USES EFFECTIVE ADVERTISING

Herrmann's Victrola Shop Secures a Whiteman Orchestra for the Annual Baby Parade in Port Richmond—Advertising Used to Advantage

Under the direction of Herrmann's Victrola Shops, of Port Richmond and Stapleton, S. I., Paul Whiteman's Piccadilly players will appear September 15 at the Coliseum at Port Richmond, to furnish the musical program in celebration of the annual baby parade. This baby parade, which is held under the auspices of the Port Richmond Board of Trade, is one of the important events of the social season, and Mr. Herrmann is using generous publicity featuring the affair.

Mr. and Mrs. W. P. Manning, of the W. P. Manning Music Co., Columbia dealer, of Augusta, Ga., have just returned from an extended vacation trip to the West.

INTRODUCTORY OFFER
OF
THE KRASCO ASSEMBLED UNIT

\$24.30 For a nickel-plated sample unit consisting of a powerful, silent, four-spring Krasco motor containing 64 feet of spring, a perfect drawn brass tone arm without die-cast parts of any kind, a reproducer of the finest quality possible to make and a dependable in-built automatic repeater and stop, all mounted upon a black enameled plate. Exactly as shown below. A half hour and a half dozen screws install it in any cabinet. Plays and repeats any make of record any number of times, then stops automatically with the needle suspended above record.



Will play ten 10-inch records with one winding.
The greatest single talking machine improvement since the invention of the disc record.

WILL GO IN ANY CABINET

Licensed under the Brooks-Klemm Patents

MANUFACTURERS, JOBBERS and DEALERS using the KRASCO ASSEMBLED UNIT are more than doubling sales. Ask for full particulars—THE PRICE IS LOW.

KRASCO MFG. COMPANY

451 East Ohio Street

CHICAGO, ILL.

Mid-West Point of View

WESTERN DIVISION OF THE WORLD, CHICAGO, ILL., SEPT. 8, 1923. THIS is not the first time we have said it, but that is because it is one of those things which need saying over and over again. It is

Doesn't
Pay to
Knock

not the first time, that is to say, that we have thought it necessary to ask the retail trade what possible benefit any one can suppose is derivable from the practice of knocking a competitor's goods. We had always hoped that the talking machine trade in the mid-West would keep itself free from a practice which has always had a blighting effect and which at one time was the disgrace as well as the misfortune of the piano industry. Unhappily there are not wanting signs of a recrudescence of this detestable practice. One begins to hear of very nasty things said by salesmen about competing machines, and even about competing records, though fortunately in neither case is it easy to find plausible excuses for the poisoned word. After all, there may be honest differences of opinion in respect of the reproducing abilities of various talking machines, or about the comparative artistic value of records; but the true salesman devotes his time to talking about his own goods, and ignores those of his rivals. Of course he does, for at the best he cannot know much about his competitor save what rumor tells him. Even if he had once worked for a rival his knowledge is no longer first-hand. How much better it would be if every head of every retail house in our city would post up in every salesroom a replica of that significant sign which hangs in the warerooms of the Steger & Sons Pianoforte Mfg. Co., in Chicago. We have quoted it before. Let us quote it again in all its sterling simplicity:

"An expression of opinion by our salesmen concerning our competitors or their goods is absolutely forbidden."

There you have it. Perfectly simple, and in its import and application simply perfect. *There* is the only sound policy, most lucidly expressed. Why does not everybody adopt it?

THE tendency to concentrate one's selling efforts upon some one style or number of talking machine in one's line, and to ignore the

A Poor
Sales
Policy

others, is probably almost universal; but it is none the less a mistaken and a thoroughly erroneous practice. Every established line of machines includes at least one very popular, easily-selling, model. This may be either an upright or a console; but in the present day it is more likely to be a console. As things stand to-day it is a very simple matter to sell goods of that particular kind; because the public is interested in low-price consoles. That is so far to the good, but it is by no means to the good when all the efforts of a sales organization are concentrated on that one good seller. It simply means that everybody is taking the short and easy way of making a sales record, without thinking about the foolishness of such a policy. For one thing, the name of a house, which ought to be known for fineness of work and achievement, becomes associated in a community with an article not really representative of its finest ideas. For another thing, no factory force can suddenly begin to turn out unheard-of quantities of one model without inflicting upon the merchants much delay and disappointment. Again, the merchant himself gains nothing in the end by such a process, for he simply destroys the value in his community of all the reputation and character which enable that manufacturer to undertake the production of fine goods. The name value of the line a merchant represents varies directly as its embodiment in high-class machines: but how can such production be kept up, to maintain that name value, if the merchant is doing all he can to persuade his community that the best representative of it is some low-priced model, instead of the fine and artistic models which form the backbone of the production and the foundation of the reputation? It is really just about as easy to sell the whole line, if intelligence is used, and foresight; but this means looking ahead from the chance of to-day to the event of to-morrow. And that, apparently, implies a task too big for a great many merchants.

PORTABLE machines are still generally held as mere seasonal goods, but the tradition is receiving a very hard blow this season. For manufacturers who have been making and shipping portables all Summer are continuing to receive orders for them and are finding it necessary to contemplate continuing their production all the Winter. How is this? It seems that some merchants last Christmas, being short of regular goods, disinterred from their stock-rooms some of the portables which had been left unsold from the previous rather depressed Summer, and put them on their floors. They found to their surprise that these little fellows at once sold, without any trouble and in fact with superlative ease. At once the manufacturers were asked to supply some more. Thus the process of converting the portable from a seasonable to an all-year instrument, so quietly begun, has steadily gone on, until to-day it seems as if we shall have to consider grouping the talking machine under three standard classifications, upright, console and portable, all of which are to be considered as year-round sellers. This is a development which should be welcomed by all. It is never the easiest thing in the world to find out what people really want, and amidst one hundred and ten millions there is room for all kinds of tastes and varieties of taste. The portable is becoming important. We hope it will continue to be so. There is a place for it. It is easy to sell, its sale is profitable, and it is not a competitor with the upright or console. Its presence renders unnecessary the manufacture of unduly low-priced uprights and widens the scope of the talking machine's appeal.

The New
Standard
Type

LITTLE attention has been given to one of the most important events which the near future has in store for the Chicago trade. This is the opening, on January 1, 1924, of the wonderful new Furniture Mart on the Lake Shore Drive. Chicago has long suffered under the infliction of inadequate quarters for the semi-annual

The
Furniture
Mart

trade fairs at which the furniture manufacturers acquaint the dealers with their latest productions. Grand Rapids has for years held the primacy, with Jamestown, N. Y., in these great markets from which the public is rigidly excluded; but Chicago is only now taking her rightful place in this big movement. The country is big and no one or two cities can supply all the needs of the nationwide furniture business. Chicago's new Furniture Mart will be interesting to our trade because it will offer to talking machine manufacturers the best of opportunities to put themselves in touch with their retailers at the two best periods of the year for wholesale buying, while at the same time offering permanent all-year-round showroom headquarters in a building specially devoted to the purpose and free from every kind of distraction, yet perfectly adapted to its own special end; which is that of bringing manufacturer and merchant together. The Vitanola Talking Machine Co. is taking space in the new building, and, in fact, its present Chicago headquarters, into which it has just moved from the Saginaw factory, are only temporary. Some may say that the talking machine does not belong in the furniture trade. It is certainly a domestic article, and one indeed which furniture dealers can handle profitably. The new Furniture Mart is likely therefore to have more than one talking machine manufacturer for a tenant.

ALTHOUGH the holiday season is yet afar off there is ample evidence in certain quarters that talking machine dealers who were over-careful about placing advance orders for machine stocks are going to see business go by them before the first of the year because they haven't the goods on hand to meet the demand. Each year we hear that the peak of the talking machine demand has passed and each year almost there is a scarcity of the popular machine models. It happens with startling regularity as the holiday season approaches and there is little comfort to the dealer in criticizing the manufacturer for lack of production or the jobber for lack of special service. What is needed is foresight.

From our CHICAGO HEADQUARTERS

REPUBLIC BLDG., 209 SOUTH STATE ST TELEPHONE WABASH 5242

EDWARD VAN HARLINGEN

WILLIAM BRAID WHITE

EUGENE F. CAREY

ARTHUR E. NEALY

A. SNYDER

DEALERS IN THE MID-WEST TERRITORY MAKE PREPARATIONS FOR A BIG FALL TRADE

Retailers Unanimous in Expressions of Prosperity in Every Branch of Trade—Heavy Ordering Indicates Determination of Dealers Not to Be Caught Short of Instruments This Fall

CHICAGO, ILL., September 8.—The retail trade as a whole is predicting one of the best Fall seasons that it has ever experienced and, in line with this prediction, goods are being ordered accordingly. On every hand we receive the information from retailers that the trade during the Summer has been exceptionally good, with the exception of a week or so, when there was

quite a lapse; nevertheless, retailers are fairly well satisfied with the business consummated for the past several months.

The portable trade was very good during the Summer, but it was somewhat slow in the sales of these instruments during the latter part of August. With September, however, there was a tendency toward revival of this business and,

judging from present indications, we may look forward to a continued activity for the balance of the year at least.

As far as records are concerned business was exceptionally good throughout the entire Summer months and it is at present going along very nicely, with no signs of a let-up. "Blue" numbers and "class" records are very popular throughout Chicago at present and, according to the wholesale men, these types of records are being very favorably received in all parts of the country.

Regarding talking machines, both uprights and consoles have been accounting for themselves in satisfactory sales during the Summer and, judging from reports received by retailers and wholesalers, the sales of the console instrument are somewhat in excess of the upright type.

Wholesalers Report Heavy Ordering

Throughout the wholesale trade we find that the dealers have been ordering very heavily and this ordering began towards the latter part of August. The wholesale men are of the opinion that the retailers are pushing stronger than ever and, judging from the amount of orders that dealers are sending in, the retail trade as a whole contemplates selling a tremendous amount of machines in the next few months. One thing noticeable in the wholesale trade this season is that a large number of the retailers are sending in, along with their orders, inquiries pertaining to further shipments. It seems that a number of these retailers are making preparations in advance of the holiday season, and doing everything that they can do to anticipate their future requirements. As we can easily remember, for the past several years the trade has been quite lax in anticipating its "future" requirements and, consequently, when the holiday activities came around they were at a loss as to what to do regarding immediate shipments.

Heretofore this laxity on the part of the retailers has caused the manufacturer to build instruments only a little in excess of actual orders. His reason for this was obvious in that he did not deem it wise to overload his warerooms and do all anticipating for the retailer. Therefore, when the retailer came along at the last minute and requested immediate shipment there was no possibility of carrying orders and, in order to do what he could, the manufacturer was forced to work nights, days and holidays to get out the instruments. This, of course, has a reaction on the retailer in that it cut down his margin, as the manufacturing costs were necessarily somewhat increased, owing to this overtime work. It is hoped by the manufacturers that more of the dealers will see the wisdom of anticipating their requirements early, as it undoubtedly will give the manufacturer a better opportunity to turn out goods in a manner that will allow a better margin of profit to the retailer.

Broadcaster Corp. Is Chartered

The Broadcaster Corp., successor to the Linerphone Talking Machine Co., 316 Union Park court, has just been incorporated for \$125,000, on which there is claimed \$100,000 has been paid in, the balance to be paid up by January 1. The corporation papers were taken out under the State laws of Illinois and the officers named are Max Rovech, president; Saul Meltzer, vice-president; Arran Meltzer and Sol L. Zax, secretary and general manager. The purpose of the new broadcaster corporation is to manufacture and deal in talking machines and, in addition, it will install radio sets.

The officers of the company have announced

(Continued on page 102)



For The New Edison



Showing Reproducer of Jewel Needle Equipment Turned Up to Change Needle; Also Position When Not in Use



Showing Reproducer of Jewel Needle Equipment in Position for Playing Edison Record With Fibre Needle.

Plays all types of records. Operates the same as the "EDISON" with the LEVER.

No adjustments necessary when changing from lateral to vertical cut records. Stop prevents swinging to the right.

Needle scratch almost entirely removed.

Turning back of Reproducer permits of easy access to needle socket and saves records from unnecessary scratching.

Is the ONLY equipment that plays vertical cut records with a Fibre needle in the proper "EDISON" position with the Reproducer turned FACE DOWN to the record, giving it a floating action.

Needle CENTERS on all records.

Straight air-tight construction and absence of movable joints insure perfect reproduction and great volume.

Pivoted ball-joint insures perfect reproduction and freedom of movement both vertically and horizontally.

Weight is the lightest that can produce perfect results, thus saving the record, and permitting a freedom and sweetness of tone considered impossible.

Indestructible NCM-Y-KA diaphragms do not blast, crack, split or warp, and are the greatest development in phonographic sound reproduction in years.

NOT
Just Another Equipment
BUT

a distinct improvement in Tone Reproduction as well as in Mechanical Construction and Finish.

Send for descriptive circular which contains "HINTS REGARDING THE CARE OF A PHONOGRAPH."

WRITE YOUR EDISON JOBBER. HE HAS IT.

Price the same. Liberal discount to dealers.

GUARANTEED IN EVERY WAY.

MONEY BACK IF NOT SATISFIED.

We handle highest grade Jewel Point Needles.



Showing Reproducer of Jewel Needle Equipment in Position for Playing Lateral Cut Records on Edison Phonograph



Showing Back View of Jewel Needle Equipment in Position for Playing Lateral Cut Records on Edison Phonograph

JEWEL PHONOPARTS COMPANY, 160 W. Whiting St., Chicago

FROM OUR CHICAGO HEADQUARTERS—(Continued from page 101)

the taking over of a new manufacturing plant located at 2414 to 2424 West Twentieth street, Chicago, wherein they are occupying the entire second and third floors, which offer a space of approximately 35,000 square feet. The old trade name of Linerphone will be dropped entirely from the product of this concern and in its place the name Broadcaster will be used.

A. B. Cornell, of Jewel Fame, at Helm

After a lapse of seven weeks A. B. Cornell, treasurer and sales director of the Jewel Phonographs Co., has returned to his desk at headquarters. During his absence he spent some of his time at his Summer home in Summerville, N. J., and the balance of the time in calling on the trade. In a chat with Mr. Cornell he reported that the trade in general has very favorably received the new Jewel line of tone arms and attachments, as well as the Jewel-Tone needle equipment. This latter product of the Jewel Co. has been constantly growing in demand since its introduction to the trade and Mr. Cornell is of the opinion that this demand will continue with increased steadiness for the balance of the year.

Lincoln T. M. Shop Opens New Store

The Lincoln Talking Machine Shop, at 3100 Lincoln avenue, is opening a new store at the corner of Lincoln and Lawrence avenues, which will be ready for occupancy about September 15. This concern retails both the Sonora and the Brunswick lines at its old locations and at the new shop will carry the same lines, as well as a well-known line of pianos, player rolls and musical instruments.

Gets in Touch With 30,000 Colored Elks

It was estimated that more than 30,000 persons rode in the gala procession put on by the Improved Benevolent Order of Elks, a colored organization which swept through Chicago's South Side streets on August 28. The organization brought 50,000 colored visitors to Chicago for the convention, which lasted from

Tuesday until Friday, and the entire number of visitors as well as Chicago's own colored populace, which is said to number around 200,-



King Oliver's Jazz Band

000, had their attention called to the colored catalog of the General Phonograph Corp. by the Consolidated Talking Machine Co., of this city.



Erskine Tate's Orchestra Draws Crowds

All along the line of march and throughout the entire colored district the Consolidated Co. saw to it that there were plenty of placards mentioning colored artists who can be heard on the Okeh record. The principal features, however, were Erskine Tate and His Vendome Or-

chestra, King Oliver and His Jazz Band, Mamie Smith and numerous other nationally known colored artists who have recorded for Okeh records. The placarding of the colored district was personally supervised by E. A. Fearn, of the Consolidated Co., who spared no expense in this work.

Blackman Music Co. Incorporates

The Blackman Music Co., of this city, has filed papers of incorporation in the State of Illinois for a capital of \$100,000. The incorporators named are Fred K. Dabson, Gustavus Dabson and John M. Cameron. The purpose of the organization is to deal in musical instruments and radio sets. The company has its headquarters at 2845 West Nineteenth street, Chicago.

Ashley Visiting Points in the West

M. F. Ashley, vice-president of the Krasco Mfg. Co., left Chicago about the twentieth of August for a trip throughout the West, where he will call on the trade. His trip took him to Denver, Salt Lake City, Los Angeles and other Coast commercial centers and he is expected to return to Chicago about the middle of September.

Isham Jones Goes Big in Golf

The latest reports coming from the Byrn Mawr Golf Club indicate that Isham Jones, of Brunswick recording fame, is still in the line insofar as championship is concerned. It is stated by those who actually saw the contest that Mr. Jones was trimming all comers until he ran up against a certain player who turned out to be Bobby Bensing, son of the president of the Brunswick-Balke-Collender Co. and assistant secretary and treasurer of that concern. It is said that Bob has made an average of 75 on all courses around Chicago and that when Isham went up against him he decided that he had a better chance at playing a saxophone than he had at a niblick.

While we are on the subject of golf we would like to know why someone don't get up a talk-



Style J Mahogany



Style M Equipped With Albums

KIMBALL PHONOGRAPHS

Appeal to Those Who Demand the Best

The dealer who sells the Kimball will not only have ready sales but satisfied customers and is building future business. Compare the Kimball in Construction or visible beauty, or in TONE or accurate reproduction and there is none to excel. Exclusive features appeal to buyers.

Console and Upright Types;
Variety of designs;
Wide range of prices;

Ask about Territory and Agency Terms.

W. W. KIMBALL CO.

Established 1857

Kimball Hall

306 So. Wabash Ave.

CHICAGO

Manufacturers of Phonographs, Pianos, Player Pianos,
Pipe Organs; Distributors of Okeh Records

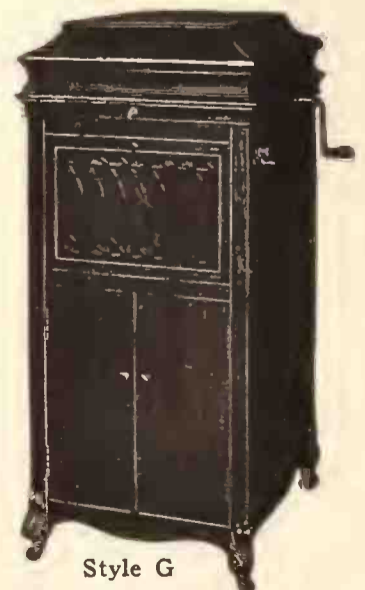

Style G

Kimball Phonographs Play ALL Records

FROM OUR CHICAGO HEADQUARTERS—(Continued from page 102)

ing machine men's association here in Chicago. We have a lot of enthusiasts, but it seems that we lack a leader and, in order to start the ball rolling, all the boys in the Brunswick organization are willing to stand Bobby up against all comers in the trade.

Illinois Sonora Campaign

Sales Manager L. Golder, of the Illinois Phonograph Corp., Sonora distributor, Chicago, reports that Sonora dealers throughout his territory are exhibiting considerable interest concerning the rather unique advertising campaign which Sonora will start about September 15 in the daily newspapers throughout this section. Just what this campaign will consist of Mr. Golder has not as yet mentioned, but he promises one of the most interesting series of newspaper advertisements that have been seen in this section for a long while. His office is in receipt of samples of the new Sonora DeLuxe period models which came in towards the latter part of August and Mr. Golder reports that the local Sonora dealers who have come down to the National avenue showroom of Sonora have been placing very substantial orders for these new DeLuxe period instruments.

Activities of Sterling Devices Co.

Fred Keller, of the Sterling Devices Co., has just returned from a trip through the Eastern territory and is happy to report that the trade outlook in that section is very bright. While in the East he made arrangements to bring his family from Philadelphia to Chicago to take up their residence here. Heretofore Mr. Keller was not actively associated with the plant activities of Sterling, but his former association was as Eastern representative of this concern in Philadelphia. Now that his activities confine him wholly to Chicago he has decided to locate permanently in this city.

Julius Keller, Sr., production manager of the Sterling Devices Co., is at present at Lake Winnebago, Wis., taking a well-earned rest, and immediately after his sojourn of two weeks at the Lake he will return to Chicago, calling on the trade en route.

Cole & Dunas Distributing Strings

Cole & Dunas have just been appointed local distributors by the National Music String Co., New Brunswick, N. J., to handle its well-known Bell Brand and Black Diamond lines of musical instrument strings. Cole & Dunas are about to place on the market their new Olympian attachment for playing both hill-and-dale and

The Oro-Tone PORTO-TYPE

Vacation days are over but sales of the Oro-Tone Porto-Type are going right on. The attractive appearance of this new machine and the splendid tone quality, rivaling full size phonographs, make it an "all year" seller. Sample sent on approval.

SPECIFICATIONS

CASE—Exceptionally strong to withstand the severe use given portable machines. **MOTOR**—Mounted in rigid cast-iron frame and plays two records with one winding. **TOPE ARM and REPRODUCER** is the standard Oro-Tone Equipment and plays all records. **RECORD-FILING COMPARTMENT** holds twelve ten-inch records. **CONVENIENCE**—All parts and records are contained within the Porto-Type, thus insuring safety even with rough handling. **DIMENSIONS**—Length 16½ inches; Width 11½ inches; Height (closed) 7 inches. Weight, 20 pounds.

LIST PRICES

With Standard Tone Arm Shown on Porto-Type \$35.00
 With Oro-Tone Automatic Equipment (see ad elsewhere) \$37.50
 Do not fail to mention style or arm wanted. Usual Discount Allowed to Responsible Dealers.

Send for Sample on 10 Days' Approval



Pat. Appld. for

The Oro-Tone Co.
 QUALITY FIRST

1000-1010 George St. CHICAGO

lateral-cut records. The new attachment is simply constructed and is well thought out in design, the working parts being of a minimum number and of the highest grade metal.

Visits Aeolian Salon

R. E. Miller, representative of the Aeolian Co., who travels the Eastern territory for the Melody Music Roll Co., was visiting Chicago while on a short vacation and was seen at the Aeolian Salon in Mandel Bros. by The World representative. Incidentally, this is the first vacation that Mr. Miller has had in seven years.

"Hot Roasted Peanuts"

Unusual interest has been aroused in Chicago by the recent appearance of a new music roll, entitled "Hot Roasted Peanuts." This roll was introduced to the trade by Cole & Dunas, which concern was recently appointed distributors for the Connorized Co. The song contained on the roll entitled "Hot Roasted Pea-

nuts" is of the novelty type and enclosed in each box along with the roll is a peanut in a little whistle. Joe Dunas, of Cole & Dunas, believes that the peanut and whistle were put there for a good purpose in that the person pumping the piano is supposed to crumble the peanut shell and blow the whistle.

Oriole Orchestra Touring

The Oriole Orchestra, an exclusive Brunswick organization, which has been attracting considerable attention at the Edgewater Beach Hotel for several months, will temporarily discontinue its activities on October 1 in order to take up a two weeks' tour of the East. At the termination of the tour the Orioles will rest up for two weeks and then return to the Edgewater Beach Hotel on November 1. During the absence of this organization from Edgewater Beach the month will be filled by Bennie Krueger and His Orchestra, another exclusive Brunswick organization which comes from the Eastern territory.

Introduce Leather Bulletin Board

One of the latest dealer helps to come from the Brunswick advertising department is an all-leather bulletin board which is finished in polychrome bronze and gold. In size it is 17½ inches wide by 32 inches high and has embossed across the top the Brunswick name and a few words pertaining to Brunswick daily releases. On the face of the bulletin board there are five counter-sunk spaces, wherein can be easily placed paper strips containing printed announcements of any daily Brunswick releases.

C. S. Tay Sales Co. Chartered

A charter of incorporation was recently granted to the C. S. Tay Sales Co., 53 West Jackson boulevard, Chicago, with a capital of \$2,000. Incorporators are G. W. Marquis, Morris Sider and Clarence S. Tay. The concern will deal in talking machines, radio supplies and accessories.

Vitanola Adds Roll Cabinets

The Vitanola Talking Machine Co. has, in course of construction, a very suitable line of player roll cabinets. The line will be comprehensive in every detail and is expected by the officers of the Vitanola Co. to be ready for the trade at an early date. The new Vitanola player roll cabinets are in keeping with the design and construction methods embodied in the manufacture of the well-known Vitanola talking machine and the occasion for the introduction has

(Continued on page 104)

Positively
 Eliminate
 All
 Surface
 Noise

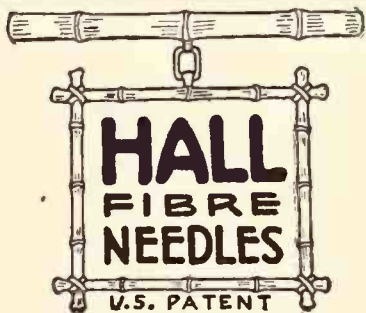

Cannot
 Possibly
 Injure
 Records

Suggest—Demonstrate—Push
HALL FIBRE NEEDLES

They are absolutely distinctive—Not in competition with any other needle.

Profitable—because they are responsible for the sale of more better class records.

Semi-permanent—play 35 to 50 records with each needle.

Display them and you will easily sell them.

HALL MANUFACTURING CO.

Successors to B & H FIBRE MFG. CO.

33-35 West Kinzie Street,

CHICAGO, ILL.

FROM OUR CHICAGO HEADQUARTERS—(Continued from page 103)

arisen purely from dealer demand throughout the country, this demand coming from those who have long recognized Vitanola products and workmanship.

Careless Fellow Causes Small Fire

Davidson's Talking Machine Shop at 234 South Wabash avenue, exclusive Victor dealer, was the scene of considerable excitement recently, due to the breaking out of a fire, which caused a small loss. It seems that a customer carelessly threw a lighted match into a bundle of paper supplies, which in turn caused an immense amount of smoke. Luckily, however, the fire was extinguished immediately.

Vitanola President in the East

M. C. Schiff, president of the Vitanola Talking Machine Co., left on the first of the month for an extensive trip through the Eastern territory. He intends calling on the trade in practically every large city in the eastern part of the United States. The results of Mr. Schiff's travels are already strikingly written upon the

order books of the Vitanola Talking Machine Co. He recently finished a trip throughout the southern section of the country, and while in that territory was instrumental in opening a considerable number of large new Vitanola accounts.

New York Album & Card Co. President Here

Max Willinger, president of the New York Album & Card Co., recently spent a week in Chicago calling on the local trade. He also spent some time at the Chicago factory of his company and superintended several items throughout the plant which will in due time be of benefit to the trade.

Child Saxophonist Records

One of the proudest fathers in the Chicago trade is John Jaros, proprietor of the Jaros Palace of Music, with headquarters at 2813 West Twenty-second street. The reason of all this paternal proudness being his talented ten-year-old daughter, Blanche, who is speedily becoming recognized as the Child Wonder saxophonist.



Patented Aug. 14, '23
Other Patents Pending

Secret of Success

lies in ability to make turnovers. About all you must do is to show the *Triplex*. It sells better than the ordinary type of talking machines.

Triplex Artistic Phono. Co.

Pershing Road and Ridgeland Avenue
BERWYN, ILLINOIS

Miss Blanche has appeared on the programs in many of Chicago's leading theatres and, in addition to her ability as saxophonist, this versatile young miss is attracting considerable atten-



Blanche Jaros, Child Saxophonist

tion as a ballet and toe dancer, as well as a singer. Her ability as a saxophonist is commendable in that she is perfectly at home with her instrument, whether the number being played is of the classical or popular type.

Recently the little lady, assisted by her sister Hattie at the piano and her brother Jerry on the violin, made two special Okeh records. The numbers were "Velma," by Rudy Wiedoeft, and "Frolics of Spring." It is said by those in position to know that one of Chicago's best-known music publishers will feature Miss Blanche on the cover of two songs which are speedily becoming popular.

New Brunswick Dealer in Detroit

H. B. Bibb, manager of the Chicago district of the Brunswick Co., announces that the complete Brunswick line has been taken on by the Crowley-Miliner Co., of Detroit, Mich. This concern is one of the largest department stores in the State of Michigan. The talking machine department is managed by Larry Dow.

Take on More Space

The Blood Tone Arm Co., 326 River street, has again found it necessary to take on additional space so as to care for its rapidly growing business. The new room is to be used as a department for maringing and soldering tone arms. Plans are also being made to install a printing department and when this is consummated all assembling and manufacturing required in the building of the Blood Tone Arm Co. will be done under one roof.

New Columbia Dealer

The Mont Claire Music Store has recently opened at 7160 West Grand avenue, Chicago, Ill., handling new Columbias and new process Columbia records. George Tomaso is the proprietor and will be assisted by his son. Modern fixtures have been installed, the decorative scheme being in white enamel and blue.

Forster Numbers in Great Favor

In connection with the popularity of the late

(Continued on page 106)

Merit Induces Recognition Recognition Induces Sales Volume

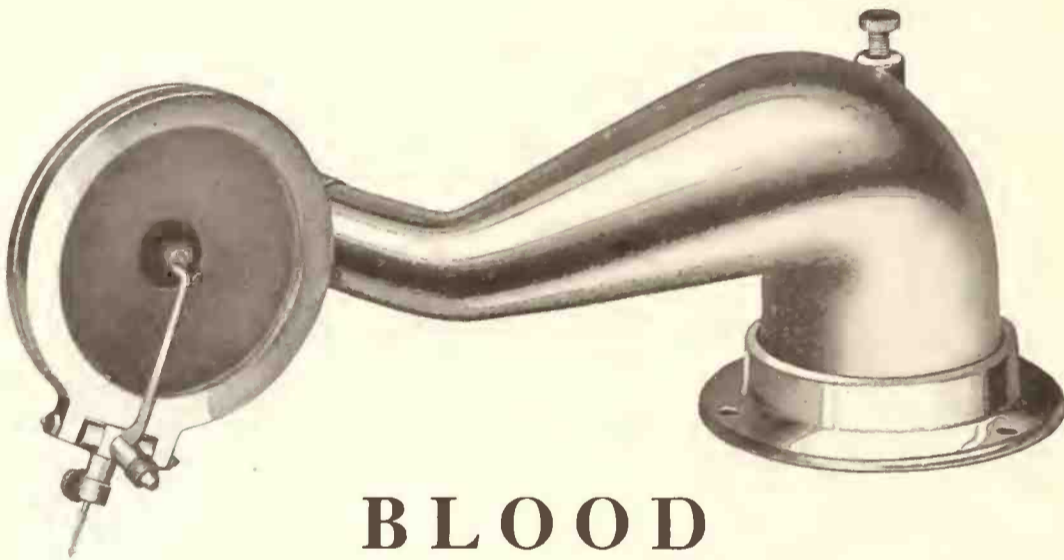
**B L O O D**

Merit is recognized by leading manufacturers and Sales Volume follows as a natural consequence.

In keeping abreast of BLOOD sales volume, we find it necessary to increase our plant space from time to time.

Today we are doing practically all of our manufacturing under one roof, thereby insuring greater production, better inspection of assembly, and speedier shipment.

Blood management is doing everything in its power to expedite shipment. To farsighted manufacturers who anticipate their requirements previous to an unprecedented Fall business.

Again we caution the manufacturer to take inventory of his tone arm stock. Laxity at this time may invite future loss.

The Blood Tone Arm Company

326 River St.

CHICAGO, ILL



CONSOLIDATED SERVICE

quickly earns and retains the unlimited confidence of those OKeh dealers who partake of its many merits and advantages.

Why? Because we keep on hand at all times a thoroughly complete stock of all records listed in the OKeh catalogues. Because we use only the speediest of modern methods of distribution. Because we constantly offer new and valuable sales helps. Because we are always ready and cheerfully willing to lend a helping hand in the sensible solution of our dealers' sales and business problems. In other words, we are striving just as earnestly and just as conscientiously to *maintain* the present efficiency of Consolidated Service as we did to *attain* it.

A more reliable combination could hardly be found than that of Consolidated Service and

OKeh Records
The Records of Quality

Consolidated Talking Machine Co.

227 W. Washington Street

CHICAGO, ILL.

Branches:

2957 Gratiot Ave., Detroit, Mich.
1121 Nicollet Ave., Minneapolis, Minn.

FROM OUR CHICAGO HEADQUARTERS—(Continued from page 104)

numbers published by the Forster Music Publishers, Inc., there has been some activity among the personnel of the company. Dan Winkler, New York manager of the company, spent the week of August 15 in Chicago, while John Fink, manager of the professional department, has returned from Atlantic City, after spending the months of July and August at the seashore resort promoting the Forster publications. Maurice L. Adler, sales manager, also returned to his desk after spending a month in the East.

Mr. Adler reports that the outlook for Fall is more encouraging than ever before and that the last few months have shown between 40 and 60 per cent increase in sales and there is no indication that the sheet music industry will have cause to complain over business in the immediate future.

"Oh! Harold," one of Forster's popular numbers, is now being featured at the Auditorium in connection with Harold Lloyd in "Safety Last." Other late numbers that are very popular throughout the country are "Rose of Sunny

"Tonofone"

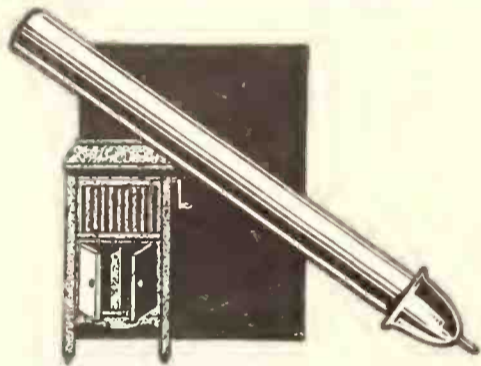

Semi-Permanent Needles are now being sold by over 8,000 dealers.

Play 20 to 50 selections each.

Give Accurate Reproduction.

Absolutely DO NOT DAMAGE the Finest Records.

Play with Minimum Surface Noise.

Medium

For all Vocal and Instrumentals Records.

Loud

For all Dancing and Band Records.



Packed in Colored Display Cartons

One hundred packages to carton.

Red and White cartons contain 25c packages; Blue and White, 10c packages.

RETAIL PRICES

Package 12 needles..... 25 cents

Package 4 needles..... 10 cents

100% Profit to Dealers

Jobbers' proposition on request.

THE TONOFONE COMPANY
110 So. Wabash Ave., CHICAGO, ILL.

Inventors and Sole Makers

Eastern and Export Representatives:
South Atlantic Export Co.
25 Broad St., New York, N. Y.

The Name "KRASCO" on a Talking Machine Motor means that you are assured of the best possible quality of high grade material and workmanship.

The Hall Mark of Dependability, Service and Quality

"KRASCO"

A Revelation in Smoothness and Quietness

Simple in design, compact, sturdy, mechanically right. Built to meet the most exacting demands for long distance playing on one winding.

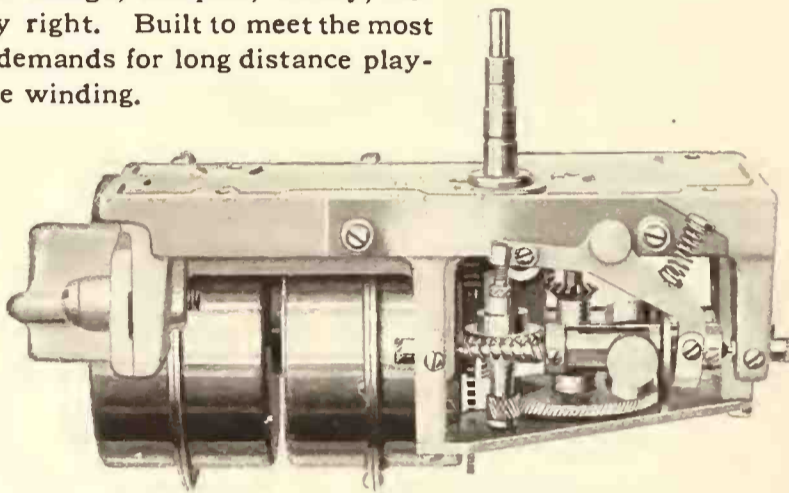

Six sizes, from a double spring motor playing four 10-inch records to a four-spring playing ten.

Each and every part used in the building of Krasco Motors is produced by the Krasco Manufacturing Co. Krasco is built—not made or assembled.

May we quote you prices and send descriptive literature?

KRASCO MFG. COMPANY

451 East Ohio Street

CHICAGO

Italy," "Mellow Moon," "Chinky," "Down by the Wishing Well," "Where the Sacramento River Flows" and "When Clouds Have Vanished and Skies Are Blue."

Columbia Activities

W. J. Thomas, of Divernon, Ill., Columbia dealer, ran a beautiful Columbia display at the Sangamon County Institute recently.

R. F. Perrin, Columbia dealer in Arlington Heights, is showing the new model Columbias at the Cook County Fair. He has a beautiful display of pianos, Columbia phonographs, etc.

One of the visitors to the Columbia office recently was J. C. Cowser, of Farmington, Ill., who spent a week in the city, accompanied by his wife.

H. H. Barker, of the Barker Furniture Co., Indiana Harbor, visited the Columbia offices in Chicago recently and inspected the new line of Columbias. He was much pleased with business conditions and predicts an early Fall business revival.

A recent addition to the Columbia fold is the C. E. Hurd Music Shop, of Freeport, Ill., which has just added a complete line of Columbia machines and new process records.

The Svaboda Furniture Co., of Kewanee, Wis., ran an interesting Columbia display at the County Fair held there recently.

H. E. Miller Visits Chicago

H. E. Miller, representative of the Aeolian Co., who travels the Eastern territory for the Melodee Music Roll Co., spent a part of his vacation in Chicago calling on his old friends in the trade. While here he spent considerable time at the Aeolian-Vocalion sales office at the Mandel Bros. department store.

Now Yahr & Lange Sales Manager

After five years of active service with the sales force of the local Columbia branch, Irving S. Leon has severed his connection with that office and is with the sales department of Yahr & Lange, Sonora distributors, with headquarters

in Milwaukee. While associated with the Columbia sales office Mr. Leon traveled the northern part of Illinois and during the years of his activity in this capacity became known to



Irving S. Leon

practically every talking machine dealer in that section. In his new capacity Mr. Leon will have charge of the traveling force of the Yahr & Lange talking machine division, which covers



"BROKEN-HEARTED MELODY"

By Isham Jones

THE MOST ORIGINAL-MOST HAUNTING-SWEETEST WALTZ PUBLISHED

FORSTER MUSIC PUBLISHER INC.
 235 SOUTH WABASH AVE.
 CHICAGO

FROM OUR CHICAGO HEADQUARTERS—(Continued from page 106)

a large part of the State of Wisconsin, as well as the northern peninsula of Michigan.

A Musical Trio in the North Woods

When three "good fellows" make a hasty retreat from the "Great White Way" and pitch their tent in the northern part of Wisconsin there is bound to be something doing. Such was the case when Dave M. Allen, of Leo Feist, Frank Westphal and M. G. Peters found themselves at the Little White Birch Lodge, Star Lake, Wis., last month, for according to these three gentlemen they found more pleasure



Left: Dave Allen Right: M. G. Peters

in the Northern woods than they ever found along the "Rialto" or at Rainbo Gardens. Besides the charms of nature, there was every kind of sport to indulge in, while the three spent several weeks visiting the Wisconsin lakes, marking a vacation that will long be remembered. The first stop was the Little White Birch Lodge at Star Lake, Wis., where several days were spent, and then the party journeyed to Eagle River and spent five days at a camp with friends, who cordially provided them with horses, boats, machines and everything necessary for outdoor life.

Tonofone Head on Eastern Trip

Miss E. E. Powell, secretary of the Tonofone Co., is making preparations to leave for a short visit to Paducah, Ky., where she intends to remain for a few days prior to leaving for a trip throughout the Eastern trade. Miss Powell's plans call for business visits to Boston, New York and other large Eastern cities and in all probability will be away from her desk at headquarters for about three weeks. Miss Powell reports that the sales of Tonofone have been

keeping up remarkably well during the Summer months and she has found it necessary to add additional help in order to take care of Tonofone's constantly growing demand.

Prof. Cheney on Lecture Tour

Towards the latter part of the month of August, Prof. Forest Cheney, of the Cheney Talking Machine Co., left for a visit to the mid-West and Coast sections of the country, where he will lecture and visit Cheney dealers. Prof. Cheney will carry out the same program he held to earlier in the year when he made a tour of the eastern section of the country. The only difference this time is that the professor will not go from town to town driving his famous "Blue Gull" Packard, but will make use of the railroads instead.

The first stop on the program called for a visit to Cheney dealers in the Omaha territory, which will be followed by visits to Council

Bluffs, Denver and other big mid-West cities, whence he will gradually work his way to the Coast, where he will call on all of the Cheney dealers.

His program will comprise sales talks on the Cheney talking machine and heart-to-heart talks with the sales people with whom he comes in contact. The lectures themselves will consist of technicalities embodied in the building of Cheney instruments and the reasons for these embodiments.

No definite return was announced by Prof. Cheney upon his departure, but it is expected that he will return to Chicago headquarters in about eight weeks.

D. W. Kimball Marries

On Saturday evening, September 8, D. W. Kimball, son of C. N. Kimball, president of the W. W. Kimball Co., was married to Miss Mary (Continued on page 108)

A Remarkable Trade Stimulator

which you can use to wonderful advantage in increasing your business. Why let your competitor get it all? Here's a solution to your trade problems.



Mahogany and walnut finishes. Gold trimmings and 3 spring motor. Plays all disc records with a full rich tone. Send for further particulars.

SONATA MANUFACTURING CO., Inc.

664-66 W. Austin Ave.

Chicago, Ill.

A Better Fibre Needle Cutter for Less Money

RETAIL PRICE \$1.00

The ALTO



Manufactured by

ALTO MFG. CO.

1801-1803 Cornelia Ave., CHICAGO, ILL.

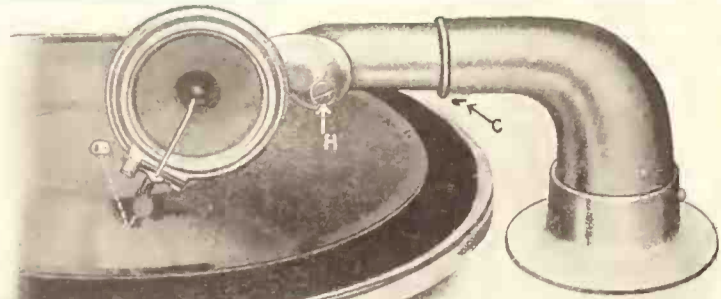

Oro-Tone No. 20

A New Tone Arm and Reproducer with Many Advantages for Manufacturers

A tone arm and reproducer of excellent material and workmanship with extra loud tone of surprising quality. Already meeting with remarkable success among manufacturers who want a thoroughly dependable article at a low price.

Send for Sample on Approval

The Oro-Tone Co.
QUALITY FIRST

1000-10 George Street, CHICAGO
Distributed in Australia by United Distributors Co.,
Melbourne and Sydney

THE NO. 20 TONE ARM
PLAYS ALL RECORDS

Adjustable in length from 6¾ to 8½ inches or from 8 to 9½ inches.

Description: No. 20—Base. No. 21—Large Elbow. No. 5—Adjustable Length Extension. No. 22—Throw-Back Elbow. C—Lock Screw for length adjustment. H—Assembly Screw for joining throw-back elbow to adjustable extension. G—Lock Screw to prevent Assembly Screw H from working loose. J—Boss Containing Spring and Ball to insure snug, smooth operation in turning reproducer for playing all records. B—Neat Beaded Turning Joint. K—Rubber Bushing to insulate reproducer from tone arm.

FROM OUR CHICAGO HEADQUARTERS—(Continued from page 107)

Knox Winton, daughter of Mrs. William Crayton Winton, of Duluth, Minn., at the home of the bride. The Kimball family, consisting of Mr. and Mrs. C. N. Kimball, the Misses Mary and Elizabeth Kimball and William Wallace Kimball, were present. After October 1 Mr. Kimball will bring his bride to Evanston, Ill., where they will reside.

Both D. W. Kimball and his brother, W. W. Kimball, recently took up commercial activities when they became associated with the firm of W. W. Kimball Co., after their graduation from college. At the present time D. W. Kimball is connected with the advertising department of the Kimball Co., while W. W. Kimball is associated with the retail branch of the business.

It is the intention of both brothers to go through the various departments throughout the whole Kimball organization and learn every

angle of the business. Both have already adapted themselves to their new duties, and through concentrated effort they are rapidly gaining a thorough knowledge of all branches of the music industry.

New Music Shops in Chicago

The Chicago office of the Columbia Graphophone Co. this week gave out news that it had opened two new accounts in Chicago territory, one being the Tri-Art Shop, at 517 S. Cicero avenue, and the other one the Monte Claire Music Store, at 7160 W. Grand avenue. Both new shops will handle the Columbia line of instruments and the Columbia New Process records exclusively.

The proprietor of the Tri-Art Shop is J. J. Klapka, who is also a member of the Klapka & Hollicky retail music establishment at 5915 W. Twenty-sixth street. Mr. Klapka has been associated with the trade for a number of years,

and in opening his new store he has taken advantage of his years of experience by laying out a most modern and attractively decorated retail store.

The Monte Claire Music Store is operated by George Tomaso, who will be assisted by his son. Here also the installed fixtures are of most modern type, and the decoration scheme is carried out in white enamel and blue.

Why Not?

Throughout the Chicago trade one frequently hears the word "Golf" used and if a little investigation is made by the hearer of the word he will soon find that the speaker is very much interested in the game and from time to time goes out to the links. In the past three or four years the golf fans have been becoming very numerous throughout the talking machine trade, but as yet no one seems to have made an attempt to bring the talking machine boys to-

The BROADCASTER CORPORATION

*A Bigger Plant
A Greater Organization*

Facilitates a larger and more Superior Talking Machine Production at LOWER PRICES.

Users of either large or small quantities of talking machines are urged to write for information regarding our line — useful for special sale purposes.

Write for price list and specifications of our other models



Model No. 3
BROADCASTER
50" High, 20" Wide,
20½" Deep. Guaranteed
two-spring motor. Figured
birch 5-ply. Finished in
mahogany and walnut.
French polished, finish or
dull.
A Rare Buy!



Model C-3
Specifications:
39 inches wide, 23 inches deep,
35½ inches high. Gold plated.
Three-spring motor. Plush-velvet
turntable. Piano hand-polished
finish. Finished in Mahogany
and Walnut. ¾-5 ply
Veneers

BROADCASTER CORPORATION

(SUCCESSOR TO THE LINERPHONE T. M. CO.)

New Plant 2414 to 2430 N. Cullerton St.

CHICAGO, ILL.

FROM OUR CHICAGO HEADQUARTERS—(Continued from page 108)

LAKESIDE SUPPLY CO.

73 W. Van Buren St. Chicago, Ill.

Balanced Cover Support

Top Regulation

For Console and Upright Cabinets

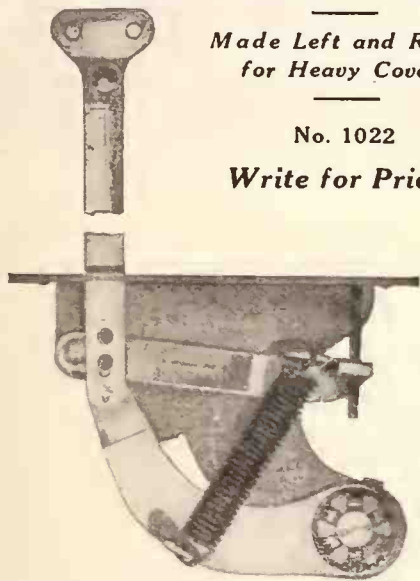

Made Left and Right for Heavy Covers

No. 1022

Write for Prices

gether for the purpose of organizing a talking machine golf club.

With the boys in the piano game, however, an entirely different situation exists. They have had for many years an organization known as the Chicago Piano Golf Association, whose members congregate with great regularity for the purpose of seeing who is the best pill-knocker. Every couple of weeks they hold a meet and after each meet someone comes home with a nice little prize of some kind.

At last, however, many of the talking machine men are getting jealous of the piano men and they have been asserting that there are just as good players in the talking machine business as there are in the piano business and at the present time the argument is waxing so hot that we may expect to see the organization of the talking machine golf club almost any day. To begin with, the talking machine men have at least one member of the trade whose prowess as a golfer is known on every link

locally and upon a large number of those out of town. This is no other than "Bobby" Ben-zinger, of the Brunswick-Balke-Collender Co., upon whom the local trade is willing to bet as the most likely contender for the championship.

Fletcher-Wickes Organizes Research Plant

One of the most elaborate demonstration rooms that has ever been erected in a talking machine plant in Chicago was recently completed at the headquarters of the Fletcher-Wickes Co., manufacturer of the well-known Fletcher tone arm and reproducer. The new demonstration room was furnished in mahogany throughout and boasts of a large assortment of well-known talking machines and models which are used for the purpose of demonstrating the Fletcher-Wickes tone arm and reproducer.

Another addition to the Fletcher-Wickes plant has been the installation of a large experimental room wherein this company carries on experimental work on tone arms, sound boxes and electric motors. This room is in charge of an expert mechanic, who, with his several assistants, does nothing but research work in tone production and motor building.

The balance of the plant is given over to offices and assembly rooms and the entire equipment throughout has been designed with painstaking care so as to eliminate every possible bit of lost motion.

Spencerian Shown at Ohio Meeting

Ben Wood, sales manager of Westphono, Inc., is among those members of the Chicago trade who is taking in the Ohio Merchants' Convention, scheduled for September 10. Mr. Wood will exhibit his product, the Spencerian portable, and immediately after the convention will make a tour of the Eastern trade.

According to Mr. Wood, indications point to a very favorable continuance of the portable business and jobbers all over the country are reporting to him that the recent slump in the sales of portables has been replaced by a brisk demand. It is expected by many men in the trade that an immense number of portables will be purchased for the Christmas trade and these will be used as gifts during the holidays.

McArthur in New Offices

R. N. McArthur, sales and advertising manager of Barnhart Bros. & Spindler, is now settled in his new office on the third floor of the Barnhart plant at Throop and Monroe

(Continued on page 110)

An Exceptional Line for Wide Awake Dealers COLUMBIAN BABY GRAND



Elastic touch. Faultless Action. Mahogany Finish Only. Size, 59"x56".



These high-grade Consoles come in Mahogany and Walnut finishes.

No. 20



Nickel or Gold Hardware. Workmanship Guaranteed. Prices that appeal.

No. 30



Our No. 10 identical to No. 20, except Gum Panels and Straight Back Legs.

No. 40



STYLE No. 4 48" high, 21" wide, 23" deep; 5-ply. Genuine Mahogany or Oak



STYLE No. 16 2-Spring Motor Holds 10 Records Plays All Disc Records

EXCEL PHONOGRAPH CO.

Manufacturers

400-412 West Erie St. CHICAGO, ILL.

THE GEER REPEATER

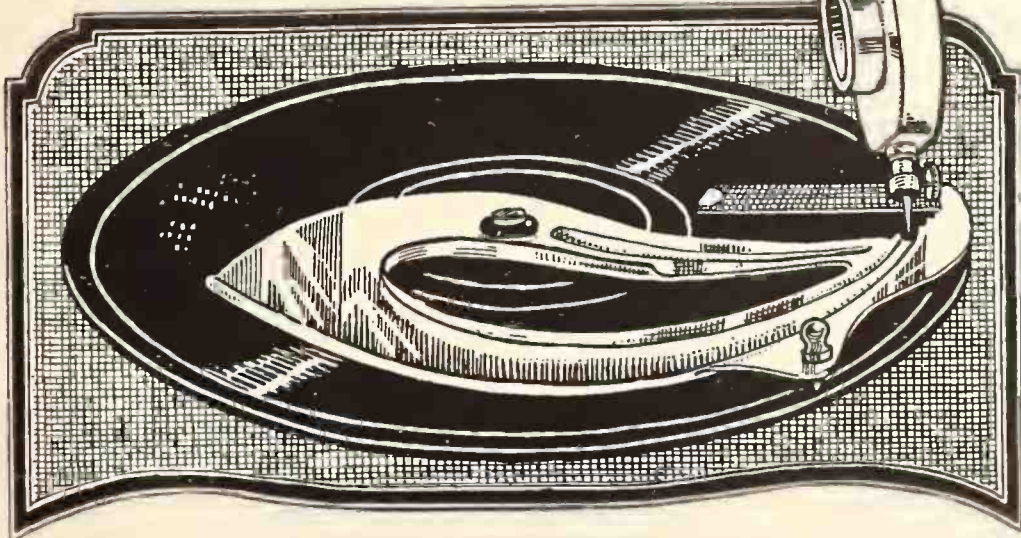

STANDARD OF THE WORLD

The Improved Geer Repeater is today recognized everywhere as the standard repeating device. It is adjustable, plays all records completely through and will give a lifetime of perfect service.

Price \$1.50

Walbert Manufacturing Company

925-41 Wrightwood Avenue

Chicago, Ill.

I've got those Blue Hoosier Blues

BLUE HOOSIER BLUES

An Indiana Fox-Trot

"You can't go wrong With any FEIST song"

© LEO. FEIST INC. N.Y.C.

FROM OUR CHICAGO HEADQUARTERS—(Continued from page 109)

streets. The new office is in the lately erected section of the Barnhart plant and is almost exactly over the location of his old one. Business expansion necessitated the erection of the new addition to the plant and since its erection quite a bit of the old space formerly occupied by offices is now utilized for the manufacture of tone arms, sound boxes and cover supports. In connection with the latter item, it may be said that the Barnhart cover support business has lately grown to large proportions and many manufacturers throughout the country have recently adopted it as part of their standard equipment.

ODEON RECORD FEATURED AS "BLUES"

Enterprising Chicago Dealer Uses Unique Selling Idea Which Results in the Sale of 2,500 Records of One Selection in One Month

A. H. Thallmayer, manager of the foreign record department of the General Phonograph Corp., maker of Okeh and Odeon records, received recently some interesting figures from the Rialto Music Shop of Chicago, one of the company's dealers. This enterprising merchant is using a megaphone attachment to increase the volume of the records that he plays in order to attract the attention of prospective purchasers, and a few weeks ago he featured Odeon

record No. 10096, the title of which is "The Mariechen Walzer."

The peculiar melody of this waltz, played in typical peasant style, attracted the attention of several members of the colored race who passed the Rialto Music Shop while the record was playing. Whenever this particular type of customer visited the establishment the owner of the store stated that the name of the record was the "Mariechen Blues." The sale of the record was invariably made after a demonstration, although it is quite possible that the use of the word "blues" was a factor in interesting the purchaser. As a matter of fact, this record has met with such popular demand among the clientele of the Rialto Music Shop that more than 2,500 of the number were sold in one month and the popularity of the record induced the General Phonograph Corp. to publish it in its American series, where it is now listed.

SHOWS A 20 PER CENT INCREASE

CHICAGO, ILL., September 7.—According to a statement issued by M. A. Healy, president of Lyon & Healy, Inc., net sales for the period ending June 30, 1923, showed an increase of over 20 per cent over the same period last year. The sales record for six months is \$3,945,809.07 as compared with \$3,279,531.08, a most satisfactory increase in business.

INAUGURATES DEALER CAMPAIGN

Brunswick-Balke-Collender Co. Starts Campaign With Dealers Pertaining to the Progress of the Company in the Industry

CHICAGO, ILL., September 7.—The Brunswick-Balke-Collender Co. has started a campaign with its dealers relating to the progress of the Brunswick organization in the talking machine industry. With the success of the Brunswick phonograph and the ever-increasing demand the company again expresses its appreciation to Brunswick dealers for their confidence and co-operation in the policies of the company that have achieved this goal.

This campaign gives to these merchants a short history of the progress made, beginning with the introduction of the Brunswick phonographs, explaining the advent and progress of the various features of the Brunswick machine. Various precedents established in the industry to-day are pointed out as having been originated by the Brunswick Co.

The campaign has a particular educational value to the dealer in reviewing the various features, policies of the company and their influence in the industry. Moreover, selling arguments which may have been forgotten, but which are nevertheless established, can again be gleaned from this campaign and be brought forward as the background of each step in the progress and development of business.

This campaign will be carried on through advertising in the trade papers, co-ordinated with letters sent out from the headquarters of the company. The first of the series of letters has been sent out reviewing the precedents established by the company.

DAILY PAPER ADVERTISING STARTED

CHICAGO, ILL., September 7.—Last week the first full-page advertisement appeared in all the leading daily papers throughout the country by the Brunswick-Balke-Collender Co. starting the national campaign that the company recently announced. This campaign has been inaugurated by the advertising department, and each release of the various advertisements will appear simultaneously all over the country. The first advertisement, attractively illustrated with pen and ink sketch, is in line with the recent program whereby hits are being released daily and listed, in addition to giving a description of the Brunswick phonograph and Brunswick record.

TEMPLIN STORES OPEN BRANCH

GOSHEN, IND., September 7.—The Templin Music Store of Elkhart and Mishawaka opened a new music store here recently. V. H. Nelson, of Elkhart, who has been connected with the Elkhart store for the past seventeen years, is the manager of the new store.

Repair Parts

For All and Every Motor That Was Ever Manufactured

We can supply any part. The largest and most complete assortment of repair parts—in the United States—on hand, for old, obsolete and present-day motors. If your order cannot be filled from stock, we will make it up special.

Special prices on main springs, governor springs, micras, repair parts, motors, tone arms, steel needles, etc., in quantity lots.

Expert repairing on all makes of phonographs and motors.

INCORPORATED UNDER THE LAWS OF ILLINOIS

High Grade Talking Machines, Disc Records, Talking Machine Supplies, Etc.

227-229 W. WASHINGTON ST. CHICAGO ILL.

Branches: 2957 Gratiot Ave., Detroit, Mich. 1121 Nicollet Ave., Minneapolis, Minn.

TRADE MARK "CONSOLA"

CABLE ADDRESS "CONSOLA"

DAILY PAPER ADVERTISING STARTED

CHICAGO, ILL., September 7.—Last week the first full-page advertisement appeared in all the leading daily papers throughout the country by the Brunswick-Balke-Collender Co. starting the national campaign that the company recently announced. This campaign has been inaugurated by the advertising department, and each release of the various advertisements will appear simultaneously all over the country. The first advertisement, attractively illustrated with pen and ink sketch, is in line with the recent program whereby hits are being released daily and listed, in addition to giving a description of the Brunswick phonograph and Brunswick record.

TEMPLIN STORES OPEN BRANCH

GOSHEN, IND., September 7.—The Templin Music Store of Elkhart and Mishawaka opened a new music store here recently. V. H. Nelson, of Elkhart, who has been connected with the Elkhart store for the past seventeen years, is the manager of the new store.

FROM OUR CHICAGO HEADQUARTERS—(Continued from page 110)

LYMAN'S ORCHESTRA FOR BRUNSWICK

Recordings of California Ambassador Orchestra Made in Los Angeles by Brunswick—First Records to be Released in Near Future

LOS ANGELES, CAL., September 4.—Los Angeles' most famous popular music organization, Abe Lyman's California Ambassador Orchestra, has just completed a number of popular recordings for the Brunswick-Balke-Collender Co. The orchestra was recently signed up exclusively by the Brunswick organization, and immediately upon the consummation of the deal the Brunswick Co. established a temporary recording laboratory in Los Angeles for the sole purpose of recording newly acquired talent.

The recording for Brunswick was done under the supervision of Skinker Darby, chief of the Brunswick Co.'s recording division, and Walter Hansehan, head of the recording department. Both of these men, along with their assistants and the necessary paraphernalia used in recording, came all the way from New York and spent five weeks in preparing and recording the Ambassador Orchestra. Records of the new organization will be released shortly, and the repertoire consists of such numbers as "No, No, Nora," "Cut Yourself a Piece of Cake," "Mid-



Lyman's California Ambassador Orchestra night Rose," and "Havana Tango." Abe Lyman's California Ambassador Orchestra has attained much popularity since the opening of the Coconut Grove Hotel in May, 1922. The orchestra is considered one of the biggest attractions in Southern California, and before coming to this city the orchestra was well known in Chicago, having played in the Colonial and Arsonnia cafés in that city. Prior to this engagement the organization appeared in vaudeville with Gilda Gray, of "Ziegfeld Follies."

A great deal of the success of the orchestra is due to Abe Lyman, whose personality sells the orchestra to the public. He is one of the old school of stick-juggling directors, and his antics are an endless amusement to his spectators. He is of the inventive type and seems to be able to inspire his men with a peppy spirit which keeps them at a high pitch. The music of this orchestra carries with it the true spirit of California, and at times it is almost oriental in color. The greatest effects attained by the orchestra are reached in its playing softly and



EDISON'S ENVIABLE REPUTATION

More than four million people have been convinced beyond all question by actual test, that EDISON reproduction of music cannot be detected from the original music. If you are a live wire and if there is no Edison dealer in your town, we invite your interest in an Edison dealership.

THE PHONOGRAPH CO.

229 South Wabash Avenue
CHICAGO, ILL.

slowly, and at all times with a decided rhythm which seems never to lapse or lag because of the original effects.

Abe Lyman himself has the distinction, besides that of a drummer, in that he is the composer of many numbers which have been popular, such as "Peggy Dear," "Apple Sauce," "I Cried for You," "In the Land of Shady Palm Trees," "Before You Go," etc., etc.

In commenting on the acquisition of Abe Lyman's California Ambassador Orchestra the Brunswick Co. feels that in offering this orchestra to the music-loving public it is making available to the entire world the individual and characteristic music of California, which is duly becoming so popular. Furthermore, the Brunswick Co. feels confident that the popularity of these records will eventually warrant the erecting of a recording and pressing plant in Los Angeles which will in turn greatly expedite recording shipments throughout the Coast territory.

LARGER QUARTERS IN SPRINGFIELD

The Brightwood Music Shoppe, Springfield, Mass., of which Ben Brodsky is manager, has arranged to enlarge its quarters to take care of the increased business in pianos and talking machines. The addition will be eleven feet wide and fifty feet deep, making this a very commodious and attractive establishment.

C. L. WALDO PASSES AWAY

Prominent Music Merchant of Minneapolis and a Founder of the Foster & Waldo Music Co. Dies in That City After Long Illness

MINNEAPOLIS, MINN., September 4.—C. L. Waldo, one of the founders of the Foster & Waldo Music Co., this city, died at his home here last Sunday in his seventy-first year. The end came after nearly four years of ill health. Mr. Waldo was born in Jefferson, Wis., and came to Minneapolis thirty-six years ago. Three years later he became associated with Robert O. Foster in the Foster & Waldo Music Co. and aided materially in building up one of the most prominent music businesses in the mid-West. He was a member of the Minneapolis Minikahda and Minneapolis Automobile Clubs. The funeral will be held tomorrow from his late residence.

WINTER PIANO CO. ALTERATIONS

ERIE, PA., September 4.—Alterations including the installation of racks and show cases are in progress in the Winter Piano Co.'s store on State street in order to accommodate the new line of small musical merchandise, which is to be carried this Fall. The decision to inaugurate the new department came as a result of an unusually good season in the piano and talking machine fields.

STERLING Attachments and Tone-Arms

The STERLING Edison attachment is operated by the lever, same as the Edison. The needle of the STERLING is *always* central, whether playing lateral or hill and dale records. STERLING Edison and Victor attachments are universally used because of their superior appearance and perfect reproduction of any make record.



STERLING ATTACHMENT ON EDISON MACHINE

It pays to be a STERLING Dealer. If your Jobber cannot supply you with STERLING write direct to factory. STERLING Tone-arms are made in different styles to suit any phonograph.

There are still a few desirable Territories open.

STERLING DEVICES MANUFACTURING CO., 412 Orleans Street, Chicago, Ill.

LOS ANGELES

All Branches of the Talking Machine Business Enjoy Brisk Demand—Association Stages August Meeting—News of the Month

LOS ANGELES, CAL., September 3.—August proved to be another good Summer month for the sale of talking machines, although, perhaps, it did not measure up to July and, according to reports from the various departments, portables are not by any means monopolizing the types of instruments sold to the exclusion of others, many high priced period models and others presenting their quota day by day. Collections are good and terms on which machines are being sold, although lower than they were a year or two ago, are respectably high, and consist always—except in the case of one or two—of a 10 per cent down payment and the balance maturing within fifteen months or less.

Fitzgerald Shows Remarkable Increase

C. H. Mansfield, manager of the phonograph department of the Fitzgerald Music Co., reports a wonderful increase of sales in his department. He states that the totals during the first six months of 1923 reveal an increase of two and a half times over those for the corresponding period of 1922. Mr. Mansfield is a great believer in using outside salesmen and employs from ten to twelve men in this way, besides the inside men; prospects are, of course, furnished to these outside men, and reports are filed and the whole matter handled in a most progressive and intelligent manner.

Double-sided Red Seal Records Please

The announcement of the manufacture of double-sided Victor Red Seal records and the issuance of the new catalog have been received with great enthusiasm by all Victor dealers, who believe that this will stimulate sales enormously. The advertising of new prices on the present Victor Red Seal single-sided records has been made by most of the dealers, although there was a slight uncertainty in the minds of most of them at first as to how this advertising should be worded.

R. P. Hamilton Returns to Coast

After attending the annual convention at the Victor factory R. P. Hamilton, Pacific Coast representative of the Victor Talking Machine Co., returned to California and visited Los Angeles for a few days only and proceeded to San Francisco. Mr. Hamilton stated that the work on the new pressing plant and recording laboratory in Melrose is progressing satisfactorily. Pacific Coast Victor dealers are evincing the greatest interest in the new plant and

anticipate the best results in service and up-to-date releases.

Seeks for Distributor of Phonographs

George H. Bohlen, Pacific Coast representative of the W. W. Kimball Co., spent a few days in Los Angeles last month. In addition to visiting the Platt Music Co. as representative of the Kimball piano in this section, Mr. Bohlen is planning to establish a good jobbing and distributing connection for Kimball products in southern California.

Association Holds August Meeting

The August meeting of the Music Trades Association of Southern California was occupied with the discussion of several matters, and among them the question of music stores keeping open in the evening from 6 p. m. to 9 p. m. Several members declared that a good deal more business could be secured if all music stores kept open, while others claimed that the business which was now being obtained by the few who always kept open would be divided up—in the event of all keeping open—and would be reduced to an unprofitable minimum. W. H. Richardson, of Richardson's, Inc., stated that he believed the music business corresponded in many respects to the theatre and amusement business, and that the former should keep open during the evenings with the result of a greatly increased business.

New Victor Models Make Hit

A. G. Cook, manager of the phonograph department of the Geo. J. Birkel Co., expressed great satisfaction over the new Victor mahogany and walnut console models which have just been placed on the market. He stated that at present his house, in common with the other Victor dealers, had been able to obtain samples only, but that a number of orders had been taken from them; the period models which the Victor Co. are making to order have also proved exceedingly attractive and can be made to match any scheme of architectural design or period.

To Open Fine New Home

The formal opening of the Southern California Music Co.'s new store at 808 South Broadway will take place on Wednesday of this week, and thousands of invitations have been sent out. Five stories out of the eight are to be occupied by the music store—in fact, most of the stock has already been moved in. The eighth floor includes a beautiful auditorium

with a seating capacity of 300, and, the floors being left level instead of sloping, can be used for dancing. The first floor is beautifully decorated, harmonizing with the Italian architecture which prevails throughout the entire building. The ceiling has been exquisitely hand painted by special artists, many weeks being occupied with this work alone. The record demonstration rooms are each individually and collectively gems of architecture with their small Italian arched ceilings, and they number two or three dozen. The Victor and Brunswick departments and salesrooms are on the second—or mezzanine—floor, and are arranged in the most complete and admirable manner possible. Without going into details of the other departments it is sufficient to state that this new store is the most beautiful to be found in the entire country. F. L. Grannis, of the Southern California Music Co., is mostly responsible for the excellent results.

Famous Actor Buys Phonograph

Cullen Landis recently purchased a magnificent \$1,200 period phonograph from the Fitzgerald Music Co. C. H. Mansfield, manager of the phonograph department of the Fitzgerald Music Co., stated that Mr. Landis had chosen this instrument for his magnificent new home in Hollywood.

NEW OUTING JOBBERS AND DEALERS

A. W. Deas, Jr., Returns From Satisfactory Trip—Yahr & Lange Drug Co. Appointed Outing Jobber for Large Territory

A. W. Deas, Jr., sales manager of the Outing Talking Machine Co., Mt. Kisco, N. Y., recently returned from a trip through New York and Pennsylvania, where he opened up a number of new dealer accounts for the Outing jobbers in these territories. He will leave shortly for a trip to Chicago, St. Louis and the mid-Western territory.

A. J. Coté, president and general manager of the Outing Talking Machine Co., states that the Outing is being received very favorably in foreign countries. A good export business is being enjoyed by this company, with the Latin-American countries being the largest consumers. The Yahr & Lange Drug Co., Milwaukee, Wis., has recently been appointed an Outing jobber for the Wisconsin and northern Michigan territory.

Cliff Hess, director of the recording of popular Vocalion records for the Aeolian Co., has just returned from a fishing trip among the Thousand Islands, where he had a good rest.

THE TROTTER ELECTRIC MOTOR

Is an Attractive Retail Proposition for Phonograph Dealers

EASILY INSTALLED

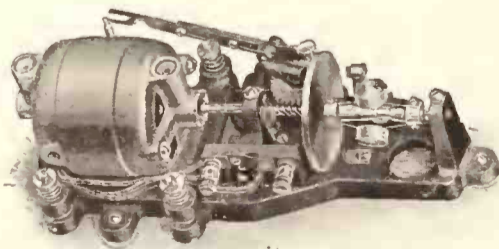

WILL RUN ON ANY CURRENT

GUARANTEED FOR ONE YEAR

The Trotter motor can be sold to any one who owns a spring motor driven phonograph. Any one can install it and when following printed instructions can change his phonograph into an electric machine in ten minutes.

PLYMOUTH PHONO PARTS CO.

PLYMOUTH, WISCONSIN

DISTRIBUTORS

Plaza Music Co., 18 West 20th Street, New York — Lakeside Supply Co., 73 West Van Buren Street, Chicago.

THE ORO-TONE AUTOMATIC No. 16 TONE ARM AND REPRODUCER

Plays All Records, Giving Perfect Reproduction
No Adjustments to Make—No Weights to Shift



**FOR LATERAL
CUT RECORDS**

Gives perfect needle
center, correct
weight and angle
automatically.

*The Franchise for
using the No. 16
Oro-Tone Auto-
matic Tone Arm
and Reproducer
will be sold only to
a limited number
of manufacturers.
Will you be one?*



**FOR VERTICAL
CUT RECORDS**

Gives correct Edison weight,
position and needle center
by a turn of hand.



*Dealers want the
Perfect Oro-Tone
Automatic Tone
Arm and Repro-
ducer on the pho-
nographs they sell
because by actual
test the public pre-
fers the Oro-Tone.
Oro-Tone equip-
ment will increase
your sales.*

Oro-Tone Leadership Is Based on the Oro-Tone Policy of Quality First

This remarkable tone arm and reproducer gives superb tone values. It reproduces perfectly. Edison records can be played with the ordinary fibre needle, producing wonderful tone and volume.

All adjustments to play either lateral or vertical cut records are automatic. Send for sample on approval.

The Oro-Tone Co.
QUALITY FIRST

1000-1010 George Street

Chicago, Illinois

Manufactured in Canada under the trade name "Oro-Tone-Banfield" by W. H. Banfield & Sons, Ltd. Distributed in Australia by United Distributors Co., Melbourne and Sydney.

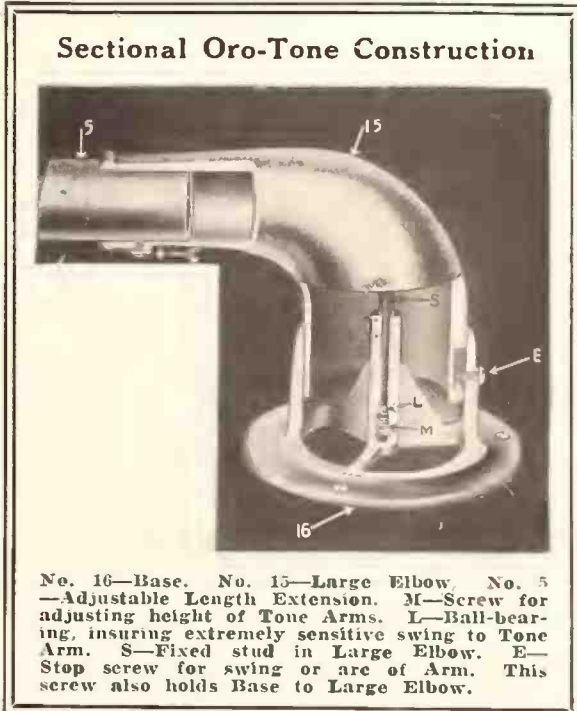

Sectional Oro-Tone Construction

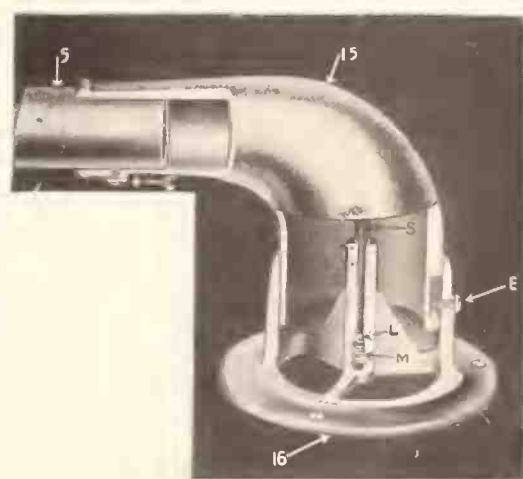

No. 16—Base. No. 15—Large Elbow. No. 5—Adjustable Length Extension. M—Screw for adjusting height of Tone Arms. L—Ball-bearing, insuring extremely sensitive swing to Tone Arm. S—Fixed stud in Large Elbow. E—Stop screw for swing or arc of Arm. This screw also holds Base to Large Elbow.



Carolina Mammy

A Real Southern Mammy Song

"You can't go wrong
With any FEIST song"

EDISON CONTEST WINNERS ON TRIP

Leaders in Annual Sales Contest Conducted by Harger & Blish, Edison Jobbers, Des Moines, Ia., End Long Eastern Trip at Thos. A. Edison, Inc., Laboratories, Orange, N. J.

Harger & Blish, Edison jobbers, Des Moines, Ia., brought their annual sales contest for 1923 to a successful conclusion the last week in August. The prize-winners at that time arrived at the Edison Laboratories in Orange, where they were conducted through the entire plant and where they also made special souvenir records in the Edison recording laboratories. During one of the evenings they spent in the East they were taken as guests to see the "Ziegfeld Follies."

The first prize in this contest was won by Harry Shroyer, of the Shroyer Music House, Bethany, Mo., who sold forty-six Edison phonographs in ten weeks, and in a town with a population of about three thousand. It seems

that in the contests conducted in previous years Mr. Shroyer has always won a place, so that his winning first prize this year indicates that he is setting a faster and faster pace for himself each year. His record is extraordinary for a large size city, but such a record in a relatively small community is indeed unique. The other persons who won places in the contest and, as a result, won the free trip were: H. A. Lorenzen, Paule Jewelry Co., Burlington, Ia.; A. L. Heggland, Pierre, S. D.; Floyd Cooper, F. M. Cooper & Son, Woodward, Ia., and A. F. O'Dell, Keokuk, Ia.

The complete trip took in Rochester, the Thousand Islands, a trip down the St. Lawrence to Kingston and Montreal, another boat trip to Quebec, a five-day cruise around Halifax, a trip from there to New York and a sojourn in New York and Orange.

In chatting with The World H. H. Blish, Jr., who accompanied the winners on the trip, stated that the records turned in this year exceeded those turned in for several years previous. This

Mr. Blish considers indicative of the fact that conditions are now satisfactory in his territory and that the outlook for Fall business warrants real confidence. He added that wheat does not constitute over 8 per cent of the Iowa crop and that, therefore, it does not have a great bearing on the general prosperity of this great agricultural State.

FISCHER PHONOGRAPH POPULAR

Mayer Bros. & Bramley Report Active Dealer Demand—Two-toned Consoles Big Sellers

During the past few weeks Mayer Bros. & Bramley, New York, manufacturers of the Fischer phonograph, have added a number of dealers to their list of representatives. "We are making rapid progress," stated an officer of the company in a chat with The World. "Our company has adopted a policy of selling direct to the dealers and we are co-operating with our trade in making their turnover active.

"At the present time we are shipping our instruments to all parts of this country, Canada and abroad, with an active demand for period consoles in mahogany and walnut. The two-tone effect in our Rosemary model is meeting with the hearty approval of the trade and we are urging our dealers to anticipate their orders for the coming Fall and holiday season, as there is every reason to predict a demand that will be far in excess of production."

NEW BRUNSWICK AGENCIES OPENED

Among the latest additions to Brunswick boosters announced by Percy A. Ware, sales promotion manager of the Eastern phonograph division of the Brunswick Co., are Brodrib & Blair, 12 Riverside avenue, Bristol, Conn.; Miller's Music Store, Troy, N. Y.; Morris Music Shop, 659 Lenox avenue, New York City; Kravetz Music House, 409 S. Main street, Phillipsburg, N. J.; Harry Fritz, Wallingford, Conn., and Harry C. Grove, Inc., Washington, D. C.

WILL OPEN NEW DAVEGA STORE

Another link in the Davega chain of stores will soon be opened at Fourth avenue and Twenty-third street, New York. This is in line with the plans for expansion announced some time ago by Abram Davega, of Davega, Inc. The Victor line of talking machines and various accessories will be handled.

NEW EDISON WINDOW DISPLAY

The latest Edison window display which has been issued for the use of Edison dealers is devoted to the featuring of one record, namely, the song "I'll Take You Home Again, Kathleen." The display pieces are very unusual, from the standpoint of coloring, and create an excellent window. The vocal selection featured in it is the largest selling record in the entire Edison catalog over the period of ten years.

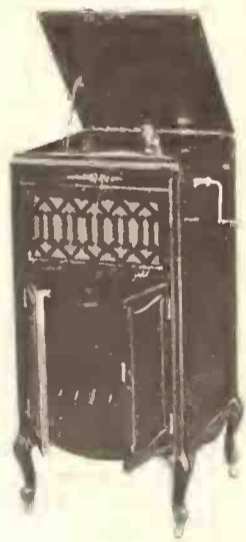

Here is a Good Money- Making Idea!

HAVE a phonograph sale and offer this beautiful Empire XA1 with an assortment of records for \$89.50! At the peak price this model retailed for \$225, and at the price you can make on it now you can sell dozens in a special sale. Our word for it, you can make a big profit *quick*, by turning a number of these in a special sale. This is a real machine, a wonderful value for you and your customers. Brown or red mahogany, top, front, sides and back. Full French-turned legs all round. H-49, W-22, D-22. Heineman No. 44 motor. Heineman tone arm, nickel trimmed. How many can you sell in one week's intensive selling? Write for our interesting proposition.

The UDELL WORKS

28th Street and Barnes Avenue
INDIANAPOLIS

Another Superior Point for THE NEW COLUMBIA

Tone-control leaves have long been acknowledged as an exclusive Columbia feature of highest worth. Every model of the New Columbia has this proved point of superiority, with the addition of many refinements in operation of this feature. The New Columbia, by reason of these tone-control leaves, is the only Console instrument that delivers sound on a level with the auditor's ears.

**COLUMBIA GRAPHOPHONE CO.
New York**



KIMBERLEY ENLARGING FACILITIES

Well-known Talking Machine Manufacturer Getting Ready for Fall Trade—Seven Models in 1923 Line—A New \$100 Console Now Being Produced—Planning Sales Campaign

The Kimberley Phonograph Co., Perth Amboy, N. J., is making plans for the enlargement of its factory facilities in order to prepare for



Kimberley Co.'s New \$100 Model

Fall trade. Details have been completed for an aggressive sales campaign and, with its increased facilities, the Kimberley organization will be in a position to meet the requirements of its trade efficiently. The line for the 1923-1924 season will consist of seven models, comprising four uprights and three consoles. The

uprights will be known as the Ambassador, Bellevue, Commodore and Dartmouth, and the consoles as the Exeter and Favorite. The latest addition to the line, the \$100 console shown in the accompanying illustration, has not yet been christened. The retail prices will range from \$125 to \$250 for the uprights and \$100 to \$275 for the consoles.

Kimberley phonographs are well known to the general trade, as they have been marketed for the past five years and are now being sold by dealers throughout the country. The instruments are manufactured in the company's up-to-date plant in Perth Amboy, and particular attention is devoted to the cabinet design and finish. All of the models in the present line will include in their equipment an all-brass tone arm and sound box which were selected by the company after extended tests.

David Isenberg, president of the Kimberley Phonograph Co., is well known in the talking machine trade, and under his capable direction the sales totals have increased steadily. Mr. Isenberg gives his personal attention to the manufacturing and merchandising of the instruments, and his thorough knowledge of the dealers' requirements has enabled him to give the Kimberley clientele practical co-operation. Included in the plans for the Fall campaign will be the appointment of jobbers in a few territories that are now open.

Edward Skinner, of the Phonograph Corp. of Manhattan, returned Tuesday after Labor Day from a one week's vacation, during part of which he called on the music merchants located in eastern Pennsylvania.

USES EFFECTIVE DISPLAY SIGN

MILWAUKEE, Wis., Sept. 4.—The Kunzelmann-Esser Co., of this city, Sonora dealer, is a keen believer in the use of effective publicity and the accompanying illustration shows a sign that

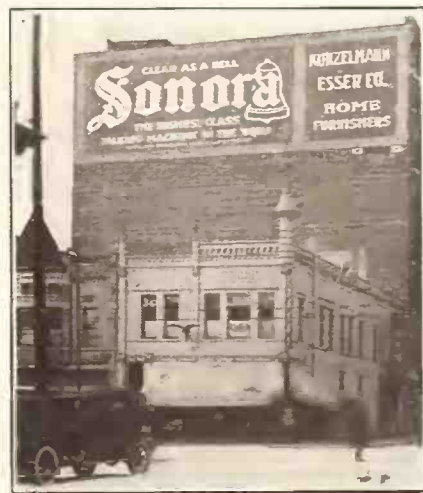

A Striking Sonora Design

this company recently ordered as a part of its Sonora campaign. Incidentally, this enterprising dealer is making rapid progress in the development of Sonora business in this territory and plans are being made for a record-breaking Fall and Winter trade.

NEW STORE IN PEKIN, ILL.

Ehrlicher Bros., well-known drug store operators, have opened a new music store in Pekin, Ill., at 414 Court street, where a full line of musical goods will be carried.

OUTING TALKING MACHINE CO., Inc., Mount Kisco, N. Y.

JOB B E R S



- A. C. ERISMAN CO.174 Tremont St., Boston, Mass.
- BRISTOL & BARBER CO., INC.3 East 14th St., New York, N. Y.
- CABINET & ACCESSORIES CO., INC.3 West 16th St., New York, N. Y.
- GENERAL PHONOGRAPH CORP.15 West 18th St., New York, N. Y.
- GEORGE C. ULRICH & CO.56 Estey Bldg., Philadelphia, Pa.
- STARR PHONOGRAPH CO.634 Grant St., Pittsburgh, Pa.
- J. K. POLK, INC.294 Decatur St., Atlanta, Ga.
- IROQUOIS SALES CORP.210 Franklin St., Buffalo, N. Y.
- VOCALION CO. OF OHIO.328 Superior St., W., Cleveland, O.
- C. L. MARSHALL CO.514 Griswold St., Detroit, Mich.
- CONSOLIDATED TALKING MACHINE CO.,
227 Washington St., Chicago, Ill.
- CONSOLIDATED TALKING MACHINE CO.,
1121 Nicollet Ave., Minneapolis, Minn.
- YARR & LANGE DRUG CO. Milwaukee, Wis.
- THE DUNNING CO.303 Second St., Des Moines, Iowa
- RENIER MUSIC HOUSE.545 Main St., Dubuque, Iowa
- ARTOPHONE CORP.1103 Olive St., St. Louis, Mo.
- ARTOPHONE CORP.203 Kansas City Life Bldg., Kansas City, Mo.
- MARTIN WEISS CO. Dallas, Texas
- WALTER S. GRAY & CO.,
1054 Mission St., San Francisco Cal.; Los Angeles, Portland, Seattle

Export:—CHIPMAN, LTD.

New York, London, Montreal, Wellington, Sydney, Melbourne, Perth, Havana, Mexico City, Buenos Aires, Rio De Janeiro, Santiago de Chile.
Cable Address: Chipmonk, New York

ATLANTA

Fair Crops in Southeastern Territory Brighten Fall Outlook—The Month's Trade Activities

ATLANTA, Ga., September 7.—August in the main has been a month of considerable business and the feeling is well developed that the South will have the best Fall since the depression struck. Crops in general are at least fair, although cotton in many sections is far from normal. The worst-hit sections have developed other crops to at least partly take its place and the good prices will mean profits to those who do get a goodly number of bales.

B. J. Shepperd Co., Victor dealer, of Savannah, Ga., is reported as planning to move to a more central location.

I. M. Bame, of Bame's, Inc., has returned to town after taking a well-earned vacation. He went by boat from Savannah to Philadelphia and spent some time in the City of Brotherly Love.

Strand consoles will be sold throughout south Georgia and Florida by the Empire Music Co., of Atlanta, the first move towards developing this section to the utmost being the warehousing of a complete stock of Strands in Jacksonville. This will permit of giving the dealers quick service. M. E. Lyle will maintain general supervision over the entire Southeast, but will work the trade through this new representative.

Business with the S. W. Gardner Music Co. is growing nicely. Mr. Gardner recently acquired the Victor line for Gastonia and has now fitted up the entire second story of his building as showrooms for the display and demonstration of pianos and phonographs. The Victor, Edison and Strand are the three lines featured.

The phonograph department at John L. Moore & Sons has been moved and relocated next to the art department. Space has been arranged so that the period models of the Victor and Strand are displayed in separate compartments, with the correct art surroundings. Altogether the result is one of unusual charm and general attractiveness.

Leon Hylan, popular representative of the Talking Machine Co., Birmingham, has once more taken to the road, after an illness in the



“We Serve the South”

IN your preparations for the Fall increase in Okeh sales don't overlook one of the most important factors in your attainment of a successful season. With a dependable distributor service at your convenience, the kind that is quick, accurate, and thoroughly dependable in the pinches, you are equipped to consistently give your customers complete satisfaction at all times.

We would appreciate the opportunity to demonstrate the advantages of Polk Service. It would readily disclose the reasons why we are at present playing so large a part in aiding hundreds of Okeh dealers throughout the South to reap the benefits that come from handling the fast-selling

Okeh Records

The Records of Quality

Wholesale Phonograph Division

JAMES K. POLK, Incorporated

Offices and Show Rooms:

294 Decatur Street ATLANTA, GA.

Inquiries from Dealers Solicited

hospital at Atlanta which housed him for about a month.

M. E. Lyle has returned from a short trip into North and South Carolina. He reports business as flourishing and finds a tendency on the part of dealers to begin ordering now, as almost everyone realizes this Fall will show a great shortage of period design consoles.

Miss Florence Myers, well known to many of Atlanta's record and roll-buying public, is now connected with the Empire Music Co. at its Victrola department in High's.

W. White, proprietor of the White Music Co., Columbus, Ga., visited the local Columbia branch recently and reported that business conditions in his community are in splendid shape.

Columbia record A-3937, "Sweet Pal," is selling "big" in Memphis, Tenn., and surrounding territory. Reinhardt's, Inc., live Columbia dealer, sold the idea of "Sweet Pal" Week to

all of the merchants, orchestras and picture theatres in Memphis and, as a result of this cooperation, the sales of merchandise showed a large increase. A similar program is contemplated in other Southern cities.

S. M. Frenkel, manager of Ludden & Bates, Columbia dealers, this city, is spending several weeks away from Atlanta on his vacation.

Columbia Salesman R. W. Richardson is now spending a two weeks' vacation in and around Memphis, Tenn.

DEALERS IN CANTON DISTRICT BUSY

Indications Point to Shortage of Instruments When Fall Trade Hits Its Stride—Exhibits at Fairs and Other News

CANTON, O., September 6.—Improvement in both talking machines and records is shown with the advent of September, and indications are that, when the Fall business hits its stride, there will not be sufficient stock on hand to meet the demand.

The William R. Zollinger Co., Victor dealer, presented a most striking exhibit recently at the Stark County Fair. In charge of M. E. Pyle, manager of the department, all the new Victor models were displayed and the entire September record list was demonstrated.

The Carrollton, O., branch store of the Alford & Fryar Piano Co. will be discontinued this week. The store was in charge of Al Walthamath.

George C. Wille, of the Wille Music Co., with his family, has returned from a vacation near Akron.

Announcement is made by the store of J. H. Johnson & Sons, Alliance, O., that all talking machine lines, with the exception of the Victor, will be dropped.

The Henry Ackerman Piano Co., Marion, O., will remodel its store and, when completed, will have considerably more space for the display of talking machines.

The most conspicuous exhibit at the annual Stark County Fair, held here recently, was that of the Rhines Edison Co., with stores in Canton and Massillon. Many live prospects were secured.

Seven Canton music stores will participate in the Trade Extension Week to be held the last week of the month by the Canton Merchants' Association, which has for its object the development of business.



The Name "EDISON"

FAMOUS the world over the name EDISON in the phonograph industry stands for tonal supremacy and merchandising prestige.

The EDISON Dealer has sales arguments at his disposal that are unlimited in scope and importance. Emphasize the supremacy of the EDISON consistently and aggressively—sales will multiply steadily.

We have a few towns in our zone open for the proper Edison dealer representation

PHONOGRAPHS, INC.

EDISON DISTRIBUTORS

41 Cone Street - - - Atlanta, Ga.

Holiday Foresight

It is not far from the facts to say that the profit shown each year by successful Victor dealers corresponds largely with the preparation they make to meet the demand during September, October, November and December.

The dealer's choice of a dependable Victor wholesaler is becoming increasingly important. On September 1st there were seven Victor wholesalers in Greater New York as compared with eleven a year ago. This increases the responsibility of the present wholesalers. They must be ready with stock, to meet the usual heavy holiday business and, in addition, a greatly stimulated demand, which we believe is inevitable.

Victor dealers who may make changes in their source of supply cannot exercise the best holiday foresight without keenly analyzing the dependability of various Victor wholesalers.

Our holiday foresight consists in having made unusual preparation to take care of those Victor dealers who have depended upon us as their main source of supply for some time past, as well as those who are arranging to do so.

We are prepared to accept the responsibility of handling a Victor dealer's entire business if within a reasonable distance of New York. There is no kind of service or support that is desirable, reasonable and dependable that we cannot give.

Blackman Dealers again are going to be in an enviable position.

Place an order now for your estimated requirements of all Victrolas for delivery during September, October, November and December.

It has always been the Blackman Policy to allow dealers to adjust advance orders according to current needs.

Our moral obligations are highly respected by us. Therefore, dealers who cooperate with us by placing advance orders promptly are entitled to first consideration during a holiday shortage.

Why take a chance when Blackman Service costs no more?



MILWAUKEE

Outlook for Fall Business Best in Years—Machine Shortage Imminent—Trade Represented at Wisconsin Fair—The Month's News

MILWAUKEE, Wis., September 7.—Prospects for a big Fall and holiday trade—perhaps the biggest on record—appear before Milwaukee and Wisconsin talking machine dealers at this time. The trade has behind it a July and August volume that surpassed anything ever known in these so-called dull months and the early part of September has developed more than the accustomed volume as well.

The wholesale and manufacturing trade is entering the Fall season with more orders on the books and a larger Summer production than at any time since 1920 and some have even exceeded the record of that remarkable year. Operating schedules of factories call for maximum capacity until the end of the year. There

is likely to be a serious shortage of instruments before December 1, it is stated, because the exceptionally heavy run of orders for the console styles keeps most factories from thirty to sixty days behind on orders for immediate delivery even at this early date. The standard upright models are selling well, too, but it is becoming more and more apparent that the console type is outdistancing the original "box" style.

Shortage of Victor Machines

In the past thirty days the shortage of Victor merchandise noted at the middle of August has been accentuated by the increase in orders from the retail trade, according to Harry A. Goldsmith, secretary of the Badger Talking Machine Co., Victor jobber for Wisconsin and Upper Michigan. While the Victor factories are operating night and day, yet the jobbing trade is unable to secure all of the instruments desired and dealers are obliged to take their turn in replenishing their floor stocks and accumulating warehouse supplies for later trade. The rural districts are producing a gratifying business.

Victor trade is especially good in the console styles, Nos. 400, 405 and 410 having an exceptionally good call. Mr. Goldsmith reports that improvement in the demand for records has continued and the Red Seal numbers are moving briskly since the price was reduced.

Excellent Brunswick Prospects

P. H. McCulloch, talking machine department manager of the local branch of the Brunswick-Balke-Collender Co., is happy over the prospects for more liberal shipments now that the Muskegon factories are devoting the vast space formerly given over to the tire departments to the production of Brunswick instruments and records. In view of the heavy demand for the console styles, this enlargement of output is particularly gratifying, as it has been impossible to deliver anywhere near the number of instruments called for by orders of dealers in this territory. Milwaukee branch business so far this year runs easily 40 to 45 per cent ahead of the corresponding period of 1922, according to Mr. McCulloch.

Edison Records Selling Well

Milwaukee Edison dealers are enthusiastic over current trade and look for a big holiday business. Edison records, especially the popular numbers, are selling far better than ever before and dealers find it difficult to keep their stocks rounded out.

Heavy Increase Over Last Year

Fred E. Yahr, president of the Yahr & Lange Drug Co., distributor of the Sonora and the Okeh record, says sales for the first eight months of the year were approximately equal to the sales of the entire year of 1922 and that prospects are for a very large increase over last year when 1923 comes to an end. Mr. Yahr has been devoting much of his time to the development of the musical merchandise division of his house; in fact, until a short time ago he bore the brunt of the work. Now he has acquired an able assistant in the person of Irving S. Leon, an experienced talking machine man, who already has accomplished much in broadening the scope of the organization to handle even a larger volume than before. Yahr & Lange are among the very largest Sonora and Okeh distributors in the country.

To Display at Food Exposition

Nearly all of the local jobbers and many of the dealers of Milwaukee have reserved space at the fifth annual Food and Household Exposition to be held in the Municipal Auditorium from October 15 to 21. The music industry has been given marked recognition this year and a distinct division has been given over to these exhibits. In addition the show management has arranged elaborate competitions to determine

the champion pianist of Wisconsin and the champion amateur orchestra of the State. Valuable awards will be given for excellence. The second award in the piano contest is a \$750 Sonora talking machine purchased from the Yahr & Lange Drug Co., musical merchandise division. Third award in the orchestra contest is a \$385 Bush & Lane Duo-Vox talking machine from the Noll Piano Co.; fourth award, a \$175 Aeolian-Vocalion console instrument, from the Milwaukee Piano Mfg. Co.

Exhibitors at the Wisconsin State Fair

The talking machine trade was well represented among the exhibitors at the seventy-third annual Wisconsin State Fair in Milwaukee during the week ended September 1 and all who participated report a relatively excellent result from sales solicitation, especially among out-of-town visitors, many from the rural districts. Despite a streak of rainy weather, the attendance was nearly equal to the record-breaking number admitted to the fair in 1922.

Victrolas Installed by North Shore Line

One of the newest features adopted by the Chicago, North Shore & Milwaukee Line to make its interurban electric cars more and more popular is the installation of Victrolas in all of the new parlor observation cars which have recently been added to the service. It is the first electric line to offer such accommodations.

Now Rinzel-Tesch, Inc.

The old-established Victor house of Harry W. Krienitz, Inc., at 459 Eleventh avenue, has undergone a change of name, following the retirement of Mr. Krienitz, who has been dealing in the line in this city for more than twenty years. The new firm name is Rinzel-Tesch, Inc., and consists of Peter J. Rinzel and William H. Tesch, former associates of Mr. Krienitz.

New Branch in Oconto

Arno Maigatter, proprietor of Maigatter's Music House at Oconto Falls, Wis., has opened a branch store in Oconto, Wis., in the building recently vacated by the local post office.

Incorporated to Make New Machine

The Prairie du Chien (Wis.) Mfg. Co. has been incorporated with \$20,000 capital stock to engage in the manufacture of a combination talking machine and light fixture for the home. The lamp-instrument has been in development for several years and the enterprise has received much local backing.

Watertown Dealer Incorporates

Henry J. Krier, dealer in furniture and talking machines at Watertown, Wis., has incorporated his business as the Henry J. Krier Co., with \$6,000 capital. Associate incorporators are Edward C. Wolfram and Edward McAdams.

Death of John E. Dummer

John E. Dummer, treasurer of the Yahr & Lange Drug Co., died August 14 after a brief illness. He was fifty years of age and joined the Yahr-Lange forces in 1908.

A New Retail House Organized

The North Avenue Music Shop, Inc., is a new corporation organized with \$25,000 capital stock to deal in talking machines, pianos, etc. The incorporators are A. H. Nemitz, Hugo Honcher and Ralph Straus. The concern will open for business in a new building on North avenue.

Chas. J. Orth Expands

Charles J. Orth, Inc., a leading Brunswick dealer, has recently made extensive changes in the store which not only enlarge the floor space, but provide an exceptionally attractive new front, with a single window to take the place of the split windows originally installed. The entrance is now at the extreme left instead of the center. New demonstration and display rooms have been added and the entire store has been redecorated in beautiful style.

A feature of the remodeled store is an ingenious arrangement whereby music from a Brunswick within the store is carried out into the street by means of piping concealed from view. The outlet is at the base of the display window and is hidden by a shutter, which mystifies passersby. The scheme has none of the offensive features of loud-speaking attachments often similarly used.



standex
"Stands for Display"
REG. U.S. PAT. OFF.

The New Metal
Display Stand
for Universal
Use in Music Shops

ECONOMICAL
ATTRACTIVE
SUBSTANTIAL

May be used for Displaying
10 in. and 12 in. Records,
Monthly Window Service,
Sheet Music,
Phonograph Displays, etc.

6 FOR \$2⁷⁵

Made in one size and finish for
all purposes

Manufactured by

MUSICAL PRODUCTS DISTRIBUTING CO., INC.
37 East 18th Street New York
Attractive Offer to Distributors



THE ORSENIKO PERIOD PHONOGRAPH



WREST GOTHIC

For ten years we have been not only advocating but making Period Phonographs.

Our persistent and successful efforts have practically forced every well-known phonograph manufacturer to attempt imitating them.

For those who are more interested in fine cabinet construction, excellent finish and superior tonal qualities than they are in price, invariably select the Orsenigo Period Phonograph.

THE ORSENIKO COMPANY, Inc.

Showrooms: 383 Madison Avenue
at 46th Street
New York City, N. Y.

Factory: Skillman Ave. and Rawson St.
Long Island City, N. Y.



CLEVELAND

Trade Planning Fall Drives—Eclipse Co.'s Financing Plan in Force—Carola Co. to Increase Output—New Agencies—The News

CLEVELAND, O., September 6.—Jobbers and retailers of this territory have set their courses for the Fall and Winter business. Present indications are that this will be the biggest year in the history of the industry. Contrary to reports, industrial activities have not lessened. Official figures show that the Cleveland district population has increased in the last year by 90,000, which, according to the usual average, means close to 20,000 families that have to be provided with housing and the things, musical and otherwise, that make home as well.

The Eclipse Co.'s Financing Plan

The jobbing element has been extending itself to aid the retailer to cash in on the new business that the many encouraging factors will create. One of these is the new financing plan of the Eclipse Musical Co., which will give the retailer new money to do more business with, though not necessitating the acquisition of additional outside capital. This has been accomplished through a special arrangement with a financial institution by Edward B. Lyons, general manager, the Eclipse.

The plan differs somewhat from other similar arrangements in that the Eclipse, as the wholesaler, is the medium through which the deferred payment accounts are discounted. The same principle of the dealer making his collections from the customer holds in this instance, so that the contact between dealer and customer, and between dealer and jobber, is maintained. The plan has been in operation only a few weeks, but already dealers are taking advantage of it and acquainting themselves with its possibilities before the time that they will need it most—this Fall and Winter.

Artists' Appearances to Help

Another effort that will bring good results for the dealer later on is the continuance of the personal appearance of artists programmed by the Cleveland district Brunswick organization, under management of Leslie I. King. The Benjie Krueger Orchestra is being used by many dealers in the Pittsburgh territory at this time, attracting attention to their stores that will make for business building during the Fall.

A like effort has been put forth by the Columbia district office here, under the management of S. S. Larmon. One of the most successful ventures in this connection has been with the Lassies-Whites Minstrels, Columbia artists, co-operating with the I. Corsuch Co., at Springfield.

Sonora to Tie Up With Fairs

County fairs will be used extensively by the Sonora Phonograph Ohio Co. this year, with

direct tie-ups for dealers. First of these was the Lake County Fair, at Painesville, with the McLean Music Co. participating, and another, the Montgomery County Fair, at Dayton, for the Wayne Music Co., of that city. All kinds of literature and advertising material will be supplied from the Cleveland offices, according to General Manager J. T. Pringle, with special service from traveling representatives wherever they are found to be needed.

Carola Extending Operations

Extension of its operations in this and other countries is being made by the Carola Co. Improvements in the plant will provide an additional output by 50 per cent, according to N. I. Schwartz, general manager. Improvements have been made in the models themselves, the cabinet type being finished in several colors of baked enamel and the portable in a high-grade leather finish. Not only is the entire country now covered, with 1,500 representatives in all the States of the Union, but business is being closed in foreign countries, notably New Zealand, Australia, Japan and Porto Rico.

New Brunswick Agencies

Among the Brunswick establishments to open is that of Hagemester Bros., at St. Clair and East 139th streets. The Hagemesters formerly were in the drug business and handled talking machines in a small way. They saw possibilities, were weaned away from the drug business and now are regular talking machine dealers. Walter Hagemester formerly stood so strongly in drugdom that for a considerable period he was president of the Northern Ohio Druggists' Association. Other new Brunswick establishments include the Colonial Music Co., at the Cleveland "Y"; the United Music Co., in the new residential section at Kinsman and East 123rd streets, and the Brunswick Music Shoppe at Elyria.

Wolfe Music Co. Opens Branch

Still another new establishment, but an old firm, is the uptown branch of the Wolfe Music Co., at St. Clair and East 125th streets. This branch has been patterned somewhat after the main store downtown, though not quite so elaborate. Souvenirs, silver needle cases, were distributed and many manufacturers' and jobbers' representatives called during opening week. The Victor line is featured at both Wolfe stores.

Letters Show Business Can Be Secured

Another aid to doubling Thomas dealers, and one that contains a punch without hitting too hard, is contained in a series of peppy letters being sent out by the Cleveland Talking Machine Co., Victor wholesaler. These letters, at

the start, have told of a certain dealer, name not mentioned, who doubted that there was any business, but thought he would try to stir up some by the old reliable method of house-to-house calls. The first week brought him two sales for his effort. This encouraged him. The next week brought a better showing, and he is keeping this program up right along. The big thing the jobber aims to show, points out Howard J. Shattle, general manager, is that the business is to be had, only it needs a little going after to get it.

Selling Newspapers on Free Publicity

Dealers themselves are seeing the possibilities in advertising, and this is notably so in connection with the work the Brunswick interests in Cleveland are doing for Brunswick dealers. In connection with the campaign on personal appearances of artists, newspapers in the different cities have been induced to run in their news columns material on the concerts. With few exceptions, according to L. S. McLeod, branch manager, newspapers have responded and dealers, in turn, have returned the favor by taking paid advertising space. Without exception all dealers can trace new business, and increased business from old clients, as a result of this publicity. The move, in the opinion of Mr. McLeod, is proof that newspapers can come to recognize the material that the dealer sells as music, rather than merely merchandise.

Edison Dealers Getting the Business

The sales contest which is being conducted by the Phonograph Co., Edison distributor, with offices in this city and Cincinnati, to date has been productive of much business for those dealers who are participating, and this means practically every Edison dealer served by the Phonograph Co. Points are awarded to contestants on the basis of sales, and the dealers have been placed in classes according to the populations of the communities which they serve. As a result of the contest the energies of the dealers have been stimulated to such an extent that most of them enter the Fall season with better sales totals than was the case a year ago and, from all indications, this year will be a banner one.

Schafer Handles Columbia

Additions to the Columbia family include the new establishment of the Schafer Music House, at Batavia, N. Y., and Giba's Variety Store, at Toledo, both handsome stores.

Makes Dollar Day Pay

It may be that some dealers take advantage of jobbers' suggestions more consistently than others, but the experience of Johnston's Music House, with two stores in Detroit, as told by H. C. Schultz, Detroit representative of Columbia, is an apt illustration. At Ferndale, Detroit suburb, merchants decided to put on a Dollar Day. Johnston's spotted an empty store near the center of town, filled it up with records, machines, sheet music and the like, hired musicians in attractive costume, imported some of the music publishers' song pluggers and, in fact,

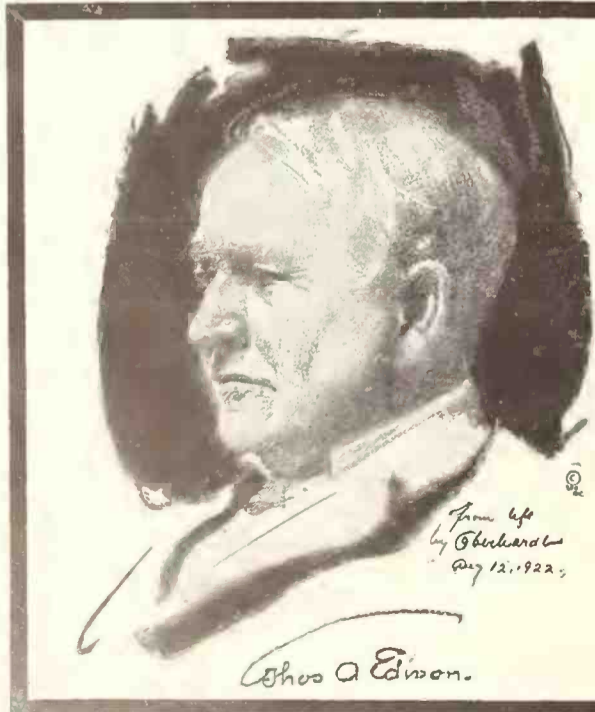

Become the Leading Music House

of your community by adding The New Edison to your business.

The New Edison adds PRESTIGE and PROFITS: both are essential for success.

Edison is First in Quality, Cabinets and Late Hits. (New records are issued weekly.)

Already a machine shortage is forecasted for the coming season and it appears that we will be unable to accept new accounts after October 15th, being forced to conserve our stock for established dealers. Write or wire us at once for information.

THE PHONOGRAPH COMPANY

Exclusive Edison Distributors

Cincinnati, Ohio:
314 West Fourth St.

Cleveland, Ohio:
1240 Huron Rd.

The Big Comedy Song Sensation
CUT YOURSELF A PIECE OF CAKE

And Make Yourself at Home

"You can't go wrong
 With any FEIST song"

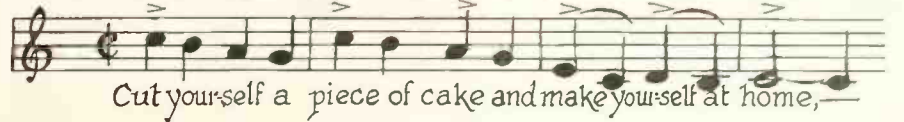

©LEO.FEIST Inc.
 N.Y.C.

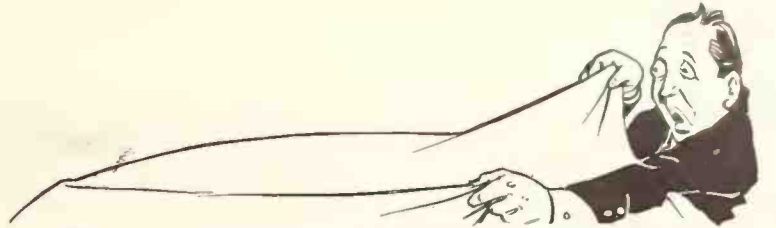

conducted a jamboree of music for one day. This particular part of the festivities was a center of attraction through the day, many machines were sold, many more records and sheet music copies were disposed of, and the whole affair proved lasting in publicity effect, as a considerable volume of new business at home has proved since.

Eagerly Awaits New Red Seals

Double-facing of Red Seal records by the Victor interests is one of the best gains for business and for better music, in the opinion of W. D. Sayle, executive of the Cleveland Talking Machine Co. Long before these records were ready for delivery, later in September, many dealers had anticipated their requirements and had impressed the value of the new records upon their clientele, according to Mr. Sayle. Victor jobbers here have consistently advocated better music as a powerful force in the perpetuation of the talking machine industry and this move is a step in that direction, dealers now realize.

C. L. Marshall Co. Adds to Staff

The C. L. Marshall Co., of this city, distributor of the Pooley and Outing phonographs and Vocalion Red records, is leaving nothing undone to prepare for a banner Fall trade. The company recently added to its sales staff Clair Osterling, formerly associated with the Stradivara Co., who will cover northern Ohio, and W. C. Bickham, previously connected with the Capitol Music Co., of Columbus, who will cover southern Ohio and Kentucky. Among the new Pooley accounts opened recently were F. H. Frazelle, Toledo, O.; A. E. Coen Furniture Co., of Bowling Green, Ky., and the Baker Music Co., Marion, O. The prospects are splendid for future business and the August sales totals for the Vocalion record department showed a substantial increase. C. L. Marshall, head of the company, returned recently from his "last" fishing trip of the season, during which he demonstrated conclusively his ability as a fisherman.

Many New Sonora Franchises

Among the more recent additions of new dealers to the fold in and near Cleveland are included many who have joined with Sonora. These are the Madison Music Shoppe, Lakewood; Boyer & Smith Music Shop, Lancaster; George T. Peters, Ashville, and the Ober Furniture Co., Chagrin Falls. These have been added during the recent trips of J. L. Du Breuil, sales manager, and Carl E. Kraner, southern Ohio representative.

Meanwhile some of the new period models of Sonora, which have been promised from the Saginaw factory, have reached Cleveland and literature on these will be distributed immediately.

Billboards Prove Good Advertising

Billboards as productive of new business have proved immediately successful, according to information gathered by J. T. Pringle, general manager, the Sonora Phonograph Ohio Co., from the Loewer Co., Columbus. This firm started some time back with one or two boards

as an experiment. Now these are placed at all important points in and near the city, each of them painted and carrying a reproduction of some Sonora model.

Late President's Records in Demand

Now that he is gone the words of the late President Harding are cherished more than ever and this seems proved by the large number of records made by him, which include the speech on patriotism and "Lead, Kindly Light," which were produced by Columbia. During the period of mourning and since many dealers have disposed of large quantities of these records and have used window displays with Mr. Harding's picture, flags and mourning material.

Bessie Smith selections are selling stronger than ever, according to the Frey-Magnon Co., live Columbia dealer in Ybor City, Fla. Mr. Magnon has distributed several thousand fliers recently, listing all of Bessie Smith's selections.

EDISON RECORDING STAFF BUSY

Following a week's vacation the recording staff of Thos. A. Edison, Inc., has resumed operations. Some of the most recent recordings made for early release include several by Charles Matson's Creole Serenaders for the Edison race record catalog. There are also a number of new recordings by Willie Creager's Dance Orchestra and Kaplan's Melodists, two popular aggregations of artists.

MAKES EDISON SALES AT FAIR

BURLINGTON, IA., September 7.—At the Tri-State Fair held in this city the early part of August a very successful exhibit was made by the Paule Jewelry Co., Edison dealer. Practically every one of the instruments included in the display was sold at the Fair, which is not a common occurrence at events of this character.



Caveat Emptor

Is no longer the cry

When the Roman Empire had reached the pinnacle of political achievement, its commercial structure fell for lack of business confidence.

Caveat Emptor (Let the buyer beware) was the cry of the multitude. But in those days the public had nothing by which to measure the value of goods or the integrity of the maker.

The harp was the most commonly known instrument, but there were hundreds of different harps sold at what price could be got. What the harp was to the Romans the Victrola is to America today. *Caveat Emptor* is no longer the cry. The Victrola is the gold standard of value in musical instruments. That is why the business of Victor dealers remains more steadfast through temporary periods of fluctuation.

Music merchants in Northern Ohio who are enjoying Victor business also know what it means to have 24-hour Eclipse Service. Are you one of them?

THE ECLIPSE  **MUSICAL** ©
 VICTOR WHOLESALERS CLEVELAND OHIO



Tell me a story, Tell me what you're al - - ways dream - - - ing;

Tell Me A Story

Light, Tuneful and Original Fox Trot

You can't go wrong with any FEIST song



INDIANAPOLIS

Dealers and Jobbers Report Satisfactory Sales—A. C. Hawkins Tenders Resignation—Many New Agencies Established—The News

INDIANAPOLIS, IND., September 6.—F. X. Donovan, manager of the talking machine department of the Pearson Piano Co., which handles Cheney, Victor and Vocalion machines, has just returned from the Cheney factory at Grand Rapids, Mich. The Cheney console is going well in local trade and is proving a popular type. This company is featuring a special sale of used instruments which has proved a stimulant to business. R. W. Shufflebarger has been added to the sales force.

Mr. Friedman, manager of the phonograph department of Charles Mayer & Co., reports an unusual business in Sonora machines for August. Part of this gain is attributed to the newspaper advertising and the feature sale on discontinued models. Ira Williams, Victor dealer of the New York Store, is preparing for a good Fall business. R. R. Follis, manager of the talking machine department of L. S. Ayers, reports a popular demand for Victor consoles. The reduction of price in Red Seal records has resulted in increasing the demand at this store.

C. P. Herderman, Brunswick dealer, reports

that sales for the last six months have shown about a 20 per cent increase over a like period of last year. The Raleigh type of Brunswick has shown the largest sale and is proving so popular that it has been difficult for this store to keep their deliveries up with their sales. The record business at this store has been better than during last August.

A. C. Hawkins, formerly secretary-treasurer and manager of the Indianapolis Talking Machine Co., Victor dealer, has resigned. The vacancy thus created has not yet been filled.

Frederick Pullen, manager of the Phonograph Corp. of Indiana, states that the first week of August showed about 100 per cent increase over any week for the previous three months. New dealers continue to be established, chief among whom are A. C. Stephenson, Jasonville, Ind.; H. T. Walker, Montpelier, Ind.; E. T. Marshall, Martin, Ill.; Buzard Bros., Shelburn, Ind.; F. W. Shrieman, Corydon, Ind.; Mr. Scott, of Haines-Essex, Decatur, Ill., and D. H. Lloyd, Champaign, Ill. Jewell Carmpmill, accountant and office manager, is leaving for Florida the

first of November and Roy S. Carson, it is announced, will fill his place. Joseph Wilson, assistant secretary of Thos. A. Edison, Inc., was a visitor here the latter part of August.

W. H. Meskill, Edison dealer, is well pleased with business in Edison products. His plan has been to make a complete canvass of the homes, gathering data for future as well as present use. He has secured space in the weekly program book of Keith's Vaudeville House and arranged announcements at some of the local motion picture houses. This advertising, he feels, will produce results desired in increasing Edison sales.

John McKenna, manager of the Chicago branch of the Columbia Co. and vice-president of the Piano Club of Chicago, along with A. B. Creal, regional representative, and C. E. Beisel, is covering the Middle Western States, interviewing dealers and displaying the new motor for Columbia machines. They are, likewise, showing all the late Columbia models. The showing was made at a local hotel August 26 to 31. The distinct features of the new motor are the three springs that work independent of each other, enabling the motor to run, although one or two of the springs may be broken; the tone arm and motor constructed all in one piece; the central oiling system from the outside; new reproducing device and automatic start and stop.

The Gennett records have sold well during August, according to T. H. Brackin, local manager of the Starr Piano Co.

One of the busiest wholesale concerns in this territory is the Phonograph Corp. of Indiana, Edison jobber, which has opened many new Edison accounts throughout this territory recently. The growing demand both for instruments and records indicates that dealers are enjoying a prosperous season and general reports from dealers in all sections show that Edison retailers throughout the district are in an optimistic frame of mind concerning Fall prospects for a satisfactory business.

ANNOUNCE NEW EDISON SUPPLEMENTS

The next record supplements to be issued by Thomas A. Edison, Inc., will be changed considerably. The new size will be 3¼ inches by 6¼ inches and, hence, suitable for enclosing in the ordinary size envelopes. It will be printed in two colors on a special glossy stock. The cover page is of a striking sort and bears the title "Edison Recent Record Releases." This new style of supplement will be used hereafter as the standard form.

EDISON ARTIST BACK FROM EUROPE

Albert Spaulding, famous violinist and Edison artist, is expected back from Europe shortly. His forthcoming season will include his thirty-sixth appearance as soloist with the New York Symphony Orchestra.

99+ % Perfect Edison Record Service

*That's the kind of support we are offering
Edison Merchants in this trade territory*



Service that Satisfies!

There are a few open towns in Indiana and Eastern Illinois, where the Edison franchise may be secured by qualified merchants.

Edison Merchants make money—
make money through a continuous
turnover.

Write for details.

Phonograph Corporation of Indiana

325 North Delaware Street

Indianapolis, Indiana

New EMERSON CONSOLES

Supreme Quality at Popular Prices

We present to the trade an entirely new line of "Period" Consoles — Each equipped with the famous straight grained spruce,

Music-Master Amplifier

The Fount of Pure Tone



List \$110
"WAYNE"
Adam design. Brown Mahogany finish. Height 35 inches, width 33 inches, depth 21 inches.



List \$125
"LADY CHURCHILL"
"Queen Anne" Period. Brown Mahogany finish. Height 35 inches, width 33 inches, depth 21 inches.



List \$135
"PIEDMONTE"
Italian Renaissance. Brown Mahogany finish or American Walnut finish. Height 35 inches, width 36 inches, depth 21 inches.

The cross section of the "Music-Master" horn shows how the fibres of spruce lie parallel. Only in this manner can the rich, warm resonance of the famous Stradivarius violin be obtained.

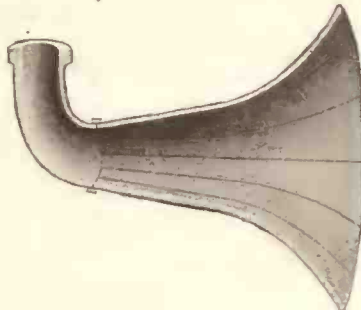

The new improved *Emerson Thrush Throat* tone arm and convenient *throw back* reproducer and numerous other exclusive patented features.

So markedly has the demand for the New Emerson grown that our distribution has *trebled* in the last six months.

Enterprising dealers cannot afford to overlook the extraordinary merchandising possibilities and the greater profits in the New Emerson Console line.

Its remarkable record in sales establishes the Emerson as an unquestionable leader in the phonograph market.

Hear the unexcelled quality of tone. *See* the authentic period design — with their master craftsmanship and beautiful finish, *and be convinced!*

We invite you to participate in our special introductory offer on a get acquainted sample order. Mail coupon.



List \$150
"BLENHEIM"
"Queen Anne" Special. Brown Mahogany or American Walnut finish. Height 35 inches, width 36 inches, depth 21 inches.



List \$175
"BEVERLY"
"William and Mary" design. Brown Mahogany or American Walnut finish, gold trim. Height 35 inches, width 36 inches, depth 21 inches.



List \$200
"ALARIC"
"Gothic" design. Brown Mahogany or Walnut finish, gold trim. Height 40 inches, width 27 inches, depth 22 inches.

WASMUTH-GOODRICH COMPANY

PERU, INDIANA
MANUFACTURERS OF EMERSON PHONOGRAPHS
Eastern States Distributor
Emerson Phonograph Company
105 West 20th Street
NEW YORK, N. Y.
Central States Sales Representative
L. C. SAMUELS
22 Quincy Street
CHICAGO, ILL.
Southern States Sales Representative
L. W. FREEMAN
306 Candler Building
ATLANTA, GA.
Western States Sales Representative
THOMAS W. HINDLEY
New Montgomery and Howard Sts.
SAN FRANCISCO, CAL.

In all the world no console like this — at the price

"BERGUNDY"

"Louis XV" Period. Brown Mahogany or American Walnut finish. Width 40 inches, height 37½ inches, depth 21 inches.



List \$225

WASMUTH-GOODRICH CO.
Peru, Indiana

Gentlemen:
Please send me complete catalog, Special Introductory offer, and discounts.

Name.....
Address.....
City.....
State.....

IN PITTSBURGH

Industrial Prosperity Basis for Optimism Throughout the Local Trade—Dealers Plan for Fall—News and Activities of the Month

PITTSBURGH, PA., September 7.—Talking machine dealers here are unanimous in their expressions that every indication points to a well-defined Fall and holiday business of real magnitude. Naturally this is founded on the excellent industrial conditions that prevail in the Pittsburgh and adjoining districts. In a word, busy mills mean big payrolls, and this is always reflected in brisk business, in which the talking machine trade is bound to share.

Rosenbaum Co. Adds Brunswick

One of the outstanding events of the past few days in talking machine circles here was the announcement by the Rosenbaum Co. of the taking on in its talking machine department of the Brunswick line. Chauncey R. Parsons, manager of the department, stated that the business in the Victor and Sonora lines for the past few weeks had been exceptionally good, and that with the addition of the Brunswick line there was given the buying public a choice of three of the leading talking machines. Mr. Parsons is very optimistic relative to the outlook for the Fall trade, and is making preparations for what he terms a "big business."

Planning Series of Edison Tone-tests

With the usual up-to-date business methods that have always characterized the Buehn Phonograph Co. and made it one of the leading talking machine distributors in western Pennsylvania, announcement had been made of a series of tone-tests to be held in the Pittsburgh Zone by Edison dealers during the early part of October. The artists will be Miss Elizabeth Spencer, vocalist, and Harold Lyman, flutist, with a piano accompanist. A. A. Buehn, treasurer of the Buehn Phonograph Co., stated that advance orders for the Edison line were quite flattering and that he anticipated a highly satisfactory volume of business. A new Edison dealer who will be served by the Buehn Co. is the firm of Buchheit Bros., of Indiana, Pa.

Victor Prospects Very Bright With Mellor

Thomas T. Evans, manager of the wholesale Victor department of the C. C. Mellor Co., before going "down on the farm" for a well-earned vacation, stated to The World representative that he stood "pat" on his previous expressions

relative to an impending shortage of Victor merchandise. Mr. Evans stated that as far as he could ascertain by careful study and investigation in his territory the Victor business will be much greater than ever and that the live Victor dealer who has prepared for the requirements of his community will undoubtedly have a very prosperous Fall and holiday season.

W. C. Dierks, treasurer and general manager of the C. C. Mellor Co., spent several days at Lexington, Ky., at the horse fete.

H. H. Fler, manager of the retail Victor department of the C. C. Mellor Co., is back at his desk after a vacation outing at Lake Chautauqua. Mr. Fler is looking forward to a very good season in Victrolas and Victor records.

Sell "Blossom Time" Records

During the week of September 3 the musical play "Blossom Time," a Franz Schubert interpretation, was given at the Alvin Theatre. Victor talking machine dealers had the Victor records with the music of the operetta on sale.

Says the Tide Has Turned

John Henk, of the Columbia Music Co., Edison and Columbia dealer, reports a brisk trade for the past two weeks and stated that he was sure that a turn in the business channel had come and that from now on there would be a more pronounced demand for the Columbia and Edison lines.

Friends Seeking Newton B. Heims

Friends of Newton B. Heims, formerly engaged in the talking machine trade, with offices in the Jenkins Arcade, are eager to learn of his present whereabouts. Advertisements have been placed in the Pittsburgh newspapers to that effect. He has not been heard from for some time. Mr. Heims was, prior to engaging in business for himself, connected with the W. F. Frederick Piano Co.

Columbia Manager Enthusiastic

S. H. Nichols, the well-known and popular manager of the Pittsburgh branch of the Columbia Graphophone Co., spent several weeks at Battle Creek, Mich., on his vacation. Mr. Nichols is highly pleased with the trend of business in the Columbia line and says that with the new Columbia models and the new process Columbia

records the Columbia dealers will be in a strong position. Mr. Nichols previously had made a trip through West Virginia and found a very optimistic spirit prevailing among the trade.

Harry Goldman, the Columbia dealer in Broughton, Pa., has completed his new Columbia Grafonola Shop—a model of its kind.

Sees Record-breaking Fall

Frank Dorian, of the General Radio Corp., Strand phonograph and Okeh record distributor, as well as dealer in the "Geraco" products, states that the Fall trade was bound to be a record breaker, basing his views on the general line of orders that had been booked.

Columbias in Demonstrating Rooms

The Waterson, Berlin & Snyder Song Shop, on Fifth avenue, has been made more modern by the introduction of the new Columbia automatic stop and start phonographs in its hearing rooms. This feature of the new model will save much time in demonstration.

G. A. Breslin, of Volshon & Breslin, Northside Columbia dealers, has returned from a vacation trip to Lake Erie.

Planning Strong Sonora Campaign

H. Milton Miller, manager of the Sonora Distributing Co., stated that there was every indication that "the Sonora line will be more popular than ever this season." Mr. Miller emphasized the fact that the Sonora dealers are preparing for an intensive campaign for sales, in which they will have the co-operation of the company.

Progress of Starr Products

Paul S. Mechling, sales manager of the Dawson Bros. Piano Co., Starr phonograph and Genett record dealer, stated that the Starr line was meeting with notable success in its introduction into many homes of residents of the Tri-State territory. Mr. Mechling has just returned from a camping trip to Slippery Rock, Pa. C. L. Dawson, president of the firm, spent the Summer in a series of long automobile trips. Mr. Dawson is very fond of automobiling and takes advantage of every fine day that he can leave the office early to "take a spin."

Looks for Active September

R. R. Myers, the manager of the Victor department of Spear & Co., stated that there was a fair volume of business handled during August and that the indications for September were "most flattering." Mr. Myers has a fine and well-equipped department under his direction.

Department Stores Well Prepared

The large department stores such as the Joseph Horne Co., which handles Victor, Sonora, Cheney and Pooley phonographs; Boggs & Buhl, with the Victor, Cheney and Columbia; Kaufmann & Baer Co., with the Victor, Strand and Nightingale, and Kaufmann's with the Victor, are fully equipped for the Fall business. A. R. Meyers, of Horne's; Henry Wood, of Boggs & Buhl; Frank J. Coyne, of Kaufmann & Baer Co., and Mrs. C. H. Walrath, of Kaufmann's, all experts in talking machine salesmanship programs, are convinced that the Fall business will be a highly satisfactory one.

C. C. Latus to Visit Europe

C. C. Latus, Pittsburgh correspondent of The World, and executive secretary of the Piano Merchants' Association of Pittsburgh, sails on September 12 on the steamer Paris of the French Line for a short tour of Europe. He will visit France, Switzerland, Austria, Great Britain, Germany and Holland, and will return to Pittsburgh the last week in October. He will be accompanied by Mrs. Latus.

Good Salesmanship Will Win Out

George H. Rewbridge, the energetic manager of the wholesale Victor department of the W. F. Frederick Piano Co., is very optimistic concerning the Fall and holiday sales of the Victor lines. He said: "There is bound to be an unprecedented sale of Victor talking machines and Victor records this Fall, due to the fact that the Victor retail dealers are keenly alive to the possibilities of up-to-date salesmanship when properly exploited in talking machine circles."

George S. Hards, the well-known Victor dealer of Dormont, a suburb of Pittsburgh, reports the outlook good for the Fall season.



As the stamp "sterling" is to silver, so is the name of EDISON to the Phonograph—a mark of highest quality.

New models attractively priced, make the Edison franchise more desirable than ever.

BUEHN PHONOGRAPH CO.

EDISON DISTRIBUTORS

421 SEVENTH AVE.

PITTSBURGH

New Edison Records Every Week

KIRALY VISITS COLUMBIA OFFICES

Famous Hungarian Baritone and Exclusive Columbia Artist Now on Concert Tour—Will Make Columbia Records Here

A recent visitor to the executive offices of the Columbia Graphophone Co. of New York was Ernest Kiraly, the famous Hungarian baritone, who arrived in this country a short while ago to fill a twelve weeks' engagement on the concert stage. Mr. Kiraly, who is a resident of Budapest, has been making records for the Columbia Co. for the past twelve years, recording all of his numbers at the Columbia laboratories in Vienna. He is recognized as one of the fore-



Ernest Kiraly

most interpreters of Hungarian folk songs and is popular throughout Europe.

During his visit to the Columbia offices Mr. Kiraly expressed his keen appreciation of the tone quality and smooth surface of the New Process Columbia records, and was so interested in this product that he arranged to make a series of records in New York. While here Mr. Kiraly emphasized the fact that he has confined his recording activities to the Columbia Co. exclusively during his entire experience. He stated that during the war some of his records had reached outside channels, owing to the automatic suspension of his contract and the consequent distribution of his records as a subject of free trading.

In an official statement issued to the Hungarian newspapers recently Mr. Kiraly advised the public that he had never made anything but Columbia records and was working under an exclusive Columbia contract. Simultaneously with his present concert tour the Columbia Co. has received twelve of Mr. Kiraly's recordings from Vienna, which will be released in the near future.

THOS. F. GREEN RETURNS TO DESK

President of Silas E. Pearsall Co. Recovers From Recent Illness—Welcomes Brother After Latter's Trip Abroad

The many friends in the trade of Thomas F. Green, president of the Silas E. Pearsall Co., Victor wholesaler, will be glad to know that this popular Victor executive is back at his desk after an extended illness. For the time being Mr. Green is "taking it easy," but he is fast regaining his usual health and vigor. A few days ago Mr. Green and the members of his family welcomed Mr. Green's brother, Milton C., who returned on the "Berengaria," after a trip abroad. Included in his luggage was a police dog which is now the center of attraction for the Green youngsters at their beautiful home in Great Neck, L. I.

W. D. WILEY'S WORK FOR MUSIC

ANNA, ILL., September 1.—Union County, Ill., has been much interested in music appreciation work for several years. For the fourth time in as many years a place on the program of the Union County Teachers' Institute was given to a Victor representative. Miss Golda Airy, of the educational department of the Koerber-Brenner Co., was in charge of the singing this year and gave two demonstrations each day of the teaching of music appreciation.

The Institute was held in Anna, Ill., August 21-24. W. D. Wiley is the Victor dealer in Anna and he had an extensive exhibit of Victrolas and Victor literature, as well as of school supplies, which he handles.

Mr. Wiley has used recently, with success, mimeographed copies of post-cards bearing news of new records. "Baby Sister Blues" was the occasion for a card which had the distinction of being illustrated by the famous cartoonist, Willard, of Chicago, who was visiting in his home town, Anna, opportunely.

ANOTHER OKEH WEDDING

The office staff of the General Phonograph Corp., 25 West Forty-fifth street, New York, lost one of its veterans this week when Miss Elsa Schumaker resigned as a member of the organization to prepare for her marriage to Richard Wilemborg. Miss Schumaker, who has been secretary to W. G. Pilgrim, treasurer of the organization for the past few years, joined the General Phonograph Corp.'s staff in 1915, and since that time has been one of the most popular and efficient members of the organization. She leaves with the good wishes of her co-workers, who joined in giving her a testimonial luncheon.



**PLAYS EDISON RECORDS
The "VICSONIA"
REPRODUCER**

Truly a Reproducer that will please the most cultured musician and discriminating critics. For over nine years the recognized medium for playing EDISON Records on VICTOR and COLUMBIA Machines.

Made in Silver and Gold. Fitted with Sapphire or Diamond Point. One Silver, Sapphire Point Reproducer Sent on Receipt of \$4.50.

VICSONIA MFG. CO.
INCORPORATED
313 East 134th Street NEW YORK



No. 35769/11

Areca Plant, natural prepared, 36 inches high, with 11 leaves and pot, complete \$3.50 each, per dozen \$35.00.

Our Fall Catalogue No. 35, with illustrations in colors of Artificial Flowers, Plants, Vines, Trees, etc., Mailed Free for the Asking.

FRANK NETSCHERT, Inc.
61 BARCLAY ST. NEW YORK, N. Y.

**REGAL
50c
RECORDS**

Certainly, it pays to sell the REGAL 50c record—

You know that thousands of good customers are actually side-stepping the store that does not handle the good 50c record—

You know that the REGAL 50c record has come to stay—that it will continue to thoroughly satisfy the public and give profit to the dealer—

Why don't you write for this highly profitable proposition? Get the facts. TODAY is the best time!

REGAL RECORD CO.
20 W. 20th ST. NEW YORK

TOLEDO

Jobbers Rushed as Dealers Prepare for Big Fall Trade—Optimism Grows With Sales—The News

TOLEDO, O., September 6.—With the advent of September, dealers are turning their attention to putting over a record Fall talking machine volume. Summer sales have eclipsed the showing of any similar season within the past three years. Therefore, merchants are highly optimistic about the immediate future. Moreover, local retailers realize that a shortage of new console models is very probable, and many are placing orders for a sufficient number of machines to take care of Autumn needs.

The Toledo Talking Machine Co., Victor jobber, is swamped with orders for the new consoles as well as Red Seal records. Retailers are using this record shift as a talking point and

urge customers to buy at what is termed a reduction in price. The weekly Victor record release, which will become effective the 21st, will have the hearty co-operation of dealers. Several are already planning to employ unusual display schemes in connection with the records announced for release on that day.

Trade during August, Chas. H. Womeldorff states, was good—recording another increase. The September outlook is bright and this month will be one of the biggest months of the year. Wm. B. Gannon, Michigan representative of the house, and family are motoring in the East. A. S. Leybourne, office manager, and family motored to Niagara Falls. Chas. H. Womeldorff motored to Middleport, O., for a visit with his mother.

At the J. W. Greene Co. sales continue to grow. On a recent Saturday the listening booth capacity of the department overflowed into the sales and office sections.

A direct-mail letter campaign was launched the first of the month, inviting patrons to come and listen to the better records, including Red

Seal releases. Considerable business resulted. The record approval plan which is operated on a wide scale here has been changed to the extent that customers using this service must now return all records not retained to the store within twenty-four hours. Cheney, Brunswick and Victrola rooms are nearing completion for the store opening, which will be an event of September. Pratt Egbert, well-known talking machine salesman, has joined the J. W. Greene sales force. Kenneth Kneisel will manage the new small goods department which will be opened this Fall.

Grinnell Bros. experienced a splendid August volume. Models 400 and 405 Victrolas sold more rapidly than they could be supplied. Orders are already booked for holiday delivery. The house is experiencing a shortage of many Red Seal records. The twenty-three Grinnell stores throughout Ohio, Indiana and Michigan are closing a volume which exceeds that of a year ago.

At the Lion Store Music Rooms, Fall trade has opened in earnest. The sales increase here is a large one. At the present time there are six more sales ladies employed in the department than there were last year at this time. Four girls were added the past week, A. J. Pete states. Six new demonstration booths will be added during the month and a new rapid-service elevator which will discharge and take on passengers in the department is a new service feature. John Croxton, son of Frank Croxton, of the Eight Victor Artists, has been named assistant manager of the department.

Frank H. Frazelle Piano Co., through its outside force, is bringing to the notice of prospects the Canterbury and Kenilworth Sonora models. Also the latest Vocalion phonograph.

The Goosman Piano Co. is achieving fine results with the 50 per cent record stock-buying plan. That is, next week's buying will be one-half of this week's sales. Through the system stocks are always fresh. Records are not regarded as hits, but as numbers to be sold. Hits usually last about three weeks and often leave many unsold numbers. The plan increases turnover and keeps stock assortments complete, according to Miss Grace Greenman.

Fred N. Goosman will attend the convention of the Ohio Music Merchants' Association at Cincinnati, O., September 10.

The Whitney-Blaine-Wilderdmuth Co. is centering efforts upon the 400, 405 and 410 Victrolas. The drive marks the beginning of a Fall campaign which has for its aim the building of a clientele among the middle-class buyers. The Zenith radio outfit is dealt in here. After cooler weather comes demonstrations will be carried on. David Blaine, president, and Henry Wilderdmuth, treasurer, have reservations at the Hotel Gibson, Cincinnati, for the Ohio convention.

The Cable Company has adopted the plan of featuring a new record every other day with good results. Victors, Brunswicks and Columbias are featured. Window displays match the newspaper and store announcements of records and machines, thus tying the three into one great business-building force. P. F. Thomas and Howard Roth, salesmen, are vacationing in northern Michigan.

H. G. Pulfrey, formerly of the Cable Company, Toledo, but now manager of the University Music Co., Ann Arbor, Mich., is moving his family to that city.

F. Q. Edwards, manager of the La Salle & Koch Co., is vacationing on Thunder Bay, Wis.

Rae's Record Shop, Vocalion and Columbia dealer, has inaugurated a Fall sales drive.

The Da-Lite-Electric Display Co., 116 North Erie street, starting September 21, will issue a panel a week to its service customers. This is to conform to the Victor record release. Merchants hereafter will receive fifty-two panels a year. Moreover, twelve Red Seal panels will be issued to the Victor trade October 1 as a special service to Victor dealers who desire to push records of better music.

Henry Wasserman, of the United Music Co., is convalescing at Mount Clemens, Mich., after a severe sick spell.



Another Use For Loud Speaker

When the static is too great for radio reception your AUDIOPHONE Loud Speaker can be used with the Bristol Phonograph Record Reproducer on your phonograph. Then you may have concert or dance program without interruption.

Attached instantly without mutilating the instrument in any way—the Bristol Phonograph Record Reproducer can be used with any make of phonograph.

Equipped with such an outfit there are no disappointments—it is always ready—never fails. For dance music you have the equivalent of an orchestra, but without the expense.

The tone of the phonograph thus amplified thru the AUDIOPHONE has volume enough to fill large rooms and the quality is round—smooth—and beautiful—entirely free from mechanical noises.

Remember that the same AUDIOPHONE Loud Speaker is used in common for both radio reception and phonograph record reproduction.

Write for Bulletin 3007 and we will advise where you may hear a demonstration.



TRADE MARK
AUDIOPHONE
REG. U. S. PAT. OFFICE

THE BRISTOL COMPANY
WATERBURY, CONN.

Branch Offices:

Boston New York Pittsburgh Philadelphia
Detroit Chicago St. Louis San Francisco

Here is the Phonograph Dealer's comeback at Radio. You are the logical distributors for the apparatus. Are you prepared to serve your customers? Many are now handling it. We have representatives in many of the principal cities and would like to come to you with demonstrations.

DOMES of SILENCE
"Better than Casters"

Made under Patent No. 995758 which has been vigorously contested and sustained by the Court of Appeals. Any infringers and those involved in the manufacture, sale or use of same will be liable for prosecution and subsequent damages.

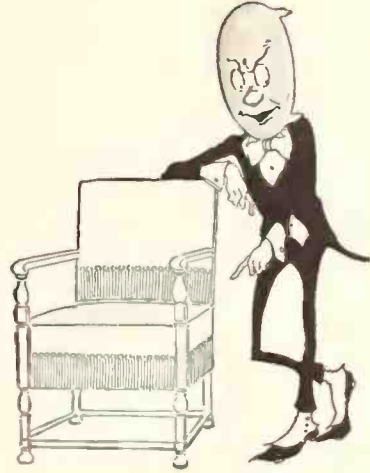

**Furniture Footwear
 Should Serve—But
 Never be Seen**

FOOTWEAR that elevates furniture destroys the beauty of its lines. Better looking furniture always sells easier.

That's why so many successful merchants always show furniture, as originally designed, resting squarely on the floor.

DOMES of SILENCE are invisible permitting furniture to rest squarely on the floor.

Yet they provide easy, silent movement without damage to furniture, floors or floor coverings. Help your dealer customers now by adopting **DOMES of SILENCE** as standard equipment.

DOMES of SILENCE *Division*

Henry W. Peabody & Co.
 17 State Street, New York City



**Economy in
 Manufacture**

If **DOMES of SILENCE** cost more than Casters—if it cost more in labor expense to attach them—there might be reason to hesitate adopting them but they cost less than the cheapest grade of casters. They cost practically nothing in labor and expense to attach. They are better than casters. They add a distinct selling feature to your furniture.

P1096

*What we say above about Furniture applies also
 to Phonographs*

BALTIMORE

Rush of Orders for Fall Stocks Keeping Wholesalers Busy—Columbia Wholesalers, Inc., Elects—News and Activities of Month

BALTIMORE, Md., September 10.—While the retail trade here last month was rather quiet the local jobbers report one of the biggest months in the history of the business. Fall and Winter orders are being placed in much larger numbers than for several years, and ability to fill orders already booked is the principal cause for worry.

August is termed the "vacation month" here, and added to this is the fact that last month was one of the hottest Augusts experienced in many years, which accounts for the dropping off in the retail business. Another reason assigned by a number of dealers is that many of the department stores advertised sales of cut price machines, ranging in price from \$49 up, which also had a tendency to curtail business of the music shops.

Dealers generally, however, are optimistic over the outlook for Fall and Winter trade, and are placing larger orders than has been the rule, since the peak of "wartime prosperity," and, as one retail dealer put it, "every cloud has its silver lining, and the silver lining to the 'bargain sales' held by the department stores last month is that we are beginning to have good results from them in the way of record sales. Since about the middle of August my record sales have almost doubled, and hundreds of new customers have been made for the firm. I also anticipate selling some new machines and never overlook an opportunity to demonstrate the advantage of a standard make machine over those that are manufactured for quick turnovers in the way of 'bargain sales.'"

Report Substantial Increases in Sales

E. F. Droop & Sons, local Victor jobbers, is one of the houses reporting a substantial increase in sales last month, which, according to Manager W. C. Roberts, makes eight consecutive months this year showing an increase over the corresponding periods of last year. "In fact," said Mr. Roberts, "my only anxiety now is, will I be able to supply the orders that we have already booked? This is especially true of the 210's and 80's, on both of which types we have been oversold for nearly a year. These machines are the most popular among our trade, and we have never been able to keep our orders on these two types filled since last October."

Mr. Roberts, who has just returned from a three-weeks' trip to Maine, is very optimistic over the outlook for Fall and Winter, and confidently predicts that he will have no trouble in keeping up his record of each month, beating the corresponding month of last year.

C. F. Shaw, manager of the local Brunswick agency, is another jobber who is very enthusiastic over the business done last month as well as the advance orders booked for Fall and Winter. The agency has been oversold for some time on most of the popular types, especially the York machine, and he looks for even better results on their new console, the Raleigh, the advance orders on which are very satisfactory, according to Mr. Shaw.

These two reports are practically the same as are being made by the other jobbers here, including the Columbia Wholesalers, Inc., distributors of the Columbia machines; Cohen & Hughes, Inc., and Eisenbrandt's, the other two Victor jobbers.

The Voluna Corp., manufacturer of the Voluna reproducer, is preparing to put its new Voluna machine on the market after making a number of improvements in the original model.

Cohen & Hughes' Activities

F. J. Totten, sales manager of the Baltimore and Washington branches of Cohen & Hughes, Inc., has been spending several days a week here, during the absence of T. Ralph Clark, local sales manager, who is away on vacation at Atlantic City and also paying a visit to his

former home in Philadelphia. Mr. Totten said business of both houses was very good and the August business of the Washington branch was the best of any month on record.

Officers of Columbia Wholesalers, Inc.

L. L. Andrews has been elected president of Columbia Wholesalers, Inc., and W. H. Swartz continues as secretary and treasurer. J. H. Swope, vice-president of the Western National Bank, has been elected as a director.

The executives of this institution are immensely pleased over the big increase in business being shown over the same period of the previous year. With only a slight increase in the number of dealers, there has been an average increase for the five months since organization of approximately 200 per cent. This increase applies on both phonographs and records—but especially the latter, as there is a great scarcity of phonographs.

Visitors to Columbia Headquarters

Visitors to the local Columbia branch recently included Messrs. Funkhouser and Minium, of the M. P. Moller Co., Hagerstown, Md.; C. F. Rotering, of Emmitsburg, Md.; L. M. Harrell, Jr., of Portsmouth, Va.; Fred Y. Mills, of Hagerstown, Md.; Morris Baron, of the Shecter Music Co., Cumberland, Md.; Mr. Medaniels, of Adkins & Co., Lynehburg, Va.; M. Philips, of Washington, D. C., and Sol. Friedberg, of the Grafonola Shop, Norfolk, Va.

Wm. Biel Returns From Europe

Wm. Biel, secretary of Cohen & Hughes, Inc., Victor distributor of this city, accompanied by Mrs. Biel, arrived home on the Aquitania on September 6. Mr. and Mrs. Biel spent an enjoyable time visiting the many points of interest in England, Ireland, Scotland and France.

I. Son Cohen, president of the company, in speaking of the Fall outlook, bespoke the co-operation of the dealer in the early ordering and acceptance of merchandise, and in return pledged every facility of his firm in the delivery of goods throughout the busy month ahead to the best of their ability.

Equip New Brunswick Display Rooms

Manager C. F. Shaw, of the local Brunswick headquarters, has made many improvements in the way of new display rooms for machines and records as well as enlarging the office in order to meet the demands of the growing business of the branch, which has almost doubled in the past year. Mr. Shaw reports excellent results from the dealers' co-operative advertising campaign which the Brunswick is putting on throughout the country, Harry C. Grove and Chas. Schwartz & Sons, both of Washington, being two of the latest of the larger dealers in this territory to sign up.

The opening of the Hagerstown Brunswick Music Shop on the first of the month was one of the events of the town, according to E. Wallerstein, Hagerstown representative, who assisted in the opening of the handsome new store at 14 East Washington street, of which Dever P. Stewart is the proprietor.

H. H. Sheldon, assistant manager of the Brunswick agency is back on the job again after paying a visit to his old home in St. Louis.

Mrs. Haenle, of the New York branch of the Brunswick, is making a trip through the local territory giving sales lectures in the Brunswick stores in all the principal cities.

Pathé Agency With A. L. Rose & Co.

A. L. Rose & Co., who have taken over the Pathé agency here for both machines and records, report very good results from a corner store sale of cabinets, which they have placed in a number of stores throughout the city. The cabinets hold 12 records and are changed or replenished each week. They installed one of

their electric machines at a carnival for the benefit of a local hospital last week and supplied dance music for a large crowd.

The Hammann-Levin Co. reports excellent results during the past month from a feature sale of Carola portable machines.

H. Kippnes, local distributor of the Phonolamp, contemplates moving from his present location at 105 North Eutaw street and will probably locate in the shopping district.

Files Articles of Incorporation

The Record Distributing Co., Inc., 2227 Pennsylvania avenue, has filed articles of incorporation with the State Tax Commission. The company is capitalized at \$10,000 and is authorized to manufacture and deal in phonographs and records, etc. The incorporators are Jacob L. Rose, Frank C. Cozzens and Arthur L. Rose.

New Columbia Dealers

New Columbia dealers in the Baltimore territory include Barker Bros., Greensboro, N. C.; Tipton Furniture Co., Hickory, N. C.; Weinberg's Department Store, Lexington, Va.; F. B. Hammann Co., this city; Weaver Piano Co.; A. S. Cross, Baltimore, Md.; C. L. Totten, Saltville, Va.; Oakland Hardware & Furniture Co., Oakland, Md.; G. S. Tucker Co., Selma, Clayton and Raleigh, N. C.

A. S. Cross, former Columbia employe, has just opened a very attractive exclusive Columbia store on Patterson Park avenue, under the name Patterson Music Shop.

Sanders & Stayman are featuring a sale of Vocalions at \$100 which is meeting with big success, according to Manager Turlington.

J. H. Williams, who recently bought the store of the C. B. Noon Co., Inc., will discontinue the talking machine line after disposing of the stock on hand.

A good advertising stunt featuring—"Yes! We Have No Bananas" was used by Trout's Music Shop, this city. Mr. Trout strung about fifteen bunches of bananas in front of his store, and then gave one banana away with every record.

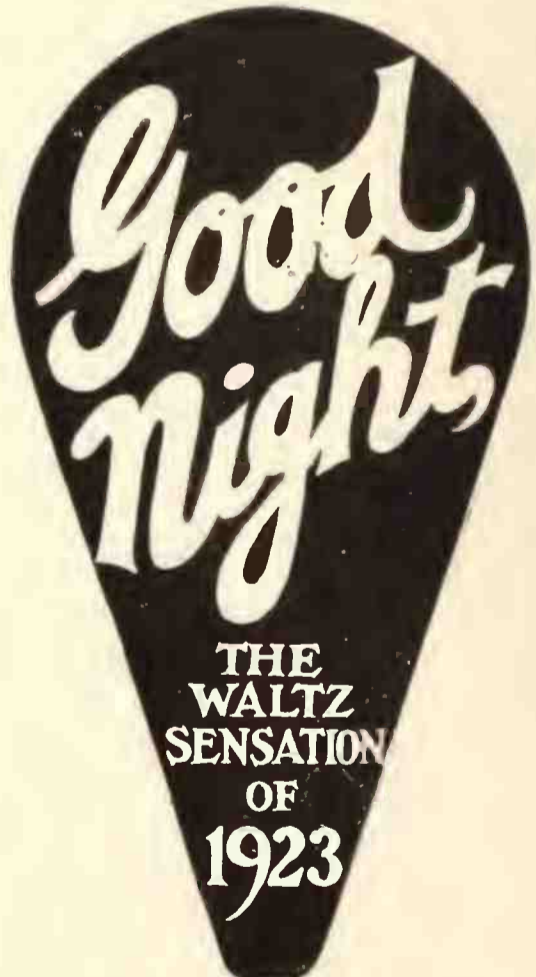



“Being there” when wanted is another attribute of Cohen & Hughes service. It is not thrust unwillingly on the retailer, but is ready at all times when and as needed.

Cohen and Hughes, Inc.
 Baltimore, Md. VICTOR DISTRIBUTORS Washington, D. C.

"TIE UP WITH A WINNER!"

The NEW EDISON Phonograph

Is Acknowledged "THE DADDY OF THEM ALL"

THE LIVE DEALER

Can take advantage of this public confidence by tying up with an agency for the New Edison Phonograph.

"YOUR MIND IS AT REST WHEN YOU SELL THE BEST"



1114
Olive
Street

Write for the LIBERAL Edison Agency Proposition for Your Town

Southwestern

EDISON DISTRIBUTOR

St. Louis, Mo.

S A I N T L O U I S

Upright Instruments Stage Comeback—Showing Special Machines for Demonstration Purposes—News and Activities of the Month

St. Louis, Mo., September 6.—The seasonal pick-up in the talking machine business, scheduled for this month, arrived ahead of time, getting nicely under way in the latter part of August. The only trouble was that it caught distributors, in some instances, not fully prepared, and dealers have not been able to get all the models desired. The early start and the momentum that has been gained are interpreted as assurance of big business this Fall. Business was unexpectedly good throughout the entire month, both retail and wholesale, in city and country, and this condition still continues. The demand for machines has now definitely changed complexion from the cheaper machines for casual Summer use to the better qualities required for the home. It is a matter of comment in some quarters that there is a noticeable comeback of interest in the conventional models, in grades running over \$200. Consoles, however, are still strong. In records jazz has had its swing during the Summer, but now there is an increasing call for the records of vocal and instrumental music of the better quality. This is a significant sign and bespeaks

an increasing trade in this type of record during the Fall and Winter months.

New Brunswick Demonstration Machines

The local branch of the Brunswick Co. is getting ready to supply dealers with demonstration uprights to harmonize with fixtures—an ivory machine for an ivory booth, a mahogany machine for a mahogany booth, and so on. Seven enamels are to be supplied. The idea is to put an end to demonstrating machines that clash with the surroundings. The first machine, now on exhibition here, is finished in ivory. Style 117 is to be used for all the special demonstrating machines.

Fay-Buchanan Music Co. Enlarges

The Fay-Buchanan Music Co., recently incorporated, has taken over the St. Louis branch of the Connorized Music Roll Co. at Thirteenth and Olive streets. The new company will continue to distribute the Starr phonographs and Gennett records. E. E. Fay, formerly manager of the branch, is vice-president and treasurer of the new firm. L. S. Buchanan, who is associated with him, was at one time connected with the

Bollman Bros. Piano Co. Latterly he has been in the real estate business.

Traces Record Sales to Opera

The successful season of Municipal Opera at Forest Park stimulated sales of light opera records. The Koerber-Brenner Music Co. traced definitely to opera influences sales of 319 "Naughty Marietta," 231 "Prince of Pilsen," 149 "Sweethearts," 293 "Merry Widow" and 143 "Spring Maid" records.

Edwin Schiele Home From Europe

Edwin Schiele, president of the Artophone Corp., and his wife, have returned from a trip to Europe. During their absence the company's place of business at 1103 Olive street was destroyed by fire. Plans are being worked out at the temporary location on Pine street, where dealers' needs are being fully looked after, for a permanent resumption, but these have not been fully completed.

New Edison Agencies

New Edison agencies have been established by the Silverstone Music Co. as follows: At Little Rock, Ark., Bowser Music Co., which has been handling the Columbia; Pine Bluff, Ark., Tedstrom Furniture Co.; Fordyce, Ark., Benton Furniture Co., which is new in the talking machine business. The accounts were obtained by G. Manne, who has just returned from a successful Southern trip.

Mark Silverstone, president of the Silverstone Music Co., Edison distributor, has been invited by Thomas A. Edison to a personal conference, and will leave soon for Orange, N. J. Myron Goldberg, vice-president of the Silverstone Music Co., has returned from an automobile tour to Atlantic City and through Canada. He was gone a month.

O. A. Reynolds, Illinois traveler for the Silverstone Music Co., has been kept at his home in Springfield, Ill., the past month on account of the illness of his wife. Paul Gold, retail manager of the Silverstone Music Co., has gone to Memphis, Tenn., on a two weeks' vacation. Miss Vivian Dewes, of the company, has returned from a vacation in the Missouri Ozarks.

News Gleanings

H. J. Arbuckle, manager of Widener's, has returned from an automobile tour to Chicago and Milwaukee and through Michigan.

R. V. Salzmann, Vocalion district manager, with headquarters in Chicago, was here two weeks in August looking over the St. Louis territory, opening new accounts and getting better acquainted with the dealers.

Miss Dorothy Howard, of the Vocalion record department of the Aeolian Co., is away on a vacation trip.

E. E. Fay, vice-president of the Fay-Buchanan Music Co., has returned from a motor trip to Chicago and the lakes, accompanied by his wife and baby.

W. P. Geissler, manager of the Famous & Barr Co. talking machine department, has returned from Chicago, where he placed large orders for Fall deliveries. T. N. McLemore, for-

THE Artophone CORPORATION

Complete stock of all

OKEH and ODEON Records

The OKEH policy of "Hit numbers when they are Hits" is a tremendous advantage to the dealer. There are still some very valuable OKEH agencies open. WRITE FOR FULL PARTICULARS.

THE Artophone CORPORATION

1213-15 Pine Street

St. Louis, Mo.

203-5-7 Kansas City Life Bldg., Kansas City, Mo.

Complete stock of all phonograph accessories and supplies

merly of the Roach Furniture Co. and the O. K. Houck Piano Co., Memphis, Tenn., has joined Mr. Geissler's organization.

Geo. W. Lyle, of the Manufacturers' Phonograph Co., was in St. Louis the first of the month, conferring with the Artophone officials about plans for the future.

The first shipment of the Raleigh, new Brunswick model, to be sold at \$200, has been received in St. Louis and is making a good impression.

F. S. Horning, manager of the Stix, Baer & Fuller talking machine department, has returned from an automobile trip through Missouri, Illinois and Iowa.

George F. Standke, manager of the Kieselhorst Piano Co.'s talking machine department, went to Clinton County, Mo., to spend Labor Day on his father's farm.

Baldwin Co. Moves "Talker" Stock

The Baldwin Co., in order to provide show space for grand pianos, has removed the talking machine booths from the west side of its main storeroom, concentrating the machines and demonstration booths on the east side.

Miss Lipscomb in New Post

Miss Aurelia Lipscomb, formerly with the Scruggs-Vandervoort-Barney Victrola department, is now with the Smith-Reis Piano Co., replacing Miss Marian Cartwright, who has returned to Kieselhorst's.

Demonstrates Victor on Vacation

Miss Wallie Griesedieck, formerly of Kieselhorst Piano Co., now at Vandervoort's, spent a long and delightful vacation at Pippin Place in the Ozarks. Miss Griesedieck has been assisting Mrs. Hill, secretary, in arranging evening entertainment for the guests. Among other pleasant evenings, Miss Griesedieck gave a Victrola concert with the Victor records on hand, showing the guests many things about the compositions which they never noticed before, drawing upon her experience before audiences in St. Louis.

Koerber-Brenner Visitors

J. W. Strain, of Carrollton, Ill., and Mr. and Mrs. Parrish, of Metropolis, Ill., Victor dealers, called recently at the Koerber-Brenner offices.

ARTHUR BERGH JOINS OKEH STAFF

Well-known Recording Director Appointed General Manager of Okeh Recording Laboratories—Ideally Qualified for Important Post—Is an Accomplished Musician and Pioneer

Otto Heineman, founder and president of the General Phonograph Corp., New York, manufacturer of Okeh and Odeon records, announced this week the appointment of Arthur Bergh as general manager of the company's recording laboratories at 145 West Forty-fifth street, New York, succeeding Fred W. Hager, who had resigned from the company's service. The appointment of Mr. Bergh to this important position will be welcome news to Okeh jobbers and dealers everywhere, as he is recognized throughout the industry as one of the foremost members of the recording and musical worlds.



Arthur Bergh

A pioneer in the record industry, Mr. Bergh was for a number of years general manager of several prominent recording laboratories, and in that position furnished the trade with the latest hits with maximum efficiency and rapidity. In recent years he has been engaged in research work in the recording field, and has also spent some time abroad investigating conditions in Europe.

In addition to possessing an intimate knowledge of the technical phases of the recording laboratory, Mr. Bergh is a musician of exceptional ability and noteworthy accomplishment. In fact, his unusual musical knowledge has been a paramount factor in his success as a recording director, and he brings to the General Phonograph Corp. an invaluable experience that will be placed at the disposal of the Okeh

clientele. Incidentally Mr. Bergh is popular throughout the music publishing industry, numbering among his personal friends the foremost members of the publishing fraternity.

Chas. L. Hibbard, technical chief of the Okeh recording laboratory and one of the pioneers in the industry, will remain in his present position with increased activities and responsibilities. Mr. Hibbard is well known throughout the talking machine trade, and he has contributed materially to the success of Okeh records. According to present plans there will be no other changes in the personnel of the Okeh recording division.

INTRODUCES THE "MAGIC-TONE"

Burton Collver Heads Company Distributing New Tone Controlling Device—Dealer Representation Now Being Secured

Burton Collver, well known in the music industry as a sales executive and more recently identified with the radio field, is now president of the Magic-Tone Sales Co., New York, N. Y., which is the sole distributor of a new device known as the "Magic Tone." The basic principle of the Magic-Tone, which is attached to the stylus bar of the reproducer, is to function as a mute, thereby modifying loud tones and absorbing a large percentage of surface noises. In his sales literature Mr. Collver states that the Magic-Tone entirely eliminates metallic harshness and, by varying the position of the device on the stylus bar, soft, medium and loud tones may be obtained.

In order to co-operate with the dealers the Magic-Tone Sales Co. has prepared an attractive counter display stand which serves as a silent salesman and, under Mr. Collver's direction, literature for mailing purposes is also ready for the use of the dealers. The first Magic-Tones were displayed in New York during July and August and the results of the tests proved so satisfactory that dealer representation on a large scale has already been secured.

TO OUR DEALERS.

It is our business to better your business. With this ambition ever and always in mind, Dealers have come to know and depend upon the merits and advantages of our

DE LUXE NEEDLES

(Best By Every Practical Test)

DUO-TONE COMPANY, INCORPORATED

Sole Manufacturers of De Luxe Needles
ANSONIA, CONN.



Full Tone

DON'T FORGET THESE FACTS
Perfect Reproduction of Tone No Scratchy Surface Noise
PLAYS 100-200 RECORDS



Medium Tone

Three for 30 cents (40 cents in Canada)
LIBERAL TRADE DISCOUNTS

The CORNELL COLLEGE SONG HIT
LAST NIGHT ON THE BACK PORCH
(I LOVED HER - BEST OF ALL)

by LEW BROWN and
CARL SCHRAUBSTADER

ORCH. BY
LEE TERRY



A
SINGING
FOX TROT



I'VE
GOT
THE
YES
WE
HAVE
NO
BANANA
BLUES

MISSISSIPPI RIPPLES

Waltz
by JAMES F. HANLEY
and MARY EARL
REG. U.S. PAT. OFF.



ARRANGEMENT BY
LEE TERRY



I'VE GOT THE YES WE HAVE NO
Banana Blues

I'VE GOT THE YES WE HAVE NO
Banana Blues

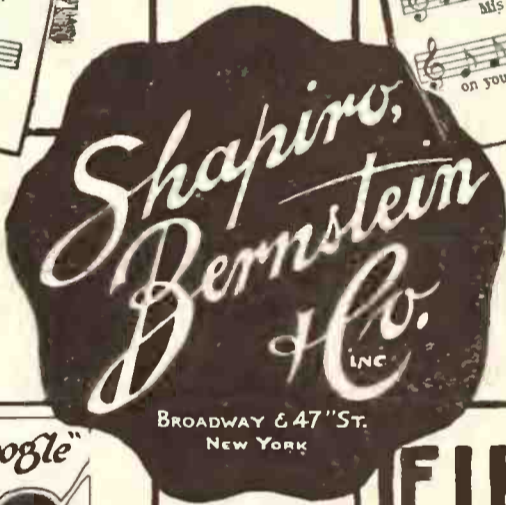

BROADWAY & 47th ST.
NEW YORK

By the Writer of "Barney Google"

CON CONRAD
FOX -
TROT



ORCH BY
LEE TERRY



I'VE
GOT
THE
YES
WE
HAVE
NO
BANANA
BLUES

**IF I KNEW YOU THEN
AS I KNOW YOU NOW**

By LEW BROWN
BILLY JOYCE &
JAMES F. HANLEY



GLEANINGS *from the* WORLD *of* MUSIC

BASES FOR OPTIMISM OVER THE DEMAND IN THE FALL

Publishers Just Completing One of the Most Active Summer Seasons in Their History—Merit of New Numbers Being Released Sure to Create Heavy Demand for Them

With the opening of the September season it is natural to become optimistic over the prospects for Fall, so far as popular sheet music is concerned. These rosy expectations, however, are based upon good foundations and, whether or not the early plans bring results hoped for, there is certain to be considerable activity and satisfactory business.

There are many reasons for this optimism, including the one that the publishers very often hold back for several weeks on their activities until the opening of the theatrical season. When that period arrives, however, publicity campaigns are immediately inaugurated, new numbers released, enthusiasm aroused and every department of the publishing business is put on its mettle to get an early start.

This can be said of the opening of any Fall season, but there are several angles in the present situation which can hardly be overlooked and which give more than the usual assurance of a most active Fall. The publishers have passed through one of the most active Summer periods for several seasons. This was due to the prevalence of a goodly number of successful issues. We had the spectacle this Summer of seeing a song reach over a million copies in point of sale. This, and other successes, made the music counters more active than usual. It demonstrated what has long been contended—that good songs will sell, provided intelligent merchandising methods are resorted to.

This Summer activity and the result in profits for both the publisher and dealer are the best bases for optimism; in fact, they could not be improved upon. At any rate, as far as the popular publishers are concerned, plans were never more extensive than those that are arranged for this Fall.

Another factor that is of value as a foundation for optimistic predictions is the merit of the new numbers released. The various catalogs seemingly all have several numbers that are very much worth while.

Plans to realize on the momentum in sales created during the busy Summer are covering every channel of activity. Bands, orchestras, motion picture houses and all other mediums of publicity which in the past have been found effective as creators of sales for sheet music are being indulged in by all of the leading music publishing houses.

If the numbers issued prove up to expectations a big Fall is assured. If great quantities of sheet music can be sold during the Summer months there is no question about the success of the Fall if the songs are meritorious in the sense that they meet with popular approval, upon which, of course, success depends.

A new store was recently opened in Toledo by Frank Flightner, who will feature the Columbia line of machines and records. The establishment is under the management of Jacob Frame.

MacFARLANE SINGS BALL BALLAD

Well-known Baritone Featuring "Ten Thousand Years From Now," Latest Ball Number

George MacFarlane, who for many years has been well known to vaudeville audiences as one of the most entertaining baritone singers of all time, is always one of the first artists to introduce new songs from the pen of Ernest R. Ball. Recently he included Ball's new ballad, "Ten Thousand Years From Now" with so much success that he found it necessary to take it from its original position in the program and use it as an encore number only.

MacFarlane recently appeared at Keith's Palace Theatre, New York City, and is booked by the Keith organization for the entire circuit during the coming season. Besides "Ten Thousand Years From Now," published by M. Witmark & Sons, he will use several other numbers from that catalog, including "Out There in the Sunshine With You," "Bebe," "Can't Yo' Heah Me Callin', Caroline?"

STASNY NEW NUMBER POPULAR

"Don't Waste Your Tears Over Me" is the title of a new song which was recently released by the A. J. Stasny Music Co., Inc. The number has been demonstrated by several music departments and the melody made immediate appeal. The piano copies carry a fox-trot chorus and this has added to its early recognition. A particularly attractive and appropriate title page has been given the number and this, undoubtedly, has helped to increase sales.

Stasny's Atlantic City Hits



Sun-Kist Rose

Sensational Fox-Trot Hit

Featured by
Vincent Lopez
and his
Hotel
Pennsylvania
Orchestra

The Biggest
Selling Waltz
of the
Season
Featured
by
Ray Miller's
Orchestra



"Big International Hit"

WALTZ ME TO SLEEP

(In Your Arms)

A Melody You Cannot Resist!

ORDER NOW

A. J. STASNY MUSIC CO., Inc.
56 WEST 45TH STREET, NEW YORK CITY

Released by Leading
Record and Roll Companies

Another "LET THE REST OF THE WORLD GO BY"



**OUT THERE
IN THE SUNSHINE
WITH YOU**

Music by
ERNEST R. BALL

Lyric by J. KEIRN BRENNAN

M. Witmark & Sons, 1650 Broadway, New York

BAMBERGER & CO. TO PAY ROYALTIES FOR COPYRIGHTS

Newark Department Store Bows to Decision of District Court and Will Not File Appeal—Victory for Society of American Composers, Authors and Publishers

L. Bamberger & Co., the defendants in the radio-copyright suit brought by the American Society of Composers, Authors and Publishers, which was decided in favor of the plaintiffs in a recent decision handed down by Judge Lynch in the United States District Court, Newark, N. J., have decided to drop the plan for an appeal.

Following this decision on the part of Bamberger's, probably the largest department store in the State of New Jersey, which operates a radio broadcasting station, a license was taken out by this company from the American Society of Composers, Authors and Publishers for the purpose of playing songs and instrumental selections controlled by that organization.

The suit was in the nature of a test case and was the first legal decision on the question of radio broadcasting involving the use of copyrighted works in the series of controversies which has raged for many months mostly outside of the courts.

The fact that the Bamberger organization has decided to accept the District Court's decision and the contentions of the American Society as to copyright rights where radio renditions are involved is most welcome to the majority of composers and publishers. A continuance of the suit through an appeal, or a series of appeals, might keep the question open several years. If any other radio broadcasting station plans to fight the Society for what is termed its property it will be necessary to commence suit in a United States District Court, with the handicap of having on record a similar suit decided in favor of the Society and which, undoubtedly, would be taken into consideration by every District Court.

The fact that indirect profit only was involved has simply served to strengthen the publishers' stand in this case. The above suit involved the broadcasting of the well-known standard success "Mother Machree," published by M. Witmark & Sons.

It might be here pointed out that the Society's bringing action on an old standard number eliminated some of the earlier contentions of radio broadcasting stations that they did much to popularize songs. Naturally, a number which is as universally known as the above issue hardly needs to be popularized.

NEW DENVER PROFESSIONAL OFFICE

Sherman, Clay & Co. Establish Office in Colorado City, With Harry S. Wilson in Charge

SAN FRANCISCO, CAL., September 5.—Sherman, Clay & Co. are opening a new professional office in Denver, Col., according to announcement made by Ed. Little, manager of the publishing and sheet music departments. Harry S. Wilson has been engaged as manager of this office. Harvey Orr is starting on a long trip for Sherman, Clay & Co., singing some of the firm's latest hits, including "I Cried for You," "Other Lips," "Just an Old Love Song" and "The West, a Nest and You." After singing from the Coast to Chicago Mr. Orr will carry his music missionary work through the South.

Ralph Errolle, Edison artist, sang the tenor rôle in a number of operas produced by the DeFoe Opera Co. in Toronto, Canada, during the week of September 2.

BERLIN BRINGS OUT "TUT" SONG

"Three Thousand Years Ago," by Gerber and Egan, to Be Published by That House

There have been several King Tut songs and at least two of them had some popularity. Up to the present time, however, they have not proved overwhelming successes. It is somewhat surprising, therefore, to see a large publishing organization accept a new song carrying a "Tut" title. The fact that Irving Berlin, Inc., will publish Alex Gerber and Jack Egan's "Three Thousand Years Ago," a comedy song of the "Tut" style, speaks well for its merit.

In this new offering the writers have tried to make comparisons between the present and ancient Egyptian days. The result is a comedy song with a long list of extra verses, five of which are reproduced in the piano copies. The vocal rendition of the number has been reserved to the team of Murray and Alan, now playing Keith vaudeville.

FALL CAMPAIGN OF JACK MILLS, INC.

Jack Mills, Inc., which recently moved into its new building, 150 West Forty-sixth street, New York City, plans a Fall campaign on the following songs: "Just a Girl That Men Forget," a ballad which is receiving exceptional popularity in vaudeville; "Hey! You Want Any Cod Fish?," a novelty, and "Love Is Just a Flower" and "Havana," both of the latter from the Pacific Coast. The catalog series of "Beautiful Ballads" will also be exploited.

The A. J. Stasny Music Co., Inc., recently issued a new song and instrumental number, entitled "Waltz Me to Sleep" (In Your Arms). The number, as a waltz, has been tried out by numerous orchestras and has met with favor from them.

• SOUTHERN FOX-TROT SONG •



ALABAMY BLACKSHEEP

WON'T YOU RETURN TO MY FOLD

By King Zany & Roy Ingraham

M. Witmark & Sons., 1650 Broadway, New York

SAM FOX MAKING FALL PLANS

Arranging Extensive Sales Promotion and Exploitation Campaign on Many Numbers Which Have Been Tested Here and in Europe

Sam Fox, of the Sam Fox Publishing Co., who returned from Europe early this Summer, has been making quick trips between the New York offices of his company and the executive offices in Cleveland, O., arranging the coming season's activities. The Fall plans, as recently outlined by the sales department of his organization, call for extensive sales and exploitation campaigns, involving a series of numbers which have been proved meritorious by trial, or which have had previous popularity in the capitals of Europe.

Among the numbers that are to be exploited this Fall is one of the outstanding hits of this season's "Folies Bergere," discovered by Mr. Fox while attending a performance of the above production in Paris, and for which he immediately secured the American publishing rights. The final negotiations for this piece, which is entitled "Nights in the Woods," were closed by cable.

In addition to the above number, while Mr. Fox was in Vienna, he obtained what is described as "a beautiful Viennese melody," entitled "Just One More Kiss." Both of these numbers are of the highest type European popular successes and of the caliber that generally meets wide American approval. There will be other Fox prints exploited during the coming season, but the above two numbers will receive the full support of the whole organization during the early months of the Fall.

As announced some time ago, while Mr. Fox was in London he established relations with one of the largest wholesale and retail organizations in the United Kingdom, the Keith Prowse Co., Ltd. This well-known firm has secured the selling agency of the Fox catalog in Great Britain and the colonies, excluding Canada and Australia.

EDWARD B. MARKS BACK FROM TRIP

Covered 2,000 Miles by Motor Through Adirondacks, White Mountains, the Berkshires and Maine Lakes on Pleasure and Business

Edward B. Marks, of the Edward B. Marks Music Co., recently returned from a 2,000-mile motor trip, covering interesting points in the Adirondacks, the White Mountains, the Berkshires and the lakes of Maine. According to Mr. Marks there were very few songs whistled on the streets in the territory visited as compared with former years. However, some of the outstanding successes, such as "Yes! We Have No Bananas" and "Parade of the Wooden Soldiers," were heard now and then. In places where dancing was in vogue such songs as "Barney Google," "You've Got to See Mamma," "March of the Siamese," "Just for To-night" and "Bambalina" seemed to be the favorites.

Songs that spell Profits

"Be First With a HEARST"

- Wonderful Child
- She's Got Another Daddy
- Beautiful Rose
- Home—My Lovin' Dixie Home
- In The Land of Sweet Sixteen
- Many Years
- Always Looking For A Little Sunshine
- Just a Little Gold Watch and Chain
- In Baby's Smile
- Love is Love For Ever
- Lonesome Two
- Piano Dream
- Step

Order From Your Jobber or Direct

HEARST MUSIC PUBLISHERS LTD
 1658 BROADWAY NEW YORK PHOENIX BLDG. WINNIPEG 199 YONGE ST TORONTO

No Loss on a Hearst Song — Money Back Guarantee

FORSTER PUBLICATIONS POPULAR

Win Great Vogue With Orchestra Leaders Throughout the Country

The catalog of Forster, Music Publisher, Inc., never seemed more active than the present season. Besides the successful fox-trot, "Oh! Harold," written by Lee S. Roberts, which is also arranged for a one-step and the collegiate walk, there are several other songs in the catalog which are having good sales. Particular mention should be made of the novelty fox-trot "Dreams of India." The publications of this enterprising Chicago publisher are forging ahead in all parts of the country. Its representatives find orchestra leaders particularly responsive to the Forster prints and its dance arrangements find much favor with the public.

SINGS THE "GULF COAST BLUES"

Bessie Smith, the new colored singing artist, who recently signed up exclusively to record for the Columbia records, made her introduction to that laboratory by singing "Gulf Coast Blues," a Clarence Williams Music Publishing Co. number. Miss Smith was heretofore unknown, but with her first release on the Columbia "blues" enthusiasts throughout the country hail her as an exceptional find.

"Gulf Coast Blues," following the introduction by Miss Smith, has been recorded by practically all the talking machine record companies throughout the country. Its sales have not only been active in record form, but the demand for the piano copies has shown substantial increase ever since the number was first released.

POPULAR BALLAD SUCCESSES

THE WORLD IS WAITING FOR THE SUNRISE
 BY LOCKHART & SEITZ

IF WINTER COMES
 BY ARKELL & TENNENT

SMILE THROUGH YOUR TEARS
 BY BERNARD HAMBLÉN

ROSES OF PICARDY
 BY WEATHERLY & WOOD

SONG OF SONGS
 BY VAUCAIRE-LUCAS-MOYA

THE BELLS OF ST. MARY'S
 BY FURBER & ADAMS

SOME DAY YOU WILL MISS ME
 BY GREY & DAREWSKI

THERE'S A SONG IN MY HEART
 BY BERNARD HAMBLÉN

CHAPPELL-HARMS, INC.
 185 MADISON AVE, NEW YORK

"LOVE TALES" FINDING FAVOR

New Leo Feist Number Being Used by Many Artists Upon the Vaudeville Stage

Leo Feist, Inc., recently added the song "Love Tales" to its catalog. The number was immediately accepted everywhere, particularly among orchestras, as a favorite. Since its release its sales have developed rapidly and its popularity as a song and dance seems on the increase. The Feist organization is placing the number with many vaudevillians and, from present indications, it will be one of the outstanding numbers of that catalog during the Fall and Winter season just opened.

"Easy Melody" is the title of a song which originally had some success in St. Louis territory. The number is by Gene Rodemich and Larry Connelly, of the Hotel Statler Orchestra, in the above city. The number has been purchased by Leo Feist, Inc., which has made an immediate release to the profession.

LATEST BROADWAY BLUES

"YOU'RE ALWAYS MESSIN' 'ROUND WITH MY MAN"

"KEEP YOURSELF TOGETHER SWEET PAPA"

"BLACK MAN" (BE ON YO'WAY)

"TIRED O'THE BLUES"

"COTTON BELT BLUES"

"LOW-DOWN PAPA"

SPENCER WILLIAMS

MUSIC COMPANY INC.

1547 BROADWAY

NEW YORK

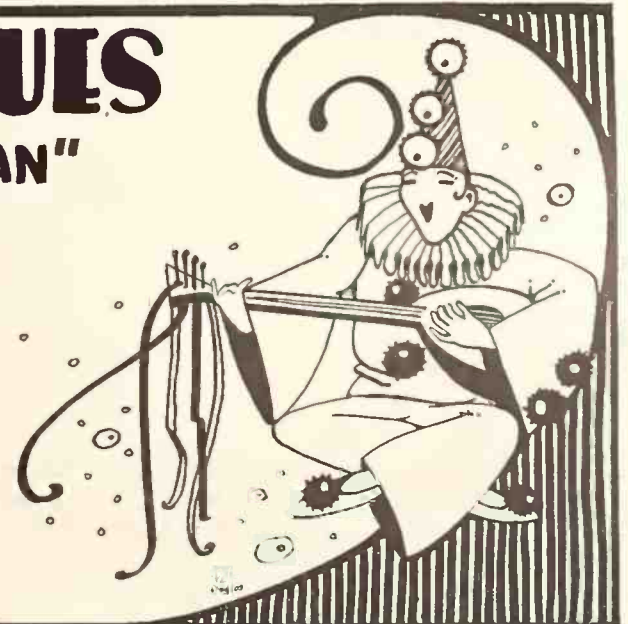

FOUR SENSATIONAL SONG HITS
 SUNG AND PLAYED FROM COAST TO COAST
LOVE
 MY HEART IS CALLING YOU
INDIANA MOON
 WHEN YOU WALKED OUT
SOMEONE ELSE WALKED RIGHT IN
THAT OLD GANG OF MINE
 IRVING BERLIN, Inc., 1607 BROADWAY, NEW YORK CITY

THREE SIMULTANEOUS WINDOW DISPLAYS ON ONE SONG

Schmoeller & Mueller, A. Hospe & Co. and Edward Patton Feature "Cut Yourself a Piece of Cake" in Their Windows During One Week in Omaha in Conjunction With Theatre Appearance

Although the Leo Feist, Inc., number "Cut Yourself a Piece of Cake and Make Yourself at Home" can be considered among the newer issues it has made a most active place for itself on the retailers' music counters throughout the country. The number is of the type, of course,

than others, according to their merits. But this Feist issue has received an exceptionally large amount of such publicity. This is due to the fact that the title lends itself readily for all sorts of publicity ideas.

The publisher thinks an occasional display in a town on each of his issues is good co-operation. To have three such displays on an individual number by three of the largest houses in a single city is reaching the high mark of dealer "hook-ups." This is what happened in Omaha, Neb., when three of the largest houses there made unique, elaborate and attractive displays on "Cut Yourself a Piece of Cake" in conjunction with the appearance at the Rialto Theatre, of George Getsey, who was featuring the number.

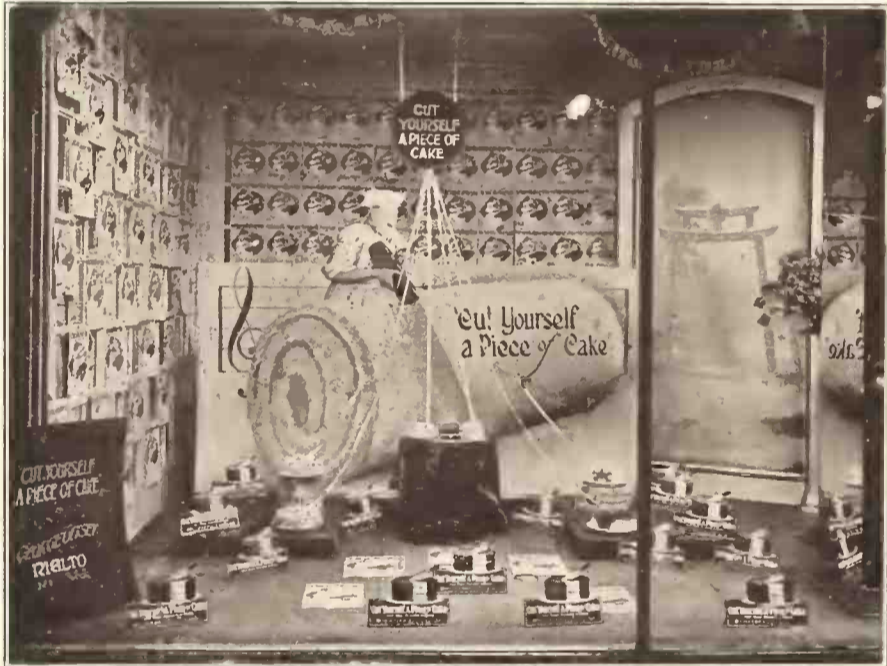

Making the Title Alive

that is now meeting general public approval, but the Feist organization has made a Summer campaign on this issue which has been as large as, if not larger than, on issues of a more normal season.

The result of all this has been that "Cut Yourself a Piece of Cake" is proving a money-maker for the trade. Most songs that become popular get a number of window displays, some more

Reproductions of these unusual windows and the spirit of the co-operation of the dealers are herewith shown. They include the enterprising houses of Schmoeller & Mueller, A. Hospe & Co. and Edward Patton. It might also be added that there was substantial proof that these displays created sales. This was shown by the large number of passers-by who were attracted to the windows and who entered the stores.

Of course, in addition to George Getsey's appearance at the Rialto Theatre, the various or-

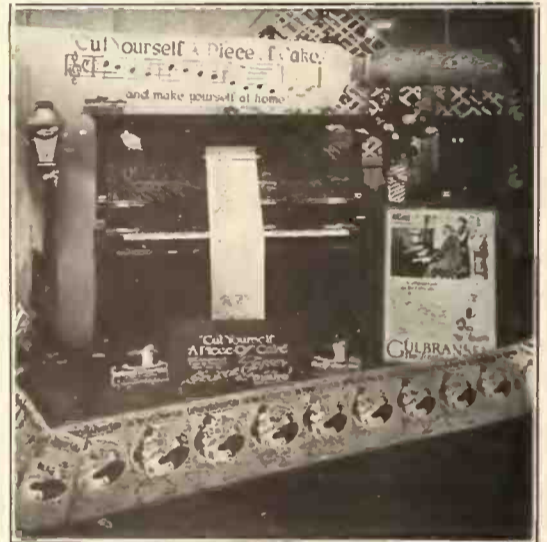

Featuring the Theatre Appearance



A Real Cake in the Window

chestras throughout the city frequently programmed "Cut Yourself a Piece of Cake."

THREE HOT TUNES—HOT OFF THE PRESS—BEING PLAYED EVERYWHERE

ALL WRONG **SALT YOUR SUGAR** **WHAT COULD BE SWEETER**

IRVING BERLIN, Inc., 1607 BROADWAY, NEW YORK CITY

SWEET CARMEN

A Rhythmic Fox-Trot Tango -

"You can't go wrong
With any FEIST song"

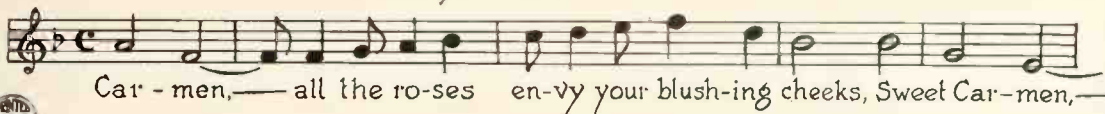

BERLIN GETS "TOPSY AND EVA" SONGS

Negotiations for Publishing Rights of Songs in New Musical Show Closed

LOS ANGELES, CAL., September 10.—The new musical show "Topsy and Eva," in which the Duncan Sisters are starred and which played several unusually successful weeks in San Francisco, opened here this evening for a short stay prior to its departure for New York. Several songs in the show, particularly "Rememb'ring," have had unusual notice from some of the leading publishing houses of the country, so much so that negotiations for the publication rights have been closed by telegraph with Irving Berlin, Inc.

It is said the Duncan Sisters alone, with a fair show behind them and their inimitable methods of singing and entertaining, would make this production a success. With this outstanding hit ("Rememb'ring") there is no question of its stay on Broadway and of a long tour throughout the country.

Among other songs of the show that are worth mentioning are "Just in Love With Me," "Um Um Da Da," "Moon Am Shinin'," "Do Re Me" (In the Music Lesson), "In the Autumn," "Lickin's," "Sighing," "We'll Dance Through Life Together" and "High Brown Colored Lady."

NEW BLUES NUMBER DOING WELL

"Blue Hoosier Blues," from the catalog of Leo Feist, Inc., is, undoubtedly, one of the most original offerings of its type heard in many seasons. The early response to the Feist publicity on the number has been quite active and, undoubtedly, justifies that organization in its newer plans for the extension of its exploitation, which includes a publicity drive of national proportions.

CLOSES SUMMER DRIVE ON FOX-TROT

A. J. Stasny Music Co. Concludes Successful Campaign Among Eastern Beach Resorts

The A. J. Stasny Music Co. has just closed a Summer campaign on its fox-trot success, "Sun-Kist Rose," in Atlantic City, Asbury Park and other coast resorts. While the primary purpose of publishers' campaigns in beach territory is to "put the song in the air," so that visitors on returning to their homes will purchase

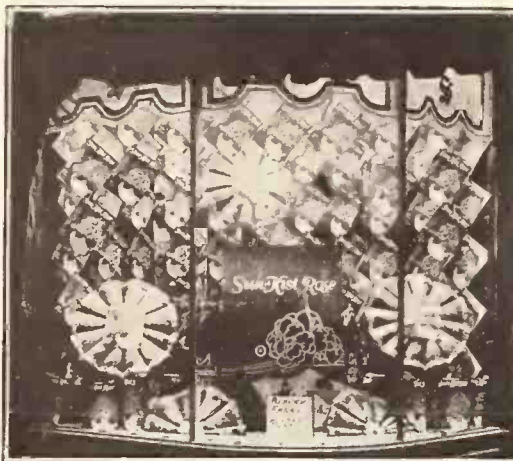

"Sun-Kist Rose" Featured in Atlantic City

the sheet music, rolls and records of the number, there is considerable music sold on the music counters of the boardwalks and the business centers proper.

A case of a heavy Summer sale of sheet music at coast resorts was recently demonstrated by the L. R. Steel Stores, Inc., Asbury Park, N. J., which made a special feature of the Stasny number "Sun-Kist Rose" and which reported exceptionally heavy sales. The title pages of the song were displayed in the window and the number was demonstrated at the music counter, both of which proved good sales-creators.

HERBERT SPENCER IN NEW POST

Succeeds George Sheffield as Recording Manager of Edward B. Marks Music Co.

George Sheffield, who was for many years connected with the talking machine industry as a recording manager and who more recently has been manager of the mechanical reproduction department of the Edward B. Marks Music Co., has severed his connections with the music business entirely and has become associated with a well-known artist for the purpose of conducting a painting emporium on one of the leading avenues in New York City.

Mr. Sheffield leaves with the best wishes of the Edward B. Marks Co. and his associates. He will be succeeded in his mechanical reproduction activities by Herbert Spencer, of the writing staff of the Edward B. Marks Music Co., who is well-known for some popular successes, "Underneath the Stars" and his newest number, "Kiss Me With Your Eyes." This latter is an Edward B. Marks Music Co. release.

AL BEILIN WITH M. WITMARK

Made Professional Manager of Popular Department—Al Cook in Executive Capacity

Al Beilin, one of the best-known professional managers in the popular music publishing business and more recently of the firm of Beilin & Horowitz, has been appointed professional manager of the popular department of M. Witmark & Sons.

Al Cook, who has been professional manager of M. Witmark & Sons for many, many years, continues in that executive capacity. However, according to the publishers' announcement, he will confine his activities and give individual attention to the users of "Witmark Black and White Series."

Another "McCarthy-Tierney" Masterpiece!—

SAWMILL RIVER ROAD

That Irresistible Fox Trot From *Glory*

"You can't go wrong
With any FEIST song"

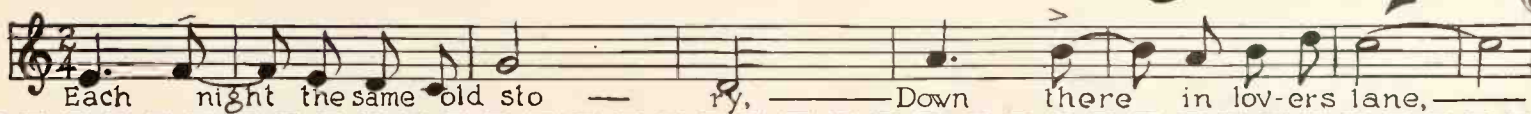

THE HOWARD BROS.

STARTED THIS ONE IN CHICAGO, AND IT LANDED FROM COAST TO COAST

DO YOU, DONT YOU, WILL YOU, WONT YOU

CHORUS
Can't you hear me say ing, "Do you, Don't you, Will you, Wont you love"

JEROME H. REMICK & Co., NEW YORK--CHICAGO--DETROIT



FEATURED AT ATLANTIC CITY

Joe Moss Does Good Exploitation Work With Several Remick Numbers

Among the entertainers appearing at Atlantic City who have done much to make that resort musical this season are Joe Moss and his entertainers at the Beaux Arts. This is one of the most popular of Summer shows with a fine singing chorus, some unusual leading voices, no



Joe Moss and His Entertainers

little comedy and exceptional ability to sing popular songs at their best.

Towards the close of each Summer season, popular music publishers make special efforts to exploit their numbers advantageously in Atlantic City, as it is really the pre-opening ground for the Fall season. Numbers are often tried out on the dance floors, in the cabarets and other public places for the purpose of not only giving the song a start and feeling the pulse of the public, but because it is considered a particularly effective time to have audiences who are about to return to their homes carry away tunes and melodies.

At the close of the Summer season at Atlantic

City, most of these publicity forces arrive at the New York professional offices or elsewhere and place these numbers with vaudeville teams about to go on the road. Thus the people who have returned to their homes will again hear the numbers in the vaudeville theatres, and, in a good many cases, this double publicity assures sales.

Among the songs Joe Moss introduced at the Beaux Arts this season have been several from the catalog of Jerome H. Remick & Co.

"LITTLE JESSIE JAMES" A HIT

New Musical Comedy by Thompson and Archer Being Published by Leo Feist, Inc.

There recently opened at the Longacre Theatre a new musical comedy presented by L. Lawrence Weber, entitled "Little Jessie James." The book and lyrics are by Harlan Thompson and the music by Harry Archer, who is not a novice at writing the scores for musical productions.

Various New York papers received the show most favorably as, indeed, did the out-of-town critics and public where it had previously appeared during the early Summer months. Undoubtedly, from present indications, it will run long into the coming season. Nan Halperin is starred and sings some of the outstanding songs. She has an inimitable way of rendering the numbers, and, with her personal charms, will do much to assure the show success as well as the songs that she sings.

Among the leading songs are "I Love You" and "Little Jessie James," "My Home Town in Kansas" and "From Broadway to Main Street." Among others who appear in the cast are Miriam Hopkins, Lucila Mendez, Clara Thropp and Winifred Harris. Leo Feist, Inc., publishes the music, which has already conclusively demonstrated its possibilities for popular favor.

BIG DRIVE ON "INDIANA MOON"

Heavy Sales Follow Opening Gun of Exploitation Campaign in Rochester, N. Y., on Waltz From the Catalog of Irving Berlin, Inc.

According to reports from Rochester, N. Y., during a week's featuring of "Indiana Moon," a waltz from the Irving Berlin, Inc., catalog, in that city by the various dance orchestras, motion picture houses and other channels of publicity, some extraordinary sales of the number were made, one store alone selling over 2,000 copies. This was the opening feature of one of the biggest campaigns ever inaugurated by the above publishing house. Similar activities are to be carried out in hundreds of other centers. In Rochester these previous publicity and sales exploitation methods are to be supplemented by a newspaper campaign. This will extend to some surrounding cities.

This latter publicity will appear in over 200 papers throughout the United States. Most of this advertising will appear in story form and will be illustrated with thematics of "Indiana Moon." In all territory where this advertising will appear the usual publicity, with the aid of the theatres, motion picture houses and orchestras, will be a part of the program.

REMICK & CO. GET NEW SONG

Jerome H. Remick & Co., publishers of the most successful cartoon song "Barney Google," have just accepted for publication a new novelty cartoon number, entitled "They'll Never Bring Up Father 'Till They Tear Down Dinty Moore's." It is by George McManus, the well-known cartoonist, Dave Reed and J. Vincent Healy. The Remick organization, including the sales, band, orchestra and professional departments, is to make a feature of this new humorous song during the early months of the Fall season.

THAT HAUNTING STRAIN IS

LOU'S IANA

FOR A FOX TROT--BLUES OR SONG
by KAHN & DONALDSON

CHORUS
I've got the blues for Lou's-ian-a Blues for Lou's-ian-a Won der why I ran a-way

JEROME H. REMICK & Co. NEW YORK-CHICAGO-DETROIT



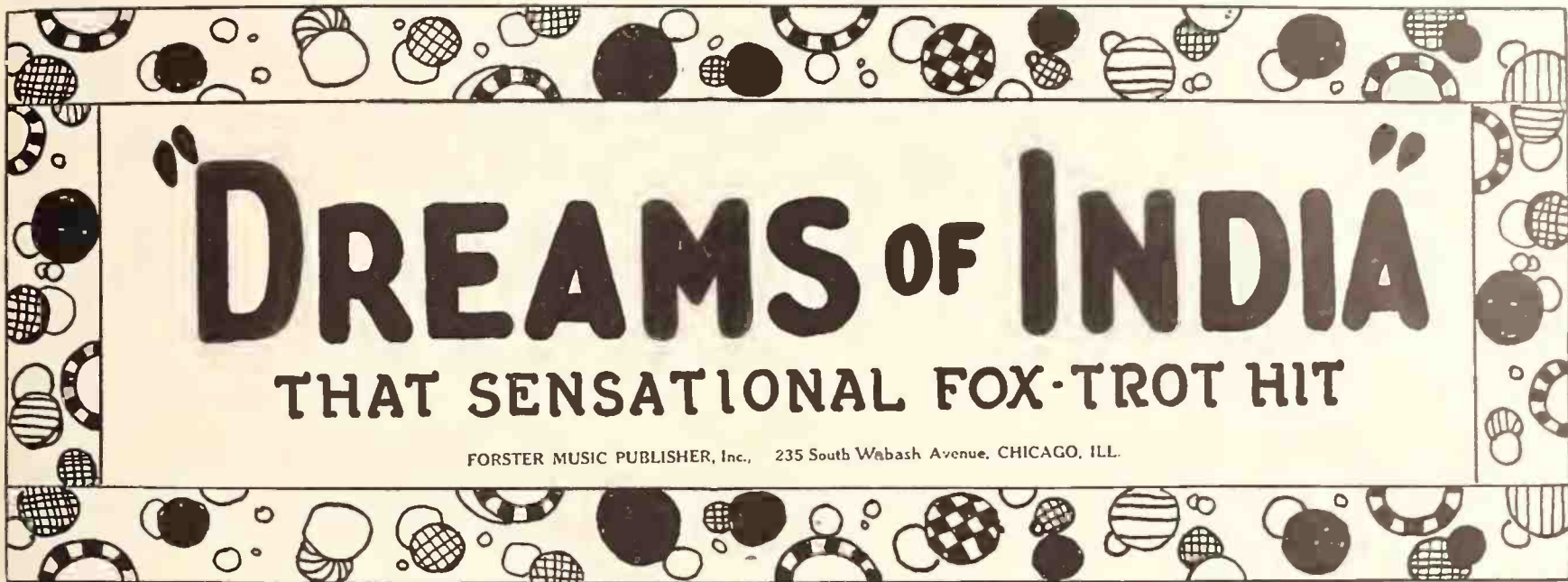

DREAMS OF INDIA

THAT SENSATIONAL FOX-TROT HIT

FORSTER MUSIC PUBLISHER, Inc., 235 South Wabash Avenue, CHICAGO, ILL.

ERNEST R. BALL VISITING ENGLAND

Singing at Leading Music Halls of Great Britain During Five Weeks' Tour

Ernest R. Ball, the well-known composer-entertainer, sailed recently on the S. S. "Baltic" for his first appearance at some of the leading vaudeville houses in Great Britain. Mr. Ball's career is one of the most remarkable among American popular composers, recording as it does a success extending for a period of years.

He opened at the Alhambra in Glasgow, the week of September 3, and he will appear in Liverpool and London, where he is booked at the famous Paladium. Altogether he will play about five weeks on this introductory trip, at the conclusion of which he will return to the United States for an extended tour on the Orpheum Circuit.

Mr. Ball's fame as a songwriter has been for some time pretty well established in Great Britain, where his best-known ballads have repeated earlier American successes. Notably well known to English music lovers are "Love Me and the World Is Mine," "When Irish Eyes Are Smiling," "A Little Bit of Heaven," "Mother Macchree," "Let the Rest of the World Go By" and "Till the Sands of the Desert Grow Cold."

NEW COHN SONG FOR REMICK

Irving Cohn, who collaborated in the writing of "Yes! We Have No Bananas," has placed with Jerome H. Remick & Co. a new song, entitled "Sweet Butter" (I'd Love It on My Toast). The Remick organization has decided to exploit it on a wide scale. Orchestrations will be released at once and several weeks later it is to be placed in the programs of a number of vaudeville stars. The sales department of the above firm thinks this new offering is a rare find.

AMERICAN JAZZ IN ENGLAND

Paul Specht Declares That English Musicians Are Much Enthused Over It

Paul Specht, who returned recently with his orchestra after a tour of England and the Continent, recently commented on the growth of the American style of jazz in England and stated that he had noticed certain English musicians in the audience night after night, making notes of various phases of American musical renditions that were new to them. He said that instrument dealers and manufacturers in England had told him that since the foremost American dance orchestras had invaded Great Britain the sale of saxophones had doubled and even in some instances trebled, and the output of other musical instruments had likewise increased.

PHIL PONCE SONG IN "FOLLIES"

Jimmy Hussey Featuring "It Shouldn't Taste From Herring" in That Show

"It Shouldn't Taste From Herring," recently introduced by Jimmy Hussey in the Ziegfeld Follies, is a Phil Ponce publication.

Phil Ponce, the publisher, is enjoying a few days' rest somewhere in Massachusetts, according to the Ponce publicity department. Those Massachusetts boys are certainly doing well. There is President Coolidge, Secretary of War Weeks, Senator Lodge, Speaker of the House Gillette, and Phil Ponce, making the "Cat's Whiskers" grow.

Among the new songs added to the catalog of Leo Feist, Inc., is a number that had its original success in Chicago, entitled, "No, No, Nora." It is by Gus Kahn, Ted Fiorito and Ernie Erdman.

HEARST NEW YORK OFFICES

New Suite in Roseland Building Embodies Every Comfort for the Profession

Hearst, Music Publishers, Ltd., have arranged for a new suite of offices in the Roseland Building, 1658 Broadway, New York City. The quarters are undergoing alterations and will be ready to welcome the trade and profession early in September, with every possible facility for the comfort and convenience of the profession embodied. Each piano room faces Fifty-first street windows, thus the demonstration rooms are exceptionally well ventilated. The Hearst number "Some Day You Will Cry Over Somebody Else" is being introduced by the Bison City Four on its tour of the West Coast.

EXPECT TO DUPLICATE SUCCESS

The original success of "Yes! We Have No Bananas" will, evidently, be of exceptional value in the exploitation of its successor, "Yes! We Have No Banana Blues." The publishers, Shapiro, Bernstein & Co., Inc., have, undoubtedly, taken this into consideration because their plans for this, their newest offering, are extensive.

THREE NEW CONRAD NUMBERS

Con Conrad, one of the best-known and most successful of the younger songwriters, has placed three songs with the Edward B. Marks Music Co. They are "Lover," a fox-trot; "Life-saving Jim" and "No Tickee, No Shirtie."

"Ala Moana," a novelty from the catalog of Irving Berlin, Inc., which was obtained by that organization from the Pacific Coast, has succeeded in well justifying the amount paid to the writers for the publication privilege and for the campaign of exploitation inaugurated.



THE NEWEST SONG SUCCESS

"ROSE SUNNY ITALY"

FORSTER MUSIC PUBLISHER, Inc., 235 South Wabash Avenue, CHICAGO ILL.

The Sensational Parisian Success "NIGHTS IN THE WOODS"

The Hit of the "Folies Bergere," Paris, whose popularity is spreading all over the European Continent. Its contagious melody is making it an International Hit. America will soon be dancing to its entrancing strains.

Published as Song and Fox Trot

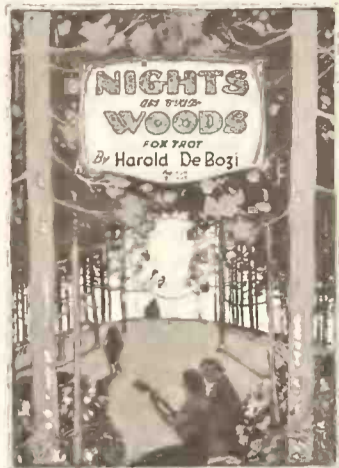

FOX FEATURES "AUNT HAGAR'S BLUES"

SAN ANTONIO, TEX., September 6.—The Fox Co., Columbia dealer in this city, recently created considerable interest with its window display, featuring "Aunt Hagar's Blues." A large illuminated sign about five by twelve feet occupied the center of the two windows, with the name of the selection in large red letters trans-



Window Display Made by The Fox Co.

parent. The center was a cut-out of Aunt Hagar, with blue lights flashing off and on, and a generous display of Columbia records featuring the selection gave a sales value to the window. Incidentally, this display was responsible for the sale of 1,000 of the Ted Lewis records of "Aunt Hagar's Blues."

Among the new songs added to the catalog of Shapiro, Bernstein & Co., Inc., are "Somebody Else Took You Out of My Arms, But They Can't Take You Out of My Heart," by Billy Rose and Con Conrad, and "Last Night on the Back Porch."

PATHE POPULARITY INCREASING

Despite Late Appearance of Pathé Models on Market Good Demand Is Enjoyed

Despite the usual quietness of Summer business all five of the models at present constituting the Pathé line sold well. The new Pathé portable, although placed on the market a little late for the full amount of Summer business, was well received and developed a large amount of orders. It is expected that the portable will prove a good all-year-round seller. The three console models in their various period designs are much in demand and Model 15, the only upright model in the line, admirably fills the demand for that type of machine. The Pathé Phono. & Radio Corp., Brooklyn, N. Y., is making energetic plans for the Fall season and expects to make a record in volume of sales.

NEW VICTOR ORDER BLANK

A combined advance list and order blank for the October records in foreign languages has been prepared by the Victor Talking Machine Co. for distribution to dealers. Beside each title of a foreign record there is space for the dealer to make a notation of the quantity of each record desired. Included in the list are Bohemian, Croatian, French-Canadian, German, Greek, Jewish, Hungarian, Italian, Lithuanian, Mexican, Norwegian, Slovenian and Swedish records.

CELEBRATE ARTIST'S APPEARANCE

Minneapolis Victor Dealers Stage Theatre Party in Honor of Aileen Stanley, Victor Artist, Who Sang in Twin City Theatres

MINNEAPOLIS, MINN., September 6.—"The Phonograph Girl," Miss Aileen Stanley, is the luminary about which the interest of the Twin City trade has centered in the last fortnight. Miss Stanley has the distinction of singing for Victor, Vocalion, Edison, Okeh and Gennett records and admits that not so long ago she sang for ten makes, but found that pace too strenuous. She is singing this week at the Capitol Theatre in St. Paul, after completing a week's engagement in Minneapolis.

Victor dealers, jobbers and their sales forces of the "Flour City," numbering seventy-five, celebrated Miss Stanley's appearance Friday night, August 31, with a theatre party, for which five rows of the front, center seats were reserved. Immense Victor dogs flanked the large Victrola, which divided honors with a grand piano flying Victor pennants. After receiving a huge bouquet of pink roses from her "Victor friends" Miss Stanley responded by singing her latest Victor release, "Maggie," a record in which she and Billy Murray collaborate. The party was arranged by Murray K. Kirschbaum, manager of the Victrola department of the L. S. Donaldson Co., assisted by C. L. Carlson, manager of Howard, Farwell & Co.

Miss Stanley's rendition of "Lonesome Cry Baby" was particularly interesting because it was written by her accompanist, Bob Buttenuth, and is featured in the sheet music display in the windows of the Metropolitan Music Co.

Miss Stanley was as greatly admired off as on the stage, her beauty and lovely figure, as well as her gracious manner, making her a great favorite. She has left many autographed records and photos with the dealers.

The European Sensation Direct from Vienna "JUST ONE MORE KISS"

This haunting melody direct from Vienna is destined to become a sensation in America. It is the favorite dance hit in all the Night Clubs of the European Capitals and will completely captivate this country.

Published as Song and Fox Trot



THE FIRST HIT OF THE NEW SEASON---A CATCHY LYRIC, A GREAT DANCE, A MARVELOUS SONG

THAT BIG BLOND MAMMA OF MINE

By
Billy Rose
and
Jimmy Monaco



JEROME H. REMICK & Co.
NEW YORK--CHICAGO--DETROIT



TRADE LIKES BENNY DAVIS RECORDS

Records Made by Popular Artist and Song-writer for Emerson Phonograph Co. Meet With Popular Approval of Dealers

The new records by Benny Davis, who was recently added to the staff of exclusive artists of the Emerson Phonograph Co., Inc., have



Benny Davis

made a favorable impression upon the trade. Benny Davis is well known along Broadway, not only as a singer who has made his appearance at some of its most popular resorts, but as a songwriter who has contributed some of the best sellers of the past few years. He has a particularly loud, clear voice and an inimitable style, all of which he manages to get into his records. His first release was a record of "Stella," his own number, and "My Sweetie Went Away"; his next release will include "No, No, Nora," which has already been accepted as an unusually popular song, and "Sweet Henry," a jazzy selection which is finding some favor.

Benny Davis is the writer of such songs as "Margie," "Make Believe," "Angel Child" and other well-known success. All of these, and other Davis numbers, have achieved popularity.

NEW AGER, YELLEN & BORNSTEIN SONG

Ager, Yellen & Bornstein, Inc., have released a new song of the ballad order, entitled "You Didn't Want Me When I Wanted You" (I'm Somebody Else's Now). This number and "Louisville Lou" and "Mamma Goes Where Papa Goes" will be the features of this firm's activities during the coming season.

Hal Lothrop, of the J. E. Lothrop Piano Co., Columbia dealer, Dover, N. H., recently returned from a three months' sojourn in Europe.

NOW IT IS GOING ON THE STAGE

George W. Lederer has acquired the stage rights to the title "Yes! We Have No Bananas" and expects to produce a comedy with songs under that title within a month. The arrangement for the use of the title was made with Louis Bernstein, of Shapiro, Bernstein & Co., Inc., publishers of the original "Blues" and its later sequel of the number shows no signs of letting up in popularity.

BALLAD BY ERNEST BALL'S SON

Roland Ball, son of Ernest Ball, the successful ballad writer, has composed a melody for "Come Back to Mother Machree," the lyric of which was written by George Graff, Jr. M. Witmark & Sons, publishers of all the Ernest Ball music, will also issue this new song as it issues his father's work.

A NEW BERLIN COMEDY SONG

"Nobody Can Love Me Like My Old Tomato Can" to Be Exploited Widely by Publishers—Indications Point to Wide Popularity

A new comedy song has been accepted for publication by Irving Berlin, Inc. While it is the newest addition to this catalog the sales and professional departments have already decided to exploit it widely. The number is entitled "Nobody Can Love Me Like My Old Tomato Can," and is from the pens of Billy Baskette, who has written a number of popular successes in the past, and William Downs. Several vaudeville singers have introduced the song and the early indications seem to point to wide popularity. This, together with the fact that the Berlin organization is showing unusual interest as to the future of this number, should assure an unusual sale.

Championship Songs in all classes—

The RAGE in Waltzes

Just For To-night

The RAGE in Foxtrots

March of the Siamese

The RAGE in Voice Songs

Kiss Me With Your Eyes

The RAGE in "nut" songs

Nutsey Fagan

The RAGE in Ballads

All That I Want To Be Left Alone

sheet music-records-rolls-everywhere!

Edw. B. Marks Music Co. West 46th St. N.Y. City next to N.Y.A. (no number necessary)

The Overnight Song Hit!



HUNGRY
For Profits?
Have Some
codfish!
PROFITS
ARE IN
SEASON
You Can't
Order Too
Many.

Soon to be released on all Phonograph Records and Music Rolls.

JACK MILLS, Inc.

Music Publishers

152-4 West 45th Street,

New York, N. Y.

"The House That Jack Built"

"ALL MUDDLED UP" A LONDON HIT

Thousands of Paul Specht Columbia records of "All Muddled Up" were purchased by J. Lyons & Co., Ltd., of London, and distributed by that firm in honor of Specht's engagements at the New Corner House and at the Empress Rooms of the Royal Palace, both under control of Lyons. "All Muddled Up" is one of Paul Specht's best recordings, and special labels were printed by the Lyons firm for the occasion of the distribution of the discs as souvenirs. Francis, Day & Hunter publish the number in England by arrangement with Leo Feist, Inc.

NEW SONGS IN BERLIN CATALOG

Among the new songs added to the catalog of Irving Berlin, Inc., which will be heard frequently during the coming season are "Sittin' in the Corner," described as another "All by Myself"; "Bit by Bit," a new song which had its original success in Chicago; and a jazz tune entitled "Salt Your Sugar," and "Shuffle Along."

BRUNSWICK GETS BLUE RIBBON

TOWANDA, PA., September 7.—L. C. Gillette, local Brunswick dealer, recently entered a Brunswick Tudor model in the competition at the Bradford County Fair for the best phonograph on all points, which won the blue ribbon.

A REAL REGULAR RECORD CUSTOMER

JACKSONVILLE, FLA., September 6.—Miss F. F. Miller, saleslady in charge of the Chadwick Furniture Co.'s Columbia department, this city, has on file a standing order for twelve Columbia New Process records to be sent to Frank H. Jones, of Tuinucu, Cuba, every ten days. Mr. Jones is an ardent radio enthusiast and finds a great deal of satisfaction and pleasure in using the New Process records for "broadcasting" purposes. Miss Miller and other members of the Chadwick organization have "listened in" on several occasions and enjoyed the music immensely.

LOCAL COLUMBIA BRANCH ACTIVE

W. G. Monroe, of the New York wholesale branch of the Columbia Graphophone Co., reports a marked increase in business during the last two months, as compared with 1922. An exceptional Fall business is anticipated and all indications point to a very satisfactory season. S. H. Porges, foreign record salesman for the Columbia local branch, reports that the foreign record sales are increasing daily. Particular stress is being placed on the sale of Spanish records, and several new accounts have been opened during the last week which will deal almost exclusively in Spanish records, which are rapidly becoming more popular.

CHILDREN'S RECORDS CREATE SALES

Popularity of Records for Youngsters Makes Them Easily Salable by Live Dealers—Window Displays Bring Big Returns

The demand for children's records seems to be on the increase. This is undoubtedly due to the wide range of material that is being incorporated in these products. The retailers throughout the country also are doing much to exploit these goods. A display or demonstration of these children issues invariably creates sales. This, together with the fact that such sales mean additional profits and an increased volume of business that is not obtained through regular talking machine business, makes the stocking of such goods attractive to the dealer.

That children's records prove a valuable adjunct to the retailer's business is shown by the number of exclusive window displays given to these products. A good example of this was recently shown by Eisenberg's, one of the leading department stores of Baltimore, which made a particularly fine window showing on "Little Tots' Nursery Tunes," a product manu-



Eisenberg's Attractive "Little Tots" Window factured by the Regal Record Co., Inc. A reproduction of this attractive window is shown herewith. A special showing of this and similar products created a healthy volume of additional sales, according to the management of Eisenberg's.

OF DISTINGUISHED LINEAGE

Friends of Arthur Middleton, Edison artist, have learned that the Arthur Middleton, one of the signers of the American Declaration of Independence, was a forebear of this artist.

— FIVE "BLUES" HITS —

OH DADDY BLUES . . . GULF COAST BLUES
MY PILLOW AND ME-BLUES . . . MICHIGAN WATER BLUES

'TAINT NOBODY'S BIZ-NESS IF I Do

CLARENCE WILLIAMS MUSIC PUB. CO., Inc.

1547 BROADWAY, NEW YORK CITY

THE FOREMOST "BLUES" PUBLISHERS IN THE COUNTRY

DIRECT FACTORY PRICE—JUST MENTION THE QUANTITY

MOTORS	CASTINGS {	TURNABLES	Stylus Bars	
TONE ARMS		Grey Iron		Screw Machine Parts
REPRODUCERS		and Brass for		TONE ARMS
		HORNS and THROATS		

Direct Quantity Importations On { JEWEL and STEEL (Bulk or Packed)
PHONOGRAPH NEEDLES
GENUINE RUBY BENGAL MICA

D. R. DOCTOROW

Vanderbilt Ave. Bldg.
51 East 42nd Street, New York
Tel. Vanderbilt 5462
Murray Hill 800

SELVIN'S ORCHESTRA A BUSY BUNCH

Sign Exclusive Contract to Record for Vocalion
—Ben Selvin's Activities Excite Admiration

It was recently announced that Ben Selvin and His Orchestra have again signed an exclusive contract to record for the Vocalion. Mr. Selvin is one of the best-known orchestra leaders in the United States and his organization has become familiar to thousands of record pur-



Ben Selvin and His Orchestra, Which Records for Vocalion

chasers throughout the country during the past few years.

Although only twenty-eight years old he not only directs the Selvin Orchestra at the Moulin Rouge, New York, but he directs and manages the Bar Harbor Society Orchestra and the Broadway Syncopators, both exclusively Vocalion combinations.

Selvin's Orchestra has made records for a number of leading talking machine record organizations and the versatility shown by his artists and the novel arrangements made for his popular selections have found particular favor among dance enthusiasts.

It is said, besides furnishing six records or twelve selections a month for the Vocalion list, his orchestra also accompanies most of the Vocalion artists in their recordings of popular songs. An idea of the extent of his musical activities might be gleaned from the fact that he keeps three arrangers busy preparing effective and novel orchestrations.

IRVING KURTZ APPOINTED RECEIVER

Creditors of Cabinet & Accessories Co. Co-operating to Continue Operations

Irving Kurtz, attorney, talking machine dealer and president of The Talking Machine Men, Inc., has been appointed receiver for the Cabinet & Accessories Co., Inc., 3 West Sixteenth street, New York, which company was petitioned into bankruptcy recently. The liabilities of the concern are given as \$35,000, with assets about \$17,000, the receiver's bond being fixed at \$7,500.

This receivership is described as friendly and the petitioning creditors are said to be co-operating toward the reorganization of the company, which, it is hoped, will continue on a new and better basis than heretofore. Upon the retirement of the receiver it is planned that Otto Goldsmith, for many years president of the Cabinet & Accessories Co., will continue in charge of the affairs of the company.

NEW LONG CONSOLE CABINET READY

Geo. A. Long Cabinet Co. Introduces New Console Cabinet—Designed to Accommodate the Victrola IX—A Very Artistic Design

The Geo. A. Long Cabinet Co., Hanover, Pa., manufacturer of Long cabinets and well known throughout the talking machine trade as the maker of Long consoles to accommodate table machines, has just placed on the market a new console cabinet which will be known as No. 90. This cabinet is designed to accommodate the Victrola IX and is thoroughly in accord with the distinctive lines of the Long console cabinets, which have won popularity throughout the trade.

The new console cabinet No. 90 has four doors and one drawer and its attractive lines will undoubtedly meet with an enthusiastic reception from the trade. It is finished in mahogany, and H. C. Naill, secretary of the company, states that deliveries will start about October 15. This cabinet, although it is built especially to accommodate the Victrola IX, can also be fitted to take care of the Victrola VIII.

In a chat with The World Mr. Naill, who was a recent visitor to New York, stated that orders are being received in good-sized quantities for the console cabinets Nos. 601, 603, 608 and 610, which were introduced some time ago to accommodate Victrolas VI and IV. The standard Long record cabinets are also meeting with an active sale and it is evident the company will close one of the best Fall seasons in its history.

SONORA DEALER ANTICIPATES DEMAND

SYRACUSE, N. Y., September 6.—The Gibson-Snow Co., Inc., of this city, Sonora jobber, has just shipped seventy-nine Sonora phonographs to C. W. Ludwig & Sons, Rochester, N. Y. These enterprising dealers, like many others in Syracuse territory, appreciate the wisdom of getting as many machines in their possession as they can handle before the car and phonograph shortage becomes acute.

FEDERAL TEL. & TEL. ACTIVITIES

C. Kurtzmann Will Visit Trade Throughout Country—Company Has Prepared Extensive Sales and Publicity Campaign—Complete Line of Radio Sets Ready for Trade

C. Kurtzmann, of the Federal Telephone & Telegraph Co., manufacturer of Federal radio receiving sets and parts, who has been making his headquarters at the New York offices of the company, will hereafter be located at the factory and executive offices in Buffalo, N. Y. According to Mr. Kurtzmann's present plans he will spend the greater part of his time visiting the trade throughout the country, and he is now preparing an itinerary that will enable him to call upon the dealers and jobbers in practically all of the leading trade centers.

During the past few months the Federal Telephone & Telegraph Co. has been rounding out its line of instruments for the 1923-24 trade, and at the present time the company has a complete line of radio-receiving sets that include a number of models particularly suitable for sale by the talking machine dealer. An extensive advertising campaign that will benefit the jobber and dealer has been approved by the officials of the company and is now under way.

Mr. Kurtzmann is ideally qualified to co-operate with the talking machine trade, as he is a member of a famous piano manufacturing family bearing his name and was identified with music activities for many years. During recent years he has been devoting his time to radio activities and he is keenly enthusiastic regarding the sales possibilities of Federal radio-receiving sets in the talking machine industry.

STANDARD T. M. CO.'S BENEDICTS

Two Representatives of Pittsburgh Victor Wholesaler's Staff Desert Bachelorhood—Both "Grooms" Well Known in Trade

PITTSBURGH, PA., September 10.—R. J. Coleman, special representative of the Standard Talking Machine Co., of this city, Victor wholesaler, and formerly associated with the Victor Talking Machine Co.'s educational department, was married Saturday, September 8, to Miss Caroline Emily Grade, of Coudersport, Pa., at the home of the bride. Mr. and Mrs. Coleman left immediately for a trip on the Great Lakes, after which they will spend some time with Mr. Coleman's mother at New Albany, Ind., returning to Pittsburgh, which will be their home. Mrs. Coleman is an accomplished musician, having played the pipe organ in the First Lutheran Church at Coudersport for some time past.

On Saturday, August 18, C. E. Willis, traveling representative of the Standard Talking Machine Co., was united in marriage to Miss Mary Elizabeth Moore, of Pittsburgh, leaving immediately for a two weeks' wedding trip. Mr. Willis is well known throughout the Victor trade in the Tri-State territory, having served in different capacities in this section for the past ten years. The newlyweds are now at home to their many friends at 1813 Brownsville road, Carrick, Pittsburgh.



Featured by **RAY MILLER'S ORCHESTRA**
New York **A. J. STASNY MUSIC CO., Inc.** London

PORTLAND, ORE.

*Retailers and Wholesalers Very Busy—Excellent Fall Outlook—
Expansions and Stores Opened—Prominent Visitors—The News*

PORTLAND, ORE., September 4.—Business during the past month was very brisk, according to local retail dealers, while wholesalers say they have all they can do to keep up with orders. Dealers who thought that July was a big month for portable machines say that August far outstripped July for this model, and that record sales picked up remarkably during the last two weeks of the month.

Harry Marshall, district manager of the Edison Phonograph Co., with headquarters in this city, made an extensive trip to a section of his vast territory and motored as far north as Bellingham, east through the Wenatchee and Yakima valleys and down into the Walla Walla country and Pendleton. Mr. Marshall says:

"Conditions look very good and the thing that impressed me most was the optimistic view the farmers are taking of the wheat situation, crops being greater than in recent years. Dealers everywhere I visited reported increasing business, and H. E. Roberts, of Wenatchee, showed the sale of six Edison phonographs in ten days' time and says his business is greatly in excess of last year. Kinney Bros. & Sipprell, of Everett, Wash., report that their volume of business for July nearly equaled that of last December." Mr. Marshall, who also visited the Pendleton Music Shop, reports wonderful improvement in the rearrangement of this store, the enlarged floor space and additional booths adding greatly to its efficiency.

The Economy Drug & Music Co., of Pendleton, is now in its new store, one of the most attractive establishments in the Northwest. The music department occupies a separate store, which is so conveniently connected with the drug store that the whole is one store and yet entirely distinctive. Thomas Youngman does a big business and carries the Edison, Victor and Brunswick lines. He is also the agent for the American Co. line of pianos and the Gulbransen.

E. J. Condon, for six years traveler for the Edison out of Portland, and who for the past six weeks has been very ill at the Portland Medical Hospital, is reported greatly improved.

Elmer Hunt, wholesale manager of Sherman, Clay & Co., announces J. G. McKay, of Rainer, and Arthur W. Burton, of Powers, Ore., as new Victor dealers. Mr. Hunt reports the demand for the new Art Models Nos. 400 and 405, which have just been received, far exceeding his expectations. Mr. Hunt expects the drop in Red Seal record prices to materially increase business and says it will give the dealers a splendid opportunity to balance their stocks. Victor dealers are all accepting the announcement of the weekly release of supplement records beginning September 21 with great favor.

Several changes have been made in the personnel of the phonograph departments during the past month. Helen Briggs, for the past four years connected with the phonograph department of the Seiberling-Lucas Music Co., has joined the forces of the Hyatt Talking Machine Co., and C. Jellison has been placed in charge of the department and will be assisted in the record department by Alma Strayer. A. T. Erickson, formerly of the phonograph department of Murgittroyd's Drug Store, of Spokane, Wash., has taken charge of the Victrola department of the Powers Furniture Co., to take the place of P. J. Heinz, who has been in charge of the department for the past three years. Mr. Heinz resigned to join the sales force of the Powers Furniture Co., with which he was associated before taking charge of the phonograph department. Emilie Holloway, of the record department of the Wiley B. Allen Co., resigned to become the bride of Dr. W. J. January, of Oakland, Cal. Audrey White and Helen Watts have been added to the department and will assist Miss Erma Ewart, who has charge of the record department of the Wiley B. Allen Co.

F. W. Stephenson, secretary of Sherman, Clay & Co., of San Francisco, was a visitor to the local store this month on his return from a motor trip with his family to Yellowstone Park.

S. J. Scrivens, of Vancouver, B. C., and formerly with the Fitzgerald Music Co., of Los Angeles, has been added to the Victrola department of Sherman, Clay & Co.

Geo. W. Lyle, president of the Strand Phonograph Co., of Salem, Ind., was a recent local visitor, and while here he made his headquarters with L. D. Heater, distributor of the Strand phonograph in this section. While in Portland Mr. Lyle, with the assistance of Mr. Heater, closed several important Strand deals.

W. E. Henry, of San Francisco, Pacific Coast agent for the General Phonograph Corp., manufacturer of Okeh and Odeon records, and W. C. Fuhri, of New York, general sales manager for Okeh records, were also visitors to the L. D. Heater establishment. After business was transacted Mr. Heater took the visitors on the famous Columbia River Highway trip.

A. J. Kendrick, of Chicago, general sales manager of the phonograph division of the Brunswick-Balke-Collender Co., called on M. Davis, district manager, and together visited the trade.

The Vernonia Drug Co., of Vernonia, Ore., is a new Brunswick agency, with William Folger as manager.

The announcement of the installing of a pressing plant in California by the Brunswick Co., to be ready about January 1, meets with the hearty approval of the local house.

The Hyatt Talking Machine Co., which recently moved into new quarters at 386 Morrison street, advertised its new location by distributing 60,000 cards to prospective customers.

BUBBLE BOOKS Make Friends For You

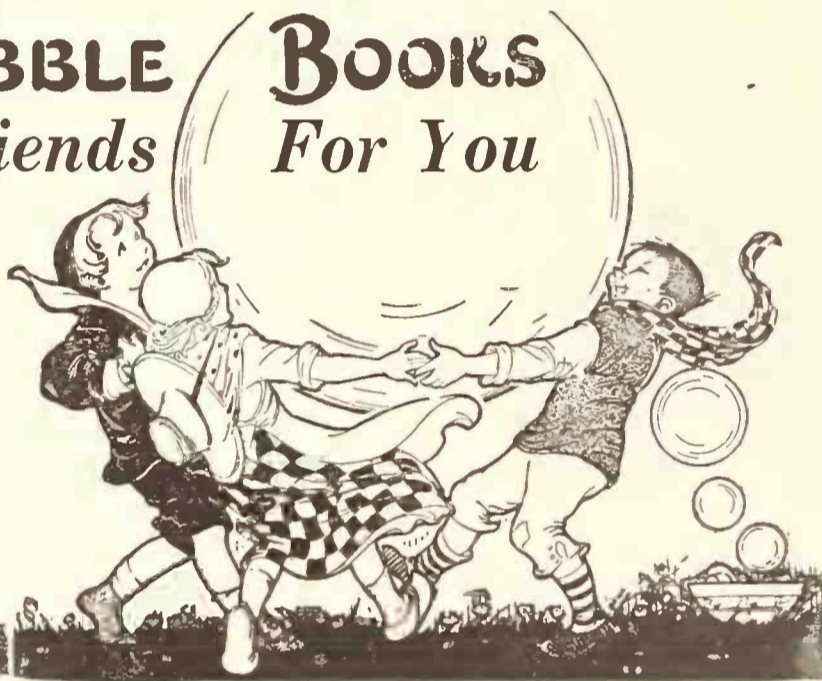

IT'S a universal human trait to trust ever afterwards the people who once prove trustworthy. So it is with a store that once wins the confidence of its customers. Bubble Books are excellent stock in trade, for this reason. Whenever you introduce them they make friends for you.

Tell your customers that all children adore the books "that sing" all the old familiar Mother Goose rhymes and games. When they take the first one home they will find out that you did not exaggerate. They have discovered that children can be kept amused for hours at a time, playing the charming records and reading the rhymes and stories that are so beautifully illustrated.

These customers will come back for another and another—until they have bought all fourteen Bubble Books. You have won their respect for your judgment. They will take your word on other merchandise.

The best way to introduce Bubble Books is through the Bubble Book Hour. It will bring customers to your store during your dull time. The children will love it—the parents will thank you—it will advertise your store throughout the neighborhood. Ask us for information about Bubble Book Hour.

BUBBLE BOOKS "that Sing"

Retail at \$1.00 a book with three records

By RALPH MAYHEW and BURGESS JOHNSON *Illustrated by Rhoda Chase*

When you sell one you sell a habit and when you sell a habit you're building business.

HARPER & BROS., Bubble Book Division

Established 1817

49 East 33rd Street

New York City

IN THE MUSICAL MERCHANDISE FIELD

SMALL GOODS POPULARITY GROWS

Many Dealers Find That Addition of Sideline of Musical Merchandise Is a Profitable Investment if Properly Handled

The last few months have witnessed a remarkable development of the popularity of musical merchandise departments among talking machine dealers, many of whom formerly looked askance at sidelines. Many dealers have installed stocks of small goods, and in most cases the experiment has proved satisfactory beyond expectations, the small capital required for such a stock, quick turnover with consequent profits and the comparatively small space which such a department occupies, enabling retailers to enter this field without great trouble and expense.

Reports emanating from various wholesalers of musical merchandise indicate that talking machine dealers generally now realize that an easy selling sideline, such as small goods, is a most profitable investment, not only for the reasons mentioned above but primarily because of the fact that experience has proved that when business in talking machines and records is inclined to be below par there is usually a fertile sales field for string and band instruments. Indeed, according to information gathered from the dealers themselves, patrons who have purchased talking machines and records are often fine prospects for the small musical instruments, and many concerns have boosted their profits materially by promoting intensive sales drives directed toward their old customers.

That the sideline in the talking machine store is here to stay is evidenced by these facts, and it is safe to say that no merchant engaged in the talking machine business can do better than by adding musical merchandise, which is especially adapted as a sideline for this type of business. Some merchants have tried merchandise foreign to the music business as sidelines, but seldom with any great success.

PAUL WHITEMAN TO PLAY IN GOTHAM

Paul Whiteman and His Orchestra, who are at present engaged in recording some of the latest dance hits for the Victor Co. in the New York studio, will appear at the Palais Royal this Fall as in former years. Mr. Whiteman will make records until September 27.

NEW B & D SUPER BANJOS

"Banjos of Quality"

JUST OUT

New Illustrated Catalogue

*There's A Reason Why
Particular Trade Buys*

B & D SUPER BANJOS

The Bacon Banjo Co., Inc.
Groton, Conn.

PROGRESSIVE CORP. ENTERS FIELD

New Gotham Concern Will Distribute Well-known Makes of Musical Instruments

A new entry into the ranks of musical instrument distributors is the Progressive Musical Instrument Corp., 319 Sixth avenue, New York City, organized several months ago, which is now prepared to deliver its products.

A long list of well-known makes of musical instruments and merchandising supplies will be distributed by this organization. Included in these are the Holton band instruments, Bacon banjos, guitars and ukuleles, M. Hohner harmonicas and accordions, Ludwig & Ludwig drums and other manufacturers' products which are nationally known.

The Progressive Musical Instrument Corp. states that it will make a special feature of twenty-four-hour shipments. It plans to appoint exclusive dealers in particular territories and, in keeping with its name, will introduce a series of new progressive ideas in the distribution of the products carried. Some of the best-known and long-experienced figures in the musical instrument and talking machine industries are members of the new organization.

OPENS STORE IN READING, CAL.

READING, CAL., September 4.—W. H. Bergh, well-known local business man, recently opened a new store in which a complete line of talking machines, records and musical merchandise is handled. Mr. Bergh has built up a large clientele through progressive business methods.

A NEW YORK INCORPORATION

A charter of incorporation has been granted to Rosenthal-Low, of New York. The concern will engage in the manufacture of musical instruments, with a capital of \$40,000. Incorporators are S. N. Rosenthal, J. Low and N. Weiss.

To Dealers:

When considering the proposition of taking on a full line of musical instruments and accessories why not give "Strings" your earliest approval. WHY? Because of small investment—steady sales—fine profits—then get the best—



'AN ASSORTED GROSS AT LESS THAN GROSS RATE'

DISPLAY CASE

For Window and Counter

Write for Introductory Offer

STANDARD MUSICAL STRING & MFG. CORP.

104 South 4th Street Brooklyn, N. Y.

HARMONICA BAND CARNIVAL

A harmonica band, composed of the boys who recently won honors in the City Harmonica Contest, was a feature of the carnival held by the Playground Division under the direction of Supervisor of Recreation of New York James B. Mulholland, on September 8. The various activities carried on in the playgrounds during the past year were exhibited.

BRUNO

THE OLDEST AND
LARGEST MUSICAL
MERCHANDISE HOUSE
IN AMERICA

Exclusively Wholesale
ESTABLISHED 1834

C. BRUNO & SON, INC.
351-53 FOURTH AVE. NEW YORK CITY

IN THE MUSICAL MERCHANDISE FIELD—(Continued from page 145)

NEW HARMONICA INSTRUCTION BOOK

Issued by M. Hohner, Contains Interesting Articles on the Art of Playing Harmonicas

Considerable interest is manifested by the trade in the new harmonica instruction book which has been issued within the last few weeks by M. Hohner, harmonica and accordion manufacturer, New York City. This booklet is complete in every detail and contains clearly written articles on such subjects as: "How to Play the Hohner Harmonica," "Playing the Scale," "Playing a Melody," "Securing Artistic and Tremolo Effects," "Obtaining an Accompaniment." A large double-page illustration shows the Hohner harmonica as featured in the Rivoli and Rialto Symphony Orchestras. Space is given to the new Hohner chromatic harmonica as well as many highly complimentary newspaper opinions of the Hohner. The booklet concludes with a highly interesting article concerning the manufacture of Hohner harmonicas.

ENLARGE BACON BANJO PLANT

Rapid Increase in Demand Compelled Enlargement of Manufacturing Facilities

GROTON, CONN., September 7.—The large and steady demand for Bacon banjos has already necessitated the erection of an addition to the factory of the Bacon Banjo Co., Inc., of this city. Work is about completed and early use of the increased facilities provided is expected. The popularity of the B. & D. super banjo is reported by David L. Day, general manager of the company, to be increasing steadily. This instrument is particularly popular with the professional player. Many well-known banjoists are proud owners of these instruments. F. J. Bacon, president of the company, and Dr. E. E. Winship, one of the directors, were recently granted a patent on a new tail piece which, it is claimed, greatly improves the tone of the banjo. This improved tail piece is already being used on the Bacon banjo.

BUEGELEISEN BACK FROM EUROPE

Samuel Buegeleisen, head of the musical merchandise wholesale house of Buegeleisen & Jacobson, 5 Union Square, New York, returned August 31 on the S.S. "Berengaria" from Europe, where he spent the Summer enjoying a rest from his executive duties.

Gretsch American Saxophones

Gretsch - American Saxophone Service

- 1—GOOD Saxophones!
- 2—24-Hour Service on Your Orders.
- 3—Generous Margin of Profit.
- 4—Advertising Literature with Your Imprint—FREE!
- 5—Cuts, Ideas for Newspaper Ads, etc., Awaiting Your Call.

Sell More Saxophones!

It's easy with Gretsch-Americans!

The splendid tone and quality of the instruments themselves—the wide margin of profit our wholesale prices permit—the prompt service we give your orders—these are all features that make it easy and pleasant to sell Gretsch-American Saxophones.

And mighty profitable too!

Ask us, on your business letter-head, for Saxophone Prices and Descriptive Catalog. For dealers only

The FRED. GRETSCH MFG. COMPANY

Musical Instrument Makers Since 1883

60 BROADWAY

BROOKLYN, N. Y.

PREPARING NEW BRUNO CATALOG

Booklet Descriptive of Lines Handled by Well-known Importers of Musical Instruments Soon Will Be Ready for Distribution

C. Bruno & Son, Inc., New York City, importers and wholesalers of musical merchandise, are preparing a new catalog which is almost completed and soon will be ready for distribution. It is predicted by the company that this new catalog will constitute the handsomest and most comprehensive piece of literature of this character ever produced by C. Bruno & Son, Inc. The timely appearance of this catalog at the beginning of what is expected to be one of the biggest Fall seasons in the history of the industry is most opportune and it will undoubtedly have a decidedly stimulating effect on the sale of Bruno merchandise during the busy season with which the trade is confronted.

SAXOPHONE HOLDER MAKES BOW

Device Recently Presented to Trade by the Fred. Gretsch Mfg. Co. Goes Over Big

The Fred. Gretsch Mfg. Co., manufacturer and wholesaler of musical instruments, Brooklyn, N. Y., has lately presented to the trade the Gretsch-American folding saxophone and combination holder. This holder, which folds up to fit any standard size music case, is adjustable in height and allows the saxophone player to adjust it to his exact requirements. The holder can be used to hold the saxophone alone or to include several combinations of musical instruments as well. The value of this holder for window display is also pointed out.

Walter Grctsch, secretary and treasurer of the organization, sailed on September 15 for the musical merchandise markets of Europe where he expects to spend some time making a careful selection of the best in European markets for the Fall and Winter seasons.

BUESCHER EMPLOYES HOLD PICNIC

Entertainment Provided Largely by Great Band Composed of Employees Themselves

ELKHART, IND., September 1.—The annual picnic of the Buescher Band Instrument Co. factory employees and their families was held last week

at Christiana Tavern. A whole day was devoted to the affair, a caravan of automobiles leaving the factory at 9:30. Entertainment was provided throughout the day by an immense band composed entirely of factory members. Two baseball games were played and other sports were enjoyed. Free coffee, ice cream and lemonade was dispensed by the company to its guests, all of whom united in declaring it the best outing ever.

FOURTYNE STORE ADDS SMALL GOODS

MEMPHIS, TENN., September 3.—A musical instrument and sheet music department will be added to the Fourtyne Music Store, 111 Madison avenue. The store has handled phonographs and records exclusively up to installing this new department and, through aggressive methods, a growing business has been enjoyed.

GOOD PROFITS

BANJOS	V E G A	TRUMPETS
MANDOLINS		TROMBONES
LUTES		SAXOPHONES
GUITARS		CLARINETS

New Catalogs—Just Out

THE VEGA COMPANY

155 Columbus Ave. Boston, Mass.

HOHNER Harmonicas and Accordions

THE WORLD'S BEST



Hohner publicity which now begins will include magazines of national circulation reaching over 50 million readers each month. Plan to benefit by this publicity.

Ask Your Jobber

M. HOHNER 114-116 East 16th Street
New York City



HOHNER PRODUCTS AWARDED FIRST PRIZE AT THE PANAMA-PACIFIC INTERNATIONAL EXPOSITION SAN FRANCISCO 1915

TO ORGANIZE BUESCHER BAND

Employes of Elkhart Band Instrument Factory to Have Own Organization

ELKHART, IND., September 4.—At a meeting of about fifty musician employes of the Buescher Band Instrument Co. last week plans were considered for the establishment of a Buescher band. The impromptu band organized by George Dierstein, cornet tester at the factory, at the Buescher picnic last week proved so successful that it has prompted the men to think of a regular factory band. Everyone was enthusiastic and agreed to do his best to make it the finest band in Indiana.

Officers elected were F. A. Buescher, president; Allan Loomis, vice-president; Homer Spicer, manager; C. A. Kline, secretary-treasurer; George Dierstein, director. A record was taken of those present and the instruments played by each man. In a talk to the men Mr. Buescher stated that the success of the band rested entirely with them.

INSTALLING NEW EQUIPMENT

Zimmerman-Bitter Co. Secures Important Contracts—Emanuel Blout Redecorating Store

The Zimmerman-Bitter Construction Co., New York, recently secured two additional contracts for the installation of its equipment; one contract calling for the renovating and redecorating of the store of Emanuel Blout at 481 Orange street, Newark, N. J. The front of the store will be remodeled and the interior redecorated in French period design. Piano rooms, record, musical instrument and sheet music departments will be installed. The company has also secured the contract for the installation of equipment in the quarters of the Musical Products Distributing Co., New York.

NEW STORE OPENS IN HARTFORD

C. W. Cain and John Vendetti, two Hartford, Conn., musicians, have opened a band instrument store to be known as the Hartford Band Instrument Co., with headquarters at 16 Market street, in that city.

A charter of incorporation has been granted to the Gaiety Talking Machine Co., of New York City, with a capital of \$5,000. Incorporators are A. Markowitz, H. Gellman and W. Haines.

JUNIOR OPERETTAS WELL RECEIVED

Vulcan Record Corp. Receives Numerous Dealer and Jobber Applications—"Little Red Riding Hood" Records Now Being Delivered—Production Facilities Increased to Meet Demand

The Vulcan Record Corp., 15 East Fortieth street, New York, which announced a new record recently known as the "Junior Operetta Series," states that it is making rapid progress in the production and marketing of these records. Deliveries of the "Little Red Riding Hood" selections are now being made and factory facilities are being increased rapidly in order to give the trade efficient service and co-operation.

In a chat with The World Fred Hedinger, secretary and general manager of the company,

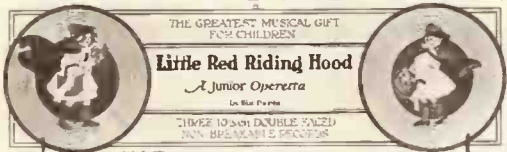

"Little Red Riding Hood" Display Sign stated as follows: "Since announcing the Junior Operetta Series, a few weeks ago, we have received applications for dealer franchises from all parts of the country. All of these applications call for good-sized orders and we are increasing our production as rapidly as possible in order to meet the requirements of the trade. We have also received numerous applications from well-known and responsible firms in the leading trade centers who are desirous of acting as jobbers for our product. In all probability we will announce the appointment of jobbers very shortly and these distributors will be given every opportunity to serve the dealers in their territories efficiently and satisfactorily.

"In addition to the 'Little Red Riding Hood' Junior Operetta records we expect to announce in the near future additional sets of records in our series, such as 'Cinderella,' 'Snow White,' 'Three Bears' and other fairly tales that are popular the world over. Judging from the enthusiastic reception accorded our first announcement there is an unlimited field for this class of records and we are gratified at the interest and response manifested by the talking machine dealers.

H. V. Lippert, music dealer, Dyersville, Ia., recently sold his entire stock of talking machines, pianos, etc., to H. R. Flammang, who has moved the music stock to his jewelry store.

"TREASURE CHEST" DEMAND GROWS

Victor Dealers in All Parts of the Country Ordering Sets of Records Selected by C. Bruno & Son Through Local Wholesalers

The hearty response which met the first appearance of the "Treasure Chest," produced by C. Bruno & Son, Inc., Victor wholesalers, New York City, continues strongly. The "Treasure Chest," it will be remembered, is an attractively cartoned set of six double-faced, ten-inch orchestral musical gems from the Victor catalog. These selections embrace music of six foreign nations. Although the first response was naturally from Victor dealers in the metropolitan territory dealing regularly with C. Bruno & Son, Inc., the demand is now also from Victor retailers in cities of all sections of the country. In accordance with the suggestion made by C. Bruno & Son, Inc., these Victor retailers are placing their orders through their local Victor distributors. Wm. J. Haussler, president of the company, reports Victor wholesalers everywhere are placing substantial orders for the "Treasure Chest." The many repeat orders now being received for the "Treasure Chest" are a visible indication of the success with which it has met, as well as its growing popularity.

IMPROVEMENTS AT FREDERICKS

Main Floor Redecorated—Audak Record Demonstration Device Added to Speed Service

UNIONTOWN, PA., September 8.—The W. P. Frederick Piano Co., this city, is undergoing extensive improvements in preparation for the Fall and Winter trade. The entire Main street floor has been redecorated and new lights and carpets are being installed. An improvement in the Victrola department is the installation of an Audak, which is the latest improvement in record demonstrating devices.

This instrument takes the place of extra booths and allows the customer to hear a record without anyone else hearing the same record demonstrated.

R. B. WHEELAN HOME FROM EUROPE

R. B. Wheelan, president of Health Builders, Inc., arrived in New York on Monday, September 10, after several months of touring Europe. Mr. Wheelan was accompanied by Mrs. Wheelan, and while abroad they visited a large number of the points of interest.

The Waltz Sensation for 1923

Goodnight!

Watch this Baby GROW!



You can't go wrong - With any 'FEIST' song

DETROIT

Prosperous Outlook for Auto Industry Is Reflected in General Good Business—News of Month

DETROIT, MICH., September 8.—Dealers around this part of the country are looking forward to record business and anticipate that each month will show up at least 100 per cent better than last year. In fact, some of the months this year have already enjoyed such a record—and business, on the whole, from January to August 31 is considerably ahead of the same period last year for everybody. Automobile manufacturers see very little let-up in production, as orders are still coming in faster than they can be handled, and there is nothing to indicate that there will be any change, except that business a little later will not be quite up to what it has been all Spring and early Summer. But this falling off is naturally expected around October, November and December. What applies to Detroit applies to all the other cities in Michigan where motor manufacturing is the biggest industry. And over in the city of Grand Rapids the furniture factories are going full speed, with indications that they will continue right through the Fall and Winter. In Battle Creek the cereal food manufacturers are busier than ever; in Kalamazoo the paper manufacturers cannot begin to take care of orders, and we could go right down the line and mention similar business conditions in every big city in the State.

This is State Fair Week in Detroit, and it is bringing many thousands of visitors from all parts of Michigan, Ohio and Indiana. It is being staged on a more mammoth scale than ever. In visiting the Administration Building the other night The World correspondent noticed a very attractive exhibit by Grinnell Bros., in which every type of Victor talking machine and all the latest Victor records were being exhibited and sold.

This being the forty-second anniversary month for the J. L. Hudson Co., special offerings are being made in the various departments, which include the talking machine division. In this department are handled the Victor, Brunswick, Cheney and Poole instruments, as well as Victor and Brunswick records.

In this issue is an important announcement by Lind & Marks Co., which is distributor for the Vocalion and Vocalion records. The announcement is in connection with the Wolverine phonograph which it is manufacturing and has been for the past three years. But only now has the firm been in a position to take on additional business, due to increased factory facilities. The Wolverine is made in two finishes—walnut and mahogany. The Wolverine portable has been a very popular seller all Summer. The other models range in price from

The
Pooley
PHONOGRAPH

The Phonograph Line That Speaks for Itself

By superior quality and value alone has the Pooley Phonograph achieved recognition and prestige. The reputation of the manufacturers for producing nothing but the best has been zealously guarded in the production of these instruments, and the high class houses now selling Pooley Phonographs are a recommendation and evidence of their excellence.

Successful and growing concerns are the ones with the ambition and purpose of securing for their customers the best for the money, and genuine values at consistent prices make sales easy, and build up a satisfied, loyal class of trade.

We offer you in the Pooley line the highest types of the artistic blending of musical instruments into fine furniture. Eight consoles and one upright style. Complete line on display at Detroit and Cleveland.

Inquiries Solicited.

C. L. MARSHALL COMPANY, Wholesale Distributors
Michigan, Ohio, Kentucky, W. Va., W. Pa. and E. Ind.

Pooley Phonographs, Outing Portables and Criterion Musical Merchandise Products
Detroit, 514 Griswold St. Cleveland, 328 Superior, W.

\$100 to \$215 retail. Lind & Marks are now selling thirty-eight accounts in the city of Detroit and about 400 in the State, which is a phenomenal showing, considering the short period of time they have been in business. A feature of the Wolverine is that a five-year certificate of guarantee goes with every machine sold, and there are many satisfied owners of these fine instruments in this section.

A. A. Fair, now special representative of the Pathé Phonograph & Radio Corp., was a recent Detroit visitor. Mr. Fair was formerly sales manager of the Jewett Phonograph Co., as well as salesman of the phonograph department of the Aeolian Co. and for several years with the Columbia Co.

J. F. Quinn, manager of The Brunswick Shop, is on a motor trip and will be back some time this month. His family is with him. They expect to visit all points in the East, including Bridgeport, Conn., the former home of Mr. Quinn, as well as New York City and Atlantic City. P. J. Gordon, manager of the store in his absence, told The World correspondent that business was coming splendidly, was far ahead of last year, and that the outlook for Fall has never been better.

Brunswick records are again being distributed locally through the Detroit branch of the Brunswick-Balke-Collender Co. This is proving of great value to the Detroit dealers handling the Brunswick, as it is giving them much better service.

R. B. Alling, manager of the Phonograph Co., of Detroit, Edison jobber, states that business has shown splendid improvement since August 15, and that everything looks good for the balance of the year. "We have sold more high priced phonographs than ever in our history during the past ninety days," he declared. "It is surprising to us where all the business came from."

HOLLENBACH BUYS EILER ASSETS

SPokane, WASH., September 4.—C. E. Hollenbach, of the Hollenbach Piano Co., of this city, who formerly was office boy in Eiler's Music House, which has been in the hands of a receiver since November last, has purchased the assets of the company from the receiver. It is reported that a financial consideration of \$20,000 was involved in the deal.

TO COVER METROPOLITAN TERRITORY

The Favorite Manufacturing Co. announces the appointment of I. Rosen to its list of sales representatives. Mr. Rosen will cover the metropolitan district where he has a large acquaintance among retail talking machine dealers. For a number of years he represented well-known talking machine products, and his long experience in serving retailers well qualifies him for his new activities.

**If the Best is the Cheapest to Buy,—
Then the Best is the Cheapest to Sell.**

Music lovers everywhere recognize that only the New Edison can give real music; for it is the only phonograph that actually Re-Creates the artist's performance. Its realism is so profound that the music critics have been unable to distinguish the original from the Re-Creation.



Write us for our latest agency proposition

The Phonograph Company of Detroit

Distributors for Michigan and Northern Ohio

1540 Woodward Avenue

Detroit, Michigan

The NEW 1924 Models of the

Wolverine

PHONOGRAPH

We have just now some very attractive and profitable territory open, we might suggest early application.

Best materials obtainable, made as good as humanly possible and priced moderately—The Wolverine.

The Standard of Comparison



Model 505
Height 46 inches
Width 21 inches
Depth 22 inches **\$100**

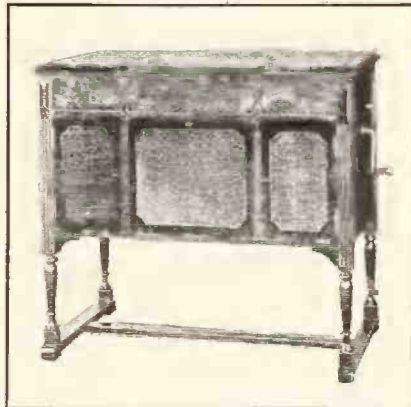

Model 800 Tudor Console
Two views of this Tudor Period Console, showing instrument open and closed.
Height 34 inches Length 38 inches Depth 22 inches **\$175**



Model 400 Queen Anne Console
Height 35 inches
Length 36 inches
Depth 21 inches **\$125**



Model 300 Sheraton Console
Height 35 inches
Length 34 inches
Depth 21 inches **\$100**

THREE advantages to the dealer stand out prominently in our line. First, of course, is quality such as you can guarantee to the trade and backed by our certificate of guarantee.

Second, is popular price, which brings our machines into a wider range of homes.

Third and highly important, is the larger profit in a dependable Phonograph.

When we say "The Standard of Comparison" we mean that the Wolverine, placed side by side with any machines made, will stand out in a manner to delight the true lover of music.

Equipment of the Wolverine

Only the highest quality of materials are used in Wolverine cabinets and the workmanship cannot be surpassed.

The Universal Tone Arm plays all records.

Automatic stop, scientific tone modifier and all exposed metal parts heavily plated with nickel.

Our models 270-800 and our Louis XV Console come with full set of Albums.

The 800 model and Louis XV Console have all metal gold plated.

The Wolverine line is not a new or experimental one, but has been successfully on the market over three years.

This is the first time our production has increased sufficiently to allow us to advertise.



Model 900 Stuart Console
Height 35 inches
Length 36 inches
Depth 21 inches **\$150**



Model 600 Adam Console
Height 35 inches
Length 36 inches
Depth 21 inches **\$125**



Louis XV Console
Height 35½ in.
Length 40 in.
Depth 23 in. **\$215**

All machines shipped direct from Cleveland or Detroit. Address all communications to offices at Detroit.

Manufacturers of the Wolverine Phonographs and wholesale distributors of Aeolian Vocalion and Vocalion Red Records.

LIND AND MARKS CO.

Congress and Bates Streets

DETROIT, MICH.



Another Superior Point for THE NEW COLUMBIA

When you have played a record through to the very last note, the New Columbia motor comes silently to a stop. The *new*, non-set, automatic stop does it. There is nothing to adjust! And it stops any record, long or short—of any make—with wide or narrow playing surfaces—every time!

COLUMBIA GRAPHOPHONE CO.
New York

ALBANY

*Traveling Music Shop on Wheels
Boosts Sales—Many Fair Exhibits
—Other Activities of the Trade*

ALBANY, N. Y., September 7.—The first traveling music shop on wheels was started out last month by the Baker Music House and it is not only attracting considerable attention along its routes, but is expected to call the attention of dealers to a new method of advertising and getting business. The new store is a big truck mounted on a Ford chassis, with portable steps in the rear. It is fully equipped with a Story & Clark player-piano, upright and console models of Columbia phonographs, Starr table instruments and Columbia portables, a line of Lyon & Healy musical merchandise, Conn cornets, saxophones and other band instruments, as well as all music supplies. It is used principally in the country districts, each farm house being visited and the occupants invited to enter and listen to the latest records and piano rolls. The interior is prettily decorated with chairs and settees for prospective customers and, with two large windows, makes a cozy "store." All country picnics and public entertainments are attended and music supplied for dancing and entertainment. E. T. Leary, formerly of the Utica Baker store, and George H. Lehr, of the Albany store, are in charge. The

truck has been well received by the farmers and the Baker delivery trucks have been kept busy following up the "store" making deliveries. O. E. Kellogg, general manager of the Baker Music House, is enthusiastic over the success of the experiment and is already planning more "wheel stores" for next Summer. Concerning the Fall business outlook Mr. Kellogg says he believes the sales in all lines handled by his firm will be limited only by the amount that can be secured from jobbers and manufacturers and that a shortage is already being experienced in many lines. The business of the past Summer, he says, has been the best in history.

Dealers Exhibiting at Fairs

Many of the local dealers are exhibiting their lines at the country fairs and consider it an excellent method of obtaining prospects for future sales. The Baker Music House is having an exhibit at all the fairs within the territory served by its branch stores. At the Hudson Falls Fair Starr phonographs and Remington and Story & Clark pianos were shown. It was in charge of Juan Silva, manager of the Baker Glens Falls store, assisted by Howard Brazee, of Albany, and Chris Cummings, manager of the Green Island store. At the Balston Spa Fair radio was strongly featured, being in charge of R. C. Garbardt, manager of the radio department of the Baker stores; Howard Brazee, and W. G. Webster, manager of the Balston Spa store. Columbia talking machines were exhibited. The exhibit at the Chatham Fair was in charge of J. T. Rider, manager of the Hud-

son store, and Columbia phonographs and pianos were shown. The Thomas Music Store will only have an exhibit at the Altamont Fair. It will be confined to all models of Victrolas and will be in charge of F. M. Hulett, Herbert Earl, Willard Marshman and Alfred Garrison. McClure & Dorwaldt will have exhibits at the Cobleskill and Altamont Fairs of Victrola and Sonora models. Mr. McClure will be in charge of the Cobleskill exhibit and Mr. Dorwaldt at Altamont. The other dealers believe the advertising and resulting sales are worth the cost of the exhibits.

Joseph Kennah Promoted

Joseph Kennah, who has been associated with Henry Pommer & Sons since the inception of the present business two years ago, has been placed in charge of a new department as service manager. Mr. Kennah plans to call on every purchaser of a talking-machine several times a year and see that the phonograph is working properly and he will take orders for new records. The Raleigh, the latest Brunswick console model, is expected to be a great seller. The Pommer store recently installed a new line of Emerson records.

Edison Dealers Busy

Edison dealers throughout the territory covered by the American Phonograph Co., Edison jobber for this territory, with headquarters in this city, are doing a good business. This is evidenced by the volume of orders being received by the American Phonograph Co., and the demands of the dealers for instruments indicate, also, that they are anticipating a good Fall business and are preparing accordingly.

The "Upright or Console" Problem

The question of the extent of the demand for upright models of talking machines the coming Fall and Winter season, because of the attractive new console and period models, will be a serious one with dealers in placing their orders. L. H. Schutter, manager of the Thomas Music Stores, recently sold three upright Victrola models in one day, each of the purchasers making the selection in comparison with consoles at the same price. Mr. Schutter said he was inclined to place but few orders for uprights, but the one day's experience has convinced him that the older styles are not to become obsolete, but will continue to be the choice of many purchasers, and he is considering making one-half of his order of the older styles.

Al Edelson, of the Strand Temple of Music, has returned from New York City, where he placed a large order for phonographs for the Fall trade. He said he believed there would be a lessened demand for the upright models, but he selected about one-third of these types. He and Mrs. Schutter are enthusiastic over Fall business prospects.

Stage Anniversary Business Drive

McClure & Cowles have had a very successful fifteenth anniversary drive for business on Victrolas, Sonoras, pianos and players. The business the past Summer is reported as having been the best in the fifteen years since the firm was founded.

EDISON—

The Key to Opportunity!

Do you know that right now—this very day—in your town, the opportunity to develop a highly profitable Edison business is before you?

You should know—and you should act.

Nominate yourself for this opportunity of profit before it is too late. Find out all about this "once-in-a-lifetime" Edison sales opportunity.

Write or telephone today. Don't delay finding out all you would like to know about an Edison franchise.



AMERICAN PHONOGRAPH CO.
707-09 BROADWAY, ALBANY, N. Y.

Emerson Records

Fifty Cents Retail



IRVING AND JACK KAUFMAN

The Emerson Record is the only record being sold today at popular prices on a policy which protects the high-grade phonograph dealer from undesirable competition.

The Emerson Record is the **ONLY RECORD** on the market today which is being sold universally at **FIFTY CENTS** retail.

The Emerson Record in most part is recorded by **EXCLUSIVE EMERSON ARTISTS** on a par with those recording the highest priced popular records.

The Emerson Record is out first with all the American Song Hits of the day.

The Emerson Record has a very large foreign catalog in Italian, Jewish, Polish, Russian and German.

The Emerson Record is sold only in phonograph shops doing business according to the best ethics and standards of the phonograph trade.

The Emerson Record at fifty cents retail nets the dealer the same margin of profit he receives from standard phonograph records retailing at much higher prices.

LATEST IRVING AND JACK KAUFMAN RECORDS

- 10657—Just a Girl That Men Forget
That Old Gang of Mine
- 10661—I've Got the Yes! We Have No Banana
Blues
Three Thousand Years Ago
- 10649—Cut Yourself a Piece of Cake
Hi-Lee Hi-Lo
- 10614—Beside a Babbling Brook
Ten-Ten-Tennessee
- 10594—Who's Sorry Now?
Any Place That I Make Money Is Home,
Sweet Home, to Me
- 10590—No One Loves You Any Better Than
Your M-A-M-M-Y
Crying for You
- 10581—Little Rover
New Hampshire
- 10572—Way Down Yonder in New Orleans
Way Down East in Maine
- 10571—Honeymoon Time
(Baby Blue Eyes)
- 10565—Porcelain Maid
Crinoline Days

Clip the attached coupon, fill out and mail to us. We will send you a dealer's application and very interesting information as to the policy under which the Emerson Record is now sold, together with a catalog of our latest American and Foreign records.

Emerson Phonograph Company, Inc.
105-111 West 20th Street
New York City

Please mail me at once full information as to your Agency proposition on the Emerson Records at Fifty Cents Retail, together with the details of the policy under which this record is sold.

FIRM

STREET

CITY

STATE

W. D. ANDREWS CO.

DISTRIBUTORS OF
VICTROLAS and VICTOR RECORDS

"Service That Satisfies"

SYRACUSE, N. Y.

IN SYRACUSE

Exhibits at Fairs Occupy Attention of Retailers—Planning Fall Drive—M. Doyle Marks Co. Remodels—Trade News and Activities

SYRACUSE, N. Y., September 7.—Business in this city and environs has held up in a satisfactory manner, according to reports of retailers and wholesalers. The Fair season is now in full sway and dealers in this section of the State have been taking advantage of the opportunity of displaying their lines in attractively arranged booths, which, in most instances, have proved the equal in drawing power of the other exhibits. While sales traceable directly to the fair displays have not been many, some immediate sales were made. What is of greater importance, however, is the fact that in all cases dealers succeed in securing the names of considerable numbers of live prospects, which they vigorously follow up by means of outside salesmen and direct mail. The effect of these campaigns is cumulative and thus the exhibits return excellent dividends for the trouble and expense involved.

The influx of orders being received by wholesalers indicates that dealers are ordering their

Fall and early Winter stocks in anticipation of the usual seasonal buying revival. On the whole, there is much reason for optimism in this territory over the business outlook at the present time.

Make Exhibit at Trumansburg Fair

The Stover-Updike Hardware Co., of Trumansburg, N. Y., Edison dealer, had a very handsome exhibit at the Trumansburg Fair during the week of August 13. Frank E. Bolway & Son, Inc., who are the Edison jobbers for this zone, have been co-operating with the different dealers who are exhibiting at Fairs and had one of their representatives, John Essig, Jr., spend two days at the Trumansburg Fair, assisting the Edison dealer.

Big Increase in Edison Business

A representative of Schuderer & Castle, Edison dealers in Rome, N. Y., who was in the office of Frank E. Bolway & Son the other day, stated that their Edison record business from August 1 to 10 inclusive amounted to more than

their entire August, 1922, record business. They have been making quite a drive on attachments among the talking machine owners, making it possible to play Edison records on all makes of talking machines and, as a result, their record business has increased considerably. Schuderer & Castle state that one of the reasons for their record business increasing to such an extent is that the Edison Laboratory has been getting out the "hits" long before the public has sickened of them and turned to later numbers released by music publishers.

Gibson-Snow Co. Planning Fall Drive

The Gibson-Snow Co., Sonora jobber, is making plans for a banner Fall trade and the members of the company's sales staff are asking Sonora dealers to anticipate their Fall requirements as much as possible. Practically every Sonora dealer in this territory is keenly optimistic regarding the outlook for Fall business and good-sized orders are being received from the retailers throughout this section of the State. The Gibson-Snow travelers state that not only are the dealers placing orders, but the merchandise is moving, which is a very satisfactory condition. One of the interesting features of Sonora activities the past month has been the enthusiastic reception accorded the July-August issue of the Sonora Bell, the house organ issued by the Sonora Phonograph Co. This number contains valuable selling helps for the dealers and the Gibson-Snow Co. has a number of extra copies on hand which it will be glad to distribute upon request.

Bolway Enlarges Edison Representation

Frank E. Bolway & Son, Inc., Edison jobbers, have started a campaign to enlarge their representation and plan to take on several new dealers during the next two or three months. During the past week they report that Wallace J. Vastbinder, of Seneca Falls, N. Y., who has just opened up a very nice music store, has signed up as an Edison dealer. W. H. Griffin, of Norwich, N. Y., also is now handling the New Edison. Other new accounts opened include H. J. Hunter, Parish, N. Y.; Bowman & Jones, Cleveland, N. Y.; M. C. Benson, Hastings, N. Y.; A. E. Olmstead & Son, Orwell, N. Y. F. E. Bolway & Son report that they have numerous inquiries for the Edison line, which goes to show that it is steadily becoming better known by the buying public and merchants are realizing this demand.

Victor Dealers Doing Good Business

The W. D. Andrews Co., Victor wholesaler, with headquarters in this city, has been enjoying an excellent business and present indications are that the Fall business will be very satisfactory. Victor dealers throughout this territory are taking advantage of every opportunity to increase their sales and this activity has kept the business volume up to par thus far this year.

M. Doyle Marks Co. Remodels
Extensive remodeling of the establishment of

The "Wise" Sonora Dealer Is Ordering His Machines NOW



SERENADE SONORA

There is going to be a shortage of Sonora product this Fall, and the wise Sonora dealer will be making a profitable move if he places his orders as far in advance of October 15th as possible.

This suggestion is offered after receiving reports from all parts of our territory, and we have no hesitancy in predicting that the 1923 Fall months will be a banner Sonora season. Are you equipped to get your share?

GIBSON-SNOW CO., Inc.
SYRACUSE NEW YORK

the M. Doyle Marks Co., Elmira, N. Y., Victor and Edison dealer, was recently completed and this concern now has one of the most up-to-date stores in the vicinity. The record department has been moved to the first floor and the entire second floor is used for the display of an extensive line of talking machines.

OSCAR W. RAY HOME FROM EUROPE

General Manager of Vocalion Division of Aeolian Co. Returns From Extended Tour of Europe—Makes Important New Contract

Oscar W. Ray, general manager of the Vocalion Red Record Division, of the Aeolian Co., returned on Monday, September 3, on the "Leviathan," from an extended tour through Europe, occupying over three months, in the course of which he looked after the business interests of the Aeolian Co. in London, Berlin and Paris and, incidentally, he studied existing business conditions in England and also on the Continent.

In discussing business conditions in Europe at present Mr. Ray stated that the politics, exchange and business situation generally, among the various nations, were changing so rapidly that it was impossible to prophesy with any accuracy the outcome. He declared, however, that there was every indication that the interest of America and its co-operation are needed by European nations to bring them out of the present state of chaos.

In a brief interview Mr. Ray said: "During my travels I had a wonderful opportunity to hear the music of Europe and witness the important part that it has in the lives of the people on the Continent.

"Many important contracts were made for the Aeolian Co. for the exclusive right to leading artists of Europe for Vocalion Red records, and a special announcement will be made in regard to these contracts at a later date. We are now equipped and prepared for the biggest year in the history of Vocalion Red records, and our dealers may be assured a most successful future."

The NEW EDISON

in

New Models, New Prices

EDISON FEATURES

Permanent Diamond Point Reproducer.
Plays all Makes of Records Better.
Edison Records Play Longer, Wear Longer.
New Improved Records.

Dealers proposition submitted upon request

Frank E. **BOLWAY** & Son Inc.

SYRACUSE

Jobbers

Est. 1889

F. WOODS WITH STARR LABORATORY

Frederick Woods has succeeded Thos. Griselle as musical director of the Starr Recording Laboratory in New York where Gennett records are made. Mr. Griselle was forced to resign on account of illness.

A Brunswick phonograph has been installed in the Saratoga Springs, N. Y., training quarters of Jack Dempsey, heavy-weight champion prize fighter of the world, who is at present training for his bout with Luis Firpo, the "wild bull of the Pampas."

M. I. S. CO.'S NEW "CUT" BOOK

Victor Wholesaler Issues Second Edition of "Cut" Book—Attractive Illustrations for Dealers' Publicity Make Book Valuable

The advertising department of the Musical Instrument Sales Co., New York, Victor wholesaler, has just prepared the second edition of M. I. S. Victrola illustrations for use by Victor dealers in their printed advertising. This book

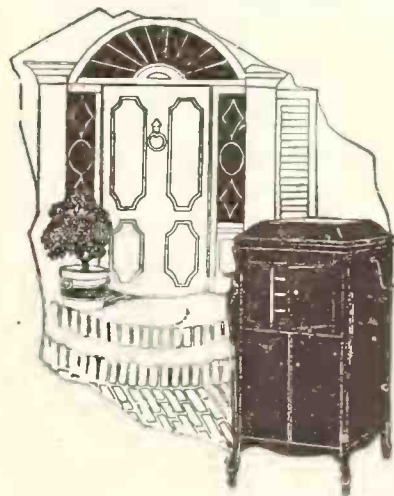

Illustration in M. I. S. Co.'s New Book contains a unique assortment of especially designed plates and matrices which effectively feature the Victrola and which provide the dealer with material for a whole year's advertising campaign.

The wide popularity and success of the first edition of the M. I. S. cut book demonstrated the value of this service to the Victor dealers and influenced the publication of the second edition. All of the illustrations in the new edition (with very few exceptions) are entirely different from the previous book, depicting the current model Victrolas in an attractive and impressive way. It is suggested that the dealers consider the use of these illustrations in newspaper advertisements, mailing cards and folders, letter-heads and envelopes, seasonal circulars, bill heads, etc.

**Are You Selling
In Great Britain?**

The very thing for all out to cultivate a big export trade is to get within the vision of the Buyer's Eyes. His exclusive notice is worthy of a special effort to gain, and that is why we invite You to very carefully consider one of the best Export Trade Opportunities ever submitted.

For many years past, the English publishing house of G. D. Ernest & Co. has issued a valuable trade work—

The Music Trades Diary, Year Book and Directory

It carries the advertisements of representative British firms, and the 1924 edition should most certainly include an announcement of your products.

Its circulation covers United Kingdom dealers in music and all kinds of musical instruments; also large buyers in the Colonies and foreign countries.

Thus are the markets of the world thrown open to You in the most direct way—not for one week, but for twelve solid months.

If you write at once there is just time to hear more about it before finally deciding the amount of advertisement space you will require. Ask for our prospectus on the subject.

G. D. ERNEST & CO.

Bessemer House, Duke Street, Adelphi, London, W. C. 2.

The Waltz Sensation for 1923

Goodnight!

Watch
this Baby
GROW!



"You can't go wrong - With any FEIST songs"

VICTOR JOBBERS DECIDE OWNERSHIP OF GOLF TROPHIES

Golf Matches Held at Sea View Club on September 5 to Determine Final Possessor of the Johnson and Blackman Cups—Lew Collings Wins First and Fred Oliver Second

ABSECON, N. J., September 6.—In order to determine who were entitled to the final possession of the Johnson cup and the Blackman cup, two valuable trophies offered to stimulate interest among the golfers in the ranks of the Victor talking machine jobbers, the one presented by President Eldridge R. Johnson, of the Victor Talking Machine Co., and the other by J. Newcomb Blackman, head of the Blackman Talking Machine Co., New York, two lively golf matches were held at the Sea View Club here recently, participated in by those who in former tournaments had won legs on the prospective cups.

The contestants for the Johnson cup were Lew Collings, of Collings & Co., Newark, N. J.; French Nestor, of the French Nestor Co., Jacksonville, Fla., and C. A. Grinnell, of Grinnell Bros., Detroit, and the play was decidedly close, despite the fact that Mr. Grinnell had just about recovered from a recent illness and was not in

his best form, although he insisted in carrying on. Thirty-six holes were played, with the result that Collings came through with a gross net score of 178, Nestor with a gross of 186 and a net of 180, and Grinnell with a gross of 194 and a net of 186. The match was actually won in the last nine holes, in the course of which Collings played four holes in par and came through with a score of 40.

The contestants for the Blackman cup were Louis Buehn, of the Louis Buehn Co., Philadelphia; Fred P. Oliver, of the Blackman Talking Machine Co., New York, and C. G. Campbell, of the Knight-Campbell Co., Denver, Col. The latter, being unable to attend, relinquished his claims to the cup and the match was played off by the remaining contestants. Both Buehn and Oliver played a close game, with the result that Buehn, without a handicap, brought in a score of 190, while Oliver, with a handicap of 16, came through with a net of 188. At the

twenty-seventh hole Buehn had caught up on Oliver's handicap and had him one up, but the latter put up a startling finish, taking three of the final line holes in par. An interesting feature of the play was that the contestants in both matches were even at the thirty-fourth hole, the cups being won by one stroke each in the thirty-fifth and thirty-sixth holes.

The arrangements for the tournament were under the direction of J. C. Roush, of the Standard Talking Machine Co., Pittsburgh, whose success in determining the handicap was evidenced by the close play. Mr. Roush himself acted as scorer and referee in the play for the Johnson cup, while W. F. Davisson, of the Perry B. Whitsit Co., Columbus, acted in a similar capacity for the Blackman match.

The cups were presented to the match winners at the clubhouse at the conclusion of the tournament, following which the contestants were the guests of Mr. Roush at dinner. The day following the majority of those who participated in the play or attended the matches visited the Victor factory in Camden.

APPEAL TO HELP L. P. VALIQUET

Veteran Phonograph Inventor Has Been Ill for Eight Months—S. A. Ribolla, in Letter to the Trade, Appeals for Assistance

CHICAGO, ILL., September 5.—S. A. Ribolla, general manager of the General Phonograph Corp. of Illinois, with headquarters in this city, has sent a letter to the trade appealing for assistance in behalf of L. P. Valiquet, one of the veterans of the phonograph industry, who had been seriously ill for a period of about eight months. In his letter Mr. Ribolla states: "Mr. Valiquet's illness cost him about \$4,000 and his financial resources are now entirely exhausted. He is not entirely recovered, but he is able to be about for several hours each day, although he is in no position to do any lucrative work. As he is one of the real pioneers in the phonograph industry in this country I believe that a great many members in this trade will respond to this appeal if their attention is called to Mr. Valiquet's plight. I would suggest that any subscriptions be mailed direct to L. P. Valiquet, 5472 Everett avenue, Chicago, Ill."

Mr. Valiquet's experience in the talking machine field dates back to 1898, when he completed a disc talking machine and record which was placed on the market under the name of "Zon-O-Phone" and which won popularity the world over. He afterwards devoted considerable time to designing and constructing spring motors for illustrated song and picture machines and, in more recent years, was connected with the Aeolian Co., General Phonograph Corp. and the Krasberg Mfg. Co.

STANDARD CO. DEALERS TO MEET

Standard Talking Machine Co. to Hold Convention of Victor Dealers Next Month

PITTSBURGH, PA., September 7.—The meeting of the Victor dealers in this territory, planned for the present month under the auspices of the Standard Talking Machine Co., has been postponed until October at a date to be announced later. The meeting will be devoted almost entirely to a discussion of ways and means for organizing and handling successfully crews of outside salesmen and the chief speaker will be Martin L. Pierce, of the Hoover Suction Sweeper Co., who will tell of the methods pursued by his company. A Victor factory official is also scheduled to attend the meeting.

NEW STORE IN MARLBORO, MASS.

MARLBORO, MASS., September 8.—B. C. Taylor, who has been engaged in the music business in New Hampshire for many years, has just opened a new music store here at 195 Main street. The concern will be called the Brunswick Shoppe and will carry Brunswicks.

—here's the newest phonograph toy

THE PHONOGRAPH PHOLLIES

The Cop, the Dancer, the Comedian, the Clown and Jenny, the Mule—O, they're funny! The Comedian makes love

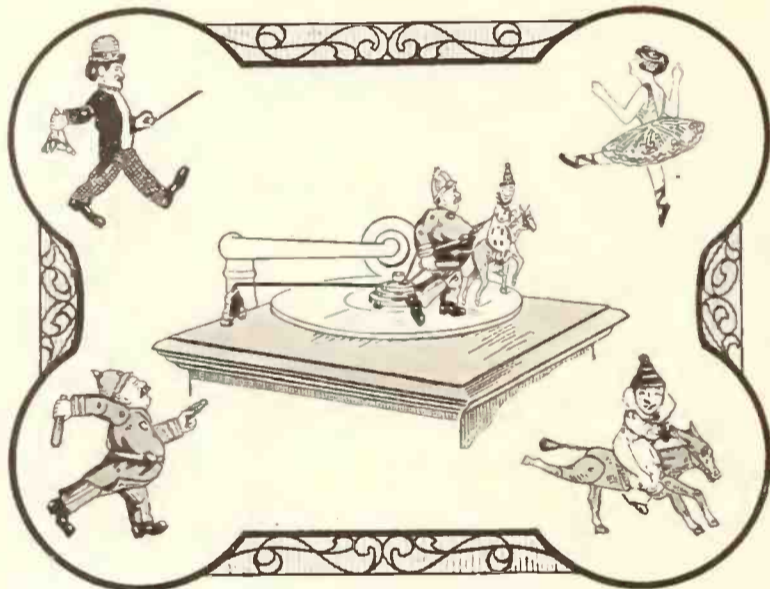

to the Dancer; the Mule tries to throw the Clown and kicks off the Cop's hat. The Cop finally runs the whole bunch in.

Here Are The Other National Funmakers

THE MAGNETIC DANCERS — They waltz, fox-trot or two-step like a couple on a ballroom floor. Price \$1.00

THE RASTUS FAMILY — Don't miss these favorites—

Ragtime Rastus, Price \$1.25

Boxing Darkies, Price \$1.50

Shimandy... Price \$1.65

THE FIGHTING ROOSTERS—My, but they're a scrappy pair! Price \$1.65

Order the Full Assortment. You can sell them all as easily as one.

You Can Build Up A Splendid Holiday Trade With These National Toys

THEY take up small space and they SELL SWIFTLY. Put them in your windows and watch the crowds gather.

Order a few just as a starter. You'll be surprised how quickly they'll go. Phonograph Phollies (set of 5 figures) sell for \$1.65. Combination of Comedian and Dancing Girl, \$1.00; Cop and Clown, \$1.00.

Usual Trade Discounts.

NATIONAL CO. BOSTON MASS.

108 BROOKLINE STREET

CAMBRIDGE, MASS., U. S. A.

**FOURTEEN ELABORATE NEW ART MODEL VOCALIONS
BY NOTED DECORATORS ANNOUNCED BY AEOLIAN CO.**

Seven Leading Decorators of New York and London Lend Talents to Creation of Notable Series of Cabinets—Extensive Campaign in High-class National Magazines Launched

The wholesale Vocalion phonograph division of the Aeolian Co. has just announced to the trade the addition of a series of fourteen most elaborate special design period models, each model the work of a decorator of international prominence and representing the finest examples of the cabinetmaker's art. These fourteen new models, each distinctive in itself, will prove welcome additions to the company's regular line of upright and console period models and will be calculated to enable the Vocalion dealer to appeal to the most exclusive clientele.

The new models, five of which are reproduced herewith, are unusually elaborate and in their designing seven famous decorating houses have had a part, among them Wm. Baumgarten & Co., D. S. Hess & Co., the Tiffany Studios, Wm. Pierre Stymus, Jr., H. F. Huber & Co. and W. & J. Sloane, of New York, and Charles, of London. Each of the new models not only represents an impressive development of the decorative art, as applied to phonograph cabinets, but is based upon some authentic period creation, several of the designs being copied in whole or in part from some antique of definite standing.

Several of the special period models are at present on display in the Vocalion showrooms at Aeolian Hall, New York, and have attracted a great amount of attention from visitors. In a short time the company will begin shipping the new models to its retail representatives, who, as in the case of all Vocalion phonograph products, will be supplied by the company direct.

In presenting the new styles to the public the Aeolian Co. has arranged for a most elaborate advertising campaign on a particularly high-class basis, running four-page inserts, with the various art period styles reproduced in seven or eight colors, in a number of the leading magazines of the country, particularly those known for the exclusive character of their circulation. Among the publications in which the supplements will appear will be Scribner's, World's Work, Atlantic Monthly, Harper's, Century, Review of Reviews, Architecture, Art and Decoration, Country Life, Garden Magazine, House Beautiful, Vogue, Vanity Fair and House and Garden, representing a total circulation of several millions monthly going into the finest homes in the country.

The creation of the various special period models has been the work of months, from the time the original sketches were prepared by the various decorators until all details were completed and the work of building the special cabinets finally finished. Not only will the new models enable the dealers to appeal to the most exclusive and aristocratic trade in their territories, aided materially, of course, by the national magazine advertising of the company and the follow-up and service aids calculated to benefit the dealer directly, but they will open the way for making the Vocalion a factor in the decorative field, practically all the cabinets being designed to fit in well with elaborate home treatments created and carried out by the prominent decorators themselves.

The rich carvings, the hand-painted panels,

the lacquer and the gold leaf that are found in the various cabinets lend distinction and richness to the design, and the new models as a whole serve to complete and round out the extensive Vocalion line as it is at present con-

period styles in color is now in course of preparation and will be ready for distribution shortly.

The mechanical equipment of the various new art models is also of special and elaborate character. The motors are electrically operated and each model is provided with a decorative electric light to facilitate the changing of needles. The turntables are covered with rich velour, as are the turntables of all Vocalion machines, and are designed to facilitate the removal of records. All visible metal parts are



Five of the New Special Art Model Vocalions

- 1—Chinese model with base in Georgian style of hand-carved wood finished in gold-leaf antique. Chest of Japanese lacquer with flat decorations hand-painted and relief decorations of composition applied with brush. Hinges of bronze hand-chased. Designed by Wm. Baumgarten & Co., New York.
- 2—Commode design in Georgian period of mahogany with matched veneers. Back also finished. Designed by D. S. Hess & Co., New York.
- 3—Italian period model of hand-carved walnut. Upper section for Vocalion and records. Lower section for Duo-Art rolls. Designed by D. S. Hess & Co., New York.
- 4—Commode in Eighteenth Century Venetian design. Body hand-painted and glazed. Interior in glazed ivory antique finish. Designed by Wm. Baumgarten & Co., New York.
- 5—Commode design in Adam style of satinwood with delicate inlay. Doors decorated with hand-painted floral plaques. Designed by Tiffany Studios, New York.

stituted. In addition to the reproductions shown in the layout on this page there are others to be found in the supplement of the Aeolian Co. appearing elsewhere in this issue. A brochure showing the complete range of fourteen special

gold-plated and each model bears a small brass plate upon which appears the name of the designer, a feature which it is believed will appeal to those of discrimination who purchase instruments for their artistic values.

STYLUS BARS

Stylus Bar & Mfg. Co.

Clague Rd.

North Olmsted . . . OHIO

P. O., ROCKY RIVER, O.

Phonograph Parts and Supplies

MOTORS, TONEARMS, SOUNDBOXES, SPRINGS AND NEEDLES OUR SPECIALTY

Lowest Prices and Best Qualities Always Available for Delivery Anywhere

Send for Bargain List of Repair Parts and Motors

THE VAL'S ACCESSORY HOUSE

1000-1002 Pine Street

St. Louis, Mo.

"You can't go wrong
With any FEIST song"



© LEO FEIST Inc.
N.Y.C.

HI-LEE HI-LO

日來來來與與與與
(Which means in Chinese -I LOVE YOU)

GET it you'll LIKE it

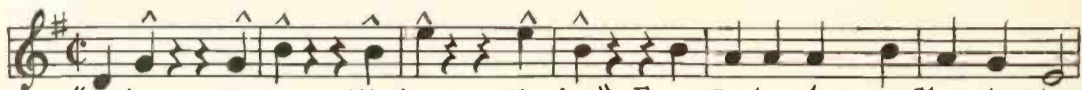

"Hi Lee, Hi Lo, Hi Lee Hi Lo," From Pe-kin down to Shanghai town.

NEW ORLEANS

Maison Blanche Launches Essay Contest—Brunswick Co. Leases New Home—W. F. Nipper Now With House of Werlein—Month's News

NEW ORLEANS, LA., September 5.—Under the direction of J. D. Moore, manager of the musical department of the Maison Blanche Co., there was launched on September 1 a business, as well as a strong interest-creating campaign, that is expected to materially develop the department and substantially aid the month's trade totals. The idea, as formulated, amounts to this: The house possesses a slogan, "It Makes a Difference Where You Buy Your Victrola or Brunswick." This statement will be altered so as to read, "Why Does It Make a Difference Where You Buy . . . ?" That question will constitute the subject of a brief contest essay to be not more than 100 words in length and open to the general public, exclusive of employes of the company. Prizes amounting to \$385 will be awarded for the four best answers received. The contest will continue through September 30 and the winners will be announced as soon after the first of October as it is possible for the judges to determine the quartet of leaders. The first prize offered will be a \$200 talking machine; second prize, a \$150 talking machine; third prize, \$25 worth of records, and fourth prize, \$10 worth of records.

"In order to submit an intelligent, comprehensive paper in the competition it will be necessary for the contestants to visit the store and obtain, to the best of their ability, some idea of the methods used in the conduct of our business. We expect to draw a great many people who, possibly, would not otherwise visit the store or the department. Should our surmises prove to be correct, we will be amply repaid for our efforts," Mr. Moore stated.

New Edison Accounts

Last week Manager W. W. Twigg, of the Diamond Music Co., local Edison jobber, succeeded in naming three additional country representatives for Edison machines, records and accessories: F. W. Gatlin, of Poplarville, Miss., and the Collins Furniture Co., of Collins, in the same State. The third new dealer was Goldby's store of Amite City, La.

Heavy Edison Orders From Texas

An influx of heavy ordering from Texas points has been recorded on the firm's books of late. The Oliver Music House, located in Houston, Tex., and one of the new dealers in Edisons, has besought Mr. Twigg to supply them with a very large stock for the Christmas season. They

explained that their order had been turned in at such an early date in order to prevent future inability to obtain the goods which they feel are going to be needed very badly. They predict a great demand for Edisons in Houston and vicinity this Fall and Winter. The Jesse French Piano Co. also used every available means of communication to insure ample stock to meet the requirements which they feel certain are coming. The Heidelberg Furniture Co., of Jackson, Miss., though barely thirty days old, as far as handling Edisons is concerned, has virtually doubled initial orders.

The retail division of the company, under the direction of Mr. Billiet, is also showing pleasing gains. The console models continue to stand pre-eminent in the machine sales records of this progressive house.

Lease New Home for Brunswick Co.

F. W. Jackson, manager of the St. Louis office of the Brunswick Co., was in the city for a few days, attending to some matters of business affecting the future quarters of the New Orleans sub-station. Mr. Jackson succeeded in concluding a lease for a long period on the building at 228 Bourbon street. This building, which contains a great deal more floor space than the present location, will become the permanent home of the branch October 1. It is situated closer to the important commercial section of the city, and is therefore more accessible to Brunswick dealers. This is expected to facilitate the exchange of business between both parties. Incidentally, it might be mentioned here that C. A. Reynolds, formerly connected with the Brunswick Kansas City office, has been transferred to New Orleans. Mr. Reynolds will make this city his headquarters and travel throughout the territory in the interest of the trade. Frank Allen has been appointed city sales manager of the branch. He will look after the office duties as the direct subordinate of Mr. Reynolds.

Dwyer Piano Co. Busy

James T. Dwyer, president of the Dwyer Piano Co., returned recently from a several weeks' vacation spent in the North Carolina mountains. Reports from Mr. Dwyer's house are to the effect that they feel that they are coming in for their share of the business now in circulation. The upright models of Victor machines showed a sudden, although brief, rise to popularity, figuring in one or two business transactions made by the Dwyer Co. One customer telephoned her order for a machine and asked that it be brought out to the house. An upright and a console were bundled on the truck and taken out to the prospect. When asked which model she preferred, without hesitation she selected the bulky but attractive upright model.

Slump Gives Way to Prosperity

An unexpected recovery from the mid-month idleness of trade was experienced by Lee Outten, sales manager of the Dugan Piano Co. Mr. Outten, who is handling both the talking machine and piano end of the business in the absence of Martin Grigler, manager of the former department, on a vacation trip in Michigan,

(Continued on page 157)

Quality



Prestige

Edison Dealers Figure This Way

**YOUR Sale of an Edison Assures
Y O U a Satisfied Customer.**

**YOUR Satisfaction —
Y O U Have Sold THE BEST.**

Investigate Edison Dealer Proposition

SOUTHERN DISTRIBUTORS

DIAMOND MUSIC CO., Inc.

341 Barrone Street

New Orleans, La.

Another Superior Point for THE NEW COLUMBIA

Simply move the tone-arm of the New Columbia to playing position. Instantly the motor leaps into action. No fumbling for starting levers! Nothing to get out of order!

**COLUMBIA GRAPHOPHONE CO.
New York**



states that he was unable to diagnose the sudden lull that occurred about the middle of last month. With equal suddenness a recovery came, several high-priced instruments being carted away from the firm to repose in the parlors of New Orleanians.

Gennett Records Becoming Popular

Gennett records, made by the Starr Piano Co., of Richmond, Ind., and distributed in this territory by Albert T. Thompson, music factor, have cut a wide swath in the disc entertainment desired by the New Orleans public, according to Mr. Thompson. The prestige of this product is increasing by leaps and bounds, though faced with a strong handicap in the early stages of its introduction. Mr. Thompson was told, when he took over the agency, a little over a year ago, that he would experience great difficulty in breaking into the field, regarded as impregnable controlled by the older established line. He has succeeded in perfecting an organization that is carrying the Gennett steadily forward. The record is being recognized in the local music field and its reward is rapidly becoming pronounced. The M. & M. Music Store, 2652 Orleans street, this city, recently put in the line. An order for twenty-five upright Starr machines from the Jazz Music Shop was recently filled by Mr. Thompson.

Red Seal Demand Grows

The 20 to 25 per cent discount provided some time back by the Victor Talking Machine Co. on the single-faced Red Seal records has awakened a well-supported demand for these records made by the famous classical artists of the world, according to John A. Hofheintz, wholesale manager of Philip Werlein, Ltd. The house expects to be able to announce price listings on the new Red Seal double-faced Victor records that are to supplant the single type about September 21. The weekly record release, taking the place of the former monthly procedure, has also proved very popular, Mr. Hofheintz said.

Paul S. Felder, secretary and treasurer of the company, returned from a fortnight's visit to the Victor factory at Camden, N. J. Miss Emma Delery, popular young lady in the wholesale department of the company, is spending a three weeks' vacation in the South Carolina mountains.

F. L. Hough Makes Home Here

Frank L. Hough, appointed factory representative of the Victor Talking Machine Co., has taken up his residence in the city. Mr. and Mrs. Hough have leased a pretty apartment in Prytania street. Mr. Hough, through his pleasing personality and general ability, has won for himself a host of friends among local music men, as well as others with whom he comes in contact in the city.

Constructing Special Victrola

The Victor line which the Harry B. Loeb Piano Co. lately added has already shown up very satisfactorily. Mr. Loeb is working on a special talking machine that is to be specially constructed for one of his customers. The machine will be electrically equipped, console type, built to resemble a permanent table. It is

expected to cost in the neighborhood of \$1,000. The instrument is to be elaborately decorated so as to correspond with the interior of the music room of a palatial New Orleans home, which is being prepared by an expert interior decorator.

Ernest L. Staples, manager of the Victrola department of the L. Grunewald Piano Co., is spending his vacation touring in the Middle West. He will visit Chicago, Niagara Falls, Detroit and several Great Lakes centers.

W. F. Nipper With Philip Werlein

W. F. Nipper, well known in talking machine circles in Memphis, Tenn., has been appointed a member of the traveling staff of Philip Werlein, Ltd., Victor wholesaler. Mr. Nipper has been associated with the music field for the past six years, having been connected for some time with the O. K. Houck Piano Co., Memphis, Tenn., where he was identified with the sale of Victor merchandise, specializing in the stimulation of Victor Red Seal record business. His various activities in a retail way should enable him to achieve success in the Louisiana and Texas territories, which he will cover for Philip Werlein, Ltd., and his wide knowledge of the problems of the retail merchant should make him a valuable help to the trade.

W. A. BROPHY RETURNS FROM EUROPE

Wm. A. Brophy, general manager of the recording laboratories of the Brunswick-Balke-Collender Co., New York, returned to his desk recently, after a two months' visit abroad. Mr. Brophy was accompanied on his trip by Geo. W. Case, patent counsel for the Brunswick Co., and while in Europe conferred with B. E. Bensing, president of the Brunswick-Balke-Collender Co. relative to important matters.

ST. LOUIS MUSIC CO. CHARTERED

The St. Louis Music Co., of St. Louis, Mo., has been granted a charter of incorporation under the laws of that State, with a capital of \$30,000, to manufacture, buy and sell musical accessories and instruments. R. C. Laver, C. W. Laver and A. M. Conroy, all of St. Louis, are the incorporators.

W. C. FUHRI ON WESTERN TRIP

W. C. Fuhri, general sales manager of the General Phonograph Corp., New York, is at present away on a short trip which will include a visit to the Okeh jobbers in Chicago, St. Louis and New Orleans.

ZIMMERMAN · BITTER
CONSTRUCTION · COMPANY

Presents a New Installation



LANDAY BROS.
775 Broad St., Newark, N. J.

This interior, the second of a series featuring seven Landay stores equipped by Zimmerman-Bitter, illustrates the specially designed Z-B musical instrument display case unit.

quality  *design*

Record Racks Display Cases
Hearing Rooms Musical Instrument
Service Counters Cases, Etc.

Prices on request

ZIMMERMAN-BITTER
CONSTRUCTION COMPANY
325-27 East 94th Street, New York
Phone Lenox 2960

TALKING MACHINE DEALERS DISCUSS EFFECT OF RADIO

Publication in Radio Field Gets Some Interesting Information From Questionnaires Sent to Members of Talking Machine Trade—Opinions Divided as to Results on Sales

In an effort to determine the effect of radio on talking machine business, as viewed by dealers in talking machines and records, one of the publications in the radio field, the Wireless Age, recently made a survey of the talking machine trade and gathered some interesting figures.

According to the details as compiled by the magazine, 76 per cent of the dealers who replied to the questionnaire, the total number being 317 out of 7,500 cards mailed, reported that they believed that the radio was instrumental in selling records for them, while 24 per cent took the opposite view or did not commit themselves.

Of those who did have definite ideas to express 23 per cent held that radio had been a gain to their business, 33 per cent believed they saw a loss, 11 per cent believed they were getting an even break and 33 per cent did not commit themselves. Among the dealers who reported business gains through radio 43 per cent sell radio apparatus, while 27 per cent of those who see a dropping off in record business are also radio dealers, as are 35 per cent of those who hold the "fifty-fifty" attitude.

Quite a number of dealers declared that talking machine owners in substantial numbers were sold on the merits of various selections by radio and frequently purchased records of those selections without demonstration, thus saving considerable time.

An interesting opinion was offered by Frank A. French, an Edison dealer of Manchester, N. H., who stated that "the studio shop" which he operates took on radio in the belief that it is a matter of self-protection in that without radio their phonograph business would suffer. The theory was that under such a policy the store could sell the customer the radio and later a phonograph, after he had been sold on the music of various orchestras and artists, but that without the radio to attract him in his first enthusiasm, the later phonograph and record business would go to some other concern. One of the arguments used for the sale of the phonograph is that it is not subject to static and interference as is the radio outfit.

A number of dealers saw in the radio a means for stimulating interest in music and, eventually, in musical instruments and considered this result as offsetting any temporary loss of record sales. Others held the opinion that, with the adjustment of the differences between the broadcasters and music publishers over copy-right and royalties, there would be a more gen-

eral broadcasting of popular songs which would lead directly to increased record sales.

Few, if any, of the dealers, in expressing opinions as to the gain or loss realized through the advent of radio, had any definite figures or statistics to back up their statements and in most cases simply attributed loss or gain of trade to the radio without any very careful analysis.

It is significant that less than 5 per cent of the dealers to whom questionnaires were sent were sufficiently interested in the matter to fill out the questionnaire or to write a letter explaining their stand. The figures as offered by the Wireless Age, therefore, can be accepted only as an opinion of a very small minority of

talking machine dealers who have taken direct cognizance of radio and its effect on business in one way or another. Perhaps the percentages might hold good throughout the trade if a general survey were made, but that is doubtful. The fact to be considered, of course, is that dealers without exception realize the standing and importance of radio and in many cases are seeking to adjust themselves to the situation it has brought about either through handling radio apparatus in conjunction with their talking machine lines as a stimulus to business or in changing about their selling campaigns, with a view to offsetting the influence of radio.

It is significant that a large number of dealers who have made direct use of radio, either for the broadcasting of regular monthly releases or by tying up directly with broadcasting programs, have managed to get results in record sales and increased interest from patrons.

VICTOR RED SEAL RECORD EXCHANGE PUT INTO EFFECT

Under the Exchange Plan Victor Dealers Have Opportunity for Replacing 75 Per Cent of Single-faced Red Seal Stock With New Double-faced Red Seal Records

When the Victor Talking Machine Co. announced some time ago the plan for issuing all Red Seal records in double-faced form, with a general downward revision of list prices, it was stated that an exchange would be put into effect to take care of stocks of single-faced Red Seal records on dealers' shelves.

This new exchange was put into effect this month and is most extensive in character, covering 75 per cent of the present listings of Red Seal records in twenty different series and comprising a total of over 1,700 selections.

The new exchange is operated through the wholesalers and affords the dealer an opportunity of securing new double-faced records in exchange for 75 per cent of his stock of single-faced records on a record-for-record, class-for-class basis, with the dealer reimbursing the wholesaler whom he selects for the carrying out of the exchange for the difference between the cost of the new double-sided record and that of the single-faced record returned. Under the terms of the exchange all shipments of records from dealers must be in the hands of carriers by September 15.

In arranging for the exchange the dealers were given the privilege of selecting the jobber through whom they desired to operate, subject to the latter's approval. The plan of operating through wholesalers was adopted in the belief that it would eliminate delays and confusion and would work out more satisfactorily from the dealer's end by speeding replacement stocks.

The record series included in the record exchange are of the ten-inch, 61,000, 64,000, 66,000, 81,000, 87,000, 91,000 and 87,500; twelve-inch, 71,000, 74,000, 85,000, 88,000, 92,000, 89,000, 95,202-11, 95,213, 95,100, 95,212, 96,000 and 96,200.

In announcing this exchange to take care of 75 per cent of existing stocks it is described as being the "first instalment," with the assurance that other exchanges will follow to take care of remaining stocks of single-faced records.

REFLEXO CO-OPERATING WITH TRADE

New Display Stand to Aid Needle Sales—L. J. Unger on Canadian Trade Trip

To further co-operate with its many distributors in their Fall selling Reflexo Products, Inc., New York, has had printed a supply of standard size loose-leaf sheets for the jobbers' salesmen's binders. These sheets are attractively printed in colors and feature both the Reflexo blue steel flat needle and the Gilt Edge needle. Reproductions are shown of the display cartons and display stands on both brands. A new display stand for the Reflexo blue steel needle has been placed on the market. All of these style needles will hereafter come packed in the new stand, which, it is expected, will increase sales. The approach of the Fall season has caused a decided increase in the demand for the Dancetone grade of needle. L. J. Unger, general manager of the company, is on a trade tour of Canada.

CLARAVOX REPRODUCERS REFLECT CREDIT ON EDISON PRODUCTS



EDISON DEALERS

CLARAVOX Correctly Plays Victor Records on Edison Phonographs

This CLARAVOX attachment sold three Edison Phonographs this past month for one Edison Dealer. The ability to correctly play a few choice records other than the Edison clinched all three sales. New CLARAVOX diaphragm gives results never before heard from lateral cut records.

Usual discounts to dealers. Retail price complete \$7.50

STANDARD Diamond Point

Original Claravox Reproducer. Employs a genuine flawless diamond and CLARAVOX Stylus and Diaphragm.

Usual discounts to dealers. Retail price \$12.50

SPECIAL Jewel Point

Special jewel which nearest approaches permanency of diamond. New CLARAVOX Diaphragm and Stylus.

Usual discounts to dealers. Retail price \$7.50

A post card will bring any of these products on 10 days trial

THE CLARAVOX COMPANY, Youngstown, Ohio

CLARAVOX—MAKES PHONOGRAPHS SOUND REAL



No. 1
Suitable for Regular Commercial Product

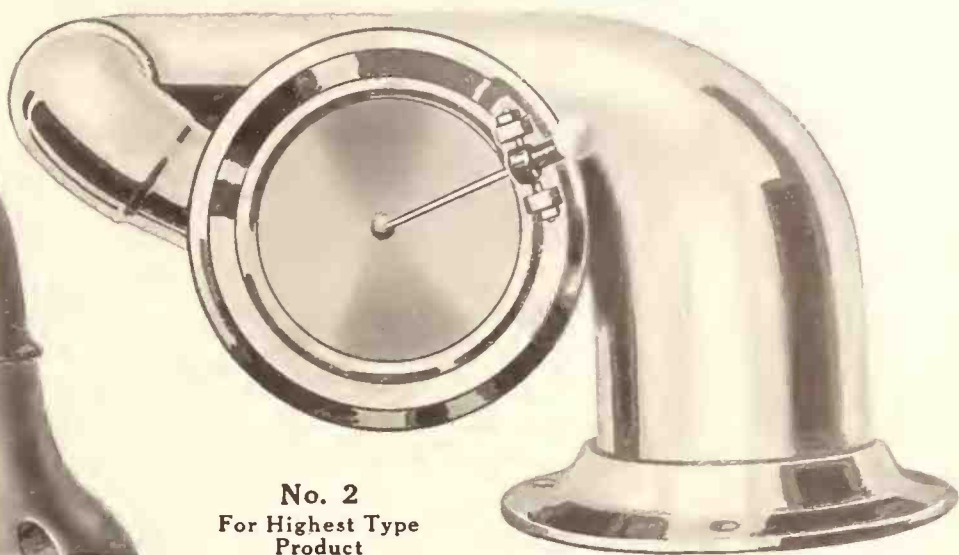

No. 2
For Highest Type Product

To The Manufacturer:

You can save money by using Triangle equipment. It is as good as the best, and better than the most. And *Costs Less*, besides being guaranteed for five years. It has taken years to bring Triangle Equipment to its present state of perfection. Its high standard of excellence is known and appreciated in nearly every *country in the world*. The many complaints you are now receiving of not enough volume; blasting; too much surface noise; not swinging free, and many others, can be entirely eliminated by the use of Triangle Tone Arms and Reproducers.

Triangle is universal; plays all kinds of records, and is also backed by our five-year iron-clad guarantee. Samples sent on approval.

TRIANGLE

To The Dealer:

Insist on Triangle Tone Arms and Reproducers when placing your order for Phonographs, and your Phonographs will stay sold. You will have to pay no repair bills. Our five-year guarantee insures you against this expense. Send direct to us for samples and give them the severest test possible. Then tell your manufacturer or jobber you want Triangle and they will be glad to accommodate you.

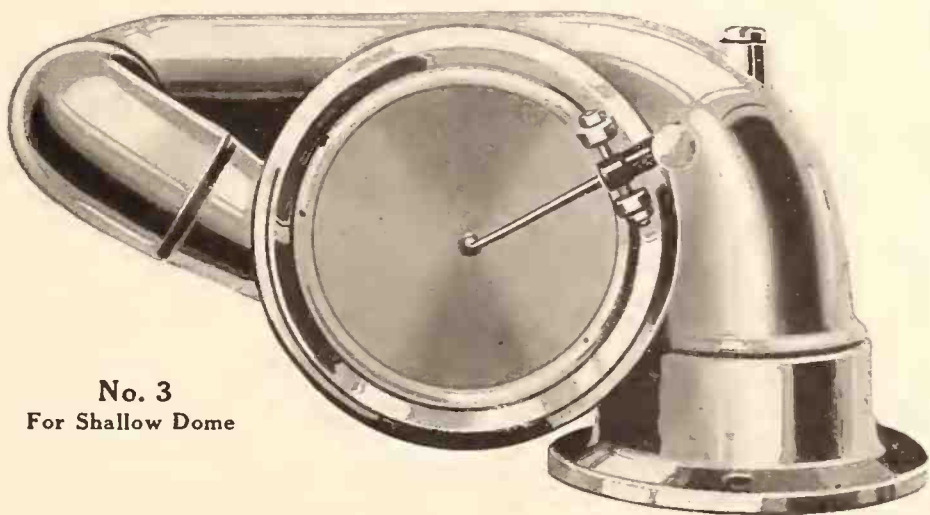

No. 3
For Shallow Dome

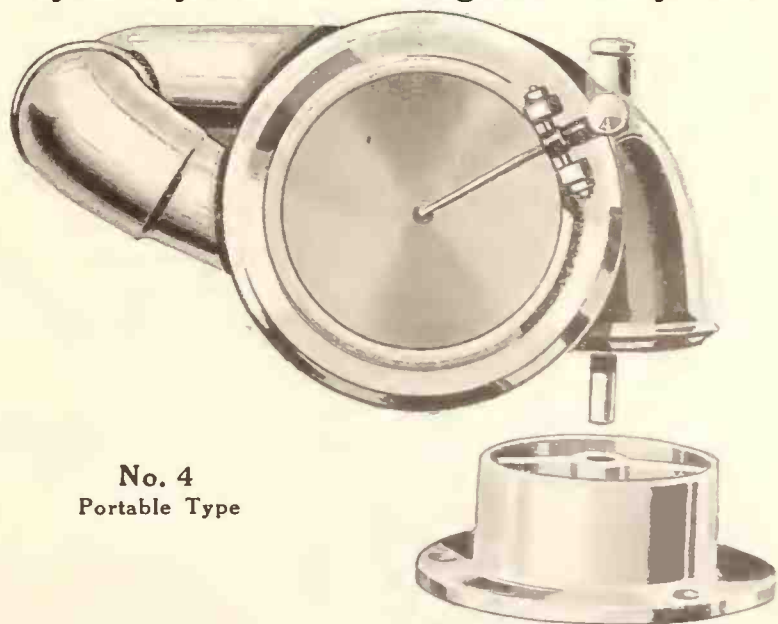

No. 4
Portable Type

Manufactured by **TRIANGLE PHONO PARTS CO.**, 718-724 Atlantic Ave., Brooklyn, N. Y.
Western Sales Office: 1500 Republic Building, Chicago, Ill.

KANSAS CITY

Business Outlook Is Encouraging—Monthly Conferences Prove Value—R. L. DuBois Promoted—New Dealers—News of Month

KANSAS CITY, Mo., September 8.—August has been a busy and successful month with all music men in Kansas City who handle pianos, for there has been a very vigorous drive made for business in that line. There has been a large amount of space taken in the daily papers and the result has been correspondingly large sales. The effect on the talking machine business has been that in these stores there has been a slackening up of sales.

On the other hand the stores which handle talking machines exclusively have had a good business, and the interest in music which was aroused by the advertising of pianos was reflected in the sales of phonographs. There has been a good sale of records throughout the month. The portable machines also have had a good sale.

The prospects for good business here during the Fall months are excellent. While there are parts of the territory in which the drought has cut down the production of corn, in most of the district there is the prospect for either the "best crop ever," or at least "a fine crop." The fact that the price is better also will affect the buying ability of the farmers and thus the general prosperity of the whole people.

Monthly Conferences of Jenkins Staff

The J. W. Jenkins Sons Music Co. is recognizing these conditions and is preparing to take advantage of them. The wholesale Victor department is having a dealers' conference in Kansas City each month. It is held at one of the leading hotels in the city in the evening and follows a dinner furnished by the department. The plans of the Victor Co. are fully explained and discussed and suggestions on sales methods are secured from dealers. The new records are played, and talked over, and interest is increased in a contest, in which the dealers guess which will be the best-selling record. Other features are introduced to add interest. The four conferences which have been held have been so successful that it is the intention to continue them indefinitely.

A large amount of interest is reported among the dealers in connection with the Victor Co.'s plan for the exchange of double-face records for the single-face records which are now in

stock. The inquiries as to particulars are many and the orders from Victor dealers for the exchanges are on the increase.

R. L. DuBois Made Edison Manager

Announcement is made by the Phonograph Co., distributor of the Edison for the Kansas City territory, of the promotion of R. L. DuBois to the position of manager of the wholesale department of the Edison in Kansas City. Mr. DuBois started with the Edison Co. in the Chicago office ten years ago and served there as credit and office manager under C. E. Goodwin. About four years ago he was transferred to the Kansas City office, where he served in a similar capacity under the direction of Mr. Blackman. Upon the retirement of Mr. Blackman Mr. DuBois was his logical successor. Since his appointment he has been getting in personal touch, as far as possible, with the dealers of the territory. During August the following dealers have called at the wholesale office in Kansas City: H. H. Kahn, Innes-Cosgrove Music Co., Wichita, Kan.; W. L. Eshelman, Eshelman Music Shop, St. Joseph, Mo.; A. K. Snyder, Winfield, Kan.; Carl Botefuhr, Botefuhr Music Co., Pittsburg, Kan.; H. L. Kelley, H. L. Kelley & Son, Lexington, Mo.; J. Jenkinson, Esbon, Kan.; C. H. Andrews, Andrews Music House, Hiawatha, Kan.; J. M. Yoder, Yoder's Studio, Herington, Kan.; Ernest Runnenburger, Runnenburger Bros., Harrisonville, Mo.; Forrest Smith, Richmond, Mo.

New Columbia Dealers

The Berry-Dalbey Music Co., 4102 Prospect avenue, which operates a large music store in the southeastern part of the city, has just placed a large order for Columbia phonographs and records, which it is to handle exclusively. The store has been fitted with the most modern equipment obtainable and presents an attractive appearance.

Hourigan Bros., Rocheport, Mo., have just opened their elaborately furnished Columbia department. Large crowds attended the opening, filling the place both afternoon and evening.

The Highfill's Drug Store, Marshfield, Mo., has just opened an exclusive Columbia department and reports that it is already doing a nice business in both records and machines.

MICA DIAPHRAGMS

Absolutely Guaranteed Perfect
We get the best India Mica directly.
We supply the largest Phonograph Manufacturers.

Ask for our quotations and samples before placing your order.

American Mica Works
47 West St. New York

Schuler's Prescription Store, 1812 West Forty-fifth street, recently installed a complete line of Columbias and records. This firm has a very attractive drug store in the southwestern part of the city and intends doing a considerable amount of advertising which, they feel confident, will bring results.

Brunswick Dealers Place Fall Orders

The mail orders which were received by the Brunswick wholesale department the first of September indicate, according to the manager, that the Fall business is to be unusually good. There has been a good business in the wholesale department in filling orders for the dealers who are anticipating a good trade during the Fall. During a trip over the territory Mr. Schoenly found that the dealers in all districts which had not been struck by the drought are full of optimism and that in all the territory there has been a decided improvement during the past year or so in the merchandising methods of the dealers. Especially is this so among those merchants who in the past had a few machines, but did not maintain a department for their sale and who are now devoting considerable attention to the talking machine business.

Columbia Visitors

J. H. Robinson, of Chillicothe, Mo., was a recent visitor to the Kansas City branch and stated there is a marked increase in the volume of record business, due to exceptionally good dance hits and colored records.

E. D. Gillen, of the Gillen Furniture Co., Blytheville, Ark., recently visited the Kansas City branch, placing a large order for the new type Columbias and a large quantity of records.

Post Cards Bring Business

F. Lombardi, of the Royal Music Co., advises that interest in Columbia records has been stimulated to a considerable degree through the use of post cards. These contain a list of the latest release records, stating that any records desired will be sent either on telephone request or else on return of the post card with the selections marked and the name and address listed. The entire mailing list was circulated in this manner and resulted in many orders, both by telephone and by mail, with a consequent increase in profits.

FALL ORDERS FOR ALBUM & CARD CO.

Max Willinger, president of the New York Album & Card Co., returned to New York on Friday, September 7, after spending several weeks at the Chicago headquarters of the company. Mr. Willinger received substantial orders while he was away and reports that both dealers and manufacturers throughout the Middle Western territory state that the increased demand for Fall is already being felt. Both the New York and Chicago factories of the New York Album & Card Co. are very busy and every indication is that this good business will continue through the Fall and Winter seasons, with still further gains possible.

NEW STORE IN GARDNER, MASS.

GARDNER, Mass., Sept. 10.—A new music store at 67 Parker street will be established by H. S. Brown, of Fitchburg, who has maintained a salesroom in the Rome Block for some time. A complete line of pianos and talking machines will be handled.

EDISON DEALERS!

And Music Dealers who have been intending to apply for an Edison Dealership!

We can take care of your needs NOW.
Don't let the Fall rush find you unprepared—when we too may be short of the models in greatest demand.

Edison Service for
the Southwest

The Phonograph Co.
1215 McGee St.
KANSAS CITY, MO.



Long Console Cabinet No. 90

*Designed to accommodate the VICTROLA IX
The most attractive console cabinet on the market*

List Price \$40—Usual Trade Discounts



Long Console Cabinet No. 90
Four Doors and One Horizontal Drawer



**Long Console Cabinet
No. 90, Open**

The LONG CONSOLE CABINET No. 90, designed to accommodate the VICTROLA IX, is, without question, the finest cabinet ever introduced to the trade. It is finished in mahogany and its attractive lines compare favorably with the most artistic period console talking machines marketed by the leading manufacturers.

Deliveries start October 15th.

Order *now* to avoid delays.

Can also be fitted to accommodate Victrola VIII.

We would suggest that you place orders now for Long Console Cabinets Nos. 601, 603, 608 and 610, designed to accommodate Victrolas VI and IV, and for Upright Cabinet No. 606 for the Victrola IV.



The Geo. A. Long Cabinet Company
HANOVER, PA.

HAPPENINGS IN THE DOMINION OF CANADA

INTERESTING DEVELOPMENTS IN TORONTO TERRITORY

Andrew P. Frangipane, Mutual Phonoparts Secretary, Looks Over Canadian Field—Other Prominent Visitors—Thomas Devine New Columbia Traveler—Discontinue Record Approval Plan

TORONTO, ONT., September 7.—Andrew P. Frangipane, secretary of the Mutual Phonoparts Mfg. Co., New York, was a recent visitor to Toronto during the first week of the exhibition. The object of this gentleman's visit was to size up the talking machine situation in Canada and discuss with George S. Braden, sales manager for Russell Gear & Machine Co., Ltd., sole distributor of Mutual products in Canada and other British possessions, the possibilities for Fall and Winter trade.

Thomas Devine has come to Toronto to ally himself with the Columbia Graphophone Co. Mr. Devine hails from Kansas City and is a Canadian by birth. He will travel Toronto and nearby territory and should prove a valuable acquisition to Mr. McMurtry's selling staff.

Congratulations are being extended to G. Bradford Heintzman, of Heintzman & Co., Ltd., Toronto, on the occasion of his recent marriage to Mrs. Margaret W. Holt, daughter of Col. Alexander Wilson. The honeymoon trip was by motor to New York and the Berkshires.

H. S. Berliner, president of the Compo Co., Ltd., Lachine, Que., which firm has recording laboratories in Montreal, was a recent visitor to his firm's Ontario distributing house, the Sun Record Co., this city.

The Scythes Vocalion Co., Ltd., has in course of preparation a new record catalog comprising a list of Vocalion English recordings that are suitable for the Canadian market.

The death of Frank Stanley, following an illness of several months, occurred in Toronto recently. The late Mr. Stanley, in addition to being a piano manufacturer, had a large retail following in the talking machine trade where he was extremely popular.

A visitor to Canada recently was A. H. Curry, vice-president in charge of the phonograph division of Thomas A. Edison, Inc., Orange, N. J. Mr. Curry was accompanied by his wife and three children. While in Toronto he took the opportunity of calling upon the Edison jobbers, R. S. Williams & Sons Co., Ltd. He then journeyed to Montreal by boat, where he visited the Edison jobbers in that city, which is also the R. S. Williams & Sons Co., Ltd. From Montreal he went to Quebec and from there to St. John, N. B., where he conferred with W. H. Thorne & Co., Ltd., Edison jobbers in that territory.

The His Master's Voice Victor dealers at Kitchener, Ont., have generally discontinued letting records out on approval. It is stated that immediately after the decision went into effect business improved decidedly.

Boyle's Drug Store, His Master's Voice Victor dealer, Brampton, Ont., has opened a new Victrola department.

Miss Oliver, formerly of the record department of Whaley Royce & Co., Ltd., has joined the Victrola department of the Nordheimer Piano & Music Co., Ltd.

ENERGY OF MONTREAL DEALERS RESULTS IN MANY SALES

Talking Machine Displayed as Part of Furnished Room Creates Business—Summer Visitors a Source of Profits—New Stores Opened—Prospects for Fall Business Unusually Bright

MONTREAL, QUE., September 7.—The National Stove & Furniture Co., His Master's Voice dealer in this city, is having considerable success in its sales plan of showing the Victrola in its store set-ups as necessary for the complete furnishing of a living-room.

The Radio, Victrola & Optics, His Master's Voice dealers, on Notre Dame street, are attracting a good deal of attention to their store through the medium of a hidden outside horn, which carries the sound from the instrument inside the store to passers-by.

Mrs. Maclaine, of Layton Bros., Ltd., Brunswick dealers, who has charge of the record department, reports good sales in Brunswick records. They are renovating the interior of their store.

F. R. Pilon, of Como, Que., is canvassing the Summer visitors there with great effect. He recently distributed among the Summer residents 100 record catalogs and instrument folders and is visiting all these people personally.

The Sam Howard Publishing Co., which has opened a new store in the Papineau avenue Theatre Building, has decided to put in Brunswick records.

The International Music Store has had a real live rascalon in its window, which has attracted a considerable crowd and thereby helped its business.

J. S. Shield, of Berliner Gramophone Co., Ltd., has returned to headquarters at Montreal from a tour of dealers in western Canada. He is pleased with the prospects for Fall business in the Western provinces. In an interview with the Vancouver Sun Mr. Shield stated that his firm expected to double the space occupied at its quarters within the next year.

The eleventh annual picnic of the employees of the Berliner Gramophone Co. was held re-

cently, when employees, their families and friends to the number of about 750 went on the steamer "Three Rivers" to Lavaltrie. A program of sports was enjoyed and on the return trip the "long service" checks were distributed.

ACTIVITIES OF WINNIPEG TRADE

Important Court Decision on Price Maintenance in Case of Berliner Gramophone Co. Against Fowler Piano Co.—Other News

WINNIPEG, MAN., September 7.—In the early Spring of this year the stock in trade of the Fowler Piano Co., of Winnipeg, was damaged by fire and on the adjustment of the loss some "His Master's Voice" products, which had been purchased under one of the Berliner Gramophone Co., of Montreal, regular Class "A" dealer's contracts, were repurchased from the underwriters. In the month of July a sale was made contrary to the restrictions of Class "A" dealer's contract. The Berliner Gramophone Co. immediately applied in the city of Winni-

peg, to a judge of the Court of the King's Bench, for an injunction restraining the Fowler Co. from disposing of any "His Master's Voice" products at prices below the licensed retail price. A decision was given in favor of the plaintiff.

The Civic Park Board of the City of Winnipeg has arranged for a series of eighteen Sunday concerts to be given in the public parks.

Cassidy's, Ltd., representatives for Columbia machines and records in Manitoba, are distributing to the trade a series of Dr. Coue's lectures which they are broadcasting by radio.

Tom Robinson states that there is always a steady demand for his English edition of Vocalion records and that he is getting his full share of piano as well as phonograph sales.

Evan Jones, junior member of the firm of Jones & Cross, Edmonton, Alta., who has been enjoying a fine holiday in Honolulu, is expected to return home shortly.

FORECAST "TALKERS" IN 1623

It is interesting to know that as early as 1623 Sir Francis Bacon, in his New Atlantis, visioned the talking machine, radio and other then "impossibilities" which are now taken more or less for granted. In the following words Bacon previsioned the talking machine, amplifier and telephone:

"We represent and imitate all artificial sounds and letters and the voices and notes of beasts and birds. We have certain helps which set to the ear do further the hearings greatly. We have also divers strange and artificial echoes, reflecting the voice many times, and, as it were, tossing it; and some that give back the voice louder than it came, some shriller and some deeper; yea, some rendering the voice differing in the letters or articulate sound from that they receive. We have also means to convey sounds in trunks and pipes, in strange lines and distances."

REMODELING SAN DIEGO STORE

SAN DIEGO, CAL., Sept. 5.—The local branch store of the Wiley B. Allen Co. is undergoing extensive alterations and remodeling and a sum of between \$25,000 and \$30,000 is being expended on these improvements, which should make this music store one of the handsomest in San Diego. Elevators are being installed and a very beautiful ornamental staircase built, as well as artistic general decorations. J. H. Cooley, San Diego branch manager, is supervising the work in collaboration with E. Palmer Tucker, general manager for Southern California, whose headquarters are in Los Angeles.

Ben Reynolds & Co., Sonora and Victor dealers of Washington, Pa., had a fine display of Victrolas and Victor records and Sonora phonographs at the Washington County annual fair at Arden, Pa., the week of August 27. There were recitals given at frequent intervals during the fair to the throngs of visitors.

Talking Machine Springs and Repair Parts

NONE BETTER IN QUALITY NONE LOWER IN PRICE

THE RENÉ MANUFACTURING CO.
MONTVALE, NEW JERSEY

Why Interest Should Be Charged on Sales

Ohio Association President Points to Necessity for Charging Interest on "Talker" Sales in Instructive Paper at Convention

[The following very interesting paper on the necessity of charging interest on talking machine sales was read by W. G. Bowie before the annual convention of the Music Merchants' Association of Ohio in Cincinnati on September 12.—EDITOR'S NOTE.]

The subject of interest on talking machine sales is of vital importance to all dealers who sell on the instalment plan. You know everyone is interested in something; some of us are interested in golf; some in the Volstead Act; some in musical instruments, and last, but not least, we must not forget the bankers who are interested only in interest.

To face the facts, if you were to go to your banker to-morrow morning and ask for a loan the first thing you would want to know would be what rate of interest you would have to pay. If a stock salesman were to call on you and you were interested in buying his stocks or bonds the first thing you would want to know, and the first thing the salesman would try to impress upon you, would be the rate of interest these stocks would pay upon your investment. If the State or National Government wants to borrow from banks or individuals the first thing they state is the rate of interest these bonds will bear; in fact, in any case where there is an investment made, or a loan negotiated, the most important factor is interest. If you, as a dealer, sell a phonograph on time you are loaning in most cases, where standard instruments are sold, from 55 to 60 per cent of the selling price of that machine and, consequently, interest has an important bearing on ultimate profits.

When the Profit Is Realized

There is no question but that you are entitled to interest on that loan. We will grant that you are making a gross profit of from 40 to 45

per cent on each sale, but any merchant who conducts a retail establishment is entitled to a profit. However, you do not collect this profit until after the original investment has been returned to you in payments. There are many articles of merchandise sold for cash upon which the percentage of profit is greater than that on the phonograph, so that eliminates the argument that might be advanced that your profit takes care of the interest problem.

Interest as a Sales Argument

In collecting your profit on a time sale you wait six or eight months, as the case may be, before collecting one dollar over and above your original investment. Therefore, when you sell an instrument on time and charge a legal rate of interest, which in the State of Ohio is 6 per cent, you are only getting what the common laws of business state that you are entitled to. Then you have the problem of the cash buyer. Any man who buys an article for cash that is commonly bought or sold on time believes that he is entitled to some discount from the advertised time price. The item of interest is small, but if you have nothing to offer this cash buyer the natural result will be that your business will eventually become one of instalment sales only, and I believe that no dealer here would like such a condition to come about.

The greatest opponents of the interest charge in my experience in Cleveland have been the department stores, but I am glad to say that of late they are the greatest advocates for its continuance and have so gone on record in our association meetings.

The phonograph industry to-day is not what

it was five years ago, and this, I believe, is due somewhat to the dealers themselves. Advertising sales of discontinued models and bankrupt stocks at very low prices have been the evils of the trade. The average dealer selling standard makes tries to compete with this by advertising nothing down, low terms, no interest, etc. The result has been that the buying public has become so confused by these conditions that it is not uncommon to have a customer ask for a period console in a two-tone case for about \$65, nothing down, \$5 per month and no interest. However, these conditions, I believe, are gradually improving as the stocks of bankrupt manufacturers and discontinued models are steadily being absorbed by the buying public.

Improve Conditions With Quality Appeal

The best way, however, to improve our general trade conditions is to advertise and sell quality. Get reasonable terms, charge a fair rate of interest on instalment sales, and in that way regain the confidence and respect of the people. There is no denying the fact that the phonograph has been the greatest musical educator the world has ever known. This is due to the music memory and other contests conducted in our public schools which the leading manufacturers of talking machines have advocated and promoted for some years. Any man can take pride in the fact that he is connected with an industry that brings culture and refinement to each home, and my final word is that every one of us here, from to-day on, should give particular attention to the promotion of not only interest on talking machines but interest in talking machines.



Patent Applied for

Illustration shows the position for playing Victor and all other lateral cut records. Note the dotted line which shows the exact centering of the needle on the record and which prevents the reproducer from coasting when record is finished playing.



Patent Applied for

Illustration shows the position for playing Edison and all other vertical cut records. Note the dotted line which shows the exact centering of the needle when turned to play vertical cut records. The pressure or weight on the record is the same as that of the regular Edison reproducer.

ORO-TONE No. 4

The most scientific attachment ever produced for playing all disc records on the Edison Phonograph

THE Oro-Tone No. 4 automatically centers the needle with turn-table spindle (see dotted lines) when turned to position to play either lateral or vertical cut records and will not coast when record is played through.

This No. 4 automatically adjusts itself to the correct weight and the correct angle of reproducer on the record, when turned to play Victor and other lateral cut records, and also automatically adjusts itself to the correct Edison weight and angle when turned in the flat or Edison position.

A simple turn of the hand and the Oro-Tone No. 4 is ready to play perfectly any record desired. It plays Edison records with the regular fibre needle with splendid volume and the entire absence of surface noise.

LIST PRICES

- No. 4 Edison Automatic Equipment
- NICKEL FINISH.....\$7.00
- GOLD FINISH.....\$9.00
- GOLD OXIDIZE.....\$9.00
- Attractive Needle Cup Case, each 35c.

Usual discount allowed to responsible dealers. Please furnish references if you are not rated.

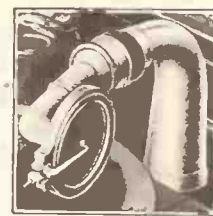

Easy to Change Needle by Turning up Reproducer

The Oro-Tone Co.
QUALITY FIRST

1000 George St. Chicago, Ill.

Ask Your Edison Jobber for Sample

Attractive Needle Cases, with three gun metal needle cups and place for reproducer, can be had for 35c each, less usual discounts.



My won-der-ful one, When - ev - er I'm dream-ing, Love's love-light a-gleam-ing, I see.—

Wonderful One

Music by
PAUL WHITEMAN
and Ferdie Grofé

Lyrics by
Dorothy Terriss
author of
"Three O'clock in the Morning"

BIG WALTZ HIT

"You can't go wrong
With any FEIST songs"



COLUMBUS

Business Through Increased Importance of Music in Schools Expected—Activities of Month

COLUMBUS, O., September 8.—With the opening of schools and colleges and the resumption of educational activities generally talking machine dealers are looking forward to a busy Fall season, to be followed by a busier holiday season. It is the expectation of dealers that music will be considered more important as a subject of study in the public schools this year than heretofore.

Local theatre-goers have been captivated by the Clyde Doerr Orchestra, Victor artists, which is appearing daily in the vaudeville program offered by the Keith Theatre and dealers have profited by tying up with it.

The Otto B. Heaton Co., Victor dealer, featured the Clyde Doerr Orchestra records in a window display. A large picture of this orchestra was well placed in the window. Surrounding it in an attractive manner were the Doerr records. On invitation of one of the attaches of the Otto B. Heaton Co., Mr. Doerr visited the store, where he met and chatted

with the members of the sales and office force. To one of them he stated that this was his last week in vaudeville.

The Robert L. Seeds Co. is now in its new location at 112 South High street. Six hundred invitations were issued to patrons and friends to attend the formal opening on Friday evening, September 7, and as a result the store was crowded. Cheney and Columbia lines are sold by this concern. Seven record demonstrating booths and two extra large machine demonstrating booths have been installed. All the woodwork in the store is finished in mahogany and buff.

Officers of the Robert L. Seeds Co. are Ian S. Seeds, president; F. Marion Cheney, secretary and treasurer, and R. P. Knell, credit manager.

The Henry Ackerman Co., Victor dealer, Marion, O., furnished a number of educational records and a Victrola for use by Miss Helen Roberts, Marion County music supervisor, on the occasion of a lecture which she delivered before a teachers' institute.

F. & R. Lazarus Co. announces that C. C. Hinterschied has been appointed manager of the Victrola department. He is a man of wide experience in Victor service.

The Elite Music Store, Victrola specialist, has arranged a window display that is attracting considerable attention. The floor space in

the windows is covered with black and white checks. Several art model Victrolas; a large picture carrying the leading Victor artists, draped in red velvet, placed on an easel, are splendidly displayed on the checkered floor.

An unusually attractive Brunswick window was displayed recently by Goldsmith's Complete Music Store. Popular console and upright Brunswick machines, as well as two portable types, were on display. The newest Brunswick records containing operatic, popular and jazz recordings were artistically arranged along with these machines.

Alterations are under way at the Spence Music Store, Victor dealer. Carpenters are busily engaged in building a balcony that will practically add one-third to the present floor space. Victrolas as well as supplies of small goods will be displayed on the balcony.

COMPLETE EDISON TONE-TEST PLANS

Bookings for Season Show Comprehensive Plans to Demonstrate Merits of the Edison

The bookings for the forthcoming Edison Tone-Test season are now pretty well made up. Helen Davis and Victor Young, Edison artists, will make the Dallas, Tex., territory in October and Detroit territory the early part of November. The trio, consisting of Glen Ellison, Sybil Sanderson Fagan and Alta Hill, will make the Indianapolis territory the latter part of October and Cincinnati territory the first half of November. Marie Morrissey will spend two weeks during November in Philadelphia territory. Elizabeth Spencer will be in the Pittsburgh territory the first part of October; Philadelphia territory, the latter part of October; Cleveland territory, the first part of November, and Des Moines territory, the latter part of November.

A. HEINEMAN RETURNS FROM EUROPE

Adolf Heineman, vice-president of the General Phonograph Corp., New York, returned to New York a fortnight ago on the steamer "Manchuria," after spending two months in Germany, accompanied by Mrs. Heineman. The trip was in the nature of a vacation and Mr. Heineman spent most of his time in Berlin, where he called upon many of his personal and business friends. The factories of the Carl Lindstrom Co. were visited and Mr. Heineman acquired an intimate knowledge of business and economic conditions. Among the other cities that Mr. Heineman included in his itinerary were Hamburg and Luneburg, the home town of the Heineman family.

The formal opening of the enlarged store of the Lynbrook Music Shop, Lynbrook, L. I., was held recently by Jay O. Benton, proprietor, whose business now occupies two floors.

FELT



SATISFACTION

PERMANENT patronage is invariably the result of satisfaction.

Leading manufacturers of talking machines continue to favor us with their orders for turntable felt, year

after year, for one reason only—satisfaction.

Other manufacturers may be interested in knowing about this source of felt supply. An inquiry will receive careful attention.

American Felt Company

TRADE MARK



BOSTON
211 Congress Street

CHICAGO
325 South Market Street

NEW YORK—114 East 13th Street

SAVINGS NOW TOP THREE BILLIONS

Report Shows That 4,109,549 in New York State Have Deposits Totaling \$3,040,788,000

Talking-machine dealers in New York State should realize that there is real business to be had this Fall if they go after it strenuously, owing to the fact that deposits in the 145 savings banks in the State of New York passed the 3,000,000,000 mark on July 1 of this year. According to preliminary figures issued by the Savings Banks Association of the State of New York the amount due depositors on that date, including dividends credited, was \$3,040,788,000, an increase of \$249,435,000 over the amount due depositors a year ago and an increase of \$148,319,000 since January 1, 1923.

There has also been a notable increase in the number of depositors in savings banks. The total on July 1, 1923, was 4,109,549, a gain of 193,637 over a year ago and of 124,581 over January 1, 1923.

In New York City alone the amount of deposits in savings banks, including dividends credited, was \$2,263,376,000 on July 1, a gain of \$193,633,000 over a year ago and of \$118,463,000 over January 1, 1923. In New York City the number of depositors in savings banks was 2,820,198 on July 1 of this year. Since the population of the city, according to 1920 census, was 5,620,048, this indicates that every second person in the city has a savings account in a savings bank. In the last year there has been a gain in depositors in the city of 139,666 and in the last six months the gain has been 95,364.

"TALKER" MARKET IN SYRIA

WASHINGTON, D. C., September 6.—A firm in Damascus, Syria, desires the agency for American-made talking machines and musical instruments, according to advices received by the Bureau of Foreign and Domestic Commerce here. Write the Bureau and refer to File 7336.

NEW SHOP TO CATER TO FOREIGNERS

Victor Establishment Opened in Toledo, O., by H. L. Wasserman Will Specialize in the Sale of Foreign Recordings—Promising Outlook

TOLEDO, O., September 7.—Harry L. Wasserman has opened an exclusive Victrola shop on St. Clair street, adjacent to the Rivoli Theatre, under the name of the United Music Store. The shop will cater to the foreign record buyer. A survey of the city has revealed, including French, Hebrew, Italian, German, Hungarian, Spanish, Polish, that he will have upward of 40,000 prospects. Every foreign language record listed in the Victor catalog will be carried in stock, as well as other records.

Mr. Wasserman was formerly connected with one of Detroit's leading music houses. He also held a number of important State and county offices in that section. He decided to locate in Toledo after he found that the opportunity for success with the kind of establishment he is bringing here was very promising.

REMODELED LYNBROOK SHOP OPENS

Jay O. Benton Practically Doubles Size of Store Giving Him Increased Display Room

LYNBROOK, L. I., September 10.—The formal opening of the remodeled Lynbrook Music Shop was held here recently, after the completion of alterations, which added the second floor of the building as an additional show room. Jay O. Benton, proprietor of the concern, has fitted out the upper floor, formerly a large court room, with a series of studios, where instruction on various instruments will be given by expert teacher. There will also be a large salesroom for pianos and talking machines on this floor, leaving more room on the main floor for the record booths. The entire establishment has been redecorated.

SOUTHERN EMERSON DISTRIBUTOR

L. W. Freeman Will Distribute Emerson Phonographs in Atlanta Territory—Well Known Throughout the Southern Territory

L. W. Freeman, Southern sales manager for the Wasmuth-Endicott Co., manufacturer of "Kitchen Maid" kitchen cabinets and built-in equipment, with headquarters in the Candler Building, Atlanta, Ga., will also distribute Emerson phonographs manufactured by the Wasmuth-Goodrich Co. Mr. Freeman's twelve years of consistent sales effort in behalf of "Kitchen Maid" products have won for him an extensive following in Southern territory. His activities have not alone been confined to kitchen cabinets, for he is also one of the most successful furniture distributors in the South, handling a special line of dining room and library tables, as well as dining room furniture.

GILLINGHAM SAFE IN JAPAN

The many friends in the trade of L. E. Gillingham, well-known recording expert, will be glad to learn that Mr. Gillingham and his family survived the terrible catastrophes in Japan. A cable was received by Mr. Gillingham's mother stating that the family was safe, but no word has yet been received regarding Russell Hunting, Jr. Both Mr. Gillingham and Mr. Hunting have been associated for some time past with the Nipponophone Co., talking machine and record manufacturer in Yokohama, Japan.

PHILLIPS PHONO PARTS CO. BUSY

Based upon the ordering of phono parts, the production of machines this Fall will doubtlessly reach large figures. William Phillips, president of the Wm. Phillips Phono Parts Co., New York City, reports that August orders were exceptionally good, totaling about four times the volume of August of last year.

**Here Is *the* BIG VALUE
CHARMAPHONE MODEL NO. 18**



MODEL 18
31½" Long
21½" Wide
34" High

Dealer's Price \$45⁰⁰

This NEW CHARMAPHONE No. 18 is without doubt the best buy of the season. It means pleased customers and large profits.

Retailers are making it their leader everywhere. It is an attractive cabinet—fine mahogany finish—double spring motor—fine nickered parts—Charmaphone tone arm and sound box.

SEND FOR SAMPLE AT ONCE

Immediate Delivery.

CHARMAPHONE CO.

39 W. 32nd St., New York City

Featuring the MUSICAL POSSIBILITIES of the TALKING MACHINE

[EDITOR'S NOTE.—This is the thirtieth of a series of articles by William Braid White devoted to the various interesting opportunities which prevail in the domain of education for the retailer of talking machines. The subject is one of great interest and we commend these articles to the consideration of all who are devoting attention to the featuring and developing of the musical possibilities of the talking machine.]

BALANCING THE RECORD LIBRARY

It would certainly be unfair to say that the existing collections of records, as we find them to-day, are exactly one-sided; but it would not be unfair to say that they bear unduly upon certain sides of musical performance. Now this is not a matter for any particular blame, since from the beginning of things in this trade it has been necessary to proceed slowly, one step at a time, and to give the people what they want at all times. In consequence of this economic necessity, however, we find that in certain classes of music there is an overplus and in certain others a distinct deficiency.

Such a state of affairs is, of course, not at all what one should prefer, for one of the essentials to the permanence of the talking machine industry, in face of the competition of other means for music reproduction, is a thoroughly well-balanced accumulation and supply of every kind of music. It is always in the matter of some similarly neglected point that weakness develops in any industry. These weaknesses are often dangerous and sometimes fatal. We do not want any of them, if we can help it, in the music industry.

Record All Good Dance Music

A well-balanced music catalog should be, and doubtless is, the aim of every manufacturer of records, though, of course, the temptation is ever present to follow each whim of public taste and so gradually to load up with a mass of ephemeral matter, each number of which has a very short vogue and is then lost for good. Of course, there is no sense in neglecting profits which, as it were, wait for one at the door, only asking to be let in. For my part I thoroughly believe in recording all the good dance music there is. The work of orchestras, like the various Whiteman organizations, for instance, represents true musicianship. When modern dance music is properly performed and recorded by

artistic players it is very good stuff indeed. I have listened to dance orchestras whose power over a crowd containing many very fine and artistic dancers, dancers capable of the real poetry of motion, was positively wonderful, almost hypnotic in fact. Now, music of that sort is not likely to be lost in the course of a day or two. It is going to last for a good long time, and some of it may last permanently. Now, the complaint is not with this highly developed dance music. The complaint is much more with the attempts which have been made and are being made to fill out the lists of standard interpretations, the lists of music which is expected, whether on account of intrinsic merit or of the desirability of preserving the art of some great personality passed away, to remain a permanent good seller and a permanent element in a permanent collection of musical art.

Recording From Two Standpoints

Now, we always have to consider the recording question from two standpoints. On the one hand, records are music, *qua* music. On the other hand they are the preservation of the voices and the technique of many great singers and players. The selling appeal is probably first to be based upon the personality question. It is always easier to sell Caruso's voice than to sell Celeste Aida, as Celeste Aida. This is because in vocal matters the interpretation is everything, and the music only too often of secondary importance.

To a certain extent this is also true of instrumental music. The interpretation tends to become much more important than anything else. But not to so great or exclusive an extent, because those who care for instrumental music usually care, at least in part, for the music itself, and are not so completely hypnotized by the warmth or beauty of this singer's interpretation. It is usually, therefore, not so difficult, or commercially so risky, to use artistic sense in balancing up instrumental collections.

Order of Popularity

To maintain a fairly balanced collection, however, it is necessary to give every kind of music its fair chance. Of course, dance music sells easiest, blues songs and other characteristic

racial rhythms come next in order probably, and then follow the records of great voices. These latter are of the utmost importance, for, little as the people at large may care about musical art, they do love fine voices and fine singing. After these, and at a long interval, come solo records of violin, cello and piano. Still further behind comes instrumental ensemble music, followed by symphonic records.

Band Music Neglected

Yet this, of course, is a very rough classification, and many modifications must be made in it. For instance, I have said nothing about military band music. No music is more fascinating and none more thoroughly fitted to the genius of the talking machine. Yet the recording of fine music by the military bands has greatly lagged. Here is a concrete example of what I mean by lack of balance in catalog making.

The term "Military Bands" includes what are also called "Concert Bands" for the purpose of this classification, and it must be evident to any one who has ever heard the best of the latter, such as the U. S. Marine Band, that here is a marvelous field awaiting us to be opened up by exploiting the appeal of these fine organizations to the native musical taste of the people. Imagine the Hallelujah Chorus from the Messiah recorded in an adequate arrangement by the U. S. Marine Band, or by Sousa's or Ellery's bands. Some remarkably fine specimens of German concert band recording have lately been placed on the American market, and they show wonderfully well how big a field there is yet to be exploited.

Band music, as I envisage it, should not be confined to marches and similar elementary matters. It should include virtually all the concert overtures, popular movements from symphonies, selections from favorite operas, and so on. There is already some of this material in the domestic catalogs, but I do not think there is half enough.

It would be more than merely interesting to see the results flowing from a campaign to put a lot of music of this sort up to the people. The response would probably be better by a good deal than the conservatives are willing to admit.

In the same way, too, a little research and some system injected into the methods of choosing orchestral and ensemble music to be recorded, would probably yield encouraging results in sales, and likewise balance up the catalogs wonderfully. As an example: If we could only have just one Haydn string quartet (say the Op. 64 No. 5, which takes the fancy of the veriest musical boob at first hearing), what a fine thing it would be!

Warning, Not Scolding

There is much more to be said, but I do not want to be thought a common scold. That is to say, I do not want any one to think that I am finding fault and picking flaws. Any one can indulge in that detestable practice and I do not propose to be included in the category. On the contrary, what I am trying to do is to show all concerned that the present position of the talking machine industry not merely entitles but virtually forces us, if we are to hold our own, into a position of positive handling of our problems. We must consider them all from every standpoint and we must be prepared to do all that competing methods of reproducing music can do; and then some! That is why we need to take serious thought about the condition of the present accumulation of records to the end that we may fill up the gaps, exploit not only a few but all the classes of music so fast as we can teach the people to absorb them, and thus balance up our position and make ourselves impregnable strong.

We Serve New York!



ALL along the line, preparations for a busy season are being made. Fall business is rapidly getting under way. A short time will see it hitting its full stride. Don't be caught short. Prepare for that inevitable increase in the demand for

OKeh Records

The Records of Quality

As always, we are ready to serve you quickly and efficiently no matter what your demands for these fast-selling records may be. We are able to do this because we carry at all times a thoroughly complete stock of OKeh Records that is never allowed to deplete.

GENERAL PHONOGRAPH CORPORATION

New York Distributing Division

15 West 18th Street

New York City

Distributors
for
OUTING
and
ODEONETTE
Portable
Machines

Dollar Happiness FOR CHILDREN

Sold Exclusively to Music Trade

Announcing—

Beginning August 1st Bobolink Books are confined exclusively to the music trade. Dealers have readily grasped the importance of this policy.

Seven Complete Books

Each book contains FOUR selections on two double-faced records. There are piano-scores, stories, pictures and games. More are in preparation.

Dealer Service

A metal rack built to hold twelve Bobolink Books is given free with each order for 12 books of each number. Circulars for monthly mailing list are free for the asking.

Four-color Cutout display piece for window or interior display is given free with an order for four or more books of each number.

Displays for Big Windows

Oil painted panel-screens 7 feet high, center panel five feet wide, two side panels 3½ feet wide, are supplied free.

Series of three entirely different designs are now traveling in different parts of the country. Write at once, as perhaps one is in your territory at the present time or will be available at a later date.

Displays for Small Windows

Black and white silhouette single panels 5 feet high 5 feet wide on grooved pedestals are now being routed from the Atlantic to the Pacific. Write for a date.

Each series of panels for both large and small windows is the highest order of art. The display will lend attractiveness to your store and is acceptable to the most particular window decorator.

Order an introductory assortment of 12 each Nos. 1 to 4 Song Books, Nos. 1 and 2 Reading Books, No. 1 Game Book. Total 84 Books, 1 Display Rack, 1 Display Cutout, supply of Circulars, Net cost \$52.08 F. O. B. New Haven.

The La Velle Mfg. Co. NEW HAVEN
CONN.

Bob O Link Books

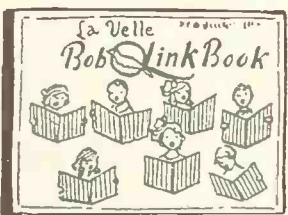
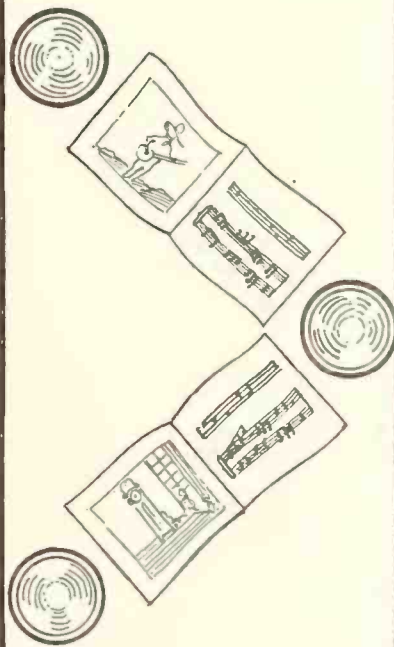
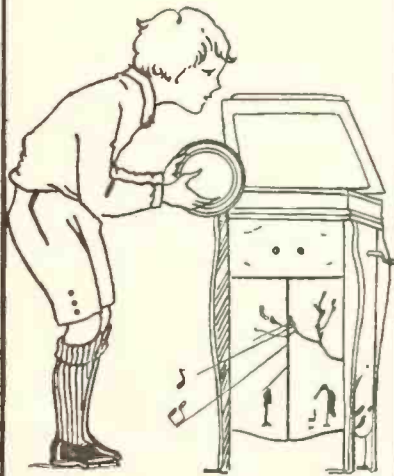
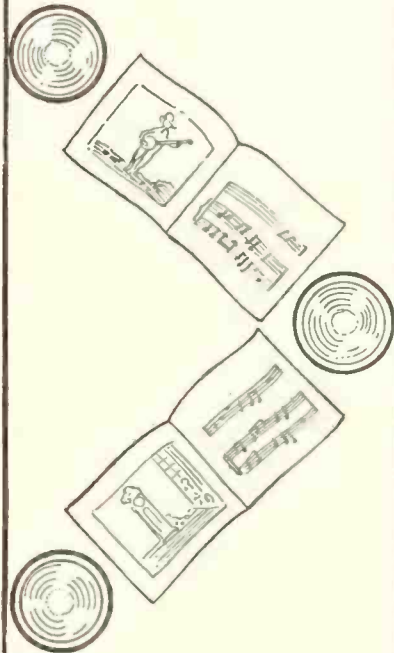
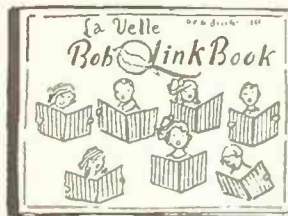

NATIONAL RADIO WEEK

Will Be Held This Year From November 25 to December 1—In Charge of Notable Committees

National Radio Week will be held this year from November 25 to December 1, according to an announcement made recently by the National Radio Week executive committee of the Radio Trade Association. The Radio Week committee as just announced by President Shaw, of the Association, will include F. Clifford Estey, president of the National Chelsea Radio Corp., Boston, Mass.; Theodore R. Gerken, of the Marshall-Gerken Co., Toledo, O.; Benjamin Gross, of the Radio Stores Corp., New York City, and the editors of several of the leading radio trade papers. Additions to the membership of this committee may be announced at a later date.

Publicity for the National Radio Week will be handled by a special committee of publicity experts, headed by Pierre Boucheron, director of publicity for the Radio Corp. of America. There will be a special program committee to take care of radio broadcasting during National Radio Week, and full details regarding this week may be obtained from the secretary of the Radio Trade Association, 1133 Broadway.

BOBOLINK FALL DRIVE UNDER WAY

NEW HAVEN, CONN., September 10.—The La Velle Mfg. Co., of this city, has announced that the sale of Bobolink books is now confined to the music trade exclusively. The particularly strong holiday appeal to be found in this merchandise is being featured in an extensive Fall campaign now under way. A number of effective dealer service helps have been evolved which will undoubtedly greatly increase sales. This service covers window trims, literature for mailing purposes and a metal rack to hold twelve Bobolink books.

VOCALION RECORDS SELLING WELL

SAN FRANCISCO, CAL., Sept. 6.—The Munson-Rayner Corp. has now completed its handsome quarters at 86 Second street and reports a heavy business in Vocalion records. There is a great rivalry developing between Ed. Zuchelli, in charge of the record department of the Los Angeles Munson-Rayner firm, and the San Francisco department, in charge of Thos. G. Rockwell, as to who will sell the most records. Both say that Vocalions are scoring heavily.

TRINITY RADIO PHONOGRAPH READY

Combination Radio and Phonograph Introduced by Trinity Phonograph Co.—Dealers Using Newspaper Advertising to Advantage

BOSTON, MASS., September 6.—The Trinity Phonograph Co., of this city, manufacturer of the Trinity console phonograph, is meeting with considerable success in the introduction of the Trinity radio phonograph, which has been advertised extensively through newspaper campaigns. This instrument, which is a combination radio and phonograph, has many features which are presented to advantage in the publicity used by the dealers handling the product.

The cabinet, which is a handsome console, is finished in red or brown mahogany and is designed after the Queen Anne period. A standard spring motor is used or the Kendrick & Davis electric drive unit may be substituted. The radio is a Maclite four-tube set with the latest improvements in radio construction. The company is preparing for an active Fall trade, as the talking machine dealers are taking a keen interest in the sales possibilities of this new combination radio and phonograph.

BRILLIANTONE NEEDLES IN DEMAND

August sales of Brilliantone needles surpassed all previous records for this month, thus maintaining the remarkable lead in business this year over all previous years. The new Brilliantone daylight sign is now to be found in retailers' warerooms in many cities. Sydney Risser, of the sales staff of the Brilliantone Steel Needle Co., New York City, was a recent sojourner in the Boston and New England territory, while R. C. Norman is away on an extensive trip covering New York State, Pennsylvania and Ohio. Harry W. Acton, secretary of the company, returned recently from a very enjoyable vacation spent with his family at the seashore.

THE BRUNSWICK IN DETROIT

H. B. Bibb, manager of the Chicago district of the Brunswick Co., has announced the taking on of the complete Brunswick line by the Crowley-Milner Co., of Detroit, Mich.

This concern is one of the largest department stores in the State of Michigan, and for a number of years has been handling the Victor line exclusively. The talking machine department is managed by Larry Dow.

PHONOGRAPH DE LUXE

The instrument of incomparable tone, that plays any record better than you have ever heard it played before.

Complete line of table, upright and console models.

Write for catalog on

New Portable AND New Console

Cash in on the Regina; now is the time. Also Regina Music Boxes with or without phono attachment.

Regina Hexaphones and Mandolin orchestrons.

Regina tune discs and parts for any instrument ever manufactured by the Regina Co.

Send for particulars on territory arrangements.

The Regina Phonograph Co.

MANUFACTURERS

RAHWAY

NEW JERSEY

SONORA DEALER USES OUTDOOR SIGNS

SCRANTON, PA., September 4.—When Mr. Peuser, the owner of Peuser's Sonora Shop, of this city, decided upon the use of outdoor road signs he proceeded to find the best locations possible for their erection and he certainly succeeded. The accompanying illustration shows one of Mr.



Featuring the Sonora in Scranton

Peuser's signs on the "Lackawanna Trail," the main highway to Scranton from the West. The sign is right on the bend in the road, where the trail narrows down between two big hills. Hundreds of motorists pass the sign daily and it is already proving a business stimulator.

Andrew P. Frangipane, general manager Mutual Phono Parts Mfg. Co., has returned to New York from his Canadian trip.

VICTOR DISTRIBUTORS

PERRY B. WHITSIT CO.

'Record Business

THE Whitsit organization is paying close attention to the dealers' activities in connection with the development of Victor record business. Our facilities and experience are at your disposal—why not take advantage of it?

COLUMBUS - OHIO

THE marked increase in the sales and popularity of Okeh Records for 1923 firmly establishes them as one of the fastest selling records on the market today.

To the dealer who handles a record with so rapid a turnover as Okeh, prompt delivery of all record orders is of vital importance. Our complete stock of every record in the Okeh catalog enables us to give dealers in the South quick, reliable service.

Our dealer proposition is an interesting one. It will pay you to investigate the advantages that accompany the handling of

Okeh Records

The Record of Quality

INDEPENDENT JOBBING COMPANY

122 East Centre Street, N.

Goldsboro, N. C.

A Better RECORD



A Better SERVICE



TURNER MUSIC CO. EXPANDING

Two New Branch Stores Will Soon Be Opened by Prominent Florida Music House—Will Operate Five Stores in Leading Cities

TAMPA, FLA., September 8.—The Turner Music Co., 608 Franklin street, this city, will soon open a handsome new establishment in St. Petersburg, Fla. The store, one of the finest in the South, will be located at 1 Alhambra Arcade. W. B. Word will be manager and J. D. Saumenig, assistant manager.

Another branch will be opened the middle of this month at 136 South Orange avenue, Orlando, Fla., with J. V. Borum as manager and Earle Stafford as assistant. The present plans of the Turner Music Co. for the expansion of the business also include the opening of another store on November 1, at West Palm Beach, making altogether five stores operated in this State by the company, as well as an agency in Jacksonville. In addition to a large stock of pianos the Turner Music Co. handles the Victor, Edison, Brunswick and Sonora lines of phonographs, records and a large stock of musical instruments.

INTRODUCES NEW ELECTRIC MOTOR

H. A. Robbins Sales Agent for Kendrick & Davis Electric Motor—Has Various Mechanical Features Which Add to Efficiency

BOSTON, MASS., September 7.—H. A. Robbins, who has been identified with the talking machine industry for many years, is now the sole sales agent for the Kendrick & Davis electric drive for phonographs. This product is manufactured by the Kendrick & Davis Co., one of the country's foremost electrical manufacturers, and it represents the efforts of a corps of expert engineers. This electric drive has an automatic switch that starts the motor and is a positive playing stop, also acting as a protection lock when the machine is not in use. It is a Universal motor operating on A.C. or D.C. and is equipped with a resistance unit which takes care of varying voltages.

OKEH RECORD HAS TIMELY NEWS

Volume 1, No. 2, of the Okeh Record, the house organ published by the General Phonograph Corp., New York, manufacturer of Okeh and Odeon records, contains a number of interesting news items that can be used to advantage by the company's dealers. The first page of this house organ features "Dajos Bela and His Orchestra," exclusive Odeon artists, who

have made a number of Okeh records that have been enthusiastically received by the trade. Among the other news items presented in this edition of the Okeh Record are the following: "Sophie Tucker Busy on the Pacific Coast," "Vincent Lopez Joins Kiwanis," "Gerald Griffin Honored," "Okeh Record Stars as Radio Broadcasters," "Sara Martin Becomes a Composer" and other items of general interest to dealers handling the General Phonograph Corp. line.

The Grand Rapids Phonograph Co., New York City, has been chartered by C. Stein, M. Lefkowitz and M. Kaplan, with a capital of \$10,000.

We will sell for Spot Cash and at prices below cost of production

COLUMBIA GRAFONOLAS AND RECORDS

Practically the remainder of the former stock of over Fifty Thousand Grafonolas and Ten Million Records from the 1922 catalog recently released from the factory and sold off by the leading department stores of the United States.

GRAFONOLAS

Less Than Three Thousand All Told. Various 1922 Models in Original Cases and assorted finishes.

Shipments F.O.B. Baltimore, Dallas and Seattle. Write for latest quotations, stating quantities, models and finishes desired.

RECORDS

About One Million All Told. Series "A" in Ten-Inch 75c Double Discs

A plentiful assortment of all American selections, including many popular hits of the 1922 catalog. Single shipments of 1,000 at 14½c; 5,000 at 14c; 10,000 at 13c; 20,000 at 12½c. Terms: Cash, F. O. B. Bridgeport, Conn.

14½c Each

Series "A" in Twelve-Inch \$1.25 and \$1.50 Double Discs

Including Symphony and Operatic labels of famous singers and instrumentalists. Single shipments of 1,000 at 39½c; 5,000 at 38c; 10,000 at 37c.

39½c Each

Terms: Cash, F. O. B. Bridgeport, Conn.

Series "E" in Ten-Inch 75c Double Discs

Several stocks aggregating a half-million FOREIGN LANGUAGE Selections with listed inventories from 1922 catalog covering a wide range of Selections. 1,000 at 25c.

25c Each

Terms: Cash, F. O. B. Bridgeport and Dallas.

Write for quotations on larger quantities, stating languages desired.

COMING OUT FOR OCTOBER DELIVERY

A Wonderful Console Model for \$150 selling value.

To cost the dealer approximately \$50. Write now for particulars and exclusive territory.

LOUIS JAY GERSON

Agent, Broker and Exporter of High Grade Radio and Phonograph Specialties
63 Reade Street Telephone 0146 Worth
Cable Code: Gersondale, New York NEW YORK CITY

AMOS EARL RUSSELL MARRIED

One of the important social events in Troy, N. Y., on Saturday evening, September 8, was the marriage of Miss Grace Mae Lee to Amos Earl Russell, who for many years has been prominent in the talking machine trade and who is now connected with the house of Cluett & Sons in Troy. The local papers devoted considerable space to the event and the happy couple were given a splendid send-off by their many friends. After the honeymoon trip Mr. and Mrs. Russell will make their home at 2152 Fourteenth street, in the Beman Park section of the city.



As Table Model

Size 13 inches wide, 12 inches deep, 7½ inches high

THE MADISON

A real phonograph serving a double purpose, adaptable for home or outdoors, very light and compact.

Sells at a popular price, with all the qualities of a high priced instrument.

The quickest seller in the phonograph trade. Stock the Madison for an additional source of profit.

A few jobbing territories open. Quantity prices and literature on request.

MADISON MUSIC COMPANY

114 East 28th Street

New York

THE TRINITY TRIUMPH

A "Trinity" Radio-Phonograph (Maclite Equipped)

As the scope of both the phonograph and radio has advanced, so has the popular desire grown for the instrument that combines the wonders of both into a single unit of amusement and beauty at a moderate price.

In the *Radio-Phonograph* the most advanced principles of both instruments are built into one cabinet of the same dimensions as Console type phonograph.

All equipment is contained within the cabinet, including the loud speaker. No wires are visible excepting the new type antenna and ground leads, which are readily hidden.



The Phonograph

A Trinity—"Sweet as the Chimes." Cabinet of five-ply veneer; English Brown or Dark Red Mahogany; Queen Anne Period. Standard type motor and reproducer of quality. Tone chamber of selected spruce. K. & D. electric drive optional.

The Radio

A Maclite—A four-tube set; a successful tuned impedance type radio frequency set; a singular achievement in advance radio engineering that brings in distant stations (through the tone chamber of the phonograph, which acts as a loud speaker) with exceptional clarity and without distortion. The "A" and "B" batteries are of the highest standard (Maclite).

Representatives Desired Everywhere

Trinity Phonograph Company
Boston, Mass., U. S. A.

HOW A LIVE DEALER MADE GOOD

Advertising, Personal Contact With Patrons and Efficient Motor Delivery Important Elements in Success of Don C. Preston

BAKERSFIELD, CAL., September 4.—Good advertising, personal contact with customers and an efficient motor delivery equipment are the three things that have made it possible for Bakersfield's smallest music store in a very short time to grow to be one of the largest and most complete establishments of its kind in central California. Don C. Preston, who is to-day celebrating his fourth anniversary, is also writing history that is most interesting.

Mr. Preston started business in Bakersfield in a small store room on East Nineteenth street in the Fall of 1919, after he had covered every State in the Union as a traveling representative for one of the largest distributors of musical

instruments. He had been in business but thirty days when he realized the magnitude of his new venture and leased a small space in the building he now occupies. With the able assistance of Mrs. Preston, in the first sixteen months more than \$100,000 worth of musical instruments were sold.

May 30, 1921, fire destroyed his stock of goods and fixtures. After the fire more space was obtained adjoining the old location. Upon moving back into the new store pianos were added to the popular line of Sonora phonographs; sheet music, band and orchestra instruments. The first of this year the store, of which J. G. Gray is sales manager, was again enlarged.

A branch store was opened in Taft in March, 1921, with John MacDonald in charge. A few months ago the Taft branch was moved to a location near the Taft post office, giving that city a fine establishment.

NEW PLAYER TONE CONSOLES

Two Models Added to Player-Tone Line—I. Goldsmith Returns From Successful Western Trip—Tells of Greatly Improved Conditions

PITTSBURGH, PA., September 7.—I. Goldsmith, president of the Player-Tone Talking Machine Co., of this city, returned to his desk to-day after a Western trip which included a visit to the company's factories at Grand Rapids, Mich. In a chat with *The World*, Mr. Goldsmith stated that his trip was very successful and that he had closed arrangements with several prominent houses whereby his company's products would receive aggressive representation the coming season. He is enthusiastic regarding the business outlook, predicting that the coming Fall will be one of the most prosperous seasons in the history of the talking machine industry.

"General conditions throughout the Middle West are very satisfactory," said Mr. Goldsmith. "Every one of our dealers is optimistic in discussing the business outlook for the next few months and we believe that there is going to be a shortage of some of our models, notwithstanding the fact that we have increased our factory output substantially. One of the purposes of my recent trip was the speeding up of production so that our dealers might receive maximum co-operation and service when most needed.

"We have just added two console models to our line and judging from all indications they will be among our sales leaders before the year is over. There is also an active demand for upright models, and, in fact, the trade seems to be in a position to absorb without difficulty a large amount of standard merchandise that is backed up by responsible manufacturers."

TRIANGLE REPRODUCERS IN DEMAND

Manufacturers Increasing Production to Supply Trade With the Important Specialty

The Triangle Phono-Parts Co., 722 Atlantic avenue, Brooklyn, N. Y., announces a considerable increased production in its Triangle reproducer. This product, one of a series of tone arms and reproducers manufactured by this organization, has become quite popular with retailers and manufacturers, necessitating an increase of floor space devoted to its production. While the Triangle concern remains at its old address, it has taken over much larger quarters and the new layout and arrangement of the manufacturing plant will add considerably to the efficiency of production.

Orders for the Triangle reproducers have been considerably on the increase during recent weeks and the manufacturers have not only made changes to take care of this new demand but, in addition, they are preparing an extensive exploitation campaign which should further increase the sales.

Easiest to Carry—Easiest to Play—Easiest to Sell

THE SWANSON PORTABLE

DEALERS
IMPORTANT
ANNOUNCEMENT



Put a display of Swanson Portables and a sign, "Don't Be a Wanter, Be an Owner," in your windows when the feature picture "The Wanters" appears at your local theatre this fall. The Swanson Portable has an important part in this movie, a John M. Stahl production with an all-star cast, including Marie Prevost, Huntley Gordon and Louise Fazenda. Tie up to this—It will mean good business.



SWANSON PORTABLE PHONOGRAPH DISTRIBUTORS

738 So. Los Angeles St.
LOS ANGELES, CALIFORNIA

Survey of the Talking Machine Industry

Music Industries Chamber of Commerce Prepares Interesting Information Regarding Existing Stocks and Retail Trade Prospects

The Music Industries Chamber of Commerce has just completed an extensive survey of the music industry to determine the actual condition of stocks and the business prospects in retail establishments throughout the country, both in relation to retail business and to the demands that have been made and will be made upon manufacturers, together with the plans made to handle those demands.

The condition of the talking machine trade was taken into account in carrying out the survey and the report relative to that branch of the industry says in part: "With respect to phonographs, a far healthier condition is shown to exist than last year. Retail stocks are generally considerably smaller and there has apparently been a healthy liquidation of stocks during the year. This also applies to inventories of repossessed phonographs. The failure of merchants to anticipate their Fall and holiday

requirements of phonographs is even more noticeable than in the case of pianos. Nearly half the merchants have not yet placed orders for any of their holiday requirements, which is a higher percentage than at this time last year, when merchants were not particularly optimistic about Fall and holiday business."

The inventory of new phonographs in the hands of dealers as compared with last year is as follows:

Over 50 per cent increase.....	3 per cent
25-50 per cent increase.....	9 per cent
Up to 25 per cent increase.....	16 per cent
About the same.....	32 per cent
Up to 25 per cent decrease.....	23 per cent
25-50 per cent decrease.....	12 per cent
Over 50 per cent decrease.....	5 per cent
Stock of repossessed phonographs compared with last year:	
Over 50 per cent increase.....	1 per cent
25-50 per cent increase.....	1 per cent
Up to 25 per cent increase.....	6 per cent

About the same.....	37 per cent
Up to 25 per cent decrease.....	20 per cent
25-50 per cent decrease.....	9 per cent
Over 50 per cent decrease.....	18 per cent

Percentage of additional requirements up to January 1, 1924, for which additional orders have been placed:

75-100 per cent.....	9 per cent
50-75 per cent.....	16 per cent
25-50 per cent.....	15 per cent
Up to 25 per cent.....	13 per cent
None.....	47 per cent

Regarding sales since June 1, compared with last year, 67 per cent of the dealers reported increases, 10 per cent of them stating that the increase had been over 50 per cent. Twenty per cent of the dealers reported business as being about the same and only 13 per cent reported decreases. Likewise 69 per cent of the dealers questioned look for an increase in Fall and holiday business, with 24 per cent expecting it to be the same as last year.

PLANNING SALES DRIVE ON EDISONS

T. B. Parsons, Manager Jesse French & Sons, Mobile, Ala., Visits New Orleans to Confer With Diamond Music House Regarding Plans

NEW ORLEANS, LA., September 8.—T. B. Parsons, manager of the Jesse French & Sons Piano Co., of Mobile, Ala., accompanied by E. D. Dent, shop superintendent of the firm, and Mrs. Dent, who is head of the record department of the house, spent two days in this city recently conferring with W. W. Twigg, wholesale manager, and J. A. Billiet, retail manager of the Diamond Music House, here, relative to matters pertaining to the retail distribution of Edison products in Mobile. The Jesse French Co. was recently appointed representative for the Edison line in the Alabama city. Mrs. Dent spent her time in selecting a full line of records that she will introduce to clients in her home city. Mr. Parsons, in speaking of the progress obtained during the short period of their incumbency said that surprising results greeted them at every turn. He stressed this particularly as meaning that even more flattering gains will be shown when the campaign which is now in process of preparation is properly opened.

VICTOR FACTORY AT FULL BLAST

Plant Settles Down to Elaborate Production Schedule Following General Vacation Period—Excellent Progress on New Pressing Plant

The factory of the Victor Talking Machine Co. is now working in full force on a production schedule which is probably the most exhaustive in the company's history, although there are already indications that even the great activity will not be able to prevent a shortage of goods during the Fall and Winter, especially in the popular types of Victrolas.

The experiment of shutting down the entire factory for a period of two weeks in order that each employe might have a liberal vacation with pay proved a distinct success, for not only did the factory organization return to work on practically 100 per cent basis when the vacation period was up, but the company is receiving applications for employment from workers in many other fields. Work on the immense new record pressing plant is progressing rapidly, and it is expected that the new building will be completed, equipped and ready for operation as per schedule. The additional facilities will be welcome as affording means for catching up on record shipments generally.

HARRY T. LEEMING QUILTS TRADE

Former Sales Manager of Pathé Phonograph & Radio Corp. Resigns to Become a Sales Executive of the Mennen Chemical Co.

The talking machine industry has lost one of its foremost figures in Harry T. Leeming, who has severed his connection as sales manager of the Pathé Phonograph & Radio Corp., Brooklyn, N. Y., to enter a foreign field.

Mr. Leeming has been connected with the phonograph industry for nearly twenty years. In announcing his plans he stated: "For some little time past I have given a considerable amount of thought to entering an entirely different line of activity. I finally made up my mind to make the move, but I want my good friends in the trade to know that I am thinking of them and I also want to tell them that Pathé is going to go over very big and that they need have no doubts as to the ultimate future of Pathé and its products. If I should decide, at some future date, to again re-enter the industry, you can rest assured it will be with Pathé."

Mr. Leeming goes to his duties as a sales executive with the Mennen Chemical Co. No successor to Mr. Leeming has been appointed as yet by the Pathé organization.



Style F-502

HAAG RECORD FILING CABINET

Edison Dealers, Attention

Now Furnished in English Brown to Match the New Edison Products

Also Furnished in Dark Red and Brown Mahogany

Haag Record Files made in sizes to fit all makes of phonographs and will accommodate all sizes and makes of records. Just press the button.

Write for Full Particulars

HAAG & BISSEX COMPANY, Inc.
 Calvert Building Baltimore, Md.

Kendrick & Davis Electric Drive for Phonographs

Motor is 7 inches long, 3 inches deep and 4 inches wide. Weight 4 lbs.

An unusual feature—

An automatic switch which starts the motor is a positive playing stop and acts as a protective lock when machine is not in use.

SPECIFICATIONS

Universal Motor
Resistance Unit which cares for varying voltages
Direct Drive, one-piece shaft, all tool steel; noiseless non-strip gear
Bronze bearings, self-oiling
Composition, non-vibrating frame

Price but little higher than standard spring motor

H. A. ROBBINS

Sole sales agent

142 Berkeley St., Boston, Mass.

FINE SITUATION IN PITTSBURGH

Joseph C. Roush, of the Standard Talking Machine Co., Brings Enthusiastic Report Regarding the Business Outlook in That Section

A recent visitor to New York was Joseph C. Roush, head of the Standard Talking Machine Co., Pittsburgh, who came to the city, accompanied by Mrs. Roush, chiefly for the purpose of witnessing the Davis Cup Match at Forest Hills Stadium, Mr. Roush being an enthusiastic tennis fan. After a short stay in the metropolis Mr. Roush left for Absecon, N. J., to arrange for the golf matches to decide the permanent ownership of the Johnson and Blackman cups, played for for several years by golf enthusiasts among the talking machine jobbers.

Mr. Roush was enthusiastic regarding the business prospects in the Pittsburgh territory for the coming months and stated that the steel industry, upon which the Pittsburgh section depends so much, was in a most healthy condition, the introduction of the eight-hour day in the mills having solved the unemployment question completely. Moreover, the steel mills have already on hand enough orders to keep them operating for months to come. The coal situation does not worry the Pittsburgh trade, for there seems to be no prospect of a sympathetic strike on the part of the bituminous miners.

The new weekly releases of Victor records, and particularly the introduction of Red Seal records with the downward revision of list prices, has served to stimulate business materially in the Pittsburgh territory, said Mr. Roush, and will have a very noticeable effect on Fall and Winter business.

The Forbes-Meagher Music Co., Madison, Wis., is remodeling and enlarging its establishment. New record racks, counters and demonstration rooms have been added.

TRADE ACTIVE IN SALT LAKE CITY

Growing Interest in Music and Improved Industrial Conditions Reflected in Prosperity—Changes in the Trade—The News

SALT LAKE CITY, UTAH, September 4.—Judging by the remarks made during the past few days by jobbers and dealers, the phonograph business is better than it has been for a long time. Victors, Brunswicks, Edisons, Columbias, etc., have all been selling well. This happy state of affairs is, to a great extent, due to improved industrial conditions and the fact that there is more interest in music at this time than there has been in years. Musical organizations and choirs, too, are now getting together after the Summer holidays and this is having a considerable effect on sales.

The Brunswick-Balke-Collender Co. has presented the patients of the tuberculosis ward of the County Hospital with a large selection of records.

R. W. Carlson succeeds John H. Young as manager of the Thatcher Music Co., Logan.

The Keith-O'Brien Co. has discontinued its talking machine department on account of having less space in its new store. This firm carried Victor and Edison machines.

Wm. P. Berry, manager of the phonograph department of the Glen Bros.-Roberts Piano Co., has been selected as assistant manager of the local store of the company. Mr. Berry will, however, still have charge of the phonograph department, which is being enlarged.

Miss Sarah Chipman has been added to the staff of the talking machine department of the Glen Bros.-Roberts Piano Co.

Miss Gussie Pearson, well known as a talking machine saleswoman, has joined the Fisher Music Co., East Broadway.

Brunswick dealers at Provo, Utah, report business as increasing. Both the Lindley

Heindselman Music Co. and the Bates Stores Co. state that they have had good business through the Summer months and prospects are good for Fall.

Chas. King, formerly assistant secretary of the Consolidated Music Co., has been given a position in the phonograph department.

Your correspondent has to-day visited the new phonograph department of the great Z. C. M. I. department store. Henry Gardner, the well-known veteran in local music trade circles, who is in charge, said business was coming along nicely. His department is very attractive. There are five booths, all neat and inviting. Columbias and Brunswicks are carried.

R. F. Perry, of the Brunswick-Balke-Collender Co., reports an unusual big volume of sales during the Summer months. Visitors to the local branch during the past month included W. F. Cooper, of the mechanical department of the Brunswick Co.; A. J. Kendrick, general sales manager; Mr. Dives, of the Dives Furniture Co., Brunswick dealer, Malad, Idaho, and Elmer Madsen, of the Manti Music Co., Manti, Utah.

R. G. Thomas, manager of the Brunswick department of Browning Bros. Co., and Ezra B. Jones, of the Jones Phonograph Store, both Brunswick dealers at Ogden, Utah, returned from their vacations this past week.

Much space was devoted in the Salt Lake Tribune on Sunday, August 26, to Brunswick phonographs and records. Besides a large advertisement by the Brunswick Co., there were also large Brunswick advertisements by the following Brunswick dealers in Salt Lake City: Daynes Beebe Music Co., Z. C. M. I., O'Loughlins and Utah Music Co.

Miss Beth Ericson, head of the educational department of the John Elliot Clark Co., Victor wholesaler and dealer, has gone to Medicine Bow Lodge, a Wyoming resort, where she will address a teachers' institute and demonstrate the Victor machine.

NATIONAL METALS DEPOSITING CORPORATION

FACTORY
 34 East Sidney Ave., Mt. Vernon, N.Y.
 Telephone: Oakwood 8845

MOUNT VERNON — NEW YORK
 MANUFACTURERS OF

LABORATORY
 9 East 47th St., New York City
 Tel. Vanderbilt 4153



WE DEPOSIT THE
FINEST COPPER
 IN THE WORLD

FOR YOUR CONVENIENCE
 DELIVER RECORDED WAX
 TO OUR LABORATORY



OUR
IMPROVEMENT
 ALL STAMPERS
 HAVE
**HIGHLY POLISHED
 MACHINED BACKS**

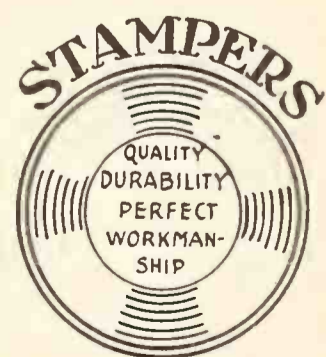

Immediate Delivery Guaranteed!!

on All Samples of

Oh! Pep!

SOLID BRASS

DRAWN TONE ARMS

The Oh Pep Phonoparts Co. has at last surmounted all difficulties incident to the bringing out of its SOLID BRASS DRAWN TONE ARM and is now in position to make immediate delivery of samples of all sizes of its product.

Remember

Oh! Pep! Tone Arms and Reproducers incorporate no Die Castings whatsoever.

Oh! Pep! Tone Arms are of one piece Solid Brass Tubing, bent and tapered to shape, and of uniform thickness throughout.

Oh! Pep! Tone Arms will be shipped at once upon receipt of order accompanied by check covering cost of sample.

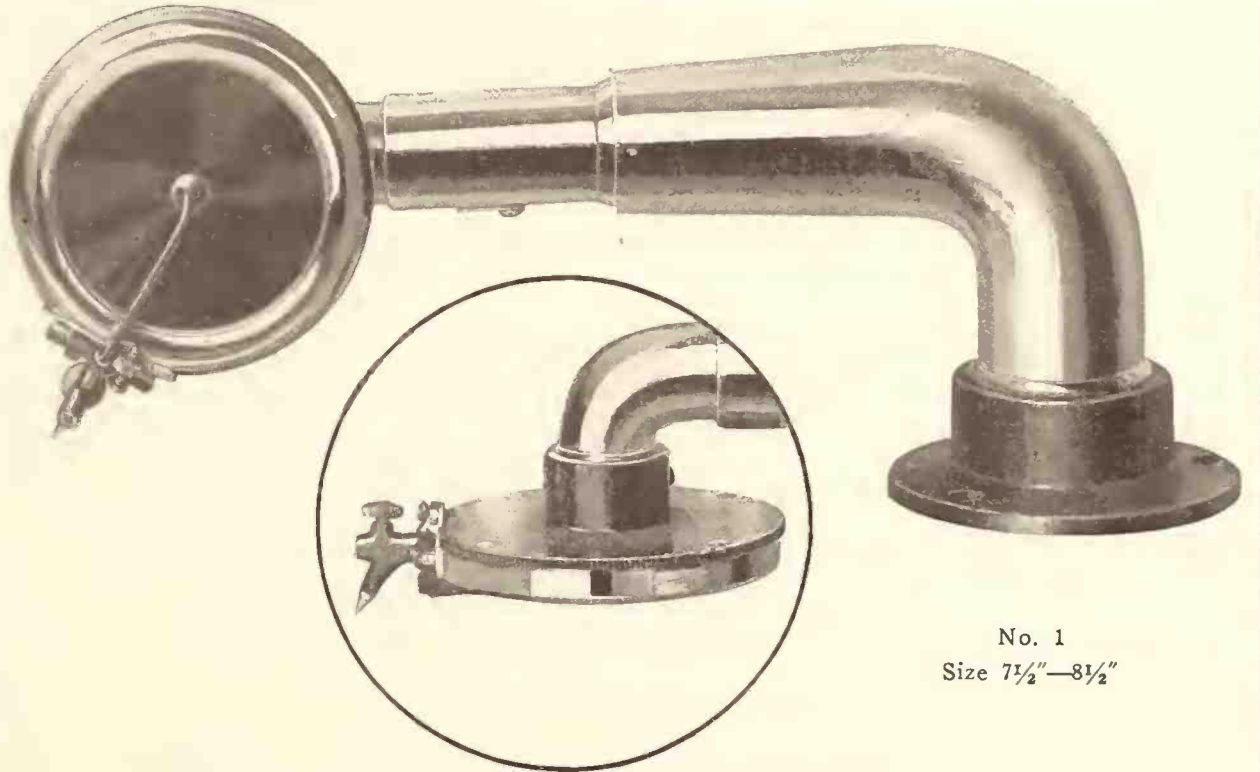

No. 1
Size 7½" — 8½"

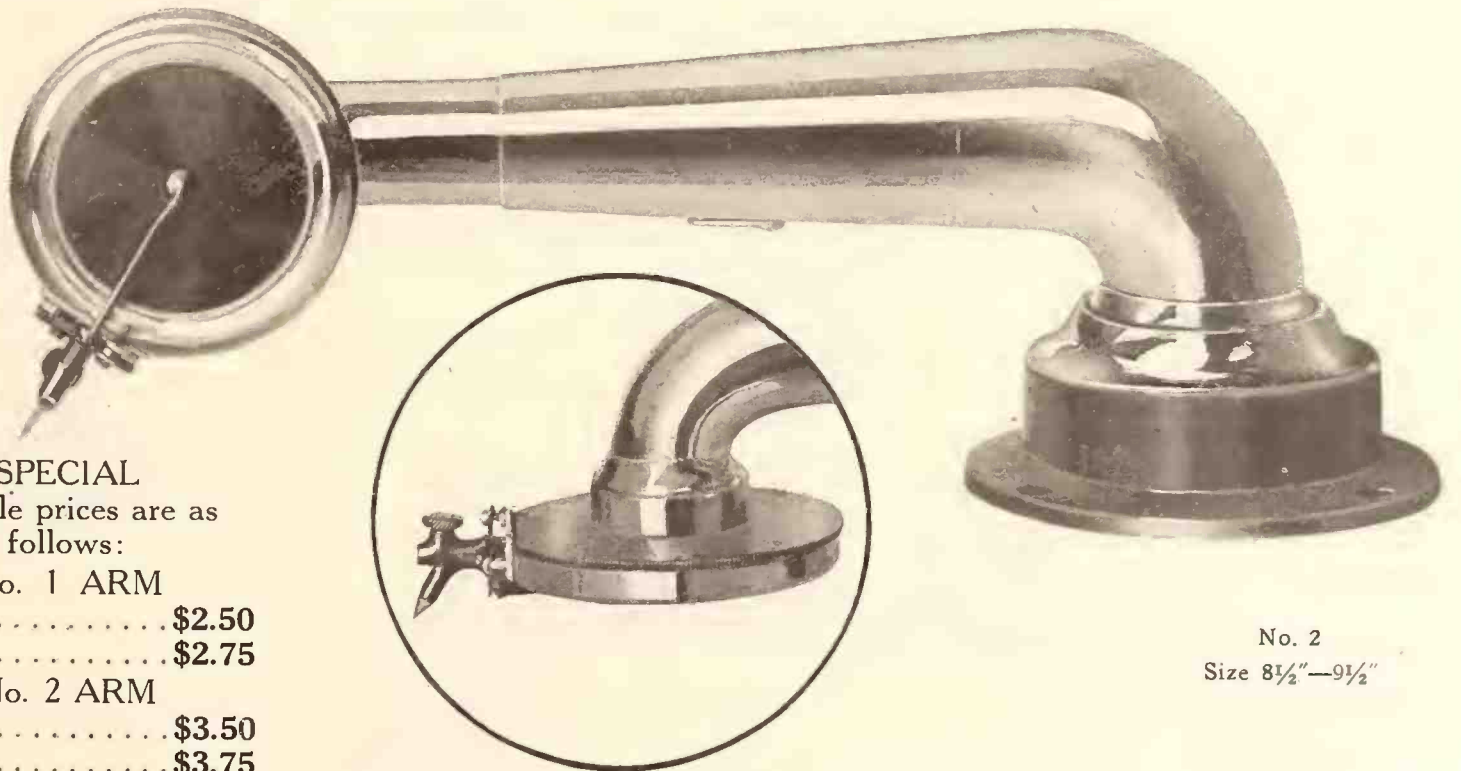

No. 2
Size 8½" — 9½"

SPECIAL
Sample prices are as follows:

No. 1 ARM	
7½"\$2.50
8½"\$2.75
No. 2 ARM	
8½"\$3.50
9½"\$3.75

The above prices include an Oh! Pep! Reproducer which is of Pressed Steel. If Solid Pressed Brass Reproducer is desired add 25c extra.



6912 Cottage Grove Ave.

Chicago, Ill.

RECORD SALES LEAD IN AKRON, O.

Increased Demand for Records of All Classes Makes Up for Lethargy in Other Branches of the Trade—The Month's News Budget

AKRON, OHIO, September 4.—Despite the complaints regarding the business of the past few weeks heard in some quarters here, a general survey of the trade indicates that business as a whole, particularly in the talking machine trade, has been somewhat better than that for the corresponding period last year. During the past week or ten days there has been a noticeable pick-up in buying, which augurs well for the Fall and early Winter business.

One of the outstanding features of the talking machine trade in recent weeks is the unusually big increase in record sales. All local stores report records are moving better than for many months and the people are buying all classes of records and not so much stress is being placed on dance records now.

The Earle Poling Music Co. will undergo extensive alterations within the next month to make room for the installation of new cases in which talking machine accessories and small musical merchandise will be displayed.

Miss Charlotte Roderick, for some time identified with the talking machine trade here, has assumed charge of the record department of George S. Dales Co.

George C. Wille, Canton music dealer, was a recent caller on Earle Poling and closed negotiations for the appearance in Canton at some January date of Ignace Paderewski, noted pianist and Victor artist, who will appear under the direction of Mr. Poling, after his appearance at the Armory here.

George Birbeck, representing the Eclipse Musical Co., Cleveland, who called on the George S. Dales Co., M. O'Neil Co. and the Earle Poling Music Co. last week, reports business on the increase throughout eastern Ohio.

H. H. Fleer, representing the C. C. Mellor

K-E AUTOMATIC STOPS



The K-E is still the best Automatic Stop made Because it:

- Avoids motor strain
- Is not attached to Tone Arm
- Low installation cost
- No extra parts
- Operates all Records.

Send 50c. for sample

Kirkman Engineering Corporation
484-490 BROOME ST. NEW YORK

Co., Pittsburgh, Pa., Victor distributor, also spent a day recently with Earle Poling, of the Earle Poling Music Co.

Miss Grace Barr, from the educational department of the Victor Talking Machine Co., Camden, N. J., was a speaker at the Summit County Teachers' Institute held in Perkins' Auditorium the week of August 26. She also spoke to Portage County teachers at Ravenna, O., on "How Music Talks to Us."

B. A. Emerson, of the B. A. Emerson Music Co., reports Columbia records, especially the new Ted Lewis numbers, as experiencing unusually heavy sales the past few weeks.

"Machine sales have held up exceptionally well during the month of August and should show a tendency to improve after Labor Day," said Earle Poling, manager of the Earle Poling Music Co. "Our Red Seal record business continues to be very active," he remarked. "Even in August, a dull month for the trade, sales were way ahead of last year." He said the recent price reduction had a tendency to help

sales of Red Seal records because people who never bought before are doing so now.

The George S. Dales Co. has opened a complete electrical appliance and radio department in the South Howard street part of the store.

The M. O'Neil Co. states business in Victrolas and Cheneys is better than a year ago.

Six of the leading music houses of the city will exhibit talking machines at the coming annual Summit County fair, which opens September 11 and continues five days. Dealers claim this is the best medium they know of through which to connect with rural prospects.

Akron music dealers are lending co-operation to a plan for the establishment of a department by the Akron Retail Merchants' Association for the collection of delinquent accounts. This bureau will be opened in the Buckeye Building at headquarters of the Merchants' Association. It will be in charge of Wilbur G. Foster. It is said eleven local music houses do a credit business and in the future their delinquent accounts will be handled through this bureau.

THE EMPIRE UNIVERSAL TONE ARMS AND REPRODUCERS

Positively Create Richness and Fullness of Tone Combined with Perfect Reproduction.

Send for sample of our new Tone Arm for Portable Machines and Edison Attachments.

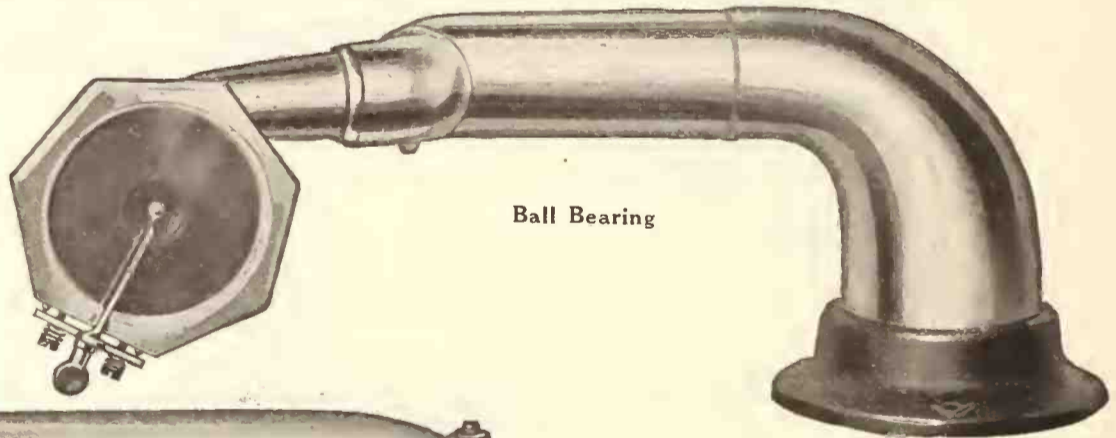

Ball Bearing

Pivot Base

We invite a personal test. There is nothing more convincing. Order a sample arm and test it out. It will win you on merit only. Our prices are low and the quality second to none.

Write or wire us for samples and quotations and give us an outline of your requirements.

Send for sample of our new Tone Arm for Portable Machines and Edison Attachments.

THE EMPIRE PHONO PARTS COMPANY, 1362 East Third Street, Cleveland, O.

Established in 1914

Manufacturers of High-Grade Tone Arms and Reproducers

W. J. McNAMARA, President

Cable Address "Emphono"

Federal

FEDERAL RADIO INSTRUMENTS ARE DESIGNED BY FEDERAL RADIO ENGINEERS AND EVERY PROCESS OF PRODUCTION IN THE FEDERAL FACTORY IS UNDER THEIR CLOSE SUPERVISION

FEDERAL RADIO INSTRUMENTS ARE GUARANTEED UNQUALIFIEDLY AGAINST DEFECTS IN MATERIAL AND WORKMANSHIP AND MANUFACTURED IN KEEPING WITH THE FEDERAL POLICY AND TRADITIONS OF A QUARTER OF A CENTURY FOR PRODUCING ONLY EQUIPMENT OF THE HIGHEST QUALITY

THE SIGNAL SUCCESS IN MANUFACTURING RADIO EQUIPMENT OF THIS TYPE HAS EARNED FOR FEDERAL RADIO PRODUCTS THE REPUTATION OF "THE STANDARD OF THE RADIO WORLD"

Federal Telephone and Telegraph Co.

BUFFALO, N. Y.

Boston New York Philadelphia Chicago Pittsburgh
San Francisco Bridgeburg, Canada London, England

Ev - 'ry - bod - y hand in hand, Swing-in' down the lane,

SWINGIN' DOWN the LANE

An Old Fashioned Song With a Fox Trot Swing

"You can't go wrong With any FEIST song" ©Leo Feist Inc. N.Y.C.

EMPLOYES OF BUSH & LANE PIANO CO. HOLD ANNUAL OUTING AT GENISON PARK

HOLLAND, MICH., September 1.—Harmony was the keynote of the annual outing of the Bush & Lane Piano Co. at Genison Park just outside of Holland on Thursday, last, just as it is the keynote every day among the employes of the company. Everything was there to make the event a success, and in the words of W. H. Beach, treasurer and general manager of the company, "Even the weather man showed his favor." The various games were entered into with enthusiasm, many worthwhile prizes awaiting the winners. The "eats" were consumed with equal enjoyment, and, on the whole it was a happy day for all, a day which will be looked back upon by those present with pleasure.

W. H. Beach was honored by his employes in the presentation of a gold-headed cane. Replying to this token of esteem Mr. Beach took occasion to express his own happiness and referred to Walter L. Lane, president of the company, whom he held up as an inspiration to those possessed of an enthusiastic love for their work. Pride of workmanship and adherence to high ideals is the big element in the success which Bush & Lane instruments have enjoyed, and this has been brought about by the combination of conscientious workers and inspired executives who believe that the human element is one of great importance in the manufacture of pianos and talking machines.

Games and sports occupied almost the entire day. There were all of the usual events, with a lot more added besides. Thirty-two contests, all held within the space of six or seven hours, mean real organizing ability, even when pleasure is the animating cause. That, however, is precisely what the organizers of the Bush & Lane picnic accomplished. There was not a dull moment from the time the crowd thronged into the interurban going out to Genison Park until they thronged back again to go home. The list of prizes donated by concerns in the music industry who deal with the Bush & Lane Piano Co. expressed in an emphatic way the esteem in which the Holland concern is held by its business colleagues. It was a most enjoyable affair which no one present would have missed.

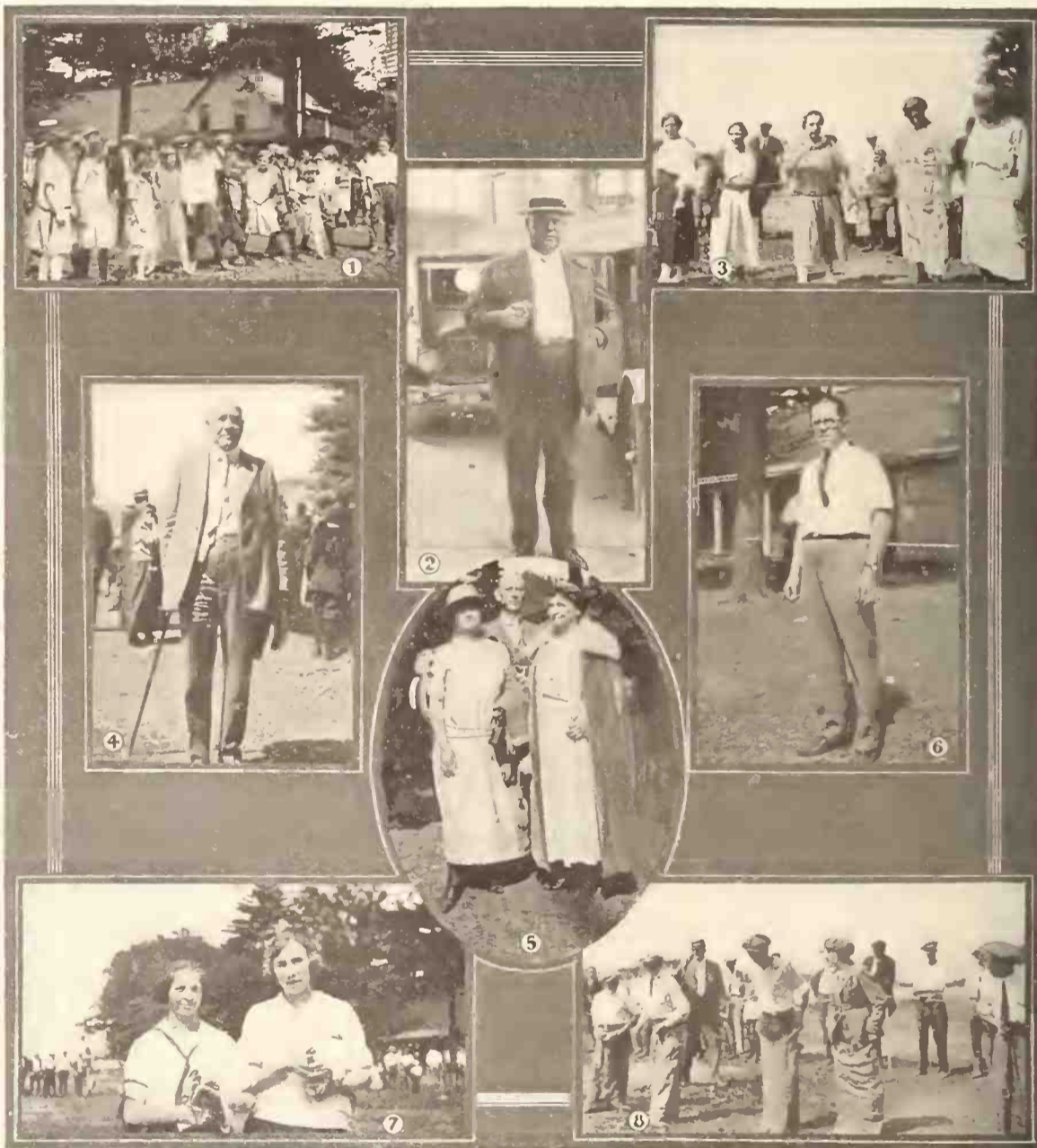

Annual Outing of Bush & Lane Piano Co. Employees

1. Getting Ready to Show Some Speed. 2. President Walter Lane. 3. The Ladies Were Out in Force. 4. W. H. Beach, Treasurer and General Manager, Was Presented With a Gold-headed Cane. 5. A Happy Group of Beaches. 6. G. Kennedy, of the Phonograph Department, Is Not So Austere as He Looks in This Picture. 7. Two Winners of the Chicken Race. 8. The Sack Race.

Size 13x13x7 1/2"
Wonderful—Loud—Clear—Tone
Mahogany finish or Leatheroid covering. Weight, 13 lbs.

NEW IMPROVED
Fulton "AUTOMATIC" Portable
Model No. 25

Sample to Dealers **\$12.50** Discount in Quantities
CASH WITH ORDER

This remarkable new portable is equipped with a durable motor, and a new feature patented throw-in-arm. No parts to disconnect when closing up. Simply close the lid, and the tone arm falls in automatically with it; open the lid and the tone arm comes up in position ready to play. We still have a limited quantity of our Model 35 at the same price, \$12.50. Phonograph and Accessories, Repair Parts for All Makes. Puritone and Truetone Needles at 25c per M in lots of 10 M and up.

Fulton Talking Mach. Co. 253 Third Ave. New York City

COLUMBIA NEWS ITEMS

O. F. Benz, record sales manager of the Columbia Graphophone Co., returned recently from a trip to Dallas, New Orleans, Atlanta and Kansas City, where he visited the Columbia branches and the dealers. He reports the business outlook as very promising, with all of the dealers making plans for an excellent Fall trade.

Robert F. Porter, field sales manager of the company, is back at his desk after a short Western trip, which included a visit to some of the branches as far West as Kansas City.

E. A. Manning, assistant manager of the Columbia branch in Philadelphia, resigned from the company's service a few days ago and his successor has not yet been appointed.

Another Superior Point for THE NEW COLUMBIA

A Portable Model that gives a volume of sound equal to instruments costing twice as much! The New Columbia Portable is sturdy, compact, convenient, convincing—absolutely without a rival in its field.

COLUMBIA GRAPHOPHONE CO.
New York



MARKETING THE "WOLVERINE" LINE

Lind & Marks Co., Detroit, Announces Campaign Featuring Popular Phonograph Line—Factory Facilities Increased Substantially—Now Handled by Many Michigan Dealers

DETROIT, MICH., September 5.—The Lind & Marks Co., of this city, one of the leading concerns in the local talking machine trade, is inaugurating an aggressive campaign, based on increased factory production, in behalf of the "Wolverine" line of phonographs, which it is



"Wolverine" Tudor Model

manufacturing. This line of instruments has been on the market for the past three years, but, owing to the fact that production facilities were inadequate for expansion, it was impossible to handle any trade outside of the State of Michigan. In this one State, however, phenomenal progress has been made by the Lind & Marks Co. in the establishment of dealer representation, and there are approximately 400 dealers handling the Wolverine phonograph in Michigan alone.

The "Wolverine" line is complete in every detail, comprising instruments retailing from \$100 to \$215, together with a popular portable selling at \$35. Among the models in the line are the Sheraton, Adam, Tudor, Queen Anne, Stuart and Louis XV consoles, all of which have proved ready sellers with the Michigan dealers. The cabinet designs of these instruments follow closely the periods they represent and the Lind & Marks Co. has received many letters of approval from the dealers referring to the tone quality of the product.

S. E. Lind, president of the Lind & Marks Co., is one of the best-known talking machine men in this part of the country, having been identified with the industry for many years. He was formerly manager of the Detroit branch of the Columbia Graphophone Co. and in this important position won the esteem and friendship of the dealers throughout his territory. Mr. Lind's thorough knowledge of the requirements of the retail trade are being used to advantage in the merchandising of the Wolverine phonograph and, under his capable direction, an intensive sales campaign has been prepared that will undoubtedly enable the company to attain nation-wide distribution for its product. A five-year guarantee is a feature of this sales plan.

FRED R. SHERMAN VISITS THE EAST

Head of Sherman, Clay & Co., San Francisco, Victor Wholesalers, Enthusiastic Regarding Business Conditions on the Pacific Coast

Fred R. Sherman, president of Sherman, Clay & Co., San Francisco, Cal., Victor wholesalers for the Pacific Coast territory, as well as extensive dealers in pianos, sheet music and musical merchandise generally, arrived in New York with Mrs. Sherman early in September for the purpose of meeting their daughter, Miss Frances Sherman, on her return from a three months' tour of Europe.

Mr. Sherman brought with him a very optimistic report regarding business conditions on the Pacific Coast, which, he declared, were far more prosperous than in many Eastern sections. His company operates fourteen branches, in addition to a number of sub-branches in the various cities and towns along the Pacific Coast, and in each district prosperity prevailed. The fruit growers are getting good money for large crops, particularly the vineyard owners, who are realizing \$150 per ton for grapes that brought only \$30 before prohibition. The oil boom in Los Angeles has also stimulated trade in that section, so a natural reaction is looked for later. Much of the good business is due to the influx of settlers from the East.

The Victor business on the Coast is holding up in remarkable shape, said Mr. Sherman, and he was particularly enthusiastic regarding plans

for the erection of a recording and record-pressing plant by the Victor Co. in East Oakland, Cal., across the bay from San Francisco. The recording plant will make possible the featuring of many more Pacific Coast artists and musical organizations, which fact is calculated to stimulate record demand west of the Rockies where the artists are known, and the operation of the pressing plant will greatly facilitate the delivery of records and save the time now consumed in transporting record stocks.

A. F. MACOUN WITH L. BAUMANN & CO.

A. F. Macoun, well known in the local retail field and identified with the talking machine industry for many years, has been appointed buyer of the talking machine departments of Ludwig Baumann & Co., Newark, N. J. This prominent furniture house now has an establishment on Market street, in Newark, and on September 25 will open another store on Central avenue, in that city, which promises to be one of the most pretensions furniture houses in New Jersey. Mr. Macoun will be the buyer for the talking machine department for the two stores and his long experience in the talking machine trade ideally qualifies him for his important new post.

Edgar Newman, treasurer of the Maison Blanche Co., Victor dealer, New Orleans, La., who has been in Europe for several months with his family, is expected to return shortly.

The Songster

WIDE-AWAKE phonograph dealers will realize instantly the sales possibilities of this new and unusual phonograph. The tone chamber of the Songster is made from select violin spruce in its natural state; it is not veneered, as in usual tone chamber construction. Specially constructed "violin" chambers at both sides of this tone chamber collect the tone vibrations and reflect them in deepened, mellow tones that surprise and delight the hearer. The Songster's tonal system is its dominating virtue; the Songster's variety of design and finish equals any machine on the market. The Songster is now making big profits for many dealers in the Northwest. It can't help but do the same for you.

Write today for illustrated details of Songster design and construction. Ask for our special offer to dealers.

The SONGSTER PHONOGRAPH CO.

219 West Michigan Street—Duluth, Minnesota



PIERRE BOUCHERON VISITS TRADE

Director for Radio Corp. Publicity Returns From Visit to Jobbers and Dealers in the West

Pierre Boucheron, director of publicity for the Radio Corp. of America, New York, manufacturer of Radiolas, returned recently from a trip through the Middle West, where he visited RCA jobbers and dealers with the idea of getting their views regarding publicity plans for the coming season. Mr. Boucheron has made a careful study of the problems confronting the radio dealer and the data that he secured on his recent trip will be used as the basis for the mammoth campaign that will be sponsored by the Radio Corp. of America during the next few months. It is also quite likely that this sales and publicity material will be used as a basis for a handbook to be distributed among the dealers in order to assist them in securing maximum results from their efforts.

INCREASE CAPITAL TO \$515,000

The American Talking Machine Co., Victor jobber, with headquarters on Livingston street, Brooklyn, N. Y., has increased its capital from \$10,000 to \$515,000.

QUINCY, MASS., FIRM CHARTERED

QUINCY, MASS., September 9.—Walter H. Sturgis, Inc., of this city, has been incorporated with a capital of \$50,000 to deal in "talkers."

L. L. KILMER IN NEW QUARTERS

L. Lemuel Kilmer, proprietor of the Edison department in the Heller & Son Furniture Co., South Bend, Ind., is planning to move into a new store at 415 South Michigan street, where he will operate the Quality Music Shop, featuring the Edison.

H. GERMAIN HOME FROM EUROPE

Makes Interesting Comments on Business Prospects and Trade Methods

H. Germain, president of the Plaza Music Co., 18 West Twentieth street, New York City, recently returned from a ten weeks' stay in the larger capitals of Europe. Mr. Germain visited England, France and Germany. In reviewing the European business situation upon his return, Mr. Germain said: "France seems, for the moment, in the best shape economically, but I cannot persuade myself to view many phases of the general European situation favorably in any respect."

Mr. Germain made a minute study of business conditions in all of the larger centers of Europe, particularly as relating to the music business. "One interesting illustration of the different way in which the English view modern business was afforded in the case of the display of a portable phonograph in a London shop window. The instrument bore a price card on which it was stated that the price was guaranteed and that any attempt by any other tradesman to cut it would be met under a law that they have there to prevent price-cutting. The British law apparently recognizes a standard arrangement of price through agreement by both manufacturer and retailer."

NEW BUSH & LANE JOBBER

CLEVELAND, O., September 11.—The Bush & Lane Piano Co. has just consummated arrangements whereby H. B. Bruck & Sons Co., of this city, will be wholesale distributors for the new line of Bush & Lane phonographs. The new enterprise will be in charge of C. H. Kennedy, who is well and favorably known in talking machine trade circles. The territory includes Ohio, western Pennsylvania and the City of Detroit.

NIPPONOPHONE CO. PLANT DESTROYED

In the great earthquake and fire which caused such a great loss of life and property in Japan the reports are that the great plant of the Nipponophone Co., manufacturers of talking machines and records in Yokohama, was destroyed. It is good news, however, that J. R. Geary, an American, long associated with this organization, escaped, as did his wife and two sons.

B. E. BENSINGER HOME AGAIN

B. E. Bensinger, president of the Brunswick-Balke-Collender Co., who has been on an extensive tour through Germany, England, France, Italy and Switzerland, accompanied by Mrs. Bensinger, arrived in New York on the S. S. "Paris" on Friday last. He had a most enjoyable time and is in splendid health.

There is no truth in the published statement that the Chautauqua Phonograph Co., of Washington, D. C., has gone out of business.



THE SHELTON Electric Motor

The "Simplicity" electrifies Victor, Edison and Columbia phonographs by simply taking off winding handle and placing motor against turntable. Automatic switch in motor operated when the turntable is started or stopped. Operating on AC or DC current of 110 volts. Specify type of current when ordering.

SHELTON ELECTRIC CO., 16 East 42nd Street, New York

Victor Wholesalers



The House of Mellor in Pittsburgh since 1831



OHIO MUSIC MERCHANTS' ASSOCIATION HOLD CONVENTION

Talking Machine Interests Take a Prominent Part in the Program of the Annual Meeting of the State Body Held in Cincinnati, September 11 and 12

CINCINNATI, O., September 12.—Problems that have to do distinctly with talking machine stores and departments are having a prominent place in the program of the annual convention of the Music Merchants' Association of Ohio, in session at the Hotel Gibson here yesterday and to-day. A number of talking machine men, as well as many dealers operating talking machine departments, are members of the Association and support it in its various activities.

The convention proper opened yesterday morning, following the annual golf tournament played at the Western Hills Country Club. The convention delegates were welcomed to Cincinnati by W. C. Culkins, vice-president of Chamber of Commerce in the absence of Mayor Carrel, to whom suitable response was made by A. B. Smith, president of the Association. The president, in his annual report, covered

the progress made by the Association and what had been accomplished for the benefit of the music dealers throughout Ohio through organized effort. Secretary Rexford C. Hyre, of Cleveland, also reviewed in detail what the Association had done for its members during the year and announced that, up to the time of the convention, there were 207 dealers on the membership roll, or about 25 per cent of all the dealers in the State.

Among the papers read at the convention which were of special interest to the talking machine men was one on "Trade-ins," by Alfred L. Smith, general manager of the Music Industries Chamber of Commerce; another on "Radio and Its Relation to the Music Business," by Elmer H. Wilkinson, general manager of the Jewett Radio & Phonograph Co., Detroit; "Advantages of Maintaining a Musical Merchandise Department," by James R. Frew, vice-president of the Euclid Music Co., Cleveland; "Finance," by Richard W. Lawrence, president of the Music Industries Chamber of Commerce; "Modern Musical Merchandising," by Arthur Weldon, of Columbus; "Interest on Talking Machine Sales," by Wm. G. Bowie, of Cleveland, president of the Music Merchants' Association of Northern Ohio (which appears elsewhere in this issue), and "Collections and Repossessions," by J. Fred Van Court, Cincinnati.

There was also an elaborate program of entertainment, including a trip to Cody's Farm on the Lexington Pike, Ky., where an elaborate chicken dinner was served and old-time country sports indulged in; luncheons each day at the Cincinnati Chamber of Commerce, and the annual banquet at the Hotel Gibson to-night, after which there will be dancing.

As is usually the case at the Ohio conventions, a number of piano and talking machine manufacturers took advantage of the opportunity of making displays of their products, the talking machine manufacturers represented including the Brunswick-Balke-Collender Co. and the Bush & Lane Piano Co. Other exhibitors included the Sterling Roll & Record Co., showing Strand consoles, Okeh records, Outing portables, and Arthur Brand & Co., Cincinnati, displaying accessories.

IMPORTANT ANNOUNCEMENT COMING

The Aeolian Co. is planning to make an important announcement in the near future regarding its double-faced Vocalion records, according to Oscar W. Ray, general manager of the Vocalion Red Record Division.

NEW QUARTERS IN RENO, NEV.

RENO, NEV., September 8.—Sherman, Clay & Co. have leased new quarters in this city for their local branch at 142 North Virginia street. The new warerooms are now being remodeled and will shortly be ready for occupancy. W. A. MacDonald is the local manager.

TO OPEN NEW STORE IN ROCKFORD

ROCKFORD, IND., Sept. 7.—Mrs. R. T. Rounds and her daughter, Margaret, will shortly open a music store in this city.

Tonnollo's Victor Shop, Ossining, N. Y., has been purchased by R. Dunlap, who operates a store in Peekskill, N. Y. The name of the Ossining store has been changed to the Dunlap Music Shop.

FOR SALE

1,500 High-class Complete Phonographs; standard equipment; three sizes; three styles; various finishes. Immediate or later delivery.

HOUGHTON MFG. CO., Marion, Ohio

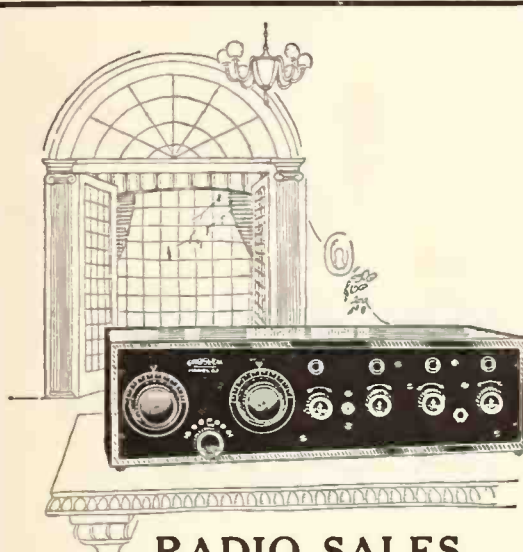

RADIO SALES INCREASING

This fall will see Radio increasing in public favor by leaps and bounds. Already dealers in radio equipment are buying large stocks to meet the huge demand. From a small start Radio has won a permanent place in the markets of the world and will forge still further to the front.

Why not be ready for this demand yourself and receive your share of the profits? Other Talking Machine Dealers realize this and are reaping the benefits daily.

By selling Crosley Radio equipment you will get a line that is second to none in America. Many distance records have been broken with Crosley sets. They operate easily and efficiently and reduce static to a minimum. The national advertising of the Crosley Manufacturing Company will help you still further.

There are Crosley sets for all persons and at all prices ranging from a two-tube set, at \$28, to the beautiful console model, at \$150. Also a complete line of exceptionally fine parts.

For Sale by Good Jobbers Everywhere
Write for Complete Catalog

Crosley Manufacturing Co.
926 Alfred Street Cincinnati, O.

The Crosley Model X-J pictured above—price \$65—is one of the most perfect sets on the market today. Similar in design and structure to the now famous Model X—it embodies even greater refinement of detail, enabling people to hear clearly and distinctly at unbelievable distances.

"The Highest Class Needle in the World"

It stands to reason that the company which for years has built "The Highest Class Talking Machine in the World" would, when it placed a needle on the market, put out nothing but what could be sold as "The Highest Class Needle in the World."

Thousands of dealers will testify to the fact that the Sonora Semi-Permanent Needle is just that—the best and most satisfactory needle they ever offered their customers.

Why not send for a sample?

Sonora Phonograph Company, Inc.

279 Broadway New York

Canadian Distributors:
Sonora Phonograph, Ltd., Toronto



Fall Business is Good for Sonora Dealers

Confident of the ever-growing Sonora demand which is plainly apparent on all sides, Sonora dealers' confidence in the product they handle is further increased by the knowledge that Sonora has launched a tremendous fall newspaper campaign to help them move their stock. The cooperation they are receiving from Sonora is acting as a tremendous incentive to intensive merchandising, the profitable results from which are already proving to be tremendous.

Sonora Phonograph Company, Inc.

279 Broadway New York

Canadian Distributors:
Sonora Phonograph, Ltd., Toronto

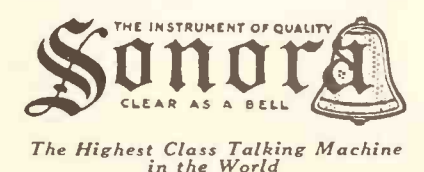

WORLD'S CLASSIFIED ADVERTISING

Any member of the trade may forward to this office a "Situation" advertisement intended for this Department to occupy a space of four lines, agate measure, and it will be inserted free. Replies will also be forwarded without cost. Additional space will be at the rate of 25c. per line. If bold faced type is desired the cost of same will be 25c. per line. Rates for all other classes of advertising on application.

WANTED—Resident salesman in Cleveland, Ohio, to sell extremely high-class popular priced phonograph line to retail dealers. Prefer man already acquainted with trade in Cleveland and surrounding territory. Extremely attractive proposition for right man. Write giving experience and references to Lind & Marks Co., corner of Bates and Congress, Detroit, Michigan.

SALESMEN WANTED—In every state to sell the "Magic-Tone"; liberal commission. See our advertisement on page 99. This is a brand new selling proposition and quick action is necessary to secure territory. Write fully about your experience, lines represented, etc. Magictone Sales Co., 105 West 40th St., New York, N. Y.

WANTED—Manager for talking machine store in Philadelphia. Salary and share of profits. Business established six years and has large foreign trade. Must be in a position to invest from \$1,500 to \$2,000 which will be fully secured. Address with full particulars, "Box 1312," care The Talking Machine World, 383 Madison Ave., New York, N. Y.

WANTED — A number of live-wire, thoroughly experienced talking machine salesmen. Will pay \$60 a week and commission, which will approximate \$100 a week earnings to the right applicant. Call to see Saul Birns, 111 Second Ave., New York, N. Y., any morning between 10 and 12 o'clock.

POSITION WANTED by phonograph foreman with 20 years' experience and thorough knowledge of finishing and every branch of phonograph manufacturing. Can furnish first-class references. Will go anywhere. Address "Box 1300," care The Talking Machine World, 383 Madison Ave., New York, N. Y.

WANTED—High-grade young men to travel extensively as radio salesmen for well-known manufacturer of established mechanical and electrical lines. Must be capable of highest type of sales and service work in demonstrating and introducing line of patented radio equipment. Character references required. Excellent opportunity for promotion as sales and service engineers. Write stating experience, education, age and salary desired. "Box 1323," care The Talking Machine World, 383 Madison Ave., N. Y.

POSITION WANTED—Well educated young man with valuable all-around experience in the phonograph business is desirous of obtaining a connection with established house in either sales or executive capacity. Address "Box 1319," care The Talking Machine World, 383 Madison Ave., New York, N. Y.

POSITION WANTED—All-around mechanic on motors, tone arms and sound boxes. Have been foreman for over three years with nine years experience. Address "Box 1320," care The Talking Machine World, 383 Madison Ave., New York, N. Y.

POSITION WANTED—as manager of music business. Several years managerial experience. Address "Live Wire," 29 Hurlbut St., Albany, N. Y.

POSITION WANTED by expert phonograph repair mechanic. Long experience and capable of taking charge of repair department. References available from well known concerns. Address "Box 1299," care The Talking Machine World, 383 Madison Ave., New York, N. Y.

POSITION WANTED—Recorder with over 25 years experience has his own recording machine, is open for engagement. Address "Box 1324," care The Talking Machine World, 383 Madison Ave., New York, N. Y.

FOR SALE

One million foreign records, Columbia 1922 catalogue, all languages. Sold in small quantities or in one lot. Lovey & Alweis, 402 W. 40th St., New York, N. Y.

SPRINGS

VICTOR		
1 1/4"x.022x17', bent each end.....	No. 6543	\$.57
1 1/4"x.022x18' 6" marine ends.....	No. 3014	.58
1 1/4"x.022x17' marine ends.....	No. 3014	.55
1 1/4"x.022x17' bent arbor.....	No. 5362	.57
1 1/4"x.022x13' bent arbor.....	No. 5423	.50
1 1/4"x.022x9' bent arbor.....	No. 5427	.42
1 1/4"x.022x9', bent each end.....	No. 6546	.42
1"x.020x13' 6" marine ends.....	No. 2141	.32
1"x.020x15' marine ends.....	No. 3335	.35
1"x.020x15' bent arbor.....	No. 5394	.38
1"x.020x15', bent at each end.....	No. 6546	.43
7/8"x.020x9' marine ends.....	No. 988	.29
COLUMBIA		
1"x.028x10' Universal.....	No. 2951	.33
1"x.028x11' Universal.....	No. 2951	.35
1"x.030x11' hook ends.....		.45
1"x11' for motor No. 1.....	No. 1219	.35
HEINEMAN		
1"x.025x12' motors, Nos. 33 & 77.....		.33
1 3/16"x.026x19', also Pathé.....		.75
1 3/16"x.026x17'.....	No. 4	.59
MEISSELBACH		
7/8"x10' motors, Nos. 9 & 10.....		.29
1"x9' motors, Nos. 11 & 12.....		.29
1"x16' motors, Nos. 16, 17 & 19.....		.49
2"x.022x16', rectangular hole, 18k10.....		1.20
SAAL-SILVERTONE		
1"x.027x10', rectangular hole.....	No. 144	.42
1"x.027x13', rectangular hole.....	No. 145	.48
1"x.027x16', rectangular hole.....	No. 146	.58
BRUNSWICK		
1"x.025x12', rect'gular hole, regular.....	No. 201	.45
1"x.025x18', rect'gular hole, regular.....	No. 401	.60
KRASBERG		
1"x12' motor 2A, pear-shape and rect. holes		.45
1"x16' Motor 3 & 4, on outer end.....		.55
EDISON DISC		
1 1/2"x.028x25' regular size disc motors.....		1.25
1"x.032x11', Standard.....		.55
1 5/16", Home.....		.70
1 5/16"x18' type A 150, old style disc.....		1.28
1" Amberola 30-50-75.....		.56
1 1/16", B 80.....		1.15
SUNDRIES		
1"x.025x16' rectangular hole.....		.50
1"x.025x16', pear-shaped hole.....		.50
7/8"x.023x10', marine ends, Hein. Col., etc..		.29
3/4"x.025x10', marine ends, Hein. Col., etc..		.27
5/8"x.020x9', marine ends.....		.21
1/2"x.020x9', marine ends.....		.18
Victor Gov. springs, No. 1729.....	per 100	.95
Victor Gov. sprg. screws, No. 3304.....	per 100	.92
Victor Gov. balls, n/style, No. 3302.....	each	.07
Victor Gov. spring screw washer.....	per 100	.72
Columbia Gov. springs, No. 3510.....	per 100	.95
Colum. Gov. sprg. screws, No. 439.....	per 100	.92
Columbia Gov. sprg. screw washers.....	per 100	.72
Columbia Gov. ball, lead, flat and spring..		.08
Columbia Gov. ball, new style & spring....		.08
Turntable felts, all wool, green, 10", round		.15
Turntable felts, all wool, green, 12", round		.18

TALKING MACHINE SUPPLY CO., PARK RIDGE, N. J.

WANTED

Any amount of Victor, Columbia, Brunswick or any other well-known make of talking machines or records, motors or tone arms. This is a spot cash proposition and must be acted upon immediately. Address Chicago Phonograph Realization, 1427 Carroll Ave., Chicago, Ill.

FOR SALE

Three Unico demonstrating rooms, size 6 by 9 each, ivory finish, sound proof. Also four Unico record racks, each with capacity of one thousand records. For price and details apply to "Box 477," Charlottesville, Va.

CARVED LEGS

Eight designs in gum, oak and mahogany. Prices reduced. Send for circular. Klise Mfg. Co., Grand Rapids, Mich.

IMPORTED HOMOKORD RECORDS

In German, Russian, Polish, Irish and Hungarian. Ask for catalog and prices. Favorite Mfg. Co., 105 East 12th St., New York, N. Y.

GOOD BUSINESS OPPORTUNITY

Just received patent on automatic stop for talking machine. Nothing approaching it now on the market. Will sell outright. Address A. G. Atwell, 27 Rockingham St., Cambridge, Mass.

FOR SALE

Only exclusive music store in an Ohio town of 12,000 population. Exclusive franchise for Edison, Cheney, Starr, Columbia phonographs and Starr pianos. Will sacrifice for \$8,500.00. Cash or good security. Address "Box B. O. B.," care The Talking Machine World, 383 Madison Ave., New York, N. Y.

SALESMEN WANTED

Exceptional opportunity for good producing salesmen to connect with progressive manufacturer of player-roll cabinets, bookcases, phonographs and piano benches. We have some very good territory still open. Apply to Frank H. Isaacs, Salesmanager, 469 Seventh Ave., New York, N. Y.

FOR SALE

Piano store, including Victor and Edison dealerships. Old established business showing good profit. Big opportunity for development. Centrally located in New England farming district. Address "Box 1321," care The Talking Machine World, 383 Madison Ave., New York, N. Y.

COLUMBIA GRAFONOLAS WANTED

Type 2 instruments in any finishes and quantities. Will pay cash. Must be new. State models, finishes and quantity. Address Phillips Grafonola Shop, 14 East Third St., Bethlehem, Pa.

DEALERS ATTENTION

Repairs and parts for Mandel and all other motors. Distributors of Wall Kane needles. We carry a full line of all well known motors and tonearms. Send for price list. Mandel Phonoparts Co., 1530 Milwaukee Ave., Chicago, Ill.

SPOT CASH

Wanted phonograph motors, hardware, legs, etc. Also veneered panels. Must be cheap.

Illinois Phonograph & Supply Co.
237 S. Market St. Chicago, Ill.

FOR SALE

600 46" cabinets; straight legs, all gum mahogany finish. Will sell either one hundred lots or entire lot. Very reasonable. Chicago Phonograph Realization, 1427 Carroll Ave., Chicago, Ill.

FOR SALE

Victor talking machine agency in good territory. 19 miles from Boston. Will sell at inventory, with or without jewelry connection. Address "Box 123," Walpole, Mass.

PATHE SAPPHIRE BALL RECORDS WANTED

30108; 70042; 70021; 70005 (or 30008). One each. If you can supply them write to "Box 1310," care The Talking Machine World, 383 Madison Ave., New York, N. Y.

FOR SALE

Established, going phono parts business. Patent rights, dies, stock on hand, etc. A splendid opportunity worth investigating. Sold to settle estate. Address "Box 1314," care The Talking Machine World, 383 Madison Ave., New York, N. Y.

POSITION WANTED by recording expert with 25 years' experience in all parts of the world; thoroughly practical in all branches of recording and record manufacture; has own complete modern recording apparatus. Write "Box 1322," care The Talking Machine World, 383 Madison Ave., New York, N. Y.



EUROPEAN HEADQUARTERS

2 GRESHAM BLDG., BASINGHALL ST., E.C. LONDON

W. LIONEL STURDY, MANAGER

Prolonged Heat Wave Fails to Seriously Affect Trade—Preparations for Fall Under Way—Radio Horizon Gradually Clearing Up—Exercise Records Make Debut—British Kodisk, Ltd., Inaugurates Competition—Plan to Revise Copyright Act—Gramophone Co., Ltd., Introduces New Table Grand—Other Important News and Activities of the Month

LONDON, E. C., September 3.—Though laboring under the disadvantage of a prolonged heat wave (at time of writing) the gramophone trade is making no bad showing. Indeed, as a result of the educational and instructive work of record and instrument manufacturers, dealers have little excuse for avoiding their responsibility. Every shopman is a public servant, the gramophone dealer not excepted, and even during the so-called "off" season the public expects and admires service. Many times have I found in even small districts dealers of extremely wide difference as regards ideas of service. One will go out to attract custom; the other leaves it all to chance. Thus do we find the enterprising dealer who makes light of troubles and heat waves in a position to say, "Well, things are not so bad, after all." That is the kind of dealer deserving of every encouragement from manufacturers, and they are pleased to give it.

Preparing for Fall Season

Much thought is being given by every section of the trade concerning prospects of the season. Preparations have long since been in hand. It might almost have been said they have reached fruition. The firm which has not made full arrangements and planned its policy for the season so close upon us will certainly suffer a big disadvantage. Regarded as a foregone conclusion that competition will be keener than ever during the next few months, it is to be expected that most firms are ready to meet the occasion by improving the quality of their products and, in some cases perhaps, offering inducements in the way of slight price reductions.

There is a tendency towards reduction in the price of records, though any general or drastic alteration, it may be said at once, is quite out of the question. Prices of materials and manufacturing costs are still high and will not permit any retail price easement of the commercial article. I think, however, we may look forward to reductions here and there in prices of gramophones, especially so in view of the action of the "His Master's Voice" Co. in issuing a cheap, popular-price table grand, as reported elsewhere. This is almost bound to cause a reaction in other manufacturing quarters, resulting in very

keen competition of price, if not of quality, particularly as regards the table grand type of instrument.

My inquiries go to show a general belief exists that the coming season will be a good one. I cannot say that this belief is based on any special grounds, but the optimistic spirit which prevails will certainly carry us a long way towards the goal of achievement and success.

Domestic Radio Situation Less Involved

With the approach of Autumn anticipations are rising as to prospects of revived activity in wireless trade circles. Of late the demand has been very slack, especially for complete sets, partly because the public is getting wise to the comparatively heavy costs in contrast to the cost of parts which the average man or boy can himself fairly easily assemble. These assemblers do not contribute anything for service for the simple reason that it is illegal to assemble and, therefore, no license is obtainable, this apart from the few licenses issued to so-called experimenters. The government, alive to the position, appointed a committee to report upon this aspect of affairs, it being thought desirable to regulate the position. This committee's report, expected in August, has been delayed. Its publication is eagerly awaited. There is little doubt that a license costing 10/- will be granted to amateurs desirous of making or assembling their own sets. Pending this license there is little doubt that sales of parts and even complete instruments are adversely affected.

One other aspect is that of payment of royalties to copyright owners by the British Broadcasting Co., Ltd. An agreement has been reached with the Performing Rights Society by which the British Broadcasting Co. pays broadcasting royalty fees of 2/6 to 10/6 for individual copyrights and between £5 and £50 for broadcasting a complete theatrical performance. This agreement is to be retroactive. Negotiations with other societies are still proceeding.

Physical Fitness Records Introduced

Quite a novelty for the British market is the introduction of Captain A. Birley's series of physical fitness records. These tell us how to regulate exercises and do physical jerks—accompanied by music, as it were—and so to keep fit and well. A chart illustrating the different drill movements is furnished free. The new records have occasioned unusual interest.

Some "Live" Trade Brieflets

Registration of new companies during the first six months of this year shows an increase compared with the corresponding period of 1922. Though no music trade companies were regis-

Hornless, Table Grand, Upright and Horizontal Cabinet Grands

Actual Manufacturers Export a specialty

REX GRAMOPHONE COMPANY

59 Chiswell Street, LONDON, E. C., England
Cable Address "Lyrecodisc, London"

tered during this period new private music concerns numbered thirty, with a total capital of about £130,000.

Thomas Dawkins & Co., Ltd., musical instrument and gramophone merchants, London, have been compelled to consult their creditors. Established about 150 years, the firm has built up a world-wide connection. The news was received with general regret.

W. R. Steel, managing director of W. R. Steel (Redditch), Ltd., the big gramophone needle manufacturer, has resigned his position.

A dissolution of partnership has taken place between Miss E. J. Senier and J. H. Russell, carrying on business as the Gramophone Exchange, this city. The business is continued by Mr. Russell in partnership with C. Walters.

Kodisk £1,000 Prize Competition

An example of real enterprise is furnished by the action of British Kodisk, Ltd., in launching at this time a competition with prizes totaling £1,000. It is hardly necessary to describe at length exactly what the Kodisk stands for. Let it suffice to say that this metal disc enables one to record at home. To further make known its functions this side the Kodisk people have inaugurated a generous scheme by which merit alone will count for reward. The first prize, £500, will go to the person making the clearest and most distinct record, £50 as prizes to contestants under twelve years, £50 to the dealer who sells the first-prize Kodisk and £50 for the best window display. Other prizes will bring the total to an outlay of £1,000. The judges are the Earl of Hardwicke, Louis Sterling and Miss José Collins.

British Industries Fair 1924

Usually this exhibition is held in February; next year the date-period is April 28 to May 9. In explanation of the change the Department of Overseas Trade points to the incident of the British Empire Exhibition at Wembley from April to October. Any great gap between the opening of the two exhibitions, as normally would be the case, it is thought would affect the

(Continued on page 182)

EDISON BELL



CABLE "PHONOKINO, LONDON"

ARE THE GREATEST VALUE FOR MONEY PRODUCED IN GREAT BRITAIN

TEN INCH

DOUBLE SIDED

NEEDLE CUT

PLAY ON ALL GRAMOPHONES

Catalogue contains 4000 Titles by the Premier Artistes, Instrumentalists, Orchestras and Bands of the British Empire

DEALERS PREPARED TO DO BUSINESS ARE INVITED TO COMMUNICATE WITH

Proprietors and Manufacturers, J. E. HOUGH, Ltd., 62 Glengall Road, London, S. E. 15, England

A "Wow" of a Tune

HOT DAWG

A Doggone Catchy Fox Trot
With Plenty of Mustard

"You can't go wrong
With any FEIST song"



©LEO.FEIST Inc.N.Y.C.

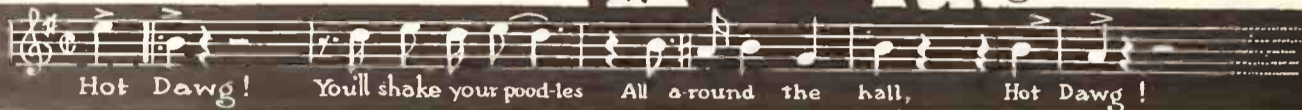

Hot Dawg! You'll shake your pood-les All a-round the hall, Hot Dawg!

FROM OUR EUROPEAN HEADQUARTERS—(Continued from page 181)

attendance of overseas buyers. Their arrival in England can now be timed to fit in with the dual opening dates.

Amendment of Copyright Act Suggested

What amounts to a revision of the Copyright Act of 1911 is contained in a bill introduced in the British Parliament by Frank Gray, M. P. By the absence of any prominent or other notice on musical works a performer is often quite unwittingly led into infringement of a copyright. It is true that copyright under the 1911 act automatically obtains for a period and that public performers should be aware of this, but a good many are not. And, again, often the absence of any date of first publications renders it difficult to know whether a copyright subsists or not in the work. Mr. Gray would therefore come to the rescue by securing the passage of his bill, the text of which is as follows:

1. The following paragraph shall be added after paragraph (VI) of sub-section 2 of the copyright act, 1911:—

(VII) The performance in public of a published musical work, unless the title page, or the first page if there is no title page, bears a notice to the effect that the right of public performance is reserved.

2. (1.) Where the right to publish any musical work and the right to perform such work become vested in different persons, it shall be lawful for the owner of the right to publish the work, requiring him to print the notice aforesaid on every copy of the work.

(2.) If the owner for the time being of the right to publish any musical work shall, after notice has been given to him or his predecessor in title, in accordance with this section, fail to print the notice so required upon every published copy of the work, the owner of the right to perform such work shall be entitled to recover from him such damages and costs as he might have recovered from any person if the notice aforesaid had been so printed.

3 (1.) This act may be cited as the Copyright (musical works) Act, 1923, and the Copyright Act, 1911, and this Act may be cited together as the Copyright Acts, 1911 and 1923.

(2.) This Act shall not apply to works first published in a foreign country with which His Majesty has entered into a convention relating to Copyright.

(3.) This Act shall apply to works first published on and after the first day of January, nineteen hundred and twenty-four.

Y. W. H. N. B.

Here is a criptic caption. Of course, it stands for the answer to and comment upon most things just now—"Yes, We Have No Bananas." By its contradiction and absurdity this title has simply created a furore for the song. In sheet music form or on records the demand is simply enormous. Every company has now listed it and special "pressings" seem the order of the day. The following story is now going the rounds: Fair damsel to out-of-date music retailer, "Eh! have you that song 'Yes, We Have No Bananas'?" Salesman (referring to alphabetical list), "Yes, no, madam; I am sorry we have not, but I see we have 'Yes, Let Me Like a Soldier Fall.'" As the rest of the story is a blank it is presumed the young lady fainted.

The Gramola Introduced

This is the name of a new table grand just marketed by the Gramophone Co., Ltd., and which, as reported last month, has created quite a sensation throughout the trade by reason of the extraordinary value it represents. The

Gramola is a handsome instrument—dome-top mahogany cabinet 12½ inches high, 15½-inch base, with nickel-plated and enamel fittings, single-spring motor, speed regulator, taper arm with ball-bearing socket and goose neck, needle bowls, Gramola sound box, all at £6 retail, or in oak, £5. Though the famous "H. M. V." trade-mark is absent it bears the words "Manufactured by the Gramophone Co., Ltd.," which is good enough warrant for most people. The raison d'être of the Gramola is, in the company's own words, "to meet the demand expressed by many of our dealers for a table grand instrument to sell at a price that will enable them to compete with 'cheap' types at present on the market." There you have it in a nutshell, so to speak. The bulk demand for gramophones these days is confined to models below the value of £10. There are many types of table grands on the market from £4 10/- up and, while the "quality" prestige of the Dog is still strong, it is evident that present economic

conditions have, to an extent, forced would-be buyers to treat the question of price as a first consideration of purchase. The fear is expressed in trade circles that the "H. M. V." action will seriously affect the sales of other table grand manufactures. All's fair in love and war!

Zonophone Music

There is a very good selection of vocal and instrumental music apparent in the latest batch of records to hand from the British Zonophone Co., just the kind that should make for heavy sales. The new Zonophone artist, Browning Mummery, has, if one might so term it, been well discovered. He possesses a powerful tenor voice of operatic standard and two good examples of his work are found on twelve-inch record No. A-274, "Your Tiny Hand Is Frozen," from "La Bohème," and "On With the Motley," from "I Pagliacci," in both of which his delivery is superb. In the extensive ten-inch list the contributions of the Dorian Singers, male quartet, are worthy of praise.

IF YOU handle or are thinking of handling other products, in addition to talking machines and records—you need **THE MUSIC TRADE REVIEW**, which is the most authoritative and informative business paper at your command, covering every branch of the music industry—pianos, players, reproducers, organs, automatics, band instruments, musical merchandise, small goods, sheet music, talking machines, etc., etc.

Twelve to fourteen feature articles, showing how the other fellow is increasing his profits, appear each month in **THE REVIEW**—that's why it is the most profitable weekly paper in the field for you to read and why it will assuredly help you increase your profits.

\$2 Brings You 52 Issues of The Review.

WATCH



THE MUSIC TRADE REVIEW

IN 1923

383 MADISON AVE.

NEW YORK CITY

Established 1876 — The Oldest and Largest in Its Field.

LATEST PATENTS RELATING TO TALKING MACHINES AND RECORDS

WASHINGTON, D. C., September 8.—Phonograph Reproducer. Arthur W. Schreiner, Brooklyn, N. Y. Patent No. 1,459,605.

This invention relates to a phonograph reproducer primarily designed to improve the tone color and fullness of note so greatly desired in this class of instrument.

It has been found that very remarkable improvements can be made in the clearness and volume of music played from ordinary phonograph records whether they be old or new, and regardless of whether they be orchestral, vocal, band, or simple instrumental pieces. Particular improvement can be noticed in the reproduction of notes from the piano.

In particular, the method of supporting the needle is of the utmost importance, and it must be so supported to be movable in every direction so as to give every slight indentation on the record opportunity to operate the diaphragm.

Furthermore, the volume of the reproduction may be greatly increased by using both sides of the diaphragm. To this end the inventor has devised novel means of valving the air pulsations from the diaphragm so as to effect a continuous flow of waves forward through the phonograph horn or emitting tube. This also produces a clear sound free from the usual

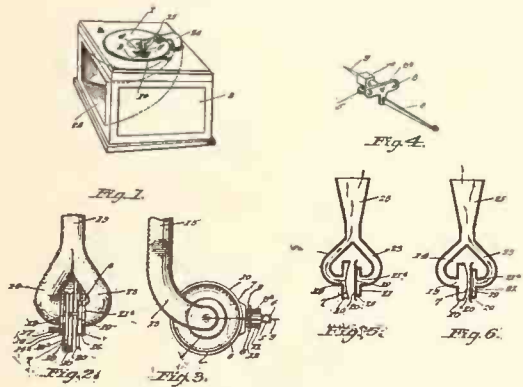

stiffness and apparent incompleteness of note. This quality is attributed largely to the straight forward flow of the sound waves resulting from a valving arrangement and the use of both sides of the diaphragm.

Figure 1 is a perspective view showing the reproducer in use on a phonograph, which may be of any standard design or make. Fig. 2 is a plan view of the reproducer partly shown in section. Fig. 3 is a side elevation of Fig. 2. Fig. 4 shows the detail construction of the needle support. Figs. 5 and 6 are diagrammatic views showing valving action of reproducer.

Sound Box. Alfred A. Dennis, Grand Rapids, Mich. Patent No. 1,459,577.

This invention relates to a sound box for phonographs, being primarily directed to a novel construction in which the diaphragm thereof may be tensioned by application of an adjustable and yielding spring tension thereon, similar to and producing the same desirable results as does the construction shown in Patent No. 1,393,434, granted October 11, 1921, without the more or less troublesome manufacturing and production faults thereof, the present construction being easily and readily manufactured without especially skilled and careful labor. A further object of the invention is to make the sound box also more or less productive of many of the desirable results coming from the structure shown in pending application for patent Ser. No. 476,977, filed June 13, 1921, in so far as an adjustment of the air volume space under the diaphragm is concerned, but without changing the vibratory area of the diaphragm, this remaining the same at all times. The invention, in fact, combines all of the desirable characteristics of two prior applications,

with an elimination of the faults thereof, with the production of a structure which is in shape for practical manufacture to produce a sound box which may be applied to practically all of the common makes of tone arms used in phonographs.

Figure 1 is a front elevation of the sound box of the invention in its preferred form. Fig. 2 is a rear elevation thereof. Figs. 3 and 4 are vertical sections through the sound box, but with the parts in different positions in the two views. Figs. 5 and 6 are sections like that shown in Fig. 3 of two slightly modified forms of structure of the invention. Fig. 7 is a perspective view of the movably mounted ring which is used in the sound boxes for changing

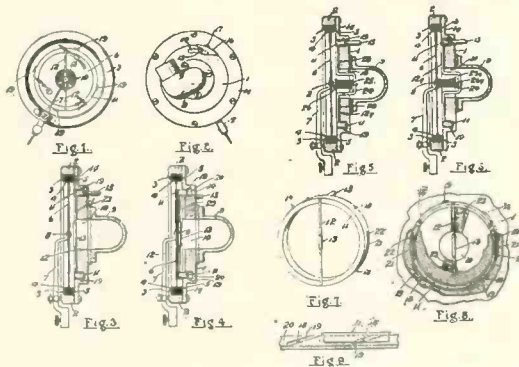

the air volume back of the diaphragm and for actuating the spring member toward or away from the same. Fig. 8 is a fragmentary enlarged partial section and front elevation of the sound box, showing features of the interior construction, and Fig. 9 is a fragmentary vertical section and development taken on the curved line 9-9 of Fig. 8.

Sound Recording and Reproducing Apparatus. James Kendall Delano, New York. Patent No. 1,459,088.

This invention relates to sound recording and reproducing apparatus, and comprises conduits which provide separate sound paths between the vibratory element or diaphragm of the sound box and the opposite extremity of said sound conducting or amplifying means. More specifically, the invention relates to a talking machine or phonograph having a sound box or reproducer provided with a plurality of separate impulse chambers in operative relation to the vibratory element of the sound box (in combination with a compound tone arm and an amplifying horn both embodying in a compact unitary structure separate conduits which afford separate continuous sound paths between said impulse chambers and the outer end of the amplifying horn.

One of the objects of the present invention is the elimination in large measure of the stated difficulties inherent in talking machines at present commonly in use, thereby making possible

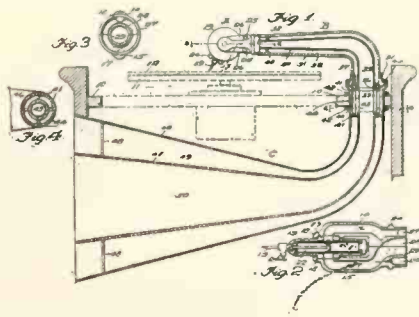

much more nearly correct recording and reproduction of sounds. Another object is to materially increase the sound volume and power of which the usual talking machine is capable, while at the same time guarding against interference of sound impulses, a defect characterizing constructions heretofore proposed.

Figure 1 is a vertical section through the tone arm and horn of a talking machine constructed

in accordance with the invention, certain parts being in elevation. Fig. 2 is a section through the sound box on the line 2-2 of Fig. 1. Fig. 3 is an end view of the sound box throat. Fig. 4 is a transverse section through the coupling between the tone arm and horn, on the line 4-4 of Fig. 1.

Talking Machine Cabinet. Nick Tota, Camden, N. J. Patent No. 1,460,289.

This invention relates to a new and useful improvement in talking machine cabinets, and has for its object to so construct such a cabinet that the sound emanating from the talking machine will be greatly amplified and projected outside of the machine.

A further object of the invention is to provide a tilting mirror adapted to close the front of the upper portion of the cabinet when the talking machine is not in use and so pivoted that when it is swung to give access to the talking machine it will reflect the turntable, the record thereon and the sound box and tone arm so that the reflection of these parts of the machine may be plainly seen by a person sitting in the room where the machine is located.

Still further objects are to provide for dividing the outflowing sound waves when desired so that a portion of the sound may be conveyed through the front of the cabinet and the amount of such divergence being controlled by the swinging of the mirror and provision made for the proper storing of record discs and also for the housing of the motor and the radio-phone apparatus.

Figure 1 is a front view of a cabinet made in accordance with an improvement showing the

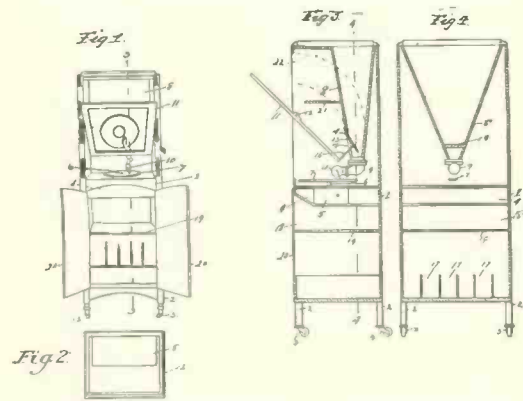

mirror in its tilted position and illustrating the manner in which the reflection of the working parts of the talking machine will be viewed in said mirror. Fig. 2 is a plan view of Fig. 1. Fig. 3 is a section at the line 3-3 of Fig. 1. Fig. 4 is a section at the line 4-4 of Fig. 3.

Automatic Talking Machine. Lee G. Daniels, Rockford, Ill. Patent No. 1,461,111.

The primary object of the present invention is to provide a talking machine of novel construction, which shall automatically play a plurality of records, one after another until all are played, and which will, if desired, continuously play the records in succession.

More particularly, this invention contemplates as an object the provision of a talking machine including a revoluble table carrying a plurality of circumferentially spaced record turntables which are carried successively to a playing station beneath the reproducer, the stylus of the latter being lowered onto the record at this station and, when the playing is completed, being raised to an inoperative position. Suitable mechanism is provided for indexing the table to position the record turntables at each playing station and to automatically lower and raise the reproducer stylus at the desired intervals.

Figure 1 is a plan view of an automatic talking machine embodying the improvements; Fig. 2, a side elevation of the machine looking at the

(Continued on page 184)

PATENTS RELATING TO TALKING MACHINES AND RECORDS—(Continued from page 183)

near side, as shown in Fig. 1; Fig. 3, a fragmentary sectional view taken on the line 3—3 of Fig. 1; Fig. 4, a fragmentary plan sectional view taken substantially on the line 4—4 of Fig. 2; Figs. 5 and 6, detail sectional views taken substantially on the lines 5—5 and 6—6, respectively, of Fig. 2; Fig. 7, a detail sectional view

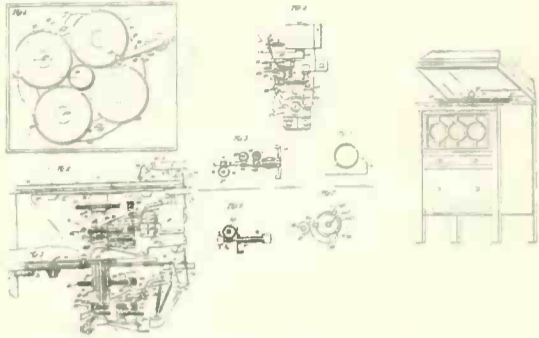

taken on the line 7—7 of Fig. 3; Fig. 8, a detail sectional view taken on the line 8—8 of Fig. 2, and Fig. 9, a front quarterly elevation of a talking machine embodying the improvements.

Amplifier. Rufus P. Silverthorn, Marion, O. Patent No. 1,461,685.

This invention relates to improvements in sound amplifiers for phonographs, the object being to provide an amplifier which is so constructed that it will bring out tones otherwise lost in the playing of a record. A further object is to provide a distinctly novel means for suspending the amplifier directly under the tone arm of a phonograph so that the amplifier does not contact with the cabinet of a phonograph and the nuisance of cabinet vibration is entirely done away with. A still further object is to provide improved means for strengthening and bracing the mouth of the horn of the amplifier so that it may be conveniently supported in the manner above described without affecting the character of the sounds transmitted there-through.

In the accompanying drawings Figure 1 is a front end view of the improved amplifier; Fig. 2 is a bottom plan view thereof; Fig. 3 is a view in

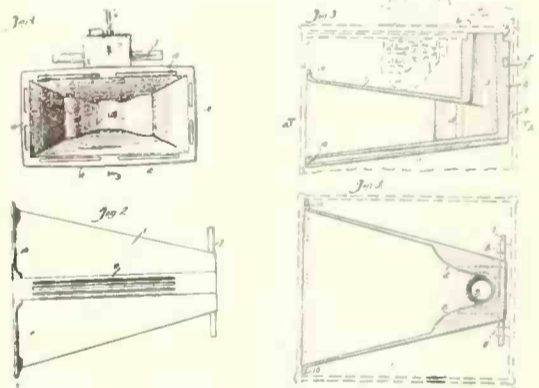

longitudinal section on the line 3—3 of Fig. 1, the dotted lines indicating a phonograph cabinet, and Fig. 4 is a view in longitudinal section on the line 4—4 of Fig. 3.

Sound-reproducing Machine. Giovanni Di Falco, New York. Patent No. 1,462,269.

This invention relates to sound-reproducing machine constructed in the form of an old-fashioned clock and provided in the top thereof with a clock mechanism and centrally thereof with a sound-reproducing mechanism and at the lower portion thereof with means for supporting and storing records, and the object of the invention is to provide a machine of the class and for the purpose specified with means where-

by the tone arm of a machine of this class may be automatically moved into positions to permit of the repeating or the reproduction of a predetermined record; a further object being to provide means in operative connection with the clock mechanism of the machine whereby the rotary disc supporting table may be automatically started at a predetermined hour.

Figure 1 is a front view of the improved machine with parts of the construction broken away; Fig. 2, a detail view of a part of the construction shown in Fig. 1 on an enlarged scale; Fig. 3, a partial section on the line 3—3 of Fig. 2; Fig. 4, a detail sectional view on the line 4—4 of Fig. 1 on an enlarged scale; Fig. 5, a diagrammatic view of the tone arm operating mechanism which is employed and showing the same in a position about to be raised and moved outwardly and radially over a record; Fig. 6, a

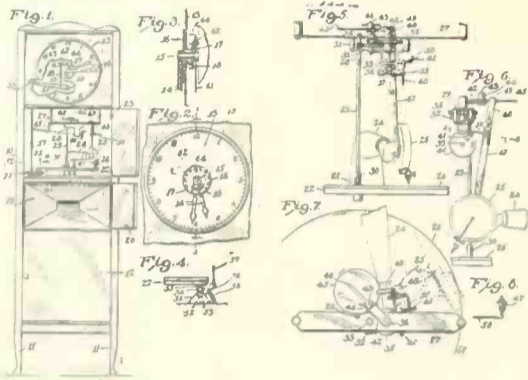

side view of the construction shown in Fig. 5; Fig. 7, a plan view of the construction shown in Figs. 5 and 6 and indicating the movement of the tone arm of the improved mechanism, and Fig. 8, a partial sectional view on the line 8—8 of Fig. 6, showing another important detail of the construction.

Tone Modifier for Sound-reproducing Machines. Fred W. Cooley, Minneapolis, Minn. Patent No. 1,462,320.

This invention relates to a tone modifier adapted to be used in connection with the tone arm of a sound-reproducing machine and to be placed in said machine in the path of the sound waves from the tone arm to the sound chamber. It comprises an improvement in a tone modifier of the general type disclosed in Patent No. 1,349,604, granted to applicant of August 17, 1920.

It is an object of this invention to improve the character of the tension device disclosed in said patent and the manner of attaching the same, as well as to improve the means for connecting and spacing the tubes used.

Figure 1 is a vertical section of a device showing the same applied to the tone arm of a sound-reproducing machine; Fig. 2 is a vertical section of a device taken at right angles to the

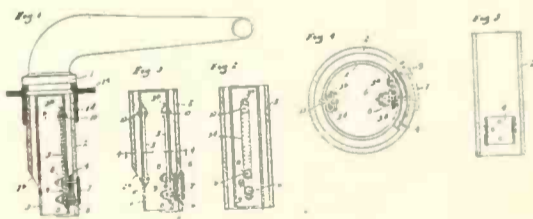

section of Fig. 1; Fig. 3 is a vertical section of the device similar to that of Fig. 1 showing a modification thereof; Fig. 4 is a horizontal section on an enlarged scale taken on line 4—4 of Fig. 3, and Fig. 5 is a vertical section of the outer tube also showing the spacing means between the tubes.

Talking Machine. Bert Edward Lane, Camden, N. J. Patent No. 1,462,114.

One object of this invention is to provide improved sound conducting means for talking machines which can be made cheaply and durably. Another object is to so construct this invention that it will permit the free movement of the sound transmitting elements of a talking machine and to avoid undue friction between the several parts.

Still further objects are to make the parts in a manner so that they can be easily assem-

bled or taken apart, of comparatively light weight but of such strength as to withstand hard usage without injury thereto.

Figure 1 is a fragmentary elevation of a portion of a talking machine showing in central vertical section the invention as forming a part thereof. Fig. 2 is a fragmentary section taken on the line 2—2 of Fig. 1. Fig. 3 is a section

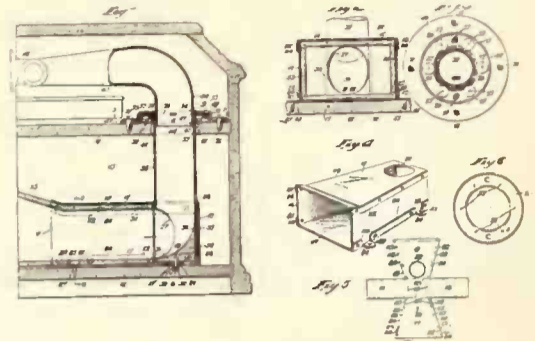

taken on the line 3—3 of Fig. 1. Fig. 4 is a perspective view of an amplifying box or housing which forms a part of the invention. Fig. 5 is a developed form or blank from which the box or housing of Fig. 4 is made, said blank being stamped or cut from a piece of sheet material, and Fig. 6 is a top plan view of a roller-retaining ring which forms a part of the invention.

Tone Arm. Frank Oberst, Glendale, N. Y., assignor to the Sonora Phonograph Co., New York. Patent No. 1,459,743.

This invention relates to tone arms for talking machines and has for its objects to provide means for facilitating the removal and renewing of the stylus.

A further object is the production of a tone arm having relatively movable members and wherein rattling will be prevented and eliminated, and in which the various elements which go to make up the tone arm will be rigidly secured together and easily and readily assembled and disassembled and accidental displacement avoided.

In the drawings Figure 1 is a side elevation, partly in section, of a tone arm embodying the invention; Fig. 1a is a detailed sectional view

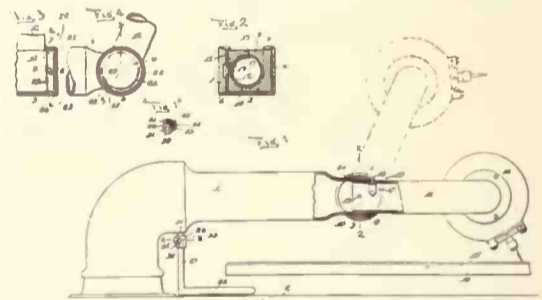

of the clamping means indicated in Fig. 1; Fig. 2 is a section on the line 2—2 of Fig. 1; Fig. 3 is a detailed sectional view of a modification, the section being indicated by the line 3—3 on Fig. 4, and Fig. 4 is a section on the line 4—4 of Fig. 3.

Sound Arm Coupling for Talking Machines. Horace Hurm, Paris, France. Patent No. 1,466,554.

This invention relates to tone arm couplings for talking machines and has for its object the production of a tone arm which will be at the same time air-tight and flexible in the two planes in which mobility is required. A further object is to provide a tone arm coupling comprising two bellows connected together and in communication, one bellows being hinged vertically and therefore swingable in a horizontal plane and the other hinged horizontally and swingable in a vertical plane.

Stylus Support for Talking Machines. Horace Hurm, Paris, France. Patent No. 1,466,555.

The subject of this invention is a stylus support for talking machines, the principal characteristic of which is that it is formed as a sort of lattice construction extending over the whole length of the support. This renders it possible for the stylus support to be small in inertia, yet sufficiently rigid to resist bending—a very important consideration.

REPAIRS

All Makes of Talking Machines
Repaired Promptly and Efficiently

REPAIR PARTS FOR ALL MACHINES

ANDREW H. DODIN

28 Sixth Avenue New York
TELEPHONE, SPRING 1194

Advance RECORD BULLETINS for October, 1923

COLUMBIA GRAPHOPHONE CO.

- SYMPHONY RECORDS**
- A3949 Marche Militaire (Militar-Marsch) (Schubert) Opus 51, No. 1)—Part 1—Piano Solo, Mischa Levitzki 10
- Marche Militaire (Militar-Marsch) (Schubert) Opus 51, No. 1)—Part 2—Piano Solo, Mischa Levitzki 10
- A6229 La Traviata—"Ah, Fors' è Lui" (The One of Whom I Dreamed) (Verdi)—Soprano Solo, Florence Macbeth 12
- La Traviata—"Sempere Libera" (I'll Fulfill the Round of Pleasure) (Verdi)—Soprano Solo, Florence Macbeth 12
- 98079 The Kerry Dance (Molloy)—Tenor Solo, Tandy Mackenzie 12
- A3947 Danny Boy (Weatherly)—Mezzo-soprano Solo, Barbara Maurel 10
- A Summer Night (Thomas)—Mezzo-soprano Solo, Barbara Maurel 10
- S1024 Spanish Dance (Granados-Kreisler)—Violin Solo, Duca de Kerekjarto 10
- A6228 In Heavenly Love Abiding (Ewing)—Contralto Solo, Nevada Van der Veer 12
- Shepherd, Show Me How to Go (Brackett-Eddy)—Contralto Solo, Nevada Van der Veer 12
- A3944 Cut Yourself a Piece of Cake (James)—Fox-trot, Ted Lewis and His Band 10
- The Duck's Quack (Maguire)—Fox-trot, Frank Westphal and His Orchestra 10
- A3956 My Sweetie Went Away (Turk-Handman)—Fox-trot, California Ramblers 10
- I Love Me (Mahoney)—Fox-trot, California Ramblers 10
- A3940 Love Tales (Leonore) (Vincent Rose)—Fox-trot, Eddie Elkins' Orchestra 10
- Mad ('Cause You Treat Me This Way) (McHugh)—Fox-trot, Eddie Elkins' Orchestra 10
- A3948 First, Last and Always (Akst)—Fox-trot, The Happy Six 10
- Lou'siana (Donaldson)—Fox-trot, The Happy Six 10
- A3957 Annabelle (Henderson)—Fox-trot, Ted Lewis and His Band 10
- Love (My Heart Is Calling You) (Cooper)—Fox-trot, Eddie Elkins' Orchestra 10
- A3953 Broken Hearted Melody (Isham Jones)—Waltz, Ferera's Hawaiian Instrumental Quartet 10
- Hula-Hula Rose (Reed-Awan)—Waltz, Ferera's Hawaiian Instrumental Quartet 10
- A3952 The Life of a Rose (Gershwin) (Intro.: "Where Is She?" from "George White's Scandals")—Medley Fox-trot, The Columbians 10
- Where the Ganges Flows (Von Tilzer) (Intro.: "Just a Pretty Little Home," from "Adrienne")—Medley Fox-trot, The Columbians 10
- A3950 Worried and Lonesome Blues (Johnson)—Fox-trot, Piano Solo, James P. Johnson 10
- Weeping Blues (Johnson)—Fox-trot, Piano Solo, James P. Johnson 10
- A3954 Cut Yourself a Piece of Cake (James)—Tenor and Baritone Duet, Jones-Hare 10
- Hey! You Want Any Codfish? (We Only Got Mack'rel To-day) (Ima Fish and Ura Herring)—Tenor and Baritone Duet, Furman-Nash 10
- A3955 My Sweetie Went Away (Turk-Handman), Dolly Kay, Comedienne 10
- Oh! Sister, Ain't That Hot! (White-Donaldson), Dolly Kay, Comedienne 10
- A3945 Just a Girl That Men Forget (Duhin-Rath-Garren)—Tenor Solo, Charles Hart 10
- Midnight Rose (Pollack)—Tenor Solo, Charles Hart 10
- A3946 Ten Thousand Years From Now (Ball)—Tenor Solo, Edwin Dale 10
- The Kingdom Within Your Eyes (Nicholls)—Tenor Solo, Edwin Dale 10
- A3942 Nobody in Town Can Bake a Sweet Jelly Roll Like Mine (Spencer-Williams), Bessie Smith, Comedienne 10
- If You Don't, I Know Who Will (Williams), Bessie Smith, Comedienne 10
- MID-MONTH LIST**
- DANCE MUSIC**
- A3944 Cut Yourself a Piece of Cake (James)—Fox-trot, Ted Lewis and His Band 10
- The Duck's Quack (Maguire)—Fox-trot, Frank Westphal and His Orchestra 10
- A3940 Love Tales (Leonore) (Vincent Rose)—Fox-trot, Eddie Elkins' Orchestra 10
- Mad ('Cause You Treat Me This Way) (McHugh)—Fox-trot, Eddie Elkins' Orchestra 10
- A3948 First, Last and Always (Akst)—Fox-trot, The Happy Six 10

- Lou'siana (Donaldson)—Fox-trot, The Happy Six 10
- POPULAR SONGS**
- A3946 Ten Thousand Years From Now (Ball)—Tenor Solo, Edwin Dale 10
- The Kingdom Within Your Eyes (Nicholls)—Tenor Solo, Edwin Dale 10
- A3945 Just a Girl That Men Forget (Duhin-Rath-Garren)—Tenor Solo, Charles Hart 10
- Midnight Rose (Pollack)—Tenor Solo, Charles Hart 10

VICTOR TALKING MACHINE CO.

- LIST FOR SEPTEMBER 21**
- 35726 Gems from "Aida" (Verdi)—Part 1, Victor Opera Company 12
- Gems from "Aida" (Verdi)—Part 2, Victor Opera Company 12
- 19114 Cut Yourself a Piece of Cake, Billy Murray 10
- Maggie! ("Yes! Ma'am!"), Aileen Stanley-Billy Murray 10
- 19113 The Argentines, the Portuguese and the Greeks, The Duncan Sisters 10
- Stick in the Mud, The Duncan Sisters 10
- DANCE RECORDS**
- 19121 I Love Me—Fox-trot, International Novelty Orch. 10
- No, No, Nora—Fox-trot, Benson Orch. of Chicago 10
- 19122 Somebody's Wrong—Fox-trot, The Benson Orch. of Chicago 10
- Love Tales—Fox-trot, The Great White Way Orchestra 10
- 19115 The Sweetheart of Sigma Chi—Waltz, Whitey Kaufman's Orig. Penn. Serenaders 10
- Indiana Moon—Waltz, The Troubadours 10
- DOUBLE-FACE RED SEAL RECORDS**
- 10000 Lucia—"Chi Mi Frena" (What Restrains Me) (Donizetti)—Sextet, in Italian, Galli-Curci, Egner, Caruso, de Luca, Journet, Bada Rigoletto—"Bella figlia dell'amore" (Fairest Daughter of the Graces) (Verdi)—Quartet, in Italian, Galli-Curci, Perini, Caruso, de Luca 12
- 6374 Symphonie Pathétique—Allegro con grazia—2nd Movement (Tchaikowsky), Mengelberg and New York Philharmonic Orch. 12
- Symphonie Pathétique—Adagio lamentoso—4th Movement (Tchaikowsky), Mengelberg and New York Philharmonic Orch. 12
- 917 Song of the Traveler (Chant du Voyageur) (Paderewski)—Piano, Ignace Jan Paderewski 10
- Etude in G Sharp Minor (Op. 25, No. 6) (Chopin)—Piano, Ignace Jan Paderewski 10
- LIST FOR SEPTEMBER 28**
- 19126 When Will the Sun Shine for Me? Sterling Trio 10
- Carolina Mammy, Sterling Trio 10
- 35727 Tannhauser—Overture, Part 1, Victor Symphony Orch. 12
- Tannhauser—Overture, Part 2, Victor Symphony Orch. 12
- 35728 Tannhauser—Overture, Part 3, Victor Symphony Orch. 12
- Tannhauser—Fest March (Act II), Victor Symphony Orch. 12
- DANCE RECORDS**
- 19127 Henpecked Blues—Fox-trot, Whitey Kaufman's Orig. Penn. Serenaders 10
- Louisville—Fox-trot, S. S. Leviathan Orch. 10
- 19128 The Gold Digger—Fox-trot, Charles Dornberger and His Orch. 10
- Chick-a-Dee—Fox-trot, International Novelty Orch. 10
- 19129 Tell Me a Story—Fox-trot, S. S. Leviathan Orch. 10
- Love Is Just a Flower—Fox-trot, Benson Orch. of Chicago 10
- DOUBLE-FACE RED SEAL RECORDS**
- 918 Remember the Rose (Mitchell-Simons), John McCormack 10
- Sometime You'll Remember (Wallace-Head), John McCormack 10
- 6103 The Emperor Quartet—Theme and Variations, Elman String Quartet 12
- Andante Cantabile—From String Quartet, Op. 11, Elman String Quartet 12
- 10002 Martha—Siam giunti, o giovinette (This Is Your Future Dwelling) (Act II) (Flotow)—Quartet, in Italian, Alda, Jacoby, Caruso, Journet 12
- Martha—Che vuol dir Gio (Surprised and Astounded!) (Flotow)—Quartet, in Italian, Alda, Jacoby, Caruso, Journet 12
- 19109 Waitin' for the Evenin' Mail—Fox-trot, Tennessee Ten 10
- Tain't Nobody's Biz-ness If I Do—Medley Fox-trot, Tennessee Ten 10

- 19110 Dirty Hands! Dirty Face! (Featured in "Bomho")—Fox-trot, Joe Raymond and His Orch. 10
- My Sweetie Went Away—Fox-trot, Joe Raymond and His Orch. 10
- LIST FOR OCTOBER 5**
- 45369 Will Rogers Nominates Henry Ford for President—Humorous Monologue, Will Rogers 10
- Will Rogers Tells Traffic Chiefs How to Direct Traffic—Humorous Monologue, Will Rogers 10
- 19112 Silver Threads Among the Gold, Henry Burr—Peerless Quartet 10
- When You and I Were Young, Maggie, Henry Burr—Peerless Quartet 10
- 19131 My Pal, John Steel 10
- Just a Girl That Men Forget, Henry Burr 10
- 19132 Three Thousand Years Ago, Billy Murray 10
- It's a Lotta Bologny, Billy Murray 10
- DANCE RECORDS**
- 19125 Oh Susanna—Medley Fox-trot, The Great White Way Orch. 10
- Southern Melodies—Waltz, The Troubadours 10
- 19130 That Big Blond Mamma—Fox-trot, Tennessee Ten 10
- Sobbin' Blues—Fox-trot, The Benson Orch. of Chicago 10
- DOUBLE-FACE RED SEAL RECORDS**
- 6375 Gioconda—Suicidio (Suicide Remains) (Ponchielli)—In Italian, Maria Jeritza 12
- Alceste—Divinités du Styx (Divinities of the Nether World) (Gluck)—In French, Maria Jeritza 12
- 6376 Slavonic Dance No. 2 (Dvorák-Kreisler)—Violin, Jascha Heifetz 12
- Slavonic Dance No. 3 (Dvorák-Kreisler)—Violin, Jascha Heifetz 12

AEOLIAN CO.

- VOCALION RECORDS**
- OPERATIC**
- 30177 Brindisi (Drinking Song) (From "Martha") (Friedrich von Flotow)—Baritone, in Italian; Aeolian Orch. Accom., Giacomo Rimini 10
- Conducted by Gennaro Papi, Metropolitan Opera House Conductor
- 30176 Il Sogno (The Dream) (From "Manon") (Massenet)—Tenor, in Italian; Aeolian Orch. Accom., Giulio Crimi 10
- STANDARD**
- 52051 La Paloma (The Dove) (Yradier)—Serenade; Soprano, in Italian; Aeolian Orch. Accom., Rosa Raisa 12
- 30178 A Song of India (Chanson Indoue) (From "Sadko") (Rimsky-Korsakow)—Tenor, in Russian; Aeolian Orch. Accom., Vladimir Rosing 10
- 60008 Kiss Me Again (Blossom-Herbert)—Soprano, Aeolian Orch. Accom., May Peterson 10
- Toyland (From "Babes in Toyland") (MacDonough-Herbert)—Soprano, Aeolian Orch. Accom., May Peterson 10
- 24047 Take a Look at Molly (Lockwood-Lockwood)—Tenor, Orch. Accom., Colin O'More 10
- The Fairy Tales of Ireland (Lockton-Coates)—Tenor, Orch. Accom., Colin O'More 10
- SACRED**
- 30179 Where Is My Boy To-night? (Robert Lowry)—Baritone, Aeolian Orch. Accom., John Charles Thomas 10
- 14627 Into the Woods My Master Went (Lanier-Herbert)—Baritone, Orch. Accom., Homer Rodeheaver 10
- A Rainbow on the Cloud (Hewitt-Gabriel)—Baritone, Orch. Accom., Homer Rodeheaver 10
- INSTRUMENTAL**
- 60010 La Gitana (Arabo-Spanish Gipsy Song of the 18th Century) (Kreisler)—Violin Solo, Piano Accom. by Frank Tresselt, Paul Kochanski 10
- Hungarian Dance, No. 1 (Brahms-Joachim)—Violin Solo, Piano Accom. by Frank Tresselt, Paul Kochanski 10
- 70005 Le Carnaval Russe (Russian Carnival) (Wieniawski)—Violin Solo, Piano Accom. by Frank Tresselt, Paul Kochanski 12
- Malaguena (From "Spanish Dances," Op. 21, No. 1) (Sarasate)—Violin Solo, Piano Accom. by Frank Tresselt, Paul Kochanski 12
- 14638 Rakes of Clonmel (Intro.: "Sarsfield's Jig")—Irish Jig; Accordion, Banjo, Harp, Guitar, Flanagan Brothers 10
- Cavan Reel (Intro.: "Gardener's Daughter")—Irish Reel; Accordion, Banjo, Harp, Guitar, Flanagan Brothers 10
- 14626 Ambassador March (Bagley), Lt. F. W. Sutherland and His 7th Reg. Band 10
- Garde du Corps (Hall)—March, Lt. F. W. Sutherland and His 7th Reg. Band 10
- (Continued on page 186)

EASY MELODY

"YOU CAN'T GO WRONG WITH ANY FEIST SONG"

That Easy to Remember - Hard to Forget Fox Trot

Eas - y Mel - o - dy, it haunts me, Al - ways on my mind;

©LEO FEIST Inc. N.Y.C.



A NEW KIND OF "LOW DOWN" TUNE WITH A GREAT STORY...

Somebody's Wrong

by WHITING, EGAN & MARSHALL

CHORUS

Some - bod-y's wrong! Some - bod-y's wrong No - bod-y's kiss - es ev - er haunt my

JEROME H. REMICK & CO. New York-Chicago-Detroit

ADVANCE RECORD BULLETINS FOR OCTOBER—(Continued from page 185)

- | | | |
|--|--|---|
| <p>14625 Pere de la Victoire (Father of Victory March) (Ganne)—Accordion Solo...A. Palet Gallarini 10
French National Defile March (Turllet)—Accordion Solo...A. Palet Gallarini 10</p> <p>NOVELTY</p> <p>14624 Invitation Waltz (Anita Owen)—Whistling, Orch. Accomp...Margaret McKee 10
Salut D'Amour (Greeting of Love) (Elgar)—Whistling, Orch. Accomp...Margaret McKee 10</p> <p>DANCE</p> <p>14637 Oh! Harold (Lee S. Roberts)—Collegiate Walk and Fox-trot, with Vocal Chorus by Irving Kaufman...Selvin's Orch. 10
Annabelle (Brown-Henderson)—Fox-trot, Selvin's Orch. 10</p> <p>14639 Cut Yourself a Piece of Cake (Billy James)—Fox-trot, with Vocal Chorus by Irving Kaufman...The Bar Harbor Society Orch. 10
That Big Blonde Mamma (Rose-Monaco)—Fox-trot...The Bar Harbor Society Orch. 10</p> <p>14640 No, No, Nora (Fiorita-Erdman-Kahn)—Fox-trot, Albert E. Short and His Tivoli Syncopaters 10
Tweet Tweet (Egbert Van Alstyne)—Fox-trot, Bird Whistling by Sibyl Sanderson Fagan, Albert E. Short and His Tivoli Syncopaters 10</p> <p>14641 Midnight Rose (Pollack-Mitchell)—Fox-trot, Albert E. Short and His Tivoli Syncopaters 10
Bebe (Silver-Coslow)—Fox-trot, Albert E. Short and His Tivoli Syncopaters 10</p> <p>14643 Where the Ganges Flows (From "Adrienne") (A. Von Tilzer-Brown)—Fox-trot, The Ambassadors 10
In the Land of Shady Palm Trees (Lyman-Arnheim)—Fox-trot...The Ambassadors 10</p> <p>14642 The Waltz of Love (Come, Let Us Dance) (Armstrong-Dyson)—Waltz, Albert E. Short and His Tivoli Syncopaters 10
Just for To-night (Geiger-Macdonald)—Waltz, The Southampton Serenaders 10</p> <p>14629 Old Favorite Medley Waltz (Intro.: "My Bonnie," "Juanita," "How Can I Leave Thee?", "Good Night, Ladies"), Aeolian Dance Orch. 10
George M. Cohan Medley Fox-trot (Intro.: "Grand Old Flag," "So Long, Mary," "Give My Regards to Broadway," "Mary Is a Grand Old Name," "I'm a Yankee Doodle Dandy"), Aeolian Dance Orch. 10</p> <p>14511 El Clackson (Ricardo Garcia de Avellano)—Fox-trot...Manecoles Orch. 10
Palabras de amor (Words of Love) (Roberto Henkel)—Waltz...Manecoles Orch. 10</p> <p>14564 The Tango Girl (La Chula Tanguista) (Tecquin-Rica)—Fox-trot...Max Dolin's Orch. 10
The Peacock (Fox del Pavo Real) (Elizondo-Ruiz)—Fox-trot...Max Dolin's Orch. 10</p> <p>VOCAL</p> <p>14644 Oh! Gee, Oh! Gosh, Oh! Golly, I'm in Love (Breuer-Olson-Johnson)—Comedy Song, Accomp. by Selvin's Orch., Ernest Hare-Billy Jones 10
"Maggie" (Yes! Ma'am!) Come Right Upstairs (Tucker-Moore)—Comedy Song, Accomp. by Selvin's Orch., Ernest Hare-Billy Jones 10</p> <p>14645 I've Got the Yes! We Have No Banana Blues (Hanley-King-Brown)—Comedy Song, Accomp. by The Ambassadors, Isabelle Patricola 10
Abie's Irish Rose (James Hanley)—Comedy Song, Accomp. by The Ambassadors, Isabelle Patricola 10</p> <p>14646 That Old Gang of Mine (Henderson-Rose-Dixon)—Male Quartet, Orch. Accomp., Criterion Quartet 10
Last Night on the Back Porch (I Loved Her Best of All) (Brown-Schraubstader)—Male Quartet, Orch. Accomp., Criterion Quartet 10</p> <p>14647 Dus Gute Kvitel (Louis Gilrod)—New Year Song, in Jewish; Orch. Accomp., Simon Pascal 10
Leshunu Toivu Tikusevi (Louis Gilrod)—New Year Song, in Jewish; Orch. Accomp., Simon Pascal 10</p> <p>14574 Fuimnecenne a Napule (Back to Naples) (A. Bascetta)—Folk Song—Mezzo-soprano, in Neapolitan; con Orch. Neapolitana...Ria Rosa 10
Siente a mme iammo a Spusa! (Let Us Get Married) (Buongiovanni-Canoro)—Folk Song—Mezzo-soprano, in Neapolitan; con Orch. Neapolitana...Ria Rosa 10</p> <p>14628 Jeg saa ham som barn (Traditional)—Folk Song—Tenor, in Neapolitan; Orch. Accomp., Carsten Woll 10
Amdagen (Arlberg)—Tenor, in Norwegian; Orch. Accomp., Carsten Woll 10</p> | <p>Cavalleria Rusticana—Addio alla madre (Turidu's Farewell) (Mascagni)—Tenor, with Orch. Accomp.—In Italian...Giacomo Lauri-Volpi 10</p> <p>13094 Sweet and Low (Tennyson-Barnby)—Soprano and Male Trio, with Orch. Accomp., Marie Tiffany and Male Trio 10
Just You (Miller-Burleigh)—Soprano, with Orch. Accomp., Marie Tiffany 10</p> <p>5192 Mignon Overture—Part 1 (Thomas)—Concert Band...Vessella's Italian Band 10
Mignon Overture—Part 2 (Thomas)—Concert Band...Vessella's Italian Band 10</p> <p>13096 Fallen Leaf (Indian Love Song) (Logan-Logan)—Tenor, with Orch. Accomp., Theo. Karle 10
Smile Through Your Tears (Hamblen)—Tenor, with Orch. Accomp., Theo. Karle 10</p> <p>2467 Lonesome, That's All (Roberts-Bradley)—Violin Solo, with Orch. Accomp., Frederic Fradkin 10
I'm Waiting for Ships That Never Come In (Yellen-Oiman)—Violin Solo, with Orch. Accomp., Frederic Fradkin 10</p> <p>2468 On the Automobile—Monologue...Senator Ford 10
Woman in History—Monologue...Senator Ford 10</p> <p>2470 I've Been Saving for a Rainy Day (Swanstrom Clark)—Comedienne, with Orch. Accomp., Marion Harris 10
"Tain't Nuthin' Else (Davis-Santley)—Comedienne, with Orch. Accomp., Marion Harris 10</p> <p>2475 Stingo, Stungo (Brown-Hanley)—Comedienne, with Orch. Accomp., Margaret Young 10
He May Be Your Good Man Friday (But He's Mine on Saturday Night) (Raskin-Pinkard)—Comedienne, with Orch. Accomp., Margaret Young 10</p> <p>2471 What Could Be Sweeter (Kahn-Panico)—Fox-trot, for Dancing...Isham Jones' Orch. 10
All Wrong (Martin-Jones)—Fox-trot, for Dancing...Isham Jones' Orch. 10</p> <p>2469 Indiana Moon (Davis-Jones)—Waltz, for Dancing...Carl Fenton's Orch. 10
I'll Take You Home Again, Pal o' Mine (Dixon-Sacre)—Waltz, for Dancing...Carl Fenton's Orch. 10</p> <p>2472 Love (My Heart Is Calling You) (Young-Lewis-Cooper)—Fox-trot, for Dancing, Bennie Krueger's Orch. 10
Mad ('Cause You Treat Me This Way) (Heath-Mellugh)—Fox-trot, for Dancing, Bennie Krueger's Orch. 10</p> <p>2473 South Sea Eyes (Akst)—Fox-trot, for Dancing, Oriole Orch. 10
Slow Poke (Flaggen-Gold)—Fox-trot, for Dancing...Oriole Orch. 10</p> <p>2474 On the Isle of Wicki Wacki Woo (Kahn-Donaldson)—Fox-trot, for Dancing, Gene Rodemich's Orch. 10
Oh! Sister, Ain't That Hot! (White-Donaldson)—Fox-trot, for Dancing...Gene Rodemich's Orch. 10</p> | <p>80759 A Dream...Charles Hart 10
I Hear You Calling Me, Elizabeth Spencer and Chorus</p> <p>51187 Daddy's Wonderful Pal...Lewis James 10
Carolina Mammy...Walter Scanlan and Chorus</p> <p>51186 Scottish Melodies, No. 1—Violin Solo, Violet McGregor 10
Scottish Melodies, No. 2—Violin Solo, Violet McGregor 10</p> <p>51200 Cruel Back Bitin' Blues—A Great Aching Chant, Ellen Coleman 10
You Got Ev'ry Thing a Sweet Mama Needs (But Me)...Ellen Coleman 10</p> <p>51202 Broken-hearted Melody Waltz, Waikiki Hawaiian Orchestra 10
Hula-Hula Rose...Waikiki Hawaiian Orchestra 10</p> <p>51208 Who's Sorry Now?—Waltz, Piano Solo, Ernest L. Stevens 10
Broken-hearted Melody (Intro.: "Moon River")—Waltz, Piano Solo...Ernest L. Stevens 10</p> <p>51210 Dear Little Boy of Mine...Jim Doherty 10
That Wonderful Mother of Mine...Will Oakland 10</p> <p>51217 Love's Lament—Piano Solo...Henry W. Lange 10
Love Is All (From "Adrienne")—Waltz, Piano Solo...Ernest L. Stevens 10</p> <p>51216 The Story of Midsummer Night's Dream—Part 1, Edna Bailey 10
The Story of Midsummer Night's Dream—Part 2, Edna Bailey 10</p> <p>80761 Un bel di vedremo (Madama Butterfly)...Anita Rio 10
Romance de l'Etoile (Tannhauser)...Orpheus Langevin 10</p> <p>51207 On the Isle of Wicki Wacki Woo...Aileen Stanley 10
What You Was, You Used to Be (But You Ain't No More)...Sally Collins 10</p> <p>80760 The Gipsy's Warning...Betsy Lane Shepherd 10
The Gay Gitana...Betsy Lane Shepherd 10</p> <p>82299 Mira, o Norma (Norma)...Alice Verlet-Anita Rio 10
Ah! ne fuis pass encore! (Romeo et Juliette), Alice Verlet-Ralph Errolle 10</p> |
|--|--|---|

EDISON DISC RECORDS

- ALREADY RELEASED SPECIALS**
- 82297 Long Ago in Alcalá...Arthur Middleton 10
Down Deep Within the Cellar...Arthur Middleton 10
- 51199 From de Ol' Home Town (The Meeting of Lincoln and Glascoe)...Jones-Hare 10
Stavin' Change (The Meanest Man in New Orleans)...Al Bernard 10
- 80756 Finlandia—Tone Poem, American Symphony Orchestra 10
Badinage...American Symphony Orchestra 10
- 80755 Hush-a-Bye-Bay...The Homestead Trio 10
King Love!—Waltz Song, Betsy Lane Shepherd and Chorus 10
- 51179 Abie at the Opera—Vaudeville Specialty...Paul Burns 10
Goldberg's Automobile Troubles—Hebrew Monologue...Dave Martin 10
- FLASHES**
- 51201 Chick-a-Dee—Fox-trot...Kaplan's Melodists 10
Where the Ganges Flows (From "Adrienne")—Fox-trot...Broadway Dance Orchestra 10
- 51203 Tell Me a Story—Fox-trot...Kaplan's Melodists 10
I'm Goin' Back to My Mammy—Fox-trot, Kaplan's Melodists 10
- 51204 Shuffin' Mose—Fox-trot...Original Memphis Five 10
The Great White Way Blues—Fox-trot, Original Memphis Five 10
- 51205 Roses of Picardy—Fox-trot, Atlantic Dance Orchestra 10
In a Tent—Fox-trot...Atlantic Dance Orchestra 10
- 51206 Cut Yourself a Piece of Cake (And Make Yourself at Home)...Jones-Hare 10
Stingo Stungo...Robert White 10
- 51219 Marcheta (A Love Song of Old Mexico)—Vocal obbligato by Betsy Lane Shepherd...Walter Scanlan 10
Say It With a Ukulele...Bailey-Bent 10
- GENERAL LIST**
- 51195 Someone Is Thinking of You (Pensando En Ti), Imperial Marimba Band 10
The Haunting Waltz...Imperial Marimba Band 10
- 51196 Parade of the Wooden Soldiers, Harvey Hindermeyer and Chorus 10
That's My Baby...Robert Denning-Jack Holt 10
- 51197 Every Day...George Wilton Ballard 10
Long Ago 'Mid Apple Blossoms, George Wilton Ballard 10

EDISON BLUE AMBEROL RECORDS

- 4729 Sweet Roses...Joseph Phillips and Chorus 10
4730 I'm Yours With Love and Kisses...That Girl Quartet 10
4766 Valse Intermezzo (From "The Love Cure")—Piano Solo...Ernest L. Stevens 10
- 4767 Old King Tut (In Old King Tutankhamen's Day)...Billy Jones-Ernest Hare 10
4768 Ange d'Amour (Angel of Love)—Waltz, American Symphony Orchestra 10
- 4769 A Kiss in the Dark (Intro.: "Weaving My Dreams")—Medley Waltz...Kaplan's Melodists 10
4770 Voce di donna (La Gioconda)...Merle Alcock 10
4771 Still, Still With Thee...Criterion Quartet 10
- SPECIAL RELEASE**
- BLUE AMBEROL RECORDS**
- 4772 Yes! We Have No Bananas—Fox-trot, Green Brothers' Novelty Band 10
4773 Carolina Mammy...Walter Scanlan and Chorus 10
4774 Benny! Be Yourself!—Fox-trot, Green Brothers' Novelty Band 10
- 4775 Bebe—Fox-trot...Atlantic Dance Orchestra 10
4776 Night After Night—Fox-trot...Kaplan's Melodists 10
4777 That's My Baby...Robert Denning-Jack Holt 10
4778 Yes! We Have No Bananas...Billy Jones 10
4779 Louisville Lou—Fox-trot...Paul Victorin's Orchestra 10

OKEH RECORDS

- DANCE RECORDS**
- 4875 Wonderful You (From the musical comedy "Lady Butterfly") (Verner Jansen)—Fox-trot...Markel's Orch. 10
Am I to Blame? (Billy Fazioli)—Fox-trot, Markel's Orch. 10
- 4877 Stella (Al Jolson-Benny Davis-Harry Akst)—Fox-trot, Singing Chorus by Billy Jones, Rega Dance Orch. 10
'N That's Better (Charles Tobias-Louis Breau)—Fox-trot, Singing Chorus by Billy Jones, Rega Dance Orch. 10
- 4878 Wonderful One (Paul Whiteman-Ferdie Grofe)—Waltz, V. Lopez and His Hotel Pennsylvania Orch. 10
On a Moonlight Night (L. Wolfe Gilbert)—Waltz, V. Lopez and His Hotel Pennsylvania Orch. 10
- 4880 Farewell Blues (Leon Rappolo-Paul Mares-Elmer Schoebel)—Fox-trot...Handy's Orch. 10
Gulf Coast Blues (Clarence Williams)—Fox-trot...Handy's Orch. 10
- 4881 Swingin' Down the Lane (Isham Jones)—Fox-trot, V. Lopez and His Hotel Pennsylvania Orch. 10
When You're Near (Al Sherman-Sam Coslow)—Fox-trot, V. Lopez and His Hotel Pennsylvania Orch. 10
- 4883 I Never Miss the Sunshine (Norman Jay Harvey)—Fox-trot, Piano Solo by Del Symonds; Jules R. Herbaveaux, Director, Guyon's Paradise Orch. 10
Bebe (Abner Silver)—Fox-trot...Markel's Orch. 10
- 4884 I Cried for You! (Now It's Your Time to Cry Over Me) (Arthur Freed-Gus Arnheim-Abe 10

BRUNSWICK RECORDS

- 50037 Goldene Kreuz—Wie anders war es (How Times Have Changed) (Brüll)—Baritone, with Orch. Accomp.—In German...Michael Bohnen 10
Goldene Kreuz Bom! Bom! Bom! (Brüll)—Baritone, with Orch. Accomp.—In German, Michael Bohnen 10
- 50038 Andrea Chenier—Un di all' assurro spazio (Once O'er the Azure Fields) (Giordano)—Tenor, with Orch. Accomp.—In Italian, Giacomo Lauri-Volpi 10



"OH! HAROLD"

By Lee S. Roberts

A GREAT SONG, A GREAT DANCE TUNE (Fox Trot, One Step or Collegiate Walk)

FORSTER MUSIC PUBLISHER INC.
735 SOUTH WABASH AVE
CHICAGO

ADVANCE RECORD BULLETINS FOR OCTOBER—(Continued from page 186)

<p>Lyman)—Fox-trot.....Markel's Orch. 10 Rosetime and You (From the musical comedy "Go-Go") (C. Luckeyth Roberts)—Fox-trot, Markel's Orch. 10</p> <p>4885 Tin Roof Blues (New Orleans Rhythm Kings)—Fox-trot.....Harry Raderman's Jazz Orch. 10 Wolverine Blues (John Spikes-Benjamin Spikes-Fred Morton)—Fox-trot, Harry Raderman's Jazz Orch. 10</p> <p>4886 Sundown Blues (W. C. Handy)—Fox-trot, Handy's Orch. 10 Florida Blues (W. K. Phillips)—Fox-trot, Handy's Orch. 10</p> <p>4888 In a Tent (T. Koehler-F. Magin-J. Lyons)—Fox-trot; B. H. Warner, Director, Warner's Seven Aces 10 Eddie, Steady (E. Cantor)—Fox-trot; B. H. Warner, Director.....Warner's Seven Aces 10</p> <p>4889 Black Cat Blues (C. C. Fulcher)—Fox-trot, Fulcher's Novelty Orch. 10 Eskimo Song (C. C. Fulcher)—Fox-trot, Fulcher's Novelty Orch. 10</p> <p>4892 Just a Breath of Hawaii (Mary Earl)—Waltz, Ferera Waikiki Sextet 10 One Little Smile (Before We Say Farewell) (E. Herbert)—Waltz...Ferera Waikiki Sextet 10</p> <p>4893 Mixing the Blues (W. Page)—Piano Solo, Clarence Williams 10 The Weary Blues (A. Matthews)—Piano Solo, Clarence Williams 10</p> <p>4896 Memphis Blues (W. C. Handy)—Fox-trot, Handy's Orch. 10 St. Louis Blues (W. C. Handy)—Fox-trot, Handy's Orch. 10</p> <p style="text-align: center;">OKEH VOCAL RECORDS</p> <p>4876 Yes! We Have No Bananas (F. Silver-I. Cohn) Tenor, with Orch. Accomp.....Billy Jones 10 Maggie! (Yes! Ma'am) (Come Right Upstairs) (L. Moore-J. Tucker)—Soprano-Tenor Duet, with Orch. Accomp., Billy Jones-Virginia Burt 10</p> <p>4879 Daddy's Wonderful Pal (M. C. Freedman-B. Nelson-H. Link)—Tenor, Solo, Piano Accomp. by Justin Ring.....Lewis James 10 Some Day You'll Cry Over Someone as I Have Cried Over You (J. Osterman-D. Crilly-M. Charles)—Tenor, with Orch. Accomp., Lewis James 10</p> <p>4882 Born and Bred in Brooklyn (Over the Bridge) (From the musical comedy "The Rise of Rosie O'Reilly") (G. M. Cohan)—Tenor, with Orch. Accomp.....Sam Ash 10 When June Comes Along With a Song (From the musical comedy "The Rise of Rosie O'Reilly") (G. M. Cohan)—Contralto-Baritone Duet, with Orch. Accomp., Chester Strong-Marcia A. Freer 10</p> <p>4887 Swing Low, Sweet Chariot—Colored Male Quartet.....Morehouse College Quartet 10 Down by the Riverside—Colored Male Quartet, Morehouse College Quartet 10</p> <p>4891 Pale Moon (Indian Love Song) (J. G. M. Glick-F. K. Logan)—Tenor, Accomp. by Piano, Flute and Bells.....Lewis James 10 My Gal Sal (P. Dresser)—Tenor, With Orch. Accomp.....Gerald Griffin 10</p>	<p>4894 Pua Sadinia (Flower)—Tenor Solo, Prince Lei Lani 10 Lei Poni Moi (Wreath of Carnations)—Tenor Solo.....Prince Lei Lani 10</p> <p>4895 Eileen Alanna—Tenor Solo, Accomp. by Piano and Harp.....Emmet O'Mara 10 The Bard of Armagh (From Herbert Hughes' Collections)—Tenor Solo, Piano Accomp., Gerald Griffin 10</p> <p style="text-align: center;">OKEH NOVELTY RECORD</p> <p>4890 The Little Old Log Cabin in the Lane—Fiddling Solo, Vocal Chorus.....Fiddlin' John Carson 10 The Old Hen Cackled and the Rooster's Going to Crow—Fiddling Solo, Vocal Chorus, Fiddlin' John Carson 10</p> <p>8077 Deceitful Blues (P. Bradford)—Contralto Solo, Piano Accomp.....Kitty Brown 10 I Don't Let No One Man Worry Me (P. Bradford)—Contralto Solo, Piano Accomp., Kitty Brown 10</p> <p>8078 Nobody in Town Can Bake Sweet Jelly Roll Like Mine (S. Williams-C. Williams)—Contralto Solo, Piano Accomp. by C. Williams, Sara Martin 10 If You Don't Like It, Leave (C. Todd)—Contralto Solo, Piano Accomp. by C. Williams, Sara Martin 10</p> <p>8080 Satisfied Blues (A Barrel House Blues) (L. Fowler)—Contralto Solo, Piano Accomp., Helen Baxter 10 Daddy, Ease It to Me (L. Fowler)—Contralto Solo, Piano Accomp.....Helen Baxter 10</p> <p>8082 Hesitation Blues (B. Smythe)—Contralto Duet, Piano Accomp. by C. Williams, Cornet Obligato by T. Morris....Sara Martin-Eva Taylor 10 That Free and Easy Papa o' Mine (C. Williams)—Contralto Duet, Piano Accomp. by C. Williams, Cornet Obligato by T. Morris, Sara Martin-Eva Taylor 10</p> <p>8083 Ye Shall Reap Just What You Sow (A. Robinson)—Contralto Solo, Piano Accomp. by C. Williams.....Sara Martin 10 You Just Can't Have No One Man by Yourself (Johnson-Gilbert)—Contralto Solo, Piano Accomp. by C. Williams.....Sara Martin 10</p> <p>8084 Tired o' Waitin' Blues (P. Grainger-B. Ricketts)—Contralto Solo, Piano Accomp. by C. Williams.....Sara Martin 10 Just Thinkin' Blues (P. Grainger-B. Ricketts)—Contralto Solo, Piano Accomp. by C. Williams.....Sara Martin 10</p> <p>8085 Uncle Sam Blues (S. Martin-C. Williams)—Contralto Solo, Piano Accomp. by C. Williams.....Sara Martin 10 New Orleans Hop Scop Blues (G. W. Thomas)—Contralto Solo, Piano Accomp. by C. Williams.....Sara Martin 10</p>	<p>3060 Pola Negri—Orchestra, Marek Weber and His Orch. 12 Out on the Prairies—Orchestra, Marek Weber and His Orch. 12</p> <p>3061 Colombine—Orchestra, Marek Weber and His Orch. 12 Ambrosia—Orchestra, Marek Weber and His Orch. 12</p> <p>3062 Badinage—Pipe Organ Solo.....Paul Mania 12 Song Without Words—Andante E Major (Mendelssohn)—Violin, Piano and Organ, Stabernack Trio 12</p> <p>5020 Invitation to the Dance (Weber)—Part I—Symphony Orch....Dr. Weissmann and The Orch. of the State Opera House, Berlin 12 Invitation to the Dance (Weber)—Part II—Symphony Orch....Dr. Weissmann and The Orch. of the State Opera House, Berlin 12</p> <p>5021 Frühling Zog Ein (Spring Has Come)—Tenor, with Piano Accomp.—Sung in German, Richard Tauber 12 Liebesfeier (Love's Festival)—Tenor, with Piano Accomp.—Sung in German....Richard Tauber 12</p> <p style="text-align: center;">FONOTIPIA RECORD <i>(Recorded in Europe)</i></p> <p>63005 I Puritani—A te o cara (Often, Dearest)—Tenor, with Orch. Accomp.—Sung in Italian, Giacomo Lauri-Volpi 10</p>
---	--	---

GENNETT LATERAL RECORDS

GREEN LABEL GENNETTS

<p>10078 Serenade (Moszkowsky)—Violin; Piano Accomp., Thos. Grisselle.....Scipione Guidi 10 Spanish Dance (Granados-Kreisler)—Violin; Piano Accomp., Thos. Grisselle.....Scipione Guidi 10</p> <p>10079 A Perfect Day (Carrie Jacobs-Bond)—Tenor; Violin Obligato, Scipione Guidi; Piano Accomp., Thos. Grisselle.....Henry Moeller 10 Calm as the Night (Bohm)—Tenor; Violin Obligato, Scipione Guidi; Piano Accomp., Thos. Grisselle.....Henry Moeller 10</p>	<p style="text-align: center;">GENNETT PHYSICAL CULTURE RECORDS Gennett Physical Culture Exercises (On Gennett Records 5031, 5032, 5033), By Clarence Nichols, Director</p> <p style="text-align: center;">NUMBERS OF VARIED APPEAL</p> <p>5185 March Barrancas (Brownfield)—Accordion, Harvey Brownfield 10 Medley of "Poet and Peasant" and "When You and I Were Young, Maggie"—Accordion, Harvey Brownfield 10</p> <p>5199 Beautiful Spring—Accordion....Harvey Brownfield 10 Prize of Victory—Accordion....Harvey Brownfield 10</p> <p>5190 Broken-hearted Melody (Kahn-Jones)—Waltz, Palakiko Pala's Hawaiian Serenaders 10 Hula-Hula Rose (Reed-Awan)—Waltz, Palakiko Pala's Hawaiian Serenaders 10</p> <p>5191 Melodies of Home (Zimmermann), Fritz Zimmermann-Marcelle Grandville, Yodlers 10 The Country Lovers (Zimmermann), Fritz Zimmermann-Marcelle Grandville, Yodlers 10</p> <p style="text-align: right;"><i>(Continued on page 188)</i></p>
---	--

ODEON RECORDS

(Recorded in Europe)

<p>3059 Miss Nightingale—Orchestra, Marek Weber and His Orch. 12 Big Ben (When Big Ben's Chimes Ring Out)—Orchestra.....Marek Weber and His Orch. 12</p>	
--	--

THREE RECORD RECORD-BREAKERS

Three Thousand Years Ago

The Greatest Comedy Song in Years

Treat 'Em Rough

A Real Peppy, Snappy Jazz Tune

Black Sheep Blues

Blues, 'Nuff Said

IRVING BERLIN, Inc., 1607 BROADWAY, NEW YORK CITY

A SNAPPY FOX TROT SONG

Oh, You Little SUN-OVER-GUN



You can't go wrong with any FEIST song



© 1923 Leo. Feist, Inc.

ADVANCE RECORD BULLETINS FOR OCTOBER—(Continued from page 187)

- 5204 Uncle Josh in the Cafeteria (Stewart)—Monologue...
5205 Gaelic Barn Dance...
5195 Sad 'N' Lonely Blues (Grainger-Wilson)—Piano Accomp...
5196 Sweet Woman (How I'd Love to Sweet Papa You) (Rose-Dixon-Henderson)—Tenor...
LATEST DANCE MELODIES
5186 Oh! Gee, Oh! Gosh, Oh! Golly I'm in Love (Olson-Breuer)—Fox-trot...
5187 Bad News Blues (Akst-Davis)—Fox-trot...
5188 Indiana Moon (Davis-Jones)—Waltz...
5189 I've Been a Fool (Frederick-Holmer-Landry-Hagen)...
5192 Pharaoh (Malool)—Egyptian Fox-trot...
5197 Pickles (Gowan-Rosoff)—Fox-trot...
5198 My Old Love (Alfonso Espareza Oteo)—Mexican Love Song...
5202 Love Tales (Ryan)—Fox-trot...
5203 El Opio—Fox-trot...
5207 Four Little Black Berries (O'Connor)—Waltz...
FOREIGN SELECTIONS
S5181 Social Club (Paso-doble flamenco) (M. Martinez P.)...
S5182 "Te He Perdido y No Puedo Olvidarte" (Larry Conley)—Fox-trot...
S5194 La Cegadora—Fox-trot...
EMERSON RECORDS
LATEST DANCE HITS
10665 Just a Girl That Men Forget—Waltz...
10660 No, No, Nora—Fox-trot...
10659 Gold Diggers—Fox-trot...
10664 Big Blond Mamma—Fox-trot...
LATEST SONG HITS
10657 Just a Girl That Men Forget—Tenor Solo...
10661 I've Got the Yes! We Have No Banana Blues—

- Tenor and Baritone Duet, Orch. Accomp...
Three Thousand Years Ago—Tenor Solo, Orch. Accomp...
10662 Sweet Henry—Tenor Solo, Orch. Accomp...
No, No, Nora—Tenor Solo, Orch. Accomp...
10663 Wonderful One—Tenor Solo, Orch. Accomp...
Ten Thousand Years From Now—Tenor Solo, Orch. Accomp...
Vernon Dalhart

REGAL RECORDS

DANCE RECORDS

- 9523 I'll Hop, Skip and Jump Into My Mammy's Arms—Fox-trot...
9524 Hot Roasted Peanuts—Fox-trot...
9525 That Big Blonde Mamma—Fox-trot...
9526 Love Tales—Fox-trot...
9527 Underneath the Sip, Sip, Sippy Moon—Fox-trot...
9528 Midnight Rose—Fox-trot...
9529 Love (My Heart Is Calling You)—Fox-trot...
9530 Chick-a-Dee—Fox-trot...
9531 I've Got the Yes! We Have No Banana Blues—Comedy Solo...
9532 If I Knew You Then as I Know You Now—Tenor Solo...
9533 Cut Yourself a Piece of Cake—Comedy Solo...
9534 Marcheta—Tenor Solo...
9535 Ten Thousand Years From Now—Tenor Solo...

POPULAR VOCAL RECORDS

PATHE PHONOGRAPH & RADIO CORP.

BANDS

- 021036 Anvil Polka—Descriptive...
021037 Boston Commandery March...
021038 Coo Coo's Nest (Intro.: "Mason's Apron")...
021041 Every Step Brings Me Closer to My Honey Lamb...
021043 When I Come Back to You—Fox-trot...
021044 Stealing to Virginia—Fox-trot...
021045 Page Mr. Paderewski—Fox-trot...
021046 Stingo, Stungo (From "Geo. White's Scandals")...
021047 Where the Ganges Flows (From "Adrienne")...
021048 Born and Bred in Brooklyn (From "The Rise of Rosie O'Reilly")...
021049 'Neath Egyptian Skies—Fox-trot...

- Underneath the Sip, Sip, Sippy Moon—Fox-trot...
021050 That Big Blonde Mamma—Fox-trot...
Oh! Min—Fox-trot...
021051 No, No, Nora—Fox-trot...
021052 I Wish I Had Someone to Cry Over Me, Kiss Me With Your Eyes...
021053 Swingin' Down the Lane...
021054 I've Got the Yes! We Have No Banana Blues, Oh! Sister, Ain't That Hot!...

BANNER RECORDS

DANCE RECORDS

- 1236 Hot Roasted Peanuts—Fox-trot...
1237 Midnight Rose—Fox-trot...
1238 I'll Hop, Skip and Jump Into My Mammy's Arms...
1239 Love (My Heart Is Calling You)—Fox-trot...
1240 That Big Blonde Mamma—Fox-trot...
1241 Love Tales—Fox-trot...
1242 Underneath the Sip, Sip, Sippy Moon—Fox-trot...
1243 Somebody's Wrong—Fox-trot...
1244 I've Got the Yes! We Have No Banana Blues...
1245 If I Knew You Then as I Know You Now...
1246 Cut Yourself a Piece of Cake—Comedy Solo...
1247 Wonderful One—Tenor Solo...
1248 Ten Thousand Years From Now—Tenor Solo...

SOUTHERN VICTOR WHOLESALERS The Corley Company RICHMOND VIRGINIA

The Toledo Talking Machine Co. Toledo, Ohio Wholesale Victor Exclusively

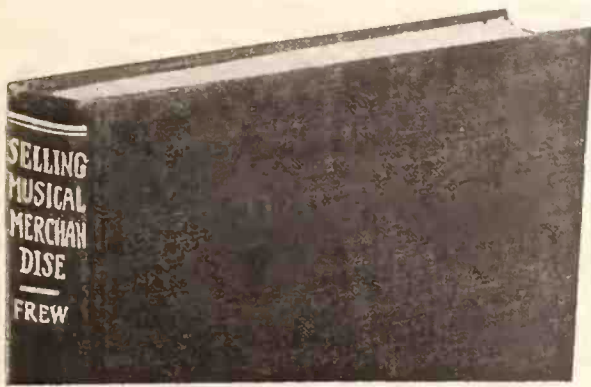

SELLING MUSICAL MERCHANDISE

By J. R. FREW

This is a practical book that describes the methods pursued by a successful music dealer in conducting his musical merchandise departments. It covers every routine problem incident to establishing and operating a department devoted to band and orchestra instruments.

This branch of the music industry has had a very prosperous year and an excellent opportunity awaits other dealers who take it up. It requires a small investment, gets quick turnover, involves no risk and, in addition to being highly profitable itself, increases the sale of talking machines, records, etc., and helps make a given store the music center of its community.

READ THE CONTENTS of THIS PRACTICAL BOOK

Chapter	From the Publisher. Introduction.
	PART I
	THE PROBLEM OF BUYING
	I. Buying in General.
	II. Importance of Quality in Buying.
	III. Where to Buy.
	IV. Future Buying.
	V. Buying for Special Sales.
	VI. Some Don'ts for the Buyer.
	PART II
	THE PROBLEM OF PUBLICITY
	VII. Advertising in General.
	VIII. Space or Display Advertising.
	IX. Advertising by Personal Contact.
	X. Advertising Through Service.
	XI. Direct and Mail Advertising.
	XII. Advertising Through Musical Attractions.
	PART III
	THE PROBLEM OF MANAGEMENT
	XIII. Management in General.
	XIV. Stock Display.
	XV. The Care of Stock.
	XVI. Inventory and Sales Analysis.
	XVII. The Question of Credit.
	XVIII. The Repair Department.
	XIX. The Value of Co-operation.
	PART IV
	THE PROBLEM OF SELLING
	XX. Selling in General.
	XXI. The Sales Organization.
	XXII. Psychology of Salesmanship.
	XXIII. Collective Selling.
	XXIV. Organizing a Band or Orchestra.
	XXV. The Used Instrument Problem.
	PART V
	INSTRUMENTATION
	XXVI. Musical Organizations and their Instrumentation.
	XXVII. The Principal Instruments of the Band and Orchestra Described.
	APPENDIX
	List of Principal Musical Merchandise Products

FREE INSPECTION OFFER

Edward Lyman Bill, Inc.
383 Madison Avenue, New York.

You may send me, on five days' free inspection, your book **SELLING MUSICAL MERCHANDISE**. I agree to return it to you within five days, or remit \$2.00

Name

Address City

CONSTRUCTIVE ARTICLES IN THIS ISSUE OF THE WORLD

Ready Reference for Salesmen, Dealers and Department Heads

Retail Methods in New Zealand Described by L. Alfred Eady..	3	Making Small Advertisements Effective	48
Delivery Service As a Business Builder	4	Novel Record Advertising Stunt That Went Over Big.....	54
Sales Arguments That Win the Customer	6	New Form of Retail Swindle Exposed	54
Principles of Retail Advertising Success	8	Reason Why the Salesman Should Study the Talking Machine Which He Handles and Sells..	58
Vigorous Policy in Retailing Necessary During Fall and Winter Seasons	10	Tax Problems Are Again to the Fore in Washington.....	60
New Campaigns in Developing Record Sales	10	Concert Plans of Famous Recording Artists.....	62-64
Caution in Expanding Retail Business Is Advisable.....	10	The Mid-West Point of View....	100
Discussion of Problems Associated With Replacements	11	Bases for Optimism Over the Demand Which Will Prevail in Sheet Music Field.....	133
Management Reflected in Sales Results	12	Gleanings From the World of Music	133-142
How Letters Pave the Way to More Business	14	Happenings in the Musical Merchandise Field	145-147
Undeveloped Fields in the Selling of Talking Machines	19	Talking Machine Dealers Discuss the Effect of Radio.....	158
Making Every Employee a Prospect Getter	20-21	Victor Red Seal Record Exchange Put Into Effect.....	158
Why Dealers Should Create Interest in New Phonograph Styles....	25	Why Interest Should Be Charged on Talking Machine Sales....	163
Concentrated Canvassing Insures Results	31	Enormous Savings Deposits Predicate Business for Dealers Who Seek It	165
Why Dealers Should Observe Care in Accepting Registered Liberty Bonds	38	Featuring the Musical Possibilities of the Talking Machine.....	166
Important New Field for Women's Work	40	Survey of the Talking Machine Industry	171
Time the Little "Big Man" Secured Recognition	41	Latest Patents of Interest to the Talking Machine Trade.....	183-184
Securing and Keeping Up Mailing List	43	Advance List of Talking Machine Records for September.....	185-188
Satisfactory Report on Exports and Imports of Talking Machines, Records and Supplies	46		

Correspondence From Leading Cities:

Ogden, 52—Richmond, 56—Dallas, 67—Cincinnati, 68—Brooklyn, 74-75—San Francisco, 77—Philadelphia, 79-83—Omaha, 84—Buffalo, 86-87—Minneapolis and St. Paul, 88-89—Des Moines, 93—Boston, 95-98—Chicago, 101-110—Los Angeles, 112—Atlanta, 116—Milwaukee, 118—Cleveland, 120-121—Indianapolis, 122—Pittsburgh, 124—Toledo, 126—Baltimore, 128—St. Louis, 130—Portland, 144—Detroit, 148—Albany, 150—Syracuse, 152-153—New Orleans, 156-157—Kansas City, 160—Dominion of Canada, 162—Columbus, 164—Salt Lake City, 172—Akron, 174—European News From The World's London Office, 181-182.

TEST IT. 

OUR VICTOR

Record Service

has a reputation for efficiency.
Suppose you try it.

E. F. DROOP & SONS CO.
1300 G. STREET, WASHINGTON, D. C.
201 N. HOWARD STREET, BALTIMORE, MD

W. J. DYER & BRO.
DYER B'LD'G, ST. PAUL, MINN.
NORTHWESTERN DISTRIBUTORS
OF THE

VICTOR
Machines, Records and Supplies



Shipped Promptly to all Points in the Northwest

A C B Z A C D F H K L N P Q S U A X V B D F G I J L N P Q S U V X Z V C E F H J K W O P R Y A C E M O N
INDEX TO ADVERTISERS
 T S R P O M K V H F E C V B C E F H K L M W O P R T U N Y L B D E G I J K M O P Q S T S V W X Y Z

A

Aeolian Co. Insert following page 18

Alto Mfg. Co. 107

American Felt Co. 164

American Mica Works. 160

American Phonograph Co. 150

American Talking Machine Co. 74

Andrews, Curtis N. 86

Andrews, W. D., Co. 152

Artophone Corp. 130

Audak Co. 21

B

Bacon Banjo Co. 145

Bagshaw Co., W. H. 32

Bakertone Corp. 87

Barnhart Bros. & Spindler. Inside back cover

Berlin, Inc., Irving. 136, 187

Blackman Talking Machine Co. 117

Blood Tone Arm Co. 104

Bolway & Son, Frank E. 153

Brand & Co., William. 22

Brilliantone Steel Needle Co. 33

Bristol Co. 126

Broadcaster Phono. Co. 108

Bruno & Son, Inc., C. 53, 145

Bruns & Sons, A. 30

Brunswick-Balke-Collender Co. 90, 91

Buehn Co., Inc., Louis. 79

Buehn Phono. Co. 124

Buescher Band Instrument Co. 72

Buffalo Talking Machine Co. 86

C

Centonze Music Co., A. 75

Chappell-Harms, Inc. 135

Charmaphone Co. 165

Cheney Talking Machine Co. 94

Claravox Co. 158

Claremont Waste Mfg. Co. 48

Classified Want Ads. 180

Cohen & Hughes. 129

Columbia Graphophone Co. 16, 17, 30, 34, 38, 56, 75, 84, 89, 98, 115, 150, 157, 177

Columbia Mantel Co. 34

Commercial Art Shop. 25

Consolidated Talking Machine Co. 105, 110

Corley Co. 188

Crosley Mfg. Co. 179

Cutting & Washington Radio Corp. 69

D

Da-Lite Elec. Display Co. 41

Davis Mfg. & Sales Co. 70

Diamond Music Co. 156

Diapbragn Co. 24

Ditson & Co., Chas. H. 95

Ditson Co., Oliver. 95

Doctorow, D. R. 143

Dodin, Andrew H. 184

Doehler Die Casting Co. 75

Doerr-Andrews-Doerr. 41

Droop & Sons Co., E. F. 189

Duo-Tone Co. 131

Dyer & Co., W. J. 189

E

Eastern Talking Machine Co. 95

Eclipse Musical Co. 121

Edison, Inc., Thos. A. 26, 27, 28, 29, back cover

Edison Phonographs, Ltd. 77

Eight Popular Victor Artists. 14

Emerson Phonograph Co. 151

Empire Phono. Parts Co. 174

Ernest & Co., G. D. 153

Everybody's Talking Machine Co. 13

Excel Phonograph Mfg. Co. 109

F

Federal Tel. & Tel. Co. 175

Feist, Leo. 24, 40, 46, 50, 52, 56, 66, 68, 70, 83, 93, 110, 114, 121, 122, 128, 137, 147, 153, 156, 173, 185, 188

Fletcher-Wickes Co. 71

Forster Music Pub. 107, 139, 187

Fox Pub. Co., Sam. 140

Fox-Vliet Drug Co. 45

Fulton Talking Machine Co. 173

G

General Phonograph Corp.—Inserts following pages 50, 66 and 82

General Phonograph Corp. (New York Distributing Division) 166

General Phonograph Corp. of New England. 96

General Phonograph Mfg. Co. 51

General Radio Corp. 81

Gerson, Louis Jay. 169

Gibson-Snow Co. 45, 152

Girard Phono. Co. 80

Greater City Phonograph Co. 6, 45

Gretsch Mfg. Co., Fred. 146

Guarantee F. M. Supply Co. 83

Guden & Co., H. A. 54

H

Haag & Bissex Co., Inc. 171

Hall Mfg. Co. 103

Harger & Blish. 93

Harper & Bros. 144

Haynes Co., C. B. 56

Hearth Builders. 23

Hearst Music Pubrs., Ltd. 135

Hessig-Ellis Drug Co. 45

Honner, M. 147

Hough, J. E., Ltd. 181

I

Ideal Repair Service. 42

Iisley, Doubleday & Co. 42

Independent Jobbing Co. 168

Independent Recording Labs. 150

Iroquois Sales Co. 46

Italian Book Co. 46

J

Jewel Phonoparts Co. 57, 101

Junod & Co., L. H. 60

K

Kennedy Co., Colin B. 15

Kent Co., F. C. 48

Kiefer-Stewart Co. 45

Kimball Co., W. W. 102

Kimberley Phono. Co. 55

Kirkman Engg. Corp. 174

Kraft, Bates & Spencer, Inc. 97

Krasco Mfg. Co. 99, 106

L

Lakeside Supply Co. 109

Lauter Co., H. 66

La Velle Mfg. Co. 167

Lee-Coit-Andreesen Hdw. Co. 45

Lind & Marks Co. 149

Long Cabinet Co., Geo. A. 161

Long Island Phonograph Co. 74

Lucker, Laurence H. 88

M

Madison Music Co. 169

Magic Tone Sales Co. 99

Magnavox Co. 45

Manufacturers' Phono. Co. 85

Marks Music Co., Edw. B. 141

Marshall Co., C. L. 148

Mayer Bros. & Bramley. 87

Mellor Co., C. C. 178

Mermod & Co. 54

Mills Pub. Co., Jack. 142

Modernola Co. 43

Moore-Bird & Co. 45

Musical Instrument Sales Co. 12

Musical Products Distr. Co. 118

Mutual Phono. Parts Mfg. Co. 39

N

National Co. 154

National Metals Depositing Corp. 172

National Publishing Co. 18

Naturelle Co. 8

Netschert, Frank. 125

New England Talking Machine Co. 98

New York Album & Card Co. 4

Nye & Co., Wm. F. 77

O

Ob! Pep Phono. Parts Co. 173

Oro-Tone Co. 103, 108, 113, 163

Orsenigo Co. 119

Outing Talking Machine Co. 115

P

Pardee-Ellenberger Co. 96

Pathé Phonograph & Radio Corp. 63

Peabody & Co., Henry W. 127

Pearsall Co., Silas E. 11

Peckham Mfg. Co. 24

Peerless Album Co. 9

Penn Phonograph Co. 82

Philadelphia Badge Co. 52, 81

Phillips Phonograph Parts Co., Wm. 64

Phonograph Co., Inc. 116

Phonograph Co., Chicago. 111

Phonograph Co., Cincinnati. 68

Phonograph Co., Cleveland. 120

Phonograph Co., Detroit. 148

Phonograph Co., Kansas City, Mo. 160

Pbonograph Corp. of Indiana. 122

Pbonograph Corp. of Manhattan. 18

Phonomotor Co. 59

Player-Tone Talking Machine Co. 61

Plaza Music Co. 31, 58

Pleasing Sound Phono. Co. 73

Plymouth Phono. Parts Co. 112

Plywood Corp. 41

Polk Co., Inc., J. K. 116

Progressive Musical Instrument Corp. 47

Proudfit Sporting Goods Co. 52

R

Radio Corp. of America. Insert following page 34

Rapid Repeater Co. 73

Reflexo Products Co. 22

Regal Record Co. 49, 125

Regina Phono. Co. 168

Remick Co., Jerome H. 138, 141, 186

Rene Manufacturing Co. 162

Rex Gramophone Co. 181

Robbins, H. A. 172

S

Shapiro, Bernstein & Co. 132

Shelton Elec. Co. 178

Sherman, Clay & Co. 62

Shultz Bros. 84

Silent Motor Corp. 42

Silverstone Music Co. 130

Smith Drug Co., C. D. 45

Sonata Mfg. Co. 107

Songster Phono. Co. 177

Sonora Co. of Philadelphia. 45

Sonora Distributing Co. of Pittsburgh. 45

Sonora Phono. Co. of New England. 45

Sonora Phonograph Co., Inc. Inside front cover, 44, 45, 179

Sonora Phono. Co. of Illinois. 45

Sonora Phonograph—Ohio Co. 45

Sonora Sales Co. of New Jersey. 45

Southern Drug Co. 45

Southern Sonora Co. 45

Specialty Phono. & Acc. Co. 35

Standard Musical String Co. 145

Star Mach. & Nov. Co. 34

Starr Piano Co. 78

Stasny Music Co., A. J. 133, 143

Steinert & Sons Co., M. 97

Sterling Devices Mfg. Co. 111

Strevell-Paterson Hardware Co. 45

Stylus Bar & Mfg. Co. 155

Swanson Portable Phono Distr. 170

T

Talking Machine Co., Philadelphia. 82

Talking Machine Supply Co. 180

Texas-Oklahoma Phono. Co. 67

Texas Radio Sales Co. 67

Toledo Talking Machine Co. 188

Tonofone Co. 106

Triangle Phono. Parts Co. 159

Trinity Phono. Co. 170

Triplex Artistic Phono. Co. 104

U

Udell Works. 114

Unique Reproduction Co. 19

Unit Construction Co. 65

United Mfg. & Distr. Co. 92

United Orchestras, Inc. 73

United Music Stores. 80

V

Val's Accessory House. 155

Van Veen & Co. 35

Vega Co. 146

Viesonia Mfg. Co. 125

Victor Talking Machine Co. Front cover, 5, 7

Vulcart Record Corp. 36, 37

W

Walbert Mfg. Co. 109

Wall Kane Needle Mfg. Co. 38

Waltball Music Co. 45

Wasmuth-Goodrich Co. 123

Weymann & Son, H. A. 80

Whitsit Co., Perry B. 168

Widdicomb Furniture Co. 76

Williams Pub. Co., Clarence. 142

Williams Co., Spencer. 135

Witmark & Son, M. 134

Wolf Mfg. Industries. 89

Y

Yahr & Lange Drug Co. 41

Z

Zimmerman-Bitter Constr. Co. 157

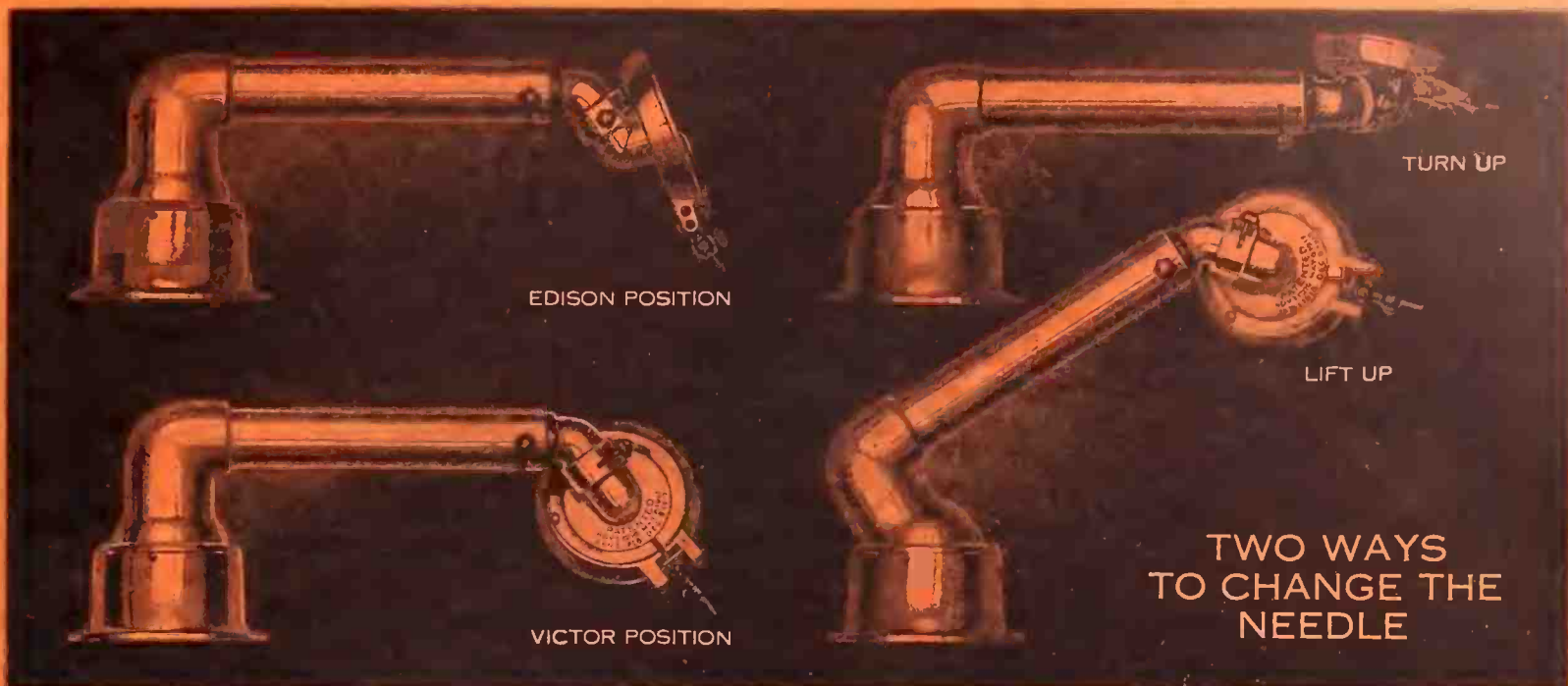

The SCOTFORD TONEARM & SUPERIOR REPRODUCER

HOW TO SELL A PHONOGRAPH

To the Dealer or Salesman:

The Scottford Tonearm and Superior Reproducer are used by a number of manufacturers of high grade phonographs. If your store handles any one of these instruments you can increase your sales and profits by thoroughly learning and then informing the customer of the "Twelve Points" of superiority given below. Remember it is no proof of selling ability to take an order for a phonograph, the preference for which has been fixed in the customer's mind by big national advertising campaigns. Such order taking proves the power of advertising—not the sagacity of salesmanship. The saving in advertising cost is made up for by extra quality and extra profit for the store in the Scottford equipped instrument. There is a better future for the business in the lasting satisfaction of the purchaser who takes an instrument of genuine music into his home. Give the customer a comparison of tone on all the different makes. If he is not deaf, he must appreciate the extraordinary difference in tone—the Scottford's genuine musical reproduction, without the metallic sharpness, and without the scratch. Then prove yourself not an order taker but a salesman by continuing with a detailed explanation of why the Scottford is better as analyzed in the "Twelve Points."

Keep the tonearm unscrewed at the base, so you may lift it off in your hand for thorough examination inside and out—not necessary to screw it down until sold and ready to deliver

TWELVE POINTS

- 1—Its good looks. A neat, trim, tailormade appearance. Nicely proportioned lines which any artist will approve. Not the swollen appearance of the continuous taper nor angular lines in conflict with the cabinet design.
- 2—The substantial, simple construction—cast parts of solid white brass, long straight tube of yellow brass, hard rubber bushing to prevent metallic vibration at the reproducer connection elbow.
- 3—No obstruction anywhere inside—an absolutely clear passage, with the approved two-inch inside diameter at base, and a solid 45-degree deflecting plane at the turn to direct the sound waves straight downward into the amplifying chamber.
- 4—The simple swinging movement of the tonearm base—how freely it floats when lifted up onto the record—but how a supporting lug inside the base at back prevents the arm from swinging when off the record and does not allow the needle point to let down so low as to mar the cabinet.
- 5—The handy lift-up or side turn, affording two ways to change the needle.
- 6—Light pressure on the record—the squareness of the turn causing the weight to be supported by the base, whereas a more curving turn would throw too much weight forward to the needle point.
- 7—How perfectly the needle centers the groove—turning the reproducer for playing lateral or vertical cut records leaves the needle on exactly the same point at the same and only correct angle. A minimum of surface noise on records noted for scratch.
- 8—Reproducer frame split clear through—making it a spring, held under tension by the long screw which adjusts the pivotal mounting of the stylus bar.
- 9—Any looseness that might ever develop in the pivoting of the stylus bar may be readily detected and instantly corrected by adjusting the long screw until the needle holder and stylus bar feel tight.
- 10—The inclined position of the reproducer and angle of the stylus bar by which a greater impulse is imparted to the diaphragm, with finer sensitivity to minor vibrations than the ordinary straight upright design.
- 11—Fineness of the mica diaphragm—a perfect crystal edge disc of selected clear Indian mica costing five times as much as the "seconds" and "thins" used in cheap soundboxes.
- 12—Perfect insulation—a rubber gasket entirely separating the reproducer frame from the backplate, and again a complete break in the contact of metals by the hard rubber bushing in the tonearm. This double insulation insuring against metallic effect in the tone, and preventing the surface scratch being magnified by the metals of the reproducer and tonearm.

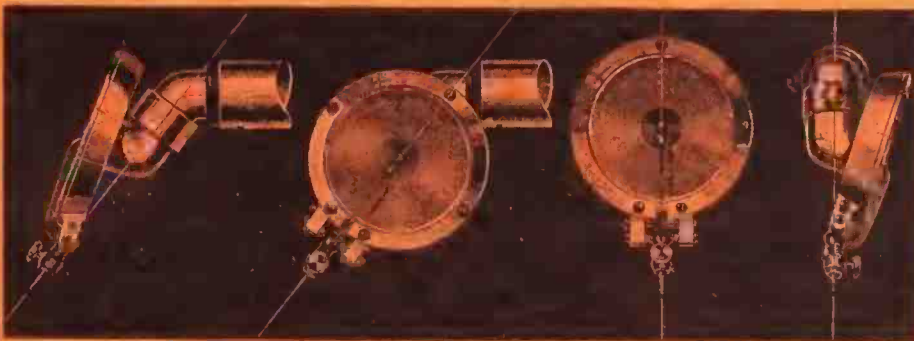

The Reproducer turns on its axis—the needle remaining on exactly the same center and at the same correct angle in both positions



THE SUPERIOR LID SUPPORT

Balances the Lid at any point

The final point of excellence in the equipment of a cabinet that often decides the sale. A touch of one finger lifts or closes the lid, which stops at any point desired. Cannot warp the cover. Noiseless in operation. The simplest support made. Easiest to install.

We are prepared to supply this Tonearm and Reproducer to a number of additional manufacturers of phonographs in certain parts of the United States, and contracts remain open for some foreign countries. Write us for particulars and prices.



We are able to supply this Support in any quantity. Made of steel, high grademickel or gold plate finish. Samples sent to manufacturers anywhere for trial. Write for low quantity prices. State type and weight of lid.

BARNHART BROTHERS & SPINDLER

SUPERIOR SPECIALTIES FOR PHONOGRAPHS MONROE & THROOP STREETS, CHICAGO

THE NEW EDISON is the only phonograph that dares the supreme test—comparison with living artists.

Repeated tests before critical audiences have incontrovertibly proven that the devices perfected by Mr. Edison have bridged the gap between ordinary reproduction and actual Re-Creation.



*See Pages 26, 27,
28 and 29 inside*

JOBBER OF THE NEW EDISON, EDISON RE-CREATION, THE NEW EDISON DIAMOND AMBEROLA AND BLUE AMBEROL RECORDS

CALIFORNIA
Los Angeles—Edison Phonographs, Ltd.
San Francisco—Edison Phonographs, Ltd.

COLORADO
Denver—Denver Dry Goods Co.

GEORGIA
Atlanta—Phonographs, Inc.

ILLINOIS
Chicago—The Phonograph Co.
Wm. H. Lyons (Amberola only).

INDIANA
Indianapolis—Phonograph Corporation of Indiana.

IOWA
Des Moines—Harger & Blish.

LOUISIANA
New Orleans—Diamond Music Co., Inc.

MASSACHUSETTS
Boston—Pardee-Ellenberger Co.
Iver Johnson Sporting Goods Co.
(Amberola only).

MICHIGAN
Detroit—Phonograph Co. of Detroit.

MINNESOTA
Minneapolis—Laurence H. Lucker.

MISSOURI
Kansas City—The Phonograph Co. of Kansas City.
St. Louis—Silverstone Music Co.

MONTANA
Helena—Montana Phonograph Co.

NEBRASKA
Omaha—Shultz Bros.

NEW JERSEY
Orange—The Phonograph Corp. of Manhattan.

NEW YORK
Albany—American Phonograph Co.
Syracuse—Frank E. Bolway & Son, Inc., W. D. Andrews Co.
(Amberola only).

OHIO
Cincinnati—The Phonograph Co.
Cleveland—The Phonograph Co.

OREGON
Portland—Edison Phonographs, Ltd.

PENNSYLVANIA
Philadelphia—Girard Phonograph Co.
Pittsburgh—Buchn Phonograph Co.
Williamsport—W. A. Myers.

RHODE ISLAND
Providence—J. A. Foster Co.
(Amberola only).

TEXAS
Dallas—Texas-Oklahoma Phonograph Co.

UTAH
Ogden—Proudfit Sporting Goods Co.

VIRGINIA
Richmond—The C. B. Haynes Co., Inc.

WISCONSIN
Milwaukee—The Phonograph Co. of Milwaukee.

CANADA
Montreal—R. S. Williams & Sons Co., Ltd.
St. John—W. H. Thorne & Co., Ltd.
Toronto—R. S. Williams & Sons Co., Ltd.
Vancouver—Kent Piano Co., Ltd.
Winnipeg—R. S. Williams & Sons Co., Ltd.
Babson Bros. (Amberola only).