

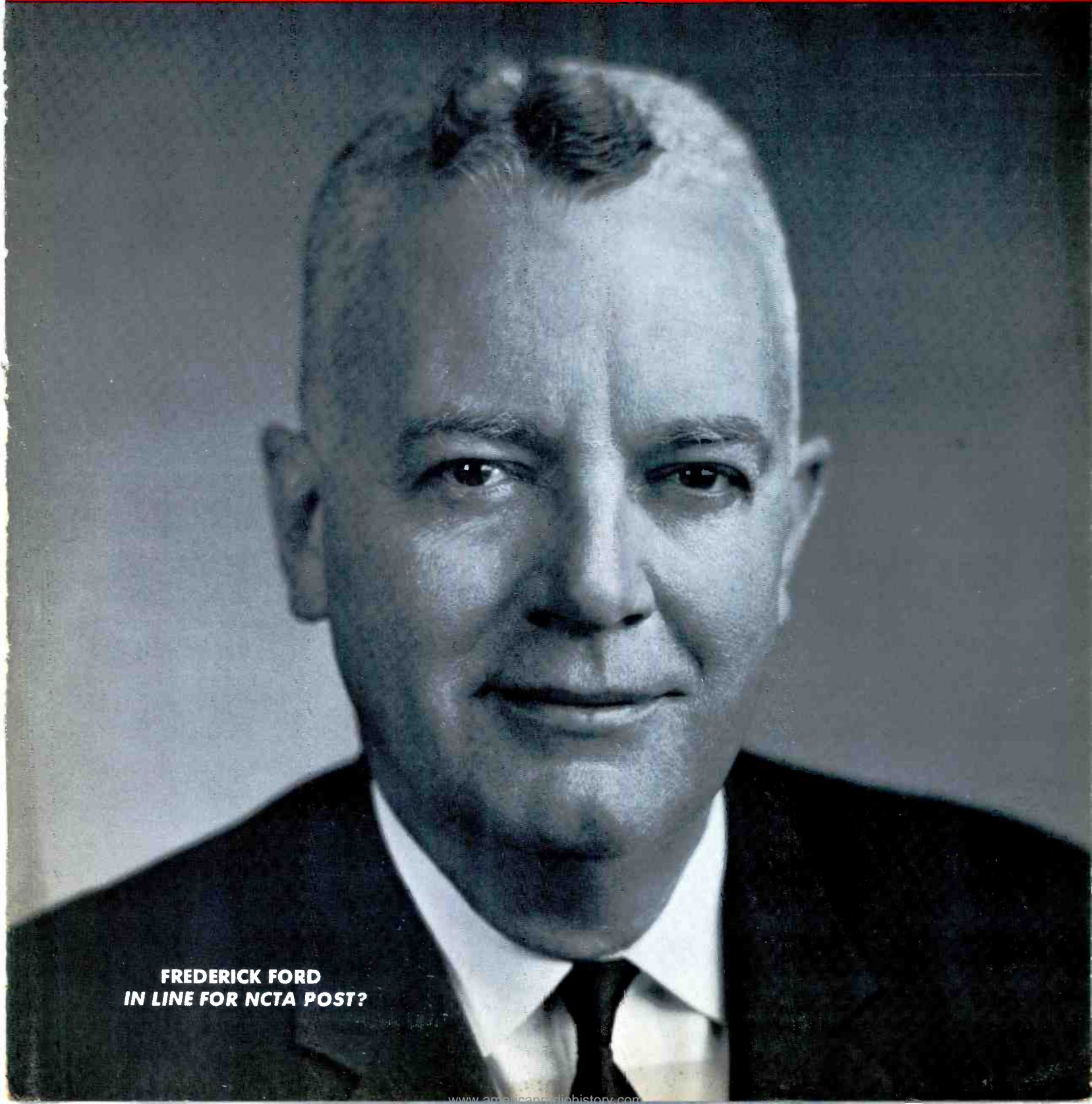

December 1964

AL BODDY FCB TV 104
1962 S. Stearns Dr.
Los Angeles, Cal.

TV & Communications



**FREDERICK FORD
IN LINE FOR NCTA POST?**

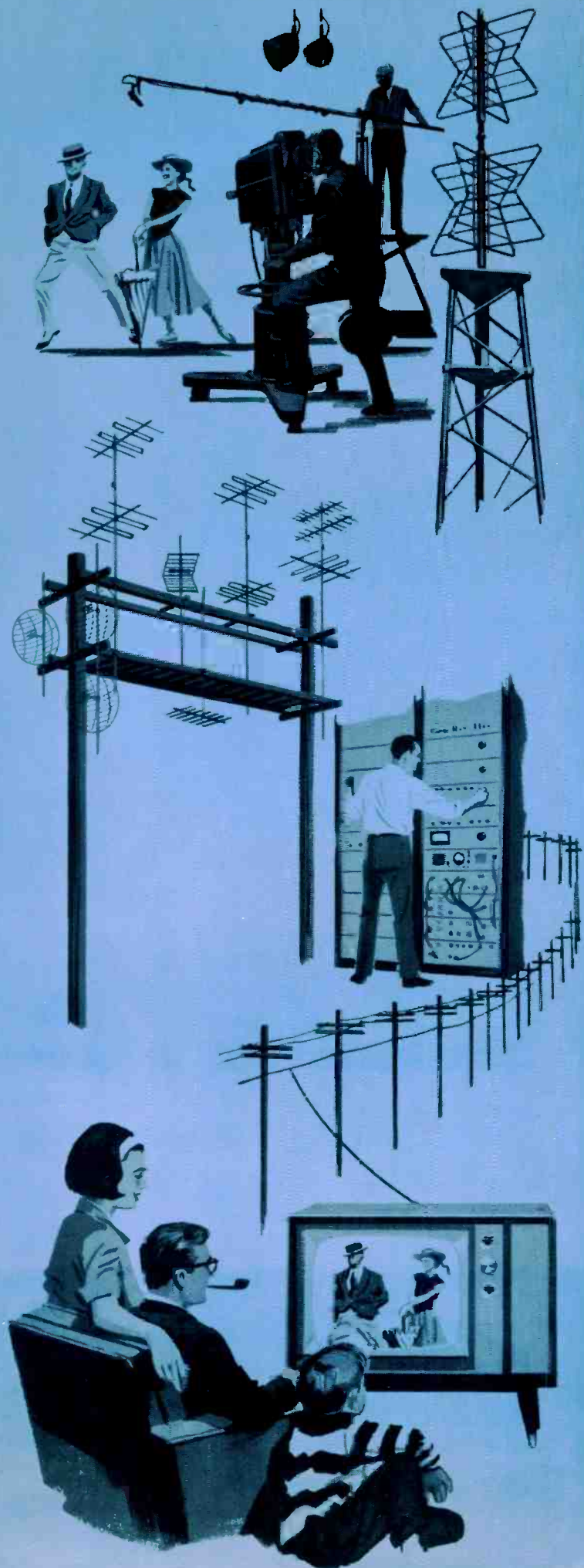

For
broadcast-quality
CATV pictures,
insist on
JERROLD
Solid-State
Equipment

Community-antenna system equipment by Jerrold lets you meet the increasing demands of CATV subscribers for expanded services, 12-channel capability, studio-quality color reception.

New Jerrold solid-state channel pre-amplifiers, super-cascader mainline amplifiers, bridging amplifiers, and line extenders constitute the first totally reliable transistorized equipment designed for community-antenna systems.

This new solid-state distribution equipment is a fitting companion to the quality Jerrold microwave transmitters and receivers, antennas, modulators, Channel Commander control centers, coaxial cable, and tap-off equipment that have made and kept Jerrold the leading name in CATV.

Jerrold means more to you than reliable equipment. It means a nationwide network of experienced men with the industry's richest stockpile of technical and management know-how. It means an intimacy with your business and community-relations problems unmatched in the entire CATV field.

To assure the ultimate in picture quality in CATV, contact Jerrold today.

JERROLD
ELECTRONICS

Community Systems Division
15th & Lehigh Ave.
Philadelphia, Pa. 19132
Phone (215) 226-3456

A subsidiary of THE JERROLD CORPORATION

NEW by

viking



THE
MUSTANG
TRANSISTOR
LINE
EXTENDER

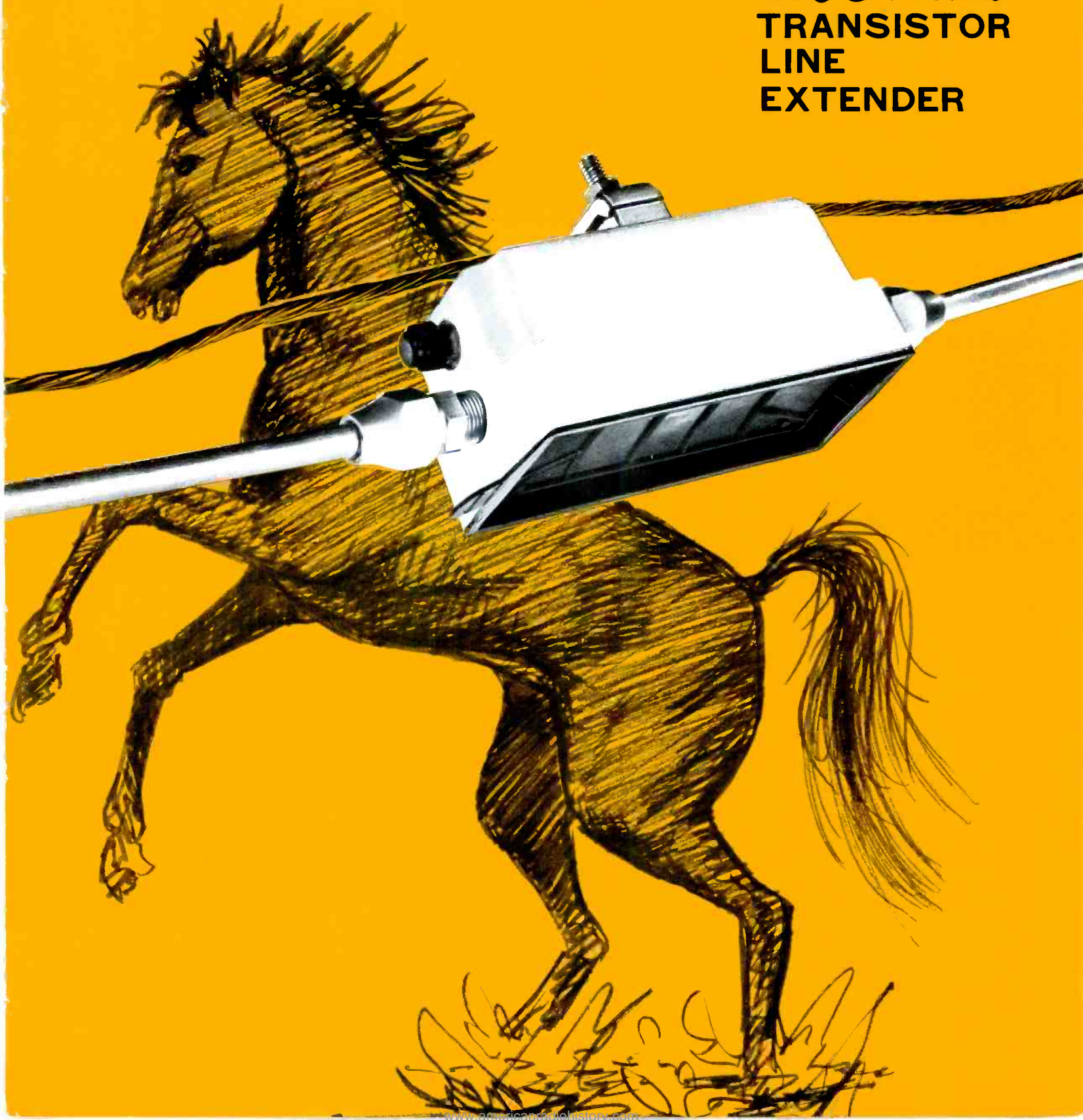



Features

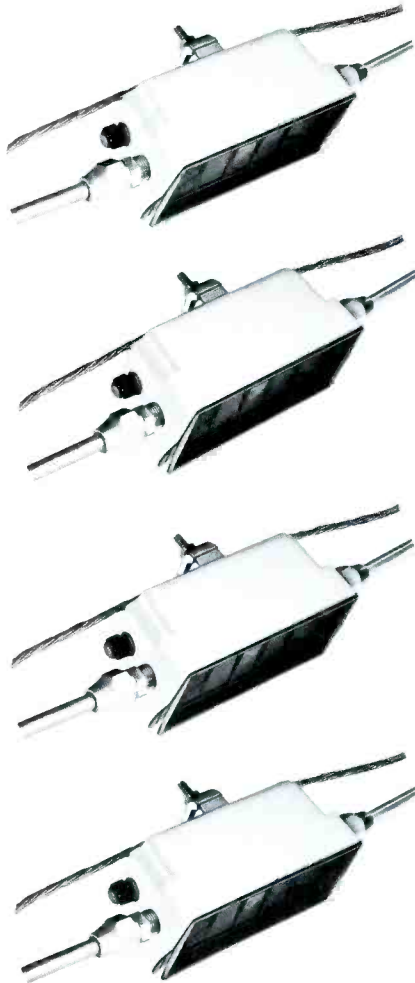

THE ONLY LINE EXTENDER MADE WITH FITTINGS FOR ALL CABLES

DESIGNED FOR TROUBLE-FREE OPERATION UNDER ADVERSE CONDITIONS.

24 V.A.C. CABLE POWERED WITH INTERNAL REGULATION.

3 DOUBLE DIFFUSED SILICON PLANAR EPITAXIAL RF TRANSISTORS

BEST ABILITY TO HANDLE HIGH SIGNAL LEVELS OF MANY TV CHANNELS SIMULTANEOUSLY.

SEPERATE GAIN AND TILT CONTROLS FOR MAXIMUM FLEXIBILITY UNDER ANY CONDITIONS.

EVERY COMPONENT RATED AND TESTED TO OPERATE IN THE TEMPERATURE RANGE FROM -40°F to $+160^{\circ}\text{F}$ INCLUDING FILTER CAPACITORS.

BEST INPUT MATCH (V.S.W.R.) OF ANY UNIT IN THE INDUSTRY AND AN EXCELLENT OUTPUT MATCH.

CAST ALUMINUM CASE AND FITTINGS AVAILABLE TO SUIT ANY CABLE.

VIKING'S EXCLUSIVE VIK-O-PROCESS PLATING TO PREVENT CORROSION PROBLEMS FOR YEARS OF ADDED LIFE.

The Viking "Mustang" #560 Line Extender offers the best features of transistors for use in small or large C A T V systems - low power consumption, small size, stable gain, low maintenance and economical remote power flexibility for one or many amplifiers.

The amplifier is designed with silicon RF transistors, temperature stable capacitors for all critical applications, and special electrolytic capacitors for operation through wide temperature extremes. The amplifier's solid-state voltage regulator handles any power from 17 to 30 V A.C.

The "Mustang" has separate gain and tilt controls to allow for compensation for various cable lengths. (An internally adjusted control may also be varied for specially short runs.)

Power to run the amplifier is remotely supplied from a 24 V A.C. source, such as the Viking 561, duplexed on the coaxial cable carrying the R.F. signal. A switch eliminates power from the output line or passes it on for cascaded amplifiers.

The "Mustang" Line Extender has a VIK-O-PROCESSED die-cast case, and its plated brass chassis and anodized aluminum bottom cover practically eliminate weathering effects. In addition, they serve as an efficient transistor heat sink and RF shield, preventing radiation or noise pickup. A snap-on cover of heavy polyethylene weather-protects the bottom.

TV & COMMUNICATIONS



DECEMBER 1964
Volume 1 — Number 12

Published By Communications Publishing Corp., PO Box 63992, Oklahoma City, Okla.



MICROWAVE is our SPECIALTY!

NOW SERVING ...

- Borrego Springs, California
- Victorville, California
- Yuma, Arizona
- Page, Arizona
- Barstow, California
- Showlow, Arizona
- Silver City, New Mexico
- Flagstaff, Arizona
- El Centro, California
- Pinetop, Arizona
- Snowflake, Arizona

CALL ON US FOR ...

- * Path Studies & Engineering
- * Turnkey Business Microwave Systems
- * Maintenance of Your Existing System

Antennavision Service Co., Inc.

2949 W. Osborn Rd.
Phoenix, Arizona

A MICRO-WAVE COMMUNICATIONS
COMMON CARRIER

To: ANTENNAVISION
2949 W. Osborn Rd.
Phoenix, Arizona

I am interested in a "No obligation" microwave estimate ...

Reply to
Name _____
Address _____
City _____

TABLE OF CONTENTS

Your Advertising and You

CATV Promotional Basics by S. S. Street 19

A Lawyer Looks at Cable TV

Vernon C. Kohlhaas, Pierson, Ball & Dowd 28

Chasing Ghosts

William A. Rheinfelder, Ameco, Inc. 31

Instructional Television Service

Dr. Byron W. St. Clair, Westbury CATV Corp. 39

Editorial	8	Letters to the Editor	17
News Spectrum	10	New Product Review	44
Subscription Form	12	Ownership Statement	45
Focus on Progress	16	Classified Advertising	45

STAFF

Stanley M. Searle
Editor

Sherrill D. Dunn
Managing Editor

Leo G. Sands
Charles Wigutow
Lon Cantor

Contributing Editors

Jean Schaefer
Art Director

Patrick T. Pogue
Business Manager

Robert A. Searle
Advertising Sales

Rita Corona
Circulation

GENERAL OFFICES

1839 N. W. 16th (P.O. Box 63992) Oklahoma City 6, Oklahoma (405) JACKSON 8-3532

CIRCULATION: TV & Communications is circulated through United States and foreign mails on the tenth day of each month, to individuals and firms dealing in products and services for closed circuit and community antenna television, television broadcast, and microwave. Circulation is both paid and controlled. A detailed circulation breakdown by reader occupation is available upon request.

SUBSCRIPTIONS: TV & Communications subscription rate in the North American Continent is \$5.00 per year for surface mail. Subscriptions outside continental North America are \$7.00 per year, remittance to be made by bank money order or check, acceptable in United States banks. TV & Communications is published 12 times per year.

ADVERTISING: Commercial display advertising is accepted from manufacturers and suppliers of electronics equipment and allied services, at the discretion of TV & Communications management. Advertising rate card and circulation breakdown are available upon request.

COPYRIGHT: Contents of this publication are copyrighted by Communications Publishing Corporation. No material, either written or graphic, may be reproduced without the written permission of the Publishers.

TV & COMMUNICATIONS (title registered at US. Post Office). Second-class postage paid at Oklahoma City, Okla. Subscribers should allow six weeks for change of address.

PUBLISHERS: Patrick T. Pogue and Stanley M. Searle.

YOU said it!



SUPERIOR **Cell-O-Air[®] Coaxial Cable** with "COPPERGARD" is the star performer in CATV

Through superior design and highest possible quality of manufacture, Superior's Cell-O-Air Coaxial Cable with Coppergard offers you these advantages:

- Up to 20% lower attenuation.
- Solid tubular Coppergard corrugated 5-mil copper shield for positive protection against radiation leak.
- Far better long-term transmission stability.
- Corrugations permit hand bending to an acceptable limit of 20 times the cable diameter, for maximum flexibility without fracturing shield.

"We . . . like the Superior Cable we have used so far which was 4920 feeder and 4930 trunk."

"Superior Cable #4920 has been in the air five months . . . there's a great amount of salt in the air and high annual rainfall. Loss measurements showed .906 DB/100' on Ch. 6 and 1.54 DB/100' on Ch. 13. Additional attenuation due to aging, both channels, is approximately 3/10 of 1% over published specs . . . and, over the five month period, the additional attenuation is linear. Superior 4920 cable is far superior."

"During the past 12 months we have installed more than 1,600,000 feet of Superior 4920 Coppergard Coaxial. Of the total footage you supplied, no reels were rejected because of electrical integrity or cable quality or workmanship. You will be interested to learn that 4920 delivers far more in performance than you ever claimed for it."



ELECTRONIC WIRES
AND CABLES

Manufactured by
SUPERIOR CABLE

Superior Cable Corporation • Hickory, North Carolina

Biting the Hand

The November 28 issue of *TV GUIDE* contained an editorial devoted to the "community antenna television confusion." The anti-CATV attitude expressed by *TV Guide's* editors seems unbecoming and surprisingly out of context! As if the cable television industry did not have enough enemies *outside* the camp, now Triangle Publications' *TV Guide* is telling America that because of CATV serious "problems developed, one more complicated than the other."

According to *TV Guide*, "the only solution seems to be some sort of regulation that would empower the FCC to regulate CATV and keep television on an even keel." The avowed intent of said legislation: "to keep more interesting Americans from upsetting the TV picture."

Among the problems which *TV Guide* associates with Community Television's "wildfire" growth is the allegation that "it was difficult for a new UHF station to compete in an area when most people were already receiving network programs." In cases where new community antenna systems "did well in areas already served by only one to two local channels by bringing in channels from distant cities," *TV Guide* says, "local channels felt this was unfair competition."

As part of the "problem" the editorial mentions that CATV systems "went into cities already served by stations

carrying all three networks. They brought in stations that had good sports and movies to offer. Many more problems developed . . ."

I wonder how the editors of *TV Guide* feel that the interests of television viewers are adversely affected by multi-station reception and "good sports and movies"?

An even better question is why *TV Guide* is critical of community antenna television when the publishers of that magazine are themselves actively involved in CATV. Their editorial cites the "problem" of CATV operations going "into cities already served by stations carrying all three networks." Meanwhile, Triangle Publications, owner of WFIL-TV in Philadelphia, is among the applicants for a franchise to operate a CATV in Philadelphia! Since *TV Guide* is published by Triangle, with offices in Philadelphia, we find it hard to believe that the magazine's editors are unaware of their own company's activities in community television. Triangle Publications' discrediting of CATV, through their *TV Guide* editorial, seems to be a classic case of "biting the hand that feeds you." Just what the motive was for alerting America's television viewers to supposed CATV "confusion" and "problems" remains very much a mystery to us. We hope that prudent management in the Triangle organization will make some effort to erase the negative CATV image they have tried to paint.

TAME Motives Clear

A recent statement by Morton Leslie should remove any remaining doubts about the precise purpose of TAME, the Television Accessory Manufacturers Institute. In a letter published by "the supreme effort" a Kansas City, Mo. TESA newsletter, Leslie outlined TAME motives:

"Antenna and accessories sales exceed \$50,000,000 annually. Virtually all of these sales are made through the dealer and service technician. What business can afford to

permit even a fraction of their antenna and accessories sales to disappear without some semblance of fight?"

The mercenary motives of TAME are sometimes crudely cloaked in a guise of "public interest." But Mr. Leslie, acting chairman of the group, leaves no doubt about his outfit's real intentions.

To say that CATV is bad because it may reduce antenna sales (an unproven allegation) is like arguing against electric ranges because they may hinder the sale of coal. Or, following Mr. Leslie's brand of logic, the community television operators could justifiably lobby against the manufacturer of home receiving antennas because they might cut down the number of cable subscribers!

When an operator seeking a franchise is opposed by TAME he should let the city councilmen read the above quotation of Mr. Leslie in which he so clearly states TAME's self-serving objectives.

In the same article quoted above, Mr. Leslie states that except for topographically isolated cities he has "rarely seen a picture rendered by a CATV system equal in quality to that which can be obtained by a properly designed and installed antenna system." Hopefully, however, you can convince the city councilmen in your area to base their judgments upon the facts of actual observation rather than the partisan and unfounded allegations of TAME.

NCTA CODE OF ETHICS

To furnish service impartially at fair, equitable and non-discriminatory charges.

To furnish adequate equipment and qualified personnel to achieve and maintain the highest standard of technical performance.

To provide courteous and prompt handling of all service requests.

To deliver those television signals received by the System without any alterations or deletions of the broadcast intelligence.

To recognize and respect the rights of non-subscribers to television reception without electromagnetic interference from the System.

To keep the community adequately and accurately informed of the functions and services of the System.

To operate the System in accordance with the best business practices and to comply with all legally applicable governmental regulations.

To recognize and fulfill our obligation to further the civic development of the community.



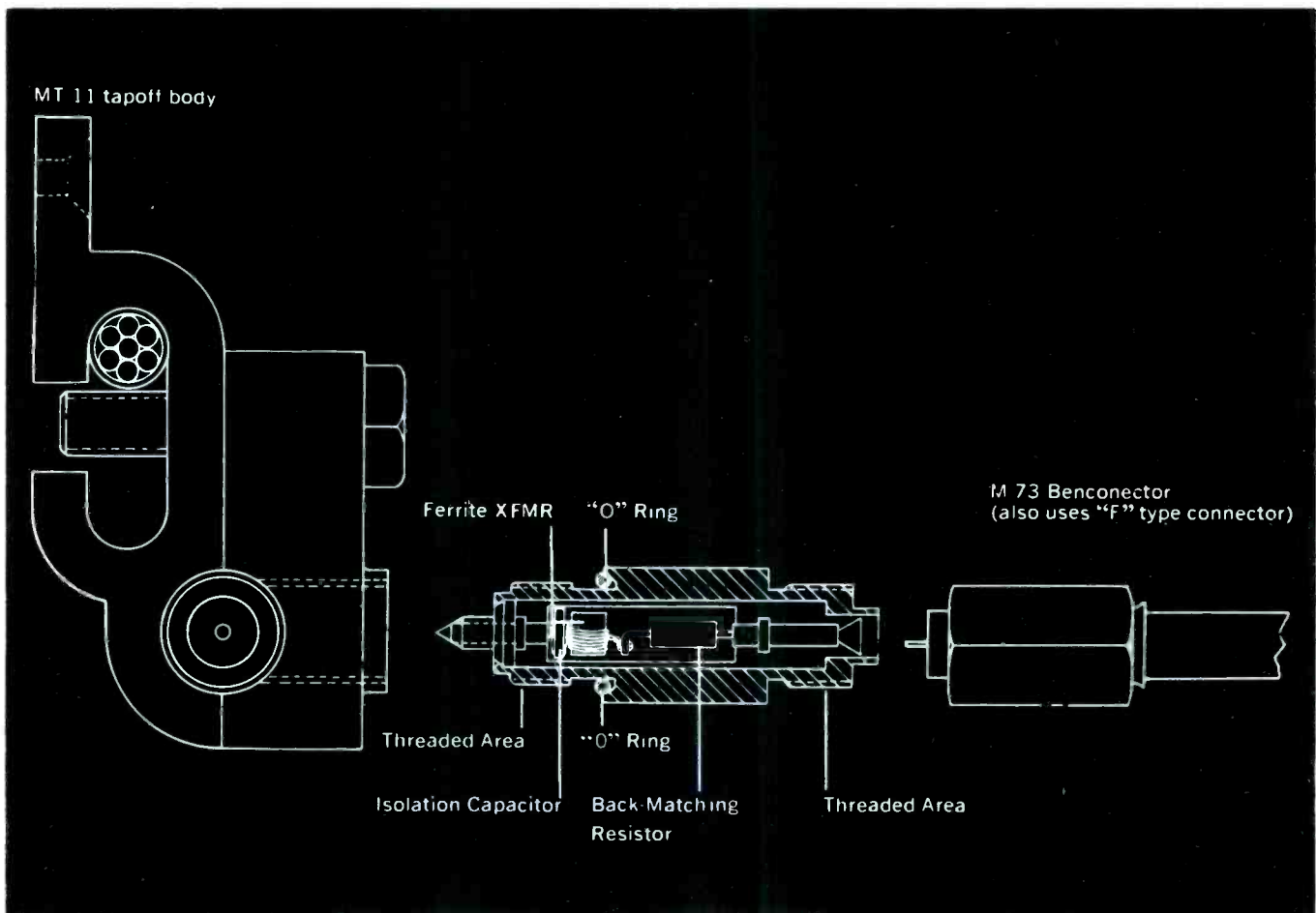

Protect your investment in the rest of the system. New Blonder-Tongue "Stinger"

The purpose of a good CATV system is to deliver superior black and white and color reception to its subscribers. The new Blonder-Tongue "Stinger" VHF back-matched pressure taps helps achieve this objective.

Designed for insertion in the Blonder-Tongue MT-11 tapoff body or the bodies of other tapoff makes, these VHF taps cover channel 2 through 13, sub-channels & FM. They provide excellent results when installed in new systems, or when used as replacements in low band VHF systems being converted to full band VHF. Transformer and resistive models are available in these isolation values: 12, 15, 20 and 25db, transformer type; 30, 35, 40 and 45 and 50db, resistive type. "Stingers" are back-matched to protect

against line mismatches — cause of suck-outs, traps and other problems that deteriorate TV reception. An extremely low VSWR, low insertion loss, flat frequency response assure ghost-free, smear free black & white and brilliant color on all VHF channels from 2 to 13. The "Stinger" offers top quality, maintenance free performance. A weather-proof seal between the tapoff block and the body of the "Stinger" is accomplished by a neoprene "O" ring which, under pressure, completely fills all voids between the tapoff and the "Stinger" body. This minimizes the need of a rubber or plastic boot which tends to collect moisture. Increased attenuation caused by moisture creeping up the threads to the cable conductor is eliminated.

Another vital consideration in CATV and MATV installations is ease of installation. With the "Stinger", no pre-drilling of the coax cable is necessary except where metallic sheathed cable is used. A stainless steel corrosion-proof prod bites through the cable easily. This prod is insulated to prevent loose strands of the sheath from working their way into the cable and causing shorts.

The "Stinger" is designed for universal connection to the drop lines with either a Benconnector or type "F" connector. Further, the connector socket of the "Stinger" accepts the center conductor of regular or foam RG-59/U cable creating a positive spring type connection. Protect your investment with the Blonder-Tongue "Stinger".



BLONDER-TONGUE LABORATORIES, INC.
9 Alling Street, Newark 2, N.J.

News SPECTRUM

NAMING OF FORD TO NCTA PRESIDENCY ANTICIPATED

For many weeks it has been widely rumored that FCC Commissioner Frederick W. Ford would be named as the new president of the National Community Television Association. The post has been vacant since the resignation of William Dalton last year.

Ford served as Chairman of the Commission during 1960 and 1961. He was reappointed in July, 1964 for a second seven year term. However, since June many community antenna operators have expressed interest in convincing Mr. Ford to accept the top NCTA job. It is now generally believed that his resignation from the Commission and acceptance of the NCTA post are imminent.

NCTA, SYSTEMS OPPOSE ABC PETITION

National Community Television Association and several CATV systems have filed comments with the FCC in opposition to the recent American Broadcasting Company petition. Target of the ABC petition is to establish zones for television stations to serve and to limit the use of their signals to those zones.

In its comments NCTA told the Commission that approval of the conditions proposed by ABC would possibly destroy CATV's ability to perform its service. The Association pointed out that the destruction of "a great portion of the industry" would inevitably follow. The purpose for community antenna television is "to meet the public demand for TV reception not otherwise available in adequate quantity or quality," NCTA said.

The ABC petition is apparently aimed at major cities, however, passage of the petition would deprive "a substantial proportion" of CATV subscribers of multi-channel reception. NCTA cited the recent subscriber reaction when the FCC deprived them of a portion of their reception by imposing certain conditions in approving the sale of WBOY-TV, Clarksburg, West Virginia to Fortnightly Corpo-

ration. (Fortnightly owns systems in Clarksburg and Fairmont, West Virginia, the two communities that reacted to the Commission's actions.)

Individual and group comments were also filed by CATV systems. A New England group refuted the "economic injury" assumption in ABC's petition. The Group cited two instances of alleged economic injury and argued that in both cases the stations have experienced favorable financial conditions.

Five broadcast-CATV interest groups supported existing FCC "local station protection" proposals, however, they noted that the need for extreme actions as proposed by ABC has not yet been demonstrated.

Another group of 55 CATV operators and microwave owners filed a pleading arguing that the ABC petition would constitute "censorship."

CATV SYSTEMS HAVE NOT HURT EXISTING TELEVISION STATIONS, JERROLD SAYS IN FCC COMMENTS

The nation's community antenna television systems have had no adverse economic impact on the operations of existing broadcasting television stations in this country.

This is the contention of Jerrold Electronics Corporation, in comments

submitted to the Federal Communications Commission, in which it urged the FCC to adopt a "case-by-case approach" in deciding whether existing stations need protection from a CATV

The 16-page Jerrold statement asserted that the history of the past 12 years has established "a complete lack of impact" by community antenna systems on the existence and growth of broadcast television in the United States.

Of the 107 UHF stations that have gone off the air, only 10 were in CATV communities. And two of these ten wrote letters commending CATV for helping them to stay on the air as long as they did.

The Jerrold statement pointed out that during similar FCC hearings in 1958 and 1959, a Senate Committee heard testimony from licensees of 12 small-market television stations, all charging that CATV operations would drive them off the air by dividing the available audience until a profitable economic base was destroyed.

Jerrold noted that, in the six years since this testimony, none of these 12 stations have gone off the air, and that "on the contrary, all but two of them have increased their rates substantially since that time."

The Jerrold statement, in suggesting the more logical case-by-case approach on the part of the FCC, concluded that "it is clear that the predictions made by these stations six years ago have not come to pass, and it must now be obvious that there has been no significant economic impact of CATV systems on television stations

AT&T REVERSES SOUTHERN BELL POLE LINE POLICY

A statement of policy issued by AT&T last month has clarified that company's stand on pole line attachments. Southern Bell will be affected by the policy.

Recently Southern Bell had refused to write new pole attachment contracts ("TV&C" November). That company, however, was offering signal conveying services on a "lease back" basis as an alternative.

Included in the policy statement are certain conditions whereby the lease back arrangement can be put into effect. The policy notes that "should there be simultaneous requests from more than one CATV company for pole attachment agreements in

the same area, the telephone company will not attempt to judge between applicants." The company added that "as an alternative, necessary channels for CATV transmission will be furnished to all who request them."

Lease back will also be offered when an agreement is already in existence. Bell said that pole line space in generally not available to accommodate more than one CATV company.

AT&T's statement followed a recent meeting between officials of AT&T and the National Community Television Association. NCTA was represented by General Counsel Robert H. L'Heureux and NCTA Pole Line Committee Chairman Ben Conroy.

**ENTRON, INC. BECOMES OWNER
IN JACKSONVILLE, N.C. SYSTEM**

Entron, Inc. became an owner, through partnership, in the Jacksonville Cable Television Company in Jacksonville, North Carolina, announced Robert J. McGeehan, President of Entron, Inc., manufacturers of community, master and educational TV systems.



R to L - Robert J. McGeehan, President of Entron, Inc.; Fred Stegner, President, Jacksonville Cable Television Co.; and Albert J. Ellis, attorney.

The Jacksonville company recently signed with Entron for the construction is estimated at \$300,000.

Fred Stegner, President of the Jacksonville company, said that the new system will enable subscribers to obtain channels 5, 6, 7, 9, 11 and 12—including all networks.

LEE READY FOR CATV LEGISLATION

In his keynote talk before the concluding NAB regional-conference, FCC Commissioner Robert E. Lee told broadcasters that the commission has the legal right to regulate CATV. The

FCC "cannot afford to wait" for Congress to pass legislation, the Commissioner said.

Although he would not object to legislation, if it comes quickly, Mr. Lee said that he is now "willing to take the giant step of assuming jurisdiction over CATV." He described CATV as the most pressing problem before the Federal agency and said that "Some firm decisions, even if they don't please all of you, are better than the indecisions" that have been a part of the FCC history.

**TEXAS BROADCASTING
PURCHASES MADE**

Application has been filed with the FCC by Texoma Broadcasting Company the purchase of KLFY-TV, Lafayette, La. In another move, acquisition of TV Cable of Austin (Texas) was completed by Capital Cable of Austin.

Texas Broadcasting owns 29% interest in KWTX Broadcasting Co. which in turn owns 80% of Texoma.

Acquisition of TV Cable resulted in a total of more than 5,000 subscribers for both CATV systems. The total purchase price was not announced.

CATV SYSTEM SOLD

Daniels & Associates, Inc. of Denver, Colorado announces that Vestal Video, Inc. of Vestal, New York has been sold to Mr. Larry Flinn of New York City, New York. The CATV system, formerly owned by Mr. John S. Riggs, serves over 800 subscribers.

EMPLOYMENT SERVICE

**An Employment Service for
Cable Television?**

It's here now!

**Are you a cable TV operator
looking for a man . . . or a
man looking for a cable sys-
tem job?**

We can bring you together for both your mutual benefit. An employment service, exclusively devoted to the interests of the cable television interests, has been needed. TeleSystems Corporation is filling a genuine need in the CATV Industry by providing this service.

Many, many miles separate job seeker from the job opportunity. It would take great expense to pursue the opportunities that are now open. Similarly, much time and needless expense is lost in seeking the ideal person for the opening.

CATV has been growing fast. Ownership can benefit by the years of experience we have had in staffing our CATV systems. We have established significant criteria by which to judge whether a prospective employee is the right person for the job.

Often persons with good backgrounds in closely allied industries can make a successful transfer into CATV.

Or men with Manager or Chief Technician potential have pushed past the limits of their present opportunities and are seeking advancement in this exciting industry.

TeleSystems Corporation will help bring you together: System Owner—and job seeker.

Write or Call:

**Manager
Personnel Placement Division
TeleSystems Corporation
113 S. Easton Road
Glenside, Pennsylvania
(215) TUrnER 4-6635**

**ALL INQUIRIES ARE HELD IN
STRICTEST CONFIDENCE**

TELESYSTEMS CORPORATION

113 S. EASTON ROAD
GLENSIDE, PA.

SITCO Heavy Duty Quads and Yagis

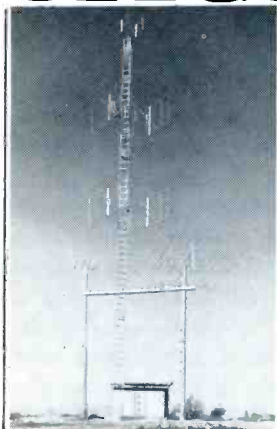

Designed by SITCO for Translator off-the-air pickup, Community TV and extreme fringe area requirements.

The SITCO Models 94 and 102 Quad Mount Antenna Arrays are designed to produce high gain, high front-to-back ratio and large aperture to weak signals. A completely balanced system which reduces noise pick-up and greatly improves the signal-to-noise ratio.

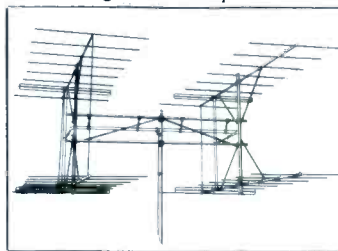

Model No. 94-HD 32-element Quad Channels 5 or 6

NOW, all SITCO element ends are machined to reduce static leakage. The signal-to-noise ratio is increased at sites where signal levels are low.

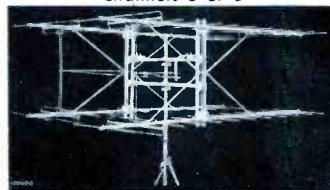

Model No. 102-HD 48-element Quad For all hi-band channels



SITCO WEDGE SCREW FASTENERS

Write for Free SITCO Catalog

SIMPLICITY TOOL COMPANY
2850 NORTH MISSISSIPPI • PORTLAND 12, OREGON

The purchase price was in excess of \$200,000 and marks the 68th transaction handled by Daniels & Associates.

AMERICAN CABLEVISION PURCHASES CATV SYSTEMS

Jack Kent Cooke, President of Jack Kent Cooke, Incorporated, Beverly Hills, Calif., and Alvin H. Hartman, Chairman of the Board of CATV Inc., Providence, Rhode Island, jointly announced today that Jack Kent Cooke, Incorporated through its division American Cablevision Co., has purchased all of the CATV systems owned by CATV Inc. The systems are located in Laguna Beach, Calif., Barstow, Calif., Palestine, Texas, Graham, Texas and Keene, N.H. The purchase price was four million six hundred thousand dollars (\$4,600,000).

This is American Cablevision Co.'s first purchase in the CATV field. Cooke says he will shortly announce several more major CATV purchases.

The transaction was handled by Daniels & Associates, Inc., Denver, Colo.

SUPREME COURT DENIES FANNER PETITION

On October 12, 1964, the Supreme Court of the United States denied the petition for writ of certiorari filed by

The Fanner Manufacturing Company in an attempt to reverse the judgment against Fanner obtained by Preformed Line Products Company.

As a result of the Supreme Court's action, the Federal District Court in Cleveland has received a mandate under which Fanner is permanently enjoined from further infringement of Preformed's dead-end patent No. 2,761,273.

The case will remain pending while a special master appointed by the Court determines the amount of damages to be awarded to Preformed to compensate the company for Fanner's past infringement of the patent.

ENTRON DECLARES DIVIDENDS; ANNOUNCES SIX MONTHS EARNINGS

The Board of Directors of Entron, Inc., at its regular meeting on November 30, approved a 5% stock dividend followed by a .05¢ cash dividend payable January 15, 1965 to stockholders of record December 15, 1964. The cash dividend will include shares resulting from the stock dividend. Entron will purchase fractional shares created by the 5% stock dividend at the closing market price on January 14, 1965, announced Robert J. McGeehan, Entron president.

"Customer demand for Entron's new high level CATV amplification equipment and our aggressive re-entry in the market has placed us in a position of paying the first dividend since Entron went public in 1959," said McGeehan.

According to Mr. McGeehan, net sales of \$985,339 for the six month period ending August 31, 1964 is a 50% increase over the corresponding period of 1963. Pre-tax earnings for the current period were \$66,472 reversing a loss of \$66,912 for the same period last year. As a result of Entron's current backlog of \$638,000, up 100% from the like 1963 period, and the present sales volume, McGeehan predicted that Entron will substantially exceed last year's sales volume.

Entron is a pioneer in the manufacture and development of community antenna television equipment. It has recently been awarded contracts totaling in excess of \$1,000,000 to construct CATV systems in Utica, New York; Lawrenceville and Bridgeport, Indiana; Jacksonville, North Carolina; Napoleon, Ohio; and Andalusia, Alabama.

REEVES WILL BUILD S.C. SYSTEM

Reeves Broadcasting Corporation announced that, in a competitive hearing, it had been awarded a permit to build and operate a Community Antenna Television system in Aiken, South Carolina. Approximately 6,000 homes in the metropolitan area will be served by a 70 mile. 12 channel system on which construction will begin this coming Spring.

Reeves currently owns CATV franchises or operations in 3 Virginia communities, 3 in South Carolina, 2 in Alabama, and 2 in Pennsylvania.



AIR DELIVERY PREVENTS DAMAGE TO CATV HEAD-END EQUIPMENT

Experience has taught Mr. Jim Davidson of Davco Electronics that a short trip by air is much safer for CATV equipment than the longer, rougher ride afforded by ordinary truck or rail shipment. The photo shows Jim with the Functional Design Head-End which he had just unloaded at Camden, Ark., for the "turnkey" system which Davco constructed there for Cam-Tel Company.

The Camden head-end was the eleventh to be delivered in as many weeks.

REEVES ACQUIRES ALABAMA STOCK

It has been announced by J. Drayton Hastie, President of Reeves Broadcasting Corporation, that Reeves has acquired the stock of Alabama Cablevision Company, which owns and operates a community antenna television system serving Gadsden, Alabama. Reeves will immediately upgrade the existing 90-mile system and add an additional 60 miles of cable to serve a potential of 15,000 homes. This is the second CATV system acquired by Reeves in the State of Alabama, and brings to a total of five the number of systems Reeves has acquired since March 1, 1964.

Mr. Hastie noted that the Corporation is actively negotiating for the acquisition of other systems and franchises with the expectation of further advancing its aggressive program in the rapidly expanding community antenna television industry.

BE A SUCCESS!

Read TV & Communications

Every month "TV & C" brings you complete news coverage of the booming cable television field. Keep getting ahead; be a regular subscriber.

MAIL THIS COUPON TODAY

TV & Communications
P.O. Box 63992
Oklahoma City, Okla.

Please start my subscription to "TV&C"
 1 Yr. 2 Yrs. 3 Yrs.
Rates: \$5 a year, \$9 for two years,
\$12 for three years.
Foreign: \$2 a year additional

Name _____
Address _____
City _____
State _____

Check here if this is a renewal CHECK ENCLOSED BILL ME.

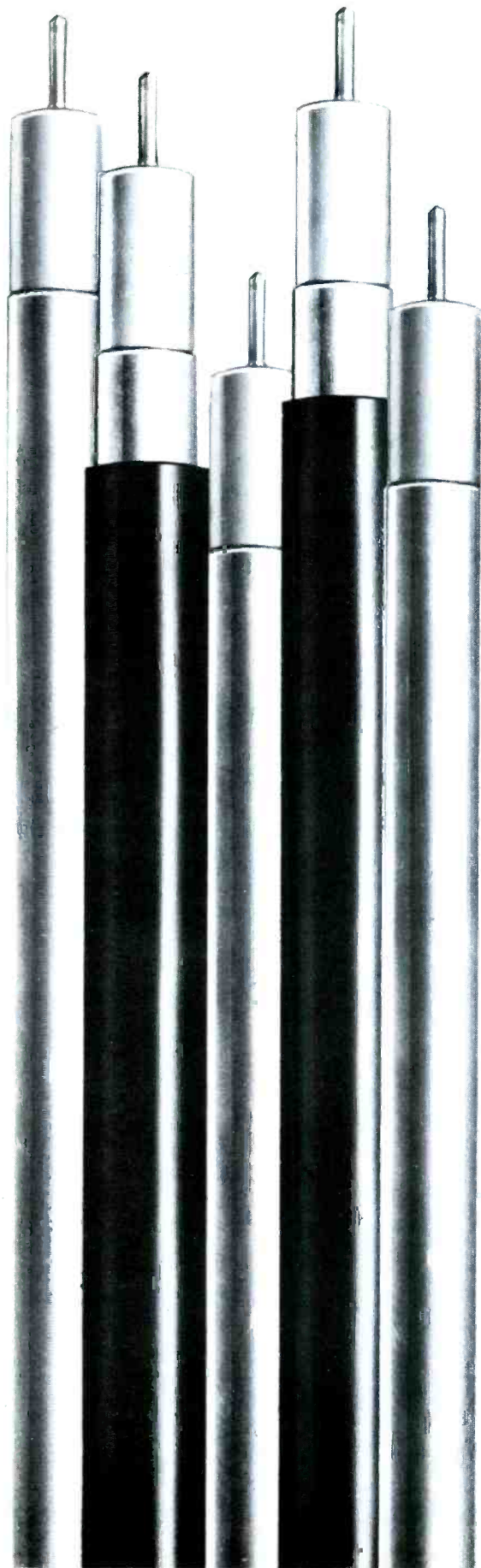

In a dilemma: whether to build your system for fast capital gains or for maximum operating profits?

*Before you install a so-called
economy cable system,
ask these 8 questions:*

1. Is it water & water vapor proof?
2. Is the cable self sealing when tapped?
3. What is the guaranteed maximum attenuation?
4. Will it produce an acceptable color TV picture?
5. Does it give 26 db minimum return loss guarantee
(Required for minimum ghosting)?
6. Will the quality be the same 5 years from installation?
7. Will the cable be adaptable to all pay TV applications?
8. Will it give radiation protection
when high power lever amplifiers are used?

*If you install Times JT1000 seamless aluminum tube
sheath cable, the answer will be yes to all the above.*

Whether your objective is capital gains or long-term, high net profit, you should give careful consideration to installing a long-life, high-quality cable system—JT1000 series cable, your best profit insurance. Don't settle for a system that continually degrades from the day you install it, and which may prematurely require replacement in 3 to 5 years.

DON'T TAKE OUR WORD FOR IT.

Return loss measurement is a crucial determining factor. Through this one test alone, you can prove to yourself the return loss quality of standard JT1000 cables. Times will gladly lend you a Return Loss Measurement Adapter Kit. It's absolutely free of charge. Just write or phone our Sales Manager, and he'll send you the Kit.



PROVE IT
TO YOURSELF
FREE TEST KIT



Division of The International Silver Company • Wallingford, Connecticut

TRANSMISSION SYSTEM DESIGN AND ENGINEERING • STANDARD AND SPECIAL PURPOSE COAXIAL
CABLE • MULTICONDUCTOR CABLE • COMPLETE CABLE ASSEMBLIES • TEFLON* HOOK-UP WIRE

*A DuPont Trademark

OKLAHOMA-KANSAS CATV GROUP MEETS

An informal discussion on "TAME and Related Problems," led by Curtis M. Faris, Guymon TV, Guymon, Oklahoma highlighted the morning session of the Annual Oklahoma-Kansas CATV Association meeting.

The November meeting also featured a "Report on National Association of Broadcasters Meeting" by Ralph L. "Bud" Weir, Board Member of NCTA and President of KSLN-TV, Salina, Kansas; discussion of "Excise Taxes in CATV" by Eugene Kuntz, Oklahoma City attorney and University of Oklahoma professor. A synopsis of the "Activities of NCTA" was presented by Wally Briscoe of the NCTA staff, and a report on "Recent FCC Developments" by Jack Matthews, Washington, D.C. attorney, rounded out the meeting.

Mr. Faris told of TAME's Morton Leslie commenting that they will work (1) to prevent franchises from being let; (2) seek Federal legislation of CATV, and (3) work with "similar interest" groups such as the NAB.

"Translators," Mr. Faris said, are "socialistic and economically unsound . . . the ultimate consequence of VHF translators is chaos."

In his talk, Bud Weir suggested that CATV operators get to know their legislators—"they are either going to be for or against us."



Curt Faris



Ralph L. Weir



Eugene Kuntz



Wally Briscoe



Jack Matthews



Arthur Baum, Viking President, orders refreshments as guests contemplate CATV



George Milner, Ron Holley and Don Turley, (l to r) Vumore, in Viking suite.



Ted Baum

Sherrill Dunn (r) with Weldon Johnson

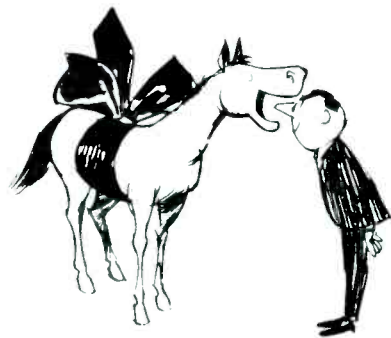

LOOK HIM IN THE MOUTH...

Always look a gift catalog in the mouth. It's the only way to be sure of what to expect. For instance, our gift catalog (it's free). Take a good look and order something that you've been having trouble finding. You'll get it from us, and it'll be the best you can find anywhere, and you'll get it fast. Our catalog is over 100 pages, fully indexed and illustrated, our quality is the highest, our service is the fastest. Try us just once, and see.

TV CABLE SUPPLY CO.
BOX 38 • CARLISLE, PENNA.
PH 717-243-4918



Wally Briscoe urged the association to help strengthen the national organization of the industry. He asked that they inform NCTA of local problems in order to help solve the problems of the entire industry.

Throughout the day-long meeting Viking Cable Company maintained a hospitality suite. CATV operators had an opportunity to discuss equipment and cables with Arthur Baum, President of the New Jersey based firm. Also hosting the Viking social hour after the meeting was Ted Baum, Plant Manager of Viking Cable.

CAREER OPPORTUNITY

Excellent position as a Technical Writer available to young man with some experience in CATV construction, maintenance or equipment design. State experience, present position and expected starting salary . . . in letter to:

Dep 128-TV & Communications
Box 63992
Oklahoma City, Oklahoma

TELESYSTEMS is people...



Frank Nowaczek, Assistant to the President, has a detailed understanding of CATV problems. Formerly Director of Research for the National Community Antenna Television Association during the past five years, Frank's experience embraces the legal, utility and economic issues facing CATV in the years to come.

With TeleSystems Corporation, Frank is an active participant in the organization and management of CATV companies. Anticipating and solving special problems for clients is among Frank's prime responsibilities.

Critical analysis, sound evaluations, are more good reasons why clients find it's smart to work with **Frank Nowaczek and TeleSystems Corporation.**

CATV CONSULTATION



TeleSystems Corporation offers a complete consultation service to clients. Whether you need franchise information, legal consultation, franchise procurement, or system financing.

You'll profit by a call to TeleSystems Corporation.

Serving CATV Systems in Engineering, Construction, Equipment, Promotion and Management.



TELESYSTEMS CORPORATION

113 South Easton Road, Glenside, Pennsylvania • 215 TU4-6635

FOCUS

... On Progress

SUPERIOR OPENS BROWNWOOD PLANT

J. H. Bowman, vice-president in charge of sales for Superior Cable Corporation, announced that the company's new Brownwood Division wire and cable plant at Brownwood, Texas will be dedicated in early December with an informal two-day Open House.

On December 10, James E. Webb, Brownwood Division plant manager, welcomed special guests including civic and business leaders and telephone and communications industry officials. A dedication ceremony was followed by an inspection tour of the new plant and a dedication luncheon.

The plant was then opened to the general public, with all Brownwood area residents cordially invited to visit the new facility and take part in the plant tours.

Superior Cable's new Brownwood Division plant, with 60,000 square feet of manufacturing area and office space, is expected to reach full production capacity in early January and will produce telephone and communications cable for shipment to the southwestern and west coast areas.

In addition to Mr. Bowman, the two-day Open House was attended by *J. L. Robb*, President of Superior Cable Corporation; *L. J. Styles*, Vice-President, Manufacturing; *W. T. Smith*, Vice-President, Engineering; *D. W. Hoffman*, industrial Sales manager; *Marvin Chenault*, southwestern sales representative; and other company officials from Superior Cable Corporation's headquarters in Hickory, North Carolina.

MacGREGOR MOVES TO DANIELS

Bill Daniels announces another addition to the staff of Daniels & Associates. The newest associate, *A. Ross MacGregor*, 32, joins the Daniels staff in November. Mr. MacGregor is from Port Arthur, Ontario, Canada, where he constructed, managed and was part-owner of the present 11,000 subscriber Lakehead Videon system.

Long considered one of the outstand CATV operators in Canada,

MacGregor prior to his connection with Lakehead Videon was associated with National Trust Company of Canada and the Canadian Acceptance Corporation in Canada.

Mr. MacGregor's principal responsibilities with the Denver-based organization will be in the areas of system operational and financial management.

COOLIDGE LEAVES NGC; STARTS ELECTRONIX

Mr. Vern L. Coolidge has resigned from his position as Senior Engineer with National General Corporation. Engaged in the CATV industry since 1952, Mr. Coolidge has designed and built systems the country over, the newest being the 12 channel system in Biloxi, Mississippi.

Mr. Coolidge will maintain residence in Hattiesburg, Mississippi. He will activate a newly formed corporation known as Electronix, Inc., which will engage in general consulting, franchise acquisition, complete systems design, construction and systems maintenance in all echelons.

BETCHEN TO HEAD JERROLD MANUFACTURING

In conjunction with an expansion of production facilities, Jerrold Electronics has named *Maury Betchen* to head their manufacturing operation. The announcement was made by *Robert Beisswenger*, Jerrold Vice President and General Manager. Mr. Betchen replaces *Len Rosenfeld*.

In announcing Mr. Betchen's appointment, Mr. Beisswenger pointed out that Jerrold production facilities had recently been increased by 28,000 square feet "to keep pace with the increased demand for our products."

Mr. Betchen spent 12 years with RCA, including tenure as Plant Manager of their Detroit plant.

CHAMBERS WISWELL & MOORE CO. NAMED

Westbury CATV Corp., Mount Vernon, N.Y. has appointed Chambers Wiswell & Moore Co., Inc., of Stamford, Connecticut as its marketing, sales promotion and advertising counsel.

AMECO ADDS PERSONNEL

Mr. John Buchanan, Vice President in Charge of Marketing and Sales, Ameco, Inc., Phoenix, announced the appointment of *Mr. Frank B. Court*, who will be in charge of Engineering Sales and Market Development.

Mr. Court will be responsible in the following areas: Specialized Technical Sales Accounts and Marketing Development (including telephone, Canadian and foreign markets), Design and Development Construction Program, Packaging Design, Plant Coordination and Connector Administration Liaison.

Prior to coming with Ameco, Inc., Mr. Court was Secretary, Treasurer and Director as well as Engineering Manager for Dynamics Research, Inc.,

George W. Green has recently been named treasurer of Ameco, Inc., Phoenix, Arizona.

Green, who is 33 years old, holds a masters degree from New York University in Finance and an undergraduate degree from St. John's University in Accounting.



Prior to joining Ameco, he was associated with Booth Leasing Corporation, a wholly-owned subsidiary of the Greyhound Corporation and the largest firm of equipment lessors in the United States. During his association with this company he was responsible for many of their recent sizable investments in the community antenna television field. Green's extensive business background also includes association with Hayden Stone & Co., investment bankers, and Peat, Marwick, Mitchell & Co., the nation's largest firm of certified public accountants.

CHENOR IS FORMED

William S. Kingman, President of the Chenango and Unadilla Telephone Corporation, announced the formation of a wholly-owned subsidiary, Chenor Communications, Inc., to operate in the broad field of communications with particular emphasis on CATV within New York State.

At the organizational meeting of the Board of Directors, Sterling F. Higley was elected President of the new firm. Mr. Higley announced the Chenor Communications, Inc., intends to build new CATV systems in New York State as well as acquire existing systems.

Mr. Higley is currently President of the New York State Community Television Association, as well as President of Valley Video, Inc., the CATV system serving Norwich, N.Y.

CHICAGO FIRM SELLS TARZIAN TAPE

Escor Sales, of Chicago, Illinois has been appointed sales representatives for Sarkes Tarzian Inc., Magnetic Tape Division, according to Fred Lucas, sales manager.

RUPP IS NEW CCTV REPRESENTATIVE

Herbert Rupp has been named Railroad Account Executive in eastern United States by Motorola Communications and Electronics, Inc.



In his new position, Rupp sells two-way radio and industrial closed circuit television systems to railroads in the eastern seaboard states.

Rupp, who has been on Motorola's National Office Engineering Staff since 1955, holds an electrical engineering degree from Northwestern University.

JERROLD CATV SCHOOL BURSTING AT SEAMS

A capacity crowd attended the Jerrold Electronics CATV school in late October. The group, largest ever for Jerrold, got a one week course in CATV installation, design and maintenance techniques.

The CATV operators and technicians were also introduced to the complete new line of Jerrold equipment.

As a break in the heavy technical

sessions, Jerrold hosted the group to an evening at the Latin Casino, where they enjoyed the performances of Tony Martin and Cyd Charisse.

Under the direction of Vic Nicholson, one of the country's best known CATV engineers, the Jerrold CATV schools held through the years have served to introduce and standardize many industry practices.



LETTERS

Gentlemen:

We would like to take this opportunity to commend you upon the fine job your publication has been doing in its coverage of the CATV industry. We would also like to give to you our reaction concerning the idea of a bi-weekly publication.

We have watched the CATV industry move forward with gathering momentum since early in 1953 and for many years found it impossible to keep abreast of its progress . . .

We hope you will seriously consider a bi-weekly publication and feel certain that it will be welcomed with open arms by your subscribers both present and future.

Again, our hearty congratulations on an excellent job.

Gail W. Park

Manager

Warren Television Corp.

Warren, Penna.

Gentlemen:

Responding to your request for opinions on the publishing frequency of *TV & COMMUNICATIONS*, I am inclined to favor the present schedule.

First, there is the question of whether advertising support would be sufficient to maintain 24 issues a year of the same high quality as current editions. Jerrold Electronics Corporation would undoubtedly increase advertising commensurate with semi-monthly issuance. But, frankly, I suspect that many smaller firms would be unable to immediately double their advertising budgets. Since publishing expenses would be approximately doubled this could effect the quality or size of *TV & COMMUNICATIONS*.

Secondly, I doubt that most of your readers have time to fully assimilate this type of magazine every two weeks. Perhaps this is the reason for most successful books in similar fields staying with a monthly schedule.

We believe that it is extremely important, especially at this time, for the CATV industry to have a strong representative voice through *TV & COMMUNICATIONS*. The bigger and more comprehensive the magazine becomes, the more stature it will bring to the CATV industry.

WANT A LITTLE PERSONAL ATTENTION?



Call 206 624-6505. The people at Jack Pruzan company will give just the personal attention to your problems that you want. We understand your needs, have a detailed knowledge of the industry and accurate, up-to-date information on our large inventories.

Our personal care of details will convince you how firmly we believe in our basic plan of doing business. Simply—keep full inventory of all items in convenient locations...price fair...ship fast...always take customer seriously, never self. That's all...plus personal attention to every customer requirement.

Find out today how well it can work for you — **CALL 206 624-6505.**

JACK PRUZAN COMPANY

1963 FIRST AVENUE SO. • SEATTLE, WASHINGTON 98134
PHONE 206 624-6505

CABLES and WIRES
POLE LINE HARDWARE
TOOLS
SAFETY EQUIPMENT
STRAND
TERMINALS and
SPLICING MATERIALS
SPECIALTIES

JACK PRUZAN CO., 1963 First Ave. So., Seattle, Wash. 98134

Yes, we'd like your personal attention to our material needs. Please send us your new, complete Catalog/Stock list.

Firm Name _____

Address _____

City & State _____

By _____ Title _____

Our suggestion is simply to keep up the good work of building a strong monthly publication.

Sel Kremer
Director of Advertising
& Promotion
The Jerrold Corporation

Gentlemen:

I am very pleased to receive your *TV & Communications* each month. I understand that this order was originally negotiated by an English agent of yours and as I am anxious to maintain continuity, I would be pleased if you would ask him to contact me when the annual subscription again becomes due.

I understand you also have an associated journal dealing with two-way radio which I believe is called *Communications*. Could you also arrange for me to subscribe annually to this magazine.

H. N. Storey, Director
H. N. Storey, Ltd.
Gateshead, England

• *At present we do not have an agent in England so we have processed your renewal to TV & COMMUNICATIONS and your new subscription to COMMUNICATIONS MAGAZINE here at our main office.*

Gentlemen:

We would like to renew our subscription order to *TV & COMMUNICATIONS* and add 5 new subscriptions. We would like to have these all billed on one bill to us at the above address, however, we would like to have each copy mailed to our other systems offices. . . Would you please send me the rates for these subscriptions?

Mrs. Marji Kirby
Office Manager
Valley Telecasting Company
Yuma, Arizona

• *The quantity rate for 5 or more subscriptions is \$4.00 per year. For 11 or more subscriptions the rate is just \$3.00 per year.*

Gentlemen:

Because of their affiliation with "Tame," we have discontinued the Finney line of antenna components.

We request that operators remove all Finney catalog sheets and price lists from their Davco Catalogs.

Jim Davidson, President
DAVCO Electronics Corp.

Your Advertising and You



By S. S. STREET
*Advertising Director,
TeleSystems Corp.*

Let us give some common names. Band-Aid, Coke, Bayer's. Don't these words bring up the familiar items: Adhesive bandage, Coca Cola, Aspirin? These advertisers got there first with the "mostest." Each of the products is established by the company's private trade name. Advertising has done this. Even if it does take as much as 12% of the total sales revenue, the value of a judiciously applied advertising budget is recognized among the largest corporations.

Cable television operators can well profit from such histories of successful identification of a common kind of product with an exclusive trade name.

Essentially, cable systems are out to gather more subscribers. One lesson that can be learned from "band-aids" or "coke" is the benefit of identifying TV reception with cable television. Sure, you can bulldoze your way into public recognition by spending a lot of money, a lot more than you would have to if you planned your program. There is no denying that favorable repetition of cable television daily in all the media in massive doses will keep your name out there. But this is wasteful and unnecessary. Without control, it may even backfire and bring about an unwanted reaction.

You should conduct your own private research program. This may be a matter of bringing into focus answers you already know. If you have lived in and with a cable community, you already know something about the various economic and cultural layers of people. You know where your cable has had most acceptance, where you have fewest subscribers. Ask yourself, why?

In seeking answers to these questions, you will make a fresh assessment of what television means to the residents of your town. The answers will not be the same for everybody. And you will consider what is available on the cable to satisfy your present and prospective viewers.

The chances are that you will discover that television has a number of differing appeals. It may basically be

entertainment, but to others it is a news and information service. To some it may be a way of easing loneliness, and still to others it may be a source of thrills. Or the television set can bring home any combination of these services. After you have done this cable market survey for yourself, how do you make use of your information? There are "nuts and bolts" answers that have been developed by practice and measurement of results in a number of our systems.

Our first requirement is a medium in which our cable TV story can be told. Is it a newspaper town? Then the paper is the place we have found to give greatest return for each dollar spent in advertising. The local radio station runs a close second. Choose the hour of the day, and proximity to interesting programs to give you the most active listening audience. Within your community you can assess the attention captured by billboards, or displays in areas of point of purchase. You might place your own posters in TV stores and repair shops; or at the bank or office of the power company.

Good advertising is not a matter of placing promotion anywhere haphazardly just because someone sells you the idea. All your advertising should be built into a planned approach, so that the result will be a cumulative build-up. Every exposure will add to the results of an organized campaign. The dollars spent will be much more fruitful.

Your ads should be informative, and easy to read and understand. Pictorial tricks are better avoided. Some advertisers pat themselves on the back for spelling a name and having the first letter of each name spell out a descriptive word. Others have tricky diagrams that bring together



An effective cardboard sign incorporating a double page, color reprint from a local newspaper with a bright CABLE-TV headline.

Andrews has the experience and know how to take complete care of any tower need. At Andrews SIMPLICITY in design means SIMPLICITY in erection . . . this give you more tower for less money. Before installation, your tower is completely assembled and tested. In this way, your tower can be built to be installed in any location your system calls for. Write or call today for free descriptive literature.

**CORRECTLY
ERECT!**

**ANDREWS TOWER
COMPANY, INC.**

1420 Layton Ave.
Fort Worth, Texas 76117
TE 1-1222 - Area Code 817

FINANCING AND
LEASING AVAILABLE

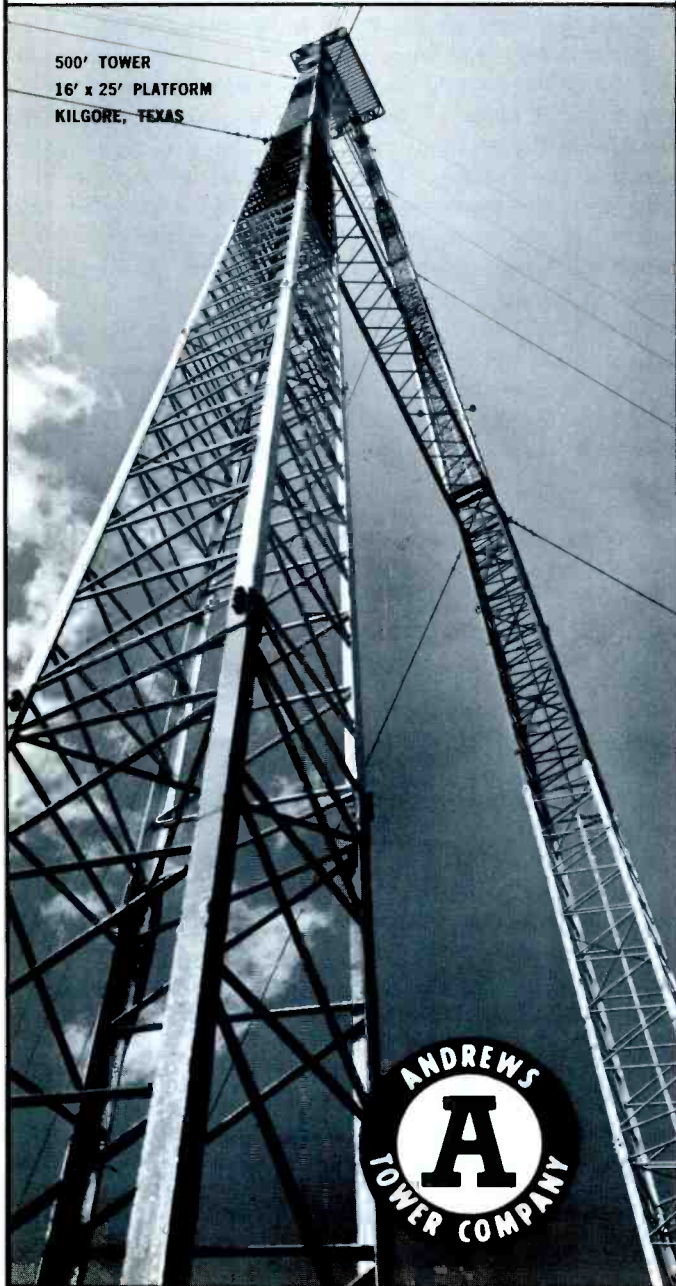

500' TOWER
16' x 25' PLATFORM
KILGORE, TEXAS

message and product in a jig-saw puzzle arrangement. About all this kind of advertising accomplishes is to give some satisfaction to the person who designed it.

You are selling cable television, an antenna service that brings in more channels, with better pictures. Emphasize your "product's" benefits in your advertisements.

There are no antenna hazards when a home receives TV by cable. It is an economical service, because no householder could begin to match this kind of reception, unless he spent thousands of dollars in exceptionally tall towers, antennas, amplifiers, and maintenance work.

Be specific. Name the channels and the networks that can be watched by cable. Similarly, state the charges. You might break it down into so many pennies a day to receive such a profusion of entertainment, information and education.

If there is an offer, give it in clear, precise language. And by all means, end the advertising message with a suggestion of some action by the reader: "Stop in our office . . . Call today."

Your newspaper ad should be identified with all the other ads you have run. The company logotype should appear every time; a person on merely sighting the ad



Participation in local trade shows is a good advertising expenditure. This display was seen by 9,000 people in a local (electrical) trade show, cost under \$500 and signed up 21 subscribers.

knows that it is yours. Still, something to keep in mind is the need to keep your ad simple while incorporating all the elements cited here.

The ad should be part of a series, which means that one advertisement must not try to accomplish too much. A complicated piece of typography will tend to cancel itself out by producing a muddled advertisement. You will find by planning and budgeting your ads in a series, you will benefit from a cheaper rate. You will earn a lower contract rate because you will know in advance how much space you will be using, and can fit your plans into the least costly space rate on contract.

Planning ahead of time gives you the advantage of obtaining proofs. Even the best designed ads invite ideas for improvement after the type has been set. You should be able to get enough proofs to use for distribution and window display. You might want to make special mailings as a supplement to the appearance of the ad in the newspaper.

SIGN PROGRAM

Remember that signs, whether in shop windows or on the roadside, must be "read" from a reasonable distance.

ETCHED CIRCUIT SOLID-STATE ATM-70 AMPLIFIER

Nothing can compare with the all-band ATM-70. All other mainline amplifiers now become obsolete. The ATM-70 etched circuit outperforms them all! ATM-70 specifications are unsurpassed! ATM-70 dependability is unmatched! ATM-70 performance is unchallenged! Consider the following:

- USES LESS POWER
- LOWER NOISE FIGURE
- PROVIDES HIGHER OUTPUT
- WIDER TEMPERATURE RANGE
- GREATER CASCADABILITY

The sensational ATM-70... ready for your cable system. And exclusively from Ameco... the proven standard of the CATV industry.

LIGHT... COMPACT EASY TO MOUNT

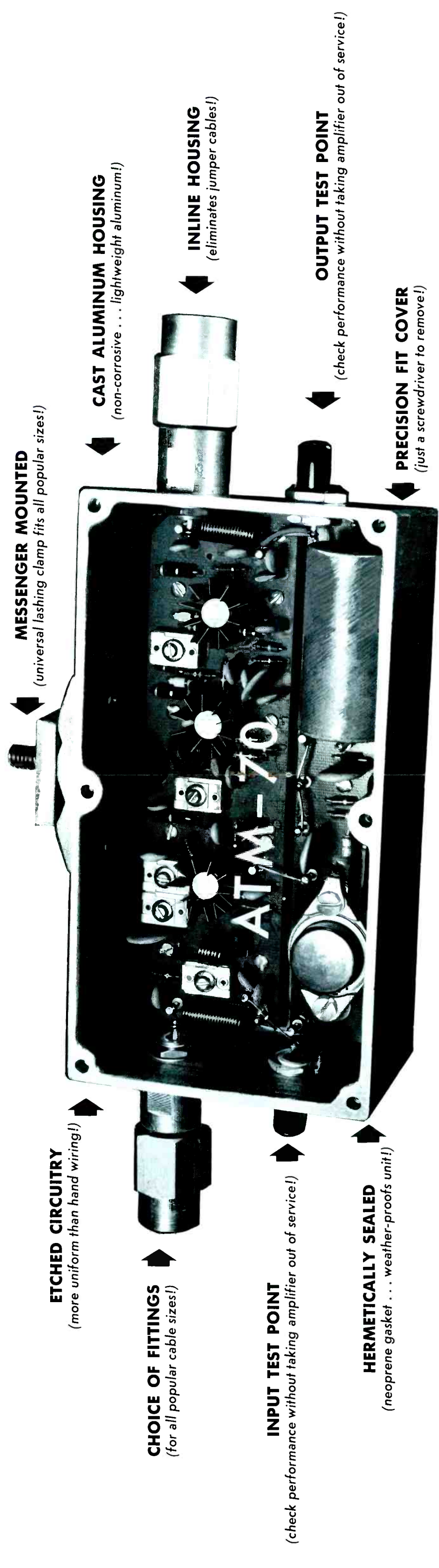

MESSENGER MOUNTED
(universal lashing clamp fits all popular sizes!)

ETCHED CIRCUITRY
(more uniform than hand wiring!)

CAST ALUMINUM HOUSING
(non-corrosive... lightweight aluminum!)

CHOICE OF FITTINGS
(for all popular cable sizes!)

INLINE HOUSING
(eliminates jumper cables!)

INPUT TEST POINT
(check performance without taking amplifier out of service!)

HERMETICALLY SEALED
(neoprene gasket... weather-proofs unit!)

OUTPUT TEST POINT
(check performance without taking amplifier out of service!)

PRECISION FIT COVER
(just a screwdriver to remove!)



**ATM-70
MAINLINE
AMPLIFIER**

Solid... rugged... reliable

ACTUAL SIZE OF ATM-70
6 1/2" x 3 1/2" x 2"

LIKE TO SEE THIS REVOLUTIONARY NEW AMPLIFIER? GIVE YOUR TECH-REP A RING!

SAN FRANCISCO, CALIFORNIA
P.O. Box 80253
400 S. 4th St.
Zip: 94114

PORTLAND, OREGON
1460 SE 95th
400 S. 4th St.
Zip: 97215

OMAHA, NEBRASKA
6324 Maple
400 S. 4th St.
Zip: 68104

HARRISBURG, PENNSYLVANIA
P.O. Box 3346
400 S. 4th St.
Zip: 17101

DECATUR, ALABAMA
1624 5th Ave. SE
400 S. 4th St.
Zip: 35602

DALLAS, TEXAS
6111 Harry Hines Blvd.
400 S. 4th St.
Zip: 75201

CINCINNATI, OHIO
P.O. Box 1335
400 S. 4th St.
Zip: 45201

ALBANY, NEW YORK
P.O. Box 223
400 S. 4th St.
Zip: 12201

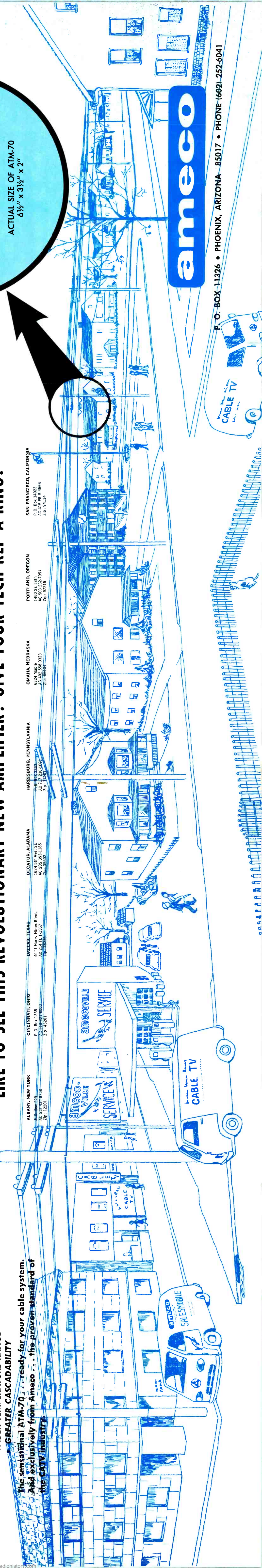

ameco

P.O. BOX 11326 • PHOENIX, ARIZONA 85017 • PHONE (602) 252-6041

**AMECO
DOES
IT
AGAIN!**

A Lawyer Looks at Cable TV

By Vernon C. Kohlhaas

Vernon C. Kohlhaas is an attorney for Washington, D. C. law firm Pierson, Ball & Dowd. The firm represents the Hartford, Connecticut subscription television endeavor, several radio and television stations and several CATV systems.

Let us first consider CATV in its basic historical role as a master antenna service which picks up programs of outlying television stations and distributes them by wire to individual customers at a flat rate.

A continuing legal problem facing the CATV operator arises out of the contention of broadcast stations that they have a property right in the programs they broadcast, which entitles them to some control over their unauthorized use by CATV systems for profit. This contention is the subject of litigation in two pending cases.

In recognition that judicial relief may be inadequate, legislation has also been proposed which would amend Section 325 of the Communications Act so as to require CATV operators to obtain the consent of originating stations, in the same manner that broadcast stations are now required to obtain consent of an originating station for rebroadcast purposes.

The Federal Communications Commission has held that it does not have direct regulatory power over CATV operations. However, in the *Carter Mountain* case, it exercised its licensing power over microwave facilities for the purpose of indirectly regulating CATV operations using such microwave facilities so as to protect local television stations from adverse competitive effects.

In implementing that decision, the Commission proposes to adopt a policy which would require CATV systems to carry the programs of local stations and to afford such local stations protection from program duplication as a condition to receiving a microwave license.

However, since only 20% of the nation's CATV systems require microwave facilities, this indirect approach is considered by many to be inadequate to achieve the underlying purpose of the *Carter Mountain* decision. As a result, there are a number of legislative proposals which would give the Commission the power to regulate ALL CATV systems directly.

While CATV operators disagree that any of the above reasons justify their being regulated by the Federal Communications Commission, they tacitly support some limited type of FCC regulation, for a singular reason of their own. They would like to have Congress preempt the field so that they would be subject to uniform regulation by the FCC rather than by the multiple and

oftentimes conflicting regulations of the states, counties and cities with which they now have to deal.

While there will undoubtedly be compromises in the CATV legislative objectives of the broadcasters, the Commission and the CATV operators, there is little doubt that all CATV operators will be brought within the regulatory control of the FCC in the not too distant future.

We add new dimensions to the CATV operators' problems if we add to their historical master antenna role the possibility that they may originate programming of their own. CATV program origination would precipitate pressures to bring CATV operators within the exclusive regulatory control of the FCC.

Further, if such practice becomes widespread, it will undoubtedly affect joint ownership of broadcast stations and CATV systems, because of the possibility of conflicts with the Commission's policies against concentration of communications media and excessive multiple ownership.

Most serious economic and technical studies have concluded that the assumption that CATV systems will serve as a built-in nucleus for nation-wide subscription television operations in the immediate future is a popular myth. Economic considerations, such as additional plant investment, program procurement costs and basic CATV charges of \$75 a year for conventional programming reception, indicate that CATV communities may be among the last, rather than among the first, to receive subscription television service. Thus, recent worries of the FCC that CATV systems originating programs may soon create new regulatory problems would appear to be jumping the gun.

In discussing the legal problems of subscription television, it is necessary at the outset to distinguish between broadcast subscription and wire subscription. The FCC has exclusive regulatory authority over broadcast subscription, while regulatory control over wire to date has been left in the hands of state and local authorities.

There was a belief several years ago that this jurisdictional difference might permit wire operations to obtain a significant competitive headstart over broadcast subscription, because wire did not have to go through proceedings before the FCC in order to commence operations. Pat Weaver's experience in California indicates, however, that this optimism may have been somewhat premature.

Multiply Weaver's California headaches by 50 states and it would not be surprising to find wire television inviting uniform exclusive regulatory control by the FCC. In addition, wire subscription is even now subject to more FCC control than many suppose, whenever coaxial or microwave inter-city connections are needed.

The most immediate regulatory problem of broadcast subscription is to obtain authorization from the FCC to expand beyond the limited Hartford trial to a nation-wide operation.

As a result of court decisions upholding Commission authorization of the Hartford trial, it has now been established that the Commission has the statutory power to authorize broadcast subscription if it finds it in the public interest to do so.

The Hartford trial has established the technical feasibility of broadcast subscription and has effectively refuted a number of other contentions which have been advanced against broadcast subscription in the past. I will here limit myself to briefly discussing the emotion-packed myth that broadcast subscription would destroy the capacity of the present system to continue to provide advertising-financed programming free to the public. This charge is usually phrased in terms of siphoning of viewers, programs and talent.

The basic weakness of the siphoning argument is that it ignores economic reality.

First, why would television stations suddenly abandon approximately a billion and a half dollars of annual advertising revenues in order to convert their operations exclusively to subscription, which most realistic revenue projections indicate may produce only 50 or 75% as much? Why not get both?

Even more pertinent, numerous economic surveys of subscription's potential, supported by empirical experience in Toronto and Hartford, indicate that the public's recreational budget will not permit the spending of more than \$100 to \$125 a year for subscription programming. This amount would provide 2 to 3 hours of subscription programming a week—or slightly more than one program per week.

Allowing for the fact that subscription television will never have 100% nationwide penetration, the viewing of this amount of subscription programming would be less than 1% of the 35 hours per week that the American public now watches television. In terms of viewer-siphoning, this assumes that subscription viewing would be entirely subtractive rather than additive.

In short, the public's recreational budget would not allow it to absorb sufficient subscription programming time to deprive advertising-financed programming of its present broadcast time. It is equally clear that the cost-per-thousand economics of advertisers will still make the support of conventional programming a sound business venture.

In Hartford, 80% of the subscription fare consists of current motion pictures, supplemented by Broadway plays, specials and heavyweight fights, which establishes, among other things, that it is not necessary to siphon off talent and

(Continued on page 45)
DECEMBER 1964

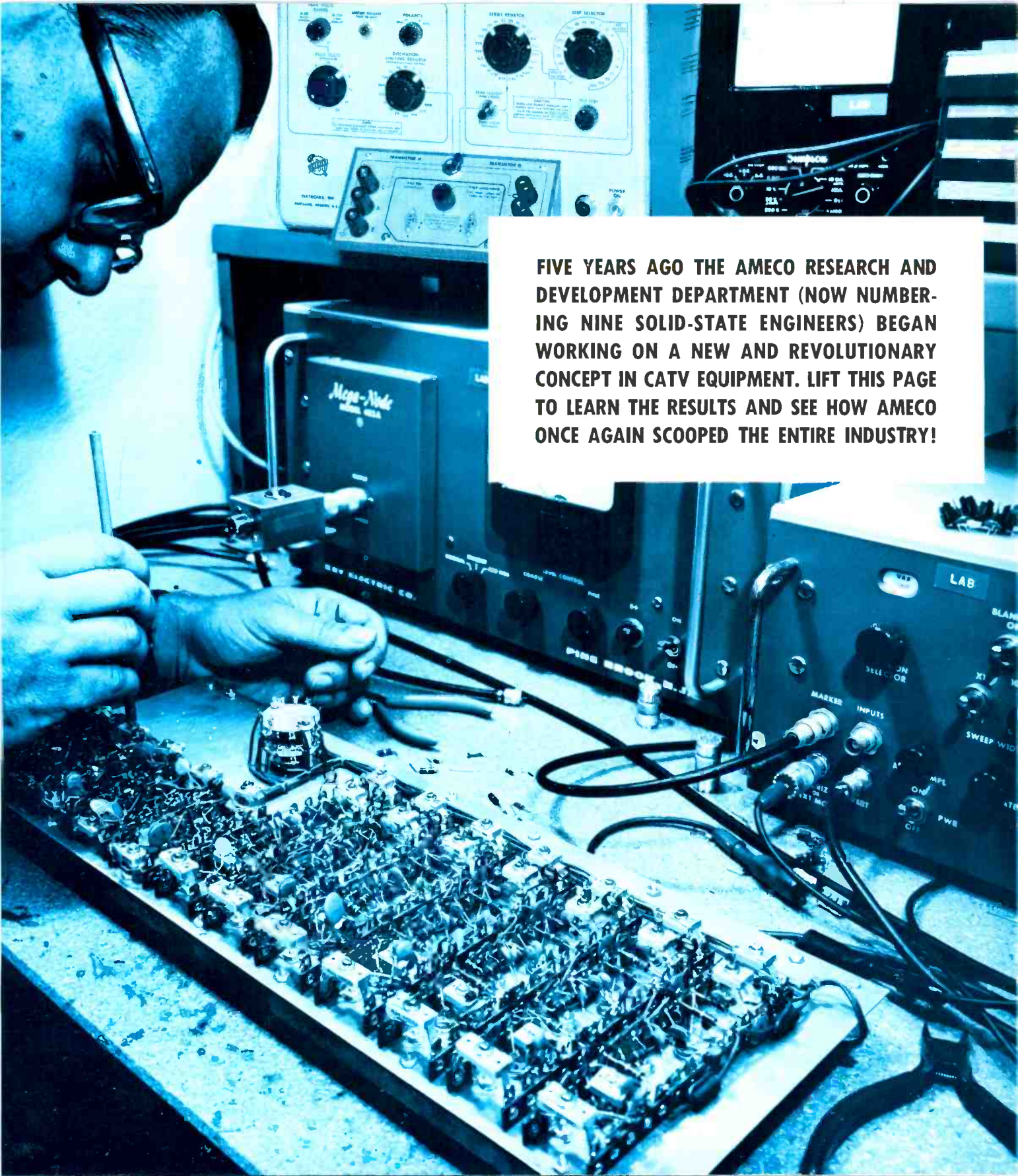

FIVE YEARS AGO THE AMECO RESEARCH AND DEVELOPMENT DEPARTMENT (NOW NUMBERING NINE SOLID-STATE ENGINEERS) BEGAN WORKING ON A NEW AND REVOLUTIONARY CONCEPT IN CATV EQUIPMENT. LIFT THIS PAGE TO LEARN THE RESULTS AND SEE HOW AMECO ONCE AGAIN SCOOPED THE ENTIRE INDUSTRY!

While others imitate... Ameco originates!

WHAT MAKES THIS CATV CABLE DIFFERENT?

There's a lot more to CATV cable than is revealed by nominal attenuation figures. Factors that these figures don't show can cause subscriber complaints, added expense for extra repeaters, other problems. Read why.

Nominal attenuation is not a guarantee.

Because electrically uniform CATV cable is more difficult to make than many people know, the cable you buy may cause *actual* losses a good deal higher than the "nominal" the manufacturer was shooting for. Unless it's Rome *Unifoam*[®] cable. Only Rome can assure you of typical figures like these (actual losses in db per 100 feet in tests of 100 standard lengths of 1/2" 75 Ω cable in a recent production lot):

	at 100 mc	at 220 mc
average attenuation, all cables	0.81	1.25
maximum attenuation	0.85	1.30
attenuation in 97% of cables	below 0.84	below 1.28
attenuation in 84% of cables	below 0.83	below 1.27

Bearing in mind the cost of repeaters, it's obvious that performance like this makes a real difference in installation cost.

The uniformity these figures show makes a big difference, too. You don't have to test your cables and pick the best lengths for the difficult runs: *every* length of Rome *Unifoam* cable will give you the transmission efficiency you expect.

HOLES IN THE SPECTRUM Attenuation at 100 and 220 mc isn't the whole story. What goes on over the whole spectrum? Plenty.

You call them "holes in the frequency spectrum." We call them *attenuation peaks*: discrete frequencies at which the cable, for various reasons, causes much greater loss than at other frequencies. Result: bad picture. Or poor sound. Or no sound at all.

90% of Rome *Unifoam* cable shows no measurable attenuation peak at any frequency from 54 to 220 mc. And no length leaves the plant (in the unlikely event it ever got produced) with attenuation peaks—at any frequency—greater than a 2.5% deviation from a smooth curve (at 220 mc, with 1/2" 75 Ω cable,



this would be 0.3 db per 1,000 feet). You can be certain every frequency will come through just as you want it to.

FORGET ABOUT MISMATCH: the uniformity of the capacitance and characteristic impedance of Rome *Unifoam* cables, length after length and lot after lot, eliminates any loss of signal strength due to mismatch between lengths. And the uniformity of physical dimensions makes it possible to get consistently reliable and efficient splices, taps and terminations.

UNCLE SAM may have had something to do with the remarkable quality of Rome *Unifoam*. We've been making ultra-precise high-frequency cables used for missile tracking sites since the beginning. We've learned more than a little about what it takes in manufacturing equipment and procedures to make cable that's more uniform than engineers dreamed was possible only a few years ago.

Rome mixes its own foamable polyethylene on an as-needed basis, eliminating the problems of contamination or moisture pickup encountered in shipping and storage. The quality and uniformity of the foam insulation determines in great part the electrical uniformity of CATV cable.

Elaborate, electronically-monitored equipment continuously patrols every phase of the insulating operation. Critical parameters—including capacitance, insulation diameter, process temperature and others—are controlled and chart-recorded automatically. A complete record of every foot of Rome *Unifoam* produced is always available.

WHAT'S IN IT FOR YOU: the best CATV cable possible... in a full range of sizes. Rome *Unifoam* CATV Cable transmits every frequency you want with minimum loss. And the price is right. Competitive.

GET THE WORD: for a copy of our folder on Rome *Unifoam* CATV Cable, call your nearest Rome/Alcoa representative or write **Rome Cable Division of Alcoa**, Dept40-124, Rome, N. Y. 13440.

*Rome Unifoam—Trademark of Rome Cable Division of Alcoa

Rome Cable
DIVISION OF ALCOA

CHASING GHOSTS

By WILLIAM A. RHEINFELDER
Ameco, Inc.

Extensive studies of the visibility of ghosts have been made by various investigators ¹⁾. The findings (fig. 1) are briefly as follows:

No ghost is visible if the reflected signal is 40 db or more below the desired signal. Also, for a time delay of 18 nanoseconds or less, no ghost is observed. As time delay increases, the reflection must be proportionately decreased in amplitude in order to be invisible on the screen. Time delay as shown in fig. 1 can be converted to length of a transmission line using the corresponding propagation constants. In fig. 2, curves A and F represent the limits of ghost perceptibility with "lossless" lines. For example, a "lossless" line of 100 ft. length with a propagation constant of 81% requires a reflection to be at least 23 db below signal level in order to be unobjectionable. This is the same as saying that a ghost delayed 0.25 nanoseconds (one two hundredth of the picture width) becomes invisible if 23 db below the signal. The

curve of fig. 1 has been established with studio monitoring equipment. It is likely that a considerably stronger reflection than indicated remains unnoticed with the typical home TV receiver due to lack of definition and focus. Therefore, practical requirements can be relaxed somewhat from the "ideal" curves for community TV systems.

Effect of "Lossy" Transmission Line

Losses of practical cables result in an increase of signal to reflection ratio when traveling from the point of mismatch toward the generator (fig. 3). For every unit of distance from the point of reflection, the signal to reflection ratio increases by 2 k x, where k is the loss per unit distance and x is the distance. The factor 2 arises from the fact that while the signal increases toward the generator, the reflection decreases in the same proportion. At any given point x, a different signal to reflection ratio can be tolerated depending on the cable used. In fig. 2, curves for various popular cables are

plotted. As can be seen, there exists a critical length of cable which requires the lowest reflection coefficient at the point of mismatch in order to avoid ghosts in the picture. For example, with 1/2" aluminum coaxial cable (curve B), the critical length is 500 ft. at channel 2. The reflection at the point of mismatch must then be down at least 30 db. With fig. 4, this calls for a VSWR of 1.066 at the point of mismatch! Worst case conditions are listed in Table I.

It would be impractical and costly to design and manufacture amplifiers and other system components with a match of such a close tolerance. Even if no taps were used for a distance from 150 to 1200 ft. from the receiving end of the cable, the VSWR would still have to be 1.16 or better. Admittedly, this is a worst case condition, using channel 2 and a low loss cable. However, it is clear that a different concept is needed in practical systems rather than the brute force method of decreasing VSWR

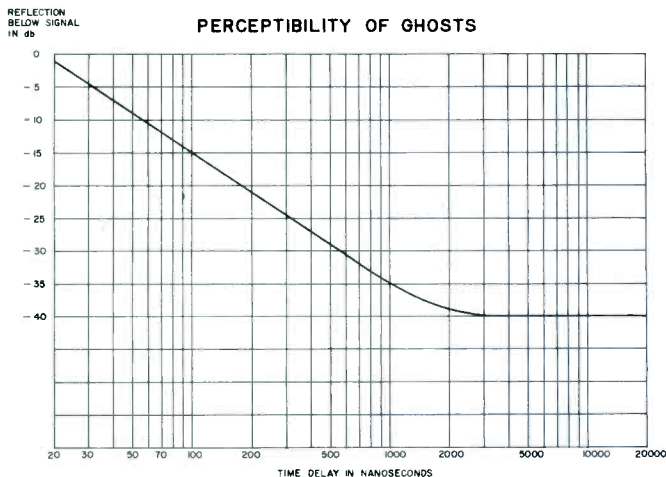

FIGURE 1

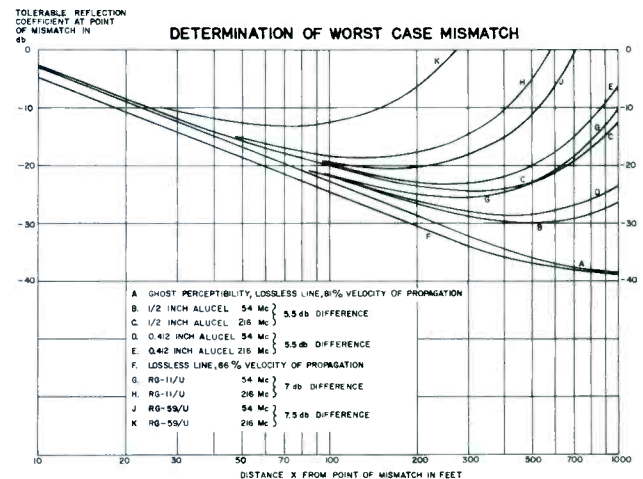

FIGURE 2

Table 1
Conditions for Worst Reflections

Cable	Critical Length		Max. Refl. Coeff.		Max. VSWR		Difference in Return Loss
	216 Mc.	54 Mc.	216 Mc.	54 Mc.	216 Mc.	54 Mc.	
RG 59/U	75 ft	150 ft	-13 db	-20.5 db	1.57	1.21	7.5 db
RG 11/U	140 ft	300 ft	-18.5 db	-25.5 db	1.26	1.11	7 db
.412	250 ft	450 ft	-23.0 db	-28.5 db	1.15	1.08	5.5 db
1/2	350 ft	500 ft	-24.5 db	-30 db	1.125	1.065	5.5 db

sufficiently in all parts of a system to meet the set forth requirements.

Methods of Reducing Reflections Due to Mismatch

As was mentioned, there are limitations to the match which can be achieved in practical amplifiers and system components. A VSWR of 1.5 can generally be met at no great cost, although it would be desirable from other considerations (such as noise figure) to sometimes have a higher input VSWR. On the other hand, a

GENERATION OF ECHOES

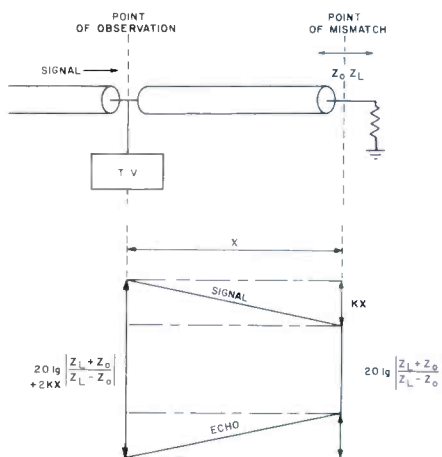

FIGURE 3

VSWR of better than 1.1 is in most cases costly to achieve and would be an impractical figure to use in a system design. Therefore, other means of reducing ghosts must be used.

One possibility is the deliberate introduction of additional loss in the cable. This loss would have to be less at channel 13, in proportion to the cable losses. Such a network would, therefore, produce a partial cable equalization. For example, it might have the inverse response of 5 db (loss at channel 13) cable. That is the loss of this equalizer would be 5 db at channel 2 and 2.1 db at ch. 13.

With 500 ft. of 1/2" aluminum cable, a VSWR of 1.066 was required at the matching point without added equalizer. This VSWR is increased to 1.21 with equalizer (from fig. 5) at channel 2. Similarly, at channel 13

a VSWR of 1.15 was required without this equalizer (from figs. 2 and 4). This goes up to 1.24 with equalizer (fig. 5). Such an equalizer need not have a very low VSWR itself, because it is located adjacent to or part of the tap (fig. 1 and 4). However, with consideration for earlier taps in the system, this equalizer should have a VSWR equal to or less

than the system amplifiers.

Therefore, the use of this equalizer results in a rather practical system even using the worst case conditions. The ghost reducing network of the previous example had an insertion loss of only 2.1 db (at channel 13) and simultaneously provided equalization for 5 db of cable (fig. 6). This method could eventually result in a

**ALL THE PEOPLE
HERE AT TELEMATION**
*Manufacturers of the
TMW-2B Weather Channel*

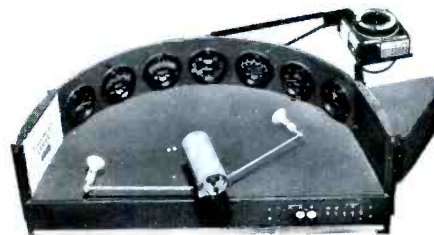

*Wish a Merry Christmas
and a Joyous New Year*

**TO ALL THE FINE PEOPLE
IN THE CATV INDUSTRY**



TELEMATION INC.

2275 South West Temple
Salt Lake City, Utah 84115
Dept. VO



REFLECTION
BELOW SIGNAL
IN db.

REFLECTED TO INCIDENT WAVE VS. VSWR

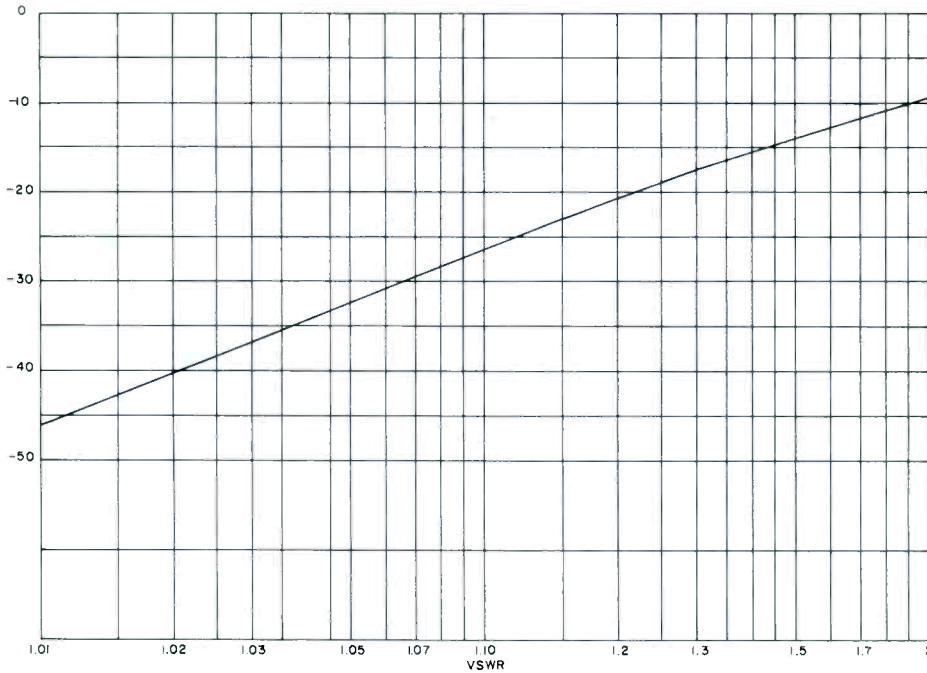

FIGURE 4

reduced cost of the repeater amplifiers since less equalization must then be provided in the amplifier. Obviously the major disadvantage of this concept is the insertion loss taken. Another disadvantage shared with all types of passive cable equalization is that the system signal to noise ratio is less than if all equalization were provided in the repeater amplifier itself. However, where passive equalizers are used, it is a simple matter of locating the equalizers adjacent to the tap locations. As minimum values of equalization per equalizer should be considered approximately 2.1 db loss at channel 13 and 5 db at channel 2, as in the example given. This leads to a required VSWR of 1.2 at the mismatch point (following amplifier) which can be achieved in practical circuits.

Another, better concept is based on the use of directional couplers. A directional coupler is a three terminal network having input, output and coupled tap. Insertion loss is loss from input to output. Tap loss is from input to tap. Isolation is loss from output to tap. Directivity is isolation minus tap loss (fig. 7).

Tap loss is a design feature and can be made any desired value, for example, 10 db. For given tap loss, there exists a minimum theoretical insertion loss, for example, 0.45 db for 10 db tap loss. Isolation and directiv-

ity can theoretically be made infinite but practical limits exist.

Using a directional coupler any echo being reflected from the point of mismatch is greatly attenuated due

to the directivity of this network. The signal to reflection ratio at the tap output of the directional coupler is improved by the sum of insertion loss and directivity. In the example given in fig. 8, a maximum VSWR of 6.9 (1) could be tolerated at the amplifier. However, the signal to reflection ratio (S/R) is only 10.5 db at the input of the directional coupler. This low figure may cause trouble elsewhere in the system if the output VSWR of the preceding amplifier is excessive.

Fig. 9 gives the improvement possible with a directional coupler. Also plotted are the worst case VSWR's for various cables which would have to be met if no ghost reducing network were used. For example, for a VSWR of 1.25 (impedance mismatch at end of line), a directional coupler of 12 db directivity is sufficient to reduce the VSWR to the required 1.06 for a 1/2" aluminum cable at channel 2. Only 6 db directivity is sufficient at channel 13 for the same cable. Directional couplers with a directivity better than 20 db can readily be constructed. The insertion loss can be made quite small dependent on the

CORRECTION OF VSWR FOR ADDED LOSS

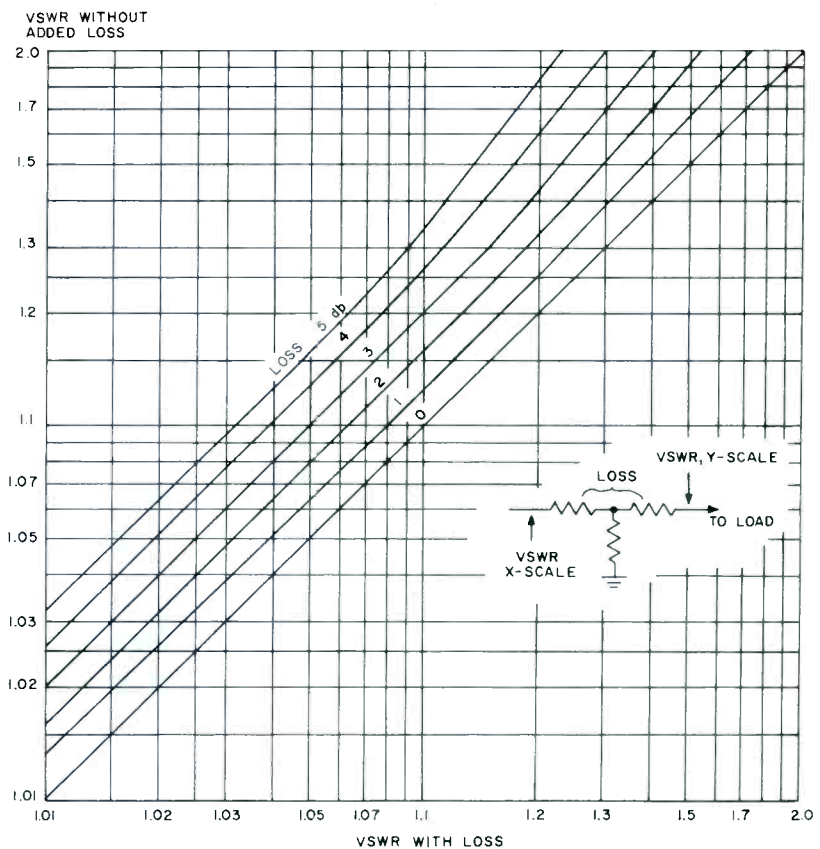

FIGURE 5

tap loss taken. While the echo is not passed on to the tap, it is still transmitted back to the input and could cause difficulties somewhere else in the system. Therefore, it is necessary to consider separately various sections of a practical system for a worst case analysis.

Main Trunk Line Without Taps

It will be only necessary to calcu-

late the low frequency case (channel 2) for low loss cable to include all other less critical applications. Cable data for two repeater spacings are given in Table II.

The permissible S/R given refers to the whole system. It can be shown of reflected signal to the system in the worst case of identical phase relationships. Therefore, the system re-

turn loss will be less than that of the individual section. The system signal to reflection ration (S/R) in db is then:

$$S/R \text{ (system)} = S/R \text{ (section)} - 10 \lg n \quad (1)$$

Where n = number of sections (amplifiers)

Also,

$$S/R \text{ (section)} \text{ in db} = 2 \times \text{cable}$$

WE'RE EXPANDING!

MEN WANTED

RF Amplifier Design Engineers
 Antenna Engineers
 Mechanical Engineers
 Laboratory and Field Technicians

HERE IS AN OPPORTUNITY for qualified men to put their talent and abilities to use in a fast-growing corporation that is recognized as a leading manufacturer of TV and FM antennas and RF distribution systems. Expanded facilities and product lines require that we enlarge our engineering staff in the job categories outlined above. You will be working on exciting new products in one of the most modern, fully equipped electronics laboratories in the industry. (No military contracts.) Salaries are commensurate with experience and ability. There are numerous

company benefits including a profit sharing plan, vacation plan and company-paid insurance. Our manufacturing plant and laboratory facilities are located in an attractive, friendly city on the beautiful Mississippi river where you and your family can really enjoy life to its fullest. Write stating your experience and an application form will be sent immediately to those persons who qualify. All inquiries will be held in strictest confidence. Address letter to: Personnel Dept., Winegard Company, 3000 Kirkwood, Burlington, Iowa.



WINEGARD COMPANY, 3000 KIRKWOOD, BURLINGTON, IOWA

Intercontinental Industries Inc.

2241 NW 40 - SUITE 203-M OKLAHOMA CTY. OKLAHOMA

The development of Lustre-Span, a new high-strength rigid vinyl, has made it possible to produce extremely versatile pre-fabricated buildings at very low cost. Specifications of the new structures reveal their usefulness in dozens of applications, such as CATV Head-End equipment buildings, microwave relay stations, remote transmitters and commercial buildings. Modules are available as small as 4' x 4' with no limit on maximum size of structure.

Quickly erected, pre-fabricated units are constructed of rigid-vinyl corrugated panels with framework of extruded aluminum alloy. Simple, one-day erection requires only screw-driver, wrenches and drill. These lightweight buildings are

secured to foundation by anchor bolts, per "South Florida Building Code."

LOW THERMAL CONDUCTIVITY

Ideal for extreme climatic conditions, the walls and roof have a thermal conductivity factor of only 1.3 BTU/s.f./hr./in. (Will not rust or rot and is not subject to insect attack or fading.) The glossy surface of the tough rigid-vinyl reflects the sun's rays, maintaining a low interior temperature.

All of these properties are equally valuable whether in a 4' x 4' transmitter shack or a 20' x 80' retail or service facility. And the savings are just as great, proportionately, in either type of application.

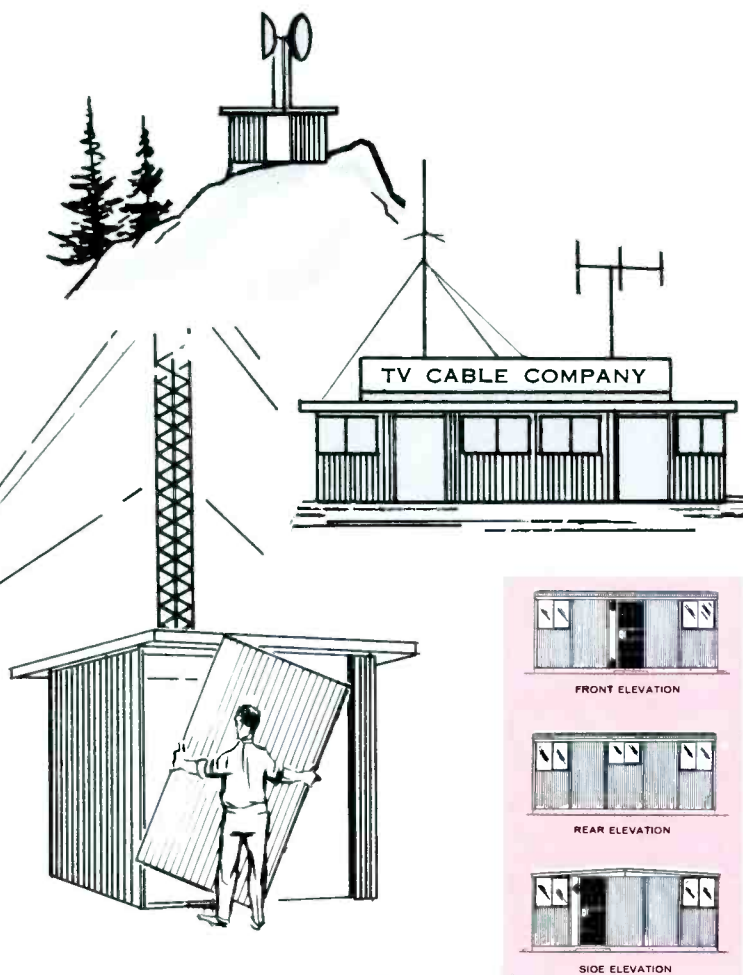

ERECTION and DISASSEMBLY:

RODUN buildings may be assembled by the use of hand tools only—screw drivers, open-end and socket wrenches, and a hand drill. Waterproof and weathertight construction is obtained by caulking vinyl panels to frame members with a non-hardening compound that is supplied with the building.

RODUN structures may be readily disassembled, using the tools described for erection, moved to a new site and again easily re-erected. Only the foundation walls and anchor bolts are left behind.

DESIGN LOADS:

Wind — "South Florida Building Code"

Roof — Live load of 20 lbs. per square foot

Seismic — Reaction is negligible, since weight of the RODUN House is but 1,200 pounds.

MATERIAL SPECIFICATIONS:

Aluminum: The extrusions for structural frame are of ALCOA aluminum alloy 6063-T6, with the following minimum properties:

Ultimate strength — Tension	30,000 psi
Yield strength — Tension	25,000 psi
Compressive strength	25,000 psi
Ultimate strength — Shear	19,000 psi
Yield strength — Shear	14,000 psi
Modulus of Elasticity	10,000,000 psi

Finish — Unless otherwise ordered, mill finish.

Tolerances — The extrusions and fabrication of all parts shall be to the tolerances given in "The Aluminum Construction Manual", published by the Aluminum Association (1959), pages 52 to 56.

Fabrication — The fabrication of all parts by drilling, cutting, punching, mitering or other means will be in accordance with Section 1 of American Society of Civil Engineers Proceedings Paper No. 970, entitled "Specifications for Structures of Aluminum Alloy".

MONSANTO LUSTRA-SPAN VINYL PANELS:

Property	Value	A.S.T.M. Test No.
Specific Gravity	1.37	D-792-60T
Thermal Conductivity, "k" (BTU/Sq. Ft./Hr./°F/Inch)	1.26	C-177
Tensile strength, psi	7,000	D-638-60T
Flexural strength, psi	14,500	D-790-59T
Hardness (Durometer D)	76 min.	D-1706
Izod Impact at 73°F	1.3	D-256

Fire Resistance rating by Underwriters' Laboratories, Inc. and Factory Mutual Engineering Division: Non-combustible.

VIN-I-KING PANELS:

Thermal Conductivity, "k" (BTU/Sq. Ft./Hr./°F/Inch)	0.44
---	------

Fire Resistance rating, per U.S. Department of Commerce Commercial Standard CS-45-60: Self-extinguishing.

Note: When the exterior walls and roof are faced with VIN-I-KING panels on the interior, the dead air space between the outer LUSTRA-SPAN panels and the inner VIN-I-KING panels, coupled with the low "k" factors of both materials, results in a double wall of exceptional thermal efficiency.



INTERCONTINENTAL INDUSTRIES, INC.

2241 N.W. 40th STREET

OKLAHOMA CITY, OKLAHOMA

PHONE: JA 4-3384

CABLE ADDRESS: FIBCO

loss in db + input return loss
(2) + output return loss

From Table II, for 15 db spacing, a system S/R of 25.2 db is permissible. For 25 amplifiers, typically the return loss per section must be 14 db less, or 39.2 db. With a cable loss of 6.5 db, this leads with equation (2) to a sum of input and output return loss of 26.2 db. This figure could be achieved, for example, with an input VSWR of 1.25 (18 db) and an output VSWR of 2.25 (8.2 db) or a VSWR of 1.5 (14 db) for both input and output. These values can be nor-

GHOST SUPPRESSION
WITH PASSIVE EQUALIZERS

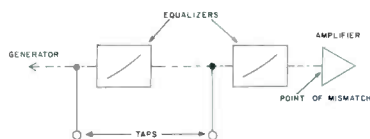

FIGURE 6

mally met in amplifier design. Also this example is a worst case condition, assuming low loss cable, close spacing and channel 2. It seems, therefore, that untapped main trunk lines represent no great problem with regard to reflections.

Tapped Feeder Lines

A spacing as shown in fig. 8 might exist as a worst case. Since a S/R of 30 db is required at the TV set for this critical cable length, this requires a reflection down 23 db at the amplifier or an input VSWR of 1.15 for the amplifier if no directional coupler were used. This is an undesirably low figure. Also, the tap itself must have the same VSWR to avoid difficulties at earlier tap positions. Actually, if five sections similar to fig. 8 were used, the allowable reflection per section would have to be decreased by 7 db more so that the S/R at each mismatch is only 30 db corresponding to a VSWR of 1.066 which is unreasonable. Clearly, therefore, in high quality systems, the use of directional couplers is indicated. 2)

In fig. 10, a typical feeder system is shown with four taps spaced 125 feet apart between two line extender amplifiers. The feeder line is 0.412 inch aluminum cable. There are several reflections possible, within a 125 foot section, over several sections with the worst case being 400 to 600 feet, and reflections at the TV set back to the tap.

Curve D of fig. 2 gives the required

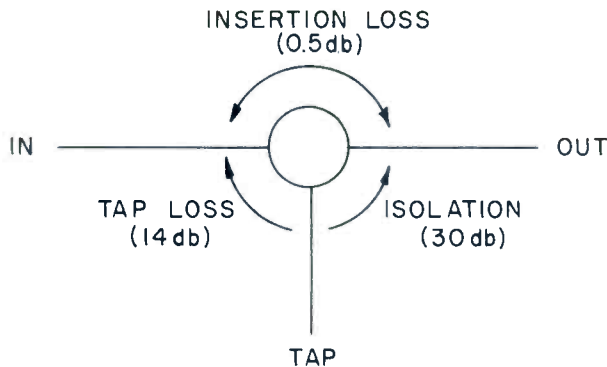

DIRECTIVITY =
ISOLATION - TAP LOSS
(16 db)

DIRECTIONAL COUPLER

FIGURE 7

minimum return losses. For 125 feet, it would be 23 db and for 400 feet, it is 28.5 db.

First, let us discuss reflections in a 125 foot section. For five sections in cascade, according to fig. 10, the required return loss goes up 7 db to

30 db (equ. 1). With equation 2, the required sum of input and output return loss is then 28 db per section. A VSWR of 1.5 would be sufficient at each point of mismatch, corresponding to 14 db each. For a distribution system with four feeder amplifiers in

TABLE II
Permissible Signal to Reflection Ratios (S/R) for 1/2" Aluminum Cable

Spacing (db) (Loss at ch. 13)	Loss (db) at 54 Mc.	Length in ft.	S/R in db	VSWR
22	9.5	1750	18	1.28
15	6.5	1150	25.2	1.12



ARMADILLO FIBERGLASS BUILDINGS



- VHF STATION
- TELEPHONE BOOTH
- SIGNAL EQUIPMENT HOUSING
- CONTROL EQUIPMENT HOUSING
- HOT BOX DETECTION BUILDING
- METER HOUSE
- MICROWAVE REPEATER BUILDING
- CALORIMETER BUILDING
- INSTRUMENT SHELTER
- BEACON CONTROL HOUSING
- MISCELLANEOUS USES

FEATURES: Non Oxidizing — Seamless — Non Porous — Superior Insulation — More Durable
Portable — Structurally Stable — Less Maintenance

ARMADILLO MFG. CO. • 847 E. COLFAX AVE. • DENVER, COLO.

REDUCTION OF REFLECTION BY DIRECTIONAL COUPLER

TYPICAL EXAMPLE WITH MAXIMUM PERMISSIBLE MISMATCH IN BRACKETS

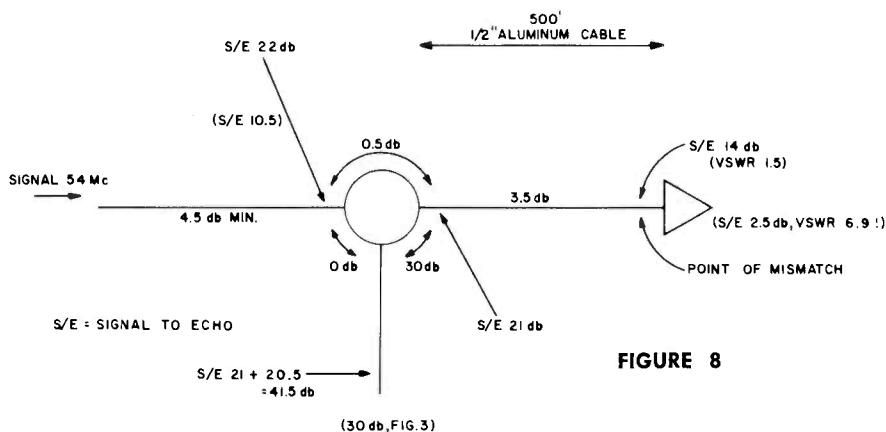

FIGURE 8

WORST CASE REFLECTIONS AND IMPROVEMENT BY DIRECTIONAL COUPLER

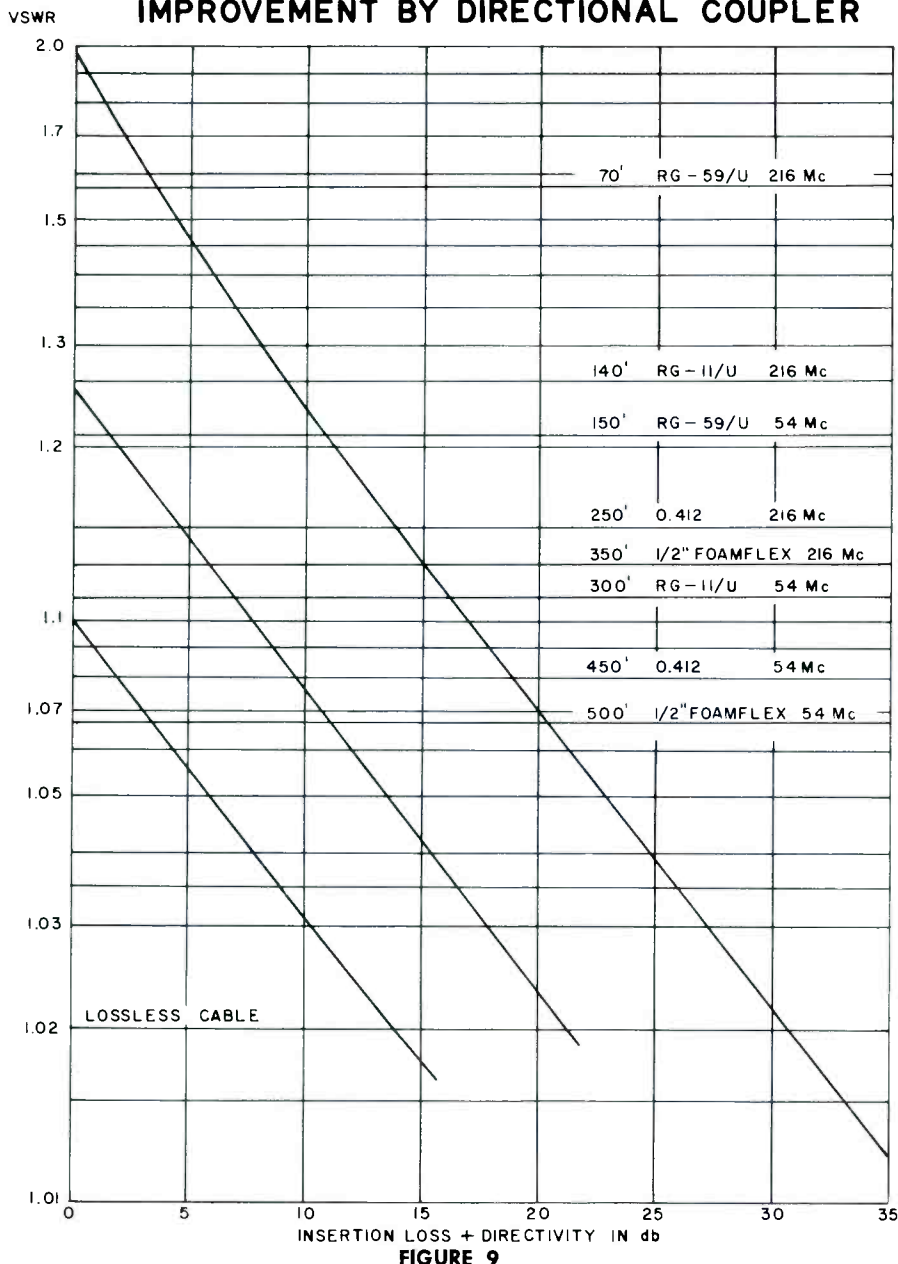

FIGURE 9

to the tap and is reflected back to the TV receiver. This can lead to serious difficulties. For example, the average house drop is 150 feet of RG-59U cable. From fig. 2 curve I, this re-cascade, a further derating by 6 db is necessary. This reduces the allowable VSWR to 1.28 if all mismatches are equal. However, if we assume for example, an output VSWR of 2.0 for a line extender amplifier, the permissible VSWR for the taps (or the input of a line extender amplifier) is reduced to 1.12. Therefore, a directional coupler is needed for the taps.

(With the value of fig. 8, a VSWR of 6.9 for the amplifier would be permissible if a directional coupler is used.

Now let us consider the 500 foot section where a return loss of 28.5 db was required. This corresponds to taps B and C in fig. 10 and a reflection at F. The sum of input and output return losses is with equation 2, and 3 db cable loss, 22.5 db. For four line extender amplifiers, this figure is again increased by 6 db, so that the worst case figure is again 28.5 db. This leads to virtually the same results as for the 125 foot section, and again calls for directional couplers to insure freedom from ghosts.

Reflections Due to Mismatched TV-receivers

Another important point of mismatch is the TV set itself. A reflected signal travels back through the tap. If directional couplers are used, the output signal will be clean, however, the echo is still transmitted back into the input of the directional coupler. No interference at other directional taps is possible, though. The echo would have to travel clear back to the previous line extender and be reflected on its output mismatch. The worst case condition is pictured in fig. 10 for tap B. An echo coming from the TV set at B is reduced by 11 db to the line extender, while the signal is increased by the same amount (assuming a 10 db tap loss). This increases the signal to reflection ratio by 22 db. Only 12 db return loss is then needed for the sum of TV and line extender mismatch, a figure easy to achieve.

Another substantial improvement results by the use of directional couplers because of the backmatch provided at the tap. With an unmatched tap, a signal reflected at the TV set travels



\$295

Complete with
carrying case
and batteries

SADELCO'S NEW STANDARD IN VHF FIELD STRENGTH METERS

THIS IS THE FASTEST, AND EASIEST TO READ FIELD STRENGTH
METER AVAILABLE TODAY

All wiring printed on glass epoxy • Tuned circuits use small, shock resistant fibreglass coil forms or subminiature fully encapsulated fixed inductances • Latest semi-conductor diodes and transistors • Reduced battery current consumption lengthens battery life • Long term stability, temperature compensated • VHF TV FM in two ranges (54-108 Mc & 174-216 Mc) • Peak reading, Carriers marked • 75 ohm, F connector, matched input • Calibrated from minus 33 to plus 60 db in 1 db divisions and from 10 microvolts to 1.0 volts • AGC assures accuracy of plus or minus 1.75 db or better



formerly Telco

BOX 38, CARLISLE, PENNA.

PHONE 717-243-4918

"The place to buy EVERYTHING for your CATV system"

quires a return loss of about 21 db for both the TV and the tap. This condition is met if both mismatches have a VSWR of 2 to 1 or less. A normal capacitive tap does not meet this back match and frequently leads to ghosting problems.

A Note on Measurement of VSWR

If a test set-up as in fig. 11 is used, the measured VSWR will be reduced from the VSWR of the circuit under test by twice the cable losses. A correction is readily possible using fig. 5. For example, with a cable of 3 db

COMMON METHOD OF MEASURING VSWR

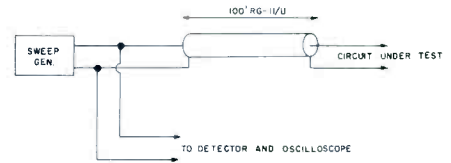

FIGURE 11

loss, a VSWR of 1.25 will be measured while the actual VSWR of the circuit under test is 1.56. Considering the data of fig. 2 it becomes clear that for channel 13 a smaller return loss is sufficient, about 6 db less than with channel 2. A cable of 5 db loss at channel 13 has about 2 db loss at channel 2. The difference in return loss is then 6 db. With this cable equal VSWR at all channels will automatically result in a correctly weighted VSWR at the amplifier position.

For increased accuracy, it is recommended, however, to rather use a lower loss cable in conjunction with fig. 5 or to use a comparison technique. 3)

Literature

- 1) P. Mertz, Influence of Echoes on TV-Transmission, Journal of the SMPTE May 1953, Pg. 572-596
- 2) Jacob Shekel, CATV Reflections, TV-Horizons, April & May 1962
- 3) Ken Simmons, Wide Band Impedance Measurement, Jerrold Technical Newsletter, August 1958.

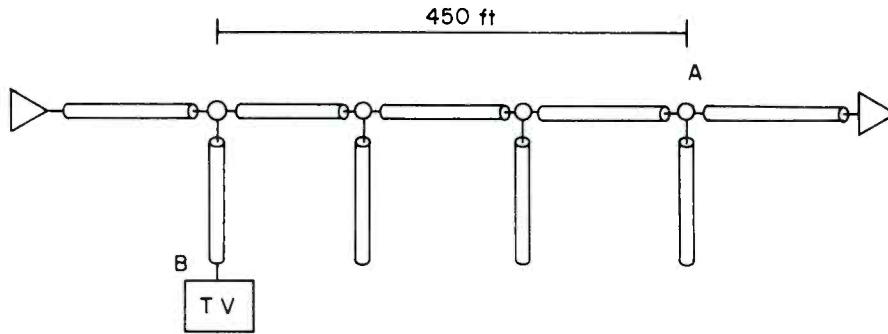

REFLECTION AT	RECEIVER AT	MINIMUM RETURN LOSS	MAXIMUM VSWR	
			WITHOUT DIRECTIONAL COUPLER	WITH DIRECTIONAL COUPLER
A	B	30 db	1.06	1.44

REFLECTIONS IN DISTRIBUTION SYSTEM

FIGURE 10

IN CATV EQUIPMENT GET

THE BEST OF ALL!

FROM THE COMPANY THAT IS TRULY
"Of CATV People . . . By CATV People
. . . For CATV People"

★ SUPPLY ★ ASSEMBLY ★ CONSTRUCTION

The knowledge gained through a decade of successful system design and operation is now available to you. We feature the best of all major equipment lines—as well as complete layout and installation service. Call us!

"From A Single Tap To A Turn-Key System"

EQUIPMENT COMPANY
144 Lakeside Ave.
EAsT 9-1798
Seattle, Washington

CATV FINANCING

... gives you room to grow and the POWER to expand

- MONEY** • For purchasing systems
- MONEY** • For new equipment
- MONEY** • For expansion
- MONEY** • For turn-keys

Phone us collect—Area Code 317, MELROSE 8-1331. Ask for: Harold Ewen, Gail Oldfather, or Jim Ackerman.

ECONOMY FINANCE CORPORATION

108 East Washington St., Indianapolis 4, Indiana

2600 mc. Instructional Television

By Dr. Byron W. St. Clair
President, Westbury CATV Corp.

Forward-looking educators have been eagerly awaiting the time when they could use the capabilities of the television medium under their own control, throughout their own school system. Their requirement is for a system more intimate and flexible and less expensive than a wide area high powered educational television broadcast station. Multiple channels are also desired. The frequency band from 2500 to 2690 mc has been set aside for the "Instructional Television Fixed Service" by the Federal Communications Commission. The rules which were adopted governing this service permit the distribution of television signals from one central point to many schools in an economical fashion. This new service has been enthusiastically received by educators as being the missing link which heretofore has prevented them from realizing the full potential of closed circuit television on a school system wide basis.

Instructional Television brings films, slides, videotapes, and on-the-spot demonstrations to students far more vividly because the instruction is directed to the individual. He has a front row seat with an unobstructed view. He learns faster and more easily.

A 2500 Mc Instructional Television System in its simplest form consists of a transmitter located at a strategic point transmitting a signal, identical in form but higher in frequency (2500 megacycles) than a normal television station. The signal is transmitted in selected directions to

reach various receiving points. It may be a narrow beam in one instance, or a circular transmission pattern in another. At the receiving point, the incoming signal is simply processed (heterodyned) to a standard VHF television channel as shown in Figure 1. It is distributed throughout the school buildings to standard television receivers by normal co-axial cable systems as presently in use in many schools.



Through this system, a program originating in a school system's central facilities, whether from camera, film or videotape, is made available in any classroom within range of the signal. The distance depends upon the terrain between the transmitter and the receiving sites. In most situations, the useful radius can be large enough to encompass all schools in a particular district. In difficult terrain or for larger areas it is possible to have a system extending an originating transmitter with one or more Automatic Unattended Repeater Stations. In this way, up to several counties may be incorporated into one teaching area which benefits from Instructional Television.

The basic capacity for any single school originating point may be as high as five programs with a corresponding number of channel assignments required. Part 74, Subpart I of the Federal Communications Commission's rules allows for the assignment of groups of one to four channels for each transmitting location. In addition, applicants may be eligible for a 5th channel, normally used for special purposes, such as a return circuit, or as an inter-connecting link with another school district. When repeaters are required, additional groups of channels may be utilized.

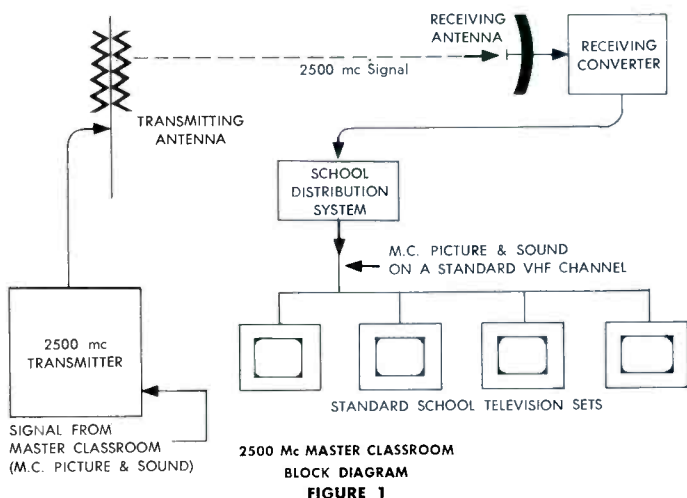

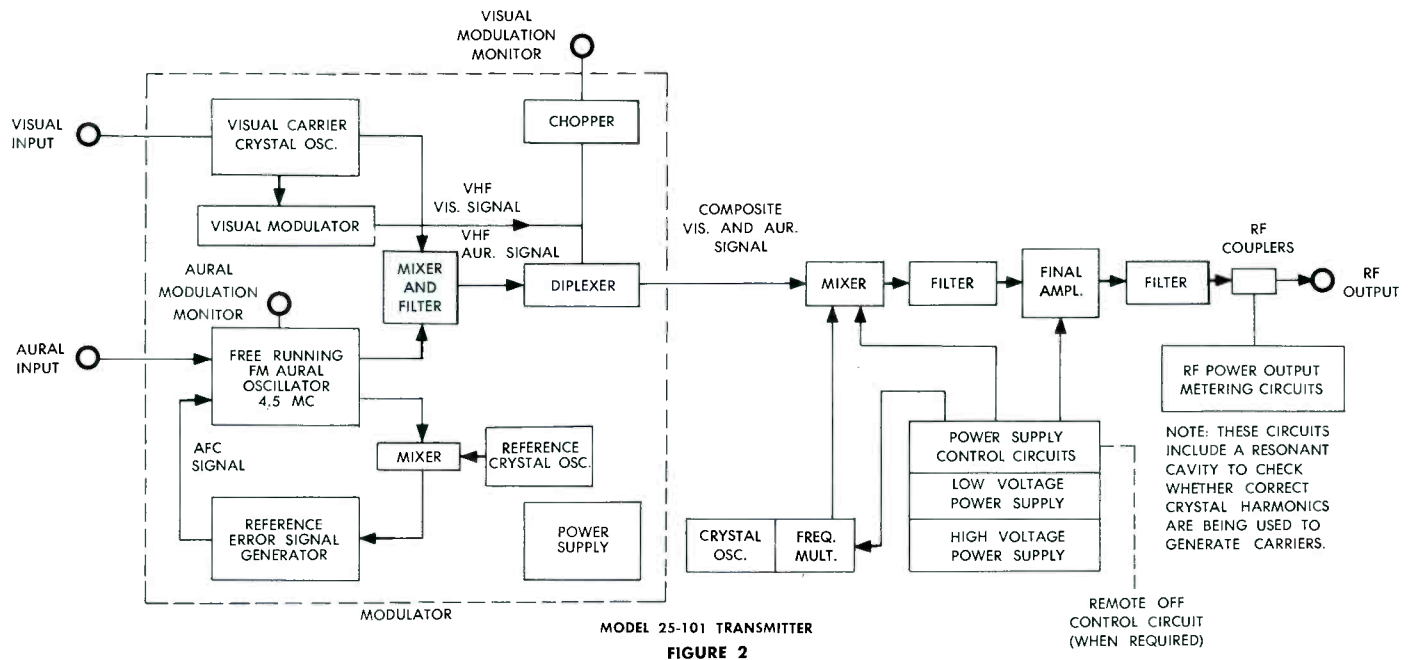

FIGURE 2

The first step toward construction of a 2500 Mc Instructional Television System is an engineering study leading to a system design. Then an FCC application (Form No. 330P) must be filed, specifying details and location of the transmitter and related antennas. The location and height of the receiving antennas must be specified. The usual legal and financial information required by the FCC regarding the applicant must also be supplied.

There are no restrictions on the type of material transmitted so long as it is related to education or instruction. Equipment for receiving will not normally be found in the hands of the public. Furthermore, programs transmitted fall under the secrecy provisions of Federal Law, and contents may not be divulged by any unauthorized viewer to other parties. It is therefore possible to include specialized material not appropriate for public showing, such as medical training programs or refresher courses. In addition to regular classroom use, teacher-training programs may be conducted. Parochial schools expect to find this particularly valuable. School administrative matters, such as bulletins and instructions for teachers, can also be transmitted.

Facilities in this new service permit the distribution of a wide variety of instructional material. Its private nature makes possible freedom and flexibility not found in regular telecasting. Unlike Educational Telecasting, its use can be completely matched to the requirements of the local school administration. For example, demonstrations from a central point may be conducted with scheduled pauses for classroom discussion. A teacher can call on demonstration or enrichment material for his class to meet his special requirements. He may communicate easily with the program source by conventional telephone. He may use television for live action, film, or videotape demonstration for a few minutes, go back to classroom discussion of the subject in question, then return to illustrative material on the receiver.

In addition to the two basic systems already outlined, other variations are possible to meet the needs of specialized school complexes.

For example, a Regional System might include several originating locations, each serving a group of schools using

the regional system exceeds a fifty mile area, the use of conventional microwave should be considered for inter-locality connections.

In a regional system, an extra well-equipped central studio is desirable. It will generate the more elaborate programs for the various individual or originating centers. For example, a large county should have a master studio, originating centers at each city within the county, and

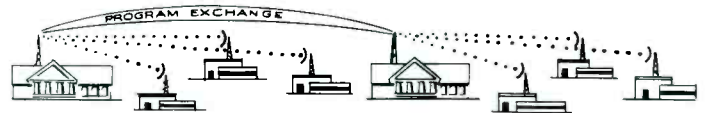

repeaters as required. While the originating stations may repeat one another from time to time, each should be completely set up to service the needs of its locality. Where repeater stations strategically located. In this way, the programs from at least one originating station will reach every school throughout the teaching area.



All universities encounter the problem of teaching very large groups of students. Gathering people from all corners of the campus is inconvenient, and the facilities are frequently lacking. Some closed circuit television is in use on campuses, but the lack of adequate distribution facilities between buildings has prevented its large scale use. The 2500 Mc Instructional Television system bridges this gap.

Medical schools and teaching hospitals are faced with unique problem. In advanced teaching and research, it is impractical for large numbers of students to view a patient directly without being a source of disturbance. Medical teaching authorities are already using closed circuit television and are pioneers in the use of color. The critical nature of medical education and expensive facilities required to teach advanced subjects are overriding factors of greater importance than the most of installing and main-

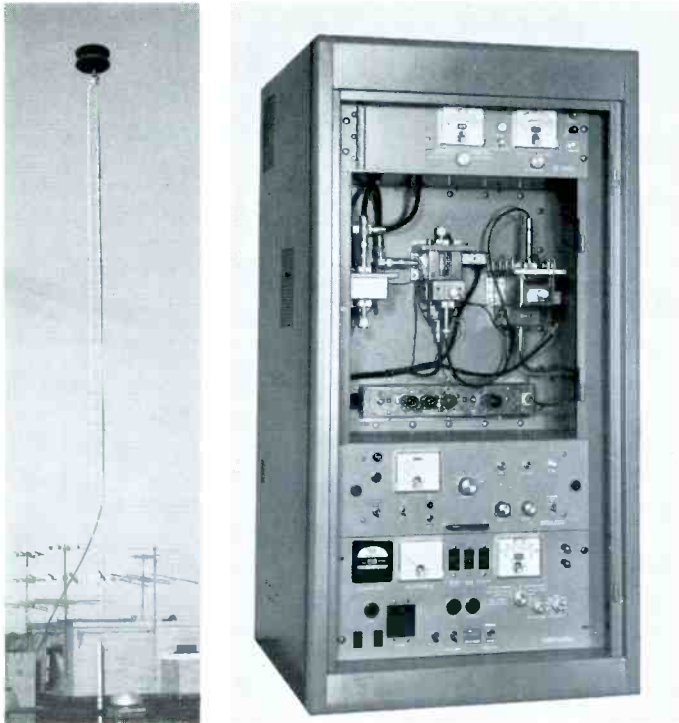

Model 25-101 Westbury ETV Transmitter.

taining color equipment. With 2500 mc "Open-Closed Circuit" distribution, material can be transmitted in color, if necessary. It can also be made available throughout all branches of a Medical School plus Teaching Hospital even though spread out over a city.

TECHNICAL FEATURES

The technical characteristics specified by the FCC rules are substantially the same as those of a regular television broadcast station. The visual carrier is amplitude modulated and the aural carrier is FM. The visual carrier is located 1.25 mc above the lower edge of the channel and the aural carrier is 4.5 mc above the visual. The standard technical characteristics were chosen so that the signal could be viewed directly on a standard TV set after merely undergoing a frequency conversion to a standard VHF channel. Transmitter power output is normally ten watts, although higher power may be authorized in some circumstances.

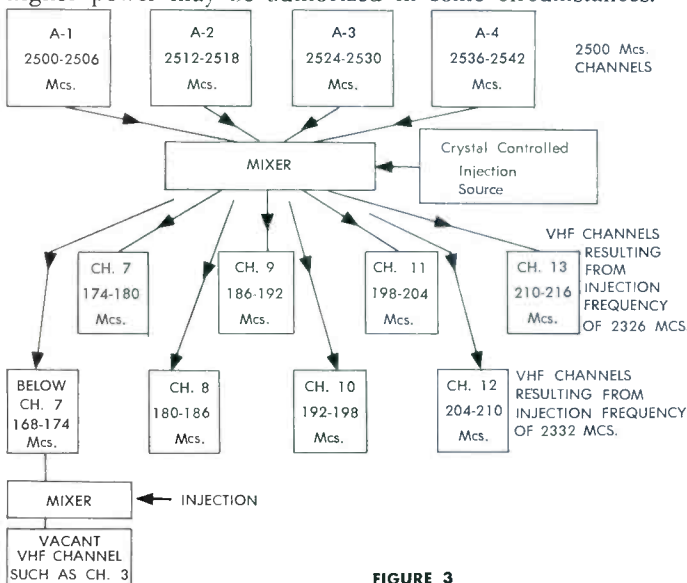
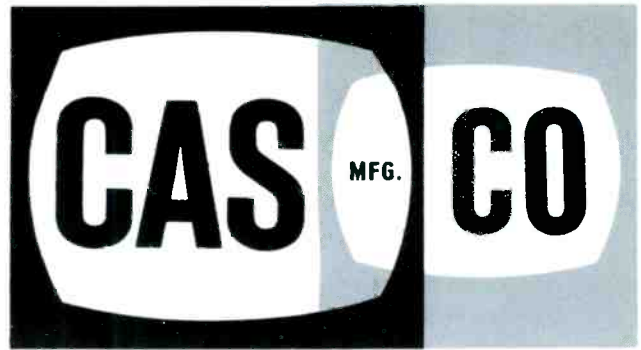

FIGURE 3



**Pioneer Manufacturers of
Transistorized CATV Equipment**

ALL BAND • TRANSISTORIZED • LINE POWERED

New **CATV AMPLIFIERS** *New*

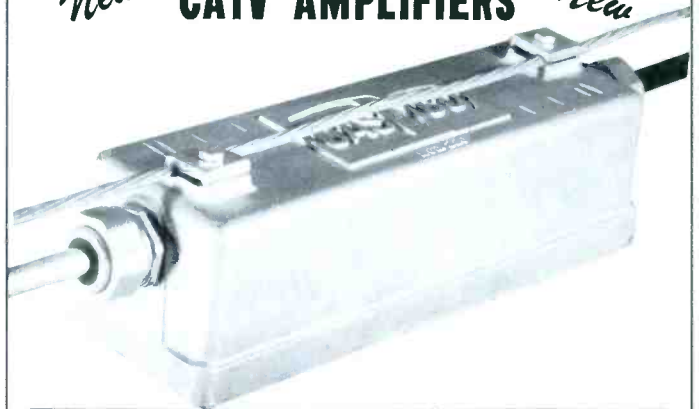

TRA-217	24 DB Line Amplifier (Cast aluminum, No. 220 housing)
TRA-220S	Deluxe 25 DB High-level CAS-cader (Cast aluminum, No. 220 housing)
TRA-220D	Deluxe 25 DB High-level CAS-cader and Distribution Amplifier combined (Cast Aluminum, No. 220 housing)

• WEATHERPROOF • NO CONNECTORS REQUIRED

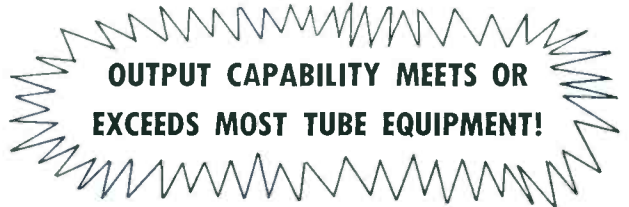

CAS ALSO:

- OFFERS FULL LINE OF FITTINGS & ACCESSORIES
- REPRESENTS BERKSHIRE-CATV CABLES
- DOES TURN-KEY ENGINEERING AND CONSTRUCTION

Call On CAS For All Your CATV Requirements.



P.O. Drawer B
Mineral Wells, Texas
FA 5-5124

CAS Mates Quality with Economy

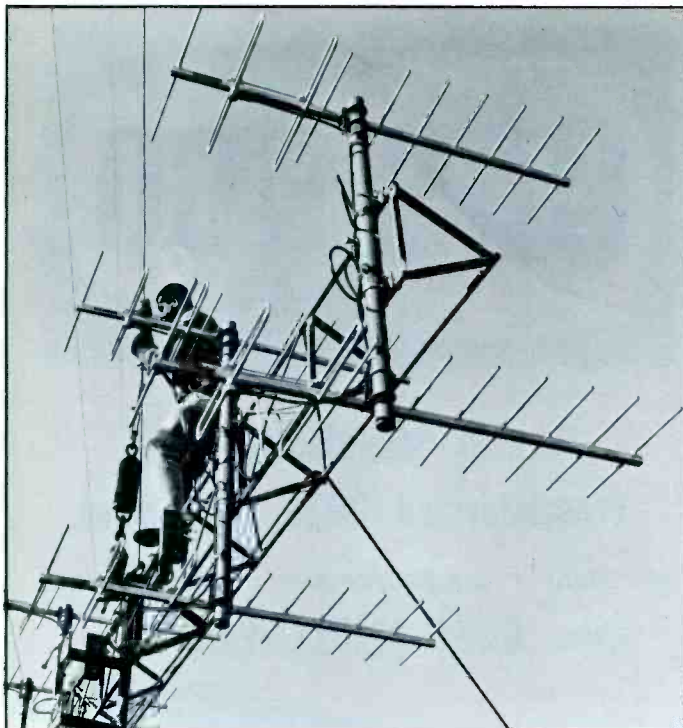

DO THE JOB RIGHT!

... With a Ft. Worth Tower

Years of successful tower construction have given us the necessary experience to provide you with the best qualified engineering, the most reliable construction and the most economical purchase or lease cost in the CATV industry.

Steady progress in perfecting engineering and manufacturing processes, along with recent personnel and equipment expansions, give Ft. Worth an unprecedented capability. Take advantage of our experience by calling for a quote on your next tower requirement.

Since it costs no more to have the full assurance of the latest engineering and construction knowledge, call or write Fort Worth Tower Company, Inc., for a quotation on your next tower job. President Tommy Moore will personally assure you of excellent service and realistic pricing.



Write for Full Details

Fort Worth Tower Co. Inc.

P.O. Box 8597 — Fort Worth, Texas — (817) GL 1-1281

— Associated Companies —

Tommy Moore, Inc. — Big State Engineering, Inc.
Tower Construction Finance, Inc.

TABLE I

Visual Power Output:	10 watts peak sync.
Aural Power Output:	1 watt
Output Impedance:	50 ohms Type N Connector standard
Frequency:	One six megacycle channel in the frequency range 2500 to 2690 Mcs.
Visual Modulation:	AM vestigial sideband (A5)
Aural Modulation:	FM, 25 Kc. deviation (F3)
Visual Frequency Response:	Flat within plus or minus 1 db to 3.58 Mcs.
Video Input:	Composite, 1 Volt negative
Aural Response:	Plus or minus 1 db with standard 75 Microsecond pre-emphasis
Aural Noise:	FM 55 db below 25 Kc swing AM 50 db below carrier level

The transmitter block diagram is shown in Figure 2 for an originating station. There are two departures from VHF TV broadcast transmitter practice: 1) The signal is modulated at a much lower frequency than the output and at a low level and heterodyned to the final frequency and raised to the ten watt power level. 2) The visual and aural carriers are combined early in the transmitter and carried together through the intermediate steps of the final stage. The transmitter is thus simpler and the requirement for a diplexer to combine the outputs from separate visual and aural transmitters is eliminated. Technical characteristics of the transmitter are listed in Table I.

There are thirty-one channels with frequencies as shown in Table II. Most educators will eventually require more than one channel. When an educational system requests a second, third or fourth channel the additional channels will be chosen within the same group as the first one. Thus when multiple signals are to be received at any location they will be on alternate channels. These signals will be processed by a broadband converter which will simultaneously convert them to alternate VHF channels, e.g.—the

GROUP A		GROUP B		GROUP C		GROUP D	
Chan. No.	Band Limits Mcs	Chan. No.	Band Limits Mcs	Chan. No.	Band Limits Mcs	Channel No.	Band Limits Mcs
A-1	2500-2506	B-1	2506-2512	C-1	2548-2554	D-1	2554-2560
A-2	2512-2518	B-2	2518-2524	C-2	2560-2566	D-2	2566-2572
A-3	2524-2530	B-3	2530-2536	C-3	2572-2578	D-3	2578-2584
A-4	2536-2542	B-4	2542-2548	C-4	2584-2590	D-4	2590-2596
GROUP E		GROUP F		GROUP G		GROUP H	
Chan. No.	Limits Mcs Band	Chan. No.	Limits Mcs Band	Chan. No.	Band Limits Mcs	Channel No.	Band Limits Mcs
E-1	2596-2602	F-1	2602-2608	G-1	2644-2650	H-1	2650-2656
E-2	2608-2614	F-2	2614-2620	G-2	2656-2662	H-2	2662-2668
E-3	2620-2626	F-3	2626-2632	G-3	2668-2674	H-3	2674-2680
E-4	2632-2638	F-4	2638-2644	G-4	2680-2686		

first to VHF Channel 7, the second to VHF Channel 9, etc. The conversion should be to unused VHF channels so that other bulk conversion combinations will have to be used in many locations. Some of these are shown in Figure 3. Note that the converter is fixed and selection of the desired program is made by the VHF channel selector on the TV set at the point of viewing. In this way one crystal controlled converter is sufficient for as many as four channels and the one common conversion permits the use of crystal control at reasonable cost.

A typical receiving converter block diagram is shown in Figure 4. The converter must be simple in design and highly reliable in operation. These objectives must be achieved in a design that can be produced at a moderate price as the cost of the large number of receiving installa-

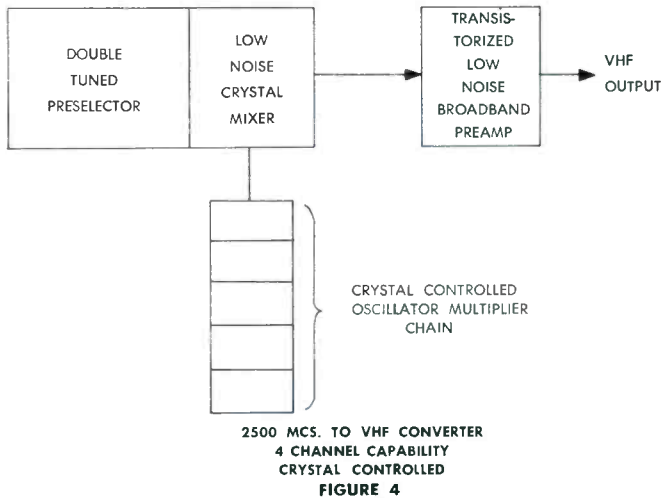

tions in a typical system outweighs the cost of the transmitter installation. A conventional design consisting of a passive preselector, crystal mixer and oscillator-multiplier chain best suits these requirements. The overall noise figure of the receiving converter is highly dependent upon the noise figure of the first amplifier following the mixer. Any losses between the mixer and the first amplifier would also seriously deteriorate the noise performance. For these reasons the amplifier is transistorized and made an integral part of the converter. The converter is designed to be mounted outdoors at the receiving antenna. The output of the converter (including post conversion amplifier) is typically 10 to 20 db above a millivolt. While this signal can be used to feed the television sets directly in a small school, in most instances it will be combined into a conventional in-school distribution system along with the available off-the-air educational and commercial stations.

Transmitting antenna requirements vary widely depending upon the extent of the area to be covered and the location of the transmitter with respect to the area. Omnidirectional antennas are required in many instances and in this instance a single transmitter can cover a radius of up to fifteen miles except where shadowing exists. At the other extreme parabolic antennas will be used for transmitting to areas which are a few degrees wide. Semi-parabolic antennas and other moderately wide horizontal coverage antennas are also available. They may be combined in modular fashion to produce two or more lobes as required to cover the areas where schools are found. The use of modular antennas to achieve specific transmitting antenna patterns will become more important as a means of eliminating inter-system interference as the number of systems increases. By concentrating the transmitted signal in the areas where it will be used, protection will be afforded to other areas. One transmitting antenna array and transmission line can serve up to four transmitters through multiplexing.

The Instructional Television Fixed Service makes it possible for the first time to distribute television signals from one central point to the schools in a city, school district or even a county without going to the expense of installing and operating a complete educational television broadcast station. It removes the principal barrier to the use of closed circuit type television throughout a school system and gives promise of being an important factor in the educator's search for more efficient and improved instruction. □

Our new line of HYBRID INLINE DIRECTIONAL MATCHED COUPLERS with 1-2-4 OUTPUTS

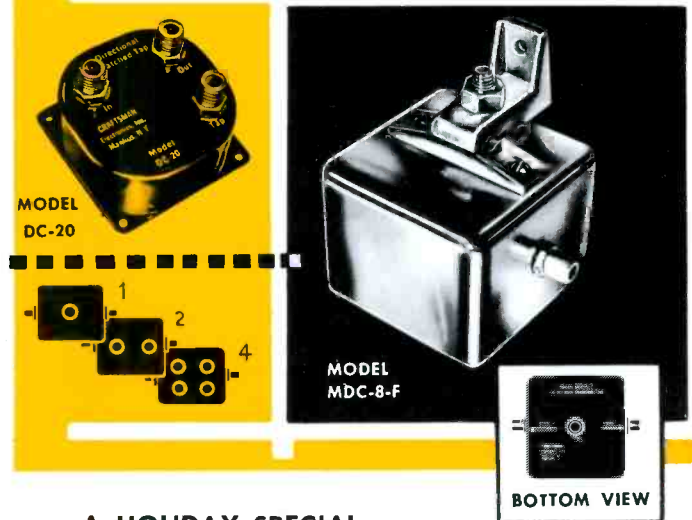

A HOLIDAY SPECIAL . . . TO INCREASE YOUR CATV SALES

FACT . . . Craftsman has the only Hybrid Directional Coupler available.

FACT . . . Craftsman saves you money with the lowest possible cost.

NEWS . . . Craftsman now saves you more money with the same high quality. That's right—Craftsman's Holiday Special gives you the same fine Craftsman Directional Coupler; but at a special, low, low price. (And, you can take advantage of this price until February 1, 1965.)

FEATURES

- LOW COST—See Price Listing
- HYBRID DIRECTIONAL-COUPLER CIRCUITRY
- WIDE BANDWIDTH—5-220 mc.
- COMPACT, RADIATION-PROOF HOUSING with a special sun reflective paint
- THRU LOSS—1/2 db
- HIGH ISOLATION
- EXCELLENT MATCH ON ALL TERMINALS 75 Ω MATCHED
- WEATHERPROOF-EPOXY SEAL

FITTING: TAP ATTENUATION 8-12-16-20-24 db
ALL FITTINGS IN AND OUT

MODEL	PRICE LIST		
	(ALL TAPS WITH "F" CONNECTORS)	2 TAPS	4 TAPS
MDC-F	\$4.35	\$6.95	\$7.95
MDC-UHF	4.95	7.25	8.25
MDC-A-.412	7.25	8.50	9.50
MDC-A-.500	8.25	9.50	10.50

Unit comes equipped with Strand and Pole Mounts.
Specify number of taps required.

These prices subject to change without notice.

Send for our catalog for complete specification details.

EXECUTIVE OFFICES and MANUFACTURING

CRAFTSMAN
ELECTRONIC PRODUCTS, INC.
133 WEST SENECA ST. MANLIUS, N. Y. 13104
Area Code: 315 Phone: OVerbrook 2-9105

SALES OFFICES

CHAMBERSBURG, PA
Girard (Jerry) Conn
AC(717)263-8258

DALLAS, TEXAS
Randy Wright
Fred Garza
AC(214)357-4501

GREENVILLE, MISS.
Hollis Rogers
AC(601)332-7568

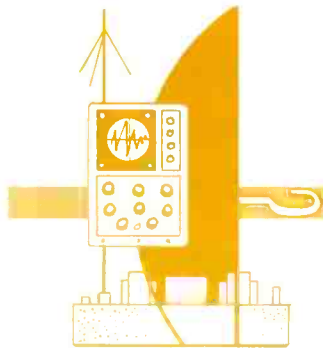

PRODUCT REVIEW

AMPLIFIER INTRODUCED BY CAS.

A new line amplifier "priced low enough to be used as an extender" has been introduced by **CAS MANUFACTURING COMPANY, 400 North Oak, Mineral Wells, Texas**, according to John Campbell, President of the firm.



The TRA-217 boasts such features as high gain and high output capabilities, wide bandwidth, compactness. The cable-powered transistorized amplifier is housed in a cast aluminum weatherproof strand mounting enclosure featuring a hinged down-swinging door that permits easy access to all controls for adjusting gain, high, low, or over-all tilt. The unit requires no connectors and may be inserted or removed from the housing without disturbing the case mounting.

Full details and electrical specifications are available from Mr. Campbell at CAS.

TACO OFFERS FOUR FOOT DISH FOR ETV RECEPTION

The TACO EPA-4 antenna is a new receiving unit designed for use in the 2.5-2.7 Gc Educational Television band. With a four foot dish reflector and di-



pole driver it offers 27 db gain. The broad-band feed covers the entire frequency range with a maximum 1.3:1 VSWR, eliminating any need or provision for field tuning adjustment. Impedance is 50 ohms.

Construction of the EPA-4 parabolic reflector is of "Tacoformed" aluminum. Despite its light weight, the antenna will withstand windloads of 30 PSF. Mounting is intended for a 3 IPS pipe, provision is made for 360° azimuth adjustment and 5° tilt above or below horizontal.

For further information on the EPA-4 or other models designed for ETV service, write to **Defense and Industrial Division, TACO, Sherburne, N.Y.**

"SURE-GRIP" TAP FROM TSC

TeleSystems Corporation now has available an improved pressure tap for use with all common plastic or aluminum feeder cables. According to the manufacturer the zinc plated Tele-Tap "Sure-Grip" incorporates many unique innovations designed for fast, reliable installations.



These advanced features include: self-tightening grounding pins, "snap-on" design, longer seal for maximum moisture protection, rounded edge to prevent cable cutting, stainless steel thread insert, and a non-slip grip.

For full specifications contact **TeleSystems Corporation, 113 South Easton Road, Glenside, Pennsylvania.**

PREFORMED HAS NEW DEAD-ENDS

A new single-leg dead-end manufactured especially for use with RG-59/U coaxial cable in community antenna television systems is now being produced and marketed by **Preformed Line Products Company, 5349 St. Clair Avenue, Cleveland, Ohio.**

Called "Telegrig," the new item is a one-piece unit in a helical configuration. Designed for easy installation in seconds, it is simply wrapped on the cable, then hooked to the tap-off at the cable, pole

or the spool insulator at the service drop. No tools are required.

The Telegrig, tested thoroughly in the laboratory and in service, holds the rated strength of the cable without exerting concentrated stresses or creating kinks or breaks to cause "snow" on television receivers. Instead, very low stresses are distributed over a wide area, and the cable maintains a comparatively straight axis through the dead-end.

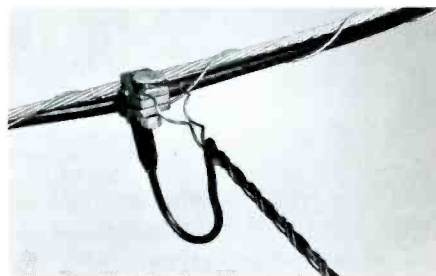

A short-radius twist at the leg end of the unit prevents spinout. The Telegrig is priced economically and is the only flexible dead-end available commercially.

Complete information about the Telegrig may be obtained from **Preformed Line Products Company.**

ARMADILLO UTILITY BUILDINGS

Armadillo Manufacturing Co. recently announced availability of their new utility building line, Series 601.

The new line of fiberglass structures was designed primarily to handle housing requirements for radio, control, and signal equipment. Sizes range from 30 inches square to 6 feet by 8 feet, with variable ceiling heights.

Each building is fully constructed and assembled and then covered with fiberglass—all in one operation. The result is a very economical package building with immediate availability.

Prices are available from **Armadillo Manufacturing Company, 847 East Colfax Ave., Denver, Colorado.**

SYSTEM PLANNING GUIDE

The first television system planning guide designed especially for architects and consulting engineers has been published by **Blonder-Tongue Labs., Inc.**

Contained in a large, rugged three-ring binder, the guide provides information about TV systems products and services, including: application data, product specifications, design data, general specification and prices.

According to **Blonder-Tongue**, the guide has been designed as a continuous service, which will be updated with new information as it becomes available. Copies can be obtained only through the company's franchised installers. Additional information is available from **Blonder-Tongue at 9 Alling Street, Newark, N.J. 07102.**

STATEMENT OF OWNERSHIP, MANAGEMENT AND CIRCULATION as required by the Act of October 23, 1962; Section 4369, United States Code.

1. Date of filing: December 8, 1964.
2. Title of publication: TV & Communications.
3. Frequency of issue: Monthly.
4. Location of known office of publication: 1839 N. W. 16, Oklahoma City Oklahoma 73106.
5. Location of the headquarters or general business offices of the publishers: 1839 N. W. 16, Oklahoma City, Oklahoma 73106.
6. Names and addresses of publisher, editor and managing editor.
Publisher — Communications Publishing Corporation, 1839 N. W. 16, Oklahoma City, Okla.
Editor — Stanley M. Searle, 2033 Manchester Drive, Oklahoma City, Okla.
Managing Editor — Sherrill D. Dunn, 102 N. Markwell, Moore, Okla.
7. The owner is: (If owned by a corporation, its name and address must be stated and also immediately thereunder the names and addresses of stockholders owning or holding 1 percent or more of total amount of stock. If not owned by a corporation, the names and addresses of the individual owners must be given. If owned by a partnership or other unincorporated firm, its name and address, as well as that of each individual must be given.)
Stanley M. Searle — 2033 Manchester Drive, Oklahoma City, Okla.
Patrick T. Pogue — 2224 Laneway Drive, Oklahoma City, Okla.
Jean Schaefer — 1416 N. W. 105, Oklahoma City, Okla.
Sherrill D. Dunn — 102 N. Markwell, Moore, Okla.
8. Known bondholders, mortgagees, and other security holders owning or holding 1 percent or more of total amount of bonds, mortgages or other securities:
None.

9. Paragraph 7 and 8 include, in cases where the stockholder or security holder appears upon the books of the company as trustee or in any other fiduciary relation, the name of the person or corporation for whom such trustee is acting, also the statements in the two paragraphs show the affiant's full knowledge and belief as to the circumstances and conditions under which stockholders and security holders who do not appear upon the books of the company as trustees, hold stock and securities in a capacity other than that of a bona fide owner. Names and addresses of individuals who are stockholders of a corporation which itself is a stockholder or holder of bonds, mortgages or other securities of the publishing corporation have been included in paragraphs 7 and 8 when the interests of such individuals are equivalent to 1 percent or more of the total amount of the stock or securities of the publishing corporation.

10. This item must be completed for all publications except those which do not carry advertising other than the publisher's own and which are named in Sections 132.231, 132.232, and 132.233, Postal Manual (Sections 4355a, 4355b, and 4356 of Title 39, United States Code).

A. Total number of copies printed (net press run): 6591 average number of copies of each issue during the preceding 12 months. 6500 single issue nearest filing date.

B. Paid Circulation:
1. To term subscribers by mail, carrier delivery or by other means: 5500 average number of copies of each issue during the preceding 12 months. 5590 single issue nearest filing date.
2. Sales through agents, news dealers, or otherwise: None.

C. Free distribution (including samples) by mail, carrier delivery, or by other means: 1091 average number of copies of each issue during the preceding 12 months. 910 single issue nearest filing date.

D. Total number of copies distributed (Sum of lines B1, B2 and C): 6591 average number of copies of each issue during the preceding 12 months. 6500 single issue nearest filing date.

I certify that the statements made by me are correct and complete.

Stanley M. Searle
Publisher

Rate for classifieds is \$1.00 per line or fraction thereof for advertising which, in our opinion, is obviously of a non-commercial nature. A charge of \$20.00 per column inch (2 1/4" col.) is made to all commercial advertisers. Deadline for receipt of copy, 1st of preceding month.

TV & COMMUNICATIONS

Continued from page 28

existing programs from conventional television in order to operate. Experience in Hartford establishes that the public is highly selective even where the program fare is limited to box-office attractions.

Every known index shows that subscription television will succeed only if it offers unique and high-quality box-office programs which are beyond the economic reach of the producers of advertising-sponsored programs. It is axiomatic that the public will not pay to view a type of program on one station which is available free on another.

Broadcasting has grown up under a system of free enterprise and has always contended that the regulation of the competitive market place will better serve the public than detailed FCC regulation—a thesis which I heartily endorse.

But you can't have it both ways. If

you start running constantly to the Commission and Congress for protection from imagined competitive effects of subscription television — either over-the-air or wire — and CATV, you are going to pay a heavy concomitant price for such protection by finding your own business, advertising and program activities subjected to much greater government regulation in the future.

This is not solely my warning, but also the public warning of influential members of Congress. This has been the inevitable fate of every business which has fallen into the trap of demanding government protection.

All things considered, I believe that broadcasters not only should, but must, embrace subscription TV and CATV as supplementary sources of programming revenue. If you do not, I am certain that the wire proponents and closed circuit theater interests will. □

CLASSIFIED SECTION

ELECTRONIC ENGINEER

Career Opportunity

Have you had extensive experience in
**Design, Construction and
Maintenance of
Community Antenna
Television Systems?**

Are you responsible, mature and cost conscious? Are you a self-starter? Are you a good administrator? Are you effective in winning the cooperation and respect of other people? Do you express yourself well in both oral and written communications?

Are you interested in details, yet capable of seeing the broad picture?

Do you enjoy extensive travel?

Do you want to get in on the ground floor of a young, aggressive, financially-sound company and grow with it?

If you have these qualifications and can meet our high standards, we offer an outstanding opportunity for a life-time career with a Norfolk-based CATV management firm. Salary open. Write:

J. W. Diederich, Vice President
TeleCable Corporation
150 West Brambleton Avenue
Norfolk, Virginia 23501

Direct Salesman

Needed for the Midwest and Pacific Coast area. Your application will be kept strictly confidential, of course. Mail resume to . . .

GIRARD CONN
CRAFTSMAN
ELECTRONIC PRODUCTS, INC.
1070 Coldbrook Ave.
Chambersburg, Penna.

FRANCHISES WANTED. Will pay cash for secure CATV franchises in Washington, Oregon, Kansas and Oklahoma. Small systems will be considered. Send details, including population, subscriber potential, terms of franchise and pole agreement to: **Dept. 115—TV & Communications Box 63992 — Oklahoma City, Okla.**

Experienced Chief Technician

Immediate opening for CATV Chief Technician. Must be qualified to train, organize and direct work of installers and assistant technician. Thorough knowledge of maintenance and trouble shooting procedures required. Send complete resume and references to:

Television Cable Co.
P.O. Box 895
Myrtle Beach, S.C., 29577



RICHARD D. OBARSKI & associates

CATV consulting, management, engineering and construction. TV Cameras, closed circuit television installation. Twelve years in CATV.

2441 Hillsboro Ave., Dallas, Texas
Phone 214 328-2126

WANTED

Technical Sales Representatives to operate out of California, Texas and Southeastern U.S. All applications will be held in strict confidence. Forward your application to:

Robert Baum,
**Viking Cable Company
Hoboken, New Jersey
830 Monroe Street**

Seasons Greetings

from all of us at

DAYCO

J.D. Kerce
Kim Sanford
Erin Aldon
Sam Boyer
Stan Velez
Hugh Matique
James Jones
Nelson Bible
David Enfinger
Coyce Walker
Noyce G. Bonitt
B. Wilson
Coy Smith
Tommy Kinison
Marjorie Millikin
Eue millikin
Delbert Platt
Billy Nelson
Bill Hawley
William Carter
Doyle Sanders
Robert Thomas, Jr.
Cid Clayton
Phyllis Barber
Mark Spurland
Delores Wallace
Luanne Millikin
Gary W. Irisham
Jim Foston
David Young
Wm. Spanavick
J.D. Davidson
Noreen Davidson
Jas. Robertson
Norman Farley
D.C. Ellis
Coyce Eugene Barnett
Martha Crossen
Floyd Stewart
Carol Tracy
Junior Michigan
Charles King
Woodson Gilcher
W.D. Bennett, Jr.
Richard Day
Harry Fletcher

Jim Davidson
PRESIDENT

UPGRADE YOUR SYSTEM WITH ENTRON'S **MATCHED** MULTIEE TAPS

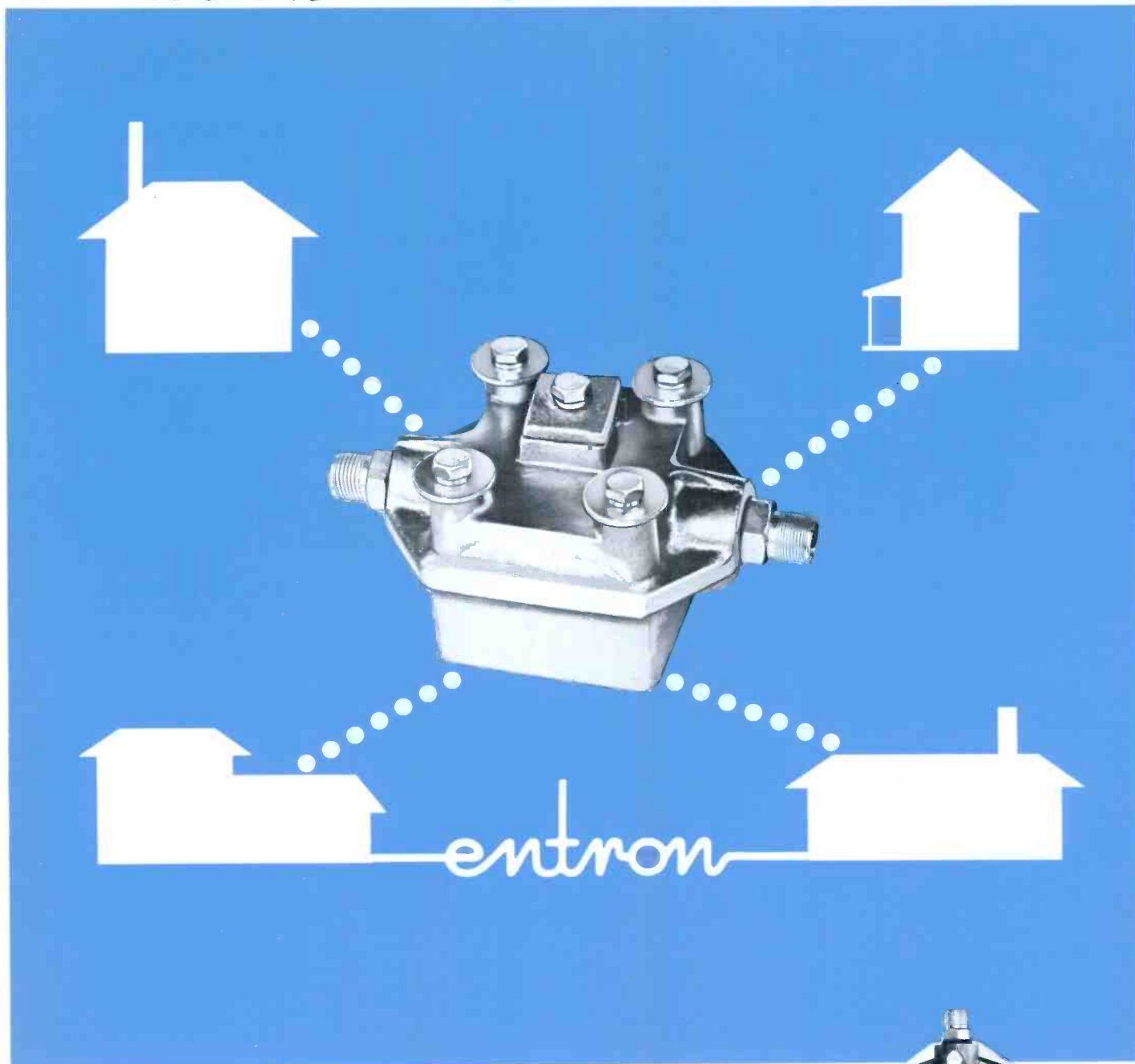

For new systems and system conversions Entron has designed the finest quality tapoffs . . . **MULTEE**, the new 4-way tap.

Ultimate thru-line match and backmatch for all band color
Extremely low insertion loss (0.3 db average) • Seven attenuation values
High isolation between tapoffs • Fully weatherproof . . . strand mounted

Supplied with UHF or complete aluminum flare fittings for thru-line . . . threaded tapoff fittings. **Immediate Delivery!**

entron
INCORPORATED

SILVER SPRING, MARYLAND—(301) 622-2000

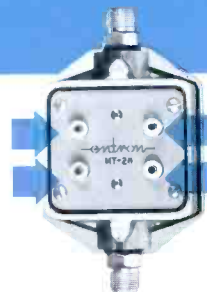

MT Series MULTEE Tapoff.
Four threaded output fittings.

NEW!



MULTITAPS

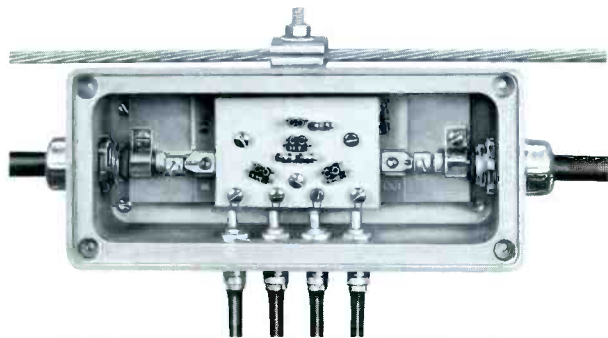
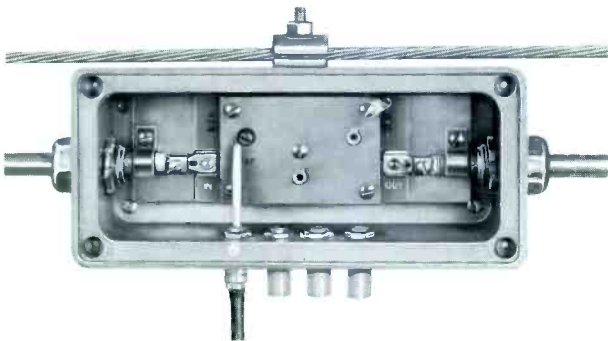

- WEATHER-TIGHT DIE CAST HOUSING
- ADAPTS TO VARIOUS FEEDER CABLES
- PRINTED CIRCUIT TAPS AND ADDERS
- COMPLETE — NO MATING PARTS TO BUY

SKL was the first to introduce the multiple output directional coupler line tap. Now we are proud to announce a newly engineered version of our Multitap — professional in design, proficient in performance and profitable for you in price.

Retaining the electrically superior directional coupler principle in a compact printed circuit tap and tap adder combination, SKL Multitaps are available in values of 10, 16 or 22 db tap loss. They mount easily to the messenger strand, and their adjustable input and output fittings accommodate any feeder cables from 3/8" to 1/2" O.D. Tap adder inserts serve up to four subscribers from one location with *one* low through loss.

The Multitap combines top quality with real economy. When serving four subscribers, it costs only \$3.125 per tap. Try some in your system. After you do, we think you'll want a lot more!

SPECIFICATIONS

Multitaps

TAP LOSS FREQUENCY RESPONSE: Combined with 50 to 80 feet of RG-59/U cable, no more than ± 1.5 db from average value in VHF TV bands.

IMPEDANCE: 75 ohms at all three terminals.

RETURN LOSS: 20 db min. at all three terminals.

Model	Tap Loss At 216 mc	Insertion Loss 54 - 216 mc
410	10 db	1.5 db max.
416	16 db	1.0 db max.
422	22 db	1.0 db max.

Tap Adders

FREQUENCY RESPONSE: Same as Multitap by itself.

TAP LOSS: Sum of Multitap loss and splitting loss (see below).

FEEDER LINE INSERTION LOSS: None.

IMPEDANCE: 75 ohms at all terminals.

RETURN LOSS: 16 db min. at all terminals.

	Model 402	Model 404
No. of Outputs:	2	4
Splitting Loss:	3.5 db max.	7.0 db max.
Isolation between Outputs:	23 db min.	26 db min.



SPENCER-KENNEDY LABORATORIES, INC.

1320 SOLDIERS FIELD ROAD • BOSTON 35, MASSACHUSETTS • TEL. 617-254-5400